



Cisco 1000 Series Software Configuration Guide, Cisco IOS XE Gibraltar 16.12.x

First Published: 2018-09-12

Last Modified: 2020-10-15

Americas Headquarters

Cisco Systems, Inc.
170 West Tasman Drive
San Jose, CA 95134-1706
USA
<http://www.cisco.com>
Tel: 408 526-4000
800 553-NETS (6387)
Fax: 408 527-0883



CONTENTS

CHAPTER 1

Overview 1

- Introduction to Cisco 1000 Series Integrated Services Routers 1
- Sections in this Document 1

CHAPTER 2

Using Cisco IOS XE Software 5

- Accessing the CLI Using a Router Console 5
 - Accessing the CLI Using a Directly-Connected Console 5
 - Connecting to the Console Port 5
 - Use the Console Interface 6
 - Using SSH to Access Console 6
- Accessing the CLI from a Remote Console Using Telnet 7
 - Preparing to Connect to the Router Console Using Telnet 7
 - Using Telnet to Access a Console Interface 8
- Accessing the CLI from a Remote Console Using a Modem 8
- Accessing the CLI from a Micro USB Serial Console Port 9
- Keyboard Shortcuts 9
- Using the History Buffer to Recall Commands 9
 - Understanding Command Modes 10
 - Understanding Diagnostic Mode 11
 - Getting Help 12
- Using the no and default Forms of Commands 16
- Using the factory reset Commands 16
- Saving Configuration Changes 16
- Managing Configuration Files 17
- Filtering Output from the show and more Commands 17
- Powering Off a Router 18

| | |
|------------------------------------------------------------------------------|-----------------------------------|
| Finding Support Information for Platforms and Cisco Software Images | 18 |
| Using Cisco Feature Navigator | 18 |
| Using Software Advisor | 18 |
| Using Software Release Notes | 18 |
| CLI Session Management | 18 |
| Information About CLI Session Management | 19 |
| Changing the CLI Session Timeout | 19 |
| Locking a CLI Session | 19 |
| Initial Bootup Security | 20 |
| <hr/> | |
| CHAPTER 3 | Installing the Software 23 |
| Installing the Software | 23 |
| Licensing | 24 |
| Cisco Software Licensing | 24 |
| Consolidated Packages | 24 |
| Technology Packages | 25 |
| Unlicensed Feature: Example | 25 |
| LED Indicators | 26 |
| Related Documentation | 26 |
| How to Install and Upgrade the Software | 26 |
| Managing and Configuring a Router to Run Using Individual Packages | 31 |
| How to Install and Upgrade the Software for Cisco IOS XE Denali Release 16.3 | 37 |
| Installing a Firmware Subpackage | 43 |
| Upgrading the Firmware on xDSL NIMs | 48 |
| Provisioning Files | 58 |
| File Systems | 58 |
| Autogenerated File Directories and Files | 59 |
| Flash Storage | 60 |
| Configuring the Configuration Register for Autoboot | 60 |
| Crypto Throughput Licensing | 60 |
| Unlicensed Feature: Example | 62 |
| LED Indicators | 63 |
| Related Documentation | 63 |
| How to Install and Upgrade the Software | 63 |

| | |
|---------------------------------------------------------------------------------------------------|----|
| Managing and Configuring a Router to Run Using a Consolidated Package | 63 |
| Managing and Configuring a Consolidated Package Using copy and boot Commands | 63 |
| Configuring a Router to Boot the Consolidated Package via TFTP Using the boot Command: Example | 65 |
| Managing and Configuring a Router to Run Using Individual Packages | 70 |
| Installing Subpackages from a Consolidated Package | 70 |
| Installing Subpackages from a Consolidated Package on a Flash Drive | 79 |
| How to Install and Upgrade the Software for Cisco IOS XE Everest Release 16.6 | 80 |
| Upgrading to Cisco IOS XE Everest 16.6.2 Release | 80 |

CHAPTER 4**Basic Router Configuration 81**

| | |
|--------------------------------------------------------|----|
| Default Configuration | 81 |
| Configuring Global Parameters | 84 |
| Configuring Gigabit Ethernet Interfaces | 84 |
| Configuring a Loopback Interface | 85 |
| Configuring Module Interfaces | 87 |
| Enabling Cisco Discovery Protocol | 87 |
| Configuring Command-Line Access | 87 |
| Configuring Static Routes | 89 |
| Configuring Dynamic Routes | 90 |
| Configuring Routing Information Protocol | 90 |
| Configuring Enhanced Interior Gateway Routing Protocol | 95 |

CHAPTER 5**Console Port, Telnet, SSH Handling, and Reset Button 97**

| | |
|------------------------------------------------------------|-----|
| Restrictions and Notes for Console Port, Telnet, and SSH | 97 |
| Console Port Overview | 97 |
| Console Port Handling Overview | 97 |
| Telnet and SSH Overview | 98 |
| Reset Button Overview | 98 |
| Information About Reset Button Functionality | 98 |
| Prerequisites for Enabling the Reset Button Functionality | 99 |
| Restrictions for Reset Button | 100 |
| How to Enable the Reset Button Functionality | 100 |
| Example: Enable and Disable the Reset Button Functionality | 101 |

| | |
|---------------------------------------------------------------|-----|
| Configuring a Console Port Transport Map | 101 |
| Viewing Console Port, SSH, and Telnet Handling Configurations | 103 |
| Configuring Console Port for Modem Connection | 105 |

| | | |
|------------------|----------------------------------------------------------------------------|------------|
| CHAPTER 6 | Setting Up Factory Default Device Using WebUI | 107 |
| | Using Basic or Advanced Mode Setup Wizard | 108 |
| | Configure LAN Settings | 109 |
| | Configure Primary WAN Settings | 109 |
| | Configure Secondary WAN Settings | 110 |
| | Configure Security Settings | 111 |
| | Using Web User Interface for Day One Setup | 111 |
| | Monitor and Troubleshoot Device Plug and Play (PnP) Onboarding using WebUI | 112 |

| | | |
|------------------|-------------------------------------------------------------------------------------------------|------------|
| CHAPTER 7 | Process Health Monitoring | 115 |
| | Monitoring Control Plane Resources | 115 |
| | Avoiding Problems Through Regular Monitoring | 115 |
| | Cisco IOS Process Resources | 115 |
| | Overall Control Plane Resources | 117 |
| | Monitoring Hardware Using Alarms | 119 |
| | Router Design and Monitoring Hardware | 119 |
| | BootFlash Disk Monitoring | 119 |
| | Approaches for Monitoring Hardware Alarms | 119 |
| | Viewing the Console or Syslog for Alarm Messages | 119 |
| | Network Management System Alerts a Network Administrator when an Alarm is Reported Through SNMP | 121 |

| | | |
|------------------|------------------------------------------------------|------------|
| CHAPTER 8 | G.Fast and VDSL2 35b Profile | 123 |
| | Feature Information for G.fast and VDSL2 35b Profile | 123 |
| | Restrictions for G.Fast and VDSL2 35b | 124 |
| | Information About G.Fast and VDSL2 35b | 124 |
| | Overview of G.fast and VDSL2 35b | 124 |
| | Benefits of Implementing G.fast | 125 |
| | Key DSL features on G.fast and VDSL2 35b | 125 |
| | Configure G.Fast and VDSL2 35b | 126 |

| | |
|-------------------------------------------------------|-----|
| Configuring G.fast on the Cisco 1000 ISR | 126 |
| Example: G.Fast and VDSL2 35b | 126 |
| Example: The following is sample output for VDSL2 35b | 126 |
| Example: The following is sample output for G.fast | 127 |
| Additional References for G.fast or VDSL2 35b | 129 |

CHAPTER 9**Dying Gasp Through SNMP, Syslog, and Ethernet OAM 131**

| | |
|-----------------------------------------------------------------------------|-----|
| Restrictions for Dying Gasp Support | 131 |
| Information About Dying Gasp Through SNMP, Syslog and Ethernet OAM | 132 |
| Dying Gasp | 132 |
| How to Configure Dying Gasp Through SNMP, Syslog and Ethernet OAM | 132 |
| Dying Gasp Trap Support for Different SNMP Server Host/Port Configurations | 132 |
| Environmental Settings on the Network Management Server | 132 |
| Message Displayed on the Peer Router on Receiving Dying Gasp Notification | 133 |
| Displaying SNMP Configuration for Receiving Dying Gasp Notification | 133 |
| Configuration Examples for Dying Gasp Through SNMP, Syslog and Ethernet OAM | 133 |
| Example: Configuring SNMP Community Strings on a Router | 133 |
| Example: Configuring SNMP-Server Host Details on the Router Console | 134 |
| Feature Information for Dying Gasp Support | 134 |

CHAPTER 10**Encrypted Traffic Analytics 135**

| | |
|-----------------------------------------------------|-----|
| Feature Information for Encrypted Traffic Analytics | 135 |
| Restrictions for Encrypted Traffic Analytics | 136 |
| Information About Encrypted Traffic Analytics | 136 |
| Data Elements for Encrypted Traffic | 136 |
| How to Configure Encrypted Traffic Analytics | 137 |
| Enabling ET-Analytics on an Interface | 137 |
| Applying an ACL in the Allowed list | 137 |
| Verifying the ET-Analytics Configuration | 138 |

CHAPTER 11**Smart Licensing 141**

| | |
|------------------------------------------------|-----|
| Smart Licensing Client | 141 |
| Prerequisites for Cisco Smart Licensing Client | 141 |
| Restrictions for Cisco Smart Licensing Client | 141 |

- Information About Cisco Smart Licensing Client 141
 - Cisco Smart Licensing - An Overview 141
 - HSECK9 142
 - Transitioning from CSL to Smart Licensing 142
- Cisco One Suites 143
- How to Activate Cisco Smart Licensing Client 143
 - Enable Smart Licensing 143
 - Device Registration 144
 - Install and Upgrade Licenses Using Software Activation Commands 145
- Troubleshooting for Cisco Smart Licensing Client 146
- Configuration Examples for Cisco Smart Licensing Client 147
 - Example: Displays summary information about all licenses 147
 - Example: Enabling Smart Licensing 147

CHAPTER 12

IPv6 Support on Switch Virtual Interface 149

- Information About IPv6 Support on Switch Virtual Interface 149
 - Overview of the Switch Virtual Interface 149
 - Cisco IOS Software Features Supported by Switch Virtual Interface 149
 - Additional Information for IPv6 Support on Switch Virtual Interface 152
- Configuration Examples for IPv6 Support on Switch Virtual Interface 153
 - Easy VPN Remote and NAT 153
 - Example: DHCP 153
 - Example: QoS Marking 155
 - Example: PBR 156

CHAPTER 13

Configuring VDSL2 and ADSL2/22 Plus for Cisco C1100 Series ISRs 159

- DSL Feature Specifications 160
- Configuring DSL 161
 - Configuring ADSL 161
 - Configuring Auto Mode 162
 - Configuring ADSL1 and ADSL2/2+ plus Annex A and Annex M Mode 162
- Configuring VDSL2 163
- Examples of DSL Interface Configuration 164
- Features Supported in xDSL 165

| | |
|------------------------------------------------------------------------------------|-----|
| ATM Conditional Debug Support | 165 |
| ATM OAM Loopback Mode Detection | 165 |
| ATM Oversubscription for DSL | 165 |
| ATM Routed Bridge Encapsulation (RBE) Concept | 167 |
| Default Route on a PPP Virtual Access Interface | 167 |
| Dynamic Bandwidth Change for ATM PVCs | 167 |
| Enabling ATM Dynamic Bandwidth | 168 |
| Disabling ATM Dynamic Bandwidth | 169 |
| How the ATM Dynamic Bandwidth Feature Works | 169 |
| Upgrading the Firmware on DSL Interface | 171 |
| IP to ATM CoS, Per-VC WFQ and CBWFQ QoS: PPPoE QoS Markings of .1P Bits in S (AOL) | 177 |
| Low Latency Queueing | 177 |
| Modular QoS CLI (MQC) Unconditional Packet Discard | 177 |
| MQC Policy Map Support on Configured VC Range ATM | 177 |
| Multilink PPP (MLPPP) bundling | 177 |
| PPPoE Enhancement with RFC 4638 | 178 |
| PPPoEoA over ATM AAL5Mux | 178 |
| PPP Over ATM (IETF-Compliant) | 178 |
| PPPoE Specification Conformance with PADT Message | 178 |
| QoS on Dialer | 178 |
| QoS: PPPoE QoS Markings of .1P Bits | 179 |
| RBE Client Side Encapsulation with QoS | 179 |
| VC Bundling | 179 |
| Show and Debug Commands | 179 |
| Module Specific Show Commands | 184 |
| Packet Flow Specific to ATM PVC Related Show and Debug Commands | 192 |
| Collecting DSL Training Logs | 194 |
| Sample Configurations | 197 |
| Sample MLPPP Configurations and Show Commands | 197 |
| Sample PPPoA Configuration | 200 |
| Sample PPPoEoA Configuration | 201 |

| | |
|----------------------------------------------------------------------|-----|
| Finding Feature Information | 203 |
| Overview of Cisco LTE/5G | 204 |
| Prerequisites for Configuring Cisco LTE/5G | 206 |
| Restrictions for Configuring Cisco LTE/5G | 206 |
| Features not Supported in Cisco LTE/5G | 206 |
| Cisco LTE/5G Features | 207 |
| 4G GPS and NMEA | 207 |
| Example: Connecting to a Server Hosting a GPS Application | 208 |
| Dual SIM Card | 208 |
| Auto SIM | 209 |
| Enable Auto SIM | 209 |
| Example: List the firmware when Auto-SIM is Enabled | 209 |
| Disable Auto SIM | 210 |
| Example: List the firmware when Auto-SIM is Disabled | 210 |
| Using a SIM Card | 210 |
| Changing the PIN | 211 |
| Locking and Unlocking a SIM Card Using a PIN | 211 |
| Configure CHV1 for Unencrypted Level 0 | 212 |
| Configure CHV1 for Unencrypted Level7 | 212 |
| Configure CHV1 for Unencrypted Level7 | 214 |
| Short Message Service (SMS) Capabilities | 215 |
| Data Account Provisioning | 216 |
| IP Multimedia Subsystem Profiles | 216 |
| LTE/5G LEDs | 216 |
| Configuring Cisco LTE/5G | 217 |
| Verifying Modem Signal Strength and Service Availability | 217 |
| Guidelines for Creating, Modifying, or Deleting Modem Data Profiles | 218 |
| Creating, Modifying, or Deleting Data Profiles Using EXEC Mode | 219 |
| Creating, Modifying, or Deleting Data Profiles in Configuration Mode | 221 |
| Configuration Examples | 222 |
| Configuration Example | 223 |
| Configure Radio Band Selection | 224 |
| Multiple PDN Contexts | 225 |
| Configuring a SIM for Data Calls | 229 |

| | |
|---------------------------------------------------------------------------|-----|
| Locking and Unlocking a SIM Card Using a PIN Code | 229 |
| Changing the PIN Code | 230 |
| Verifying the Security Information of a Modem | 230 |
| Configuring Automatic Authentication for a Locked SIM | 230 |
| Configuring an Encrypted PIN for a SIM | 231 |
| Applying a Modem Profile in a SIM Configuration | 233 |
| Data Call Setup | 234 |
| Configuring the Cellular Interface | 234 |
| Configuring DDR | 235 |
| Enabling 4G GPS and NMEA Data Streaming | 236 |
| Configuring 4G SMS Messaging | 239 |
| Configuring Modem DM Log Collection | 241 |
| Example | 243 |
| Enabling Modem Crashdump Collection | 245 |
| Displaying Modem Log Error and Dump Information | 246 |
| Verifying the LTE/5G Router Information | 246 |
| Configuring Cellular Modem Link Recovery | 249 |
| Cellular Modem Link Recovery Parameters | 250 |
| Verifying the Cellular Modem Link Recovery Configuration | 251 |
| Configuration Examples for 3G and 4G Serviceability Enhancement | 253 |
| Example: Sample Output for the show cellular logs dm-log Command | 253 |
| Example: Sample Output for the show cellular logs modem-crashdump Command | 253 |
| Configuration Examples for LTE/5G | 254 |
| Example: Basic Cellular Interface Configuration: Cisco LTE/5G | 254 |
| Configuration Examples for Cisco LTE/5G | 254 |
| Cellular Back-off: Example | 256 |
| Example: GRE Tunnel over Cellular Interface Configuration | 261 |
| Example: LTE/5G as Backup with NAT and IPsec | 261 |
| Example: SIM Configuration | 263 |
| Locking the SIM Card | 263 |
| Unlocking the SIM Card | 264 |
| Automatic SIM Authentication | 264 |
| Changing the PIN Code | 265 |
| Configuring an Encrypted PIN | 266 |

| | |
|-------------------------------------------------------------------------|-----|
| Upgrading the Modem Firmware | 266 |
| Upgrading the Modem Firmware Manually With CLI | 267 |
| EM74xx Manual Modem Firmware Upgrade: Example | 268 |
| Configuring dm-log to Utility Flash: Example | 269 |
| SNMP MIBs | 270 |
| SNMP LTE/5G Configuration: Example | 271 |
| Troubleshooting | 271 |
| Verifying Data Call Setup | 272 |
| Checking Signal Strength | 272 |
| Verifying Service Availability | 272 |
| Successful Call Setup | 277 |
| Modem Troubleshooting Using Integrated Modem DM Logging | 277 |
| Modem Settings for North America and Carriers Operating on 700 MHz Band | 277 |
| Changing Modem Settings | 278 |
| Electronic Serial Number (ESN) | 278 |
| Additional References | 278 |

CHAPTER 15

| | |
|--------------------------------------------|------------|
| Configuring Ethernet Switch Ports | 281 |
| Configuring VLANs | 281 |
| Configuring VTP | 282 |
| Configuring 802.1x Authentication | 283 |
| Configuring Spanning Tree Protocol | 284 |
| Configuring MAC Address Table Manipulation | 286 |
| Configuring Switch Port Analyzer | 286 |
| Configuring IGMP Snooping | 287 |
| Configuring HSRP | 287 |
| Configuring VRRP | 288 |

CHAPTER 16

| | |
|-------------------------------------------------|------------|
| Slot and Subslot Configuration | 291 |
| Configuring the Interfaces | 291 |
| Configuring the Interfaces: Example | 291 |
| Viewing a List of All Interfaces: Example | 291 |
| Viewing Information About an Interface: Example | 292 |

| | | |
|-------------------|--------------------------------------|------------|
| CHAPTER 17 | Online Insertion and Removal | 295 |
| | Soft OIR Procedures | 295 |
| | Manage OIR for Pluggable LTE Modules | 295 |

| | | |
|-------------------|-------------------------------------------------------------------------|------------|
| CHAPTER 18 | Cisco Multimode G.SHDSL EFM-ATM in Cisco ISR 1000 Series Routers | 297 |
| | Connecting Cisco G.SHDSL EFM or ATM to the Network | 297 |
| | Cisco G.SHDSL EFM or ATM | 297 |
| | Configuring Cisco G.SHDSL EFM or ATM in CPE/CO Mode | 298 |
| | Configuring NIM-4SHDSL-EA as CPE | 298 |
| | Configuring Bonding on CPE | 298 |
| | Verify the Configuration | 299 |
| | Additional References | 299 |
| | Technical Assistance | 299 |

| | | |
|-------------------|---------------------------------------------|------------|
| CHAPTER 19 | Configuring SFP Auto-Failover | 301 |
| | Enabling Auto-Detect | 301 |
| | Configuring Auto-Detect | 301 |
| | Configuring the Primary and Secondary Media | 302 |

| | | |
|-------------------|------------------------------------------|------------|
| CHAPTER 20 | Configuring Cellular IPv6 Address | 305 |
| | Cellular IPv6 Address | 305 |
| | IPv6 Unicast Routing | 305 |
| | Link-Lock Address | 305 |
| | Global Address | 306 |
| | Configuring Cellular IPv6 Address | 306 |

| | | |
|-------------------|----------------------------------------------------------------------------|------------|
| CHAPTER 21 | Prerequisites for Dying Gasp Support | 309 |
| | Restrictions for Dying Gasp Support | 309 |
| | Information About Dying Gasp Through SNMP, Syslog and Ethernet OAM | 309 |
| | Dying Gasp | 309 |
| | How to Configure Dying Gasp Through SNMP, Syslog and Ethernet OAM | 310 |
| | Dying Gasp Trap Support for Different SNMP Server Host/Port Configurations | 310 |

| | |
|-----------------------------------------------------------------------------|-----|
| Environmental Settings on the Network Management Server | 310 |
| Message Displayed on the Peer Router on Receiving Dying Gasp Notification | 311 |
| Displaying SNMP Configuration for Receiving Dying Gasp Notification | 311 |
| Configuration Examples for Dying Gasp Through SNMP, Syslog and Ethernet OAM | 311 |
| Example: Configuring SNMP Community Strings on a Router | 311 |
| Example: Configuring SNMP-Server Host Details on the Router Console | 311 |
| Feature Information for Dying Gasp Support | 312 |

CHAPTER 22**Cisco Umbrella Integration 313**

| | |
|-----------------------------------------------------------------------|-----|
| Feature Information for Cisco Umbrella Integration | 313 |
| Prerequisites for Cisco Umbrella Integration | 314 |
| Restrictions for Cisco Umbrella Integration | 314 |
| Cloud-based Security Service Using Cisco Umbrella Integration | 315 |
| Encrypting the DNS Packet | 315 |
| Benefits of Cisco Umbrella Integration | 316 |
| How to Configure Cisco Umbrella Connector | 316 |
| Configure the Cisco Umbrella Connector | 316 |
| Register the Cisco Umbrella Tag | 317 |
| Configure Cisco 1000 Series ISR as a Pass-through Server | 318 |
| Verify the Cisco Umbrella Connector Configuration | 318 |
| Show Commands | 319 |
| Show Commands at FP Layer | 319 |
| Show Commands at Cisco Packet Processor Layer | 319 |
| Data Path Show Commands | 319 |
| Clear Command | 319 |
| Troubleshoot the Cisco Umbrella Integration | 319 |
| Configuration Examples | 320 |
| Deploy the Cisco Umbrella Integration using Cisco Prime CLI Templates | 320 |
| Additional References for Cisco Umbrella Integration | 321 |

CHAPTER 23**Wireless Device Overview 323**

| | |
|-------------------------------------------------|-----|
| Wireless Connectivity for Cisco 1100 Series ISR | 323 |
| Module Management | 324 |
| Slot and Subslots for WLAN | 324 |

| | |
|------------------------------------------------------------------------------|-----|
| Supported WiFi Cards | 325 |
| Implementing Modules on Your Router | 326 |
| Accessing Your Module Through a Console Connection | 326 |
| Deactivating a Module | 326 |
| Deactivating Modules and Interfaces in Different Command Modes | 327 |
| Reactivating a Module | 328 |
| Access Points | 328 |
| Configuring and Deploying the Access Point | 329 |
| The Controller Discovery Process | 329 |
| Deploying the Access Point on the Wireless Network | 330 |
| Checking the Wireless LAN LED | 331 |
| Miscellaneous Usage and Configuration Guidelines | 332 |
| Important Information for Controller-Based Deployments | 333 |
| Deploying Cisco Mobility Express | 333 |
| Pre-Requisites for Deploying Mobility Express Solution | 333 |
| Connecting Mobility Express Capable Access Point to the Network | 333 |
| Determining image on the Access Point | 334 |
| Converting Access Point from CAPWAP to Cisco Mobility Express | 335 |
| Converting Access Point from Cisco Mobility Express to CAPWAP | 338 |
| Configuring Cisco Mobility Express controller | 339 |
| CLI Setup Wizard | 339 |
| Over-the-Air Setup Wizard | 340 |
| Network Plug and Play | 342 |
| Introduction | 342 |
| Pre-Requisites | 342 |
| APIC-EM Discovery Options | 343 |
| Configuring APIC-EM / Network PnP Server | 343 |
| APIC-EM Network Plug and Play Deployment Options with Cisco Mobility Express | 345 |
| APIC-EM controller in Private Cloud | 345 |
| Cloud Plug and Play Connect Redirect to APIC-EM Controller | 345 |
| Cloud Plug and Play Device Redirect Provisioning Workflow | 345 |
| Connecting Cisco Mobility Access Points | 349 |
| Using internal DHCP server on Cisco Mobility Express | 350 |
| Creating a DHCP Scope | 350 |

| | |
|-------------------------------------------------------------------------------|-----|
| Configuring Cisco Mobility Express for Site Survey | 351 |
| Introduction | 351 |
| Configuring Mobility Express for Site Survey Using CLI | 351 |
| Creating Wireless Networks | 355 |
| Creating Employee WLANs | 355 |
| Creating Employee WLAN with WPA2 Personal | 356 |
| Creating Employee WLAN using WPA2 Enterprise with External Radius Server | 356 |
| Creating Employee WLAN with WPA2 Enterprise and Authentication Server as AP | 356 |
| Creating Employee WLAN with WPA2 Enterprise/External RADIUS and MAC Filtering | 357 |
| Creating Guest WLANs | 358 |
| Creating Guest WLAN with Captive Portal on CMX Connect | 358 |
| Creating Guest WLAN with Internal Splash Page | 358 |
| Creating Guest WLAN with External Splash Page | 359 |
| Internal Splash Page for Web Authentication | 361 |
| Using Default Internal Guest Portal | 361 |
| Using Customized Internal Guest Portal | 362 |
| Managing WLAN Users | 362 |
| Adding MAC for Local MAC Filtering on WLANs | 363 |
| Managing Services with Cisco Mobility Express | 363 |
| Application Visibility and Control | 363 |
| Enabling Application Visibility on WLAN | 364 |
| Enabling Application Control on WLAN | 364 |
| iOS Optimized WiFi Connectivity and Fast Lane | 365 |
| Configuring Optimized WiFi Connectivity | 365 |
| Configuring Fast Lane | 366 |
| Cisco Mobility Express with CMX Cloud | 366 |
| Cisco CMX Cloud | 366 |
| Cisco CMX Cloud Solution Compatibility Matrix | 367 |
| Minimum Requirements for Cisco CMX Cloud Deployment | 367 |
| Enabling CMX Cloud Service on Mobility Express for Presence Analytics | 367 |
| Configuring Site on CMX Cloud for Presence Analytics | 367 |
| Managing the Cisco Mobility Express Deployment | 368 |
| Managing Access Points | 368 |
| Primary AP Failover and Electing a New Primary | 370 |

| | |
|-------------------------------------|-----|
| Primary AP Failover | 371 |
| Electing a new Primary Access Point | 371 |

| | | |
|-------------------|-------------------------------------------------------|------------|
| CHAPTER 24 | Small Form-Factor Pluggables for Cisco ISR1000 | 373 |
| | Configuring Third-Party SFPs | 373 |

| | | |
|-------------------|--------------------------------------|------------|
| CHAPTER 25 | System Messages | 375 |
| | Information About Process Management | 375 |
| | How to Find Error Message Details | 375 |

| | | |
|-------------------|------------------------------------------|------------|
| CHAPTER 26 | Troubleshooting | 381 |
| | Before Contacting Cisco or Your Reseller | 381 |
| | ADSL Troubleshooting | 382 |
| | SHDSL Troubleshooting | 382 |
| | VDSL2 Troubleshooting | 382 |
| | show interfaces Troubleshooting Command | 383 |
| | ATM Troubleshooting Commands | 385 |
| | ping atm interface Command | 385 |
| | show atm interface Command | 386 |
| | debug atm Commands | 386 |
| | Guidelines for Using Debug Commands | 386 |
| | debug atm errors Command | 387 |
| | debug atm events Command | 387 |
| | debug atm packet Command | 388 |
| | System Report | 389 |
| | Software Upgrade Methods | 390 |
| | Recovering a Lost Password | 391 |
| | Change the Configuration Register | 391 |
| | Reset the Router | 393 |
| | Reset the Router | 394 |
| | Reset the Password and Save Your Changes | 395 |
| | Reset the Configuration Register Value | 396 |
| | References | 397 |



CHAPTER 1

Overview

This chapter contains the following sections:

- [Introduction to Cisco 1000 Series Integrated Services Routers, on page 1](#)
- [Sections in this Document, on page 1](#)

Introduction to Cisco 1000 Series Integrated Services Routers

The Cisco 1100 Series Integrated Services Routers (ISRs) are fixed branch routers based on the Cisco IOS XE Everest 16.6.2 operating system, multi-core Data Plane.

The two types of platforms supported on Cisco 1100 Series ISRs are 8-port and 4-port platforms.

The 8-port platforms are high-performance managed service provider and enterprise platforms having:

- 8-port integrated front panel switch ports
- Optional POE on LAN daughter card with support up to 4PoE/2PoE+ ports
- Optional WLAN support - 802.11ac WAVE 2
- 4G LTE-Advanced support with carrier aggregation

The 4-port platforms are midrange performance managed service provider platforms and enterprise platforms with the following specifications:

- 4-port integrated front panel switch ports
- VDSL2 and ADSL2/2+ support
- (Optional) PoE on LAN daughter card supporting 2PoE/1PoE+ ports
- (Optional) WLAN support - 802.11ac WAVE 2
- 4G LTE-Advanced support with carrier aggregation

Sections in this Document

The following table lists the sections in this document:

| Section | Description |
|---------------------------------------------------|------------------------------------------------------------------------------------------------------------------------------------------------------------|
| Overview | Provides a high-level description of the router and describes the main internal processes of the router. |
| Using the IOS XE Software | Describes the basics of using Cisco IOS XE software with the router. |
| Smart Licensing | Describes the Smart Licensing feature simplifies the Cisco software experience and helps you to understand how Cisco software is used across your network. |
| Console Port Telnet SSH Handling and Reset | Describes software features that are common across Cisco IOS XE platforms. |
| Installing the Software | Contains important information about filesystems, packages, licensing, and installing software. |
| Basic Router Configuration | Describes the basic tasks required to configure a router. |
| Configuring VDSL2 and ADSL2/2+ for Cisco 1100 ISR | Describes the software features and configuration information for VDSL2 and ADSL2/2+. |
| Wireless Device Configuration | Describes the important tasks to be performed to connect to wireless devices. |
| 4G LTE-Advanced on Cisco 1100 ISR | Describes the software features and configuration information for Cisco 4G LTE-Advanced |
| Configuring Ethernet Switch Ports | Describes the configuration tasks for Ethernet switch ports on Cisci 1100 ISR. |
| Slot and Subslot Configuration | Describes the slot and subslot configuration. |
| Online Insertion and Removal | Describes how you can start, stop, and reload a module. |
| Process Health Monitoring | Provides information about managing and monitoring the health of various components of the router. |
| System Messages | Provides information about syslog messages. |
| Environmental Monitoring and PoE Managemnet | Describes the environmental monitoring features on a router. |
| Configuring SFP Auto-Failover | Describes the steps to configure Auto Detect, Primary and Secondary Media. |
| Configuring Cellular IPv6 Address | Describes the steps to configure cellular IPv6 address. |
| Dying Gasp Through SNMP, Syslog and Ethernet OAM | Describes Dying Gasp as one of the methods to communicate during failure, which indicates that an unrecoverable condition has occurred. |

| Section | Description |
|-----------------|-----------------------------------------------------------------|
| Troubleshooting | Describes troubleshooting topics such as ADSL, VDSL2 and so on. |



CHAPTER 2

Using Cisco IOS XE Software

This chapter contains the following sections:

- [Accessing the CLI Using a Router Console, on page 5](#)
- [Initial Bootup Security , on page 20](#)

Accessing the CLI Using a Router Console

Cisco 1100 series routers have console port with modem support.

The following sections describe the main methods of accessing the router:

- [Accessing the CLI Using a Directly-Connected Console, on page 5](#)
- [Using SSH to Access Console, on page 6](#)
- [Accessing the CLI from a Remote Console Using Telnet, on page 7](#)
- [Accessing the CLI from a Remote Console Using a Modem, on page 8](#)

Accessing the CLI Using a Directly-Connected Console

The CON port is an EIA/TIA-232 asynchronous, serial connection with no-flow control and an RJ-45 connector. The CON port is located on the front panel of the chassis.

The following sections describe the procedure to access the control interface:

Connecting to the Console Port

Procedure

- Step 1** Configure your terminal emulation software with the following settings:
- 9600 bits per second (bps)
 - 8 data bits
 - No parity

- No flow control

- Step 2** Connect to the CON port using the RJ-45-to-RJ-45 cable and the RJ-45-to-DB-25 DTE adapter or the RJ-45-to-DB-9 DTE adapter (labeled Terminal).
-

Use the Console Interface

Procedure

- Step 1** Enter the following command:

```
Router > enable
```

- Step 2** (Go to Step 3 if the enable password has not been configured.) At the password prompt, enter your system password:

```
Password: enablepass
```

When your password is accepted, the privileged EXEC mode prompt is displayed.

```
Router#
```

You now have access to the CLI in privileged EXEC mode and you can enter the necessary commands to complete your desired tasks.

- Step 3** If you enter the **setup** command, see “Using Cisco Setup Command Facility” in the “Initial Configuration” section of the Hardware Installation Guide for the Cisco 1100 Series Integrated Services Router.

- Step 4** To exit the console session, enter the **exit** command:

```
Router# exit
```

Using SSH to Access Console

Secure Shell (SSH) is a protocol which provides a secure remote access connection to network devices. To enable SSH support on the device:

Procedure

- Step 1** Configure the hostname:

```
Router#configure terminal
Enter configuration commands, one per line. End with CNTL/Z.
Router(config)#hostname xxx_lab
```

Here, *host name* is the router hostname or IP address.

- Step 2** Configure the DNS domain of the router:

```
xxx_lab(config)# xxx.cisco.com
```

- Step 3** Generate an SSH key to be used with SSH:

```
xxx_lab(config)# crypto key generate rsa  
The name for the keys will be: xxx_lab.xxx.cisco.com Choose the size of the key modulus in  
the range  
of 360 to 4096 for your General Purpose Keys. Choosing a key modulus greater than 512 may  
take a few  
minutes.  
How many bits in the modulus [512]: 1024 % Generating 1024 bit RSA keys, keys will be  
non-exportable...  
[OK] (elapsed time was 0 seconds)  
xxx_lab(config)#
```

Step 4 By default, the vty's? transport is Telnet. In this case, Telnet is disabled and only SSH is supported:

```
xxx_lab(config)#line vty 0 4  
xxx_lab(config-line)#transport input SSH
```

Step 5 Create a username for SSH authentication and enable login authentication:

```
xxx_lab(config)# username jsmith privilege 15 secret 0 p@ss3456  
xxx_lab(config)#line vty 0 4  
xxx_lab(config-line)# login local
```

Step 6 Verify remote connection to the device using SSH.

Accessing the CLI from a Remote Console Using Telnet

The following topics describe the procedure to access the CLI from a remote console using Telnet:

Preparing to Connect to the Router Console Using Telnet

To access the router remotely using Telnet from a TCP/IP network, configure the router to support virtual terminal lines using the **line vty** global configuration command. Configure the virtual terminal lines to require users to log in and specify a password.

See the [Cisco IOS Terminal Services Command Reference](#) document for more information about the **line vty global** configuration command.

To prevent disabling login on a line, specify a password with the **password** command when you configure the **login** command.

If you are using authentication, authorization, and accounting (AAA), configure the **login authentication** command. To prevent disabling login on a line for AAA authentication when you configure a list with the login authentication command, you must also configure that list using the **aaa authentication login** global configuration command.

For more information about AAA services, see the [Cisco IOS XE Security Configuration Guide: Secure Connectivity](#) and the [Cisco IOS Security Command Reference](#) documents. For more information about the **login line-configuration** command, see the [Cisco IOS Terminal Services Command Reference](#) document.

In addition, before you make a Telnet connection to the router, you must have a valid hostname for the router or have an IP address configured on the router. For more information about the requirements for connecting to the router using Telnet, information about customizing your Telnet services, and using Telnet key sequences, see the [Cisco IOS Configuration Fundamentals Configuration Guide](#).

Using Telnet to Access a Console Interface

Procedure

Step 1 From your terminal or PC, enter one of the following commands:

- **connect host** [*port*] [*keyword*]
- **telnet host** [*port*] [*keyword*]

Here, *host* is the router hostname or IP address, *port* is a decimal port number (23 is the default), and *keyword* is a supported keyword. For more information about these commands, see the [Cisco IOS Terminal Services Command Reference](#) document.

Note If you are using an access server, specify a valid port number, such as **telnet 172.20.52.40 2004**, in addition to the hostname or IP address.

The following example shows how to use the **telnet** command to connect to a router named **router**:

```
unix_host% telnet router
Trying 172.20.52.40...
Connected to 172.20.52.40.
Escape character is '^]'.
unix_host% connect
```

Step 2 Enter your login password:

```
User Access Verification
Password: mypassword
```

Note If no password has been configured, press **Return**.

Step 3 From user EXEC mode, enter the **enable** command:

```
Router> enable
```

Step 4 At the password prompt, enter your system password:

```
Password: enablepass
```

Step 5 When the **enable** password is accepted, the privileged EXEC mode prompt is displayed:

```
Router#
```

Step 6 You now have access to the CLI in privileged EXEC mode and you can enter the necessary commands to complete your desired tasks.

Step 7 To exit the Telnet session, use the **exit** or **logout** command.

```
Router# logout
```

Accessing the CLI from a Remote Console Using a Modem

To access the router remotely using a modem through an asynchronous connection, connect the modem to the port. For more information, see the "Configuring Console Port for Modem Connection" section.

Accessing the CLI from a Micro USB Serial Console Port

The router provides an additional mechanism for configuring the system: a micro USB serial console that supports remote administration of the router using a micro USB-compliant cable. See the "Connecting to a Console Terminal or Modem" section in the Hardware Installation Guide for the Cisco 1100 Series Integrated Services Router.

Keyboard Shortcuts

Commands are not case sensitive. You can abbreviate commands and parameters if the abbreviations contain enough letters to be different from any other currently available commands or parameters.

The following table lists the keyboard shortcuts for entering and editing commands.

Table 1: Keyboard Shortcuts

| Key Name | Purpose |
|----------------------------------------------------------|-------------------------------------------------------|
| Ctrl-B or the Left Arrow key ¹ | Move the cursor back one character. |
| Ctrl-F or the Right Arrow key ¹ | Move the cursor forward one character. |
| Ctrl-A | Move the cursor to the beginning of the command line. |
| Ctrl-E | Move the cursor to the end of the command line. |
| Esc B | Move the cursor back one word. |
| Esc F | Move the cursor forward one word. |

Using the History Buffer to Recall Commands

The history buffer stores the last 20 commands you entered. History substitution allows you to access these commands without retyping them, by using special abbreviated commands.

The following table lists the history substitution commands.

Table 2: History Substitution Commands

| Command | Purpose |
|---------------------------------------------------------|------------------------------------------------------------------------------------------------------------------------------------------------|
| Ctrl-P or the Up Arrow key ¹ | Recalls commands in the history buffer, beginning with the most recent command. Repeat the key sequence to recall successively older commands. |
| Ctrl-N or the Down Arrow key ¹ | Returns to more recent commands in the history buffer after recalling commands with Ctrl-P or the Up Arrow key. |
| Router# show history | While in EXEC mode, lists the last few commands you entered. |

| Command | Purpose |
|----------------------------------------------------------------------------------------|---------|
| ¹ The arrow keys function only on ANSI-compatible terminals such as VT100s. | |

Understanding Command Modes

The command modes available in Cisco IOS XE are the same as those available in traditional Cisco IOS. Use the CLI to access Cisco IOS XE software. Because the CLI is divided into many different modes, the commands available to you at any given time depend on the mode that you are currently in. Entering a question mark (?) at the CLI prompt allows you to obtain a list of commands available for each command mode.

When you log in to the CLI, you are in user EXEC mode. User EXEC mode contains only a limited subset of commands. To have access to all commands, you must enter privileged EXEC mode, normally by using a password. From privileged EXEC mode, you can issue any EXEC command—user or privileged mode—or you can enter global configuration mode. Most EXEC commands are one-time commands. For example, **show** commands show important status information, and **clear** commands clear counters or interfaces. The EXEC commands are not saved when the software reboots.

Configuration modes allow you to make changes to the running configuration. If you later save the running configuration to the startup configuration, these changed commands are stored when the software is rebooted. To enter specific configuration modes, you must start at global configuration mode. From global configuration mode, you can enter interface configuration mode and a variety of other modes, such as protocol-specific modes.

ROM monitor mode is a separate mode used when the Cisco IOS XE software cannot load properly. If a valid software image is not found when the software boots or if the configuration file is corrupted at startup, the software might enter ROM monitor mode.

The following table describes how to access and exit various common command modes of the Cisco IOS XE software. It also shows examples of the prompts displayed for each mode.

Table 3: Accessing and Exiting Command Modes

| Command Mode | Access Method | Prompt | Exit Method |
|-------------------------|-----------------------------------------------------------------------------------------|--------------------|----------------------------------------------------------------------------------------------------------------------------------------|
| User EXEC | Log in. | Router> | Use the logout command. |
| Privileged EXEC | From user EXEC mode, use the enable command. | Router# | To return to user EXEC mode, use the disable command. |
| Global configuration | From privileged EXEC mode, use the configure terminal command. | Router(config)# | To return to privileged EXEC mode from global configuration mode, use the exit or end command. |
| Interface configuration | From global configuration mode, specify an interface using an interface command. | Router(config-if)# | To return to global configuration mode, use the exit command. To return to privileged EXEC mode, use the end command. |

| Command Mode | Access Method | Prompt | Exit Method |
|--------------|----------------------------------------------------------------------------------------------------------------------------------------------------------------------------------------------------------------------------------------------------------------------------------------------------------------------------------------------------------------------------------------------------------------------------------------------------------------------------------------------------------------------------------------------------------------------------------------------------------------------------------------|-----------------|-------------------------------------------------------------------------------------------------------------------------------------------------------------------------------------------------------------------------------------------------------------------------------------------------------------------------------------------------------------------------------------------|
| Diagnostic | <p>The router boots up or accesses diagnostic mode in the following scenarios:</p> <ul style="list-style-type: none"> • In some cases, diagnostic mode will be reached when the Cisco IOS process or processes fail. In most scenarios, however, the router will reload. • A user-configured access policy is configured using the transport-map command that directs a user into diagnostic mode. • A break signal (Ctrl-C, Ctrl-Shift-6, or the send break command) is entered and the router is configured to go to diagnostic mode when the break signal is received. | Router (diag) # | <p>If failure of the Cisco IOS process is the reason for entering diagnostic mode, the Cisco IOS problem must be resolved and the router rebooted to get out of diagnostic mode.</p> <p>If the router is in diagnostic mode because of a transport-map configuration, access the router through another port or by using a method that is configured to connect to the Cisco IOS CLI.</p> |
| ROM monitor | From privileged EXEC mode, use the reload EXEC command. Press the Break key during the first 60 seconds while the system is booting. | rommon#> | To exit ROM monitor mode, manually boot a valid image or perform a reset with autoboot set so that a valid image is loaded. |

Understanding Diagnostic Mode

The router boots up or accesses diagnostic mode in the following scenarios:

- The IOS process or processes fail, in some scenarios. In other scenarios, the system resets when the IOS process or processes fail.
- A user-configured access policy was configured using the **transport-map** command that directs the user into the diagnostic mode.
- A send break signal (**Ctrl-C** or **Ctrl-Shift-6**) was entered while accessing the router, and the router was configured to enter diagnostic mode when a break signal was sent.

In the diagnostic mode, a subset of the commands that are available in user EXEC mode are made available to the users. Among other things, these commands can be used to:

- Inspect various states on the router, including the IOS state.
- Replace or roll back the configuration.
- Provide methods of restarting the IOS or other processes.
- Reboot hardware, such as the entire router, a module, or possibly other hardware components.
- Transfer files into or off of the router using remote access methods such as FTP, TFTP, and SCP.

The diagnostic mode provides a more comprehensive user interface for troubleshooting than previous routers, which relied on limited access methods during failures, such as ROMMON, to diagnose and troubleshoot Cisco IOS problems. The diagnostic mode commands can work when the Cisco IOS process is not working properly. These commands are also available in privileged EXEC mode on the router when the router is working normally.

Getting Help

Entering a question mark (?) at the CLI prompt displays a list of commands available for each command mode. You can also get a list of keywords and arguments associated with any command by using the context-sensitive help feature.

To get help that is specific to a command mode, a command, a keyword, or an argument, use one of the following commands.

| Command | Purpose |
|---------------------------------------------------|----------------------------------------------------------------------------------------------------------------------------------------------------------|
| <code>help</code> | Provides a brief description of the help system in any command mode. |
| <code>abbreviated-command-entry?</code> | Provides a list of commands that begin with a particular character string. Note There is no space between the command and the question mark. |
| <code>abbreviated-command-entry<Tab></code> | Completes a partial command name. |
| <code>?</code> | Lists all the commands that are available for a particular command mode. |
| <code>command ?</code> | Lists the keywords or arguments that you must enter next on the command line. Note There is a space between the command and the question mark. |

Finding Command Options: Example

This section provides information about how to display the syntax for a command. The syntax can consist of optional or required keywords and arguments. To display keywords and arguments for a command, enter a question mark (?) at the configuration prompt or after entering a part of a command followed by a space. The

Cisco IOS XE software displays a list and brief descriptions of the available keywords and arguments. For example, if you are in global configuration mode and want to see all the keywords and arguments for the **arap** command, you should type **arap ?**.

The <cr> symbol in command help output stands for carriage return. On older keyboards, the carriage return key is the **Return** key. On most modern keyboards, the carriage return key is the **Enter** key. The <cr> symbol at the end of command help output indicates that you have the option to press **Enter** to complete the command and that the arguments and keywords in the list preceding the <cr> symbol are optional. The <cr> symbol by itself indicates that no more arguments or keywords are available, and that you must press **Enter** to complete the command.

The following table shows examples of using the question mark (?) to assist you in entering commands.

Table 4: Finding Command Options

| Command | Comment |
|---------------------------------------------------------------------------------------------------------------------------------------------------------------------------------------------------------------------------------------------------------------------------------------------------------------------------------------------------------------------------|----------------------------------------------------------------------------------------------------------------------------------------------------------------------------------------------------------------------------------------------------------------------------------------------------------------------------------------------------------------------------------------------------------------------------------------|
| Router> enable Password: <password> Router# | Enter the enable command and password to access privileged EXEC commands. You are in privileged EXEC mode when the prompt changes to a “#” from the “>”, for example, Router> to Router# |
| Router# configure terminal Enter configuration commands, one per line. End with CNTL/Z. Router(config)# | Enter the configure terminal privileged EXEC command to enter global configuration mode. You are in global configuration mode when the prompt changes to Router (config)# |
| Router(config)# interface GigabitEthernet ? <0-0> GigabitEthernet interface number Router(config)# interface GigabitEthernet 0/? <0-5> Port Adapter number Router (config)# interface GigabitEthernet 0/0/? <0-63> GigabitEthernet interface number Router (config)# interface GigabitEthernet 0/0/0? . <0-71> Router(config-if)# | Enter interface configuration mode by specifying the interface that you want to configure, using the interface GigabitEthernet global configuration command. Enter ? to display what you must enter next on the command line. When the <cr> symbol is displayed, you can press Enter to complete the command. You are in interface configuration mode when the prompt changes to Router(config-if)# |

| Command | Comment |
|-------------------------------------------------------------------------------------------------------------------------------------------------------------------------------------------------------------------------------------------------------------------------------------------------------------------------------------------------------------------------------------------------------------------------------------------------------------------------------------------------------------------------------------------------------------------------------------------------------------------------------------------------------------------------------------------------------------------------------------------------------------------------------------------------------------------------------------------------------------------------------------------------------------------------------------------------------------------------------------------|-------------------------------------------------------------------------------------------------------------------------------------------------------------------------------------------|
| <pre> Router(config-if)# ? Interface configuration commands: . . . ip Interface Internet Protocol config commands Enable keepalive keepalive LAN Name command lan-name LLC2 Interface Subcommands load-interval Specify interval for load calculation locaddr-priority Assign a priority group logging Configure logging for interface loopback Configure internal loopback on an interface mac-address Manually set interface MAC address mls mls router sub/interface commands mpoa MPOA interface configuration commands mtu Set the interface Maximum Transmission Unit (MTU) netbios Use a defined NETBIOS access list or enable name-caching no Negate a command or set its defaults nrzi-encoding Enable use of NRZI encoding ntp Configure NTP . . . Router(config-if)# </pre> | <p>Enter ? to display a list of all the interface configuration commands available for the interface. This example shows only some of the available interface configuration commands.</p> |

| Command | Comment |
|------------------------------------------------------------------------------------------------------------------------------------------------------------------------------------------------------------------------------------------------------------------------------------------------------------------------------------------------------------------------------------------------------------------------------------------------------------------------------------------------------------------------------------------------------------------------------------------------------------------------------------------------------------------------------------------------------------------------------------------------------------------------------|------------------------------------------------------------------------------------------------------------------------------------------------------------------------------------------------------------------------------------------------------------------------------------------------------------------------------------------------------------------------------------------------------------------------------------|
| <pre>Router(config-if)# ip ? Interface IP configuration subcommands: access-group Specify access control for packets accounting Enable IP accounting on this interface address Set the IP address of an interface authentication authentication subcommands bandwidth-percent Set EIGRP bandwidth limit broadcast-address Set the broadcast address of an interface cgmpp Enable/disable CGMP directed-broadcast Enable forwarding of directed broadcasts dvmrp DVMRP interface commands hello-interval Configures IP-EIGRP hello interval helper-address Specify a destination address for UDP broadcasts hold-time Configures IP-EIGRP hold time . . . Router(config-if)# ip</pre> | <p>Enter the command that you want to configure for the interface. This example uses the ip command.</p> <p>Enter ? to display what you must enter next on the command line. This example shows only some of the available interface IP configuration commands.</p> |
| <pre>Router(config-if)# ip address ? A.B.C.D IP address negotiated IP Address negotiated over PPP Router(config-if)# ip address</pre> | <p>Enter the command that you want to configure for the interface. This example uses the ip address command.</p> <p>Enter ? to display what you must enter next on the command line. In this example, you must enter an IP address or the negotiated keyword.</p> <p>A carriage return (<cr>) is not displayed. Therefore, you must enter additional keywords or arguments to complete the command.</p> |
| <pre>Router(config-if)# ip address 172.16.0.1 ? A.B.C.D IP subnet mask Router(config-if)# ip address 172.16.0.1</pre> | <p>Enter the keyword or argument that you want to use. This example uses the 172.16.0.1 IP address.</p> <p>Enter ? to display what you must enter next on the command line. In this example, you must enter an IP subnet mask.</p> <p><cr> is not displayed. Therefore, you must enter additional keywords or arguments to complete the command.</p> |

| Command | Comment |
|-----------------------------------------------------------------------------------------------------------------------------------------------------------------------------------------------------------|----------------------------------------------------------------------------------------------------------------------------------------------------------------------------------------------------------------------------------------------------------------------------------------------------------------------------------------------------------------|
| <pre>Router(config-if)# ip address 172.16.0.1 255.255.255.0 ? secondary Make this IP address a secondary address <cr> Router(config-if)# ip address 172.16.0.1 255.255.255.0</pre> | <p>Enter the IP subnet mask. This example uses the 255.255.255.0 IP subnet mask.</p> <p>Enter ? to display what you must enter next on the command line. In this example, you can enter the secondary keyword, or you can press Enter.</p> <p><cr> is displayed. Press Enter to complete the command, or enter another keyword.</p> |
| <pre>Router(config-if)# ip address 172.16.0.1 255.255.255.0 Router(config-if)#</pre> | <p>Press Enter to complete the command.</p> |

Using the no and default Forms of Commands

Almost every configuration command has a **no** form. In general, use the **no** form to disable a function. Use the command without the **no** keyword to re-enable a disabled function or to enable a function that is disabled by default. For example, IP routing is enabled by default. To disable IP routing, use the **no ip routing** command; to re-enable IP routing, use the **ip routing** command. The Cisco IOS software command reference publications provide the complete syntax for the configuration commands and describe what the **no** form of a command does.

Many CLI commands also have a **default** form. By issuing the `<command> default` command-name, you can configure the command to its default setting. The Cisco IOS software command reference publications describe the function from a **default** form of the command when the **default** form performs a different function than the plain and **no** forms of the command. To see what default commands are available on your system, enter **default ?** in the appropriate command mode.

Using the factory reset Commands

The **factory reset** commands are used to remove all the customer specific data on a router/switch that has been added. The data can be configuration, log files, boot variables, core files, and so on.

The **factory-reset all** command erases the bootflash, nvram, rommon variables, licenses, and logs.

```
Router#factory-reset all
The factory reset operation is irreversible for all operations. Are you sure? [confirm]
*Enter*

*May 12 09:55:45.831: %SYS-5-RELOAD: Reload requested by Exec. Reload Reason: Factory Reset.
***Return to ROMMON Prompt
```

Saving Configuration Changes

Use the **copy running-config startup-config** command to save your configuration changes to the startup configuration so that the changes will not be lost if the software reloads or a power outage occurs. For example:

```
Router# copy running-config startup-config
Building configuration...
```

It may take a few minutes to save the configuration. After the configuration has been saved, the following output is displayed:

```
[OK]
Router#
```

This task saves the configuration to the NVRAM.

Managing Configuration Files

The startup configuration file is stored in the nvram: file system and the running configuration files are stored in the system: file system. This configuration file storage setup is also used on several other Cisco router platforms.

As a matter of routine maintenance on any Cisco router, users should back up the startup configuration file by copying the startup configuration file from NVRAM to one of the router's other file systems and, additionally, to a network server. Backing up the startup configuration file provides an easy method of recovering the startup configuration file if the startup configuration file in NVRAM becomes unusable for any reason.

The **copy** command can be used to back up startup configuration files.

For more detailed information on managing configuration files, see the “Managing Configuration Files” section in the [Cisco IOS XE Configuration Fundamentals Configuration Guide](#).

Filtering Output from the show and more Commands

You can search and filter the output of **show** and **more** commands. This functionality is useful if you need to sort through large amounts of output or if you want to exclude output that you need not see.

To use this functionality, enter a **show** or **more** command followed by the “pipe” character (|); one of the keywords **begin**, **include**, or **exclude**; and a regular expression on which you want to search or filter (the expression is case sensitive):

```
show command | {append | begin | exclude | include | redirect | section | tee} regular-expression
```

The output matches certain lines of information in the configuration file.

Example

In this example, a modifier of the **show interface** command (**include protocol**) is used to provide only the output lines in which the expression **protocol** is displayed:

```
Router# show interface | include protocol
GigabitEthernet0/0/0 is administratively down, line protocol is down
  0 unknown protocol drops
GigabitEthernet0/0/1 is administratively down, line protocol is down
  0 unknown protocol drops
GigabitEthernet0/0/2 is administratively down, line protocol is down
  0 unknown protocol drops
GigabitEthernet0/0/3 is administratively down, line protocol is down
  0 unknown protocol drops
GigabitEthernet0 is up, line protocol is up
  0 unknown protocol drops
Loopback0 is up, line protocol is up
  0 unknown protocol drops
```

Powering Off a Router

Before you begin

The router can be safely turned off at any time by moving the router's power supply switch to the Off position. However, any changes to the running config since the last WRITE of the config to the NVRAM is lost.

Ensure that any configuration needed after startup is saved before powering off the router. The **copy running-config startup-config** command saves the configuration in NVRAM and after the router is powered up, the router initializes with the saved configuration.

Finding Support Information for Platforms and Cisco Software Images

The Cisco IOS XE software is packaged in feature sets consisting of software images that support specific platforms. The group of feature sets that are available for a specific platform depends on which Cisco software images are included in a release. To identify the set of software images available in a specific release or to find out if a feature is available in a given Cisco IOS XE software image, you can use [Cisco Feature Navigator](#) or see the [Release Notes for Cisco IOS XE](#).

Using Cisco Feature Navigator

Use [Cisco Feature Navigator](#) to find information about platform support and software image support. Cisco Feature Navigator is a tool that enables you to determine which Cisco IOS XE software images support a specific software release, feature set, or platform. To use the navigator tool, an account on Cisco.com is not required.

Using Software Advisor

Cisco maintains the Software Advisor tool. See [Tools and Resources](#). Use the Software Advisor tool to see if a feature is supported in a Cisco IOS XE release, to locate the software document for that feature, or to check the minimum software requirements of Cisco IOS XE software with the hardware installed on your router. You must be a registered user on Cisco.com to access this tool.

Using Software Release Notes

See the [Release Notes](#) document for the Cisco 4000 Series for information about the following:

- Memory recommendations
- Open and resolved severity 1 and 2 caveats

Release notes are intended to be release-specific for the most current release, and the information provided in these documents may not be cumulative in providing information about features that first appeared in previous releases. For cumulative feature information, refer to the Cisco Feature Navigator at: <http://www.cisco.com/go/cfn/>.

CLI Session Management

An inactivity timeout is configurable and can be enforced. Session locking provides protection from two users overwriting changes that the other has made. To prevent an internal process from using all the available

capacity, some spare capacity is reserved for CLI session access. For example, this allows a user to remotely access a router.

Information About CLI Session Management

An inactivity timeout is configurable and can be enforced. Session locking provides protection from two users overwriting changes that each other has made. To prevent an internal process from using all the available capacity, some spare capacity is reserved for CLI session access. For example, this allows a user to remotely access the router.

Changing the CLI Session Timeout

Procedure

- | | |
|---------------|-------------------------------------------------------------------------------------------------------------------------------------------------------------------------------------------------------------------------------------------------------------------------------------------|
| Step 1 | <code>configure terminal</code> Enters global configuration mode |
| Step 2 | <code>line console 0</code> |
| Step 3 | <code>session-timeout <i>minutes</i></code> The value of <i>minutes</i> sets the amount of time that the CLI waits before timing out. Setting the CLI session timeout increases the security of a CLI session. Specify a value of 0 for <i>minutes</i> to disable session timeout. |
| Step 4 | <code>show line console 0</code> Verifies the value to which the session timeout has been set, which is shown as the value for " Idle Session". |
-

Locking a CLI Session

Before you begin

To configure a temporary password on a CLI session, use the **lock** command in EXEC mode. Before you can use the **lock** command, you need to configure the line using the **lockable** command. In this example the line is configured as **lockable**, and then the **lock** command is used and a temporary password is assigned.

Procedure

- | | |
|---------------|------------------------------------------------------------------------------------------------------------------------------|
| Step 1 | <code>Router# configure terminal</code> Enters global configuration mode. |
| Step 2 | Enter the line upon which you want to be able to use the lock command. <code>Router(config)# line console 0</code> |
| Step 3 | <code>Router(config)# lockable</code> Enables the line to be locked. |
| Step 4 | <code>Router(config)# exit</code> |

Step 5**Router# lock**

The system prompts you for a password, which you must enter twice.

```

Password: <password>
Again: <password>
Locked

```

Initial Bootup Security

This section contains the following:

Enforce Changing Default Password

The Enforce Changing Default Password feature allows you to change the default password and set a new password for a better encryption algorithm. The `enable secret` is a command that allows you to set a new password which helps to protect the access to different modes such as a privileged EXEC and configuration mode.

With the earlier software versions, you can bypass the option to set a new enabled password. When the device first boots up after the factory reset or fresh from the factory, the following prompt is displayed on the console:

Would you like to enter the initial configuration dialog? [yes/no]:

The earlier versions of the software allow you to answer **no** and the device changes to the **Router>** prompt with a blank enable password. At this point, you can configure the device and bring it into service with a blank enable password.

In the earlier documentation, Cisco recommended using the `enable secret` command instead of the `enable password` command because this provides an improved encryption algorithm.

Starting with Cisco IOS XE Release 17.5.1, the initial dialog is changed to force setting a new enable password and also using the `enable secret` command instead. The following is an example:

```

Would you like to enter basic management setup? [yes/no]:yes
Configuring global parameters

```

```

Enter host name [Router]:router-1

```

```

The enable secret is a password used to protect access to
privileged EXEC and configuration modes. This password, after
entered, becomes encrypted in the configuration.

```

```

Secret should be of minimum 10 characters with
at least 1 upper case, 1 lower case, 1 digit and
should not contain [cisco]

```

```

Enter enable secret: *****
Confirm enable secret:*****

```

```

The enable password is used when you do not specify an
enable secret password, with some older software versions, and
some boot images.

```

```

Enter enable password: *****

```

```

The virtual terminal password is used to protect
access to the router over a network interface.

```

```

Enter virtual terminal password:*****
Configure SNMP Network Management?no

```

Enter interface name used to connect to the management network from the above interface summary: **Ethernet0/0**

Configuring interface Ethernet0/0
Configure IP on this interface? [yes]: **no**

The following configuration command script was created:

```
hostname router-1
enable secret 9 $9$emUzIshVXwlUaE$nTzhgi9STdZKzQc4VJ0kEaCqafjUNdCD7ZUf37SY9qg
enable password password-1
```

.

.

[0] Go to the IOS command prompt without saving this config.

[1] Return back to the setup without saving this config.

[2] Save this configuration to nvram and exit.

Enter your selection [2]: **2**

.

.

router-1>**en**

Password:

router-1#**sh run | sec enable**

```
enable secret 9 $9$emUzIshVXwlUaE$nTzhgi9STdZKzQc4VJ0kEaCqafjUNdCD7ZUf37SY9qg
enable password password-1
```

The following is an example of what happens if you answer **no** to the initial configuration dialog:

Would you like to enter the initial configuration dialog? [yes/no]: **no**

The enable secret is a password used to protect access to privileged EXEC and configuration modes. This password, after entered, becomes encrypted in the configuration.

Enter enable secret: *********

Confirm enable secret: *********

Would you like to terminate autoinstall? [yes]: **yes**

.

.

router-1>**en**

Password:

router-1#**sh run | sec enable**

```
enable secret 9 $9$emUzIshVXwlUaE$nTzhgi9STdZKzQc4VJ0kEaCqafjUNdCD7ZUf37SY9qg
```

After the enable secret is prompted during the first login, you can enter a password and this password is always masked. If you enter a weak password, the device will prompt again to enter a strong password. For example, you must use the standard mix of upper-case and lower-case characters, special characters, numbers, and so on. The device will continue to prompt until you enter a strong password. You should enter the strong secret password twice for confirming and configuring the device.”



CHAPTER 3

Installing the Software

This chapter contains the following sections:

- [Installing the Software, on page 23](#)
- [Provisioning Files, on page 58](#)
- [File Systems, on page 58](#)
- [Autogenerated File Directories and Files, on page 59](#)
- [Flash Storage, on page 60](#)
- [Configuring the Configuration Register for Autoboot, on page 60](#)
- [Crypto Throughput Licensing, on page 60](#)
- [Unlicensed Feature: Example, on page 62](#)
- [LED Indicators, on page 63](#)
- [Related Documentation, on page 63](#)
- [How to Install and Upgrade the Software, on page 63](#)
- [Managing and Configuring a Router to Run Using Individual Packages, on page 70](#)
- [How to Install and Upgrade the Software for Cisco IOS XE Everest Release 16.6, on page 80](#)

Installing the Software

Installing software on the router involves installing a consolidated package (bootable image). This consists of a bundle of subpackages (modular software units), with each subpackage controlling a different set of functions.

These are the two main methods to install the software:

- **Managing and Configuring a Router to Run Using Consolidated Packages** —This method allows for individual upgrade of subpackages and generally has reduced boot times compared to the method below. Use this method if you want to individually upgrade a module's software.
- **Managing and Configuring a Router to Run Using Individual Packages** —This a simple method that is similar to a typical Cisco router image installation and management that is supported across Cisco routers.

It is better to upgrade software in a planned period of maintenance when an interruption in service is acceptable. The router needs to be rebooted for a software upgrade to take effect.

Licensing

Cisco Software Licensing

Cisco software licensing consists of processes and components to activate Cisco IOS software feature sets by obtaining and validating Cisco software licenses.

You can enable licensed features and store license files in the bootflash of your router. Licenses pertain to consolidated packages, technology packages, or individual features.

An evaluation license is automatically converted to a Right to Use model after 60 days and this license is valid permanently. The conversion to a permanent license applies only to evaluation licenses. For other features supported on your router, you must purchase a permanent license.

See the "Configuring the Cisco IOS Software Activation Feature" chapter of the [Software Activation Configuration Guide, Cisco IOS XE Release 3S](#).

Consolidated Packages

One of the following two consolidated packages (images) is preinstalled on the router:

- **universalk9**—Contains the **ipbasek9** base package and the **securityk9**, **uck9**, and **appxk9** technology packages.
- **universalk9_npe**—Contains the **ipbasek9** base package and the **securityk9_npe**, **uck9**, and **appxk9** technology packages. This image has limited crypto functionality.



Note The term npe stands for No Payload Encryption.



Note The terms super package and image also refer to a consolidated package.

To obtain software images for the router, go to <http://software.cisco.com/download/navigator.html>.

An image-based license is used to help bring up all the subsystems that correspond to a license. This license is enforced only at boot time.

Apart from the **universalk9** and **universalk9_npe** images, a Boot ROMMON image is available. For more information, see *ROMMON Images* section.

For more information about identifying digitally signed Cisco software and how to show the digital signature information of an image file, see the "Digitally Signed Cisco Software" section in the [Loading and Managing System Images Configuration Guide, Cisco IOS XE Release 3S](#).

The following examples show how to obtain software authenticity information and internal details of a package:

- *Displaying Digitally Signed Cisco Software Signature Information* section
- *Obtaining the Description of a Module or Consolidated Package* section

Many features within the consolidated package are contained in the **ipbasek9** base package. The license key for the **ipbasek9** package is activated by default.

Technology Packages

Technology packages contain software features within a consolidated package. To use different sets of features, enable the licenses of selected technology packages. You can enable the licenses for any combination of technology packages.

Each technology package has an evaluation license that converts to a Right to Use (RTU) license after 60 days and is then valid permanently.

The following is a list of technology packages:



Note In Cisco 1000 Series Integrated Series Routers, although L2TPv2 sessions comes up without appxk9, you need the appxk9 license for the traffic to go through the sessions. You also need the appxk9 license to apply the QoS policies to the L2TPv2 sessions.

securityk9

The **securityk9** technology package includes all crypto features, including IPsec, SSL/SSH, Firewall, and Secure VPN.

The **securityk9_npe** package (npe = No Payload Encryption) includes all the features in the **securityk9** technology package without the payload-encryption functionality. This is to fulfill export restriction requirements. The **securityk9_npe** package is available only in the **universalk9_npe** image. The difference in features between the **securityk9** package and the **securityk9_npe** package is therefore the set of payload-encryption-enabling features such as IPsec and Secure VPN.

uck9

The Unified Communications technology package is required to enable Cisco Unified Border Element (Cisco UBE) functionality. To use Cisco UBE features, you will require session licenses and a Security technology package to secure the media.

appxk9

The **appxk9** technology package contains Application Experience features, which are similar to the features in the DATA package of the Cisco Integrated Services Routers Generation 2 routers. For more information, see: http://www.cisco.com/c/en/us/products/collateral/cloud-systems-management/software-activation-on-integrated-services-routers-isr/white_paper_c11_556985.html#wp9000791.

There are many features in the **appxk9** package, including MPLS, PFR, L2/L3 VPN, Broadband, and AVC.

Unlicensed Feature: Example

If you try to use a feature that is part of a package that is not enabled, an error message is displayed.

In the following example, the **crypto map** command is called during configuration and an error message is displayed. This is because, the feature associated with **crypto map** is part of the **securityk9** package and the **securityk9** package is not enabled.

```
Router# configure terminal
Enter configuration commands, one per line. End with CNTL/Z.
Router(config)#crypto map
^
% Invalid input detected at '^' marker.
```

Use the **show license feature** command to view the license features that are enabled. In the following example, the **securityk9** and the **uck9** packages are not enabled.



Note **ipbasek9** is provided by default.

```
Router# show license feature
Feature name      Enforcement  Evaluation  Subscription  Enabled  RightToUse
appxk9           yes         yes         no             yes     yes
uck9             yes         yes         no             no      yes
securityk9      yes         yes         no             no      yes
ipbasek9        no          no          no             yes     yes
```

LED Indicators

For information on LEDs on the router, see "LED Indicators" in the "Overview" section of the [Hardware Installation Guide for the Cisco 4000 Series Integrated Services Routers](#).

For information on LEDs on the SSD Carrier Card NIM, see "Overview of the SSD Carrier Card NIM (NIM-SSD)" in the "Installing and Upgrading Internal Modules and FRUs" section of the [Hardware Installation Guide for the Cisco 4000 Series Integrated Services Routers](#).

Related Documentation

For further information on software licenses, see [Software Activation on Cisco Integrated Services Routers and Cisco Integrated Service Routers G2](#).

For further information on obtaining and installing feature licenses, see [Configuring the Cisco IOS Software Activation Feature](#).

How to Install and Upgrade the Software

To install or upgrade the software, use one of the following methods to use the software from a consolidated package or an individual package. Also see the overview section.

- [Managing and Configuring a Router to Run Using a Consolidated Package, on page 26](#)
- [Managing and Configuring a Router to Run Using Individual Packages, on page 31](#)

Managing and Configuring a Router to Run Using a Consolidated Package



Note Do not use these procedures if you also need to install any optional subpackages or plan to upgrade individual subpackages. See [Managing and Configuring a Router to Run Using Individual Packages, on page 31](#).

- [Managing and Configuring a Consolidated Package Using copy and boot Commands, on page 27](#)
- [Configuring a Router to Boot the Consolidated Package via TFTP Using the boot Command: Example, on page 28](#)

Managing and Configuring a Consolidated Package Using copy and boot Commands

To upgrade a consolidated package, copy the consolidated package to the **bootflash:** directory on the router using the **copy** command. After making this copy of the consolidated package, configure the router to boot using the consolidated package file.

The following example shows the consolidated package file being copied to the **bootflash:** file system via TFTP. The config register is then set to boot using **boot system** commands, and the **boot system** commands instruct the router to boot using the consolidated package stored in the **bootflash:** file system. The new configuration is then saved using the **copy running-config startup-config** command, and the system is then reloaded to complete the process.

```

Router# dir bootflash:
Directory of bootflash:/
11 drwx 16384 Dec 4 2007 04:32:46 -08:00 lost+found
86401 drwx 4096 Dec 4 2007 06:06:24 -08:00 .ssh
14401 drwx 4096 Dec 4 2007 06:06:36 -08:00 .rollback_timer
28801 drwx 4096 Mar 18 2008 17:31:17 -07:00 .prst_sync
43201 drwx 4096 Dec 4 2007 04:34:45 -08:00 .installer

928862208 bytes total (712273920 bytes free)

Router# copy tftp: bootflash:
Address or name of remote host []? 172.17.16.81
Source filename []? /auto/tftp-users/user/isr4400-universalk9.03.10.00.S.153-3.S-ext.SPA.bin
Destination filename [isr4400-universalk9.03.10.00.S.153-3.S-ext.SPA.bin]?
Accessing
tftp://172.17.16.81//auto/tftp-users/user/isr4400-universalk9.03.10.00.S.153-3.S-ext.SPA.bin
...
Loading /auto/tftp-users/user/isr4400-universalk9.03.10.00.S.153-3.S-ext.SPA.bin from
172.17.16.81 (via GigabitEthernet0):
!!!!!!!!!!!!!!!!!!!!!!!!!!!!!!!!!!!!!!!!!!!!!!!!!!!!!!!!!!!!!!!!!!!!!!!!!!!!!!!!!!!!!!!!!!!!!!!!!!!!!!!!!!!!!!!!!!!!!!!!
!!!!!!!!!!!!!!!!!!!!!!!!!!!!!!!!!!!!!!!!!!!!!!!!!!!!!!!!!!!!!!!!!!!!!!!!!!!!!!!!!!!!!!!!!!!!!!!!!!!!!!!!!!!!!!!!!!!!!!!!
!!!!!!!!!!!!!!!!!!!!!!!!!!!!!!!!!!!!!!!!!!!!!!!!!!!!!!!!!!!!!!!!!!!!!!!!!!!!!!!!!!!!!!!!!!!!!!!!!!!!!!!!!!!!!!!!!!!!!!!!
!!!!!!!!!!!!!!!!!!!!!!!!!!!!!!!!!!!!!!!!!!!!!!!!!!!!!!!!!!!!!!!!!!!!!!!!!!!!!!!!!!!!!!!!!!!!!!!!!!!!!!!!!!!!!!!!!!!!!!!!
!!!!!!!!!!!!!!!!!!!!!!!!!!!!!!!!!!!!!!!!!!!!!!!!!!!!!!!!!!!!!!!!!!!!!!!!!!!!!!!!!!!!!!!!!!!!!!!!!!!!!!!!!!!!!!!!!!!!!!!!
!!!!!!!!!!!!!!!!!!!!!!!!!!!!!!!!!!!!!!!!!!!!!!!!!!!!!!!!!!!!!!!!!!!!!!!!!!!!!!!!!!!!!!!!!!!!!!!!!!!!!!!!!!!!!!!!!!!!!!!!
[OK - 208904396 bytes]
208904396 bytes copied in 330.453 secs (632176 bytes/sec)
Router# dir bootflash:
Directory of bootflash:/
11 drwx 16384 Dec 4 2007 04:32:46 -08:00 lost+found
86401 drwx 4096 Dec 4 2007 06:06:24 -08:00 .ssh
14401 drwx 4096 Dec 4 2007 06:06:36 -08:00 .rollback_timer
28801 drwx 4096 Mar 18 2008 17:31:17 -07:00 .prst_sync
43201 drwx 4096 Dec 4 2007 04:34:45 -08:00 .installer
12 -rw- 208904396 May 28 2008 16:17:34 -07:00
isr4400-universalk9.03.10.00.S.153-3.S-ext.SPA.bin
928862208 bytes total (503156736 bytes free)
Router# configure terminal
Enter configuration commands, one per line. End with CNTL/Z.
Router(config)# boot system flash bootflash:isr4400-universalk9.03.10.00.S.153-3.S-ext.SPA.bin
Router(config)# config-reg 0x2102
Router(config)# exit
Router# show run | include boot
boot-start-marker
boot system flash bootflash:isr4400-universalk9.03.10.00.S.153-3.S-ext.SPA.bin
boot-end-marker
Router# copy run start
Destination filename [startup-config]?
Building configuration...
[OK]
Router# reload

```

Configuring a Router to Boot the Consolidated Package via TFTP Using the boot Command: Example

```

Router# configure terminal
Enter configuration commands, one per line. End with CNTL/Z.
Router(config)#boot system tftp://10.81.116.4/rtp-isr4400-54/isr4400.bin
Router(config)#config-register 0x2102
Router(config)#exit
Router# show run | include boot
boot-start-marker
boot system tftp://10.81.116.4/rtp-isr4400-54/isr4400.bin
boot-end-marker
license boot level adventerprise
Router# copy running-config startup-config
Destination filename [startup-config]?
Building configuration...
[OK]
Router# reload
Proceed with reload? [confirm]
Sep 13 17:42:54.445 R0/0: %PMAN-5-EXITACTION: Process manager is exiting: process exit with

reload chassis code

Initializing Hardware ...

System integrity status: c0000600
Failures detected:
Boot FPGA corrupt

Key Sectors: (Primary,GOOD) , (Backup,GOOD) , (Revocation,GOOD)
Size of Primary = 2288 Backup = 2288 Revocation = 300

ROM:RSA Self Test Passed
ROM:Sha512 Self Test Passed
Self Tests Latency: 58 msec

System Bootstrap, Version 12.2(20120618:163328) [username-ESGROM_20120618_GAMMA 101],
DEVELOPMENT SOFTWARE
Copyright (c) 1994-2014 by cisco Systems, Inc.
Compiled Mon 05/27/2014 12:39:32.05 by username

Current image running: Boot ROM0

Last reset cause: LocalSoft

Cisco ISR 4400 platform with 4194304 Kbytes of main memory

IP_ADDRESS: 172.18.42.119
IP_SUBNET_MASK: 255.255.255.0
DEFAULT_GATEWAY: 172.18.42.1
TFTP_SERVER: 10.81.116.4
TFTP_FILE: rtp-isr4400-54/isr4400.bin
TFTP_MACADDR: a4:4c:11:9d:ad:97
TFTP_VERBOSE: Progress
TFTP_RETRY_COUNT: 18
TFTP_TIMEOUT: 7200
TFTP_CHECKSUM: Yes
ETHER_PORT: 0

ETHER_SPEED_MODE: Auto Detect
link up...

```

```
Receiving rtp-isr4400-54/isr4400.bin from 10.81.116.4
!!!!!!!!!!!!!!!!!!!!!!!!!!!!!!!!!!!!!!!!!!!!!!!!!!!!!!
File reception completed.
Boot image size = 424317088 (0x194a90a0) bytes

ROM:RSA Self Test Passed
ROM:Sha512 Self Test Passed
Self Tests Latency: 58 msec

Package header rev 1 structure detected
Calculating SHA-1 hash...done
validate_package: SHA-1 hash:
calculated 7294dfc:892a6c35:a7a133df:18c032fc:0670b303
expected 7294dfc:892a6c35:a7a133df:18c032fc:0670b303
Signed Header Version Based Image Detected

Using FLASH based Keys of type = PRIMARY KEY STORAGE
Using FLASH based Keys of type = ROLLOVER KEY STORAGE
RSA Signed DEVELOPMENT Image Signature Verification Successful.
Package Load Test Latency : 5116 msec
Image validated
%IOSXEBOOT-4-BOOT_ACTIVITY_LONG_TIME: (local/local): load_modules took: 2 seconds,
expected max time 2 seconds

Restricted Rights Legend

Use, duplication, or disclosure by the Government is
subject to restrictions as set forth in subparagraph
(c) of the Commercial Computer Software - Restricted
Rights clause at FAR sec. 52.227-19 and subparagraph
(c) (1) (ii) of the Rights in Technical Data and Computer
Software clause at DFARS sec. 252.227-7013.

cisco Systems, Inc.
170 West Tasman Drive
San Jose, California 95134-1706

Cisco IOS Software, ISR Software (X86_64_LINUX_IOSD-UNIVERSALK9-M), Experimental Version
15.4(20140527:095327)
[v154_3_s_xe313_throttle-BLD-BLD_V154_3_S_XE313_THROTTLE_LATEST_20140527_070027-ios 156]
Copyright (c) 1986-2014 by Cisco Systems, Inc.
Compiled Tue 27-May-14 21:28 by mcpre

Cisco IOS-XE software, Copyright (c) 2005-2014 by cisco Systems, Inc.
All rights reserved. Certain components of Cisco IOS-XE software are
licensed under the GNU General Public License ("GPL") Version 2.0. The
software code licensed under GPL Version 2.0 is free software that comes
with ABSOLUTELY NO WARRANTY. You can redistribute and/or modify such
GPL code under the terms of GPL Version 2.0. For more details, see the
documentation or "License Notice" file accompanying the IOS-XE software,
or the applicable URL provided on the flyer accompanying the IOS-XE
software.

This product contains cryptographic features and is subject to United
States and local country laws governing import, export, transfer and
use. Delivery of Cisco cryptographic products does not imply
third-party authority to import, export, distribute or use encryption.
Importers, exporters, distributors and users are responsible for
compliance with U.S. and local country laws. By using this product you
agree to comply with applicable laws and regulations. If you are unable
```

to comply with U.S. and local laws, return this product immediately.

A summary of U.S. laws governing Cisco cryptographic products may be found at:
<http://www.cisco.com/wwl/export/crypto/tool/stqrg.html>

If you require further assistance please contact us by sending email to
export@cisco.com.

```
Warning: the compile-time code checksum does not appear to be present.
cisco ISR4451/K9 (2RU) processor with 1133585K/6147K bytes of memory.
Processor board ID FGL1619100P
4 Gigabit Ethernet interfaces
32768K bytes of non-volatile configuration memory.
4194304K bytes of physical memory.
7393215K bytes of Compact flash at bootflash:.
7816688K bytes of USB flash at usb0:.
```

Press RETURN to get started!

```
Router>
Router>
Router>enable
Router# show version
Cisco IOS XE Software, Version BLD_V154_3_S_XE313_THROTTLE_LATEST_20140527_070027-ext
Cisco IOS Software, ISR Software (X86_64_LINUX_IOSD-UNIVERSALK9-M), Experimental Version
15.4(20140527:095327)
v154_3_s_xe313_throttle-BLD-BLD_V154_3_S_XE313_THROTTLE_LATEST_20140527_070027-ios 156]

IOS XE Version: BLD_V154_3_S_XE313_THROTTLE_LATEST

Cisco IOS-XE software, Copyright (c) 2005-2014 by cisco Systems, Inc.
All rights reserved. Certain components of Cisco IOS-XE software are
licensed under the GNU General Public License ("GPL") Version 2.0. The
software code licensed under GPL Version 2.0 is free software that comes
with ABSOLUTELY NO WARRANTY. You can redistribute and/or modify such
GPL code under the terms of GPL Version 2.0. For more details, see the
documentation or "License Notice" file accompanying the IOS-XE software,
or the applicable URL provided on the flyer accompanying the IOS-XE
software.

ROM: IOS-XE ROMMON

Router uptime is 0 minutes
Uptime for this control processor is 3 minutes
System returned to ROM by reload
System image file is "tftp://10.81.116.4/rtp-isr4400-54/isr4400.bin"
Last reload reason: Reload Command
```

This product contains cryptographic features and is subject to United States and local country laws governing import, export, transfer and use. Delivery of Cisco cryptographic products does not imply third-party authority to import, export, distribute or use encryption. Importers, exporters, distributors and users are responsible for compliance with U.S. and local country laws. By using this product you agree to comply with applicable laws and regulations. If you are unable to comply with U.S. and local laws, return this product immediately.

A summary of U.S. laws governing Cisco cryptographic products may be found at:

```
http://www.cisco.com/wwl/export/crypto/tool/stqrg.html
```

If you require further assistance please contact us by sending email to export@cisco.com.

```
License Level: advenenterprise
License Type: EvalRightToUse
--More-- Next reload license Level: advenenterprise
```

```
cisco ISR4451/K9 (2RU) processor with 1133585K/6147K bytes of memory.
Processor board ID FGL1619100P
4 Gigabit Ethernet interfaces
32768K bytes of non-volatile configuration memory.
4194304K bytes of physical memory.
7393215K bytes of Compact flash at bootflash:.
7816688K bytes of USB flash at usb0:.
```

```
Configuration register is 0x2102
```

Managing and Configuring a Router to Run Using Individual Packages

To choose between running individual packages or a consolidated package, see *Installing the Software - Overview* section.

The following topics are included in this section:

- [Installing Subpackages from a Consolidated Package, on page 31](#)
- [Installing a Firmware Subpackage, on page 43](#)
- [Installing Subpackages from a Consolidated Package on a Flash Drive, on page 37](#)

Installing Subpackages from a Consolidated Package

Perform the following procedure to obtain the consolidated package from a TFTP server.

Another variation of this procedure obtains the consolidated package from a USB flash drive. This is described in *Installing Subpackages from a Consolidated Package on a Flash Drive*.

Before you begin

Copy the consolidated package to the TFTP server.

Procedure

| | Command or Action | Purpose |
|---------------|---------------------------------------------------------------------------------------------------------------------------------------------------------------------------------------------------------------------------------------------------------------------------------------------------------------|-------------------------------------------------------------------------------------------------------------------------------|
| Step 1 | <p>show version</p> <p>Example:</p> <pre>Router# show version Cisco IOS Software, IOS-XE Software (X86_64_LINUX_IOSD-UNIVERSALK9-M), Experimental Version 15.3(20120627:221639) [build_151722_111] Copyright (c) 1986-2012 by Cisco Systems, Inc. Compiled Thu 28-Jun-12 15:17 by mcpre .</pre> | Shows the version of software running on the router. This can later be compared with the version of software to be installed. |

| | Command or Action | Purpose |
|---------------|---------------------------------------------------------------------------------------------------------------------------------------------------------------------------------------------------------------------------------------------------------------------|-------------------------------------------------------------------------------------------------------------------------------------------------------------------------------------------------|
| | . | |
| Step 2 | dir bootflash: Example: Router# dir bootflash: | Displays the previous version of software and that a package is present. |
| Step 3 | show platform Example: Router# show platform Chassis type: ISR4451/K9 | Displays the inventory. |
| Step 4 | mkdir bootflash: <i>URL-to-directory-name</i> Example: Router# mkdir bootflash:mydir | Creates a directory to save the expanded software image. You can use the same name as the image to name the directory. |
| Step 5 | request platform software package expand file <i>URL-to-consolidated-package</i> to <i>URL-to-directory-name</i> Example: Router# request platform software package expand file bootflash:isr4400-universalk9-NIM.bin to bootflash:mydir | Expands the software image from the TFTP server (<i>URL-to-consolidated-package</i>) into the directory used to save the image (<i>URL-to-directory-name</i>), which was created in Step 4. |
| Step 6 | reload Example: Router# reload rommon > | Enables ROMMON mode, which allows the software in the consolidated file to be activated. |
| Step 7 | boot <i>URL-to-directory-name/packages.conf</i> Example: rommon 1 > boot bootflash:mydir/packages.conf | Boots the consolidated package, by specifying the path and name of the provisioning file: packages.conf. |
| Step 8 | show version installed Example: Router# show version installed Package: Provisioning File, version: n/a, status: active | Displays the version of the newly installed software. |

Examples

The initial part of the example shows the consolidated package, isr4400-universalk9.164422SSA.bin, being copied to the TFTP server. This is a prerequisite step. The remaining part of the example shows the consolidated file, packages.conf, being booted.

```
Router# copy tftp:isr4400/isr4400-universalk9.164422SSA.bin bootflash:
Address or name of remote host []? 1.1.1.1
Destination filename [isr4400-universalk9.164422SSA.bin]?
Accessing tftp://1.1.1.1/isr4400/isr4400-universalk9.164422SSA.bin...
Loading isr4400/isr4400-universalk9.164422SSA.bin from 1.1.1.1 (via GigabitEthernet0):
!!!!!!!!!!
[OK - 410506248 bytes]
```

```
410506248 bytes copied in 338.556 secs (1212521 bytes/sec)
```

```
Router# show version
Cisco IOS Software, IOS-XE Software (X86_64_LINUX_IOSD-UNIVERSALK9-M), Experimental Version
15.3(20120627:221639) [build_151722_111]
Copyright (c) 1986-2012 by Cisco Systems, Inc.
Compiled Thu 28-Jun-12 15:17 by mcpre

IOS XE Version: 2012-06-28_15.31_mcpre
```

```
Cisco IOS-XE software, Copyright (c) 2005-2012 by cisco Systems, Inc.
All rights reserved. Certain components of Cisco IOS-XE software are
licensed under the GNU General Public License ("GPL") Version 2.0. The
software code licensed under GPL Version 2.0 is free software that comes
with ABSOLUTELY NO WARRANTY. You can redistribute and/or modify such
GPL code under the terms of GPL Version 2.0. For more details, see the
documentation or "License Notice" file accompanying the IOS-XE software,
or the applicable URL provided on the flyer accompanying the IOS-XE
software.
```

```
ROM: IOS-XE ROMMON
```

```
Router uptime is 0 minutes
Uptime for this control processor is 3 minutes
System returned to ROM by reload
System image file is "tftp:isr4400/isr4400.bin"
Last reload reason: Reload Command
```

```
This product contains cryptographic features and is subject to United
States and local country laws governing import, export, transfer and
use. Delivery of Cisco cryptographic products does not imply
third-party authority to import, export, distribute or use encryption.
Importers, exporters, distributors and users are responsible for
compliance with U.S. and local country laws. By using this product you
agree to comply with applicable laws and regulations. If you are unable
to comply with U.S. and local laws, return this product immediately.
```

```
A summary of U.S. laws governing Cisco cryptographic products may be found at:
http://www.cisco.com/wwl/export/crypto/tool/stqrg.html
```

```
If you require further assistance please contact us by sending email to
export@cisco.com.
```

```
License Level: advenenterprise
License Type: EvalRightToUse
Next reload license Level: advenenterprise
cisco ISR4451/K9 (2RU) processor with 1136676K/6147K bytes of memory.
Processor board ID FGL161611AB
4 Gigabit Ethernet interfaces
32768K bytes of non-volatile configuration memory.
4194304K bytes of physical memory.
7393215K bytes of Compact flash at bootflash:.
```

```
Configuration register is 0x8000
```

```
Router# dir bootflash:
```

```
Directory of bootflash:/
```

```
11 drwx 16384 May 3 2012 19:58:37 +00:00 lost+found
178465 drwx 4096 Jun 6 2012 15:20:20 +00:00 core
584065 drwx 4096 Jul 13 2012 19:19:00 +00:00 .prst_sync
405601 drwx 4096 May 3 2012 19:59:30 +00:00 .rollback_timer
113569 drwx 40960 Jul 13 2012 19:19:32 +00:00 tracelogs
64897 drwx 4096 May 3 2012 19:59:42 +00:00 .installer
13 -rw- 1305 May 7 2012 17:43:42 +00:00 startup-config
14 -rw- 1305 May 7 2012 17:43:55 +00:00 running-config
15 -r-- 1541 Jun 4 2012 18:32:41 +00:00 debug.conf
16 -rw- 1252 May 22 2012 19:58:39 +00:00 running-config-20120522
519169 drwx 4096 Jun 4 2012 15:29:01 +00:00 vman_fdb
```

```
7451738112 bytes total (7067635712 bytes free)
```

```
Router# show platform
```

```
Chassis type: ISR4451/K9
```

| Slot | Type | State | Insert time (ago) |
|------|------------------|------------|-------------------|
| 0 | ISR4451/K9 | ok | 15:57:33 |
| 0/0 | ISR4451-6X1GE | ok | 15:55:24 |
| 1 | ISR4451/K9 | ok | 15:57:33 |
| 1/0 | SM-1T3/E3 | ok | 15:55:24 |
| 2 | ISR4451/K9 | ok | 15:57:33 |
| 2/0 | SM-1T3/E3 | ok | 15:55:24 |
| R0 | ISR4451/K9 | ok, active | 15:57:33 |
| F0 | ISR4451-FP | ok, active | 15:57:33 |
| P0 | Unknown | ps, fail | never |
| P1 | XXX-XXXX-XX | ok | 15:56:58 |
| P2 | ACS-4450-FANASSY | ok | 15:56:58 |

| Slot | CPLD Version | Firmware Version |
|------|--------------|--------------------------------|
| 0 | 12090323 | 15.3(01r)S [ciscouser-ISRRO... |
| 1 | 12090323 | 15.3(01r)S [ciscouser-ISRRO... |
| 2 | 12090323 | 15.3(01r)S [ciscouser-ISRRO... |
| R0 | 12090323 | 15.3(01r)S [ciscouser-ISRRO... |
| F0 | 12090323 | 15.3(01r)S [ciscouser-ISRRO... |

```
Router# mkdir bootflash:isr4400-universalk9.dir1
```

```
Create directory filename [isr4400-universalk9.dir1]?
```

```
Created dir bootflash:/isr4400-universalk9.dir1
```

```
Router# request platform software package expand file bootflash:isr4400-universalk9.NIM.bin
```

```
to bootflash:isr4400-universalk9.dir1
```

```
Verifying parameters
```

```
Validating package type
```

```
Copying package files
```

```
SUCCESS: Finished expanding all-in-one software package.
```

```
Router# reload
```

```
Proceed with reload? [confirm]
```

```
*Jul 13 19:39:06.354: %SYS-5-RELOAD: Reload requested by console.Reload Reason: Reload Command.
```

```
rommon 1 > boot bootflash:isr4400-universalk9.dir1/packages.conf
```

```

File size is 0x00002836
Located isr4400-universalk9.dir1/packages.conf
Image size 10294 inode num 324484, bks cnt 3 blk size 8*512
#
File is comprised of 1 fragments (33%)

is_valid_shalhash: SHA-1 hash:
calculated 62f6235a:fc98eb3a:85ce183e:834f1cb3:8a1f71d1
expected 62f6235a:fc98eb3a:85ce183e:834f1cb3:8a1f71d1
File size is 0x04b3dc00
Located isr4400-universalk9.dir1/isr4400-mono-universalk9-build_164422SSA.pkg
Image size 78896128 inode num 324491, bks cnt 19262 blk size 8*512
#####
File is comprised of 21 fragments (0%)
.....

```

Router# **show version installed**

```

Package: Provisioning File, version: n/a, status: active
File: bootflash:isr4400-universalk9.dir1/packages.conf, on: RP0
Built: n/a, by: n/a
File SHA1 checksum: ad09affd3f8820f4844f27accladd502e0b8f459

Package: rpbases, version: 2012-07-10_16.22_mcpre, status: active
File: bootflash:isr4400-universalk9.dir1/isr4400-mono-universalk9-build_164422SSA.pkg, on:
  RP0
Built: 2012-07-10_16.22, by: mcpre
File SHA1 checksum: 5e95c9cbc4eaf5a4a5alac846ee2d0f41d1a026b

Package: firmware_attributes, version: 2012-07-10_16.22_mcpre, status: active
File: bootflash:isr4400-universalk9.dir1/isr4400-firmware_attributes_164422SSA.pkg, on:
  RP0/0
Built: 2012-07-10_16.22, by: mcpre
File SHA1 checksum: 71614f2d9cbe7f96d3c6e99b67d514bd108c6c99

Package: firmware_dsp_sp2700, version: 2012-07-10_16.22_mcpre, status: active
File: bootflash:isr4400-universalk9.dir1/isr4400-firmware_dsp_164422SSA.pkg, on: RP0/0
Built: 2012-07-10_16.22, by: mcpre
File SHA1 checksum: 8334565edf7843fe246783b1d5c6ed933d96d79e
Package: firmware_fpge, version: 2012-07-10_16.22_mcpre, status: active
File: bootflash:isr4400-universalk9.dir1/isr4400-firmware_fpge_164422SSA.pkg, on: RP0/0
Built: 2012-07-10_16.22, by: mcpre
File SHA1 checksum: eb72900ab32c1c50652888ff486cf370ac901dd7

Package: firmware_sm_lt3e3, version: 2012-07-10_16.22_mcpre, status: active
File: bootflash:isr4400-universalk9.dir1/isr4400-firmware_sm_lt3e3_164422SSA.pkg, on: RP0/0
Built: 2012-07-10_16.22, by: mcpre
File SHA1 checksum: 803005f15d8ea71ab088647e2766727ac2269871

Package: rpcontrol, version: 2012-07-10_16.22_mcpre, status: active
File: bootflash:isr4400-universalk9.dir1/isr4400-mono-universalk9_164422SSA.pkg, on: RP0/0
Built: 2012-07-10_16.22, by: mcpre
File SHA1 checksum: 980fd58fe581e9346c44417b451d1c09ebb640c2

Package: rpios-universalk9, version: dir1, status: active
File: bootflash:isr4400-universalk9.dir1/isr4400-mono-universalk9_164422SSA.pkg, on: RP0/0
Built: 2012-07-10_16.23, by: mcpre
File SHA1 checksum: 27084f7e30ald69d45a33e05d1b00345040799fb
Package: rpaccess, version: 2012-07-10_16.22_mcpre, status: active
File: bootflash:isr4400-universalk9.dir1/isr4400-mono-universalk9_164422SSA.pkg, on: RP0/0
Built: 2012-07-10_16.22, by: mcpre
File SHA1 checksum: 0119802deda2da91c38473c47a998fb3ed423448

```

Installing Subpackages from a Consolidated Package

```
Package: firmware_attributes, version: 2012-07-10_16.22_mcpre, status: n/a
File: bootflash:isr4400-universalk9.dir1/isr4400-firmware_attributes_164422SSA.pkg, on:
RP0/1
Built: 2012-07-10_16.22, by: mcpre
File SHA1 checksum: 71614f2d9cbe7f96d3c6e99b67d514bd108c6c99

Package: firmware_dsp_sp2700, version: 2012-07-10_16.22_mcpre, status: n/a
File: bootflash:isr4400-universalk9.dir1/isr4400-firmware_dsp_164422SSA.pkg, on: RP0/1
Built: 2012-07-10_16.22, by: mcpre
File SHA1 checksum: 8334565edf7843fe246783bd5c6ed933d96d79e

Package: firmware_fpge, version: 2012-07-10_16.22_mcpre, status: n/a
File: bootflash:isr4400-universalk9.dir1/isr4400-firmware_fpge-BLD-BLD_MCP_DEV_LATEST_20120710_
164422SSA.pkg, on: RP0/1
Built: 2012-07-10_16.22, by: mcpre
File SHA1 checksum: eb72900ab32c1c50652888ff486cf370ac901dd7

Package: firmware_sm_lt3e3, version: 2012-07-10_16.22_mcpre, status: n/a
File: bootflash:isr4400-universalk9.dir1/isr4400-firmware_sm_lt3e3-BLD-BLD_MCP_DEV_LATEST_
20120710_164422SSA.pkg, on: RP0/1
Built: 2012-07-10_16.22, by: mcpre
File SHA1 checksum: 803005f15d8ea71ab088647e2766727ac2269871

Package: rpcontrol, version: 2012-07-10_16.22_mcpre, status: n/a
File: bootflash:isr4400-universalk9.dir1/isr4400-rpcontrol-BLD-BLD_MCP_DEV_LATEST_20120710_
164422SSA.pkg, on: RP0/1
Built: 2012-07-10_16.22, by: mcpre
File SHA1 checksum: 980fd58fe581e9346c44417b451d1c09ebb640c2

Package: rpios-universalk9, version: 2012-07-10_16.23_mcpre, status: n/a
File: bootflash:isr4400-universalk9.dir1/isr4400-rpios-universalk9-BLD-BLD_MCP_DEV_LATEST_
20120710_164422SSA.pkg, on: RP0/1
Built: 2012-07-10_16.23, by: mcpre
File SHA1 checksum: 27084f7e30a1d69d45a33e05d1b00345040799fb

Package: rpaccess, version: 2012-07-10_16.22_mcpre, status: n/a
File: bootflash:isr4400-universalk9.dir1/isr4400-rpaccess-BLD-BLD_MCP_DEV_LATEST_20120710_
164422SSA.pkg, on: RP0/1
Built: 2012-07-10_16.22, by: mcpre
File SHA1 checksum: 0119802deda2da91c38473c47a998fb3ed423448

Package: rpbase, version: 2012-07-10_16.22_mcpre, status: n/a
File: bootflash:isr4400-universalk9.dir1/isr4400-rpbase-BLD-BLD_MCP_DEV_LATEST_20120710_
164422SSA.pkg, on: RP1
Built: 2012-07-10_16.22, by: mcpre
File SHA1 checksum: 5e95c9cbc4eaf5a4a5a1ac846ee2d0f41d1a026b

Package: firmware_attributes, version: 2012-07-10_16.22_mcpre, status: n/a
File: bootflash:isr4400-universalk9.dir1/isr4400-firmware_attributes-BLD-BLD_MCP_DEV_LATEST_
20120710_164422SSA.pkg, on: RP1/0
Built: 2012-07-10_16.22, by: mcpre
File SHA1 checksum: 71614f2d9cbe7f96d3c6e99b67d514bd108c6c99

Package: firmware_dsp_sp2700, version: 2012-07-10_16.22_mcpre, status: n/a
File: bootflash:isr4400-universalk9.dir1/isr4400-firmware_dsp_sp2700-BLD-BLD_MCP_DEV_LATEST_
20120710_164422SSA.pkg, on: RP1/0
Built: 2012-07-10_16.22, by: mcpre
File SHA1 checksum: 8334565edf7843fe246783bd5c6ed933d96d79e

Package: firmware_fpge, version: 2012-07-10_16.22_mcpre, status: n/a
```

Installing Subpackages from a Consolidated Package on a Flash Drive

The steps for installing subpackages from a consolidated package on a USB flash drive are similar to those described in Installing Subpackages from a Consolidated Package section .

Procedure

| | |
|---------------|--------------------------------------------------------------------------------------------------------------|
| Step 1 | show version |
| Step 2 | dir usbn: |
| Step 3 | show platform |
| Step 4 | mkdir bootflash:URL-to-directory-name |
| Step 5 | request platform software package expand fileusbn: package-name to URL-to-directory-name |
| Step 6 | reload |
| Step 7 | boot URL-to-directory-name/packages.conf |
| Step 8 | show version installed |

How to Install and Upgrade the Software for Cisco IOS XE Denali Release 16.3

To install or upgrade the software, use one of the following methods to use the software from a consolidated package or an individual package. Also see *Overview* section.

- *Managing and Configuring a Router to Run Using a Consolidated Package* section
- *Managing and Configuring a Router to Run Using Individual Packages* section
- *Configuring a Router to Boot the Consolidated Package via TFTP Using the boot Command: Example* section
- *Upgrading to Cisco IOS XE Denali Release 16.3* section

Upgrading to Cisco IOS XE Denali Release 16.3

Upgrading the device to Cisco IOS XE Denali Release 16.3 for the first time uses the same procedures as specified in the earlier section. In addition, Cisco IOS XE Denali Release 16.3 requires a minimum ROMMON version. When the device boots up with Cisco IOS XE Denali image for the first time, the device checks the installed version of the ROMMON, and upgrades if the system is running an older version. During the upgrade, do not power cycle the device. The system automatically power cycles the device after the new ROMMON is installed. After the installation, the system will boot up with the Cisco IOS XE image as normal.



Note When the device boots up for first time and if the device requires an upgrade, the entire boot process may take several minutes. This process will be longer than a normal boot due to the ROMMON upgrade.

The following example illustrates the boot process of a consolidated package:

```
Router# configure terminal
Enter configuration commands, one per line. End with CNTL/Z.
Router(config)#boot system tftp://10.81.116.4/rtp-isr4400-54/isr4400.bin
Router(config)#config-register 0x2102
Router(config)#exit
Router# show run | include boot
```

```

boot-start-marker
boot system tftp://10.81.116.4/rtp-isr4400-54/isr4400.bin
boot-end-marker
license boot level advanterprise
Router# copy running-config startup-config
Destination filename [startup-config]?
Building configuration...
[OK]
Router# reload
Proceed with reload? [confirm]
Sep 13 17:42:54.445 R0/0: %PMAN-5-EXITACTION: Process manager is exiting: process exit with

reload chassis code

Initializing Hardware ...

System integrity status: c0000600

Key Sectors: (Primary,GOOD), (Backup,GOOD), (Revocation,GOOD)
Size of Primary = 2288 Backup = 2288 Revocation = 300

ROM:RSA Self Test Passed
ROM:Sha512 Self Test Passed
Self Tests Latency: 58 msec

System Bootstrap, Version 12.2(20120618:163328) [username-ESGROM_20120618_GAMMA 101],
DEVELOPMENT SOFTWARE
Copyright (c) 1994-2014 by cisco Systems, Inc.
Compiled Mon 05/27/2014 12:39:32.05 by username

Current image running: Boot ROM0

Last reset cause: LocalSoft

Cisco ISR 4400 platform with 4194304 Kbytes of main memory

IP_ADDRESS: 172.18.42.119
IP_SUBNET_MASK: 255.255.255.0
DEFAULT_GATEWAY: 172.18.42.1
TFTP_SERVER: 10.81.116.4
TFTP_FILE: rtp-isr4400-54/isr4400.bin
TFTP_MACADDR: a4:4c:11:9d:ad:97
TFTP_VERBOSE: Progress
TFTP_RETRY_COUNT: 18
TFTP_TIMEOUT: 7200
TFTP_CHECKSUM: Yes
ETHER_PORT: 0

ETHER_SPEED_MODE: Auto Detect
link up...
Receiving rtp-isr4400-54/isr4400.bin from 10.81.116.4
!!!!!!!!!!!!!!!!!!!!!!!!!!!!!!!!!!!!!!!!!!!!!!!!!!!!!!!!!!!!!!
File reception completed.
Boot image size = 504063931 (0x1e0b67bb) bytes

ROM:RSA Self Test Passed
ROM:Sha512 Self Test Passed
Self Tests Latency: 58 msec

Package header rev 1 structure detected

```



```
Calculating SHA-1 hash...done
validate_package: SHA-1 hash:
calculated 7294dfc:892a6c35:a7a133df:18c032fc:0670b303
expected 7294dfc:892a6c35:a7a133df:18c032fc:0670b303
Signed Header Version Based Image Detected

Using FLASH based Keys of type = PRIMARY KEY STORAGE
Using FLASH based Keys of type = ROLLOVER KEY STORAGE
RSA Signed DEVELOPMENT Image Signature Verification Successful.
Package Load Test Latency : 5116 msec
Image validated

Detected old ROMMON version 12.2(20150910:184432), upgrade required
Upgrading to newer ROMMON version required by this version of IOS-XE, do not power cycle
the system. A reboot will automatically occur for the new ROMMON to take effect.
selected : 1
Booted : 1
Reset Reason: 1

Info: Upgrading entire flash from the rommon package
Switching to ROM 0
Upgrade image MD5 signature is b702a0a59a46a20a4924f9b17b8f0887
Upgrade image MD5 signature verification is b702a0a59a46a20a4924f9b17b8f0887
Switching back to ROM 1
ROMMON upgrade complete.

To make the new ROMMON permanent, you must restart the RP.
ROMMON upgrade successful. Rebooting for upgrade to take effect.

Initializing Hardware ...

System integrity status: 00300610
Key Sectors: (Primary,GOOD), (Backup,GOOD), (Revocation,GOOD)
Size of Primary = 2288 Backup = 2288 Revocation = 300

ROM:RSA Self Test Passed

Expected hash:
ddaf35a193617abacc417349ae204131
12e6fa4e89a97ea20a9eeee64b55d39a
2192992a274fcl1a836ba3c23a3feebbd
454d4423643ce80e2a9ac94fa54ca49f

Obtained hash:
ddaf35a193617abacc417349ae204131
12e6fa4e89a97ea20a9eeee64b55d39a
2192992a274fcl1a836ba3c23a3feebbd
454d4423643ce80e2a9ac94fa54ca49f
ROM:Sha512 Self Test Passed
Self Tests Latency: 418 msec
Rom image verified correctly

System Bootstrap, Version 12.2(20120618:163328) [username-ESGROM_20120618_GAMMA 101],
DEVELOPMENT SOFTWARE
Copyright (c) 1994-2014 by cisco Systems, Inc.
Compiled Mon 05/27/2014 12:39:32.05 by username

CPLD Version: 33 (MM/DD/YY): 06/23/14 Cisco ISR4351/K9 Slot:0

Current image running: Boot ROM1
```

```

Last reset cause: ResetRequest
Reading confreg 0x2102

Reading monitor variables from NVRAM
Enabling interrupts...done

Checking for PCIe device presence...done
Cisco ISR4351/K9 platform with 16777216 Kbytes of main memory

autoboot entry: NVRAM VALUES: bootconf: 0x0, autobootstate: 0
autobootcount: 0, autobootsptr: 0x0
Rommon upgrade requested
Flash upgrade reset 0 in progress
.....
Initializing Hardware ...

Checking for PCIe device presence...done
Reading confreg 2102
System integrity status: 0x300610
Key Sectors: (Primary, GOOD), (Backup,GOOD), (Revocation,GOOD)
Size of Primary = 2288 Backup = 2288 Revocation = 288
RSA Self Test Passed

Expected hash:
DDAF35A193617ABACC417349AE204131
12E6FA4E89A97EA20A9EEEE64B55D39A
2192992A274FC1A836BA3C23A3FEEBBD
454D4423643CE80E2A9AC94FA54CA49F

Obtained hash:
DDAF35A193617ABACC417349AE204131
12E6FA4E89A97EA20A9EEEE64B55D39A
2192992A274FC1A836BA3C23A3FEEBBD
454D4423643CE80E2A9AC94FA54CA49F
Sha512 Self Test Passed
Rom image verified correctly

System Bootstrap, Version 16.2(1r), RELEASE SOFTWARE
Copyright (c) 1994-2016 by cisco Systems, Inc.

Current image running: *Upgrade in progress* Boot ROM0

Last reset cause: BootRomUpgrade
ISR4351/K9 platform with 16777216 Kbytes of main memory

Cisco ISR 4400 platform with 4194304 Kbytes of main memory

IP_ADDRESS: 172.18.42.119
IP_SUBNET_MASK: 255.255.255.0
DEFAULT_GATEWAY: 172.18.42.1
TFTP_SERVER: 10.81.116.4
TFTP_FILE: rtp-isr4400-54/isr4400.bin
TFTP_MACADDR: a4:4c:11:9d:ad:97
TFTP_VERBOSE: Progress
TFTP_RETRY_COUNT: 18
TFTP_TIMEOUT: 7200
TFTP_CHECKSUM: Yes
ETHER_PORT: 0

ETHER_SPEED_MODE: Auto Detect
link up...

```

```

Receiving rtp-isr4400-54/isr4400.bin from 10.81.116.4
!!!!!!!!!!!!!!!!!!!!!!!!!!!!!!!!!!!!!!!!!!!!!!!!!!!!!!
File reception completed.
Boot image size = 504063931 (0x1e0b67bb) bytes

```

```

Image Base is: 0x56834018
Image Size is: 0x1E089706
Package header rev 1 structure detected
Package type:30000, flags:0x0
IsoSize = 503874534
Parsing package TLV info:
000: 000000090000001D4B45595F544C565F - KEY_TLV_
010: 5041434B4147455F434F4D5041544942 - PACKAGE_COMPATIB
020: 494C495459000000000000090000000B - ILITY
030: 4652555F52505F545950450000000009 - FRU_RP_TYPE
040: 000000184B45595F544C565F5041434B - KEY_TLV_PACK
050: 4147455F424F4F544152434800000009 - AGE_BOOTARCH
060: 0000000E415243485F693638365F5459 - ARCH_i686_TY
070: 5045000000000009000000144B45595F - PE KEY_
080: 544C565F424F4152445F434F4D504154 - TLV_BOARD_COMPAT
090: 0000000900000012424F4152445F6973 - BOARD_is
0A0: 72343330305F54595045000000000009 - r4300_TYPE
0B0: 000000184B45595F544C565F43525950 - KEY_TLV_Cryp
0C0: 544F5F4B4559535452494E4700000009 - TO_KEYSTRING

```

```

TLV: T=9, L=29, V=KEY_TLV_PACKAGE_COMPATIBILITY
TLV: T=9, L=11, V=FRU_RP_TYPE
TLV: T=9, L=24, V=KEY_TLV_PACKAGE_BOOTARCH
TLV: T=9, L=14, V=ARCH_i686_TYPE
TLV: T=9, L=20, V=KEY_TLV_BOARD_COMPAT
TLV: T=9, L=18, V=BOARD_isr4300_TYPE
TLV: T=9, L=24, V=KEY_TLV_CRYPTO_KEYSTRING
TLV: T=9, L=10, V=EnCrYpTiOn
TLV: T=9, L=11, V=CW_BEGIN=$$
TLV: T=9, L=19, V=CW_FAMILY=$isr4300$
TLV: T=9, L=59, V=CW_IMAGE=$isr4300-universalk9.2016-06-29_23.31_paj.SSA.bin$
TLV: T=9, L=19, V=CW_VERSION=$16.3.1$
TLV: T=9, L=52, V=CW_DESCRIPTION=$Cisco IOS Software, IOS-XE Software$
TLV: T=9, L=9, V=CW_END=$$
Found DIGISIGN TLV type 12 length = 392
RSA Self Test Passed

```

```

Expected hash:
DDAF35A193617ABACC417349AE204131
12E6FA4E89A97EA20A9EEEE64B55D39A
2192992A274FC1A836BA3C23A3FEEBBD
454D4423643CE80E2A9AC94FA54CA49F

```

```

Obtained hash:
DDAF35A193617ABACC417349AE204131
12E6FA4E89A97EA20A9EEEE64B55D39A
2192992A274FC1A836BA3C23A3FEEBBD
454D4423643CE80E2A9AC94FA54CA49F
Sha512 Self Test Passed
Found package arch type ARCH_i686_TYPE
Found package FRU type FRU_RP_TYPE
Calculating SHA-1 hash...Validate package: SHA-1 hash:
calculated 8B082C48:35C23C9E:8A091441:D6FACEE6:B5111533
expected 8B082C48:35C23C9E:8A091441:D6FACEE6:B5111533

```

Image validated

Restricted Rights Legend

Use, duplication, or disclosure by the Government is subject to restrictions as set forth in subparagraph (c) of the Commercial Computer Software - Restricted Rights clause at FAR sec. 52.227-19 and subparagraph (c) (1) (ii) of the Rights in Technical Data and Computer Software clause at DFARS sec. 252.227-7013.

cisco Systems, Inc.
170 West Tasman Drive
San Jose, California 95134-1706

Cisco IOS Software, ISR Software (X86_64_LINUX_IOSD-UNIVERSALK9-M), Experimental Version 16.3(20160527:095327)
[v163_throttle]
Copyright (c) 1986-2016 by Cisco Systems, Inc.
Compiled Tue 27-May-16 21:28 by mcpre

Cisco IOS-XE software, Copyright (c) 2005-2016 by cisco Systems, Inc. All rights reserved. Certain components of Cisco IOS-XE software are licensed under the GNU General Public License ("GPL") Version 2.0. The software code licensed under GPL Version 2.0 is free software that comes with ABSOLUTELY NO WARRANTY. You can redistribute and/or modify such GPL code under the terms of GPL Version 2.0. For more details, see the documentation or "License Notice" file accompanying the IOS-XE software, or the applicable URL provided on the flyer accompanying the IOS-XE software.

This product contains cryptographic features and is subject to United States and local country laws governing import, export, transfer and use. Delivery of Cisco cryptographic products does not imply third-party authority to import, export, distribute or use encryption. Importers, exporters, distributors and users are responsible for compliance with U.S. and local country laws. By using this product you agree to comply with applicable laws and regulations. If you are unable to comply with U.S. and local laws, return this product immediately.

A summary of U.S. laws governing Cisco cryptographic products may be found at:
<http://www.cisco.com/wwl/export/crypto/tool/stqrg.html>

If you require further assistance please contact us by sending email to export@cisco.com.

Warning: the compile-time code checksum does not appear to be present.
cisco ISR4451/K9 (2RU) processor with 1133585K/6147K bytes of memory.
Processor board ID FGL1619100P
4 Gigabit Ethernet interfaces
32768K bytes of non-volatile configuration memory.
4194304K bytes of physical memory.
7393215K bytes of Compact flash at bootflash:.
7816688K bytes of USB flash at usb0:.

Press RETURN to get started!

Installing a Firmware Subpackage

Before you begin

Obtain a consolidated package that contains your required firmware package and expand the package. (See [Managing and Configuring a Router to Run Using Individual Packages, on page 31](#).) Make a note of the location and name of the firmware package and use this information in the steps below for *URL-to-package-name*.

You can install a firmware subpackage if the router has been configured using, for example, [Managing and Configuring a Router to Run Using Individual Packages, on page 31](#).

Firmware subpackages are not released individually. You can select a firmware package from within a consolidated package after expanding the consolidated package. The firmware package can then be installed as shown in the procedure below.



Note Read the Release Notes document pertaining to the consolidated package to verify that the firmware within the consolidated package is compatible with the version of Cisco IOS XE software that is currently installed on a router.

Procedure

| | Command or Action | Purpose |
|---------------|---------------------------------------------------------------------------------------------------------------------------------------------------------------------------------------------------------------------------------------------------------------------------------------------------------------|-----------------------------------------------------------------------------------------------------------------------------------|
| Step 1 | show version Example: <pre>Router# show version Cisco IOS Software, IOS-XE Software (X86_64_LINUX_IOSD-UNIVERSALK9-M), Experimental Version 15.3(20120627:221639) [build_151722 111] Copyright (c) 1986-2012 by Cisco Systems, Inc. Compiled Thu 28-Jun-12 15:17 by mcpre . . .</pre> | Shows the version of software running on the router. This can later be compared with the version of software to be installed. |
| Step 2 | dir bootflash: Example: <pre>Router# dir bootflash:</pre> | Displays the previous version of software and that a package is present. |
| Step 3 | show platform Example: <pre>Router# show platform Chassis type: ISR4451/K9</pre> | Checks the inventory. Also see the example in Installing Subpackages from a Consolidated Package section . |
| Step 4 | mkdir bootflash: URL-to-directory-name Example: <pre>Router# mkdir bootflash:mydir</pre> | Creates a directory to save the expanded software image. You can use the same name as the image to name the directory. |

| | Command or Action | Purpose |
|---------------|-----------------------------------------------------------------------------------------------------------------------------------------------------------------------------------------------------------------------------------------------------------------------------|-----------------------------------------------------------------------------------------------------------------------------------------------------------------------------------------------------|
| Step 5 | request platform software package expand file <i>URL-to-consolidated-package</i> to <i>URL-to-directory-name</i> Example: <pre>Router# request platform software package expand file bootflash:isr4400-universalk9-NIM.bin to bootflash:mydir</pre> | Expands the software image from the TFTP server (<i>URL-to-consolidated-package</i>) into the directory used to save the image (<i>URL-to-directory-name</i>), which was created in the Step 4. |
| Step 6 | reload Example: <pre>Router# reload rommon ></pre> | Enables ROMMON mode, which allows the software in the consolidated file to be activated. |
| Step 7 | boot <i>URL-to-directory-name</i> /packages.conf Example: <pre>rommon 1 > boot bootflash:mydir/packages.conf</pre> | Boots the consolidated package by specifying the path and name of the provisioning file: packages.conf. |
| Step 8 | show version installed Example: <pre>Router# show version installed Package: Provisioning File, version: n/a, status: active</pre> | Displays the version of the newly installed software. |

Examples

The initial part of the following example shows the consolidated package, `isr4400-universalk9.164422SSA.bin`, being copied to the TFTP server. This is a prerequisite step. The remaining part of the example shows the consolidated file, `packages.conf`, being booted.

```
Router# tftp:isr4400/isr4400-universalk9.164422SSA.bin bootflash:
Address or name of remote host []? 1.1.1.1
Destination filename [isr4400-universalk9.164422SSA.bin]?
Accessing tftp://1.1.1.1/isr4400/isr4400-universalk9.164422SSA.bin...
Loading isr4400/isr4400-universalk9.164422SSA.bin from 1.1.1.1 (via GigabitEthernet0):
!!!!!!!!!!
[OK - 410506248 bytes]

410506248 bytes copied in 338.556 secs (1212521 bytes/sec)

Router# show version
Cisco IOS Software, IOS-XE Software (X86_64_LINUX_IOSD-UNIVERSALK9-M), Experimental Version

15.3(20120627:221639) [build_151722 111]
Copyright (c) 1986-2012 by Cisco Systems, Inc.
Compiled Thu 28-Jun-12 15:17 by mcpre

IOS XE Version: 2012-06-28_15.31_mcpre

Cisco IOS-XE software, Copyright (c) 2005-2012 by cisco Systems, Inc.
```

All rights reserved. Certain components of Cisco IOS-XE software are licensed under the GNU General Public License ("GPL") Version 2.0. The software code licensed under GPL Version 2.0 is free software that comes with ABSOLUTELY NO WARRANTY. You can redistribute and/or modify such GPL code under the terms of GPL Version 2.0. For more details, see the documentation or "License Notice" file accompanying the IOS-XE software, or the applicable URL provided on the flyer accompanying the IOS-XE software.

ROM: IOS-XE ROMMON

Router uptime is 0 minutes
Uptime for this control processor is 3 minutes
System returned to ROM by reload
System image file is "tftp:isr4400/isr4400.bin"
Last reload reason: Reload Command

This product contains cryptographic features and is subject to United States and local country laws governing import, export, transfer and use. Delivery of Cisco cryptographic products does not imply third-party authority to import, export, distribute or use encryption. Importers, exporters, distributors and users are responsible for compliance with U.S. and local country laws. By using this product you agree to comply with applicable laws and regulations. If you are unable to comply with U.S. and local laws, return this product immediately.

A summary of U.S. laws governing Cisco cryptographic products may be found at:
<http://www.cisco.com/wwl/export/crypto/tool/stqrg.html>

If you require further assistance please contact us by sending email to export@cisco.com.

License Level: advenenterprise
License Type: EvalRightToUse
Next reload license Level: advenenterprise
cisco ISR4451/K9 (2RU) processor with 1136676K/6147K bytes of memory.
Processor board ID FGL161611AB
4 Gigabit Ethernet interfaces
32768K bytes of non-volatile configuration memory.
4194304K bytes of physical memory.
7393215K bytes of Compact flash at bootflash:.

Configuration register is 0x8000

Router# **dir bootflash:**
Directory of bootflash:/

```
11 drwx 16384 May 3 2012 19:58:37 +00:00 lost+found
178465 drwx 4096 Jun 6 2012 15:20:20 +00:00 core
584065 drwx 4096 Jul 13 2012 19:19:00 +00:00 .prst_sync
405601 drwx 4096 May 3 2012 19:59:30 +00:00 .rollback_timer
113569 drwx 40960 Jul 13 2012 19:19:32 +00:00 tracelogs
64897 drwx 4096 May 3 2012 19:59:42 +00:00 .installer
13 -rw- 1305 May 7 2012 17:43:42 +00:00 startup-config
14 -rw- 1305 May 7 2012 17:43:55 +00:00 running-config
15 -r-- 1541 Jun 4 2012 18:32:41 +00:00 debug.conf
16 -rw- 1252 May 22 2012 19:58:39 +00:00 running-config-20120522
519169 drwx 4096 Jun 4 2012 15:29:01 +00:00 vman_fdb

7451738112 bytes total (7067635712 bytes free)
```

```

Router# show platform
Chassis type: ISR4451/K9

Slot Type State Insert time (ago)
-----
0 ISR4451/K9 ok 15:57:33
0/0 ISR4451-6X1GE ok 15:55:24
1 ISR4451/K9 ok 15:57:33
1/0 SM-1T3/E3 ok 15:55:24
2 ISR4451/K9 ok 15:57:33
2/0 SM-1T3/E3 ok 15:55:24
R0 ISR4451/K9 ok, active 15:57:33
F0 ISR4451-FP ok, active 15:57:33
P0 Unknown ps, fail never
P1 XXX-XXXX-XX ok 15:56:58
P2 ACS-4450-FANASSY ok 15:56:58

Slot CPLD Version Firmware Version
-----
0 12090323 15.3(01r)S [ciscouser-ISRRO...
1 12090323 15.3(01r)S [ciscouser-ISRRO...
2 12090323 15.3(01r)S [ciscouser-ISRRO...
R0 12090323 15.3(01r)S [ciscouser-ISRRO...
F0 12090323 15.3(01r)S [ciscouser-ISRRO...

Router# mkdir bootflash:isr4400-universalk9.dir1
Create directory filename [isr4400-universalk9.dir1]?
Created dir bootflash:/isr4400-universalk9.dir1
Router# request platform software package expand file bootflash:isr4400-universalk9.NIM.bin
to
bootflash:isr4400-universalk9.dir1
Verifying parameters
Validating package type
Copying package files
SUCCESS: Finished expanding all-in-one software package.

Router# reload
Proceed with reload? [confirm]

*Jul 13 19:39:06.354: %SYS-5-RELOAD: Reload requested by console. Reload Reason: Reload
Command.

rommon 1 > boot bootflash:isr4400-universalk9.dir1/packages.conf

File size is 0x00002836
Located isr4400-universalk9.dir1/packages.conf
Image size 10294 inode num 324484, bks cnt 3 blk size 8*512
#
File is comprised of 1 fragments (33%)

is_valid_shalhash: SHA-1 hash:
calculated 62f6235a:fc98eb3a:85ce183e:834f1cb3:8a1f71d1
expected 62f6235a:fc98eb3a:85ce183e:834f1cb3:8a1f71d1
File size is 0x04b3dc00
Located isr4400-universalk9.dir1/isr4400-mono-universalk9-build_164422SSA.pkg
Image size 78896128 inode num 324491, bks cnt 19262 blk size 8*512
#####
File is comprised of 21 fragments (0%)
.....

Router# show version installed
Package: Provisioning File, version: n/a, status: active

```



```
File: bootflash:isr4400-universalk9.dir1/packages.conf, on: RP0
Built: n/a, by: n/a
File SHA1 checksum: ad09affd3f8820f4844f27acc1add502e0b8f459

Package: rpbase, version: 2012-07-10_16.22_mcpred, status: active
File: bootflash:isr4400-universalk9.dir1/isr4400-mono-universalk9-build_164422SSA.pkg, on:
RP0
Built: 2012-07-10_16.22, by: mcpred
File SHA1 checksum: 5e95c9cbc4eaf5a4a5alac846ee2d0f41d1a026b

Package: firmware_attributes, version: 2012-07-10_16.22_mcpred, status: active
File: bootflash:isr4400-universalk9.dir1/isr4400-firmware_attributes_164422SSA.pkg, on:
RP0/0
Built: 2012-07-10_16.22, by: mcpred
File SHA1 checksum: 71614f2d9cbe7f96d3c6e99b67d514bd108c6c99

Package: firmware_dsp_sp2700, version: 2012-07-10_16.22_mcpred, status: active
File: bootflash:isr4400-universalk9.dir1/isr4400-firmware_dsp_164422SSA.pkg, on: RP0/0
Built: 2012-07-10_16.22, by: mcpred
File SHA1 checksum: 8334565edf7843fe246783b1d5c6ed933d96d79e
Package: firmware_fpge, version: 2012-07-10_16.22_mcpred, status: active
File: bootflash:isr4400-universalk9.dir1/isr4400-firmware_fpge_164422SSA.pkg, on: RP0/0
Built: 2012-07-10_16.22, by: mcpred
File SHA1 checksum: eb72900ab32c1c50652888ff486cf370ac901dd7

Package: firmware_sm_lt3e3, version: 2012-07-10_16.22_mcpred, status: active
File: bootflash:isr4400-universalk9.dir1/isr4400-firmware_sm_lt3e3_164422SSA.pkg, on: RP0/0
Built: 2012-07-10_16.22, by: mcpred
File SHA1 checksum: 803005f15d8ea71ab088647e2766727ac2269871

Package: rpcontrol, version: 2012-07-10_16.22_mcpred, status: active
File: bootflash:isr4400-universalk9.dir1/isr4400-mono-universalk9_164422SSA.pkg, on: RP0/0
Built: 2012-07-10_16.22, by: mcpred
File SHA1 checksum: 980fd58fe581e9346c44417b451d1c09ebb640c2

Package: rpios-universalk9, version: dir1, status: active
File: bootflash:isr4400-universalk9.dir1/isr4400-mono-universalk9_164422SSA.pkg, on: RP0/0
Built: 2012-07-10_16.23, by: mcpred
File SHA1 checksum: 27084f7e30ald69d45a33e05d1b00345040799fb
Package: rpaccess, version: 2012-07-10_16.22_mcpred, status: active
File: bootflash:isr4400-universalk9.dir1/isr4400-mono-universalk9_164422SSA.pkg, on: RP0/0
Built: 2012-07-10_16.22, by: mcpred
File SHA1 checksum: 0119802deda2da91c38473c47a998fb3ed423448

Package: firmware_attributes, version: 2012-07-10_16.22_mcpred, status: n/a
File: bootflash:isr4400-universalk9.dir1/isr4400-firmware_attributes_164422SSA.pkg, on:
RP0/1
Built: 2012-07-10_16.22, by: mcpred
File SHA1 checksum: 71614f2d9cbe7f96d3c6e99b67d514bd108c6c99

Package: firmware_dsp_sp2700, version: 2012-07-10_16.22_mcpred, status: n/a
File: bootflash:isr4400-universalk9.dir1/isr4400-firmware_dsp_164422SSA.pkg, on: RP0/1
Built: 2012-07-10_16.22, by: mcpred
File SHA1 checksum: 8334565edf7843fe246783b1d5c6ed933d96d79e

Package: firmware_fpge, version: 2012-07-10_16.22_mcpred, status: n/a
File: bootflash:isr4400-universalk9.dir1/isr4400-firmware_fpge-BLD-BLD_MCP_DEV_LATEST_
20120710_164422SSA.pkg, on: RP0/1
Built: 2012-07-10_16.22, by: mcpred
File SHA1 checksum: eb72900ab32c1c50652888ff486cf370ac901dd7

Package: firmware_sm_lt3e3, version: 2012-07-10_16.22_mcpred, status: n/a
File: bootflash:isr4400-universalk9.dir1/isr4400-firmware_sm_lt3e3-BLD-BLD_MCP_DEV_LATEST_
20120710_164422SSA.pkg, on: RP0/1
```

```

Built: 2012-07-10_16.22, by: mcpre
File SHA1 checksum: 803005f15d8ea71ab088647e2766727ac2269871

Package: rpcontrol, version: 2012-07-10_16.22_mcpre, status: n/a
File: bootflash:isr4400-universalk9.dir1/isr4400-rpcontrol-BLD-BLD_MCP_DEV_LATEST_20120710_
164422SSA.pkg, on: RP0/1
Built: 2012-07-10_16.22, by: mcpre
File SHA1 checksum: 980fd58fe581e9346c44417b451d1c09ebb640c2

Package: rpios-universalk9, version: 2012-07-10_16.23_mcpre, status: n/a
File: bootflash:isr4400-universalk9.dir1/isr4400-rpios-universalk9-BLD-BLD_MCP_DEV_LATEST_
20120710_164422SSA.pkg, on: RP0/1
Built: 2012-07-10_16.23, by: mcpre
File SHA1 checksum: 27084f7e30ald69d45a33e05d1b00345040799fb

Package: rpaccess, version: 2012-07-10_16.22_mcpre, status: n/a
File: bootflash:isr4400-universalk9.dir1/isr4400-rpaccess-BLD-BLD_MCP_DEV_LATEST_20120710_
164422SSA.pkg, on: RP0/1
Built: 2012-07-10_16.22, by: mcpre
File SHA1 checksum: 0119802deda2da91c38473c47a998fb3ed423448

Package: rpbase, version: 2012-07-10_16.22_mcpre, status: n/a
File: bootflash:isr4400-universalk9.dir1/isr4400-rpbase-BLD-BLD_MCP_DEV_LATEST_20120710_
164422SSA.pkg, on: RP1
Built: 2012-07-10_16.22, by: mcpre
File SHA1 checksum: 5e95c9cbc4eaf5a4a5a1ac846ee2d0f41d1a026b

Package: firmware_attributes, version: 2012-07-10_16.22_mcpre, status: n/a
File: bootflash:isr4400-universalk9.dir1/isr4400-firmware_attributes-BLD-BLD_MCP_DEV_LATEST_
20120710_164422SSA.pkg, on: RP1/0
Built: 2012-07-10_16.22, by: mcpre
File SHA1 checksum: 71614f2d9cbe7f96d3c6e99b67d514bd108c6c99

Package: firmware_dsp_sp2700, version: 2012-07-10_16.22_mcpre, status: n/a
File: bootflash:isr4400-universalk9.dir1/isr4400-firmware_dsp_sp2700-BLD-BLD_MCP_DEV_LATEST_
20120710_164422SSA.pkg, on: RP1/0
Built: 2012-07-10_16.22, by: mcpre
File SHA1 checksum: 8334565edf7843fe246783b1d5c6ed933d96d79e

Package: firmware_fpge, version: 2012-07-10_16.22_mcpre, status: n/a

```

Upgrading the Firmware on xDSL NIMs

To upgrade the firmware on a xDSL Network Interface Module (NIM), perform these steps:

Before you begin

When you boot the router in packages.conf mode with the Cisco IOS XE image (super package) during the installation period, you can upgrade or downgrade the firmware without reloading the router. You need to follow the steps described in Installing a Firmware Subpackage section before proceeding with the firmware upgrade.

If you do not boot the router in packages.conf mode with the Cisco IOS XE image, you need to follow the below prerequisites before proceeding with the firmware upgrade:

- Copy the firmware subpackage (NIM firmware) into bootflash:/mydir.
- Send a request to the platform software package expand file *boot flash:/mydir/<IOS-XE image>* to expand the super package.
- Reload the hardware module subslot to boot the module with the new firmware.

- Verify that the module is booted up with the new firmware using the **show platform software subslot x/y module firmware** command.

Procedure

| | Command or Action | Purpose |
|---------------|---------------------------------------------------------------------------------------------------------------------------------------------------------------------------------------------------------------------------------------------------------------------------------------|-------------------------------------------------------------------------------------------------------------------------------|
| Step 1 | copy Cisco IOS XE image into bootflash: mydir . Example: Router# mkdir bootflash:mydir | Creates a directory to save the expanded software image. You can use the same name as the image to name the directory. |
| Step 2 | request platform software package expand file <i>bootflash:/mydir/<IOS-XE image></i> to expand super package. Example: Router# request platform software package expand file bootflash:/mydir/ios4400-universalk9.03.14.00.S.155-1.S-std.SPA.bin | Expands the platform software package to super package. |
| Step 3 | reload . Example: Router# reload rommon > | Enables ROMMON mode, which allows the software in the super package file to be activated. |
| Step 4 | boot bootflash:mydir/ /packages.conf . Example: rommon 1 > boot bootflash:mydir/packages.conf | Boots the super package by specifying the path and name of the provisioning file: packages.conf. |
| Step 5 | copy NIM firmware subpackage to the folder bootflash:mydir/ . Example: Router# copy bootflash:ios4400-firmware_nim_xdsl.2014-11-17_11.05_39n.SPA.pkg bootflash:mydir/ | Copies the NIM firmware subpackage into bootflash:mydir. |
| Step 6 | request platform software package install rp 0 file <i>bootflash:/mydir/<firmware subpackage></i> . Example: Router# request platform software package install rp 0 file bootflash:mydir/ios4400-firmware_nim_xdsl.2014-11-17_11.05_39n.SPA.pkg | Installs the software package. |
| Step 7 | hw-module subslot x/y reload to boot the module with the new firmware. Example: | Reloads the hardware module subslot and boots the module with the new firmware. |

| | Command or Action | Purpose |
|---------------|--------------------------------------------------------------------------------------------------------------------------------------------------------------------------------------------------------------------------------|-------------------------------------------------------|
| | Router# hw-module subslot 0/2 reload | |
| Step 8 | <p>show platform software subslot 0/2 module firmware to verify that the module is booted up with the new firmware.</p> <p>Example:</p> <pre>Router# show platform software subslot 0/2 module firmware Pe</pre> | Displays the version of the newly installed firmware. |

Examples

The following example shows how to perform firmware upgrade in a router module:

```
Router#mkdir bootflash:mydir
Create directory filename [mydir]?
Created dir bootflash:/mydir
Router#
Router#copy bootflash:isr4400-universalk9.03.14.00.S.155-1.S-std.SPA.bin bootflash:mydir/
Destination filename [mydir/isr4400-universalk9.03.14.00.S.155-1.S-std.SPA.bin]?
Copy in progress...CCCCCCCCCCCCCCCCCCCCCCCCCCCCCCCCCCCCCCCCCCCCCCCCCCCCCCCCCCCCCCCC
CCCCCCCCCCCCCCCCCCCCCCCCCCCCCCCCCCCCCCCCCCCCCCCCCCCCCCCCCCCCCCCCCCCCCCCCCCCC
CCCCCCCCCCCCCCCCCCCCCCCCCCCCCCCCCCCCCCCCCCCCCCCCCCCCCCCCCCCCCCCCCCCCCCCCCCCC
CCCCCCCCCCCCCCCCCCCCCCCCCCCCCCCCCCCCCCCCCCCCCCCCCCCCCCCCCCCCCCCCCCCCCCCCCCCC
CCCCCCCCCCCCCCCCCCCCCCCCCCCCCCCCCCCCCCCCCCCCCCCCCCCCCCCCCCCCCCCCCCCCCCCCCCCC
CCCC
425288648 bytes copied in 44.826 secs (9487544 bytes/sec)
Router#
Router#
Router#dir bootflash:mydir
Directory of bootflash:/mydir/

632738  -rw-           425288648  Dec 12 2014 09:16:42 +00:00
isr4400-universalk9.03.14.00.S.155-1.S-std.SPA.bin

7451738112 bytes total (474025984 bytes free)
Router#

Router#request platform software package
expand file bootflash:/mydir/isr4400-universalk9.03.14.00.S.155-1.S-std.SPA.bin
Verifying parameters
Validating package type
Copying package files
SUCCESS: Finished expanding all-in-one software package.

Router#reload
Proceed with reload? [confirm]

*Dec 12 09:26:09.874: %SYS-5-RELOAD: Reload requested by console. Reload Reason:
Reload Command.Dec 12 09:26:25.156 R0/0: %PMAN-5-EXITACTION: Process manager is exiting:
process exit with reload chassis code

Initializing Hardware ...

System integrity status: 00000610
  Rom image verified correctly
  System Bootstrap, Version 15.3(3r)S1, RELEASE SOFTWARE
Copyright (c) 1994-2013 by cisco Systems, Inc.
```

```

Current image running: Boot ROM0

Last reset cause: LocalSoft
Cisco ISR4451-X/K9 platform with 4194304 Kbytes of main memory

rommon 1 boot bootflash:mydir/packages.conf

File size is 0x000028f1
Located mydir/packages.conf
Image size
10481 inode num 632741, bks cnt 3 blk size 8*512

#
File size is 0x150ae3cc
Located mydir/isr4400-mono-universalk9.03.14.00.S.155-1.S-std.SPA.pkg
Image size 353035212 inode num 356929, bks cnt 86191 blk size 8*512
#####
#####
Boot image size = 353035212 (0x150ae3cc) bytes

Package header rev 1 structure detected
Calculating SHA-1 hash...done
validate_package: SHA-1 hash:
  calculated 8e966678:8afb08f4:8a88bb8f:fe591121:8bddf4b3
  expected   8e966678:8afb08f4:8a88bb8f:fe591121:8bddf4b3

RSA Signed RELEASE Image Signature Verification Successful.
Package Load Test Latency : 3799 msec
Image validated
Dec 12 09:28:50.338 R0/0: %FLASH_CHECK-3-DISK_QUOTA: Flash disk quota exceeded
[free space is 61864 kB] - Please clean up files on bootflash.

```

Restricted Rights Legend

Use, duplication, or disclosure by the Government is subject to restrictions as set forth in subparagraph (c) of the Commercial Computer Software - Restricted Rights clause at FAR sec. 52.227-19 and subparagraph (c) (1) (ii) of the Rights in Technical Data and Computer Software clause at DFARS sec. 252.227-7013.

cisco Systems, Inc.
 170 West Tasman Drive
 San Jose, California 95134-1706

Cisco IOS Software, ISR Software (X86_64_LINUX_IOSD-UNIVERSALK9-M), Version 15.5(1)S, RELEASE SOFTWARE (fc5)
 Technical Support: <http://www.cisco.com/techsupport>
 Copyright (c) 1986-2014 by Cisco Systems, Inc.
 Compiled Thu 20-Nov-14 18:28 by mcpre

Cisco IOS-XE software, Copyright (c) 2005-2014 by cisco Systems, Inc. All rights reserved. Certain components of Cisco IOS-XE software are licensed under the GNU General Public License ("GPL") Version 2.0. The software code licensed under GPL Version 2.0 is free software that comes with ABSOLUTELY NO WARRANTY. You can redistribute and/or modify such GPL code under the terms of GPL Version 2.0. For more details, see the documentation or "License Notice" file accompanying the IOS-XE software,

or the applicable URL provided on the flyer accompanying the IOS-XE software.

This product contains cryptographic features and is subject to United States and local country laws governing import, export, transfer and use. Delivery of Cisco cryptographic products does not imply third-party authority to import, export, distribute or use encryption. Importers, exporters, distributors and users are responsible for compliance with U.S. and local country laws. By using this product you agree to comply with applicable laws and regulations. If you are unable to comply with U.S. and local laws, return this product immediately.

A summary of U.S. laws governing Cisco cryptographic products may be found at: <http://www.cisco.com/wwl/export/crypto/tool/stqrg.html>

If you require further assistance please contact us by sending email to export@cisco.com.

```
cisco ISR4451-X/K9 (2RU) processor with 1681388K/6147K bytes of memory.
Processor board ID FTX1736AJUT
2 Ethernet interfaces
4 Gigabit Ethernet interfaces
2 ATM interfaces
32768K bytes of non-volatile configuration memory.
4194304K bytes of physical memory.
7393215K bytes of flash memory at bootflash:.
```

Press RETURN to get started!

```
*Dec 12 09:28:58.922:
%IOS_LICENSE_IMAGE_APPLICATION-6-LICENSE_LEVEL:
Module name = esg Next reboot level = appxk9 and License = appxk9
*Dec 12 09:28:58.943:
%IOS_LICENSE_IMAGE_APPLICATION-6-LICENSE_LEVEL:
Module name = esg Next reboot level = ipbasek9 and License = ipbasek9
*Dec 12 09:28:58.981:
%ISR_THROUGHPUT-6-LEVEL: Throughput level has been set to 1000000 kbps
*Dec 12 09:29:13.302: %SPANTREE-5-EXTENDED_SYSID: Extended SysId enabled for type vlan
*Dec 12 09:29:14.142: %LINK-3-UPDOWN: Interface Lsmpi0, changed state to up
*Dec 12 09:29:14.142: %LINK-3-UPDOWN: Interface EOBC0, changed state to up
*Dec 12 09:29:14.142: %LINK-3-UPDOWN: Interface GigabitEthernet0, changed state to down
*Dec 12 09:29:14.142: %LINK-3-UPDOWN: Interface LIIN0, changed state to up
*Dec 12 09:28:51.438: %CMRP-3-PFU_MISSING:cmand: The platform does not detect a power
supply in slot 1
*Dec 12 09:29:01.256: %CMLIB-6-THROUGHPUT_VALUE:cmand: Throughput license found, throughput
set to 1000000 kbps
*Dec 12 09:29:03.223: %CPPHA-7-START:cpp_ha: CPP 0 preparing ucode
*Dec 12 09:29:03.238: %CPPHA-7-START:cpp_ha: CPP 0 startup init
*Dec 12 09:29:11.335: %CPPHA-7-START:cpp_ha: CPP 0 running init
*Dec 12 09:29:11.645: %CPPHA-7-READY:cpp_ha: CPP 0 loading and initialization complete
*Dec 12 09:29:11.711: %IOSXE-6-PLATFORM:cpp_cp:
Process CPP_PFILTER_EA_EVENT_API_CALL_REGISTER
*Dec 12 09:29:16.280:
%IOSXE_MGMTVRF-6-CREATE_SUCCESS_INFO:
Management vrf Mgmt-intf created with ID 1, ipv4 table-id 0x1, ipv6 table-id 0x1E000001
*Dec 12 09:29:16.330:
%LINEPROTO-5-UPDOWN: Line protocol on Interface Lsmpi0, changed state to up
*Dec 12 09:29:16.330:
%LINEPROTO-5-UPDOWN: Line protocol on Interface EOBC0, changed state to up
*Dec 12 09:29:16.330:
%LINEPROTO-5-UPDOWN: Line protocol on Interface GigabitEthernet0, changed state to down
*Dec 12 09:29:16.330:
```

```

%LINEPROTO-5-UPDOWN: Line protocol on Interface LIIN0, changed state to up
*Dec 12 09:29:17.521: %SYS-5-LOG_CONFIG_CHANGE: Buffer logging disabled
*Dec 12 09:29:18.867: %SYS-5-CONFIG_I: Configured from memory by console
*Dec 12 09:29:18.870:
%IOSXE_OIR-6-REMSPA: SPA removed from subslot 0/0, interfaces disabled
*Dec 12 09:29:18.870:
%IOSXE_OIR-6-REMSPA: SPA removed from subslot 0/1, interfaces disabled
*Dec 12 09:29:18.871:
%IOSXE_OIR-6-REMSPA: SPA removed from subslot 0/2, interfaces disabled
*Dec 12 09:29:18.873:
%SPA_OIR-6-OFFLINECARD: SPA (ISR4451-X-4x1GE) offline in subslot 0/0
*Dec 12 09:29:18.874: %SPA_OIR-6-OFFLINECARD: SPA (NIM-VA-B) offline in subslot 0/1
*Dec 12 09:29:18.874: %SPA_OIR-6-OFFLINECARD: SPA (NIM-VAB-A) offline in subslot 0/2
*Dec 12 09:29:18.876: %IOSXE_OIR-6-INSCARD: Card (fp) inserted in slot F0
*Dec 12 09:29:18.876: %IOSXE_OIR-6-ONLINECARD: Card (fp) online in slot F0
*Dec 12 09:29:18.882: %IOSXE_OIR-6-INSSPA: SPA inserted in subslot 0/0
*Dec 12 09:29:18.884: %IOSXE_OIR-6-INSSPA: SPA inserted in subslot 0/1
*Dec 12 09:29:18.884: %IOSXE_OIR-6-INSSPA: SPA inserted in subslot 0/2
*Dec 12 09:29:18.935: %SYS-5-RESTART: System restarted --
Cisco IOS Software, ISR Software (X86_64_LINUX_IOSD-UNIVERSALK9-M), Version 15.5(1)S,
RELEASE SOFTWARE (fc5)
Technical Support: http://www.cisco.com/techsupport
Copyright (c) 1986-2014 by Cisco Systems, Inc.
Compiled Thu 20-Nov-14 18:28 by mcpre
*Dec 12 09:29:18.895: %SPA-3-ENVMON_NOT_MONITORED:iomd: Environmental monitoring
is not enabled for ISR4451-X-4x1GE[0/0]
*Dec 12 09:29:19.878: %LINK-5-CHANGED: Interface GigabitEthernet0,

changed state to administratively down
*Dec 12 09:29:22.419: %SPA_OIR-6-ONLINECARD: SPA (ISR4451-X-4x1GE) online in subslot 0/0
*Dec 12 09:29:22.610: %SYS-6-BOOTTIME: Time taken to reboot after reload = 194 seconds
*Dec 12 09:29:24.354: %LINK-3-UPDOWN: Interface GigabitEthernet0/0/0,
changed state to down
*Dec 12 09:29:24.415: %LINK-3-UPDOWN: Interface GigabitEthernet0/0/2,
changed state to down
*Dec 12 09:29:24.417: %LINK-3-UPDOWN: Interface GigabitEthernet0/0/3,
changed state to down
*Dec 12 09:29:30.919: %LINK-3-UPDOWN: Interface GigabitEthernet0/0/0,
changed state to up
*Dec 12 09:29:30.925: %LINK-3-UPDOWN: Interface GigabitEthernet0/0/2,
changed state to up
*Dec 12 09:29:30.936: %LINK-3-UPDOWN: Interface GigabitEthernet0/0/3,
changed state to up
*Dec 12 09:29:31.919: %LINEPROTO-5-UPDOWN: Line protocol on Interface
GigabitEthernet0/0/0, changed state to up
*Dec 12 09:29:31.930: %LINEPROTO-5-UPDOWN: Line protocol on
Interface GigabitEthernet0/0/2, changed state to up
*Dec 12 09:29:31.936: %LINEPROTO-5-UPDOWN: Line protocol on
Interface GigabitEthernet0/0/3, changed state to up
*Dec 12 09:29:34.147: %SSH-5-ENABLED: SSH 1.99 has been enabled
*Dec 12 09:30:29.152: %SPA_OIR-6-ONLINECARD: SPA (NIM-VA-B) online in subslot 0/1
*Dec 12 09:30:29.470: %SPA_OIR-6-ONLINECARD: SPA (NIM-VAB-A) online in subslot 0/2
*Dec 12 09:30:31.152: %LINK-3-UPDOWN: Interface Ethernet0/1/0, changed state to down
*Dec 12 09:30:31.152: %LINK-3-UPDOWN: Interface ATM0/1/0, changed state to down
*Dec 12 09:30:31.470: %LINK-3-UPDOWN: Interface Ethernet0/2/0, changed state to down
*Dec 12 09:30:31.470: %LINK-3-UPDOWN: Interface ATM0/2/0, changed state to down
*Dec 12 09:31:03.074: %CONTROLLER-5-UPDOWN: Controller VDSL 0/2/0, changed state to up
*Dec 12 09:31:05.075: %LINK-3-UPDOWN: Interface Ethernet0/2/0, changed state to up
*Dec 12 09:31:06.076: %LINEPROTO-5-UPDOWN: Line protocol on Interface Ethernet0/2/0,
changed state to up
*Dec 12 09:31:12.559: %CONTROLLER-5-UPDOWN: Controller VDSL 0/1/0, changed state to up
*Dec 12 09:31:20.188: %LINK-3-UPDOWN: Interface ATM0/1/0, changed state to up
*Dec 12 09:31:21.188: %LINEPROTO-5-UPDOWN: Line protocol on Interface ATM0/1/0,
changed state to up

```

```

Router>
Router>en
Password:
Router#
Router#show controller vdsl 0/2/0
Controller VDSL 0/2/0 is UP

Daemon Status:  UP

      XTU-R (DS)  XTU-C (US)
Chip Vendor ID:  'BDCM'      'BDCM'
Chip Vendor Specific:  0x0000      0xA41B
Chip Vendor Country:  0xB500      0xB500
Modem Vendor ID:  'CSCO'      ' '
Modem Vendor Specific:  0x4602      0x0000
Modem Vendor Country:  0xB500      0x0000
Serial Number Near:      FOC18426DQ8 4451-X/K15.5(1)S
Serial Number Far:
Modem Version Near:      15.5(1)S
Modem Version Far:      0xa41b

Modem Status(L1): TC Sync (Showtime!)
DSL Config Mode: VDSL2
Trained Mode(L1): G.993.2 (VDSL2) Profile 30a

TC Mode:  PTM
Selftest Result: 0x00
DELT configuration: disabled
DELT state:  not running

Failed full inits: 0
Short inits: 0
Failed short inits: 0

Modem FW  Version: 4.14L.04
Modem PHY Version: A2pv6F039h.d24o_rc1

Line 1:

      XTU-R (DS)  XTU-C (US)
Trellis:  ON      ON
SRA:      disabled  disabled
SRA count:  0      0
Bit swap:  enabled  enabled
Bit swap count:  9      0
Profile 30a:  enabled
Line Attenuation:  3.5 dB      0.0 dB
Signal Attenuation:  0.0 dB      0.0 dB
Noise Margin:  30.9 dB      12.4 dB
Attainable Rate: 200000 kbits/s      121186 kbits/s
Actual Power:  13.3 dBm      7.2 dBm
Per Band Status:      D1 D2 D3 U0 U1 U2 U3
Line Attenuation(dB):  0.9 1.5 5.5 N/A 0.1 0.9 3.8
Signal Attenuation(dB): 0.8 1.5 5.5 N/A 0.0 0.2 3.2
Noise Margin(dB):      31.1 31.0 30.9 N/A 12.3 12.4 12.5
Total FECC:  0      0
Total ES:  0      0
Total SES:  0      0
Total LOSS:  0      0
Total UAS:  51      51
Total LPRS:  0      0
Total LOFS:  0      0
Total LOLS:  0      0

```



```

          DS Channel1  DS Channel0  US Channel1  US Channel0
Speed (kbps):      NA      100014  NA      100014
SRA Previous Speed:  NA      0      NA      0
Previous Speed:    NA      0      NA      0
Reed-Solomon EC:   NA      0      NA      0
CRC Errors:        NA      0      NA      0
Header Errors:     NA      0      NA      0
Interleave (ms):   NA      9.00  NA      0.00
Actual INP:        NA      4.00  NA      0.00

```

```

Training Log : Stopped
Training Log Filename : flash:vdslllog.bin

```

```

Router#
Router#

```

```

Router#copy bootflash:isr4400-firmware_nim_xdsl.2014-11-17_11.05_39n.SSA.pkg
bootflash:mydir/
Destination filename [mydir/isr4400-firmware_nim_xdsl.2014-11-17_11.05_39n.SSA.pkg]?
Copy in progress..CCCCCCCCCCCCCCCCCCCCCCCCCCCCCCCCCCCCCCCCCCCCCCCCCCCCCCCCCCCC
CCCCCCCCCCCCCCCCCCCCCCCCCCCCCCCCCCCCCCCCCCCCCCCCCCCCCCCCCCCC
6640604 bytes copied in 1.365 secs (4864911 bytes/sec)
Router#

```

```

Router#request platform software package install rp 0 file
bootflash:mydir/isr4400-firmware_nim_xdsl.2014-11-17_11.05_39n.SSA.pkg
--- Starting local lock acquisition on R0 ---
Finished local lock acquisition on R0

```

```

--- Starting file path checking ---
Finished file path checking

```

```

--- Starting image file verification ---
Checking image file names
Locating image files and validating name syntax
  Found isr4400-firmware_nim_xdsl.2014-11-17_11.05_39n.SSA.pkg
Verifying image file locations
Inspecting image file types
Processing image file constraints
Creating candidate provisioning file
Finished image file verification

```

```

--- Starting candidate package set construction ---
Verifying existing software set
Processing candidate provisioning file
Constructing working set for candidate package set
Constructing working set for running package set
Checking command output
Constructing merge of running and candidate packages
Checking if resulting candidate package set would be complete
Finished candidate package set construction

```

```

--- Starting ISSU compatibility verification ---
Verifying image type compatibility
Checking IPC compatibility with running software
Checking candidate package set infrastructure compatibility
Checking infrastructure compatibility with running software
Checking package specific compatibility
Finished ISSU compatibility verification

```

```

--- Starting impact testing ---
Checking operational impact of change
Finished impact testing

```

```

--- Starting list of software package changes ---
Old files list:
  Removed isr4400-firmware_nim_xdsl.03.14.00.S.155-1.S-std.SPA.pkg
New files list:
  Added isr4400-firmware_nim_xdsl.2014-11-17_11.05_39n.SSA.pkg
Finished list of software package changes

--- Starting commit of software changes ---
Updating provisioning rollback files
Creating pending provisioning file
Committing provisioning file
Finished commit of software changes

--- Starting analysis of software changes ---
Finished analysis of software changes

--- Starting update running software ---
Blocking peer synchronization of operating information
Creating the command set placeholder directory
  Finding latest command set
  Finding latest command shortlist lookup file
  Finding latest command shortlist file
  Assembling CLI output libraries
  Assembling CLI input libraries
Skipping soft links for firmware upgrade
Skipping soft links for firmware upgrade
  Assembling Dynamic configuration files
  Applying interim IPC and database definitions
rsync: getaddrinfo: cc2-0 873: Name or service not known rsync error:
error in socket IO (code 10) at /auto/mcpbuilds19/
release/03.14.00.S/BLD-V03_14_00_S_FC5/contrib/rsync/clientserver.c(104) [sender=2.6.9]
rsync: getaddrinfo: cc2-0 873: Name or service not known rsync error:
error in socket IO (code 10) at /auto/mcpbuilds19/
release/03.14.00.S/BLD-V03_14_00_S_FC5/contrib/rsync/clientserver.c(104) [sender=2.6.9]
rsync: getaddrinfo: cc2-0 873: Name or service not known rsync error:
error in socket IO (code 10) at /auto/mcpbuilds19
/release/03.14.00.S/BLD-V03_14_00_S_FC5/contrib/rsync/clientserver.c(104) [sender=2.6.9]
  Replacing running software
  Replacing CLI software
  Restarting software
  Applying final IPC and database definitions
rsync: getaddrinfo: cc2-0 873: Name or service not known rsync error:
error in socket IO (code 10) at /auto/mcpbuilds19/
release/03.14.00.S/BLD-V03_14_00_S_FC5/contrib/rsync/clientserver.c(104) [sender=2.6.9]
  Generating software version information
  Notifying running software of updates
  Unblocking peer synchronization of operating information
Unmounting old packages
Cleaning temporary installation files
  Finished update running software

SUCCESS: Finished installing software.
Router#
Router#show platform software subslot 0/2 module firmware
Avg Load info
-----
1.83 1.78 1.44 3/45 607

Kernel distribution info
-----
Linux version 3.4.11-rt19 (sapanwar@blr-atg-001) (gcc version 4.6.2
(Buildroot 2011.11) ) #3 SMP PREEMPT Fri Nov 7 09:26:19 IST 2014

```

```

Module firmware versions
-----
Modem Fw Version: 4.14L.04
Modem Phy Version: A2pv6F039h.d24o_rc1

Boot Loader: Secondary
-----
Version: 1.1

Modem Up time
-----
0D 0H 25M 38S

Router#

Router#hw-module subslot 0/2 reload
Proceed with reload of module? [confirm]
Router#
*Dec 12 09:55:59.645: %IOSXE_OIR-6-SOFT_RELOADSPA: SPA(NIM-VAB-A)
reloaded on subslot 0/2
*Dec 12 09:55:59.646: %SPA_OIR-6-OFFLINECARD: SPA (NIM-VAB-A) offline in subslot 0/2
*Dec 12 09:55:59.647: %CONTROLLER-5-UPDOWN: Controller VDSL 0/2/0, changed state to down
*Dec 12 09:57:22.514: new extended attributes received from iomd(slot 0 bay 2 board 0)
*Dec 12 09:57:22.514: %IOSXE_OIR-6-SOFT_RELOADSPA: SPA(NIM-VAB-A)
reloaded on subslot 0/2
*Dec 12 09:57:22.515: %SPA_OIR-6-OFFLINECARD: SPA (NIM-VAB-A) offline in subslot 0/2
Router#
Router#
*Dec 12 09:58:35.471: %SPA_OIR-6-ONLINECARD: SPA (NIM-VAB-A) online in subslot 0/2
*Dec 12 09:58:37.470: %LINK-3-UPDOWN: Interface Ethernet0/2/0, changed state to down
*Dec 12 09:58:37.470: %LINK-3-UPDOWN: Interface ATM0/2/0, changed state to down
Router#

Router#show platform software subslot 0/2 module firmware
Avg Load info
-----
0.84 0.23 0.08 1/45 598

Kernel distribution info
-----
Linux version 3.4.11-rt19 (sapanwar@blr-atg-001) (gcc version 4.6.2 (Buildroot 2011.11) )
#6 SMP PREEMPT Mon Nov 17 10:51:41 IST 2014

Module firmware versions
-----
Modem Fw Version: 4.14L.04
Modem Phy Version: A2pv6F039n.d24o_rc1

Boot Loader: Secondary
-----
Version: 1.1

Modem Up time
-----
0D 0H 0M 42S

Router#

```

Provisioning Files

This section provides background information about the files and processes used in [Managing and Configuring a Router to Run Using Individual Packages](#), on page 70.

The consolidated package on a router consists of a collection of subpackages and a provisioning file titled `packages.conf`. To run the software, the usual method used is to boot the consolidated package, which is copied into memory, expanded, mounted, and run within memory. The provisioning file's name can be renamed but subpackage file's names cannot be renamed. The provisioning file and subpackage files must be kept in the same directory. The provisioning file does not work properly if any individual subpackage file is contained within a different directory.



Note An exception to this is that if a new or upgraded module firmware package is subsequently installed, it need not be in the same directory as the provisioning file.

Configuring a router to boot, using the provisioning file `packages.conf`, is beneficial because no changes have to be made to the boot statement after the Cisco IOS XE software is upgraded.

File Systems

The following table provides a list of file systems that can be seen on the Cisco 1100 series routers.

Table 5: Router File Systems

| File System | Description |
|-------------|------------------------------------------------------------------------------------------------------------------------------------------------------------------------|
| bootflash: | Boot flash memory file system. |
| flash: | Alias to the boot flash memory file system above. |
| cns: | Cisco Networking Services file directory. |
| nvrn: | Router NVRAM. You can copy the startup configuration to NVRAM or from NVRAM. |
| obfl: | File system for Onboard Failure Logging (OBFL) files. |
| system: | System memory file system, which includes the running configuration. |
| tar: | Archive file system. |
| tmpsys: | Temporary system files file system. |
| usb0: | The Universal Serial Bus (USB) flash drive file systems. Note The USB flash drive file system is visible only if a USB drive is installed in usb0: port. |

Use the ? help option, or use the **copy** command in command reference guides, if you find a file system that is not listed in the table above.

Autogenerated File Directories and Files

This section discusses the autogenerated files and directories that can be created, and how the files in these directories can be managed.

Table 6: Autogenerated Files

| File or Directory | Description |
|----------------------|------------------------------------------------------------------------------------------------------------------------------------------------------------------------------------------------------------------------------------------------------------------------------------------------------------------------------------------------------------------------------------------------------------|
| crashinfo files | Crashinfo files may appear in the bootflash: file system. These files provide descriptive information of a crash and may be useful for tuning or troubleshooting purposes. However, the files are not part of router operations, and can be erased without impacting the functioning of the router. |
| core directory | The storage area for .core files. If this directory is erased, it will automatically regenerate itself at bootup. The .core files in this directory can be erased without impacting any router functionality, but the directory itself should not be erased. |
| lost+found directory | This directory is created on bootup if a system check is performed. Its appearance is completely normal and does not indicate any issues with the router. |
| tracelogs directory | The storage area for trace files. Trace files are useful for troubleshooting. If the Cisco IOS process fails, for instance, users or troubleshooting personnel can access trace files using diagnostic mode to gather information related to the Cisco IOS failure. Trace files, however, are not a part of router operations, and can be erased without impacting the router's performance. |

Important Notes About Autogenerated Directories

Important information about autogenerated directories include:

- Autogenerated files on the bootflash: directory should not be deleted, renamed, moved, or altered in any way unless directed by Cisco customer support.



Note Altering autogenerating files on the bootflash: may have unpredictable consequences for system performance.

- Crashinfo, core, and trace files can be deleted.

Flash Storage

Subpackages are installed to local media storage, such as flash memory. For flash storage, use the **dir bootflash:** command to list the file names.



Note Flash storage is required for successful operation of a router.

Configuring the Configuration Register for Autoboot

The configuration register can be used to change router behavior. This includes controlling how the router boots. Set the configuration register to 0x0 to boot into ROM, by using one of the following commands:

- In Cisco IOS configuration mode, use the **config-reg 0x0** command.
- From the ROMMON prompt, use the **confreg 0x0** command.

For more information about the configuration register, see [Use of the Configuration Register on All Cisco Routers](#) and [Configuring a Router to Boot the Consolidated Package via TFTP Using the boot Command: Example, on page 65](#).



Note Setting the configuration register to 0x2102 will set the router to autoboot the Cisco IOS XE software.



Note The console baud rate is set to 9600 after changing the **confreg** to 0x2102 or 0x0. If you cannot establish a console session after setting **confreg**, or garbage output appears, change the setting on your terminal emulation software to 9600.

Crypto Throughput Licensing

The Cisco 1100 series routers currently support two levels of crypto throughput licensing. The default crypto throughput level is 50 Mbps.

- The licensed level for Cisco 1111-8P SKU is 250 Mbps.
- The licensed level for Cisco 1111-4P SKU is 150 Mbps.

The following example is for the Cisco 1111-4P SKU:

Verify the current crypto throughput level

```
Router#sh platform hardware throughput crypto
The current crypto level is 50000 kb/s <---- This indicates the current crypto throughput.
```

Make changes to the existing crypto throughput level

```
Router(config)#platform hardware throughput crypto ?
  150000  throughput in kbps
  50000   throughput in kbps
```

```
Router(config)#platform hardware throughput crypto 150000
Feature Name:throughput
```

PLEASE READ THE FOLLOWING TERMS CAREFULLY. INSTALLING THE LICENSE OR LICENSE KEY PROVIDED FOR ANY CISCO PRODUCT FEATURE OR USING SUCH PRODUCT FEATURE CONSTITUTES YOUR FULL ACCEPTANCE OF THE FOLLOWING TERMS. YOU MUST NOT PROCEED FURTHER IF YOU ARE NOT WILLING TO BE BOUND BY ALL THE TERMS SET FORTH HEREIN.

Use of this product feature requires an additional license from Cisco, together with an additional payment. You may use this product feature on an evaluation basis, without payment to Cisco, for 60 days. Your use of the product, including during the 60 day evaluation period, is subject to the Cisco end user license agreement

http://www.cisco.com/en/US/docs/general/warranty/English/EU1KEN_.html
If you use the product feature beyond the 60 day evaluation period, you must submit the appropriate payment to Cisco for the license. After the 60 day evaluation period, your use of the product feature will be governed solely by the Cisco end user license agreement (link above), together with any supplements relating to such product feature. The above applies even if the evaluation license is not automatically terminated and you do not receive any notice of the expiration of the evaluation period. It is your responsibility to determine when the evaluation period is complete and you are required to make payment to Cisco for your use of the product feature beyond the evaluation period.

Your acceptance of this agreement for the software features on one product shall be deemed your acceptance with respect to all such software on all Cisco products you purchase which includes the same software. (The foregoing notwithstanding, you must purchase a license for each software feature you use past the 60 days evaluation period, so that if you enable a software feature on 1000 devices, you must purchase 1000 licenses for use past the 60 day evaluation period.)

Activation of the software command line interface will be evidence of your acceptance of this agreement.

```
ACCEPT? (yes/[no]): yes
```

```
*Jul 14 08:12:41.898: %LICENSE-6-EULA_ACCEPTED: EULA for feature throughput 1.0 has been
accepted. UDI=C1111-8P:FGL212694M3; StoreIndex=3:Built-In License Storage% The config will
take effect on next reboot
```

Check the show license feature, throughput license at this point would not be enabled.

```
Router#sh license feature
```

| Feature name | Enforcement | Evaluation | Subscription | Enabled | RightToUse |
|-------------------|-------------|------------|--------------|---------|------------|
| appxk9 | | yes | yes | | no |
| no | yes | | | | |
| securityk9 | | yes | yes | no | yes |
| yes | | | | | |
| ipbasek9 | no | no | no | | no |
| no | | | | | |
| FoundationSuiteK9 | yes | yes | no | | no |
| yes | | | | | |
| throughput | yes | yes | no | | No<-- |
| internal_service | yes | no | no | | no |
| no | | | | | |

Save the configuration

```
Router#wr mem
  Building configuration...
```

```
[OK]
```

Reload the router

```
Router#reload
  Proceed with reload? [confirm]
```

Verify the new crypto throughput level

```
Router#sh platform hardware throughput crypto
  The current crypto level is 150000 kb/s.
```

Verify if the throughput license is enabled

```
Router#sh license feature
Feature name      Enforcement  Evaluation  Subscription  Enabled  RightToUse
appxk9           no          yes         yes           yes      no
  no              yes
securityk9      yes         yes         yes           no       yes
  yes
ipbasek9         no          no          no            no       no
  no
FoundationSuiteK9 yes         yes         no            no
yes
throughput      yes         yes         no            yes<--
yes
internal_service yes         no          no            no       no
no
=====
```

Unlicensed Feature: Example

If you try to use a feature that is part of a package that is not enabled, an error message is displayed.

In the following example, the **crypto map** command is called during configuration and an error message is displayed. This is because, the feature associated with **crypto map** is part of the **securityk9** package and the **securityk9** package is not enabled.

```
Router# configure terminal
Enter configuration commands, one per line. End with CNTL/Z.
Router(config)#crypto map
^
% Invalid input detected at '^' marker.
```

Use the **show license feature** command to view the license features that are enabled. In the following example, the **securityk9** and the **uck9** packages are not enabled.



Note **ipbasek9** is provided by default.

```
Router# show license feature
Feature name      Enforcement  Evaluation  Subscription  Enabled  RightToUse
appxk9           yes         yes         no            yes      yes
uck9             yes         yes         no            no       yes
```

| | | | | | |
|------------|-----|-----|----|-----|-----|
| securityk9 | yes | yes | no | no | yes |
| ipbasek9 | no | no | no | yes | yes |

LED Indicators

For information on LEDs on the router, see the "LED Indicators" section of the Hardware Installation Guide for the Cisco 1100 Series Integrated Services Routers.

Related Documentation

For further information on software licenses, see [Software Activation on Cisco Integrated Services Routers and Cisco Integrated Service Routers G2](#).

For further information on obtaining and installing feature licenses, see [Configuring the Cisco IOS Software Activation Feature](#).

How to Install and Upgrade the Software

To install or upgrade the software, use one of the following methods to use the software from a consolidated package or an individual package.



Note When a device is in the installation mode, formatting of the boot drive, bootflash/flash is not recommended. Formatting is blocked to ensure stability of the running image and to avoid any impact to upgrade of the software.

Managing and Configuring a Router to Run Using a Consolidated Package



Note Do not use these procedures if you also need to install any optional subpackages or plan to upgrade individual subpackages. See [Managing and Configuring a Router to Run Using Individual Packages, on page 70](#).

Managing and Configuring a Consolidated Package Using copy and boot Commands

To upgrade a consolidated package, copy the consolidated package to the **bootflash:** directory on the router using the **copy** command. After making this copy of the consolidated package, configure the router to boot using the consolidated package file.

The following example shows the consolidated package file being copied to the **bootflash:** file system via TFTP. The config register is then set to boot using **boot system** commands, and the **boot system** commands instruct the router to boot using the consolidated package stored in the **bootflash:** file system. The new

configuration is then saved using the **copy running-config startup-config** command, and the system is then reloaded to complete the process.

```
Router# dir bootflash:
Directory of bootflash:/
  11  drwx           16384  Jun 13 2017 14:13:26 +00:00  lost+found
105249 drwx           4096  Jul 12 2017 15:48:19 +00:00  .installer
48577  drwx           4096  Jun 13 2017 14:16:31 +00:00  core
56673  drwx           4096  Jul 12 2017 18:42:01 +00:00  .prst_sync
145729 drwx           4096  Jun 13 2017 14:14:47 +00:00  .rollback_timer
  12  -rw-             0  Jun 13 2017 14:14:58 +00:00  tracelogs.a4i
348129 drwx           8192  Jul 12 2017 19:47:16 +00:00  tracelogs
  13  -rw-             30  Jul 12 2017 18:42:01 +00:00  throughput_monitor_params
  14  -rw-             35  Jun 13 2017 15:32:49 +00:00  pnp-tech-time
  15  -rw-          134096  Jun 13 2017 15:32:50 +00:00  pnp-tech-discovery-summary
  16  -rw-          2425808  Jul 12 2017 17:18:59 +00:00
C1100-ROMMON-20170621-SecureBoot-Aikido-SSA.pkg
6650826752 bytes total (5914554368 bytes free)
```

```
Router# copy tftp: bootflash:Address or name of remote host []? 172.18.40.4
Destination filename [c1100.bin]?
Accessing tftp://172.18.40.4/user5/c1100.bin...
Loading user5/c1100.bin from 172.18.40.4 (via GigabitEthernet0/0/0):
-----
[OK - 379357675 bytes]
```

```
Router# dir bootflash:
Directory of bootflash:/

  11  drwx           16384  Jun 13 2017 14:13:26 +00:00  lost+found
105249 drwx           4096  Jul 12 2017 15:48:19 +00:00  .installer
48577  drwx           4096  Jun 13 2017 14:16:31 +00:00  core
56673  drwx           4096  Jul 12 2017 18:42:01 +00:00  .prst_sync
145729 drwx           4096  Jun 13 2017 14:14:47 +00:00  .rollback_timer
  12  -rw-             0  Jun 13 2017 14:14:58 +00:00  tracelogs.a4i
348129 drwx           8192  Jul 12 2017 19:47:16 +00:00  tracelogs
  13  -rw-             30  Jul 12 2017 18:42:01 +00:00  throughput_monitor_params
  14  -rw-             35  Jun 13 2017 15:32:49 +00:00  pnp-tech-time
  15  -rw-          134096  Jun 13 2017 15:32:50 +00:00  pnp-tech-discovery-summary
  16  -rw-          2425808  Jul 12 2017 17:18:59 +00:00
C1100-ROMMON-20170621-SecureBoot-Aikido-SSA.pkg
  17  -rw-          379357675  Jul 12 2017 19:00:30 +00:00  c1100.bin

6650826752 bytes total (5914554368 bytes free)
```

```
Router# configure terminal
Enter configuration commands, one per line. End with CNTL/Z.
Router(config)# boot system flash bootflash:c1100.bin
Router(config)# config-reg 0x2102
Router(config)# exit
Router# show run | include boot
boot-start-marker
boot system flash bootflash:c1100.bin boot-end-marker
Router# copy run start
Destination filename [startup-config]? Building configuration...
[OK]
Router# reload
```

Configuring a Router to Boot the Consolidated Package via TFTP Using the boot Command: Example

```
Router# configure terminal

Enter configuration commands, one per line. End with CNTL/Z.
Router(config)#boot system tftp://172.18.40.4/<path>/c1100.bin
Router(config)#config-register 0x2102
Router(config)#exit

Router# show run | include boot
boot-start-marker
boot system tftp /<path>/c1100-universalk9_ias.16.06.02.SPA.bin 223.255.254.254
boot-end-marker
diagnostic bootup level minimal
Router#

Router# copy running-config startup-config
Destination filename [startup-config]? Building configuration...
[OK]
Router# reload
The following license(s) are transitioning, expiring or have expired.
Features with expired licenses may not work after Reload.
Feature: internal_service ,Status: expiring, Period Left: 270 wks 2 days
Proceed with reload? [confirm]

*Jul 12 19:56:22.981: %SYS-5-RELOAD: Reload requested by console. Reload Reason: Reload
Command.UEFI firmware (version MARVELL devel-17.1.0 built at 01:11:40 on Jun 22 2017)

Armada Platform Init

Board is TSN-P2H
Comphy-0: SGMII2 3.125 Gbps
Comphy-1: SGMII3 1.25 Gbps
Comphy-2: USB3_HOST0 5 Gbps
Comphy-3: USB3_HOST1 5 Gbps
Comphy-4: SGMII0 1.25 Gbps
Comphy-5: PCIE2 5 Gbps

Utmiphy: stage: Check PLL.. Passed
UTMI PHY 0 initialized to USB Host0
Utmiphy: stage: Check PLL.. Passed
UTMI PHY 1 initialized to USB Host1
Successfully installed controller 0 at 0xF2701000
Successfully installed controller 1 at 0xF2701100
Successfully installed controller 2 at 0xF2211000
PciEmulation: Skip SD/MMC device with index 0
Successfully installed protocol interfaces
Y[=3hfs_ext4_volume_mount: success, blocksize 4096
fsw_ext4_volume_mount: success, blocksize 4096
fsw_ext4_volume_mount: success, blocksize 4096
fsw_ext4_volume_mount: success, blocksize 4096
fsw_ext4_volume_mount: success, blocksize 4096
fsw_ext4_volume_mount: success, blocksize 4096
fsw_ext4_volume_mount: success, blocksize 4096
fsw_ext4_volume_mount: success, blocksize 4096
fsw_ext4_volume_mount: success, blocksize 4096
fsw_ext4_volume_mount: success, blocksize 4096
fsw_ext4_volume_mount: success, blocksize 4096
fsw_ext4_volume_mount: success, blocksize 4096
fsw_ext4_volume_mount: success, blocksize 4096
fsw_ext4_volume_mount: success, blocksize 4096
fsw_ext4_volume_mount: success, blocksize 4096
```

```
fsw_ext4_volume_mount: success, blocksize 4096

Starting ROMMON...
Rom image verified correctly

System Bootstrap, Version 12.2[16.6(1r)RC3], DEVELOPMENT SOFTWARE
Copyright (c) 1994-2017 by cisco Systems, Inc.
Compiled at Wed Jun 21 21:09:42 2017 by user2

!!! DEBUG CPLD Version Installed. For INTERNAL USE ONLY !!!

Current image running: Boot ROM1

Last reset cause: LocalSoft
C1111-8PLTEEAWE platform with 4194304 Kbytes of main memory

.....

      IP_ADDRESS: 172.18.42.231
      IP_SUBNET_MASK: 255.255.255.0
      DEFAULT_GATEWAY: 172.18.42.1
      TFTP_SERVER: 172.18.40.4
      TFTP_FILE: user5/c1100.bin
      TFTP_MACADDR: D4:8C:B5:83:A3:6C
      ETHER_PORT: 0
Unable to get TFTP file size - Using maximum size of 1073741824 bytes.
```

```
Package header rev 3 structure detected
IsoSize = 344424448
Calculating SHA-1 hash...Validate package: SHA-1 hash:
      calculated 5361A704:82F2A7F9:200C5D02:1209D89B:14A7FAFB
      expected   5361A704:82F2A7F9:200C5D02:1209D89B:14A7FAFB
```

```
RSA Signed DEVELOPMENT Image Signature Verification Successful
Image validated
      DXE      809 ms
      BDS     1153 ms
      BDS       21 ms
Total Time = 1984 ms
```

```
Starting OS kernel...
```

Restricted Rights Legend

```
Use, duplication, or disclosure by the Government is
subject to restrictions as set forth in subparagraph
(c) of the Commercial Computer Software - Restricted
Rights clause at FAR sec. 52.227-19 and subparagraph
(c) (1) (ii) of the Rights in Technical Data and Computer
Software clause at DFARS sec. 252.227-7013.
```

```
cisco Systems, Inc.
170 West Tasman Drive
San Jose, California 95134-1706
```

```
Cisco IOS Software [Fuji], ISR Software (ARMV8EB_LINUX_IOSD-UNIVERSALK9_IAS-M), Experimental
  Version 16.7.20170621:131015 [polaris_dev-/scratch/user5/tsn_0620 104]
Copyright (c) 1986-2017 by Cisco Systems, Inc.
Compiled Wed 21-Jun-17 09:12 by user5
```

Cisco IOS-XE software, Copyright (c) 2005-2017 by cisco Systems, Inc. All rights reserved. Certain components of Cisco IOS-XE software are licensed under the GNU General Public License ("GPL") Version 2.0. The software code licensed under GPL Version 2.0 is free software that comes with ABSOLUTELY NO WARRANTY. You can redistribute and/or modify such GPL code under the terms of GPL Version 2.0. For more details, see the documentation or "License Notice" file accompanying the IOS-XE software, or the applicable URL provided on the flyer accompanying the IOS-XE software.

This product contains cryptographic features and is subject to United States and local country laws governing import, export, transfer and use. Delivery of Cisco cryptographic products does not imply third-party authority to import, export, distribute or use encryption. Importers, exporters, distributors and users are responsible for compliance with U.S. and local country laws. By using this product you agree to comply with applicable laws and regulations. If you are unable to comply with U.S. and local laws, return this product immediately.

A summary of U.S. laws governing Cisco cryptographic products may be found at: <http://www.cisco.com/wwl/export/crypto/tool/stqrg.html>

If you require further assistance please contact us by sending email to export@cisco.com.

```
cisco C1111-8PLTEEAW (1RU) processor with 1463766K/6147K bytes of memory.
Processor board ID FGL21071SK5
1 Virtual Ethernet interface
11 Gigabit Ethernet interfaces
2 Cellular interfaces
32768K bytes of non-volatile configuration memory.
4194304K bytes of physical memory.
6598655K bytes of flash memory at bootflash:.
0K bytes of WebUI ODM Files at webui:.
```

```
%INIT: waited 0 seconds for NVRAM to be available
```

Press RETURN to get started!

```
*Jul 12 20:02:38.716: %SMART_LIC-6-AGENT_READY: Smart Agent for Licensing is initialized
*Jul 12 20:02:39.070: %IOS_LICENSE_IMAGE_APPLICATION-6-LICENSE_LEVEL: Module name = esg
Next reboot level = ipbasek9 and License = No valid license found
*Jul 12 20:02:40.781: %ISR_THROUGHPUT-6-CRYPTO: Crypto level has been set to 50000 kbps
*Jul 12 20:02:46.668: %SPANTREE-5-EXTENDED_SYSID: Extended SysId enabled for type vlan
*Jul 12 20:02:46.855: in NSH init
*Jul 12 20:02:47.097: %LINK-3-UPDOWN: Interface Lsmpi0, changed state to up
*Jul 12 20:02:47.098: %LINK-3-UPDOWN: Interface EOBC0, changed state to up
*Jul 12 20:02:47.098: %LINK-3-UPDOWN: Interface LIINO, changed state to up
*Jul 12 20:02:47.142: aaa proxy process: dmiauthd mqipc init failed
*Jul 12 20:02:47.171: %PNP-6-PNP_DISCOVERY_STOPPED: PnP Discovery stopped (Startup Config Present)
*Jul 12 20:01:43.752: %IOSXE-3-PLATFORM: R0/0: kernel: [ 105.413908] cpld_ioctl (line
```

Configuring a Router to Boot the Consolidated Package via TFTP Using the boot Command: Example

```

1307): ioctl not implemented: type=122 number=180
*Jul 12 20:01:59.696: %IOSXE-1-PLATFORM: R0/0: kernel: [ 121.345752] moka_fpga_open
*Jul 12 20:02:42.243: %CMLIB-6-THROUGHPUT_VALUE: R0/0: cmand: Throughput license found,
throughput set to 50000 kbps
*Jul 12 20:02:48.098: %LINEPROTO-5-UPDOWN: Line protocol on Interface Vlan1, changed state
to down
*Jul 12 20:02:48.098: %LINEPROTO-5-UPDOWN: Line protocol on Interface Lsmpi0, changed state
to up
*Jul 12 20:02:48.099: %LINEPROTO-5-UPDOWN: Line protocol on Interface EOBC0, changed state
to up
*Jul 12 20:02:48.099: %LINEPROTO-5-UPDOWN: Line protocol on Interface LIIN0, changed state
to up
*Jul 12 20:02:52.867: %CRYPTO_ENGINE-5-KEY_ADDITION: A key named TP-self-signed-3241146330
has been generated or imported
*Jul 12 20:02:56.210: %SYS-2-PRIVCFG_DECRYPT: Successfully apply the private config file
*Jul 12 20:02:56.298: %SYS-5-CONFIG_I: Configured from memory by console
*Jul 12 20:02:56.311: %IOSXE_OIR-6-REMSPA: SPA removed from subslot 0/0, interfaces disabled
*Jul 12 20:02:56.311: %IOSXE_OIR-6-REMSPA: SPA removed from subslot 0/1, interfaces disabled
*Jul 12 20:02:56.311: %IOSXE_OIR-6-REMSPA: SPA removed from subslot 0/2, interfaces disabled
*Jul 12 20:02:56.311: %IOSXE_OIR-6-REMSPA: SPA removed from subslot 0/3, interfaces disabled
*Jul 12 20:02:56.325: %SPA_OIR-6-OFFLINECARD: SPA (C1111-2x1GE) offline in subslot 0/0
*Jul 12 20:02:56.338: %SPA_OIR-6-OFFLINECARD: SPA (C1111-ES-8) offline in subslot 0/1
*Jul 12 20:02:56.339: %CELLWAN-2-MODEM_DOWN: Modem in NIM slot 0/2 is DOWN
*Jul 12 20:02:56.339: %CELLWAN-2-MODEM_DOWN: Modem in NIM slot 0/2 is DOWN
*Jul 12 20:02:56.340: %SPA_OIR-6-OFFLINECARD: SPA (C1111-LTE) offline in subslot 0/2
*Jul 12 20:02:56.340: %SPA_OIR-6-OFFLINECARD: SPA (ISR-AP1100AC-E) offline in subslot 0/3
*Jul 12 20:02:56.343: %IOSXE_OIR-6-INSCARD: Card (fp) inserted in slot F0
*Jul 12 20:02:58.205: %SYS-5-RESTART: System restarted --
Cisco IOS Software [Fuji], ISR Software (ARMV8EB_LINUX_IOSD-UNIVERSALK9_IAS-M), Experimental
Version 16.7.20170621:131015 [polaris_dev-/scratch/user5/tsn_0620 104]
Copyright (c) 1986-2017 by Cisco Systems, Inc.
Compiled Wed 21-Jun-17 09:12 by user5
*Jul 12 20:02:58.252: %SSH-5-ENABLED: SSH 1.99 has been enabled
*Jul 12 20:02:58.464: %CRYPTO_ENGINE-5-KEY_ADDITION: A key named
TP-self-signed-3241146330.server has been generated or imported
*Jul 12 20:03:01.059: %SYS-6-BOOTTIME: Time taken to reboot after reload = 400 seconds
*Jul 12 20:03:07.272: %CRYPTO_ENGINE-5-KEY_ADDITION: A key named CISCO_IDEVID_SUDI has been
generated or imported
*Jul 12 20:03:12.073: %SPA_OIR-6-ONLINECARD: SPA (C1111-ES-8) online in subslot 0/1
*Jul 12 20:03:12.140: %LINK-3-UPDOWN: Interface Cellular0/2/0, changed state to down
*Jul 12 20:03:12.141: %LINK-3-UPDOWN: Interface Cellular0/2/1, changed state to down
*Jul 12 20:03:12.286: %SPA_OIR-6-ONLINECARD: SPA (C1111-LTE) online in subslot 0/2
*Jul 12 20:03:12.342: new extended attributes received from iomd(slot 0 bay 3 board 0)
*Jul 12 20:03:12.349: %SPA_OIR-6-ONLINECARD: SPA (C1111-2x1GE) online in subslot 0/0
*Jul 12 20:03:12.774: %SPA_OIR-6-ONLINECARD: SPA (ISR-AP1100AC-E) online in subslot 0/3
*Jul 12 20:03:13.927: %LINK-3-UPDOWN: Interface GigabitEthernet0/1/0, changed state to down
*Jul 12 20:03:13.961: %LINK-3-UPDOWN: Interface GigabitEthernet0/1/1, changed state to down
*Jul 12 20:03:13.981: %LINK-3-UPDOWN: Interface GigabitEthernet0/1/2, changed state to down
*Jul 12 20:03:14.005: %LINK-3-UPDOWN: Interface GigabitEthernet0/1/3, changed state to down
*Jul 12 20:03:14.021: %LINK-3-UPDOWN: Interface GigabitEthernet0/1/4, changed state to down
*Jul 12 20:03:14.033: %LINK-3-UPDOWN: Interface GigabitEthernet0/1/5, changed state to down
*Jul 12 20:03:14.041: %LINK-3-UPDOWN: Interface GigabitEthernet0/1/6, changed state to down
*Jul 12 20:03:14.045: %LINK-3-UPDOWN: Interface GigabitEthernet0/1/7, changed state to down
*Jul 12 20:03:14.055: %LINK-3-UPDOWN: Interface Wlan-GigabitEthernet0/1/8, changed state
to down
*Jul 12 20:03:14.297: %LINK-3-UPDOWN: Interface GigabitEthernet0/0/0, changed state to down
*Jul 12 20:03:14.323: %LINK-3-UPDOWN: Interface GigabitEthernet0/0/1, changed state to down
*Jul 12 20:03:17.613: %LINK-3-UPDOWN: Interface Wlan-GigabitEthernet0/1/8, changed state
to up
*Jul 12 20:03:18.613: %LINEPROTO-5-UPDOWN: Line protocol on Interface
Wlan-GigabitEthernet0/1/8, changed state to up
*Jul 12 20:03:18.621: %LINEPROTO-5-UPDOWN: Line protocol on Interface Vlan1, changed state
to up
*Jul 12 20:03:18.961: %LINK-3-UPDOWN: Interface GigabitEthernet0/0/0, changed state to up

```

```
*Jul 12 20:03:19.962: %LINEPROTO-5-UPDOWN: Line protocol on Interface GigabitEthernet0/0/0,
changed state to up
*Jul 12 20:03:40.876: %IOSXE-3-PLATFORM: R0/0: ngiolite: Modem VID/PID: 1199 9071
*Jul 12 20:03:40.880: %IOSXE-3-PLATFORM: R0/0: ngiolite: Modem is in connected state
*Jul 12 20:04:06.349: %CELLWAN-5-SIM_DETECT_START: [Cellular0/2/0]: SIM presence detection
starts !!
*Jul 12 20:04:08.976: %CELLWAN-5-SIM_DETECT_COMPLETE: [Cellular0/2/0]: SIM presence detection
has completed !!
*Jul 12 20:04:09.228: %CELLWAN-2-SIM_NOT_PRESENT: [Cellular0/2/0]: SIM is not present in
NIM SIM Slot.
*Jul 12 20:05:14.464: %CELLWAN-2-MODEM_UP: Modem in NIM slot 0/2 is now UP
*Jul 12 20:05:14.665: %CELLWAN-2-MODEM_RADIO: Cellular0/2/0 Modem radio has been turned on
```

```
Router>
Router>enable
Router#show version
Cisco IOS XE Software, Version 16.06.02
Cisco IOS Software [Everest], ISR Software (ARMV8EB_LINUX_IOSD-UNIVERSALK9_IAS-M), Version
16.6.2, RELEASE SOFTWARE (fc2)
Technical Support: http://www.cisco.com/techsupport
Copyright (c) 1986-2017 by Cisco Systems, Inc.
Compiled Wed 01-Nov-17 03:00 by mcpre
```

Cisco IOS-XE software, Copyright (c) 2005-2017 by cisco Systems, Inc.
All rights reserved. Certain components of Cisco IOS-XE software are
licensed under the GNU General Public License ("GPL") Version 2.0. The
software code licensed under GPL Version 2.0 is free software that comes
with ABSOLUTELY NO WARRANTY. You can redistribute and/or modify such
GPL code under the terms of GPL Version 2.0. For more details, see the
documentation or "License Notice" file accompanying the IOS-XE software,
or the applicable URL provided on the flyer accompanying the IOS-XE
software.

ROM: IOS-XE ROMMON

```
Router uptime is 3 minutes
Uptime for this control processor is 5 minutes
System returned to ROM by Reload Command
System image file is "usb0:c1100-universalk9_ias.16.06.02.SPA.bin"
Last reload reason: Reload Command
```

This product contains cryptographic features and is subject to United
States and local country laws governing import, export, transfer and
use. Delivery of Cisco cryptographic products does not imply
third-party authority to import, export, distribute or use encryption.
Importers, exporters, distributors and users are responsible for
compliance with U.S. and local country laws. By using this product you
agree to comply with applicable laws and regulations. If you are unable
to comply with U.S. and local laws, return this product immediately.

A summary of U.S. laws governing Cisco cryptographic products may be found at:
<http://www.cisco.com/wwl/export/crypto/tool/stqrg.html>

If you require further assistance please contact us by sending email to
export@cisco.com.

Suite License Information for Module:'esg'

```

-----
Suite                Suite Current      Type                Suite Next reboot
-----
FoundationSuiteK9   None                None                None
securityk9
appxk9

```

Technology Package License Information:

```

-----
Technology          Technology-package  Technology-package
                  Current           Type                Next reboot
-----
appxk9              None                None                None
securityk9          None                None                None
ipbase              ipbasek9           None                ipbasek9

```

```

cisco C1111-8PLTELAWN (1RU) processor with 1464345K/6147K bytes of memory.
Processor board ID FGL212392WT
8 Virtual Ethernet interfaces
11 Gigabit Ethernet interfaces
2 Cellular interfaces
32768K bytes of non-volatile configuration memory.
4194304K bytes of physical memory.
6762495K bytes of flash memory at bootflash:.
7855044K bytes of USB flash at usb0:.
0K bytes of WebUI ODM Files at webui:.

```

Configuration register is 0x2100

Router#

Managing and Configuring a Router to Run Using Individual Packages

To choose between running individual packages or a consolidated package, see the *Installing the Software - Overview* section.

Installing Subpackages from a Consolidated Package

Perform the following procedure to obtain the consolidated package from a TFTP server.

Another variation of this procedure obtains the consolidated package from a USB flash drive. This is described in the *Installing Subpackages from a Consolidated Package on a Flash Drive*.

Before you begin

Copy the consolidated package to the TFTP server.

Procedure

| | Command or Action | Purpose |
|--------|-------------------------------------------------------------------------------------------------------------------------------------------------------------------------------------------------------------------------------------------------------------------------------------------------------------------------------------------------------------------------------------------------------------------------------------------------------------------------------------------------------------------------------------------------------------------------------------------------------------------------------------------------------------------------------------------------------------------------------------------------------------------------------------------------------------------------------------------------------------------------------------------------------------------------------------------------------------------------------------------------------------------------------------------------------------------------------------------------------------------------------------------------------------------------------------------------------------------------------------------------------------------------------------------------------------------------------------------------------------------------------------------------------------------------------------------------------------------------------------------------------------------------------------------------------------------------------------------------------------------------------------------------------------------|-------------------------------------------------------------------------------------------------------------------------------|
| Step 1 | <p>show version</p> <p>Example:</p> <pre>Router# show version Cisco IOS XE Software, Version 16.06.02 Cisco IOS Software [Everest], ISR Software (ARMV8EB_LINUX_IOSD-UNIVERSALK9_IAS-M), Version 16.6.2, RELEASE SOFTWARE (fc2) Technical Support: http://www.cisco.com/techsupport Copyright (c) 1986-2017 by Cisco Systems, Inc. Compiled Wed 01-Nov-17 03:00 by mcpre Cisco IOS-XE software, Copyright (c) 2005-2017 by cisco Systems, Inc. All rights reserved. Certain components of Cisco IOS-XE software are licensed under the GNU General Public License ("GPL") Version 2.0. The software code licensed under GPL Version 2.0 is free software that comes with ABSOLUTELY NO WARRANTY. You can redistribute and/or modify such GPL code under the terms of GPL Version 2.0. For more details, see the documentation or "License Notice" file accompanying the IOS-XE software, or the applicable URL provided on the flyer accompanying the IOS-XE software. ROM: IOS-XE ROMMON Router uptime is 3 minutes Uptime for this control processor is 5 minutes System returned to ROM by Reload Command System image file is "usb0:c1100-universalk9_ias.16.06.02.SPA.bin" Last reload reason: Reload Command This product contains cryptographic features and is subject to United States and local country laws governing import, export, transfer and use. Delivery of Cisco cryptographic products does not imply third-party authority to import, export, distribute or use encryption. Importers, exporters, distributors and users are responsible for compliance with U.S. and local country laws. By using this product you</pre> | Shows the version of software running on the router. This can later be compared with the version of software to be installed. |

| | Command or Action | Purpose | | | | | | | | | | | | | | | | |
|-------------------|------------------------------------------------------------------------------------------------------------------------------------------------------------------------------------------------------------------------------------------------------------------------------------------------------------------------------------------------------------------------------------------------------------------------------------------------------------------------------------------------------------------------------------------------------------------------------------------------------------------------------------------------------------------------------------------------------------------------------------------------------------------------------------------------------------------------------------------------------------------------------------------------------------------------------------------------------------------------------------------------------------------------------------------------------------------------------------------------------------------------------------------------------|--------------------|--------------------|--------------------|--------------------|------------|---------|------|-------------|------------|----------|----------|------|--------|--|--|--|--|
| | <p>agree to comply with applicable laws and regulations. If you are unable to comply with U.S. and local laws, return this product immediately.</p> <p>A summary of U.S. laws governing Cisco cryptographic products may be found at: http://www.cisco.com/wwl/export/crypto/tool/stqrg.html</p> <p>If you require further assistance please contact us by sending email to export@cisco.com.</p> <p>Suite License Information for Module:'esg'</p> | | | | | | | | | | | | | | | | | |
| | <table border="1"> <thead> <tr> <th data-bbox="479 758 542 779">Suite</th> <th data-bbox="542 758 727 779"></th> <th data-bbox="727 758 878 779">Suite Current</th> <th data-bbox="878 758 974 779">Suite Next reboot</th> </tr> <tr> <th data-bbox="479 785 542 806">Type</th> <th data-bbox="542 785 727 806"></th> <th data-bbox="727 785 878 806"></th> <th data-bbox="878 785 974 806"></th> </tr> </thead> </table> | Suite | | Suite Current | Suite Next reboot | Type | | | | | | | | | | | | |
| Suite | | Suite Current | Suite Next reboot | | | | | | | | | | | | | | | |
| Type | | | | | | | | | | | | | | | | | | |
| | <table border="1"> <tbody> <tr> <td data-bbox="479 863 542 884">FoundationSuiteK9</td> <td data-bbox="542 863 727 884">None</td> <td data-bbox="727 863 878 884">None</td> <td data-bbox="878 863 974 884">None</td> </tr> <tr> <td data-bbox="479 890 542 911">None</td> <td data-bbox="542 890 727 911">None</td> <td data-bbox="727 890 878 911">None</td> <td data-bbox="878 890 974 911">None</td> </tr> <tr> <td data-bbox="479 938 542 959">securityk9</td> <td data-bbox="542 938 727 959"></td> <td data-bbox="727 938 878 959"></td> <td data-bbox="878 938 974 959"></td> </tr> <tr> <td data-bbox="479 966 542 987">appxk9</td> <td data-bbox="542 966 727 987"></td> <td data-bbox="727 966 878 987"></td> <td data-bbox="878 966 974 987"></td> </tr> </tbody> </table> <p>Technology Package License Information:</p> | FoundationSuiteK9 | None | None | None | None | None | None | None | securityk9 | | | | appxk9 | | | | |
| FoundationSuiteK9 | None | None | None | | | | | | | | | | | | | | | |
| None | None | None | None | | | | | | | | | | | | | | | |
| securityk9 | | | | | | | | | | | | | | | | | | |
| appxk9 | | | | | | | | | | | | | | | | | | |
| | <table border="1"> <thead> <tr> <th data-bbox="479 1142 542 1163">Technology</th> <th data-bbox="542 1142 727 1163">Technology-package</th> <th data-bbox="727 1142 878 1163">Technology-package</th> <th data-bbox="878 1142 974 1163">Technology-package</th> </tr> <tr> <th data-bbox="479 1169 542 1190"></th> <th data-bbox="542 1169 727 1190">Current</th> <th data-bbox="727 1169 878 1190">Type</th> <th data-bbox="878 1169 974 1190">Next reboot</th> </tr> </thead> </table> | Technology | Technology-package | Technology-package | Technology-package | | Current | Type | Next reboot | | | | | | | | | |
| Technology | Technology-package | Technology-package | Technology-package | | | | | | | | | | | | | | | |
| | Current | Type | Next reboot | | | | | | | | | | | | | | | |
| | <table border="1"> <tbody> <tr> <td data-bbox="479 1272 542 1293">appxk9</td> <td data-bbox="542 1272 727 1293">None</td> <td data-bbox="727 1272 878 1293">None</td> <td data-bbox="878 1272 974 1293">None</td> </tr> <tr> <td data-bbox="479 1320 542 1341">securityk9</td> <td data-bbox="542 1320 727 1341">None</td> <td data-bbox="727 1320 878 1341">None</td> <td data-bbox="878 1320 974 1341">None</td> </tr> <tr> <td data-bbox="479 1369 542 1390">ipbase</td> <td data-bbox="542 1369 727 1390">ipbasek9</td> <td data-bbox="727 1369 878 1390">ipbasek9</td> <td data-bbox="878 1369 974 1390">None</td> </tr> </tbody> </table> <p>cisco C1111-8PLTELAWN (1RU) processor with 1464345K/6147K bytes of memory. Processor board ID FGL212392WT 8 Virtual Ethernet interfaces 11 Gigabit Ethernet interfaces 2 Cellular interfaces 32768K bytes of non-volatile configuration memory. 4194304K bytes of physical memory. 6762495K bytes of flash memory at bootflash:. 7855044K bytes of USB flash at usb0:. 0K bytes of WebUI ODM Files at webui:.</p> <p>Configuration register is 0x2100</p> | appxk9 | None | None | None | securityk9 | None | None | None | ipbase | ipbasek9 | ipbasek9 | None | | | | | |
| appxk9 | None | None | None | | | | | | | | | | | | | | | |
| securityk9 | None | None | None | | | | | | | | | | | | | | | |
| ipbase | ipbasek9 | ipbasek9 | None | | | | | | | | | | | | | | | |

| | Command or Action | Purpose |
|---------------|-------------------------------------------------------------------------------------------------------------------------------------------------------------------------------------------------------------------------------------------------------------------|-------------------------------------------------------------------------------------------------------------------------------------------------------------------------------------------------|
| | Router# . | |
| Step 2 | dir bootflash: Example: Router# dir bootflash: | Displays the previous version of software and that a package is present. |
| Step 3 | show platform Example: Router# show platform Chassis type: C1100 | Displays the inventory. |
| Step 4 | mkdir bootflash: <i>URL-to-directory-name</i> Example: Router# mkdir bootflash:mydir | Creates a directory to save the expanded software image. You can use the same name as the image to name the directory. |
| Step 5 | request platform software package expand file <i>URL-to-consolidated-package</i> to <i>URL-to-directory-name</i> Example: Router# request platform software package expand file bootflash:c1100-universalk9-ias.bin to bootflash:mydir | Expands the software image from the TFTP server (<i>URL-to-consolidated-package</i>) into the directory used to save the image (<i>URL-to-directory-name</i>), which was created in Step 4. |
| Step 6 | reload Example: Router# reload rommon > | Enables ROMMON mode, which allows the software in the consolidated file to be activated. |
| Step 7 | boot <i>URL-to-directory-name/packages.conf</i> Example: rommon 1 > boot bootflash:mydir/packages.conf | Boots the consolidated package, by specifying the path and name of the provisioning file: packages.conf. |
| Step 8 | show version installed Example: Router# show version installed Package: Provisioning File, version: n/a, status: active | Displays the version of the newly installed software. |

Examples

The initial part of the example shows the consolidated package, c1100.bin, being copied to the TFTP server. This is a prerequisite step. The remaining part of the example shows the consolidated file, packages.conf, being booted.

```
Router# copy tftp:c1100.bin bootflash:
Address or name of remote host []? 172.18.40.4
Destination filename [c1100.bin]?
Accessing tftp://172.18.40.4/user5/c1100.bin...
Loading user5/c1100.bin from 172.18.40.4 (via GigabitEthernet0/0/0):
```

```
[OK - 379357675 bytes]
```

```
379357675 bytes copied in 382.880 secs (990800 bytes/sec)
```

```
Router# show version
Cisco IOS XE Software, Version 16.06.02
Cisco IOS Software [Everest], ISR Software (ARMV8EB_LINUX_IOSD-UNIVERSALK9_IAS-M), Version
 16.6.2, RELEASE SOFTWARE (fc2)
Technical Support: http://www.cisco.com/techsupport
Copyright (c) 1986-2017 by Cisco Systems, Inc.
Compiled Wed 01-Nov-17 03:00 by mcpre
```

```
Cisco IOS-XE software, Copyright (c) 2005-2017 by cisco Systems, Inc.
All rights reserved. Certain components of Cisco IOS-XE software are
licensed under the GNU General Public License ("GPL") Version 2.0. The
software code licensed under GPL Version 2.0 is free software that comes
with ABSOLUTELY NO WARRANTY. You can redistribute and/or modify such
GPL code under the terms of GPL Version 2.0. For more details, see the
documentation or "License Notice" file accompanying the IOS-XE software,
or the applicable URL provided on the flyer accompanying the IOS-XE
software.
```

```
ROM: IOS-XE ROMMON
```

```
Router uptime is 3 minutes
Uptime for this control processor is 5 minutes
System returned to ROM by Reload Command
System image file is "usb0:c1100-universalk9_ias.16.06.02.SPA.bin"
Last reload reason: Reload Command
```

This product contains cryptographic features and is subject to United States and local country laws governing import, export, transfer and use. Delivery of Cisco cryptographic products does not imply third-party authority to import, export, distribute or use encryption. Importers, exporters, distributors and users are responsible for compliance with U.S. and local country laws. By using this product you agree to comply with applicable laws and regulations. If you are unable to comply with U.S. and local laws, return this product immediately.

A summary of U.S. laws governing Cisco cryptographic products may be found at:
<http://www.cisco.com/wwl/export/crypto/tool/stqrg.html>

If you require further assistance please contact us by sending email to export@cisco.com.

Suite License Information for Module:'esg'

```
-----
Suite                Suite Current      Type                Suite Next reboot
-----
FoundationSuiteK9    None                None                None
securityk9
appxk9
```

Technology Package License Information:

```
-----
Technology           Technology-package   Technology-package
                   Current             Type                Next reboot
-----
appxk9               None                None                None
securityk9           None                None                None
ipbase                ipbasek9            None                ipbasek9
```

cisco C1111-8PLTELAWN (1RU) processor with 1464345K/6147K bytes of memory.
 Processor board ID FGL212392WT
 8 Virtual Ethernet interfaces
 11 Gigabit Ethernet interfaces
 2 Cellular interfaces
 32768K bytes of non-volatile configuration memory.
 4194304K bytes of physical memory.
 6762495K bytes of flash memory at bootflash:.
 7855044K bytes of USB flash at usb0:.
 0K bytes of WebUI ODM Files at webui:.

Configuration register is 0x2100

Router#

Router# **dir bootflash:**

Directory of bootflash:/

Directory of bootflash:/

```

  11 drwx                16384 Jun 13 2017 14:13:26 +00:00 lost+found
105249 drwx              4096 Jul 12 2017 15:48:19 +00:00 .installer
48577 drwx              4096 Jun 13 2017 14:16:31 +00:00 core
56673 drwx              4096 Jun 13 2017 14:14:40 +00:00 .prst_sync
145729 drwx             4096 Jun 13 2017 14:14:47 +00:00 .rollback_timer
  12 -rw-                0 Jun 13 2017 14:14:58 +00:00 tracelogs.a4i
348129 drwx             4096 Jul 12 2017 15:53:50 +00:00 tracelogs
  13 -rw-                30 Jul 12 2017 15:49:42 +00:00 throughput_monitor_params
  14 -rw-                35 Jun 13 2017 15:32:49 +00:00 pnp-tech-time
  15 -rw-             134096 Jun 13 2017 15:32:50 +00:00 pnp-tech-discovery-summary
```

6650826752 bytes total (6297722880 bytes free)

Router# **show platform**

Chassis type: C1111-8PLTELAWN

```
Slot      Type                State                Insert time (ago)
-----
```

```

0          C1111-8PLTELANW      ok          00:04:56
0/0       C1111-2x1GE          ok          00:02:41
0/1       C1111-ES-8           ok          00:02:40
0/2       C1111-LTE            ok          00:02:41
0/3       ISR-AP1100AC-N       ok          00:02:41
R0        C1111-8PLTELANW      ok, active  00:04:56
F0        C1111-8PLTELANW      ok, active  00:04:56
P0        PWR-12V              ok          00:04:30

```

```

Slot      CPLD Version      Firmware Version
-----
0         17100501             16.6(1r)RC3
R0        17100501             16.6(1r)RC3
F0        17100501             16.6(1r)RC3

```

Router#

Router# **mkdir bootflash:c1100.dir1**

Create directory filename [c1100.dir1]? Created dir bootflash:/c1100.dir1

Router# **request platform software package expand file bootflash:c1100.bin to bootflash:c1100.dir1**

```

Jul 12 20:18:28.059 RP0/0: %INSTALL-5-OPERATION_START_INFO: Started expand package
bootflash:c1100.bin
Verifying parameters
Expanding superpackage bootflash:c1100.bin
Validating package type

```

```

*Jul 12 20:18:28.029: %IOSXE-5-PLATFORM: R0/0: Jul 12 20:18:28 packtool:
%INSTALL-5-OPERATION_START_INFO: Started expand package bootflash:c1100.binCopying package
files
SUCCESS: Finished expanding all-in-one software package.
Jul 12 20:19:57.041 RP0/0: %INSTALL-5-OPERATION_COMPLETED_INFO: Completed expand package
bootflash:c1100.bin

```

Router# **reload**

Proceed with reload? [confirm]

```

*Jul 13 19:39:06.354: %SYS-5-RELOAD: Reload requested by console.Reload Reason: Reload
Command.

```

rommon 1 > **boot bootflash:c1100.dir/packages.conf**

Located packages.conf

```

=====
Package header rev 3 structure detected
IsoSize = 0
Calculating SHA-1 hash..Validate package: SHA-1 hash:
calculated 9E5196BD:ED7FB430:538521E5:90175EED:B3AD33B7
expected   9E5196BD:ED7FB430:538521E5:90175EED:B3AD33B7

```

RSA Signed DEVELOPMENT Image Signature Verification Successful

Image validated

DXE 809 ms

BDS 1153 ms

BDS 21 ms

Total Time = 1984 ms

.....

Router# **show version installed**

```
Package: Provisioning File, version: n/a, status: active
  Role: provisioning file
  File: bootflash:c1100.dir/packages.conf, on: RP0
  Built: n/a, by: n/a
  File SHA1 checksum: a02d730877371ac9c033e90444094bb441adc8e5

Package: mono-universalk9_ias, version: 2017-06-21_09.16_user5, status: active
  Role: rp_base
  File: bootflash:c1100.dir/c1100-mono-universalk9_ias.2017-06-21_09.16_user5.SSA.pkg, on: RP0
  Built: 2017-06-21_09.16, by: user5
  File SHA1 checksum: 1e44c63d734c574b986c9332c1bad8580f55e992

Package: rpboot, version: 2017-06-21_09.16_user5, status: active
  Role: rp_boot
  File: bootflash:c1100.dir/c1100-rpboot.2017-06-21_09.16_user5.SSA.pkg, on: RP0
  Built: 2017-06-21_09.16, by: user5
  File SHA1 checksum: n/a

Package: firmware_c1100_gfast, version: 2017-06-21_09.16_user5, status: active
  Role: firmware_c1100_gfast
  File: bootflash:c1100.dir/c1100-firmware_c1100_gfast.2017-06-21_09.16_user5.SSA.pkg, on: RP0/0
  Built: 2017-06-21_09.16, by: user5
  File SHA1 checksum: 996bc2d56bdb9d4e13f45a613db1bc41d0b6d291

Package: firmware_c1100_vadsl, version: 2017-06-21_09.16_user5, status: active
  Role: firmware_c1100_vadsl
  File: bootflash:c1100.dir/c1100-firmware_c1100_vadsl.2017-06-21_09.16_user5.SSA.pkg, on: RP0/0
  Built: 2017-06-21_09.16, by: user5
  File SHA1 checksum: a2a7daf772c30fc4cec5befac29ff320d8d47152

Package: mono-universalk9_ias, version: 2017-06-21_09.16_user5, status: active
  Role: rp_daemons
  File: bootflash:c1100.dir/c1100-mono-universalk9_ias.2017-06-21_09.16_user5.SSA.pkg, on: RP0/0
  Built: 2017-06-21_09.16, by: user5
  File SHA1 checksum: 1e44c63d734c574b986c9332c1bad8580f55e992

Package: mono-universalk9_ias, version: 2017-06-21_09.16_user5, status: active
  Role: rp_iosd
  File: bootflash:c1100.dir/c1100-mono-universalk9_ias.2017-06-21_09.16_user5.SSA.pkg, on: RP0/0
  Built: 2017-06-21_09.16, by: user5
  File SHA1 checksum: 1e44c63d734c574b986c9332c1bad8580f55e992

Package: mono-universalk9_ias, version: 2017-06-21_09.16_user5, status: active
  Role: rp_security
  File: bootflash:c1100.dir/c1100-mono-universalk9_ias.2017-06-21_09.16_user5.SSA.pkg, on: RP0/0
  Built: 2017-06-21_09.16, by: user5
  File SHA1 checksum: 1e44c63d734c574b986c9332c1bad8580f55e992

Package: mono-universalk9_ias, version: 2017-06-21_09.16_user5, status: active
  Role: rp_webui
  File: bootflash:c1100.dir/c1100-mono-universalk9_ias.2017-06-21_09.16_user5.SSA.pkg, on: RP0/0
  Built: 2017-06-21_09.16, by: user5
  File SHA1 checksum: 1e44c63d734c574b986c9332c1bad8580f55e992

Package: firmware_c1100_gfast, version: 2017-06-21_09.16_user5, status: n/a
  Role: firmware_c1100_gfast
```

```

File: bootflash:c1100.dir/c1100-firmware_c1100_gfast.2017-06-21_09.16_user5.SSA.pkg, on:
RP0/1
Built: 2017-06-21_09.16, by: user5
File SHA1 checksum: 996bc2d56bdb9d4e13f45a613db1bc41d0b6d291

Package: firmware_c1100_vadsl, version: 2017-06-21_09.16_user5, status: n/a
Role: firmware_c1100_vadsl
File: bootflash:c1100.dir/c1100-firmware_c1100_vadsl.2017-06-21_09.16_user5.SSA.pkg, on:
RP0/1
Built: 2017-06-21_09.16, by: user5
File SHA1 checksum: a2a7daf772c30fc4cec5befac29ff320d8d47152

Package: mono-universalk9_ias, version: 2017-06-21_09.16_user5, status: n/a
Role: rp_daemons
File: bootflash:c1100.dir/c1100-mono-universalk9_ias.2017-06-21_09.16_user5.SSA.pkg, on:
RP0/1
Built: 2017-06-21_09.16, by: user5
File SHA1 checksum: 1e44c63d734c574b986c9332c1bad8580f55e992
Package: mono-universalk9_ias, version: 2017-06-21_09.16_user5, status:
n/a
Role: rp_iosd
File: bootflash:c1100.dir/c1100-mono-universalk9_ias.2017-06-21_09.16_user5.SSA.pkg, on:
RP0/1
File SHA1 checksum: 1e44c63d734c574b986c9332c1bad8580f55e992

Package: mono-universalk9_ias, version: 2017-06-21_09.16_user5, status: n/a
Role: rp_security
File: bootflash:c1100.dir/c1100-mono-universalk9_ias.2017-06-21_09.16_user5.SSA.pkg, on:
RP0/1
Built: 2017-06-21_09.16, by: user5
File SHA1 checksum: 1e44c63d734c574b986c9332c1bad8580f55e992

Package: mono-universalk9_ias, version: 2017-06-21_09.16_user5, status: n/a
Role: rp_webui
File: bootflash:c1100.dir/c1100-mono-universalk9_ias.2017-06-21_09.16_user5.SSA.pkg, on:
RP0/1
Built: 2017-06-21_09.16, by: user5
File SHA1 checksum: 1e44c63d734c574b986c9332c1bad8580f55e992

Package: mono-universalk9_ias, version: 2017-06-21_09.16_user5, status: n/a
Role: rp_base
File: bootflash:c1100.dir/c1100-mono-universalk9_ias.2017-06-21_09.16_user5.SSA.pkg, on:
RP1
Built: 2017-06-21_09.16, by: user5
File SHA1 checksum: 1e44c63d734c574b986c9332c1bad8580f55e992

Package: rpboot, version: 2017-06-21_09.16_user5, status: n/a
Role: rp_boot
File: bootflash:c1100.dir/c1100-rpboot.2017-06-21_09.16_user5.SSA.pkg, on: RP1
Built: 2017-06-21_09.16, by: user5
File SHA1 checksum: n/a

Package: firmware_c1100_gfast, version: 2017-06-21_09.16_user5, status: n/a
Role: firmware_c1100_gfast
File: bootflash:c1100.dir/c1100-firmware_c1100_gfast.2017-06-21_09.16_user5.SSA.pkg, on:
RP1/0
Built: 2017-06-21_09.16, by: user5
File SHA1 checksum: 996bc2d56bdb9d4e13f45a613db1bc41d0b6d291

Package: firmware_c1100_vadsl, version: 2017-06-21_09.16_user5, status: n/a
Role: firmware_c1100_vadsl
File: bootflash:c1100.dir/c1100-firmware_c1100_vadsl.2017-06-21_09.16_user5.SSA.pkg, on:
RP1/0
Built: 2017-06-21_09.16, by: user5

```



```
File SHA1 checksum: a2a7daf772c30fc4cec5befac29ff320d8d47152

Package: mono-universalk9_ias, version: 2017-06-21_09.16_user5, status: n/a
    Package: mono-universalk9_ias, version: 2017-06-21_09.16_user5, status:
active
    Role: cc
    File: bootflash:c1100.dir/c1100-mono-universalk9_ias.2017-06-21_09.16_user5.SSA.pkg, on:
SIP0/0
    Built: 2017-06-21_09.16, by: user5
    File SHA1 checksum: 1e44c63d734c574b986c9332c1bad8580f55e992

Package: mono-universalk9_ias, version: 2017-06-21_09.16_user5, status: active
    Role: cc
    File: bootflash:c1100.dir/c1100-mono-universalk9_ias.2017-06-21_09.16_user5.SSA.pkg, on:
SIP0/1
    Built: 2017-06-21_09.16, by: user5
    File SHA1 checksum: 1e44c63d734c574b986c9332c1bad8580f55e992

Package: cc, version: unknown, status: active
    Role: cc
    File: unknown, on: SIP0/2
    Built: unknown, by: unknown
    File SHA1 checksum: unknown

Package: cc, version: unknown, status: active
    Role: cc
    File: unknown, on: SIP0/3
    Built: unknown, by: unknown
    File SHA1 checksum: unknown

Package: cc, version: unknown, status: n/a
    Role: cc
    File: unknown, on: SIP0/4
    Built: unknown, by: unknown
    File SHA1 checksum: unknown

Package: cc, version: unknown, status: n/a
    Role: cc
    File: unknown, on: SIP0/5
    Built: unknown, by: unknown
    File SHA1 checksum: unknown

Package: mono-universalk9_ias, version: 2017-06-21_09.16_user5, status: n/a
    Role: cc_spa
    File: bootflash:c1100.dir/c1100-mono-universalk9_ias.2017-06-21_09.16_user5.SSA.pkg, on:
SIP1
    Built: 2017-06-21_09.16, by: user5
    File SHA1 checksum: 1e44c63d734c574b986c9332c1bad8580f55e992

Package: mono-universalk9_ias, version: 2017-06-21_09.16_user5, status: n/a
    Role: cc_spa
    File: bootflash:c1100.dir/c1100-mono-universalk9_ias.2017-06-21_09.16_user5.SSA.pkg, on:
SIP2
    Built: 2017-06-21_09.16, by: user5
    File SHA1 checksum: 1e44c63d734c574b986c9332c1bad8580f55e992
```

Installing Subpackages from a Consolidated Package on a Flash Drive

The steps for installing subpackages from a consolidated package on a USB flash drive are similar to those described in the Installing Subpackages from a Consolidated Package section.

Procedure

- Step 1** `show version`
 - Step 2** `dir usbn:`
 - Step 3** `show platform`
 - Step 4** `mkdir bootflash:URL-to-directory-name`
 - Step 5** `request platform software package expand fileusbn: package-name to URL-to-directory-name`
 - Step 6** `reload`
 - Step 7** `boot URL-to-directory-name/packages.conf`
 - Step 8** `show version installed`
-

How to Install and Upgrade the Software for Cisco IOS XE Everest Release 16.6

To install or upgrade the software, use one of the following methods to use the software from a consolidated package or an individual package.

Upgrading to Cisco IOS XE Everest 16.6.2 Release

Upgrading the device to Cisco IOS XE Everest 16.6.2 release for the first time uses the same procedures as specified in the earlier section. In addition, Cisco IOS XE Everest 16.6.2 release requires a minimum ROMMON version. When the device boots up with Cisco IOS XE Everest image for the first time, the device checks the installed version of the ROMMON, and upgrades if the system is running an older version. During the upgrade, do not power cycle the device. The system automatically power cycles the device after the new ROMMON is installed. After the installation, the system will boot up with the Cisco IOS XE image as normal.



Note When the device boots up for first time and if the device requires an upgrade, the entire boot process may take several minutes. This process will be longer than a normal boot due to the ROMMON upgrade.

The following example illustrates the boot process of a consolidated package:

Not supported for C1100 in this release since C1100 is shipped with the minimum Rommon version.



CHAPTER 4

Basic Router Configuration

This chapter contains the following sections:

- [Default Configuration, on page 81](#)
- [Configuring Global Parameters, on page 84](#)
- [Configuring Gigabit Ethernet Interfaces, on page 84](#)
- [Configuring a Loopback Interface, on page 85](#)
- [Configuring Module Interfaces, on page 87](#)
- [Enabling Cisco Discovery Protocol, on page 87](#)
- [Configuring Command-Line Access, on page 87](#)
- [Configuring Static Routes, on page 89](#)
- [Configuring Dynamic Routes, on page 90](#)

Default Configuration

When you boot up the router for the first time, the router looks for a default file name—the PID of the router. For example, the Cisco 1000 Series Integrated Services Routers look for a file named **isr1100.cfg**. The Cisco 1000 Series ISR looks for this file before finding the standard files **-router-config** or the **ciscortr.cfg**.

The Cisco 1000 ISR looks for the **isr1100.cfg** file in the bootflash. If the file is not found in the bootflash, the router then looks for the standard files **-router-config** and **ciscortr.cfg**. If none of the files are found, the router then checks for any inserted USB that may have stored these files in the same particular order.



Note If there is a configuration file with the PID as its name in an inserted USB, but one of the standard files are in bootflash, the system finds the standard file for use.

Use the **show running-config** command to view the initial configuration, as shown in the following example:

```
Router# show running-config
Building configuration...

Current configuration : 1749 bytes
!
! Last configuration change at 20:23:33 UTC Fri Nov 3 2017
!
version 16.6
```

```
service timestamps debug datetime msec
service timestamps log datetime msec
platform qfp utilization monitor load 80
no platform punt-keepalive disable-kernel-core
!
hostname Router
!
boot-start-marker
boot-end-marker
!
!
!
no aaa new-model
!
!
!
!
!
!
!
!
!
!
!
!
!
subscriber templating
!
!
multilink bundle-name authenticated
!
!
!
crypto pki trustpoint TP-self-signed-4175586959
  enrollment selfsigned
  subject-name cn=IOS-Self-Signed-Certificate-4175586959
  revocation-check none
  rsakeypair TP-self-signed-4175586959
!
!
crypto pki certificate chain TP-self-signed-4175586959
!
!
license udi pid C1111-8PLTELA sn FGL212694ML
!
diagnostic bootup level minimal
spanning-tree extend system-id
!
!
!
redundancy
  mode none
!
controller Cellular 0/2/0
  lte modem link-recovery disable
!
!
vlan internal allocation policy ascending
!
!
!
!
!
!
interface GigabitEthernet0/0/0
  no ip address
```

```
shutdown
negotiation auto
!
interface GigabitEthernet0/0/1
no ip address
shutdown
negotiation auto
!
interface GigabitEthernet0/1/0
!
interface GigabitEthernet0/1/1
!
interface GigabitEthernet0/1/2
!
interface GigabitEthernet0/1/3
!
interface GigabitEthernet0/1/4
!
interface GigabitEthernet0/1/5
!
interface GigabitEthernet0/1/6
!
interface GigabitEthernet0/1/7
!
interface Cellular0/2/0
ip address negotiated
ipv6 enable
!
interface Cellular0/2/1
no ip address
shutdown
!
interface Vlan1
no ip address
!
ip forward-protocol nd
ip http server
ip http authentication local
ip http secure-server
!
!
!
!
!
!
control-plane
!
!
line con 0
transport input none
stopbits 1
line vty 0 4
login
!
wsma agent exec
!
wsma agent config
!
wsma agent filesys
!
wsma agent notify
!
!
end
```

Configuring Global Parameters

To configure the global parameters for your router, follow these steps.

Procedure

| | Command or Action | Purpose |
|---------------|-------------------------------------------------------------------------------------------------------------------------|-------------------------------------------------------------------------------------------------------------------------------------------------------------------------------------------------------------------------------------------|
| Step 1 | configure terminal Example: <pre>Router> enable Router# configure terminal Router(config)#</pre> | Enters global configuration mode when using the console port. Use the following to connect to the router with a remote terminal: <pre>telnet router-name or address Login: login-id Password: ***** Router> enable</pre> |
| Step 2 | hostname name Example: <pre>Router(config)# hostname Router</pre> | Specifies the name for the router. |
| Step 3 | enable password password Example: <pre>Router(config)# enable password cr1ny5ho</pre> | Specifies a password to prevent unauthorized access to the router. Note In this form of the command, password is not encrypted. |
| Step 4 | no ip domain-lookup Example: <pre>Router(config)# no ip domain-lookup</pre> | Disables the router from translating unfamiliar words (typos) into IP addresses. For complete information on global parameter commands, see the Cisco IOS Release Configuration Guide documentation set. |

Configuring Gigabit Ethernet Interfaces

To manually define onboard Gigabit Ethernet interfaces, follow these steps, beginning from global configuration mode.

Procedure

| | Command or Action | Purpose |
|---------------|---------------------------------------------------|---------------------------------------------------------------|
| Step 1 | interface slot/bay/port Example: | Enters the configuration mode for an interface on the router. |

| | Command or Action | Purpose |
|---------------|-----------------------------------------------------------------------------------------------------------------------------------------|----------------------------------------------------------------------------------------------------------------------------------------|
| | Router(config)# interface 0/0/1 | |
| Step 2 | ip address <i>ip-address mask</i> Example: Router(config-if)# ip address 192.168.12.2 255.255.255.0 | Sets the IP address and subnet mask for the specified interface. Use this Step if you are configuring an IPv4 address. |
| Step 3 | ipv6 address <i>ipv6-address/prefix</i> Example: Router(config-if)# ipv6 address 2001.db8::ffff:1/128 | Sets the IPv6 address and prefix for the specified interface. Use this step instead of Step 2, if you are configuring an IPv6 address. |
| Step 4 | no shutdown Example: Router(config-if)# no shutdown | Enables the interface and changes its state from administratively down to administratively up. |
| Step 5 | exit Example: Router(config-if)# exit | Exits the configuration mode of interface and returns to the global configuration mode. |

Configuring a Loopback Interface

Before you begin

The loopback interface acts as a placeholder for the static IP address and provides default routing information. To configure a loopback interface, follow these steps.

Procedure

| | Command or Action | Purpose |
|---------------|------------------------------------------------------------------------------------------------------------------------------------------------|-----------------------------------------------------------------------------------------------------------------------------------------------------------------------------------------|
| Step 1 | interface <i>type number</i> Example: Router(config)# interface Loopback 0 | Enters configuration mode on the loopback interface. |
| Step 2 | (Option 1) ip address <i>ip-address mask</i> Example: Router(config-if)# ip address 10.108.1.1 255.255.255.0 | Sets the IP address and subnet mask on the loopback interface. (If you are configuring an IPv6 address, use the ipv6 address <i>ipv6-address/prefix</i> command described below. |

| | Command or Action | Purpose |
|---------------|------------------------------------------------------------------------------------------------------------------------------------|-----------------------------------------------------------------------------------------------|
| Step 3 | (Option 2) ipv6 address <i>ipv6-address/prefix</i> Example: Router(config-if)# 2001:db8::ffff:1/128 | Sets the IPv6 address and prefix on the loopback interface. |
| Step 4 | exit Example: Router(config-if)# exit | Exits configuration mode for the loopback interface and returns to global configuration mode. |

The loopback interface in this sample configuration is used to support Network Address Translation (NAT) on the virtual-template interface. This configuration example shows the loopback interface configured on the Gigabit Ethernet interface with an IP address of 192.0.2.0/16, which acts as a static IP address. The loopback interface points back to virtual-template1, which has a negotiated IP address.

```
!
interface loopback 0
ip address 192.10.2.3 255.255.0.0 (static IP address)
ip nat outside
!
interface Virtual-Template1
ip unnumbered loopback0
no ip directed-broadcast
ip nat outside
```

Verifying Loopback Interface Configuration

Enter the **show interface loopback** command. You should see an output similar to the following example:

```
Router# show interface loopback 0
Loopback0 is up, line protocol is up
  Hardware is Loopback
  Internet address is 192.0.2.0/16
  MTU 1514 bytes, BW 8000000 Kbit, DLY 5000 usec,
    reliability 255/255, txload 1/255, rxload 1/255
  Encapsulation LOOPBACK, loopback not set
  Last input never, output never, output hang never
  Last clearing of "show interface" counters never
  Queueing strategy: fifo
  Output queue 0/0, 0 drops; input queue 0/75, 0 drops
  5 minute input rate 0 bits/sec, 0 packets/sec
  5 minute output rate 0 bits/sec, 0 packets/sec
    0 packets input, 0 bytes, 0 no buffer
    Received 0 broadcasts, 0 runts, 0 giants, 0 throttles
    0 input errors, 0 CRC, 0 frame, 0 overrun, 0 ignored, 0 abort
    0 packets output, 0 bytes, 0 underruns
    0 output errors, 0 collisions, 0 interface resets
    0 output buffer failures, 0 output buffers swapped out
```

Alternatively, use the **ping** command to verify the loopback interface, as shown in the following example:

```
Router# ping 192.0.2.0
```



```
Type escape sequence to abort.
Sending 5, 100-byte ICMP Echos to 192.0.2.0, timeout is 2 seconds:
!!!!
Success rate is 100 percent (5/5), round-trip min/avg/max = 1/2/4 ms
```

Configuring Module Interfaces

For detailed information about configuring service modules, see the Wireless Device Overview chapter and the Cisco Fourth-Generation LTE-Advanced chapter.

Enabling Cisco Discovery Protocol

Cisco Discovery Protocol (CDP) is enabled by default on the router.

For more information on using CDP, see [Cisco Discovery Protocol Configuration Guide, Cisco IOS XE Release 3S](#).

Configuring Command-Line Access

To configure parameters to control access to the router, follow these steps.

Procedure

| | Command or Action | Purpose |
|---------------|---------------------------------------------------------------------------------------------------------------------------------------------------|------------------------------------------------------------------------------------------------------------------------------------------------------------------------------------------------------------------------------------------------------------------------------------------------------------------------|
| Step 1 | line [console tty vty] <i>line-number</i> Example: Router(config)# line console 0 | Enters line configuration mode, and specifies the type of line. The example provided here specifies a console terminal for access. |
| Step 2 | password <i>password</i> Example: Router(config-line)# password 5dr4Hepw3 | Specifies a unique password for the console terminal line. |
| Step 3 | login Example: Router(config-line)# login | Enables password checking at terminal session login. |
| Step 4 | exec-timeout <i>minutes</i> [<i>seconds</i>] Example: Router(config-line)# exec-timeout 5 30 Router(config-line)# | Sets the interval during which the EXEC command interpreter waits until user input is detected. The default is 10 minutes. Optionally, adds seconds to the interval value. The example provided here shows a timeout of 5 minutes and 30 seconds. Entering a timeout of 0 0 specifies never to time out. |

| | Command or Action | Purpose |
|---------------|---------------------------------------------------------------------------------------------------------------------------------------|----------------------------------------------------------------------|
| Step 5 | exit Example: Router(config-line)# exit | Exits line configuration mode to re-enter global configuration mode. |
| Step 6 | line [console tty vty] line-number Example: Router(config)# line vty 0 4 Router(config-line)# | Specifies a virtual terminal for remote console access. |
| Step 7 | password password Example: Router(config-line)# password aldf2ad1 | Specifies a unique password for the virtual terminal line. |
| Step 8 | login Example: Router(config-line)# login | Enables password checking at the virtual terminal session login. |
| Step 9 | end Example: Router(config-line)# end | Exits line configuration mode, and returns to privileged EXEC mode. |

Example

The following configuration shows the command-line access commands.

You do not have to input the commands marked **default**. These commands appear automatically in the configuration file that is generated when you use the **show running-config** command.

```
!
line console 0
exec-timeout 10 0
password 4youreyesonly
login
transport input none (default)
stopbits 1 (default)
line vty 0 4
password secret
login
!
```

Configuring Static Routes

Static routes provide fixed routing paths through the network. They are manually configured on the router. If the network topology changes, the static route must be updated with a new route. Static routes are private routes unless they are redistributed by a routing protocol.

To configure static routes, follow these steps.

Procedure

| | Command or Action | Purpose |
|---------------|------------------------------------------------------------------------------------------------------------------------------------------------------------------------------------------------------------------|-------------------------------------------------------------------------------------------------------------------------------------------|
| Step 1 | (Option 1) ip route <i>prefix mask {ip-address interface-type interface-number [ip-address]}</i> Example: Router(config)# ip route 192.10.2.3 255.255.0.0 10.10.10.2 | Specifies a static route for the IP packets. (If you are configuring an IPv6 address, use the ipv6 route command described below.) |
| Step 2 | (Option 2) ipv6 route <i>prefix/mask {ipv6-address interface-type interface-number [ipv6-address]}</i> Example: Router(config)# ipv6 route 2001:db8:2::/64 2001:db8:3::0 | Specifies a static route for the IP packets. |
| Step 3 | end Example: Router(config)# end | Exits global configuration mode and enters privileged EXEC mode. |

In the following configuration example, the static route sends out all IP packets with a destination IP address of 192.168.1.0 and a subnet mask of 255.255.255.0 on the Gigabit Ethernet interface to another device with an IP address of 10.10.10.2. Specifically, the packets are sent to the configured PVC.

You do not have to enter the command marked **default**. This command appears automatically in the configuration file generated when you use the **running-config** command.

```
!
ip classless (default)
ip route 2001:db8:2::/64 2001:db8:3::0
```

Verifying Configuration

To verify that you have configured static routing correctly, enter the **show ip route** command (or **show ipv6 route** command) and look for static routes marked with the letter S.

When you use an IPv4 address, you should see verification output similar to the following:

```

Router# show ip route
Codes: C - connected, S - static, R - RIP, M - mobile, B - BGP
       D - EIGRP, EX - EIGRP external, O - OSPF, IA - OSPF inter area
       N1 - OSPF NSSA external type 1, N2 - OSPF NSSA external type 2
       E1 - OSPF external type 1, E2 - OSPF external type 2
       i - IS-IS, su - IS-IS summary, L1 - IS-IS level-1, L2 - IS-IS level-2
       ia - IS-IS inter area, * - candidate default, U - per-user static route
       o - ODR, P - periodic downloaded static route

Gateway of last resort is not set

    10.0.0.0/24 is subnetted, 1 subnets
C       10.108.1.0 is directly connected, Loopback0
S*     0.0.0.0/0 is directly connected, FastEthernet0

```

When you use an IPv6 address, you should see verification output similar to the following:

```

Router# show ipv6 route
IPv6 Routing Table - default - 5 entries
Codes: C - Connected, L - Local, S - Static, U - Per-user Static route
       B - BGP, R - RIP, H - NHRP, I1 - ISIS L1
       I2 - ISIS L2, IA - ISIS interarea, IS - ISIS summary, D - EIGRP
       EX - EIGRP external, ND - ND Default, NDp - ND Prefix, DCE -
Destination
NDR - Redirect, O - OSPF Intra, OI - OSPF Inter, OE1 - OSPF ext 1
OE2 - OSPF ext 2, ON1 - OSPF NSSA ext 1, ON2 - OSPF NSSA ext 2
ls - LISP site, ld - LISP dyn-EID, a - Application

C     2001:DB8:3::/64 [0/0]
      via GigabitEthernet0/0/2, directly connected
S     2001:DB8:2::/64 [1/0]
      via 2001:DB8:3::1

```

Configuring Dynamic Routes

In dynamic routing, the network protocol adjusts the path automatically, based on network traffic or topology. Changes in dynamic routes are shared with other routers in the network.

A router can use IP routing protocols, such as Routing Information Protocol (RIP) or Enhanced Interior Gateway Routing Protocol (EIGRP), to learn about routes dynamically.

Configuring Routing Information Protocol

To configure the RIP on a router, follow these steps.

Procedure

| | Command or Action | Purpose |
|---------------|-----------------------------------------------------------------------------------|------------------------------------------------------------------|
| Step 1 | router rip Example: Router(config)# router rip | Enters router configuration mode, and enables RIP on the router. |

| | Command or Action | Purpose |
|---------------|---------------------------------------------------------------------------------------------------------------------------------------------------------------------------|--------------------------------------------------------------------------------------------------------------------------------------------------------------------|
| Step 2 | version {1 2} Example: Router(config-router)# version 2 | Specifies use of RIP version 1 or 2. |
| Step 3 | network <i>ip-address</i> Example: Router(config-router)# network 192.168.1.1 Router(config-router)# network 10.10.7.1 | Specifies a list of networks on which RIP is to be applied, using the address of the network of each directly connected network. |
| Step 4 | no auto-summary Example: Router(config-router)# no auto-summary | Disables automatic summarization of subnet routes into network-level routes. This allows subprefix routing information to pass across classful network boundaries. |
| Step 5 | end Example: Router(config-router)# end | Exits router configuration mode, and enters privileged EXEC mode. |

The following configuration example shows RIP Version 2 enabled in IP networks 10.0.0.0 and 192.168.1.0. To see this configuration, use the **show running-config** command from privileged EXEC mode.

```

!
Router# show running-config
Building configuration...

Current configuration : 5980 bytes
!
! Last configuration change at 13:56:48 PST Fri Nov 3 2017 by admin
!
version 16.6
service timestamps debug datetime msec
service timestamps log datetime msec
service call-home
platform qfp utilization monitor load 80
no platform punt-keepalive disable-kernel-core
platform shell
!
hostname Router
!
boot-start-marker
boot system tftp /auto/tftp-sjc-users5/c1100-universalk9_ias.16.06.02.SPA.bin 223.255.254.254
boot-end-marker
!
!
vrf definition VRF-example
  description VRF-example
!

```

```

no logging console
!
aaa new-model
!
!
!
aaa login success-track-conf-time 1
!
!
!
aaa session-id common
!
transport-map type persistent webui tsn_sol
server
secure-server
!
clock timezone PST -23 0
call-home
contact-email-addr dsfdsfds@cisco.com
profile "ewrewtrwrewr"
destination address email cisco@cisco.com
!
!
ipv6 unicast-routing
ipv6 dhcp pool 234324
!
!
!
!
!
!
!
subscriber templating
!
!
multilink bundle-name authenticated
passthru-domain-list 34324
match 3r4324
passthru-domain-list ewtrewr
match asfdkdslkf.com
!
!
!
crypto pki trustpoint TP-self-signed-2994767669
enrollment selfsigned
subject-name cn=IOS-Self-Signed-Certificate-2994767669
revocation-check none
rsa-keypair TP-self-signed-2994767669
!
crypto pki trustpoint TP-self-signed-3039537782
enrollment selfsigned
subject-name cn=IOS-Self-Signed-Certificate-3039537782
revocation-check none
rsa-keypair TP-self-signed-3039537782
!
!
crypto pki certificate chain TP-self-signed-2994767669
crypto pki certificate chain TP-self-signed-3039537782
!
!
license udi pid C1111-8PLTELAWN sn FGL212392WT
!

```

```
redundancy
  mode none
!
controller Cellular 0/2/0
  lte modem link-recovery disable
!
!
vlan internal allocation policy ascending
!
!
!
!
!
!
interface Loopback3
  no ip address
!
interface Loopback50
  ip address 5.5.5.5 255.255.255.255
!
interface Loopback100
  no ip address
!
interface Loopback544534
  no ip address
!
interface Loopback32432532
  no ip address
!
interface Port-channel2
  no ip address
  no negotiation auto
!
interface GigabitEthernet0/0/0
  description Interface for WebUI access
  ip address 192.168.1.46 255.255.255.0
  negotiation auto
  spanning-tree portfast disable
!
interface GigabitEthernet0/0/1
  description Interface for TFTP
  ip address 15.15.15.1 255.255.255.0
  negotiation auto
  spanning-tree portfast disable
!
interface GigabitEthernet0/1/0
  spanning-tree portfast disable
!
interface GigabitEthernet0/1/1
!
interface GigabitEthernet0/1/2

!
interface GigabitEthernet0/1/3
!
interface GigabitEthernet0/1/4
!
interface GigabitEthernet0/1/5
!
interface GigabitEthernet0/1/6
!
interface GigabitEthernet0/1/7
!
interface Wlan-GigabitEthernet0/1/8
```

```

!
interface Cellular0/2/0
  pulse-time 1
!
interface Cellular0/2/1
  no ip address

!
interface Vlan1
  ip address 10.10.10.1 255.255.255.0
!
router rip
  version 2
  network 10.0.0.0
  network 192.168.1.0
!
!
address-family ipv4 unicast autonomous-system 44
!
  af-interface GigabitEthernet0/0/0
    no split-horizon
  exit-af-interface
!
  topology base
  exit-af-topology
exit-address-family
!
!
!
!
control-plane
!
banner login ^CTSN_WebUI^C
!
line con 0
  transport input none
  stopbits 1
line vty 0 4
  exec-timeout 0 0
  transport input telnet ssh
  transport output all
line vty 5 15
  transport input all
  transport output all
!
wsma agent exec
!
wsma agent config
!
wsma agent filesys
!
wsma agent notify
!
!
end

Router#

```

Verifying Configuration

To verify that you have configured RIP correctly, enter the **show ip route** command and look for RIP routes marked with the letter R. You should see an output similar to the one shown in the following example:

```

Router# show ip route
Codes: C - connected, S - static, R - RIP, M - mobile, B - BGP
       D - EIGRP, EX - EIGRP external, O - OSPF, IA - OSPF inter area
       N1 - OSPF NSSA external type 1, N2 - OSPF NSSA external type 2
       E1 - OSPF external type 1, E2 - OSPF external type 2
       i - IS-IS, su - IS-IS summary, L1 - IS-IS level-1, L2 - IS-IS level-2
       ia - IS-IS inter area, * - candidate default, U - per-user static route
       o - ODR, P - periodic downloaded static route

Gateway of last resort is not set

    10.0.0.0/24 is subnetted, 1 subnets
C       10.108.1.0 is directly connected, Loopback0
R       3.0.0.0/8 [120/1] via 2.2.2.1, 00:00:02, Ethernet0/0/0

```

Configuring Enhanced Interior Gateway Routing Protocol

To configure Enhanced Interior Gateway Routing Protocol (EIGRP), follow these steps.

Procedure

| | Command or Action | Purpose |
|---------------|--------------------------------------------------------------------------------------------------------------------------------------------------|---------------------------------------------------------------------------------------------------------------------------------------------------------------------------------------|
| Step 1 | router eigrp <i>as-number</i> Example: Router(config)# router eigrp 109 | Enters router configuration mode, and enables EIGRP on the router. The autonomous-system number identifies the route to other EIGRP routers and is used to tag the EIGRP information. |
| Step 2 | network <i>ip-address</i> Example: Router(config)# network 192.168.1.0 Router(config)# network 10.10.12.115 | Specifies a list of networks on which EIGRP is to be applied, using the IP address of the network of directly connected networks. |
| Step 3 | end Example: Router(config-router)# end | Exits router configuration mode, and enters privileged EXEC mode. |

Example

The following configuration example shows the EIGRP routing protocol enabled in IP networks 192.168.1.0 and 10.10.12.115. The EIGRP autonomous system number is 109. To see this configuration, use the **show running-config** command.

```

Router# show running-config
.
.
.
!
router eigrp 109
 network 192.168.1.0
 network 10.10.12.115

```

```
!
.
.
.
```

Verifying Configuration

To verify that you have configured IP EIGRP correctly, enter the **show ip route** command, and look for EIGRP routes marked by the letter D. You should see verification output similar to the following:

```
Router# show ip route
Codes: C - connected, S - static, R - RIP, M - mobile, B - BGP
       D - EIGRP, EX - EIGRP external, O - OSPF, IA - OSPF inter area
       N1 - OSPF NSSA external type 1, N2 - OSPF NSSA external type 2
       E1 - OSPF external type 1, E2 - OSPF external type 2
       i - IS-IS, su - IS-IS summary, L1 - IS-IS level-1, L2 - IS-IS level-2
       ia - IS-IS inter area, * - candidate default, U - per-user static route
       o - ODR, P - periodic downloaded static route

Gateway of last resort is not set

    10.0.0.0/24 is subnetted, 1 subnets
C       10.108.1.0 is directly connected, Loopback0
D       3.0.0.0/8 [90/409600] via 2.2.2.1, 00:00:02, Ethernet0/0
```



CHAPTER 5

Console Port, Telnet, SSH Handling, and Reset Button

This chapter contains the following sections:

- [Restrictions and Notes for Console Port, Telnet, and SSH, on page 97](#)
- [Console Port Overview, on page 97](#)
- [Console Port Handling Overview, on page 97](#)
- [Telnet and SSH Overview, on page 98](#)
- [Reset Button Overview, on page 98](#)
- [Configuring a Console Port Transport Map, on page 101](#)
- [Viewing Console Port, SSH, and Telnet Handling Configurations, on page 103](#)
- [Configuring Console Port for Modem Connection , on page 105](#)

Restrictions and Notes for Console Port, Telnet, and SSH

- Configuring the diagnostic and wait banners is optional, but recommended. The banners are especially useful as indicators to users about the status of their Telnet or SSH attempts.

Console Port Overview

The console port on the router is an EIA/TIA-232 asynchronous, serial connection with no flow control and an RJ-45 connector. The console port is used to access the router and is located on the front panel of the Route Processor.

For information on accessing the router using the console port, see [Using Cisco IOS XE Software, on page 5](#).

Console Port Handling Overview

If you are using the console port to access the router, you are automatically directed to the Cisco IOS command-line interface (CLI).

If you are trying to access the router through the console port and send a break signal (by entering **Ctrl-C** or **Ctrl-Shift-6**, or by entering the **send break** command at the Telnet prompt) before connecting to the CLI, you are directed to a diagnostic mode if the non-RPIOS subpackages are accessible. These settings can be changed by configuring a transport map for the console port and applying that transport map to the console interface.

Telnet and SSH Overview

Telnet and SSH on the router can be configured and handled like Telnet and SSH on other Cisco platforms. For information on traditional Telnet, see the line command in the [Cisco IOS Terminal Services Command Reference, Release 12.2](#) document.

For information on configuring traditional SSH, see the “Configuring Secure Shell” chapter in the [Cisco IOS Terminal Services Command Reference, Release 12.2](#) document.

Reset Button Overview

The Reset button functionality is configured on all Cisco 1000 Series Integrated Services Routers (ISRs) by default. You can use the Reset button to recover Cisco 1000 Series ISRs that become non-responsive due to incorrect configuration or when users are unable to login due to incorrect credentials.

Information About Reset Button Functionality

To enable the Reset button functionality on these devices, configure the device with the password recovery service using the **service password-recovery** command, and to disable the feature, use either the **no service password-recovery** command or the **no service password-recovery strict** command.

You can enable the Reset button feature on the device only under any of these scenarios:

- during hardware initialization, or
- after the device is powered on, or
- at the **reload** command

In Cisco IOS XE Gibraltar 16.12 releases and earlier, you can enable the Reset button feature only if you use **service password-recovery** configuration. However, to disable the feature, use the **no service password-recovery** or **no service password-recovery strict** configurations.

From Cisco IOS XE Amsterdam 17.2.1r release and later, the Reset button feature is entirely disabled with the **no service password-recovery strict** configuration.

Below are the tables that show the behavior of the Reset button feature in various possible combinations under service password recovery and no service password recovery:

Table 7: Service Password-Recovery

| Press Reset Button (STATUS) | | | | Behavior | | | |
|-----------------------------|--------------|---------------|-----------------|----------|--------|-------|--|
| Sl. No | Golden Image | Golden Config | Start up config | Image | Config | Extra | |
| | | | | | | | |

| | | | | | | |
|---|--------|--------|--------|----------|--------|----------------|
| 1 | Exists | Exists | Exists | Golden | Golden | - |
| 2 | Exists | Exists | None | Golden | Golden | - |
| 3 | Exists | None | Exists | Golden | PnP | Delete startup |
| 4 | Exists | None | None | Golden | PnP | - |
| 5 | None | Exists | Exists | Standard | Golden | - |
| 6 | None | Exists | None | Standard | Golden | - |
| 7 | None | None | Exists | Standard | PnP | Delete startup |
| 8 | None | None | None | Standard | PnP | - |

Table 8: No Service Password-Recovery

| Press Reset Button (STATUS) | | | | Behavior | | |
|-----------------------------|--------------|---------------|-----------------|----------|--------|-------|
| Sl. No | Golden Image | Golden Config | Start up config | Image | Config | Extra |
| 1 | Exists | In NVRAM | Exists | Golden | PnP | Wipe |
| 2 | Exists | In Bootflash | Exists | Golden | Golden | Wipe |
| 3 | Exists | In NVRAM | None | Golden | PnP | Wipe |
| 4 | Exists | In Bootflash | None | Golden | Golden | Wipe |
| 5 | Exists | None | Exists | Golden | PnP | Wipe |
| 6 | Exists | None | None | Golden | PnP | Wipe |
| 7 | None | In NVRAM | Exists | Standard | PnP | Wipe |
| 8 | None | In Bootflash | Exists | Standard | Golden | Wipe |
| 9 | None | In NVRAM | None | Standard | PnP | Wipe |
| 10 | None | In Bootflash | None | Standard | Golden | Wipe |
| 11 | None | None | Exists | Standard | PnP | Wipe |
| 12 | None | None | None | Standard | PnP | Wipe |

Prerequisites for Enabling the Reset Button Functionality

- Ensure that the ROMmon version on the device is at least 17.2(1r)
- Ensure to configure the golden.bin image and golden.cfg configuration.

Restrictions for Reset Button

- The Cisco 1000 Series Integrated Service Routers do not support the Reset button functionality in the controller mode. Therefore, the reset button does not function to restore a golden image or configuration in the controller mode.
- The Reset button feature is disabled if the Cisco 1000 ISRs go into ROMMON mode or into the IOS mode.

How to Enable the Reset Button Functionality

This task describes how to enable Reset button feature on the Cisco 1000 Series ISR device:

Procedure

| | Command or Action | Purpose |
|---------------|-------------------------------------------------------------------------------------------------------------------------|---------------------------------------------------------------------------------------------------------------------------------------------------------------------------------------------------------------------------------------------------------------------------------------------------------------------------------------------------------------------------------------------------------|
| Step 1 | configure terminal Example: Device# <code>configure terminal</code> | Enters global configuration mode. |
| Step 2 | service password-recovery Example: Device(config)# <code>service password-recovery</code> | Configures the password recovery service on the device. |
| Step 3 | no service password-recovery Example: Device(config)# <code>no service password-recovery</code> | (Optional) Disables the Reset button feature on the device. You can recover the non-responsive device; however, the device is reconfigured because all user configurations and keys are deleted. Note Ensure that the device has a golden.bin and golden.cfg configurations on the device as a recovery mechanism so that the startup-config file on the IOS NVRAM is not deleted. |
| Step 4 | exit Example: Device(config)# <code>exit</code> | Exits the configuration mode and returns to the privileged exec mode. |
| Step 5 | no service recovery-service strict Example: | Disables the Reset button feature on the device. |

| | Command or Action | Purpose |
|--|-------------------------------------------------------------------|-----------------------------------------------------------------------------------------------------------------------------------------------------------------------------------------------------------------------------------------------------------------------------------------------------------------------------------------------------|
| | Device(config)# no service recovery-service strict exit | Note From Cisco IOS XE Amsterdam 17.2 release and later, if you use the no service recovery-service strict command, even with a golden.bin or golden.cfg configuration on the device, you will not be able to recover the device, and therefore has to be returned and replaced through Return Material Authorization (RMA) to Cisco. |

Example: Enable and Disable the Reset Button Functionality

```
Device# configure terminal
Enter configuration commands, one per line. End with CNTL/Z.

Device(config)# service password-recovery
Executing this command enables the password recovery mechanism.
Device(config)#

Device# configure terminal
Enter configuration commands, one per line. End with CNTL/Z.
Device(config)# no service password-recovery

WARNING:
Executing this command will disable the password recovery mechanism.
Do not execute this command without another plan for password recovery.

Are you sure you want to continue? [yes]: yes
Device(config)#
```

Configuring a Console Port Transport Map

This task describes how to configure a transport map for a console port interface on the router.

Procedure

| | Command or Action | Purpose |
|---------------|-------------------------------------------------------------------------------------------|-----------------------------------------------------------------------|
| Step 1 | enable Example: Router> enable | Enables privileged EXEC mode. Enter your password if prompted. |
| Step 2 | configure terminal Example: Router# configure terminal | Enters global configuration mode. |

| | Command or Action | Purpose |
|--------|----------------------------------------------------------------------------------------------------------------------------------------------------------------------------------------------------------------------------------------------------------------|----------------------------------------------------------------------------------------------------------------------------------------------------------------------------------------------------------------------------------------------------------------------------------------------------------------------------------------------------------------------------------------------------------------------------------------------------------------------------------------------------------------------------------------------------------------------------------------------------------------------------------------------------------------------------------------------------------------------------------------------------------------------|
| Step 3 | <p>transport-map type console <i>transport-map-name</i></p> <p>Example:</p> <pre>Router(config)# transport-map type console consolehandler</pre> | Creates and names a transport map for handling console connections, and enters transport map configuration mode. |
| Step 4 | <p>connection wait [allow [interruptible] none [disconnect]]</p> <p>Example:</p> <pre>Router(config-tmap)# connection wait none</pre> | <p>Specifies how a console connection will be handled using this transport map.</p> <ul style="list-style-type: none"> • allow interruptible—The console connection waits for a Cisco IOS VTY line to become available, and also allows users to enter diagnostic mode by interrupting a console connection that is waiting for a Cisco IOS VTY line to become available. This is the default setting. <p>Note Users can interrupt a waiting connection by entering Ctrl-C or Ctrl-Shift-6.</p> <ul style="list-style-type: none"> • none—The console connection immediately enters diagnostic mode. |
| Step 5 | <p>(Optional) banner [diagnostic wait] <i>banner-message</i></p> <p>Example:</p> <pre>Router(config-tmap)# banner diagnostic X Enter TEXT message. End with the character 'X'. --Welcome to Diagnostic Mode-- X Router(config-tmap)#</pre> | <p>(Optional) Creates a banner message that will be seen by users entering diagnostic mode or waiting for the Cisco IOS VTY line because of the console transport map configuration.</p> <ul style="list-style-type: none"> • diagnostic—Creates a banner message seen by users directed to diagnostic mode because of the console transport map configuration. <p>Note Users can interrupt a waiting connection by entering Ctrl-C or Ctrl-Shift-6.</p> <ul style="list-style-type: none"> • wait—Creates a banner message seen by users waiting for Cisco IOS VTY to become available. • <i>banner-message</i>—Banner message, which begins and ends with the same delimiting character. |
| Step 6 | <p>exit</p> <p>Example:</p> <pre>Router(config-tmap)# exit</pre> | Exits transport map configuration mode to re-enter global configuration mode. |

| | Command or Action | Purpose |
|---------------|--------------------------------------------------------------------------------------------------------------------------------------------------------------------------------|---------------------------------------------------------------------------------------------------------------------------------------------------------------------------------------------------------------------------------------------|
| Step 7 | <pre>transport type console console-line-number input transport-map-name</pre> <p>Example:</p> <pre>Router(config)# transport type console 0 input consolehandler</pre> | <p>Applies the settings defined in the transport map to the console interface.</p> <p>The <i>transport-map-name</i> for this command must match the <i>transport-map-name</i> defined in the transport-map type console command.</p> |

Examples

The following example shows how to create a transport map to set console port access policies and attach to console port 0:

```
Router(config)# transport-map type console consolehandler
Router(config-tmap)# connection wait allow interruptible
Router(config-tmap)# banner diagnostic X
Enter TEXT message. End with the character 'X'.
--Welcome to diagnostic mode--
X
Router(config-tmap)# banner wait X
Enter TEXT message. End with the character 'X'.
Waiting for IOS vty line
X
Router(config-tmap)# exit
Router(config)# transport type console 0 input consolehandler
```

Viewing Console Port, SSH, and Telnet Handling Configurations

Use the following commands to view console port, SSH, and Telnet handling configurations:

- **show transport-map**
- **show platform software configuration access policy**

Use the **show transport-map** command to view transport map configurations.

```
show transport-map [all | name transport-map-name | type [console ]]
```

This command can be used either in user EXEC mode or privileged EXEC mode.

Example

The following example shows transport maps that are configured on the router: console port (consolehandler):

```
Router# show transport-map allTransport Map:
Name: consolehandler Type: Console Transport

Connection:
Wait option: Wait Allow Interruptable Wait banner:

Waiting for the IOS CLI bshell banner:
Welcome to Diagnostic Mode
```

```
Router# show transport-map type consoleTransport Map:
Name: consolehandler
```

```
REVIEW DRAFT - CISCO CONFIDENTIAL
```

```
Type: Console Transport
```

```
Connection:
```

```
Wait option: Wait Allow Interruptable Wait banner:
```

```
Waiting for the IOS CLI Bshell banner:
```

```
Welcome to Diagnostic Mode
```

```
Router# show transport-map type persistent sshTransport Map:
```

```
Name: consolehandler Type: Console Transport
```

```
Connection:
```

```
Wait option: Wait Allow Interruptable Wait banner:
```

```
Waiting for the IOS CLI Bshell banner:
```

```
Welcome to Diagnostic Mode
```

Use the **show platform software configuration access policy** command to view the current configurations for handling the incoming console port, SSH, and Telnet connections. The output of this command provides the current wait policy for each type of connection (Telnet, SSH, and console), as well as information on the currently configured banners.

Unlike the **show transport-map** command, the **show platform software configuration access policy** command is available in diagnostic mode so that it can be entered in scenarios where you need transport map configuration information, but cannot access the Cisco IOS CLI.

Example

The following example shows the **show platform software configuration access policy** command.

```
Router# show platform software configuration access policyThe current access-policies
```

```
Method : telnet
```

```
Rule : wait with interrupt Shell banner:
```

```
Welcome to Diagnostic Mode
```

```
Wait banner :
```

```
Waiting for IOS Process
```

```
Method : ssh Rule : wait Shell banner: Wait banner :
```

```
Method : console
```

```
Rule : wait with interrupt Shell banner:
```

```
Wait banner :
```

Configuring Console Port for Modem Connection

Cisco 1100 Series router supports connecting a modem to the router console port for EXEC dial in connectivity. When a modem is connected to the console port, a remote user can dial in to the router and configure it. To configure a modem on the console port, perform these steps:

Procedure

- Step 1** Connect the RJ-45 end of the adapter cable to the console port on the router.
- Step 2** Use the **show line** command to determine the async interface of the console port:

```
Router# show line

Router#show line
Tty Line Typ Tx/Rx A Modem Roty AccO AccI Uses Noise Overruns Int
* 0 0 CTY - - - - 0 0 0/0 -
866 866 VTY - - - - 0 0 0/0 -
867 867 VTY - - - - 0 0 0/0 -
868 868 VTY - - - - 0 0 0/0 -
869 869 VTY - - - - 0 0 0/0 -
870 870 VTY - - - - 0 0 0/0 -
```

- Step 3** Use the following commands to configure the router console line::

```
Router(config)# line con 0

Router(config-line)#modem inOut
Router(config-line)#modem autoconfigure type usr_sportster
Router(config-line)#speed 115200 [Speed to be set according to the modem manual]
Router(config-line)#stopbits 1 [Stopbits to be set according to the modem manual]
Router(config-line)#transport input all
Router(config-line)#flowcontrol hardware [flowcontrol to be set according to the modem manual]
Router(config-line)#password cisco
Router(config-line)#login
Router(config-line)#end
Router(config)#enable password lab
```

- Step 4** Use the reverse telnet method on the modem to verify the modem connectivity and configuration string:

```
Router(config)#int loopback 0
Router(config-if)#ip add 1.1.1.1 255.255.255.0
Router(config-if)#end
Router#telnet 1.1.1.1 2001
Trying 1.1.1.1, 2001 ... Open

User Access Verification

Password: <enter the password given under line configuration>

at <<<=== Modem command
OK <<<=== This OK indicates that the modem is connected successfully to the console port.
```

- Step 5** Use an analog phone to verify that the phone line is active and functions properly. Then, connect the analog phone line to the modem.
- Step 6** Initialize an EXEC modem call to the router from another device (PC) to test the modem connection.
- Step 7** When the connection is established, the dial in client is prompted for a password. Enter the correct password.

Note: This password should match the one that is configured on the console port line.



CHAPTER 6

Setting Up Factory Default Device Using WebUI

Quick Setup Wizard allows you perform the basic router configuration. To configure the router:



Note Before you access the WebUI, you need to have the basic configuration on the device.

Procedure

- Step 1** Ensure that the router is in the factory fresh mode. If the router is not in the factory fresh mode, use the write erase option to erase all the configuration from the router.
- Step 2** Ensure that the following basic configuration is available on the device.
- ```
!
!
ip dhcp excluded-address 192.168.1.1 192.168.1.5
!
ip dhcp pool WEBUIPool
network 192.168.1.0 255.255.255.0
default-router 192.168.1.1
dns-server 192.168.1.1
!
!
username webui privilege 15 secret cisco
!
interface Vlan1
ip address 192.168.1.1 255.255.255.0
ip nat inside
no shutdown
!
```
- Step 3** Connect the PC to any of the switch port which is the member of VLAN1. By default, all the ports will be the member of VLAN1 and the PC receives the IP address from the pool WEBUIPool.
- Step 4** After your PC receives the IP address, launch the browser, type <https://192.168.1.1/webui/#/dayZeroRouting> or enter <http://192.168.1.1/webui/#/dayZeroRouting>.
- Step 5** Enter the default username (webui) and default password (cisco).

- [Using Basic or Advanced Mode Setup Wizard, on page 108](#)
- [Configure LAN Settings, on page 109](#)

- [Configure Primary WAN Settings, on page 109](#)
- [Configure Secondary WAN Settings, on page 110](#)
- [Configure Security Settings, on page 111](#)
- [Using Web User Interface for Day One Setup, on page 111](#)
- [Monitor and Troubleshoot Device Plug and Play \(PnP\) Onboarding using WebUI , on page 112](#)

## Using Basic or Advanced Mode Setup Wizard

To configure the router using the basic or advanced mode setup:

### Procedure

---

- Step 1** Choose the **Basic Mode** or **Advanced Mode** and click **Go To Account Creation Page**.
- Step 2** Enter the username and password. Reenter the password to confirm.
- Step 3** Click **Create and Launch Wizard**.
- Step 4** Enter the device name and domain name.
- Step 5** Select the appropriate time zone from the **Time Zone** drop-down list.
- Step 6** Select the appropriate date and time mode from the **Date and Time** drop-down list.
- Step 7** Click **LAN Settings**.

# Configure LAN Settings

## Procedure

- Step 1** Choose the **Web DHCP Pool/DHCP Pool** name or the **Create and Associate Access VLAN** option.
- If you choose the Web DHCP Pool, specify the following:
    - Pool Name**—Enter the DHCP Pool Name.
    - Network**—Enter network address and the subnet mask.
  - If you choose the Create and Associate Access VLAN option, specify the following:
    - Access VLAN**—Enter the Access VLAN identification number. The range is from 1 to 4094.
    - Network**—Enter the IP address of the VLAN.
    - Management Interfaces**—Select the interface and move to the selected list box using the right and left arrows. You can also double click or drag and drop to move the interface to the selected list box.
- Step 2** Click **Primary WAN Settings**.

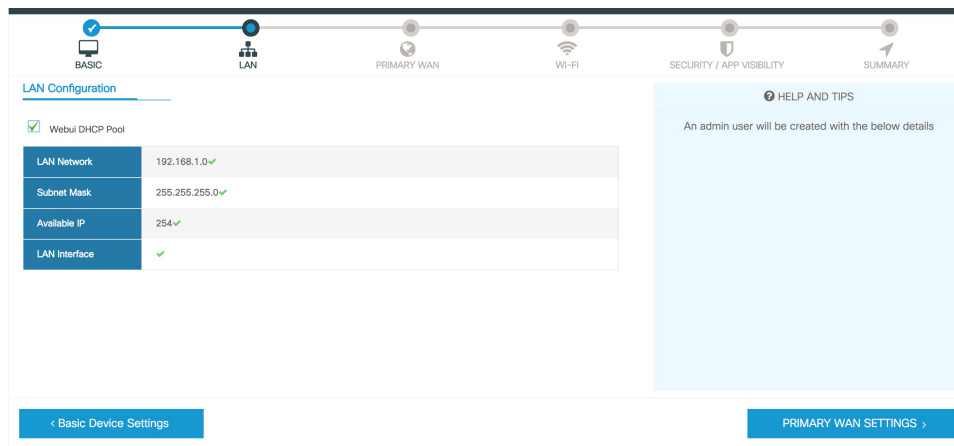

# Configure Primary WAN Settings

## Procedure

- Step 1** Select the primary WAN type. You can configure Serial, 3G/4G, Ethernet, or Broadband (xDSL) as primary WAN depending on the WAN types supported by the router.
- Step 2** Select the interface from the drop-down list.

- Step 3** Check the **Get DNS Server info directly from ISP** check box to get the DNS server information directly from the service provider. You can also manually enter the Primary DNS and Secondary DNS.
- Step 4** Check the **Get IP automatically from ISP** check box to get the IP address information directly from the service provider. You can also manually enter the IP address and subnet mask.
- Step 5** Check the **Enable NAT** check box to enable NAT. It is recommended to enable NAT.
- Step 6** Check the **Enable PPPOE** check box to enable PPPoE. If you have enabled PPPoE, select the required authentication mode. The options are: **PAP** and **CHAP**.
- Step 7** Enter the username and password provided by the service provider.
- Step 8** Click **Security / APP Visibility WAN Settings**.

## Configure Secondary WAN Settings

For advanced configuration, you should configure the secondary WAN connection.

### Procedure

- Step 1** Select the secondary WAN type. You can configure Serial, 3G/4G, Ethernet, or Broadband (xDSL) as a secondary WAN depending on the WAN types supported by the router.
- Step 2** Select the interface from the drop-down list.
- Step 3** Check the **Get DNS Server info directly from ISP** check box to get the DNS server information directly from the service provider. You can also manually enter the Primary DNS and Secondary DNS.
- Step 4** Check the **Get IP automatically from ISP** check box to get the IP address information directly from the service provider. You can also manually enter the IP address and subnet mask.
- Step 5** Check the **Enable NAT** check box to enable NAT. It is recommended to enable NAT.
- Step 6** Check the **Enable PPPOE** check box to enable PPPoE. If you have enabled PPPoE, select the required authentication mode. The options are **PAP** and **CHAP**.
- Step 7** Enter the username and password provided by the service provider.
- Step 8** Click **Security / APP Visibility WAN Settings**.



# Configure Security Settings

## Procedure

- Step 1** Check the **Enable Cisco Recommended Security Settings** check box to ensure that all passwords are not shown in plain text. The passwords are encrypted.
- Step 2** Click **Day 0 Config Summary**.
- Step 3** To preview the configuration, click **CLI Preview** to preview the configuration.
- Step 4** Click **Finish** to complete the Day Zero setup.

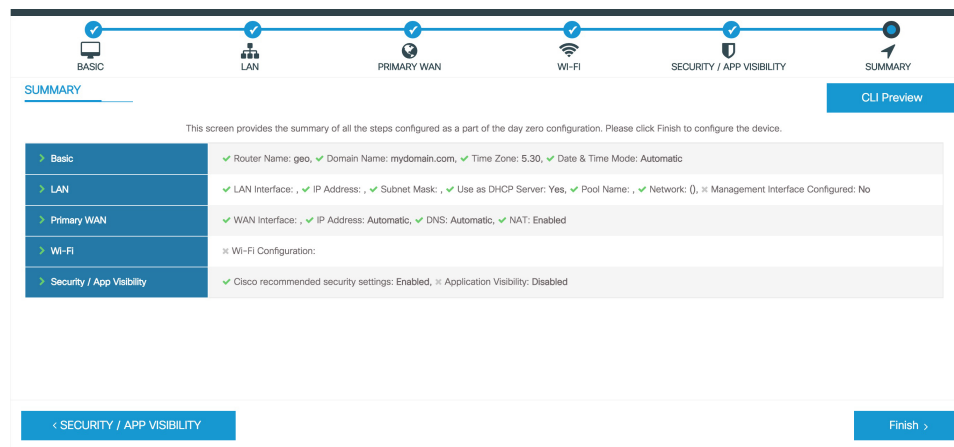

## Using Web User Interface for Day One Setup

To configure the Web user interface:

### Before you begin

- You need to configure at least 30 VTY lines on the device for the Web UI information to be displayed without errors.
- You need a user with privilege 15 to access the configuration screens on Web UI. If the privilege is less than 15, you can access only the Dashboard and Monitoring screens on Web UI.

To create a user account, use the **username <username> privilege <privilege> password 0 <passwordtext>**

```
Device #configure terminal
```

```
Device (config)# username <username> privilege <privilege> password 0 <passwordtext>
```

## Procedure

- Step 1** Configure the HTTP server. By default, the HTTP server configuration should be present on the device. Ensure the configuration by checking if the **ip http server** and **ip http secure-server** commands are present in the running configuration.

```
Device #configure terminal
Device (config)#ip http server
Device (config)#ip http secure-server
```

- Step 2** Set up the authentication options to log into Web UI. You can use one of these methods to authenticate:
- You can authenticate using local database. To use a local database for Web UI authentication, ensure to have the **ip http authentication local** command in the running configuration. This command is preconfigured on the device. If the command is not present, configure the device as shown in this example:

```
Device #configure terminal
Device (config)#ip http authentication local
```

- Authenticate using AAA options. To use AAA authentication for Web UI, ensure to configure 'ip http authentication aaa' on the device. Also, ensure that the required AAA server configuration is present on the device.

```
Device #configure terminal
Device (config)#ip http authentication local
```

- Step 3** Launch the browser. In the address bar, type the IP address of the device. For a secure connection, type `https://ip-address`.
- Step 4** Enter the default username (webui) and default password (cisco).
- Step 5** Click **Log In**.

# Monitor and Troubleshoot Device Plug and Play (PnP) Onboarding using WebUI

*Table 9: Feature History*

| Feature Name                                               | Release Information          | Description                                                                                                                                                                        |
|------------------------------------------------------------|------------------------------|------------------------------------------------------------------------------------------------------------------------------------------------------------------------------------|
| Monitor and Troubleshoot Device PnP Onboarding using WebUI | Cisco IOS XE Release 17.5.1a | You can now monitor and troubleshoot your Day-0 device onboarding using WebUI through PnP onboarding. If the automated PnP onboarding fails, you can manually onboard your device. |

A device can be automatically onboarded to Cisco vManage through either Zero Touch Provisioning (ZTP) or the Plug and Play (PnP) process. This section describes the procedure to monitor and troubleshoot device onboarding through the PnP method. This feature on WebUI enables you to monitor and troubleshoot the PnP

onboarding process, and also see its real-time status. If this onboarding is stuck or fails, you can terminate the process and onboard your device manually.

### Prerequisites

- Your device (a computer that can run a web browser) running the WebUI and the device you are onboarding must be connected through an L2 switch port (NIM) on the device.
- The DHCP client-identifier on your device must be set to string “webui”.
- Your device must support Cisco SD-WAN Day-0 device onboarding on WebUI.

### Troubleshoot Device PnP Onboarding

To troubleshoot device onboarding through PnP in controller mode:

1. Enter the controller mode in WebUI:

- Switching from autonomous mode to controller mode:

Usually, when you boot your device for the first time it is in autonomous mode. Go to the URL <https://192.168.1.1/webui/> and log in using the default credentials— webui/cisco. If your device supports Cisco SD-WAN Day-0 device onboarding on WebUI, you can switch to the controller mode by selecting **Controller Mode**. A dialogue box appears, asking if you want to continue. Click **Yes**. Your device reloads to switch to controller mode.

- Booting your device in controller mode:

If your device is already in the controller mode, you do not have to make any changes to the mode. Go to the URL <https://192.168.1.1> or <https://192.168.1.1/webui>. If your device supports Cisco SD-WAN Day-0 device onboarding on WebUI, the URL is redirected to <https://192.168.1.1/ciscosdwan/> and you can log in using the default credentials for Cisco IOS XE SD-WAN devices - admin/admin.



---

**Note** If the device does not have start-up configuration at the time of PnP onboarding, the WebUI is enabled by default on supported devices.

---

2. On the **Welcome to Cisco SDWAN Onboarding Wizard** page, click **Reset Default Password**.



---

**Note** The default password of your Day-0 device is weak. Therefore, for a secure log in, you must reset the password when you first log in to the device on WebUI. The WebUI configuration is automatically deleted after the device is onboarded successfully. In rare cases where the template configuration for your device on Cisco vManage has the WebUI configuration, it is not deleted even after a successful device onboarding.

---

3. You are redirected to the Device hardware and software details page. Enter your password and click **Submit**.
4. The next page displays the onboarding progress and lists statuses of different components of the PnP Connect Portal and Cisco SD-WAN controllers. If the PnP IPv4 component fails, it indicates that the device PnP onboarding has failed.

To view and download logs for the onboarding process, click the information icon on the right hand side of the SDWAN Onboarding Progress bar.

5. If the automated PnP onboarding fails, click **Terminate Automated Onboarding**. This allows you to onboard your device manually.
6. A dialogue box appears. To continue with the termination, click **Yes**. It might take a few minutes for the termination to complete.
7. On the Bootstrap Configuration page click **Select File** and choose the bootstrap file for your device. This file can be either a generic bootstrap file (common platform-specific file) or a full configuration bootstrap file that you can download from Cisco vManage. This file must contain details such as the vBond number, UUID, WAN interface, root CA and configuration.
8. Click **Upload**.
9. After your file is successfully uploaded, click **Submit**.
10. You can see the SDWAN Onboarding Progress page again with statuses of the Cisco SD-WAN controllers. To open the Controller Connection History table click the information icon on the right hand side of the SDWAN Control Connections bar. In this table you can see the state of your onboarded device. After the onboarding is complete, the state of your device changes to **connect**.



## CHAPTER 7

# Process Health Monitoring

---

This chapter describes how to manage and monitor the health of various components of your router. It contains the following sections:

- [Monitoring Control Plane Resources, on page 115](#)
- [Monitoring Hardware Using Alarms, on page 119](#)

## Monitoring Control Plane Resources

The following sections explain the details of memory and CPU monitoring from the perspective of the Cisco IOS process and the overall control plane:

- [Avoiding Problems Through Regular Monitoring, on page 115](#)
- [Cisco IOS Process Resources, on page 115](#)
- [Overall Control Plane Resources, on page 117](#)

## Avoiding Problems Through Regular Monitoring

Processes should provide monitoring and notification of their status/health to ensure correct operation. When a process fails, a syslog error message is displayed and either the process is restarted or the router is rebooted. A syslog error message is displayed when a monitor detects that a process is stuck or has crashed. If the process can be restarted, it is restarted; else, the router is restarted.

Monitoring system resources enables you to detect potential problems before they occur, thus avoiding outages. It also establishes a baseline for a normal system load. You can use this information as a basis for comparison, when you upgrade hardware or software to see if the upgrade has affected resource usage.

## Cisco IOS Process Resources

You can view CPU utilization statistics on active processes and see the amount of memory being used in these processes using the **show memory** command and the **show process cpu** command. These commands provide a representation of memory and CPU utilization from the perspective of only the Cisco IOS process; they do not include information for resources on the entire platform. When the **show memory** command is used in a system with 4 GB RAM running a single Cisco IOS process, the following memory usage is displayed:

```

Router# show memory
Tracekey : 1#24c450a57e03d03a6788866ae1d462e4
Address Bytes Prev Next Ref PrevF NextF what Alloc
PC
Head Total(b) Used(b) Free(b) Lowest(b) Largest(b)
Processor 7F51210010 1499843648 303330248 1196513400 786722360 713031588
lsmapi_io 7F506281A8 6295128 6294304 824 824 412
Dynamic heap limit(MB) 680 Use(MB) 0

```

## Processor memory

```

Address Bytes Prev Next Ref PrevF NextF what
Alloc PC
7F51210010 0000000568 00000000 7F512102A0 001 ----- ----- *Init*
:400000+896EB88
7F512102A0 0000032776 7F51210010 7F51218300 001 ----- ----- Managed Chunk Q
:400000+295B3C8
7F51218300 0000000056 7F512102A0 7F51218390 001 ----- ----- *Init*
:400000+896EB88
7F51218390 0000012808 7F51218300 7F5121B5F0 001 ----- ----- *Init*
:400000+896EB88
Address Bytes Prev Next Ref PrevF NextF what
Alloc PC
7F5121B5F0 0000032776 7F51218390 7F51223650 001 ----- ----- List Elements
:400000+2948680
7F51223650 0000010008 7F5121B5F0 7F51225DC0 001 ----- ----- List Headers
:400000+2948680
7F51225DC0 0000032776 7F51223650 7F5122DE20 001 ----- ----- IOSXE Process S
:400000+295B3C8
7F5122DE20 0000032776 7F51225DC0 7F51235E80 001 ----- ----- IOSXE Queue Pro
:400000+295B3C8
7F51235E80 0000065544 7F5122DE20 7F51245EE0 001 ----- ----- IOSXE Queue Bal
:400000+295B3C8
7F51245EE0 0000000112 7F51235E80 7F51245FA8 001 ----- ----- *Init*
:400000+2951DE0
7F51245FA8 0000036872 7F51245EE0 7F5124F008 001 ----- ----- *Init*
:400000+2950FB4
7F5124F008 0000010008 7F51245FA8 7F51251778 001 ----- ----- Platform VM Pag
:400000+295B3C8
7F51251778 0000000328 7F5124F008 7F51251918 001 ----- ----- *Init*
:400000+896EB88
7F51251918 0000000328 7F51251778 7F51251AB8 001 ----- ----- *Init*
:400000+896EB88
7F51251AB8 0000000896 7F51251918 7F51251E90 001 ----- ----- Watched Message
:400000+295B3C8
...

```

The **show process cpu** command displays Cisco IOS CPU utilization average:

```

Router# show process cpu
CPU utilization for five seconds: 1%/1%; one minute: 1%; five minutes: 1%
PID Runtime(ms) Invoked uSecs 5Sec 1Min 5Min TTY Process
 1 0 21 0 0.00% 0.00% 0.00% 0 Chunk Manager
 2 5692 12584 452 0.00% 0.00% 0.00% 0 Load Meter
 3 0 1 0 0.00% 0.00% 0.00% 0 PKI Trustpool
 4 0 1 0 0.00% 0.00% 0.00% 0 Retransmission o
 5 0 1 0 0.00% 0.00% 0.00% 0 IPC ISSU Dispatc
 6 16 12 1333 0.00% 0.00% 0.00% 0 RF Slave Main Th
 7 4 1 4000 0.00% 0.00% 0.00% 0 EDDRI_MAIN

```

|     |              |         |       |       |       |       |     |                  |
|-----|--------------|---------|-------|-------|-------|-------|-----|------------------|
| 8   | 0            | 1       | 0     | 0.00% | 0.00% | 0.00% | 0   | RO Notify Timers |
| 9   | 38188        | 8525    | 4479  | 0.00% | 0.04% | 0.05% | 0   | Check heaps      |
| 10  | 12           | 1069    | 11    | 0.00% | 0.00% | 0.00% | 0   | Pool Manager     |
| 11  | 0            | 1       | 0     | 0.00% | 0.00% | 0.00% | 0   | DiscardQ Backgro |
| PID | Runtime (ms) | Invoked | uSecs | 5Sec  | 1Min  | 5Min  | TTY | Process          |
| 12  | 0            | 2       | 0     | 0.00% | 0.00% | 0.00% | 0   | Timers           |
| 13  | 0            | 29      | 0     | 0.00% | 0.00% | 0.00% | 0   | WATCH_AFS        |
| 14  | 0            | 1       | 0     | 0.00% | 0.00% | 0.00% | 0   | MEMLEAK PROCESS  |
| 15  | 3840         | 23732   | 161   | 0.00% | 0.00% | 0.00% | 0   | ARP Input        |
| 16  | 1156         | 65637   | 17    | 0.00% | 0.00% | 0.00% | 0   | ARP Background   |
| 17  | 0            | 2       | 0     | 0.00% | 0.00% | 0.00% | 0   | ATM Idle Timer   |
| 18  | 0            | 1       | 0     | 0.00% | 0.00% | 0.00% | 0   | ATM ASYNC PROC   |
| 19  | 0            | 1       | 0     | 0.00% | 0.00% | 0.00% | 0   | CEF MIB API      |
| 20  | 0            | 1       | 0     | 0.00% | 0.00% | 0.00% | 0   | AAA_SERVER_DEADT |
| 21  | 0            | 1       | 0     | 0.00% | 0.00% | 0.00% | 0   | Policy Manager   |
| 22  | 0            | 2       | 0     | 0.00% | 0.00% | 0.00% | 0   | DDR Timers       |
| PID | Runtime (ms) | Invoked | uSecs | 5Sec  | 1Min  | 5Min  | TTY | Process          |
| 23  | 76           | 19      | 4000  | 0.00% | 0.00% | 0.00% | 0   | Entity MIB API   |
| 24  | 124          | 38      | 3263  | 0.00% | 0.00% | 0.00% | 0   | PrstVbl          |
| 25  | 0            | 2       | 0     | 0.00% | 0.00% | 0.00% | 0   | Serial Backgroun |
| 26  | 0            | 1       | 0     | 0.00% | 0.00% | 0.00% | 0   | RMI RM Notify Wa |
| 27  | 0            | 2       | 0     | 0.00% | 0.00% | 0.00% | 0   | ATM AutoVC Perio |
| 28  | 0            | 2       | 0     | 0.00% | 0.00% | 0.00% | 0   | ATM VC Auto Crea |
| 29  | 768          | 31455   | 24    | 0.00% | 0.00% | 0.00% | 0   | IOSXE heartbeat  |
| 30  | 180          | 1866    | 96    | 0.00% | 0.00% | 0.00% | 0   | DB Lock Manager  |
| 31  | 0            | 1       | 0     | 0.00% | 0.00% | 0.00% | 0   | DB Notification  |
| 32  | 0            | 1       | 0     | 0.00% | 0.00% | 0.00% | 0   | IPC Apps Task    |
| 33  | 0            | 1       | 0     | 0.00% | 0.00% | 0.00% | 0   | ifIndex Receive  |

...

## Overall Control Plane Resources

Control plane memory and CPU utilization on each control processor allows you to keep a tab on the overall control plane resources. You can use the **show platform software status control-processor brief** command (summary view) or the **show platform software status control-processor** command (detailed view) to view control plane memory and CPU utilization information.

All control processors should show status, Healthy. Other possible status values are Warning and Critical. Warning indicates that the router is operational, but that the operating level should be reviewed. Critical implies that the router is nearing failure.

If you see a Warning or Critical status, take the following actions:

- Reduce the static and dynamic loads on the system by reducing the number of elements in the configuration or by limiting the capacity for dynamic services.
- Reduce the number of routes and adjacencies, limit the number of ACLs and other rules, reduce the number of VLANs, and so on.

The following sections describe the fields in the **show platform software status control-processor** command output.

### Load Average

Load average represents the process queue or process contention for CPU resources. For example, on a single-core processor, an instantaneous load of 7 would mean that seven processes are ready to run, one of

which is currently running. On a dual-core processor, a load of 7 would mean that seven processes are ready to run, two of which are currently running.

### Memory Utilization

Memory utilization is represented by the following fields:

- Total—Total system memory
- Used—Consumed memory
- Free—Available memory
- Committed—Virtual memory committed to processes

### CPU Utilization

CPU utilization is an indication of the percentage of time the CPU is busy, and is represented by the following fields:

- CPU—Allocated processor
- User—Non-Linux kernel processes
- System—Linux kernel process
- Nice—Low-priority processes
- Idle—Percentage of time the CPU was inactive
- IRQ—Interrupts
- SIRQ—System Interrupts
- IOWait—Percentage of time CPU was waiting for I/O

### Example: show platform software status control-processor Command

The following are some examples of using the **show platform software status control-processor** command:

```
Router# show platform software status control-processor
RP0: online, statistics updated 5 seconds ago
Load Average: healthy
 1-Min: 0.90, status: healthy, under 5.00
 5-Min: 0.87, status: healthy, under 5.00
 15-Min: 0.95, status: healthy, under 5.00
Memory (kb): healthy
 Total: 3448368
 Used: 1979068 (57%), status: healthy
 Free: 1469300 (43%)
 Committed: 2002904 (58%), under 90%
Per-core Statistics
CPU0: CPU Utilization (percentage of time spent)
 User: 1.54, System: 1.33, Nice: 0.00, Idle: 97.11
 IRQ: 0.00, SIRQ: 0.00, IOWait: 0.00
CPU1: CPU Utilization (percentage of time spent)
 User: 1.53, System: 0.82, Nice: 0.00, Idle: 97.64
 IRQ: 0.00, SIRQ: 0.00, IOWait: 0.00
CPU2: CPU Utilization (percentage of time spent)
```



```
User: 2.77, System: 9.38, Nice: 0.00, Idle: 87.84
IRQ: 0.00, SIRQ: 0.00, IOWait: 0.00
CPU3: CPU Utilization (percentage of time spent)
User: 12.62, System: 64.63, Nice: 0.00, Idle: 22.74
IRQ: 0.00, SIRQ: 0.00, IOWait: 0.00
```

```
Router# show platform software status control-processor brief
```

```
Load Average
```

```
Slot Status 1-Min 5-Min 15-Min
RP0 Healthy 0.87 0.87 0.94
```

```
Memory (kB)
```

```
Slot Status Total Used (Pct) Free (Pct) Committed (Pct)
RP0 Healthy 3448368 1996720 (58%) 1451648 (42%) 2003380 (58%)
```

```
CPU Utilization
```

```
Slot CPU User System Nice Idle IRQ SIRQ IOWait
RP0 0 1.54 0.92 0.00 97.53 0.00 0.00 0.00
 1 1.64 1.12 0.00 97.22 0.00 0.00 0.00
 2 3.32 8.36 0.00 88.30 0.00 0.00 0.00
 3 12.58 64.44 0.00 22.97 0.00 0.00 0.00
```

## Monitoring Hardware Using Alarms

### Router Design and Monitoring Hardware

The router sends alarm notifications when problems are detected, allowing you to monitor the network remotely. You do not need to use **show** commands to poll devices on a routine basis; however, you can perform onsite monitoring if you choose.

### BootFlash Disk Monitoring

The bootflash disk must have enough free space to store two core dumps. This condition is monitored, and if the bootflash disk is too small to store two core dumps, a syslog alarm is generated, as shown in the following example:

```
Oct 6 14:10:56.292: %FLASH_CHECK-3-DISK_QUOTA: R0/0: flash_check: Flash disk quota exceeded
[free space is 1429020 kB] - Please clean up files on bootflash.
```

## Approaches for Monitoring Hardware Alarms

### Viewing the Console or Syslog for Alarm Messages

The network administrator can monitor alarm messages by reviewing alarm messages sent to the system console or to a system message log (syslog).

## Enabling the logging alarm Command

The **logging alarm** command must be enabled for the system to send alarm messages to a logging device, such as the console or a syslog. This command is not enabled by default.

You can specify the severity level of the alarms to be logged. All the alarms at and above the specified threshold generate alarm messages. For example, the following command sends only critical alarm messages to logging devices:

```
Router(config)# logging alarm critical
```

If alarm severity is not specified, alarm messages for all severity levels are sent to logging devices.

## Examples of Alarm Messages

The following are examples of alarm messages that are sent to the console.

### Alarms

To view alarms, use the **show facility-alarm status** command. The following example shows a critical alarm for the power supply:

```
Device# show facility-alarm status
Source Severity Description [Index]

Cellular0/2/0 INFO Physical Port Administrative State Down [2]
Cellular0/2/1 INFO Physical Port Administrative State Down [2]
```

To view critical alarms, use the **show facility-alarm status critical** command, as shown in the following example:

```
Device# show facility-alarm status critical
system Totals Critical: 4 Major: 0 Minor: 0
Source Time Severity Description [Index]

GigabitEthernet0/1/0 Jul 12 2017 22:27:25 CRITICAL Physical Port Link Down [1]
GigabitEthernet0/1/1 Jul 12 2017 22:27:25 CRITICAL Physical Port Link Down [1]
GigabitEthernet0/1/2 Jul 12 2017 22:27:25 CRITICAL Physical Port Link Down [1]
GigabitEthernet0/1/3 Jul 12 2017 22:27:25 CRITICAL Physical Port Link Down [1]
```

To view the operational state of the major hardware components on the Device, use the **show platform diag** command. This example shows that power supply P0 has failed:

```
Device# show platform diag

Chassis type: C1117-4PLTEEA

Slot: 0, C1117-4PLTEEA
 Running state : ok
 Internal state : online
 Internal operational state : ok
 Physical insert detect time : 00:01:52 (09:02:14 ago)
 Software declared up time : 00:03:12 (09:00:54 ago)
 CPLD version : 17100501
 Firmware version : 16.6(1r)RC3

Sub-slot: 0/0, C1117-1x1GE
 Operational status : ok
 Internal state : inserted
 Physical insert detect time : 00:04:34 (08:59:32 ago)
 Logical insert detect time : 00:04:34 (08:59:32 ago)
```

```

Sub-slot: 0/1, C1117-ES-4
 Operational status : ok
 Internal state : inserted
 Physical insert detect time : 00:04:34 (08:59:32 ago)
 Logical insert detect time : 00:04:34 (08:59:32 ago)

Sub-slot: 0/2, C1117-LTE
 Operational status : ok
 Internal state : inserted
 Physical insert detect time : 00:04:34 (08:59:32 ago)
 Logical insert detect time : 00:04:34 (08:59:32 ago)

Sub-slot: 0/3, C1117-VADSL-A
 Operational status : ok
 Internal state : inserted
 Physical insert detect time : 00:04:34 (08:59:32 ago)
 Logical insert detect time : 00:04:34 (08:59:32 ago)

Slot: R0, C1117-4PLTEEA
 Running state : ok, active
 Internal state : online
 Internal operational state : ok
 Physical insert detect time : 00:01:52 (09:02:14 ago)
 Software declared up time : 00:01:52 (09:02:14 ago)
 CPLD version : 17100501
 Firmware version : 16.6(1r)RC3

Slot: F0, C1117-4PLTEEA
 Running state : ok, active
 Internal state : online
 Internal operational state : ok
 Physical insert detect time : 00:01:52 (09:02:14 ago)
 Software declared up time : 00:04:06 (09:00:00 ago)
 Hardware ready signal time : 00:02:44 (09:01:22 ago)
 Packet ready signal time : 00:04:31 (08:59:35 ago)
 CPLD version : 17100501
 Firmware version : 16.6(1r)RC3

Slot: P0, PWR-12V
 State : ok
 Physical insert detect time : 00:02:24 (09:01:43 ago)

Slot: GE-POE, Unknown
 State : NA
 Physical insert detect time : 00:00:00 (never ago)

```

## Reviewing and Analyzing Alarm Messages

To facilitate the review of alarm messages, you can write scripts to analyze alarm messages sent to the console or syslog. Scripts can provide reports on events such as alarms, security alerts, and interface status.

Syslog messages can also be accessed through Simple Network Management Protocol (SNMP) using the history table defined in the CISCO-SYSLOG-MIB.

## Network Management System Alerts a Network Administrator when an Alarm is Reported Through SNMP

The SNMP is an application-layer protocol that provides a standardized framework and a common language used for monitoring and managing devices in a network.

SNMP provides notification of faults, alarms, and conditions that might affect services. It allows a network administrator to access router information through a network management system (NMS) instead of reviewing logs, polling devices, or reviewing log reports.

To use SNMP to get alarm notification, use the following MIBs:

- ENTITY-MIB, RFC4133(required for the CISCO-ENTITY-ALARM-MIB, ENTITY-STATE-MIB and CISCO-ENTITY-SENSOR-MIB to work)
- CISCO-ENTITY-ALARM-MIB
- ENTITY-STATE-MIB
- CISCO-ENTITY-SENSOR-MIB(for transceiver environmental alarm information, which is not provided through the CISCO-ENTITY-ALARM-MIB)



## CHAPTER 8

# G.Fast and VDSL2 35b Profile

---

Cisco 1000 Series Intergration Services Routers (ISR) support single multimode G.fast and VDSL2 35b port, which are based on Fiber to X (FTTX) technology, to help accelerate ultra-broadband deployments at customer premises.

This chapter provides basic configuration procedures of the G.fast and VDSL2 35b and contains the following sections:

- [Feature Information for G.fast and VDSL2 35b Profile, on page 123](#)
- [Restrictions for G.Fast and VDSL2 35b, on page 124](#)
- [Information About G.Fast and VDSL2 35b, on page 124](#)
- [Configure G.Fast and VDSL2 35b, on page 126](#)
- [Example: G.Fast and VDSL2 35b, on page 126](#)
- [Additional References for G.fast or VDSL2 35b, on page 129](#)

## Feature Information for G.fast and VDSL2 35b Profile

The following table provides release information about the feature or features described in this module. This table lists only the software release that introduced support for a given feature in a given software release train. Unless noted otherwise, subsequent releases of that software release train also support that feature.

Use Cisco Feature Navigator to find information about platform support and Cisco software image support. To access Cisco Feature Navigator, go to [www.cisco.com/go/cfn](http://www.cisco.com/go/cfn). An account on Cisco.com is not required.

Table 10: Feature Information for G.Fast and VDSL2 35b

| Feature Name                 | Releases                         | Feature Information                                                                                                                                                                                                                                                                                                                                                                                                                                                                 |
|------------------------------|----------------------------------|-------------------------------------------------------------------------------------------------------------------------------------------------------------------------------------------------------------------------------------------------------------------------------------------------------------------------------------------------------------------------------------------------------------------------------------------------------------------------------------|
| G.Fast and VDSL2 35b Profile | Cisco IOS XE Fuji Release 16.7.1 | <p>Cisco 1000 Series Intergration Services Routers (ISR) uses G.fast and VDSL2 35b profiles, which are based on Fiber to X (FTTx) technology, to help accelerate ultra-broadband deployments at customer premises.</p> <p>G.fast and VDSL2 35b are supported on the following platforms:</p> <ul style="list-style-type: none"> <li>• Cisco ISR C1112</li> <li>• Cisco ISR C1113</li> </ul> <p>In this release, no commands were either introduced or modified by this feature.</p> |

## Restrictions for G.Fast and VDSL2 35b

- G.Fast and VDSL2 35b profile is supported only on Cisco 1100 Series Integrated Services Routers (ISRs).

## Information About G.Fast and VDSL2 35b

### Overview of G.fast and VDSL2 35b

G.fast is a digital subscriber line (DSL) protocol standard for local loops shorter than 500 m, with performance targets between 150 Mbit/s and 1 Gbit/s, depending on loop length. G.fast uses the gigabit broadband access technology for plain old telephone service (POTS) services that provides ultra-broadband speeds over existing wired infrastructure.

According to ITU-T G.9701, G.fast supports asymmetric and symmetric transmission at an aggregate net data rate upto 1 Gbit per sec on twisted paired wires. G.fast uses a spectrum of upto 106 MHz with all the necessary functionalities to support far-end cross-talk (FEXT) cancellation between multiple paired wires, thereby facilitating low power operation.

VDSL2 35b operates on frequencies upto 35.324 MHz with subcarrier spacing of 4.3125 kHz, supports vectoring that is compatible with ITU-T G.993.2 profile 17a. VDSL2 35b supports service providers to optimize their network infrastructure, provides simplified deployment and provisioning options, thereby lowering the overall operational cost for implementing ITU-T G.993.2.



---

**Note** There is no specific command to implement G.fast on the Cisco 1000 Series Integrated Services Routers (ISRs).

---

## Benefits of Implementing G.fast

The ISR1000 series routers with G.fast technology provides better and improved performance using vectoring technology with dedicated speed upto 1 gigabits per sec. The infrastructural changes at customer premises is minimal because G.fast can co-exist with legacy xDSL. G.fast equipment can be deployed from fibre-fed distribution points (fibre to the distribution point, FTTdp) located very near the customer premises, or within buildings (fibre to the building, FTTB) where the existing copper wiring can be used.

## Key DSL features on G.fast and VDSL2 35b

- G.fast basic standards: ITU-T G.9700 [21], ITU-T G.9701 [22], ITU-T G.9701 Amendment 1 [23], ITU-T G.997.2 [24]
- 106a and 106b profiles are supported on all G.fast supported ISR1000 Series Integrated Services Routers.
- Firmware sub-package upgrade or downgrade
- Seamless Rate Adaptation (SRA)
- Fast Rate Adaption (FRA)
- Impulse noise protection
- DSL Line Train Logging
- Vectoring, G.993.5 (G.Vector)
- Dying gasp
- Bit Swap
- Auto-Sensing Support:
- G.fast/VDSL2 combo PHY
- G.fast US/DS ratio and start frequency range
- IOS CLI
- Controller Interface CLIs
- ATM/Ethernet Interface CLIs
- Show/Debug CLIs
- MIB Support
- ADSL-LINE MIB (RFC 2662)
- VDSL2-LINE-MIB (RFC 5650)
- ENTITY-MIB
- IF-MIB
- TR-069 (CWMP)



**Note** VDSL2 bonding is not supported on C1100 Series Integrated Services Routers. SRA and Bit Swap are enabled by default.

For more information on firmware upgrade and training logs, refer to the [Upgrading the Modem Firmware](#) and [Collecting DSL and Training Logs](#) sections.

## Configure G.Fast and VDSL2 35b

### Configuring G.fast on the Cisco 1000 ISR

```
Device# configure terminal
 controller VDSL slot/subslot/port
 operating mode auto
end
```

#### Before you begin

Configure the modem in the auto mode for the modem to work with G.fast and VDSL2 35b.

## Example: G.Fast and VDSL2 35b

### Example: The following is sample output for VDSL2 35b

```
Device# show controllers vdsL 0/3/0
Controller VDSL 0/3/0 is UP

Daemon Status: UP

Chip Vendor ID: XTU-R (DS) XTU-C (US)
Chip Vendor Specific: 'BDCM' 'BDCM'
Chip Vendor Country: 0x0000 0xC08A
Chip Vendor Country: 0xB500 0xB500
Modem Vendor ID: 'CSCO' ' '
Modem Vendor Specific: 0x4602 0x0000
Modem Vendor Country: 0xB500 0x0000
Serial Number Near: FGL215092KJ C1113-8P 16.8.20180
Serial Number Far:
Modem Version Near: 16.8.20180107:17011
Modem Version Far: 0xc08a

Modem Status: TC Sync (Showtime!)
DSL Config Mode: AUTO
Trained Mode: G.993.2 (VDSL2) Profile 35b

TC Mode: PTM
Selftest Result: 0x00
DELT configuration: disabled
DELT state: not running
```



```

Failed full inits: 0
Short inits: 0
Failed short inits: 0

Modem FW Version: 4.16L.05
Modem PHY Version: A2pvfbH043j.d26r

Line 0:

 XTU-R (DS) XTU-C (US)
Trellis: ON ON
SRA: enabled enabled
SRA count: 0 0
Bit swap: enabled enabled
Bit swap count: 13 0
Line Attenuation: 5.7 dB 0.0 dB
Signal Attenuation: 6.4 dB 0.0 dB
Noise Margin: 7.9 dB 16.0 dB
Attainable Rate: 350000 kbits/s 61133 kbits/s
Actual Power: 7.0 dBm 2.8 dBm
Per Band Status: D1 D2 D3 U0 U1 U2 U3
Line Attenuation(dB): 3.2 3.6 6.7 N/A 0.0 0.0 N/A
Signal Attenuation(dB): 3.3 3.6 6.0 N/A 0.0 0.0 N/A
Noise Margin(dB): 8.1 8.0 7.9 N/A 19.1 14.8 N/A
Total FECC: 1968322 1142
Total ES: 1005 98
Total SES: 966 88
Total LOSS: 77 30
Total UAS: 50116 48436
Total LPRS: 0 0
Total LOFS: 1312 0
Total LOLS: 0 0

 DS Channel1 DS Channel0 US Channel1 US Channel0
Speed (kbps) : NA 348077 NA 61133
SRA Previous Speed: NA 0 NA 0
Previous Speed: NA 806105 NA 202881
Reed-Solomon EC: NA 37263 NA 0
CRC Errors: NA 827 NA 63
Header Errors: NA 0 NA 0
Interleave (ms): NA 0.00 NA 0.00
Actual INP: NA 23.00 NA 22.00

Training Log : Stopped
Training Log Filename : flash:vdslllog.bin

```

## Example: The following is sample output for G.fast

```

Device# show controllers vdsL 0/3/0
Controller VDSL 0/3/0 is UP

Daemon Status: UP

 XTU-R (DS) XTU-C (US)
Chip Vendor ID: 'BDCM' 'BDCM'
Chip Vendor Specific: 0x0000 0xC00E
Chip Vendor Country: 0xB500 0xB500
Modem Vendor ID: 'CSCO' 'BDCM'
Modem Vendor Specific: 0x4602 0x0000
Modem Vendor Country: 0xB500 0xB500

```

Example: The following is sample output for G.fast

```
Serial Number Near: FGL213191DQ C1113-8P 16.8.20171
Serial Number Far: eq nr port:00 oemid softwarere
Modem Version Near: 16.8.20171023:08025
Modem Version Far: 0xc00e
```

```
Modem Status: TC Sync (Showtime!)
DSL Config Mode: AUTO
```

**Trained Mode: G.9701 (GFAST) Profile 106b**

```
TC Mode: PTM
Selftest Result: 0x00
DELT configuration: disabled
DELT state: not running
```

```
Failed full inits: 0
Short inits: 0
Failed short inits: 0
```

```
Modem FW Version: 4.16L.05
Modem PHY Version: A2pvfbH043j.d26r
```

Line 0:

|                      | XTU-R (DS)     | XTU-C (US)     |
|----------------------|----------------|----------------|
| Trellis:             | ON             | ON             |
| SRA:                 | enabled        | enabled        |
| SRA count:           | 1              | 5              |
| Bit swap:            | enabled        | enabled        |
| Bit swap count:      | 0              | 0              |
| Line Attenuation:    | 0.0 dB         | 0.0 dB         |
| Signal Attenuation:  | 0.0 dB         | 0.0 dB         |
| Noise Margin:        | 6.4 dB         | 8.9 dB         |
| Attainable Rate:     | 833400 kbits/s | 215007 kbits/s |
| Actual Power:        | 0.0 dBm        | 4.1 dBm        |
| RTX uc :             | 0              | 0              |
| RTX tx :             | 15             | 26             |
| BSW Completed :      | 1              | 4              |
| SRA Completed :      | 0              | 2              |
| FRA Completed :      | 0              | 0              |
| RPA Completed :      | 0              | 0              |
| TIGA Completed :     | 0              | 0              |
| Attainable Exp Thru: | 833400         | 214167         |
| Error Free Thru :    | 805596         | 202930         |
| Total FECC:          | 351            | 170            |
| Total ES:            | 0              | 0              |
| Total SES:           | 0              | 0              |
| Total LOSS:          | 0              | 0              |
| Total UAS:           | 80545          | 80545          |
| Total LPRS:          | 0              | 0              |
| Total LOFS:          | 0              | 0              |
| Total LOLS:          | 0              | 0              |

|                       | DS Channel1 | DS Channel0   | US Channel1 | US Channel0   |
|-----------------------|-------------|---------------|-------------|---------------|
| <b>Speed (kbps) :</b> | <b>NA</b>   | <b>805677</b> | <b>NA</b>   | <b>202951</b> |
| SRA Previous Speed:   | NA          | 805687        | NA          | 202920        |
| Previous Speed:       | NA          | 805677        | NA          | 202920        |
| Reed-Solomon EC:      | NA          | 351           | NA          | 170           |
| CRC Errors:           | NA          | 0             | NA          | 0             |
| Header Errors:        | NA          | 0             | NA          | 0             |
| Interleave (ms):      | NA          | 2810.82       | NA          | 0.00          |
| Actual INP:           | NA          | 1.47          | NA          | 0.00          |

```
Training Log : Stopped
Training Log Filename : flash:vdslllog.bin
```

## Additional References for G.fast or VDSL2 35b

### MIBs

| MIB                                                         | MIBs Link                                                                                                                                       |
|-------------------------------------------------------------|-------------------------------------------------------------------------------------------------------------------------------------------------|
| <ul style="list-style-type: none"> <li>CISCO-MIB</li> </ul> | To locate and download MIBs for selected platforms, Cisco IOS releases, and feature sets, use the URL here: <a href="#">Cisco MIB Locator</a> . |

### Technical Assistance

| Description                                                                                                                                                                                                                                                                                                                                                                                                                                                                                                                                                             | Link                                                                                                              |
|-------------------------------------------------------------------------------------------------------------------------------------------------------------------------------------------------------------------------------------------------------------------------------------------------------------------------------------------------------------------------------------------------------------------------------------------------------------------------------------------------------------------------------------------------------------------------|-------------------------------------------------------------------------------------------------------------------|
| <p>The Cisco Support website provides extensive online resources, including documentation and tools for troubleshooting and resolving technical issues with Cisco products and technologies.</p> <p>To receive security and technical information about your products, you can subscribe to various services, such as the Product Alert Tool (accessed from Field Notices), the Cisco Technical Services Newsletter, and Really Simple Syndication (RSS) Feeds.</p> <p>Access to most tools on the Cisco Support website requires a Cisco.com user ID and password.</p> | <a href="http://www.cisco.com/cisco/web/support/index.html">http://www.cisco.com/cisco/web/support/index.html</a> |





## CHAPTER 9

# Dying Gasp Through SNMP, Syslog, and Ethernet OAM

---

Dying Gasp—One of the following unrecoverable condition occurs:

- System reload
- Interface shutdown
- Power failure—supported on specific platforms

This type of condition is vendor specific. An Ethernet Operations, Administration, and Maintenance (OAM) notification about the condition may be sent immediately.

- [Restrictions for Dying Gasp Support, on page 131](#)
- [Information About Dying Gasp Through SNMP, Syslog and Ethernet OAM, on page 132](#)
- [How to Configure Dying Gasp Through SNMP, Syslog and Ethernet OAM, on page 132](#)
- [Configuration Examples for Dying Gasp Through SNMP, Syslog and Ethernet OAM, on page 133](#)
- [Feature Information for Dying Gasp Support, on page 134](#)

## Restrictions for Dying Gasp Support

- The dying gasp feature is not supported if you remove the power supply unit (PSU) from the system.
- SNMP trap is sent only on power failure or removal of power supply cable on selected platforms.
- The dying gasp support feature cannot be configured using CLI. To configure hosts using SNMP, refer to the SNMP host configuration examples below.
- In the case of system reload or interface shutdown on the Cisco 4000 Series ISRs and Cisco 1100 Series ISRs running Cisco IOS-XE Everest Release 16.6.2, dying gasp packets are sent to peer routers. However, the system state is not captured in the system logs (syslogs) or SNMP traps.

# Information About Dying Gasp Through SNMP, Syslog and Ethernet OAM

## Dying Gasp

One of the OAM features as defined by IEEE 802.3ah is Remote Failure Indication, which helps in detecting faults in Ethernet connectivity that are caused by slowly deteriorating quality. Ethernet OAM provides a mechanism for an OAM entity to convey these failure conditions to its peer via specific flags in the OAM PDU. One of the failure condition method to communicate is Dying Gasp, which indicates that an unrecoverable condition has occurred; for example, when an interface is shut down. This type of condition is vendor specific. A notification about the condition may be sent immediately and continuously.

## How to Configure Dying Gasp Through SNMP, Syslog and Ethernet OAM

### Dying Gasp Trap Support for Different SNMP Server Host/Port Configurations



---

**Note** You can configure up to five different SNMP server host/port configurations.

---

### Environmental Settings on the Network Management Server

```
setenv SR_TRAP_TEST_PORT=UDP port
setenv SR_UTIL_COMMUNITY=public
setenv SR_UTIL_SNMP_VERSION=v2c
setenv SR_MGR_CONF_DIR=Path to the executable snmpinfo.DAT file
```

The following example shows SNMP trap configuration on the host:

```
Router# configure terminal
Enter configuration commands, one per line. End with CNTL/Z.
Router(config)#
Router(config)# snmp-server host 7.0.0.149 vrf Mgmt-intf version 2c public udp-port 6264
Router(config)#
Router(config)# ^Z
Router#
```

After performing a power cycle, the following output is displayed on the router console:

```

Router#
System Bootstrap, Version 16.6(2r), RELEASE SOFTWARE (fc1)
Technical Support: http://www.cisco.com/techsupport
Copyright (c) 1994-2017 by cisco Systems, Inc.
Current image running: Boot ROM0
Last reset cause: LocalSoft
C1111-8PLTELA platform with 4194304 Kbytes of main memory
rommon 1 >

=====
Dying Gasp Trap Received for the Power failure event:

 Trap on the Host
 ++++++

snmp-server host = 7.0.0.149 (nms1-lnx) and SR_TRAP_TEST_PORT=6264
/auto/sw/packages/snmp/15.4.1.9/bin> /auto/sw/packages/snmp/15.4.1.9/bin/traprcv
Waiting for traps.
Received SNMPv2c Trap:
Community: public
From: 7.29.25.101
snmpTrapOID.0 = ciscoMgmt.305.1.3.5.0.2
ciscoMgmt.305.1.3.6 = Dying Gasp - Shutdown due to power loss

```

## Message Displayed on the Peer Router on Receiving Dying Gasp Notification

```

001689: *May 30 14:16:47.746 IST: %ETHERNET_OAM-6-RFI: The client on interface Gi0/0/0 has
received a remote failure indication from its remote peer(failure reason = remote client
power failure action =)

```

## Displaying SNMP Configuration for Receiving Dying Gasp Notification

Use the show running-config command to display the SNMP configuration for receiving dying gasp notification:

```

Router# show running-config | i snmp
snmp-server community public RW
snmp-server host 7.0.0.149 vrf Mgmt-intf version 2c public udp-port 6264
Router#

```

# Configuration Examples for Dying Gasp Through SNMP, Syslog and Ethernet OAM

## Example: Configuring SNMP Community Strings on a Router

Setting up the community access string to permit access to the SNMP:

**Example: Configuring SNMP-Server Host Details on the Router Console**

```
Router> enable
Router# configure terminal
Router(config)# snmp-server community public RW
Router(config)# exit
```

For more information on command syntax and examples, refer to the Cisco IOS Network Management Command Reference.

**Example: Configuring SNMP-Server Host Details on the Router Console**

Specifying the recipient of a SNMP notification operation:

```
Router> enable
Router# configure terminal
Router(config)# snmp-server host X.X.X.XXX vrf mgmt-intf version 2c public udp-port 9800
Router(config)# exit
```

For more information on command syntax and examples, refer to the Cisco IOS Network Management Command Reference.

**Feature Information for Dying Gasp Support**

The following table provides release information about the feature or features described in this module. This table lists only the software release that introduced support for a given feature in a given software release train. Unless noted otherwise, subsequent releases of that software release train also support that feature.

Use Cisco Feature Navigator to find information about platform support and Cisco software image support. To access Cisco Feature Navigator, go to [www.cisco.com/go/cfn](http://www.cisco.com/go/cfn). An account on Cisco.com is not required.

**Table 11: Feature Information for Dying Gasp Support**

| Feature Name | Releases                    | Feature Information for                                                                                                                                                                                                                                                                                                                                                                                                              |
|--------------|-----------------------------|--------------------------------------------------------------------------------------------------------------------------------------------------------------------------------------------------------------------------------------------------------------------------------------------------------------------------------------------------------------------------------------------------------------------------------------|
| Dying Gasp   | Cisco IOS XE Release 16.6.2 | Ethernet OAM provides a mechanism for an OAM entity to convey failure conditions to its peer via specific flags in the OAM PDU. One of the failure condition method to communicate is Dying Gasp, which indicates that an unrecoverable condition has occurred; for example, when an interface is shut down. This type of condition is vendor specific. A notification about the condition may be sent immediately and continuously. |





# CHAPTER 10

## Encrypted Traffic Analytics

Encrypted Traffic Analytics (ET-Analytics) is used to identify malware communications in encrypted traffic. ET-Analytics uses passive monitoring, extraction of relevant data elements, and supervised machine learning with cloud-based global visibility. ET-Analytics uses Cisco NetFlow record fields to detect whether the packet flow has malware, and these NetFlow record fields include IDP (initial data packet) and SPLT (Sequence of Packet Length and Time).

- [Feature Information for Encrypted Traffic Analytics, on page 135](#)
- [Restrictions for Encrypted Traffic Analytics, on page 136](#)
- [Information About Encrypted Traffic Analytics, on page 136](#)
- [How to Configure Encrypted Traffic Analytics, on page 137](#)
- [Verifying the ET-Analytics Configuration, on page 138](#)

## Feature Information for Encrypted Traffic Analytics

The following table provides release information about the feature or features described in this module. This table lists only the software release that introduced support for a given feature in a given software release train. Unless noted otherwise, subsequent releases of that software release train also support that feature.

Use Cisco Feature Navigator to find information about platform support and Cisco software image support. To access Cisco Feature Navigator, go to [www.cisco.com/go/cfn](http://www.cisco.com/go/cfn). An account on Cisco.com is not required.

**Table 12: Feature Information for Encrypted Traffic Analytics (ET-Analytics)**

| Feature Name                | Releases | Feature Information                                                                                                                                                                                                                                                                                                                                                                                                                                                       |
|-----------------------------|----------|---------------------------------------------------------------------------------------------------------------------------------------------------------------------------------------------------------------------------------------------------------------------------------------------------------------------------------------------------------------------------------------------------------------------------------------------------------------------------|
| Encrypted Traffic Analytics |          | Encrypted Traffic Analytics (ET-Analytics) is used to identify malware communications in encrypted traffic. ET-Analytics uses passive monitoring, extraction of relevant data elements, and supervised machine learning with cloud-based global visibility. ET-Analytics uses Cisco NetFlow record fields to detect whether the packet flow has malware, and these NetFlow record fields include IDP (initial data packet) and SPLT (Sequence of Packet Length and Time). |

# Restrictions for Encrypted Traffic Analytics

ET-Analytics is not supported on management interfaces, VRF-Aware Software Infrastructure (VASI) interface, and internal interfaces.

## Information About Encrypted Traffic Analytics

### Data Elements for Encrypted Traffic

ET-Analytics uses intraflow metadata to identify malware components, maintaining the integrity of the encrypted traffic without the need for bulk decryption and without compromising on data integrity.

ET-Analytics extracts the following main data elements from the network flow: the sequence of packet lengths and times (SPLT), TLS-specific features, and the initial data packet (IDP). Cisco's Application-Specific Integrated Circuit (ASIC) architecture provides the ability to extract these data elements without slowing down the data network. Separate templates can be defined for each of the data elements.

Transport Layer Security (TLS) is a cryptographic protocol that provides privacy for applications. TLS is usually implemented with common protocols such as HTTP for web browsing or Simple Mail Transfer Protocol (SMTP) for email. HTTPS is the use of TLS over HTTP; this protocol is used to secure communication between a web server and client and is supported by most major web servers.

The TLS template is used to report several of the TLS parameters in use for a flow. These parameters help in finding the use of insecure cipher suites, out-of-date protocol version, and so on.

- **Sequence of Packet Lengths and Times (SPLT)** SPLT contains the length (number of bytes) of each packet's application payload for the first several packets of a flow, along with the inter-arrival times of those packets. SPLT can be represented as an array of packet sizes (in bytes) along with an array of times (in milliseconds) indicating the time since the previous packet was observed. The SPLT template is used to report packet size and timing information for a flow, which is useful to analyze encrypted traffic and find malicious flows or perform other classifications.
- **Initial Data Packet (IDP)** IDP obtains packet data from the first packet of a flow. It allows extraction of data such as an HTTP URL, DNS hostname/address, and other data elements. The TLS handshake is composed of several messages that contain unencrypted metadata used to extract data elements such as cipher suites, TLS versions, and the client's public key length. The IDP template is used to report packet data from the first data packet of a flow. This template allows collectors to perform application classification of a flow (for example, using Snort).

# How to Configure Encrypted Traffic Analytics

## Enabling ET-Analytics on an Interface

### Procedure

|        | Command or Action                                        | Purpose                                                                                                            |
|--------|----------------------------------------------------------|--------------------------------------------------------------------------------------------------------------------|
| Step 1 | <b>enable</b>                                            | Enables privileged EXEC mode. <ul style="list-style-type: none"> <li>• Enter your password if prompted.</li> </ul> |
| Step 2 | <b>configure terminal</b>                                | Enters global configuration mode.                                                                                  |
| Step 3 | <b>et-analytics</b>                                      | Enters encrypted traffic analytics configuration mode.                                                             |
| Step 4 | <b>ip flow-record destination</b> <i>ip-address port</i> | Specifies NetFlow collector IP address and port number. A maximum of four exporters is supported.                  |
| Step 5 | <b>exit</b>                                              | Returns to global configuration mode.                                                                              |
| Step 6 | <b>interface</b> <i>interface-id</i>                     | Specifies the interface and port number and enters interface configuration mode.                                   |
| Step 7 | <b>et-analytics enable</b>                               | Enables encrypted traffic analytics on this interface.                                                             |
| Step 8 | <b>end</b>                                               | Returns to privileged EXEC mode.                                                                                   |

### Example

```

Device> enable
Device# configure terminal
Device(config)# et-analytics
Device(config-et-analytics)# ip flow-record destination 192.0.2.1 2055
Device(config-et-analytics)# exit
Device(config)# interface gigabitethernet 0/0/1
Device(config-if)# et-analytics enable
Device(config-if)# end

```

## Applying an ACL in the Allowed list

### Procedure

|        | Command or Action | Purpose                       |
|--------|-------------------|-------------------------------|
| Step 1 | <b>enable</b>     | Enables privileged EXEC mode. |

|               | Command or Action                                                                       | Purpose                                                                                                        |
|---------------|-----------------------------------------------------------------------------------------|----------------------------------------------------------------------------------------------------------------|
|               |                                                                                         | <ul style="list-style-type: none"> <li>• Enter your password if prompted.</li> </ul>                           |
| <b>Step 2</b> | <b>configure terminal</b>                                                               | Enters global configuration mode.                                                                              |
| <b>Step 3</b> | <b>et-analytics</b>                                                                     | Enters encrypted traffic analytics configuration mode.                                                         |
| <b>Step 4</b> | <b>whitelist acl</b> <i>access-list</i>                                                 | The allowed list specifies the access list traffic. The access list can be a standard, extended, or named ACL. |
| <b>Step 5</b> | <b>exit</b>                                                                             | Returns to global configuration mode.                                                                          |
| <b>Step 6</b> | <b>ip access-list extended</b> <i>access-list</i>                                       | Specifies a named extended access list and enters extended access list configuration mode.                     |
| <b>Step 7</b> | <b>permit ip</b> { <i>ip-address</i>   <b>any</b>   <b>host</b>   <b>object-group</b> } | Specifies the packets to forward to a source host or source IP address.                                        |
| <b>Step 8</b> | <b>end</b>                                                                              | Returns to privileged EXEC mode.                                                                               |

### Example

```

Device> enable
Device# configure terminal
Device(config)# et-analytics
Device(config-et-analytics)# whitelist acl eta_whitelist
Device(config-et-analytics)# exit
Device(config)# ip access-list extended eta_whitelist
Device(config-ext-nacl)# permit ip host 198.51.100.1 any
Device(config-ext-nacl)# permit ip any host 198.51.100.1
Device(config-ext-nacl)# permit ip host 198.51.200.1 any
Device(config-ext-nacl)# permit ip any host 198.51.200.1
Device(config-ext-nacl)# end

```

## Verifying the ET-Analytics Configuration

The following **show** commands are used to see the platform ET-analytics, threat-visibility interfaces, FMAN FP global and interface information, and ET-analytics datapath information. Given below are the sample outputs of the **show** commands.

```

Device# show platform hardware qfp active feature et-analytics data interface gigabitEthernet
 2

uidb handle: 0x3fe
Interface Name: GigabitEthernet2

```

**Device# show platform hardware qfp active feature et-analytics data memory**

ET-Analytics memory information:

```
Size of FO : 3200 bytes
No. of FO allocs : 952903
No. of FO frees : 952902
```

**Device# show platform hardware qfp active feature et-analytics data runtime**

ET-Analytics run-time information:

```
Feature state : initialized (0x00000004)
Inactive timeout : 15 secs (default 15 secs)
Flow CFG information : !Flow Table Infrastructure information internal to ETA!
 instance ID : 0x0
 feature ID : 0x0
 feature object ID : 0x0
 chunk ID : 0x4
```

**Device# show platform hardware qfp active feature et-analytics datapath stats export**

ET-Analytics 192.168.1.100:2055 Stats:

Export statistics:

```
Total records exported : 2967386
Total packets exported : 1885447
Total bytes exported : 2056906120
Total dropped records : 0
Total dropped packets : 0
Total dropped bytes : 0
Total IDP records exported :
 initiator->responder : 805813
 responder->initiator : 418799
Total SPLT records exported:
 initiator->responder : 805813
 responder->initiator : 418799
Total SALT records exported:
 initiator->responder : 0
 responder->initiator : 0
Total BD records exported :
 initiator->responder : 0
 responder->initiator : 0
Total TLS records exported :
 initiator->responder : 171332
 responder->initiator : 174860
```

ET-Analytics 172.27.56.99:2055 Stats:

Export statistics:

```
Total records exported : 2967446
Total packets exported : 1885448
Total bytes exported : 2056909280
Total dropped records : 0
Total dropped packets : 0
Total dropped bytes : 0
Total IDP records exported :
 initiator->responder : 805813
 responder->initiator : 418799
Total SPLT records exported:
 initiator->responder : 805813
```

```
 responder->initiator : 418799
Total SALT records exported:
 initiator->responder : 0
 responder->initiator : 0
Total BD records exported :
 initiator->responder : 0
 responder->initiator : 0
Total TLS records exported :
 initiator->responder : 171332
 responder->initiator : 174860
```

**Device# show platform hardware qfp active feature et-analytics datapath stats flow**

```
ET-Analytics Stats:
Flow statistics:
feature object allocs : 0
feature object frees : 0
flow create requests : 0
flow create matching : 0
flow create successful: 0
flow create failed, CFT handle: 0
flow create failed, getting FO: 0
flow create failed, malloc FO : 0
flow create failed, attach FO : 0
flow create failed, match flow: 0
flow create, aging already set: 0
flow ageout requests : 0
flow ageout failed, freeing FO: 0
flow ipv4 ageout requests : 0
flow ipv6 ageout requests : 0
flow whitelist traffic match : 0
```



# CHAPTER 11

## Smart Licensing

---

This chapter contains the following sections:

- [Smart Licensing Client, on page 141](#)

### Smart Licensing Client

Smart Licensing Client feature is a standardized licensing platform that simplifies the Cisco software experience and helps you to understand how Cisco software is used across your network. Smart Licensing is the next generation licensing platform for all Cisco software products.

### Prerequisites for Cisco Smart Licensing Client

- Ensure that Call Home is not disabled before using the Smart Licensing Client feature.

### Restrictions for Cisco Smart Licensing Client

- You require a virtual account in the Smart Licensing server for registration.

### Information About Cisco Smart Licensing Client

#### Cisco Smart Licensing - An Overview

Cisco Smart Licensing is a flexible licensing model that provides you with an easier, faster, and more consistent way to purchase and manage software across the Cisco portfolio and across your organization. And it's secure – you control what users can access. With Smart Licensing you get:

- **Easy Activation:** Smart Licensing establishes a pool of software licenses that can be used across the entire organization—no more PAKs (Product Activation Keys).
- **Unified Management:** My Cisco Entitlements (MCE) provides a complete view into all of your Cisco products and services in an easy-to-use portal, so you always know what you have and what you are using.
- **License Flexibility:** Your software is not node-locked to your hardware, so you can easily use and transfer licenses as needed.

To use Smart Licensing, you must first set up a Smart Account on Cisco Software Central (<http://software.cisco.com/>).

For a more detailed overview on Cisco Licensing, go to <https://cisco.com/go/licensingguide>.

## HSECK9

The **HSECK9** license is required for a feature to have full crypto functionality. Without the **HSECK9** license, only 225 secure tunnels and 85 Mbps of crypto bandwidth would be available. The **HSECK9** license allows features in the **securityk9** technology package to use the maximum number of secure tunnels and crypto bandwidth. To enable the **HSECK9** license, purchase the **FL-44-HSEC-K9** license from Cisco.com and install it using the **license install license-files** command. For further information on obtaining and installing feature licenses, see configuring the Cisco IOS software activation.



---

**Note** The **HSECK9** feature does not have an evaluation license that converts to an RTU license after 60 days; a feature license must be obtained.

---

To enable the license for the **HSECK9** feature, use the **securityk9** technology package.

For more information on how to enable license boot level securityk9 or license feature hseck9, refer to [Smart Licensing using Policy](#).

### HSECK9 Feature License Removal

To remove the HSECK9 feature license from your device, you need to follow an order of steps to successfully remove the license. User can reinstate this license at a later date, if required. If these steps are not followed, the feature license comes back up as authorized after the reload.

To remove the HSECK9 feature license, perform these steps:

#### Procedure

---

- Step 1** Deregister the device.
  - Step 2** Unconfigure the HSEC license using the **no license featurehseck9** command.
  - Step 3** Save the running configuration using the **write memory** command.
  - Step 4** (optional) If the device still shows up after deregistering, remove the device from the licensing portal.
  - Step 5** Reload the device.
  - Step 6** Verify that the license has been removed using the **show license detail** command.
- 

## Transitioning from CSL to Smart Licensing

In the Smart Licensing Model, customers can activate licensed objects without the use of a special software key or upgrade license file. The customers simply activate the new functionality using the appropriate product commands and configurations and the functionality is activated. A software reboot may or may not be required depending on the product capabilities and requirements.

Similarly, downgrading or removing an advanced feature, performance, or functionality would require a removal of the configuration or command.



Once either of these actions has been taken, the change in license state is noted by the Smart Software Manager upon next synchronization and an appropriate action is then taken.

## Cisco One Suites

Cisco ONE Suites is a new way for customers to purchase infrastructure software. Cisco ONE offers a simplified purchasing model, centered on common customer scenarios in the data center, wide area network, and local access networks.

## Cisco One Suites

Cisco ONE Suites is a new way for customers to purchase infrastructure software. Cisco ONE offers a simplified purchasing model, centered on common customer scenarios in the data center, wide area network, and local access networks.

# How to Activate Cisco Smart Licensing Client

## Enable Smart Licensing

### Procedure

|               | Command or Action                                                              | Purpose                                                                                                                                                                                                                                                                                                                                              |
|---------------|--------------------------------------------------------------------------------|------------------------------------------------------------------------------------------------------------------------------------------------------------------------------------------------------------------------------------------------------------------------------------------------------------------------------------------------------|
| <b>Step 1</b> | <b>enable</b><br><b>Example:</b><br>Device> enable                             | Enables privileged EXEC mode. <ul style="list-style-type: none"> <li>• Enter your password if prompted.</li> </ul>                                                                                                                                                                                                                                   |
| <b>Step 2</b> | <b>configure terminal</b><br><b>Example:</b><br>Device# configure terminal     | Enters global configuration mode.                                                                                                                                                                                                                                                                                                                    |
| <b>Step 3</b> | <b>license smart enable</b><br><b>Example:</b><br>Device# license smart enable | Activates Smart Licensing on the device. <p><b>Note</b> When you enable Smart Licensing, the Cisco Software License (CSL) and all licensing calls pass through the Smart Agent.</p> For the 'no' case, if Smart Licensing is already registered, the Smart Agent performs the "license smart deregister" operation that deactivates Smart Licensing. |
| <b>Step 4</b> | <b>exit</b><br><b>Example:</b><br>Device# exit                                 | Exits the global configuration mode.                                                                                                                                                                                                                                                                                                                 |

|               | Command or Action                                                      | Purpose                                                     |
|---------------|------------------------------------------------------------------------|-------------------------------------------------------------|
| <b>Step 5</b> | <b>write memory</b><br><b>Example:</b><br>Device# write memory         | Saves the running configuration to NVRAM.                   |
| <b>Step 6</b> | <b>show license all</b><br><b>Example:</b><br>Device# show license all | (Optional) Displays summary information about all licenses. |

## Device Registration

### Procedure

|               | Command or Action                                                                                                                       | Purpose                                                                                                                                                                                                                                                                                                                                                                                                                                |
|---------------|-----------------------------------------------------------------------------------------------------------------------------------------|----------------------------------------------------------------------------------------------------------------------------------------------------------------------------------------------------------------------------------------------------------------------------------------------------------------------------------------------------------------------------------------------------------------------------------------|
| <b>Step 1</b> | <b>enable</b><br><b>Example:</b><br>Device> enable                                                                                      | Enables privileged EXEC mode. <ul style="list-style-type: none"> <li>• Enter your password if prompted.</li> </ul>                                                                                                                                                                                                                                                                                                                     |
| <b>Step 2</b> | <b>license smart register idtoken <i>idtoken</i></b><br><b>[force]</b><br><b>Example:</b><br>Device# license smart register idtoken 123 | Registers the device with the back-end server. Token id can be obtained from your virtual a/c in the Smart Licensing server. <ul style="list-style-type: none"> <li>• <b>force:</b> To forcefully register your device irrespective of either the device is registered or not.</li> </ul> <p><b>Note</b> The device supplies the token ID to the Cisco server, which sends back a “Device Certificate” that is valid for 365 days.</p> |
| <b>Step 3</b> | <b>license smart deregister</b><br><b>Example:</b><br>Device# license smart deregister                                                  | Deregisters the device from the backend server.                                                                                                                                                                                                                                                                                                                                                                                        |
| <b>Step 4</b> | <b>license smart renew [ID   auth]</b><br><b>Example:</b><br>Device# license smart renew ID                                             | (Optional) Manually renews the ID certification or authorization.                                                                                                                                                                                                                                                                                                                                                                      |

## Install and Upgrade Licenses Using Software Activation Commands

### Before you begin

To install or upgrade a license by using the **license install** command, you must have already received the license file from the Cisco Product License Registration portal at <http://www.cisco.com/go/license> (or you already backed up the license by using the **license save** command).

If you use Microsoft Entourage and receive the license file from Cisco in an e-mail attachment, the license file will contain UTF-8 marking. These extra bytes in the license file cause it to be unusable during license installation. To work around this issue, you can use a text editor to remove the extra characters and then install the license file. For more information about UTF-8 encoding, go to this URL:

<http://www.w3.org/International/questions/qa-utf8-bom>.



**Note** The installation process does not install duplicate licenses. This message appears when duplicate licenses are detected:

```
Installing...Feature:xxx-xxx-xxx...Skipped:Duplicate
```



**Note** A standby device reboots twice when there is a mismatch of licenses.

### Procedure

|               | Command or Action                                                                                                                                                                                   | Purpose                                                                                                                                                                                                                                               |
|---------------|-----------------------------------------------------------------------------------------------------------------------------------------------------------------------------------------------------|-------------------------------------------------------------------------------------------------------------------------------------------------------------------------------------------------------------------------------------------------------|
| <b>Step 1</b> | Obtain the PAK.                                                                                                                                                                                     | The PAK is provided to you when you order or purchase the right to use a feature set for a particular platform. <ul style="list-style-type: none"> <li>The PAK serves as a receipt and is used as part of the process to obtain a license.</li> </ul> |
| <b>Step 2</b> | <b>enable</b><br><b>Example:</b><br><br>Device> enable                                                                                                                                              | Enables privileged EXEC mode. <ul style="list-style-type: none"> <li>Enter your password if prompted.</li> </ul>                                                                                                                                      |
| <b>Step 3</b> | <b>show license udi</b><br><b>Example:</b><br><br>Device# show license udi                                                                                                                          | Displays all the UDI values that can be licensed in a system. <ul style="list-style-type: none"> <li>You need the UDI of the device as part of the process to obtain a license.</li> </ul>                                                            |
| <b>Step 4</b> | Convert the PAK to a license by entering the PAK and the UDI into the Cisco Product License Registration portal:<br><a href="http://www.cisco.com/go/license">http://www.cisco.com/go/license</a> . | After entering the appropriate information, you will receive an e-mail containing the license information that you can use to install the license:                                                                                                    |

|               | Command or Action                                                                                                                                             | Purpose                                                                                                                                                                                                                                                                                        |
|---------------|---------------------------------------------------------------------------------------------------------------------------------------------------------------|------------------------------------------------------------------------------------------------------------------------------------------------------------------------------------------------------------------------------------------------------------------------------------------------|
|               |                                                                                                                                                               | <ul style="list-style-type: none"> <li>Copy the license file received from the Cisco Product License Registration portal to the appropriate file system on the device.</li> </ul> <p>or</p> <ul style="list-style-type: none"> <li>Click the <b>Install</b> button on the web page.</li> </ul> |
| <b>Step 5</b> | <b>license install</b> <i>stored-location-url</i><br><b>Example:</b><br><pre>Device# license install tftp://infra-sun/&lt;user&gt;/license/5400/38a.lic</pre> | Installs the license. <ul style="list-style-type: none"> <li>Accept the end-user license agreement if prompted.</li> </ul>                                                                                                                                                                     |
| <b>Step 6</b> | <b>configure terminal</b><br><b>Example:</b><br><pre>Device# configure terminal</pre>                                                                         | Enters the global configuration mode.                                                                                                                                                                                                                                                          |
| <b>Step 7</b> | <b>license boot level</b> {metroaggrservices}<br><b>Example:</b><br><pre>Device(config)# license boot level metroaggrservices</pre>                           | Activates the metroaggrservices license on the device upon the next reload.                                                                                                                                                                                                                    |
| <b>Step 8</b> | <b>write memory</b><br><b>Example:</b><br><pre>Device# write memory</pre>                                                                                     | Saves the running configuration to NVRAM.                                                                                                                                                                                                                                                      |
| <b>Step 9</b> | <b>reload</b><br><b>Example:</b><br><pre>Device# reload</pre>                                                                                                 | (Optional) Restarts the device to enable the new feature set.<br><br><b>Note</b> A reload is not required when moving from an evaluation license to a permanent license of the same license level on the devices.                                                                              |

## Troubleshooting for Cisco Smart Licensing Client

You can troubleshoot Smart Licensing enabling issues using the following commands on the device:

- **show version**
- **show running-config**
- **show license summary**
- **show license all**

- **show license tech support**
- **show license status**
- **debug smart\_lic error**
- **debug smart\_lic trace**

## Configuration Examples for Cisco Smart Licensing Client

**Example: Displays summary information about all licenses**

**Example: Enabling Smart Licensing**

Use the **license smart enable** command to confirm if Smart Licensing is enabled.





## CHAPTER 12

# IPv6 Support on Switch Virtual Interface

This document provides an overview of the switch virtual interface (SVI) for Cisco 1000 Series and Cisco 4000 Series Integrated Services Routers.

- [Information About IPv6 Support on Switch Virtual Interface, on page 149](#)
- [Configuration Examples for IPv6 Support on Switch Virtual Interface, on page 153](#)

## Information About IPv6 Support on Switch Virtual Interface

### Overview of the Switch Virtual Interface

Cisco offers different flavors of integrated switching modules for the modular Cisco 1000 and 4000 Series Integrated Services Routers: the Cisco 4-Port Gigabit Ethernet Switch modules with Next-Generation WAN Interface Cards (NGWIC), 16- and 36-port Cisco EtherSwitch modules, the Cisco EtherSwitch 4-port and 9-port high-speed WAN interface cards (HWICs), the Cisco EtherSwitch service modules, and the Enhanced Cisco EtherSwitch service modules.

The integrated switch ports for the fixed-configuration Integrated Services Routers and the switch ports on the HWICs/NGWICs do not natively support Layer 3 addresses or Layer 3 features. They must be assigned to a SVI and use a VLAN interface for Layer 3 features. SVI represents a logical Layer 3 interface on a switch. In addition to basic routing, SVI can be used to support additional features for the network that the SVI represents.

### Cisco IOS Software Features Supported by Switch Virtual Interface

The table lists the Cisco IOS Software features supported by SVI and summarized the typical use of these features. Please refer to the Feature Navigator Tool to check whether a specific platform supports a specific feature.

**Table 13: Cisco IOS Software Features Supported by SVI**

| Cisco IOS Software Feature | SVI Use Scenario | SVI Support Status |
|----------------------------|------------------|--------------------|
| Routing Features           |                  |                    |

| Cisco IOS Software Feature                          | SVI Use Scenario                                                                                                                                                                                                                                       | SVI Support Status       |
|-----------------------------------------------------|--------------------------------------------------------------------------------------------------------------------------------------------------------------------------------------------------------------------------------------------------------|--------------------------|
| Routing Protocols                                   | Interconnects Layer 3 networks using protocols such as Routing Information Protocol (RIP), Open Shortest Path First (OSPF) Protocol, and Enhanced Interior Gateway Routing Protocol (EIGRP) configured under SVI                                       | Yes                      |
| IP Version 6 (IPv6)                                 | Provides IPv6 support                                                                                                                                                                                                                                  | Yes<br>(Gibraltar 16.12) |
| Network Address Translation (NAT)                   | Translates public IP addresses to private address pools, and private addresses to public IP addresses; SVI is typically used as a NAT inside interface                                                                                                 | Yes                      |
| Dynamic Host Configuration Protocol (DHCP)          | <ul style="list-style-type: none"> <li>• DHCP server feature: Dynamically assigns private IP addresses to devices connected to the switch ports</li> <li>• DHCP client feature: Allows the SVI to receive a dynamically assigned IP address</li> </ul> | Yes                      |
| Hot Standby Routing Protocol (HSRP)                 | Supports redundancy and high availability with a secondary device connected to the LAN with SVI, using HSRP                                                                                                                                            | Yes                      |
| Virtual Router Redundancy Protocol (VRRP)           | Supports redundancy and high availability with a secondary device connected to the LAN with SVI, using VRRP                                                                                                                                            | Yes                      |
| Gateway Load Balancing Protocol (GLBP)              | Supports redundancy and high availability with a secondary device connected to the LAN with SVI, using GLBP                                                                                                                                            | Yes                      |
| Policy-Based Routing (PBR)                          | Creates policy maps for routing decisions and QoS settings                                                                                                                                                                                             | Yes                      |
| Point-to-Point Protocol (PPP) over Ethernet (PPPoE) | Provides PPPoE client support for a device (such as a DSL modem) connected to the switch port; typically used when the SVI is the only interface available to provide backup using the external device                                                 | Yes                      |
| Multicast                                           | Provides multicast support for clients connected to the switch ports                                                                                                                                                                                   | No                       |
| VPN Routing and Forwarding (VRF)                    | Associates a VRF instance with an SVI to map VLANs to different logical or physical VPN WAN connections                                                                                                                                                | Yes                      |
| Layer 2 Tunnel Protocol Version 3 (L2TPv3)          | Provides LAN extension between remote sites; SVI is used as the Layer 2 tunnel termination point                                                                                                                                                       | Yes (17.2 or later)      |
| Ethernet over MPLS (EoMPLS)                         | Provides Ethernet extension between remote sites; SVI interface used as the EoMPLS pseudowire attachment circuit                                                                                                                                       | No                       |
| Security Features                                   |                                                                                                                                                                                                                                                        |                          |



| Cisco IOS Software Feature                                                                                                     | SVI Use Scenario                                                                                                                                                                                                                                                                                     | SVI Support Status |
|--------------------------------------------------------------------------------------------------------------------------------|------------------------------------------------------------------------------------------------------------------------------------------------------------------------------------------------------------------------------------------------------------------------------------------------------|--------------------|
| IP Security (IPsec)                                                                                                            | <ul style="list-style-type: none"> <li>• Supports Easy VPN remote as the inside interface</li> <li>• Provides IPsec tunnel termination on the SVI; typically used when SVI is the only interface available to provide backup WAN connection with an external device (such as a DSL modem)</li> </ul> | Yes                |
| Generic Routing Encapsulation (GRE)                                                                                            | Provides GRE tunnel termination on the SVI; typically used when SVI is the only interface available to provide backup WAN connection with an external device (such as a DSL modem)                                                                                                                   | Yes                |
| Firewall                                                                                                                       | Provides Firewall support for VLANs                                                                                                                                                                                                                                                                  | No                 |
| Intrusion Prevention System (IPS)                                                                                              | Provides IPS support for VLANs                                                                                                                                                                                                                                                                       | Yes                |
| IP access control lists (ACLs)                                                                                                 | Provides packet filtering to control network traffic and restrict the access of users and devices to the network                                                                                                                                                                                     | Yes                |
| Network Admission Control (NAC)                                                                                                | Enforces NAC of endpoint devices connected to the VLAN                                                                                                                                                                                                                                               | No                 |
| Auth-proxy                                                                                                                     | Authenticates inbound and outbound users connected to the VLAN                                                                                                                                                                                                                                       | No                 |
| Quality-of-Service (QoS) Features                                                                                              |                                                                                                                                                                                                                                                                                                      |                    |
| Classification with standard and extended access list                                                                          | Provides QoS classification with standard and extended access lists                                                                                                                                                                                                                                  | No                 |
| Classification with IP type of service (ToS): IP precedence, differentiated services code point (DSCP), or destination address | Provides QoS classification with IP ToS bits                                                                                                                                                                                                                                                         | No                 |
| Classification with Network-Based Application Recognition (NBAR) with TCP                                                      | Provides QoS classification with NBAR TCP traffic                                                                                                                                                                                                                                                    | No                 |
| Class-based marking                                                                                                            | Provides QoS marking based on user-defined traffic class with DSCP and IP precedence values                                                                                                                                                                                                          | No                 |
| Policing                                                                                                                       | Limits the input or output transmission rate on SVI and specifies traffic handling policies when the traffic either conforms to or exceeds the specified rate limits                                                                                                                                 | No                 |
| Committed Access Rate                                                                                                          | Limits the input or output transmission rate on SVI                                                                                                                                                                                                                                                  | No                 |
| Class-Based Traffic Shaping                                                                                                    | Provides Generic Traffic Shaping based on user defined traffic class                                                                                                                                                                                                                                 | No                 |

| Cisco IOS Software Feature              | SVI Use Scenario                                                                                                                                                                                       | SVI Support Status |
|-----------------------------------------|--------------------------------------------------------------------------------------------------------------------------------------------------------------------------------------------------------|--------------------|
| Generic-Traffic Shaping                 | Limits the transmission rate of data to match the speed of the remote, target interface and helps ensure that the traffic conforms to policies contracted for it                                       | No                 |
| Weighted Random Early Detection (WRED)  | Provides early detection of congestion and differentiated performance characteristics for different classes of service                                                                                 | No                 |
| Class-Based Weighted Fair Queue (CBWFQ) | Allocates bandwidth based on user-defined traffic class                                                                                                                                                | No                 |
| Low-Latency Queue (LLQ)                 | Provides strict priority queuing with CBWFQ to allow delay-sensitive data such as voice to be dequeued and sent first, giving delay-sensitive data preferential treatment over other traffic           | No                 |
| Hierarchical QoS                        | Using a modular QoS command-line interface (CLI) in a hierarchical structure, provides a high degree of granularity for QoS policies and helps meet complex service-level agreement (SLA) requirements | No                 |
| EVC under SVI                           | -                                                                                                                                                                                                      | Yes (16.9.1)       |
| NBAR on SVI                             | -                                                                                                                                                                                                      | Yes (17.2)         |

## Additional Information for IPv6 Support on Switch Virtual Interface

SVI on Cisco Integrated Services Routers is designed to provide basic Layer 3 functions for the Layer 2 switch ports that belong to a specific VLAN. The SVI does not provide the same feature set and functions as the integrated Layer 3 Ethernet ports of the integrated services routers and should not be used to entirely replace the Layer 3 Ethernet ports. Customer who need additional Layer 3 Ethernet ports for their Integrated Services Routers may consider the use of 1- and 2-Port Fast Ethernet High-Speed WIC for modular ISR platforms. The guidelines presented in this document summarize feature support considerations for an Integrated Services Router deployment that uses SVIs.

For more information, please refer to the following links:

- Cisco 4-Port and 8-Port Gigabit Ethernet Switch NIM
- Cisco IOS Security Configuration Guide:  
[http://www.cisco.com/en/US/partner/products/ps6441/products\\_configuration\\_guide\\_book09186a008049e249.html](http://www.cisco.com/en/US/partner/products/ps6441/products_configuration_guide_book09186a008049e249.html)
- Cisco IOS Quality-of-Service Solutions Configuration Guide:  
[http://www.cisco.com/en/US/partner/products/ps6441/products\\_configuration\\_guide\\_book09186a008065c7a1.html](http://www.cisco.com/en/US/partner/products/ps6441/products_configuration_guide_book09186a008065c7a1.html)

# Configuration Examples for IPv6 Support on Switch Virtual Interface

## Easy VPN Remote and NAT

### Easy VPN Remote and NAT

[http://www.cisco.com/en/US/technologies/tk583/tk372/technologies\\_white\\_paper09186a00801fdef9.shtml](http://www.cisco.com/en/US/technologies/tk583/tk372/technologies_white_paper09186a00801fdef9.shtml)

## Example: DHCP

```
! SDM Default Configuration
! The default startup configuration file for Cisco Router and Security Device Manager (SDM)
! DO NOT modify this file; it is required by SDM as is for factory defaults
! Version 1.0
!
hostname yourname
!
logging buffered 51200 warnings
!
username cisco privilege 15 secret 0 cisco
!
ip dhcp excluded-address 10.10.10.1
!
ip dhcp pool sdm-pool
import all
network 10.10.10.0 255.255.255.248
default-router 10.10.10.1
lease 0 2
!
no ip domain lookup
ip domain-name yourdomain.com
!
interface FastEthernet2
no ip address
no shutdown
!
interface FastEthernet3
no ip address
no shutdown
!
interface FastEthernet4
no ip address
no shutdown
!
interface FastEthernet5
no ip address
no shutdown
!
interface FastEthernet6
no ip address
no shutdown
!
```

## Example: DHCP

```

interface FastEthernet7
no ip address
no shutdown
!
interface FastEthernet8
no ip address
no shutdown
!
interface FastEthernet9
no ip address
no shutdown
!
interface Vlan1
description $ETH-SW-LAUNCH$$INTF-INFO-FE 2$
ip address 10.10.10.1 255.255.255.248
ip tcp adjust-mss 1452
!
ip http server
ip http access-class 23
ip http secure-server
ip http authentication local
ip http timeout-policy idle 60 life 86400 requests 10000
!
access-list 23 permit 10.10.10.0 0.0.0.7
!
banner login ^

Cisco Router and Security Device Manager (SDM) is installed on this device.
This feature requires the one-time use of the username "cisco" with the password "cisco".
The default username and password have a privilege level of 15.
Please change these publicly known initial credentials using SDM or the IOS CLI.
Here are the Cisco IOS commands.
username <myuser> privilege 15 secret 0 <mypassword>
no username cisco
Replace <myuser> and <mypassword> with the username and password you want to use.
For more information about SDM please follow the instructions in the QUICK START
GUIDE for your router or go to http://www.cisco.com/go/sdm

^
!
no cdp run
!
!
line con 0
login local
line vty 0 4
access-class 23 in
privilege level 15
login local
transport input telnet
transport input telnet ssh
line vty 5 15
access-class 23 in
privilege level 15
login local
transport input telnet
transport input telnet ssh
!
! End of SDM default config file
end

```

## Example: QoS Marking

```
Current configuration: 2002 bytes
!
version 12.4
service timestamps debug datetime msec
service timestamps log datetime msec
no service password-encryption
!
hostname 1841-SVI-DUT
!
boot-start-marker
boot-end-marker
!
no aaa new-model
!
resource policy
!
mmi polling-interval 60
no mmi auto-configure
no mmi pvc
mmi snmp-timeout 180
ip subnet-zero
ip cef
!
class-map match-all non-critical-traffic
match access-group name ACL2
class-map match-all PREC-5
match ip precedence 5
class-map match-all critical-traffic
match access-group name ACL1
class-map match-all DSCP-AF
match dscp af21
!
!
policy-map mark-traffic
class critical-traffic
set ip dscp cs5
class non-critical-traffic
set ip precedence 2
!
interface FastEthernet0/0
ip address 20.0.0.2 255.255.255.0
speed 100
full-duplex
!
interface FastEthernet0/1
ip address 202.82.33.153 255.255.255.252
shutdown
duplex auto
speed auto
!
interface FastEthernet0/0/0
!
interface FastEthernet0/0/1
!
interface FastEthernet0/0/2
!
interface FastEthernet0/0/3
duplex full
speed 100
!
interface Vlan1
```

**Example: PBR**

```

ip address 10.0.0.2 255.255.255.0
service-policy input mark-traffic
!
ip classless
ip route 0.0.0.0 0.0.0.0 10.0.0.1
!
ip http server
no ip http secure-server
!
ip access-list standard ACL
ip access-list standard ACL1
permit 10.0.0.100
!
ip access-list extended ACL2
permit ip host 10.0.0.1 host 20.0.200.1
!
control-plane
!
line con 0
exec-timeout 0 0
privilege level 15
line aux 0
line vty 0 4
exec-timeout 0 0
login
!
scheduler allocate 20000 1000
end

```

**Example: PBR**

```

interface FastEthernet0/0/0
!
interface FastEthernet0/0/1
!
interface FastEthernet0/0/2
!
interface FastEthernet0/0/3
duplex full
speed 100
!
interface Vlan1
ip address 10.0.0.2 255.255.255.0
ip policy route-map PBR
!
route-map PBR permit 10
match ip address ACL2
set ip precedence critical
!
ip classless
ip route 0.0.0.0 0.0.0.0 10.0.0.1
!
ip http server
no ip http secure-server
!
ip access-list standard ACL
ip access-list standard ACL1
permit 10.0.0.100
!
ip access-list extended ACL2
permit ip host 10.0.0.1 host 20.0.200.1

```

```
!
control-plane
!
```







# CHAPTER 13

## Configuring VDSL2 and ADSL2/22 Plus for Cisco C1100 Series ISRs

VDSL2 and ADSL2/2+ Cisco C1100 Series Integrated Services Router provide highly reliable WAN connections for remote sites. These interfaces offer cost-effective virtualized WAN connections in both point-to-point and point-to-multipoint designs.

Organization needs high speed digital data transmission to operate between their data equipment and central office, usually located at the telecom service provider premises. The Cisco multimode VDSL2 and ADSL1/2/2+ provides 1-port (2-pair) multimode VDSL2 and ADSL2+ WAN connectivity. This connectivity in combination with Cisco C1100 Series Integrated Service Routers, provides high-speed digital data transmission between customer premises equipment (CPE) and the central office.

This capability enables service providers and resellers to offer additional services, such as business-class security, voice, video, and data; differentiated classes of service (QoS), and managed network access over existing telephony infrastructure. These value-added features, along with the flexible manageability and reliability of Cisco IOS Software, provide the mission-critical networking features that businesses expect.

The following table describes the VDSL2 and ADSL2/2+ Variants:

| Product Number      | Description                                                                                                                                                                                                                                                                                                                              |
|---------------------|------------------------------------------------------------------------------------------------------------------------------------------------------------------------------------------------------------------------------------------------------------------------------------------------------------------------------------------|
| C1117-4P - Annex A  | 1-port (2-pair) VDSL2/ADSL2+ over POTS <ul style="list-style-type: none"> <li>• VDSL2 over POTS Band Plans               <ul style="list-style-type: none"> <li>• VDSL2 profiles: 8a, 8b, 8c, 8d, 12a, 12b, 17a</li> </ul> </li> <li>• Vectoring</li> <li>• ADSL1/2/2+ Annex A, ADSL2 Annex L, non-optimized ADSL2/2+ Annex M</li> </ul> |
| C1117-4PM - Annex M | 1-port (2-pair) VDSL2/ADSL2+ over POTS with Annex M <ul style="list-style-type: none"> <li>• VDSL2 over POTS Band Plans               <ul style="list-style-type: none"> <li>• VDSL2 profiles: 8a, 8b, 8c, 8d, 12a, 12b, 17a</li> </ul> </li> </ul>                                                                                      |

| Product Number       | Description                                                                                                                                                                                                    |
|----------------------|----------------------------------------------------------------------------------------------------------------------------------------------------------------------------------------------------------------|
|                      | <ul style="list-style-type: none"> <li>• Vectoring</li> <li>• Optimized ADSL2/2+ Annex M</li> <li>• ADSL/ADSL2/2+ Annex A</li> </ul>                                                                           |
| C1116-4P - Annex B/J | 1-port (1-pair) VDSL2/ADSL2+ over ISDN <ul style="list-style-type: none"> <li>• ADSL1/2/2+ Annex B, non-optimized ADSL2/2+ Annex J</li> <li>• VDSL2 over ISDN Band Plans (8a to 17a) with Vectoring</li> </ul> |

For more information on DSLAM interoperability, refer to the Cisco Multimode VDSL2 and ADSL2/2 Network Interface Module Datasheet.

- [DSL Feature Specifications, on page 160](#)
- [Configuring DSL, on page 161](#)
- [Features Supported in xDSL , on page 165](#)
- [Show and Debug Commands, on page 179](#)
- [Sample Configurations, on page 197](#)

## DSL Feature Specifications

*Table 14: DSL Feature Specifications*

|                                    |                                                                                                                                                                                                                                                                    |
|------------------------------------|--------------------------------------------------------------------------------------------------------------------------------------------------------------------------------------------------------------------------------------------------------------------|
| Multimode DSL (VDSL2 and ADSL2/2+) | <ul style="list-style-type: none"> <li>• Broadcom chipset</li> <li>• One RJ-14 VDSL2 interface</li> <li>• Independent module firmware subpackage loading</li> <li>• Dying gasp</li> <li>• Support for double-ended line testing (DELT) diagnostics mode</li> </ul> |
|------------------------------------|--------------------------------------------------------------------------------------------------------------------------------------------------------------------------------------------------------------------------------------------------------------------|

**Table 15: VDSL2 Feature Specifications**

|       |                                                                                                                                                                                                                                                                                                                                                                    |
|-------|--------------------------------------------------------------------------------------------------------------------------------------------------------------------------------------------------------------------------------------------------------------------------------------------------------------------------------------------------------------------|
| VDSL2 | <ul style="list-style-type: none"> <li>• ITU G.993.2 (VDSL2) and ITU G.993.5 (VDSL2)</li> <li>• 997 and 998 band plans</li> <li>• VDSL2 profiles: 8a, 8b, 8c, 8d, 12a, 12b, and 17a</li> <li>• Vectoring</li> <li>• U0 band support (25 to 276 kHz)</li> <li>• Ethernet packet transfer mode (PTM) based only on IEEE 802.3ah 64/65 octet encapsulation</li> </ul> |
|-------|--------------------------------------------------------------------------------------------------------------------------------------------------------------------------------------------------------------------------------------------------------------------------------------------------------------------------------------------------------------------|

**Table 16: ADSL2/2+ Feature Specifications**

|          |                                                                                                                                                                                                                                                                                                                                                                                                                                                                                                                                                                                                                                                                                                                                            |
|----------|--------------------------------------------------------------------------------------------------------------------------------------------------------------------------------------------------------------------------------------------------------------------------------------------------------------------------------------------------------------------------------------------------------------------------------------------------------------------------------------------------------------------------------------------------------------------------------------------------------------------------------------------------------------------------------------------------------------------------------------------|
| ADSL2/2+ | <ul style="list-style-type: none"> <li>• ADSL over POTS with Annex A and Annex B ITU G. 992.1 (ADSL), G.992.3 (ADSL2), and G.992.5 (ADSL2+)</li> <li>• ADSL over POTS with Annex M (extended upstream bandwidth) G.992.3 (ADSL2) and G.992.5 (ADSL2+)</li> <li>• G.994.1 ITU G.hs</li> <li>• Reach-extended ADSL2 (G.922.3) Annex L for increased performance on loop lengths greater than 16,000 feet from central office</li> <li>• T1.413 ANSI ADSL DMT issue 2 compliance</li> <li>• DSL Forum TR-067, and TR-100 conformity</li> <li>• Impulse noise protection (INP) and extended INP</li> <li>• Downstream power backoff (DPBO)</li> <li>• Asynchronous transfer mode (ATM) only</li> <li>• Maximum 8 PVCs per interface</li> </ul> |
|----------|--------------------------------------------------------------------------------------------------------------------------------------------------------------------------------------------------------------------------------------------------------------------------------------------------------------------------------------------------------------------------------------------------------------------------------------------------------------------------------------------------------------------------------------------------------------------------------------------------------------------------------------------------------------------------------------------------------------------------------------------|

## Configuring DSL

Cisco C1100 Series Integrated Services Routers (ISRs) support asymmetric digital subscriber line (ADSL) 1/2/2+ and very high speed digital subscriber line 2 (VDSL2) transmission modes, also called multimode.

### Configuring ADSL

Perform the below mentioned steps to configure a DSL controller.

## Configuring Auto Mode

### Procedure

|               | Command or Action                                                                                                  | Purpose                                                                 |
|---------------|--------------------------------------------------------------------------------------------------------------------|-------------------------------------------------------------------------|
| <b>Step 1</b> | <b>enable</b><br><b>Example:</b><br>router> enable                                                                 | Enables privileged EXEC mode.                                           |
| <b>Step 2</b> | <b>configure terminal</b><br><b>Example:</b><br>router# configure terminal                                         | Enters global configuration mode.                                       |
| <b>Step 3</b> | <b>controller VDSL slot/subslot/port</b><br><b>Example:</b><br>router(config-controller)# controller<br>vdsl 0/3/0 | Enters configuration mode for the VDSL controller.                      |
| <b>Step 4</b> | <b>operating mode auto</b><br><b>Example:</b><br>router(config-controller)# operating mode<br>auto                 | Configures the auto operating mode, which is the default configuration. |
| <b>Step 5</b> | <b>end</b><br><b>Example:</b><br>router(config-controller)# end                                                    | Exits controller configuration mode.                                    |

## Configuring ADSL1 and ADSL2/2+ plus Annex A and Annex M Mode

### Procedure

|               | Command or Action                                                                                                  | Purpose                                            |
|---------------|--------------------------------------------------------------------------------------------------------------------|----------------------------------------------------|
| <b>Step 1</b> | <b>enable</b><br><b>Example:</b><br>router> enable                                                                 | Enables privileged EXEC mode.                      |
| <b>Step 2</b> | <b>configure terminal</b><br><b>Example:</b><br>router# configure terminal                                         | Enters global configuration mode.                  |
| <b>Step 3</b> | <b>controller VDSL slot/subslot/port</b><br><b>Example:</b><br>router(config-controller)# controller<br>vdsl 0/3/0 | Enters configuration mode for the VDSL controller. |

|               | Command or Action                                                                                                                                                                                                        | Purpose                                                                                                                                                                                                                                                                                                                                                                                                                                                                                                                                                                                                                                                                                                                                                                                                                                                                                      |
|---------------|--------------------------------------------------------------------------------------------------------------------------------------------------------------------------------------------------------------------------|----------------------------------------------------------------------------------------------------------------------------------------------------------------------------------------------------------------------------------------------------------------------------------------------------------------------------------------------------------------------------------------------------------------------------------------------------------------------------------------------------------------------------------------------------------------------------------------------------------------------------------------------------------------------------------------------------------------------------------------------------------------------------------------------------------------------------------------------------------------------------------------------|
| <b>Step 4</b> | <p><b>operating mode</b> {<i>adsl1</i>   <i>adsl2 annex a</i>   <i>annex m</i>   <i>adsl2+ annex a</i>   <i>annex m</i>}}</p> <p><b>Example:</b></p> <pre>router(config-controller)# operating mode adsl2+ annex m</pre> | <p>Configures the operating mode.</p> <ul style="list-style-type: none"> <li>• ADSL1—Configures operation in ITU G.992.1 Annex A full-rate mode.</li> <li>• ADSL2—Configures operation in ADSL2 operating mode-ITU G.992.3 Annex A, Annex L, and Annex M. If an Annex operating mode is not chosen, Annex A, Annex L, and Annex M are enabled. The final mode is decided by negotiation with the DSL access multiplexer (DSLAM).</li> <li>• ADSL2+—Configures operation in ADSL2+ mode-ITU G.992.5 Annex A and AnnexM. If an Annex A operating mode is not chosen, both Annex and Annex M is enabled. The final mode is decided by negotiation with DSLAM.</li> <li>• Annex A and M—(Optional) If the annex option is not specified, both Annex A and Annex M are enabled. The final mode is decided by negotiation with the Digital Synchronous Line Access Multiplexer (DSLAM).</li> </ul> |
| <b>Step 5</b> | <p><b>end</b></p> <p><b>Example:</b></p> <pre>router(config-controller)# end</pre>                                                                                                                                       | Exits controller configuration mode.                                                                                                                                                                                                                                                                                                                                                                                                                                                                                                                                                                                                                                                                                                                                                                                                                                                         |

## Configuring VDSL2

### Procedure

|               | Command or Action                                                                             | Purpose                                            |
|---------------|-----------------------------------------------------------------------------------------------|----------------------------------------------------|
| <b>Step 1</b> | <p><b>enable</b></p> <p><b>Example:</b></p> <pre>router&gt; enable</pre>                      | Enables privileged EXEC mode.                      |
| <b>Step 2</b> | <p><b>configure terminal</b></p> <p><b>Example:</b></p> <pre>router# configure terminal</pre> | Enters global configuration mode.                  |
| <b>Step 3</b> | <p><b>controller VDSL</b> <i>slot/subslot/port</i></p> <p><b>Example:</b></p>                 | Enters configuration mode for the VDSL controller. |

|               | Command or Action                                                                                                    | Purpose                                                                                     |
|---------------|----------------------------------------------------------------------------------------------------------------------|---------------------------------------------------------------------------------------------|
|               | <code>router(config-controller)# controller vdsl 0/3/0</code>                                                        |                                                                                             |
| <b>Step 4</b> | <b>operating mode</b> <i>mode</i><br><b>Example:</b><br><code>router(config-controller)# operating mode vdsl2</code> | Configures the operating mode. The operating mode is VDSL2. Enables 8a through 17a profile. |
| <b>Step 5</b> | <b>end</b><br><b>Example:</b><br><code>router(config-controller)# end</code>                                         | Exits controller configuration mode.                                                        |

## Examples of DSL Interface Configuration

In Cisco IOS XE, ATM PVCs can be configured under ATM sub-interfaces only. PVC configuration is not allowed under the main ATM interface. You can configure 8 point to point sub-interfaces either with one PVC configured under each point to point sub-interface or single multi-point sub-interface.

You do not need to configure the **tx-ring-limit** command in the Cisco C1100 Series Integrated Services Routers, if you are migrating from classic Cisco IOS and using **tx-ring-limit** command to reduce the latency. Because the DSL modules buffers have been fine tuned for the optimal performance and latency.

The following example shows how to configure ATM interface:

```
interface ATM0/3/0
 no ip address
 no atm oversubscribe
 no atm enable-ilmi-trap
 no shut

interface ATM0/3/0.1 point-to-point
 ip address 71.71.71.1 255.255.255.0
 no atm enable-ilmi-trap
 pvc 1/77
 vbr-rt 400 400
```

The following example shows how to configure Ethernet interface.

```
interface Ethernet0/3/0
 ip address 75.75.75.1 255.255.255.0
 load-interval 30
 no negotiation auto
```

If the trained mode is VDSL2 or VDSL2+, the TC mode should be in Packet Transfer Mode (PTM). In this case, the PTM Ethernet interface is in the **up** state. All other upper layer parameters such as PPP, IP, and so on should be configured under the Ethernet interface. If the trained mode is ADSL, ADSL2, or ADSL2+, the TC mode should be ATM and all the upper layer parameters should be configured under the ATM Permanent Virtual Circuit (PVC). If you change the operating mode between ADSL and VDSL, you need not to reboot the router in order to activate the corresponding Ethernet or ATM interfaces. In case of PTM mode, check with your ISP if they are expecting Dot1q tag configuration on the CPE. ISP should provide Dot1q tag value.

```
Router(config)#interface Ethernet0.835
Router(config-subif)#encapsulation dot1Q 835
Router(config-subif)#pppoe-client dial-pool-member 1
```

## Features Supported in xDSL

### ATM Conditional Debug Support

Most ATM debugging commands are implemented either at the system level or at the interface level. The ATM Conditional Debug Support feature allows debugging to be limited specifically to an ATM interface, to a virtual channel identifier (VCI), or to a virtual path identifier/virtual channel identifier (VPI/VCI) pair, through use of the debug condition interface command.

For more information on configuring ATM conditional debug support feature, see the [ATM Conditional Debug Support](#) document.

### ATM OAM Loopback Mode Detection

The Loopback Mode Detection Through OAM feature allows you to enable automatic detection of when a peer ATM interface is in loopback mode. When loopback is detected on an interface where end-to-end F5 Operation, Administration, and Maintenance (OAM) is enabled, the impacted permanent virtual circuit (PVC) is moved to a DOWN state, and traffic is suspended. When the loopback condition in the peer ATM interface is removed, the PVC is moved back to an UP state.

For more information on configuring ATM OAM Loopback Mode Detection, see the [Loopback Mode Detection through OAM](#) document.

### ATM Oversubscription for DSL

The ATM Oversubscription for DSL feature enables users to improve network utilization of otherwise underutilized shared networks by leveraging statistical multiplexing on ATM networks. Instead of supporting only unconditional reservation of network bandwidth to VBR PVCs, the Router offers PVC oversubscription to statistically guarantee bandwidth to VBR PVCs.

In Cisco IOS XE Release 3.14.0S or later, the ATM Oversubscription feature enables you to specify the amount of oversubscription (oversubscription factor) equal to twice the line rate. Following are the features of oversubscription:

- Oversubscription is allowed on VBR-rt and VBR-nrt.
- Under no over subscription condition, PVCs can be configured up to line rate. For example, if the line rate is 1000 Kbps. The SCR or PCR of a VBR PVC cannot be more than 1000 Kbps if there are no other PVCs. If there is a CBR PVC with PCR of 500Kbps, then the maximum SCR or PCR allowed on the VBR PVC is 500 Kbps.
- When over-subscription is enabled, multiple VBR-rt or VBR-nrt PVCs are allowed to be configured even if the sum of their SCRs exceeds the actual bandwidth available over the physical line. Suppose oversubscription is enabled and over subscription factor of 2 is set for a line rate of 1000k sum of SCRs of VBR-rt and VBR-nrt can be less than or equal to 2000k, this is excluding CBR PVCs bandwidth.

- If the user configures VBR-rt or VBR-nrt more than the configured oversubscription factor then PVC will be configured for the bandwidth available. If there is no oversubscription bandwidth left then VC will be downgraded to UBR. For example for line rate of 1000k, with oversubscription factor 2: PVC1 is vbr-rt 400k 400k, PVC2 is vbr-nrt 1600k 1600k and PVC3 is vbr-rt 500k 500k. In this case the PVC1 and PVC2 will be configured to given pcr and scr, PVC3 will be downgraded to UBR class.
- If there is no bandwidth left, then some PVCs may be downgraded to UBR class.
- PCR & SCR of VBR PVC can never exceed the line rate even if there is enough available bandwidth for the configured PCR and SCR.

Oversubscription of the ATM interfaces is enabled by default and is subject to infinite oversubscription factor which is not supported on DSL NIM. User must enable oversubscription factor.

The following configuration enables the oversubscription 2. The only oversubscription factor supported is 2.

```
Router(config)#interface atm 0/3/0
Router(config-if)#atm oversubscription factor 2
Router(config-if)#exit
```

To disable oversubscription of the interface, use the no atm oversubscribe command.

For example, the following configuration disables oversubscription of the ATM 0/1/0 interface:

```
Router(config)#interface atm 0/3/0
Router(config-if)#no atm oversubscribe
Router(config-if)#exit
```

#### Example:

Below is the example for the sum of pvc rates less than the line rate of 1561kbps.

```
Router#show atm pvc
 VCD / Peak Av/Min Burst
Interface Name VPI VCI Type Encaps SC Kbps Kbps Cells St
0/3/0.1 2 0 32 PVC SNAP CBR 300 UP
 (C) CBR 300
0/3/0.2 3 0 33 PVC SNAP CBR 100 UP
 (C) CBR 100
0/3/0.3 4 0 34 PVC SNAP VBR 400 200 10 UP
 (C) VBR 400 200 10
0/3/0.4 5 0 35 PVC SNAP VBR 600 300 10 UP
 (C) VBR 600 300 10
0/3/0.5 6 0 36 PVC SNAP VBR 300 150 10 UP
 (C) VBR 300 150 10
0/3/0.6 7 0 37 PVC SNAP VBR 700 450 10 UP
 (C) VBR 700 450 10
0/3/0.7 8 0 38 PVC SNAP UBR 1561 UP
 (C) UBR 0
0/3/0.8 1 0 39 PVC SNAP UBR 1000 UP
 (C) UBR 1000
```

When line rate gets downgraded to 294 kbps, CBR and VBR PVC rates gets adjusted dynamically as below.

```
Router#show atm pvc
 VCD / Peak Av/Min Burst
Interface Name VPI VCI Type Encaps SC Kbps Kbps Cells St
```



```

0/3/0.1 2 0 32 PVC SNAP CBR 294 UP
 (C) CBR 300
0/3/0.2 3 0 33 PVC SNAP UBR 294 UP
 (C) CBR 100
0/3/0.3 4 0 34 PVC SNAP VBR 294 200 10 UP
 (C) VBR 400 200 10
0/3/0.4 5 0 35 PVC SNAP VBR 294 294 1 UP
 (C) VBR 600 300 10
0/3/0.5 6 0 36 PVC SNAP VBR 94 94 1 UP
 (C) VBR 300 150 10
0/3/0.6 7 0 37 PVC SNAP UBR 294 UP
 (C) VBR 700 450 10
0/3/0.7 8 0 38 PVC SNAP UBR 294 UP
 (C) UBR 0
0/3/0.8 1 0 39 PVC SNAP UBR 294 UP
 (C) UBR 1000

```

## ATM Routed Bridge Encapsulation (RBE) Concept

ATM routed bridge encapsulation (RBE) is used to route IP over bridged RFC 1483 Ethernet traffic from a stub-bridged LAN.

For more information on configuring ATM RBE, see the [Providing Connectivity Using ATM Routed Bridge Encapsulation over PVCs](#) document.

## Default Route on a PPP Virtual Access Interface

If a Virtual-Template (VT) interface is configured to obtain its IP address by IPCP, the dynamically created Virtual-Access (VA) interface gets the IP address after PPP negotiation. Since the Virtual-access is created dynamically, we cannot configure mappings on the dynamic interface. Also, there is no way to configure a static route through the virtual-access interface; we need to insert a default route via the next-hop address for the virtual-access and this is achieved using "ppp ipcp route default".

For more information on the usage of the command, see the [ppp ipcp default route](#) command document.

## Dynamic Bandwidth Change for ATM PVCs

The ATM Dynamic Bandwidth for ATM PVCs over DSL feature provides the ability to configure Cisco IOS-XE software to automatically adjust PVC bandwidth in response to changes in the total available interface bandwidth. This feature eliminates the manual intervention every time DSL line rate changes, and allows the available bandwidth to be used effectively at all times.

It is recommended to enable ATM Dynamic Bandwidth feature on ATM interfaces. For more information on enabling the ATM Dynamic Bandwidth feature, refer the section "Enabling ATM Dynamic Bandwidth".

**Note**

- When there is a change in line condition or DSL line flaps, ATM interface Bandwidth gets updated after line condition is stable. PVC Service Class bandwidth and Multilink Bundle bandwidth (if MLPPP is configured) gets adjusted dynamically. As a result, traffic flows according to the adjusted bundle bandwidth.
- When "bandwidth x" is configured under dialer and there is a change in line condition or DSL line flaps, ATM interface Bandwidth gets updated after line condition is stable. PVC Service Class bandwidth gets adjusted dynamically, but Multilink Bundle bandwidth (if MLPPP is configured) does not get updated dynamically because of fixed dialer bandwidth configuration. Because of this, throughput might not be achieved as expected. It is recommended not to configure "bandwidth x" under dialer interface for MLP ATM configurations to be in sync with ATM interface/Service Class bandwidth.

## Enabling ATM Dynamic Bandwidth

By default ATM dynamic bandwidth feature is enabled. If ATM dynamic bandwidth is disabled, perform the below steps to enable the feature:

```
Router#conf t
Enter configuration commands, one per line. End with CNTL/Z.
Router(config)#int atm0/3/0
Router(config-if)#atm bandwidth dynamic
Router(config-if)#end
Router#
```

### Sample configuration:

```
!
interface ATM0/3/0
no ip address
load-interval 30
no atm enable-ilmi-trap
!
```

Show atm pvc output with atm dynamic bandwidth enabled.

### Example 1:

```
Router#show atm pvc
 VCD / Peak Av/Min Burst
Interface Name VPI VCI Type Encaps SC Kbps Kbps Cells St
0/1/0.1 1 8 37 PVC MUX UBR 1045 UP
 (C) UBR 0
Router#
```

### Example 2:

```
Router#show atm pvc
 VCD / Peak Av/Min Burst
Interface Name VPI VCI Type Encaps SC Kbps Kbps Cells St
0/3/0.1 2 0 32 PVC SNAP CBR 294 UP
 (C) CBR 300
Router#
```



**Note** (C) is the configured rates.

In example 2, CBR PVC was configured with PCR as 300 kbps. Due to line rate change, PCR rate has dynamically changed to 294 kbps.

## Disabling ATM Dynamic Bandwidth

```
Router#conf t
Enter configuration commands, one per line. End with CNTL/Z.
Router(config)#int atm0/3/0
Router(config-if)#no atm bandwidth dynamic
Router(config-if)#end
Router#
Router#sh run int atm0/3/0
Building configuration...

Current configuration : 110 bytes
!
interface ATM0/3/0
 no ip address
 load-interval 30
 no atm bandwidth dynamic
 no atm enable-ilmi-trap
end

Router#
```

Show atm pvc output with atm dynamic bandwidth feature disabled:

```
Router#show atm pvc | sec 0/3/0
0/1/0.1 1 8 37 PVC MUX UBR 1045 UP
Router#
```

## How the ATM Dynamic Bandwidth Feature Works

When the total available bandwidth on a DSL interface changes, all of the PVCs configured under the ATM sub-interface(s) are re-created.

If necessary and applicable for a particular PVC based on its service class, new values are applied for the following parameters when PVCs are re-created:

- PCR—peak cell rate
- SCR—sustainable cell rate

The following steps are performed by the Cisco IOS-XE software to determine what value should be assigned to a parameter when a PVC is re-created in response to a change in total available bandwidth:

- A value is calculated for the parameter. The calculation takes into account the configured value for the parameter, the active value for the parameter (if it is different from the configured value), and the change in total available bandwidth.
- The calculated value is compared to the configured value of the parameter and to the maximum available cell rate, and a new value is determined. The new value is applied when the PVC is re-created.

The following sections describe how the new parameter values are determined when a PVC is re-created for supported QoS classes:

### CBR PVCs

When the total available bandwidth changes, PVCs configured with CBR service class are recreated as follows:

- If the configured PCR value is less than the calculated PCR value, the PVC is recreated with the configured PCR value.
- If the configured PCR value is greater than the calculated PCR value, the PVC is recreated with the calculated value with no change in class.
- If there is no bandwidth left for the CBR PVC, then CBR PVCs will be downgraded to UBR class with a PCR value equal to the maximum available rate.

### VBR PVCs

When the total available bandwidth changes, PVCs configured with VBR service class are re-created as follows:

- If the configured PCR value is less than the calculated PCR value, the PVC is recreated with the configured PCR value.
- If the configured PCR value is greater than the calculated PCR value, the PVC is recreated with a new PCR value. The new PCR value will be the lower of the following values:
  - The calculated PCR value
  - The maximum available cell rate
- If the configured SCR value is less than the calculated PCR value, the PVC is re-created with the configured SCR value.
- If the configured SCR value is greater than the calculated PCR value, the PVC is recreated with a new SCR value. The new SCR value will be the lower of the following values:
  - The calculated PCR value
  - The maximum available cell rate

### UBR PVCs

When the total available bandwidth changes, PVCs configured with UBR service class are re-created as follows:

- If the PCR configuration is set to the default, the PVC is re-created with a PCR value equal to the new line rate.
- If the configured PCR value is less than the calculated PCR value, the PVC is re-created with the configured PCR value.
- If the configured PCR value is greater than the calculated PCR value, the PVC is recreated with a new PCR value. The new PCR value will be the lower of the following values:
  - The calculated PCR value

- New line rate

### Example:

Below is the example for the sum of pvc rates less than the line rate of 1561kbps.

```
Router#show atm pvc
 VCD / Peak Av/Min Burst
Interface Name VPI VCI Type Encaps SC Kbps Kbps Cells St
0/3/0.1 2 0 32 PVC SNAP CBR 300 UP
 (C) CBR 300
0/3/0.2 3 0 33 PVC SNAP CBR 100 UP
 (C) CBR 100
0/3/0.3 4 0 34 PVC SNAP VBR 400 200 10 UP
 (C) VBR 400 200 10
0/3/0.4 5 0 35 PVC SNAP VBR 600 300 10 UP
 (C) VBR 600 300 10
0/3/0.5 6 0 36 PVC SNAP VBR 300 150 10 UP
 (C) VBR 300 150 10
0/3/0.6 7 0 37 PVC SNAP VBR 700 450 10 UP
 (C) VBR 700 450 10
0/3/0.7 8 0 38 PVC SNAP UBR 1561 UP
 (C) UBR 0
0/3/0.8 1 0 39 PVC SNAP UBR 1000 UP
 (C) UBR 1000
```

When line rate gets downgraded to 687kbps, CBR and VBR PVC rates gets adjusted dynamically as below.

```
Router#show atm pvc
 VCD / Peak Av/Min Burst
Interface Name VPI VCI Type Encaps SC Kbps Kbps Cells St
0/3/0.1 2 0 32 PVC SNAP CBR 300 UP
 (C) CBR 300
0/3/0.2 3 0 33 PVC SNAP CBR 100 UP
 (C) CBR 100
0/3/0.3 4 0 34 PVC SNAP VBR 287 200 10 UP
 (C) VBR 400 200 10
0/3/0.4 5 0 35 PVC SNAP VBR 87 87 1 UP
 (C) VBR 600 300 10
0/3/0.5 6 0 36 PVC SNAP UBR 687 UP
 (C) VBR 300 150 10
0/3/0.6 7 0 37 PVC SNAP UBR 687 UP
 (C) VBR 700 450 10
0/3/0.7 8 0 38 PVC SNAP UBR 687 UP
 (C) UBR 0
0/3/0.8 1 0 39 PVC SNAP UBR 687 UP
 (C) UBR 1000
```

## Upgrading the Firmware on DSL Interface

To upgrade the firmware on a DSL interface, perform these steps:

### Before you begin

When you boot the router in packages.conf mode with the Cisco IOS XE image (super package) during the installation period, you can upgrade or downgrade the firmware without reloading the router.

If you do not boot the router in `packages.conf` mode with the Cisco IOS XE image, you must follow the prerequisites given below, before proceeding with the firmware upgrade:

- Copy the firmware subpackage into `bootflash:/mydir`.
- Type the **request platform software package expand file** command `boot flash:/mydir/<IOS-XE image>` to expand the super package.
- Type the **reload** command to load the module with the new firmware
- Boot the router with `packages.conf`.
- Copy the firmware subpackage to the folder `bootflash:mydir/`.
- Issue **request platform software package install** `rp 0 file bootflash:/mydir/<firmware subpackage>` .
- Reload the hardware module subslot to boot the module with the new firmware.
- Verify that the module is booted up with the new firmware using the **show platform software subslot 0/3 module firmware** command.

### Procedure

|               | Command or Action                                                                                                                                                                                                                                                                               | Purpose                                                                                                                       |
|---------------|-------------------------------------------------------------------------------------------------------------------------------------------------------------------------------------------------------------------------------------------------------------------------------------------------|-------------------------------------------------------------------------------------------------------------------------------|
| <b>Step 1</b> | copy Cisco IOS XE image into bootflash:<br><b>mydir</b> .<br><br><b>Example:</b><br>Router# <code>mkdir bootflash:mydir</code>                                                                                                                                                                  | Creates a directory to save the expanded software image.<br><br>You can use the same name as the image to name the directory. |
| <b>Step 2</b> | <b>request platform software package expand file</b> <code>bootflash:/mydir/&lt;IOS-XE image&gt;</code> to expand super package.<br><br><b>Example:</b><br>Router# <code>request platform software package expand file bootflash:/mydir/c1100-universalk9.03.14.00.S.155-1.S-std.SPA.bin</code> | Expands the platform software package to super package.                                                                       |
| <b>Step 3</b> | <b>reload</b> .<br><br><b>Example:</b><br>Router# <code>reload rommon &gt;</code>                                                                                                                                                                                                               | Enables ROMMON mode, which allows the software in the super package file to be activated.                                     |
| <b>Step 4</b> | <b>boot bootflash:mydir/ /packages.conf</b> .<br><br><b>Example:</b><br>rommon 1 > <code>boot bootflash:mydir/packages.conf</code>                                                                                                                                                              | Boots the super package by specifying the path and name of the provisioning file: <code>packages.conf</code> .                |
| <b>Step 5</b> | <b>copy</b> firmware subpackage to the folder <b>bootflash:mydir/</b> .<br><br><b>Example:</b><br>Router# <code>copy bootflash:c1100-universalk9.03.14.00.S.155-1.S-std.SPA.bin</code>                                                                                                          | Copies the firmware subpackage into <code>bootflash:mydir</code> .                                                            |

|               | Command or Action                                                                                                                                                                                                                                                                         | Purpose                                                                         |
|---------------|-------------------------------------------------------------------------------------------------------------------------------------------------------------------------------------------------------------------------------------------------------------------------------------------|---------------------------------------------------------------------------------|
|               | <code>bootflash:mydir/</code>                                                                                                                                                                                                                                                             |                                                                                 |
| <b>Step 6</b> | <p><b>request platform software package install</b><br/> <i>rp 0 file bootflash:/mydir/&lt;firmware subpackage&gt;.</i></p> <p><b>Example:</b></p> <pre>Router#request platform software package install rp 0 file bootflash:mydir/c1100-universalk9.03.14.00.S.155-1.S-std.SPA.bin</pre> | Installs the software package.                                                  |
| <b>Step 7</b> | <p><b>hw-module subslot x/y reload</b> to boot the module with the new firmware.</p> <p><b>Example:</b></p> <pre>Router#hw-module subslot 0/3 reload</pre>                                                                                                                                | Reloads the hardware module subslot and boots the module with the new firmware. |
| <b>Step 8</b> | <p><b>show platform software subslot 0/3 module firmware</b> to verify that the module is booted up with the new firmware.</p> <p><b>Example:</b></p> <pre>Router# show platform software subslot 0/3 module firmware Pe</pre>                                                            | Displays the version of the newly installed firmware.                           |

The following example shows how to perform firmware upgrade in a router module:

```
Router#mkdir bootflash:mydir
Create directory filename [mydir]?
Created dir bootflash:/mydir
Router#
Router#copy bootflash:c1100-universalk9.03.14.00.S.155-1.S-std.SPA.bin bootflash:mydir/
Destination filename [mydir/c1100-universalk9.03.14.00.S.155-1.S-std.SPA.bin]?
Copy in progress...CCCCCCCCCCCCCCCCCCCCCCCCCCCCCCCCCCCCCCCCCCCCCCCCCCCCCCCCCCCC
CCCCCCCCCCCCCCCCCCCCCCCCCCCCCCCCCCCCCCCCCCCCCCCCCCCCCCCCCCCCCCCCCCCCCCCC
CCCCCCCCCCCCCCCCCCCCCCCCCCCCCCCCCCCCCCCCCCCCCCCCCCCCCCCCCCCCCCCCCCCCCCCC
CCCCCCCCCCCCCCCCCCCCCCCCCCCCCCCCCCCCCCCCCCCCCCCCCCCCCCCCCCCCCCCCCCCCCCCC
CCCCCCCCCCCCCCCCCCCCCCCCCCCCCCCCCCCCCCCCCCCCCCCCCCCCCCCCCCCCCCCCCCCCCCCC
CCCC 425288648 bytes copied in 44.826 secs (9487544 bytes/sec)
Router#
Router#
Router#dir bootflash:mydir
Directory of bootflash:/mydir/
632738 -rw- 425288648 Dec 12 2014 09:16:42 +00:00
c1100-universalk9.03.14.00.S.155-1.S-std.SPA.bin
7451738112 bytes total (474025984 bytes free)
Router#

Router#request platform software package
expand file bootflash:/mydir/c1100-universalk9.03.14.00.S.155-1.S-std.SPA.bin
Verifying parameters
Validating package type
Copying package files
SUCCESS: Finished expanding all-in-one software package.

Router#reload
```

```
System configuration has been modified. Save? [yes/no]: yes
Building configuration...
```

```
[OK]
Proceed with reload? [confirm]
Rom image verified correctly
```

```
System Bootstrap, Version C900-1100-20170915-SDR52-Micron-Toshiba, DEVELOPMENT SOFTWARE
Copyright (c) 1994-2017 by cisco Systems, Inc.
```

```
Current image running: Boot ROM1
```

```
Last reset cause: LocalSoft
C1111-8PLTTEAWR platform with 4194304 Kbytes of main memory
```

```
rommon 1 boot bootflash:mydir/packages.conf
```

```
File size is 0x000028f1 Located mydir/packages.conf Image size 10481 inode num 632741, bks
cnt 3 blk size 8*512 # File size is 0x150ae3cc Located mydir/
c1100-universalk9.03.14.00.S.155-1.S-std. SPA.pkg Image size 353035212 inode num 356929,
bks cnt 86191 blk size 8*512
#####
Boot image size =
353035212 (0x150ae3cc) bytes Package header rev 1 structure detected Calculating SHA-1
hash...done validate_package: SHA-1 hash: calculated
8e966678:8afb08f4:8a88bb8f:fe591121:8bddf4b3 expected
8e966678:8afb08f4:8a88bb8f:fe591121:8bddf4b3 RSA Signed RELEASE Image Signature Verification
Successful. Package Load Test Latency : 3799 msec Image validated Dec 12 09:28:50.338 R0/0:
%FLASH_CHECK-3-DISK_QUOTA: Flash disk quota exceeded [free space is 61864 kB] - Please
clean up files on bootflash.
```

```
Technical Support: http://www.cisco.com/techsupport Copyright (c) 1986-2014 by Cisco Systems,
Inc. Compiled Thu 20-Nov-14 18:28 by mcpre Cisco IOS-XE software, Copyright (c) 2005-2014
by cisco Systems, Inc. All rights reserved. Certain components of Cisco IOS-XE software
are licensed under the GNU General Public License ("GPL") Version 2.0. The software code
licensed under GPL Version 2.0 is free software that comes with ABSOLUTELY NO WARRANTY. You
can redistribute and/or modify such GPL code under the terms of GPL Version 2.0. For more
details, see the documentation or "License Notice" file accompanying the IOS-XE software,
or the applicable URL provided on the flyer accompanying the IOS-XE software. This product
contains cryptographic features and is subject to United States and local country laws
governing import, export, transfer and use. Delivery of Cisco cryptographic products does
not imply third-party authority to import, export, distribute or use encryption. Importers,
exporters, distributors and users are responsible for compliance with U.S. and local country
laws. By using this product you agree to comply with applicable laws and regulations. If
you are unable to comply with U.S. and local laws, return this product immediately. A summary
of U.S. laws governing Cisco cryptographic products may be found at:
```

```
Router>
Router>en
Password:
```

```
Router#
Router show controller vdsl 0/3/0
Controller VDSL 0/3/0 is UP
```

```
Daemon Status: UP

 XTU-R (DS) XTU-C (US)
Chip Vendor ID: 'BDCM' 'BDCM'
Chip Vendor Specific: 0x0000 0xA3A3
Chip Vendor Country: 0xB500 0xB500
Modem Vendor ID: 'CSCO' 'BDCM'
Modem Vendor Specific: 0x4602 0x0000
```



```

Modem Vendor Country: 0xB500 0xB500
Serial Number Near: C1117-4P16.6.201707
Serial Number Far:
Modem Version Near: 16.6.20170704:13462
Modem Version Far: 0xa3a3

```

```

Modem Status: TC Sync (Showtime!)
DSL Config Mode: AUTO
Trained Mode: G.992.5 (ADSL2+) Annex A

```

```

TC Mode: ATM
Selftest Result: 0x00
DELT configuration: disabled
DELT state: not running

```

```

Failed full inits: 0
Short inits: 0
Failed short inits: 0

```

```

Modem FW Version: 4.14L.04
Modem PHY Version: A2pv6F039t.d26d

```

Line 0:

|                     | XTU-R (DS)    | XTU-C (US)   |
|---------------------|---------------|--------------|
| Trellis:            | ON            | ON           |
| SRA:                | disabled      | disabled     |
| SRA count:          | 0             | 0            |
| Bit swap:           | enabled       | enabled      |
| Bit swap count:     | 0             | 325          |
| Line Attenuation:   | 1.0 dB        | 3.2 dB       |
| Signal Attenuation: | 1.9 dB        | 2.7 dB       |
| Noise Margin:       | 12.5 dB       | 11.4 dB      |
| Attainable Rate:    | 27580 kbits/s | 1257 kbits/s |
| Actual Power:       | 6.3 dBm       | 12.0 dBm     |
| Total FECC:         | 0             | 0            |
| Total ES:           | 0             | 0            |
| Total SES:          | 0             | 0            |
| Total LOSS:         | 0             | 0            |
| Total UAS:          | 81            | 81           |
| Total LPRS:         | 0             | 0            |
| Total LOFS:         | 0             | 0            |
| Total LOLS:         | 0             | 0            |

|                     | DS Channel1 | DS Channel0 | US Channel1 | US Channel0 |
|---------------------|-------------|-------------|-------------|-------------|
| Speed (kbps):       | NA          | 25004       | NA          | 1111        |
| SRA Previous Speed: | NA          | 0           | NA          | 0           |
| Previous Speed:     | NA          | 0           | NA          | 0           |
| Total Cells:        | NA          | 120724290   | NA          | 5356209     |
| User Cells:         | NA          | 0           | NA          | 0           |
| Reed-Solomon EC:    | NA          | 0           | NA          | 0           |
| CRC Errors:         | NA          | 0           | NA          | 0           |
| Header Errors:      | NA          | 0           | NA          | 0           |
| Interleave (ms):    | NA          | 7.00        | NA          | 5.41        |
| Actual INP:         | NA          | 1.29        | NA          | 1.56        |

```

Training Log : Stopped
Training Log Filename : flash:vdslllog.bin

```

```

Router#
Router#

```

```

Router# copy bootflash: c1100-firmware_c1100_vadsl2017-07-07_23.01.SSA.pkg
bootflash:mydir/ Destination filename
[mydir/c1100-firmware_c1100_vadsl2017-07-07_23.01.SSA.pkg]?
Copy in progress...CCCCCCCCCCCCCCCCCCCCCCCCCCCCCCCCCCCCCCCCCCCCCCCCCCCCCCCCCCCC
CCCCCCCCCCCCCCCCCCCCCCCCCCCCCCCCCCCCCCCCCCCCCCCCCCCCCCCCCCCC 6640604 bytes copied in 1.365 secs (4864911
bytes/sec)
Router#

```

```

Router#request platform software package install rp 0 file

```

```

bootflash: c1100-firmware_c1100_vadsl2017-07-07_23.01_.SSA.pkg

```

```

--- Starting local lock acquisition on R0 --- Finished local lock acquisition on R
--- Starting file path checking --- Finished file path checking --- Starting image file
verification

```

```

--- Checking image file names Locating image files and validating name syntax Found Verifying
image file locations Inspecting image file types Processing image file constraints Creating
candidate provisioning file Finished image file verification --- Starting candidate package
set construction --- Verifying existing software set Processing candidate provisioning
file Constructing working set for candidate package set Constructing working set for running
package set Checking command output Constructing merge of running and candidate packages
Checking if resulting candidate package set would be complete Finished candidate package
set construction --- Starting ISSU compatibility verification --- Verifying image type
compatibility Checking IPC compatibility with running software Checking candidate package
set infrastructure compatibility Checking infrastructure compatibility with running software
Checking package specific compatibility Finished ISSU compatibility verification --- Starting
impact testing --- Checking operational impact of change Finished impact testing ---
Starting list of software package changes --- Old files list: Removed
c1100-firmware_c1100_vadsl2017-07-07_23.01_.SSA.pkg New files list: Added
c1100-firmware_c1100_vadsl2017-07-07_23.01_.SSA_39n.SSA.pkg Finished list of software
package changes --- Starting commit of software changes --- Updating provisioning rollback
files Creating pending provisioning file Committing provisioning file Finished commit of
software changes --- Starting analysis of software changes --- Finished analysis of software
changes --- Starting update running software --- Blocking peer synchronization of operating
information Creating the command set placeholder directory Finding latest command set
Finding latest command shortlist lookup file Finding latest command shortlist file
Router#

```

```

Router#

```

```

Router#show platform software subslot 0/3 module firmware

```

```

Avg Load info

```

```

1.83 1.78 1.44 3/45 607

```

```

Kernel distribution info

```

```

Linux version 3.4.11-rt19 (sapanwar@blr-atg-001) (gcc version 4.6.2 (Buildroot 2011.11))

```

```

#3 SMP PREEMPT Fri Nov 7 09:26:19 IST 2014

```

```

Module firmware versions

```

```

Modem Fw Version: 4.14L.04

```

```

Modem Phy Version: A2pv6F039t.d24o_rc1

```

```

Boot Loader: Secondary

```

```

Version: 1.1

```

```

Modem Up time

```

```

0D 0H 25M 38S

```

```

Router#

```

## IP to ATM CoS, Per-VC WFQ and CBWFQ QoS: PPPoE QoS Markings of .1P Bits in S (AOL)

IP to ATM CoS support for a single ATM VC allows network managers to use existing features, such as committed access rate (CAR) or policy-based routing (PBR), to classify and mark different IP traffic by modifying the IP Precedence field in the IP version 4 (IPv4) packet header. Subsequently, Weighted Random Early Detection (WRED) or distributed WRED (DWRED) can be configured on a per-VC basis so that the IP traffic is subject to different drop probabilities (and therefore priorities) as IP traffic coming into a router competes for bandwidth on a particular VC.

For more information, see the [Configuring IP to ATM CoS](#) document.

## Low Latency Queueing

Low Latency Queuing (LLQ) allows delay-sensitive data such as voice to be dequeued and sent first (before packets in other queues are dequeued), giving delay-sensitive data preferential treatment over other traffic. The **priority** command is used to allow delay-sensitive data to be dequeued and sent first. LLQ enables use of a single priority queue within which individual classes of traffic can be placed. For more details on configuring LLQ, see the following documents:

[Low Latency Queueing with Priority Percentage Support](#)

[Configuring Low Latency Queueing](#)

## Modular QoS CLI (MQC) Unconditional Packet Discard

The Modular QoS CLI (MQC) Unconditional Packet Discard feature allows customers to classify traffic matching certain criteria and then configure the system to unconditionally discard any packets matching that criteria. The Modular QoS CLI (MQC) Unconditional Packet Discard feature is configured using the Modular Quality of Service Command-Line Interface (MQC) feature. Packets are unconditionally discarded by using the new **drop** command within the MQC.

For more information on configuring Modular QoS CLI unconditional packet discard feature, see the [Modular QoS CLI Unconditional Packet Discard](#) document.

## MQC Policy Map Support on Configured VC Range ATM

The Modular Quality of Service Command Line Interface (MQC) Policy Map support on Configured VC Range ATM feature extends the functionality for policy maps on a single ATM VC to the ATM VC range.

For more information on configuring MQC Policy Map Support on Configured VC Range ATM, see the [MQC Policy Map on Configured VC Range ATM](#) document.

## Multilink PPP (MLPPP) bundling

This feature describes how to configure Multilink PPP over broadband interfaces. Configuring Multilink PPP over broadband includes configuring Multilink PPP over ATM (MLPoA), Multilink PPP over Ethernet (MLPoE), Multilink PPP over Ethernet over ATM (MLPoEoA), and so on.

For more information on Multilink PPP bundles and to configure Multilink PPP minimum links, Bundling and Multilink PPP support on multiple VC's, see the following documents:

[Configuring Multilink PPP Connections for Broadband and Serial Topologies](#)

[ATM Multilink PPP Support on Multiple VCs](#)

## PPPoE Enhancement with RFC 4638

The PPP over Ethernet Client feature provides PPP over Ethernet (PPPoE) client support on routers on customer premises.

For more information on configuring PPP over Ethernet feature, see the [PPP over Ethernet Client](#) document.

## PPPoEoA over ATM AAL5Mux

The PPPoEoA over ATM AAL5MUX feature enables PPP over Ethernet (PPPoE) over ATM adaptation layer 5 (AAL5)-multiplexed permanent virtual circuits (PVCs), reducing logical link control (LLC) and Subnetwork Access Protocol (SNAP) encapsulation bandwidth usage and thereby improving bandwidth usage for the PVC.

For more information on configuring PPPoEoA over ATM AAL5MUX feature, see [How to Configure PPPoEoA over ATM AAL5MUX](#) at [PPPoEoA over ATM AAL5Mux](#).

## PPP Over ATM (IETF-Compliant)

PPP over ATM enables a high-capacity central site router with an ATM interface to terminate multiple remote PPP connections. PPP over ATM provides security validation per user, IP address pooling, and service selection capability.

For more information on configuring PPP over ATM for different encapsulation types, see the following documents:

[Providing Protocol Support for Broadband Access Aggregation of PPP over ATM Sessions](#)

[Configuring PPP over ATM with NAT](#)

## PPPoE Specification Conformance with PADT Message

The PPP over Ethernet Client feature provides PPP over Ethernet (PPPoE) client support on routers on customer premises.

For more information on configuring PPP over Ethernet feature, see the [PPP over Ethernet Client](#) document.

## QoS on Dialer

QoS on dialer interfaces feature provides support for Point-to-Point Protocol over Ethernet (PPPoE) and Point-to-Point Protocol over Asynchronous Transfer Mode (PPPoA) configurations on dialer interfaces. The feature provides support for Modular QoS CLI (MQC)-based queuing and shaping that supports per-customer quality of service (QoS). For more details on configuring QoS on dialer, see the [Shaping on Dialer Interfaces](#) document.

## QoS: PPPoE QoS Markings of .1P Bits

The 802.1P CoS Bit Set for PPP and PPPoE Control Frames feature provides the ability to set user priority bits in the IEEE 802.1Q tagged frame to allow traffic prioritization. This capability enables a way to provide best effort quality of service (QoS) or class of service (CoS) at layer 2 without requiring reservation setup.

For more information on configuring PPPoE QoS Markings of 802.1P bits feature, see the [802.1P CoS Bit Set for PPP and PPPoE Control Frames](#) document.

## RBE Client Side Encapsulation with QoS

The RBE client side encapsulation with QoS feature provides secure connectivity to an ATM bridged network in which previously a broadband access server would not forward Address Resolution Protocol (ARP) requests or perform proxy ARP, and would respond to ARPs for its own IP address only. This feature combines RBE with QoS policy-based routing to provide security to the entire network. RBE was developed to address known issues with RFC1483 bridging such as broadcast storms and security.

For more information on configuring ATM RBE with QoS, see the following documents:

[RBE Client Side Encapsulation with QoS and the Command References](#)

[RBE Client Side Encapsulation with QoS](#)

## VC Bundling

APP License is required to support this feature on this module in Cisco IOS XE.

```
Router(config)#license boot level appxk9
```

ATM VC bundle management allows you to define an ATM VC bundle and add VCs to it. You can configure multiple Permanent Virtual Circuits (PVC) that have different QoS characteristics between two end devices. Each VC of a bundle has its own ATM traffic class and ATM traffic parameters. You can apply attributes and characteristics to discrete VC bundle members, or you can apply them collectively at the bundle level.

For more details on configuring VC Bundling, see the [Configuring ATM](#) document.

## Show and Debug Commands

Verifies that the configuration is set properly.

```
Router#show controller vdsl 0/3/0
Controller VDSL 0/3/0 is UP

Daemon Status: UP

Chip Vendor ID: XTU-R (DS) XTU-C (US)
Chip Vendor Specific: 'BDCM' 'BDCM'
Chip Vendor Country: 0x0000 0xA3A3
Modem Vendor ID: 'CSCO' 'BDCM'
Modem Vendor Specific: 0x4602 0x0000
Modem Vendor Country: 0xB500 0xB500
Serial Number Near: C1117-4P16.6.201707
Serial Number Far:
Modem Version Near: 16.6.20170704:13462
```

## Show and Debug Commands

```

Modem Version Far: 0xa3a3

Modem Status: TC Sync (Showtime!)
DSL Config Mode: AUTO
Trained Mode: G.992.5 (ADSL2+) Annex A

TC Mode: ATM
Selftest Result: 0x00
DELT configuration: disabled
DELT state: not running

Failed full inits: 0
Short inits: 0
Failed short inits: 0

Modem FW Version: 4.14L.04
Modem PHY Version: A2pv6F039t.d26d

Line 0:

 XTU-R (DS) XTU-C (US)
Trellis: ON ON
SRA: disabled disabled
SRA count: 0 0
Bit swap: enabled enabled
Bit swap count: 0 100
Line Attenuation: 1.0 dB 3.2 dB
Signal Attenuation: 1.9 dB 2.6 dB
Noise Margin: 12.4 dB 11.2 dB
Attainable Rate: 27576 kbits/s 1253 kbits/s
Actual Power: 6.3 dBm 12.0 dBm
Total FECC: 0 0
Total ES: 0 0
Total SES: 0 0
Total LOSS: 0 0
Total UAS: 81 81
Total LPRS: 0 0
Total LOFS: 0 0
Total LOLS: 0 0

 DS Channel1 DS Channel0 US Channel1 US Channel0
Speed (kbps): NA 25004 NA 1111
SRA Previous Speed: NA 0 NA 0
Previous Speed: NA 0 NA 0
Total Cells: NA 37914565 NA 1674506
User Cells: NA 0 NA 0
Reed-Solomon EC: NA 0 NA 0
CRC Errors: NA 0 NA 0
Header Errors: NA 0 NA 0
Interleave (ms): NA 7.00 NA 5.41
Actual INP: NA 1.29 NA 1.56

```

```

Training Log : Stopped
Training Log Filename : flash:vdslllog.bin

```

```
Router#show platform software subslot 0/3 module firmware
```

```
Avg Load info
```

```

2.00 1.88 1.19 1/46 598
```

```
Kernel distribution info
```

```

```

```
Linux version 3.4.11-rt19 (pavrao@bgl-ads-1863) (gcc version 4.6.2 (Buildroot 2011.11))
#3 SMP PREEMPT Tue Jun 27 18:47:55 IST 2017
```

```
Module firmware versions
```

```

Modem Fw Version: 4.14L.04
Modem Phy Version: A2pv6F039t.d26d
```

```
Boot Loader: Secondry
```

```

Version: 1.1
```

```
Modem Up time
```

```

0D 0H 13M 47S
```

```
Router#show platform software subslot 0/3 module status
```

```
Process and Memory
```

```

Mem: 43020K used, 76596K free, 0K shrd, 3200K buff, 9668K cached
CPU: 0% usr 4% sys 0% nic 95% idle 0% io 0% irq 0% sirq
Load average: 2.00 1.90 1.24 1/46 602
```

| PID | PPID | USER  | STAT | VSZ  | %MEM | CPU | %CPU | COMMAND                          |
|-----|------|-------|------|------|------|-----|------|----------------------------------|
| 518 | 322  | admin | S    | 6092 | 5%   | 0   | 0%   | dslngmt                          |
| 538 | 537  | admin | S    | 6092 | 5%   | 0   | 0%   | dslngmt                          |
| 537 | 518  | admin | S    | 6092 | 5%   | 0   | 0%   | dslngmt                          |
| 516 | 322  | admin | S    | 4056 | 3%   | 1   | 0%   | tr64c -m 0                       |
| 323 | 322  | admin | S    | 3948 | 3%   | 1   | 0%   | ssk                              |
| 521 | 519  | admin | S    | 3932 | 3%   | 1   | 0%   | consoled                         |
| 322 | 1    | admin | S    | 3596 | 3%   | 1   | 0%   | /bin/smd                         |
| 312 | 311  | admin | S    | 2976 | 2%   | 0   | 0%   | /bin/swmdk                       |
| 311 | 310  | admin | S    | 2976 | 2%   | 0   | 0%   | /bin/swmdk                       |
| 313 | 311  | admin | S    | 2976 | 2%   | 0   | 0%   | /bin/swmdk                       |
| 310 | 1    | admin | S    | 2976 | 2%   | 0   | 0%   | /bin/swmdk                       |
| 602 | 601  | admin | R    | 1680 | 1%   | 0   | 0%   | /usr/bin/top -b -n 1 -d 30       |
| 1   | 0    | admin | S    | 1676 | 1%   | 0   | 0%   | init                             |
| 519 | 1    | admin | S    | 1676 | 1%   | 0   | 0%   | -/bin/sh -l -c consoled          |
| 601 | 538  | admin | S    | 1672 | 1%   | 0   | 0%   | sh -c /usr/bin/top -b -n 1 -d 30 |
| 363 | 322  | admin | S    | 1552 | 1%   | 0   | 0%   | dhcpcd                           |
| 517 | 322  | admin | S    | 1480 | 1%   | 0   | 0%   | dsldiagd                         |
| 326 | 322  | admin | S    | 1432 | 1%   | 0   | 0%   | dnsproxy                         |
| 511 | 2    | admin | SW   | 0    | 0%   | 1   | 0%   | [dsl0]                           |
| 241 | 2    | admin | SW   | 0    | 0%   | 0   | 0%   | [bcmsw_rx]                       |
| 145 | 2    | admin | SW   | 0    | 0%   | 1   | 0%   | [mtdblock0]                      |
| 260 | 2    | admin | SW   | 0    | 0%   | 1   | 0%   | [bcmsw_timer]                    |
| 206 | 2    | admin | SW   | 0    | 0%   | 1   | 0%   | [bcmFlwStatsTask]                |
| 5   | 2    | admin | SW   | 0    | 0%   | 0   | 0%   | [kworker/u:0]                    |
| 9   | 2    | admin | SW   | 0    | 0%   | 1   | 0%   | [ksoftirqd/1]                    |
| 10  | 2    | admin | SW   | 0    | 0%   | 0   | 0%   | [kworker/0:1]                    |
| 8   | 2    | admin | SW   | 0    | 0%   | 1   | 0%   | [kworker/1:0]                    |
| 156 | 2    | admin | SW<  | 0    | 0%   | 0   | 0%   | [linkwatch]                      |
| 50  | 2    | admin | SW   | 0    | 0%   | 1   | 0%   | [bdi-default]                    |
| 69  | 2    | admin | DW   | 0    | 0%   | 1   | 0%   | [skbFreeTask]                    |
| 87  | 2    | admin | SWN  | 0    | 0%   | 1   | 0%   | [kswapd0]                        |
| 88  | 2    | admin | SW   | 0    | 0%   | 1   | 0%   | [fsnotify_mark]                  |
| 7   | 2    | admin | SW   | 0    | 0%   | 1   | 0%   | [migration/1]                    |
| 152 | 2    | admin | SW   | 0    | 0%   | 1   | 0%   | [kworker/1:1]                    |
| 329 | 2    | admin | DW   | 0    | 0%   | 0   | 0%   | [Avs65_Task]                     |
| 160 | 2    | admin | SW<  | 0    | 0%   | 0   | 0%   | [deferwq]                        |
| 11  | 2    | admin | SW<  | 0    | 0%   | 1   | 0%   | [khelper]                        |
| 12  | 2    | admin | SW   | 0    | 0%   | 1   | 0%   | [kworker/u:1]                    |
| 48  | 2    | admin | SW   | 0    | 0%   | 0   | 0%   | [sync_supers]                    |
| 261 | 2    | admin | SW   | 0    | 0%   | 1   | 0%   | [bcmsw]                          |
| 52  | 2    | admin | SW<  | 0    | 0%   | 1   | 0%   | [kblockd]                        |





```

xt_mark 813 0 - Live 0xc0350000
xt_mac 739 0 - Live 0xc034a000
xt_DSCP 1819 0 - Live 0xc0344000
xt_dscp 1187 0 - Live 0xc033d000
pwrnmngtd 8147 0 - Live 0xc0336000 (P)
bcmvlan 90718 0 - Live 0xc0312000 (P)
p8021ag 5891 0 - Live 0xc02e8000 (P)
bcmarl 6338 0 - Live 0xc02df000 (P)
nciTMSkmod 306764 0 - Live 0xc0288000 (P)
bcm_enet 199999 1 pwrnmngtd, Live 0xc01ec000
adslldd 458747 0 - Live 0xc0120000 (P)
bcmxtmcfg 75415 1 adslldd, Live 0xc009b000 (P)
pktflow 85993 2 bcmarl,bcm_enet, Live 0xc0067000 (P)
bcm_bpm 9827 0 [permanent], Live 0xc0045000 (P)
bcm_ingqos 8159 0 - Live 0xc003a000 (P)
chipinfo 1325 0 - Live 0xc0031000 (P)

```

System Memory status

```

MemTotal: 119616 kB
MemFree: 76496 kB
Buffers: 3220 kB

Cached: 9732 kB
SwapCached: 0 kB
Active: 5300 kB
Inactive: 9572 kB
Active(anon): 1924 kB
Inactive(anon): 0 kB
Active(file): 3376 kB
Inactive(file): 9572 kB
Unevictable: 0 kB
Mlocked: 0 kB
SwapTotal: 0 kB
SwapFree: 0 kB
Dirty: 0 kB
Writeback: 0 kB
AnonPages: 1976 kB
Mapped: 2764 kB
Shmem: 0 kB
Slab: 26208 kB
SReclaimable: 556 kB
SUnreclaim: 25652 kB
KernelStack: 752 kB
PageTables: 252 kB

```

```

NFS_Unstable: 0 kB
Bounce: 0 kB
WritebackTmp: 0 kB
CommitLimit: 59808 kB
Committed_AS: 4888 kB
VmallocTotal: 1032116 kB
VmallocUsed: 1544 kB
VmallocChunk: 1028200 kB

```

## Module Specific Show Commands

| Command                                                                                                     | Purpose                                                                                                                           |
|-------------------------------------------------------------------------------------------------------------|-----------------------------------------------------------------------------------------------------------------------------------|
| <b>show platform software subslot <i>slot/subslot</i> module firmware</b>                                   | Displays firmware version, CFE version, build label of both module (base board).                                                  |
| <b>show platform software subslot <i>slot/subslot</i> module status</b>                                     | Displays CPU utilization, memory utilization, firmware status, and so on.                                                         |
| <b>show platform hardware subslot <i>slot/subslot</i> module device help</b>                                | Displays device information specific to the module (for example, Phy, Non-Interface Registers).                                   |
| <b>show platform hardware subslot <i>slot/subslot</i> module host-if status</b>                             | Displays configuration and status for the host interface port(s) (that is, ports connected to the backplane switch) of baseboard. |
| <b>show platform hardware subslot <i>slot/subslot</i> module host-if statistics</b>                         | Displays link statistics for the host interface port(s) (that is, ports connected to the backplane switch).                       |
| <b>show platform hardware subslot <i>slot/subslot</i> module interface <i>interface name</i> status</b>     | Displays status, configuration and IID for specified user-visible interface.                                                      |
| <b>show platform hardware subslot <i>slot/subslot</i> module interface <i>interface name</i> statistics</b> | Displays link statistics including FC info for specified user-visible interface.                                                  |

```

Router#show platform software subslot 0/3 module firmwareAvg Load info

2.00 1.88 1.19 1/46 598

Kernel distribution info

Linux version 3.4.11-rt19 (pavrao@bgl-ads-1863) (gcc version 4.6.2 (Buildroot 2011.11))
#3 SMP PREEMPT Tue Jun 27 18:47:55 IST 2017

Module firmware versions

Modem Fw Version: 4.14L.04
Modem Phy Version: A2pv6F039t.d26d

Boot Loader: Secondary

Version: 1.1

Modem Up time

```

0D 0H 13M 47S

Router#show platform software subslot 0/3 module status

Process and Memory

```

Mem: 43020K used, 76596K free, 0K shrd, 3200K buff, 9668K cached
CPU: 0% usr 4% sys 0% nic 95% idle 0% io 0% irq 0% sirq
Load average: 2.00 1.90 1.24 1/46 602
 PID PPID USER STAT VSZ %MEM CPU %CPU COMMAND
 518 322 admin S 6092 5% 0 0% dslmgmt
 538 537 admin S 6092 5% 0 0% dslmgmt
 537 518 admin S 6092 5% 0 0% dslmgmt
 516 322 admin S 4056 3% 1 0% tr64c -m 0
 323 322 admin S 3948 3% 1 0% ssk
 521 519 admin S 3932 3% 1 0% consoled
 322 1 admin S 3596 3% 1 0% /bin/smd
 312 311 admin S 2976 2% 0 0% /bin/swmdk
 311 310 admin S 2976 2% 0 0% /bin/swmdk
 313 311 admin S 2976 2% 0 0% /bin/swmdk
 310 1 admin S 2976 2% 0 0% /bin/swmdk
 602 601 admin R 1680 1% 0 0% /usr/bin/top -b -n 1 -d 30
 1 0 admin S 1676 1% 0 0% init
 519 1 admin S 1676 1% 0 0% -/bin/sh -l -c consoled
 601 538 admin S 1672 1% 0 0% sh -c /usr/bin/top -b -n 1 -d 30
 363 322 admin S 1552 1% 0 0% dhcpcd
 517 322 admin S 1480 1% 0 0% dsldiagd
 326 322 admin S 1432 1% 0 0% dnsproxy
 511 2 admin SW 0 0% 1 0% [dsl10]
 241 2 admin SW 0 0% 0 0% [bcmsw_rx]
 145 2 admin SW 0 0% 1 0% [mtdblock0]
 260 2 admin SW 0 0% 1 0% [bcmsw_timer]
 206 2 admin SW 0 0% 1 0% [bcmFlwStatsTask]
 5 2 admin SW 0 0% 0 0% [kworker/u:0]
 9 2 admin SW 0 0% 1 0% [ksoftirqd/1]
 10 2 admin SW 0 0% 0 0% [kworker/0:1]
 8 2 admin SW 0 0% 1 0% [kworker/1:0]
 156 2 admin SW< 0 0% 0 0% [linkwatch]
 50 2 admin SW 0 0% 1 0% [bdi-default]
 69 2 admin DW 0 0% 1 0% [skbFreeTask]
 87 2 admin SWN 0 0% 1 0% [kswapd0]
 88 2 admin SW 0 0% 1 0% [fsnotify_mark]
 7 2 admin SW 0 0% 1 0% [migration/1]
 152 2 admin SW 0 0% 1 0% [kworker/1:1]
 329 2 admin DW 0 0% 0 0% [Avs65_Task]
 160 2 admin SW< 0 0% 0 0% [deferwq]
 11 2 admin SW< 0 0% 1 0% [khelper]
 12 2 admin SW 0 0% 1 0% [kworker/u:1]
 48 2 admin SW 0 0% 0 0% [sync_supers]
 261 2 admin SW 0 0% 1 0% [bcmsw]
 52 2 admin SW< 0 0% 1 0% [kblockd]
 2 0 admin SW 0 0% 1 0% [kthreadd]
 3 2 admin SW 0 0% 0 0% [ksoftirqd/0]
 4 2 admin SW 0 0% 0 0% [kworker/0:0]
 89 2 admin SW< 0 0% 1 0% [crypto]
 6 2 admin SW 0 0% 0 0% [migration/0]
```

Processors utilization

```

Linux 3.4.11-rt19 ((none)) 01/01/70 _mips_ (2 CPU)
00:14:47 CPU %usr %nice %sys %iowait %irq %soft %steal %guest %idle
00:14:47 all 0.13 0.00 1.42 0.00 0.00 0.17 0.00 0.00 98.28
00:14:47 0 0.13 0.00 1.52 0.00 0.00 0.28 0.00 0.00 98.07
```



```

bcmarl 6338 0 - Live 0xc02df000 (P)
nciTMSkmod 306764 0 - Live 0xc0288000 (P)
bcm_enet 199999 1 pwrnmngtd, Live 0xc01ec000
adslidd 458747 0 - Live 0xc0120000 (P)
bcmxtmcfg 75415 1 adslidd, Live 0xc009b000 (P)
pktflow 85993 2 bcmarl,bcm_enet, Live 0xc0067000 (P)
bcm_bpm 9827 0 [permanent], Live 0xc0045000 (P)
bcm_ingqos 8159 0 - Live 0xc003a000 (P)
chipinfo 1325 0 - Live 0xc0031000 (P)

```

System Memory status

```

MemTotal: 119616 kB
MemFree: 76496 kB
Buffers: 3220 kB
Cached: 9732 kB
SwapCached: 0 kB
Active: 5300 kB
Inactive: 9572 kB
Active(anon): 1924 kB
Inactive(anon): 0 kB
Active(file): 3376 kB
Inactive(file): 9572 kB
Unevictable: 0 kB
Mlocked: 0 kB
SwapTotal: 0 kB
SwapFree: 0 kB
Dirty: 0 kB
Writeback: 0 kB
AnonPages: 1976 kB
Mapped: 2764 kB
Shmem: 0 kB
Slab: 26208 kB
SReclaimable: 556 kB
SUnreclaim: 25652 kB
KernelStack: 752 kB
PageTables: 252 kB
NFS_Unstable: 0 kB
Bounce: 0 kB
WritebackTmp: 0 kB
CommitLimit: 59808 kB
Committed_AS: 4888 kB
VmallocTotal: 1032116 kB
VmallocUsed: 1544 kB
VmallocChunk: 1028200 kB

```

```

Router#show platform hardware subslot 0/3 module interface ethernet 0/3/0 statistics
Mode: PTM IID : 1

```

```

Queue Stats LP HP
Throttles 0 0
Enables 0 0
Throttles Ref 0 0
Enables Ref 55 55
Throttled 0 0
Tx Packets 14 0
Tx Bytes 6046 0
Tx Q Drops 0 0
Rx Packets 0 NA
Rx Bytes 0 NA
Rx Q Drops 0 NA
Max Q Depth 400 400
Q Depth 0 0
XON Q Depth 25 25
XOFF Q Depth 35 35

```

End of XDSL Interface Statistics

```

Router#show platform hardware subslot 0/3 module interface atm 0/3/0 statistics
Mode: ATM IID:3 PVC:8/37
=====

```

```

Queue Stats LP HP
Throttles 0 0
Enables 0 0
Throttles Ref 0 0
Enables Ref 1543 1543
Throttled 0 0
Tx Packets 7306 0
Tx Bytes 277628 0
Tx Q Drops 0 0
Rx Packets 0 NA
Rx Bytes 0 NA
Rx Q Drops 0 NA
Max Q Depth 400 400
Q Depth 0 0
XON Q Depth 96 96
XOFF Q Depth 100 100

```

End of XDSL Interface Statistics

```

Router#show platform hardware subslot 0/3 module device help
help The current information
conn Conn mgr details
rp RP details
rgmii BCM switch port RGMIID details
mips BCM switch port MIPS details
steering Steering driver details
dma BCM switch and xtm DMA details

```

```

Router#show platform hardware subslot 0/3 module device conn
Connection Manager Statistics
Total number of packets used by NGIO is: 1 (2 Kbytes)
Processing statistics, processed: 427
Queue depth: current: 0 max: 5
handler (ms): min/avg/max: 0/0/0
NGIO (ms): min/avg/max: 0/0/10
statistics per invocation: avg: 1 max: 6
Corrupted packet Overrun: errors 0
Corrupted packet Underrun errors: 0
packet out of memory errors: 0

```

```

 local remote
 pkts in pkts out errors pkts in pkts out errors
Control Point: 0: Last update was 280 ms ago
SAP 7: 0 0 0 0 0 0
SAP 6: 0 0 0 0 0 0
SAP 5: 0 0 0 0 0 0
SAP 4: 0 0 0 0 0 0
SAP 3: 0 0 0 0 0 0
SAP 2: 14 85 0 68 13 0
SAP 1: 12 873 0 872 12 0
SAP 0: 402 328 0 326 401 0
Total : 428 1286 0 1266 426 0
Heartbeats Local Remote
State: HB_INACTIVE HB_ACTIVE
 in 184 28
 out 28 184
 acks in 28 183
 acks out 184 28
 lost 0 0
 resets 0 0
Grand Total: 428 1286 0 1266 426 0

```

```
Router#show platform hardware subslot 0/3 module device rp
```

```

Reliable Protocol Statistics
link 0 packets in 435
link 0 packets out 1346
link 0 acks in 1342
link 0 acks out 435
link 0 retries 2
link 0 timeouts 0
link 0 delete errors 0
link 0 errors 0
link 0 transmit errors 0
link 0 revision errors 0
link 0 duplicates 0
link 0 out of sequence 0
link 0 out of window 0
link 0 current queue depth 0
link 0 max queue depth 14
link 0 processed 435
link 0 delivered 435
link 0 minimum latency(ms) 0
link 0 maximum latency(ms) 120
link 0 average latency(ms) 3

```

```
Router#show platform hardware subslot 0/3 module device rgmii
```

```

RGMII Tx Stats

1762802 tx_octets_lo, 0 tx_octets_hi
0 tx_drop_pkts, 273 tx_qos_pkts
11 tx_bcast_pkts, 272 tx_mcast_pkts
14152 tx_ucast_pkts, 0 tx_col
0 tx_single_col, 0 tx_multi_col
0 tx_defer, 0 tx_late_col
0 tx_excess_col, 0 tx_framein_disc
0 tx_pause_pkts, 102618 tx_qos_octets_lo
0 tx_qos_octets_hi
RGMII Rx Stats

7103314 rx_octets_lo, 0 rx_octets_hi
0 rx_undersize_pkts, 0 rx_pause_pkts
0 rx_oversize_pkts, 0 rx_jabber
0 rx_align_err, 0 rx_fcs_err

```

```

7103314 rx_good_octets_lo, 0 rx_good_octets_hi
0 rx_drop_pkts, 14092 rx_ucast_pkts
0 rx_mcast_pkts, 2 rx_bcast_pkts
0 rx_fragments, 0 rx_excess_frame_disc
0 rx_symbol_err, 9 rx_qos_pkts
4055 rx_qos_octets_lo, 0 rx_qos_octets_hi

Router#show platform hardware subslot 0/3 module device dma
BCMSW DAM info

== dma controller registers ==
controller config: 00000003
ch: config:int stat:int mask
rx:00000001:00000000:00000007
tx:00000000:00000007:00000000

== sram contents ==
ch: bd base: status:current bd content
rx:078ec000:0000000b:08402000:07b37060
tx:07ae2000:0000004a:003c6110:05e96002

== MIPS and MISC registers ==
CP0 cause: 00000000
CP0 status: 10008d01
XTM Rx DMA info

Ch 0, NumRxBds: 776, HeadIdx: 1, TailIdx: 1, AssignedBds: 776
DMA cfg: 0x00000001, intstat: 0x00000000, intmask: 0x00000007

Ch 1, NumRxBds: 16, HeadIdx: 1, TailIdx: 1, AssignedBds: 16
DMA cfg: 0x00000001, intstat: 0x00000000, intmask: 0x00000007
XTM Tx Bonding DMA info

No Bonding Information
XTM Tx DMA info

Ch 0, NumTxBds: 400, HeadIdx: 3, TailIdx: 3, FreeBds: 400
BD RingOffset: 0x00000003, Word1: 0x01bd60f3

Ch 1, NumTxBds: 400, HeadIdx: 0, TailIdx: 0, FreeBds: 400
BD RingOffset: 0x00000000, Word1: 0x00000000

Router#show platform hardware subslot 0/3 module device mips
MIPS Tx Stats

7112517 tx_octets_lo, 0 tx_octets_hi
0 tx_drop_pkts, 11 tx_qos_pkts
2 tx_bcast_pkts, 0 tx_mcast_pkts
14161 tx_ucast_pkts, 0 tx_col
0 tx_single_col, 0 tx_multi_col
0 tx_defer, 0 tx_late_col
0 tx_excess_col, 0 tx_framein_disc
0 tx_pause_pkts, 4997 tx_qos_octets_lo
0 tx_qos_octets_hi
MIPS Rx Stats

1780378 rx_octets_lo, 0 rx_octets_hi
0 rx_undersize_pkts, 0 rx_pause_pkts
0 rx_oversize_pkts, 0 rx_jabber
0 rx_align_err, 0 rx_fcs_err
1780378 rx_good_octets_lo, 0 rx_good_octets_hi

```



```

0 rx_drop_pkts, 14223 rx_ucast_pkts
272 rx_mcast_pkts, 12 rx_bcast_pkts
0 rx_fragments, 0 rx_excess_frame_disc
0 rx_symbol_err, 273 rx_qos_pkts
102618 rx_qos_octets_lo, 0 rx_qos_octets_hi

```

Router#**show platform hardware subslot 0/3 module device steering**

```

Steering drv Data path stats
Mode: PTM, IID:1
25 low_watermark, 35 high_watermark
0 FcDrops
----Egress path----
Tx Priority queue :0
11 RxPkts, 4711 RxBytes, 11 TxPkts, 4711 TxBytes, 0 RxDroppedPkts, 0 RxDroppedBytes
0 TxDroppedPkts, 0 TxDroppedBytes
Tx Priority queue :1
0 RxPkts, 0 RxBytes, 0 TxPkts, 0 TxBytes, 0 RxDroppedPkts, 0 RxDroppedBytes
0 TxDroppedPkts, 0 TxDroppedBytes
----Ingress path----
0 RxPkts, 0 RxBytes
0 RxDroppedPkts, 0 RxDroppedBytes
0 TxPkts, 0 TxBytes
0 TxDroppedPkts, 0 TxDroppedBytes
Steering drv Control path stats
1973 pkt2Linux, 225957 pktBytes2Linux
0 pktDrops, 0 pktCpDrops

```

Router#**show platform hardware subslot 0/3 module host-if statistics**

```

Data path counters
Mode: PTM IID : 1 Module Datapath Enabled

----- Egress path -----
Enet counters
 14795 RxPkts, 7187018 RxBytes, 0 RxErrs, 0 RxDropped
Steering counters
 Tx Priority queue :0
 13 RxPkts, 5601 RxBytes, 0 RxDroppedPkts
 13 TxPkts, 5601 TxBytes, 0 TxDroppedPkts
 Tx Priority queue :1
 0 RxPkts, 0 RxBytes, 0 RxDroppedPkts
 0 TxPkts, 0 TxBytes, 0 TxDroppedPkts
NGIO Flow Control Msgs
 LP XON 51 XOFF 0, HP XON 51 XOFF 0, DroppedFCMsgs 0
 Low Watermark 25 High Watermark 35
XTM counters
 5 TxPkts, 2225 TxBytes, 0 TxErrs, 0 TxDropped

----- Ingress path -----
XTM counters
 0 RxPkts, 0 RxBytes, 0 RxErrs, 0 RxDropped
Steering counters
 0 RxPkts, 0 RxBytes, 0 RxDroppedPkts
 0 TxPkts, 0 TxBytes, 0 TxDroppedPkts
Enet counters
 15162 TxPkts, 2119357 TxBytes, 0 TxErrs, 0 TxDropped
Steering drv Control path stats
 2531 pkt2Linux, 289693 pktBytes2Linux
 0 pktDrops, 0 pktCpDrops

```

Router#**show platform hardware subslot 0/3 module host-if status**

```

Host Module L2 info:
CP_MAC: 30.f7.0d.55.40.ac

```

```

FFP_DP_MAC: 30.f7.0d.55.40.a9
FFP_FC_MAC: 30.f7.0d.55.40.a9
Module_MAC: d0.72.dc.93.f5.4b
CP VLAN ID: 2351
FFP DP VLAN ID: 2350
FFP HP1 VLAN ID: 2350
FFP HP2 VLAN ID: 2350
FC VLAN ID: 2350
Max CP MTU : 2048

```

```

Router#show platform hardware subslot 0/3 module interface ethernet 0/3/0 status
PTM Interface IID:1
Channel Status:ENABLE

```

```
-----End of XDSL Interface Status-----
```

#### Other useful CLIs for debugging issues related to packet flow:

- **show platform hardware backplaneswitch-manager rp active ffp statistics**
- **show platform hardware backplaneswitch-manager rp active subslot *subslot* GEO statistics**
- **Show platform hardware qfp act infra bqs queue out default interface *interface name***
- **show platform hardware qfp active interface if-name *interface name***
- **show platform hardware qfp active interface if-name *interface name* statistics**
- **show platform hardware qfp active statistics drop**
- **show platform hardware qfp active interface statistics clear**

## Packet Flow Specific to ATM PVC Related Show and Debug Commands

```

Router#show platform software atm F0 pvc
Forwarding Manager ATM PVC Information
Interface VCD ID Ing-ID Eg-ID VC State AOM ID
ATM0/3/0.1 1 0x1004010 0 0 0x1248 378

```

```

Router#show platform hardware qfp active infrastructure bqs interface-string
ATM0/3/0.1.1.1004010 hierarchy detail
Interface: ATM0/3/0.1.1.1004010 QFP: 0.0 if_h: 33 Num Queues/Schedules: 5
Queue specifics:
Index 0 (Queue ID:0x448, Name: ATM0/3/0.1.1.1004010)
PARQ Software Control Info:
(cache) queue id: 0x00000448, wred: 0xe79955d0, qlimit (pkts) : 64
parent_sid: 0x91, debug_name: ATM0/3/0.1.1.1004010
sw_flags: 0x08000011, sw_state: 0x00000c01, port_uidb: 65503
orig_min : 0 , min: 0
min_qos : 0 , min_dflt: 0
orig_max : 0 , max: 0
max_qos : 0 , max_dflt: 0
share : 1
plevel : 0, priority: 65535
defer_obj_refcnt: 0
ifm_h: 36, qos_h: 0x00000000, parent_obj_h: 0x00000024
ifh 33 queue_type 0(NONE)
qm_obj: 0x00007f81b81c9fa0
subdevice_id : 0

```

```

Statistics:
tail drops (bytes): 0 , (packets): 0
total enqs (bytes): 103686 , (packets): 6098
queue_depth (pkts): 0
Schedule specifics:
Index 0 (SID:0x91, Name: ATM0/3/0.1.1.1004010)
PARQ Software Control Info:
sid: 0x91, parent_sid: 0x90
evfc_fc_id: 0x5200, fc_sid: 0xffffffff
obj_id: 0x24, parent_obj_id: 0x20, debug_name: ATM0/3/0.1.1.1004010
num_entries (active): 1, num_children (max): 1
presize_hint: 0
sw_flags: 0x0842002a, sw_state: 0x00000801
orig_min : 0 , min: 0
min_qos : 0 , min_dflt: 1045000
orig_max : 0 , max: 1045000
max_qos : 0 , max_dflt: 1045000
share : 1
plevel: 0, service_fragment: False, port_uidb: 65503
priority: 0, defer_obj_refcnt: 0
ifm_h: 36, qos_h: 0x00000000, parent_obj_h: 0x00000020
ifh 33 queue_type 0(NONE)
qm_obj: 0x00007f81b81ca0f0
subdevice_id : 0
REM Schedule Info:
Cnt1=0x0 (FC_Enabled) Aggregate State=0x0 (XON XON XON)
HP2, priority level 1. Enforced State=XON (XON)
Bytes Left=2147483647, Paks Left=2147483647
Rvd Flow-On Msgs=0, Rvd Flow-Off Msgs=0
Rvd Refresh Msgs=370, Refresh xon_mismatch=0 xoff_mismatch=0
HP1, priority level 2. Enforced State=XON (XON XON)
Bytes Left=0, Paks Left=0
Rvd Flow-On Msgs=0, Rvd Flow-Off Msgs=0
Rvd Refresh Msgs=0, Refresh xon_mismatch=0 xoff_mismatch=0
LP, normal priority. Enforced State=XON (XON XON XON)
Bytes Left=2147483647, Paks Left=2147483647
Rvd Flow-On Msgs=0, Rvd Flow-Off Msgs=0
Rvd Refresh Msgs=370, Refresh xon_mismatch=0 xoff_mismatch=0
Schedule specifics:
Index 1 (SID:0x90, Name: ATM0/3/0 UBR COS)
PARQ Software Control Info:
sid: 0x90, parent_sid: 0x7f
evfc_fc_id: 0xffff, fc_sid: 0xffffffff
obj_id: 0x20, parent_obj_id: 0x1c, debug_name: ATM0/3/0 UBR COS
num_entries (active): 1, num_children (max): 1
presize_hint: 0
sw_flags: 0x08520022, sw_state: 0x00000801
orig_min : 0 , min: 0
min_qos : 0 , min_dflt: 0
orig_max : 0 , max: 0
max_qos : 0 , max_dflt: 0
share : 1
plevel: 0, service_fragment: False, port_uidb: 65504
priority: 0, defer_obj_refcnt: 0
ifm_h: 32, qos_h: 0x00000000, parent_obj_h: 0x0000001c
ifh 0 queue_type 0(NONE)
qm_obj: 0x00007f81b81caa20
subdevice_id : 0
Schedule specifics:
Index 2 (SID:0x7f, Name: ATM0/3/0)
PARQ Software Control Info:
sid: 0x7f, parent_sid: 0x7c
evfc_fc_id: 0x5100, fc_sid: 0xffffffff
obj_id: 0x1c, parent_obj_id: 0x17, debug_name: ATM0/3/0

```

```

num_entries (active): 2, num_children (max): 2
presize_hint: 0
sw_flags: 0x0842002a, sw_state: 0x00000801
orig_min : 0 , min: 1097000
min_qos : 0 , min_dflt: 1097000
orig_max : 0 , max: 1097000
max_qos : 0 , max_dflt: 1097000
share : 1
plevel: 0, service_fragment: False, port_uidb: 65525
priority: 0, defer_obj_refcnt: 0
ifm_h: 28, qos_h: 0x00000000, parent_obj_h: 0x00000017
ifh_1l queue_type 0(NONE)
qm_obj: 0x00007f81b81cb0b0
subdevice_id : 0
REM Schedule Info:
Cntl=0x0 (FC_Enabled) Aggregate State=0x0 (XON XON XON)
HP2, priority level 1. Enforced State=XON (XON)
Bytes Left=0, Paks Left=0
Rvd Flow-On Msgs=0, Rvd Flow-Off Msgs=0
Rvd Refresh Msgs=0, Refresh xon_mismatch=0 xoff_mismatch=0
HP1, priority level 2. Enforced State=XON (XON XON)
Bytes Left=0, Paks Left=0
Rvd Flow-On Msgs=0, Rvd Flow-Off Msgs=0
Rvd Refresh Msgs=0, Refresh xon_mismatch=0 xoff_mismatch=0
LP, normal priority. Enforced State=XON (XON XON XON)
Bytes Left=0, Paks Left=0
Rvd Flow-On Msgs=0, Rvd Flow-Off Msgs=0
Rvd Refresh Msgs=0, Refresh xon_mismatch=0 xoff_mismatch=0
Schedule specifics:
Index 3 (SID:0x7c, Name: Licensed Shaper)
PARQ Software Control Info:
sid: 0x7c, parent_sid: 0x0
evfc_fc_id: 0xffff, fc_sid: 0xfffff
obj_id: 0x17, parent_obj_id: 0x0, debug_name: Licensed Shaper
num_entries (active): 5, num_children (max): 5
presize_hint: 2
sw_flags: 0x0802208a, sw_state: 0x00000001
orig_min : 0 , min: 400000000
min_qos : 0 , min_dflt: 400000000
orig_max : 0 , max: 400000000
max_qos : 0 , max_dflt: 400000000
share : 1
plevel: 0, service_fragment: False, port_uidb: 0
priority: 0, defer_obj_refcnt: 0
ifm_h: 23, qos_h: 0x00000000, parent_obj_h: 0x00000000
ifh_0 queue_type 0(NONE)
qm_obj: 0x00007f81b81cbf20
subdevice_id : 0

```

- **show platform hardware qfp active interface platform ATM0/3/0.1.1.1004010 path**
- **show platform hardware qfp active interface if-name atm0/3/0.1 statistics**

## Collecting DSL Training Logs

Perform the following steps to collect the DSL training logs:

```

Router#debug vdsl controller 0/3/0 training log
VDSL Controller VDSL 0/3/0 - Training debugging is on

```

Perform the following steps to stop collecting the training logs:

```
Router#no debug vdsl controller 0/3/0 training log
[VDSL_DIAG_LOG] recvd 158991 bytes, written 158991 bytes
[VDSL_DIAG_LOG]: File written sucessfully..
VDSL Controller VDSL 0/3/0 - Training debugging is off
Router#
```

By default training log is collected in the file, **flash:vdsllog.bin\_slot-subslot**.

### Example:

```
Router#sh controller vdsl 0/3/0
Controller VDSL 0/3/0 is UP
Daemon Status: UP

 XTU-R (DS) XTU-C (US)
Chip Vendor ID: 'BDCM' 'BDCM'
Chip Vendor Specific: 0x0000 0x544D
Chip Vendor Country: 0xB500 0xB500
Modem Vendor ID: 'CSCO' 'BDCM'
Modem Vendor Specific: 0x4602 0x544D
Modem Vendor Country: 0xB500 0xB500
Serial Number Near: FOC18426DR9 4351/K9 15.5(201412
Serial Number Far:
Modem Version Near: 15.5(20141202:161930
Modem Version Far: 0x544d

Modem Status: TC Sync (Showtime!)
DSL Config Mode: AUTO
Trained Mode: G.992.5 (ADSL2+) Annex A

TC Mode: ATM

Selftest Result: 0x00
DELT configuration: disabled
DELT state: not running

Failed full inits: 0
Short inits: 0
Failed short inits: 0

Modem FW Version: 4.14L.04
Modem PHY Version: A2pv6F039h.d24o_rc1

Line 0:
 XTU-R (DS) XTU-C (US)
Trellis: ON ON
SRA: disabled disabled
SRA count: 0 0
Bit swap: enabled enabled
Bit swap count: 669 383
Line Attenuation: 3.5 dB 1.7 dB
Signal Attenuation: 3.1 dB 0.0 dB
Noise Margin: 9.4 dB 5.9 dB
Attainable Rate: 15912 kbits/s 1379 kbits/s
Actual Power: 18.0 dBm 12.2 dBm
Total FECC: 176 176
Total ES: 43 0
Total SES: 0 0
Total LOSS: 0 0
Total UAS: 50 50
Total LPRS: 0 0
Total LOFS: 0 0
```

```

Total LOLS: 0 0

 DS Channel1 DS Channel0 US Channel1 US Channel0
Speed (kbps): NA 13073 NA 1045
SRA Previous Speed: NA 0 NA 0
Previous Speed: NA 0 NA 0
Total Cells: NA 1479777783 NA 2179031143
User Cells: NA 388927 NA 6870
Reed-Solomon EC: NA 176 NA 176
CRC Errors: NA 47 NA 0
Header Errors: NA 335 NA 0
Interleave (ms): NA 1.99 NA 1.94
Actual INP: NA 0.15 NA 0.77

```

```

Training Log : Stopped
Training Log Filename : flash:vdsllog_0-1.bin

```

User can modify the file in which training logs be stored before starting the training log collection procedure by configuring **training log filename flash:user-filename**.

### Example:

```

Router#conf t
Enter configuration commands, one per line. End with CNTL/Z.

Router(config)#controller vdsl 0/3/0

Router(config-controller)#training log filename flash:mytraininglog_file

Router(config-controller)#exit

Router#show controller vdsl 0/3/0
Controller VDSL 0/3/0 is UP
Daemon Status: UP
XTU-R (DS) XTU-C (US)
Chip Vendor ID: 'BDCM' 'BDCM'
Chip Vendor Specific: 0x0000 0x544D
Chip Vendor Country: 0xB500 0xB500
Modem Vendor ID: 'CSCO' 'BDCM'
Modem Vendor Specific: 0x4602 0x544D
Modem Vendor Country: 0xB500 0xB500
Serial Number Near: FOC18426DR9 4351/K9 15.5(201412
Serial Number Far:
Modem Version Near: 15.5(20141202:161930
Modem Version Far: 0x544d

Modem Status: TC Sync (Showtime!)
DSL Config Mode: AUTO
Trained Mode: G.992.5 (ADSL2+) Annex A

TC Mode: ATM
Selftest Result: 0x00
DELT configuration: disabled
DELT state: not running

Failed full inits: 0
Short inits: 0
Failed short inits: 0

Modem FW Version: 4.14L.04
Modem PHY Version: A2pv6F039h.d24o_rc1

Line 0:

 XTU-R (DS) XTU-C (US)

```

```

Trellis: ON ON
SRA: disabled disabled
SRA count: 0 0
Bit swap: enabled enabled
Bit swap count: 669 383
Line Attenuation: 3.5 dB 1.7 dB
Signal Attenuation: 3.1 dB 0.0 dB
Noise Margin: 8.8 dB 5.9 dB
Attainable Rate: 15464 kbits/s 1379 kbits/s
Actual Power: 18.0 dBm 12.2 dBm
Total FECC: 176 176
Total ES: 43 0
Total SES: 0 0
Total LOSS: 0 0
Total UAS: 50 50
Total LPRS: 0 0
Total LOFS: 0 0
Total LOLS: 0 0

 DS Channel1 DS Channel0 US Channel1 US Channel0
Speed (kbps): NA 13073 NA 1045
SRA Previous Speed: NA 0 NA 0
Previous Speed: NA 0 NA 0
Total Cells: NA 1484200375 NA 2179384795
User Cells: NA 388991 NA 6938
Reed-Solomon EC: NA 176 NA 176
CRC Errors: NA 47 NA 0
Header Errors: NA 335 NA 0
Interleave (ms): NA 1.99 NA 1.94
Actual INP: NA 0.15 NA 0.77

Training Log : Stopped
Training Log Filename : flash:mytraininglog_file

```

## Sample Configurations

### Sample MLPPP Configurations and Show Commands

```

!
interface Ethernet0/3/0
no ip address
load-interval 30
no negotiation auto
pppoe enable
pppoe-client dial-pool-number 2
!
!
interface Dialer2
bandwidth 55000
ip address negotiated
encapsulation ppp
load-interval 30
dialer pool 1
dialer-group 1
ppp authentication chap
ppp chap hostname cisco
ppp multilink
ppp multilink endpoint string mlpp
!

```

```
Router#show pppoe session
 1 client sessions
Uniq ID PPPoE RemMAC Port VT VA State
N/A 268 a44c.119d.d671 Et0/3/0 Di2 Vi2 UP
 c067.af94.c2a8 UP
Router#
```

```
Router#show ppp multilink active
Virtual-Access3
Bundle name: cisco1/mlpp/cisco/mlpp
Remote Username: cisco1
Remote Endpoint Discriminator: [1] mlpp
Local Username: cisco
Local Endpoint Discriminator: [1] mlpp
Bundle up for 05:40:46, total bandwidth 89000, load 196/255
Receive buffer limit 24384 bytes, frag timeout 1000 ms
Bundle is Distributed
Dialer interface is Dialer1
 0/0 fragments/bytes in reassembly list
 0 lost fragments, 0 reordered
 0/0 discarded fragments/bytes, 0 lost received
 0xD received sequence, 0xC2AE3 sent sequence
Platform Specific Multilink PPP info
NOTE: internal keyword not applicable on this platform
Interleaving: Disabled, Fragmentation: Disabled
Member links: 2 (max 16, min not set)
 Vi1, since 05:40:46, 206250 weight, 1496 frag size
 Vi2, since 05:40:41, 127500 weight, 1496 frag size
```

```
Router#show platform hardware qfp active feature mlp client bundle Virtual-Access3
Bundle Interface: Virtual-Access3
Bundle State: Up
Platform Interface Handle: 35
QFP Interface Handle: 26
QFP Interface uIDB Handle: Rx 65510, Tx 65510
Shadow Base: 0x020E19D0, Size: 1160
Num Links: 2, Next Link: 2, Enabled Links Mask: 0x0003
Tx Channel: 0x32, Tx Queue ID: 0x451, Tx Flow Control SID: 0x9f
Max Frags: 0x0, Lost Fragment Timeout: 1000
Max Frag Size: 65535, Frag Delay: 30
RX Class Buffer Size: 24384
MRRU: 1524, Peer MRRU: 1524
Bundle Bandwidth: 89000 kbps
RX Classes: 1, TX Classes: 1
Bundle Flags: 0x00000011, RX DP Flags: 0x04, TX DP Flags: 0x20
Outstanding datapath proxy requests:
 Bundle Create: 0, Update: 0, Remove: 0
 Links Add: 0, Delete: 0
Member Link Interfaces:
Interface: EVSI20
 Platform Interface Handle: 20
 QFP Interface Handle: 17
 QFP Interface uIDB Handle: Rx 65519, Tx 65519
 Shadow Base: 0x02075CA0, Size: 218
 TX Chan: 52, P1 Queue ID: 1107, P2 Queue ID: 0
 Link Bandwidth: 55000 kbps, Link Weight: 206250, Link Qlimit: 2286
 Link Optimal Frag Size: 1496, Max Frag Size: 65535
 Rewrite Len w/ PID: 2 Rewrite Len w/o PID: 0
 Rewrite String: 00, 3d
 Outstanding datapath proxy requests:
 Links Add: 0, Update: 0, Delete: 0
Interface: EVSI21
```



```

Platform Interface Handle: 21
QFP Interface Handle: 18
QFP Interface uIDB Handle: Rx 65518, Tx 65518
Shadow Base: 0x01D48550, Size: 218
TX Chan: 51, P1 Queue ID: 1109, P2 Queue ID: 0
Link Bandwidth: 34000 kbps, Link Weight: 127500, Link Qlimit: 2286
Link Optimal Frag Size: 1496, Max Frag Size: 65535
Rewrite Len w/ PID: 2 Rewrite Len w/o PID: 0
Rewrite String: 00, 3d
Outstanding datapath proxy requests:
 Links Add: 0, Update: 0, Delete: 0

```

Router#**show platform hardware qfp active feature mlp datapath bundle Virtual-Access3 detail**

```

QFP: 0.0 - Bundle Rx Interface: Virtual-Access3, State: UP
Rx Bundle uIDB: 65510
 Num Links: 2, Num Classes: 1, MRRU: 1524
 Defined Links: 0x0003, Enabled Links: 0x0003
 Config Flags: 0x04 (EVSI, MCMP: Disabled, Strict Seq Check: Enabled)
 Buffer Limit: 24384 bytes per class, Lost Frag Timeout: 1000 ms
 Stats Non-MLP Encapped Rx: 0 packets
 Meta Packet Drop: 0, Attn Sync Drop: 0
 No Buffer: 0, Invalid Class: 0
 Hit Buffer Limit: 0, Rx Pkt Exceeds MRRU: 0
 Lost Frag Timeout: 0
 Reassembly QID: 0x000003F8, Qlimit: 2000, Qdepth: 0
 Bundle SB: 0x33445150, SB Size: 144
Rx Classes:
Class: 0
 Expected Seq Number: 0x00000D, In Order/In Sync Links: 0x0003/0x0003
 Stats Rx Buffered: 0/0 fragments/bytes
 Rx Fragmented: 0 fragments
 Rx Unfragmented: 13 packets
 Rx Post Reassembly: 13 packets
 Rx Discarded: 0/0 fragments/bytes
 Rx NULL Frags: 0, Rx Lost: 0
 Rx Out of Order: 0, Rx Rcv'd Lost: 0
 Reorder/Reassembly Stats:
 Reassembly Packet: 0/0 fragments/bytes
 Staged Packets: 0 (S1-empty,S2-empty)
 Inflight Packets: 0
 Class SB: 0x3334D910, SB Size: 272
Rx Member Links:
Member Link Interface: EVSI20, State: UP
 Rx Link uIDB: 65519, Link ID: 0, Link Mask: 0x0001
 Config Flags: 0x01 (EVSI)
 Class Link Buffered Fragments
 0 0
 Link SB: 0x33470430, SB Size: 32
Member Link Interface: EVSI21, State: UP
 Rx Link uIDB: 65518, Link ID: 1, Link Mask: 0x0002
 Config Flags: 0x01 (EVSI)
 Class Link Buffered Fragments
 0 0
 Link SB: 0x33470410, SB Size: 32
QFP: 0.0 - Bundle Tx Interface: Virtual-Access3, State: UP
Tx Bundle uIDB: 65510
 Num Links: 2, Num Classes: 1, Peer MRRU: 1524
 Member Links Defined: 0x0003 Enabled: 0x0003 Congested(HP/LP): 0x0000/0x0000
 Bundle Equal Cost Frag Size: 1496
 Config Flags: 0x20 (EVSI, MCMP: Disabled, MCMP Encap Seq: No,
 Interleave: Disabled, Fragmentation: Disabled
 NCP MLP Encaped: Yes, NCP Tx Link ID: 0)
 EVSI First Member Link Encap Type: 1, EVSI L2 Overhead: 20
 Bundle Flow Control SID: 0x9F, SID Update In Prog: No, Bundle Flags: 0x01

```

```

Flow Control Timer: Stopped, Xoff Timer Tics: 0, Check Interval: 4572
MLP FC: Xon, SW FC: Full-Xon, HW FC: Full-Xon
HW FC Full Xoff Events: 6410, HW FC LP Xoff Events: 0
Bundle Load Cycle ID (HP/LP): 0/2594, Next Tx Link ID (HP/LP): 0/1
Link Link Queue Cycle ID Cycle Tx Bytes Queue Depth
ID Weight Limit HP/LP HP/LP HP(agg)/LP
0 206250 9 0/2594 0/98444 0/0
1 127500 9 0/2594 0/98314 0/0
Stats Non-MLP Encapped Tx: 2 packets
 Non-MLP Priority Interleaved: 0 packets
 Tx Drop: 0, Tx ESS Packet Drop: 0
 Invalid Class: 0
Bundle SB: 0x34F6C800, SB Size: 256
Tx Classes:
Class: 0
 Next Send Seq Number: 0x976A97
 Stats Tx Pre Frag Packets: 127363735 packets
 Tx Fragmented: 0 fragments
 Tx Unfragmented: 127363735 packets
 Tx Frag Interleaved: 0 fragments
 Tx Unfrag Interleaved: 0 packets
 Class SB: 0x3334DD20, SB Size: 64
Tx Member Links:
Member Link Interface: EVSI20, Parent: Ethernet0/3/0, State: UP
Tx Link uIDB: 65519, Link ID: 0, Link Mask: 0x0001
 Config Flags: 0x01 (EVSI)
 EVSI Parent Encap Type: 1, EVSI L2 Overhead: 20
 Link Weight: 206250, Frag Size: 1496
 P1 Tx QID: 0x00000453, Qdepth: 0
 P2 Tx QID: 0x00000000, Qdepth: 0
 Default Tx QID: 0x00000452, Qdepth: 0
L2 Rewrite String: 003D
 Rewrite length w/ PID: 2, Length w/o PID: 0
Link SB: 0x34FAB0C0, SB Size: 144
Member Link Interface: EVSI21, Parent: Ethernet0/3/0, State: UP
Tx Link uIDB: 65518, Link ID: 1, Link Mask: 0x0002
 Config Flags: 0x01 (EVSI)
 EVSI Parent Encap Type: 1, EVSI L2 Overhead: 20
 Link Weight: 127500, Frag Size: 1496
 P1 Tx QID: 0x00000455, Qdepth: 0
 P2 Tx QID: 0x00000000, Qdepth: 0
 Default Tx QID: 0x00000454, Qdepth: 0
L2 Rewrite String: 003D
 Rewrite length w/ PID: 2, Length w/o PID: 0
Link SB: 0x34FAB030, SB Size: 144

```

## Sample PPPoA Configuration

```

interface ATM0/2/0.1 point-to-point
ip unnumbered Loopback0
no atm enable-ilmi-trap
pvc 71/200
 oam-pvc 0
 encapsulation aal5mux ppp dialer
 dialer pool-member 151
!
interface Dialer151
ip address negotiated
encapsulation ppp
load-interval 30
dialer pool 151
ppp chap hostname BBIP45687587@adslmax.bt.com

```

```
 ppp chap password 0 cisco1
 !
 dialer-list 1 protocol ip permit
 !
```

## Sample PPPoEoA Configuration

```
interface ATM0/1/0
 no ip address
 no atm enable-ilmi-trap
 !
interface ATM0/1/0.10 point-to-point
 no atm enable-ilmi-trap
 cdp enable
 pvc 22/62
 ubr 1045
 encapsulation aal5mux pppoe-client
 pppoe-client dial-pool-number 120
 !
!
interface Dialer120
 mtu 1492
 ip address negotiated
 ip nat outside
 encapsulation ppp
 load-interval 30
 dialer pool 120
 dialer-group 1
 ppp mtu adaptive
 ppp chap hostname test@cisco.com
 ppp chap password 0 cisco
 ppp ipcp address required
 ppp link reorders
 !
```





## CHAPTER 14

# Cisco LTE/5G on Cisco 1000 Series Integrated Services Router

---

This chapter provides an overview of the software features and configuration information for Cisco LTE/5G on the Cisco 1000 Series Integrated Services Router (ISR).

For information on Cisco 3G/4G LTE and LTEA Omnidirectional Dipole Antenna (LTE-ANTM-SMA-D), see the [Cisco 4G LTEA, 4G LTE, and 3G LTE-ANTM-SMA-D](#) section.

For more information on Cisco LTE/5G SKUs, faceplates, and LED descriptions, see the Cisco 1000 Series Integrated Services Router (ISR) Hardware Installation Guide.

- [Finding Feature Information, on page 203](#)
- [Overview of Cisco LTE/5G , on page 204](#)
- [Prerequisites for Configuring Cisco LTE/5G, on page 206](#)
- [Restrictions for Configuring Cisco LTE/5G , on page 206](#)
- [Features not Supported in Cisco LTE/5G, on page 206](#)
- [Cisco LTE/5G Features, on page 207](#)
- [Configuring Cisco LTE/5G, on page 217](#)
- [Configuring Cellular Modem Link Recovery , on page 249](#)
- [Verifying the Cellular Modem Link Recovery Configuration , on page 251](#)
- [Configuration Examples for 3G and 4G Serviceability Enhancement, on page 253](#)
- [Configuration Examples for LTE/5G, on page 254](#)
- [Upgrading the Modem Firmware, on page 266](#)
- [SNMP MIBs, on page 270](#)
- [Troubleshooting, on page 271](#)
- [Additional References, on page 278](#)

## Finding Feature Information

Your software release may not support all the features documented in this module. For the latest feature information and caveats, see the release notes for your platform and software release.

Use Cisco Feature Navigator to find information about platform support and Cisco software image support. To access Cisco Feature Navigator, go to <http://www.cisco.com/go/cfn> . An account on Cisco.com is not required.

# Overview of Cisco LTE/5G

Cisco LTE/5G supports the following modes:

- **4G LTE**—4G LTE mobile specification provides multi-megabit bandwidth, more efficient radio network, latency reduction, and improved mobility. LTE solutions target new cellular networks. These networks initially support up to 300 Mb/s peak rates in the downlink and up to 50 Mb/s peak rates in the uplink. The throughput of these networks is higher than the existing 3G networks.
- **3G Evolution High-Speed Packet Access (HSPA/HSPA+)**—HSPA is a UMTS-based 3G network. It supports High-Speed Downlink Packet Access (HSDPA) and High-Speed Uplink Packet Access (HSUPA) data for improved download and upload speeds. Evolution High-Speed Packet Access (HSPA+) supports Multiple Input/Multiple Output (MIMO) antenna capability.

The following table describes the Cisco 4G LTE Cat 6 SKUs:

**Table 17: Cisco 4G LTE Cat 6 SKUs**

| Region Theaters | Cisco LTE Advanced 3.0 LTEEA SKU (European Union, North America)                                                                                                                                                                                                                                                                                                                                                                                                                                                                         | Cisco LTE Advanced 3.0 LTELA SKUs (Latin America, Asia-Pacific)                                                                                                                                                                                                                                                                                                                                                                                                                               |
|-----------------|------------------------------------------------------------------------------------------------------------------------------------------------------------------------------------------------------------------------------------------------------------------------------------------------------------------------------------------------------------------------------------------------------------------------------------------------------------------------------------------------------------------------------------------|-----------------------------------------------------------------------------------------------------------------------------------------------------------------------------------------------------------------------------------------------------------------------------------------------------------------------------------------------------------------------------------------------------------------------------------------------------------------------------------------------|
| Bands           | <p>LTE bands 1-5, 7, 12, 13, 20, 25, 26, 29, 30, and 41</p> <p>FDD LTE 700 MHz (band 12), 700 MHz (band 29), 800 MHz (band 20), 850 MHz (band 5 CLR), 850 MHz (band 26 Low), 900 MHz (band 8), 1800 MHz (band 3), 1900 MHz (band 2), 1900 MHz (PCS band 25), 1700 MHz and 2100 MHz (band 4 AWS), 2100 MHz (band 1), 2300 MHz (band 30), or 2600 MHz (band 7)</p> <p>TDD LTE 2500 MHz (band 41)</p> <p>Carrier aggregation band combinations:<br/>1+8; 2+(2,5,12,13,29); 3+(7,20); 4+(4,5,12,13,29); 7+(7,20); 12+30, 5+30, and 41+41</p> | <p>LTE bands 1, 3, 5, 7, 8, 18, 19, 21, 28, 38, 39, 40, and 41</p> <p>FDD LTE 700 MHz (band 28), 850 MHz (band 5 CLR), 850 MHz (bands 18 and 19 Low), 900 MHz (band 8), 1500 MHz (band 21), 1800 MHz (band 3), 2100 MHz (band 1), or 2600 MHz (band 7)</p> <p>TDD LTE 1900 MHz (band 39), 2300 MHz (band 40), 2500 MHz (band 41), or 2600 MHz (band 38)</p> <p>Carrier aggregation band combinations:<br/>1+(8,18,19,21); 3+(5,7,19,28); 7+(5,7,28); 19+21, 38+38, 39+39,40+40, and 41+41</p> |

The following figure explains the 4G LTE packet core network architecture.

Figure 1: 4G LTE Packet Core Network Architecture

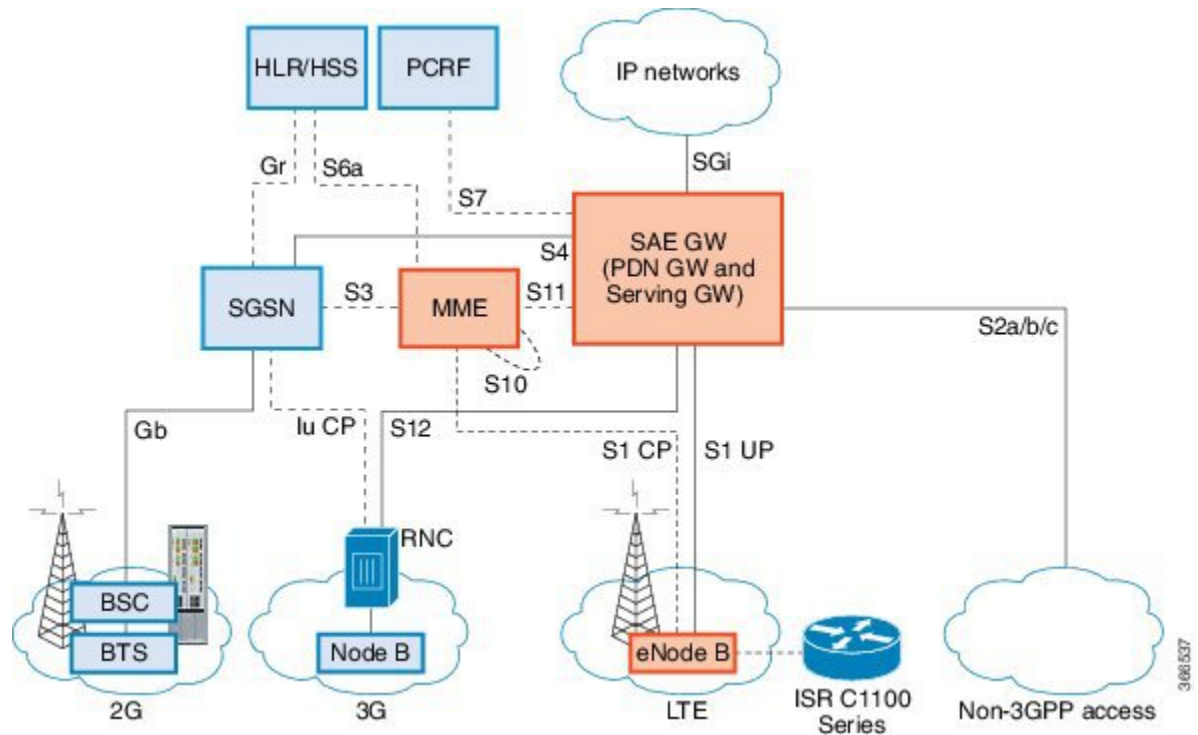

|          |                                                                                                                                                                                                                                                                                                                                                                                                                                                                                                                                                                                                                                                                                                                                                                                                                                                                                                                                                  |
|----------|--------------------------------------------------------------------------------------------------------------------------------------------------------------------------------------------------------------------------------------------------------------------------------------------------------------------------------------------------------------------------------------------------------------------------------------------------------------------------------------------------------------------------------------------------------------------------------------------------------------------------------------------------------------------------------------------------------------------------------------------------------------------------------------------------------------------------------------------------------------------------------------------------------------------------------------------------|
| Gateways | <p>The Serving Gateway (SGW) routes and forwards user data packets, while also acting as the mobility anchor for the user plane, and is the anchor for mobility between LTE and other 3GPP technologies. The Packet Data Network (PDN) Gateway (PGW) provides connectivity from the User Equipment (UE) to external packet data networks by being the point of exit and entry of traffic for the UE.</p> <p>A UE may have simultaneous connectivity with more than one PGW for accessing multiple PDNs. The PGW performs policy enforcement, packet filtering for each user, charging support, lawful interception, and packet screening. Another key role of the PGW is to act as the anchor for mobility between 3GPP and non-3GPP technologies such as WiMAX and 3GPP2 (CDMA 1X and EvDO).</p> <p>The System Architecture Evolution GW (SAE GW) is the entity that covers the PGW and SGW functionality in the Evolved Packet Core (EPC).</p> |
| RNC      | <p>The Radio Network Controller (RNC) is responsible for controlling the Radio Access Network (RAN) that are connected to it. The RNC carries out radio resource management and some of the mobility management functions and is the point where encryption is done before user data is sent to and from the mobile. The RNC connects to the Circuit-Switched Core Network through the Media Gateway (MGW).</p>                                                                                                                                                                                                                                                                                                                                                                                                                                                                                                                                  |
| BTS      | Base Transceiver Station.                                                                                                                                                                                                                                                                                                                                                                                                                                                                                                                                                                                                                                                                                                                                                                                                                                                                                                                        |
| BSC      | Base Station Controller.                                                                                                                                                                                                                                                                                                                                                                                                                                                                                                                                                                                                                                                                                                                                                                                                                                                                                                                         |
| SGSN     | Service GPRS Support Node.                                                                                                                                                                                                                                                                                                                                                                                                                                                                                                                                                                                                                                                                                                                                                                                                                                                                                                                       |

## Prerequisites for Configuring Cisco LTE/5G

- If the signal is not good at the router, use the Cisco offered antenna accessories and extension cables to place the antenna away from router in a better coverage area.
- You must have LTE/5G network coverage where your router is physically placed. For a complete list of supported carriers.
- You must subscribe to a service plan with a wireless service provider and obtain a Subscriber Identity Module (SIM) card. Only micro SIM is supported.
- You must install the SIM card before configuring the LTE/5G on Cisco C1100 series router.
- The standalone antenna that supports GPS capabilities must be installed for the GPS feature to work. See the [Cisco 4G Indoor/Outdoor Active GPS Antenna \(GPS-ACT-ANTM-SMA\)](#) document for installation information.

## Restrictions for Configuring Cisco LTE/5G

- Currently, cellular networks support only user initiated bearer establishment.
- Due to the shared nature of wireless communications, the experienced throughput varies depending on the number of active users or congestion in a given network.
- Cellular networks have higher latency compared to wired networks. Latency rates depend on the technology and carrier. Latency also depends on the signal conditions and can be higher because of network congestion.
- CDMA-EVDO, CDMA-1xRTT, and GPRS technology modes are not supported.
- Any restrictions that are part of the terms of service from your carrier.
- SMS—Only one text message up to 160 characters to one recipient at a time is supported. Larger texts are automatically truncated to the proper size before being sent.
- It is strongly recommended that you configure SNMP V3 with authentication/privacy.

## Features not Supported in Cisco LTE/5G

The following features are not supported on Cisco LTE/5G C1100 Series ISR, when compared to Classic IOS:

- TTY support or Line
- Chat script/dialer string
- External Dialer
- DM log output to USB flash is not supported.



# Cisco LTE/5G Features

Cisco LTE/5G supports the following major features:

- Global Positioning System (GPS) and National Marine Electronics Association (NMEA) streaming.
- Short Message Service (SMS)
- 3G/4G Simple Network Management Protocol (SNMP) MIB
- SIM lock and unlock capabilities
- Dual SIM
- Auto SIM
- NeMo
- Public Land Mobile Network (PLMN) selection
- IPv6
- Multiple PDN
- LTE Link Recovery

The following sections explain the Cisco LTE/5G features:

## 4G GPS and NMEA

Active GPS is supported on the SubMiniature version A (SMA) port. Active GPS antenna is supported only in the standalone mode. An Active GPS antenna includes a built-in Low-Noise Amplifier that provides sufficient gain to overcome coaxial cable losses while providing the proper signal level to the GPS receiver. Active GPS antennae require power from the GPS receiver SMA port to operate. See the [Example: Connecting to a Server Hosting a GPS Application, on page 208](#) for more information.

National Marine Electronics Association (NMEA) streams GPS data either from a LTE/5G through a virtual COM port and a TCP/IP Ethernet connection to any marine device (such as a Windows-based PC) that runs a commercially available GPS-based application.

The following GPS and NMEA features are supported on the Cisco LTE/5G:

- GPS standalone mode (satellite-based GPS)
- Cisco IOS CLI display coordinates.
- External application displays router map location
- Objects in the CISCO-WAN-3G-MIB supports GPS and NMEA features
- The Cisco LTE/5G only supports NMEA over IP and uses show commands in the platform



---

**Note** Assisted GPS mode is not supported.

---

For instructions on setting up the GPS antenna, see the [Cisco 4G Indoor/Outdoor Active GPS Antenna \(GPS-ACT-ANTM-SMA\)](#) document.

## Example: Connecting to a Server Hosting a GPS Application

You can feed the NMEA data to a remote server that hosts the GPS application. The server can be connected to the router either directly using an Ethernet cable or through a LAN or WAN network. If the application supports serial port, run a serial port emulation program to create a virtual serial port over the LAN or WAN connection.



---

**Note** Microsoft Streets & Trips is a licensed software that you can download from the Microsoft website.

---

To connect a Cisco LTE/5G through IP to a PC running Microsoft Streets & Trips, perform the following steps:

1. Connect the PC to the router using an Ethernet cable.
2. Ensure that the PC and router can ping.
3. Launch the serial port redirector on the PC.
4. Create a virtual serial port that connects to the NMEA port on the router.
5. Launch **Microsoft Streets & Trips** on your PC.
6. Select the GPS Menu.
7. Click Start Tracking.
8. If you have acquired a location fix from the **show cellular 0/2/0 gps** command output on the router, the current location is plotted on the graph, and a reddish brown dotted cursor with a circle around it is seen on the map.



---

**Note** If you have not acquired a location fix, the Microsoft application times out and disconnects.

---

## Dual SIM Card

SIM card primary slot is selected when router boots up or when NIM reloads. The default slot is 0. If SIM card is not present in the primary slot, select the alternative slot if SIM card is present.

```
controller cellular 0/2/0
lte sim primary slot <slot#>
```

If the active SIM card loses connectivity to the network a failover to the alternative SIM card slot occurs.

By default the failover timer is two minutes. The failover timer can be set from 1 to 7 minutes.

```
controller cellular 0/2/0
lte failovertimer <3-7>
```

You can also manually switch the SIM slot via the command line interface.

```
cellular 0/2/0 lte sim activate slot <0-1>
```

## Auto SIM

The Auto SIM feature detects the SIM and loads the corresponding firmware. For example, if a Verizon SIM is detected, the modem loads the Verizon firmware. If you switch the SIM to an ATT SIM, the modem will load ATT firmware.

When Auto-SIM is enabled, it is said to be in Auto-SIM mode and when disabled, it is known as Manual mode. In Auto-SIM mode, the modem selects the right carrier firmware from the list of firmwares available. When in manual mode, you can select the firmware manually. Modem resets every time you make a config change from Auto-SIM enabled to disabled or vice-versa.



**Note** Auto SIM is always enabled by default.

## Enable Auto SIM

### Procedure

|               | Command or Action                                                                                                                                                   | Purpose                                                                                                                                                                 |
|---------------|---------------------------------------------------------------------------------------------------------------------------------------------------------------------|-------------------------------------------------------------------------------------------------------------------------------------------------------------------------|
| <b>Step 1</b> | <b>configure terminal</b><br><br><b>Example:</b><br><br>Router# configure terminal                                                                                  | Enters configuration mode.                                                                                                                                              |
| <b>Step 2</b> | <b>Cellular slots/sub-slots/interface lte firmware-activate firmware-index</b><br><br><b>Example:</b><br><br>Router(config)# Cellular 0/2/0 lte firmware-activate 1 | Activates the firmware index.<br><br><b>Note</b> For the LTE/5G, the <i>unit</i> argument identifies the slot, subslot, and the interface separated by slashes (0/2/0). |

## Example: List the firmware when Auto-SIM is Enabled

```
Device# show cellular 0/2/0
firmware Idx Carrier FwVersion PriVersion Status
1 ATT 02.28.00.00 002.035_000 Inactive
2 GENERIC 02.28.00.00 002.035_000 Active
3 ROGERS 02.28.00.00 001.012_000 Inactive
4 SPRINT 02.14.03.02 002.012_000 Inactive
5 VERIZON 02.28.00.00 002.042_000 Inactive
```

```
Firmware Activation mode = AUTO
```

## Disable Auto SIM

### Procedure

|               | Command or Action                                                                                                            | Purpose                             |
|---------------|------------------------------------------------------------------------------------------------------------------------------|-------------------------------------|
| <b>Step 1</b> | <b>configure terminal</b><br><br><b>Example:</b><br><br>Router# configure terminal                                           | Enters configuration mode.          |
| <b>Step 2</b> | <b>controller cellular slots/sub-slots/interface</b><br><br><b>Example:</b><br><br>Router(config)# controller cellular 0/2/0 | Specifies the controller interface. |
| <b>Step 3</b> | <b>no lte firmware auto-sim</b><br><br><b>Example:</b><br><br>Router(config-if)# no lte firmware auto-sim                    | Disable auto SIM.                   |

### Example: List the firmware when Auto-SIM is Disabled

```
Device# show cellular 0/2/0 firmware
Idx Carrier FwVersion PriVersion Status
1 ATT 02.28.00.00 002.035_000 Active
2 GENERIC 02.28.00.00 002.035_000 Inactive
3 ROGERS 02.28.00.00 001.012_000 Inactive
4 SPRINT 02.14.03.02 002.012_000 Inactive
5 VERIZON 02.28.00.00 002.042_000 Inactive
```

```
Firmware Activation mode = Manual
```

## Using a SIM Card

Cisco LTE/5G needs an active SIM card provided by a service provider. The SIM cards are usually provided in an unlocked state so that it can be used without a Personal Identification Number (PIN). If the SIM is unlocked, it can be inserted into a LTE/5G and used without an authorization code.

The SIM can be initially locked with a PIN code (4 to 8 digits s long) defined by the service provider. Contact your service provider for the PIN code.

The SIM-Lock feature allows a SIM to be locked or unlocked with a PIN code so that it is used only in an authorized device. Perform the SIM lock and unlock procedures using the Cisco IOS CLI through a console or Telnet/SSH to the ISR.

After the SIM is locked, it cannot initiate a call unless authentication is done using the same PIN. Authentication is done automatically by Cisco IOS through configuration of the PIN. This mandatory configuration for automatic SIM authentication is done using the Cisco IOS CLI as part of the router startup configuration.

After the Cisco IOS configuration is in place, the ISR can initiate an LTE connection. The ISR uses the configured PIN to authenticate prior to the LTE connection. If the Cisco IOS PIN configuration is missing or if the PIN is incorrect, the SIM authentication will fail and the connection will not be initiated.

If the locked SIM is moved to a different ISR or to another device, or if the LTE/5G in which the locked SIM resides is moved to a different LTE/5G slot in the same ISR, the ISR configuration should be changed. The configuration is associated with the cellular controller that is specific to an ISR LTE/5G slot number. This will ensure that the SIM card will not be used in any unauthorized device, or, if there are multiple LTE/5G in a single ISR, that the appropriate PIN is applied to each LTE/5G SIM. An authentication command (with the same PIN used to lock the SIM) must be defined on the new device or on the new cellular controller slot to successfully initiate the LTE connection.

The following procedures are used to configure a SIM:



#### Caution

It is very important to use the correct PIN after it is configured. The SIM card will be blocked if the wrong PIN is entered three consecutive times on a locked SIM during authentication or when trying to unlock a locked SIM. You can unblock a blocked SIM card using the PUK code. Contact your service provider for the PUK code. Use the **cellular** <slot> **lte sim unblock** <PUK code> <new PIN code> command to unblock the SIM.

## Changing the PIN

Ensure to enter the correct PIN, the SIM card gets blocked if the wrong PIN is entered three consecutive times.

### Procedure

|               | Command or Action                                                                                                                                                                                     | Purpose                                                                                                                                                                                                                                                                                                            |
|---------------|-------------------------------------------------------------------------------------------------------------------------------------------------------------------------------------------------------|--------------------------------------------------------------------------------------------------------------------------------------------------------------------------------------------------------------------------------------------------------------------------------------------------------------------|
| <b>Step 1</b> | <b>cellular</b> <i>slots subslots interface</i> <b>lte sim</b><br><b>change-pin</b> <i>current-pin new-pin</i><br><br><b>Example:</b><br><br><pre>Router# cellular 0/2/0 lte sim lock 1111 1234</pre> | <p>Locks or unlocks the SIM card using a PIN code.</p> <p><b>Note</b> Locks or unlocks the SIM card using a PIN code. <i>pin</i>—A code (4 to 8 digits long) provided by your service provider to lock or unlock the SIM card.</p> <p><b>Note</b> SIM should be in locked state when the PIN is being changed.</p> |

## Locking and Unlocking a SIM Card Using a PIN

Perform this task to lock or unlock a SIM card given by your service provider. Make sure you enter the correct PIN, the SIM card gets blocked if the wrong PIN is entered three consecutive times.

**Procedure**

|               | Command or Action                                                                                                                        | Purpose                                                                                                                                                                      |
|---------------|------------------------------------------------------------------------------------------------------------------------------------------|------------------------------------------------------------------------------------------------------------------------------------------------------------------------------|
| <b>Step 1</b> | <b>cellular <i>unit</i> lte sim {lock   unlock} <i>pin</i></b><br><b>Example:</b><br><pre>Router# cellular 0/2/0 lte sim lock 1111</pre> | Locks or unlocks the SIM card using a PIN code.<br><br><b>Note</b> <i>pin</i> —A code (4 to 8 digits long) provided by your service provider to lock or unlock the SIM card. |

**Configure CHV1 for Unencrypted Level 0****Procedure**

|               | Command or Action                                                                                                                                                                 | Purpose                                                                                                                                                                                     |
|---------------|-----------------------------------------------------------------------------------------------------------------------------------------------------------------------------------|---------------------------------------------------------------------------------------------------------------------------------------------------------------------------------------------|
| <b>Step 1</b> | <b>cellular <i>slots</i> <i>subslots</i> <i>interface</i> lte sim <i>lte</i> sim authenticate 0 <i>pin</i></b><br><b>Example:</b><br><pre>Router# controller cellular 0/0/0</pre> | Enters the cellular controller configuration mode<br><br>Use either of these commands: <b>lte sim authenticate 0 <i>pin</i></b><br>or <b>lte sim authenticate 0 <i>pin</i> slot {0   1}</b> |

**Configure CHV1 for Unencrypted Level 7**

To configure an encrypted PIN, the scrambled value of the PIN must be obtained. To get the scrambled Level 7 PIN and to configure the SIM CHV1 code for verification using this encrypted PIN, enter the following commands in the EXEC mode. When obtaining the encrypted PIN for a SIM, a username and password are created by configuring password encryption, defining the username and associated password, copying the resulting scrambled password, and using this scrambled password in the SIM authentication command.



**Note** After the scrambled PIN has been obtained and used in SIM authentication, the username created can be deleted from the Cisco IOS configuration. A SIM should be locked for SIM authentication to work.

**Procedure**

|               | Command or Action                                                                                                | Purpose                      |
|---------------|------------------------------------------------------------------------------------------------------------------|------------------------------|
| <b>Step 1</b> | <b>service password-encryption</b><br><b>Example:</b><br><pre>Router (config)# service password-encryption</pre> | Enables password encryption. |

|               | Command or Action                                                                                                                                                                        | Purpose                                                                                                                                                                                                                                                                                                                                                                                                                                                                 |
|---------------|------------------------------------------------------------------------------------------------------------------------------------------------------------------------------------------|-------------------------------------------------------------------------------------------------------------------------------------------------------------------------------------------------------------------------------------------------------------------------------------------------------------------------------------------------------------------------------------------------------------------------------------------------------------------------|
| <b>Step 2</b> | <p><i>username privilege var password pin</i></p> <p><b>Example:</b></p> <pre>Router (config)# username SIM privilege 0 password 1111</pre>                                              | <p><b>Note</b> Creates username and password.</p> <p>name - specifies the username.<i>pin</i>—A 4 to 8 digits PIN code.</p>                                                                                                                                                                                                                                                                                                                                             |
| <b>Step 3</b> | <p><b>do show run   i name</b></p> <p><b>Example:</b></p> <pre>Device(config)# do show run   i SIM</pre>                                                                                 | Shows the username configuration line with the encrypted level 7 PIN for the username created in Step 3 (user “SIM” in the example shown). Copy the scrambled password for use in Step 6 (as the PIN).                                                                                                                                                                                                                                                                  |
| <b>Step 4</b> | <p><i>username privilege 0 password pin</i></p> <p><b>Example:</b></p> <pre>Device(config)# controller cellular 0/0/0</pre>                                                              | Enters the cellular controller configuration mode.                                                                                                                                                                                                                                                                                                                                                                                                                      |
| <b>Step 5</b> | <p><b>lte sim authenticate 7pin</b> OR <b>lte sim authenticate 7 pin slot {0   1}</b></p> <p><b>Example:</b></p> <pre>Device(config-controller)# lte sim authenticate 7 055A575E70</pre> | <p>Authenticates the SIM CHV1 code by using the encrypted keyword 7 and the scrambled PIN from Step 4. The PIN is sent to the modem for authentication with each subsequent LTE connection. If authentication passes based on the configured PIN, the data call is allowed. If authentication fails, the modem does not initiate the data call.</p> <p><b>Note</b> The slot keyword and its options are available only on platforms that supports Dual-SIM feature.</p> |
| <b>Step 6</b> | <p><b>exit</b></p> <p><b>Example:</b></p> <pre>Device(config-controller)# exit</pre>                                                                                                     | (Optional) Exits the cellular controller configuration mode.                                                                                                                                                                                                                                                                                                                                                                                                            |
| <b>Step 7</b> | <p><b>no username</b><i>name</i></p> <p><b>Example:</b></p> <pre>Device(config-controller)# no username SIM</pre>                                                                        | (Optional) Removes the username and password created in Step 3                                                                                                                                                                                                                                                                                                                                                                                                          |
| <b>Step 8</b> | <p><b>no service password-encryption</b><i>name</i></p> <p><b>Example:</b></p> <pre>Device(config-controller)# no service password-encryption</pre>                                      | (Optional) Removes the username and password created in Step 3                                                                                                                                                                                                                                                                                                                                                                                                          |

## Configure CHV1 for Unencrypted Level7

To configure an encrypted PIN, the scrambled value of the PIN must be obtained. To get the scrambled Level 7 PIN and to configure the SIM CHV1 code for verification using this encrypted PIN, enter the following commands in the EXEC mode. When obtaining the encrypted PIN for a SIM, a username and password are created by configuring password encryption, defining the username and associated password, copying the resulting scrambled password, and using this scrambled password in the SIM authentication command.



**Note** After the scrambled PIN has been obtained and used in SIM authentication, the username created can be deleted from the Cisco IOS configuration. A SIM should be locked for SIM authentication to work.

### Procedure

|               | Command or Action                                                                                                                                                        | Purpose                                                                                                                                                                                                                                                                                                                                                                                                                                                      |
|---------------|--------------------------------------------------------------------------------------------------------------------------------------------------------------------------|--------------------------------------------------------------------------------------------------------------------------------------------------------------------------------------------------------------------------------------------------------------------------------------------------------------------------------------------------------------------------------------------------------------------------------------------------------------|
| <b>Step 1</b> | <b>service password-encryption</b><br><b>Example:</b><br><pre>Router (config)# service password-encryption</pre>                                                         | Enables password encryption.                                                                                                                                                                                                                                                                                                                                                                                                                                 |
| <b>Step 2</b> | <b>username privilege var password pin</b><br><b>Example:</b><br><pre>Router (config)# username SIM privilege 0 password llll</pre>                                      | <b>Note</b> Creates username and password.<br>name - specifies the username. <i>pin</i> —A 4 to 8 digits PIN code.                                                                                                                                                                                                                                                                                                                                           |
| <b>Step 3</b> | <b>do show run   i name</b><br><b>Example:</b><br><pre>Device(config)# do show run   i SIM</pre>                                                                         | Shows the username configuration line with the encrypted level 7 PIN for the username created in Step 3 (user “SIM” in the example shown). Copy the scrambled password for use in Step 6 (as the PIN).                                                                                                                                                                                                                                                       |
| <b>Step 4</b> | <b>username privilege 0 password pin</b><br><b>Example:</b><br><pre>Device(config)# controller cellular 0/0/0</pre>                                                      | Enters the cellular controller configuration mode.                                                                                                                                                                                                                                                                                                                                                                                                           |
| <b>Step 5</b> | <b>lte sim authenticate 7pin ORlte sim authenticate 7 pin slot {0   1}</b><br><b>Example:</b><br><pre>Device(config-controller)# lte sim authenticate 7 055A575E70</pre> | Authenticates the SIM CHV1 code by using the encrypted keyword 7 and the scrambled PIN from Step 4. The PIN is sent to the modem for authentication with each subsequent LTE connection. If authentication passes based on the configured PIN, the data call is allowed. If authentication fails, the modem does not initiate the data call.<br><b>Note</b> The slot keyword and its options are available only on platforms that supports Dual-SIM feature. |



|               | Command or Action                                                                                                                    | Purpose                                                        |
|---------------|--------------------------------------------------------------------------------------------------------------------------------------|----------------------------------------------------------------|
| <b>Step 6</b> | <b>exit</b><br><b>Example:</b><br>Device(config-controller)# exit                                                                    | (Optional) Exits the cellular controller configuration mode.   |
| <b>Step 7</b> | <b>no username</b> <i>name</i><br><b>Example:</b><br>Device(config-controller)# no username<br>SIM                                   | (Optional) Removes the username and password created in Step 3 |
| <b>Step 8</b> | <b>no service password-encryption</b> <i>name</i><br><b>Example:</b><br>Device(config-controller)# no service<br>password-encryption | (Optional) Removes the username and password created in Step 3 |

## Short Message Service (SMS) Capabilities

Cisco LTE/5G support receiving, transmitting, archiving, and deleting of SMS messages. This support includes the ability to view up to 25 received texts, and archive more messages in a custom file location. SMS is supported on multiple carriers. Cisco LTE/5G also have the capability to revert from LTE SMS to 3G and 2G SMS technology if necessary.

A sending device behind a Cisco LTE/5G transmits an SMS text message over the 4G cellular link through cellular towers until it the message reaches the recipient's router, which then notifies the recipient device, such as a cell phone. The receiving device uses the same process to return a reply to the sending device. The following figure describes the flow from a mobile device to a sending device. For SMS transmission to work, end users must have a text-capable device, and optionally, a text plan. If end users do not have a text plan, standard SMS rates apply to their text transmissions.

Figure 2: SMS Network

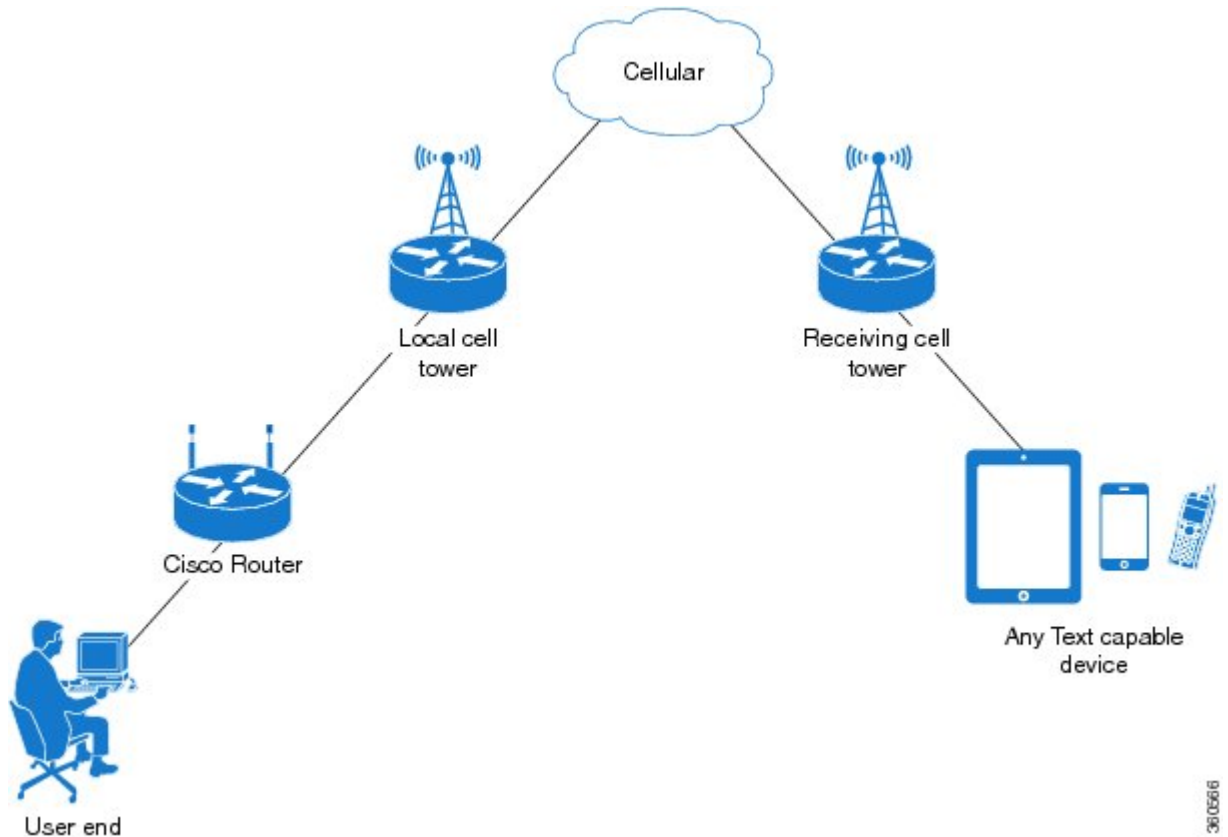

36/056/6

## Data Account Provisioning

One or more modem data profiles can be created to provision a modem on a LTE/5G SKU. An active wireless account with a service provider with one or more (dual) SIM cards must be installed. The modem data profile is pre-configured on the modem.

The following tasks are used to verify the signal strength and service availability of the modem and to create, modify, and delete modem data profiles:

### IP Multimedia Subsystem Profiles

IP Multimedia Subsystem (IMS) profiles establish a session, and are a part of the modem configuration and are stored in the modem's NVRAM. An IMS network is an access-independent and standard-based IP connectivity service that enables different types of multimedia services to end users using common Internet-based protocols.

## LTE/5G LEDs

The following table describes the LED behavior in LTE/5G.

Table 18: LTE/5G LED Indicators

| LED                                 | Color/Bar and Description |                                                                                              |
|-------------------------------------|---------------------------|----------------------------------------------------------------------------------------------|
| LTE SIM(0) & SIM(1)                 | Green (Solid)             | Modem up, SIM installed and active                                                           |
|                                     | Green Blink               | LTE data activity                                                                            |
|                                     | Off                       | Modem not up; or modem up and no SIM                                                         |
|                                     | Amber (Solid)             | Modem up, SIM installed but not active                                                       |
| RSSI - Uses Bars for LED Indication | Four Bar                  | High RSSI $\geq$ -69dBm                                                                      |
|                                     | Three Bar                 | Medium RSSI, -89dBm $\diamond$ -70dBm                                                        |
|                                     | Two Bar                   | Low RSSI, -99dBm $\diamond$ -90dBm                                                           |
|                                     | One Bar                   | RSSI $\leq$ -100dBm                                                                          |
|                                     | 0 or No Bar               | No Service                                                                                   |
| SERVICE - Uses Color Indication     | Green(solid)              | LTE signal present (RSSI LEDs will be Green)                                                 |
|                                     | Amber(solid)              | 2G/3G signal present (RSSI LEDs will be Amber)                                               |
|                                     | No Color                  | No service detected.                                                                         |
| GPS                                 | Green (Solid)             | GPS coordinates are obtained.                                                                |
|                                     | Off                       | GPS is disabled, GPS is enabled without GPS mode and NMEA configuration, or GPS is acquiring |

## Configuring Cisco LTE/5G

For LTE/5G, the numbering for slot 0, module 0, and port 0 is 0/2/0 for all commands.

## Verifying Modem Signal Strength and Service Availability

For the LTE/5G, the *unit* argument identifies the router slot, module slot, and port separated by slashes (0/2/0).

**Procedure**

|               | <b>Command or Action</b>                                                                             | <b>Purpose</b>                                                                                                                 |
|---------------|------------------------------------------------------------------------------------------------------|--------------------------------------------------------------------------------------------------------------------------------|
| <b>Step 1</b> | <b>show cellular <i>unit</i> network</b><br><b>Example:</b><br>Router# show cellular 0/2/0 network   | Displays information about the carrier network, cell site, and available service.                                              |
| <b>Step 2</b> | <b>show cellular <i>unit</i> radio</b><br><b>Example:</b><br>Router# show cellular 0/2/0 radio       | Shows the radio signal strength.<br><br><b>Note</b> The RSSI should be better than -90 dBm for steady and reliable connection. |
| <b>Step 3</b> | <b>show cellular <i>unit</i> profile</b><br><b>Example:</b><br>Router# show cellular 0/2/0 profile   | Shows information about the modem data profiles created.                                                                       |
| <b>Step 4</b> | <b>show cellular <i>unit</i> security</b><br><b>Example:</b><br>Router# show cellular 0/2/0 security | Shows the security information for the modem, such as SIM and modem lock status.                                               |
| <b>Step 5</b> | <b>show cellular <i>unit</i> all</b><br><b>Example:</b><br>Router# show cellular 0/2/0 all           | Shows consolidated information about the modem, profiles created, radio signal strength, network security, and so on.          |

## Guidelines for Creating, Modifying, or Deleting Modem Data Profiles

Customized profiles (Access Point Name (APN) in mobile networks) can be created and used on Cisco LTE/5G SKU's. Maximum number of profiles that can be created are 16.

Cisco SKU's shipping with specific carrier provisioning file (Can be found in Carrier label under "show cellular <slot> hardware"), default profiles are already populated and can be deployed readily.

In all other cases where profile configurations are not available, separate profiles should be created with required parameters.

You can create multiple profiles on Cisco LTE/5G. The following are the default internet profile numbers for the modems:

| <b>Modem</b>                | <b>Profile Number</b>        |
|-----------------------------|------------------------------|
| EM7430                      | Profile 1                    |
| EM7455 (Verizon or Sprint)  | Both Profile 1 and Profile 3 |
| EM7455 (AT&T or other SP's) | Profile 1                    |

Follow these guidelines when you configure a data profile using EXEC mode or Config mode :

- You do not have to make any profile-related changes if your modem comes with a data profile, for instance, AT&T, Sprint and Verizon.
- If any profile parameter changes are required for a connection type, the changes will likely be carried out in the default profiles.
- To configure different profile types and use them for a different connection, you can create separate profiles with different parameters (for instance, APN names). Note that only one profile is active at a given time.
- Use the **show cellular <unit> profile** command to view the data profile. An asterisk(\*) symbol is displayed against the data profile. Double asterisk(\*\*) symbol is displayed against the attach profile.
- The data profile is used to set up a data call. If you want to use a different profile, that profile needs to be made the default one. Use the **lte sim data-profile number** command to change the default profile under **controller cellular 0/2/0**.

## Creating, Modifying, or Deleting Data Profiles Using EXEC Mode

Customized profiles (Access Point Name (APN) in mobile networks) can be created and used on Cisco LTE/5G SKU's. Maximum number of profiles that can be created are 16.

Cisco SKU's shipping with specific carrier provisioning file (can be found in carrier label under **show cellular slot hardware**, default profiles are already populated and can be deployed readily.



**Note** For the LTE/5G, the *unit* argument identifies the router slot, module slot, and port separated by slashes (0/2/0).

### Procedure

|               | Command or Action                                                                                                                                                                                                                             | Purpose                                                                                                                                                                                                                                                                                                                                                                                                                                                                                                                                                                                                                                                                                                                                                                                                                                                      |
|---------------|-----------------------------------------------------------------------------------------------------------------------------------------------------------------------------------------------------------------------------------------------|--------------------------------------------------------------------------------------------------------------------------------------------------------------------------------------------------------------------------------------------------------------------------------------------------------------------------------------------------------------------------------------------------------------------------------------------------------------------------------------------------------------------------------------------------------------------------------------------------------------------------------------------------------------------------------------------------------------------------------------------------------------------------------------------------------------------------------------------------------------|
| <b>Step 1</b> | <p><b>cellular unit lte profile [create / delete] profile-number [apn [authentication [username password [bearer-type]]]]</b></p> <p><b>Example:</b></p> <pre>Router# cellular 0/2/0 lte profile create 2 apn.com pap username pwd ipv4</pre> | <p>Creates, modifies, or deletes a modem data profile in the privileged EXEC mode.</p> <ul style="list-style-type: none"> <li>• The <i>profile-number</i> argument specifies the profile number created for the modem.</li> <li>• (Optional) The <i>apn</i> argument specifies an Access Point Name (APN). An APN is provided by your service provider. Only a single APN can be specified for a single profile.</li> <li>• (Optional) The <i>authentication</i> parameter specifies the authentication type used. Acceptable parameters are <b>chap</b>, <b>none</b> (no authentication), <b>pap</b>, and <b>pap_chap</b> (PAP or CHAP authentication).</li> <li>• (Optional) The <i>username</i> and <i>password</i> arguments are given by a service provider. These are mandatory when an authentication type other than <b>none</b> is used.</li> </ul> |

|  | Command or Action | Purpose                                                                                                                                                                                                                                                                                                                                                                                                                                                                                                                |
|--|-------------------|------------------------------------------------------------------------------------------------------------------------------------------------------------------------------------------------------------------------------------------------------------------------------------------------------------------------------------------------------------------------------------------------------------------------------------------------------------------------------------------------------------------------|
|  |                   | <ul style="list-style-type: none"> <li>(Optional) The <i>PDN</i> type parameter specifies the type of packet data session established with mobile network using this profile. Acceptable parameters are: <b>ipv4</b>, <b>ipv6</b> and <b>ipv4v6</b> (IPv4 and IPv6).</li> </ul> <p>The <b>show cellular slot</b> profile displays configured profile list.</p> <p><b>Note</b>      Single asterisk(*) displayed against data profile.</p> <p>              Double asterisk(**) displayed against attached profile.</p> |

### Example

```

router# show cellular 0/2/0 profile
Profile 1 = INACTIVE **

PDP Type = IPv4v6
Access Point Name (APN) = vzwims
Authentication = None

Profile 2 = INACTIVE

PDP Type = IPv4v6
Access Point Name (APN) = vzwadmin
Authentication = None

Profile 3 = ACTIVE*

PDP Type = IPv4v6
PDP address = 100.119.136.44
PDP IPV6 address = 2600:1010:B00E:1E11:192D:3E20:199B:3A70/64 Scope: Global
Access Point Name (APN) = VZWINTERNET
Authentication = None
 Primary DNS address = 198.224.173.135
 Secondary DNS address = 198.224.174.135
 Primary DNS IPV6 address = 2001:4888:68:FF00:608:D:0:0
 Secondary DNS IPV6 address = 2001:4888:61:FF00:604:D:0:0

Profile 4 = INACTIVE

PDP Type = IPv4v6
Access Point Name (APN) = vzwapp
Authentication = None

Profile 5 = INACTIVE

PDP Type = IPv4v6
Access Point Name (APN) = vzw800
Authentication = None

Profile 6 = INACTIVE

PDP Type = IPv4v6

```

```
Access Point Name (APN) = CISCO.GW4.VZWENTP
Authentication = None
```

```
* - Default profile
** - LTE attach profile
```



**Note** If data and attach profile bindings need modification, use the **controller cellular** slot.

```
router(config-controller)# lte sim data-profile 3 attach-profile 2 slot unit
```

```
Device #show cellular 0/2/0 profile
Profile 1 = INACTIVE

PDP Type = IPv4v6
Access Point Name (APN) = test
Authentication = None

Profile 2 = INACTIVE **

PDP Type = IPv4
Access Point Name (APN) = internet
Authentication = PAP or CHAP
Username = user@solution.com
Password = cisco

Profile 3 = INACTIVE*

PDP Type = IPv4v6
Access Point Name (APN) = basic
Authentication = None

* - Default profile
** - LTE attach profile
Configured default profile for active SIM 0 is profile 2.
```

## Creating, Modifying, or Deleting Data Profiles in Configuration Mode



**Note** For the LTE/5G NIM, the *unit* argument identifies the router slot, WIC slot, and port separated by slashes (0/1/0).

### Procedure

|               | Command or Action                                                                                                                                                                                                                                                                                      | Purpose                                                                                                                                                                                                                                                                              |
|---------------|--------------------------------------------------------------------------------------------------------------------------------------------------------------------------------------------------------------------------------------------------------------------------------------------------------|--------------------------------------------------------------------------------------------------------------------------------------------------------------------------------------------------------------------------------------------------------------------------------------|
| <b>Step 1</b> | <pre><b>profile idid apn apn name [authentication</b><br/><b>[username password ]pdn-type [pdn</b><br/><b>type][slotslot-number  no-overwrite]]]</b></pre> <p><b>Example:</b></p> <pre>Router(config-controller)# profile id 1<br/>apn apn_internet authentication none<br/>pdn-type ipv4 slot 0</pre> | <p>Configures a cellular profile in the configuration mode.</p> <ul style="list-style-type: none"> <li>The <i>id</i> argument specifies the profile number created for the modem. The maximum number of profiles that can be created for each modem are given as follows:</li> </ul> |

|  | Command or Action | Purpose                                                                                                                                                                                                                                                                                                                                                                                                                                                                                                                                                                                                                                                                                                                                                                                                                                                                                                                                                                                                                                                                                                                                                                                                                                                                                                                                                                                                                                                                        |
|--|-------------------|--------------------------------------------------------------------------------------------------------------------------------------------------------------------------------------------------------------------------------------------------------------------------------------------------------------------------------------------------------------------------------------------------------------------------------------------------------------------------------------------------------------------------------------------------------------------------------------------------------------------------------------------------------------------------------------------------------------------------------------------------------------------------------------------------------------------------------------------------------------------------------------------------------------------------------------------------------------------------------------------------------------------------------------------------------------------------------------------------------------------------------------------------------------------------------------------------------------------------------------------------------------------------------------------------------------------------------------------------------------------------------------------------------------------------------------------------------------------------------|
|  |                   | <ul style="list-style-type: none"> <li>• EM7455 – Up to 16 profiles</li> <li>• EM7430 – Up to 16 profiles</li> <li>• (Optional) The <i>apn</i> argument specifies an Access Point Name (APN) in the profile. An APN is provided by your service provider. Only a single APN can be specified in a single profile.</li> <li>• (Optional) The <i>authentication</i> parameter specifies the authentication type used. Acceptable parameters are <b>chap</b>, <b>none</b> (no authentication), <b>pap</b>, and <b>pap_chap</b> (PAP or CHAP authentication).</li> <li>• (Optional) The <i>username</i> and <i>password</i> arguments are provided by a service provider. These are mandatory when an authentication type is used other than none.</li> <li>• (Optional) The <i>PDN-type</i> parameter specifies the type of packet data session established with mobile network using this profile. Acceptable parameters are: <b>ipv4</b>, <b>ipv6</b> and <b>ipv4v6</b>.</li> <li>• (Optional) The <i>slot-number</i> parameter specifies the slot number. By default, the slot-number is the current active slot-number, if not specified.</li> <li>• (Optional) <i>No-overwrite</i> action to be taken when a profile already exists in modem for the profile id. If there is a profile already exists in the modem for this profile id and no-overwrite option is specified, this configuration will not overwrite existing profile. Default is <i>overwrite</i>.</li> </ul> |

## Configuration Examples

The following example shows how to change a default profile on LTE/5G:

```
router(config-controller)# lte sim data-profile 2 attach-profile 1 slot <unit>
```

The following example shows the output of the **show cellular** command for Verizon network service:

```
router# show cellular 0/2/0 profile
Profile 1 = INACTIVE **

PDP Type = IPv4v6
```



```

Access Point Name (APN) = vzwims
Authentication = None

Profile 2 = INACTIVE

PDP Type = IPv4v6
Access Point Name (APN) = vzwadmin
Authentication = None

Profile 3 = ACTIVE*

PDP Type = IPv4v6
PDP address = 100.119.136.44
PDP IPV6 address = 2600:1010:B00E:1E11:192D:3E20:199B:3A70/64 Scope: Global
Access Point Name (APN) = VZWINTERNET
Authentication = None
 Primary DNS address = 198.224.173.135
 Secondary DNS address = 198.224.174.135
 Primary DNS IPV6 address = 2001:4888:68:FF00:608:D:0:0
 Secondary DNS IPV6 address = 2001:4888:61:FF00:604:D:0:0

Profile 4 = INACTIVE

PDP Type = IPv4v6
Access Point Name (APN) = vzwapp
Authentication = None

Profile 5 = INACTIVE

PDP Type = IPv4v6
Access Point Name (APN) = vzw800
Authentication = None

Profile 6 = INACTIVE

PDP Type = IPv4v6
Access Point Name (APN) = CISCO.GW4.VZWENTP
Authentication = None

* - Default profile
** - LTE attach profile

```

## Configuration Example

### Example Configuration under Controller Cellular

```

router(config-controller)# profile id 1 apn apn_internet authentication none pdn-type ipv4
no-overwrite

```

### Controller Cellular Running Configuration

```

Router #show running-config controller cellular <slot>
Building configuration...

Current configuration : 330 bytes
!
controller Cellular 0/2/0
profile id 1 apn apn_internet authentication none pdn-type ipv4 no-overwrite
end

```

**\*\* This will override exec mode profile configuration**

**\*\* If for a profile ID, configuration CLI exists, exec mode configuration cannot be performed.**

```
Router #show cellular <slot> profile 5
Profile 5 = INACTIVE

PDP Type = IPv4
Access Point Name (APN) = apn_old
Authentication = None
```

```
TSN1#cellular <slot> lte profile create 5 apn_new
Warning: You are attempting to create Profile 5
Profile 5 was configured through controller configuration 'profile id <profile #>'
Please execute command under controller configuration using '[no] profile id <profile #>'
for profile 5 to create
Profile 5 NOT written to modem
```

**\*\* As part of this enhancement, any attach and/or data profile changes will immediately trigger a connection reset and take effect. Below warning message will be displayed.**

```
Warning: You are attempting to modify the data/attach profile.
Connection will be reset
```

## Configure Radio Band Selection

This feature allow users to configure and lock down the modem to a specific RF band, or set of bands. The preference can be set to be equal to, or a sub-set of the capability supported by the modem/carrier combination.

The following examples show the controller configuration commands.

:

### Procedure

|               | Command or Action                                                                                                                                                                                                                           | Purpose |
|---------------|---------------------------------------------------------------------------------------------------------------------------------------------------------------------------------------------------------------------------------------------|---------|
| <b>Step 1</b> | <b>conf t</b><br><br><b>Example:</b><br>Device# conf t<br>Enter configuration commands, one per line. End with CNTL/Z.                                                                                                                      |         |
| <b>Step 2</b> | <b>controllercellular</b> <i>interface-number</i><br><br><b>Example:</b><br>Device(config)# controller cellular 0/2/0                                                                                                                       |         |
| <b>Step 3</b> | <b>lte modem</b><br><b>band-select</b> <i>indices umts3g indices lte4g indices nr5g indices slot</i><br><b>#</b><br><br><b>Example:</b><br>Device(config-controller)# lte modem<br>band-select indices umts3g 24 lte4g 48<br>nr5g 40 slot 0 |         |

## Example

```

router#show cellular 0/2/0 radio ?
 band Show Radio band settings
| history Show Radio history in graph format
| Output modifiers
| <cr>
| <cr>

router#show cell 0/2/0 radio band
LTE bands supported by modem:
- Bands 1 2 3 4 5 7 8 12 13 14 18 19 20 25 26 28 29 30 32 34 38 39 40 41 42 43 46 48 66 71.
LTE band Preference settings for the active sim(slot 0):
- Bands 1 2 3 4 5 7 8 12 13 14 18 19 20 25 26 28 29 30 32 34 38 39 40 41 42 43 46 48 66 71.

NR5G bands supported by modem:
- Bands 1 2 3 5 7 8 12 20 25 28 38 40 41 48 66 71 77 78 79.
NR5G band Preference settings for the active sim(slot 0):
- Bands 1 2 3 5 7 8 12 20 25 28 38 40 41 48 66 71 77 78 79.

3G bands supported by modem:
Index: <none>
3G band Preference settings for the active sim(slot 0):
Index: <none>

=====

Band index reference list:

For LTE and 5G, indices 1-128 correspond to bands 1-128.
For 3G, indices 1-64 maps to the 3G bands mentioned against each above.

```

## Multiple PDN Contexts

This feature enables router to connect to multiple (currently two) packet data networks. This allows users to enable different features independently on each PDN. For instance, the first PDN can be used for public Internet access and the second one for VPN connectivity; each PDN has its own set of IP addresses and QoS characteristics.

During the initialization of the router, two cellular interfaces corresponding to the two PDNs are created: cellular 0/2/0 and cellular 0/2/1

These interfaces can be viewed as two logical interfaces using the same radio resources.

The interface cellular 0/2/0 is referred as the first PDN, and cellular 0/2/1 as the second PDN.

To bring up the two PDNs, configuration needs to be applied on both the cellular interfaces in order to make two simultaneous data calls. The next step is to associate the data-bearer profile with its corresponding cellular interface or PDN. It is sufficient to associate the profile for just the first PDN under the controller cellular configuration. Note that the second PDN assumes a profile that is just one above the profile used for the first PDN. For example, if the first PDN uses profile 1, the second PDN uses profile 2 automatically when the call is initiated for the second one.

After the interesting traffic is routed through these cellular interfaces, data calls are initiated and each interface is assigned its own IP and DNS addresses provided by the cellular network.



---

**Note** Both PDNs share radio resources. Therefore, any throughput measurement needs to take into account the aggregate throughput on both PDNs, instead of just one.

---



---

**Note** For Verizon cellular network, the second PDN uses profile #6 automatically, when the call is initiated for the second data connection.

---

## Configuration Examples

The following example shows how to configure multiple PDN on Cisco LTE/5G SKU:

```
interface Cellular0/2/0
ip address negotiated
dialer in-band
dialer idle-timeout 0
dialer-group 1
ipv6 enable
pulse-time 1
!
interface Cellular0/2/1
ip address negotiated
dialer in-band
dialer idle-timeout 0
dialer-group 1
ipv6 enable
pulse-time 1
! dialer-list 1 protocol ipv6 permit
!

ip route 192.192.187.0 255.255.255.0 Cellular0/2/0
ip route 192.171.187.254 255.255.255.255 Cellular0/2/1
!
```

The following show commands can be used to verify the status of the multiple PDN calls:

```
Router#sh cellular 0/2/0 profile
Profile 1 = ACTIVE* **

PDP Type = IPv4v6
PDP address = 29.29.29.9
PDP IPV6 address = 2001:2678:2680:5DF0:D058:1AD3:C07A:297D/64 Scope: Global
Access Point Name (APN) = broadband
Authentication = None
 Primary DNS address = 8.0.0.8
 Secondary DNS address = 8.8.4.4
 Primary DNS IPV6 address = 2001:4860:4860:0:0:0:0:8888
 Secondary DNS IPV6 address = 2001:4860:4860:0:0:0:0:8844

Profile 2 = ACTIVE

PDP Type = IPv4v6
PDP address = 21.21.21.222
PDP IPV6 address = 2001:567A:567A:1479:C41B:BE17:31C2:95AC/64 Scope: Global
Access Point Name (APN) = basic
Authentication = None
 Primary DNS address = 171.70.168.183
 Secondary DNS address = 8.8.8.8
```

```
Primary DNS IPV6 address = 2001:4860:4860:0:0:0:0:8888
Secondary DNS IPV6 address = 2001:4860:4860:0:0:0:0:8844
```

```
Profile 3 = INACTIVE

PDP Type = IPv4
Access Point Name (APN) = mpdn
Authentication = None
Profile 4 = INACTIVE

PDP Type = IPv4
Access Point Name (APN) = broadband
Authentication = None

Profile 5 = INACTIVE

PDP Type = IPv4
Access Point Name (APN) = cisco.gw4.vzwentp
Authentication = None

Profile 6 = INACTIVE

PDP Type = IPv4
Access Point Name (APN) = mobility-del
Authentication = None

Profile 7 = INACTIVE

PDP Type = IPv4
Access Point Name (APN) = mobility-de2
Authentication = None

Profile 8 = INACTIVE

PDP Type = IPv4
Access Point Name (APN) = broadband
Authentication = None

Profile 9 = INACTIVE

PDP Type = IPv4
Access Point Name (APN) = mpdndt-qos
Authentication = None

Profile 10 = INACTIVE

PDP Type = IPv4
Access Point Name (APN) = mobility-de2
Authentication = None

Profile 11 = INACTIVE

PDP Type = IPv4
Access Point Name (APN) = broadband
Authentication = None

Profile 12 = INACTIVE

PDP Type = IPv4
Access Point Name (APN) = wfgos
Authentication = CHAP
Username: ipv4v6
Password: xxxxxx
```

```

Profile 13 = INACTIVE

PDP Type = IPv4
Access Point Name (APN) = broadband
Authentication = CHAP
Username: ipv4v6
Password: xxxxxxxx

Profile 14 = INACTIVE

PDP Type = IPv4
Access Point Name (APN) = mobility-de2
Authentication = CHAP
Username: ipv4v6
Password: xxxxxxxx

Profile 15 = INACTIVE

PDP Type = IPv4
Access Point Name (APN) = aaaauth
Authentication = CHAP
Username: ipv4v6
Password: xxxxxxxx

Profile 16 = INACTIVE

PDP Type = IPv4
Access Point Name (APN) = broadband
Authentication = CHAP
Username: ipv4v6
Password: xxxxxxxx

* - Default profile
** - LTE attach profile

Configured default profile for active SIM 0 is profile 1.

Router# sh cellular 0/2/0 connection
Profile 1, Packet Session Status = ACTIVE
Cellular0/2/0:
 Data Packets Transmitted = 9 , Received = 9
 Data Transmitted = 900 bytes, Received = 900 bytes
 IP address = 29.29.29.9
 IPv6 address = 2001:2678:2680:5DF0:D058:1AD3:C07A:297D/64 Scope: Global
 Primary DNS address = 8.0.0.8
 Secondary DNS address = 8.8.4.4
 Primary DNS IPV6 address = 2001:4860:4860:0:0:0:0:8888
 Secondary DNS IPV6 address = 2001:4860:4860:0:0:0:0:8844
Profile 2, Packet Session Status = ACTIVE
Cellular0/2/1:
 Data Packets Transmitted = 7 , Received = 2
 Data Transmitted = 700 bytes, Received = 176 bytes
 IP address = 21.21.21.222
 IPv6 address = 2001:567A:567A:1479:C41B:BE17:31C2:95AC/64 Scope: Global
 Primary DNS address = 171.70.168.183
 Secondary DNS address = 8.8.8.8
 Primary DNS IPV6 address = 2001:4860:4860:0:0:0:0:8888
 Secondary DNS IPV6 address = 2001:4860:4860:0:0:0:0:8844
Profile 3, Packet Session Status = INACTIVE
Profile 4, Packet Session Status = INACTIVE
Profile 5, Packet Session Status = INACTIVE
Profile 6, Packet Session Status = INACTIVE
Profile 7, Packet Session Status = INACTIVE
Profile 8, Packet Session Status = INACTIVE

```

```

Profile 9, Packet Session Status = INACTIVE
Profile 10, Packet Session Status = INACTIVE
Profile 11, Packet Session Status = INACTIVE
Profile 12, Packet Session Status = INACTIVE
Profile 13, Packet Session Status = INACTIVE
Profile 14, Packet Session Status = INACTIVE
Profile 15, Packet Session Status = INACTIVE
Profile 16, Packet Session Status = INACTIVE

```

```
Router#show ip interface brief
```

| Interface            | IP-Address   | OK? | Method | Status                | Protocol |
|----------------------|--------------|-----|--------|-----------------------|----------|
| GigabitEthernet0/0/0 | 1.3.88.55    | YES | manual | up                    | up       |
| GigabitEthernet0/0/1 | unassigned   | YES | unset  | administratively down | down     |
| GigabitEthernet0/1/0 | unassigned   | YES | unset  | administratively down | down     |
| GigabitEthernet0/1/1 | unassigned   | YES | unset  | administratively down | down     |
| GigabitEthernet0/1/2 | unassigned   | YES | unset  | administratively down | down     |
| GigabitEthernet0/1/3 | unassigned   | YES | unset  | administratively down | down     |
| GigabitEthernet0/1/4 | unassigned   | YES | unset  | administratively down | down     |
| GigabitEthernet0/1/5 | unassigned   | YES | unset  | administratively down | down     |
| GigabitEthernet0/1/6 | unassigned   | YES | unset  | administratively down | down     |
| GigabitEthernet0/1/7 | unassigned   | YES | unset  | administratively down | down     |
| Wl0/1/8              | unassigned   | YES | unset  | administratively down | down     |
| Cellular0/2/0        | 29.29.29.9   | YES | IPCP   | up                    | up       |
| Cellular0/2/1        | 21.21.21.222 | YES | IPCP   | up                    | up       |
| Vlan1                | unassigned   | YES | manual | up                    | down     |

```
Router#
```

```
Router# show ip dns view
```

```
DNS View default parameters:
```

```
DNS Resolver settings:
```

```
Domain lookup is enabled
```

```
Default domain name:
```

```
Domain search list:
```

```
Domain name-servers:
```

```
8.0.0.8
```

```
2001:4860:4860::8888
```

```
8.8.4.4
```

```
2001:4860:4860::8844
```

```
171.70.168.183
```

```
8.8.8.8
```

```
DNS Server settings:
```

```
Forwarding of queries is enabled
```

```
Forwarder addresses: DNS View default parameters: DNS Resolver settings:
```

```
Domain lookup is enabled Default domain name: Domain search list: Domain name-servers:
```

```
8.8.8.8
```

```
172.26.38.1
```

```
172.26.38.2
```

```
DNS Server settings:
```

```
Forwarding of queries is enabled
```

```
Forwarder addresses:
```

```
Router#
```

## Configuring a SIM for Data Calls

### Locking and Unlocking a SIM Card Using a PIN Code

Perform this task to lock or unlock a SIM card given by your service provider.

The SIM card gets blocked if the wrong PIN is entered three consecutive times. Make sure you enter the correct PIN the SIM is configured with. If your SIM card gets blocked, contact your service provider for a PUK code. Using the PUK code, you can unblock the SIM card.

For the LTE/5G, the *unit* argument identifies the router slot, module slot, and port separated by slashes (0/2/0).

### Procedure

|               | Command or Action                                                                                                             | Purpose                                                                                                                                                                                             |
|---------------|-------------------------------------------------------------------------------------------------------------------------------|-----------------------------------------------------------------------------------------------------------------------------------------------------------------------------------------------------|
| <b>Step 1</b> | <b>cellular <i>unit</i> lte sim {lock   unlock} <i>pin</i></b><br><b>Example:</b><br>Router# cellular 0/2/0 lte sim lock 1111 | Locks or unlocks the SIM card using a PIN code. <ul style="list-style-type: none"> <li>• <i>pin</i>—A code (4 to 8 digits long) provided by your carrier to lock or unlock the SIM card.</li> </ul> |

## Changing the PIN Code

Perform this task to change the PIN code of a SIM.

For the LTE/5G, the *unit* argument identifies the router slot, module slot, and port separated by slashes (0/2/0).

### Procedure

|               | Command or Action                                                                                                                           | Purpose                                                                                     |
|---------------|---------------------------------------------------------------------------------------------------------------------------------------------|---------------------------------------------------------------------------------------------|
| <b>Step 1</b> | <b>cellular <i>unit</i> lte sim change-pin <i>pin new-pin</i></b><br><b>Example:</b><br>Router# cellular 0/2/0 lte sim change-pin 1111 1234 | Changes the assigned PIN code. SIM should be in locked state when the PIN is being changed. |

## Verifying the Security Information of a Modem

Perform this task to verify the security information of a modem.



**Note** For the LTE/5G, the *unit* argument identifies the router slot, module slot, and port separated by slashes (0/2/0).

### Procedure

|               | Command or Action                                                                                    | Purpose                                                                     |
|---------------|------------------------------------------------------------------------------------------------------|-----------------------------------------------------------------------------|
| <b>Step 1</b> | <b>show cellular <i>unit</i> security</b><br><b>Example:</b><br>Router# show cellular 0/2/0 security | Shows the security information of the modem, including the SIM lock status. |

## Configuring Automatic Authentication for a Locked SIM

An unencrypted PIN can be configured to activate the Card Holder Verification (CHV1) code that authenticates a modem.



The SIM card gets blocked if the wrong PIN is entered three consecutive times. Make sure you enter the correct PIN the SIM is configured with. If your SIM card gets blocked, contact your service provider for a PUK code.

Follow these procedures when using an unencrypted Level 0 PIN to configure CHV1. For instructions on how to configure CHV1 using an encrypted Level 7 PIN, see the [Configuring an Encrypted PIN for a SIM, on page 231](#).

A SIM should be locked for SIM authentication to work. To verify the SIM's status, use the **show cellular unit security** command.

For the LTE/5G, the *unit* argument identifies the router slot, module slot, and port separated by slashes (0/2/0).

### Procedure

|               | Command or Action                                                                                       | Purpose                                                                                                                                                                                                                                                                                                                                                                                                                                                                                                                                     |
|---------------|---------------------------------------------------------------------------------------------------------|---------------------------------------------------------------------------------------------------------------------------------------------------------------------------------------------------------------------------------------------------------------------------------------------------------------------------------------------------------------------------------------------------------------------------------------------------------------------------------------------------------------------------------------------|
| <b>Step 1</b> | <b>configure terminal</b><br><br><b>Example:</b><br><br>Router# configure terminal                      | Enters global configuration mode.                                                                                                                                                                                                                                                                                                                                                                                                                                                                                                           |
| <b>Step 2</b> | <b>controller cellular unit</b><br><br><b>Example:</b><br><br>Router(config)# controller cellular 0/2/0 | Enters the cellular controller configuration mode.                                                                                                                                                                                                                                                                                                                                                                                                                                                                                          |
| <b>Step 3</b> | <b>lte sim authenticate 0 pin</b>                                                                       | Authenticates the SIM CHV1 code by using an unencrypted ( <b>0</b> ) keyword and PIN. This PIN is sent to the modem for authentication with each subsequent LTE connection. If authentication passes based on the configured PIN, the data call is allowed. If authentication fails, the modem does not initiate the data call.<br><br><b>Note</b> This command is valid only when an unencrypted PIN is used. To configure CHV1 code using an encrypted PIN, see the <a href="#">Configuring an Encrypted PIN for a SIM, on page 231</a> . |

## Configuring an Encrypted PIN for a SIM

To configure an encrypted PIN, the scrambled value of the PIN must be obtained. To get the scrambled Level 7 PIN and to configure the SIM CHV1 code for verification using this encrypted PIN, enter the following commands in the EXEC mode.



**Note** When obtaining the encrypted PIN for a SIM, a username and password are created by configuring password encryption, defining the username and associated password, copying the resulting scrambled password, and using this scrambled password in the SIM authentication command. After the scrambled PIN has been obtained and used in SIM authentication, the username created can be deleted from the Cisco IOS configuration.



**Note** A SIM should be locked for SIM authentication to work. To verify the SIM's status, use the **show cellular <unit> security** command.



**Note** For the 4G LTE SKU, the *unit* argument identifies the router slot, module slot, and port separated by slashes (0/2/0).

### Procedure

|               | Command or Action                                                                                                                                   | Purpose                                                                                                                                                                                                       |
|---------------|-----------------------------------------------------------------------------------------------------------------------------------------------------|---------------------------------------------------------------------------------------------------------------------------------------------------------------------------------------------------------------|
| <b>Step 1</b> | <b>configure terminal</b><br><b>Example:</b><br><pre>Router# configure terminal</pre>                                                               | Enters global configuration mode.                                                                                                                                                                             |
| <b>Step 2</b> | <b>service password-encryption</b><br><b>Example:</b><br><pre>Router(config)# service password-encryption</pre>                                     | Enables password encryption.                                                                                                                                                                                  |
| <b>Step 3</b> | <b>username <i>name</i> privilege 0 password <i>pin</i></b><br><b>Example:</b><br><pre>Router(config)# username SIM privilege 0 password 1111</pre> | Creates username and password. <ul style="list-style-type: none"> <li>• <i>name</i>—Specifies the username.</li> <li>• <i>pin</i>—Specifies the four- to eight-digit PIN code.</li> </ul>                     |
| <b>Step 4</b> | <b>do show run   i <i>name</i></b><br><b>Example:</b><br><pre>Router(config)# do show run   i SIM</pre>                                             | Shows the username configuration line with the encrypted level 7 PIN for the username created in Step 3 (user “SIM” in the example shown).<br><br>Copy the scrambled password for use in Step 6 (as the PIN). |
| <b>Step 5</b> | <b>controller cellular <i>unit</i></b><br><b>Example:</b><br><pre>Router(config)# controller cellular 0/2/0</pre>                                   | Enters the cellular controller configuration mode.                                                                                                                                                            |

|               | Command or Action                                                                                              | Purpose                                                                                                                                                                                                                                                                                                                                             |
|---------------|----------------------------------------------------------------------------------------------------------------|-----------------------------------------------------------------------------------------------------------------------------------------------------------------------------------------------------------------------------------------------------------------------------------------------------------------------------------------------------|
| <b>Step 6</b> | <b>lte sim authenticate {0   7} pin</b>                                                                        | Authenticates the SIM CHV1 code by using the encrypted keyword <b>7</b> and the scrambled PIN from Step 4. The PIN is sent to the modem for authentication with each subsequent LTE connection. If authentication passes based on the configured PIN, the data call is allowed. If authentication fails, the modem does not initiate the data call. |
| <b>Step 7</b> | <b>exit</b><br><b>Example:</b><br><br>Router(config-controller)# exit                                          | (Optional) Exits the cellular controller configuration mode.                                                                                                                                                                                                                                                                                        |
| <b>Step 8</b> | <b>no username name</b><br><b>Example:</b><br><br>Router(config)# no username SIM                              | (Optional) Removes the username and password created in Step 3.                                                                                                                                                                                                                                                                                     |
| <b>Step 9</b> | <b>no service password-encryption</b><br><b>Example:</b><br><br>Router(config)# no service password-encryption | (Optional) Disables password encryption.                                                                                                                                                                                                                                                                                                            |

## Applying a Modem Profile in a SIM Configuration

### Procedure

|               | Command or Action                                                                                   | Purpose                                                                                                                                                                                                |
|---------------|-----------------------------------------------------------------------------------------------------|--------------------------------------------------------------------------------------------------------------------------------------------------------------------------------------------------------|
| <b>Step 1</b> | <b>configure terminal</b><br><b>Example:</b><br><br>Router# configure terminal                      | Enters the global configuration mode.                                                                                                                                                                  |
| <b>Step 2</b> | <b>controller cellular unit</b><br><b>Example:</b><br><br>Router(config)# controller cellular 0/2/0 | Enters the cellular controller configuration mode.                                                                                                                                                     |
| <b>Step 3</b> | <b>lte sim data-profile number attach-profile number</b>                                            | Applies the configured profile number to the SIM and its slot number. The default (primary) slot is 0.<br><br>The <b>attach profile</b> is the profile used by the modem to attach to the LTE network. |

|  | Command or Action | Purpose                                                                                         |
|--|-------------------|-------------------------------------------------------------------------------------------------|
|  |                   | The <b>data profile</b> is the profile used to send and receive data over the cellular network. |

## Data Call Setup

To set up a data call, use the following procedures:

### Configuring the Cellular Interface

To configure the cellular interface, enter the following commands starting in EXEC mode.

For the LTE/5G, the *unit* argument identifies the router slot, module slot, and port separated by slashes (0/2/0).

If a tunnel interface is configured with **ip unnumbered cellular 0/2/0**, it is necessary to configure the actual static IP address under the cellular interface, in place of **ip address negotiated**.

#### Procedure

|               | Command or Action                                                                                 | Purpose                                                                                  |
|---------------|---------------------------------------------------------------------------------------------------|------------------------------------------------------------------------------------------|
| <b>Step 1</b> | <b>configure terminal</b><br><b>Example:</b><br><br>Router# configure terminal                    | Enters global configuration mode.                                                        |
| <b>Step 2</b> | <b>interface cellular unit</b><br><b>Example:</b><br><br>Router(config)# interface cellular 0/2/0 | Specifies the cellular interface.                                                        |
| <b>Step 3</b> | <b>ip address negotiated</b><br><b>Example:</b><br><br>Router(config-if)# ip address negotiated   | Specifies that the IP address for a particular interface is dynamically obtained.        |
| <b>Step 4</b> | <b>dialer in-band</b><br><b>Example:</b><br><br>Router(config-if)# dialer in-band                 | Enables DDR and configures the specified serial interface to use in-band dialing.        |
| <b>Step 5</b> | <b>dialer-group group-number</b><br><b>Example:</b><br><br>Router(config-if)# dialer-group 1      | Specifies the number of the dialer access group to which the specific interface belongs. |
| <b>Step 6</b> | <b>exit</b><br><b>Example:</b><br><br>Router(config-if)# exit                                     | Enters the global configuration mode.                                                    |

|               | Command or Action                                                                                                                                                                                                                                       | Purpose                                                                                                                                                                                                                                                                                                 |
|---------------|---------------------------------------------------------------------------------------------------------------------------------------------------------------------------------------------------------------------------------------------------------|---------------------------------------------------------------------------------------------------------------------------------------------------------------------------------------------------------------------------------------------------------------------------------------------------------|
| <b>Step 7</b> | <p><b>ip route</b> <i>network-number network-mask</i> {<i>ip-address   interface</i>} [<i>administrative distance</i>] [<b>name name</b>]</p> <p><b>Example:</b></p> <pre>Router(config)# ip route 209.165.200.225 255.255.255.224 cellular 0/2/0</pre> | <p>Establishes a floating static route with the configured administrative distance through the specified interface.</p> <p><b>Note</b> A higher administrative distance should be configured for the route through the backup interface so that it is used only when the primary interface is down.</p> |
| <b>Step 8</b> | <p><b>dialer-list dialer-group protocol</b> protocol-name {<b>permit   deny   list</b> <i>access-list-number   access-group</i>}</p> <p><b>Example:</b></p> <pre>Router(config)# dialer-list 1 protocol ip list 1</pre>                                 | <p>Creates a dialer list for traffic of interest and permits access to an entire protocol.</p>                                                                                                                                                                                                          |

## Configuring DDR

To configure DDR for the cellular interface, enter the following commands starting in EXEC mode.



**Note** For the LTE/5G, the *unit* argument identifies the router slot, module slot, and port separated by slashes (0/2/0).

### Procedure

|               | Command or Action                                                                                                       | Purpose                                                                                  |
|---------------|-------------------------------------------------------------------------------------------------------------------------|------------------------------------------------------------------------------------------|
| <b>Step 1</b> | <p><b>configure terminal</b></p> <p><b>Example:</b></p> <pre>Router# configure terminal</pre>                           | <p>Enters global configuration mode.</p>                                                 |
| <b>Step 2</b> | <p><b>interface cellular</b> <i>unit</i></p> <p><b>Example:</b></p> <pre>Router(config)# interface cellular 0/2/0</pre> | <p>Specifies the cellular interface.</p>                                                 |
| <b>Step 3</b> | <p><b>ip address negotiated</b></p> <p><b>Example:</b></p> <pre>Router(config-if)# ip address negotiated</pre>          | <p>Specifies that the IP address for a particular interface is dynamically obtained.</p> |
| <b>Step 4</b> | <p><b>dialer in-band</b></p> <p><b>Example:</b></p>                                                                     | <p>Enables DDR and configures the specified serial interface to use in-band dialing.</p> |

|                | Command or Action                                                                                                                                                                                          | Purpose                                                                                                                                                                                                     |
|----------------|------------------------------------------------------------------------------------------------------------------------------------------------------------------------------------------------------------|-------------------------------------------------------------------------------------------------------------------------------------------------------------------------------------------------------------|
|                | <code>Router(config-if)# dialer in-band</code>                                                                                                                                                             |                                                                                                                                                                                                             |
| <b>Step 5</b>  | <b>ip address negotiated</b><br><b>Example:</b><br><code>Router(config-if)# ip address negotiated</code>                                                                                                   | Specifies that the IP address for a particular interface is dynamically obtained.                                                                                                                           |
| <b>Step 6</b>  | <b>dialer idle-timeout <i>seconds</i></b><br><b>Example:</b><br><code>Router(config-if)# dialer idle-timeout 30</code>                                                                                     | Specifies the duration of idle time, in seconds, after which a line has no outbound traffic. "0" second means no idle timeout. The default idle timeout is 120 seconds if there is no idle timer specified. |
| <b>Step 7</b>  | <b>dialer-group group-number</b><br><b>Example:</b><br><code>Router(config-if)# dialer-group 1</code>                                                                                                      | Specifies the number of the dialer access group to which the specific interface belongs.                                                                                                                    |
| <b>Step 8</b>  | <b>exit</b><br><b>Example:</b><br><code>Router(config-if)# exit</code>                                                                                                                                     | Enters the global configuration mode.                                                                                                                                                                       |
| <b>Step 9</b>  | <b>dialer-list dialer-group protocol protocol-name {permit   deny   list <i>access-list-number</i>   access-group}</b><br><b>Example:</b><br><code>Router(config)# dialer-list 1 protocol ip list 1</code> | Creates a dialer list for traffic of interest and permits access to an entire protocol.                                                                                                                     |
| <b>Step 10</b> | <b>access-list access-list-number permit <i>ip-source-address</i></b><br><b>Example:</b><br><code>Router(config)# access-list 1 permit any</code>                                                          | Defines traffic of interest.                                                                                                                                                                                |

## Enabling 4G GPS and NMEA Data Streaming

GPS NMEA data streaming to external NMEA 2.0-compliant GPS plotter applications can be enabled on Cisco LTE/5G.



**Note** For the LTE/5G, the *unit* argument identifies the router slot, module slot, and the port, and is separated by slashes (0/2/0).

## Procedure

|               | Command or Action                                                                                                                                                                                                                   | Purpose                                                                                                                                                                                                                                                                                                                                            |
|---------------|-------------------------------------------------------------------------------------------------------------------------------------------------------------------------------------------------------------------------------------|----------------------------------------------------------------------------------------------------------------------------------------------------------------------------------------------------------------------------------------------------------------------------------------------------------------------------------------------------|
| <b>Step 1</b> | configure terminal<br><b>Example:</b><br>Router# configure terminal                                                                                                                                                                 | Enters the configuration mode.                                                                                                                                                                                                                                                                                                                     |
| <b>Step 2</b> | controller cellular <i>unit</i><br><b>Example:</b><br>Router(config)# controller cellular<br>0/2/0                                                                                                                                  | Enters the controller cellular configuration mode.                                                                                                                                                                                                                                                                                                 |
| <b>Step 3</b> | lte gps enable<br><b>Example:</b><br>Router(config-controller)# lte gps enable                                                                                                                                                      | (Optional) GPS is enabled by default. Use this command to enable the GPS feature if GPS has been disabled for any reason.                                                                                                                                                                                                                          |
| <b>Step 4</b> | lte gps mode standalone<br><b>Example:</b><br>Router(config-controller)# lte gps mode<br>standalone                                                                                                                                 | Enables the standalone GPS mode.                                                                                                                                                                                                                                                                                                                   |
| <b>Step 5</b> | lte gps nmea {ip   udp [ <i>source address</i> ][ <i>destination address</i> ][ <i>destination port</i> ]}<br><b>Example:</b><br>Router(config-controller)# lte gps nmea<br>ip<br><br>or<br>Router(config-controller)# lte gps nmea | Enables NMEA. Cisco 4G LTE Advanced support only IP NMEA. Therefore, the IP interface and serial interface options are unavailable.                                                                                                                                                                                                                |
| <b>Step 6</b> | test cellular <i>unit</i> modem-power-cycle<br><b>Example:</b><br>Router# test cellular 0/2/0<br>modem-power-cycle                                                                                                                  | GPS can take effect only after modem power cycle.                                                                                                                                                                                                                                                                                                  |
| <b>Step 7</b> | end<br><b>Example:</b><br>Router(config-controller)# end                                                                                                                                                                            | Exits the controller configuration mode and returns to the privileged EXEC mode.                                                                                                                                                                                                                                                                   |
| <b>Step 8</b> | show cellular <i>unit</i> gps<br><b>Example:</b><br>Router# show cellular 0/2/0 gps<br><br>GPS Info<br>-----<br>GPS Feature: enabled<br>GPS Mode Configured: standalone<br>GPS Port Selected: Dedicated GPS port                    | Displays a summary of the following GPS data: <ul style="list-style-type: none"> <li>• GPS state information (GPS disabled, GPS acquiring, GPS enabled)</li> <li>• GPS mode configured (standalone)</li> <li>• GPS location and timestamp information</li> <li>• GPS satellite information</li> <li>• GPS feature (enabled or disabled)</li> </ul> |

|               | Command or Action                                                                                                                                                                                                                                                                                                                                                                                                                                                                                                                                                                                                                                                                                                                                                                                                                                                                                                                                                                                                                                                            | Purpose                                                                                                                 |
|---------------|------------------------------------------------------------------------------------------------------------------------------------------------------------------------------------------------------------------------------------------------------------------------------------------------------------------------------------------------------------------------------------------------------------------------------------------------------------------------------------------------------------------------------------------------------------------------------------------------------------------------------------------------------------------------------------------------------------------------------------------------------------------------------------------------------------------------------------------------------------------------------------------------------------------------------------------------------------------------------------------------------------------------------------------------------------------------------|-------------------------------------------------------------------------------------------------------------------------|
|               | <pre>GPS Status: GPS coordinates acquired Last Location Fix Error: Offline [0x0] Latitude: 38 Deg 11 Min 22.1939 Sec North Longitude: 96 Deg 40 Min 48.7066 Sec West Timestamp (GMT): Thu Jun 29 07:13:42 2017  Fix type index: 0, Height: 318 m Satellite Info ----- Satellite #3, elevation 62, azimuth 282, SNR 53 Satellite #4, elevation 28, azimuth 61, SNR 53 Satellite #5, elevation 63, azimuth 281, SNR 54 Satellite #6, elevation 10, azimuth 254, SNR 53 Satellite #7, elevation 42, azimuth 268, SNR 53 Satellite #8, elevation 57, azimuth 106, SNR 50 Satellite #13, elevation 32, azimuth 177, SNR 54 Satellite #22, elevation 38, azimuth 210, SNR 54 Satellite #24, elevation 27, azimuth 299, SNR 54 Satellite #29, elevation 60, azimuth 317, SNR 53 Satellite #1, elevation 5, azimuth 63, SNR 0 Satellite #9, elevation 64, azimuth 264, SNR 0 Satellite #12, elevation 2, azimuth 195, SNR 0 Satellite #26, elevation 0, azimuth 331, SNR 0 Satellite #27, elevation 52, azimuth 84, SNR 0 Satellite #28, elevation 0, azimuth 0, SNR 0 Router#</pre> | <ul style="list-style-type: none"> <li>• GPS port selected (Dedicated GPS and GPS port with voltage-no-bias)</li> </ul> |
| <b>Step 9</b> | <pre>show cellular <i>unit</i> gps detail  <b>Example:</b>  Router# show cellular 0 gps detail GPS Info ----- GPS Feature: enabled GPS Mode Configured: standalone GPS Port Selected: Dedicated GPS port GPS Status: GPS coordinates acquired Last Location Fix Error: Offline [0x0] Latitude: 38 Deg 11 Min 22.1939 Sec North Longitude: 96 Deg 40 Min 48.7066 Sec West Timestamp (GMT): Thu Jun 29 07:13:42 2017 Fix type index: 0, Height: 0 m HDOP: , GPS Mode Used: not configured  Satellite Info -----</pre>                                                                                                                                                                                                                                                                                                                                                                                                                                                                                                                                                          | Displays detailed GPS data.                                                                                             |



|  | Command or Action                                                                                                                                                                                                                                                                                                                                                                                                                                                                                                                                                                                                                                                                                                          | Purpose |
|--|----------------------------------------------------------------------------------------------------------------------------------------------------------------------------------------------------------------------------------------------------------------------------------------------------------------------------------------------------------------------------------------------------------------------------------------------------------------------------------------------------------------------------------------------------------------------------------------------------------------------------------------------------------------------------------------------------------------------------|---------|
|  | Satellite #3, elevation 0, azimuth 0, SNR 53<br>Satellite #4, elevation 0, azimuth 0, SNR 52<br>Satellite #5, elevation 29, azimuth 143, SNR 51<br>Satellite #6, elevation 0, azimuth 46, SNR 53<br>Satellite #7, elevation 0, azimuth 0, SNR 52<br>Satellite #8, elevation 0, azimuth 0, SNR 53<br>Satellite #12, elevation 60, azimuth 140, SNR 54<br>Satellite #13, elevation 0, azimuth 0, SNR 54<br>Satellite #22, elevation 0, azimuth 0, SNR 51<br>Satellite #24, elevation 13, azimuth 203, SNR 53<br>Satellite #26, elevation 0, azimuth 0, SNR 53<br>Satellite #29, elevation 20, azimuth 278, SNR 52<br>Satellite #2, elevation 61, azimuth 52, SNR 0<br>Satellite #9, elevation 0, azimuth 0, SNR 0<br>Router# |         |

## Configuring 4G SMS Messaging



**Note** For the LTE/5G, the *unit* argument identifies the router slot, module slot, and the port, and is separated by slashes (0/2/0).

### Procedure

|               | Command or Action                                                                               | Purpose                                                                                                                                     |
|---------------|-------------------------------------------------------------------------------------------------|---------------------------------------------------------------------------------------------------------------------------------------------|
| <b>Step 1</b> | configure terminal<br><b>Example:</b><br>Router# configure terminal                             | Enters the configuration mode.                                                                                                              |
| <b>Step 2</b> | controller cellular <i>unit</i><br><b>Example:</b><br>Router(config)# controller cellular 0/2/0 | Enters the controller cellular configuration mode.                                                                                          |
| <b>Step 3</b> | lte sms archive path <i>FTP-URL</i><br><b>Example:</b>                                          | Specifies an FTP server folder path to send all the incoming and outgoing SMS messages. After the folder path is identified, it is appended |

|               | Command or Action                                                                                                                                                                                                                                                                                                                                                                                                                                                                                                                                                                                                                                                                                                                                                                                            | Purpose                                                                                                                                                                                                                                                                                                                                                                                                                                          |
|---------------|--------------------------------------------------------------------------------------------------------------------------------------------------------------------------------------------------------------------------------------------------------------------------------------------------------------------------------------------------------------------------------------------------------------------------------------------------------------------------------------------------------------------------------------------------------------------------------------------------------------------------------------------------------------------------------------------------------------------------------------------------------------------------------------------------------------|--------------------------------------------------------------------------------------------------------------------------------------------------------------------------------------------------------------------------------------------------------------------------------------------------------------------------------------------------------------------------------------------------------------------------------------------------|
|               | <pre>Router(config-controller)# lte sms archive path ftp://username:password@172.25.211.175/SMS-LTE</pre>                                                                                                                                                                                                                                                                                                                                                                                                                                                                                                                                                                                                                                                                                                    | <p>automatically with outbox and inbox folders for the path to which SMS messages are sent and received, for example:</p> <pre>ftp://172.25.211.175/SMS-LTE/outbox ftp://172.25.211.175/SMS-LTE/inbox</pre>                                                                                                                                                                                                                                      |
| <b>Step 4</b> | <pre>cellular <i>unit</i> lte sms view { all   <i>ID</i>   summary }</pre> <p><b>Example:</b></p> <pre>Router# cellular 0/2/0 lte sms view summary  ID FROM YY/MM/DD HR:MN:SC SIZE CONTENT 0 4442235525 12/05/29 10:50:13 137 Your entry last month has... 2 5553337777 13/08/01 10:24:56 5 First 3 5553337777 13/08/01 10:25:02 6 Second</pre>                                                                                                                                                                                                                                                                                                                                                                                                                                                              | <p>Displays the message contents of incoming texts received by a modem.</p> <ul style="list-style-type: none"> <li>• <b>all</b>—Displays the message contents of up to 255 incoming text messages received by the modem.</li> <li>• <b>ID</b>—Displays the message contents for a specified ID (0-255) of an incoming text message.</li> <li>• <b>summary</b>—Displays a summary of the incoming text messages received by the modem.</li> </ul> |
| <b>Step 5</b> | <pre>end</pre> <p><b>Example:</b></p> <pre>Router# end</pre>                                                                                                                                                                                                                                                                                                                                                                                                                                                                                                                                                                                                                                                                                                                                                 | <p>Exits the configuration mode and returns to the privileged EXEC mode.</p>                                                                                                                                                                                                                                                                                                                                                                     |
| <b>Step 6</b> | <pre>show cellular <i>unit</i> sms</pre> <p><b>Example:</b></p> <pre>Router# show cellular 0/2/0 sms Incoming Message Information ----- SMS stored in modem = 20 SMS archived since booting up = 0 Total SMS deleted since booting up = 0 Storage records allocated = 25 Storage records used = 20 Number of callbacks triggered by SMS = 0 Number of successful archive since booting up = 0 Number of failed archive since booting up = 0  Outgoing Message Information ----- Total SMS sent successfully = 0 Total SMS send failure = 0 Number of outgoing SMS pending = 0 Number of successful archive since booting up = 0 Number of failed archive since booting up = 0 Last Outgoing SMS Status = SUCCESS Copy-to-SIM Status = 0x0 Send-to-Network Status = 0x0 Report-Outgoing-Message-Number:</pre> | <p>Displays all the information in the text messages sent and received. Message information includes text messages sent successfully, received, archived, and messages pending to be sent. LTE-specific information on errors in case of a FAILED attempt may also be displayed.</p>                                                                                                                                                             |

|               | Command or Action                                                                                                                              | Purpose                                                                                                                                                                                                                                                                                                                                                                        |
|---------------|------------------------------------------------------------------------------------------------------------------------------------------------|--------------------------------------------------------------------------------------------------------------------------------------------------------------------------------------------------------------------------------------------------------------------------------------------------------------------------------------------------------------------------------|
|               | Reference Number = 0<br>Result Code = 0x0<br>Diag Code = 0x0 0x0 0x0 0x0 0x0<br><br>SMS Archive URL =<br>ftp://lab:lab@1.3.150.1/outbox        |                                                                                                                                                                                                                                                                                                                                                                                |
| <b>Step 7</b> | cellular <i>unit</i> lte sms send <i>number</i><br><br><b>Example:</b><br>Router# cellular 0/2/0 lte sms send<br>15554443333 <sms text>        | Enables a user to send a LTE/5G band SMS message to other valid recipients, provided they have a text message plan. The <i>number</i> argument is the telephone number of the SMS message recipient.<br><br><b>Note</b> 10-digit or 11-digit (phone) numbers are the proper numerical format for sending a text. For example, ##### or 1#####. Seven digits are not supported. |
| <b>Step 8</b> | cellular <i>unit</i> lte sms delete [ all   <i>id</i> ]<br><br><b>Example:</b><br>Router# cellular 0/2/0 lte sms delete [<br>all   <i>id</i> ] | (Optional) Deletes one message ID or all of the stored messages from memory.                                                                                                                                                                                                                                                                                                   |

## Configuring Modem DM Log Collection

Diagnostic Monitor (DM) Log is a modem's feature that captures data transactions between the modem and the network over the radio frequency interface. This feature is a useful tool for troubleshooting 3G and 4G data connectivity or performance issues.

Once a DM log file is captured, diagnostic software tools, such as Sierra Wireless SwiLog and Qualcomm QXDM, can be used to decode the DM log file to understand the issues. A member of Cisco TAC can help with decoding the DM log files.

To configure DM log collection, enter the following commands, starting in privileged EXEC mode.

### Procedure

|               | Command or Action                                                                                   | Purpose                                        |
|---------------|-----------------------------------------------------------------------------------------------------|------------------------------------------------|
| <b>Step 1</b> | <b>configure terminal</b><br><br><b>Example:</b><br>Router# configure terminal                      | Enters global configuration mode.              |
| <b>Step 2</b> | <b>controller cellular slot</b><br><br><b>Example:</b><br>Router(config)# controller cellular 0/2/0 | Enters cellular controller configuration mode. |

|               | Command or Action                                                                                                                                                                                                                                                                                                                                         | Purpose                                                                                                                                                                                                                                                                                                                                                                                                                                                                                                                                                                                                                                                                                                                                                                                                                                                                                                                                                                                                                                                                                                                                                                                                                                                                                                                                                                                                                                                                                                                                                                                      |
|---------------|-----------------------------------------------------------------------------------------------------------------------------------------------------------------------------------------------------------------------------------------------------------------------------------------------------------------------------------------------------------|----------------------------------------------------------------------------------------------------------------------------------------------------------------------------------------------------------------------------------------------------------------------------------------------------------------------------------------------------------------------------------------------------------------------------------------------------------------------------------------------------------------------------------------------------------------------------------------------------------------------------------------------------------------------------------------------------------------------------------------------------------------------------------------------------------------------------------------------------------------------------------------------------------------------------------------------------------------------------------------------------------------------------------------------------------------------------------------------------------------------------------------------------------------------------------------------------------------------------------------------------------------------------------------------------------------------------------------------------------------------------------------------------------------------------------------------------------------------------------------------------------------------------------------------------------------------------------------------|
| <b>Step 3</b> | <p><b>lte modem dm-log</b> {<b>autoshop</b> {<b>link-down</b>   <b>timer</b> <i>time</i>}   <b>enable</b>   <b>filesize</b> <i>size</i>   <b>filter</b>} <b>bootflash:</b><i>file</i>   <b>flash:</b><i>file</i>} <b>rotation</b>   <b>size</b> <i>log-size</i>}</p> <p><b>Example:</b></p> <pre>Router(config-controller)# lte modem dm-log enable</pre> | <p>Configures DM logging for LTE modem.</p> <ul style="list-style-type: none"> <li>• <b>autoshop</b>—Automatically stops DM log capturing based on: <ul style="list-style-type: none"> <li><b>link-down</b>—cellular interface link down event</li> <li><b>timertimer</b>—amount of time in minutes</li> </ul> </li> <li>• <b>enable</b>—Starts DM log capturing.</li> <li>• <b>filesize</b> <i>size</i>—Specifies the maximum log file size, in MB for each DM log file before creating another DM log file. Range is from 1 to 64. Default is 20.</li> <li>• <b>filter</b> <i>location:filename</i>—Specifies the DM log filter to use from the following locations: <ul style="list-style-type: none"> <li>—<b>bootflash:</b><i>file</i></li> <li>—<b>flash:</b><i>file</i></li> </ul> </li> </ul> <p><b>Note</b> Bootflash and flash are the only valid locations to store the DM log filter file.</p> <p><b>Note</b> If the DM log filter file is not specified, the generic filter file, which comes with the router will be used.</p> <p><b>Note</b> The DM log filter file needs to be in .sqf format.</p> <ul style="list-style-type: none"> <li>• <b>rotation</b>—Enables continuous DM log capturing by replacing the oldest DM log files with the latest.</li> <li>• <b>size</b> <i>log-size</i>—Specifies the maximum total size in MB of all DM log files that can be allowed in the bootflash or flash before modem stops capturing DM log files. If rotation is enabled, the oldest DM files is replaced with the latest DM file to meet this size configuration.</li> </ul> |
| <b>Step 4</b> | <p><b>end</b></p> <p><b>Example:</b></p> <pre>Router(config-controller)# end</pre>                                                                                                                                                                                                                                                                        | <p>Returns to privileged EXEC mode.</p>                                                                                                                                                                                                                                                                                                                                                                                                                                                                                                                                                                                                                                                                                                                                                                                                                                                                                                                                                                                                                                                                                                                                                                                                                                                                                                                                                                                                                                                                                                                                                      |

|               | Command or Action                                                                                                                                                                                                                                                                                                                                                                                                                                                                                                                                                                                                                        | Purpose                                                  |
|---------------|------------------------------------------------------------------------------------------------------------------------------------------------------------------------------------------------------------------------------------------------------------------------------------------------------------------------------------------------------------------------------------------------------------------------------------------------------------------------------------------------------------------------------------------------------------------------------------------------------------------------------------------|----------------------------------------------------------|
| <b>Step 5</b> | <b>show cellular <i>unit</i> logs dm-log</b><br><b>Example:</b><br><pre>Router# show cellular 0/2/0 logs dm-log Integrated DM logging is on output path = Utility Flash filter = MC74xx generic - v11026_Generic_GSM_WCDMA_LTE_IP-no-data-packets.sqf maximum log size = 0 maximum file size = 0 log rotation = disabled  33 packets sent to the modem, 4663 bytes, 0 errors 28521 packets received from the modem, 13500758 bytes, 0 input drops 28521 packets stored in utility flash, 13500758 bytes  current file size = 13500758 current log size = 13500758 total log size = 13500758 Utility Flash DM log files = (1) files</pre> | (Optional) Displays DM log configuration and statistics. |

## Example

The following example shows how to:

- Specifies the maximum size of all DM log files that can be stored in bootflash or flash to 512 MB
- Specifies the maximum size of each DM log file to 32 MB
- Uses MC7xxx\_GPS\_Log.sqf DM log filter in the flash
- Enable rotation
- Enables DM log capturing

```
Router(config-controller)# controller cell 0/2/0
Router(config-controller)# lte modem dm-log filesize 512

Router(config-controller)# controller cell 0/2/0
Router(config-controller)# lte modem dm-log filesize 32
```

The following example shows how to specify the filter file for LTE:

```
Router(config-controller)# controller cell 0/2/0
Router(config-controller)# lte modem dm-log filter flash:MC7xxx_GPS_Log.sqf
```

The following example shows how to enable DM log rotation for LTE:

```
Router(config-controller)# controller cell 0/2/0
Router(config-controller)# lte modem dm-log rotation
```

The following example shows how to specify the maximum log size for LTE:

```
Router(config-controller)# controller cell 0/2/0
Router(config-controller)# lte modem dm-log enable
```

The following example shows how to enable DM log rotation for LTE:

## Example

```
Router(config-controller)# controller cell 0/2/0
Router(config-controller)# end
```

The following example shows how to specify the maximum log size for LTE:

```
Router(config-controller)# controller cell 0/2/0
Router(config-controller)# lte modem dm-log size 1024
```

The following example shows how to enable DM log rotation for LTE:

```
Router(config-controller)# controller cell 0/2/0
Router(config-controller)# end
```

The following example shows what was configured on the router for DM log feature:

```
Router#show running-config | section controller
controller Cellular 0/2/0
lte modem dm-log filter flash:MC7xxx_GPS_Log.sqf
lte modem dm-log size 512
lte modem dm-log filesize 32
lte modem dm-log rotation
lte modem dm-log enable
lte modem dm-log size 1024
```

The following displays DM log configuration and statistics

```
Router#show cellular 0/2/0 logs dm-log
Integrated DM logging is on
output path = Utility Flash
filter = flash:MC7xxx_GPS_Log.sqf
maximum log size = 536870912
maximum file size = 33554432
log rotation = enabled

32 packets sent to the modem, 3879 bytes, 0 errors
158324 packets received from the modem, 75971279 bytes, 0 input drops
158324 packets stored in utility flash, 75971279 bytes

current file size = 8863042
current log size = 75971279
total log size = 75971279
Utility Flash DM log files = (3) files
end
```

The following shows the DM log files created:

```
Router#dir flash:dmlog*
Directory of bootflash:/dmlog*

Directory of bootflash:/

 27 -rw- 33554069 Jun 7 2018 18:08:46 -08:00 dmlog-slot2-20180607-180628.bin
 28 -rw- 33554168 Jun 7 2018 18:11:25 -08:00 dmlog-slot2-20180607-180846.bin
 29 -rw- 14188544 Jun 7 2018 18:12:37 -08:00 dmlog-slot2-20180607-181125.bin
2885718016 bytes total (521891840 bytes free)
lte modem dm-log size 1024
```

The following shows how to disable/stop DM log capturing:

```
Router(config)#controller cellular 0/2/0
Router(config-controller)#no lte modem dm-log enable
Router(config-controller)#end
```

## Enabling Modem Crashdump Collection

Modem crashdump collection is useful in debugging firmware crash. To collect crash data, the modem has to be pre-configured so that it will stay in memdump mode after a crash. Memdump mode is a special boot-and-hold mode for the memdump utility to collect crash data.

For earlier releases, the crashdump collection required the PC to be connected to the router using a USB cable or a special RJ45-USB cable on a non-HSPA+7 3G module.

As part of the 3G and 4G serviceability enhancement, the crashdump collection utility is integrated into Cisco IOS.

To enable modem crashdump collection, perform the following steps.



**Note** The integrated modem crashdump collection feature is supported only on 3G HSPA and LTE/5G based SKUs.

### Before you begin

Ensure that the following prerequisites are met before attempting to enable crashdump logging:

- The modem needs to be provisioned for modem crashdump collection. Contact Cisco TAC for details.
- The modem should be in crash state. Run tests that will result in modem firmware crash. A “MODEM\_DOWN” message on the router console or syslog is indicative of modem firmware crash.



**Note** After the modem firmware crashes, the modem is available for crashdump log collection only. Data calls cannot be made.

### Procedure

|               | Command or Action                                                                                                                                                                 | Purpose                                                                                                                                                                                                                                                                                                                                                                                                                                           |
|---------------|-----------------------------------------------------------------------------------------------------------------------------------------------------------------------------------|---------------------------------------------------------------------------------------------------------------------------------------------------------------------------------------------------------------------------------------------------------------------------------------------------------------------------------------------------------------------------------------------------------------------------------------------------|
| <b>Step 1</b> | <pre>test { cell-cwan } <i>unit</i> modem-crashdump { on <i>location</i>   off }</pre> <p><b>Example:</b></p> <pre>Router# test cell-host 0/2/0 modem-crashdump on local_uf</pre> | <p>Enables or disables modem crashdump collection.</p> <ul style="list-style-type: none"> <li>• <b>cell-host</b><br/>—Keyword for fixed platform.</li> <li>• <b>cell-cwan</b><br/>— Keyword for LTE on a modular inside platform.</li> <li>• <b>unit</b><br/>—For LTE module, this is the router slot, module slot, and port separated by slashes (for example, 0/2/0). For fixed platform, this is the number 0.</li> <li>• <b>on</b></li> </ul> |

|  | Command or Action | Purpose                                                                                                                                                                                                                                               |
|--|-------------------|-------------------------------------------------------------------------------------------------------------------------------------------------------------------------------------------------------------------------------------------------------|
|  |                   | Enables crashdump log collection. <ul style="list-style-type: none"> <li>• <i>location</i><br/>—Specifies the destination URL where the modem crashdump logs will be stored.</li> <li>• <b>off</b><br/>—Disables crashdump log collection.</li> </ul> |

## Displaying Modem Log Error and Dump Information

As part of the 3G serviceability enhancement, commands strings (**at!err** and **at!gcdump**) can be sent to the modem using Cisco IOS CLI rather than setting up a reverse telnet session to the cellular modem to obtain log error and dump information.

To obtain log error and dump information, perform the following steps.



**Note** The modem log error and dump collection feature is supported only on 3G SKUs.

### Procedure

|               | Command or Action                                                                                                                 | Purpose                                                                                                                                                                                                                                                                                                                                     |
|---------------|-----------------------------------------------------------------------------------------------------------------------------------|---------------------------------------------------------------------------------------------------------------------------------------------------------------------------------------------------------------------------------------------------------------------------------------------------------------------------------------------|
| <b>Step 1</b> | <b>show cellular <i>unit</i> log error</b><br><br><b>Example:</b><br><br>Router# show cellular 0/2/0 log error                    | Shows modem log error and dump information.                                                                                                                                                                                                                                                                                                 |
| <b>Step 2</b> | <b>test cellular <i>unit</i> modem-error-clear</b><br><br><b>Example:</b><br><br>Router# test cellular 0/2/0<br>modem-error-clear | (Optional) Clears out the error and dump registers. By default, error and dump registers are not cleared out after a read. This command changes the operation so that registers are cleared once they are read. As a result, the AT command strings are changed to “ <b>at!errclr=-1</b> ” for CDMA and “ <b>at!err=0</b> ” for GSM modems. |

## Verifying the LTE/5G Router Information

You can verify the configuration by using the following show commands:

### show version

```
Router#sh ver
Cisco IOS XE Software, Version BLD_V166_THROTTLE_LATEST_20170622_080605_V16_6_0_237
Cisco IOS Software [Everest], ISR Software (ARMV8EB_LINUX_IOSD-UNIVERSALK9_IAS-M),
```



```

Experimental Version 16.6.20170622:072729
[v166_throttle-/scratch/mcpre/BLD-BLD_V166_THROTTLE_LATEST_20170622_080605 108]
Copyright (c) 1986-2017 by Cisco Systems, Inc.
Compiled Thu 22-Jun-17 03:39 by mcpre

```

Cisco IOS-XE software, Copyright (c) 2005-2017 by cisco Systems, Inc. All rights reserved. Certain components of Cisco IOS-XE software are licensed under the GNU General Public License ("GPL") Version 2.0. The software code licensed under GPL Version 2.0 is free software that comes with ABSOLUTELY NO WARRANTY. You can redistribute and/or modify such GPL code under the terms of GPL Version 2.0. For more details, see the documentation or "License Notice" file accompanying the IOS-XE software, or the applicable URL provided on the flyer accompanying the IOS-XE software.

ROM: IOS-XE ROMMON

```

Router uptime is 2 hours, 16 minutes
Uptime for this control processor is 2 hours, 18 minutes
System returned to ROM by Reload Command
System image file is
"bootflash:c1100-universalk9_ias.BLD_V166_THROTTLE_LATEST_20170622_080605_V16_6_0_237.SSA.bin"
Last reload reason: Reload Command

```

This product contains cryptographic features and is subject to United States and local country laws governing import, export, transfer and use. Delivery of Cisco cryptographic products does not imply third-party authority to import, export, distribute or use encryption. Importers, exporters, distributors and users are responsible for compliance with U.S. and local country laws. By using this product you agree to comply with applicable laws and regulations. If you are unable to comply with U.S. and local laws, return this product immediately.

A summary of U.S. laws governing Cisco cryptographic products may be found at: <http://www.cisco.com/wwl/export/crypto/tool/stqrg.html>

If you require further assistance please contact us by sending email to [export@cisco.com](mailto:export@cisco.com).

Suite License Information for Module:'esg'

```

Suite Suite Current Type Suite Next reboot

```

Technology Package License Information:

```

Technology Technology-package Technology-package
 Current Type Next reboot

```

```

cisco C1111-8PLTEAW (1RU) processor with 1464691K/6147K bytes of memory.
Processor board ID FGL21071SK4
1 Virtual Ethernet interface
11 Gigabit Ethernet interfaces
2 Cellular interfaces
32768K bytes of non-volatile configuration memory.

```

```

4194304K bytes of physical memory.
6598655K bytes of flash memory at bootflash:.
978928K bytes of USB flash at usb0:.
0K bytes of WebUI ODM Files at webui:.

```

### show platform

```

router# sh platform
Chassis type: C1111-8PLTELANW

```

| Slot | Type            | State      | Insert time (ago) |
|------|-----------------|------------|-------------------|
| 0    | C1111-8PLTELANW | ok         | 00:04:56          |
| 0/0  | C1111-2x1GE     | ok         | 00:02:41          |
| 0/1  | C1111-ES-8      | ok         | 00:02:40          |
| 0/2  | C1111-LTE       | ok         | 00:02:41          |
| 0/3  | ISR-AP1100AC-N  | ok         | 00:02:41          |
| R0   | C1111-8PLTELANW | ok, active | 00:04:56          |
| F0   | C1111-8PLTELANW | ok, active | 00:04:56          |
| P0   | PWR-12V         | ok         | 00:04:30          |

| Slot | CPLD Version | Firmware Version |
|------|--------------|------------------|
| 0    | 17100501     | 16.6(1r)RC3      |
| R0   | 17100501     | 16.6(1r)RC3      |
| F0   | 17100501     | 16.6(1r)RC3      |

### show interfaces

```

router#sh interface cellular 0/2/0
Cellular0/2/0 is up, line protocol is up
 Hardware is LTE Adv CAT6 - Europe/North America Multimode LTE/DC-HSPA+/HSPA+/HSPA/UMTS/
 Internet address is 10.14.162.11/32
 MTU 1500 bytes, BW 50000 Kbit/sec, DLY 20000 usec,
 reliability 255/255, txload 1/255, rxload 1/255
 Encapsulation HDLC, loopback not set
 Keepalive not supported
 DTR is pulsed for 1 seconds on reset
 Last input never, output 00:00:42, output hang never
 Last clearing of "show interface" counters never
 Input queue: 0/375/0/0 (size/max/drops/flushes); Total output drops: 0
 Queueing strategy: fifo
 Output queue: 0/40 (size/max)
 5 minute input rate 0 bits/sec, 0 packets/sec
 5 minute output rate 0 bits/sec, 0 packets/sec
 5 packets input, 460 bytes, 0 no buffer
 Received 0 broadcasts (0 IP multicasts)
 0 runts, 0 giants, 0 throttles
 0 input errors, 0 CRC, 0 frame, 0 overrun, 0 ignored, 0 abort
 21 packets output, 1692 bytes, 0 underruns
 0 output errors, 0 collisions, 8 interface resets
 0 unknown protocol drops
 0 output buffer failures, 0 output buffers swapped out
 0 carrier transitions
router#

```

# Configuring Cellular Modem Link Recovery

The cellular modem link recovery feature is disabled by default and it is recommended to enable the link recovery feature.

To enable or disable the cellular modem link recovery feature, if required, perform the following steps:

## Procedure

|               | Command or Action                                                                                                                                                                                                                                                                                                                                                                                                                                                                                                                                                                                                                                                                                                                                                                                                    | Purpose                                                                                                                                                                                                                                                                                                                                                                                                                                                                                                                                                               |
|---------------|----------------------------------------------------------------------------------------------------------------------------------------------------------------------------------------------------------------------------------------------------------------------------------------------------------------------------------------------------------------------------------------------------------------------------------------------------------------------------------------------------------------------------------------------------------------------------------------------------------------------------------------------------------------------------------------------------------------------------------------------------------------------------------------------------------------------|-----------------------------------------------------------------------------------------------------------------------------------------------------------------------------------------------------------------------------------------------------------------------------------------------------------------------------------------------------------------------------------------------------------------------------------------------------------------------------------------------------------------------------------------------------------------------|
| <b>Step 1</b> | <b>configure terminal</b><br><b>Example:</b><br><pre>Router# configure terminal</pre>                                                                                                                                                                                                                                                                                                                                                                                                                                                                                                                                                                                                                                                                                                                                | Enters global configuration mode.                                                                                                                                                                                                                                                                                                                                                                                                                                                                                                                                     |
| <b>Step 2</b> | <b>controller cellular <i>unit</i></b><br><b>Example:</b><br><pre>Router(config)# controller cellular 0/2/0</pre>                                                                                                                                                                                                                                                                                                                                                                                                                                                                                                                                                                                                                                                                                                    | Enters cellular controller configuration mode.                                                                                                                                                                                                                                                                                                                                                                                                                                                                                                                        |
| <b>Step 3</b> | <b>{lte} modem link-recovery disable   no lte   modem link-recoverydisable}</b><br><b>Example:</b><br><pre>Router(config-controller)# lte modem link-recovery disable  Router(config-controller)# no lte modem link-recovery disable  Device#show run   sec controller Cellular 0/2/0 controller Cellular 0/2/0 lte modem link-recovery rssi onset-threshold -110 lte modem link-recovery monitor-timer 20 lte modem link-recovery wait-timer 10 lte modem link-recovery debounce-count 6  Example: Device#configure terminal Device(config)#controller Cellular 0/2/0 Device(config-controller)#lte modem link-recovery monitor-timer 30 Device(config-controller)#lte modem wait-timer 15 Device(config-controller)#lte modem debounce-count 8 Device(config-controller)#lte modem rssi onset-threshold -100</pre> | <p>Enables or disables the cellular modem link recovery feature.</p> <p>Enables or disables the cellular modem link recovery feature.</p> <p>Once we enable link-recovery, the default Cisco recommended values for link-recovery parameters are populated.</p> <p>We can change the values of link-recovery parameters from the default Cisco recommended values, by using cli for each parameter like in example.</p> <p><b>Note</b> Changing the default recommended cisco values is not advised as it will impact ideal performance of link-recovery feature.</p> |

|        | Command or Action                                            | Purpose                                                               |
|--------|--------------------------------------------------------------|-----------------------------------------------------------------------|
| Step 4 | <b>end</b><br><br><b>Example:</b><br><br>Router(config)# end | Exits the configuration mode and returns to the privileged EXEC mode. |

## Cellular Modem Link Recovery Parameters

There are four configurable parameters to adjust the behavior of cellular link recovery. The default values optimized for the best performance of the feature and changing it is not recommended unless advised by Cisco.

The following table explains the link recovery parameters.:

**Table 19: Link Recovery Parameters**

| Parameter                            | Description                                                                                                                                                                                                                                                                                                                                                                                                                                                                                                                                                                                                                                                                                                                                                                                                                           |
|--------------------------------------|---------------------------------------------------------------------------------------------------------------------------------------------------------------------------------------------------------------------------------------------------------------------------------------------------------------------------------------------------------------------------------------------------------------------------------------------------------------------------------------------------------------------------------------------------------------------------------------------------------------------------------------------------------------------------------------------------------------------------------------------------------------------------------------------------------------------------------------|
| <b>rssl onset-threshold</b>          | This parameter defines the RSSI value below which the link recovery feature triggers additional scrutiny to look for potential issues and take action if needed. The range of this parameter can be set from -90 dBm to -125 dBm. The recommended and default value is -110 dBm.                                                                                                                                                                                                                                                                                                                                                                                                                                                                                                                                                      |
| <b>monitor-timer</b>                 | This parameter determines how often link recovery looks for potential issues. The default value for this parameter is 20 seconds meaning that link recovery feature will be triggered every 20 seconds and look at certain parameters to determine if there is a potential issue. You can configure the monitor-timer range between 20 to 60 seconds. Increasing the monitor timer value above 20 seconds will increase the response time of the feature.                                                                                                                                                                                                                                                                                                                                                                             |
| <b>wait-timer and debounce-count</b> | The wait-timer parameter is used in conjunction with the debounce-count parameter to perform more frequent, additional checks, once the link recovery feature has identified a potential issue that needs to be recovered from, with a modem power-cycle. The default value for wait-timer is 10 seconds and the default value for debounce-count is 6. With this setting, once link recovery has identified an inoperative modem state, it performs additional checks every 10 seconds, up to 6 times, to determine if the issue has been resolved without a modem power-cycle. Reducing the debounce-count and the wait-timer makes faster link recovery, while reducing them may increase the time for recovery. The configurable range for wait-timer is 5-60 seconds. The configurable range for debounce-count is 6-20 seconds. |

## Verifying the Cellular Modem Link Recovery Configuration

To determine if the cellular modem link recovery is enabled, use the **show controller cellularunit** command. In this example, the cellular modem link recovery feature related information is highlighted.

```
Router# show controller cellular 0/2/0Interface Cellular0/2/0
LTE Module - Multimode LTE/DC-HSPA+/HSPA+/HSPA/UMTS/EDGE/GPRS unit 2
```

```
Cellular Modem Configuration
=====
Modem is recognized as valid
Power save mode is OFF
manufacture id = 0x00001199 product id = 0x000068C0
Sierra Wireless unknown modem
Modem Uplink Speed = 50000 kbit.
Modem Downlink Speed = 300000 kbit.
```

```
GPS Feature = enabled
GPS Status = NMEA Disabled
GPS Mode = not configured
```

```
Cellular Dual SIM details:
```

```

SIM 0 is present
SIM 1 is not present
SIM 0 is active SIM
```

```
Module Reload Statistics
```

```

Soft OIR reloads = 0
Hard OIR reloads = 0

```

```
Modem Management Statistics
```

```

Modem resets = 1
Modem timeouts = 0
Link recovery is ON
```

```
Registration check is ON
RSSI threshold value is -110 dBm
Monitor Timer value is 20 seconds
Wait Timer value is 10 seconds
Debounce Count value is 6
```

```
Link recovery count is 0
```

When the cellular modem link recovery occurs and modem is power cycled, you can see the %CELLWAN-2-MODEM\_DOWN message on the console logs and additionally there is a %CELLWAN-2-LINK\_RECOVERY message which indicates that action has been taken by the cellular modem link recovery feature.

Whenever the cellular modem link recovery has occurred, it updates the Modem timeouts counter under the Modem Management Statistics section of the show controller cellular unit command output. Modem parameters at the last timeout section has information that helps to identify the cause of the issue that triggered link recovery

In the following example log, the messages, modem time out counter, and modem parameters at the last time out are highlighted.

**\*Jul 19 17:15:18.980 PDT: %CELLWAN-2-LINK\_RECOVERY: Cellular0/1/0: Cellular Modem has been power cycled**

```
Device#show controller Cellular 0/2/0
Interface Cellular0/2/0
LTE Module - Multimode LTE/DC-HSPA+/HSPA+/HSPA/UMTS/EDGE/GPRS unit 2
```

## Cellular Modem Configuration

```
=====
Modem is recognized as valid
Power save mode is OFF
manufacture id = 0x00001199 product id = 0x000068C0
Sierra Wireless unknown modem
Modem Uplink Speed = 50000 kbit.
Modem Downlink Speed = 300000 kbit.
```

```
GPS Feature = enabled
GPS Status = NMEA Disabled
GPS Mode = not configured
```

## Cellular Dual SIM details:

```

SIM 0 is present
SIM 1 is not present
SIM 0 is active SIM
```

## Module Reload Statistics

```

Soft OIR reloads = 0
Hard OIR reloads = 0

```

## Modem Management Statistics

```

Modem resets = 1
Modem user initiated resets = 0
Modem user initiated power-cycles = 0
```

```
Modem timeouts = 1
```

**Modem parameters at the last timeout:**

```
LTE first time attach State was No
Radio Interface Technology Mode was AUTO
Operating Mode was Online
RSSI was -0 dBm
Packet switch domain status was Not Attached
Registration state (EMM) was Not Registered
Downlink traffic was not present
```

```
Link recovery is ON
Registration check is ON
RSSI threshold value is -110 dBm
Monitor Timer value is 20 seconds
Wait Timer value is 10 seconds
Debounce Count value is 6
```

# Configuration Examples for 3G and 4G Serviceability Enhancement

## Example: Sample Output for the show cellular logs dm-log Command

The following shows a sample output of the **show cellular logs dm-log** command:

```
Router# show cellular 0/2/0 logs dm-log
Integrated DM logging is on
filter = generic
maximum log size = 67108864
maximum file size = 20971520
log rotation = disabled
7 packets sent to the modem, 3232 bytes, 0 errors
75 packets received from the modem, 57123 bytes, 0 input drops
75 packets stored in file system, 57123 bytes, 0 errors, 0 aborts
2 max rcv queue size
current file size = 57123
current log size = 57123
total log size = 57123
DM log files: (1 files)
```

## Example: Sample Output for the show cellular logs modem-crashdump Command

The following shows a sample output of the **show cellular logs modem-crashdump** command:

```
Router# show cellular 0/2/0 logs modem-crashdump
Modem crashdump logging: off
Progress = 100%
Last known State = Getting memory chunks
Total consecutive NAKs = 0
Number of retries = 0
Memory Region Info:
1: Full SDRAM [Base:0x0, Length:0x2000000]
2: MDSP RAM A region [Base:0x91000000, Length:0x8000]
3: MDSP RAM B region [Base:0x91200000, Length:0x8000]
4: MDSP RAM C region [Base:0x91400000, Length:0xC000]
5: MDSP Register region [Base:0x91C00000, Length:0x28]
6: ADSP RAM A region [Base:0x70000000, Length:0x10000]
7: ADSP RAM B region [Base:0x70200000, Length:0x10000]
8: ADSP RAM C region [Base:0x70400000, Length:0xC000]
9: ADSP RAM I region [Base:0x70800000, Length:0x18000]
10: CMM Script [Base:0x6A350, Length:0x310]
Router#
```

# Configuration Examples for LTE/5G

## Example: Basic Cellular Interface Configuration: Cisco LTE/5G

The following example shows how to configure the cellular interface to be used as a primary and is configured as the default route:

```
Router# show running-config
interface Cellular 0/2/0
ip address negotiated
dialer in-band
dialer-group 1
ip route 172.22.1.10 255.255.255.255 cellular 0/2/0
dialer-list 1 protocol ip permit
```

## Configuration Examples for Cisco LTE/5G

The following example shows how to configure Cisco LTE/5G:

```
Router# show running-config
Building configuration...
Current configuration : 2991 bytes
!
! Last configuration change at 21:31:48 UTC Mon May 18 2015
!
version 15.5
service timestamps debug datetime msec
service timestamps log datetime msec
service internal
no platform punt-keepalive disable-kernel-core
platform shell
!
hostname C1111-LTEEA
!
boot-start-marker
!
!
!
logging buffered 10000000
no logging console
enable password lab
!
no aaa new-model
!
!
!
!
!
subscriber templating
!
multilink bundle-name authenticated
license udi pid ISR4321/K9 sn FDO181701PZ
!
spanning-tree extend system-id
```



```

!
!
redundancy
 mode none
!
!
!
!
controller Cellular 0/2/0
 lte sim data-profile 16 attach-profile 16
 lte gps mode standalone
 lte gps nmea
 lte modem link-recovery disable

interface GigabitEthernet0/0/1
 ip address 172.19.151.180 255.255.255.0
 ip nat outside

 negotiation auto
!
interface Cellular0/2/0
 ip address negotiated
 ip nat outside
 dialer in-band
 dialer idle-timeout 0
 dialer watch-group 1
 dialer-group 1
 pulse-time 1
!
interface Cellular0/2/1
 no ip address
 shutdown
 dialer in-band
 pulse-time 1
!
!
interface Vlan1
 no ip address
!
no ip nat service dns tcp
no ip nat service dns udp
ip nat inside source list 1 interface Cellular0/2/0 overload
ip forward-protocol nd
ip http server
no ip http secure-server
ip http max-connections 16
ip tftp source-interface GigabitEthernet0/0/1
ip dns server
ip route 0.0.0.0 0.0.0.0 Cellular0/2/0
ip route 223.255.254.0 255.255.255.0 1.3.0.1
!
!
access-list 1 permit 10.1.0.0 0.0.255.255
dialer watch-list 1 ip 8.8.8.8 255.255.255.255
dialer-list 1 protocol ip permit
!
snmp-server community public RO
snmp-server community private RW
snmp-server community lab RW
snmp-server host 1.3.66.144 public
snmp-server manager
control-plane
!
!

```

```

line con 0
 exec-timeout 0 0
 stopbits 1
line aux 0
 exec-timeout 0 0
 stopbits 1
line vty 0 4
 login
 transport input all
!
!
end

```

## Cellular Back-off: Example

The following example shows how to configure the cellular back-off feature to stop continuous session activation requests back to the router:

```

Router#show cell 0/2/0 all
Profile 1, Packet Session Status = INACTIVE
Profile 2, Packet Session Status = INACTIVE
Profile 3, Packet Session Status = INACTIVE
.
.
.
Profile 16, Packet Session Status = INACTIVE
Router#
Router#show cell 0/2/0 c n
Current System Time = Sun Jan 6 0:8:37 1980
Current Service Status = Normal
Current Service = Packet switched
Current Roaming Status = Roaming
Network Selection Mode = Automatic
Network = 123 456
Mobile Country Code (MCC) = 123
Mobile Network Code (MNC) = 456
Packet switch domain(P.S) state = Attached
LTE Carrier Aggregation state = Deconfigured
Registration state(EMM) = Registered
EMM Sub State = Normal Service
Tracking Area Code (TAC) = 1801
Cell ID = 768001
Network MTU is not Available
Router#
Router#ping 192.192.187.254
Type escape sequence to abort.
Sending 5, 100-byte ICMP Echos to 192.192.187.254, timeout is 2 seconds:

*Dec 20 23:22:28.025: %CELLWAN-6-CELLULAR_BACKOFF_START: Cellular0/2/0: Cellular back-off
has started on PDN 0...
Success rate is 0 percent (0/5)
Router#

Router#ping 192.192.187.254
Type escape sequence to abort.
RouterSending 5, 100-byte ICMP Echos to 192.192.187.254, timeout is 2 seconds
.
.
.
Router#show cell 0/2/0
Profile 1, Packet Session Status = INACTIVE
Profile 2, Packet Session Status = INACTIVE
Profile 3, Packet Session Status = INACTIVE

```

```

Router Call end mode = 3GPP
Router Session disconnect reason type = 3GPP specification defined(6)
Session disconnect reason = Option unsubscribed(33)
Enforcing cellular interface back-off
Period of back-off = 1 minute(s)
Profile 4, Packet Session Status = INACTIVE
...
Profile 16, Packet Session Status = INACTIVE
Router#
Router#show cell 0/2/0 cn
Sending 5, 100-byte ICMP Echos to 192.192.187.254, timeout is 2 seconds:
Router.....
Success rate is 0 percent (0/5)
Router#
Router#ping 192.192.187.254
Type escape sequence to abort.
Sending 5, 100-byte ICMP Echos to 192.192.187.254, timeout is 2 seconds:
Router.....
Success rate is 0 percent (0/5)
Router#show cell 0/2/0 cping 192.192.187.254Type escape sequence to abort.
RouterSending 5, 100-byte ICMP Echos to 192.192.187.254, timeout is 2 seconds:
Router.....
RouterSuccess rate is 0 percent (0/5)
Router#ping 192.192.187.254
Type escape sequence to abort.
Sending 5, 100-byte ICMP Echos to 192.192.187.254, timeout is 2 seconds:
.....
Success rate is 0 percent (0/5)
Router#ping 192.192.187.254sh cell 0/2/0 c
Profile 1, Packet Session Status = INACTIVE
Profile 2, Packet Session Status = INACTIVE
Profile 3, Packet Session Status = INACTIVE
RouterCall end mode = 3GPP
RouterSession disconnect reason type = 3GPP specification defined(6)
RouterSession disconnect reason = Option unsubscribed(33)
RouterEnforcing cellular interface back-off
 Period of back-off = 1 minute(s)
Profile 4, Packet Session Status = INACTIVE
...
Profile 16, Packet Session Status = INACTIVE
Router#
Router#
Router# sh cell 0/2/0 c ping 192.192.187.254
RouterType escape sequence to abort.
RouterSending 5, 100-byte ICMP Echos to 192.192.187.254, timeout is 2 seconds:
Router.....
Success rate is 0 percent (0/5)
Router#ping 192.192.187.254sh cell 0/2/0 c
Profile 1, Packet Session Status = INACTIVE
Profile 2, Packet Session Status = INACTIVE
Profile 3, Packet Session Status = INACTIVE
 Call end mode = 3GPP
 Session disconnect reason type = 3GPP specification defined(6)
 Session disconnect reason = Option unsubscribed(33)
 Enforcing cellular interface back-off
 Period of back-off = 1 minute(s)
Profile 4, Packet Session Status = INACTIVE
...
Profile 16, Packet Session Status = INACTIVE
Router#
Router#show cell 0/2/0 cping 192.192.187.254
Type escape sequence to abort.
Sending 5, 100-byte ICMP Echos to 192.192.187.254, timeout is 2 seconds:
.....

```

```

Success rate is 0 percent (0/5)
Router#ping 192.192.187.254sh cell 0/2/0 c
Profile 1, Packet Session Status = INACTIVE
Profile 2, Packet Session Status = INACTIVE
Profile 3, Packet Session Status = INACTIVE
 Call end mode = 3GPP
 Session disconnect reason type = 3GPP specification defined(6)
 Session disconnect reason = Option unsubscribed(33)
 Enforcing cellular interface back-off
 Period of back-off = 1 minute(s)
Profile 4, Packet Session Status = INACTIVE
.
.
.
Profile 16, Packet Session Status = INACTIVE
Router#
Router#
Router#
Router#show cell 0/2/0 cping 192.192.187.254
Type escape sequence to abort.
Sending 5, 100-byte ICMP Echos to 192.192.187.254, timeout is 2 seconds:
.....
Success rate is 0 percent (0/5)
Router#
Router#ping 192.192.187.254 sh cell 0/2/0 c
Profile 1, Packet Session Status = INACTIVE
Profile 2, Packet Session Status = INACTIVE
Profile 3, Packet Session Status = INACTIVE
 Call end mode = 3GPP
 Session disconnect reason type = 3GPP specification defined(6)
 Session disconnect reason = Option unsubscribed(33)
[Wed Dec 20 15:42:15.808 2017] Enforcing cellular interface back-off
Period of back-off = 5 minute(s)
Profile 4, Packet Session Status = INACTIVE
...
Profile 16, Packet Session Status = INACTIVE

Router#show cell 0/2/0 c ping 192.192.187.254
Type escape sequence to abort.
Router Sending 5, 100-byte ICMP Echos to 192.192.187.254, timeout is 2 seconds:
.....
Success rate is 0 percent (0/5)
Router#ping 192.192.187.254
Type escape sequence to abort.
Sending 5, 100-byte ICMP Echos to 192.192.187.254, timeout is 2 seconds:
...
RouterSuccess rate is 0 percent (0/2)
Router#show cell 0/2/0 c
Profile 1, Packet Session Status = INACTIVE
Profile 2, Packet Session Status = INACTIVE
Profile 3, Packet Session Status = INACTIVE
 Call end mode = 3GPP
 Session disconnect reason type = 3GPP specification defined(6)
Router Session disconnect reason = Option unsubscribed(33)
Router Enforcing cellular interface back-off
 Period of back-off = 10 minute(s)
Profile 4, Packet Session Status = INACTIVE
.
.
.
Router#show cell 0/2/0 cping 192.192.187.254
Type escape sequence to abort.
Sending 5, 100-byte ICMP Echos to 192.192.187.254, timeout is 2 seconds:
.....

```

```

Success rate is 0 percent (0/5)
Router#show cell 0/2/0 c
Profile 1, Packet Session Status = INACTIVE
Profile 2, Packet Session Status = INACTIVE
Profile 3, Packet Session Status = INACTIVE
 Call end mode = 3GPP
 Session disconnect reason type = 3GPP specification defined(6)
Router Session disconnect reason = Option unsubscribed(33)
Router Enforcing cellular interface back-off
 Period of back-off = 15 minute(s)
Profile 4, Packet Session Status = INACTIVE
...
Profile 16, Packet Session Status = INACTIVE
Router#
Router#show cell 0/2/0 c
Type escape sequence to abort.
Sending 5, 100-byte ICMP Echos to 192.192.187.254, timeout is 2 seconds:
.....
Success rate is 0 percent (0/5)
Router# show cell 0/2/0 c
Profile 1, Packet Session Status = INACTIVE
Profile 2, Packet Session Status = INACTIVE
Profile 3, Packet Session Status = INACTIVE
Router Call end mode = 3GPP
Router Session disconnect reason type = 3GPP specification defined(6)
Router Session disconnect reason = Option unsubscribed(33)
Router Enforcing cellular interface back-off
Router Period of back-off = 30 minute(s)
Profile 4, Packet Session Status = INACTIVE
.
.
.
Profile 16, Packet Session Status = INACTIVE
Router#
Router Router#show cell 0/2/0 cping 192.192.187.254
Type escape sequence to abort.
RouterSending 5, 100-byte ICMP Echos to 192.192.187.254, timeout is 2 seconds:
.....
Success rate is 0 percent (0/5)
Router#show cell 0/2/0 c
Profile 1, Packet Session Status = INACTIVE
Profile 2, Packet Session Status = INACTIVE
Profile 3, Packet Session Status = INACTIVE
 Call end mode = 3GPP
 Session disconnect reason type = 3GPP specification defined(6)
 Session disconnect reason = Option unsubscribed(33)
 Enforcing cellular interface back-off
 Period of back-off = 60 minute(s)
Profile 4, Packet Session Status = INACTIVE
.
.
.
Profile 16, Packet Session Status = INACTIVE
Router#
...
Router#show cell 0/2/0
Type escape sequence to abort.
Sending 5, 100-byte ICMP Echos to 192.192.187.254, timeout is 2 seconds:
.....
Success rate is 0 percent (0/5)
Router#ping 192.192.187.254sh cell 0/2/0 c
Profile 1, Packet Session Status = INACTIVE
Profile 2, Packet Session Status = INACTIVE
Profile 3, Packet Session Status = INACTIVE

```

## Cellular Back-off: Example

```

Call end mode = 3GPP
Session disconnect reason type = 3GPP specification defined(6)
Session disconnect reason = Option unsubscribed(33)
Enforcing cellular interface back-off
Period of back-off = 60 minute(s)
Profile 4, Packet Session Status = INACTIVE
Profile 5, Packet Session Status = INACTIVE
...
Profile 16, Packet Session Status = INACTIVE

...
Router#test cellu 0/2/0 modem-power-cylce
*Dec 21 18:45:00.469: %CELLWAN-4-MODEM_RESTART_IND: Cellular0/2/0 Modem restart User -
PowerCycle
Router[Cellular0/2/0]: NMEA streaming engine switched OFF
Router*Dec 21 18:45:02.478: %IOSXE-3-PLATFORM: R0/0: ngiolite: CWAN:FD close request from
IOS
Router *Dec 21 18:45:07.480: %IOSXE-3-PLATFORM: R0/0: ngiolite: update_modem_ctrl :
MODEM_CTRL_MSG_RESET:
*Dec 21 18:45:10.591: %CELLWAN-2-MODEM_DOWN: Modem in slot 0/2 is DOWN
*Dec 21 18:45:09.573: %IOSXE-2-PLATFORM: R0/0: kernel: cwan_netmap_rx_complete:288:cwan_eth0:
urb_status: -108
*Dec 21 18:45:09.574: %IOSXE-4-PLATFORM: R0/0: kernel: usb_control_msg failed (-19)
[Thu Dec 21 10:59:38.373 2017] *Dec 21 18:45:10.585: %IOSXE-3-PLATFORM: R0/0: ngiolite: SWI
modem Action:[remove] State[2]
*Dec 21 18:45:41.272: %IOSXE-4-PLATFORM: R0/0: kernel: usb_control_msg failed (-19)
*Dec 21 18:45:41.289: %IOSXE-4-PLATFORM: R0/0: kernel: usb 4-1: config 1 has an invalid
interface number: 8 but max is 4
*Dec 21 18:45:41.290: %IOSXE-4-PLATFORM: R0/0: kernel: usb 4-1: config 1 has an invalid
interface number: 10 but max is 4
*Dec 21 18:45:41.290: %IOSXE-4-PLATFORM: R0/0: kernel: usb 4-1: config 1 has no interface
number 1
*Dec 21 18:45:41.290: %IOSXE-4-PLATFORM: R0/0: kernel: usb 4-1: config 1 has no interface
number 4
Modem Power cycled successfully
Router#
*Dec 21 18:45:41.292: %IOSXE-2-PLATFORM: R0/0: kernel: cwan probe devpath usb-f2510000.usb3-1,
interface 8
*Dec 21 18:45:52.544: %IOSXE-4-PLATFORM: R0/0: kernel: QMIWDASetDataFormat 0
Router*Dec 21 18:45:52.544: %IOSXE-4-PLATFORM: R0/0: kernel: TE Enabled
*Dec 21 18:45:53.120: %IOSXE-2-PLATFORM: R0/0: kernel: cwan probe devpath usb-f2510000.usb3-1,
interface 10
*Dec 21 18:45:54.336: %IOSXE-4-PLATFORM: R0/0: kernel: QMIWDASetDataFormat 0
Router*Dec 21 18:45:54.336: %IOSXE-4-PLATFORM: R0/0: kernel: TE Enabled
*Dec 21 18:45:54.910: %IOSXE-3-PLATFORM: R0/0: ngiolite: SWI modem Action:[add] State[1]
*Dec 21 18:46:54.654: %CELLWAN-6-CELLULAR_BACKOFF_STOP: Cellular0/2/0: Cellular back-off
has stopped on PDN 0
*Dec 21 18:48:04.653: %CELLWAN-2-MODEM_UP: Modem in slot 0/2 is now UP
[Cellular0/2/0]: NMEA streaming engine switched ON
*Dec 21 18:48:09.875: %CELLWAN-2-MODEM_RADIO: Cellular0/2/0 Modem radio has been turned on
Router#
Router#show cell 0/2/0 c
Profile 1, Packet Session Status = INACTIVE
Profile 2, Packet Session Status = INACTIVE
Profile 3, Packet Session Status = INACTIVE
Profile 4, Packet Session Status = INACTIVE
Profile 5, Packet Session Status = INACTIVE
Profile 6, Packet Session Status = INACTIVE
Profile 7, Packet Session Status = INACTIVE
Profile 8, Packet Session Status = INACTIVE
.
.
.
Profile 16, Packet Session Status = INACTIVE

```

```

Router#show cell 0/2/0 c
Type escape sequence to abort.
Sending 5, 100-byte ICMP Echos to 192.192.187.254, timeout is 2 seconds:
...
*Dec 21 18:48:59.957: %CELLWAN-6-CELLULAR_BACKOFF_START: Cellular0/2/0: Cellular back-off
has started on PDN 0....
Success rate is 0 percent (0/5)
Router#ping 192.192.187.254sh cell 0/2/0 c
Profile 1, Packet Session Status = INACTIVE
Profile 2, Packet Session Status = INACTIVE
Profile 3, Packet Session Status = INACTIVE
Call end mode = 3GPP
Session disconnect reason type = 3GPP specification defined(6)
Router Session disconnect reason = Option unsubscribed(33)
Router Enforcing cellular interface back-off
Period of back-off = 1 minute(s)
Profile 4, Packet Session Status = INACTIVE
Profile 5, Packet Session Status = INACTIVE
.
.
Profile 16, Packet Session Status = INACTIVE

```

## Example: GRE Tunnel over Cellular Interface Configuration

The following example shows how to configure the static IP address when a GRE tunnel interface is configured with **ip address unnumbered** *cellular interface*:



**Note** The GRE tunnel configuration is supported only if the service providers provide a public IP address on the LTE interface.



**Note** For service providers using a private IP address, the point-to-point static GRE tunnel cannot be set up with a private IP address at one end and a public IP address on the other end.

```

interface Tunnel2
ip unnumbered <internal LAN interface GE0/0 etc.>
tunnel source Cellular0/2/0
tunnel destination a.b.c.d
interface Cellular0/2/0
ip address negotiated
no ip mroute-cache
dialer in-band
dialer-group 1

```

## Example: LTE/5G as Backup with NAT and IPSec

The following example shows how to configure the LTE/5G on the router as backup with NAT and IPSec:

The receive and transmit speeds cannot be configured. The actual throughput depends on the cellular network service.

For service providers using a private IP address, use the **crypto ipsec transform-set esp** command (that is, **esp-aes esp-sha256-hmac...**).

```

ip dhcp excluded-address 10.4.0.254
!
ip dhcp pool lan-pool
 network 10.4.0.0 255.255.0.0
 dns-server 10.4.0.254
 default-router 10.4.0.254
!
!
crypto isakmp policy 1
 encr 3des
 authentication pre-share
crypto isakmp key address a.b.c.d
!
!
crypto ipsec transform-set ah-sha-hmac esp-3des
!
crypto map gsml 10 ipsec-isakmp
 set peer a.b.c.d
 set transform-set
 match address 103
!
interface ATM0/2/0
 no ip address
 ip virtual-reassembly
 load-interval 30
 no atm ilmi-keepalive
 dsl operating-mode auto
!
interface ATM0/2/0.1 point-to-point
 backup interface Cellular0/2/0
 ip address negotiated
 ip mtu 1492
 ip nat outside
 ip virtual-reassembly
 encapsulation ppp
 load-interval 30
 dialer pool 2
 dialer-group 2
 ppp authentication chap callin
 ppp chap hostname cisco@dsl.com
 ppp chap password 0 cisco
 ppp ipcp dns request
 crypto map gsml

 ip nat outside
 ip virtual-reassembly
 no snmp trap link-status
 pvc 0/35
 pppoe-client dial-pool-number 2
!
!
interface Cellular0/2/0
 ip address negotiated
 ip nat outside
 ip virtual-reassembly
 no ip mroute-cache
 dialer in-band
 dialer idle-timeout 0
 dialer-group 1
 crypto map gsml

```



```

!
interface Vlan1
 description used as default gateway address for DHCP clients
 ip address 10.4.0.254 255.255.0.0
 ip nat inside
 ip virtual-reassembly
!
ip local policy route-map track-primary-if
ip route 0.0.0.0 0.0.0.0 Dialer2 track 234
ip route 0.0.0.0 0.0.0.0 Cellular0/3/0 254
!
!
ip nat inside source route-map nat2cell interface Cellular0/2/0 overload
ip nat inside source route-map nat2dsl overload
!
ip sla 1
 icmp-echo 2.2.2.2 source
 timeout 1000
 frequency 2
ip sla schedule 1 life forever start-time now
access-list 1 permit any
access-list 101 deny ip 10.4.0.0 0.0.255.255 10.0.0.0 0.255.255.255
access-list 101 permit ip 10.4.0.0 0.0.255.255 any
access-list 102 permit icmp any host 2.2.2.2
access-list 103 permit ip 10.4.0.0 0.0.255.255 10.0.0.0 0.255.255.255
dialer-list 1 protocol ip list 1
dialer-list 2 protocol ip permit
!
!
route-map track-primary-if permit 10
 match ip address 102
!
route-map nat2dsl permit 10
 match ip address 101
!
route-map nat2cell permit 10
 match ip address 101
 match interface Cellular0/2/0
!
exec-timeout 0 0
login
modem InOut

```

## Example: SIM Configuration

### Locking the SIM Card

The following example shows how to lock the SIM. The italicized text in this configuration example is used to indicate comments and are not be seen when a normal console output is viewed.

```

Router# sh cellular 0/2/0 security
Card Holder Verification (CHV1) = Disabled
SIM Status = OK
SIM User Operation Required = None
Number of CHV1 Retries remaining = 3
Router# !! SIM is in unlocked state.!
Router# cellular 0/2/0 lte sim lock 1111
!!!WARNING: SIM will be locked with pin=1111(4).
Do not enter new PIN to lock SIM. Enter PIN that the SIM is configured with.
Call will be disconnected!!!
Are you sure you want to proceed?[confirm]

```

```

Router#
Apr 26 19:35:28.339: %CELLWAN-2-MODEM_DOWN: Modem in NIM slot 0/2 is DOWN
Apr 26 19:35:59.967: %CELLWAN-2-MODEM_UP: Modem in NIM slot 0/2 is now UP
Router#
Router# sh cellular 0/2/0 security
Card Holder Verification (CHV1) = Enabled
SIM Status = Locked
SIM User Operation Required = Enter CHV1
Number of CHV1 Retries remaining = 3
Router# !! SIM is in locked state.!

```

## Unlocking the SIM Card

The following example shows how to unlock the SIM. The italicized text throughout this configuration example is used to indicate comments and will not be seen when a normal console output is viewed.

```

Router# sh cellular 0/2/0 security
Card Holder Verification (CHV1) = Enabled
SIM Status = Locked
SIM User Operation Required = Enter CHV1
Number of CHV1 Retries remaining = 3
Router# !! SIM is in locked state.!
Router# cellular 0/2/0 lte sim unlock 1111
!!!WARNING: SIM will be unlocked with pin=1111(4).
Do not enter new PIN to unlock SIM. Enter PIN that the SIM is configured with.
Call will be disconnected!!!
Are you sure you want to proceed?[confirm]
Router#
Router# sh cellular 0/2/0 security
Card Holder Verification (CHV1) = Disabled
SIM Status = OK
SIM User Operation Required = None
Number of CHV1 Retries remaining = 3
Router# !! SIM is in unlocked state.!

```

## Automatic SIM Authentication

The following example shows how to configure automatic SIM authentication. The italicized text throughout this configuration example is used to indicate comments and will not be seen when a normal console output is viewed.

```

Router# show cellular 0/2/0 security
Card Holder Verification (CHV1) = Disabled
SIM Status = OK
SIM User Operation Required = None
Number of CHV1 Retries remaining = 3
Router# !! SIM is in unlocked state.!Router# cellular 0/2/0 lte sim lock 1111
!!!WARNING: SIM will be locked with pin=1111(4).
Do not enter new PIN to lock SIM. Enter PIN that the SIM is configured with.
Call will be disconnected!!!
Are you sure you want to proceed?[confirm]
Router#
Apr 26 21:22:34.555: %CELLWAN-2-MODEM_DOWN: Modem in NIM slot 0/2 is DOWN
Apr 26 21:23:06.495: %CELLWAN-2-MODEM_UP: Modem in NIM slot 0/2 is now UP
Router#
Router# sh cellular 0/2/0 security
Card Holder Verification (CHV1) = Enabled
SIM Status = Locked
SIM User Operation Required = Enter CHV1
Number of CHV1 Retries remaining = 3
Router# !! SIM is in locked state. SIM needs to be in locked state for SIM authentication

```

```

to ! work.!Router#
Router# configure terminal
Enter configuration commands, one per line. End with CNTL/Z.
Router(config)# controller cellular 0/2/0
Router(config-controller)# lte sim authenticate 0 1111
CHV1 configured and sent to modem for verification
Router(config-controller)# end
Router#
Apr 26 21:23:50.571: %SYS-5-CONFIG_I: Configured from console by console
Router#
Router# sh cellular 0/2/0 security
Card Holder Verification (CHV1) = Enabled
SIM Status = OK
SIM User Operation Required = None
Number of CHV1 Retries remaining = 3
Router#! SIM is now in locked state but it can be used for connectivity since authentication
is ! good. Authentication can be saved in the router configuration so that when you boot
up ! the router with the same locked SIM, connection can be established with the correct !
Cisco IOS configuration.!

```

## Changing the PIN Code

The following example shows how to change the assigned PIN code. The italicized text throughout this configuration example is used to indicate comments and will not be seen when a normal console output is viewed.

```

Router# sh cellular 0/2/0 security
Card Holder Verification (CHV1) = Disabled
SIM Status = OK
SIM User Operation Required = None
Number of CHV1 Retries remaining = 3
Router#! SIM is in unlocked state.!Router#
Router# cellular 0/2/0 lte sim lock 1111
!!!WARNING: SIM will be locked with pin=1111(4).
Do not enter new PIN to lock SIM. Enter PIN that the SIM is configured with.
Call will be disconnected!!!
Are you sure you want to proceed?[confirm]
Router#
Apr 26 21:58:11.903: %CELLWAN-2-MODEM_DOWN: Modem in NIM slot 0/2 is DOWN
Apr 26 21:58:43.775: %CELLWAN-2-MODEM_UP: Modem in NIM slot 0/2 is now UP
Router#
Router# sh cellular 0/2/0 security
Card Holder Verification (CHV1) = Enabled
SIM Status = Locked
SIM User Operation Required = Enter CHV1
Number of CHV1 Retries remaining = 3
Router#! SIM is in locked state. SIM needs to be in locked state to change its PIN.!Router#
Router# cellular 0/2/0 lte sim change-pin 1111 0000
!!!WARNING: SIM PIN will be changed from:1111(4) to:0000(4)
Call will be disconnected. If old PIN is entered incorrectly in 3 attempt(s), SIM will be
blocked!!!
Are you sure you want to proceed?[confirm]
Resetting modem, please wait...
CHV1 code change has been completed. Please enter the new PIN in controller configuration
for verification
Router#
Apr 26 21:59:16.735: %CELLWAN-2-MODEM_DOWN: Modem in NIM slot 0/2 is DOWN
Apr 26 21:59:48.387: %CELLWAN-2-MODEM_UP: Modem in NIM slot 0/2 is now UP
Router#
Router#
Router# sh cellular 0/2/0 security
Card Holder Verification (CHV1) = Enabled

```

```

SIM Status = Locked
SIM User Operation Required = Enter CHV1
Number of CHV1 Retries remaining = 3
Router#! SIM stays in locked state, as expected, but with new PIN.!Router# cellular 0/2/0
lte sim unlock 0000
!!!WARNING: SIM will be unlocked with pin=0000(4).
Do not enter new PIN to unlock SIM. Enter PIN that the SIM is configured with.
Call will be disconnected!!!
Are you sure you want to proceed?[confirm]
Router#
Router# show cellular 0/2/0 security
Card Holder Verification (CHV1) = Disabled
SIM Status = OK
SIM User Operation Required = None
Number of CHV1 Retries remaining = 3
Router#! Unlock with new PIN is successful. Hence, changing PIN was successful.!

```

## Configuring an Encrypted PIN

The following example shows how to configure automatic SIM authentication using an encrypted PIN. The italicized text throughout this configuration example is used to indicate comments and will not be seen when a normal console output is viewed.

```

Router# configure terminal
Enter configuration commands, one per line. End with CNTL/Z.
Router(config)# service password-encryption
Router(config)# username SIM privilege 0 password 1111
Router(config)# do sh run | i SIM
username SIM privilege 0 password 7 055A575E70.!! Copy the encrypted level 7 PIN. Use this
scrambled PIN in the SIM authentication ! command.!

Router(config)# controller cellular 0/2/0
Router(config-controller)# lte sim authenticate 7 055A575E70
CHV1 configured and sent to modem for verification
Router(config-controller)# exit
Router(config)# no username SIM
Router(config)# end
May 14 20:20:52.603: %SYS-5-CONFIG_I: Configured from console by console

```

## Upgrading the Modem Firmware

The following table describes the Sierra Wireless modems that are supported on Cisco LTE/5G. The firmware for the modem is upgradable using Cisco IOS commands. The firmware is a Crossword Express (cwe) file and can be downloaded from the wireless software download page on Cisco.com.



---

**Note** Firmware upgrade is supported on utility flash.

---

Use only Cisco certified firmware. Using a firmware version not certified by Cisco may impact the wireless service provider network adversely.



---

**Caution** Do not disconnect power or switch the router off during the firmware upgrade process. This may result in permanent modem failure.

---



**Note** Firmware downgrade is not supported.

*Table 20: Modem SKUs*

| SKU            | Modem  | Firmware | Release               |
|----------------|--------|----------|-----------------------|
| EHWIC-4G-LTE-A | MC7700 | MC7700   | Cisco 16.6.1 or Later |

## Upgrading the Modem Firmware Manually With CLI

### Procedure

|               | Command or Action                                                                                                                                                                                                 | Purpose                                                                                                                                                                                                                                                                                                               |
|---------------|-------------------------------------------------------------------------------------------------------------------------------------------------------------------------------------------------------------------|-----------------------------------------------------------------------------------------------------------------------------------------------------------------------------------------------------------------------------------------------------------------------------------------------------------------------|
| <b>Step 1</b> | Go to the Cisco Wireless WAN software download website at:<br><a href="http://software.cisco.com/download/navigator.html">http://software.cisco.com/download/navigator.html</a>                                   | Provides access to Cisco Wireless WAN software downloads page to select the firmware for Cisco LTE/5G.<br><br><b>Note</b> This website is only available to registered Cisco.com users.                                                                                                                               |
| <b>Step 2</b> | On the Cisco Wireless WAN software page, go to <b>Products</b> -> <b>Cisco Interfaces and Modules</b> -> <b>Cisco High-Speed WAN interface Cards</b> and select your product from the list of available cards.    | Select your product for firmware upgrade.                                                                                                                                                                                                                                                                             |
| <b>Step 3</b> | Select and download the appropriate firmware.                                                                                                                                                                     | Download the modem firmware file to flash memory on the router.                                                                                                                                                                                                                                                       |
| <b>Step 4</b> | <b>terminal monitor</b><br><br><b>Example:</b><br><br>Router# terminal monitor                                                                                                                                    | Enables the logging console in privileged EXEC mode.                                                                                                                                                                                                                                                                  |
| <b>Step 5</b> | <b>microcode reload cellular pa-bay slot modem-provision</b><br>[flash:<firmware_directory_name>]<br><br><b>Example:</b><br>Router# microcode reload cellular 0 2 modem-provision bootflash:/<firmware_directory> | Initiates the firmware upgrade process.<br><br><ul style="list-style-type: none"> <li>• pa-bay—Use 0 for LTE/5G.</li> <li>• slot—For LTE/5G, slot number, 0 to 3, where the LTE/5G is plugged in.</li> <li>• For remote download, you can transfer this using the wireless link from Cisco.com onto flash.</li> </ul> |
| <b>Step 6</b> | <b>show cellular 0/2/0 hardware</b><br><br><b>Example:</b>                                                                                                                                                        | Verifies the firmware upgrade process.                                                                                                                                                                                                                                                                                |

|  | Command or Action                                                                                                                     | Purpose |
|--|---------------------------------------------------------------------------------------------------------------------------------------|---------|
|  | <pre>Router# show cellular 0 hardware Modem Firmware built = 2016/06/30 10:54:05 Hardware Version = 1.0 Device Model ID: EM7455</pre> |         |

## EM74xx Manual Modem Firmware Upgrade: Example

```
Router# sh cellu 0/2/0 hardware
Modem Firmware Version = SWI9X30C_02.20.03.00
Modem Firmware built = 2016/06/30 10:54:05
Hardware Version = 1.0
Device Model ID: EM7455
International Mobile Subscriber Identity (IMSI) = <imsi>
International Mobile Equipment Identity (IMEI) = <imei>
Integrated Circuit Card ID (ICCID) = <iccid>
Mobile Subscriber Integrated Services
Digital Network-Number (MSISDN) =
Modem Status = Modem Online
Current Modem Temperature = 44 deg C
PRI SKU ID = 1102526, PRI version = 002.020_000, Carrier = AT&T
OEM PRI version = 006
Router#cd fw_22_vzw
Router#dir
Directory of bootflash:/fw_22_vzw/

227586 -rw- 64389490 Jun 30 2000 10:21:29 +00:00 74XX_02.20.03.22.cwe
227587 -rw- 16951 Jun 30 2000 10:22:10 +00:00
7455_02.20.03.22_Verizon_002.026_000.nvu

6816092160 bytes total (5965422592 bytes free)
Router#cd
Router#microcode reload cellular 0 2 modem-provision bootflash:/fw_22_vzw/
Reload microcode? [confirm]
Log status of firmware download in router flash?[confirm]
Firmware download status will be logged in bootflash:fwlogfile
Microcode Reload Process launched for cwan slot/bay =0/2; hw type=0x102download option = 0

Router#Success !! send FW Upgrade command to card

The interface will be Shut Down for Firmware Upgrade
This will terminate any active data connections.

Modem will be upgraded!
Upgrade process will take up to 15 minutes. During
this time the modem will be unusable.
Please do not remove power or reload the router during
the upgrade process.

*Jul 6 10:19:34.701: %LINK-5-CHANGED: Interface Cellular0/2/0, changed state to
administratively down
*Jul 6 10:19:34.701: %LINK-5-CHANGED: Interface Cellular0/2/1, changed state to
administratively down

FIRMWARE INFO BEFORE UPGRADE:
Modem Device ID: EM7455 MODEM F/W Boot Version: SWI9X30C_02.20.03.00
Modem F/W App Version: SWI9X30C_02.20.03.00 Modem SKU ID: 1102526
Modem Package Identifier: Modem Carrier String: 4
```

```

Modem PRI Ver: 000.006 Modem Carrier Name: ATT
Modem Carrier Revision: 002.020_000

FW_UPGRADE: Modem needs CWE, PRI
*Jul 6 10:19:57.978: %CELLWAN-2-MODEM_DOWN: Modem in NIM slot 0/2 is DOWN
FW_UPGRADE: Upgrade begin at Thu Jul 6 10:20:01 2000
FW_UPGRADE: Upgrade end at Thu Jul 6 10:21:14 2000
FW_UPGRADE: Firmware upgrade success.....
FW_UPGRADE: Waiting for modem to become online

FIRMWARE INFO AFTER UPGRADE:
Modem Device ID: EM7455 MODEM F/W Boot Version: SWI9X30C_02.20.03.22
Modem F/W App Version: SWI9X30C_02.20.03.22 Modem SKU ID: 1102526
Modem Package Identifier: Modem Carrier String: 5
Modem PRI Ver: 000.006 Modem Carrier Name: VERIZON
Modem Carrier Revision: 002.026_000

F/W Upgrade: Firmware Upgrade has Completed Successfully
*Jul 6 10:21:55.275: %CELLWAN-2-MODEM_RADIO: Cellular0/2/0 Modem radio has been turned on
*Jul 6 10:21:57.276: %LINK-3-UPDOWN: Interface Cellular0/2/0, changed state to down
*Jul 6 10:21:57.277: %LINK-3-UPDOWN: Interface Cellular0/2/1, changed state to down
Router#
Router# sh cellu 0/2/0 hardware
Modem Firmware Version = SWI9X30C_02.20.03.22
Modem Firmware built = 2016/10/11 16:03:14
Hardware Version = 1.0
Device Model ID: EM7455
International Mobile Subscriber Identity (IMSI) =<imsi>
International Mobile Equipment Identity (IMEI) = <imei>
Integrated Circuit Card ID (ICCID) = <iccid>
Mobile Subscriber Integrated Services
Digital Network-Number (MSISDN) = <msisdn>
Modem Status = Modem Online
Current Modem Temperature = 0 deg C
PRI SKU ID = 1102526, PRI version = 002.026_000, Carrier = Verizon
OEM PRI version = 006

```

## Configuring dm-log to Utility Flash: Example

```

Router(config)#controller cellular 0/2/0
Router(config-controller)#lte modem dm-log enable
Router(config-controller)#
*May 8 17:57:09.905: %SYS-5-CONFIG_I: Configured from console by console
Router#
Router#sh cell 0/2/0 log dm-log
Integrated DM logging is on
output path = Utility Flash
filter = bootflash:v11026_Generic_GPS.sqf
maximum log size = 0
maximum file size = 0
log rotation = disabled

32 packets sent to the modem, 4021 bytes, 0 errors
23668 packets received from the modem, 11131720 bytes, 0 input drops
23668 packets stored in utility flash, 11131720 bytes

current file size = 11131720
current log size = 11131720
total log size = 11131720
Utility Flash DM log files: (1) files

```

# SNMP MIBs



**Note** It is recommended that you configure SNMP V3 with authentication/privacy when implementing SNMP SET operation.

The following Simple Management Network Protocol (SNMP) MIBs are supported on Cisco LTE/5G:

- IF-MIB
- ENTITY-MIB
- CISCO-WAN-3G-MIB
- CISCO-WAN-CELL-EXT-MIB

For the CISCO-WAN-3G-MIB, the following tables and sub-tables are supported for 3G and LTE technologies:

- ciscoWan3gMIB(661)
- ciscoWan3gMIBNotifs(0)
- ciscoWan3gMIBObjects(1)
- c3gWanCommonTable(1)
- c3gWanGsm(3)
- c3gGsmIdentityTable(1)
- c3gGsmNetworkTable(2)
- c3gGsmPdpProfile(3)
- c3gGsmPdpProfileTable(1)
- c3gGsmPacketSessionTable(2)
- c3gGsmRadio(4)
- c3gGsmRadioTable(1)
- c3gGsmSecurity(5)
- c3gGsmSecurityTable(1)

For the CISCO-WAN-CELL-EXT-MIB, the following tables and sub-tables are supported for LTE technology only:

- ciscoWanCellExtMIB(817)
- ciscoWanCellExtMIBNotifs(0)
- ciscoWanCellExtMIBObjects(1)
- ciscoWanCellExtLte(1)



- cwceLteRadio(1)
- cwceLteProfile(2)

You can download the MIBs from the Cisco MIB Locator at <http://www.cisco.com/go/mibs>.

## SNMP LTE/5G Configuration: Example

The following example describes how to configure 3G 4G MIB trap on the router:

```
controller Cellular 0/2/0
lte event rssi onset mib-trap All-lte
lte event rssi onset threshold -100
lte event rssi abate mib-trap All-lte
lte event rssi abate threshold -90
lte event temperature onset mib-trap
lte event temperature onset threshold 55
lte event temperature abate mib-trap
lte event temperature abate threshold 50
lte event modem-state mib-trap all
lte event service mib-trap
lte event network mib-trap
lte event connection-status mib-trap All-lte
lte event rsrp onset mib-trap All-lte
lte event rsrp onset threshold -85
lte event rsrp abate mib-trap All-lte
lte event rsrp abate threshold -80
lte event rsrq onset mib-trap All-lte
lte event rsrq onset threshold -8
lte event rsrq abate mib-trap All-lte
lte event rsrq abate threshold -6
```

The following example describes how to configure SNMP capability on the router:

```
snmp-server group neomobilityTeam v3 auth notify 3gView
snmp-server view 3gView ciscoWan3gMIB included
snmp-server community neomobility-test RW snmp-server community public RW
snmp-server enable traps c3g
snmp server enable traps LTE
snmp-server host 172.19.153.53 neomobility c3g snmp-server host 172.19.152.77 public c3g
snmp-server host 172.19.152.77 public udp-port 6059
```

The following example describes how to configure an external host device to communicate with the router through SNMP:

```
setenv SR_MGR_CONF_DIR /users/<userid>/mibtest
setenv SR_UTIL_COMMUNITY neomobility-test
setenv SR_UTIL_SNMP_VERSION -v2c
setenv SR_TRAP_TEST_PORT 6059
```

## Troubleshooting

This section provides the essential information and resources available for troubleshooting the Cisco LTE/5G feature.

## Verifying Data Call Setup

To verify the data call setup, follow these steps:

1. After you create a modem data profile using the cellular profile create command and configuring DDR on the cellular interface, send a ping from the router to a host across the wireless network.
2. If the ping fails, debug the failure by using the following debug and show commands:
3. **debug chat**
4. **debug modem**
5. **debug dialer**
6. **show cellular all**
7. **show controller cell0/2/0**
8. **show interface cellular**
9. **show running-config**
10. **show ip route**
11. **show platform**
12. Save the output from these commands and contact your system administrator.

## Checking Signal Strength

If the Received Signal Strength Indication (RSSI) level is very low (for example, if it is less than  $-110$  dBm), follow these steps:

### Procedure

|               | Command or Action                                                                               | Purpose |
|---------------|-------------------------------------------------------------------------------------------------|---------|
| <b>Step 1</b> | Check the antenna connection. Make sure the TNC connector is correctly threaded and tightened.  |         |
| <b>Step 2</b> | If you are using a remote antenna, move the antenna cradle and check if the RSSI has improved.  |         |
| <b>Step 3</b> | Contact your wireless service provider to verify if there is service availability in your area. |         |

## Verifying Service Availability

The following is a sample output for the **show cellular all** command for a scenario where the antenna is disconnected and a modem data profile has not been created.

```
Router# show cellular 0/2/0 all
```

## Hardware Information

=====

```
Modem Firmware Version = SWI9X30C_02.20.03.00
Modem Firmware built = 2016/06/30 10:54:05
Hardware Version = 1.0
Device Model ID: EM7455
International Mobile Subscriber Identity (IMSI) = 123456000031546
International Mobile Equipment Identity (IMEI) = 356129070052334
Integrated Circuit Card ID (ICCID) = 8949001508130031546
Mobile Subscriber Integrated Services
Digital Network-Number (MSISDN) =
Modem Status = Modem Online
Current Modem Temperature = 42 deg C
PRI SKU ID = 1102526, PRI version = 002.017_000, Carrier = Generic
OEM PRI version = 002
```

## Profile Information

=====

Profile 1 = ACTIVE\* \*\*

-----

```
PDP Type = IPv4v6
PDP address = 29.29.29.196
PDP IPV6 address = 2001:2678:2680:5FD7:DDE7:70E1:DC07:CCB7/64 Scope: Global
Access Point Name (APN) = broadband
Authentication = None
 Primary DNS address = 8.0.0.8
 Secondary DNS address = 8.8.4.4
 Primary DNS IPV6 address = 2001:4860:4860:0:0:0:0:8888
 Secondary DNS IPV6 address = 2001:4860:4860:0:0:0:0:8844
```

Profile 2 = ACTIVE

-----

```
PDP Type = IPv4v6
PDP address = 21.21.21.206
PDP IPV6 address = 2001:567A:567A:1480:5DD6:18D1:BD63:49DA/64 Scope: Global
Access Point Name (APN) = basic
Authentication = None
 Primary DNS address = 171.70.168.183
 Secondary DNS address = 8.8.8.8
 Primary DNS IPV6 address = 2001:4860:4860:0:0:0:0:8888
 Secondary DNS IPV6 address = 2001:4860:4860:0:0:0:0:8844
```

Profile 3 = INACTIVE

-----

```
PDP Type = IPv4
Access Point Name (APN) = mpdn
Authentication = None
```

Profile 4 = INACTIVE

-----

```
PDP Type = IPv4
Access Point Name (APN) = broadband
Authentication = None
```

Profile 5 = INACTIVE

-----

```
PDP Type = IPv4
Access Point Name (APN) = cisco.gw4.vzwentp
Authentication = None
```

Profile 6 = INACTIVE

-----

```
PDP Type = IPv4
```

```
Access Point Name (APN) = mobility-de1
Authentication = None
```

```
Profile 7 = INACTIVE

```

```
PDP Type = IPv4
Access Point Name (APN) = mobility-de2
Authentication = None
```

```
Profile 8 = INACTIVE

```

```
PDP Type = IPv4
Access Point Name (APN) = broadband
Authentication = None
```

```
Profile 9 = INACTIVE

```

```
PDP Type = IPv4
Access Point Name (APN) = mpdndt-qos
Authentication = None
```

```
Profile 10 = INACTIVE

```

```
PDP Type = IPv4
Access Point Name (APN) = mobility-de2
Authentication = None
```

```
Profile 11 = INACTIVE

```

```
PDP Type = IPv4
Access Point Name (APN) = broadband
Authentication = None
```

```
Profile 12 = INACTIVE

```

```
PDP Type = IPv4
Access Point Name (APN) = wfgos
Authentication = CHAP
Username: ipv4v6
Password:
```

```
Profile 13 = INACTIVE

```

```
PDP Type = IPv4
Access Point Name (APN) = broadband
Authentication = CHAP
Username: ipv4v6
Password:
```

```
Profile 14 = INACTIVE

```

```
PDP Type = IPv4
Access Point Name (APN) = mobility-de2
Authentication = CHAP
Username: ipv4v6
Password:
```

```
Profile 15 = INACTIVE

```

```
PDP Type = IPv4
Access Point Name (APN) = aaaauth
Authentication = CHAP
Username: ipv4v6
Password:
```

```
Profile 16 = INACTIVE
```

```

```

```
PDP Type = IPv4
Access Point Name (APN) = broadband
Authentication = CHAP
Username: ipv4v6
Password:
```

```
* - Default profile
** - LTE attach profile
```

```
Configured default profile for active SIM 0 is profile 1.
```

#### Data Connection Information

```
=====
```

```
Profile 1, Packet Session Status = ACTIVE
Cellular0/2/0:
Data Packets Transmitted = 198 , Received = 209
Data Transmitted = 14410 bytes, Received = 24882 bytes
IP address = 29.29.29.196
IPv6 address = 2001:2678:2680:5FD7:DDE7:70E1:DC07:CCB7/64 Scope: Global
Primary DNS address = 8.0.0.8
Secondary DNS address = 8.8.4.4
Primary DNS IPV6 address = 2001:4860:4860:0:0:0:0:8888
Secondary DNS IPV6 address = 2001:4860:4860:0:0:0:0:8844
Profile 2, Packet Session Status = ACTIVE
Cellular0/2/1:
Data Packets Transmitted = 12 , Received = 13
Data Transmitted = 1200 bytes, Received = 1144 bytes
IP address = 21.21.21.206
IPv6 address = 2001:567A:567A:1480:5DD6:18D1:BD63:49DA/64 Scope: Global
Primary DNS address = 171.70.168.183
Secondary DNS address = 8.8.8.8
Primary DNS IPV6 address = 2001:4860:4860:0:0:0:0:8888
Secondary DNS IPV6 address = 2001:4860:4860:0:0:0:0:8844
Profile 3, Packet Session Status = INACTIVE
Profile 4, Packet Session Status = INACTIVE
Profile 5, Packet Session Status = INACTIVE
Profile 6, Packet Session Status = INACTIVE
Profile 7, Packet Session Status = INACTIVE
Profile 8, Packet Session Status = INACTIVE
Profile 9, Packet Session Status = INACTIVE
Profile 10, Packet Session Status = INACTIVE
Profile 11, Packet Session Status = INACTIVE
Profile 12, Packet Session Status = INACTIVE
Profile 13, Packet Session Status = INACTIVE
Profile 14, Packet Session Status = INACTIVE
Profile 15, Packet Session Status = INACTIVE
Profile 16, Packet Session Status = INACTIVE
```

#### Network Information

```
=====
```

```
Current System Time = Tue Jan 8 23:24:22 1980
--More--
*Jun 19 06:13:14.665: %IOSXE_OIR-6-INSSPA: SPA inserted in sCurrent Service Status = Normal
Current Service = Packet switched
Current Roaming Status = Roaming
Network Selection Mode = Automatic
Network = 123 456
Mobile Country Code (MCC) = 123
Mobile Network Code (MNC) = 456
```

```

Packet switch domain(P.S) state = Attached
LTE Carrier Aggregation state = Deconfigured
Registration state(EMM) = Registered
EMM Sub State = Normal Service
Tracking Area Code (TAC) = 1801
Cell ID = 768001
Network MTU is not Available

```

```

Radio Information
=====

```

```

Radio power mode = online
LTE Rx Channel Number = 2000
LTE Tx Channel Number = 20000
LTE Band = 4
LTE Bandwidth = 10 MHz
Current RSSI = -71 dBm
Current RSRP = -95 dBm
Current RSRQ = -7 dB
Current SNR = 26.4 dB
Physical Cell Id = 12
Number of nearby cells = 1
Idx PCI (Physical Cell Id)

1 12
Radio Access Technology(RAT) Preference = LTE
Radio Access Technology(RAT) Selected = LTE

```

```

Modem Security Information
=====

```

```

Active SIM = 0
SIM switchover attempts = 0
Card Holder Verification (CHV1) = Disabled
SIM Status = OK
SIM User Operation Required = None
Number of CHV1 Retries remaining = 3

```

```

Cellular Firmware List
=====

```

| Idx | Carrier | FwVersion   | PriVersion  | Status   |
|-----|---------|-------------|-------------|----------|
| 1   | ATT     | 02.20.03.00 | 002.019_000 | Inactive |
| 2   | GENERIC | 02.20.03.00 | 002.017_000 | Active   |
| 3   | SPRINT  | 02.20.03.22 | 002.020_000 | Inactive |
| 4   | TELSTRA | 02.20.03.00 | 002.018_000 | Inactive |
| 5   | VERIZON | 02.20.03.22 | 002.026_000 | Inactive |

```

Firmware Activation mode : AUTO

```

```

GPS Information
=====

```

```

GPS Info

GPS Feature: enabled
GPS Mode Configured: not configured
GPS Status: NMEA Disabled

```

```

SMS Information
=====

```

```

Incoming Message Information

SMS stored in modem = 0
SMS archived since booting up = 0
Total SMS deleted since booting up = 0
Storage records allocated = 25

```

```

Storage records used = 0
Number of callbacks triggered by SMS = 0
Number of successful archive since booting up = 0
Number of failed archive since booting up = 0

Outgoing Message Information

Total SMS sent successfully = 0
Total SMS send failure = 0
Number of outgoing SMS pending = 0
Number of successful archive since booting up = 0
Number of failed archive since booting up = 0
Last Outgoing SMS Status = SUCCESS
Copy-to-SIM Status = 0x0
Send-to-Network Status = 0x0
Report-Outgoing-Message-Number:
 Reference Number = 0
 Result Code = 0x0
 Diag Code = 0x0 0x0 0x0 0x0 0x0

SMS Archive URL =

Error Information
=====

This command is not supported on 4G modems.

Modem Crashdump Information
=====
Modem crashdump logging: off

```

## Successful Call Setup

The following is a sample output when a call is set up. It shows a received IP address from the network. Call setup is successful and data path is open.

```

debug dialer
debug cellular 0/2/0 messages callcontrol

```

## Modem Troubleshooting Using Integrated Modem DM Logging

As part of the 3G and 4G serviceability enhancement in Cisco IOS Release 15.2(4)M2 and Cisco IOS Release 15.3(1)T, DM log collection has been integrated into Cisco IOS, eliminating the need for an external PC and simplifying the DM log collection process. The `lte modem dm-log` command can be used in controller cellular configuration mode to configure integrated DM logging to monitor traffic on the modem. See the [Cisco 3G and 4G Serviceability Enhancement User Guide](#) for more information on configuring Integrated DM Logging parameters.

## Modem Settings for North America and Carriers Operating on 700 MHz Band

For LTE-EA deployments in North America and for carriers operating in the 700 MHz band, the following changes to the modem settings are required to prevent long network attach times.

The output of `show cellular x/x/x all` command shows the following:

- Current RSSI is -125 dBm

- LTE Technology Preference = No preference specified (AUTO)

The following sections explain useful commands for changing modem settings:

## Changing Modem Settings

To change the modem settings to force the modem to scan different technologies, use the following Cisco IOS command:

```
Router# cellular 0/2/0 lte technology ?
auto Automatic LTE Technology Selection
 lte LTE
 umts UMTS
```

## Electronic Serial Number (ESN)

The ESN number is located directly on the modem label in hexadecimal notation. It can also be retrieved using the Cisco IOS CLI using the show cellular *slot/port/module hardware* command.

The sample output below shows the ESN number:

```
Hardware Information
=====
Electronic Serial Number (ESN) = 0x603c9854 [09603971156]
Electronic Serial Number (ESN) = <specific ESN in hexadecimal> [specific ESN in decimal]
```

## Additional References

### Related Documents

| Related Topic                      | Document Title                                                                                                                                                                                                                                                                                                                                                             |
|------------------------------------|----------------------------------------------------------------------------------------------------------------------------------------------------------------------------------------------------------------------------------------------------------------------------------------------------------------------------------------------------------------------------|
| Hardware Overview and Installation | <ul style="list-style-type: none"> <li>• <i>Cisco 4G-LTE Wireless WAN EHWIC</i></li> </ul> <a href="http://www.cisco.com/en/US/docs/routers/access/interfaces/ic/hardware/installation/guide/EHWIC-4G-LTE.html">http://www.cisco.com/en/US/docs/routers/access/interfaces/ic/hardware/installation/guide/EHWIC-4G-LTE.html</a>                                             |
|                                    | <ul style="list-style-type: none"> <li>• <i>Cisco Fourth-Generation LTE Network Interface Module Installation Guide</i></li> </ul> <a href="http://www.cisco.com/c/en/us/td/docs/routers/access/interfaces/NIM/hardware/installation/guide/4GLTENIM.html">http://www.cisco.com/c/en/us/td/docs/routers/access/interfaces/NIM/hardware/installation/guide/4GLTENIM.html</a> |



| Related Topic                       | Document Title                                                                                                                                                                                                                                                                                                                                                                                                                                                                                                                                                                                                                                                                                                                                                                                                                                                                                                                                                                                                                                                                                                                                                                                                                                                                                                                                                                                                                                                                                                                                                                                                                                                                                                                                                                                                                                                                                                                                                                                                                                                                                                                                                                                                                                                                                                                                                                                                                                                                                                                                                                                                                                                                                                                                                                                                                                                                                            |
|-------------------------------------|-----------------------------------------------------------------------------------------------------------------------------------------------------------------------------------------------------------------------------------------------------------------------------------------------------------------------------------------------------------------------------------------------------------------------------------------------------------------------------------------------------------------------------------------------------------------------------------------------------------------------------------------------------------------------------------------------------------------------------------------------------------------------------------------------------------------------------------------------------------------------------------------------------------------------------------------------------------------------------------------------------------------------------------------------------------------------------------------------------------------------------------------------------------------------------------------------------------------------------------------------------------------------------------------------------------------------------------------------------------------------------------------------------------------------------------------------------------------------------------------------------------------------------------------------------------------------------------------------------------------------------------------------------------------------------------------------------------------------------------------------------------------------------------------------------------------------------------------------------------------------------------------------------------------------------------------------------------------------------------------------------------------------------------------------------------------------------------------------------------------------------------------------------------------------------------------------------------------------------------------------------------------------------------------------------------------------------------------------------------------------------------------------------------------------------------------------------------------------------------------------------------------------------------------------------------------------------------------------------------------------------------------------------------------------------------------------------------------------------------------------------------------------------------------------------------------------------------------------------------------------------------------------------------|
| Supported Cisco antennas and cables | <ul style="list-style-type: none"> <li>• <i>Installing Cisco Interface Cards in Cisco Access Routers</i></li> </ul> <a href="http://www.cisco.com/en/US/docs/routers/access/interfaces/ic/hardware/installation/guide/inst_ic.html">http://www.cisco.com/en/US/docs/routers/access/interfaces/ic/hardware/installation/guide/inst_ic.html</a> <ul style="list-style-type: none"> <li>• <i>Cisco 4G/3G Omnidirectional Dipole Antenna (4G-LTE-ANTM-D)</i></li> </ul> <a href="http://www.cisco.com/en/US/docs/routers/access/wireless/hardware/notes/4G3G_ant.html">http://www.cisco.com/en/US/docs/routers/access/wireless/hardware/notes/4G3G_ant.html</a> <ul style="list-style-type: none"> <li>• <i>Cisco 4G Indoor Ceiling-Mount Omnidirectional Antenna (4G-ANTM-OM-CM)</i></li> </ul> <a href="http://www.cisco.com/en/US/docs/routers/access/wireless/hardware/notes/antcm4gin.html">http://www.cisco.com/en/US/docs/routers/access/wireless/hardware/notes/antcm4gin.html</a> <ul style="list-style-type: none"> <li>• <i>Cisco Outdoor Omnidirectional Antenna for 2G/3G/4G Cellular (ANT-4G-OMNI-OUT-N)</i></li> </ul> <a href="http://www.cisco.com/en/US/docs/routers/connectedgrid/antennas/installing/Outdoor_Omni_for_2G_3G.html">http://www.cisco.com/en/US/docs/routers/connectedgrid/antennas/installing/Outdoor_Omni_for_2G_3G.html</a> <ul style="list-style-type: none"> <li>• <i>Cisco Integrated 4G Low-Profile Outdoor Saucer Antenna (ANT-4G-SR-OUT-TNC)</i></li> </ul> <a href="http://www.cisco.com/en/US/docs/routers/connectedgrid/antennas/installing/4G_LowProfile_Outdoor_Saucer.html">http://www.cisco.com/en/US/docs/routers/connectedgrid/antennas/installing/4G_LowProfile_Outdoor_Saucer.html</a> <ul style="list-style-type: none"> <li>• <i>Cisco Single-Port Antenna Stand for Multiband TNC Male-Terminated Portable Antenna (Cisco 4G-ANTM-SS)</i></li> </ul> <a href="http://www.cisco.com/en/US/docs/routers/access/wireless/hardware/notes/4Gantex15-10r.html">http://www.cisco.com/en/US/docs/routers/access/wireless/hardware/notes/4Gantex15-10r.html</a> <ul style="list-style-type: none"> <li>• <i>Cisco 4G Lightning Arrestor (4G-ACC-OUT-LA)</i></li> </ul> <a href="http://www.cisco.com/en/US/docs/routers/access/wireless/hardware/notes/4Glar.html">http://www.cisco.com/en/US/docs/routers/access/wireless/hardware/notes/4Glar.html</a> <ul style="list-style-type: none"> <li>• <i>Lightning Arrestor for the Cisco 1240 Connected Grid Router</i></li> </ul> <a href="http://www.cisco.com/en/US/docs/routers/connectedgrid/lightning_arrestor/Lightning_Arrestor_for_the_Cisco_1240.html">http://www.cisco.com/en/US/docs/routers/connectedgrid/lightning_arrestor/Lightning_Arrestor_for_the_Cisco_1240.html</a> <ul style="list-style-type: none"> <li>• <i>Cisco 4G Indoor/Outdoor Active GPS Antenna (GPS-ACT-ANTM-SMA)</i></li> </ul> |
| Datasheet                           | <ul style="list-style-type: none"> <li>• Modules data sheets for ISR4k</li> </ul> <a href="http://www.cisco.com/c/en/us/products/routers/4000-series-integrated-services-routers-isr/datasheet-listing.html">http://www.cisco.com/c/en/us/products/routers/4000-series-integrated-services-routers-isr/datasheet-listing.html</a> <ul style="list-style-type: none"> <li>• LTE datasheet</li> </ul> <a href="http://www.cisco.com/en/US/docs/routers/access/wireless/hardware/notes/4Gantex15-10r.html">http://www.cisco.com/en/US/docs/routers/access/wireless/hardware/notes/4Gantex15-10r.html</a> <a href="http://www.cisco.com/c/en/us/td/docs/routers/access/4400/roadmap/isr4400roadmap.html">http://www.cisco.com/c/en/us/td/docs/routers/access/4400/roadmap/isr4400roadmap.html</a>                                                                                                                                                                                                                                                                                                                                                                                                                                                                                                                                                                                                                                                                                                                                                                                                                                                                                                                                                                                                                                                                                                                                                                                                                                                                                                                                                                                                                                                                                                                                                                                                                                                                                                                                                                                                                                                                                                                                                                                                                                                                                                             |

## MIBs

| MIB                                                                                                                               | MIBs Link                                                                                                                                                                                                                              |
|-----------------------------------------------------------------------------------------------------------------------------------|----------------------------------------------------------------------------------------------------------------------------------------------------------------------------------------------------------------------------------------|
| <ul style="list-style-type: none"> <li>• IF-MIB</li> <li>• CISCO-ENTITY-VENDORTYPE-OID-MIB</li> <li>• CISCO-WAN-3G-MIB</li> </ul> | <p>To locate and download MIBs for selected platforms, Cisco software releases, and feature sets, use Cisco MIB Locator found at the following URL:</p> <p><a href="http://www.cisco.com/go/mibs">http://www.cisco.com/go/mibs</a></p> |

**RFCs**

| <b>RFC</b> | <b>Title</b>                                      |
|------------|---------------------------------------------------|
| RFC 3025   | Mobile IP Vendor/Organization-Specific Extensions |

**Technical Assistance**

| <b>Description</b>                                                                                                                                                                                                                                                                                                                                                                    | <b>Link</b>                                                                                                       |
|---------------------------------------------------------------------------------------------------------------------------------------------------------------------------------------------------------------------------------------------------------------------------------------------------------------------------------------------------------------------------------------|-------------------------------------------------------------------------------------------------------------------|
| The Cisco Support and Documentation website provides online resources to download documentation, software, and tools. Use these resources to install and configure the software and to troubleshoot and resolve technical issues with Cisco products and technologies. Access to most tools on the Cisco Support and Documentation website requires a Cisco.com user ID and password. | <a href="http://www.cisco.com/cisco/web/support/index.html">http://www.cisco.com/cisco/web/support/index.html</a> |



## CHAPTER 15

# Configuring Ethernet Switch Ports

---

This chapter contains the following sections:

- [Configuring VLANs, on page 281](#)
- [Configuring VTP, on page 282](#)
- [Configuring 802.1x Authentication, on page 283](#)
- [Configuring Spanning Tree Protocol, on page 284](#)
- [Configuring MAC Address Table Manipulation, on page 286](#)
- [Configuring Switch Port Analyzer, on page 286](#)
- [Configuring IGMP Snooping, on page 287](#)
- [Configuring HSRP , on page 287](#)
- [Configuring VRRP , on page 288](#)

## Configuring VLANs

A VLAN is a switched network that is logically segmented by function, project team, or application, without regard to the physical locations of the users. VLANs have the same attributes as physical LANs, but you can group end stations even if they are not physically located on the same LAN segment. Any switch port can belong to a VLAN, and unicast, broadcast, and multicast packets are forwarded and flooded only to end stations in the VLAN. Each VLAN is considered a logical network, and packets destined for stations that do not belong to the VLAN must be forwarded through a router. A VLAN is a switched network that is logically segmented by function, project team, or application, without regard to the physical locations of the users. VLANs have the same attributes as physical LANs, but you can group end stations even if they are not physically located on the same LAN segment. Any switch port can belong to a VLAN, and unicast, broadcast, and multicast packets are forwarded and flooded only to end stations in the VLAN. Each VLAN is considered a logical network, and packets destined for stations that do not belong to the VLAN must be forwarded through a router.



---

**Note** Internal VLANs cannot be configured. By default, these are the VLAN IDs from 2350 - 2449. Use the **show vlan internal usage** command to check for the range of internal VLANs.

---

Example: VLAN configuration

```
Router# configure terminal
Router(config)# vlan 1
Router(config)# vlan 2
```

```
Router(config)# interface vlan 1
Router(config-if)# ip address 1.1.1.1 255.255.255.0
Router(config-if)# no shut
Router(config-if)# interface vlan 2
Router(config-if)# ip address 2.2.2.2 255.255.255.0
Router(config-if)# no shut
Router(config-if)# interface gigabitethernet 0/1/0
Router(config-if)# switchport mode access
Router(config-if)# switchport access vlan 1
Router(config-if)# interface gigabitethernet 0/1/1
Router(config-if)# switchport access vlan 2
Router(config-if)# exit
```

## Configuring VTP

VTP is a Layer 2 messaging protocol that maintains VLAN configuration consistency by managing the addition, deletion, and renaming of VLANs on a network-wide basis. VTP minimizes misconfigurations and configuration inconsistencies that can cause several problems, such as duplicate VLAN names, incorrect VLAN-type specifications, and security violations.

Before you create VLANs, you must decide whether to use VTP in your network. Using VTP, you can make configuration changes centrally on one or more switches and have those changes automatically communicated to all the other switches in the network. Without VTP, you cannot send information about VLANs to other switches. VTP is designed to work in an environment where updates are made on a single switch and are sent through VTP to other switches in the domain. It does not work well in a situation where multiple updates to the VLAN database occur simultaneously on switches in the same domain, which would result in an inconsistency in the VLAN database.

You should understand the following concepts for configuring VTP.

- **VTP domain:** A VTP domain (also called a VLAN management domain) consists of one switch or several interconnected switches or switch stacks under the same administrative responsibility sharing the same VTP domain name. A switch can be in only one VTP domain. You make global VLAN configuration changes for the domain.
- **VTP server:** In VTP server mode, you can create, modify, and delete VLANs, and specify other configuration parameters (such as the VTP version) for the entire VTP domain. VTP Version 3 should be configured on each switch manually including the VTP server and client. VTP servers advertise their VLAN configurations to other switches in the same VTP domain and synchronize their VLAN configurations with other switches based on advertisements received over trunk links. VTP server is the default mode.
- **VTP client:** A VTP client behaves like a VTP server and transmits and receives VTP updates on its trunks, but you cannot create, change, or delete VLANs on a VTP client. VLANs are configured on another switch in the domain that is in server mode.
- **VTP transparent:** VTP transparent switches do not participate in VTP. A VTP transparent switch does not advertise its VLAN configuration and does not synchronize its VLAN configuration based on received advertisements. However, in VTP version 2 or version 3, transparent switches do forward VTP advertisements that they receive from other switches through their trunk interfaces. You can create, modify, and delete VLANs on a switch in VTP transparent mode.
- VTP pruning is not supported.

For detailed information on VTP, see the following web link:

[http://www.cisco.com/c/en/us/td/docs/routers/access/interfaces/software/feature/guide/geshwic\\_cfg.html#wp1046901](http://www.cisco.com/c/en/us/td/docs/routers/access/interfaces/software/feature/guide/geshwic_cfg.html#wp1046901)

#### Example: Configuring VTP

The following example shows how to configure the switch as a VTP server:

```
Router# configure terminal
Router(config)# vtp mode server
Router(config)# vtp domain Lab_Network
Router(config)# exit
```

The following example shows how to configure the switch as a VTP client:

```
Router# configure terminal
Router(config)# vtp domain Lab_Network
Router(config)# vtp mode client
Router(config)# exit
```

The following example shows how to configure the switch as VTP transparent:

```
Router# configure terminal
Router(config)# vtp mode transparent
Router(config)# exit
```

## Configuring 802.1x Authentication

IEEE 802.1x port-based authentication defines a client-server-based access control and authentication protocol to prevent unauthorized clients from connecting to a LAN through publicly accessible ports. The authentication server authenticates each client connected to a switch port before allowing access to any switch or LAN services. Until the client is authenticated, IEEE 802.1x access control allows only Extensible Authentication Protocol over LAN (EAPOL), Cisco Discovery Protocol (CDP), and Spanning Tree Protocol (STP) traffic through the port to which the client is connected. After authentication, normal traffic passes through the port.

With IEEE 802.1x authentication, the devices in the network have specific roles:

- **Supplicant**—Device (workstation) that requests access to the LAN and switch services and responds to requests from the router. The workstation must be running IEEE 802.1x-compliant client software such as that offered in the Microsoft Windows XP operating system. (The supplicant is sometimes called the client.)
- **Authentication server**—Device that performs the actual authentication of the supplicant. The authentication server validates the identity of the supplicant and notifies the router whether or not the supplicant is authorized to access the LAN and switch services. The Network Access Device transparently passes the authentication messages between the supplicant and the authentication server, and the authentication process is carried out between the supplicant and the authentication server. The particular EAP method used will be decided between the supplicant and the authentication server (RADIUS server). The RADIUS security system with EAP extensions is available in Cisco Secure Access Control Server Version 3.0 or later. RADIUS operates in a client and server model in which secure authentication information is exchanged between the RADIUS server and one or more RADIUS clients.
- **Authenticator**—Router that controls the physical access to the network based on the authentication status of the supplicant. The router acts as an intermediary between the supplicant and the authentication server, requesting identity information from the supplicant, verifying that information with the authentication server, and relaying a response to the supplicant. The router includes the RADIUS client, which is responsible for encapsulating and decapsulating the EAP frames and interacting with the authentication server.

For detailed information on how to configure 802.1x port-based authentication, see the following link:

[http://www.cisco.com/c/en/us/td/docs/ios-xml/ios/sec\\_usr\\_8021x/configuration/15-mt/sec-user-8021x-15-mt-book/config-ieee-802x-pba.html](http://www.cisco.com/c/en/us/td/docs/ios-xml/ios/sec_usr_8021x/configuration/15-mt/sec-user-8021x-15-mt-book/config-ieee-802x-pba.html)

Example: Enabling IEEE 802.1x and AAA on a Switch Port

This example shows how to configure Cisco 1100 series router as 802.1x authenticator:

```
Router> enable
Router# configure terminal
Router(config)# dot1x system-auth-control
Router(config)# aaa new-model
Router(config)# aaa authentication dot1x default group radius
Router(config)# interface gigabitethernet 0/1/0
Router(config-if)# switchport mode access
Router(config-if)# access-session port-control auto
Router(config-if)# dot1x pae authenticator
Router(config-if)# access-session closed
Router(config-if)# access-session host-mode single-host
Router(config-if)# end
```

## Configuring Spanning Tree Protocol

Spanning Tree Protocol (STP) is a Layer 2 link management protocol that provides path redundancy while preventing loops in the network. For a Layer 2 Ethernet network to function properly, only one active path can exist between any two stations. Multiple active paths among end stations cause loops in the network. If a loop exists in the network, end stations might receive duplicate messages. Switches might also learn end-station MAC addresses on multiple Layer 2 interfaces. These conditions result in an unstable network. Spanning-tree operation is transparent to end stations, which cannot detect whether they are connected to a single LAN segment or a switched LAN of multiple segments.

The STP uses a spanning-tree algorithm to select one switch of a redundantly connected network as the root of the spanning tree. The algorithm calculates the best loop-free path through a switched Layer 2 network by assigning a role to each port based on the role of the port in the active topology:

- Root—A forwarding port elected for the spanning-tree topology
- Designated—A forwarding port elected for every switched LAN segment
- Alternate—A blocked port providing an alternate path to the root bridge in the spanning tree
- Backup—A blocked port in a loopback configuration

The switch that has all of its ports as the designated role or as the backup role is the root switch. The switch that has at least one of its ports in the designated role is called the designated switch. Spanning tree forces redundant data paths into a standby (blocked) state. If a network segment in the spanning tree fails and a redundant path exists, the spanning-tree algorithm recalculates the spanning-tree topology and activates the standby path. Switches send and receive spanning-tree frames, called bridge protocol data units (BPDUs), at regular intervals. The switches do not forward these frames but use them to construct a loop-free path. BPDUs contain information about the sending switch and its ports, including switch and MAC addresses, switch priority, port priority, and path cost. Spanning tree uses this information to elect the root switch and root port for the switched network and the root port and designated port for each switched segment.

When two ports on a switch are part of a loop, the spanning-tree port priority and path cost settings control which port is put in the forwarding state and which is put in the blocking state. The spanning-tree port priority

value represents the location of a port in the network topology and how well it is located to pass traffic. The path cost value represents the media speed.

For detailed configuration information on STP see the following link:

[http://www.cisco.com/c/en/us/td/docs/routers/access/interfaces/NIM/software/configuration/guide/4\\_8PortGENIM.html#pgfId-1079138](http://www.cisco.com/c/en/us/td/docs/routers/access/interfaces/NIM/software/configuration/guide/4_8PortGENIM.html#pgfId-1079138)

#### Example: Spanning Tree Protocol Configuration

The following example shows configuring spanning-tree port priority of a Gigabit Ethernet interface. If a loop occurs, spanning tree uses the port priority when selecting an interface to put in the forwarding state.

```
Router# configure terminal
Router(config)# interface gigabitethernet 0/1/0
Router(config-if)# spanning-tree vlan 1 port-priority 64
Router(config-if)# end
```

The following example shows how to change the spanning-tree port cost of a Gigabit Ethernet interface. If a loop occurs, spanning tree uses cost when selecting an interface to put in the forwarding state.

```
Router#configure terminal
Router(config)# interface gigabitethernet 0/1/0
Router(config-if)# spanning-tree cost 18
Router(config-if)# end
```

The following example shows configuring the bridge priority of VLAN 10 to 33792:

```
Router# configure terminal
Router(config)# spanning-tree vlan 10 priority 33792
Router(config)# end
```

The following example shows configuring the hello time for VLAN 10 being configured to 7 seconds. The hello time is the interval between the generation of configuration messages by the root switch.

```
Router# configure terminal
Router(config)# spanning-tree vlan 10 hello-time 7
Router(config)# end
```

The following example shows configuring forward delay time. The forward delay is the number of seconds an interface waits before changing from its spanning-tree learning and listening states to the forwarding state.

```
Router# configure terminal
Router(config)# spanning-tree vlan 10 forward-time 21
Router(config)# end
```

The following example shows configuring maximum age interval for the spanning tree. The maximum-aging time is the number of seconds a switch waits without receiving spanning-tree configuration messages before attempting a reconfiguration.

```
Router# configure terminal
Router(config)# spanning-tree vlan 20 max-age 36
Router(config)# end
```

The following example shows the switch being configured as the root bridge for VLAN 10, with a network diameter of 4.

```
Router# configure terminal
Router(config)# spanning-tree vlan 10 root primary diameter 4
Router(config)# exit
```

## Configuring MAC Address Table Manipulation

The MAC address table contains address information that the switch uses to forward traffic between ports. All MAC addresses in the address table are associated with one or more ports. The address table includes these types of addresses:

- **Dynamic address:** a source MAC address that the switch learns and then drops when it is not in use. You can use the aging time setting to define how long the switch retains unseen addresses in the table.
- **Static address:** a manually entered unicast address that does not age and that is not lost when the switch resets.

The address table lists the destination MAC address, the associated VLAN ID, and port associated with the address and the type (static or dynamic).

See the “Example: MAC Address Table Manipulation” for sample configurations for enabling secure MAC address, creating a static entry, set the maximum number of secure MAC addresses and set the aging time.

For detailed configuration information on MAC address table manipulation see the following link:

[http://www.cisco.com/c/en/us/td/docs/routers/access/interfaces/software/feature/guide/geshwic\\_cfg.html#wp1048223](http://www.cisco.com/c/en/us/td/docs/routers/access/interfaces/software/feature/guide/geshwic_cfg.html#wp1048223)

### Example: MAC Address Table Manipulation

The following example shows creating a static entry in the MAC address table.

```
Router# configure terminal
Router(config)# mac address-table static 0002.0003.0004 interface GigabitEthernet 0/1/0
vlan 3
Router(config)# end
```

The following example shows setting the aging timer.

```
Router# configure terminal
Router(config)# mac address-table aging-time 300
Router(config)# end
```

## Configuring Switch Port Analyzer

Cisco 1100 Series ISRs support local SPAN only, and upto one SPAN session. You can analyze network traffic passing through ports by using SPAN to send a copy of the traffic to another port on the switch or on another switch that has been connected to a network analyzer or other monitoring or security device. SPAN copies (or mirrors) traffic received or sent (or both) on source ports to a destination port for analysis. SPAN does not affect the switching of network traffic on the source ports. You must dedicate the destination port for SPAN use. Except for traffic that is required for the SPAN or RSPAN session, destination ports do not receive or forward traffic.

Only traffic that enters or leaves source ports or traffic that enters or leaves source can be monitored by using SPAN; traffic routed to a source cannot be monitored. For example, if incoming traffic is being monitored, traffic that gets routed from another source cannot be monitored; however, traffic that is received on the source and routed to another can be monitored.

For detailed information on how to configure a switched port analyzer (SPAN) session, see the following web link:



[http://www.cisco.com/c/en/us/td/docs/switches/lan/catalyst3750/software/release/15-0\\_2\\_se/configuration/guide/scg3750/swspan.html](http://www.cisco.com/c/en/us/td/docs/switches/lan/catalyst3750/software/release/15-0_2_se/configuration/guide/scg3750/swspan.html)

#### Example: SPAN Configuration

The following example shows how to configure a SPAN session to monitor bidirectional traffic from a Gigabit Ethernet source interface:

```
Router# configure terminal
Router(config)# monitor session 1 source gigabitethernet 0/1/0
Router(config)# end
```

The following example shows how to configure a gigabit ethernet interface as the destination for a SPAN session:

```
Router# configure terminal
Router(config)# monitor session 1 destination gigabitethernet 0/1/0
Router(config)# end
```

The following example shows how to remove gigabit ethernet as a SPAN source for SPAN session 1:

```
Router# configure terminal
Router(config)# no monitor session 1 source gigabitethernet 0/1/0
Router(config)# end
```

## Configuring IGMP Snooping

IGMP snooping constrains the flooding of multicast traffic by dynamically configuring Layer 2 interfaces so that multicast traffic is forwarded to only those interfaces associated with IP multicast devices. As the name implies, IGMP snooping requires the LAN switch to snoop on the IGMP transmissions between the host and the router and to keep track of multicast groups and member ports. When the switch receives an IGMP report from a host for a particular multicast group, the switch adds the host port number to the forwarding table entry; when it receives an IGMP Leave Group message from a host, it removes the host port from the table entry. It also periodically deletes entries if it does not receive IGMP membership reports from the multicast clients.

The multicast router sends out periodic general queries to all VLANs. All hosts interested in this multicast traffic send join requests and are added to the forwarding table entry.

Use the **[no] ip igmp snooping enable** command to configure IGMP Snooping on Cisco 1100 Series ISRs.

By default, IGMP snooping is globally enabled in Cisco 1100 Series ISRs.

## Configuring HSRP



---

**Note** HSRP is supported only on the SVI interface.

---

The Hot Standby Router Protocol (HSRP) is Cisco's standard method of providing high network availability by providing first-hop redundancy for IP hosts on an IEEE 802 LAN configured with a default gateway IP address. HSRP routes IP traffic without relying on the availability of any single router. It enables a set of

router interfaces to work together to present the appearance of a single virtual router or default gateway to the hosts on a LAN. When HSRP is configured on a network or segment, it provides a virtual Media Access Control (MAC) address and an IP address that is shared among a group of configured routers. HSRP allows two or more HSRP-configured routers to use the MAC address and IP network address of a virtual router. The virtual router does not exist; it represents the common target for routers that are configured to provide backup to each other. One of the routers is selected to be the active router and another to be the standby router, which assumes control of the group MAC address and IP address should the designated active router fail.

HSRP uses a priority mechanism to determine which HSRP configured device is to be the default active device. To configure a device as the active device, you assign it a priority that is higher than the priority of all the other HSRP-configured devices. The default priority is 100, so if you configure just one device to have a higher priority, that device will be the default active device. In case of ties, the primary IP addresses are compared, and the higher IP address has priority. If you do not use the standby preempt interface configuration command in the configuration for a router, that router will not become the active router, even if its priority is higher than all other routers.

For more information about configuring HSRP, see the following link:

[http://www.cisco.com/c/en/us/td/docs/ios-xml/ios/ipapp\\_fhrp/configuration/15-mt/fhp-15-mt-book/fhp-hsrp.html](http://www.cisco.com/c/en/us/td/docs/ios-xml/ios/ipapp_fhrp/configuration/15-mt/fhp-15-mt-book/fhp-hsrp.html)

#### Example: Configuring HSRP

In this example, Router A is configured to be the active device for group 1 and standby device for group 2. Device B is configured as the active device for group 2 and standby device for group 1.

```
RouterA# configure terminal
RouterA(config)# interface vlan 2
RouterA(config-if)# ip address 10.1.0.21 255.255.0.0
RouterA(config-if)# standby 1 priority 110
RouterA(config-if)# standby 1 preempt
RouterA(config-if)# standby 1 ip 10.1.0.3
RouterA(config-if)# standby 2 priority 95
RouterA(config-if)# standby 2 preempt
RouterA(config-if)# standby 2 ip 10.1.0.4
RouterA(config-if)# end

RouterB# configure terminal
RouterB(config)# interface vlan 2
RouterB(config-if)# ip address 10.1.0.22 255.255.0.0
RouterB(config-if)# standby 1 priority 105
RouterB(config-if)# standby 1 preempt
RouterB(config-if)# standby 1 ip 10.1.0.3
RouterB(config-if)# standby 2 priority 110
RouterB(config-if)# standby 2 preempt
RouterB(config-if)# standby 2 ip 10.1.0.4
```

## Configuring VRRP

The Virtual Router Redundancy Protocol (VRRP) is an election protocol that dynamically assigns responsibility for one or more virtual routers to the VRRP routers on a LAN, allowing several routers on a multiaccess link to utilize the same virtual IP address. A VRRP router is configured to run the VRRP protocol in conjunction with one or more other routers attached to a LAN. In a VRRP configuration, one router is elected as the primary virtual router, with the other routers acting as backups in case the primary virtual router fails.

An important aspect of the VRRP is VRRP router priority. Priority determines the role that each VRRP router plays and what happens if the primary virtual router fails. If a VRRP router owns the IP address of the virtual router and the IP address of the physical interface, this router will function as a primary virtual router. Priority

also determines if a VRRP router functions as a virtual router backup and the order of ascendancy to becoming a primary virtual router if the primary virtual router fails. You can configure the priority of each virtual router backup using the `vrrp priority` command.

By default, a preemptive scheme is enabled whereby a higher priority virtual router backup that becomes available takes over for the virtual router backup that was elected to become primary virtual router. You can disable this preemptive scheme using the `no vrrp preempt` command. If preemption is disabled, the virtual router backup that is elected to become virtual router primary remains the primary until the original primary virtual router recovers and becomes primary again.

The primary virtual router sends VRRP advertisements to other VRRP routers in the same group. The advertisements communicate the priority and state of the primary virtual router. The VRRP advertisements are encapsulated in IP packets and sent to the IP Version 4 multicast address assigned to the VRRP group. The advertisements are sent every second by default; the interval is configurable.

For more information on VRRP, see the following link:

[http://www.cisco.com/c/en/us/td/docs/ios-xml/ios/ipapp\\_fhrp/configuration/15-mt/fhp-15-mt-book/fhp-vrrp.html](http://www.cisco.com/c/en/us/td/docs/ios-xml/ios/ipapp_fhrp/configuration/15-mt/fhp-15-mt-book/fhp-vrrp.html)

#### Example: Configuring VRRP

In the following example, Router A and Router B each belong to two VRRP groups, group1 and group 5. In this configuration, each group has the following properties:

##### Group 1:

- Virtual IP address is 10.1.0.10.
- Router A will become the primary for this group with priority 120.
- Advertising interval is 3 seconds.
- Preemption is enabled.

##### Group 5:

- Router B will become the primary for this group with priority 200.
- Advertising interval is 30 seconds.
- Preemption is enabled.

```
RouterA(config)# interface vlan 2
RouterA(config-if)# ip address 10.1.0.2 255.0.0.0
RouterA(config-if)# vrrp 1 priority 120
RouterA(config-if)# vrrp 1 authentication cisco
RouterA(config-if)# vrrp 1 timers advertise 3
RouterA(config-if)# vrrp 1 timers learn
RouterA(config-if)# vrrp 1 ip 10.1.0.10
RouterA(config-if)# vrrp 5 priority 100
RouterA(config-if)# vrrp 5 timers advertise 30
RouterA(config-if)# vrrp 5 timers learn
RouterA(config-if)# vrrp 5 ip 10.1.0.50
RouterA(config-if)# no shutdown
RouterA(config-if)# end
RouterB(config)# interface vlan 2
RouterB(config-if)# ip address 10.1.0.1 255.0.0.0
RouterB(config-if)# vrrp 1 priority 100
RouterB(config-if)# vrrp 1 authentication cisco
RouterB(config-if)# vrrp 1 timers advertise 3
RouterB(config-if)# vrrp 1 timers learn
RouterB(config-if)# vrrp 1 ip 10.1.0.10
```

```
RouterB(config-if)# vrrp 5 priority 200
RouterB(config-if)# vrrp 5 timers advertise 30
RouterB(config-if)# vrrp 5 timers learn
RouterB(config-if)# vrrp 5 ip 10.1.0.50
RouterB(config-if)# no shutdown
RouterB(config-if)# end
```



# CHAPTER 16

## Slot and Subslot Configuration

This chapter contains the following sections:

- [Configuring the Interfaces, on page 291](#)

### Configuring the Interfaces

The following sections describe how to configure interfaces and also provide examples of configuring the router interfaces:

#### Configuring the Interfaces: Example

The following example shows the **interface gigabitEthernet** command being used to add the interface and set the IP address. **0/0/0** is the slot/subslot/port. The ports are numbered 0 to 3.

```
Router# show running-config interface gigabitEthernet 0/0/0
Building configuration...
Current configuration : 71 bytes
!
interface gigabitEthernet0/0/0
no ip address
negotiation auto
end

Router# configure terminal
Enter configuration commands, one per line. End with CNTL/Z.
Router(config)# interface gigabitEthernet 0/0/0
```

#### Viewing a List of All Interfaces: Example

In this example, **show interfaces summary** command is used to display all the interfaces:

```
Router# show interfaces summary
*: interface is up
IHQ: pkts in input hold queue IQD: pkts dropped from input queue
OHQ: pkts in output hold queue OQD: pkts dropped from output queue
RXBS: rx rate (bits/sec) RXPS: rx rate (pkts/sec)
TXBS: tx rate (bits/sec) TXPS: tx rate (pkts/sec)
TRTL: throttle count

Interface
TXBS TXPS TRTL IHQ IQD OHQ OQD RXBS RXPS
```

## Viewing Information About an Interface: Example

```

* GigabitEthernet0/0/0 0 0 0 0 0 0
 0 0 0
* GigabitEthernet0/0/1 0 0 0 0 0 0
 0 0 0
* GigabitEthernet0/1/0 0 0 0 0 0 0
 0 0 0
* GigabitEthernet0/1/1 0 0 0 0 0 0
 0 0 0
* GigabitEthernet0/1/2 0 0 0 0 0 0
 0 0 0
* GigabitEthernet0/1/3 0 0 0 0 0 0
 0 0 0

Interface IHQ IQD OHQ OQD RXBS RXPS
TXBS TXPS TRTL

* GigabitEthernet0/1/4 0 0 0 0 0 0
 0 0 0
* GigabitEthernet0/1/5 0 0 0 0 0 0
 0 0 0
* GigabitEthernet0/1/6 0 0 0 0 0 0
 0 0 0
* GigabitEthernet0/1/7 0 0 0 0 0 0
 0 0 0
* W10/1/8 0 0 0 0 0 0
 0 0 0
* Cellular0/2/0 0 0 0 0 0 0
 0 0 0
 Cellular0/2/1 0 0 0 0 0 0
 0 0 0
* Loopback3 0 0 0 0 0 0
 0 0 0
* Loopback50 0 0 0 0 0 0
 0 0 0
* Loopback100 0 0 0 0 0 0
 0 0 0
* Loopback544534 0 0 0 0 0 0
 0 0 0

```

## Viewing Information About an Interface: Example

The following example shows how to display a brief summary of an interface's IP information and status, including the virtual interface bundle information, by using the **show ip interface brief** command:

```

Router# show ip interface brief
Interface IP-Address OK? Method Status Protocol
GigabitEthernet0/0/0 192.168.1.46 YES NVRAM up up
GigabitEthernet0/0/1 15.15.15.1 YES NVRAM up up
GigabitEthernet0/1/0 unassigned YES unset up up
GigabitEthernet0/1/1 unassigned YES unset up up
GigabitEthernet0/1/2 unassigned YES unset up up
GigabitEthernet0/1/3 unassigned YES unset up up
GigabitEthernet0/1/4 unassigned YES unset up up
GigabitEthernet0/1/5 unassigned YES unset up up
GigabitEthernet0/1/6 unassigned YES unset up up
GigabitEthernet0/1/7 unassigned YES unset up up
W10/1/8 unassigned YES unset up up
Cellular0/2/0 unassigned YES NVRAM up up
Cellular0/2/1 unassigned YES NVRAM administratively down down
Loopback3 unassigned YES unset up up
Loopback50 5.5.5.5 YES NVRAM up up
Loopback100 unassigned YES unset up up

```

|                  |            |     |       |      |      |
|------------------|------------|-----|-------|------|------|
| Loopback544534   | unassigned | YES | unset | up   | up   |
| Loopback32432532 | unassigned | YES | unset | up   | up   |
| Port-channel2    | unassigned | YES | unset | down | down |
| Vlan1            | 10.10.10.1 | YES | NVRAM | up   | up   |







## CHAPTER 17

# Online Insertion and Removal

Online insertion and removal (OIR) enables you to replace faulty modules without affecting system operation. There is only soft OIR, which is done via CLI.

- [Soft OIR Procedures, on page 295](#)
- [Manage OIR for Pluggable LTE Modules, on page 295](#)

## Soft OIR Procedures

The following describes the soft OIR procedures:

```
Router# hw-module subslot 0/0 start
client#
*Oct 26 21:50:22.272: %IOSXE_OIR-6-SOFT_STARTSPA: SPA(C1111-2x1GE) restarted in subslot 0/0
client#
*Oct 26 21:50:28.553: %SPA_OIR-6-ONLINECARD: SPA (C1111-2x1GE) online in subslot 0/0

Router# hw-module subslot 0/0 stop
Proceed with stop of module? [confirm]

*Oct 26 21:50:15.498: %SPA_OIR-6-OFFLINECARD: SPA (C1111-2x1GE) offline in subslot 0/0
*Oct 26 21:50:15.499: %IOSXE_OIR-6-SOFT_STOPSPA: SPA(C1111-2x1GE) stopped in subslot 0/0,
interfaces disabled

Router# hw-module subslot 0/0 reload
Proceed with reload of module? [confirm]
Router#
*Nov 6 17:23:58.176: %IOSXE_OIR-6-SOFT_RELOADSPA: SPA(C1111-2x1GE) reloaded on subslot 0/0
*Nov 6 17:23:58.179: %SPA_OIR-6-OFFLINECARD: SPA (C1111-2x1GE) offline in subslot 0/0
*Nov 6 17:24:09.320: %SPA_OIR-6-ONLINECARD: SPA (C1111-2x1GE) online in subslot 0/0
```

## Manage OIR for Pluggable LTE Modules

To replace a faulty pluggable module, or to swap a module when the system is in operation, use the following CLI:

**hw-module subslot <subslot> stop**

Wait for the module to power off and then remove the module. Insert another pluggable LTE module into the slot, which is automatically detected, powers-up, and is authenticated.

```
Router# hw-module subslot 0/2 stop
Proceed with stop of module? [confirm]

Router#
*Oct 26 21:50:15.498: %SPA_OIR-6-OFFLINECARD: SPA (C1111-2x1GE) offline in subslot 0/2
*Oct 26 21:50:15.499: %IOSXE_OIR-6-SOFT_STOPSPA: SPA(C1111-2x1GE) stopped in subslot 0/2,
interfaces disabled
```



## CHAPTER 18

# Cisco Multimode G.SHDSL EFM-ATM in Cisco ISR 1000 Series Routers

G.SHDSL is the technology that allows devices to send and receive high-speed symmetrical data streams over a single pair of copper wires at rates between 192 kbps and 15.36 Mbps. This document describes how to configure Cisco G.SHDSL Ethernet in the first mile (EFM) and Asynchronous Transfer Mode (ATM). Cisco G.SHDSL EFM/ATM Network Interface Module (NIM) connects Cisco ISR 1000 Series Routers with central office Digital Subscriber Line Access Multiplexers (DSLAMs) and provides up to four lines of G.SHDSL (ITU-T 991.2) connectivity.

- [Connecting Cisco G.SHDSL EFM or ATM to the Network, on page 297](#)
- [Cisco G.SHDSL EFM or ATM, on page 297](#)
- [Configuring Cisco G.SHDSL EFM or ATM in CPE/CO Mode, on page 298](#)
- [Configuring NIM-4SHDSL-EA as CPE, on page 298](#)
- [Configuring Bonding on CPE, on page 298](#)
- [Additional References, on page 299](#)

## Connecting Cisco G.SHDSL EFM or ATM to the Network

For connecting Cisco G.SHDSL EFM/ATM NIMs to a network, see the section about connecting an interface card to a network in [Connecting DSL WAN Interface Cards](#).

## Cisco G.SHDSL EFM or ATM

Cisco G.SHDSL EFM/ATM NIM support up to four pairs of digital subscriber lines (DSL). The DSL pairs are bundled in groups and configured in the Cisco IOS command-line interface (CLI) by using the `dsl-group` command. Selecting the mode (ATM or EFM) is done by using the `mode` command.

The NIM supports the following features:

- You can configure up to 4 DSL groups.
- Auto mode is supported only on one DSL group. For instance, DSL group 0.
- In ATM mode, the NIM supports maximum throughput of 22.7Mbps; each line supports 5704kbps.
- In EFM mode, the NIM supports maximum throughput of 61.4Mbps; each line supports maximum of 15Mbps with 128-TCPAM.

- In EFM mode, you can configure a DSL group with any one of the lines in 2-wire non-bonding mode or with multiple lines in bonding mode.
- Depending on the mode (ATM or EFM), the corresponding interface (ATM or EFM) is automatically created.

## Configuring Cisco G.SHDSL EFM or ATM in CPE/CO Mode

You can configure the NIM in termination mode (either in CPE or CO). NIM in CO mode supports only limited features:

### Configuring NIM-4SHDSL-EA as CPE

This section describes the following topics:

The following example shows how to configure Termination CPE.



**Note** The default termination is CPE.

```
Router# conf t
Router(config)# controller shdsl 0/1/0
Router(config-controller)# termination cpe
```

### Configuring Bonding on CPE

To ensure a successful bonding group in the ATM mode configuration, confirm that the central office (CO) network equipment that is connected with the Cisco NIM-4SHDSL-EA is also configured with the same bonding group type.

The following example shows how to configure an ATM M-pair bonding on CPE:

```
Router(config)# controller shdsl 0/1/0 Router(config-controller)# termination cpe
Router(config-controller)# mode atm
Router(config-controller)# dsl-group 0 pairs 0-3 m-pair
Router(config-controller-dsl-group)#
M-pair mode should be either one of these:
o 0-1
o 0-2
o 0-3
o 2-3
```

The following example shows how to configure an EFM bonding on CPE:

```
Router(config)# controller shdsl 0/1/0 Router(config-controller)# termination cpe
Router(config-controller)# mode efm
Router(config-controller)# dsl-group 0 pairs 0 efm-bond
Router(config-controller-dsl-group)#
```

## Verify the Configuration

The following example shows the output of a 2-wire configuration in ATM mode:

```
Router# show controllers shdsl 0/1/0
Controller SHDSL 0/1/0 is UP
Hardware is NIM-4SHDSL-EA, on slot 0,bay 0 Capabilities: EFM: 2-wire, EFM-Bond, Annex A,
B, F & G
ATM: 2-wire, Mpair, Annex A, B, F & G CPE termination
Configured Mode: ATM cdb=0x7F7ED60CF480
...
...
...
ATM Stats:
ATM-TC Tx: data cells: 0, Idle/Unassigned: 0 ATM-TC Rx: data cells: 0, uncorr HEC: 0
ATM-TC Rx: OCD: 0, LCD start: 0, LCD end: 0
Group 1 is not configured Group 2 is not configured
```

## Additional References

The following sections provide references related to the power efficiency management feature.

### MIBs

| MIBs                         | MIBs Link                                                                                                                                                                                                                                                                                              |
|------------------------------|--------------------------------------------------------------------------------------------------------------------------------------------------------------------------------------------------------------------------------------------------------------------------------------------------------|
| CISCO-ENTITY-FRU-CONTROL-MIB | To locate and download MIBs for selected platforms, Cisco IOS releases, and feature sets, use the Cisco MIB Locator at: <a href="http://www.cisco.com/go/mibs">http://www.cisco.com/go/mibs</a> .<br><br>Also see the "MIB Specifications Guide for the Cisco 1100 Series Integrated Service Routers". |

## Technical Assistance

| Description                                                                                                                                                                                                                                                                                                                                                                                                                                                                                                                                                             | Link                                                                                                              |
|-------------------------------------------------------------------------------------------------------------------------------------------------------------------------------------------------------------------------------------------------------------------------------------------------------------------------------------------------------------------------------------------------------------------------------------------------------------------------------------------------------------------------------------------------------------------------|-------------------------------------------------------------------------------------------------------------------|
| <p>The Cisco Support website provides extensive online resources, including documentation and tools for troubleshooting and resolving technical issues with Cisco products and technologies.</p> <p>To receive security and technical information about your products, you can subscribe to various services, such as the Product Alert Tool (accessed from Field Notices), the Cisco Technical Services Newsletter, and Really Simple Syndication (RSS) Feeds.</p> <p>Access to most tools on the Cisco Support website requires a Cisco.com user ID and password.</p> | <a href="http://www.cisco.com/cisco/web/support/index.html">http://www.cisco.com/cisco/web/support/index.html</a> |





# CHAPTER 19

## Configuring SFP Auto-Failover

This chapter contains the following sections:

- [Enabling Auto-Detect, on page 301](#)

### Enabling Auto-Detect

When the media-type is not configured, the Auto-Detect feature is enabled by default. The Auto-Detect feature automatically detects the media that is connected and links up. If both the media are connected, whichever media comes up first is linked. By default, the media-type on FPGE ports is set to auto-select. User can overwrite the media-type configuration to either RJ-45 or SFP using the **media-type rj45/sfp** command under the FPGE interface. The media type configuration also falls back to “Auto-select” mode when the **no media-type** command is configured. You can use the **no media-type** command in interface configuration mode to enable the Auto-Detect feature.

### Configuring Auto-Detect

The Auto-Detect feature is enabled by default on the Front Panel Gige Ports. Auto-Failure is enabled by default when auto-select is enabled. To configure the Auto-Detect, perform these steps:

#### Procedure

|               | Command or Action                                                                                                          | Purpose                                                                 |
|---------------|----------------------------------------------------------------------------------------------------------------------------|-------------------------------------------------------------------------|
| <b>Step 1</b> | <b>configure terminal</b><br><b>Example:</b><br>Router# configure terminal                                                 | Enters global configuration mode.                                       |
| <b>Step 2</b> | <b>interface gigabitethernet {slot   bay   port}</b><br><b>Example:</b><br>Router(config)# interface gigabitethernet 0/0/0 | Enters interface configuration mode.                                    |
| <b>Step 3</b> | <b>media-type auto-select</b><br><b>Example:</b>                                                                           | Auto-select mode uses whichever connector is attached. The options are: |

|               | Command or Action                                      | Purpose                                                                                                                                                      |
|---------------|--------------------------------------------------------|--------------------------------------------------------------------------------------------------------------------------------------------------------------|
|               | Router(config-if)# media-type auto-select              | <ul style="list-style-type: none"> <li>• <b>rj45</b>—Uses RJ45 connector.</li> <li>• <b>sfp</b>—Uses SFP connector.</li> <li>• <b>auto-select</b></li> </ul> |
| <b>Step 4</b> | <b>End</b><br><b>Example:</b><br>Router(config-if)#end | Exits configuration mode.                                                                                                                                    |

### Examples

The following example shows the default configuration and the show running configuration does not show any media type when the no media-type is selected.

```
Router(config)# show running interface gigabitethernet 0/0/0
Building configuration...

Current configuration : 71 bytes
!
interface GigabitEthernet0/0/0
 no ip address
 negotiation auto
end
```

## Configuring the Primary and Secondary Media

When the router receives an indication that the primary media is down, the secondary failover media is enabled. After the switchover, the media does not switch back to primary media when the primary media is restored. You need to use either **shut** or **no shut** command or reload the module to switch the media-type back to primary(preferred) media.

To assign the primary or secondary failover media on the GE-SFP port, perform these steps:

### Procedure

|               | Command or Action                                                                                                                  | Purpose                              |
|---------------|------------------------------------------------------------------------------------------------------------------------------------|--------------------------------------|
| <b>Step 1</b> | <b>configure terminal</b><br><b>Example:</b><br>Router# configure terminal                                                         | Enters global configuration mode.    |
| <b>Step 2</b> | <b>interface gigabitethernet {slot   bay   port}</b><br><b>Example:</b><br>Router(config)# interface gigabitethernet slot/bay/port | Enters interface configuration mode. |



|               | Command or Action                                                                                            | Purpose                                                                    |
|---------------|--------------------------------------------------------------------------------------------------------------|----------------------------------------------------------------------------|
| <b>Step 3</b> | <b>media-type rj45 autofailover</b><br><b>Example:</b><br>Router(config-if)# media-type rj45<br>autofailover | Configures the port with rj45 as the primary media for automatic failover. |
| <b>Step 4</b> | <b>End</b><br><b>Example:</b><br>Router(config-if)#end                                                       | Exits configuration mode.                                                  |

### Examples

The following example shows the primary configuration.

```
Router(config)# show running interface gigabitethernet 0/0/0
Building configuration...

Current configuration : 102 bytes
!
interface GigabitEthernet0/0/0
 no ip address
 media-type rj45 auto-failover
 negotiation auto
end
```





## CHAPTER 20

# Configuring Cellular IPv6 Address

This chapter contains the following sections:

- [Cellular IPv6 Address, on page 305](#)

## Cellular IPv6 Address

IPv6 addresses are represented as a series of 16-bit hexadecimal fields separated by colons (:) in the format: x:x:x:x:x:x:x. Following are two examples of IPv6 addresses:

- 2001:CDBA:0000:0000:0000:0000:3257:9652
- 2001:CDBA::3257:9652 (zeros can be omitted)

IPv6 addresses commonly contain successive hexadecimal fields of zeros. Two colons (::) may be used to compress successive hexadecimal fields of zeros at the beginning, middle, or end of an IPv6 address (the colons represent successive hexadecimal fields of zeros). The table below lists compressed IPv6 address formats.

An IPv6 address prefix, in the format ipv6-prefix/prefix-length, can be used to represent bit-wise contiguous blocks of the entire address space. The ipv6-prefix must be in the form documented in RFC 2373 where the address is specified in hexadecimal using 16-bit values between colons. The prefix length is a decimal value that indicates how many of the high-order contiguous bits of the address comprise the prefix (the network portion of the address). For example, 2001:cdba::3257:9652 /64 is a valid IPv6 prefix.

## IPv6 Unicast Routing

An IPv6 unicast address is an identifier for a single interface, on a single node. A packet that is sent to a unicast address is delivered to the interface identified by that address.

Cisco 1100 Series supports the following address types:

### Link-Lock Address

A link-local address is an IPv6 unicast address that can be automatically configured on any interface using the link-local prefix FE80::/10 (1111 1110 10) and the interface identifier in the modified EUI-64 format. An link-local address is automatically configured on the cellular interface when an IPv6 address is enabled.

After the data call is established, the link-local address on the cellular interface is updated with the host generated link-local address that consists of the link-local prefix FF80::/10 (1111 1110 10) and the auto-generated

interface identifier from the USB hardware address. The figure below shows the structure of a link-local address.

## Global Address

A global IPv6 unicast address is defined by a global routing prefix, a subnet ID, and an interface ID. The routing prefix is obtained from the PGW. The Interface Identifier is automatically generated from the USB hardware address using the interface identifier in the modified EUI-64 format. The USB hardware address changes after the router reloads.

## Configuring Cellular IPv6 Address

To configure the cellular IPv6 address, perform these steps:

### Procedure

|               | Command or Action                                                                                      | Purpose                                                                           |
|---------------|--------------------------------------------------------------------------------------------------------|-----------------------------------------------------------------------------------|
| <b>Step 1</b> | <b>configure terminal</b><br><b>Example:</b><br>Router# configure terminal                             | Enters global configuration mode.                                                 |
| <b>Step 2</b> | <b>interface Cellular {type number}</b><br><b>Example:</b><br>Router(config)# interface cellular 0/1/0 | Specifies the cellular interface.                                                 |
| <b>Step 3</b> | ip address negotiated<br><b>Example:</b><br>Router(config-if)# ipv6 address negotiated                 | Specifies that the IP address for a particular interface is dynamically obtained. |
| <b>Step 4</b> | load-interval <i>seconds</i><br><b>Example:</b><br>Router(config-if)# load-interval 30                 | Specifies the length of time for which data is used to compute load statistics.   |
| <b>Step 5</b> | dialer in-band<br><b>Example:</b><br>Router(config-if)# dialer in-band                                 | Enables DDR and configures the specified serial interface to use in-band dialing. |
| <b>Step 6</b> | dialer idle-timeout <i>seconds</i><br><b>Example:</b><br>Router(config-if)# dialer idle-timeout 0      | Specifies the dialer idle timeout period.                                         |
| <b>Step 7</b> | dialer string <i>string</i><br><b>Example:</b><br>Router(config-if)# dialer string lte                 | Specifies the number or string to dial.                                           |

|                | <b>Command or Action</b>                                                                                                                                                                                                                                   | <b>Purpose</b>                                                                                                                                     |
|----------------|------------------------------------------------------------------------------------------------------------------------------------------------------------------------------------------------------------------------------------------------------------|----------------------------------------------------------------------------------------------------------------------------------------------------|
| <b>Step 8</b>  | <b>dialer-group</b><br><b>group-number</b><br><br><b>Example:</b><br>Router(config-if)# dialer-group 1                                                                                                                                                     | Specifies the number of the dialer access group to which the specific interface belongs.                                                           |
| <b>Step 9</b>  | no peer default ip address<br><br><b>Example:</b><br>Router(config-if)# no peer default ip address                                                                                                                                                         | Removes the default address from your configuration.                                                                                               |
| <b>Step 10</b> | ipv6 address autoconfig<br><br><b>Example:</b><br>Router(config-if)# ipv6 address autoconfig                                                                                                                                                               | Enables automatic configuration of IPv6 addresses using stateless autoconfiguration on an interface and enables IPv6 processing on the interface.  |
| <b>Step 11</b> | async mode interactive<br><br><b>Example:</b><br>Router(config-if)# async mode interactive                                                                                                                                                                 | Please provide the inputs?                                                                                                                         |
| <b>Step 12</b> | routing dynamic<br><br><b>Example:</b><br>Router(config-if)#routing dynamic                                                                                                                                                                                | Enables the router to pass routing updates to other routers through an interface.                                                                  |
| <b>Step 13</b> | <b>dialer-list</b><br><b>dialer-group</b><br><b>protocol</b><br><b>protocol-name</b><br><b>{permit  deny list</b><br><b> access-list-number  </b><br><b>access-group }</b><br><br><b>Example:</b><br>Router(config)# dialer-list 1 protocol<br>ipv6 permit | Defines a dial-on-demand routing (DDR) dialer list for dialing by protocol or by a combination of a protocol and a previously defined access list. |
| <b>Step 14</b> | <b>ipv6 route</b><br><i>ipv6-prefix/prefix-length 128</i><br><br><b>Example:</b><br>Router(config)#ipv6 route<br>2001:1234:1234::3/128 Cellular0/1/0                                                                                                       |                                                                                                                                                    |
| <b>Step 15</b> | <b>End</b><br><br><b>Example:</b><br>Router (config-if) #end                                                                                                                                                                                               | Exits to global configuration mode.                                                                                                                |

### Examples

The following example shows the Cellular IPv6 configuration .

```
Router(config)# interface Cellular0/0/0
ip address negotiated
load-interval 30
dialer in-band
dialer idle-timeout 0
dialer string lte
dialer-group 1
no peer default ip address
ipv6 address autoconfig
async mode interactive
routing dynamic
!
interface Cellular0/1/0
ip address negotiated
load-interval 30
dialer in-band
dialer idle-timeout 0
dialer string lte
dialer-group 1
no peer default ip address
ipv6 address autoconfig
async mode interactive
routing dynamic

dialer-list 1 protocol ipv6 permit
ipv6 route 2001:1234:1234::/64 Cellular0/1/0
ipv6 route 2001:4321:4321::5/128 Cellular0/1/1
```



## CHAPTER 21

# Prerequisites for Dying Gasp Support

You must enable Ethernet OAM before configuring Simple Network Management Protocol (SNMP) for dying gasp feature. For more information, see [Enabling Ethernet OAM on an Interface](#).

- [Restrictions for Dying Gasp Support, on page 309](#)
- [Information About Dying Gasp Through SNMP, Syslog and Ethernet OAM, on page 309](#)
- [How to Configure Dying Gasp Through SNMP, Syslog and Ethernet OAM, on page 310](#)
- [Configuration Examples for Dying Gasp Through SNMP, Syslog and Ethernet OAM, on page 311](#)
- [Feature Information for Dying Gasp Support, on page 312](#)

## Restrictions for Dying Gasp Support

- The dying gasp feature is not supported if you remove the power supply unit (PSU) from the system.
- SNMP trap is sent only on power failure or removal of power supply cable on selected platforms.
- The dying gasp support feature cannot be configured using CLI. To configure hosts using SNMP, refer to the SNMP host configuration examples below.
- In the case of system reload or interface shutdown on the Cisco 4000 Series ISRs and Cisco 1100 Series ISRs running Cisco IOS-XE Everest Release 16.6.2, dying gasp packets are sent to peer routers. However, the system state is not captured in the system logs (syslogs) or SNMP traps.

## Information About Dying Gasp Through SNMP, Syslog and Ethernet OAM

### Dying Gasp

One of the OAM features as defined by IEEE 802.3ah is Remote Failure Indication, which helps in detecting faults in Ethernet connectivity that are caused by slowly deteriorating quality. Ethernet OAM provides a mechanism for an OAM entity to convey these failure conditions to its peer via specific flags in the OAM PDU. One of the failure condition method to communicate is Dying Gasp, which indicates that an unrecoverable condition has occurred; for example, when an interface is shut down. This type of condition is vendor specific. A notification about the condition may be sent immediately and continuously.

# How to Configure Dying Gasp Through SNMP, Syslog and Ethernet OAM

## Dying Gasp Trap Support for Different SNMP Server Host/Port Configurations



**Note** You can configure up to five different SNMP server host/port configurations.

### Environmental Settings on the Network Management Server

```
setenv SR_TRAP_TEST_PORT=UDP port
setenv SR_UTIL_COMMUNITY=public
setenv SR_UTIL_SNMP_VERSION=v2c
setenv SR_MGR_CONF_DIR=Path to the executable snmpinfo.DAT file
```

The following example shows SNMP trap configuration on the host:

```
Router# configure terminal
Enter configuration commands, one per line. End with CNTL/Z.
Router(config)#
Router(config)# snmp-server host 7.0.0.149 vrf Mgmt-intf version 2c public udp-port 6264
Router(config)#
Router(config)# ^Z
Router#
```

After performing a power cycle, the following output is displayed on the router console:

```
Router#
System Bootstrap, Version 16.6(2r), RELEASE SOFTWARE (fc1)
Technical Support: http://www.cisco.com/techsupport
Copyright (c) 1994-2017 by cisco Systems, Inc.
Current image running: Boot ROM0
Last reset cause: LocalSoft
C1111-8PLTELA platform with 4194304 Kbytes of main memory
rommon 1 >

=====
Dying Gasp Trap Received for the Power failure event:

 Trap on the Host
+++++++

snmp-server host = 7.0.0.149 (nms1-lnx) and SR_TRAP_TEST_PORT=6264
/auto/sw/packages/snmp/15.4.1.9/bin> /auto/sw/packages/snmp/15.4.1.9/bin/traprcv
Waiting for traps.
Received SNMPv2c Trap:
```



```
Community: public
From: 7.29.25.101
snmpTrapOID.0 = ciscoMgmt.305.1.3.5.0.2
ciscoMgmt.305.1.3.6 = Dying Gasp - Shutdown due to power loss
```

## Message Displayed on the Peer Router on Receiving Dying Gasp Notification

```
001689: *May 30 14:16:47.746 IST: %ETHERNET_OAM-6-RFI: The client on interface Gi0/0/0 has
received a remote failure indication from its remote peer(failure reason = remote client
power failure action =)
```

## Displaying SNMP Configuration for Receiving Dying Gasp Notification

Use the show running-config command to display the SNMP configuration for receiving dying gasp notification:

```
Router# show running-config | i snmp
snmp-server community public RW
snmp-server host 7.0.0.149 vrf Mgmt-intf version 2c public udp-port 6264
Router#
```

## Configuration Examples for Dying Gasp Through SNMP, Syslog and Ethernet OAM

### Example: Configuring SNMP Community Strings on a Router

Setting up the community access string to permit access to the SNMP:

```
Router> enable
Router# configure terminal
Router(config)# snmp-server community public RW
Router(config)# exit
```

For more information on command syntax and examples, refer to the Cisco IOS Network Management Command Reference.

### Example: Configuring SNMP-Server Host Details on the Router Console

Specifying the recipient of a SNMP notification operation:

```
Router> enable
Router# configure terminal
Router(config)# snmp-server host X.X.X.XXX vrf mgmt-intf version 2c public udp-port 9800
Router(config)# exit
```

For more information on command syntax and examples, refer to the Cisco IOS Network Management Command Reference.

## Feature Information for Dying Gasp Support

The following table provides release information about the feature or features described in this module. This table lists only the software release that introduced support for a given feature in a given software release train. Unless noted otherwise, subsequent releases of that software release train also support that feature.

Use Cisco Feature Navigator to find information about platform support and Cisco software image support. To access Cisco Feature Navigator, go to [www.cisco.com/go/cfn](http://www.cisco.com/go/cfn). An account on Cisco.com is not required.

**Table 21: Feature Information for Dying Gasp Support**

| Feature Name | Releases                    | Feature Information for                                                                                                                                                                                                                                                                                                                                                                                                              |
|--------------|-----------------------------|--------------------------------------------------------------------------------------------------------------------------------------------------------------------------------------------------------------------------------------------------------------------------------------------------------------------------------------------------------------------------------------------------------------------------------------|
| Dying Gasp   | Cisco IOS XE Release 16.6.2 | Ethernet OAM provides a mechanism for an OAM entity to convey failure conditions to its peer via specific flags in the OAM PDU. One of the failure condition method to communicate is Dying Gasp, which indicates that an unrecoverable condition has occurred; for example, when an interface is shut down. This type of condition is vendor specific. A notification about the condition may be sent immediately and continuously. |



## CHAPTER 22

# Cisco Umbrella Integration

---

The Cisco Umbrella Integration feature enables cloud-based security service by inspecting the Domain Name System (DNS) query that is sent to the DNS server through the Cisco 1000 Series Integrated Services Routers (ISRs). The security administrator configures policies on the Cisco Umbrella portal to either allow or deny traffic towards the fully qualified domain name (FQDN). Cisco 1000 Series ISR acts as a DNS forwarder on the network edge, transparently intercepts DNS traffic, and forwards the DNS queries to the Cisco Umbrella portal.

- [Feature Information for Cisco Umbrella Integration](#) , on page 313
- [Prerequisites for Cisco Umbrella Integration](#), on page 314
- [Restrictions for Cisco Umbrella Integration](#) , on page 314
- [Cloud-based Security Service Using Cisco Umbrella Integration](#), on page 315
- [Encrypting the DNS Packet](#), on page 315
- [Benefits of Cisco Umbrella Integration](#), on page 316
- [How to Configure Cisco Umbrella Connector](#), on page 316
- [Verify the Cisco Umbrella Connector Configuration](#), on page 318
- [Show Commands](#), on page 319
- [Clear Command](#), on page 319
- [Troubleshoot the Cisco Umbrella Integration](#), on page 319
- [Configuration Examples](#), on page 320
- [Deploy the Cisco Umbrella Integration using Cisco Prime CLI Templates](#), on page 320
- [Additional References for Cisco Umbrella Integration](#), on page 321

## Feature Information for Cisco Umbrella Integration

The following table provides release information about the feature or features described in this module. This table lists only the software release that introduced support for a given feature in a given software release train. Unless noted otherwise, subsequent releases of that software release train also support that feature.

Use Cisco Feature Navigator to find information about platform support and Cisco software image support. To access Cisco Feature Navigator, go to [www.cisco.com/go/cfn](http://www.cisco.com/go/cfn). An account on Cisco.com is not required.

Table 22: Feature Information for Cisco Umbrella Integration

| Feature Name               | Releases                            | Feature Information                                                                                                                                                                                                                                                                                                                                      |
|----------------------------|-------------------------------------|----------------------------------------------------------------------------------------------------------------------------------------------------------------------------------------------------------------------------------------------------------------------------------------------------------------------------------------------------------|
| Cisco Umbrella Integration | Cisco IOS XE Everest Release 16.6.1 | The Cisco Umbrella Integration feature enables cloud-based security service by inspecting the DNS query that is sent to the DNS server through Cisco 1000 Series Integrated Services Routers (ISR). The security administrator configures policies on the Umbrella cloud to either allow or deny traffic towards the fully qualified domain name (FQDN). |

## Prerequisites for Cisco Umbrella Integration

Before you configure the Cisco Umbrella Integration feature on the Cisco 1000 Series ISR, ensure that the following are met:

- The Cisco 1000 Series ISR has a security K9 license to enable Cisco Umbrella Integration.
- The Cisco 1000 Series ISR runs the Cisco IOS XE Everest 16.6.3 software image or later.
- Cisco Umbrella subscription license is available.
- The DNS traffic passed through the Cisco 1000 Series ISR.
- Communication for device registration to the Cisco Umbrella server is through HTTPS. This requires a root certificate to be installed on the router. To download this certificate directly from a link instead of pasting it in, you can find the certificate here: <https://www.digicert.com/CACerts/DigiCertSHA2SecureServerCA.crt>

## Restrictions for Cisco Umbrella Integration

- If an application or host uses IP address directly instead of DNS to query domain names, policy enforcement is not applied.
- When the client is connected to a web proxy, the DNS query does not pass through the Cisco device. In this case, the connector does not detect any DNS request and the connection to the web server bypasses any policy from the Cisco Umbrella portal.
- When the Cisco Umbrella Integration policy blocks a DNS query, the client is redirected to a Cisco Umbrella block page. HTTPS servers provide these block pages and the IP address range of these block pages is defined by the Cisco Umbrella portal.
- User authentication and identity is not supported in this release.
- The type A, AAAA, and TXT queries are the only records that are redirected. Other types of query bypasses the connector. Cisco Umbrella Connector maintains a list of IP address that is known for malicious traffic. When the Cisco Umbrella roaming client detects the destination of packets to those addresses, it forwards those addresses to Cisco Umbrella cloud for further inspection.
- Only the IPv4 address of the host is conveyed in the EDNS option.

- A maximum of 64 local domains can be configured, and the allowed domain name length is 100 characters.

## Cloud-based Security Service Using Cisco Umbrella Integration

The Cisco Umbrella Integration feature provides cloud-based security service by inspecting the DNS query that is sent to the DNS server through Cisco 1000 Series ISRs. When a host initiates the traffic and sends a DNS query, the Cisco Umbrella Connector in Cisco 1000 Series ISR intercepts and inspects the DNS query. If the DNS query is for a local domain, it forwards the query without changing the DNS packet to the DNS server in the enterprise network. If it is for an external domain, it adds an Extended DNS (EDNS) record to the query and sends it to Cisco Umbrella Resolver. An EDNS record includes the device identifier information, organization ID and client IP. Based on this information, Cisco Umbrella Cloud applies different policies to the DNS query.

## Encrypting the DNS Packet

The DNS packet sent from the Cisco 1000 Series ISR to Cisco Umbrella Integration server must be encrypted if the EDNS information in the packet contains information such as user IDs, internal network IP addresses, and so on. When the DNS response is sent back from the DNS server, Cisco 1000 Series ISR decrypts the packet and forwards it to the host.

You can encrypt DNS packets only when the DNScrypt feature is enabled on the Cisco 1000 Series ISR.

Cisco 1000 Series ISR uses the following Anycast recursive Cisco Umbrella Integration servers:

- 208.67.222.222
- 208.67.220.220
- 2620:119:53::53
- 2620:119:35::35

The Figure 1 describes the Cisco Umbrella Integration topology.

Figure 3: Cisco Umbrella Integration Topology

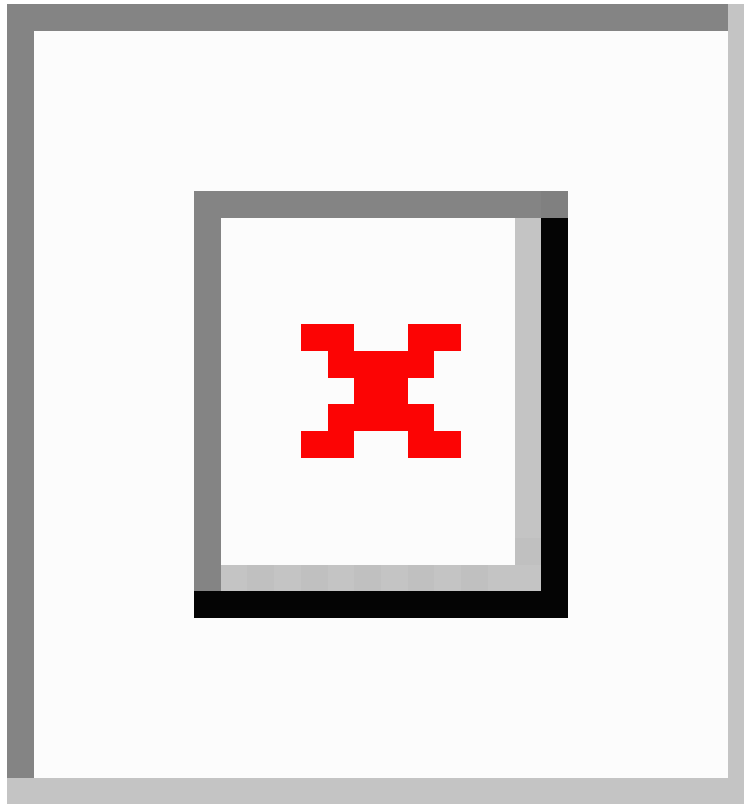

## Benefits of Cisco Umbrella Integration

Cisco Umbrella Integration provides security and policy enforcement at DNS level. It enables the administrator to split the DNS traffic and directly send some of the desired DNS traffic to a specific DNS server (DNS server located within the enterprise network). This helps the administrator to bypass the Cisco Umbrella Integration.

## How to Configure Cisco Umbrella Connector

### Configure the Cisco Umbrella Connector

To configure Cisco Umbrella Connector:

- Get the API token from the Cisco Umbrella registration server.
- Have the root certificate establish the HTTPS connection with the Cisco Umbrella registration server. Import the root certificate of DigiCert given below into the device using the **crypto pki trustpool import terminal** command.

```

-----BEGIN CERTIFICATE-----
MIIElDCCA3ygAwIBAgIQAf2j627KdciIQ4tyS8+8kTANBgkqhkiG9w0BAQsFADBh
MQswCQYDVQQGEwJVUzEVMBMGA1UEChMMRGlnaUNlcnQgSW5jMRkwFwYDVQQLExB3
d3cuZGlnaWNlcnQuY29tMSAwHgYDVQDExdEaWdpQ2VydCBHbG9iYWwgUm9vdCBd
QTAEFw0xMzAzMDgxMjAwMDBaFw0yMzAzMDgxMjAwMDBaME0xCzAJBgNVBAYTAlVT
MRUwEwYDVQQKEwxEaWdpQ2VydCBJbWxJzAlBgNVBAMTHkRpZ21lZDZlX0lFNlQlIgtI
U2VjdXJlIFNlcnZlcjBDQlRlcnZlcjBDQlRlcnZlcjBDQlRlcnZlcjBDQlRlcnZlcj
nf36QYSvx6+M/hpzTc8z15CilodTgyu5pnVILR1WN3vaMTIa16yrBvSqXUu3R0bd
KpPdKc55gIDvEwRqFDu1m5K+wgd1Tvza/P96rtxcflUxD0g5B6TXvi/TC2rSsd9f
/lD0UzslgN2ujkSYs58009rg1/RrKatEp0tYhG2SS4HD2nOLEpdIkARFdrRdNzGX
kujNVA075ME/OV4uuPncfhCohkEAjUVmR7ChZc6gqikJTvOX6+guqw9ypzAO+sf0
/RR3w6RbKkFfCs/mc/bdFWJscAwEAaOCAVowggFWMBIGA1UdEwEB/wQIMAYBAf8C
AQAwDgYDVR0PAAQH/BAQDAgGGMDQGCCsGAQUFBwEBBCGwJjAkBggrBgEFBQcwAYYY
aHR0cDovL29jc3AuZGlnaWNlcnQuY29tMHsGA1UdHwR0MHIwN6A1oDOGMMWh0dHA6
Ly9jcmlwZG91LnRlcnZlcjZlX0lMnVbS9EaWdpQ2VydEdsb2JhbFJvb3RDQS5jcmwwN6A1
oDOGMMWh0dHA6Ly9jcmlwZG91LnRlcnZlcjZlX0lMnVbS9EaWdpQ2VydEdsb2JhbFJvb3RD
QS5jcmwwPQYDVR0gBDYwNDAyBgRVHSAAMCOWKAYIKwYBBQUHAQEWHGh0dHBzOi8v
d3d3LmRlcnZlcjZlX0lMnVbS9DUFMwHQYDVR0OBByEFA+AYRyCMWHVLYjnjUY4tCzh
xtniMB8GA1UdIwQYMBaFAFAPEUDVW0Uy7ZvCj4hsbw5eyPdFVMA0GCSqGSIb3DQEB
CwUAA4IBAQAjPt9L0jFCpbZ+QlwaRMxp0Wi0XUvgBCFSS+JtzLHgl4+mUwnNqip1
5TlPho0lbllyYoIQm5vuh7ZPHLgLTUq/sELfENqzqPlt/yGFUzZgTHb07Djc1lGA
8MXW5dRNJ2Srm8c+cftI17gzbcKTB+6WohsYFfZcTEDts8Ls/3HB40f/1LkAtDdC
2iDJ6m6K7hQGrn2iWZiIqBtvLfTyyRRfJs8sjX7tN8Cp1Tm5gr8ZDOo0rwAhaPit
c+LJMto4JQtV05od8GiG7S5BN098pVAdvzr508EIDObtHopYJeS4d60tbvVS3bR0
j6tJLp07kzQoH3j0lOrHvdPjBzRzeXDLz
-----END CERTIFICATE-----

```

- Verify that the PEM import is successful. A message is displayed after importing the certificate.

This is the sample configuration:

```

enable
configure terminal
parameter-map type umbrella global
token AABBA59A0BDE1485C912AFE472952641001EEEC
exit

```

## Register the Cisco Umbrella Tag

1. Configure the umbrella parameter map as shown in the previous section.
2. Configure **umbrella out** on the WAN interface:

```

interface gigabitEthernet 0/0/0
 umbrella out

```

3. Configure **umbrella in** on the LAN interface:

```

interface vlan20
 umbrella in mydevice_tag

```



**Note** For Cisco 1000 Series ISRs, the length of the hostname and umbrella tag should not exceed 49 characters.

4. After you configure **umbrella in** with a tag using the **umbrella in mydevice\_tag** command, the Cisco 1000 Series ISR registers the tag to the Cisco Umbrella portal.

- The Cisco 1000 Series ISR initiates the registration process by resolving *api.opendns.com*. You need to have a name server (*ip name-server x.x.x.x*) and domain lookup (*ip domain-lookup*) configured on Cisco 1000 Series ISR to successfully resolve the FQDN.



**Note** You should configure the **umbrella out** command before you configure **opendns in** command. Registration is successful only when the port 443 is in *open* state and allows the traffic to pass through the existing firewall.

## Configure Cisco 1000 Series ISR as a Pass-through Server

You can identify the traffic to be bypassed using domain names. In the Cisco 1000 Series ISR, you can define these domains in the form of regular expressions. If the DNS query that is intercepted by the Cisco 1000 Series ISR matches one of the configured regular expressions, then the query is bypassed to the specified DNS server without redirecting to the Cisco Umbrella cloud. This sample configuration shows how to define a regex parameter-map with a desired domain name and regular expressions:

```
Device# configure terminal
Device(config)# parameter-map type regex dns_bypass
Device(config)# pattern www.fisco.com
Device(config)# pattern .*engineering.fisco.*
```

Attach the regex param-map with the umbrella global configuration as shown below:

```
Device(config)# parameter-map type umbrella global
Device(config-profile)# token AADD5FF6E510B28921A20C9B98EEFF
Device(config-profile)# local-domain dns_bypass
```

## Verify the Cisco Umbrella Connector Configuration

Verify the Cisco Umbrella Connector configuration using the following commands:



# Show Commands

## Show Commands at FP Layer

## Show Commands at Cisco Packet Processor Layer

## Data Path Show Commands

# Clear Command

### **clear platform hardware qfp active feature umbrella datapath stats**

The **clear platform hardware qfp active feature umbrella datapath stats** command clears the Umbrella connector statistics in datapath.

```
Device# clear platform hardware qfp active feature umbrella datapath stats
Umbrella Connector Stats Cleared
```

# Troubleshoot the Cisco Umbrella Integration

Troubleshoot issues that are related to enabling Cisco Umbrella Integration feature using these commands:

- **debug umbrella device-registration**
- **debug umbrella config**
- **debug umbrella dnscrypt**

Depending on the OS, run either of these two commands from the client device:

- The **nslookup -type=txt debug.umbrella.com** command from the command prompt of the Windows machine
- The **nslookup -type=txt debug.umbrella.com** command from the terminal window or shell of the Linux machine

```
nslookup -type=txt debug.opendns.com 8.8.8.8
Server: 8.8.8.8
Address: 8.8.8.8#53
```

```
Non-authoritative answer:
debug.opendns.com text = "server r6.mum1"
debug.opendns.com text = "device 010A826AAABB6C3D"
debug.opendns.com text = "organization id 1892929"
debug.opendns.com text = "remoteip 171.168.1.7"
debug.opendns.com text = "flags 436 0 6040 39FF0000000000000000"
debug.opendns.com text = "originid 119211936"
debug.opendns.com text = "orgid 1892929"
```

```

debug.opendns.com text = "orgflags 3"
debug.opendns.com text = "actype 0"
debug.opendns.com text = "bundle 365396"
debug.opendns.com text = "source 72.163.220.18:36914"
debug.opendns.com text = "dnscrypt enabled (713156774457306E)"

```

When you deploy the Cisco Umbrella Integration feature:

- If you use the multiple EDNS options, DNS packets containing EDNS (DNSSEC) will not pass through the device. For assistance, contact Cisco Technical Support.
- If the WAN interface is down for more than 30 minutes, the device may reload with an exception. Disable the DNSCrypt to stop this exception. For assistance, contact Cisco Technical Support .

## Configuration Examples

This example shows how to enable Cisco Umbrella Integration on Cisco 1000 Series ISRs:

# Deploy the Cisco Umbrella Integration using Cisco Prime CLI Templates

You can use the Cisco Prime CLI templates to provision the Cisco Umbrella Integration deployment. The Cisco Prime CLI templates make provisioning Cisco Umbrella Integration deployment simple.



**Note** The Cisco Prime CLI templates is supported only on Cisco Prime version 3.1 or later.

To use the Cisco Prime CLI templates to provision the Cisco Umbrella Integration deployment, perform these steps:

### Procedure

- Step 1** Download the Cisco Prime templates corresponding to the Cisco IOS XE version running on your system.
- Step 2** Unzip the file, if it is a zipped version.
- Step 3** From Cisco Prime Web UI, choose **Configuration > Templates > Features and Technologies**, and then select **CLI Templates (User Defined)**.
- Step 4** Click **Import**.
- Step 5** Select the folder where you want to import the templates and click **Select Templates** and choose the templates that you just downloaded.
- Step 6** The following Cisco Umbrella Integration templates are available:
  - Umbrella—Use this template to provision Umbrella Connector on Cisco 1000 Series ISR.

- Umbrella Cleanup—Use this template to remove previously configured Umbrella Connector on Cisco 1000 Series ISR.

## Additional References for Cisco Umbrella Integration

### Related Documents

| Related Topic     | Document Title                                                                                                                                                                                                                                                                                                                                                          |
|-------------------|-------------------------------------------------------------------------------------------------------------------------------------------------------------------------------------------------------------------------------------------------------------------------------------------------------------------------------------------------------------------------|
| Security commands | <ul style="list-style-type: none"><li>• <a href="#">Cisco IOS Security Command Reference: Commands A to C</a></li><li>• <a href="#">Cisco IOS Security Command Reference: Commands D to L</a></li><li>• <a href="#">Cisco IOS Security Command Reference: Commands M to R</a></li><li>• <a href="#">Cisco IOS Security Command Reference: Commands S to Z</a></li></ul> |

### Technical Assistance

| Description                                                                                                                                                                                                                                                                                                                                                                                                                                                                                                                                                             | Link                                                                    |
|-------------------------------------------------------------------------------------------------------------------------------------------------------------------------------------------------------------------------------------------------------------------------------------------------------------------------------------------------------------------------------------------------------------------------------------------------------------------------------------------------------------------------------------------------------------------------|-------------------------------------------------------------------------|
| <p>The Cisco Support website provides extensive online resources, including documentation and tools for troubleshooting and resolving technical issues with Cisco products and technologies.</p> <p>To receive security and technical information about your products, you can subscribe to various services, such as the Product Alert Tool (accessed from Field Notices), the Cisco Technical Services Newsletter, and Really Simple Syndication (RSS) Feeds.</p> <p>Access to most tools on the Cisco Support website requires a Cisco.com user ID and password.</p> | <a href="http://www.cisco.com/support">http://www.cisco.com/support</a> |





## CHAPTER 23

# Wireless Device Overview

Wireless devices (commonly configured as access points ) provide a secure, affordable, and easy-to-use wireless LAN solution that combines mobility and flexibility with the enterprise-class features required by networking professionals. When configured as an access point, the wireless device serves as the connection point between wireless and wired networks or as the center point of a stand-alone wireless network. In large installations, wireless users within radio range of an access point can roam throughout a facility while maintaining seamless, uninterrupted access to the network.

With a management system based on Cisco IOS software, wireless devices are Wi-Fi CERTIFIED™, 802.11a-compliant, 802.11b-compliant, 802.11g-compliant, and 802.11n-compliant wireless LAN transceivers.

By adhering to the 802.11ac Wave 2 standard, the Cisco 1100 Series WLAN offers a data rate of up to 867 Mbps on the 5-GHz radio. This exceeds the data rates offered by access points that support the 802.11n standard. It also enables a total aggregate dual-radio data rate of up to 1 Gbps. This provides the necessary foundation for enterprise and service provider networks to stay ahead of the performance expectations and needs of their wireless users.

By leverage Cisco AP 1815i, the Cisco 1100 Series WLAN delivers industry-leading performance for highly secure and reliable wireless connections and provides a robust mobility end-user experience. For more detail specific information with Cisco Access point 1815i is available at: <http://www.cisco.com/c/en/us/products/collateral/wireless/aironet-1815-series-access-points/datasheet-c78-738243.html>.

- [Wireless Connectivity for Cisco 1100 Series ISR, on page 323](#)
- [Module Management, on page 324](#)
- [Access Points, on page 328](#)
- [Deploying Cisco Mobility Express, on page 333](#)
- [Configuring Cisco Mobility Express controller, on page 339](#)
- [Using internal DHCP server on Cisco Mobility Express , on page 350](#)
- [Configuring Cisco Mobility Express for Site Survey, on page 351](#)
- [Creating Wireless Networks , on page 355](#)
- [Managing Services with Cisco Mobility Express , on page 363](#)
- [Managing the Cisco Mobility Express Deployment , on page 368](#)
- [Primary AP Failover and Electing a New Primary , on page 370](#)

## Wireless Connectivity for Cisco 1100 Series ISR

This module describes how to configure the WiFi card to the internal switch interface on the Cisco C1100 Integrated Services Routers (ISRs).

The WiFi card is connected to the internal switch interface, the *Wlan-GigabitEthernet* interface. The configuration of this interface is identical to the *GigabitEthernet 0/1/0* interface.

For Cisco 1111-8P Series of ISRs, it is always *Wlan-GigabitEthernet 0/1/8*; and for Cisco 1111-4P, 1116-4P, and 1117-4P Series of ISRs, it is always *Wlan-GigabitEthernet 0/1/4*.

```
Router# show run int Wlan-GigabitEthernet 0/1/4
Building configuration...
```

```
Current configuration : 43 bytes
!
interface Wlan-GigabitEthernet0/1/4
end
```

```
Router#
```

## Module Management

The router configures, manages, and controls the supported interfaces and modules using the module management facility built in its architecture. This new centralized module management facility provides a common way to control and monitor all the modules in the system regardless of their type and application.

## Slot and Subslots for WLAN

This section contains information on slots and subslots for WLAN. Slots specify the chassis slot number in your router and subslots specify the slot where the service modules are installed.

The table below describes the slot number for the Cisco 1100 Series ISR models.

**Table 23: Slot Numbers for Cisco 1100 Series ISR Models**

| Cisco 1100 Series SKU | WiFi Slot |
|-----------------------|-----------|
| C1111-8PWB            | 0/2       |
| C1111-8PLTEEAWB       | 0/3       |
| C1113-8PWE            | 0/2       |
| C1113-8PMWE           | 0/3       |
| C1113-8PLTEEAWE       | 0/4       |
| C1111-4PWE            | 0/2       |
| C1116-4PLTEEAWE       | 0/4       |
| C1116-4PWE            | 0/3       |
| C1117-4PLTEEAWE       | 0/4       |
| C1117-4PWE            | 0/3       |
| C1117-4PMLTEEAWE      | 0/4       |

| Cisco 1100 Series SKU | WiFi Slot |
|-----------------------|-----------|
| C1117-4PMWE           | 0/3       |

**Note**

- The WiFi slot is 0/2, if there is no 4G-LTE Advanced capability or no DSL configured.
- The WiFi slot is 0/3, if the model has either the 4G-LTE Advanced or VDSL/ADSL functionalities.
- The WiFi slot is 0/4, if the model has both 4G-LTE Advanced or VDSL/ADSL functionalities
- There will be no WiFi slot on the non-WiFi SKUs.

## Supported WiFi Cards

The supported WiFi card Product IDs (PIDs) are as follows:

- ISR-AP1100AC-A
- ISR-AP1100AC-B
- ISR-AP1100AC-H
- ISR-AP1100AC-D
- ISR-AP1100AC-E
- ISR-AP1100AC-F
- ISR-AP1100AC-N
- ISR-AP1100AC-R
- ISR-AP1100AC-Q
- ISR-AP1100AC-Z

```
Router#show platform
```

```
Chassis type: C1111-8PLTELAN
```

| Slot | Type           | State      | Insert time (ago) |
|------|----------------|------------|-------------------|
| 0    | C1111-8PLTELAN | ok         | 00:04:56          |
| 0/0  | C1111-2x1GE    | ok         | 00:02:41          |
| 0/1  | C1111-ES-8     | ok         | 00:02:40          |
| 0/2  | C1111-LTE      | ok         | 00:02:41          |
| 0/3  | ISR-AP1100AC-N | ok         | 00:02:41          |
| R0   | C1111-8PLTELAN | ok, active | 00:04:56          |
| F0   | C1111-8PLTELAN | ok, active | 00:04:56          |
| P0   | PWR-12V        | ok         | 00:04:30          |

| Slot | CPLD Version | Firmware Version |
|------|--------------|------------------|
| 0    | 17100501     | 16.6(1r)RC3      |
| R0   | 17100501     | 16.6(1r)RC3      |
| F0   | 17100501     | 16.6(1r)RC3      |

```
Router#
```

## Implementing Modules on Your Router

- [Accessing Your Module Through a Console Connection, on page 326](#)

### Accessing Your Module Through a Console Connection

Before you can access the modules, you must connect to the host router through the router console or through Telnet. After you are connected to the router, you must configure an IP address on the Gigabit Ethernet interface connected to your module. Open a session to your module using the **hw-module session** command in privileged EXEC mode on the router.

To establish a connection to the module, connect to the router console using Telnet or Secure Shell (SSH) and open a session to the switch using the **hw-module session slot/subslot** command in privileged EXEC mode on the router.

Use the following configuration examples to establish a connection:

- The following example shows how to open a session from the router using the **hw-module session** command:

```
Router# hw-module session slot/card
Router# hw-module session 0/2 endpoint 0

Establishing session connect to subslot 0/2
```

- The following example shows how to exit a session from the router, by pressing **Ctrl-A** followed by **Ctrl-Q** on your keyboard:

```
type ^a^q
picocom v1.7

port is : /dev/ttyS3
flowcontrol : none
baudrate is : 9600
parity is : none
databits are : 8
escape is : C-a
local echo is : no
noinit is : no
noreset is : no
nolock is : yes
send_cmd is : sz -vv
receive_cmd is : rz -vv
imap is :
omap is :
emap is : crCrLf,delbs,

Terminal ready
```

### Deactivating a Module

A module can be removed from the router without first being deactivated. However, we recommend that you perform a graceful deactivation (or graceful power down) of the module before removing it. To perform a graceful deactivation, use the **hw-module subslot slot/subslot stop** command in EXEC mode.





**Note** When you are preparing for an OIR of a module, it is not necessary to independently shut down each of the interfaces before deactivating the module. The **hw-module subslot slot/subslot stop** command in EXEC mode automatically stops traffic on the interfaces and deactivates them along with the module in preparation for OIR. Similarly, you do not have to independently restart any of the interfaces on a module after OIR.

The following example shows how to use the **show facility-alarm status** command to verify if any critical alarm is generated when a module is removed from the system:

```
Device# show facility-alarm status
System Totals Critical: 5 Major: 1 Minor: 0

Source Severity Description [Index]

Power Supply Bay 1 CRITICAL Power Supply/FAN Module Missing [0]
GigabitEthernet0/0/0 CRITICAL Physical Port Link Down [1]
GigabitEthernet0/0/1 CRITICAL Physical Port Link Down [1]
GigabitEthernet0/0/2 CRITICAL Physical Port Link Down [1]
GigabitEthernet0/0/3 CRITICAL Physical Port Link Down [1]
xcvr container 0/0/0 INFO Transceiver Missing [0]
xcvr container 0/0/1 INFO Transceiver Missing [0]
xcvr container 0/0/2 INFO Transceiver Missing [0]
xcvr container 0/0/3 INFO Transceiver Missing [0]
V: 1.0v PCH R0/18 MAJOR Volt Above Normal [3]
```



**Note** A critical alarm (Active Card Removed OIR Alarm) is generated even if a module is removed after performing graceful deactivation.

## Deactivating Modules and Interfaces in Different Command Modes

You can deactivate a module and its interfaces using the **hw-module subslot** command in one of the following modes:

- If you choose to deactivate your module and its interfaces by executing the **hw-module subslot slot/subslot shutdown unpowered** command in global configuration mode, you are able to change the configuration in such a way that no matter how many times the router is rebooted, the module does not boot. This command is useful when you need to shut down a module located in a remote location and ensure that it does not boot automatically when the router is rebooted.
- If you choose to use the **hw-module subslot slot/subslot stop** command in EXEC mode, you cause the module to gracefully shut down. The module is rebooted when the **hw-module subslot slot/subslot start** command is executed.

To deactivate a module and all of its interfaces before removing the module, use one of the following commands in global configuration mode.

### Procedure

|        | Command or Action                                        | Purpose                                                                                |
|--------|----------------------------------------------------------|----------------------------------------------------------------------------------------|
| Step 1 | <b>hw-module subslot slot/subslot shutdown unpowered</b> | Deactivates the module located in the specified slot and subslot of the router, where: |

|               | Command or Action                                                                                                                     | Purpose                                                                                                                                                                                                                                                                                                                                                                                                                                                                                                                                                                                                                                                                                                                              |
|---------------|---------------------------------------------------------------------------------------------------------------------------------------|--------------------------------------------------------------------------------------------------------------------------------------------------------------------------------------------------------------------------------------------------------------------------------------------------------------------------------------------------------------------------------------------------------------------------------------------------------------------------------------------------------------------------------------------------------------------------------------------------------------------------------------------------------------------------------------------------------------------------------------|
|               | <b>Example:</b><br><pre>Router(config)# hw-module subslot 0/2 shutdown unpowered</pre>                                                | <ul style="list-style-type: none"> <li>• <i>slot</i>—Specifies the chassis slot number where the module is installed.</li> <li>• <i>subslot</i>—Specifies the subslot number of the chassis where the module is installed.</li> <li>• <b>shutdown</b>—Shuts down the specified module.</li> <li>• <b>unpowered</b>—Removes all interfaces on the module from the running configuration and the module is powered off.</li> </ul>                                                                                                                                                                                                                                                                                                     |
| <b>Step 2</b> | <b>hw-module subslot slot/subslot [reload   stop   start]</b><br><br><b>Example:</b><br><pre>Router# hw-module subslot 0/2 stop</pre> | Deactivates the module in the specified slot and subslot, where: <ul style="list-style-type: none"> <li>• <i>slot</i>—Specifies the chassis slot number where the module is installed.</li> <li>• <i>subslot</i>—Specifies the subslot number of the chassis where the module is installed.</li> <li>• <b>reload</b>—Stops and restarts the specified module.</li> <li>• <b>stop</b>—Removes all interfaces from the module and the module is powered off.</li> <li>• <b>start</b>—Powers on the module similar to a physically inserted module in the specified slot. The module firmware reboots and the entire module initialization sequence is executed in the IOSd and Input/Output Module daemon (IOMd) processes.</li> </ul> |

## Reactivating a Module

If, after deactivating a module using the **hw-module subslot slot/subslot stop** command, you want to reactivate it without performing an OIR, use one of the following commands (in privileged EXEC mode):

- **hw-module subslot slot/subslot start**
- **hw-module subslot slot/subslot reload**

## Access Points

An access point connected directly to a wired LAN provides a connection point for wireless users. If more than one access point is connected to the LAN, users can roam from one area of a facility to another without losing their connection to the network. As users move out of range of one access point, they automatically connect to the network (associate) through another access point. The roaming process is seamless and transparent to the user. The figure below shows access points acting as root units on a wired LAN.

*Figure 4: Access Points as Root Units on a Wired LAN*



In an all-wireless network, an access point acts as a stand-alone root unit. The access point is not attached to a wired LAN; it functions as a hub linking all stations together. The access point serves as the focal point for communications, increasing the communication range of wireless users. Figure below shows an access point in an all-wireless network.

## Configuring and Deploying the Access Point

This section describes how to connect the access point to a wireless LAN controller. The configuration process takes place on the controller. See the Cisco Wireless LAN Controller Configuration Guide for additional information.

### The Controller Discovery Process

The access point uses standard Control and Provisioning of Wireless Access Points Protocol (CAPWAP) to communicate between the controller and other wireless access points on the network. CAPWAP is a standard, inter-operable protocol which enables an access controller to manage a collection of wireless termination points. The discovery process using CAPWAP is identical to the Lightweight Access Point Protocol (LWAPP) used with previous Cisco Aironet access points. LWAPP-enabled access points are compatible with CAPWAP, and conversion to a CAPWAP controller is seamless. Deployments can combine CAPWAP and LWAPP software on the controllers.

The functionality provided by the controller does not change except for customers who have Layer 2 deployments, which CAPWAP does not support.

In a CAPWAP environment, a wireless access point discovers a controller by using CAPWAP discovery mechanisms and then sends it a CAPWAP join request. The controller sends the access point a CAPWAP join response allowing the access point to join the controller. When the access point joins the controller, the controller manages its configuration, firmware, control transactions, and data transactions.



---

**Note** For additional information about the discovery process and CAPWAP, see the Cisco Wireless LAN Controller Software Configuration Guide. This document is available on Cisco.com.

---



---

**Note** CAPWAP support is provided in controller software release 8.5 or later. However, your controller must be running the release that supports Cisco 1100 Series access points.

---



---

**Note** You cannot edit or query any access point using the controller CLI if the name of the access point contains a space.

---



**Note** Make sure that the controller is set to the current time. If the controller is set to a time that has already passed, the access point might not join the controller because its certificate may not be valid for that time.

Access points must be discovered by a controller before they can become an active part of the network. The access point supports these controller discovery processes:

- Layer 3 CAPWAP discovery—Can occur on different subnets than the access point and uses IP addresses and UDP packets.
- Locally stored controller IP address discovery—If the access point was previously joined to a controller, the IP addresses of the primary, secondary, and tertiary controllers are stored in the access point's non-volatile memory. This process of storing controller IP addresses on an access point for later deployment is called priming the access point. For more information about priming, see the “Performing a Pre-Installation Configuration” section.
- DHCP server discovery—This feature uses DHCP option 43 to provide controller IP addresses to the access points. Cisco switches support a DHCP server option that is typically used for this capability. For more information about DHCP option 43, see the “Configuring DHCP Option 43” section.
- DNS discovery—The access point can discover controllers through your domain name server (DNS). For the access point to do so, you must configure your DNS to return controller IP addresses in response to CISCO-CAPWAP-CONTROLLER.localdomain, where localdomain is the access point domain name. Configuring the CISCO-CAPWAP-CONTROLLER provides backwards compatibility in an existing customer deployment. When an access point receives an IP address and DNS information from a DHCP server, it contacts the DNS to resolve CISCO-CAPWAP-CONTROLLER.localdomain. When the DNS sends a list of controller IP addresses, the access point sends discovery requests to the controllers.

## Deploying the Access Point on the Wireless Network

### Procedure

|               | Command or Action                                                                                 | Purpose                                                                                                                             |
|---------------|---------------------------------------------------------------------------------------------------|-------------------------------------------------------------------------------------------------------------------------------------|
| <b>Step 1</b> | Connect and power up the router.                                                                  |                                                                                                                                     |
| <b>Step 2</b> | Observe the wireless LAN LED (for LED descriptions, see “Checking the Access Point LED” section). |                                                                                                                                     |
| <b>Step 3</b> | Reconfigure the Cisco wireless LAN controller so that it is not the primary controller.           | <b>Note</b> A primary Cisco wireless LAN controller should be used only for configuring access points and not in a working network. |

## Checking the Wireless LAN LED



**Note** It is expected that there will be small variations in the LED color intensity and hue from unit to unit. This is within the normal range of the LED manufacturer's specifications and is not a defect.

The wireless LAN status LED indicates various conditions which are described in Table.

**Table 24: Wireless LAN LED**

| Message Type                | LED State                                           | Message Meanings                                                         |
|-----------------------------|-----------------------------------------------------|--------------------------------------------------------------------------|
| Boot loader status sequence | Blinking Green                                      | DRAM memory test in progress                                             |
|                             |                                                     | DRAM memory test OK                                                      |
|                             |                                                     | Board initialization in progress                                         |
|                             |                                                     | Initializing FLASH file system                                           |
|                             |                                                     | FLASH memory test OK                                                     |
|                             |                                                     | Initializing Ethernet                                                    |
|                             |                                                     | Ethernet OK                                                              |
|                             |                                                     | Starting the Cisco AP-OS operating system of the AP                      |
|                             | Initialization successful                           |                                                                          |
| Association status          | Chirping Green                                      | Normal operating condition, but no wireless client associated            |
|                             | Green                                               | Normal operating condition with at least one wireless client association |
| Operating status            | Blinking Amber                                      | Software upgrade is in progress.                                         |
|                             | Cycling through Green, Red, and Amber               | Discovery/join process is in progress.                                   |
|                             | Rapidly cycling through Red, Green, Amber, and off. | Access point location command invoked from controller web interface.     |
|                             | Blinking Red                                        | Ethernet link is not operational.                                        |

| Message Type         | LED State              | Message Meanings                                                                                                                                                                                                                                                               |
|----------------------|------------------------|--------------------------------------------------------------------------------------------------------------------------------------------------------------------------------------------------------------------------------------------------------------------------------|
| Boot loader warnings | Blinking Amber         | Configuration recovery in progress (Mode button pushed for 2 to 3 seconds)                                                                                                                                                                                                     |
|                      | Red                    | Ethernet failure or image recovery (Mode button pushed for 20 to 30 seconds)                                                                                                                                                                                                   |
|                      | Blinking Green         | Image recovery in progress (Mode button released)                                                                                                                                                                                                                              |
| Boot loader errors   | Red                    | DRAM memory test failure                                                                                                                                                                                                                                                       |
|                      | Blinking Red and Amber | FLASH file system failure                                                                                                                                                                                                                                                      |
|                      | Blinking Red and off   | One of the following: <ul style="list-style-type: none"> <li>• Environment variable failure</li> <li>• Bad MAC address</li> <li>• Ethernet failure during image recovery</li> <li>• Boot environment failure</li> <li>• No Cisco image file</li> <li>• Boot failure</li> </ul> |

## Miscellaneous Usage and Configuration Guidelines

Using the reset command you can reset the AP to the default factory-shipped configuration.

```
hw-module subslot x/y error-recovery password_reset
```



**Note** Since this is an IOS command, you must run this command on the Cisco 1100 router console, instead of the AP console.

The AP configuration files are cleared. This resets all configuration settings to factory defaults, including passwords, encryption keys, the IP address, and the SSID. However, the regulatory domain provisioning is not reset.



**Note** When you run the **hw-module subslot x/y error-recovery password\_reset** command, the AP module automatically reloads to restore the configuration settings and enters the maintenance mode. In the maintenance mode, the AP module is on power on mode. When the module configuration reset is confirmed through the console or web UI, the **hw-module subslot x/x reload force** command reloads the AP and then quits the maintenance mode.

## Important Information for Controller-Based Deployments

Keep these guidelines in mind when you use the Cisco 1100 series access points:

- The access point can only communicate with Cisco wireless LAN controllers.
- The access point does not support Wireless Domain Services (WDS) and cannot communicate with WDS devices. However, the controller provides functionality equivalent to WDS when the access point joins it.
- CAPWAP does not support Layer 2. The access point must get an IP address and discover the controller using Layer 3, DHCP, DNS, or IP subnet broadcast.
- The access point console port is enabled for monitoring and debug purposes. All configuration commands are disabled when the access point is connected to a controller.

## Deploying Cisco Mobility Express

### Pre-Requisites for Deploying Mobility Express Solution

1. It is recommended not to have any other Cisco Wireless LAN Controllers; neither appliance nor virtual in the same network during set up or during daily operation of a Cisco Mobility Express network.
2. Decide on the first Access Point to be configured as a primary Access Point. This Access Point should be capable of supporting the Wireless LAN Controller function.
3. A DHCP server must be available on the network so that Access Points and clients can obtain an IP Address. Starting AireOS® Release 8.4.100.0 or later, one can configure a DHCP server on the primary Access Point as well but this is typically used for Site Survey.

### Connecting Mobility Express Capable Access Point to the Network

Depending on the deployment, Mobility Express capable Access Points can be connected to an access port or a trunk port on the switch.

If Access Points and WLANs are all on the same network, Mobility Express capable Access Points can connect to an access port on the switch as shown below.



On Mobility Express, management traffic is untagged. If Access Points and WLANs are all on different VLANs, Mobility Express capable Access Points will connect to a trunk port on the switch and traffic for individual WLANs will be switched locally on individual VLANs. Shown below is a deployment with Access Points and WLANs on different VLANs.



```
interface GigabitEthernet1/0/37
description » Connected to Master AP «
switchport trunk native vlan 40
```

```
switchport trunk allowed vlan 10,20,30,40
switchport mode trunk
```

## Determining image on the Access Point

The Cisco 1100 Series ISR access points can either have CAPWAP image or the Cisco Mobility Express image which is capable of running the virtual Wireless LAN controller function on the Access Point.

To determine the image and capability of an Access Point, follow the procedure below:

### Procedure

|               | Command or Action                                                                                                                                                                                                                                                                                                                                                           | Purpose                                                                                                                                                                                                                                                                                                                                                                                                                                                                                                                                                                                                                                                                                                                                                                                                                                                                                                                                                                                                                                                                                                                                                                                                                                                           |
|---------------|-----------------------------------------------------------------------------------------------------------------------------------------------------------------------------------------------------------------------------------------------------------------------------------------------------------------------------------------------------------------------------|-------------------------------------------------------------------------------------------------------------------------------------------------------------------------------------------------------------------------------------------------------------------------------------------------------------------------------------------------------------------------------------------------------------------------------------------------------------------------------------------------------------------------------------------------------------------------------------------------------------------------------------------------------------------------------------------------------------------------------------------------------------------------------------------------------------------------------------------------------------------------------------------------------------------------------------------------------------------------------------------------------------------------------------------------------------------------------------------------------------------------------------------------------------------------------------------------------------------------------------------------------------------|
| <b>Step 1</b> | Login to the Access Point CLI using a console and type <b>AP#show version</b> and check the full output of show version. The default login credentials are Username: <b>Cisco</b> and Password: <b>Cisco</b> .                                                                                                                                                              |                                                                                                                                                                                                                                                                                                                                                                                                                                                                                                                                                                                                                                                                                                                                                                                                                                                                                                                                                                                                                                                                                                                                                                                                                                                                   |
| <b>Step 2</b> | If <b>show version</b> output does not display AP Image Type and AP Configuration parameters as highlighted below, it means that AP is running the CAPWAP image and a conversion to Cisco Mobility Express is required if you want to run the controller function on the Access Point. To convert from a CAPWAP Access Point to Mobility Express, go to Conversion section. | <pre>cisco ISR-AP1100AC-B ARMv7 Processor rev 5 (v71) with 1016284/594068K bytes of memory. Processor board ID AP Running Image      : 8.4.100.0 Primary Boot Image    : 8.4.100.0 Backup Boot Image     : 0.0.0.0 AP Image type        : MOBILITY EXPRESS IMAGE AP Configuration     : MOBILITY EXPRESS CAPABLE 1 Gigabit Ethernet interfaces 2 802.11 Radios Radio FW version : e1c63a0bb171f78c5800c1478007abc1 NSS FW version : not available</pre> <p>If the show version displays AP Image Type: MOBILITY EXPRESS IMAGE and AP Configuration: NOT MOBILITY EXPRESS CAPABLE , it means that even though the Access Point has the Cisco Mobility Express image, it is configured to run as a CAPWAP Access Point. In this case Access Point will not run the controller function and will not participate in the primary Election process upon failure of the active primary AP.</p> <pre>cisco ISR-AP1100AC-B ARMv7 Processor rev 5 (v71) with 1016284/754820K bytes of memory. Processor board ID AP Running Image      : 8.4.100.0 Primary Boot Image    : 8.4.100.0 Backup Boot Image     : 0.0.0.0 AP Image type        : MOBILITY EXPRESS IMAGE AP Configuration     : NOT MOBILITY EXPRESS CAPABLE 1 Gigabit Ethernet interfaces 2 802.11 Radios</pre> |



|  | Command or Action | Purpose                                                                                                                                                                                                                                                                                                                                                                                                                                                                                                                                                                                                                                                                                                                                                                                                                                                                                                                                                                                                                                                                                                                                                                                                                                                                                                                                                          |
|--|-------------------|------------------------------------------------------------------------------------------------------------------------------------------------------------------------------------------------------------------------------------------------------------------------------------------------------------------------------------------------------------------------------------------------------------------------------------------------------------------------------------------------------------------------------------------------------------------------------------------------------------------------------------------------------------------------------------------------------------------------------------------------------------------------------------------------------------------------------------------------------------------------------------------------------------------------------------------------------------------------------------------------------------------------------------------------------------------------------------------------------------------------------------------------------------------------------------------------------------------------------------------------------------------------------------------------------------------------------------------------------------------|
|  |                   | <p>Radio FW version :<br/>e1c63a0bb171f78c5800c1478007abc1<br/>NSS FW version : not available</p> <p>For this AP to run the controller function, AP Configuration has to be changed to MOBILITY EXPRESS CAPABLE . To change the AP Configuration, execute the following command from the AP CLI. AP#ap-type mobility-express tftp://</p> <p>Access Point will reboot and after it comes up, it will be capable of running the controller function. You can check the output of show version again to confirm that AP Configuration has changed to MOBILITY EXPRESS CAPABLE .</p> <p>If the show version displays AP Image Type: MOBILITY EXPRESS IMAGE and AP Configuration: MOBILITY EXPRESS CAPABLE , it means that the Access Point has the Mobility Express image and is capable of running the controller function. For this scenario, the output of the show version is shown below:</p> <pre>cisco ISR-AP1100AC-B ARMv7 Processor rev  5 (v71) with 1016284/594068K bytes of memory. Processor board ID AP Running Image      : 8.4.100.0 Primary Boot Image    : 8.4.100.0 Backup Boot Image     : 0.0.0.0 AP Image type        : MOBILITY EXPRESS IMAGE AP Configuration     : MOBILITY EXPRESS CAPABLE 1 Gigabit Ethernet interfaces 2 802.11 Radios Radio FW version     : e1c63a0bb171f78c5800c1478007abc1 NSS FW version      : not available</pre> |

## Converting Access Point from CAPWAP to Cisco Mobility Express

One can convert an Access Point running CAPWAP to Cisco Mobility Express and vice versa.

Cisco Mobility Express support on 11ac Wave 2 Access Points is introduced in different AireOS releases and it is important to note that before an Access Point can be converted to Mobility Express, it must have the minimum AireOS CAPWAP image which supported Cisco Mobility Express capability for that Access Point. Given below is the minimum OS release for an Access Point which will support conversion from CAPWAP to Cisco Mobility Express.

| Access Point      | Minimum AireOS Release with CAPWAP image |
|-------------------|------------------------------------------|
| Cisco 1100 Series | Cisco IOS XE Everest 16.6.2 Release      |



**Note** If the CAPWAP image on the Access Point is older than the minimum AireOS release capable of supporting Cisco Mobility Express, Access Point MUST first join a WLC running the minimum AireOS release or higher to upgrade its CAPWAP image. After the CAPWAP image of the AP has been upgraded, conversion of AP from CAPWAP to Mobility Express can be performed.

To perform a conversion on an Access Point running CAPWAP to Mobility Express, follow the procedure below:

### Procedure

|               | Command or Action                                                                                                                                                                                                                  | Purpose                                                                                                                                                                                                                                                                                                                                                                                                                                                                                                                                                                                                                                                                                                                                                                   |
|---------------|------------------------------------------------------------------------------------------------------------------------------------------------------------------------------------------------------------------------------------|---------------------------------------------------------------------------------------------------------------------------------------------------------------------------------------------------------------------------------------------------------------------------------------------------------------------------------------------------------------------------------------------------------------------------------------------------------------------------------------------------------------------------------------------------------------------------------------------------------------------------------------------------------------------------------------------------------------------------------------------------------------------------|
| <b>Step 1</b> | Download the conversion image for the Access Point from cisco.com to the TFTP server. It is a tar file. Do not untar the file. The following table lists the Cisco Mobility Express software for Cisco Wireless Release 8.4.100.0. |                                                                                                                                                                                                                                                                                                                                                                                                                                                                                                                                                                                                                                                                                                                                                                           |
| <b>Step 2</b> | Login to the Access Point                                                                                                                                                                                                          |                                                                                                                                                                                                                                                                                                                                                                                                                                                                                                                                                                                                                                                                                                                                                                           |
| <b>Step 3</b> | Execute AP#show version on the Access Point CLI. From the show version output, you can determine the AP Image type and AP Configuration and can then proceed with the conversion                                                   | <p>Case 1: If the AP Image type is MOBILITY EXPRESS IMAGE and AP configuration is NOT MOBILITY EXPRESS CAPABLE, enter the command below to change the AP Configuration to MOBILITY EXPRESS CAPABLE .</p> <pre>AP#ap-type mobility-express</pre> <p><b>Example:</b></p> <pre>cisco ISR-AP1100AC-E ARMv7 Processor rev  5 (v71) with 1016284/840700K bytes of memory. Processor board ID AP Running Image      : 8.4.100.0 Primary Boot Image   : 8.4.100.0 Backup Boot Image    : 8.5.107.62 1 Gigabit Ethernet interfaces 2 802.11 Radios Radio FW version : e1c63a0bb171f78c5800c1478007abc1 NSS FW version : not available  Router#ap-type mobility-express Changing AP Type to Mobility Express  Writing reload timestamp (Wed May 24 17:17:53 UTC 2017) to disk</pre> |

|  | Command or Action | Purpose                                                                                                                                                                                                                                                                                                                                                                                                                                                                                                                                                                                                                                                                                                                                                                                                                                                                                                                                                                                                                                                                                                                                                                                                                                                                                                                                                                                                                                                                                                                                                                                                                                                                   |
|--|-------------------|---------------------------------------------------------------------------------------------------------------------------------------------------------------------------------------------------------------------------------------------------------------------------------------------------------------------------------------------------------------------------------------------------------------------------------------------------------------------------------------------------------------------------------------------------------------------------------------------------------------------------------------------------------------------------------------------------------------------------------------------------------------------------------------------------------------------------------------------------------------------------------------------------------------------------------------------------------------------------------------------------------------------------------------------------------------------------------------------------------------------------------------------------------------------------------------------------------------------------------------------------------------------------------------------------------------------------------------------------------------------------------------------------------------------------------------------------------------------------------------------------------------------------------------------------------------------------------------------------------------------------------------------------------------------------|
|  |                   | <pre>Router#[05/24/2017 17:17:54.4699] UBIFS: un-mount UBI device 0, volume 3 [05/24/2017 17:17:54.5199] UBIFS: background thread "ubifs_bgt0_3" stops  [05/24/2017 17:17:56.6099] reboot: Restart</pre> <p><b>Note</b> Since the Access Point has AP Image type: MOBILITY EXPRESS IMAGE, a new image will not be downloaded. After the command is executed, the Access Point will reboot and after it comes up, the AP Configuration will be changed to MOBILITY EXPRESS CAPABLE.</p> <p>Case 2 : If the AP Image type and AP Configuration are not available, it means that the AP is running CAPWAP image. To do the conversion, execute the command below:</p> <pre>Router#ap-type mobility-express tftp://&lt;TFTP Server IP&gt;/&lt;path to tar file&gt;</pre> <p><b>Example:</b></p> <pre>Router#ap-type mobility-express tftp://10.74.5.99/8.4CCO/aplg5 Starting the ME image download... It may take a few minutes to finish download. If it is longer, please abort command, check network connection and try again ##### 100.0% Image transfer complete. Image downloaded, writing to flash... do CHECK_ME, part1 is active part Image signing verify success. upgrade.sh: btldr rel is 33 vs 33, does not need update upgrade.sh: part to upgrade is part2 upgrade.sh: activate part2, set BOOT to part2 upgrade.sh: AP primary version: 8.4.100.0 Archive done. [*10/11/2017 23:05:22.7599] AP Type changed: CAPWAP to ME. AP Mode changed to flexconnect. AP Rebooting... [*10/11/2017 23:05:22.7699] AP Rebooting: Reset Request from Controller(AP Type Changed from CAPWAP to ME)  Writing reload timestamp (Wed Oct 11 23:05:22 UTC 2017) to disk</pre> |

|               | Command or Action                                                                                                                     | Purpose                                                                                                                                                                                                                                                                                                                                                                                                                                                                                                                                        |
|---------------|---------------------------------------------------------------------------------------------------------------------------------------|------------------------------------------------------------------------------------------------------------------------------------------------------------------------------------------------------------------------------------------------------------------------------------------------------------------------------------------------------------------------------------------------------------------------------------------------------------------------------------------------------------------------------------------------|
|               |                                                                                                                                       | <pre>M-P2B#[10/11/2017 23:05:23.9699] UBIFS: un-mount UBI device 0, volume 3 [10/11/2017 23:05:24.0199] UBIFS: background thread "ubifs_bgt0_3" stops  The system is going down NOW! Sent SIGKILL to all processes.1099] Requesting system reboot99] [10/11/2017 23:05:26.1099] reboot: Restarting</pre> <p><b>Note</b> After the image download is complete, it will be written to the flash followed by a reboot. After the AP comes up, AP Image type will be MOBILITY EXPRESS IMAGE and AP Configuration will MOBILITY EXPRESS CAPABLE</p> |
| <b>Step 4</b> | If this is the first Access Point in the network, it will start the controller function and will broadcast the CiscoAirProvison SSID. |                                                                                                                                                                                                                                                                                                                                                                                                                                                                                                                                                |

## Converting Access Point from Cisco Mobility Express to CAPWAP

There are typically two reasons why one would want to convert an Access Point running Mobility Express image to CAPWAP. There are as follows:

1. You want to keep the Access Point in a Mobility Express deployment but do not want the Access point to participate in the primary election process upon a failover of the primary AP.
2. You want to migrate one or more Access Points with Mobility Express to an appliance or vWLC based deployment.
  1. If your reason to convert to CAPWAP is 1 above, follow the procedure below:
    - a. Login to the Access Point CLI either through console or ssh and go to exec mode. If you are trying to convert the primary AP to CAPWAP, connecting a console will lead you to the controller CLI. To get to the AP CLI, type `apciscohell` at the controller prompt and login to the Access Point shell.
    - b. Execute `ap#ap-type capwap` CLI. This will change the AP Configuration to NOT MOBILITY EXPRESS and the Access Point will no longer participate in the primary election process.
  2. If your reason to convert to CAPWAP is 2 above, follow the procedure below:
    - a. Login to the Access Point CLI either via console or ssh and go to exec mode.
    - b. Execute the following CLI.

```
(Cisco Controller) >config ap unifiedmode <switch_name> <switch_ip_address>
```

<switch\_name> and <switch\_ip\_address> is the name and IP address respectively of the WLC to which the APs need to be migrate.



**Note** The above command converts all connected Access Points with AP Configuration: MOBILITY EXPRESS CAPABLE to AP Configuration: NOT MOBILITY EXPRESS CAPABLE . When this command is issued, the APs are reloaded, and they come back up and look for the controller (switch\_ip\_address) to join.

# Configuring Cisco Mobility Express controller

## CLI Setup Wizard

To use the Setup Wizard from CLI, you must connect to the console port of the Access Point. The default parameters for the console ports are 9600 baud, eight data bits, one stop bit, and no parity. The console ports do not support hardware flow control.

After connecting to the console port on the Access Point, power up the Access Point. After a few minutes, Access Point will start the Controller.

To configure the Mobility Express controller, follow the steps as shown in the example below:

```
System Name [Cisco_2c:3a:40] (31 characters max): me-wlc
Enter Country Code list (enter 'help' for a list of countries) [US]:

Configure a NTP server now? [YES][no]: no
Configure the system time now? [YES][no]: no

Note! Default NTP servers will be used

Management Interface IP Address: 40.40.40.10
Management Interface Netmask: 255.255.255.0
Management Interface Default Router: 40.40.40.1
Cleaning up Provisioning SSID
Create Management DHCP Scope? [yes][NO]: yes
DHCP Network : 40.40.40.0
DHCP Netmask : 255.255.255.0
Router IP: 40.40.40.1
Start DHCP IP address: 40.40.40.11
Stop DHCP IP address: 40.40.40.254
DomainName :
DNS Server : [OPENDNS][user DNS]
Create Employee Network? [YES][no]: YES
Employee Network Name (SSID)? : WestAutoBody-Employee
Employee VLAN Identifier? [MGMT][1-4095]: MGMT
Employee Network Security? [PSK][enterprise]: PSK
Employee PSK Passphrase (8-38 characters)? : Cisco123
Re-enter Employee PSK Passphrase: Cisco123
Create Guest Network? [yes][NO]: YES
Guest Network Name (SSID)? : WestAutoBody-Guest
Guest VLAN Identifier? [EMPLOYEE][1-4095]: EMPLOYEE
Guest Network Security? [WEB-CONSENT][psk]: WEB-CONSENT
Create Guest DHCP Scope? [yes][NO]: NO
Enable RF Parameter Optimization? [YES][no]: YES
Client Density [TYPICAL][Low][High]: TYPICAL
Traffic with Voice [NO][Yes]: Yes
```

```
Configuration correct? If yes, system will save it and reset. [yes][NO]: yes
Cleaning up Provisioning SSID
```



**Note** The Access Point will reboot and after it comes back up, login to the Mobility Express controller WebUI from the browser using `https://<mangement_ip_address>` Cisco Mobility Express controller uses a self-signed certificate for HTTPS. Therefore, all browsers display a warning message and asks whether you wish to proceed with an exception or not when the certificate is presented to the browser. Accept the risk and proceed to access the Mobility Express Wireless LAN Controller login page.

## Over-the-Air Setup Wizard

Over-the-air is a simple and easy way to configure Mobility Express out of the box. Over-the-Air provisioning can be done using a WiFi enabled device or the Cisco Wireless app which can be downloaded from App Store for iOS devices and Play Store for Android Devices. The Cisco Wireless app provides a minimum set of configurable options to deploy Mobility Express in just a few minutes.

### Procedure

|               | Command or Action                                                                                                                                                                                           | Purpose                                                                                                                                                                                                                                                                                                                                                                                                                                                                                                                                                                                                                                    |
|---------------|-------------------------------------------------------------------------------------------------------------------------------------------------------------------------------------------------------------|--------------------------------------------------------------------------------------------------------------------------------------------------------------------------------------------------------------------------------------------------------------------------------------------------------------------------------------------------------------------------------------------------------------------------------------------------------------------------------------------------------------------------------------------------------------------------------------------------------------------------------------------|
| <b>Step 1</b> | When the LED on the Access Point chirps green, connect a WiFi enabled laptop to the CiscoAirProvision SSID. The default password is password. The laptop will get an IP address from subnet 192.168.1.0/24. | <b>Note</b> CiscoAirProvision SSID is broadcast at 2.4GHz.                                                                                                                                                                                                                                                                                                                                                                                                                                                                                                                                                                                 |
| <b>Step 2</b> | Open a web browser and browse to <code>http://mobilityexpress.cisco</code> . This will redirect to configuration wizard and the admin account page will appear.                                             |                                                                                                                                                                                                                                                                                                                                                                                                                                                                                                                                                                                                                                            |
| <b>Step 3</b> | Create an admin account on the controller by specifying the following parameters and then click on the Start button.                                                                                        | <ul style="list-style-type: none"> <li>• Enter the admin username. Maximum up to 24 ASCII characters.</li> <li>• Enter the password. Maximum up to 24 ASCII characters. When specifying a password, ensure that: <ul style="list-style-type: none"> <li>• The password must contain characters from at least three of the following classes – lowercase letters, uppercase letters, digits, special characters.</li> <li>• No character in the password can be repeated more than three times consecutively.</li> <li>• The new password must not be the same as the associated username and the username reversed.</li> </ul> </li> </ul> |

|               | Command or Action                                                                                                                                                                                                | Purpose                                                                                                                                                                                                                                                                                                                                                                                                                                                                                                                               |
|---------------|------------------------------------------------------------------------------------------------------------------------------------------------------------------------------------------------------------------|---------------------------------------------------------------------------------------------------------------------------------------------------------------------------------------------------------------------------------------------------------------------------------------------------------------------------------------------------------------------------------------------------------------------------------------------------------------------------------------------------------------------------------------|
|               |                                                                                                                                                                                                                  | <ul style="list-style-type: none"> <li>The password must not be cisco, ocsic, or any variants obtained by changing the capitalization of letters of the word Cisco. In addition, you cannot substitute 1, I, or ! for i, 0 for o, or \$ for s.</li> </ul>                                                                                                                                                                                                                                                                             |
| <b>Step 4</b> | In the Set up Your Controller section, configure the following:                                                                                                                                                  | <ul style="list-style-type: none"> <li>Enter the System Name</li> <li>Select the Country from the drop-down list</li> <li>Date and Time should be auto-filled but one can manually configure it as well</li> <li>Select the Timezone from the drop-down list</li> <li>Enter the IP address of NTP Server if there is one available. If left blank, NTP Pools will be automatically configured</li> <li>Enter the Management IP Address of the controller</li> <li>Enter the Subnet Mask</li> <li>Enter the Default Gateway</li> </ul> |
| <b>Step 5</b> | Disable Enable DHCP Server(Management Network) if an external DHCP server is being used. If internal DHCP server on the Mobility Express controller has to be used, specify the DHCP server related information. |                                                                                                                                                                                                                                                                                                                                                                                                                                                                                                                                       |
| <b>Step 6</b> | Click Next.                                                                                                                                                                                                      |                                                                                                                                                                                                                                                                                                                                                                                                                                                                                                                                       |
| <b>Step 7</b> | In the Create Your Wireless Network, under Employee Network, configure the following:                                                                                                                            | <ul style="list-style-type: none"> <li>Enter the Network Name</li> <li>Select Security as WPA2 Personal or WPA2 Enterprise from the drop-down list</li> <li>If WPA2 Personal is selected, enter the Passphrase</li> </ul>                                                                                                                                                                                                                                                                                                             |
| <b>Step 8</b> | One can also enable RF Parameter Optimization and configure the following:                                                                                                                                       | <ul style="list-style-type: none"> <li>Move the Client Density slider as needed</li> <li>From the Traffic Type, select Data or Data and Voice</li> </ul>                                                                                                                                                                                                                                                                                                                                                                              |
| <b>Step 9</b> | Click Next.                                                                                                                                                                                                      |                                                                                                                                                                                                                                                                                                                                                                                                                                                                                                                                       |

|                | Command or Action                                                                                                                               | Purpose                                                                                                                                                                                                                                                                                                                                                                                                                                                                                                                             |
|----------------|-------------------------------------------------------------------------------------------------------------------------------------------------|-------------------------------------------------------------------------------------------------------------------------------------------------------------------------------------------------------------------------------------------------------------------------------------------------------------------------------------------------------------------------------------------------------------------------------------------------------------------------------------------------------------------------------------|
| <b>Step 10</b> | Confirm the settings on the page and click on the Apply button. The Access Point will reboot and after it comes up, it will run the controller. | <p><b>Note</b> The Access Point will reboot and after it comes back up, login to the Mobility Express controller WebUI from the browser using https:&lt;management_ip_address&gt;. Cisco Mobility Express controller uses a self-signed certificate for HTTPS. Therefore, all browsers display a warning message and asks whether you wish to proceed with an exception or not when the certificate is presented to the browser. Accept the risk and proceed to access the Mobility Express Wireless LAN Controller login page.</p> |

## Network Plug and Play

### Introduction

The Cisco Network Plug and Play solution provides a simple, secure, unified, and integrated offering for enterprise network customers to ease new site rollouts for provisioning Cisco Mobility Express. The solution allows use of Cloud Redirection service, on-prem, or combination which provide a unified approach to provision enterprise networks comprised of Cisco Mobility Express, Cisco routers, switches, with a near zero touch deployment experience.

You can use the Cisco Network Plug and Play application to pre-provision the site and add Cisco Mobility Express capable access points to the site. This includes entering access point information and uploading a controller configuration file for virtual controller which will run on Mobility Express capable access points.

When an installer installs and powers up the Cisco Mobility Express capable access points, it auto-discovers the Cisco APIC-EM controller by using the DHCP, DNS or cloud redirection service. After the auto-discovery process is complete, the AP downloads the controller configuration file from local PnP server, or communicates with the cloud redirection service for direction to target PnP server.

### Pre-Requisites

- APIC-EM Release 1.4 with Cisco Network Plug and Play, virtually hosted in a Cisco UCS or equivalent server.
- Access Points—Cisco 802.11ac Wave 2 access points running Cisco Mobility Express software.
- Controller Configuration—Cisco Mobility Express controller configuration file to be uploaded on Network PnP.



## APIC-EM Discovery Options

1. DHCP server configured with option 43 to allow Cisco Mobility Express capable access points to auto-discover the APIC-EM controller (option 43 is not required if only testing cloud redirection). DHCP option 43 consists of a string value that is a configured DHCP server: option 43 ascii "5A1N;B2;K4;I192.168.1.123;J80"



**Note** 192.168.1.123 is the IP address of the APIC-EM Server

2. On-prem PnP server can be added to DNS using 'pnpserver.yourlocal.domain'. If DHCP discovery fails to get the IP address of the APIC-EM controller, for example, because option 43 is not configured, the Cisco Plug and Play Agent falls back on a DNS lookup method. Based on the network domain name returned by the DHCP server, it constructs a fully qualified domain name (FQDN) for the APIC-EM controller, using the preset hostname pnpserver. For example, if the DHCP server returns the domain name "customer.com", the Cisco Plug and Play IOS Agent constructs the FQDN "pnpserver.customer.com". It then uses the local name server to resolve the IP address for this FQDN.

Cloud redirection service requires a connection to the internet, and valid DNS server that can resolve 'devicehelper.cisco.com'. The cloud redirection service redirect Cisco Mobility Express Access Point to APIC-EM.

## Configuring APIC-EM / Network PnP Server

### Site Pre-Provisioning Workflow

Cisco Network Plug and Play allows you to pre-provision and plan for new sites. When you create a new site, Cisco Network Plug and Play enables you to pre-provision Cisco Mobility Express access point(s) controller, configuration file, product ID, and product serial # for selected Access Points. This simplifies and accelerates the time that it takes to get a site fully functional.

To pre-provision a site on your network, perform these steps:

#### Procedure

|               | Command or Action                                                                                        | Purpose |
|---------------|----------------------------------------------------------------------------------------------------------|---------|
| <b>Step 1</b> | Importing Cisco Mobility Express controller configuration                                                |         |
| <b>Step 2</b> | Creating a Project                                                                                       |         |
| <b>Step 3</b> | Adding Cisco Mobility Express capable Access Point to the Project and associating the controller config. |         |



## Importing Cisco Mobility Express Configuration File to Network PnP

### Procedure

|               | Command or Action                                                                  | Purpose                                                                            |
|---------------|------------------------------------------------------------------------------------|------------------------------------------------------------------------------------|
| <b>Step 1</b> | Login to APIC-EM controller and navigate to Network Plug and Play > Configurations |                                                                                    |
| <b>Step 2</b> | Click on Upload to upload the controller configuration.                            |                                                                                    |
| <b>Step 3</b> | Select a controller configuration file from your local machine.                    |  |

## Creating a Project

### Procedure

|               | Command or Action                                           | Purpose                                                                             |
|---------------|-------------------------------------------------------------|-------------------------------------------------------------------------------------|
| <b>Step 1</b> | Navigate to Network Plug and Play > Projects.               |                                                                                     |
| <b>Step 2</b> | Enter the name for the Project and click on the Add button. |   |
| <b>Step 3</b> | Click on the Create button to create the Project.           |  |
| <b>Step 4</b> |                                                             |                                                                                     |

## Adding Cisco Mobility Express Capable Access Point to the Project and Associating the Controller Configuration

### Procedure

|               | Command or Action                              | Purpose                                                                                                                                                                                                                                                                                                                                                                                                |
|---------------|------------------------------------------------|--------------------------------------------------------------------------------------------------------------------------------------------------------------------------------------------------------------------------------------------------------------------------------------------------------------------------------------------------------------------------------------------------------|
| <b>Step 1</b> | Navigate to Network Plug and Play > Projects.  |                                                                                                                                                                                                                                                                                                                                                                                                        |
| <b>Step 2</b> | Click on Add button under Project Devices.     |                                                                                                                                                                                                                                                                                                                                                                                                        |
| <b>Step 3</b> | In the Add Device window, enter the following: | <ul style="list-style-type: none"> <li>• Device Name—Enter the device name; unique for each site</li> <li>• Product ID—Select the Access Point device ID from the drop-down list</li> <li>• Serial Number—Enter the Serial Number of the Mobility Express Access Point</li> <li>• Config—You can either upload a new configuration or select the configuration file which was added earlier</li> </ul> |
| <b>Step 4</b> | Click the Add button.                          |                                                                                                                                                                                                                                                                                                                                                                                                        |

# APIC-EM Network Plug and Play Deployment Options with Cisco Mobility Express

There are two deployment options supported for deploying Cisco Mobility Express with Network Plug and Play.

## APIC-EM controller in Private Cloud

In this deployment option, there will be an On-Prem APIC-EM controller which can be discovered by Cisco Mobility Express Access Points using option 43 or DNS discovery.

*Figure 5: APIC-EM controller in Private Cloud flow*



Option 43 points to APIC-EM controller IP address. To configure DHCP scope with Option 43, it is important follow the format as shown below. In the example below, 192.168.1.123 is the IP address of APIC-EM controller .

```
ip dhcp pool pnp_device_pool
network 192.168.1.0 255.255.255.0
default-router 192.168.1.1
option 43 ascii "5A1N;B2;K4;I192.168.1.123;J80"
```

To discover APIC-EM controller using the DNS discovery options, configure the DNS server and domain name on the DHCP scope.

```
ip dhcp pool pnp_device_pool
network 192.168.1.0 255.255.255.0
default-router 192.168.1.1
domain-name cisco.com
dns-server 172.20.229.8
```

## Cloud Plug and Play Connect Redirect to APIC-EM Controller

Cloud re-direction service uses Cisco public hosted cloud to re-direct Cisco Mobility Express capable access points to APIC-EM controller. The minimal requirement is that the Mobility Express Access Points network have DHCP and DNS, and connectivity reachable to Cisco public cloud. There is no need to configure Option 43 on DHCP scope with this deployment option. A simple test would be to obtain DHCP address and ping 'devicehelper.cisco.com' from where the Mobility Express AP will be deployed.

*Figure 6: Cloud Plug and Play Device Redirect to APIC-EM controller flow*



## Cloud Plug and Play Device Redirect Provisioning Workflow

This section describes the steps to redirect Cisco Mobility Express Access Points to APIC-EM controller using Cloud Plug and Play Connect service.



To configure cloud Plug and Play connect redirect service, perform the following steps:

1. Obtain a Smart Account
2. Create APIC-EM Controller Profile

3. Adding Mobility Express capable Access Point to the Devices list
4. Associate Mobility Express capable Access Point to APIC-EM Controller profile

### Obtain a Smart Account

#### Procedure

|               | Command or Action                                                                                           | Purpose                                                                                                                                                                                                                                                                                                                                        |
|---------------|-------------------------------------------------------------------------------------------------------------|------------------------------------------------------------------------------------------------------------------------------------------------------------------------------------------------------------------------------------------------------------------------------------------------------------------------------------------------|
| <b>Step 1</b> | Go to <a href="http://software.cisco.com">http://software.cisco.com</a>                                     |                                                                                                                                                                                                                                                                                                                                                |
| <b>Step 2</b> | Request a Smart Account or Log In (existing Smart Account holders).                                         |                                                                                                                                                                                                                                                              |
| <b>Step 3</b> | Click on Controller Profiles. Select a Virtual Account. If you do have one, create a Virtual Account first. |                                                                                                                                                                                                                                                                                                                                                |
| <b>Step 4</b> | Click on the Add Profile to create a new controller profile.                                                |                                                                                                                                                                                                                                                              |
| <b>Step 5</b> | Select Controller Type as PNP Server from the drop-down list and click on Next.                             |                                                                                                                                                                                                                                                              |
| <b>Step 6</b> | Enter the following and click Next.                                                                         | <ul style="list-style-type: none"> <li>• Profile Name</li> <li>• Description</li> <li>• Select IPv4 or IPv6, HTTP or HTTPS and enter the IP address if the PNP Server</li> </ul> <p><b>Note</b> If you select HTTPS, then you would have import a SSL certificate. Also, optionally one can enter information of the secondary controller.</p> |

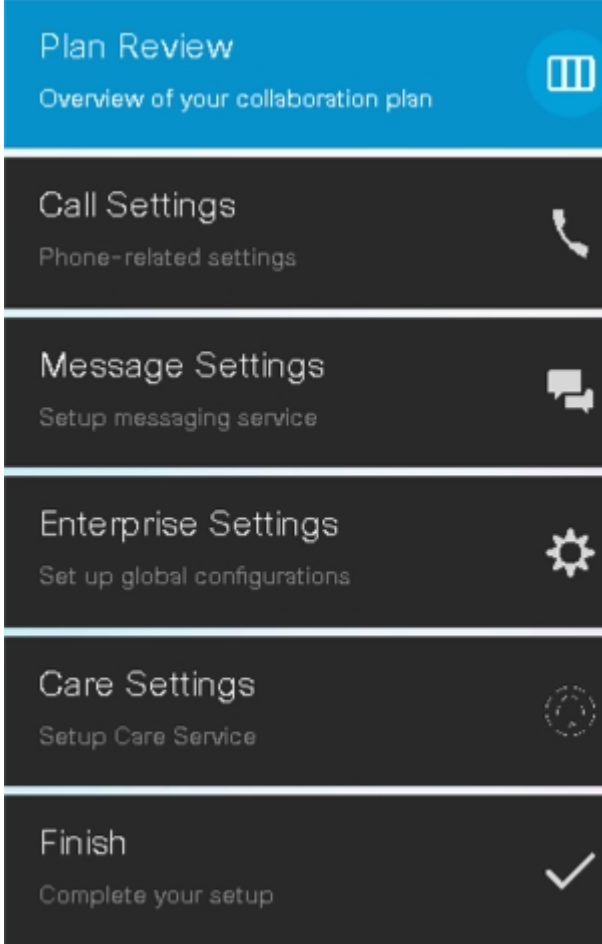
|  | Command or Action | Purpose                                                                                                                                                                                                                                                                                                                                                                                                                                                                                                                                       |
|--|-------------------|-----------------------------------------------------------------------------------------------------------------------------------------------------------------------------------------------------------------------------------------------------------------------------------------------------------------------------------------------------------------------------------------------------------------------------------------------------------------------------------------------------------------------------------------------|
|  |                   |  <p>The screenshot shows a mobile application interface with a list of configuration steps. Each step is represented by a card with a title, a subtitle, and an icon. The steps are: Plan Review (Overview of your collaboration plan), Call Settings (Phone-related settings), Message Settings (Setup messaging service), Enterprise Settings (Set up global configurations), Care Settings (Setup Care Service), and Finish (Complete your setup).</p> |

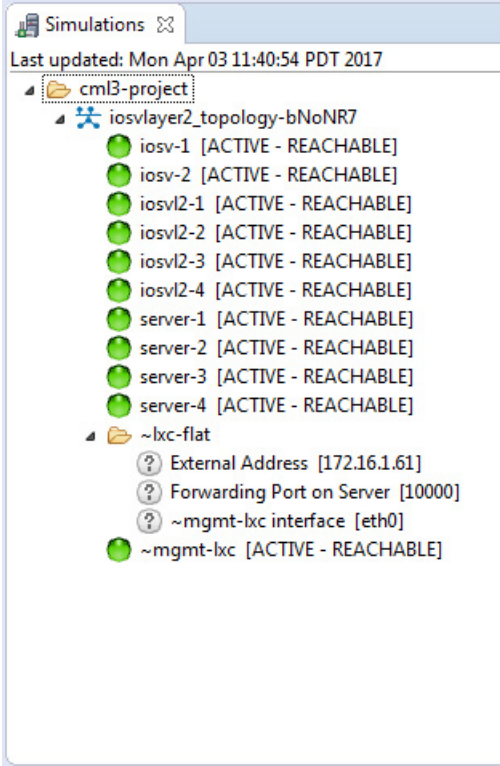
|               | Command or Action                                                                                   | Purpose                                                                                                                                                                                                                                                                                                                                                                                                                                                                                                                                                                                                                                                                                                                                                                                                                                                                                                                                                                                                |
|---------------|-----------------------------------------------------------------------------------------------------|--------------------------------------------------------------------------------------------------------------------------------------------------------------------------------------------------------------------------------------------------------------------------------------------------------------------------------------------------------------------------------------------------------------------------------------------------------------------------------------------------------------------------------------------------------------------------------------------------------------------------------------------------------------------------------------------------------------------------------------------------------------------------------------------------------------------------------------------------------------------------------------------------------------------------------------------------------------------------------------------------------|
| <b>Step 7</b> | Review the entries and click on Submit button to add the Controller Profile and finally click Done. |  <p>Simulations</p> <p>Last updated: Mon Apr 03 11:40:54 PDT 2017</p> <ul style="list-style-type: none"> <li>cm3-project       <ul style="list-style-type: none"> <li>iosvlayer2_topology-bNoNR7           <ul style="list-style-type: none"> <li>iosv-1 [ACTIVE - REACHABLE]</li> <li>iosv-2 [ACTIVE - REACHABLE]</li> <li>iosv12-1 [ACTIVE - REACHABLE]</li> <li>iosv12-2 [ACTIVE - REACHABLE]</li> <li>iosv12-3 [ACTIVE - REACHABLE]</li> <li>iosv12-4 [ACTIVE - REACHABLE]</li> <li>server-1 [ACTIVE - REACHABLE]</li> <li>server-2 [ACTIVE - REACHABLE]</li> <li>server-3 [ACTIVE - REACHABLE]</li> <li>server-4 [ACTIVE - REACHABLE]</li> </ul> </li> <li>~lxc-flat           <ul style="list-style-type: none"> <li>External Address [172.16.1.61]</li> <li>Forwarding Port on Server [10000]</li> <li>~mgmt-lxc interface [eth0]</li> <li>~mgmt-lxc [ACTIVE - REACHABLE]</li> </ul> </li> </ul> </li> </ul> |

## Create APIC-EM Controller Profile





### Procedure

|               | Command or Action                                                                                           | Purpose                                                                              |
|---------------|-------------------------------------------------------------------------------------------------------------|--------------------------------------------------------------------------------------|
| <b>Step 1</b> | Go to <a href="http://software.cisco.com">http://software.cisco.com</a> and login                           |                                                                                      |
| <b>Step 2</b> | Navigate to Provisioning > Plug and Play Connect                                                            |  |
| <b>Step 3</b> | Click on Controller Profiles. Select a Virtual Account. If you do have one, create a Virtual Account first. |                                                                                      |
| <b>Step 4</b> | Click the Add Profile to create a new controller profile.                                                   |                                                                                      |
| <b>Step 5</b> | Select Controller Type as PNP Server from the drop-down list and click on Next. .                           |                                                                                      |
| <b>Step 6</b> | Enter the following and click Next.                                                                         | <ul style="list-style-type: none"> <li>Profile Name</li> <li>Description</li> </ul>  |

|               | Command or Action                                                                                   | Purpose                                                                                                                                                                                                                                                                                       |
|---------------|-----------------------------------------------------------------------------------------------------|-----------------------------------------------------------------------------------------------------------------------------------------------------------------------------------------------------------------------------------------------------------------------------------------------|
|               |                                                                                                     | <ul style="list-style-type: none"> <li>Select IPv4 or IPv6, HTTP or HTTPS and enter the IP address if the PNP Server</li> </ul> <p><b>Note</b> If you select HTTPS, then you would have import a SSL certificate. Also, optionally one can enter information of the secondary controller.</p> |
| <b>Step 7</b> | Review the entries and click on Submit button to add the Controller Profile and finally click Done. |                                                                                                                                                                                                                                                                                               |

### Adding Cisco Mobility Express capable Access Point to the Devices List

#### Procedure

|               | Command or Action                                                                                                                                                                                         | Purpose                                                                               |
|---------------|-----------------------------------------------------------------------------------------------------------------------------------------------------------------------------------------------------------|---------------------------------------------------------------------------------------|
| <b>Step 1</b> | Navigate to Provisioning > Plug and Play Connect. Click on Devices.                                                                                                                                       |                                                                                       |
| <b>Step 2</b> | Click on Devices. Select a Virtual Account. If you do have one, create a Virtual Account first.                                                                                                           |                                                                                       |
| <b>Step 3</b> | Click on Add Devices button to add a new device (Mobility Express Access Point).                                                                                                                          |  |
| <b>Step 4</b> | Import a csv file with the Device info or select Enter Device info manually. Click Next.                                                                                                                  |  |
| <b>Step 5</b> | Click on Identify Device button. The Identify Device window will pop up. Enter Serial Number, select Base PID, and Controller Profile(created earlier). Click on the Save button followed by Next button. |  |
| <b>Step 6</b> | Review the entries and click on Submit button to add the Device. Finally, click Done.                                                                                                                     |  |
| <b>Step 7</b> | Verify that the Device has been added and the status is Pending (Redirection).                                                                                                                            |  |

## Connecting Cisco Mobility Access Points

To bring up a new Mobility Express site, make sure that Plug and Play service has been configured with Mobility Express Access Points with related controller configuration. If APIC-EM controller in Private Cloud deployment option is used, Option 43 or DNS discovery on DHCP scope must be configured. If Cloud Plug and Play Connect redirect to APIC-EM controller deployment option is used, make sure all the related configuration on Cloud Plug and Play Connect has also been done for successful redirect to APIC-EM controller.

Now, it is time to connect the Mobility Express Access Points at the site. One may connect one or more Access Points at a site. It is important to note that if multiple Mobility Express Access Points are connected at a site, primary Election will happen first and only after primary Access Point has been elected, it will initiate communication with the Network Plug and Play service and download the controller configuration file regardless of the deployment option. The other Access Points will not initiate communicate with the Network Plug and Play service. After the controller configuration file has been downloaded on the Access Point, it will reboot and after it comes up, it will run the controller. The rest of the Access Points at the site will join this primary Access Point as Subordinate Access Points.

## Using internal DHCP server on Cisco Mobility Express

### Creating a DHCP Scope

Internal DHCP server can be enabled and DHCP scope created during Day 0 from Setup Wizard as well as in Day 1 using the controller WebUI. Typically, one would create DHCP scopes in Day 1 if they want to associate the scopes with WLANs.

To create a scope and associate it to a WLAN using the controller WebUI, follow the procedure below:

#### Procedure

|               | Command or Action                                                                                  | Purpose                                                                                                                                                                                                                                                                                                                                                                                                                                                                                                                                                                                                                                                                                    |
|---------------|----------------------------------------------------------------------------------------------------|--------------------------------------------------------------------------------------------------------------------------------------------------------------------------------------------------------------------------------------------------------------------------------------------------------------------------------------------------------------------------------------------------------------------------------------------------------------------------------------------------------------------------------------------------------------------------------------------------------------------------------------------------------------------------------------------|
| <b>Step 1</b> | Navigate to Wireless Settings > DHCP Server > Add new Pool . The Add DHCP Pool window will pop up. |                                                                                                                                                                                                                                                                                                                                                                                                                                                                                                                                                                                                                                                                                            |
| <b>Step 2</b> | On the Add DHCP Pool window. Enter the following fields:                                           | <ul style="list-style-type: none"> <li>• Enter the Pool Name for the WLAN</li> <li>• Enable the Pool Status</li> <li>• Enter the VLAN ID for the WLAN</li> <li>• Enter the Lease Period for the DHCP clients. Default is 1 Day</li> <li>• Enter the Network/Mask</li> <li>• Enter the Start IP for the DHCP pool</li> <li>• Enter the End IP for the DHCP pool</li> <li>• Enter the Gateway IP for the DHCP pool</li> <li>• Enter the Domain Name (Optional) for the DHCP pool</li> <li>• For Name Servers, select User Defined if one needs to enter IP addresses of Name Servers or select OpenDNS in which case OpenDNS Name Server IP addresses are automatically populated</li> </ul> |



|               | Command or Action                                                                                                                                               | Purpose                                                                                                                                                                                                                                                                                                                                                            |
|---------------|-----------------------------------------------------------------------------------------------------------------------------------------------------------------|--------------------------------------------------------------------------------------------------------------------------------------------------------------------------------------------------------------------------------------------------------------------------------------------------------------------------------------------------------------------|
| <b>Step 3</b> | Click Apply.                                                                                                                                                    |                                                                                                                                                                                                                                                                                                                                                                    |
| <b>Step 4</b> | After creating the scope, it is time to assign the VLAN mapped to the DHCP scope to the WLAN. To assign a VLAN to WLAN, navigate to Wireless Settings > WLANs . |                                                                                                                                                                                                                                                                                                                                                                    |
| <b>Step 5</b> | If the WLAN does not exist, create a WLAN or if one does exist, edit the existing WLAN and click on the VLAN and Firewall tab.                                  |                                                                                                                                                                                                                                                                                                                                                                    |
| <b>Step 6</b> | On the VLAN and Firewall tab, configure the following:                                                                                                          | <ul style="list-style-type: none"> <li>• Select Yes for Use VLAN Tagging</li> <li>• Enter the Native VLAN ID</li> <li>• Select the DHCP Scope which was created previously for the WLAN. VLAN ID should be automatically populated after the DHCP scope is selected</li> </ul>  |
| <b>Step 7</b> | Click Apply.                                                                                                                                                    |                                                                                                                                                                                                                                                                                                                                                                    |

## Configuring Cisco Mobility Express for Site Survey

Cisco 802.11ac Wave 2 access points are capable of running Cisco Mobility Express which a virtual wireless controller function embedded on an Access Point.

Cisco Mobility Express access point running the wireless controller function will also provide wireless connectivity to the clients. It also supports internal DHCP server which enables Access Point to be used for Site Survey.

### Introduction

Cisco 802.11ac Wave 2 access points are capable of running Cisco Mobility Express which a virtual wireless controller function embedded on an Access Point.

Cisco Mobility Express access point running the wireless controller function will also provide wireless connectivity to the clients. It also supports internal DHCP server which enables Access Point to be used for Site Survey.

## Configuring Mobility Express for Site Survey Using CLI

### Procedure

|               | Command or Action                           | Purpose |
|---------------|---------------------------------------------|---------|
| <b>Step 1</b> | Connect to the console of the Access Point. |         |

|               | Command or Action                                                                                                                | Purpose                                                                                                                                                                                                                                                                                                                                                                                                                                                                                                                                                                                                                                                                                                                                                                                                                                                                                                                                                                                                                                                                                                                                                                                                                                                                                                                                                                                                                                                                                  |
|---------------|----------------------------------------------------------------------------------------------------------------------------------|------------------------------------------------------------------------------------------------------------------------------------------------------------------------------------------------------------------------------------------------------------------------------------------------------------------------------------------------------------------------------------------------------------------------------------------------------------------------------------------------------------------------------------------------------------------------------------------------------------------------------------------------------------------------------------------------------------------------------------------------------------------------------------------------------------------------------------------------------------------------------------------------------------------------------------------------------------------------------------------------------------------------------------------------------------------------------------------------------------------------------------------------------------------------------------------------------------------------------------------------------------------------------------------------------------------------------------------------------------------------------------------------------------------------------------------------------------------------------------------|
| <b>Step 2</b> | Power up the Access Point using a power adapter or battery pack.                                                                 |                                                                                                                                                                                                                                                                                                                                                                                                                                                                                                                                                                                                                                                                                                                                                                                                                                                                                                                                                                                                                                                                                                                                                                                                                                                                                                                                                                                                                                                                                          |
| <b>Step 3</b> | Wait for the Access Point to boot up completely such that it is running the Wireless Controller and is waiting to be configured. |                                                                                                                                                                                                                                                                                                                                                                                                                                                                                                                                                                                                                                                                                                                                                                                                                                                                                                                                                                                                                                                                                                                                                                                                                                                                                                                                                                                                                                                                                          |
| <b>Step 4</b> | Configure the Wireless Controller using the CLI Setup Wizard:                                                                    | <p><b>Note</b> For Site Survey, a DHCP server is required and is supported on Cisco Mobility Express. DHCP Server configuration highlighted below is mandatory if you want to enable DHCP server on Cisco Mobility Express.</p> <pre> Would you like to terminate autoinstall? [yes]:yes Enter Administrative User Name (24 characters max):admin Enter Administrative Password (3 to 24 characters max):Cisco123 Re-enter Administrative Password: Cisco123 System Name:[Cisco_3a:d2:b4] (31 characters max):me-wlc Enter Country Code list (enter 'help' for a list of countries)[US]:US Configure a NTP server now?[YES][no]:no Configure the system time now?[YES][no]:yes Enter the date in MM/DD/YY format:02/28/17 Enter the time in HH:MM:SS format:11:30:00 Enter timezone location index (enter 'help' for a list of timezones):5 Management Interface IP Address: 10.10.10.2 Management Interface Netmask: 255.255.255.0 Management Interface Default Router: 10.10.10.1 Create Management DHCP Scope?[yes][NO]:yes DHCP Network: 10.10.10.0 DHCP Netmask: 255.255.255.0 Router IP: 10.10.10.1 Start DHCP IP address: 10.10.10.10 Stop DHCP IP address: 10.10.10.250 DomainName: mewlc.local DNS Server:[OPENDNS][user DNS]OPENDNS Create Employee Network?[YES][no]:yes Employee Network Name (SSID)? :site_survey Employee VLAN Identifier?[MGMT][1-4095]:MGMT Employee Network Security?[PSK][enterprise]:PSK Employee PSK Passphrase (8-38 characters)? : Cisco123 </pre> |

|               | Command or Action                                                                                                                                                                                                                                                                                                      | Purpose                                                                                                                                                                                                                                                                                                                                                                                                                                                                                                                                                                                                                                                                                                                                                                                                                                                                                                                                                                                                                                                                                                                                                 |
|---------------|------------------------------------------------------------------------------------------------------------------------------------------------------------------------------------------------------------------------------------------------------------------------------------------------------------------------|---------------------------------------------------------------------------------------------------------------------------------------------------------------------------------------------------------------------------------------------------------------------------------------------------------------------------------------------------------------------------------------------------------------------------------------------------------------------------------------------------------------------------------------------------------------------------------------------------------------------------------------------------------------------------------------------------------------------------------------------------------------------------------------------------------------------------------------------------------------------------------------------------------------------------------------------------------------------------------------------------------------------------------------------------------------------------------------------------------------------------------------------------------|
|               |                                                                                                                                                                                                                                                                                                                        | <pre> Re-enter Employee PSK Passphrase: Cisco123 Re-enter Employee PSK Passphrase: Cisco123 Create Guest Network? [yes][NO]:NO Enable RF Parameter Optimization?[YES][no]:no Configuration correct? If yes, system will save it and reset.[yes][NO]:yes </pre>                                                                                                                                                                                                                                                                                                                                                                                                                                                                                                                                                                                                                                                                                                                                                                                                                                                                                          |
| <b>Step 5</b> | Wait for the Access Point to boot up completely. After the Wireless controller has started, log back in to the controller using administrative username or password configured during the initial setup wizard.                                                                                                        |                                                                                                                                                                                                                                                                                                                                                                                                                                                                                                                                                                                                                                                                                                                                                                                                                                                                                                                                                                                                                                                                                                                                                         |
| <b>Step 6</b> | (Optional): During the CLI setup wizard, Employee Network Security was configured to PSK. This can be disabled for easy association of clients and also disable SSID broadcast to avoid unwanted clients from joining the SSID. To disable PSK and SSID broadcast, enter the following commands in the Controller CLI. | <pre> (Cisco Controller)&gt;config wlan disable 1 (Cisco Controller)&gt;config wlan security wpa disable 1 (Cisco Controller)&gt;config wlan broadcast-ssid disable wlan 1 (Cisco Controller)&gt;config wlan enable 1 (Cisco Controller)&gt;save config </pre>                                                                                                                                                                                                                                                                                                                                                                                                                                                                                                                                                                                                                                                                                                                                                                                                                                                                                          |
| <b>Step 7</b> | To configure channel, TX power, and channel bandwidth for the radios, disable the radio first, make the changes and then re-enable it.                                                                                                                                                                                 | <p>To change the 2.4GHz radio to channel 6, follow the steps below:</p> <pre> (Cisco Controller)&gt;config 802.11b disable &lt;ap name&gt; (Cisco Controller)&gt;config 802.11b channel &lt;ap name&gt; &lt;ap name&gt; 6 (Cisco Controller)&gt;config 802.11b enable &lt;ap name&gt; </pre> <p>To change the 2.4GHz radio Transmit Power to power level 3, follow the steps below:</p> <pre> (Cisco Controller)&gt;config 802.11b disable &lt;ap name&gt; (Cisco Controller)&gt;config 802.11b txPower &lt;ap name&gt; &lt;ap name&gt; 3 (Cisco Controller)&gt;config 802.11b enable &lt;ap name&gt; </pre> <p>To change the 5 GHz radio to channel 44, follow the steps below:</p> <pre> (Cisco Controller)&gt;config 802.11a disable &lt;ap name&gt; (Cisco Controller)&gt;config 802.11a channel &lt;ap name&gt; &lt;ap name&gt; 44 (Cisco Controller)&gt;config 802.11a enable &lt;ap name&gt; </pre> <p>To change the 5 GHz radio Transmit Power to level 5, follow the steps below:</p> <pre> (Cisco Controller)&gt;config 802.11a disable &lt;ap name&gt; (Cisco Controller)&gt;config 802.11a txPower &lt;ap name&gt; &lt;ap name&gt; 5 </pre> |

|  | Command or Action | Purpose                                                                                                                                                                                                                                                                                                                                                                                                                                                                                                                                                                                                                                                                                                                                                                                                                                                                                                                                                                                                                                                                                                                                                                                                                                                                                                                                                                                                                                                                                                                                                                                                                                                                                                                                                      |
|--|-------------------|--------------------------------------------------------------------------------------------------------------------------------------------------------------------------------------------------------------------------------------------------------------------------------------------------------------------------------------------------------------------------------------------------------------------------------------------------------------------------------------------------------------------------------------------------------------------------------------------------------------------------------------------------------------------------------------------------------------------------------------------------------------------------------------------------------------------------------------------------------------------------------------------------------------------------------------------------------------------------------------------------------------------------------------------------------------------------------------------------------------------------------------------------------------------------------------------------------------------------------------------------------------------------------------------------------------------------------------------------------------------------------------------------------------------------------------------------------------------------------------------------------------------------------------------------------------------------------------------------------------------------------------------------------------------------------------------------------------------------------------------------------------|
|  |                   | <pre>(Cisco Controller)&gt;config 802.11a enable &lt;ap name&gt;</pre> <p>To change the 5 GHz radio channel width to 40MHz, follow the steps below:</p> <pre>(Cisco Controller)&gt;config 802.11a disable &lt;ap name&gt; (Cisco Controller)&gt;config 802.11a chan_width &lt;ap name&gt; 40 (Cisco Controller)&gt;config 802.11a enable &lt;ap name&gt;</pre> <p>If access points are being used for Site Survey, please note the following with respect to the XOR radio.</p> <ol style="list-style-type: none"> <li>Default operation state of XOR radio is 2.4GHz.</li> <li>When the XOR (2.4 GHz) radio is configured to operate at 5GHz, 100MHz frequency separation is required from dedicated 5GHz radio.</li> <li>When the XOR radio is configured to operate in 5GHz mode on an internal (I) Access Points, the Transmit power (tx) power will be fixed and cannot be modified.</li> <li>One can configure the XOR radio on internal (I) Access Points from 2.4GHz to 5 and vice versa. On an external (E) Access Point, one must have an external antenna plugged into the DART connector prior to changing any configuration on the XOR radio.</li> <li>To configure the XOR (2.4GHz) radio to operate at 5GHz on Access Points, follow the steps below:</li> </ol> <pre>(Cisco Controller) &gt;config 802.11-abgn disable ap (Cisco Controller) &gt;config 802.11-abgn role ap manual client-serving (Cisco Controller) &gt;config 802.11-abgn band ap ap 5GHz (Cisco Controller) &gt;config 802.11-abgn enable ap</pre> <p>To configure the XOR radio operating at 5 GHz to channel 40, follow the steps below:</p> <pre>(Cisco Controller) &gt;config 802.11-abgn disable ap (Cisco Controller) &gt;config 802.11-abgn channel ap ap 40</pre> |

|  | Command or Action | Purpose                                                                                                                                                                                                                                                                                                                                            |
|--|-------------------|----------------------------------------------------------------------------------------------------------------------------------------------------------------------------------------------------------------------------------------------------------------------------------------------------------------------------------------------------|
|  |                   | <pre>(Cisco Controller) &gt;config 802.11-abgn enable ap</pre> <p>To configure the XOR radio operating at 5 GHz channel width to 40MHz, follow the steps below:</p> <pre>(Cisco Controller) &gt;config 802.11-abgn disable ap (Cisco Controller) &gt;config 802.11-abgn chan_width ap 40 (Cisco Controller) &gt;config 802.11-abgn enable ap</pre> |

## Creating Wireless Networks

Cisco Mobility Express solution supports a maximum of 16 WLANs. Each WLAN has a unique WLAN ID (1 through 16), a unique Profile Name, SSID, and can be assigned different security policies.

Access Points broadcast all active WLAN SSIDs and enforce the policies that you define for each WLAN.

You can configure WLANs with different service set identifiers (SSIDs) or with the same SSID. An SSID identifies the specific wireless network that you want the controller to access. Creating WLANs with the same SSID enables you to assign different Layer 2 security policies within the same wireless LAN. To distinguish among WLANs with the same SSID, you must create a unique profile name for each WLAN. WLANs with the same SSID must have unique Layer 2 security policies so that clients can make a WLAN selection based on information advertised in beacon and probe responses.

A number of WLAN Security options are supported on Cisco Mobility Express solution and are outlined below:

1. Open
2. WPA2 Personal
3. WPA2 Enterprise (External RADIUS, AP)

For Guest WLAN, a number of capabilities are supported:

1. CMX Guest Connect
2. WPA2 Personal
3. Captive Portal (AP)
4. Captive Portal (External Web Server)

## Creating Employee WLANs

## Creating Employee WLAN with WPA2 Personal

### Procedure

|               | Command or Action                                                                                                 | Purpose |
|---------------|-------------------------------------------------------------------------------------------------------------------|---------|
| <b>Step 1</b> | Navigate to Wireless Settings > WLANs and then click on Add new WLAN button. The Add new WLAN Window will pop up. |         |
| <b>Step 2</b> | In the Add new WLAN window, on the General page, configure the following:                                         |         |
| <b>Step 3</b> | Click on the WLAN Security and configure the following:                                                           |         |
| <b>Step 4</b> | Click Apply.                                                                                                      |         |

## Creating Employee WLAN using WPA2 Enterprise with External Radius Server

### Procedure

|               | Command or Action                                                                                                 | Purpose |
|---------------|-------------------------------------------------------------------------------------------------------------------|---------|
| <b>Step 1</b> | Navigate to Wireless Settings > WLANs and then click on Add new WLAN button. The Add new WLAN Window will pop up. |         |
| <b>Step 2</b> | In the Add new WLAN window, on the General page configure the following:                                          |         |
| <b>Step 3</b> | Click on the WLAN Security and configure the following:                                                           |         |
| <b>Step 4</b> | Add the Radius server and configure the following:                                                                |         |
| <b>Step 5</b> | Click Apply.                                                                                                      |         |

## Creating Employee WLAN with WPA2 Enterprise and Authentication Server as AP

### Procedure

|               | Command or Action                                                                                                 | Purpose                                                                                                |
|---------------|-------------------------------------------------------------------------------------------------------------------|--------------------------------------------------------------------------------------------------------|
| <b>Step 1</b> | Navigate to Wireless Settings > WLANs and then click on Add new WLAN button. The Add new WLAN Window will pop up. |                                                                                                        |
| <b>Step 2</b> | In the Add new WLAN window, on the General page configure the following:                                          | <ul style="list-style-type: none"> <li>• Enter the Profile Name.</li> <li>• Enter the SSID.</li> </ul> |
| <b>Step 3</b> | Click on the WLAN Security and configure the following:                                                           | <ul style="list-style-type: none"> <li>• Select Security as WPA2 Enterprise.</li> </ul>                |

|               | Command or Action | Purpose                                                                                                                                                                                                                                                                                           |
|---------------|-------------------|---------------------------------------------------------------------------------------------------------------------------------------------------------------------------------------------------------------------------------------------------------------------------------------------------|
|               |                   | <ul style="list-style-type: none"> <li>Select Authentication Server as AP.</li> </ul> <p><b>Note</b> AP is the primary AP running the controller function. In this use case, controller is the Authentication Server and therefore Local WLAN user account must exist to onboard the clients.</p> |
| <b>Step 4</b> | Click the Apply.  |                                                                                                                                                                                                                                                                                                   |

## Creating Employee WLAN with WPA2 Enterprise/External RADIUS and MAC Filtering

### Procedure

|               | Command or Action                                                                                          | Purpose                                                                                                                                                                                                                                                                                             |
|---------------|------------------------------------------------------------------------------------------------------------|-----------------------------------------------------------------------------------------------------------------------------------------------------------------------------------------------------------------------------------------------------------------------------------------------------|
| <b>Step 1</b> | Navigate to Wireless Settings > WLANs and then click on Add new WLAN. The Add new WLAN Window will pop up. |                                                                                                                                                                                                                                                                                                     |
| <b>Step 2</b> | In the Add new WLAN window, on the General tab, configure the following:                                   | <ul style="list-style-type: none"> <li>Enter the Profile Name</li> <li>Enter the SSID</li> </ul>                                                                                                                                                                                                    |
| <b>Step 3</b> | Click on the WLAN Security tab and configure the following:                                                | <ul style="list-style-type: none"> <li>Enable MAC Filtering</li> <li>Select Security Type as WPA2 Enterprise</li> <li>Select Authentication Server as External RADIUS</li> <li>Select RADIUS Compatibility from the drop-down list</li> <li>Select MAC Delimiter from the drop-down list</li> </ul> |
| <b>Step 4</b> | Add the Radius server and configure the following:                                                         | <ul style="list-style-type: none"> <li>Enter the Radius IP</li> <li>Enter the Radius Port</li> <li>Enter the Shared Secret</li> <li>Click on tick icon</li> </ul>                                                                                                                                   |
| <b>Step 5</b> | Click Apply.                                                                                               |                                                                                                                                                                                                                                                                                                     |

## Creating Guest WLANs

Mobility Express controller can provide guest user access on WLANs which are specifically designated for use by guest users. To set this WLAN exclusively for guest user access, enable the Guest Network under the WLAN Security tab.

### Creating Guest WLAN with Captive Portal on CMX Connect

#### Procedure

|               | Command or Action                                                                                                 | Purpose                                                                                                                                                                                                 |
|---------------|-------------------------------------------------------------------------------------------------------------------|---------------------------------------------------------------------------------------------------------------------------------------------------------------------------------------------------------|
| <b>Step 1</b> | Navigate to Wireless Settings > WLANs and then click on Add new WLAN button. The Add new WLAN Window will pop up. |                                                                                                                                                                                                         |
| <b>Step 2</b> | In the Add new WLAN window, on the General tab, configure the following:                                          | <ul style="list-style-type: none"> <li>• Enter the Profile Name</li> <li>• Enter the SSID</li> </ul>                                                                                                    |
| <b>Step 3</b> | Enable the Guest Network under the WLAN Security tab.                                                             |                                                                                                                                                                                                         |
| <b>Step 4</b> | Select Captive Portal as CMX Connect.                                                                             |                                                                                                                                                                                                         |
| <b>Step 5</b> | Enter Captive Portal URL.                                                                                         | <b>Note</b> Captive Portal URL must have the following format:<br><a href="https://yya7lc.cmxcisco.com/visitor/login">https://yya7lc.cmxcisco.com/visitor/login</a><br>where yya7lc is your Account ID. |
| <b>Step 6</b> | Click Apply.                                                                                                      | <b>Note</b> Additional steps are required on CMX Cloud to create the Captive Portal, Site with Access Points and associating Captive Portal to the Site.                                                |

### Creating Guest WLAN with Internal Splash Page

There is an internal splash page built into the Mobility Express controller which can be used to onboard the clients connecting to Guest WLANs. This internal splash page can also be customized by uploading a customized bundle. To upload a customized internal splash page, navigate to Wireless Settings > Guest WLANs. Select Page Type as Customized and click on the Upload button to upload a customized page bundle.

For internal splash page, Cisco Mobility Express supports multiple options for Access Type. They are as follows:

1. Local User Account
2. Web Consent
3. Email Address
4. RADIUS
5. WPA2 Personal



**Procedure**

|               | <b>Command or Action</b>                                                                                          | <b>Purpose</b>                                                                                                                                                                                                                                                                                                                                                                                                                                                                                                                                                                                                                                                                                                                                                                                                                                                                                                                                                                                                                                                                          |
|---------------|-------------------------------------------------------------------------------------------------------------------|-----------------------------------------------------------------------------------------------------------------------------------------------------------------------------------------------------------------------------------------------------------------------------------------------------------------------------------------------------------------------------------------------------------------------------------------------------------------------------------------------------------------------------------------------------------------------------------------------------------------------------------------------------------------------------------------------------------------------------------------------------------------------------------------------------------------------------------------------------------------------------------------------------------------------------------------------------------------------------------------------------------------------------------------------------------------------------------------|
| <b>Step 1</b> | Navigate to Wireless Settings > WLANs and then click on Add new WLAN button. The Add new WLAN Window will pop up. |                                                                                                                                                                                                                                                                                                                                                                                                                                                                                                                                                                                                                                                                                                                                                                                                                                                                                                                                                                                                                                                                                         |
| <b>Step 2</b> | In the Add new WLAN window, on the General tab, configure the following:                                          | <ul style="list-style-type: none"> <li>• Enter the Profile Name</li> <li>• Enter the SSID</li> </ul>                                                                                                                                                                                                                                                                                                                                                                                                                                                                                                                                                                                                                                                                                                                                                                                                                                                                                                                                                                                    |
| <b>Step 3</b> | Enable the Guest Network under the WLAN Security tab.                                                             |                                                                                                                                                                                                                                                                                                                                                                                                                                                                                                                                                                                                                                                                                                                                                                                                                                                                                                                                                                                                                                                                                         |
| <b>Step 4</b> | Select Captive Portal as Internal Splash Page.                                                                    |                                                                                                                                                                                                                                                                                                                                                                                                                                                                                                                                                                                                                                                                                                                                                                                                                                                                                                                                                                                                                                                                                         |
| <b>Step 5</b> | Select one of the following Access Type as needed:                                                                | <ul style="list-style-type: none"> <li>• Local User Account–Splash Page will present the user to enter username and password which must be authenticated by the controller before network access is granted. Local WLAN users must be created on the controller to onboard the Guest clients.</li> <li>• Web Consent–Splash Page will present the user to acknowledge before network access is granted.</li> <li>• Email Address–Splash Page will present the user to enter the email address before network access is granted.</li> <li>• RADIUS–Splash Page will present the user to enter username and password which must be authenticated by the RADIUS server before network access is granted. Select Access Type as RADIUS and enter the RADIUS server configuration.</li> <li>• WPA2 Personal–This is an example of L2 + L3 (Web Consent). Layer 2 PSK security authentication will happen first followed by Splash Page which will present the user to acknowledge before network access is granted. Select Access Type as WPA2 Personal and enter the Passphrase.</li> </ul> |
| <b>Step 6</b> | Click Apply.                                                                                                      |                                                                                                                                                                                                                                                                                                                                                                                                                                                                                                                                                                                                                                                                                                                                                                                                                                                                                                                                                                                                                                                                                         |

**Creating Guest WLAN with External Splash Page**

An external splash page is one which resides on an external Web Server. Similar to the internal splash page, Cisco Mobility Express supports multiple options for Access Type with external splash page. They are as follows:

- Local User Account
- Web Consent
- Email Address
- RADIUS
- WPA2 Personal

### Procedure

|               | Command or Action                                                                                                 | Purpose                                                                                                                                                                                                                                                                                                                                                                                                                                                                                                                                                                                                                                                                                                                                                                                                                                                                                                                                                                                                          |
|---------------|-------------------------------------------------------------------------------------------------------------------|------------------------------------------------------------------------------------------------------------------------------------------------------------------------------------------------------------------------------------------------------------------------------------------------------------------------------------------------------------------------------------------------------------------------------------------------------------------------------------------------------------------------------------------------------------------------------------------------------------------------------------------------------------------------------------------------------------------------------------------------------------------------------------------------------------------------------------------------------------------------------------------------------------------------------------------------------------------------------------------------------------------|
| <b>Step 1</b> | Navigate to Wireless Settings > WLANs and then click on Add new WLAN button. The Add new WLAN Window will pop up. |                                                                                                                                                                                                                                                                                                                                                                                                                                                                                                                                                                                                                                                                                                                                                                                                                                                                                                                                                                                                                  |
| <b>Step 2</b> | In the Add new WLAN window, on the General tab, configure the following:                                          | <ul style="list-style-type: none"> <li>• Enter the Profile Name</li> <li>• Enter the SSID</li> </ul>                                                                                                                                                                                                                                                                                                                                                                                                                                                                                                                                                                                                                                                                                                                                                                                                                                                                                                             |
| <b>Step 3</b> | Enable the Guest Network under the WLAN Security tab.                                                             |                                                                                                                                                                                                                                                                                                                                                                                                                                                                                                                                                                                                                                                                                                                                                                                                                                                                                                                                                                                                                  |
| <b>Step 4</b> | Select Captive Portal as External Splash Page.                                                                    |                                                                                                                                                                                                                                                                                                                                                                                                                                                                                                                                                                                                                                                                                                                                                                                                                                                                                                                                                                                                                  |
| <b>Step 5</b> | Select one of the following Access Type as needed:                                                                | <ul style="list-style-type: none"> <li>• Local User Account–Splash Page will present the user to enter username and password which must be authenticated by the controller before network access is granted. Local WLAN users must be created on the controller to onboard the Guest clients.</li> <li>• Web Consent–Splash Page will present the user to acknowledge before network access is granted.</li> <li>• Email Address–Splash Page will present the user to enter the email address before network access is granted.</li> <li>• RADIUS–Splash Page will present the user to enter username and password which must be authenticated by the RADIUS server before network access is granted. Select Access Type as RADIUS and enter the RADIUS server configuration.</li> <li>• WPA2 Personal–This is an example of L2 + L3 (Web Consent). Layer 2 PSK security authentication will happen first followed by Splash Page which will present the user to acknowledge before network access is</li> </ul> |

|               | Command or Action | Purpose                                                                |
|---------------|-------------------|------------------------------------------------------------------------|
|               |                   | granted. Select Access Type as WPA2 Personal and enter the Passphrase. |
| <b>Step 6</b> | Click Apply       |                                                                        |

## Internal Splash Page for Web Authentication

Cisco Mobility Express supports a default internal guest portal that comes built-in and also a customized page, which can be imported by the user.

### Using Default Internal Guest Portal

To use the default Guest Portal Page or import a customized Guest Portal page, follow the procedure below:

#### Procedure

|               | Command or Action                               | Purpose                                                                                                                                                                                                                                                                                                                                                                                                                                                                                                                                                                                                                                                                                                                                                                                                                                                                                                                                                                                                                                                                                            |
|---------------|-------------------------------------------------|----------------------------------------------------------------------------------------------------------------------------------------------------------------------------------------------------------------------------------------------------------------------------------------------------------------------------------------------------------------------------------------------------------------------------------------------------------------------------------------------------------------------------------------------------------------------------------------------------------------------------------------------------------------------------------------------------------------------------------------------------------------------------------------------------------------------------------------------------------------------------------------------------------------------------------------------------------------------------------------------------------------------------------------------------------------------------------------------------|
| <b>Step 1</b> | Navigate to Wireless Settings > Guest WLANs.    |                                                                                                                                                                                                                                                                                                                                                                                                                                                                                                                                                                                                                                                                                                                                                                                                                                                                                                                                                                                                                                                                                                    |
| <b>Step 2</b> | Configure the following on the Guest WLAN page: | <ul style="list-style-type: none"> <li>• Page Type—Select as Internal (Default).</li> <li>• Preview—You can Preview the page by clicking on the Preview button.</li> <li>• Display Cisco Logo—To hide the Cisco logo that appears in the top right corner of the default page, you can choose No. This field is set to Yes by default.</li> <li>• Redirect URL After Login—To have the guest users redirected to a particular URL (such as the URL for your company) after login, enter the desired URL in this text box. You can enter up to 254 characters.</li> <li>• Page Headline—To create your own headline on the login page, enter the desired text in this text box. You can enter up to 127 characters. The default headline is Welcome to the Cisco Wireless Network.</li> <li>• Page Message—To create your own message on the login page, enter the desired text in this text box. You can enter up to 2047 characters. The default message is Cisco is pleased to provide the Wireless LAN infrastructure for your network. Please login and put your air space to work.</li> </ul> |

|               | Command or Action | Purpose |
|---------------|-------------------|---------|
| <b>Step 3</b> | Click Apply.      |         |

## Using Customized Internal Guest Portal

If a customized guest portal has to be presented to guest users, a sample page can be downloaded from cisco.com which can then be edited and imported to the Cisco Mobility Express controller. After the page has been edited and ready to be uploaded to the Cisco Mobility Express controller, follow the steps below.

### Procedure

|               | Command or Action                               | Purpose                                                                                                                                                                                                                                                                                                                                                                                                                                                                                                                                    |
|---------------|-------------------------------------------------|--------------------------------------------------------------------------------------------------------------------------------------------------------------------------------------------------------------------------------------------------------------------------------------------------------------------------------------------------------------------------------------------------------------------------------------------------------------------------------------------------------------------------------------------|
| <b>Step 1</b> | Navigate to Wireless Settings > Guest WLANs.    |                                                                                                                                                                                                                                                                                                                                                                                                                                                                                                                                            |
| <b>Step 2</b> | Configure the following on the Guest WLAN page: | <ul style="list-style-type: none"> <li>• Page Type–Select as Customized.</li> <li>• Customized page Bundle–Click on the Upload button to upload the he customized page bundle to the Mobility Express controller.</li> <li>• Preview–You can Preview the Guest portal by clicking on the Preview button.</li> <li>• Redirect URL After Login–To have the guest users redirected to a particular URL (such as the URL for your company) after login, enter the desired URL in this text box. You can enter up to 254 characters.</li> </ul> |
| <b>Step 3</b> | Click Apply.                                    |                                                                                                                                                                                                                                                                                                                                                                                                                                                                                                                                            |

## Managing WLAN Users

Cisco Mobility Express supports creation of local user accounts. These users can be authenticated for WLANs configured to use Security as WPA2 Enterprise with Authentication Server set to AP or Guest WLANs configured to use internal or external splash page with Access Type as Local User Account.

To create local user accounts, follow the procedure below:

### Procedure

|               | Command or Action                                                                  | Purpose                                                                                                                                               |
|---------------|------------------------------------------------------------------------------------|-------------------------------------------------------------------------------------------------------------------------------------------------------|
| <b>Step 1</b> | Navigate to Wireless Settings > WLAN Users and then click on Add WLAN User button. |                                                                                                                                                       |
| <b>Step 2</b> | Navigate to Wireless Settings > WLAN Users and then click on Add WLAN User button. | <ul style="list-style-type: none"> <li>• User Name–Enter the username</li> <li>• Guest User–For Guest user, enable the Guest User checkbox</li> </ul> |

|  | Command or Action | Purpose                                                                                                                                                                                                                                                                                                                                                                                                                           |
|--|-------------------|-----------------------------------------------------------------------------------------------------------------------------------------------------------------------------------------------------------------------------------------------------------------------------------------------------------------------------------------------------------------------------------------------------------------------------------|
|  |                   | <ul style="list-style-type: none"> <li>• Lifetime—For Guest User, define the user account validity. Default is 86400 seconds (or, 24 hours) from the time of its creation.</li> <li>• WLAN Profile—Select the WLAN to which the user will connect</li> <li>• Password—Enter the password for the user account</li> <li>• Description—Additional details or comments for the user account</li> <li>• Click on tickicon.</li> </ul> |

## Adding MAC for Local MAC Filtering on WLANs

Cisco Mobility Express supports MAC Filtering on WLANs on controller as well as with external RADIUS. MAC addresses can be added to the controller and be either allowed or blocked. To add MAC addresses to the controller, follow the procedure below:

### Procedure

|               | Command or Action                                                            | Purpose                                                                                                                                                                                                                                                                                      |
|---------------|------------------------------------------------------------------------------|----------------------------------------------------------------------------------------------------------------------------------------------------------------------------------------------------------------------------------------------------------------------------------------------|
| <b>Step 1</b> | Navigate to Wireless Settings > WLAN Users and click on Local MAC Addresses. |                                                                                                                                                                                                                                                                                              |
| <b>Step 2</b> | Click Add MAC Address.                                                       |                                                                                                                                                                                                                                                                                              |
| <b>Step 3</b> | In the Add MAC Address window, configure the following:                      | <ul style="list-style-type: none"> <li>• MAC Address—Enter the MAC Address of the device</li> <li>• Description—Enter the description</li> <li>• Type—Select whether this MAC has to be allowed or blocked</li> <li>• Profile Name—Select the WLAN to which the user will connect</li> </ul> |
| <b>Step 4</b> | Click Apply.                                                                 |                                                                                                                                                                                                                                                                                              |

## Managing Services with Cisco Mobility Express

### Application Visibility and Control

Network Based Application Recognition (NBAR) provides application-aware control on a wireless network and enhances manageability and productivity. It also extends Cisco's Application Visibility and Control (AVC)

as an end-to-end solution, which gives a complete visibility of applications in the network and allows the administrator to take some action on the same.

NBAR is a deep-packet inspection technology, which supports stateful L4 - L7 classification. The key use cases for NBAR are capacity planning, network usage base lining and better understanding of what applications are consuming bandwidth. Trending of application usage helps network admin improve quality of experience by protecting key applications from bandwidth-hungry applications when there is congestion on the network, capability to prioritize or de-prioritize, and drop certain application traffic. The AVC/NBAR2 engine interoperates with QoS settings on the specific WLAN.

## Enabling Application Visibility on WLAN

To configure Application Visibility on a WLAN, follow the procedure below:

### Procedure

To enable Application Visibility on WLAN, navigate to Wireless Settings > WLANs. On the Add new WLAN or Edit WLAN window, click on the Traffic Shaping tab. To enable Application Visibility on this WLAN, select Enabled for Application Visibility Control.

## Enabling Application Control on WLAN

After Application Visibility has been enabled on the WLAN, one can add control for various applications. There are two way to add control for applications. One can either add control directly from the Applications widget on the Network Summary page or one can navigate to Monitoring > Applications and add control for applications as needed.

### Adding Application Control from Network Summary Page

#### Procedure

|               | Command or Action                                                                                                                                                                                                                                                                                                                                                           | Purpose |
|---------------|-----------------------------------------------------------------------------------------------------------------------------------------------------------------------------------------------------------------------------------------------------------------------------------------------------------------------------------------------------------------------------|---------|
| <b>Step 1</b> | Add the Applications widget on the Network Summary Page. To add the Applications widget, click on the + icon on the right of the Network Summary banner. Select the Applications widget. The Applications widget will display the top 10 applications being browsed by the clients in the Mobility Express network.                                                         |         |
| <b>Step 2</b> | Click on the application you wish to add control. The Add AVC Rule window will pop up. Select the Action. Action can be Mark, Drop or Rate Limit. For Mark, one can select DSCP as Platinum, Gold, Silver, Bronze or Custom. If custom is selected, one has to specify the DSCP value. For Rate Limit, one can specify the Average Rate and Burst Rate for the application. |         |
| <b>Step 3</b> | Select one or more AVC Profile/SSID combinations.                                                                                                                                                                                                                                                                                                                           |         |
| <b>Step 4</b> | Click Apply.                                                                                                                                                                                                                                                                                                                                                                |         |

## Adding Application Control from Applications Page

### Procedure

|               | Command or Action                                                                                                                                                                                                                                                                                                                                                           | Purpose |
|---------------|-----------------------------------------------------------------------------------------------------------------------------------------------------------------------------------------------------------------------------------------------------------------------------------------------------------------------------------------------------------------------------|---------|
| <b>Step 1</b> | Navigate to Monitoring > Applications Page.                                                                                                                                                                                                                                                                                                                                 |         |
| <b>Step 2</b> | Click on the application you wish to add control. The Add AVC Rule window will pop up. Select the Action. Action can be Mark, Drop or Rate Limit. For Mark, one can select DSCP as Platinum, Gold, Silver, Bronze or Custom. If custom is selected, one has to specify the DSCP value. For Rate Limit, one can specify the Average Rate and Burst Rate for the application. |         |
| <b>Step 3</b> | Select one or more AVC Profile/SSID combinations.                                                                                                                                                                                                                                                                                                                           |         |
| <b>Step 4</b> | Click Apply.                                                                                                                                                                                                                                                                                                                                                                |         |

## iOS Optimized WiFi Connectivity and Fast Lane

### Configuring Optimized WiFi Connectivity

802.11r enabled WLAN provides faster roaming for wireless client devices. It is desired that iOS devices running iOS 10 will be able to join a WLAN with 11r enabled for better roaming experience. However, if 11r is enabled on a WLAN, the legacy devices that do not recognize the FT AKM's beacons and probe responses will not be able to join the WLAN. We need a way to identify the Client device capability and allow 11r capable device to join on the WLAN as an FT enabled device and at the same time to allow legacy device to join as an 11i/WPA2 device.

Cisco Mobility Express Release 8.4 will enable 802.11r on an 802.11i-enabled WLAN selectively for iOS devices. The capable iOS devices will identify this functionality and perform an FT Association on the WLAN. The Cisco Wireless infrastructure will allow FT association on the WLAN from devices that can negotiate FT association on a non-FT WLAN. In addition, with Mobility Express running AireOS 8.4, 802.11k and 11v features are enabled by default on an SSID. These features help clients roam better by telling them when to roam and providing them with information about neighboring APs so that no time is wasted scanning when roaming is needed. Since iOS devices support dual band, the 802.11k neighbor list is updated on dual-band, adaptively for iOS devices.

To configure 11k, r, v on a WLAN, follow the procedure below:

### Procedure

|               | Command or Action                                                                                                                                                            | Purpose                                                                               |
|---------------|------------------------------------------------------------------------------------------------------------------------------------------------------------------------------|---------------------------------------------------------------------------------------|
| <b>Step 1</b> | Enable Expert View on Cisco Mobility Express. Expert View is available on the top banner of the Cisco Mobility Express WebUI as shown below and enabled various configurable |  |

|               | Command or Action                                                                                                                                          | Purpose                                                                            |
|---------------|------------------------------------------------------------------------------------------------------------------------------------------------------------|------------------------------------------------------------------------------------|
|               | parameters which are not available in Standard view.                                                                                                       |                                                                                    |
| <b>Step 2</b> | Navigate to Wireless Settings > WLANs. On the Add new WLAN or Edit WLAN window, click on the Advanced tab. Configure 802.11k, r, v as needed on this page. |  |
| <b>Step 3</b> | Click Apply.                                                                                                                                               |                                                                                    |

## Configuring Fast Lane

Apple iOS device mark QoS as per IETF recommendations. With Mobility Express running AireOS 8.4, one can enable the Fastlane feature from CLI, which enables several beneficial functions:

Your WLC QoS configuration is optimized globally to better support real-time applications

iOS 10 devices can send upstream voice traffic without the requirement to perform WMM TSPEC/TCLAS negotiation. The infrastructure will honor the voice marking for these devices.

You can apply a QoS profile to your iOS 10 devices, and decide which applications should receive QoS marking upstream, and which applications should be sent as best effort or background.

To configure Fast Lane on a WLAN from CLI, follow the procedure below:

### Procedure

|               | Command or Action                     | Purpose                                                                                                                                                                                                                                                                                                                                                                                                                                                         |
|---------------|---------------------------------------|-----------------------------------------------------------------------------------------------------------------------------------------------------------------------------------------------------------------------------------------------------------------------------------------------------------------------------------------------------------------------------------------------------------------------------------------------------------------|
| <b>Step 1</b> | Login to the controller CLI.          |                                                                                                                                                                                                                                                                                                                                                                                                                                                                 |
| <b>Step 2</b> | Enable Fast Lane using the CLI below: | <pre>(Cisco Controller) &gt;config qos fastlane enable 1</pre> <p>Warning: This command will temporarily disable all WLANs and Networks. Active WLANs and networks will be re-enabled automatically after the configuration completes.</p> <p>This command will also override the file named AUTOQOS-AVC-PROFILE, if it exists, and will apply it to the WLAN, if Application Visibility is enabled.</p> <p>Are you sure that you want to continue? (y/N) y</p> |

## Cisco Mobility Express with CMX Cloud

### Cisco CMX Cloud

Cisco Connected Mobile Experiences Cloud (Cisco CMX Cloud) is a simple and scalable offering which enables delivery of wireless guest access and in-venue analytics, integrating seamlessly with Cisco wireless infrastructure.



This cloud-delivered Software-as-a-Service (SaaS) offering is quick to deploy and intuitive to use. It is based on CMX 10.x code and is compatible with Cisco Mobility Express Release 8.3. It offers the following services:

- Connect for Guest Access-Providing an easy-to-use guest-access solution for visitors through a custom portal using various authentication methods including social, self-registration, and Short Message Service (SMS).
- Presence Analytics-Detecting all Wi-Fi devices (the "devices") in the venue and providing analytics on their presence, including dwell times, new vs. repeat visitors, and peak time.

## Cisco CMX Cloud Solution Compatibility Matrix

- Cisco Mobility Express running AireOS Release 8.3 and later.
- All Cisco Mobility Express supported Access Points.

## Minimum Requirements for Cisco CMX Cloud Deployment

Below are the minimum requirements for CMX Cloud deployment:

1. Verify Cisco CMX Cloud Solution Compatibility Matrix above.
2. Recommended browser is Chrome 45 or later.
3. Signup at <https://cmxcisco.com> for 60 day trial or go to Cisco Commerce Workspace (CCW) and purchase license for your choice of CMX Cloud service.

## Enabling CMX Cloud Service on Mobility Express for Presence Analytics

After CMX Cloud Account has been created, next step is to configure and enable the CMX Cloud Service on primary Access Point so that it can send data to the CMX Cloud. To configure, follow the procedure below:

### Procedure

|               | Command or Action                                            | Purpose                                                                                                                           |
|---------------|--------------------------------------------------------------|-----------------------------------------------------------------------------------------------------------------------------------|
| <b>Step 1</b> | On Cisco Mobility Express WebUI, navigate to Advanced > CMX. |                                                                                                                                   |
| <b>Step 2</b> | Enter the CMX Server URL (Site URL).                         |                                                                                                                                   |
| <b>Step 3</b> | Enter the CMX Server Token (Account Token).                  |                                                                                                                                   |
| <b>Step 4</b> | Click Apply.                                                 | <b>Note</b> Click the Test Link button to verify connectivity from primary AP to CMX Cloud Site using the configured information. |

## Configuring Site on CMX Cloud for Presence Analytics

To create a site and add Access Points to the site in CMX Cloud for Presence Analytics, follow the procedure below:

**Procedure**

|               | <b>Command or Action</b>                                                                                                                                   | <b>Purpose</b>                                                                                                                                                                                                                                                                                                                |
|---------------|------------------------------------------------------------------------------------------------------------------------------------------------------------|-------------------------------------------------------------------------------------------------------------------------------------------------------------------------------------------------------------------------------------------------------------------------------------------------------------------------------|
| <b>Step 1</b> | Login to CMX Cloud account at <a href="https://cmscisco.com/">https://cmscisco.com/</a>                                                                    |                                                                                                                                                                                                                                                                                                                               |
| <b>Step 2</b> | Navigate to Manage > Cloud Enabled WLC and verify that the IP address of the WLC shows up on the list.                                                     |                                                                                                                                                                                                                                                                                                                               |
| <b>Step 3</b> | Navigate to PRESENCE ANALYTICS > Manage. You should be in the Sites pane. Click on the Add Site button to create a site.                                   |                                                                                                                                                                                                                                                                                                                               |
| <b>Step 4</b> | In the NEW SITE window, configure the following details:                                                                                                   | <ul style="list-style-type: none"> <li>• Enter the Name for the site</li> <li>• Enter the Address for the site</li> <li>• Select Timezone from the drop-down list</li> <li>• Select the Signal Strength Threshold for Ignore, Passerby, and Visitors</li> <li>• Enter the Minimum Dwell Time for Visitor (minutes)</li> </ul> |
| <b>Step 5</b> | Click Save to create the Site.                                                                                                                             |                                                                                                                                                                                                                                                                                                                               |
| <b>Step 6</b> | After the Site is created, click on Access Points under PRESENCE ANALYTICS > Manage.                                                                       |                                                                                                                                                                                                                                                                                                                               |
| <b>Step 7</b> | Select the Access Points and add them to the Site by clicking on Add to Site button and selecting the Site from the drop-down list.                        |                                                                                                                                                                                                                                                                                                                               |
| <b>Step 8</b> | Finally, navigate to Presence Analytics dashboard. Select the Site you created. Within a few minutes, you should begin to see Presence data get populated. |                                                                                                                                                                                                                                                                                                                               |

# Managing the Cisco Mobility Express Deployment

## Managing Access Points

Starting Release 8.4, Cisco Mobility Express supports up to 50 Access Points. To view the list or modify parameters on an Access Points, follow the procedure below:

## Procedure

|               | Command or Action                                                                                                                                                     | Purpose                                                                                                                                                                                                                                                                                                                                                                                                                                                                                                                                                                                                                                                                                                                                                                                                             |
|---------------|-----------------------------------------------------------------------------------------------------------------------------------------------------------------------|---------------------------------------------------------------------------------------------------------------------------------------------------------------------------------------------------------------------------------------------------------------------------------------------------------------------------------------------------------------------------------------------------------------------------------------------------------------------------------------------------------------------------------------------------------------------------------------------------------------------------------------------------------------------------------------------------------------------------------------------------------------------------------------------------------------------|
| <b>Step 1</b> | Navigate to <b>Wireless Settings &gt; Access Points</b> .                                                                                                             | <b>Note</b> The first Access Point with the P icon is the primary AP and the rest of them are Subordinate Access Points.                                                                                                                                                                                                                                                                                                                                                                                                                                                                                                                                                                                                                                                                                            |
| <b>Step 2</b> | To modify the parameters on an access point, click on the Edit button. The Access Point window will come up displaying the General parameters about the Access Point. | <ul style="list-style-type: none"> <li>• Operating Mode(Read only field)-For a primary AP, this field displays AP &amp; Controller. For other associated APs, this field displays AP only.</li> <li>• AP Mac(Read only field)–Displays the MAC address of the Access Point.</li> <li>• AP Model(Read only field)-Displays the model details of the Access Point.</li> <li>• IP Configuration–Choose Obtain from DHCP to allow the IP address of the AP be assigned by a DHCP server on the network, or choose Static IP address. If you choose Static IP address, then you can edit the IP Address, Subnet Mask, and Gateway fields.</li> <li>• AP Name–Edit the name of access point. This is a free text field.</li> <li>• Location–Edit the location for the access point. This is a free text field.</li> </ul> |
| <b>Step 3</b> | Under the Controller tab (Available only for primary AP), one can modify the following parameters:                                                                    | <ul style="list-style-type: none"> <li>• System Name–Enter the System Name for Mobility Express</li> <li>• IP Address–IP address decides the login URL to the controller's web interface. The URL is in https://&lt;ip address&gt; format. If you change this IP address, the login URL also changes.</li> <li>• Subnet Mask–Enter the Subnet Mask.</li> <li>• Country Code–Enter the Country Code.</li> </ul>                                                                                                                                                                                                                                                                                                                                                                                                      |
| <b>Step 4</b> | Under Radio 1 (2.4 GHz) and Radio 2 (5 GHz), one can edit the following parameters:                                                                                   | <ul style="list-style-type: none"> <li>• Admin Mode–Enabled/Disabled. This enables or disables the corresponding radio on the AP (2.4 GHz for 802.11 b/g/n or 5 Ghz for 802.11 a/n/ac).</li> <li>• Channel–Default is Automatic. Automatic enables Dynamic Channel Assignment.</li> </ul>                                                                                                                                                                                                                                                                                                                                                                                                                                                                                                                           |

|               | Command or Action | Purpose                                                                                                                                                                                                                                                                                                                                                                                                                                                                                                                                                                                                                                                                                                                                                                                                                                                                                                                                                                                                                                                                                                                                                                                                                                                                                                                                                                                                                                         |
|---------------|-------------------|-------------------------------------------------------------------------------------------------------------------------------------------------------------------------------------------------------------------------------------------------------------------------------------------------------------------------------------------------------------------------------------------------------------------------------------------------------------------------------------------------------------------------------------------------------------------------------------------------------------------------------------------------------------------------------------------------------------------------------------------------------------------------------------------------------------------------------------------------------------------------------------------------------------------------------------------------------------------------------------------------------------------------------------------------------------------------------------------------------------------------------------------------------------------------------------------------------------------------------------------------------------------------------------------------------------------------------------------------------------------------------------------------------------------------------------------------|
|               |                   | <p>This means that channels are dynamically assigned to each AP, under the control of the Mobility Express controller. This prevents neighboring APs from broadcasting over the same channel and hence prevents interference and other communication problems. For the 2.4GHz radio, 11 channels are offered in the US, up to 14 in other parts of the world, but only 1-6-11 can be considered non-overlapping if they are used by neighboring APs. For the 5GHz radio, up to 23 non-overlapping channels are offered. Assigning a specific value statically assigns a channel to that AP.</p> <ul style="list-style-type: none"> <li>• 802.11 b/g/n-1 to 11.</li> <li>• 802.11 a/n/ac -40, 44, 48, 52, 56, 60, 64, 100, 104, 108, 112, 116, 132, 136, 140, 149, 153, 157, 161, 165.</li> <li>• Channel Width - 20 MHz for 2.4GHz and for 20, 40 and 80 for 5 GHz.</li> <li>• Transmit Power - 1 to 8. The default value is Automatic.</li> </ul> <p>This is a logarithmic scale of the transmit power, that is the transmission energy used by the AP, 1 being the highest, 2 being half of it, 3 being 1/4th and so on. Selecting Automatic adjusts the radio transmitter output power based on the varying signal level at the receiver. This allows the transmitter to operate at less than maximum power for most of the time; when fading conditions occur, transmit power will be increased as needed until the maximum is reached.</p> |
| <b>Step 5</b> | Click Apply.      |                                                                                                                                                                                                                                                                                                                                                                                                                                                                                                                                                                                                                                                                                                                                                                                                                                                                                                                                                                                                                                                                                                                                                                                                                                                                                                                                                                                                                                                 |

## Primary AP Failover and Electing a New Primary

Cisco Mobility Express is supported on Cisco 1100 series Access Points. If you have a mix of these Access Points in a Cisco Mobility Express deployment, the primary AP election process determines which of the supported Access Point will be elected to run Mobility Express controller function in case of a Failover of the Active primary AP. VRRP is used to detect the failure of primary AP which initiates the election of a new primary.



---

**Note** Mobility Express uses MAC 00-00-5E-00-01-VRID where VRID is 1 so if there are other instances of VRRP running in the environment, use VRID other than 1 for those instances.

---

## Primary AP Failover

To have redundancy in the Mobility Express network, it must have two or more Mobility Express capable Access Points. These Access Points should have AP Image type as MOBILITY EXPRESS IMAGE and AP Configuration as MOBILITY EXPRESS CAPABLE. In an event of a failure of primary AP, another Mobility Express capable AP is elected as a primary automatically. The newly elected primary AP has the same IP and configuration as the original primary AP.



---

**Note** Given Access Point models support different scale limits in terms of the number of Access Points supported, it is highly recommended to have at least two or more Access Points which support the same scale limits.

---



---

**Note** Access Points, which have the Mobility Express Image but AP Configuration, is NOT MOBILITY EXPRESS CAPABLE, will not participate in the primary AP election process.

---

## Electing a new Primary Access Point

As mentioned above, primary Access Point election is based on a set of priorities. The priorities are as follows:

### Before you begin

Primary election process is based on a set of priorities. When an active primary Access Point fails, the election process gets initiated and it elects the Access Point with the highest priority as the primary AP.



---

**Note** During the primary Election process, even though the primary AP running the controller function is down, the remaining Access Points will fall into Standalone mode and will continue to service connected clients and switch data traffic locally. After the new primary is elected, the Standalone Access points will move to connected mode.

---

### Procedure

---

**Step 1** User Defined Primary—User can select an Access Point to be the primary Access Point. If such a selection is made, no new primary will be elected in case of a failure of the active primary. After five minutes, if the current primary is still not active, it will be assumed dead and primary Election will begin to elect a new primary. To manually define a primary, follow the procedure below:

- a) Navigate to Wireless Settings > Access Points.

- b) From the list of Access Points, click Edit icon of the Access Point which you would like to select as the primary AP.
- c) Under the General tab, click on Make me Controller button.
- d) Click Yes on the Confirmation window.

**Note** The previous primary will reboot and the selected Access Point will immediately launch the controller and become the active primary.

**Step 2** Next Preferred Primary - Admin can configure the Next Preferred Primary from CLI. When this is configured and the active primary AP fails, the one configured as the Next Preferred Primary will be elected as a primary. To configure the Next Preferred Primary, follow the procedure below:

- a) Login to the CLI of the controller.
- b) Execute the following CLI:

To configure the Next Preferred Primary, execute the following CLI:

```
(Cisco Controller) >config ap next-preferred-master <Cisco AP>
<Cisco AP> Enter the name of the Cisco AP
```

To see the Next Preferred Primary, execute the following CLI:

```
(Cisco Controller) >show ap next-preferred-master
```

To clear the Next Preferred Primary, execute the following CLI:

```
Cisco Controller) >clear ap next-preferred-master
```

**Step 3** Most Capable Access Point– If the first two priorities are not configured, primary AP election algorithm will select the new primary based on the capability of the Access Point.

**Step 4** Least Client Load– If there are multiple Access Points with the same capability, the one with least client load is elected as the primary Access Point.

**Step 5** Lowest MAC Address–If all of the Access Points are the same and have the same client load, then Access Point with the lowest MAC will be elected as a primary.

---



# CHAPTER 24

## Small Form-Factor Pluggables for Cisco ISR1000

Small Form-Factor Pluggables (SFPs) that are not Cisco certified are called third-party SFPs. Cisco approved means the SFPs have undergone rigorous testing with Cisco products and the SFPs are guaranteed to have 100% compatibility.



**Note** Cisco does not provide any kind of support for the third-party SFPs because they are not validated by Cisco.

- [Configuring Third-Party SFPs, on page 373](#)

### Configuring Third-Party SFPs

Third-party SFPs are manufactured by companies that are not on the Cisco-approved Vendor List (AVL). Currently, Cisco ISR1000 routers support only Cisco-approved SFPs. From Cisco IOS XE Fuji 16.9.1, Cisco ISR1000 routers recognize third-party SFPs.

#### Procedure

|               | Command or Action                                                                                                | Purpose                            |
|---------------|------------------------------------------------------------------------------------------------------------------|------------------------------------|
| <b>Step 1</b> | <b>configure terminal</b><br><b>Example:</b><br>Router# configure terminal                                       | Enters global configuration mode.  |
| <b>Step 2</b> | <b>service unsupported-transceiver</b><br><b>Example:</b><br>Router(config)# service unsupported-transceiver     | Enables third-party SFP support.   |
| <b>Step 3</b> | <b>interface type slot subslot port number</b><br><b>Example:</b><br>Router(config-if)# interface ethernet 0/3/0 | Selects an interface to configure. |

|               | Command or Action                                                            | Purpose                                                                                                                                                                            |
|---------------|------------------------------------------------------------------------------|------------------------------------------------------------------------------------------------------------------------------------------------------------------------------------|
| <b>Step 4</b> | <b>media-type sfp</b><br><b>Example:</b><br>Router(config-if)#media-type sfp | Changes media type to SFP.                                                                                                                                                         |
| <b>Step 5</b> | <b>speed value</b><br><b>Example:</b><br>Router# speed 100                   | Configures the speed of the interface.<br><b>Note</b> For 100BASE SFPs, configure the speed to 100 Mbps only. Similarly, for 1000BASE SFPs, configure the speed to 1000 Mbps only. |
| <b>Step 6</b> | <b>shutdown</b><br><b>Example:</b><br>Router(config)# shutdown               | Disables the interface, changing its state from administratively UP to administratively DOWN.                                                                                      |
| <b>Step 7</b> | <b>no shutdown</b><br><b>Example:</b><br>Router(config-if)# no shutdown      | Enables the interface, changing its state from administratively DOWN to administratively UP.                                                                                       |
| <b>Step 8</b> | <b>exit</b><br><b>Example:</b><br>Router(config-if)#exit                     | Exits the configuration mode and returns the global configuration mode.                                                                                                            |

### Examples

This example shows how to configure a third-party SFP on a Cisco ISR1000 Series Router:

```
Router# configure terminal
Router(config)# interface ethernet 0/3/0
Router(config-if)# service unsupported-transceiver
Router(config)# interface ethernet 0/3/0
Router(config-if)# media-type sfp
Router(config-if)# speed 100
Router(config-if)# shutdown
Router(config-if)# no shutdown
Router(config-if)# exit
Router(config)# exit
```





# CHAPTER 25

## System Messages

---

This chapter contains the following sections:

- [Information About Process Management, on page 375](#)
- [How to Find Error Message Details, on page 375](#)

### Information About Process Management

You can access system messages by logging in to the console through Telnet protocol and monitoring your system components remotely from any workstation that supports the Telnet protocol.

Starting and monitoring software is referred to as process management. The process management infrastructure for a router is platform independent, and error messages are consistent across platforms running on Cisco IOS XE. You do not have to be directly involved in process management, but we recommend that you read the system messages that refer to process failures and other issues.

### How to Find Error Message Details

To show further details about a process management or a syslog error message, enter the error message into the Error Message Decoder tool at: <https://www.cisco.com/cgi-bin/Support/Errordecoder/index.cgi>.

For example, enter the message `%PMAN-0-PROCESS_NOTIFICATION` into the tool to view an explanation of the error message and the recommended action to be taken.

The following are examples of the description and the recommended action displayed by the Error Message Decoder tool for some of the error messages.

**Error Message:** `%PMAN-0-PROCESS_NOTIFICATION : The process lifecycle notification component failed because [chars]`

| Explanation | Recommended Action |
|-------------|--------------------|
|-------------|--------------------|

The process lifecycle notification component failed, preventing proper detection of a process start and stop. This problem is likely the result of a software defect in the software subpackage.

Note the time of the message and investigate the kernel error message logs to learn more about the problem and see if it is correctable. If the problem cannot be corrected or the logs are not helpful, copy the error message exactly as it appears on the console along with the output of the **show tech-support** command and provide the gathered information to a Cisco technical support representative.

**Error Message:** %PMAN-0-PROCFAILCRIT A critical process [chars] has failed (rc [dec])

| Explanation                                                      | Recommended Action                                                                                                                                                                                                                                                                                                                                                                                                                                                                                                                                                                                                                                                                                                                                                                                                                                                                                                                                                                                                                                                                                                                                                          |
|------------------------------------------------------------------|-----------------------------------------------------------------------------------------------------------------------------------------------------------------------------------------------------------------------------------------------------------------------------------------------------------------------------------------------------------------------------------------------------------------------------------------------------------------------------------------------------------------------------------------------------------------------------------------------------------------------------------------------------------------------------------------------------------------------------------------------------------------------------------------------------------------------------------------------------------------------------------------------------------------------------------------------------------------------------------------------------------------------------------------------------------------------------------------------------------------------------------------------------------------------------|
| A process important to the functioning of the router has failed. | Note the time of the message and investigate the error message logs to learn more about the problem. If the problem persists, copy the message exactly as it appears on the console or in the system log. Research and attempt to resolve the issue using the tools and utilities provided at: <a href="http://www.cisco.com/tac">http://www.cisco.com/tac</a> . With some messages, these tools and utilities will supply clarifying information. Search for resolved software issues using the Bug Search Tool at: <a href="http://www.cisco.com/cisco/psn/bssprt/bss">http://www.cisco.com/cisco/psn/bssprt/bss</a> . If you still require assistance, open a case with the Technical Assistance Center at: <a href="http://tools.cisco.com/ServiceRequestTool/create/">http://tools.cisco.com/ServiceRequestTool/create/</a> , or contact your Cisco technical support representative and provide the representative with the information you have gathered. Attach the following information to your case in nonzipped, plain-text (.txt) format: the output of the <b>show logging</b> and <b>show tech-support</b> commands and your pertinent troubleshooting logs. |

**Error Message:** %PMAN-3-PROCFAILOPT An optional process [chars] has failed (rc [dec])

| Explanation | Recommended Action |
|-------------|--------------------|
|-------------|--------------------|

A process that does not affect the forwarding of traffic has failed.

Note the time of the message and investigate the kernel error message logs to learn more about the problem. Although traffic will still be forwarded after receiving this message, certain functions on the router may be disabled because of this message and the error should be investigated. If the logs are not helpful or indicate a problem you cannot correct, copy the message exactly as it appears on the console or in the system log. Research and attempt to resolve the issue using the tools and utilities provided at <http://www.cisco.com/tac>. With some messages, these tools and utilities will supply clarifying information. Search for resolved software issues using the Bug Search Tool at: <http://www.cisco.com/cisco/psn/bssprt/bss>. If you still require assistance, open a case with the Technical Assistance Center at: <http://tools.cisco.com/ServiceRequestTool/create/>, or contact your Cisco technical support representative and provide the representative with the information you have gathered. Attach the following information to your case in nonzipped, plain-text (.txt) format: the output of the **show logging** and **show tech-support** commands and your pertinent troubleshooting logs.

**Error Message:** %PMAN-3-PROCFAIL The process [chars] has failed (rc [dec])

| Explanation                                       | Recommended Action                                                                                                                                                                                                                                                                                                                                                                                                                                                                                                                                                                                                                                                                                                                                                                                                                                                                                                                                                                                                                                                                                                                                                                                                                                       |
|---------------------------------------------------|----------------------------------------------------------------------------------------------------------------------------------------------------------------------------------------------------------------------------------------------------------------------------------------------------------------------------------------------------------------------------------------------------------------------------------------------------------------------------------------------------------------------------------------------------------------------------------------------------------------------------------------------------------------------------------------------------------------------------------------------------------------------------------------------------------------------------------------------------------------------------------------------------------------------------------------------------------------------------------------------------------------------------------------------------------------------------------------------------------------------------------------------------------------------------------------------------------------------------------------------------------|
| The process has failed as the result of an error. | This message will appear with other messages related to the process. Check the other messages to determine the reason for the failures and see if corrective action can be taken. If the problem persists, copy the message exactly as it appears on the console or in the system log. Research and attempt to resolve the issue using the tools and utilities provided at: <a href="http://www.cisco.com/tac">http://www.cisco.com/tac</a> . With some messages, these tools and utilities will supply clarifying information. Search for resolved software issues using the Bug Search Tool at: <a href="http://www.cisco.com/cisco/psn/bssprt/bss">http://www.cisco.com/cisco/psn/bssprt/bss</a> . If you still require assistance, open a case with the Technical Assistance Center at: <a href="http://tools.cisco.com/ServiceRequestTool/create/">http://tools.cisco.com/ServiceRequestTool/create/</a> , or contact your Cisco technical support representative and provide the representative with the information you have gathered. Attach the following information to your case in nonzipped, plain-text (.txt) format: the output of the <b>show logging</b> and <b>show tech-support</b> commands and your pertinent troubleshooting logs. |

**Error Message:** %PMAN-3-PROCFAIL\_IGNORE [chars] process exits and failures are being ignored due to debug settings. Normal router functionality will be affected. Critical router functions like RP switchover, router reload, FRU resets, etc. may not function properly.

| Explanation                                                                   | Recommended Action                                                                                                                                                                                                                                                                                                                                                                                                                                                                        |
|-------------------------------------------------------------------------------|-------------------------------------------------------------------------------------------------------------------------------------------------------------------------------------------------------------------------------------------------------------------------------------------------------------------------------------------------------------------------------------------------------------------------------------------------------------------------------------------|
| A process failure is being ignored due to the user-configured debug settings. | If this behavior is desired and the debug settings are set according to a user's preference, no action is needed. If the appearance of this message is viewed as a problem, change the debug settings. The router is not expected to behave normally with this debug setting. Functionalities such as SSO switchover, router reloads, FRU resets, and so on will be affected. This setting should only be used in a debug scenario. It is not normal to run the router with this setting. |

**Error Message:** %PMAN-3-PROCHOLDDOWN The process [chars] has been helddown (rc [dec])

| Explanation                                                                                                 | Recommended Action                                                                                                                                                                                                                                                                                                                                                                                                                                                                                                                                                                                                                                                                                                                                                                                                                                                                                                                                                                                                                                                                                                                                                                                                                                       |
|-------------------------------------------------------------------------------------------------------------|----------------------------------------------------------------------------------------------------------------------------------------------------------------------------------------------------------------------------------------------------------------------------------------------------------------------------------------------------------------------------------------------------------------------------------------------------------------------------------------------------------------------------------------------------------------------------------------------------------------------------------------------------------------------------------------------------------------------------------------------------------------------------------------------------------------------------------------------------------------------------------------------------------------------------------------------------------------------------------------------------------------------------------------------------------------------------------------------------------------------------------------------------------------------------------------------------------------------------------------------------------|
| The process was restarted too many times with repeated failures and has been placed in the hold-down state. | This message will appear with other messages related to the process. Check the other messages to determine the reason for the failures and see if corrective action can be taken. If the problem persists, copy the message exactly as it appears on the console or in the system log. Research and attempt to resolve the issue using the tools and utilities provided at: <a href="http://www.cisco.com/tac">http://www.cisco.com/tac</a> . With some messages, these tools and utilities will supply clarifying information. Search for resolved software issues using the Bug Search Tool at: <a href="http://www.cisco.com/cisco/psn/bssprt/bss">http://www.cisco.com/cisco/psn/bssprt/bss</a> . If you still require assistance, open a case with the Technical Assistance Center at: <a href="http://tools.cisco.com/ServiceRequestTool/create/">http://tools.cisco.com/ServiceRequestTool/create/</a> , or contact your Cisco technical support representative and provide the representative with the information you have gathered. Attach the following information to your case in nonzipped, plain-text (.txt) format: the output of the <b>show logging</b> and <b>show tech-support</b> commands and your pertinent troubleshooting logs. |

**Error Message:** %PMAN-3-RELOAD\_RP\_SB\_NOT\_READY : Reloading: [chars]

| Explanation                                                                       | Recommended Action                                       |
|-----------------------------------------------------------------------------------|----------------------------------------------------------|
| The route processor is being reloaded because there is no ready standby instance. | Ensure that the reload is not due to an error condition. |

**Error Message:** %PMAN-3-RELOAD\_RP : Reloading: [chars]

| Explanation | Recommended Action |
|-------------|--------------------|
|-------------|--------------------|

The RP is being reloaded.

Ensure that the reload is not due to an error condition. If it is due to an error condition, collect information requested by the other log messages.

**Error Message:** %PMAN-3-RELOAD\_SYSTEM : Reloading: [chars]

| Explanation                   | Recommended Action                                                                                                                                    |
|-------------------------------|-------------------------------------------------------------------------------------------------------------------------------------------------------|
| The system is being reloaded. | Ensure that the reload is not due to an error condition. If it is due to an error condition, collect information requested by the other log messages. |

**Error Message:** %PMAN-3-PROC\_BAD\_EXECUTABLE : Bad executable or permission problem with process [chars]

| Explanation                                                                | Recommended Action                                                        |
|----------------------------------------------------------------------------|---------------------------------------------------------------------------|
| The executable file used for the process is bad or has permission problem. | Ensure that the named executable is replaced with the correct executable. |

**Error Message:** %PMAN-3-PROC\_BAD\_COMMAND:Non-existent executable or bad library used for process <process name>

| Explanation                                                                         | Recommended Action                                                                |
|-------------------------------------------------------------------------------------|-----------------------------------------------------------------------------------|
| The executable file used for the process is missing, or a dependent library is bad. | Ensure that the named executable is present and the dependent libraries are good. |

**Error Message:** %PMAN-3-PROC\_EMPTY\_EXEC\_FILE : Empty executable used for process [chars]

| Explanation                                        | Recommended Action                                    |
|----------------------------------------------------|-------------------------------------------------------|
| The executable file used for the process is empty. | Ensure that the named executable is non-zero in size. |

**Error Message:** %PMAN-5-EXITACTION : Process manager is exiting: [chars]

| Explanation                     | Recommended Action                                                                                                                                                     |
|---------------------------------|------------------------------------------------------------------------------------------------------------------------------------------------------------------------|
| The process manager is exiting. | Ensure that the process manager is not exiting due to an error condition. If it is due to an error condition, collect information requested by the other log messages. |

**Error Message:** %PMAN-6-PROCSHUT : The process [chars] has shutdown

| Explanation                           | Recommended Action                                                                     |
|---------------------------------------|----------------------------------------------------------------------------------------|
| The process has gracefully shut down. | No user action is necessary. This message is provided for informational purposes only. |

**Error Message:** %PMAN-6-PROCSTART : The process [chars] has started

| Explanation | Recommended Action |
|-------------|--------------------|
|-------------|--------------------|

|                                                     |                                                                                        |
|-----------------------------------------------------|----------------------------------------------------------------------------------------|
| The process has launched and is operating properly. | No user action is necessary. This message is provided for informational purposes only. |
|-----------------------------------------------------|----------------------------------------------------------------------------------------|

**Error Message:** %PMAN-6-PROCSTATELESS : The process [chars] is restarting stateless

| <b>Explanation</b>                             | <b>Recommended Action</b>                                                              |
|------------------------------------------------|----------------------------------------------------------------------------------------|
| The process has requested a stateless restart. | No user action is necessary. This message is provided for informational purposes only. |



## CHAPTER 26

# Troubleshooting

---

This section describes the troubleshooting scenarios.

Before troubleshooting a software problem, you must connect a terminal or PC to the router by using the light-blue console port. With a connected terminal or PC, you can view status messages from the router and enter commands to troubleshoot a problem.

You can also remotely access the interface (Ethernet, ADSL, or telephone) by using Telnet. The Telnet option assumes that the interface is up and running.

- [Before Contacting Cisco or Your Reseller, on page 381](#)
- [ADSL Troubleshooting, on page 382](#)
- [SHDSL Troubleshooting, on page 382](#)
- [VDSL2 Troubleshooting, on page 382](#)
- [show interfaces Troubleshooting Command, on page 383](#)
- [ATM Troubleshooting Commands, on page 385](#)
- [System Report, on page 389](#)
- [Software Upgrade Methods, on page 390](#)
- [Recovering a Lost Password, on page 391](#)
- [References, on page 397](#)

## Before Contacting Cisco or Your Reseller

If you cannot locate the source of a problem, contact your local reseller for advice. Before you call, you should have the following information ready:

- Chassis type and serial number
- Maintenance agreement or warranty information
- Type of software and version number
- Date you received the hardware
- Brief description of the problem
- Brief description of the steps you have taken to isolate the problem

## ADSL Troubleshooting

If you experience trouble with the ADSL connection, verify the following:

- The ADSL line is connected and is using pins 3 and 4. For more information on the ADSL connection, see the hardware guide for your router.
- The ADSL CD LED is on. If it is not on, the router may not be connected to the DSL access multiplexer (DSLAM). For more information on the ADSL LEDs, see the hardware installation guide specific for your router.
- The correct Asynchronous Transfer Mode (ATM) virtual path identifier/virtual circuit identifier (VPI/VCI) is being used.
- The DSLAM supports discrete multi-tone (DMT) Issue 2.
- The ADSL cable that you connect to the Cisco router must be 10BASE-T Category 5, unshielded twisted-pair (UTP) cable. Using regular telephone cable can introduce line errors.

## SHDSL Troubleshooting

Symmetrical high-data-rate digital subscriber line (SHDSL) is available on the Cisco 1000 Integrated Services Routers. If you experience trouble with the SHDSL connection, verify the following:

- The SHDSL line is connected and using pins 3 and 4. For more information on the G.SHDSL connection, see the hardware guide for your router.
- The G.SHDSL LED is on. If it is not on, the router may not be connected to the DSL access multiplexer (DSLAM). For more information on the G.SHDSL LED, see the hardware installation guide specific for your router.
- The correct asynchronous transfer mode (ATM) virtual path identifier/virtual circuit identifier (VPI/VCI) is being used.
- The DSLAM supports the G.SHDSL signaling protocol.

Use the **show controllers dsl 0** command in EXEC mode to view an SHDSL configuration.

## VDSL2 Troubleshooting

Very-high-data-rate digital subscriber line 2 (VDSL2) is available on the Cisco 1000 Series Integrated Services Routers. If you experience trouble with the VDSL2 connection, verify the following:

- The VDSL2 line is connected and using pins 3 and 4. For more information on the VDSL2 connection, see the hardware guide for your router.
- The VDSL2 LED CD light is on. If it is not on, the router may not be connected to the DSL access multiplexer (DSLAM). For more information on the VDSL2 LED, see the hardware installation guide specific for your router.
- The DSLAM supports the VDSL2 signaling protocol.

Use the **show controllers vdsl 0** command in EXEC mode to view a VDSL2 configuration. The debug vdsl 0 daemon state command can be used to enable the debug messages that print the state transition of VDSL2 training.

If there is trouble with the VDSL firmware file, you can reload or upgrade it without upgrading your Cisco IOS image. Use the command:



**controller vdsl 0 firmware** *flash:<firmware file name>*

to load the firmware file into the VDSL modem chipset. Then enter shutdown/no shutdown commands on the controller vdsl 0 interface. After this, the new firmware will be downloaded and the VDSL2 line starts training up.



**Note** Cisco 1000 series ISRs require that the router be reloaded (IOS reload) before the new VDSL firmware will be loaded.

If the command is not present or the named firmware file is corrupt or not available, the default firmware file *flash:vdsl.bin* is checked to be present and not corrupt. The firmware in this file is then downloaded to the modem chipset.



**Note** Cisco 1000 series ISRs will state the reason of failure during bootup if the new VDSL firmware fails to load after IOS reload.

## show interfaces Troubleshooting Command

Use the **show interfaces** command to display the status of all physical ports (Ethernet, Fast Ethernet, and ATM) and logical interfaces on the router. [Table 25: show interfaces Command Output Description](#), on page 384 describes messages in the command output.

The following example shows how to view the status of Ethernet or Fast Ethernet Interfaces:

```
Router# show interfaces ethernet 0 **similar output for show interfaces fastethernet 0
command **
Ethernet0 is up, line protocol is up
Hardware is PQUICC Ethernet, address is 0000.0c13.a4db
(bia0010.9181.1281)
Internet address is 170.1.4.101/24
MTU 1500 bytes, BW 10000 Kbit, DLY 1000 usec,
 reliability 255/255., txload 1/255, rxload 1/255
Encapsulation ARPA, loopback not set
Keepalive set (10 sec)
```

The following example shows how to view the status of ATM Interfaces:

```
Router# show interfaces atm 0
ATM0 is up, line protocol is up
Hardware is PQUICC_SAR (with Alcatel ADSL Module)
Internet address is 14.0.0.16/8
MTU 1500 bytes, sub MTU 1500, BW 640 Kbit, DLY 80 usec,
 reliability 40/255, txload 1/255, rxload 1/255
Encapsulation ATM, loopback not set
Keepalive not supported
Encapsulation(s):AAL5, PVC mode
10 maximum active VCs, 1 current VCCs
VC idle disconnect time:300 seconds
Last input 01:16:31, output 01:16:31, output hang never
Last clearing of "show interface" counters never
Input queue:0/75/0 (size/max/drops); Total output drops:0
Queueing strategy:Per VC Queueing
```

```

5 minute input rate 0 bits/sec, 0 packets/sec
5 minute output rate 0 bits/sec, 0 packets/sec
 512 packets input, 59780 bytes, 0 no buffer
 Received 0 broadcasts, 0 runts, 0 giants, 0 throttles
 0 input errors, 1024 CRC, 0 frame, 0 overrun, 0 ignored, 0 abort
 426 packets output, 46282 bytes, 0 underruns
 0 output errors, 0 collisions, 2 interface resets
 0 output buffer failures, 0 output buffers swapped out

```

The following example shows how to view the status of Dialer Interfaces:

```

Router# show interfaces dialer 1
Dialer 1 is up, line protocol is up
Hardware is Dialer interface
Internet address is 1.1.1.1/24
MTU 1500 bytes, BW 100000 Kbit, DLY 100000 usec, reliability
 255/255. txload 1/255, rxload 1/255
Encapsulation PPP, loopback not set
Keepalive set (10 sec)
DTR is pulsed for 5 seconds on reset
LCP Closed

```

The table below describes possible command output for the **show interfaces** command.

**Table 25: show interfaces Command Output Description**

| Output                                                  | Cause                                                                                                                                                                                                                                                                                                        |
|---------------------------------------------------------|--------------------------------------------------------------------------------------------------------------------------------------------------------------------------------------------------------------------------------------------------------------------------------------------------------------|
| For ATM Interfaces                                      |                                                                                                                                                                                                                                                                                                              |
| ATM 0 is up, line protocol is up                        | The ATM line is up and operating correctly.                                                                                                                                                                                                                                                                  |
| ATM 0 is down, line protocol is down                    | <ul style="list-style-type: none"> <li>The ATM interface has been disabled with the shutdown command.</li> </ul> or <ul style="list-style-type: none"> <li>The ATM line is down, possibly because the ADSL cable is disconnected or because the wrong type of cable is connected to the ATM port.</li> </ul> |
| ATM 0.n is up, line protocol is up                      | The specified ATM subinterface is up and operating correctly.                                                                                                                                                                                                                                                |
| ATM 0.n is administratively down, line protocol is down | The specified ATM subinterface has been disabled with the shutdown command.                                                                                                                                                                                                                                  |
| ATM 0.n is down, line protocol is down                  | The specified ATM subinterface is down, possibly because the ATM line has been disconnected (by the service provider).                                                                                                                                                                                       |
| For Ethernet/Fast Ethernet Interfaces                   |                                                                                                                                                                                                                                                                                                              |
| Ethernet/Fast Ethernet n is up, line protocol is up     | The specified Ethernet/Fast Ethernet interface is connected to the network and operating correctly.                                                                                                                                                                                                          |
| Ethernet/Fast Ethernet n is up, line protocol is down   | The specified Ethernet/Fast Ethernet interface has been correctly configured and enabled, but the Ethernet cable might be disconnected from the LAN.                                                                                                                                                         |

| Output                                                                          | Cause                                                                                                                                                                                                                                                                                                                                                                                                                                      |
|---------------------------------------------------------------------------------|--------------------------------------------------------------------------------------------------------------------------------------------------------------------------------------------------------------------------------------------------------------------------------------------------------------------------------------------------------------------------------------------------------------------------------------------|
| Ethernet/Fast Ethernet <i>n</i> is administratively down, line protocol is down | The specified Ethernet/Fast Ethernet interface has been disabled with the <b>shutdown</b> command, and the interface is disconnected.                                                                                                                                                                                                                                                                                                      |
| For Dialer Interfaces                                                           |                                                                                                                                                                                                                                                                                                                                                                                                                                            |
| Dialer <i>n</i> is up, line protocol is up                                      | The specified dialer interface is up and operating correctly.                                                                                                                                                                                                                                                                                                                                                                              |
| Dialer <i>n</i> is down, line protocol is down                                  | <ul style="list-style-type: none"> <li>• This is a standard message and may not indicate anything is actually wrong with the configuration.</li> </ul> or <ul style="list-style-type: none"> <li>• If you are having problems with the specified dialer interface, this can mean it is not operating, possibly because the interface has been brought down with the <b>shutdown</b> command, or the ADSL cable is disconnected.</li> </ul> |

## ATM Troubleshooting Commands

Use the following commands to troubleshoot your ATM interface:

### ping atm interface Command

Use the **ping atm interface** command to determine whether a particular PVC is in use. The PVC does not need to be configured on the router to use this command. The below example shows the use of this command to determine whether PVC 8/35 is in use.

The following example shows how to determine if a PVC is in use:

```
Router# ping atm interface atm 0 8 35 seg-loopback
Type escape sequence to abort.
Sending 5, 53-byte segment OAM echoes, timeout is 2 seconds:
!!!!
Success rate is 100 percent (5/5), round-trip min/avg/max = 148/148/148 ms
```

This command sends five OAM F5 loopback packets to the DSLAM (segment OAM packets). If the PVC is configured at the DSLAM, the ping is successful.

To test whether the PVC is being used at the aggregator, enter the following command:

```
Router# ping atm interface atm 0 8 35 end-loopback
Type escape sequence to abort.
Sending 5, 53-byte end-to-end OAM echoes, timeout is 2 seconds:
!!!!
Success rate is 100 percent (5/5), round-trip min/avg/max = 400/401/404 ms
```

This command sends end-to-end OAM F5 packets, which are echoed back by the aggregator.

## show atm interface Command

To display ATM-specific information about an ATM interface, use the **show atm interface atm 0** command from privileged EXEC mode.

The following example shows how to view information about an ATM interface:

```
Router# show atm interface atm 0
Interface ATM0:
AAL enabled: AAL5 , Maximum VCs:11, Current VCCs:0
Maximum Transmit Channels:0
Max. Datagram Size:1528
PLIM Type:INVALID - 640Kbps, Framing is INVALID,
DS3 lbo:short, TX clocking:LINE
0 input, 0 output, 0 IN fast, 0 OUT fast
Avail bw = 640
Config. is ACTIVE
```

The table below describes some of the fields shown in the command output.

**Table 26: show atm interface Command Output Description**

| Field                     | Description                                                                          |
|---------------------------|--------------------------------------------------------------------------------------|
| ATM interface             | Interface number. Always 0 for the Cisco 860 and Cisco 880 series access routers.    |
| AAL enabled               | Type of AAL enabled. The Cisco 860 and Cisco 880 series access routers support AAL5. |
| Maximum VCs               | Maximum number of virtual connections this interface supports.                       |
| Current VCCs              | Number of active virtual channel connections (VCCs).                                 |
| Maximum Transmit Channels | Maximum number of transmit channels.                                                 |
| Max Datagram Size         | Configured maximum number of bytes in the largest datagram.                          |
| PLIM Type                 | Physical layer interface module (PLIM) type.                                         |

## debug atm Commands

Use the **debug** commands to troubleshoot configuration problems that you might be having on your network. The **debug** commands provide extensive, informative displays to help you interpret any possible problems.

### Guidelines for Using Debug Commands

Read the following guidelines before using debug commands to ensure appropriate results.

- All debug commands are entered in privileged EXEC mode.
- To view debugging messages on a console, enter the **logging console debug** command.
- Most **debug** commands take no arguments.
- To disable debugging, enter the **undebg all** command.
- To use **debug** commands during a Telnet session on your router, enter the **terminal monitor** command.

**Caution**

Debugging is assigned a high priority in your router CPU process, and it can render your router unusable. For this reason, use **debug** commands only to troubleshoot specific problems. The best time to use debug commands is during periods of low network traffic so that other activity on the network is not adversely affected.

You can find additional information and documentation about the **debug** commands in the [Cisco IOS Debug Command Reference](#).

## debug atm errors Command

Use the **debug atm errors** command to display ATM errors. The **no** form of this command disables debugging output.

The following example shows how to view the ATM errors:

```
Router# debug atm errors
ATM errors debugging is on
Router#
01:32:02:ATM(ATM0.2):VC(3) Bad SAP received 4500
01:32:04:ATM(ATM0.2):VC(3) Bad SAP received 4500
01:32:06:ATM(ATM0.2):VC(3) Bad SAP received 4500
01:32:08:ATM(ATM0.2):VC(3) Bad SAP received 4500
01:32:10:ATM(ATM0.2):VC(3) Bad SAP received 4500
```

## debug atm events Command

Use the **debug atm events** command to display events that occur on the ATM interface processor and to diagnose problems in an ATM network. This command provides an overall picture of the stability of the network. The **no** form of this command disables debugging output.

If the interface is successfully communicating with the Digital Subscriber Line Access Multiplexer (DSLAM) at the telephone company, the modem state is 0x10. If the interface is not communicating with the DSLAM, the modem state is 0x8. Note that the modem state does not transition to 0x10.

The following example shows how to view the ATM interface processor events-success:

```
Router# debug atm events
Router#
00:02:57: DSL: Send ADSL_OPEN command.
00:02:57: DSL: Using subfunction 0xA
00:02:57: DSL: Using subfunction 0xA
00:02:57: DSL: Sent command 0x5
00:02:57: DSL: Received response: 0x26
00:02:57: DSL: Unexpected response 0x26
00:02:57: DSL: Send ADSL_OPEN command.
00:02:57: DSL: Using subfunction 0xA
00:02:57: DSL: Using subfunction 0xA
00:02:57: DSL: Sent command 0x5
00:03:00: DSL: 1: Modem state = 0x8
00:03:02: DSL: 2: Modem state = 0x10
00:03:05: DSL: 3: Modem state = 0x10
00:03:07: DSL: 4: Modem state = 0x10
00:03:09: DSL: Received response: 0x24
00:03:09: DSL: Showtime!
00:03:09: DSL: Sent command 0x11
00:03:09: DSL: Received response: 0x61
00:03:09: DSL: Read firmware revision 0x1A04
```

```
00:03:09: DSL: Sent command 0x31
00:03:09: DSL: Received response: 0x12
00:03:09: DSL: operation mode 0x0001
00:03:09: DSL: SM: [DMTDSL_DO_OPEN -> DMTDSL_SHOWTIME]
```

The following example shows how to view the ATM interface processor events—failure:

```
Router# debug atm events
Router#
00:02:57: DSL: Send ADSL_OPEN command.
00:02:57: DSL: Using subfunction 0xA
00:02:57: DSL: Using subfunction 0xA
00:02:57: DSL: Sent command 0x5
00:02:57: DSL: Received response: 0x26
00:02:57: DSL: Unexpected response 0x26
00:02:57: DSL: Send ADSL_OPEN command.
00:02:57: DSL: Using subfunction 0xA
00:02:57: DSL: Using subfunction 0xA
00:02:57: DSL: Sent command 0x5
00:03:00: DSL: 1: Modem state = 0x8
00:03:00: DSL: 1: Modem state = 0x8
00:03:00: DSL: 1: Modem state = 0x8
00:03:00: DSL: 1: Modem state = 0x8
00:03:00: DSL: 1: Modem state = 0x8
00:03:00: DSL: 1: Modem state = 0x8
```

## debug atm packet Command

Use the **debug atm packet** command to display all process-level ATM packets for both outbound and inbound packets. The output reports information online when a packet is received or a transmission is attempted. The **no** form of this command disables debugging output.



**Caution** Because the **debug atm packet** command generates a significant amount of output for every packet processed, use it only when network traffic is low, so that other system activities are not adversely affected.

The command syntax is:

```
debug atm packet [interface atm number [vcd vcd-number]][vc vpi/vci number]
```

```
no debug atm packet [interface atm number [vcd vcd-number]][vc vpi/vci number]
```

where the keywords are defined as follows:

**interface atm number** (Optional) ATM interface or subinterface number.

**vcd vcd-number** (Optional) Number of the virtual circuit designator (VCD).

**vc vpi/vci number** VPI/VCI value of the ATM PVC.

The below example shows sample output for the **debug atm packet** command.

```
Router# debug atm packet
Router#
01:23:48:ATM0 (0) :
VCD:0x1 VPI:0x1 VCI:0x64 DM:0x0 SAP:AAAA CTL:03 OUI:000000 TYPE:0800 Length:0x70
01:23:48:4500 0064 0008 0000 FF01 9F80 0E00 0010 0E00 0001 0800 A103 0AF3 17F7 0000
01:23:48:0000 004C BA10 ABCD ABCD ABCD ABCD ABCD ABCD ABCD ABCD ABCD ABCD ABCD
01:23:48:ABCD ABCD ABCD ABCD ABCD ABCD ABCD ABCD ABCD ABCD ABCD ABCD ABCD ABCD
01:23:48:ABCD ABCD ABCD ABCD ABCD
```

```

01:23:48:
01:23:48:ATM0(I):
VCD:0x1 VPI:0x1 VCI:0x64 Type:0x0 SAP:AAAA CTL:03 OUI:000000 TYPE:0800 Length:0x70
01:23:48:4500 0064 0008 0000 FE01 A080 0E00 0001 0E00 0010 0000 A903 0AF3 17F7 0000
01:23:48:0000 004C BA10 ABCD ABCD ABCD ABCD ABCD ABCD ABCD ABCD ABCD ABCD ABCD ABCD
01:23:48:ABCD ABCD ABCD ABCD ABCD ABCD ABCD ABCD ABCD ABCD ABCD ABCD ABCD ABCD
01:23:48:ABCD ABCD ABCD ABCD ABCD
01:23:48:

```

The table below describes some of the fields shown in the **debug atm packet** command output.

**Table 27: debug atm packet Command Output Description**

| Field            | Description                                                                |
|------------------|----------------------------------------------------------------------------|
| ATM0             | Interface that is generating the packet.                                   |
| (O)              | Output packet. (I) would mean receive packet.                              |
| VCD: 0xn         | Virtual circuit associated with this packet, where <i>n</i> is some value. |
| VPI: 0xn         | Virtual path identifier for this packet, where <i>n</i> is some value.     |
| DM: 0xn          | Descriptor mode bits, where <i>n</i> is some value.                        |
| Length: <i>n</i> | Total length of the packet (in bytes) including the ATM headers.           |

## System Report

System reports or crashinfo files save information that helps Cisco technical support representatives to debug problems that caused the Cisco IOS image to crash. It is necessary to collect critical crash information quickly and reliably and bundle it in a way that it can be identified with a specific crash occurrence. System reports are generated and saved into the '/core' directory, either on harddisk: or flash: filesystem. The system does not generate reports in case of a reload.

In case of a system crash, the following details are collected:

1. Full process core
  - IOSd core file and IOS crashinfo file if there was an IOSd process crash
2. Tracelogs
3. System process information
4. Bootup logs
5. Certain types of /proc information

This report is generated before the router goes down to rommon/bootloader. The information is stored in separate files which are then archived and compressed into the tar.gz bundle. This makes it convenient to get a crash snapshot in one place, and can be then moved off the box for analysis.

Device hostname, the ID of the module that generated the system report and its creation timestamp are embedded in the file name:

```
<hostname>_<moduleID>-system-report_<timestamp>.tar.gz
```

Example:

```
Router1_RP_0-system-report_20210204-163559-UTC
```

A device with hostname Router1 experienced an unexpected reload of RP0 module and the system-report was generated on 4th February 2021 at 4:39:59 PM UTC.

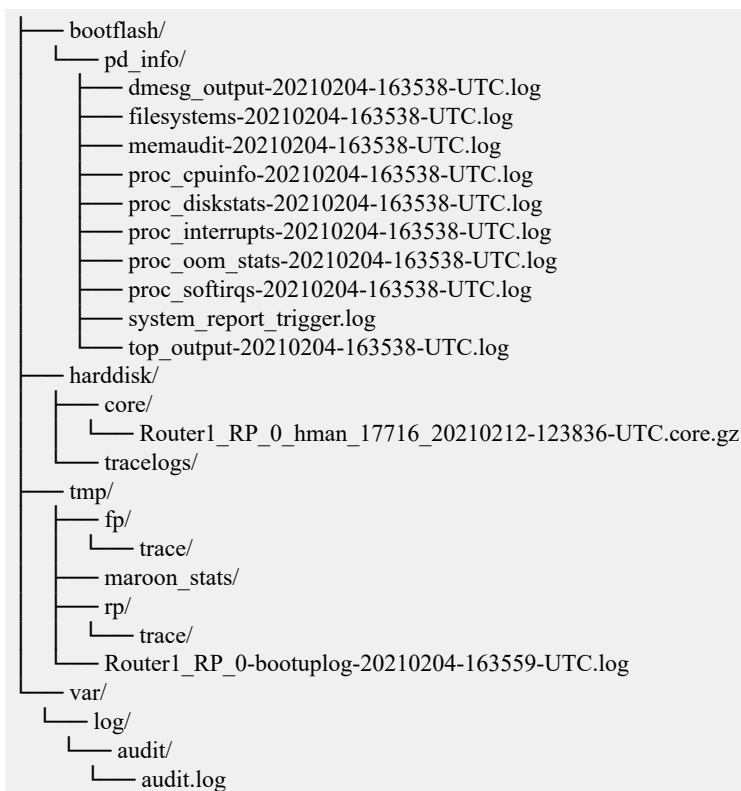

## Software Upgrade Methods

Several methods are available for upgrading software on the Cisco 860 and Cisco 880 series Integrated Services Routers, including:

- Copy the new software image to flash memory over LAN or WAN when the existing Cisco IOS software image is in use.
- Copy the new software image to flash memory over the LAN while the boot image (ROM monitor) is operating.
- Copy the new software image over the console port while in ROM monitor mode.
- From ROM monitor mode, boot the router from a software image that is loaded on a TFTP server. To use this method, the TFTP server must be on the same LAN as the router.



# Recovering a Lost Password

To recover a lost enable or lost enable-secret password, refer to the following sections:

1. Change the Configuration Register
2. Reset the Router
3. Reset the Password and Save your Changes (for lost enable secret passwords only)
4. Reset the Configuration Register Value.



---

**Note** Recovering a lost password is only possible when you are connected to the router through the console port. These procedures cannot be performed through a Telnet session.

---



---

**Tip** See the “Hot Tips” section on Cisco.com for additional information on replacing enable secret passwords.

---

## Change the Configuration Register

To change a configuration register, follow these steps:

### Procedure

---

- Step 1** Connect an ASCII terminal or a PC running a terminal emulation program to the CONSOLE port on the Fthe router.
- Step 2** Configure the terminal to operate at 9600 baud, 8 data bits, no parity, and 1 stop bit.
- Step 3** At the privileged EXEC prompt (*router\_name #*), enter the **show version** command to display the existing configuration register value (shown in bold at the bottom of this output example):

#### Example:

```
Router# show version
Cisco IOS XE Software, Version 16.06.02
Cisco IOS Software [Everest], ISR Software (ARMV8EB_LINUX_IOSD-UNIVERSALK9_IAS-M), Version
 16.6.2, RELEASE SOFTWARE (fc2)
Technical Support: http://www.cisco.com/techsupport
Copyright (c) 1986-2017 by Cisco Systems, Inc.
Compiled Wed 01-Nov-17 03:00 by mcpre
```

```
Cisco IOS-XE software, Copyright (c) 2005-2017 by cisco Systems, Inc.
All rights reserved. Certain components of Cisco IOS-XE software are
licensed under the GNU General Public License ("GPL") Version 2.0. The
software code licensed under GPL Version 2.0 is free software that comes
with ABSOLUTELY NO WARRANTY. You can redistribute and/or modify such
GPL code under the terms of GPL Version 2.0. For more details, see the
documentation or "License Notice" file accompanying the IOS-XE software,
or the applicable URL provided on the flyer accompanying the IOS-XE
software.
```

ROM: IOS-XE ROMMON

Router uptime is 6 minutes  
 Uptime for this control processor is 8 minutes  
 System returned to ROM by Reload Command  
 System image file is "usb0:c1100-universalk9\_ias.16.06.02.SPA.bin"  
 Last reload reason: Reload Command

This product contains cryptographic features and is subject to United States and local country laws governing import, export, transfer and use. Delivery of Cisco cryptographic products does not imply third-party authority to import, export, distribute or use encryption. Importers, exporters, distributors and users are responsible for compliance with U.S. and local country laws. By using this product you agree to comply with applicable laws and regulations. If you are unable to comply with U.S. and local laws, return this product immediately.

A summary of U.S. laws governing Cisco cryptographic products may be found at: <http://www.cisco.com/wwl/export/crypto/tool/stqrg.html>

If you require further assistance please contact us by sending email to [export@cisco.com](mailto:export@cisco.com).

Suite License Information for Module:'esg'

| Suite                                     | Suite Current | Type | Suite Next reboot |
|-------------------------------------------|---------------|------|-------------------|
| FoundationSuiteK9<br>securityk9<br>appxk9 | None          | None | None              |

Technology Package License Information:

| Technology | Technology-package Current | Technology-package Type | Technology-package Next reboot |
|------------|----------------------------|-------------------------|--------------------------------|
| appxk9     | None                       | None                    | None                           |
| securityk9 | None                       | None                    | None                           |
| ipbase     | ipbasek9                   | None                    | ipbasek9                       |

cisco C1111-8PLTELAWN (1RU) processor with 1464345K/6147K bytes of memory.  
 Processor board ID FGL212392WT  
 8 Virtual Ethernet interfaces  
 11 Gigabit Ethernet interfaces  
 2 Cellular interfaces  
 32768K bytes of non-volatile configuration memory.  
 4194304K bytes of physical memory.  
 6762495K bytes of flash memory at bootflash:.  
 7855044K bytes of USB flash at usb0:.  
 0K bytes of WebUI ODM Files at webui:.

Configuration register is 0x2100

Router#

**Step 4** Record the setting of the configuration register.

- Step 5** To enable the break setting (indicated by the value of bit 8 in the configuration register), enter the **config-register 0x01** command from privileged EXEC mode.
- Break enabled—Bit 8 is set to 0.
  - Break disabled (default setting)—Bit 8 is set to 1.
- 

## Reset the Router

To reset the router, follow these steps:

### Procedure

---

- Step 1** If break is disabled, turn the router off (O), wait 5 seconds, and turn it on (I) again. Within 60 seconds, press the **Break** key. The terminal displays the ROM monitor prompt.

**Note** Some terminal keyboards have a key labeled *Break*. If your keyboard does not have a Break key, see the documentation that came with the terminal for instructions on how to send a break.

- Step 2** Press break. The terminal displays the following prompt:

**Example:**

```
rommon 2>
```

- Step 3** Enter **confreg 0x142** to reset the configuration register:

**Example:**

```
rommon 2> confreg 0x142
```

- Step 4** Initialize the router by entering the **reset** command:

**Example:**

```
rommon 2> reset
```

The router cycles its power, and the configuration register is set to 0x142. The router uses the boot ROM system image, indicated by the system configuration dialog:

**Example:**

```
--- System Configuration Dialog ---
```

- Step 5** Enter **no** in response to the prompts until the following message is displayed:

**Example:**

```
Press RETURN to get started!
```

- Step 6** Press **Return**. The following prompt appears:

**Example:**

```
Router>
```

**Step 7** Enter the enable command to enter enable mode. Configuration changes can be made only in enable mode:

**Example:**

```
Router> enable
```

The prompt changes to the privileged EXEC prompt:

**Example:**

```
Router#
```

**Step 8** Enter the **show startup-config** command to display an enable password in the configuration file:

**Example:**

```
Router# show startup-config
```

---

### What to do next

If you are recovering an enable password, do not perform the steps in the Reset the Password and Save Your Changes section. Instead, complete the password recovery process by performing the steps in the Reset the Configuration Register Value section.

If you are recovering an enable secret password, it is not displayed in the **show startup-config** command output. Complete the password recovery process by performing the steps in the Reset the Password and Save Your Changes section.

## Reset the Router

To reset the router, follow these steps:

### Procedure

---

**Step 1** If break is disabled, turn the router off (O), wait 5 seconds, and turn it on (I) again. Within 60 seconds, press the **Break** key. The terminal displays the ROM monitor prompt.

**Note** Some terminal keyboards have a key labeled *Break*. If your keyboard does not have a Break key, see the documentation that came with the terminal for instructions on how to send a break.

**Step 2** Press break. The terminal displays the following prompt:

**Example:**

```
rommon 2>
```

**Step 3** Enter **confreg 0x142** to reset the configuration register:

**Example:**

```
rommon 2> confreg 0x142
```

**Step 4** Initialize the router by entering the **reset** command:

**Example:**

```
rommon 2> reset
```

The router cycles its power, and the configuration register is set to 0x142. The router uses the boot ROM system image, indicated by the system configuration dialog:

**Example:**

```
--- System Configuration Dialog ---
```

**Step 5** Enter **no** in response to the prompts until the following message is displayed:

**Example:**

```
Press RETURN to get started!
```

**Step 6** Press **Return**. The following prompt appears:

**Example:**

```
Router>
```

**Step 7** Enter the enable command to enter enable mode. Configuration changes can be made only in enable mode:

**Example:**

```
Router> enable
```

The prompt changes to the privileged EXEC prompt:

**Example:**

```
Router#
```

**Step 8** Enter the **show startup-config** command to display an enable password in the configuration file:

**Example:**

```
Router# show startup-config
```

---

**What to do next**

If you are recovering an enable password, do not perform the steps in the Reset the Password and Save Your Changes section. Instead, complete the password recovery process by performing the steps in the Reset the Configuration Register Value section.

If you are recovering an enable secret password, it is not displayed in the **show startup-config** command output. Complete the password recovery process by performing the steps in the Reset the Password and Save Your Changes section.

## Reset the Password and Save Your Changes

To reset your password and save the changes, follow these steps:

### Procedure

---

**Step 1** Enter the **configure terminal** command to enter global configuration mode:

**Example:**

```
Router# configure terminal
```

**Step 2** Enter the **enable secret** command to reset the enable secret password in the router:

**Example:**

```
Router(config)# enable secret
password
```

**Step 3** Enter **exit** to exit global configuration mode:

**Example:**

```
Router(config)# exit
```

**Step 4** Save your configuration changes:

**Example:**

```
Router# copy running-config startup-config
```

---

## Reset the Configuration Register Value

To reset the configuration register value after you have recovered or reconfigured a password, follow these steps:

### Procedure

---

**Step 1** Enter the **configure terminal** command to enter global configuration mode:

**Example:**

```
Router# configure terminal
```

**Step 2** Enter the **configure register** command and the original configuration register value that you recorded.

**Example:**

```
Router(config)# config-reg
value
```

**Step 3** Enter **exit** to exit configuration mode:

**Example:**

```
Router(config)# exit
```

**Note** To return to the configuration being used before you recovered the lost enable password, do not save the configuration changes before rebooting the router.

**Step 4** Reboot the router, and enter the recovered password.

---

## References

Refer to the following troubleshooting scenarios from the Cisco ISR guides:

- Monitor CPU Usage - <http://www.cisco.com/c/en/us/support/docs/routers/4000-series-integrated-services-routers/210760-Monitor-CPU-Usage-On-ISR4300-Series.html>
- Memory Troubleshooting Guide for Cisco 4000 Series ISRs - [http://www.cisco.com/c/en/us/td/docs/routers/access/4400/troubleshooting/memorytroubleshooting/isr4000\\_mem.html](http://www.cisco.com/c/en/us/td/docs/routers/access/4400/troubleshooting/memorytroubleshooting/isr4000_mem.html)
- Stuck in ROMMON Trouble Shooting - <http://www.cisco.com/c/en/us/support/docs/routers/4000-series-integrated-services-routers/200678-Troubleshoot-Cisco-4000-Series-ISR-Stuck.html>
- Monitoring Control Plane Resource & Hardware Alarms Trouble Shooting - [https://www.cisco.com/c/en/us/td/docs/routers/access/4400/software/configuration/guide/isr4400swcfg/bm\\_isr\\_4400\\_sw\\_config\\_guide\\_chapter\\_01000.html#concept\\_5A8508E657FA48E7B9563BE9073D4884](https://www.cisco.com/c/en/us/td/docs/routers/access/4400/software/configuration/guide/isr4400swcfg/bm_isr_4400_sw_config_guide_chapter_01000.html#concept_5A8508E657FA48E7B9563BE9073D4884)
- SFP Modules Maintenance and Troubleshooting - <http://www.cisco.com/c/en/us/support/docs/interfaces-modules/cwdm-gbic-sfp/72370-sfp-trcvr-mods.html>
- How to Find Error Message Details - [https://www.cisco.com/c/en/us/td/docs/routers/access/4400/software/configuration/guide/isr4400swcfg/bm\\_isr\\_4400\\_sw\\_config\\_guide\\_chapter\\_01001.html#concept\\_AD47EC93DC3D4557B99BC155B8BB68FA](https://www.cisco.com/c/en/us/td/docs/routers/access/4400/software/configuration/guide/isr4400swcfg/bm_isr_4400_sw_config_guide_chapter_01001.html#concept_AD47EC93DC3D4557B99BC155B8BB68FA)
- IOS XE Syslog Messages - <http://www.cisco.com/c/en/us/td/docs/ios/system/messages/guide/xemsg01.html>
- Debugging AppNav/AppNav-XE and ISR-WAAS - [http://www.cisco.com/c/en/us/td/docs/routers/access/4400/appnav/isr/isr\\_appnav/isr\\_trblshoot.html](http://www.cisco.com/c/en/us/td/docs/routers/access/4400/appnav/isr/isr_appnav/isr_trblshoot.html)
- Troubleshooting for Cisco Smart Licensing Client - [https://www.cisco.com/c/en/us/td/docs/routers/access/4400/software/configuration/guide/isr4400swcfg/isr4400swcfg\\_chapter\\_010011.html#reference\\_C0E7BB9ED86D4FA18202EE72E87EB3A9](https://www.cisco.com/c/en/us/td/docs/routers/access/4400/software/configuration/guide/isr4400swcfg/isr4400swcfg_chapter_010011.html#reference_C0E7BB9ED86D4FA18202EE72E87EB3A9)
- Retrieving the License and Configuration Files - [http://www.cisco.com/c/en/us/td/docs/routers/access/4400/flashmemory/isr4000\\_flashmem.html#72593](http://www.cisco.com/c/en/us/td/docs/routers/access/4400/flashmemory/isr4000_flashmem.html#72593)
- Power and Cooling System Trouble Shooting - <http://www.cisco.com/c/en/us/td/docs/routers/access/4400/troubleshooting/guide/isr4400trbl.html>
- T1/E1 Data Clocking Trouble Shooting and Configuration - <http://www.cisco.com/c/en/us/td/docs/routers/access/4400/feature/guide/isr4400netclock.html#54707>
- Troubleshooting Layer 2/3 Switch SW - [http://www.cisco.com/c/en/us/td/docs/routers/access/interfaces/eesm/software/configuration/guide/4451\\_config.html#pgfId-1000127](http://www.cisco.com/c/en/us/td/docs/routers/access/interfaces/eesm/software/configuration/guide/4451_config.html#pgfId-1000127)
- Best Practices for Implementing WAN MACsec and MKA - [http://www.cisco.com/c/en/us/td/docs/ios-xml/ios/macsec/configuration/xe-16/macsec-xe-16-book/wan-macsec-mka-support-enhance.html#reference\\_66BBEB1DDF3147DB8B89B6BB6CEBB7DC](http://www.cisco.com/c/en/us/td/docs/ios-xml/ios/macsec/configuration/xe-16/macsec-xe-16-book/wan-macsec-mka-support-enhance.html#reference_66BBEB1DDF3147DB8B89B6BB6CEBB7DC)

- QoS FAQ - <http://www.cisco.com/c/en/us/products/collateral/routers/asr-1000-series-aggregation-services-routers/q-and-a-c67-731655.html>
- SNMB Notification - [http://www.cisco.com/c/en/us/td/docs/routers/access/4400/technical\\_references/4400\\_mib\\_guide/isr4400\\_MIB/4400mib\\_04.html#42335](http://www.cisco.com/c/en/us/td/docs/routers/access/4400/technical_references/4400_mib_guide/isr4400_MIB/4400mib_04.html#42335)
- Monitoring router interface through MIB - [http://www.cisco.com/c/en/us/td/docs/routers/access/4400/technical\\_references/4400\\_mib\\_guide/isr4400\\_MIB/4400mib\\_05.html#96205](http://www.cisco.com/c/en/us/td/docs/routers/access/4400/technical_references/4400_mib_guide/isr4400_MIB/4400mib_05.html#96205)