



Configure SR-TE Policies

This module provides information about segment routing for traffic engineering (SR-TE) policies, how to configure SR-TE policies, and how to steer traffic into an SR-TE policy.

- [SR-TE Policy Overview, on page 1](#)
- [Usage Guidelines and Limitations, on page 2](#)
- [Instantiation of an SR Policy, on page 3](#)
- [SR-TE Policy Path Types, on page 46](#)
- [Protocols, on page 68](#)
- [Traffic Steering, on page 79](#)
- [Miscellaneous, on page 106](#)

SR-TE Policy Overview

Segment routing for traffic engineering (SR-TE) uses a “policy” to steer traffic through the network. An SR-TE policy path is expressed as a list of segments that specifies the path, called a segment ID (SID) list. Each segment is an end-to-end path from the source to the destination, and instructs the routers in the network to follow the specified path instead of following the shortest path calculated by the IGP. If a packet is steered into an SR-TE policy, the SID list is pushed on the packet by the head-end. The rest of the network executes the instructions embedded in the SID list.

An SR-TE policy is identified as an ordered list (head-end, color, end-point):

- Head-end – Where the SR-TE policy is instantiated
- Color – A numerical value that distinguishes between two or more policies to the same node pairs (Head-end – End point)
- End-point – The destination of the SR-TE policy

Every SR-TE policy has a color value. Every policy between the same node pairs requires a unique color value.

An SR-TE policy uses one or more candidate paths. A candidate path is a single segment list (SID-list) or a set of weighted SID-lists (for weighted equal cost multi-path [WECCMP]). A candidate path is either dynamic or explicit. See *SR-TE Policy Path Types* section for more information.

Table 1: Feature History Table

Feature Name	Release Information	Feature Description
Deep hashing for payloads with large MPLS label stacks	Release 7.3.1	Load balancing of non-IP traffic with large label stacks (such as L2VPN with FAT over SR-TE) is enhanced. With this enhancement, ECMP/bundle hashing is performed on the innermost 3 labels for load balancing, up to the 9th label. This results in the FAT flow label being utilized in the hash calculation for L2VPN traffic with deep label stacks. Prior to the 7.3.1 release, only labels up to the 5th were utilized.

Usage Guidelines and Limitations

Table 2: Feature History Table

Feature Name	Release Information	Feature Description
L3VPN BGP PIC over SR-TE	Release 7.3.2	<p>This feature provides BGP PIC support for L3VPN over SR policies. BGP PIC provides fast convergence when traffic switches from a primary path to a backup path.</p> <p>BGP PIC over SR-TE is supported when primary and backup paths are of the same or different resolution types.</p>

Observe the following guidelines and limitations for the platform.

- Broadcast links are not supported, configure IGP's interface as P2P (point-to-point).
- The ECMP path-set of an IGP route with a mix of SR-TE Policy paths (Autoroute Include) and unprotected native paths is supported.
- The ECMP path-set of an IGP route with a mix of SR-TE Policy paths (Autoroute Include) and protected (LFA/TI-LFA) native paths is not supported.
- Before configuring SR-TE policies, use the **distribute link-state** command under IS-IS or OSPF to distribute the link-state database to external services.
- L3VPN BGP PIC over SR-TE is supported.

BGP PIC over SR-TE is supported when primary and backup paths are of the same or different resolution types. For example, when a primary path resolves into the BSID of an SR policy, the backup path could point to either another BSID or to a native LSP. For information about BGP PIC, refer to the [Implementing BGP](#) chapter in the *Routing Configuration Guide for Cisco ASR 9000 Series Routers*.
- GRE tunnel as primary interface for an SR policy is not supported.
- GRE tunnel as backup interface for an SR policy with TI-LFA protection is not supported.

- Head-end computed inter-domain SR policy with Flex Algo constraint and IGP redistribution is not supported. This is supported with Flex Algo-aware path computation at SR-PCE, with or without IGP redistribution. See [SR-PCE Flexible Algorithm Multi-Domain Path Computation](#).
- Single-hop SR-TE Policy with pop operation forwards packet with incorrect ethertype when receiving labelled packets matching Binding SID, but works properly when plain IPv6 is sent.

Instantiation of an SR Policy

An SR policy is instantiated, or implemented, at the head-end router.

The following sections provide details on the SR policy instantiation methods:

- [gRPC API Services](#)
- [On-Demand SR Policy – SR On-Demand Next-Hop](#) , on page 3
- [Manually Provisioned SR Policy](#), on page 41
- [PCE-Initiated SR Policy](#), on page 41

On-Demand SR Policy – SR On-Demand Next-Hop

Segment Routing On-Demand Next Hop (SR-ODN) allows a service head-end router to automatically instantiate an SR policy to a BGP next-hop when required (on-demand). Its key benefits include:

- **SLA-aware BGP service** – Provides per-destination steering behaviors where a prefix, a set of prefixes, or all prefixes from a service can be associated with a desired underlay SLA. The functionality applies equally to single-domain and multi-domain networks.
- **Simplicity** – No prior SR Policy configuration needs to be configured and maintained. Instead, operator simply configures a small set of common intent-based optimization templates throughout the network.
- **Scalability** – Device resources at the head-end router are used only when required, based on service or SLA connectivity needs.

The following example shows how SR-ODN works:

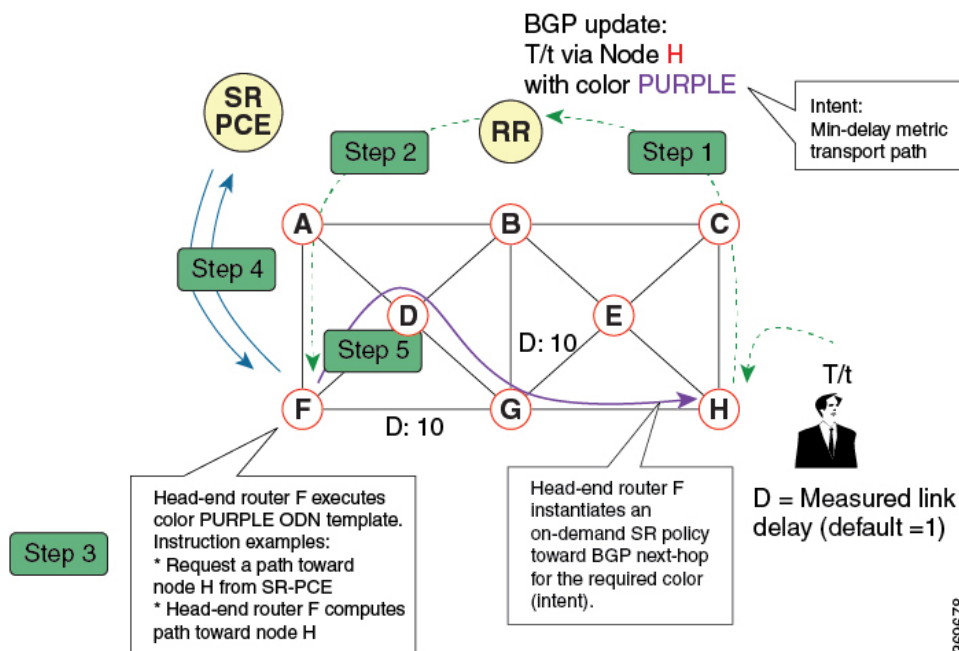

1. An egress PE (node H) advertises a BGP route for prefix T/t. This advertisement includes an SLA intent encoded with a BGP color extended community. In this example, the operator assigns color purple (example value = 100) to prefixes that should traverse the network over the delay-optimized path.
2. The route reflector receives the advertised route and advertises it to other PE nodes.
3. Ingress PEs in the network (such as node F) are pre-configured with an ODN template for color purple that provides the node with the steps to follow in case a route with the intended color appears, for example:
 - Contact SR-PCE and request computation for a path toward node H that does not share any nodes with another LSP in the same disjointness group.
 - At the head-end router, compute a path towards node H that minimizes cumulative delay.
4. In this example, the head-end router contacts the SR-PCE and requests computation for a path toward node H that minimizes cumulative delay.
5. After SR-PCE provides the compute path, an intent-driven SR policy is instantiated at the head-end router. Other prefixes with the same intent (color) and destined to the same egress PE can share the same on-demand SR policy. When the last prefix associated with a given [intent, egress PE] pair is withdrawn, the on-demand SR policy is deleted, and resources are freed from the head-end router.

An on-demand SR policy is created dynamically for BGP global or VPN (service) routes. The following services are supported with SR-ODN:

- IPv4 BGP global routes
- IPv6 BGP global routes (6PE)
- VPNv4
- VPNv6 (6vPE)
- EVPN-VPWS (single-homing)

- EVPN-VPWS (multi-homing)
- EVPN (single-homing/multi-homing)



Note For EVPN single-homing, you must configure an EVPN Ethernet Segment Identifier (ESI) with a non-zero value.



Note Colored per-ESI/per-EVI EVPN Ethernet Auto-Discovery route (route-type 1) and Inclusive Multicast Route (route-type 3) are used to trigger instantiation of ODN SR-TE policies.



Note The following scenarios involving virtual Ethernet Segments (vES) are also supported with EVPN ODN:

- VPLS VFI as vES for single-active Multi-Homing to EVPN
- Active/backup Pseudo-wire (PW) as vES for Single-Homing to EVPN
- Static Pseudo-wire (PW) as vES for active-active Multi-Homing to EVPN

SR-ODN/Automated Steering Support at ASBR for L3VPN Inter-AS Option B and L3VPN Inline Route Reflector

This feature augments support for SR-ODN and automated steering (AS) for the following scenarios:

- At ASBR nodes for L3VPN Inter-AS Option B
- At ABR nodes acting as L3VPN Inline Route Reflectors

With this feature, an ABR/ASBR node can trigger an on-demand SR policy used to steer traffic to remote colored destinations.



Note This feature is not supported when the Inter-AS Option B Per Next-Hop Label Allocation feature is enabled using the **label mode per-nexthop-received-label** command under the VPNv4 unicast address-family.

The below topology shows a network with different regions under a single BGP AS and with L3VPN services end-to-end. Nodes B and C are ABRs configured with BGP next-hop-self (NHS) for L3VPN. These ABRs program label cross connects for L3VPN destinations.

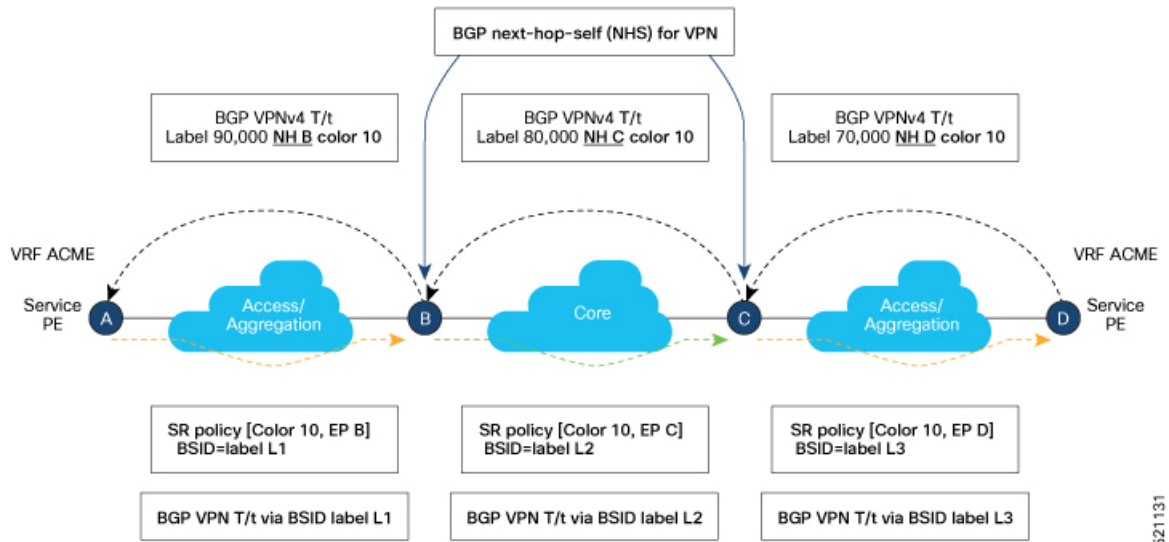

BGP advertises prefixes with SLA intent by attaching a color extended community. The objective is to steer traffic towards colored VPN prefixes with SR policies in *each* region. As shown in the figure, this feature allows ABR node B to steer traffic for remote BGP prefixes with color 10 over an SR policy with {color 10, end-point C}.

Similar behaviors apply at ASBR nodes for L3VPN Inter-AS Option B scenarios.

Configuring SR-ODN/AS at L3VPN ABR/ASBR

See the [SR-ODN Configuration Steps, on page 9](#) section for information about configuring the On-Demand Color Template.

Example – SR-ODN/AS at ASBR for L3VPN Inter-AS Option B

The following example depicts an L3VPN Inter-AS Option B scenario with node B acting as ASBR. Node B steers traffic for remote BGP prefix T/t with color 10 over an on-demand SR policy with a path to node C minimizing the TE metric.

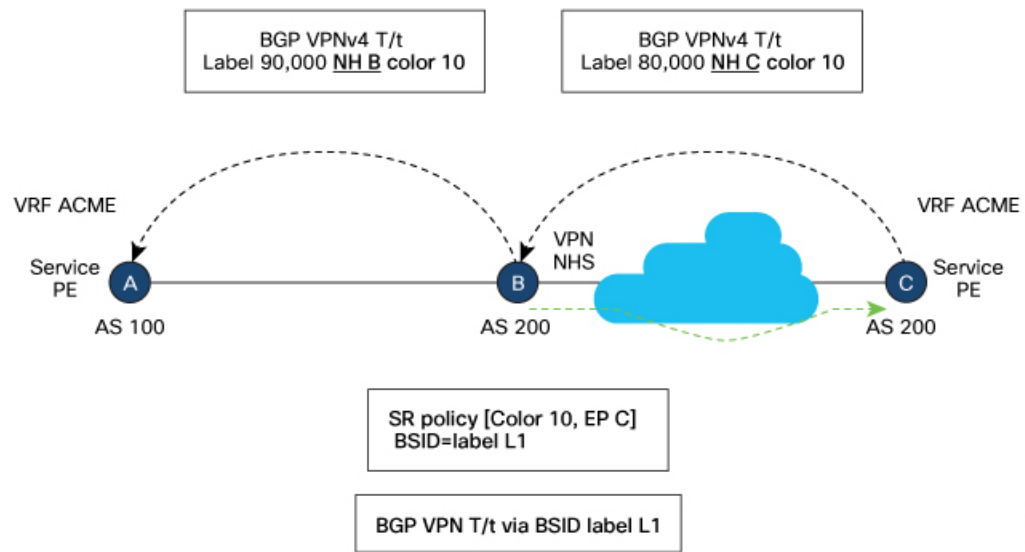

521132

Configuration on ASBR Node B

```

segment-routing
 traffic-eng
  on-demand color 10
  dynamic
   metric
    type te
  !
  !
  !
  !
router bgp 200
 address-family vpnv4 unicast
  retain route-target all
  !
 neighbor <neighbor_A>
  remote-as 100
  address-family vpnv4 unicast
  send-extended-community-ebgp
  route-policy pass-all in
  route-policy pass-all out
  !
 neighbor <neighbor_C>
  remote-as 200
  address-family vpnv4 unicast
  update-source Loopback0
  next-hop-self
  
```

Example - SR-ODN/AS at L3VPN ABR (BGP inline Route Reflector)

The following example depicts a scenario with node B acting as L3VPN BGP inline Route Reflector. Node B steers traffic for remote BGP prefix T/t with color 10 over an on-demand SR policy with a path to node C minimizing the delay metric.

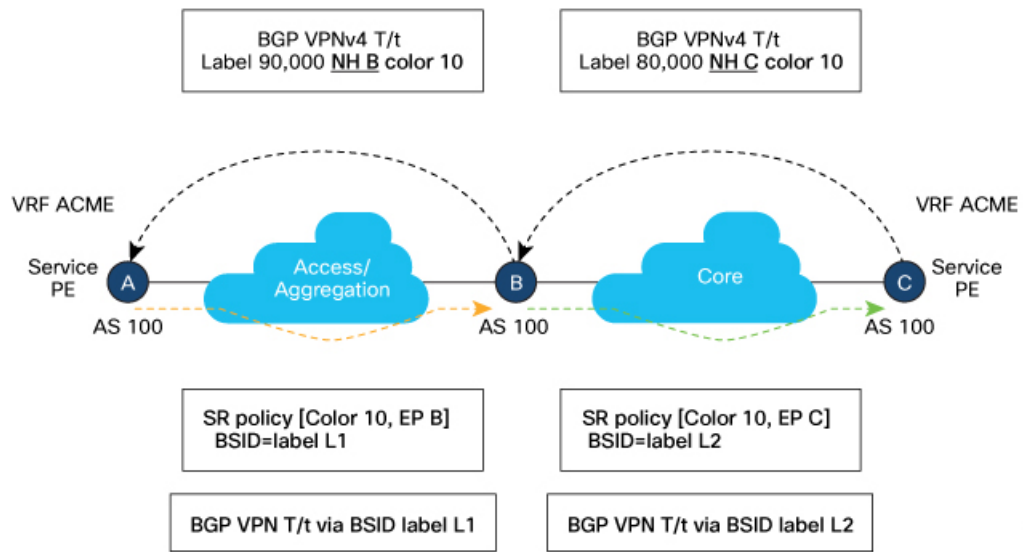

521133

Configuration on ASBR Node B

```

segment-routing
traffic-eng
  on-demand color 10
  dynamic
  metric
  type latency
  !
  !
  !
  !
router bgp 100
  ibgp policy out enforce-modifications
  address-family vpnv4 unicast
  !
  neighbor <neighbor_C>
  remote-as 100
  address-family vpnv4 unicast
  update-source Loopback0
  route-reflector-client
  next-hop-self
  !
  !
  neighbor <neighbor_A>
  remote-as 100
  address-family vpnv4 unicast
  update-source Loopback0
  route-reflector-client
  next-hop-self

```

SR-ODN Configuration Steps



Note If you are on a release before Cisco IOS XR Release 7.4.1, you can configure SR-ODN with Flexible Algorithm constraints using the **segment-routing traffic-eng on-demand color color dynamic sid-algorithm algorithm-number** command.

Starting with Cisco IOS XR release 7.4.1, you can also configure SR-ODN with Flexible Algorithm constraints using the new **segment-routing traffic-eng on-demand color color constraints segments sid-algorithm algorithm-number** command.

From Cisco IOS XR Release 7.9.1, the **segment-routing traffic-eng on-demand color color dynamic sid-algorithm algorithm-number** command is deprecated. Previous configurations stored in NVRAM will be rejected at boot-up.

Hence, for Cisco IOS XR Release 7.9.1, you must reconfigure all SR-ODN configurations with Flexible Algorithm constraints that use the **on-demand dynamic sid-algorithm** with the **on-demand constraints** command.

To configure SR-ODN, complete the following configurations:

1. Define the SR-ODN template on the SR-TE head-end router.
 (Optional) If using Segment Routing Path Computation Element (SR-PCE) for path computation:
 - a. Configure SR-PCE. For detailed SR-PCE configuration information, see [Configure SR-PCE](#).
 - b. Configure the head-end router as Path Computation Element Protocol (PCEP) Path Computation Client (PCC). For detailed PCEP PCC configuration information, see [Configure the Head-End Router as PCEP PCC](#).
2. Define BGP color extended communities. Refer to the "Implementing BGP" chapter in the [Routing Configuration Guide for Cisco ASR 9000 Series Routers](#).
3. Define routing policies (using routing policy language [RPL]) to set BGP color extended communities. Refer to the "Implementing Routing Policy" chapter in the [Routing Configuration Guide for Cisco ASR 9000 Series Routers](#).

The following RPL attach-points for setting/matching BGP color extended communities are supported:



Note The following table shows the supported RPL match operations; however, routing policies are required primarily to set BGP color extended community. Matching based on BGP color extended communities is performed automatically by ODN's on-demand color template.

Attach Point	Set	Match
VRF export	X	X
VRF import	–	X
EVI export	X	–
EVI import	X	X

Attach Point	Set	Match
Neighbor-in	X	X
Neighbor-out	X	X
Inter-AFI export	–	X
Inter-AFI import	–	X
Default-originate	X	–

4. Apply routing policies to a service. Refer to the "Implementing Routing Policy" chapter in the [Routing Configuration Guide for Cisco ASR 9000 Series Routers](#).

Configure On-Demand Color Template

- Use the **on-demand color** *color* command to create an ODN template for the specified color value. The head-end router automatically follows the actions defined in the template upon arrival of BGP global or VPN routes with a BGP color extended community that matches the color value specified in the template.

The *color* range is from 1 to 4294967295.

```
Router(config)# segment-routing traffic-eng
Router(config-sr-te)# on-demand color 10
```



Note Matching based on BGP color extended communities is performed automatically via ODN's on-demand color template. RPL routing policies are not required.

- Use the **on-demand color** *color dynamic* command to associate the template with on-demand SR policies with a locally computed dynamic path (by SR-TE head-end router utilizing its TE topology database) or centrally (by SR-PCE). The head-end router will first attempt to install the locally computed path; otherwise, it will use the path computed by the SR-PCE.

```
Router(config)# segment-routing traffic-eng
Router(config-sr-te)# on-demand color 10 dynamic
```

- Use the **on-demand color** *color dynamic pcep* command to indicate that only the path computed by SR-PCE should be associated with the on-demand SR policy. With this configuration, local path computation is not attempted; instead the head-end router will only instantiate the path computed by the SR-PCE.

```
Router(config-sr-te)# on-demand color 10 dynamic pcep
```

Configure Dynamic Path Optimization Objectives

- Use the **metric type** {*igp* | *te* | *latency*} command to configure the metric for use in path computation.

```
Router(config-sr-te-color-dyn)# metric type te
```

- Use the **metric margin** `{absolute value|relative percent}` command to configure the On-Demand dynamic path metric margin. The range for *value* and *percent* is from 0 to 2147483647.

```
Router(config-sr-te-color-dyn)# metric margin absolute 5
```

Configure Dynamic Path Constraints

- Use the **disjoint-path group-id** `group-id type {link | node | srlg | srlg-node} [sub-id sub-id]` command to configure the disjoint-path constraints. The *group-id* and *sub-id* range is from 1 to 65535.

```
Router(config-sr-te-color-dyn)# disjoint-path group-id 775 type link
```

- Use the **affinity** `{include-any | include-all | exclude-any} {name WORD}` command to configure the affinity constraints.

```
Router(config-sr-te-color-dyn)# affinity exclude-any name CROSS
```

- Use the **maximum-sid-depth** `value` command to customize the maximum SID depth (MSD) constraints advertised by the router.

The default MSD *value* is equal to the maximum MSD supported by the platform (10).

```
Router(config-sr-te-color)# maximum-sid-depth 5
```

See [Customize MSD Value at PCC, on page 69](#) for information about SR-TE label imposition capabilities.

- Use the **constraints segments sid-algorithm** `algorithm-number` command to configure the SR Flexible Algorithm constraints. The *algorithm-number* range is from 128 to 255.

```
Router(config-sr-te-color)# constraints segments sid-algorithm 128
```

- Use the **constraints segments protection** `{protected-only | protected-preferred | unprotected-only | unprotected-preferred}` command to configure the Adj-SID protection behavior constraints.

```
Router(config-sr-te-color)# constraints segments protection protected-only
```

See [Segment Protection-Type Constraint, on page 50](#) for information about Adj-SID protection behavior.

Configuring SR-ODN: Examples

Configuring SR-ODN: Layer-3 Services Examples

The following examples show end-to-end configurations used in implementing SR-ODN on the head-end router.

Configuring ODN Color Templates: Example

Configure ODN color templates on routers acting as SR-TE head-end nodes. The following example shows various ODN color templates:

- color 10: minimization objective = te-metric
- color 20: minimization objective = igp-metric
- color 21: minimization objective = igp-metric; constraints = affinity

- color 22: minimization objective = te-metric; path computation at SR-PCE; constraints = affinity
- color 30: minimization objective = delay-metric
- color 128: constraints = flex-algo

```

segment-routing
traffic-eng
on-demand color 10
dynamic
metric
type te
!
!
!
on-demand color 20
dynamic
metric
type igp
!
!
!
on-demand color 21
dynamic
metric
type igp
!
affinity exclude-any
name CROSS
!
!
!
on-demand color 22
dynamic
pcep
!
metric
type te
!
affinity exclude-any
name CROSS
!
!
!
on-demand color 30
dynamic
metric
type latency
!
!
!
on-demand color 128
constraints
segments
sid-algorithm 128
!
!
end

```

Configuring BGP Color Extended Community Set: Example

The following example shows how to configure BGP color extended communities that are later applied to BGP service routes via route-policies.



Note In most common scenarios, egress PE routers that advertise BGP service routes apply (set) BGP color extended communities. However, color can also be set at the ingress PE router.

```

extcommunity-set opaque color10-te
  10
end-set
!
extcommunity-set opaque color20-igp
  20
end-set
!
extcommunity-set opaque color21-igp-excl-cross
  21
end-set
!
extcommunity-set opaque color30-delay
  30
end-set
!
extcommunity-set opaque color128-fa128
  128
end-set
!

```

Configuring RPL to Set BGP Color (Layer-3 Services): Examples

The following example shows various representative RPL definitions that set BGP color community.

The first 4 RPL examples include the set color action only. The last RPL example performs the set color action for selected destinations based on a prefix-set.

```

route-policy SET_COLOR_LOW_LATENCY_TE
  set extcommunity color color10-te
  pass
end-policy
!
route-policy SET_COLOR_HI_BW
  set extcommunity color color20-igp
  pass
end-policy
!
route-policy SET_COLOR_LOW_LATENCY
  set extcommunity color color30-delay
  pass
end-policy
!
route-policy SET_COLOR_FA_128
  set extcommunity color color128-fa128
  pass
end-policy
!

prefix-set sample-set
  88.1.0.0/24
end-set

```

```

!
route-policy SET_COLOR_GLOBAL
  if destination in sample-set then
    set extcommunity color color10-te
  else
    pass
  endif
end-policy

```

Applying RPL to BGP Services (Layer-3 Services): Example

The following example shows various RPLs that set BGP color community being applied to BGP Layer-3 VPN services (VPNv4/VPNv6) and BGP global.

- The L3VPN examples show the RPL applied at the VRF export attach-point.
- The BGP global example shows the RPL applied at the BGP neighbor-out attach-point.

```

vrf vrf_cust1
  address-family ipv4 unicast
    export route-policy SET_COLOR_LOW_LATENCY_TE
  !
  address-family ipv6 unicast
    export route-policy SET_COLOR_LOW_LATENCY_TE
  !
!
vrf vrf_cust2
  address-family ipv4 unicast
    export route-policy SET_COLOR_HI_BW
  !
  address-family ipv6 unicast
    export route-policy SET_COLOR_HI_BW
  !
!
vrf vrf_cust3
  address-family ipv4 unicast
    export route-policy SET_COLOR_LOW_LATENCY
  !
  address-family ipv6 unicast
    export route-policy SET_COLOR_LOW_LATENCY
  !
!
vrf vrf_cust4
  address-family ipv4 unicast
    export route-policy SET_COLOR_FA_128
  !
  address-family ipv6 unicast
    export route-policy SET_COLOR_FA_128
  !
!
router bgp 100
  neighbor-group BR-TO-RR
  address-family ipv4 unicast
    route-policy SET_COLOR_GLOBAL out
  !
!
end

```

Verifying BGP VRF Information

Use the **show bgp vrf** command to display BGP prefix information for VRF instances. The following output shows the BGP VRF table including a prefix (88.1.1.0/24) with color 10 advertised by router 10.1.1.8.

```
RP/0/RP0/CPU0:R4# show bgp vrf vrf_cust1

BGP VRF vrf_cust1, state: Active
BGP Route Distinguisher: 10.1.1.4:101
VRF ID: 0x60000007
BGP router identifier 10.1.1.4, local AS number 100
Non-stop routing is enabled
BGP table state: Active
Table ID: 0xe0000007 RD version: 282
BGP main routing table version 287
BGP NSR Initial initsync version 31 (Reached)
BGP NSR/ISSU Sync-Group versions 0/0

Status codes: s suppressed, d damped, h history, * valid, > best
                i - internal, r RIB-failure, S stale, N Nexthop-discard
Origin codes: i - IGP, e - EGP, ? - incomplete
   Network          Next Hop              Metric LocPrf Weight Path
Route Distinguisher: 10.1.1.4:101 (default for vrf vrf_cust1)
*> 44.1.1.0/24      40.4.101.11             0 400 {1} i
*>i55.1.1.0/24      10.1.1.5                 100   0 500 {1} i
*>i88.1.1.0/24      10.1.1.8 C:10           100   0 800 {1} i
*>i99.1.1.0/24      10.1.1.9                 100   0 800 {1} i

Processed 4 prefixes, 4 paths
```

The following output displays the details for prefix 88.1.1.0/24. Note the presence of BGP extended color community 10, and that the prefix is associated with an SR policy with color 10 and BSID value of 24036.

```
RP/0/RP0/CPU0:R4# show bgp vrf vrf_cust1 88.1.1.0/24

BGP routing table entry for 88.1.1.0/24, Route Distinguisher: 10.1.1.4:101
Versions:
  Process          bRIB/RIB   SendTblVer
  Speaker          282        282
Last Modified: May 20 09:23:34.112 for 00:06:03
Paths: (1 available, best #1)
  Advertised to CE peers (in unique update groups):
    40.4.101.11
  Path #1: Received by speaker 0
  Advertised to CE peers (in unique update groups):
    40.4.101.11
    800 {1}
10.1.1.8 C:10 (bsid:24036) (metric 20) from 10.1.1.55 (10.1.1.8)
  Received Label 24012
  Origin IGP, localpref 100, valid, internal, best, group-best, import-candidate,
imported
  Received Path ID 0, Local Path ID 1, version 273
Extended community: Color:10 RT:100:1
  Originator: 10.1.1.8, Cluster list: 10.1.1.55
SR policy color 10, up, registered, bsid 24036, if-handle 0x08000024

Source AFI: VPNv4 Unicast, Source VRF: default, Source Route Distinguisher: 10.1.1.8:101
```

Verifying Forwarding (CEF) Table

Use the **show cef vrf** command to display the contents of the CEF table for the VRF instance. Note that prefix 88.1.1.0/24 points to the BSID label corresponding to an SR policy. Other non-colored prefixes, such as 55.1.1.0/24, point to BGP next-hop.

```
RP/0/RP0/CPU0:R4# show cef vrf vrf_cust1
```

Prefix	Next Hop	Interface
0.0.0.0/0	drop	default handler
0.0.0.0/32	broadcast	
40.4.101.0/24	attached	TenGigE0/0/0/0.101
40.4.101.0/32	broadcast	TenGigE0/0/0/0.101
40.4.101.4/32	receive	TenGigE0/0/0/0.101
40.4.101.11/32	40.4.101.11/32	TenGigE0/0/0/0.101
40.4.101.255/32	broadcast	TenGigE0/0/0/0.101
44.1.1.0/24	40.4.101.11/32	<recursive>
55.1.1.0/24	10.1.1.5/32	<recursive>
88.1.1.0/24	24036 (via-label)	<recursive>
99.1.1.0/24	10.1.1.9/32	<recursive>
224.0.0.0/4	0.0.0.0/32	
224.0.0.0/24	receive	
255.255.255.255/32	broadcast	

The following output displays CEF details for prefix 88.1.1.0/24. Note that the prefix is associated with an SR policy with BSID value of 24036.

```
RP/0/RP0/CPU0:R4# show cef vrf vrf_cust1 88.1.1.0/24
```

```
88.1.1.0/24, version 51, internal 0x5000001 0x0 (ptr 0x98c60ddc) [1], 0x0 (0x0), 0x208
(0x98425268)
Updated May 20 09:23:34.216
Prefix Len 24, traffic index 0, precedence n/a, priority 3
  via local-label 24036, 5 dependencies, recursive [flags 0x6000]
  path-idx 0 NHID 0x0 [0x97091ec0 0x0]
  recursion-via-label
  next hop VRF - 'default', table - 0xe0000000
  next hop via 24036/0/21
    next hop srte_c_10_ep labels imposed {ImplNull 24012}
```

Verifying SR Policy

Use the **show segment-routing traffic-eng policy** command to display SR policy information.

The following outputs show the details of an on-demand SR policy that was triggered by prefixes with color 10 advertised by node 10.1.1.8.

```
RP/0/RP0/CPU0:R4# show segment-routing traffic-eng policy color 10 tabular
```

Color	Endpoint	Admin State	Oper State	Binding SID
10	10.1.1.8	up	up	24036

The following outputs show the details of the on-demand SR policy for BSID 24036.



Note There are 2 candidate paths associated with this SR policy: the path that is computed by the head-end router (with preference 200), and the path that is computed by the SR-PCE (with preference 100). The candidate path with the highest preference is the active candidate path (highlighted below) and is installed in forwarding.

```
RP/0/RP0/CPU0:R4# show segment-routing traffic-eng policy binding-sid 24036

SR-TE policy database
-----

Color: 10, End-point: 10.1.1.8
Name: srte_c_10_ep_10.1.1.8
Status:
  Admin: up   Operational: up for 4d14h (since Jul  3 20:28:57.840)
Candidate-paths:
  Preference: 200 (BGP ODN) (active)
  Requested BSID: dynamic
  PCC info:
    Symbolic name: bgp_c_10_ep_10.1.1.8_discr_200
    PLSP-ID: 12
  Dynamic (valid)
    Metric Type: TE, Path Accumulated Metric: 30
    16009 [Prefix-SID, 10.1.1.9]
    16008 [Prefix-SID, 10.1.1.8]
  Preference: 100 (BGP ODN)
  Requested BSID: dynamic
  PCC info:
    Symbolic name: bgp_c_10_ep_10.1.1.8_discr_100
    PLSP-ID: 11
  Dynamic (pce 10.1.1.57) (valid)
    Metric Type: TE, Path Accumulated Metric: 30
    16009 [Prefix-SID, 10.1.1.9]
    16008 [Prefix-SID, 10.1.1.8]
Attributes:
  Binding SID: 24036
  Forward Class: 0
  Steering BGP disabled: no
  IPv6 caps enable: yes
```

Verifying SR Policy Forwarding

Use the `show segment-routing traffic-eng forwarding policy` command to display the SR policy forwarding information.

The following outputs show the forwarding details for an on-demand SR policy that was triggered by prefixes with color 10 advertised by node 10.1.1.8.

```
RP/0/RP0/CPU0:R4# show segment-routing traffic-eng forwarding policy binding-sid 24036
tabular
```

Color	Endpoint	Segment List	Outgoing Label	Outgoing Interface	Next Hop	Bytes Switched	Pure Backup
10	10.1.1.8	dynamic	16009	Gi0/0/0/4	10.4.5.5	0	
			16001	Gi0/0/0/5	11.4.8.8	0	Yes

```
RP/0/RP0/CPU0:R4# show segment-routing traffic-eng forwarding policy binding-sid 24036
detail
Mon Jul  8 11:56:46.887 PST
```

```

SR-TE Policy Forwarding database
-----

Color: 10, End-point: 10.1.1.8
  Name: srte_c_10_ep_10.1.1.8
  Binding SID: 24036
  Segment Lists:
    SL[0]:
      Name: dynamic
      Paths:
        Path[0]:
          Outgoing Label: 16009
          Outgoing Interface: GigabitEthernet0/0/0/4
          Next Hop: 10.4.5.5
          Switched Packets/Bytes: 0/0
          FRR Pure Backup: No
          Label Stack (Top -> Bottom): { 16009, 16008 }
          Path-id: 1 (Protected), Backup-path-id: 2, Weight: 64
        Path[1]:
          Outgoing Label: 16001
          Outgoing Interface: GigabitEthernet0/0/0/5
          Next Hop: 11.4.8.8
          Switched Packets/Bytes: 0/0
          FRR Pure Backup: Yes
          Label Stack (Top -> Bottom): { 16001, 16009, 16008 }
          Path-id: 2 (Pure-Backup), Weight: 64
      Policy Packets/Bytes Switched: 0/0
      Local label: 80013

```

Configuring SR-ODN: EVPN Services Examples

Configuring BGP Color Extended Community Set: Example

The following example shows how to configure BGP color extended communities that are later applied to BGP service routes via route-policies.

```

extcommunity-set opaque color-44
  44
end-set

extcommunity-set opaque color-55
  55
end-set

extcommunity-set opaque color-77
  77
end-set

extcommunity-set opaque color-88
  88
end-set

```

Configuring RPL to Set BGP Color (EVPN Services): Examples

The following examples shows various representative RPL definitions that set BGP color community.

The following RPL examples match on EVPN route-types and then set the BGP color extended community.

```

route-policy sample-export-rpl
  if evpn-route-type is 1 then
    set extcommunity color color-44
  endif

```

```

    if evpn-route-type is 3 then
        set extcommunity color color-55
    endif
end-policy

route-policy sample-import-rpl
    if evpn-route-type is 1 then
        set extcommunity color color-77
    elseif evpn-route-type is 3 then
        set extcommunity color color-88
    else
        pass
    endif
end-policy

```

The following RPL example sets BGP color extended community while matching on the following:

- Route Distinguisher (RD)
- Ethernet Segment Identifier (ESI)
- Ethernet Tag (ETAG)
- EVPN route-types

```

route-policy sample-bgpneighbor-rpl
    if rd in (10.1.1.1:3504) then
        set extcommunity color color3504
    elseif rd in (10.1.1.1:3505) then
        set extcommunity color color3505
    elseif rd in (10.1.1.1:3506) then
        set extcommunity color color99996
    elseif esi in (0010.0000.0000.0000.1201) and rd in (10.1.1.1:3508) then
        set extcommunity color color3508
    elseif etag in (30509) and rd in (10.1.1.1:3509) then
        set extcommunity color color3509
    elseif etag in (0) and rd in (10.1.1.1:2001) and evpn-route-type is 1 then
        set extcommunity color color82001
    elseif etag in (0) and rd in (10.1.1.1:2001) and evpn-route-type is 3 then
        set extcommunity color color92001
    endif
    pass
end-policy

```

Applying RPL to BGP Services (EVPN Services): Example

The following examples show various RPLs that set BGP color community being applied to EVPN services.

The following 2 examples show the RPL applied at the EVI export and import attach-points.



Note RPLs applied under EVI import or export attach-point also support matching on the following:

- Ethernet Segment Identifier (ESI)
- Ethernet Tag (ETAG)
- EVPN-Originator

```

evpn
  evi 101

```

```

    bgp
      route-target 101:1
      route-target import 100:1
      route-target export 101:1
      route-policy import sample-import-rpl
    !
    advertise-mac
    !
    !
  evi 102
    bgp
      route-target 102:1
      route-target import 100:2
      route-target export 102:1
      route-policy export sample-export-rpl
    !
    advertise-mac
    !
    !
  !

```

The following example shows the RPL applied at the BGP neighbor-out attach-point.



Note RPLs defined under BGP neighbor-out attach-point also support matching on the following:

- EVPN-Originator
-

```

router bgp 100
  bgp router-id 10.1.1.1
  address-family l2vpn evpn
  !
  neighbor-group evpn-rr
  remote-as 100
  update-source Loopback0
  address-family l2vpn evpn
  !
  neighbor 10.10.10.10
    use neighbor-group evpn-rr
    address-family l2vpn evpn
    route-policy sample-bgpneighbor-rpl out

```

Configuring SR-ODN for EVPN-VPWS: Use Case

This use case shows how to set up a pair of ELINE services using EVPN-VPWS between two sites. Services are carried over SR policies that must not share any common links along their paths (link-disjoint). The SR policies are triggered on-demand based on ODN principles. An SR-PCE computes the disjoint paths.

This use case uses the following topology with 2 sites: Site 1 with nodes A and B, and Site 2 with nodes C and D.

Figure 1: Topology for Use Case: SR-ODN for EVPN-VPWS

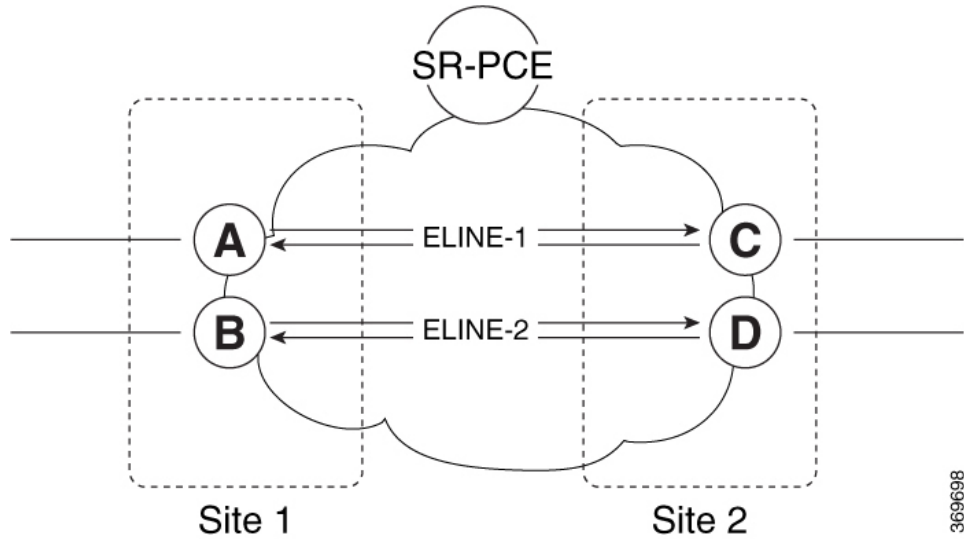

Table 3: Use Case Parameters

IP Addresses of Loopback0 (Lo0) Interfaces	SR-PCE Lo0: 10.1.1.207	
	Site 1: <ul style="list-style-type: none"> • Node A Lo0: 10.1.1.5 • Node B Lo0: 10.1.1.6 	Site 2: <ul style="list-style-type: none"> • Node C Lo0: 10.1.1.2 • Node D Lo0: 10.1.1.4
EVPN-VPWS Service Parameters	ELINE-1: <ul style="list-style-type: none"> • EVPN-VPWS EVI 100 • Node A: AC-ID = 11 • Node C: AC-ID = 21 	ELINE-2: <ul style="list-style-type: none"> • EVPN-VPWS EVI 101 • Node B: AC-ID = 12 • Node D: AC-ID = 22
ODN BGP Color Extended Communities	Site 1 routers (Nodes A and B): <ul style="list-style-type: none"> • set color 10000 • match color 11000 	Site 2 routers (Nodes C and D): <ul style="list-style-type: none"> • set color 11000 • match color 10000
Note These colors are associated with the EVPN route-type 1 routes of the EVPN-VPWS services.		
PCEP LSP Disjoint-Path Association Group ID	Site 1 to Site 2 LSPs (from Node A to Node C/from Node B to Node D): <ul style="list-style-type: none"> • group-id = 775 	Site 2 to Site 1 LSPs (from Node C to Node A/from Node D to Node B): <ul style="list-style-type: none"> • group-id = 776

The use case provides configuration and verification outputs for all devices.

Configuration	Verification
Configuration: SR-PCE, on page 22	Verification: SR-PCE, on page 26
Configuration: Site 1 Node A, on page 22	Verification: Site 1 Node A, on page 30
Configuration: Site 1 Node B, on page 23	Verification: Site 1 Node B, on page 33
Configuration: Site 2 Node C, on page 24	Verification: Site 2 Node C, on page 36
Configuration: Site 2 Node D, on page 25	Verification: Site 2 Node D, on page 38

Configuration: SR-PCE

For cases when PCC nodes support, or signal, PCEP association-group object to indicate the pair of LSPs in a disjoint set, there is no extra configuration required at the SR-PCE to trigger disjoint-path computation.



Note SR-PCE also supports disjoint-path computation for cases when PCC nodes do not support PCEP association-group object. See [Configure the Disjoint Policy \(Optional\)](#) for more information.

Configuration: Site 1 Node A

This section depicts relevant configuration of Node A at Site 1. It includes service configuration, BGP color extended community, and RPL. It also includes the corresponding ODN template required to achieve the disjointness SLA.

Nodes in Site 1 are configured to set color 10000 on originating EVPN routes, while matching color 11000 on incoming EVPN routes from routers located at Site 2.

Since both nodes in Site 1 request path computation from SR-PCE using the same disjoint-path group-id (775), the PCE will attempt to compute disjointness for the pair of LSPs originating from Site 1 toward Site 2.

```
/* EVPN-VPWS configuration */

interface GigabitEthernet0/0/0/3.2500 l2transport
 encapsulation dot1q 2500
 rewrite ingress tag pop 1 symmetric
!
l2vpn
 xconnect group evpn_vpws_group
  p2p evpn_vpws_100
   interface GigabitEthernet0/0/0/3.2500
    neighbor evpn evi 100 target 21 source 11
   !
  !
 !
!

/* BGP color community and RPL configuration */

extcommunity-set opaque color-10000
 10000
end-set
!
route-policy SET_COLOR_EVPN_VPWS
```

```

    if evpn-route-type is 1 and rd in (ios-regex '.*..*..*..*:(100)') then
        set extcommunity color color-10000
    endif
    pass
end-policy
!
router bgp 65000
neighbor 10.1.1.253
    address-family l2vpn evpn
        route-policy SET_COLOR_EVPN_VPWS out
    !
!
!

/* ODN template configuration */

segment-routing
traffic-eng
    on-demand color 11000
dynamic
    pcep
    !
    metric
        type igp
    !
    disjoint-path group-id 775 type link
    !
!
!
!
```

Configuration: Site 1 Node B

This section depicts relevant configuration of Node B at Site 1.

```

/* EVPN-VPWS configuration */

interface TenGigE0/3/0/0/8.2500 l2transport
encapsulation dot1q 2500
rewrite ingress tag pop 1 symmetric
!
l2vpn
xconnect group evpn_vpws_group
p2p evpn_vpws_101
interface TenGigE0/3/0/0/8.2500
    neighbor evpn evi 101 target 22 source 12
    !
!
!
!

/* BGP color community and RPL configuration */

extcommunity-set opaque color-10000
    10000
end-set
!
route-policy SET_COLOR_EVPN_VPWS
    if evpn-route-type is 1 and rd in (ios-regex '.*..*..*..*:(101)') then
        set extcommunity color color-10000
    endif
    pass
end-policy
!
```

```

router bgp 65000
 neighbor 10.1.1.253
   address-family l2vpn evpn
     route-policy SET_COLOR_EVPN_VPWS out
   !
 !
 !

/* ODN template configuration */

segment-routing
 traffic-eng
   on-demand color 11000
   dynamic
     pcep
     !
     metric
       type igp
     !
     disjoint-path group-id 775 type link
   !
 !
 !
 !

```

Configuration: Site 2 Node C

This section depicts relevant configuration of Node C at Site 2. It includes service configuration, BGP color extended community, and RPL. It also includes the corresponding ODN template required to achieve the disjointness SLA.

Nodes in Site 2 are configured to set color 11000 on originating EVPN routes, while matching color 10000 on incoming EVPN routes from routers located at Site 1.

Since both nodes on Site 2 request path computation from SR-PCE using the same disjoint-path group-id (776), the PCE will attempt to compute disjointness for the pair of LSPs originating from Site 2 toward Site 1.

```

/* EVPN-VPWS configuration */

interface GigabitEthernet0/0/0/3.2500 l2transport
 encapsulation dot1q 2500
 rewrite ingress tag pop 1 symmetric
 !
 l2vpn
 xconnect group evpn_vpws_group
 p2p evpn_vpws_100
   interface GigabitEthernet0/0/0/3.2500
     neighbor evpn evi 100 target 11 source 21
   !
 !
 !
 !

/* BGP color community and RPL configuration */

extcommunity-set opaque color-11000
 11000
end-set
!
route-policy SET_COLOR_EVPN_VPWS
 if evpn-route-type is 1 and rd in (ios-regex '.*...*: (100)') then
   set extcommunity color color-11000

```



```

endif
pass
end-policy
!
router bgp 65000
neighbor 10.1.1.253
address-family l2vpn evpn
route-policy SET_COLOR_EVPN_VPWS out
!
!
!

/* ODN template configuration */

```

```

segment-routing
traffic-eng
on-demand color 10000
dynamic
pcep
!
metric
type igp
!
disjoint-path group-id 776 type link
!
!
!
!

```

Configuration: Site 2 Node D

This section depicts relevant configuration of Node D at Site 2.

```

/* EVPN-VPWS configuration */

interface GigabitEthernet0/0/0/1.2500 l2transport
encapsulation dot1q 2500
rewrite ingress tag pop 1 symmetric
!
l2vpn
xconnect group evpn_vpws_group
p2p evpn_vpws_101
interface GigabitEthernet0/0/0/1.2500
neighbor evpn evi 101 target 12 source 22
!
!
!

/* BGP color community and RPL configuration */

extcommunity-set opaque color-11000
11000
end-set
!
route-policy SET_COLOR_EVPN_VPWS
if evpn-route-type is 1 and rd in (ios-regex '.*...*.*(101)') then
set extcommunity color color-11000
endif
pass
end-policy
!
router bgp 65000
neighbor 10.1.1.253

```

```

address-family l2vpn evpn
  route-policy SET_COLOR_EVPN_VPWS out
!
!
!

/* ODN template configuration */

segment-routing
traffic-eng
  on-demand color 10000
  dynamic
  pcep
  !
  metric
  type igp
  !
  disjoint-path group-id 776 type link
  !
!
!
!

```

Verification: SR-PCE

Use the **show pce ipv4 peer** command to display the SR-PCE's PCEP peers and session status. SR-PCE performs path computation for the 4 nodes depicted in the use-case.

```

RP/0/0/CPU0:SR-PCE# show pce ipv4 peer
Mon Jul 15 19:41:43.622 UTC

PCE's peer database:
-----
Peer address: 10.1.1.2
  State: Up
  Capabilities: Stateful, Segment-Routing, Update, Instantiation

Peer address: 10.1.1.4
  State: Up
  Capabilities: Stateful, Segment-Routing, Update, Instantiation

Peer address: 10.1.1.5
  State: Up
  Capabilities: Stateful, Segment-Routing, Update, Instantiation

Peer address: 10.1.1.6
  State: Up
  Capabilities: Stateful, Segment-Routing, Update, Instantiation

```

Use the **show pce association group-id** command to display information for the pair of LSPs assigned to a given association group-id value.

Based on the goals of this use case, SR-PCE computes link-disjoint paths for the SR policies associated with a pair of ELINE services between site 1 and site 2. In particular, disjoint LSPs from site 1 to site 2 are identified by association group-id 775. The output includes high-level information for LSPs associated to this group-id:

- At Node A (10.1.1.5): LSP symbolic name = bgp_c_11000_ep_10.1.1.2_discr_100
- At Node B (10.1.1.6): LSP symbolic name = bgp_c_11000_ep_10.1.1.4_discr_100

In this case, the SR-PCE was able to achieve the desired disjointness level; therefore the Status is shown as "Satisfied".

```
RP/0/0/CPU0:SR-PCE# show pce association group-id 775
Thu Jul 11 03:52:20.770 UTC
```

```
PCE's association database:
```

```
-----
Association: Type Link-Disjoint, Group 775, Not Strict
```

```
Associated LSPs:
```

```
LSP[0]:
```

```
PCC 10.1.1.6, tunnel name bgp_c_11000_ep_10.1.1.4_discr_100, PLSP ID 18, tunnel ID 17,
LSP ID 3, Configured on PCC
```

```
LSP[1]:
```

```
PCC 10.1.1.5, tunnel name bgp_c_11000_ep_10.1.1.2_discr_100, PLSP ID 18, tunnel ID 18,
LSP ID 3, Configured on PCC
```

```
Status: Satisfied
```

Use the **show pce lsp** command to display detailed information of an LSP present in the PCE's LSP database. This output shows details for the LSP at Node A (10.1.1.5) that is used to carry traffic of EVPN VPWS EVI 100 towards node C (10.1.1.2).

```
RP/0/0/CPU0:SR-PCE# show pce lsp pcc ipv4 10.1.1.5 name bgp_c_11000_ep_10.1.1.2_discr_100
Thu Jul 11 03:58:45.903 UTC
```

```
PCE's tunnel database:
```

```
-----
PCC 10.1.1.5:
```

```
Tunnel Name: bgp_c_11000_ep_10.1.1.2_discr_100
```

```
Color: 11000
```

```
Interface Name: srte_c_11000_ep_10.1.1.2
```

```
LSPs:
```

```
LSP[0]:
```

```
source 10.1.1.5, destination 10.1.1.2, tunnel ID 18, LSP ID 3
```

```
State: Admin up, Operation up
```

```
Setup type: Segment Routing
```

```
Binding SID: 80037
```

```
Maximum SID Depth: 10
```

```
Absolute Metric Margin: 0
```

```
Relative Metric Margin: 0%
```

```
Preference: 100
```

```
Bandwidth: signaled 0 kbps, applied 0 kbps
```

```
PCEP information:
```

```
PLSP-ID 0x12, flags: D:1 S:0 R:0 A:1 O:1 C:0
```

```
LSP Role: Exclude LSP
```

```
State-sync PCE: None
```

```
PCC: 10.1.1.5
```

```
LSP is subdelegated to: None
```

```
Reported path:
```

```
Metric type: IGP, Accumulated Metric 40
```

```
SID[0]: Adj, Label 80003, Address: local 11.5.8.5 remote 11.5.8.8
```

```
SID[1]: Node, Label 16007, Address 10.1.1.7
```

```
SID[2]: Node, Label 16002, Address 10.1.1.2
```

```
Computed path: (Local PCE)
```

```
Computed Time: Thu Jul 11 03:49:48 UTC 2019 (00:08:58 ago)
```

```
Metric type: IGP, Accumulated Metric 40
```

```
SID[0]: Adj, Label 80003, Address: local 11.5.8.5 remote 11.5.8.8
```

```
SID[1]: Node, Label 16007, Address 10.1.1.7
```

```
SID[2]: Node, Label 16002, Address 10.1.1.2
```

```
Recorded path:
```

```
None
```

```
Disjoint Group Information:
```

```
Type Link-Disjoint, Group 775
```

This output shows details for the LSP at Node B (10.1.1.6) that is used to carry traffic of EVPN VPWS EVI 101 towards node D (10.1.1.4).

```
RP/0/0/CPU0:SR-PCE# show pce lsp pcc ipv4 10.1.1.6 name bgp_c_11000_ep_10.1.1.4_discr_100
Thu Jul 11 03:58:56.812 UTC
```

```
PCE's tunnel database:
```

```
-----
PCC 10.1.1.6:
```

```
Tunnel Name: bgp_c_11000_ep_10.1.1.4_discr_100
```

```
Color: 11000
```

```
Interface Name: srte_c_11000_ep_10.1.1.4
```

```
LSPs:
```

```
LSP[0]:
```

```
source 10.1.1.6, destination 10.1.1.4, tunnel ID 17, LSP ID 3
```

```
State: Admin up, Operation up
```

```
Setup type: Segment Routing
```

```
Binding SID: 80061
```

```
Maximum SID Depth: 10
```

```
Absolute Metric Margin: 0
```

```
Relative Metric Margin: 0%
```

```
Preference: 100
```

```
Bandwidth: signaled 0 kbps, applied 0 kbps
```

```
PCEP information:
```

```
PLSP-ID 0x12, flags: D:1 S:0 R:0 A:1 O:1 C:0
```

```
LSP Role: Disjoint LSP
```

```
State-sync PCE: None
```

```
PCC: 10.1.1.6
```

```
LSP is subdelegated to: None
```

```
Reported path:
```

```
Metric type: IGP, Accumulated Metric 40
```

```
SID[0]: Node, Label 16001, Address 10.1.1.1
```

```
SID[1]: Node, Label 16004, Address 10.1.1.4
```

```
Computed path: (Local PCE)
```

```
Computed Time: Thu Jul 11 03:49:48 UTC 2019 (00:09:08 ago)
```

```
Metric type: IGP, Accumulated Metric 40
```

```
SID[0]: Node, Label 16001, Address 10.1.1.1
```

```
SID[1]: Node, Label 16004, Address 10.1.1.4
```

```
Recorded path:
```

```
None
```

```
Disjoint Group Information:
```

```
Type Link-Disjoint, Group 775
```

Based on the goals of this use case, SR-PCE computes link-disjoint paths for the SR policies associated with a pair of ELINE services between site 1 and site 2. In particular, disjoint LSPs from site 2 to site 1 are identified by association group-id 776. The output includes high-level information for LSPs associated to this group-id:

- At Node C (10.1.1.2): LSP symbolic name = bgp_c_10000_ep_10.1.1.5_discr_100
- At Node D (10.1.1.4): LSP symbolic name = bgp_c_10000_ep_10.1.1.6_discr_100

In this case, the SR-PCE was able to achieve the desired disjointness level; therefore, the Status is shown as "Satisfied".

```
RP/0/0/CPU0:SR-PCE# show pce association group-id 776
```

```
Thu Jul 11 03:52:24.370 UTC
```

```
PCE's association database:
```

```
-----
Association: Type Link-Disjoint, Group 776, Not Strict
```

```
Associated LSPs:
```

```
LSP[0]:
```

```
PCC 10.1.1.4, tunnel name bgp_c_10000_ep_10.1.1.6_discr_100, PLSP ID 16, tunnel ID 14,
```

```
LSP ID 1, Configured on PCC
```

```
LSP[1]:
```

PCC 10.1.1.2, tunnel name **bgp_c_10000_ep_10.1.1.5_discr_100**, PLSP ID 6, tunnel ID 21, LSP ID 3, Configured on PCC
Status: Satisfied

Use the **show pce lsp** command to display detailed information of an LSP present in the PCE's LSP database. This output shows details for the LSP at Node C (10.1.1.2) that is used to carry traffic of EVPN VPWS EVI 100 towards node A (10.1.1.5).

```
RP/0/0/CPU0:SR-PCE# show pce lsp pcc ipv4 10.1.1.2 name bgp_c_10000_ep_10.1.1.5_discr_100
Thu Jul 11 03:55:21.706 UTC
```

PCE's tunnel database:

PCC 10.1.1.2:

Tunnel Name: **bgp_c_10000_ep_10.1.1.5_discr_100**

Color: 10000

Interface Name: srte_c_10000_ep_10.1.1.5

LSPs:

LSP[0]:

source 10.1.1.2, destination 10.1.1.5, tunnel ID 21, LSP ID 3

State: Admin up, Operation up

Setup type: Segment Routing

Binding SID: 80052

Maximum SID Depth: 10

Absolute Metric Margin: 0

Relative Metric Margin: 0%

Preference: 100

Bandwidth: signaled 0 kbps, applied 0 kbps

PCEP information:

PLSP-ID 0x6, flags: D:1 S:0 R:0 A:1 O:1 C:0

LSP Role: Exclude LSP

State-sync PCE: None

PCC: 10.1.1.2

LSP is subdelegated to: None

Reported path:

Metric type: IGP, Accumulated Metric 40

SID[0]: Node, Label 16007, Address 10.1.1.7

SID[1]: Node, Label 16008, Address 10.1.1.8

SID[2]: Adj, Label 80005, Address: local 11.5.8.8 remote 11.5.8.5

Computed path: (Local PCE)

Computed Time: Thu Jul 11 03:50:03 UTC 2019 (00:05:18 ago)

Metric type: IGP, Accumulated Metric 40

SID[0]: Node, Label 16007, Address 10.1.1.7

SID[1]: Node, Label 16008, Address 10.1.1.8

SID[2]: Adj, Label 80005, Address: local 11.5.8.8 remote 11.5.8.5

Recorded path:

None

Disjoint Group Information:

Type Link-Disjoint, Group 776

This output shows details for the LSP at Node D (10.1.1.4) used to carry traffic of EVPN VPWS EVI 101 towards node B (10.1.1.6).

```
RP/0/0/CPU0:SR-PCE# show pce lsp pcc ipv4 10.1.1.4 name bgp_c_10000_ep_10.1.1.6_discr_100
Thu Jul 11 03:55:23.296 UTC
```

PCE's tunnel database:

PCC 10.1.1.4:

Tunnel Name: **bgp_c_10000_ep_10.1.1.6_discr_100**

Color: 10000

Interface Name: srte_c_10000_ep_10.1.1.6

```

LSPs:
LSP[0]:
  source 10.1.1.4, destination 10.1.1.6, tunnel ID 14, LSP ID 1
  State: Admin up, Operation up
  Setup type: Segment Routing
  Binding SID: 80047
  Maximum SID Depth: 10
  Absolute Metric Margin: 0
  Relative Metric Margin: 0%
  Preference: 100
  Bandwidth: signaled 0 kbps, applied 0 kbps
  PCEP information:
    PLSP-ID 0x10, flags: D:1 S:0 R:0 A:1 O:1 C:0
  LSP Role: Disjoint LSP
  State-sync PCE: None
  PCC: 10.1.1.4
  LSP is subdelegated to: None
  Reported path:
    Metric type: IGP, Accumulated Metric 40
    SID[0]: Node, Label 16001, Address 10.1.1.1
    SID[1]: Node, Label 16006, Address 10.1.1.6
  Computed path: (Local PCE)
    Computed Time: Thu Jul 11 03:50:03 UTC 2019 (00:05:20 ago)
    Metric type: IGP, Accumulated Metric 40
    SID[0]: Node, Label 16001, Address 10.1.1.1
    SID[1]: Node, Label 16006, Address 10.1.1.6
  Recorded path:
    None
  Disjoint Group Information:
    Type Link-Disjoint, Group 776

```

Verification: Site 1 Node A

This section depicts verification steps at Node A.

Use the **show bgp l2vpn evpn** command to display BGP prefix information for EVPN-VPWS EVI 100 (rd 10.1.1.5:100). The output includes an EVPN route-type 1 route with color 11000 originated at Node C (10.1.1.2).

```

RP/0/RSP0/CPU0:Node-A# show bgp l2vpn evpn rd 10.1.1.5:100
Wed Jul 10 18:57:57.704 PST
BGP router identifier 10.1.1.5, local AS number 65000
BGP generic scan interval 60 secs
Non-stop routing is enabled
BGP table state: Active
Table ID: 0x0 RD version: 0
BGP main routing table version 360
BGP NSR Initial initsync version 1 (Reached)
BGP NSR/ISSU Sync-Group versions 0/0
BGP scan interval 60 secs

Status codes: s suppressed, d damped, h history, * valid, > best
               i - internal, r RIB-failure, S stale, N Nexthop-discard
Origin codes: i - IGP, e - EGP, ? - incomplete
   Network          Next Hop          Metric LocPrf Weight Path
Route Distinguisher: 10.1.1.5:100 (default for vrf VPWS:100)
*> [1][0000.0000.0000.0000.0000][11]/120
      0.0.0.0                                0 i
*>i [1][0000.0000.0000.0000.0000][21]/120
      10.1.1.2 C:11000                        100      0 i

```

The following output displays the details for the incoming EVPN RT1. Note the presence of BGP extended color community 11000, and that the prefix is associated with an SR policy with color 11000 and BSID value of 80044.

```
RP/0/RSP0/CPU0:Node-A# show bgp l2vpn evpn rd 10.1.1.5:100
[1] [0000.0000.0000.0000.0000][21]/120
Wed Jul 10 18:57:58.107 PST
BGP routing table entry for [1][0000.0000.0000.0000.0000][21]/120, Route Distinguisher:
10.1.1.5:100
Versions:
  Process          bRIB/RIB  SendTblVer
  Speaker          360       360
Last Modified: Jul 10 18:36:18.369 for 00:21:40
Paths: (1 available, best #1)
  Not advertised to any peer
  Path #1: Received by speaker 0
  Not advertised to any peer
  Local
    10.1.1.2 C:11000 (bsid:80044) (metric 40) from 10.1.1.253 (10.1.1.2)
      Received Label 80056
      Origin IGP, localpref 100, valid, internal, best, group-best, import-candidate,
imported, rib-install
      Received Path ID 0, Local Path ID 1, version 358
      Extended community: Color:11000 RT:65000:100
      Originator: 10.1.1.2, Cluster list: 10.1.1.253
      SR policy color 11000, up, registered, bsid 80044, if-handle 0x00001b20

      Source AFI: L2VPN EVPN, Source VRF: default, Source Route Distinguisher: 10.1.1.2:100
```

Use the **show l2vpn xconnect** command to display the state associated with EVPN-VPWS EVI 100 service.

```
RP/0/RSP0/CPU0:Node-A# show l2vpn xconnect group evpn_vpws_group
Wed Jul 10 18:58:02.333 PST
Legend: ST = State, UP = Up, DN = Down, AD = Admin Down, UR = Unresolved,
       SB = Standby, SR = Standby Ready, (PP) = Partially Programmed

XConnect          Segment 1          Segment 2
Group  Name      ST  Description      ST  Description      ST
-----
evpn_vpws_group
      evpn_vpws_100
      UP  Gi0/0/0/3.2500  UP  EVPN 100,21,10.1.1.2  UP
-----
```

The following output shows the details for the service. Note that the service is associated with the on-demand SR policy with color 11000 and end-point 10.1.1.2 (node C).

```
RP/0/RSP0/CPU0:Node-A# show l2vpn xconnect group evpn_vpws_group xc-name evpn_vpws_100
detail
Wed Jul 10 18:58:02.755 PST

Group evpn_vpws_group, XC evpn_vpws_100, state is up; Interworking none
AC: GigabitEthernet0/0/0/3.2500, state is up
Type VLAN; Num Ranges: 1
Rewrite Tags: []
VLAN ranges: [2500, 2500]
MTU 1500; XC ID 0x120000c; interworking none
Statistics:
  packets: received 0, sent 0
  bytes: received 0, sent 0
  drops: illegal VLAN 0, illegal length 0
```

```

EVPN: neighbor 10.1.1.2, PW ID: evi 100, ac-id 21, state is up ( established )
XC ID Oxa0000007
Encapsulation MPLS
Source address 10.1.1.5
Encap type Ethernet, control word enabled
Sequencing not set
Preferred path Active : SR TE srte_c_11000_ep_10.1.1.2, On-Demand, fallback enabled
Tunnel : Up
Load Balance Hashing: src-dst-mac

```

EVPN	Local	Remote
Label	80040	80056
MTU	1500	1500
Control word	enabled	enabled
AC ID	11	21
EVPN type	Ethernet	Ethernet

```

-----
Create time: 10/07/2019 18:31:30 (1d17h ago)
Last time status changed: 10/07/2019 19:42:00 (1d16h ago)
Last time PW went down: 10/07/2019 19:40:55 (1d16h ago)
Statistics:
  packets: received 0, sent 0
  bytes: received 0, sent 0

```

Use the **show segment-routing traffic-eng policy** command with **tabular** option to display SR policy summary information.

The following output shows the on-demand SR policy with BSID 80044 that was triggered by EVPN RT1 prefix with color 11000 advertised by node C (10.1.1.2).

```

RP/0/RSP0/CPU0:Node-A# show segment-routing traffic-eng policy color 11000 tabular
Wed Jul 10 18:58:00.732 PST

```

Color	Endpoint	Admin State	Oper State	Binding SID
11000	10.1.1.2	up	up	80044

The following output shows the details for the on-demand SR policy. Note that the SR policy's active candidate path (preference 100) is computed by SR-PCE (10.1.1.207).

Based on the goals of this use case, SR-PCE computes link-disjoint paths for the SR policies associated with a pair of ELINE services between site 1 and site 2. Specifically, from site 1 to site 2, LSP at Node A (srte_c_11000_ep_10.1.1.2) is link-disjoint from LSP at Node B (srte_c_11000_ep_10.1.1.4).

```

RP/0/RSP0/CPU0:Node-A# show segment-routing traffic-eng policy color 11000
Wed Jul 10 19:15:47.217 PST

```

```

SR-TE policy database
-----

```

```

Color: 11000, End-point: 10.1.1.2
Name: srte_c_11000_ep_10.1.1.2
Status:
  Admin: up Operational: up for 00:39:31 (since Jul 10 18:36:00.471)
Candidate-paths:
  Preference: 200 (BGP ODN) (shutdown)
  Requested BSID: dynamic
  PCC info:
    Symbolic name: bgp_c_11000_ep_10.1.1.2_discr_200

```



```

    PLSP-ID: 19
    Dynamic (invalid)
Preference: 100 (BGP ODN) (active)
    Requested BSID: dynamic
    PCC info:
      Symbolic name: bgp_c_11000_ep_10.1.1.2_discr_100
      PLSP-ID: 18
    Dynamic (pce 10.1.1.207) (valid)
      Metric Type: IGP, Path Accumulated Metric: 40
      80003 [Adjacency-SID, 11.5.8.5 - 11.5.8.8]
      16007 [Prefix-SID, 10.1.1.7]
      16002 [Prefix-SID, 10.1.1.2]
  Attributes:
    Binding SID: 80044
    Forward Class: 0
    Steering BGP disabled: no
    IPv6 caps enable: yes

```

Verification: Site 1 Node B

This section depicts verification steps at Node B.

Use the **show bgp l2vpn evpn** command to display BGP prefix information for EVPN-VPWS EVI 101 (rd 10.1.1.6:101). The output includes an EVPN route-type 1 route with color 11000 originated at Node D (10.1.1.4).

```

RP/0/RSP0/CPU0:Node-B# show bgp l2vpn evpn rd 10.1.1.6:101
Wed Jul 10 19:08:54.964 PST
BGP router identifier 10.1.1.6, local AS number 65000
BGP generic scan interval 60 secs
Non-stop routing is enabled
BGP table state: Active
Table ID: 0x0 RD version: 0
BGP main routing table version 322
BGP NSR Initial initsync version 7 (Reached)
BGP NSR/ISSU Sync-Group versions 0/0
BGP scan interval 60 secs

Status codes: s suppressed, d damped, h history, * valid, > best
               i - internal, r RIB-failure, S stale, N Nexthop-discard
Origin codes: i - IGP, e - EGP, ? - incomplete
   Network          Next Hop          Metric LocPrf Weight Path
Route Distinguisher: 10.1.1.6:101 (default for vrf VPWS:101)
*> [1][0000.0000.0000.0000.0000][12]/120
           0.0.0.0                                0 i
*>i[1][0000.0000.0000.0000.0000][22]/120
           10.1.1.4 C:11000                        100    0 i

Processed 2 prefixes, 2 paths

```

The following output displays the details for the incoming EVPN RT1. Note the presence of BGP extended color community 11000, and that the prefix is associated with an SR policy with color 11000 and BSID value of 80061.

```

RP/0/RSP0/CPU0:Node-B# show bgp l2vpn evpn rd 10.1.1.6:101
[1][0000.0000.0000.0000.0000][22]/120
Wed Jul 10 19:08:55.039 PST
BGP routing table entry for [1][0000.0000.0000.0000.0000][22]/120, Route Distinguisher:
10.1.1.6:101
Versions:
  Process          bRIB/RIB  SendTblVer
  Speaker          322      322

```

```

Last Modified: Jul 10 18:42:10.408 for 00:26:44
Paths: (1 available, best #1)
  Not advertised to any peer
  Path #1: Received by speaker 0
  Not advertised to any peer
Local
  10.1.1.4 C:11000 (bsid:80061) (metric 40) from 10.1.1.253 (10.1.1.4)
    Received Label 80045
    Origin IGP, localpref 100, valid, internal, best, group-best, import-candidate,
imported, rib-install
    Received Path ID 0, Local Path ID 1, version 319
    Extended community: Color:11000 RT:65000:101
    Originator: 10.1.1.4, Cluster list: 10.1.1.253
    SR policy color 11000, up, registered, bsid 80061, if-handle 0x00000560

Source AFI: L2VPN EVPN, Source VRF: default, Source Route Distinguisher: 10.1.1.4:101

```

Use the **show l2vpn xconnect** command to display the state associated with EVPN-VPWS EVI 101 service.

```

RP/0/RSP0/CPU0:Node-B# show l2vpn xconnect group evpn_vpws_group
Wed Jul 10 19:08:56.388 PST
Legend: ST = State, UP = Up, DN = Down, AD = Admin Down, UR = Unresolved,
       SB = Standby, SR = Standby Ready, (PP) = Partially Programmed

```

XConnect Group	Name	ST	Segment 1 Description	ST	Segment 2 Description	ST
evpn_vpws_group	evpn_vpws_101	UP	TenGigE0/3/0/0/8.2500	UP	EVPN 101,22,10.1.1.4	UP

The following output shows the details for the service. Note that the service is associated with the on-demand SR policy with color 11000 and end-point 10.1.1.4 (node D).

```

RP/0/RSP0/CPU0:Node-B# show l2vpn xconnect group evpn_vpws_group xc-name evpn_vpws_101
Wed Jul 10 19:08:56.511 PST

```

```

Group evpn_vpws_group, XC evpn_vpws_101, state is up; Interworking none
AC: TenGigE0/3/0/0/8.2500, state is up
Type VLAN; Num Ranges: 1
Rewrite Tags: []
VLAN ranges: [2500, 2500]
MTU 1500; XC ID 0x2a0000e; interworking none
Statistics:
  packets: received 0, sent 0
  bytes: received 0, sent 0
  drops: illegal VLAN 0, illegal length 0
EVPN: neighbor 10.1.1.4, PW ID: evi 101, ac-id 22, state is up ( established )
XC ID 0xa0000009
Encapsulation MPLS
Source address 10.1.1.6
Encap type Ethernet, control word enabled
Sequencing not set
Preferred path Active : SR TE srte_c_11000_ep_10.1.1.4, On-Demand, fallback enabled
Tunnel : Up
Load Balance Hashing: src-dst-mac

```

EVPN	Local	Remote
Label	80060	80045
MTU	1500	1500

```

Control word enabled          enabled
AC ID          12             22
EVPN type     Ethernet       Ethernet

```

```

-----
Create time: 10/07/2019 18:32:49 (00:36:06 ago)
Last time status changed: 10/07/2019 18:42:07 (00:26:49 ago)
Statistics:
  packets: received 0, sent 0
  bytes: received 0, sent 0

```

Use the **show segment-routing traffic-eng policy** command with **tabular** option to display SR policy summary information.

The following output shows the on-demand SR policy with BSID 80061 that was triggered by EVPN RT1 prefix with color 11000 advertised by node D (10.1.1.4).

```

RP/0/RSP0/CPU0:Node-B# show segment-routing traffic-eng policy color 11000 tabular
Wed Jul 10 19:08:56.146 PST

```

Color	Endpoint	Admin State	Oper State	Binding SID
11000	10.1.1.4	up	up	80061

The following output shows the details for the on-demand SR policy. Note that the SR policy's active candidate path (preference 100) is computed by SR-PCE (10.1.1.207).

Based on the goals of this use case, SR-PCE computes link-disjoint paths for the SR policies associated with a pair of ELINE services between site 1 and site 2. Specifically, from site 1 to site 2, LSP at Node B (srte_c_11000_ep_10.1.1.4) is link-disjoint from LSP at Node A (srte_c_11000_ep_10.1.1.2).

```

RP/0/RSP0/CPU0:Node-B# show segment-routing traffic-eng policy color 11000
Wed Jul 10 19:08:56.207 PST

```

```

SR-TE policy database
-----

```

```

Color: 11000, End-point: 10.1.1.4
  Name: srte_c_11000_ep_10.1.1.4
  Status:
    Admin: up Operational: up for 00:26:47 (since Jul 10 18:40:05.868)
  Candidate-paths:
    Preference: 200 (BGP ODN) (shutdown)
      Requested BSID: dynamic
      PCC info:
        Symbolic name: bgp_c_11000_ep_10.1.1.4_discr_200
        PLSP-ID: 19
        Dynamic (invalid)
    Preference: 100 (BGP ODN) (active)
      Requested BSID: dynamic
      PCC info:
        Symbolic name: bgp_c_11000_ep_10.1.1.4_discr_100
        PLSP-ID: 18
        Dynamic (pce 10.1.1.207) (valid)
        Metric Type: IGP, Path Accumulated Metric: 40
        16001 [Prefix-SID, 10.1.1.1]
        16004 [Prefix-SID, 10.1.1.4]
  Attributes:
    Binding SID: 80061
    Forward Class: 0

```

```
Steering BGP disabled: no
IPv6 caps enable: yes
```

Verification: Site 2 Node C

This section depicts verification steps at Node C.

Use the **show bgp l2vpn evpn** command to display BGP prefix information for EVPN-VPWS EVI 100 (rd 10.1.1.2:100). The output includes an EVPN route-type 1 route with color 10000 originated at Node A (10.1.1.5).

```
RP/0/RSP0/CPU0:Node-C# show bgp l2vpn evpn rd 10.1.1.2:100
BGP router identifier 10.1.1.2, local AS number 65000
BGP generic scan interval 60 secs
Non-stop routing is enabled
BGP table state: Active
Table ID: 0x0 RD version: 0
BGP main routing table version 21
BGP NSR Initial initsync version 1 (Reached)
BGP NSR/ISSU Sync-Group versions 0/0
BGP scan interval 60 secs

Status codes: s suppressed, d damped, h history, * valid, > best
               i - internal, r RIB-failure, S stale, N Nexthop-discard
Origin codes: i - IGP, e - EGP, ? - incomplete
   Network        Next Hop        Metric LocPrf Weight Path
Route Distinguisher: 10.1.1.2:100 (default for vrf VPWS:100)
*>i [1] [0000.0000.0000.0000.0000] [11]/120
                10.1.1.5 C:10000                100      0 i
*> [1] [0000.0000.0000.0000.0000] [21]/120
                0.0.0.0                                0 i
```

The following output displays the details for the incoming EVPN RT1. Note the presence of BGP extended color community 10000, and that the prefix is associated with an SR policy with color 10000 and BSID value of 80058.

```
RP/0/RSP0/CPU0:Node-C# show bgp l2vpn evpn rd 10.1.1.2:100
[1] [0000.0000.0000.0000.0000] [11]/120
BGP routing table entry for [1] [0000.0000.0000.0000.0000] [11]/120, Route Distinguisher:
10.1.1.2:100
Versions:
  Process          bRIB/RIB  SendTblVer
  Speaker          20        20
Last Modified: Jul 10 18:36:20.503 for 00:45:21
Paths: (1 available, best #1)
  Not advertised to any peer
  Path #1: Received by speaker 0
  Not advertised to any peer
  Local
    10.1.1.5 C:10000 (bsid:80058) (metric 40) from 10.1.1.253 (10.1.1.5)
      Received Label 80040
      Origin IGP, localpref 100, valid, internal, best, group-best, import-candidate,
imported, rib-install
      Received Path ID 0, Local Path ID 1, version 18
      Extended community: Color:10000 RT:65000:100
      Originator: 10.1.1.5, Cluster list: 10.1.1.253
      SR policy color 10000, up, registered, bsid 80058, if-handle 0x000006a0

Source AFI: L2VPN EVPN, Source VRF: default, Source Route Distinguisher: 10.1.1.5:100
```

Use the **show l2vpn xconnect** command to display the state associated with EVPN-VPWS EVI 100 service.

```
RP/0/RSP0/CPU0:Node-C# show l2vpn xconnect group evpn_vpws_group
```

```
Legend: ST = State, UP = Up, DN = Down, AD = Admin Down, UR = Unresolved,
        SB = Standby, SR = Standby Ready, (PP) = Partially Programmed
```

XConnect Group	Name	ST	Segment 1 Description	ST	Segment 2 Description	ST
evpn_vpws_group	evpn_vpws_100	UP	Gi0/0/0/3.2500	UP	EVPN 100,11,10.1.1.5	UP

The following output shows the details for the service. Note that the service is associated with the on-demand SR policy with color 10000 and end-point 10.1.1.5 (node A).

```
RP/0/RSP0/CPU0:Node-C# show l2vpn xconnect group evpn_vpws_group xc-name evpn_vpws_100
```

```
Group evpn_vpws_group, XC evpn_vpws_100, state is up; Interworking none
```

```
AC: GigabitEthernet0/0/0/3.2500, state is up
```

```
Type VLAN; Num Ranges: 1
```

```
Rewrite Tags: []
```

```
VLAN ranges: [2500, 2500]
```

```
MTU 1500; XC ID 0x1200008; interworking none
```

```
Statistics:
```

```
  packets: received 0, sent 0
```

```
  bytes: received 0, sent 0
```

```
  drops: illegal VLAN 0, illegal length 0
```

```
EVPN: neighbor 10.1.1.5, PW ID: evi 100, ac-id 11, state is up ( established )
```

```
XC ID 0xa0000003
```

```
Encapsulation MPLS
```

```
Source address 10.1.1.2
```

```
Encap type Ethernet, control word enabled
```

```
Sequencing not set
```

```
Preferred path Active : SR TE srte_c_10000_ep_10.1.1.5, On-Demand, fallback enabled
```

```
Tunnel : Up
```

```
Load Balance Hashing: src-dst-mac
```

EVPN	Local	Remote
Label	80056	80040
MTU	1500	1500
Control word	enabled	enabled
AC ID	21	11
EVPN type	Ethernet	Ethernet

```
Create time: 10/07/2019 18:36:16 (1d19h ago)
```

```
Last time status changed: 10/07/2019 19:41:59 (1d18h ago)
```

```
Last time PW went down: 10/07/2019 19:40:54 (1d18h ago)
```

```
Statistics:
```

```
  packets: received 0, sent 0
```

```
  bytes: received 0, sent 0
```

Use the **show segment-routing traffic-eng policy** command with **tabular** option to display SR policy summary information.

The following output shows the on-demand SR policy with BSID 80058 that was triggered by EVPN RT1 prefix with color 10000 advertised by node A (10.1.1.5).

```
RP/0/RSP0/CPU0:Node-C# show segment-routing traffic-eng policy color 10000 tabular
```

Color	Endpoint	Admin State	Oper State	Binding SID
10000	10.1.1.5	up	up	80058

The following output shows the details for the on-demand SR policy. Note that the SR policy's active candidate path (preference 100) is computed by SR-PCE (10.1.1.207).

Based on the goals of this use case, SR-PCE computes link-disjoint paths for the SR policies associated with a pair of ELINE services between site 1 and site 2. Specifically, from site 2 to site 1, LSP at Node C (srte_c_10000_ep_10.1.1.5) is link-disjoint from LSP at Node D (srte_c_10000_ep_10.1.1.6).

```
RP/0/RSP0/CPU0:Node-C# show segment-routing traffic-eng policy color 10000
```

```
SR-TE policy database
```

```
-----
Color: 10000, End-point: 10.1.1.5
Name: srte_c_10000_ep_10.1.1.5
Status:
  Admin: up Operational: up for 00:12:35 (since Jul 10 19:49:21.890)
Candidate-paths:
  Preference: 200 (BGP ODN) (shutdown)
    Requested BSID: dynamic
    PCC info:
      Symbolic name: bgp_c_10000_ep_10.1.1.5_discr_200
      PLSP-ID: 7
    Dynamic (invalid)
  Preference: 100 (BGP ODN) (active)
    Requested BSID: dynamic
    PCC info:
      Symbolic name: bgp_c_10000_ep_10.1.1.5_discr_100
      PLSP-ID: 6
  Dynamic (pce 10.1.1.207) (valid)
    Metric Type: IGP, Path Accumulated Metric: 40
      16007 [Prefix-SID, 10.1.1.7]
      16008 [Prefix-SID, 10.1.1.8]
      80005 [Adjacency-SID, 11.5.8.8 - 11.5.8.5]
Attributes:
  Binding SID: 80058
  Forward Class: 0
  Steering BGP disabled: no
  IPv6 caps enable: yes
```

Verification: Site 2 Node D

This section depicts verification steps at Node D.

Use the **show bgp l2vpn evpn** command to display BGP prefix information for EVPN-VPWS EVI 101 (rd 10.1.1.4:101). The output includes an EVPN route-type 1 route with color 10000 originated at Node B (10.1.1.6).

```
RP/0/RSP0/CPU0:Node-D# show bgp l2vpn evpn rd 10.1.1.4:101
BGP router identifier 10.1.1.4, local AS number 65000
BGP generic scan interval 60 secs
Non-stop routing is enabled
BGP table state: Active
Table ID: 0x0 RD version: 0
BGP main routing table version 570
BGP NSR Initial initsync version 1 (Reached)
BGP NSR/ISSU Sync-Group versions 0/0
BGP scan interval 60 secs
```

```
Status codes: s suppressed, d damped, h history, * valid, > best
               i - internal, r RIB-failure, S stale, N Nexthop-discard
Origin codes: i - IGP, e - EGP, ? - incomplete
   Network           Next Hop           Metric LocPrf Weight Path
Route Distinguisher: 10.1.1.4:101 (default for vrf VPWS:101)
*>i[1][0000.0000.0000.0000.0000][12]/120
                10.1.1.6 C:10000           100      0 i
*> [1][0000.0000.0000.0000.0000][22]/120
                0.0.0.0                       0 i

Processed 2 prefixes, 2 paths
```

The following output displays the details for the incoming EVPN RT1. Note the presence of BGP extended color community 10000, and that the prefix is associated with an SR policy with color 10000 and BSID value of 80047.

```
RP/0/RSP0/CPU0:Node-D# show bgp l2vpn evpn rd 10.1.1.4:101
[1][0000.0000.0000.0000.0000][12]/120
BGP routing table entry for [1][0000.0000.0000.0000.0000][12]/120, Route Distinguisher:
10.1.1.4:101
Versions:
  Process           bRIB/RIB   SendTblVer
  Speaker           569        569
Last Modified: Jul 10 18:42:12.455 for 00:45:38
Paths: (1 available, best #1)
  Not advertised to any peer
  Path #1: Received by speaker 0
  Not advertised to any peer
Local
  10.1.1.6 C:10000 (bsid:80047) (metric 40) from 10.1.1.253 (10.1.1.6)
  Received Label 80060
  Origin IGP, localpref 100, valid, internal, best, group-best, import-candidate,
imported, rib-install
  Received Path ID 0, Local Path ID 1, version 568
  Extended community: Color:10000 RT:65000:101
  Originator: 10.1.1.6, Cluster list: 10.1.1.253
  SR policy color 10000, up, registered, bsid 80047, if-handle 0x00001720

Source AFI: L2VPN EVPN, Source VRF: default, Source Route Distinguisher: 10.1.1.6:101
```

Use the `show l2vpn xconnect` command to display the state associated with EVPN-VPWS EVI 101 service.

```
RP/0/RSP0/CPU0:Node-D# show l2vpn xconnect group evpn_vpws_group
Legend: ST = State, UP = Up, DN = Down, AD = Admin Down, UR = Unresolved,
       SB = Standby, SR = Standby Ready, (PP) = Partially Programmed

XConnect
Group      Name      ST      Segment 1      ST      Segment 2      ST
-----
evpn_vpws_group
          evpn_vpws_101
          UP      Gi0/0/0/1.2500      UP      EVPN 101,12,10.1.1.6      UP
-----
```

The following output shows the details for the service. Note that the service is associated with the on-demand SR policy with color 10000 and end-point 10.1.1.6 (node B).

```
RP/0/RSP0/CPU0:Node-D# show l2vpn xconnect group evpn_vpws_group xc-name evpn_vpws_101
Group evpn_vpws_group, XC evpn_vpws_101, state is up; Interworking none
```

```

AC: GigabitEthernet0/0/0/1.2500, state is up
  Type VLAN; Num Ranges: 1
  Rewrite Tags: []
  VLAN ranges: [2500, 2500]
  MTU 1500; XC ID 0x120000c; interworking none
  Statistics:
    packets: received 0, sent 0
    bytes: received 0, sent 0
    drops: illegal VLAN 0, illegal length 0
EVPN: neighbor 10.1.1.6, PW ID: evi 101, ac-id 12, state is up ( established )
  XC ID 0xa000000d
  Encapsulation MPLS
  Source address 10.1.1.4
  Encap type Ethernet, control word enabled
  Sequencing not set
Preferred path Active : SR TE srte_c_10000_ep_10.1.1.6, On-Demand, fallback enabled
  Tunnel : Up
  Load Balance Hashing: src-dst-mac

```

EVPN	Local	Remote
Label	80045	80060
MTU	1500	1500
Control word	enabled	enabled
AC ID	22	12
EVPN type	Ethernet	Ethernet

```

-----
Create time: 10/07/2019 18:42:07 (00:45:49 ago)
Last time status changed: 10/07/2019 18:42:09 (00:45:47 ago)
Statistics:
  packets: received 0, sent 0
  bytes: received 0, sent 0

```

Use the **show segment-routing traffic-eng policy** command with **tabular** option to display SR policy summary information.

The following output shows the on-demand SR policy with BSID 80047 that was triggered by EVPN RT1 prefix with color 10000 advertised by node B (10.1.1.6).

```
RP/0/RSP0/CPU0:Node-D# show segment-routing traffic-eng policy color 10000 tabular
```

Color	Endpoint	Admin State	Oper State	Binding SID
10000	10.1.1.6	up	up	80047

The following output shows the details for the on-demand SR policy. Note that the SR policy's active candidate path (preference 100) is computed by SR-PCE (10.1.1.207).

Based on the goals of this use case, SR-PCE computes link-disjoint paths for the SR policies associated with a pair of ELINE services between site 1 and site 2. Specifically, from site 2 to site 1, LSP at Node D (srte_c_10000_ep_10.1.1.6) is link-disjoint from LSP at Node C (srte_c_10000_ep_10.1.1.5).

```
RP/0/RSP0/CPU0:Node-D# show segment-routing traffic-eng policy color 10000
```

```
SR-TE policy database
-----
```

```

Color: 10000, End-point: 10.1.1.6
  Name: srte_c_10000_ep_10.1.1.6
  Status:

```



```

Admin: up Operational: up for 01:23:04 (since Jul 10 18:42:07.350)
Candidate-paths:
  Preference: 200 (BGP ODN) (shutdown)
    Requested BSID: dynamic
    PCC info:
      Symbolic name: bgp_c_10000_ep_10.1.1.6_discr_200
      PLSP-ID: 17
      Dynamic (invalid)
  Preference: 100 (BGP ODN) (active)
    Requested BSID: dynamic
    PCC info:
      Symbolic name: bgp_c_10000_ep_10.1.1.6_discr_100
      PLSP-ID: 16
    Dynamic (pce 10.1.1.207) (valid)
      Metric Type: IGP, Path Accumulated Metric: 40
        16001 [Prefix-SID, 10.1.1.1]
        16006 [Prefix-SID, 10.1.1.6]
Attributes:
  Binding SID: 80047
  Forward Class: 0
  Steering BGP disabled: no
  IPv6 caps enable: yes

```

Manually Provisioned SR Policy

Manually provisioned SR policies are configured on the head-end router. These policies can use dynamic paths or explicit paths. See the [SR-TE Policy Path Types, on page 46](#) section for information on manually provisioning an SR policy using dynamic or explicit paths.

PCE-Initiated SR Policy

An SR-TE policy can be configured on the path computation element (PCE) to reduce link congestion or to minimize the number of network touch points.

The PCE collects network information, such as traffic demand and link utilization. When the PCE determines that a link is congested, it identifies one or more flows that are causing the congestion. The PCE finds a suitable path and deploys an SR-TE policy to divert those flows, without moving the congestion to another part of the network. When there is no more link congestion, the policy is removed.

To minimize the number of network touch points, an application, such as a Network Services Orchestrator (NSO), can request the PCE to create an SR-TE policy. PCE deploys the SR-TE policy using PCC-PCE communication protocol (PCEP).

For more information, see the [PCE-Initiated SR Policies](#) section.

Cumulative Metric Bounds (Delay-Bound Use-Case)

Table 4: Feature History Table

Feature Name	Release Information	Feature Description
Cumulative Metric Bounds (Delay-Bound use-case)	Release 7.3.1	With this feature, SRTE calculates a shortest path that satisfies multiple metric bounds. This feature provides flexibility for finding paths within metric bounds, for parameters such as latency, hop count, IGP and TE.

SRTE can calculate a shortest path with cumulative metric bounds. For example, consider these metric bounds:

- IGP metric ≤ 10
- TE metric ≤ 60
- Hop count ≤ 4
- Latency ≤ 55

When an SR policy is configured on a head-end node with these metric bounds, a path is finalized towards the specified destination only if it meets each of these criteria.

You can set the maximum number of attempts for computing a shortest path that satisfies the cumulative metric bounds criteria, by using the **kshortest-paths** command in SR-TE configuration mode.

Restrictions

- PCE-based cumulative metric bounds computations are not supported. You must use non-PCE (SR-TE topology) based configuration for path calculation, for cumulative bounds.
- If you use PCE dynamic computation configuration with cumulative bounds, the PCE computes a path and validates against cumulative bounds. If it is valid, then the policy is created with this path on PCC. If the initial path doesn't respect the bounds, then the path is not considered, and no further K-shortest path algorithm is executed to find the path.

Configuring SRTE Shortest Path Calculation For Cumulative Metric Bounds

You can enable this feature for SR, and ODN SR policy configurations, as shown below.

SR Policy

SR Policy - A policy called **fromAtoB_XTC** is created towards destination IP address 192.168.0.2. Also, the candidate-paths preference, and other attributes are enabled.

```
Router# configure terminal
Router(config)# segment-routing traffic-eng policy fromAtoB_XTC
Router(config-sr-te-policy)# color 2 end-point ipv4 192.168.0.2
Router(config-sr-te-policy)# candidate-paths preference 100
Router(config-sr-te-policy-path-pref)# dynamic metric type te
```

Cumulative Metric bounds – IGP, TE, hop count, and latency metric bounds are set. SRTE calculates paths only when each criterion is satisfied.

```
Router(config-sr-te-policy-path-pref)# constraints bounds cumulative
Router(config-sr-te-pref-const-bounds-type)# type igp 10
Router(config-sr-te-pref-const-bounds-type)# type te 60
Router(config-sr-te-pref-const-bounds-type)# type hopcount 4
Router(config-sr-te-pref-const-bounds-type)# type latency 55
Router(config-sr-te-pref-const-bounds-type)# commit
```

ODN SR Policy

SR ODN Policy – An SR ODN policy with color 1000 is created. Also, the candidate-paths value is on-demand.

```
Router# configure terminal
Router(config)# segment-routing traffic-eng
Router(config-sr-te)# on-demand color 1000 dynamic metric type te
Router(config-sr-te)# candidate-paths on-demand
Router(config-sr-te-candidate-path-type)# exit
Router(config-sr-te-candidate-path)# exit
```

Cumulative Metric bounds – IGP, TE, hop count, and latency metric bounds are set for the policy. SRTE calculates paths, only when each criterion is satisfied.

```
Router(config-sr-te)# on-demand color 1000 dynamic bounds cumulative
Router(config-sr-te-odc-bounds-type)# type igp 100
Router(config-sr-te-odc-bounds-type)# type te 60
Router(config-sr-te-odc-bounds-type)# type hopcount 6
Router(config-sr-te-odc-bounds-type)# type latency 1000
Router(config-sr-te-odc-bounds-type)# commit
```

To set the maximum number of attempts for computing paths that satisfy the cumulative metric bounds criteria, use the **kshortest-paths** command.

```
Router# configure terminal
Router(config)# segment-routing traffic-eng
Router(config-sr-te)# kshortest-paths 120
Router(config-sr-te)# commit
```

Verification

Use this command to view SR policy configuration details. Pointers:

- The **Number of K-shortest-paths** field displays 4. It means that the K-shortest path algorithm took 4 computations to find the right path. The 4 shortest paths that are computed using K-shortest path algorithm did not respect the cumulative bounds. The fifth shortest path is valid against the bounds.
- The values for the metrics of the actual path (**TE, IGP, Cumulative Latency** and **Hop count** values in the **Dynamic** section) are within the configured cumulative metric bounds.

```
Router# show segment-routing traffic-eng policy color 2

Color: 2, End-point: 192.168.0.2
Name: srte_c_2_ep_192.168.0.2
Status:
  Admin: up Operational: up for 3d02h (since Dec 15 12:13:21.993)

Candidate-paths:

Preference: 100 (configuration) (active)

Name: fromAtoB_XTC
Requested BSID: dynamic
Constraints:
  Protection Type: protected-preferred
Affinity:
```

```

exclude-any:
  red
Maximum SID Depth: 10
IGP Metric Bound: 10
TE Metric Bound: 60
Latency Metric Bound: 55
Hopcount Metric Bound: 4

Dynamic (valid)

Metric Type: TE, Path Accumulated Metric: 52
Number of K-shortest-paths: 4
TE Cumulative Metric: 52
IGP Cumulative Metric: 3
Cumulative Latency: 52
Hop count: 3
  16004 [Prefix-SID, 192.168.0.4]
  24003 [Adjacency-SID, 16.16.16.2 - 16.16.16.5]
  24001 [Adjacency-SID, 14.14.14.5 - 14.14.14.4]

Attributes:

Binding SID: 24011
Forward Class: Not Configured
Steering labeled-services disabled: no
Steering BGP disabled: no
IPv6 caps enable: yes
Invalidation drop enabled: no

```

SR-TE BGP Soft Next-Hop Validation For ODN Policies

Table 5: Feature History Table

Feature Name	Release Information	Feature Description
SR-TE BGP Soft Next-Hop Validation For ODN Policies	Release 7.3.2	<p>This feature addresses BGP Next-Hop reachability issues through BGP Next-Hop <i>soft</i> validation, and also enhances BGP best path selection.</p> <p>New commands:</p> <ul style="list-style-type: none"> • nexthop validation color-extcomm disable • nexthop validation color-extcomm sr-policy • bgp bestpath igp-metric sr-policy

Before a BGP router installs a route in the routing table, it checks its own reachability to the Next-Hop (NH) IP address of the route. In an SR-TE domain, a NH address may not be redistributed within the AS, or to a neighbor AS. So, BGP cannot reach the NH, and does not install the corresponding route into the routing table. The following workarounds are available, but they are tedious and might impact scalability:

1. Enable a non-default, static route to null0 covering the routes

2. Inject the routes into BGP using BGP-Labeled Unicast configuration
3. Redistribute routes between IGP domains

This feature introduces a more optimal design and solution - When you enable an SR policy on the SR-TE headend router, configure the `nexthop validation color-extcomm sr-policy` command in BGP configuration mode. It instructs BGP that, instead of NH reachability validation of BGP routes, the validation is done for SR policy-installed color NH addresses. When the NH address of such a route is reachable, the route is added to the routing table.

Also, this configuration on the ingress/headend PE router reduces the route scale for NH reachability, and service (VPN) routes automatically get NH reachability.

RR configuration – For intermediate router configuration, enable the RR with the `nexthop validation color-extcomm disable` command. When enabled, and L3VPN prefixes are associated with a color ID, BGP skips NH validation on the RR.

When the RR has no reachability to the color-extcomm NH, either enable this command, or use a legacy static route.

The following sequence occurs when the headend router receives L3VPN prefixes based on a color ID such as purple, green, etc.

1. The router checks/learns the local SR policy, or requests the ODN SR policy for color ID and NH
2. BGP does validation of the SR policy routes' NH addresses and applies the corresponding NH AD/metric. For a NH with a specific BGP-based color attribute, SR-PCE provides the AD/metric

With BGP NH reachability, traffic is transported smoothly

3. On the RR, BGP does not validate NH reachability

BGP Best Path Selection Based On SR Policy Effective Metric

BGP uses an algorithm to select the best path for installing the route in the RIB or for making a choice of which BGP path to propagate. At a certain point in the process, if there is IGP reachability to a BGP NH address, the algorithm chooses the path with the lowest IGP metric as the best path. The SR Policy path metric is not considered even if it has a better metric. This feature addresses the issue.

To ensure that BGP prefers the SR policy path metric over the IGP metric, enable `bgp bestpath igp-metric sr-policy` in BGP configuration mode.

Configurations

Configuring BGP Soft Next-Hop Validation (Headend Router)

```
Headend # configure
Headend (config) # router bgp 100
Headend (config-bgp) # nexthop validation color-extcomm sr-policy
Headend (config-bgp) # commit
Headend (config-bgp) # end
```

Configuring BGP Soft Next-Hop Validation (Route Reflector)

```
RR # configure
RR (config) # router bgp 100
RR (config-bgp) # nexthop validation color-extcomm disable
RR (config-bgp) # commit
RR (config-bgp) # end
```

Configuring BGP Best Path Selection Based on SR Policy Metric (Headend Router)

```
Headend # configure
Headend (config) # router bgp 100
Headend (config-bgp) # bgp bestpath igp-metric sr-policy
Headend (config-bgp) # commit
Headend (config-bgp) # end
```

Verification

Use this command to view BGP Soft Next-Hop Validation details.

```
Headend # show bgp process detail | i Nexthop
Use SR-Policy admin/metric of color-extcomm Nexthop during path comparison: enabled ExtComm
Color Nexthop validation: SR-Policy then RIB
```

Use this command to view BGP Best Path Selection Based on SR Policy Metric.

```
Headend # show bgp vrf VRF1002 ipv4 unicast 207.77.2.0

BGP routing table entry for 207.77.2.0/24, Route Distinguisher: 18522:1002 Versions:
Process bRIB/RIB SendTblVer
Speaker 5232243 5232243 Paths: (1 available, best #1)
Advertised to CE peers (in unique update groups): 10.11.2.11 101.15.2.2
Path #1: Received by speaker 0

Advertised to CE peers (in unique update groups): 10.11.2.11 101.15.2.2
16611 770
10.1.1.33 C:1129 (bsid:27163) (admin 20) (metric 25) from 10.1.1.100 (10.1.1.33)
Received Label 24007
Origin IGP, localpref 100, valid, internal, best, group-best, import-candidate, imported
Received Path ID 1, Local Path ID 1, version 5232243
Extended community: Color:1129 RT:17933:1002 RT:18522:1002
Originator: 10.1.1.33, Cluster list: 10.1.1.100
SR policy color 1129, up, registered, bsid 27163, if-handle 0x200053dc
Source AFI: VPNv4 Unicast, Source VRF: default, Source Route Distinguisher: 18522:3002
```

Details

- **10.1.1.33 C:1129** - BGP path is selected based on the SR policy with color ID C:1129
- If no SR policy is up, or if the SR policy metric is not configured, only the RIB metric is displayed
- **admin 20** and **metric 25** are SR policy references

SR-TE Policy Path Types

A **dynamic** path is based on an optimization objective and a set of constraints. The head-end computes a solution, resulting in a SID-list or a set of SID-lists. When the topology changes, a new path is computed. If the head-end does not have enough information about the topology, the head-end might delegate the computation to a Segment Routing Path Computation Element (SR-PCE). For information on configuring SR-PCE, see *Configure Segment Routing Path Computation Element* chapter.

An **explicit** path is a specified SID-list or set of SID-lists.

An SR-TE policy initiates a single (selected) path in RIB/FIB. This is the preferred valid candidate path. A path is selected when the path is valid and its preference is the best among all candidate paths for that policy.



Note The protocol of the source is not relevant in the path selection logic.

A candidate path has the following characteristics:

- It has a preference – If two policies have the same {color, endpoint} but different preferences, the policy with the highest preference is selected.
- It is associated with a single binding SID (BSID) – A BSID conflict occurs when there are different SR policies with the same BSID. In this case, the policy that is installed first gets the BSID and is selected.
- It is valid if it is usable.

Dynamic Paths

Behaviors and Limitations

For a dynamic path that traverses a specific interface between nodes (segment), the algorithm may encode this segment using an Adj-SID. The SR-TE process prefers the protected Adj-SID of the link, if one is available. In addition, the SR-TE process prefers a manual protected Adj-SID over a dynamic protected Adj-SID.

You can configure the path to prefer the protected or unprotected Adj-SID, or to use only protected or unprotected Adj-SID. See [Segment Protection-Type Constraint, on page 50](#).

Optimization Objectives

Optimization objectives allow the head-end router to compute a SID-list that expresses the shortest dynamic path according to the selected metric type:

- IGP metric — Refer to the "Implementing IS-IS" and "Implementing OSPF" chapters in the *Routing Configuration Guide for Cisco ASR 9000 Series Routers*.
- TE metric — See the [Configure Interface TE Metrics, on page 48](#) section for information about configuring TE metrics.

This example shows a dynamic path from head-end router 1 to end-point router 3 that minimizes IGP or TE metric:

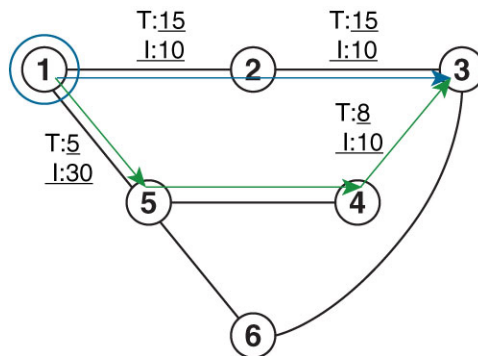

Default IGP link metric: I:10
Default TE link metric T:10

520018

- The blue path uses the minimum IGP metric: Min-Metric (1 → 3, IGP) = SID-list <16003>; cumulative IGP metric: 20
- The green path uses the minimum TE metric: Min-Metric (1 → 3, TE) = SID-list <16005, 16004, 16003>; cumulative TE metric: 23

Configure Interface TE Metrics

Use the **metric value** command in SR-TE interface submode to configure the TE metric for interfaces. The *value* range is from 0 to 2147483647.

```
Router# configure
Router(config)# segment-routing
Router(config-sr)# traffic-eng
Router(config-sr-te)# interface type interface-path-id
Router(config-sr-te-if)# metric value
```

Configuring TE Metric: Example

The following configuration example shows how to set the TE metric for various interfaces:

```
segment-routing
traffic-eng
interface TenGigE0/0/0/0
metric 100
!
interface TenGigE0/0/0/1
metric 1000
!
interface TenGigE0/0/2/0
metric 50
!
!
end
```

Constraints

Constraints allow the head-end router to compute a dynamic path according to the selected metric type:

- Affinity — You can apply a color or name to links or interfaces by assigning affinity bit-maps to them. You can then specify an affinity (or relationship) between an SR policy path and link colors. SR-TE computes a path that includes or excludes links that have specific colors, or combinations of colors. See the [Named Interface Link Admin Groups and SR-TE Affinity Maps, on page 49](#) section for information on named interface link admin groups and SR-TE Affinity Maps.
- Disjoint — SR-TE computes a path that is disjoint from another path in the same disjoint-group. Disjoint paths do not share network resources. Path disjointness may be required for paths between the same pair of nodes, between different pairs of nodes, or a combination (only same head-end or only same end-point).
- Flexible Algorithm — Flexible Algorithm allows for user-defined algorithms where the IGP computes paths based on a user-defined combination of metric type and constraint.
- Protection type — For a dynamic path that traverses a specific interface between nodes (segment), or for an explicit path using IP addresses of intermediate links, the algorithm may encode this segment using an Adj-SID. You can specify the path to prefer protected or unprotected Adj-SIDs, or to use only protected or unprotected Adj-SIDs. See [Segment Protection-Type Constraint, on page 50](#) for information about configuring the protection type.

Named Interface Link Admin Groups and SR-TE Affinity Maps

Named Interface Link Admin Groups and SR-TE Affinity Maps provide a simplified and more flexible means of configuring link attributes and path affinities to compute paths for SR-TE policies.

In the traditional TE scheme, links are configured with attribute-flags that are flooded with TE link-state parameters using Interior Gateway Protocols (IGPs), such as Open Shortest Path First (OSPF).

Named Interface Link Admin Groups and SR-TE Affinity Maps let you assign, or map, up to 256 color names for affinity and attribute-flag attributes instead of 32-bit hexadecimal numbers. After mappings are defined, the attributes can be referred to by the corresponding color name in the CLI. Furthermore, you can define constraints using *include-any*, *include-all*, and *exclude-any* arguments, where each statement can contain up to 10 colors.



Note You can configure affinity constraints using attribute flags or the Flexible Name Based Policy Constraints scheme; however, when configurations for both schemes exist, only the configuration pertaining to the new scheme is applied.

Configure Named Interface Link Admin Groups and SR-TE Affinity Maps

Use the **affinity name NAME** command in SR-TE interface submode to assign affinity to interfaces. Configure this on routers with interfaces that have an associated admin group attribute.

```
Router# configure
Router(config)# segment-routing
Router(config-sr)# traffic-eng
Router(config-sr-te)# interface TenGigE0/0/1/2
Router(config-sr-if)# affinity
Router(config-sr-if-affinity)# name RED
```

Use the **affinity-map name NAME bit-position bit-position** command in SR-TE sub-mode to define affinity maps. The *bit-position* range is from 0 to 255.

Configure affinity maps on the following routers:

- Routers with interfaces that have an associated admin group attribute.
- Routers that act as SR-TE head-ends for SR policies that include affinity constraints.

```
Router# configure
Router(config)# segment-routing
Router(config-sr)# traffic-eng
Router(config-sr-te)# affinity-map
Router(config-sr-te-affinity-map)# name RED bit-position 23
```

Configuring Link Admin Group: Example

The following example shows how to assign affinity to interfaces and to define affinity maps. This configuration is applicable to any router (SR-TE head-end or transit node) with colored interfaces.

```
segment-routing
traffic-eng
interface TenGigE0/0/1/1
affinity
name CROSS
name RED
!
```

```

!
interface TenGigE0/0/1/2
  affinity
    name RED
  !
!
interface TenGigE0/0/2/0
  affinity
    name BLUE
  !
!
affinity-map
  name RED bit-position 23
  name BLUE bit-position 24
  name CROSS bit-position 25
!
end

```

Segment Protection-Type Constraint

Table 6: Feature History Table

Feature Name	Release Information	Feature Description
Segment Protection-Type Constraint	Release 7.4.1	<p>This feature introduces the ability to control whether protected or unprotected segments are used when encoding the SID-list of an SR policy candidate path.</p> <p>The types of segments that could be used when building a SID-list include prefix SIDs and adjacency SIDs.</p>

This feature introduces the ability to control whether protected or unprotected segments are used when encoding the SID-list of an SR policy candidate path. The types of segments that could be used when building a SID-list include prefix SIDs and adjacency SIDs.

A prefix SID is a global segment representing a prefix that identifies a specific node. A prefix SID is programmed with a backup path computed by the IGP using TI-LFA.

An adjacency SID is a local segment representing an IGP adjacency. An adjacency SID can be programmed with or without protection. Protected adjacency SIDs are programmed with a link-protectant backup path computed by the IGP (TI-LFA) and are used if the link associated with the IGP adjacency fails.

Prefix SIDs and adjacency SIDs can be leveraged as segments in a SID-list in order to forward a packet along a path traversing specific nodes and/or over specific interfaces between nodes. The type of segment used when encoding the SID-list will determine whether failures along the path would be protected by TI-LFA. Depending on the offering, an operator may want to offer either unprotected or protected services over traffic engineered paths.

The following behaviors are available with the segment protection-type constraint:

- **protected-only** — The SID-list must be encoded using protected segments.

- **protected-preferred** — The SID-list should be encoded using protected segments if available; otherwise, the SID-list may be encoded using unprotected Adj-SIDs. This is the default behavior when no segment protection-type constraint is specified.
- **unprotected-only** — The SID-list must be encoded using unprotected Adj-SID.
- **unprotected-preferred** — The SID-list should be encoded using unprotected Adj-SID if available, otherwise SID-list may be encoded using protected segments.

Usage Guidelines and Limitations

Observe the following guidelines and limitations for the platform:

- This constraint applies to candidate-paths of manual SR policies with either dynamically computed paths or explicit paths.
- This constraint applies to On-Demand SR policy candidate-paths.
- PCEP has been augmented (vendor-specific object) to allow a PCC to indicate the segment protection-type constraint to the PCE.
- When the segment protection type constraint is protected-only or unprotected-only, the path computation must adhere to the constraint. If the constraint is not satisfied, the SR policy will not come up on such candidate path.
- When the segment protection-type constraint is unprotected-only, the entire SID-list must be encoded with unprotected Adj-SIDs.
- When the segment protection-type constraint is protected-only, the entire SID-list must be encoded with protected Adj-SIDs or Prefix SIDs.

Configuring Segment Protection-Type Constraint

Use the **constraints segments protection {protected-only | protected-preferred | unprotected-only | unprotected-preferred}** command to configure the segment protection-type behavior.

The following example shows how to configure the policy with a SID-list that must be encoded using protected segments:

```
Router(config-sr-te)# policy POLICY1
Router(config-sr-te-policy)# color 10 end-point ipv4 10.1.1.4
Router(config-sr-te-policy)# candidate-paths
Router(config-sr-te-policy-path)# preference 100
Router(config-sr-te-policy-path-pref)# constraints
Router(config-sr-te-policy-path-pref-const)# segments
Router(config-sr-te-policy-path-pref-const-seg)# protection protected-only
```

Configure SR Policy with Dynamic Path

To configure a SR-TE policy with a dynamic path, optimization objectives, and affinity constraints, complete the following configurations:

1. Define the optimization objectives. See the [Optimization Objectives, on page 47](#) section.
2. Define the constraints. See the [Constraints, on page 48](#) section.
3. Create the policy.

Behaviors and Limitations

You can configure the path to prefer protected or unprotected segments, or to use only protected or unprotected segments.

Examples

The following example shows a configuration of an SR policy at an SR-TE head-end router. The policy has a dynamic path with optimization objectives and affinity constraints computed by the head-end router.

```
segment-routing
traffic-eng
policy foo
color 100 end-point ipv4 10.1.1.2
candidate-paths
preference 100
dynamic
metric
type te
!
!
constraints
affinity
exclude-any
name RED
!
!
!
!
!
```

The following example shows a configuration of an SR policy at an SR-TE head-end router. The policy has a dynamic path with optimization objectives and affinity constraints computed by the SR-PCE.

```
segment-routing
traffic-eng
policy baa
color 101 end-point ipv4 10.1.1.2
candidate-paths
preference 100
dynamic
pcep
!
metric
type te
!
!
constraints
affinity
exclude-any
name BLUE
!
!
!
!
!
```

The following example shows a configuration of an SR policy at an SR-TE head-end router. The policy has a dynamic path with optimization objective and segment protection-type constraint computed by the head-end router.

```

segment-routing
traffic-eng
policy baa
  color 101 end-point ipv4 10.1.1.2
  candidate-paths
  preference 100
  dynamic
  metric
  type te
  !
  !
  constraints
  segments
  protection protected-only
  !
  !
  !
  !
  !
  !
  !
  !

```

The following example shows a configuration of an SR policy at an SR-TE head-end router. The policy has a dynamic path with optimization objective and segment protection-type constraint computed by the SR-PCE.

```

segment-routing
traffic-eng
policy baa
  color 101 end-point ipv4 10.1.1.2
  candidate-paths
  preference 100
  dynamic
  pcep
  !
  metric
  type te
  !
  !
  constraints
  segments
  protection protected-only
  !
  !
  !
  !
  !
  !
  !
  !

```

Anycast SID-Aware Path Computation

This feature allows the SR-TE head-end or SR-PCE to compute a path that is encoded using Anycast prefix SIDs of nodes along the path.

An Anycast SID is a type of prefix SID that identifies a set of nodes and is configured with n-flag clear. The set of nodes (Anycast group) is configured to advertise a shared prefix address and prefix SID. Anycast routing enables the steering of traffic toward multiple advertising nodes, providing load-balancing and redundancy. Packets addressed to an Anycast address are forwarded to the topologically nearest nodes.

For more information about this feature, see the *Anycast SID-Aware Path Computation* topic in the *Configure Segment Routing Path Computation Element* chapter.



Note For information on configuring Anycast SID, see [Configuring a Prefix-SID on the IS-IS Enabled Loopback Interface](#) and [Configuring a Prefix-SID on the OSPF-Enabled Loopback Interface](#).

Explicit Paths

SR-TE Policy with Explicit Path

Table 7: Feature History Table

Feature Name	Release Information	Feature Description
SR-TE Explicit Segment Lists with Mix of IPv4 and IPv6 Segments	Release 7.9.1	<p>This feature allows you to configure an explicit segment list with IPv4 addresses and include an IPv6 address as a non-first SID.</p> <p>You can thus deploy a centralized BGP EPE solution for 6PE in an SR-MPLS network where the last segment is associated with an EPE-enabled BGPv6 neighbor.</p>

An explicit segment list is defined as a sequence of one or more segments. A segment can be configured as an IP address or an MPLS label representing a node or a link.

An explicit segment list can be configured with the following:

- IP-defined segments
- MPLS label-defined segments
- A combination of IP-defined segments and MPLS label-defined segments

Usage Guidelines and Limitations

- An IP-defined segment can be associated with an IPv4 or IPv6 address (for example, a link or a Loopback address).
- An IPv6 address cannot be the first segment of the segment list.
 - A segment defined with an IPv6 address (for example, IPv6 EPE SID) enables use-cases such as [Use Case: Centralized BGP EPE for 6PE in an SR-MPLS Network](#) where the last segment of the explicit segment list is associated with an EPE-enabled BGPv6 neighbor.
- The BGP prefix SID label of an IPv4 /32 prefix learned via BGP-LU can be configured as the first segment of an explicit segment-list (see [Explicit Path with a BGP Prefix SID as First Segment, on page 58](#)).
- The segment must be specified as an MPLS label (the local BGP-LU label allocated at the head-end for the target prefix).

- The next-hop of the BGP Prefix SID advertisement must be reachable over a unipath route (either BGP loopback-peering reachable over unipath, or BGP interface-peering).
- When a segment of the segment list is defined as an MPLS label, subsequent segments can only be configured as MPLS labels.
- Prior to Cisco IOS XR release 7.2.1, a segment of an explicit segment list can be configured as an IPv4 address (representing a Node or a Link) using the **index index address ipv4 address** command.
Starting with Cisco IOS XR release 7.2.1, an IPv4-based segment (representing a Node or a Link) can also be configured with the new **index index mpls adjacency address** command. The configuration is stored in NVRAM in the same CLI format used to create it. There is no conversion from the old CLI to the new CLI.
Starting with Cisco IOS XR release 7.9.1, the old CLI has been deprecated. Old configurations stored in NVRAM will be rejected at boot-up.
As a result, explicit segment lists with IPv4-based segments using the old CLI must be re-configured using the new CLI.
There are no CLI changes for segments configured as MPLS labels using the **index index mpls label label** command.
- You can configure the path to prefer the protected or unprotected Adj-SID, or to use only protected or unprotected Adj-SID. See [Segment Protection-Type Constraint, on page 50](#).

Configure Local SR-TE Policy Using Explicit Paths

To configure an SR-TE policy with an explicit path, complete the following configurations:

1. Create the segment list.
2. Create the SR-TE policy.

Create a segment list with IPv4 addresses:

```
Router# configure
Router(config)# segment-routing
Router(config-sr)# traffic-eng
Router(config-sr-te)# segment-list name SIDLIST1
Router(config-sr-te-sl)# index 10 mpls adjacency 10.1.1.2
Router(config-sr-te-sl)# index 20 mpls adjacency 10.1.1.3
Router(config-sr-te-sl)# index 30 mpls adjacency 10.1.1.4
Router(config-sr-te-sl)# exit
```

Create a segment list with MPLS labels:

```
Router(config-sr-te)# segment-list name SIDLIST2
Router(config-sr-te-sl)# index 10 mpls label 16002
Router(config-sr-te-sl)# index 20 mpls label 16003
Router(config-sr-te-sl)# index 30 mpls label 16004
Router(config-sr-te-sl)# exit
```

Create a segment list with IPv4 addresses and MPLS labels:

```
Router(config-sr-te)# segment-list name SIDLIST3
Router(config-sr-te-sl)# index 10 mpls adjacency 10.1.1.2
Router(config-sr-te-sl)# index 20 mpls label 16003
```

```
Router(config-sr-te-sl)# index 30 mpls label 16004
Router(config-sr-te-sl)# exit
```

Create a segment list with IPv4 and IPv6 addresses:

```
Router# configure
Router(config)# segment-routing
Router(config-sr)# traffic-eng
Router(config-sr-te)# segment-list name SIDLIST4
Router(config-sr-te-sl)# index 10 mpls adjacency 10.1.1.2
Router(config-sr-te-sl)# index 20 mpls adjacency 10.1.1.3
Router(config-sr-te-sl)# index 30 mpls adjacency 10.1.1.4
Router(config-sr-te-sl)# index 40 mpls adjacency 2001:db8:10:1:1::100
Router(config-sr-te-sl)# exit
```

Create the SR-TE policy:

```
Router(config-sr-te)# policy POLICY2
Router(config-sr-te-policy)# color 20 end-point ipv4 10.1.1.4
Router(config-sr-te-policy)# candidate-paths
Router(config-sr-te-policy-path)# preference 200
Router(config-sr-te-policy-path-pref)# explicit segment-list SIDLIST2
Router(config-sr-te-pp-info)# exit
Router(config-sr-te-policy-path-pref)# exit
Router(config-sr-te-policy-path)# preference 100
Router(config-sr-te-policy-path-pref)# explicit segment-list SIDLIST1
Router(config-sr-te-pp-info)# exit
Router(config-sr-te-policy-path-pref)# exit
```

Running Configuration

```
Router# show running-configuration
```

```
segment-routing
traffic-eng
segment-list SIDLIST1
index 10 mpls adjacency 10.1.1.2
index 20 mpls adjacency 10.1.1.3
index 30 mpls adjacency 10.1.1.4
!
segment-list SIDLIST2
index 10 mpls label 16002
index 20 mpls label 16003
index 30 mpls label 16004
!
segment-list SIDLIST3
index 10 mpls adjacency 10.1.1.2
index 20 mpls label 16003
index 30 mpls label 16004
!
segment-list SIDLIST4
index 10 mpls adjacency 10.1.1.2
index 20 mpls adjacency 10.1.1.3
index 30 mpls adjacency 10.1.1.4
index 40 mpls adjacency 2001:db8:10:1:1::100
!
policy POLICY2
color 20 end-point ipv4 10.1.1.4
candidate-paths
preference 200
explicit segment-list SIDLIST2
!
```



```

!
preference 100
explicit segment-list SIDLIST1
!
!
!!
!

```

Verification

Improved Segment List Information for Inactive or Invalid Policies

Feature Name	Release Information	Description
Improved Segment List Information for Inactive or Invalid Policies	Release 7.3.3	This feature provides for displaying detailed segment list information, and also lists information on invalid and inactive policies. This allows you to determine if the policies have been received correctly, to the SR-TE policies with explicit path.

This feature provides for displaying detailed segment list information. This is in addition to the current behavior of displaying segment list information from active policies. For active candidate paths, the status of segment list will either be valid or invalid. If the segment list is invalid, the reason for its invalidity along with the entire label/IP stack of segment list is displayed. For inactive candidate paths, the status of segment list will always be inactive. Since the validity of segment list under inactive path is not checked, it is always displayed inactive.

Verify the SR-TE policy configuration using:

```
Router# show segment-routing traffic-eng policy name srte_c_20_ep_10.1.1.4
```

```
SR-TE policy database
```

```

-----
Color: 20, End-point: 10.1.1.4
Name: srte_c_20_ep_10.1.1.4
Status:
  Admin: up Operational: up for 00:00:15 (since Jul 14 00:53:10.615)
Candidate-paths:
  Preference: 200 (configuration) (active)
    Name: POLICY2
    Requested BSID: dynamic
    Protection Type: protected-preferred
    Maximum SID Depth: 8
    Explicit: segment-list SIDLIST2 (active)
    Weight: 1, Metric Type: TE
      16002
      16003
      16004

  Preference: 100 (configuration) (inactive)
    Name: POLICY2
    Requested BSID: dynamic
    Protection Type: protected-preferred
    Maximum SID Depth: 8
    Explicit: segment-list SIDLIST1 (inactive)

```

```

Weight: 1, Metric Type: TE
  [Adjacency-SID, 10.1.1.2 - <None>]
  [Adjacency-SID, 10.1.1.3 - <None>]
  [Adjacency-SID, 10.1.1.4 - <None>]
Attributes:
Binding SID: 51301
Forward Class: Not Configured
Steering labeled-services disabled: no
Steering BGP disabled: no
IPv6 caps enable: yes
Invalidation drop enabled: no

```

Explicit Path with a BGP Prefix SID as First Segment

Table 8: Feature History Table

Feature Name	Release Information	Feature Description
SR-TE Explicit Path with a BGP Prefix SID as First Segment	Release 7.11.1	<p>This feature allows you to configure an SR-TE policy with an explicit path that uses a remote BGP prefix SID as its first segment. This path is achieved by leveraging the recursive resolution of the first SID, which is a BGP-Label Unicast (BGP-LU) SID. BGP-LU labels are used as the first SID in the SR policy to determine the egress paths for the traffic and program the SR-TE forwarding chain accordingly.</p> <p>This allows users to enable Segment Routing to leverage their existing BGP infrastructure and integrate it with the required Segment Routing functionalities.</p>

The figure below shows a network setup where a PE router (PE1) is using BGP-SR as the routing protocol and is connected to a classic BGP-LU domain. The classic BGP-LU domain is also connected to other domains running BGP-SR.

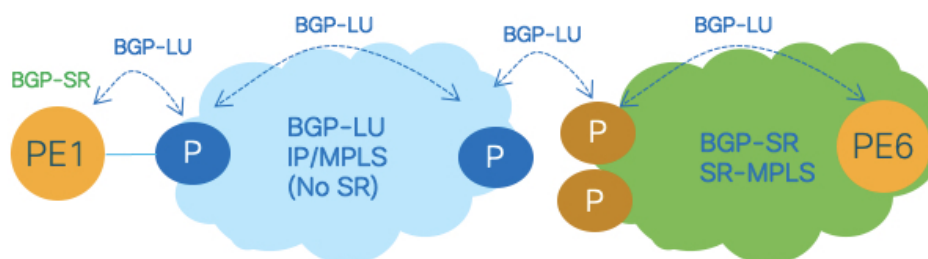

In BGP-SR, a BGP Prefix-SID is advertised along with a prefix in BGP Labeled Unicast (BGP-LU). This Prefix-SID attribute contains information about the label value and index for the route. This allows for interworking between the classic BGP-LU and BGP-SR domains.

The figure below illustrates a best-effort BGP-LU Label Switched Path (LSP) from PE1 to PE6, passing through transit Label Switching Router (LSR) nodes 2, 3, and 5.

With this setup, the operator can create an alternate path using an SR-TE policy at the ingress BGP-SR PE (PE1). The explicit path for this alternate path will follow a different transit node, using the BGP prefix SID for that transit node as the first segment.

For example, in the figure below, the SID-list shows that the explicit path uses the BGP prefix SID of transit LSR node 4 (16004) followed by the BGP prefix SID of PE6 (16006). The PE1 router resolves the first segment of this explicit path to the outgoing interface towards Node 2, using the outgoing label advertised by Node 2 for the BGP-LU prefix 10.1.1.4/32.

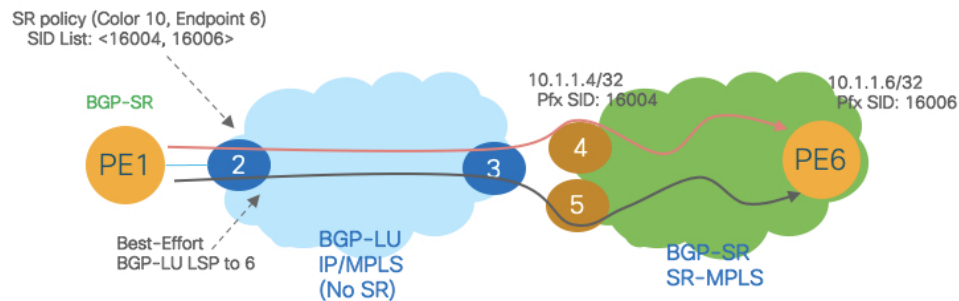

Example

The following output shows the BGP-LU routes learned at the head-end (PE1 in the illustration above). Consider the IP prefix 1.1.1.4/32. A BGP-LU local label is assigned from the SRGB with a prefix SID index of 4, resulting in the value 16004. Additionally, the classic BGP-LU upstream neighbor (P2) advertises an outgoing label of 78000 for this IP prefix.

```
RP/0/RP0/CPU0:R1# show bgp ipv4 unicast labels

BGP router identifier 1.1.1.1, local AS number 1
BGP generic scan interval 60 secs
Non-stop routing is enabled
BGP table state: Active
Table ID: 0xe0000000 RD version: 13
BGP main routing table version 13
BGP NSR Initial initsync version 6 (Reached)
BGP NSR/ISSU Sync-Group versions 0/0
BGP scan interval 60 secs

Status codes: s suppressed, d damped, h history, * valid, > best
               i - internal, r RIB-failure, S stale, N Nexthop-discard
Origin codes: i - IGP, e - EGP, ? - incomplete
   Network          Next Hop        Rcvd Label      Local Label
* > 1.1.1.1/32      0.0.0.0         nolabel         3
* > 1.1.1.2/32      10.1.2.2        3               24007
* > 1.1.1.3/32      10.1.2.2        78005           24002
* > 1.1.1.4/32      10.1.2.2        78000           16004
* > 1.1.1.5/32      10.1.2.2        78002           16005
* > 1.1.1.6/32      10.1.2.2        78001           16006
```

```

...
RP/0/RP0/CPU0:R1# show bgp ipv4 labeled-unicast 1.1.1.4/32

BGP routing table entry for 1.1.1.4/32
Versions:
  Process          bRIB/RIB  SendTblVer
  Speaker          74        74
  Local Label: 16004
Last Modified: Sep 29 19:52:18.155 for 00:07:22
Paths: (1 available, best #1)
  Advertised to update-groups (with more than one peer):
    0.2
  Path #1: Received by speaker 0
  Advertised to update-groups (with more than one peer):
    0.2
  3
  10.1.2.2 from 10.1.2.2 (1.1.1.2)
  Received Label 78000
  Origin IGP, metric 0, localpref 100, valid, external, best, group-best
  Received Path ID 0, Local Path ID 1, version 74
  Origin-AS validity: not-found
  Label Index: 4

```

The following output shows the corresponding label forwarding entry for BGP prefix SID 16004 with corresponding outgoing label and outgoing interface.

```

RP/0/RP0/CPU0:R1# show mpls forwarding labels 16002

Local  Outgoing  Prefix          Outgoing  Next Hop        Bytes
Label  Label      or ID          Interface  Hop             Switched
-----
16004  78000      SR Pfx (idx 2) Te0/0/0/0  10.1.2.2        44

```

The configuration below depicts an SR policy (color 100 and end-point 1.1.1.6) with an explicit path to PE6 using the BGP prefix SID of transit LSR node 4 (16004) as its first segment followed by the BGP prefix SID of PE6 (16006).

```

RP/0/RP0/CPU0:R1# configure
RP/0/RP0/CPU0:R1(config)# segment-routing
RP/0/RP0/CPU0:R1(config-sr)# traffic-eng
RP/0/RP0/CPU0:R1(config-sr-te)# segment-list SL-R4-R6
RP/0/RP0/CPU0:R1(config-sr-te-sl)# index 10 mpls label 16004
RP/0/RP0/CPU0:R1(config-sr-te-sl)# index 20 mpls label 16006
RP/0/RP0/CPU0:R1(config-sr-te-sl)# exit

RP/0/RP0/CPU0:R1(config-sr-te)# policy POL-to-R6
RP/0/RP0/CPU0:R1(config-sr-te-policy)# color 100 end-point ipv4 1.1.1.6
RP/0/RP0/CPU0:R1(config-sr-te-policy)# candidate-paths
RP/0/RP0/CPU0:R1(config-sr-te-policy-path)# preference 100
RP/0/RP0/CPU0:R1(config-sr-te-policy-path-pref)# explicit segment-list SL-R4-R6

RP/0/RP0/CPU0:R1# show running-configuration

segment-routing
traffic-eng
  segment-list SL-R4-R6
    index 10 mpls label 16004
    index 20 mpls label 16006
  !

```

```

policy POL-to-R6
  color 100 end-point ipv4 1.1.1.6
  candidate-paths
  preference 100
    explicit segment-list SL-R4-R6
  !
  !
  !
  !
  !
  !

```

The following output depicts the forwarding information for the SR policy including the outgoing interface and outgoing label stack.

Observe how the first segment configured (MPLS label 16004) is replaced in the forwarding with the label advertised by the BGP-LU neighbor of the SRTE head-end (MPLS label value 78000).

```
RP/0/RP0/CPU0:R1# show segment-routing traffic-eng forwarding policy color 100
```

```
SR-TE Policy Forwarding database
```

```

-----
Color: 100, End-point: 1.1.1.6
Name: srte_c_100_ep_1.1.1.6
Binding SID: 24006
Active LSP:
  Candidate path:
    Preference: 100 (configuration)
    Name: POL-to-R6
    Local label: 24005
    Segment lists:
      SL[0]:
        Name: SL-R4-R6
        Switched Packets/Bytes: 100/10000
        [MPLS -> MPLS]: 100/10000
        Paths:
          Path[0]:
            Outgoing Label: 78000
            Outgoing Interfaces: TenGigE0/0/0/0
            Next Hop: 10.1.2.2
            Switched Packets/Bytes: 100/10000
            [MPLS -> MPLS]: 100/10000
            FRR Pure Backup: No
            ECMP/LFA Backup: No
            Internal Recursive Label: Unlabelled (recursive)
            Label Stack (Top -> Bottom): { 78000, 16006 }

```

```
Policy Packets/Bytes Switched: 100/9600
```

With the SR-TE policy installed, the head-end can apply SR-TE automated steering principles when programming BGP service overlay routes.

In the following output, BGP prefix 10.0.0.0/8 with next-hop 1.1.1.6 and color 100 is automatically steered over the SR policy configured above (color 100 and end-point 1.1.1.6).

```
RP/0/RP0/CPU0:R1# show bgp
```

```

BGP router identifier 1.1.1.1, local AS number 1
BGP generic scan interval 60 secs
Non-stop routing is enabled
BGP table state: Active
Table ID: 0xe0000000 RD version: 13

```

```

BGP main routing table version 13
BGP NSR Initial initsync version 6 (Reached)
BGP NSR/ISSU Sync-Group versions 0/0
BGP scan interval 60 secs

Status codes: s suppressed, d damped, h history, * valid, > best
               i - internal, r RIB-failure, S stale, N Nexthop-discard
Origin codes: i - IGP, e - EGP, ? - incomplete
   Network                Next Hop                Metric LocPrf Weight Path
. . .
*> 10.0.0.0/8             1.1.1.6 C:100                0                0 3 i

```

Configuring Explicit Path with Affinity Constraint Validation

To fully configure SR-TE flexible name-based policy constraints, you must complete these high-level tasks in order:

1. Assign Color Names to Numeric Values
2. Associate Affinity-Names with SR-TE Links
3. Associate Affinity Constraints for SR-TE Policies

```

/* Enter the global configuration mode and assign color names to numeric values
Router# configure
Router(config)# segment-routing
Router(config-sr)# traffic-eng
Router(config-sr-te)# affinity-map
Router(config-sr-te-affinity-map)# blue bit-position 0
Router(config-sr-te-affinity-map)# green bit-position 1
Router(config-sr-te-affinity-map)# red bit-position 2
Router(config-sr-te-affinity-map)# exit

/* Associate affinity-names with SR-TE links
Router(config-sr-te)# interface Gi0/0/0/0
Router(config-sr-te-if)# affinity
Router(config-sr-te-if-affinity)# blue
Router(config-sr-te-if-affinity)# exit
Router(config-sr-te-if)# exit
Router(config-sr-te)# interface Gi0/0/0/1
Router(config-sr-te-if)# affinity
Router(config-sr-te-if-affinity)# blue
Router(config-sr-te-if-affinity)# green
Router(config-sr-te-if-affinity)# exit
Router(config-sr-te-if)# exit
Router(config-sr-te)#

/* Associate affinity constraints for SR-TE policies
Router(config-sr-te)# segment-list name SIDLIST1
Router(config-sr-te-sl)# index 10 mpls adjacency 10.1.1.2
Router(config-sr-te-sl)# index 20 mpls adjacency 2.2.2.23
Router(config-sr-te-sl)# index 30 mpls adjacency 10.1.1.4
Router(config-sr-te-sl)# exit
Router(config-sr-te)# segment-list name SIDLIST2
Router(config-sr-te-sl)# index 10 mpls adjacency 10.1.1.2

```

```

Router(config-sr-te-sl)# index 30 mpls adjacency 10.1.1.4
Router(config-sr-te-sl)# exit
Router(config-sr-te)# segment-list name SIDLIST3
Router(config-sr-te-sl)# index 10 mpls adjacency 10.1.1.5
Router(config-sr-te-sl)# index 30 mpls adjacency 10.1.1.4
Router(config-sr-te-sl)# exit

Router(config-sr-te)# policy POLICY1
Router(config-sr-te-policy)# color 20 end-point ipv4 10.1.1.4
Router(config-sr-te-policy)# binding-sid mpls 1000
Router(config-sr-te-policy)# candidate-paths
Router(config-sr-te-policy-path)# preference 200
Router(config-sr-te-policy-path-pref)# constraints affinity exclude-any red
Router(config-sr-te-policy-path-pref)# explicit segment-list SIDLIST1
Router(config-sr-te-pp-info)# exit
Router(config-sr-te-policy-path-pref)# explicit segment-list SIDLIST2
Router(config-sr-te-pp-info)# exit
Router(config-sr-te-policy-path-pref)# exit
Router(config-sr-te-policy-path)# preference 100
Router(config-sr-te-policy-path-pref)# explicit segment-list SIDLIST3

```

Running Configuration

```

Router# show running-configuration
segment-routing
traffic-eng

interface GigabitEthernet0/0/0/0
  affinity
  blue
  !
!
interface GigabitEthernet0/0/0/1
  affinity
  blue
  green
  !
!

segment-list name SIDLIST1
  index 10 mpls adjacency 10.1.1.2
  index 20 mpls adjacency 2.2.2.23
  index 30 mpls adjacency 10.1.1.4
!
segment-list name SIDLIST2
  index 10 mpls adjacency 10.1.1.2
  index 30 mpls adjacency 10.1.1.4
!
segment-list name SIDLIST3
  index 10 mpls adjacency 10.1.1.5
  index 30 mpls adjacency 10.1.1.4
!
policy POLICY1
  binding-sid mpls 1000
  color 20 end-point ipv4 10.1.1.4
  candidate-paths
  preference 100
  explicit segment-list SIDLIST3
  !
!
  preference 200

```



```

policy POLICY1
  color 20 end-point ipv4 10.1.1.4
  binding-sid mpls 1000
  candidate-paths
    preference 100
    explicit segment-list SIDLIST1
    constraints
      affinity
        exclude-any
          red
  segment-list name SIDLIST1
    index 10 address ipv4 100.100.100.100
    index 20 address ipv4 4.4.4.4

```

Affinity Constraint Validation With ECMP Anycast SID: Example

In this example, the shortest path to both node 3 and node 5 has an equal accumulative IGP metric of 20. Both paths are validated against affinity constraints.

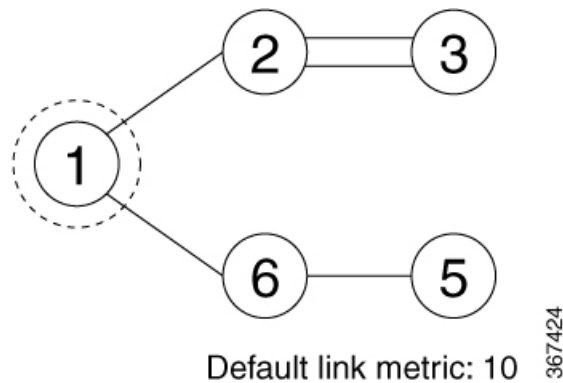

```

Name: POLICY1 (Color: 2, End-point: 198.51.100.6)
Status:
  Admin: up Operational: up for 00:03:52 (since Jan 24 01:52:14.215)
Candidate-paths:
  Preference 100:
  Constraints:
    Affinity:
      exclude-any: red
  Explicit: segment-list SIDLIST1 (active)
  Weight: 0, Metric Type: IGP
    16100 [Prefix-SID, 10.1.1.8]
    16004 [Prefix-SID, 4.4.4.4]

```

Affinity Constraint Validation With Non-ECMP Anycast SID: Example

In this example, the shortest path to node 5 has an accumulative IGP metric of 20, and the shortest path to node 3 has an accumulative IGP metric of 30. Only the shortest path to node 5 is validated against affinity constraints.

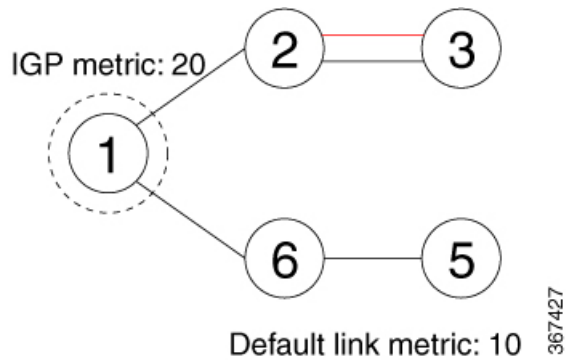

Note Even though parallel link (23) is marked with red, it is still considered valid since anycast traffic flows only on the path to node 5.

Invalid Path Based on Affinity Constraint: Example

In this example, parallel link (23) is marked as red, so the path to anycast node 3 is invalidated.

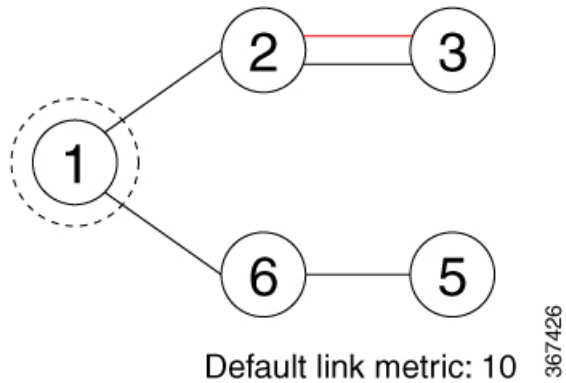

```
SR-TE policy database
```

```
-----
Name: POLICY1 (Color: 2, End-point: 198.51.100.6)
Status:
  Admin: up Operational: up for 00:03:52 (since Jan 24 01:52:14.215)
Candidate-paths:
Preference 100:
Constraints:
  Affinity:
    exclude-any: red
  Explicit: segment-list SIDLIST1 (inactive)
  Inactive Reason: Link [2.2.21.23,2.2.21.32] failed to satisfy affinity exclude-any
constraint=0x00000008, link attributes=0x0000000A
```

Configure Explicit Path with Segment Protection-Type Constraint

For an SR policy with an explicit path that includes IP addresses of links, the SR-TE process encodes these segments using the corresponding adjacency SID (Adj-SID) for each link. The type of Adj-SID used (protected

or unprotected) is determined by the segment protection-type constraint configured under the SR policy. See the [Segment Protection-Type Constraint, on page 50](#).

Configure Local SR-TE Policy Using Explicit Paths

Create a segment list with IP addresses:

```
Router# configure
Router(config)# segment-routing
Router(config-sr)# traffic-eng
Router(config-sr-te)# segment-list name SIDLIST1
Router(config-sr-te-sl)# index 10 mpls adjacency 10.1.1.2
Router(config-sr-te-sl)# index 20 mpls adjacency 10.1.1.3
Router(config-sr-te-sl)# index 30 mpls adjacency 10.1.1.4
Router(config-sr-te-sl)# exit
```

Create the SR-TE policy with segment protection-type constraint:

```
Router(config-sr-te)# policy POLICY1
Router(config-sr-te-policy)# color 20 end-point ipv4 10.1.1.4
Router(config-sr-te-policy)# candidate-paths
Router(config-sr-te-policy-path)# preference 100
Router(config-sr-te-policy-path-pref)# explicit segment-list SIDLIST1
Router(config-sr-te-pp-info)# exit
Router(config-sr-te-policy-path-pref)# constraints
Router(config-sr-te-path-pref-const)# segments
Router(config-sr-te-path-pref-const-seg)# protection protected-only
Router(config-sr-te-path-pref-const-seg)# commit
```

Running Configuration

```
Router# show running-configuration
segment-routing
 traffic-eng
  segment-list SIDLIST1
   index 10 mpls adjacency 10.1.1.2
   index 20 mpls adjacency 10.1.1.3
   index 30 mpls adjacency 10.1.1.4
  !

 policy POLICY1
  color 10 end-point ipv4 10.1.1.4
  candidate-paths
  preference 100
  explicit segment-list SIDLIST1
  !
  constraints
  segments
  protection protected-only
  !
  !
  !
```

Protocols

Path Computation Element Protocol

The path computation element protocol (PCEP) describes a set of procedures by which a path computation client (PCC) can report and delegate control of head-end label switched paths (LSPs) sourced from the PCC to a PCE peer. The PCE can request the PCC to update and modify parameters of LSPs it controls. The stateful model also enables a PCC to allow the PCE to initiate computations allowing the PCE to perform network-wide orchestration.

Configure the Head-End Router as PCEP PCC

Configure the head-end router as PCEP Path Computation Client (PCC) to establish a connection to the PCE. The PCC and PCE addresses must be routable so that TCP connection (to exchange PCEP messages) can be established between PCC and PCE.

Configure the PCC to Establish a Connection to the PCE

Use the **segment-routing traffic-eng pcc** command to configure the PCC source address, the SR-PCE address, and SR-PCE options.

A PCE can be given an optional precedence. If a PCC is connected to multiple PCEs, the PCC selects a PCE with the lowest precedence value. If there is a tie, a PCE with the highest IP address is chosen for computing path. The precedence *value* range is from 0 to 255.

```
Router(config)# segment-routing
Router(config-sr)# traffic-eng
Router(config-sr-te)# pcc
Router(config-sr-te-pcc)# source-address ipv4 local-source-address
Router(config-sr-te-pcc)# pce address ipv4 PCE-address[precedence value]
Router(config-sr-te-pcc)# pce address ipv4 PCE-address[keychain WORD]
```

Configure PCEP-Related Timers

Use the **timers keepalive** command to specify how often keepalive messages are sent from PCC to its peers. The range is from 0 to 255 seconds; the default value is 30.

```
Router(config-sr-te-pcc)# timers keepalive seconds
```

Use the **timers deadtimer** command to specify how long the remote peers wait before bringing down the PCEP session if no PCEP messages are received from this PCC. The range is from 1 to 255 seconds; the default value is 120.

```
Router(config-sr-te-pcc)# timers deadtimer seconds
```

Use the **timers delegation-timeout** command to specify how long a delegated SR policy can remain up without an active connection to a PCE. The range is from 0 to 3600 seconds; the default value is 60.

```
Router(config-sr-te-pcc)# timers delegation-timeout seconds
```

PCE-Initiated SR Policy Timers

Use the **timers initiated orphans** command to specify the amount of time that a PCE-initiated SR policy will remain delegated to a PCE peer that is no longer reachable by the PCC. The range is from 10 to 180 seconds; the default value is 180.

```
Router(config-sr-te-pcc)# timers initiated orphans seconds
```

Use the **timers initiated state** command to specify the amount of time that a PCE-initiated SR policy will remain programmed while not being delegated to any PCE. The range is from 15 to 14440 seconds (24 hours); the default value is 600.

```
Router(config-sr-te-pcc)# timers initiated state seconds
```

To better understand how the PCE-initiated SR policy timers operate, consider the following example:

- PCE A instantiates SR policy P at head-end N.
- Head-end N delegates SR policy P to PCE A and programs it in forwarding.
- If head-end N detects that PCE A is no longer reachable, then head-end N starts the PCE-initiated **orphan** and **state** timers for SR policy P.
- If PCE A reconnects before the **orphan** timer expires, then SR policy P is automatically delegated back to its original PCE (PCE A).
- After the **orphan** timer expires, SR policy P will be eligible for delegation to any other surviving PCE(s).
- If SR policy P is not delegated to another PCE before the **state** timer expires, then head-end N will remove SR policy P from its forwarding.

Enable SR-TE SYSLOG Alarms

Use the **logging policy status** command to enable SR-TE related SYSLOG alarms.

```
Router(config-sr-te)# logging policy status
```

Enable PCEP Reports to SR-PCE

Use the **report-all** command to enable the PCC to report all SR policies in its database to the PCE.

```
Router(config-sr-te-pcc)# report-all
```

Customize MSD Value at PCC

Use the **maximum-sid-depth value** command to customize the Maximum SID Depth (MSD) signaled by PCC during PCEP session establishment.

The default MSD *value* is equal to the maximum MSD supported by the platform (10).

```
Router(config-sr-te)# maximum-sid-depth value
```

For cases with path computation at PCE, a PCC can signal its MSD to the PCE in the following ways:

- During PCEP session establishment – The signaled MSD is treated as a node-wide property.
 - MSD is configured under **segment-routing traffic-eng maximum-sid-depth value** command
- During PCEP LSP path request – The signaled MSD is treated as an LSP property.

- On-demand (ODN) SR Policy: MSD is configured using the **segment-routing traffic-eng on-demand color** *color* **maximum-sid-depth** *value* command
- Local SR Policy: MSD is configured using the **segment-routing traffic-eng policy** *WORD* **candidate-paths preference** *preference* **dynamic metric sid-limit** *value* command.



Note If the configured MSD values are different, the per-LSP MSD takes precedence over the per-node MSD.

After path computation, the resulting label stack size is verified against the MSD requirement.

- If the label stack size is larger than the MSD and path computation is performed by PCE, then the PCE returns a "no path" response to the PCC.
- If the label stack size is larger than the MSD and path computation is performed by PCC, then the PCC will not install the path.



Note A sub-optimal path (if one exists) that satisfies the MSD constraint could be computed in the following cases:

- For a dynamic path with TE metric, when the PCE is configured with the **pce segment-routing te-latency** command or the PCC is configured with the **segment-routing traffic-eng te-latency** command.
- For a dynamic path with LATENCY metric
- For a dynamic path with affinity constraints

For example, if the PCC MSD is 4 and the optimal path (with an accumulated metric of 100) requires 5 labels, but a sub-optimal path exists (with accumulated metric of 110) requiring 4 labels, then the sub-optimal path is installed.

Customize the SR-TE Path Calculation

Use the **te-latency** command to enable ECMP-aware path computation for TE metric.

```
Router(config-sr-te)# te-latency
```



Note ECMP-aware path computation is enabled by default for IGP and LATENCY metrics.

Configure PCEP Redundancy Type

Use the **redundancy pcc-centric** command to enable PCC-centric high-availability model. The PCC-centric model changes the default PCC delegation behavior to the following:

- After LSP creation, LSP is automatically delegated to the PCE that computed it.
- If this PCE is disconnected, then the LSP is redelegated to another PCE.

- If the original PCE is reconnected, then the delegation fallback timer is started. When the timer expires, the LSP is redelegated back to the original PCE, even if it has worse preference than the current PCE.

```
Router(config-sr-te-pcc)# redundancy pcc-centric
```

Configuring Head-End Router as PCEP PCC and Customizing SR-TE Related Options: Example

The following example shows how to configure an SR-TE head-end router with the following functionality:

- Enable the SR-TE head-end router as a PCEP client (PCC) with 3 PCEP servers (PCE) with different precedence values. The PCE with IP address 10.1.1.57 is selected as BEST.
- Enable SR-TE related syslogs.
- Set the Maximum SID Depth (MSD) signaled during PCEP session establishment to 5.
- Enable PCEP reporting for all policies in the node.

```
segment-routing
traffic-eng
pcc
source-address ipv4 10.1.1.2
pce address ipv4 10.1.1.57
precedence 150
password clear <password>
!
pce address ipv4 10.1.1.58
precedence 200
password clear <password>
!
pce address ipv4 10.1.1.59
precedence 250
password clear <password>
!
!
logging
policy status
!
maximum-sid-depth 5
pcc
report-all
!
!
end
```

Verification

```
RP/0/RSP0/CPU0:Router# show segment-routing traffic-eng pcc ipv4 peer
```

```
PCC's peer database:
```

```
-----
```

```
Peer address: 10.1.1.57, Precedence: 150, (best PCE)
```

```
State up
```

```
Capabilities: Stateful, Update, Segment-Routing, Instantiation
```

```
Peer address: 10.1.1.58, Precedence: 200
```

```
State up
```

```
Capabilities: Stateful, Update, Segment-Routing, Instantiation
```

Peer address: 10.1.1.59, Precedence: 250

State up

Capabilities: Stateful, Update, Segment-Routing, Instantiation

Configure SR-TE PCE Groups

Table 9: Feature History Table

Feature Name	Release	Description
SR-TE PCE Groups	Release 7.3.2	<p>This feature allows an SR policy to be delegated to a set of PCE servers configured under a PCE group. Multiple PCE groups can be configured to allow SR policies on the same head-end to be delegated to different sets of PCEs.</p> <p>With this functionality, an operator can designate sets of PCEs for various purposes, such as PCE-per-service-type or PCE-per-wholesale-customers.</p>

This feature allows an SR policy to be delegated or reported to a set of PCE servers configured under a PCE group. Multiple PCE groups can be configured to allow different SR policies on the same head-end to be delegated or reported to different sets of PCEs.

With this functionality, an operator can designate sets of PCEs for various purposes, such as PCE-per-service-type or PCE-per-wholesale-customer.

In the figure below, Router A has a PCEP session with 5 PCEs. The PCEs are configured over 3 PCE groups. PCE1 is in the “default” group. PCE2 and PCE3 are in the RED group. PCE4 and PCE5 are in the BLUE group.

Figure 2: Example: PCE Groups

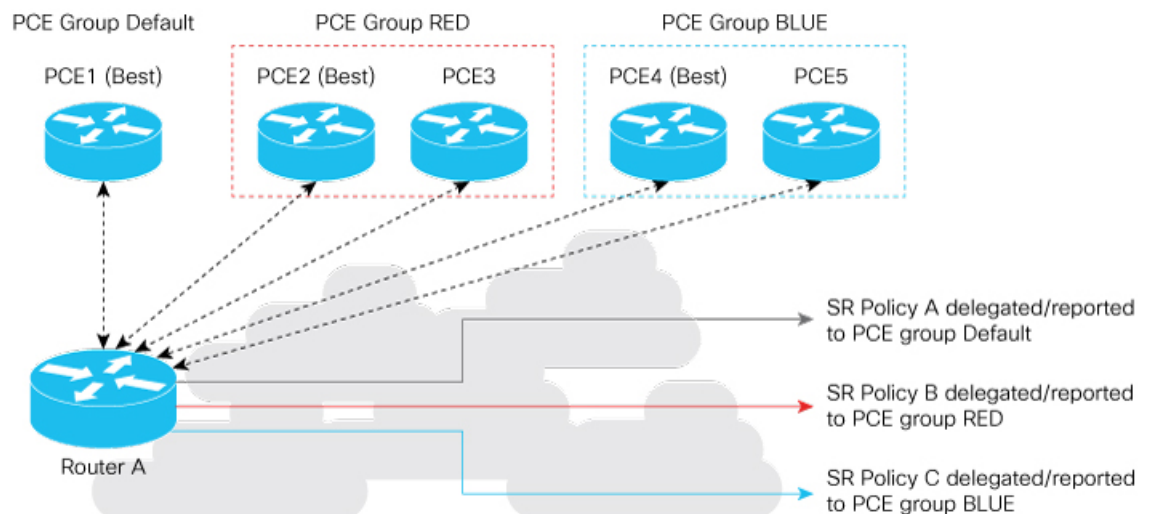

522087

In case of PCE failure, each candidate path is re-delegated to the next-best PCE within the same PCE group. For example, if the best PCE in the RED group (PCE2) fails, then all candidate paths in the RED group fallback to the secondary PCE in the RED group (PCE3). If all the PCEs in the RED group fail, then all candidate paths in the RED group become undelegated; they are not delegated to the PCEs in the BLUE group. If there are no more available PCEs in the given PCE group, then the outcome is the same as when there are no available PCEs.

Configure PCE Groups

Use the **segment-routing traffic-eng pcc pce address {ipv4 ipv4_addr | ipv6 ipv6_addr} pce-group WORD** command to configure the PCE groups.

The following example shows how to configure the PCE groups

- PCE1 in the “default” group
- PCE2 and PCE3 in the “red” group
- PCE4 and PCE5 in the “blue” group

```
Router(config)# segment-routing traffic-eng pcc
Router(config-sr-te-pcc)# pce address ipv4 10.1.1.1
Router(config-pcc-pce)# precedence 10
Router(config-pcc-pce)# exit

Router(config-sr-te-pcc)# pce address ipv4 2.2.2.2
Router(config-pcc-pce)# precedence 20
Router(config-pcc-pce)# pce-group red
Router(config-pcc-pce)# exit

Router(config-sr-te-pcc)# pce address ipv4 3.3.3.3
Router(config-pcc-pce)# precedence 30
Router(config-pcc-pce)# pce-group red
Router(config-pcc-pce)# exit

Router(config-sr-te-pcc)# pce address ipv4 4.4.4.4
Router(config-pcc-pce)# precedence 40
Router(config-pcc-pce)# pce-group blue
Router(config-pcc-pce)# exit

Router(config-sr-te-pcc)# pce address ipv4 5.5.5.5
Router(config-pcc-pce)# precedence 50
Router(config-pcc-pce)# pce-group blue
Router(config-pcc-pce)# exit
```

Verification

```
segment-routing
traffic-eng
pcc
pce address ipv4 10.1.1.1
precedence 10
!
pce address ipv4 2.2.2.2
precedence 20
pce-group red
!
pce address ipv4 3.3.3.3
precedence 30
```

```

    pce-group red
    !
    pce address ipv4 4.4.4.4
    precedence 40
    pce-group blue
    !
    pce address ipv4 5.5.5.5
    precedence 50
    pce-group blue
    !
  !
!
!
!

```

Assign PCE Group to a Candidate Path or ODN Template

Use the **segment-routing traffic-eng policy** *policy* **pce-group** *WORD* command to assign the PCE group to all candidate paths of an SR policy.

Use the **segment-routing traffic-eng policy** *policy* **candidate-paths preference** *pref* **pce-group** *WORD* command to assign the PCE group to a specific candidate path of an SR policy.

Use the **segment-routing traffic-eng on-demand color** *color* **pce-group** *WORD* command to assign the PCE group to on-demand candidate paths triggered by an ODN template.



Note Only one PCE group can be attached to a given SR policy candidate path.

The following example shows how to configure a policy with all candidate paths delegated/reported to PCEs in the default group:

```

Router(config)# segment-routing traffic-eng
Router(config-sr-te)# policy A
Router(config-sr-te-policy)# color 100 end-point ipv4 192.168.0.2
Router(config-sr-te-policy)# candidate-paths
Router(config-sr-te-policy-path)# preference 100
Router(config-sr-te-policy-path-pref)# dynamic
Router(config-sr-te-pp-info)# pcep
Router(config-sr-te-path-pcep)# exit
Router(config-sr-te-pp-info)# exit
Router(config-sr-te-policy-path-pref)# exit
Router(config-sr-te-policy-path)# exit
Router(config-sr-te-policy)# exit

```

The following example shows how to configure a policy with all candidate paths delegated/reported to PCEs in the red group:

```

Router(config-sr-te)# policy B
Router(config-sr-te-policy)# color 100 end-point ipv4 192.168.0.3
Router(config-sr-te-policy)# pce-group red
Router(config-sr-te-policy)# candidate-paths
Router(config-sr-te-policy-path)# preference 100
Router(config-sr-te-policy-path-pref)# dynamic
Router(config-sr-te-pp-info)# pcep
Router(config-sr-te-path-pcep)# exit
Router(config-sr-te-pp-info)# exit
Router(config-sr-te-policy-path-pref)# exit
Router(config-sr-te-policy-path)# exit

```

```
Router(config-sr-te-policy) # exit
```

The following example shows how to configure a policy with a specific candidate path (explicit path) reported to PCEs in the blue group:

```
Router(config-sr-te) # policy C
Router(config-sr-te-policy) # color 100 end-point ipv4 192.168.0.4
Router(config-sr-te-policy) # candidate-paths
Router(config-sr-te-policy-path) # preference 100
Router(config-sr-te-policy-path-pref) # pce-group blue
Router(config-sr-te-policy-path-pref) # explicit segment-list SLA
Router(config-sr-te-pp-info) # exit
Router(config-sr-te-policy-path-pref) # exit
Router(config-sr-te-policy-path) # exit
Router(config-sr-te-policy) # exit
```

The following example shows how to configure an ODN template with on-demand candidate paths delegated/reported to PCEs in the blue group:

```
Router(config-sr-te) # on-demand color 10
Router(config-sr-te-color) # pce-group blue
Router(config-sr-te-color) # dynamic
Router(config-sr-te-color-dyn) #pcep
Router(config-sr-te-color-dyn-pce) #
```

Running Config

```
segment-routing
traffic-eng
  on-demand color 10
  dynamic
  pcep
  !
  !
  pce-group blue
  !
  policy A
  color 100 end-point ipv4 192.168.0.2
  candidate-paths
  preference 100
  dynamic
  pcep
  !
  !
  !
  !
  !
  policy B
  color 100 end-point ipv4 192.168.0.3
  pce-group red
  candidate-paths
  preference 100
  dynamic
  pcep
  !
  !
  !
  !
  !
  policy C
  color 100 end-point ipv4 192.168.0.4
  candidate-paths
```

```

    preference 100
    explicit segment-list SLA
    !
    pce-group blue
    !
    !
    !
    !
end

```

Verification

```
Router# show segment-routing traffic-eng pcc ipv4 peer
```

```
PCC's peer database:
```

```
-----
```

```

Peer address: 10.1.1.1
  Precedence: 10 (best PCE)
  State up
  Capabilities: Stateful, Update, Segment-Routing, Instantiation

Peer address: 2.2.2.2
  Group: red, Precedence 20
  State up
  Capabilities: Stateful, Update, Segment-Routing, Instantiation

Peer address: 3.3.3.3
  Group: red, Precedence 30
  State up
  Capabilities: Stateful, Update, Segment-Routing, Instantiation

Peer address: 4.4.4.4
  Group: blue, Precedence 40
  State up
  Capabilities: Stateful, Update, Segment-Routing, Instantiation

Peer address: 5.5.5.5
  Group: blue, Precedence 50
  State up
  Capabilities: Stateful, Update, Segment-Routing, Instantiation

```

```
Router# show segment-routing traffic-eng policy name srte_c_100_ep_192.168.0.3
```

```
SR-TE policy database
```

```
-----
```

```

Color: 100, End-point: 192.168.0.3
Name: srte_c_100_ep_192.168.0.3
Status:
  Admin: up Operational: up for 00:13:26 (since Sep 17 22:52:48.365)
Candidate-paths:
  Preference: 100 (configuration)
  Name: B
  Requested BSID: dynamic
  PCC info:
    Symbolic name: cfg_B_discr_100
    PLSF-ID: 2
    Protection Type: protected-preferred
    Maximum SID Depth: 10
  PCE Group: red
  Dynamic (pce 192.168.1.4) (valid)

```

```

Metric Type: TE, Path Accumulated Metric: 10
Attributes:
  Forward Class: 0
  Steering labeled-services disabled: no
  Steering BGP disabled: no
  IPv6 caps enable: no
  Invalidation drop enabled: no

```

BGP SR-TE

BGP may be used to distribute SR Policy candidate paths to an SR-TE head-end. Dedicated BGP SAFI and NLRI have been defined to advertise a candidate path of an SR Policy. The advertisement of Segment Routing policies in BGP is documented in the IETF draft <https://datatracker.ietf.org/doc/draft-ietf-idr-segment-routing-te-policy/>

SR policies with IPv4 and IPv6 end-points can be advertised over BGPv4 or BGPv6 sessions between the SR-TE controller and the SR-TE headend.

The Cisco IOS-XR implementation supports the following combinations:

- IPv4 SR policy advertised over BGPv4 session
- IPv6 SR policy advertised over BGPv4 session
- IPv4 SR policy advertised over BGPv6 session
- IPv6 SR policy advertised over BGPv6 session

Configure BGP SR Policy Address Family at SR-TE Head-End

Perform this task to configure BGP SR policy address family at SR-TE head-end:

SUMMARY STEPS

1. **configure**
2. **router bgp** *as-number*
3. **bgp router-id** *ip-address*
4. **address-family** {**ipv4** | **ipv6**} **sr-policy**
5. **exit**
6. **neighbor** *ip-address*
7. **remote-as** *as-number*
8. **address-family** {**ipv4** | **ipv6**} **sr-policy**
9. **route-policy** *route-policy-name* {**in** | **out**}

DETAILED STEPS

	Command or Action	Purpose
Step 1	configure	

	Command or Action	Purpose
Step 2	router bgp <i>as-number</i> Example: RP/0/RSP0/CPU0:router(config)# router bgp 65000	Specifies the BGP AS number and enters the BGP configuration mode, allowing you to configure the BGP routing process.
Step 3	bgp router-id <i>ip-address</i> Example: RP/0/RSP0/CPU0:router(config-bgp)# bgp router-id 10.1.1.1	Configures the local router with a specified router ID.
Step 4	address-family { ipv4 ipv6 } sr-policy Example: RP/0/RSP0/CPU0:router(config-bgp)# address-family ipv4 sr-policy	Specifies either the IPv4 or IPv6 address family and enters address family configuration submode.
Step 5	exit	
Step 6	neighbor <i>ip-address</i> Example: RP/0/RSP0/CPU0:router(config-bgp)# neighbor 10.10.0.1	Places the router in neighbor configuration mode for BGP routing and configures the neighbor IP address as a BGP peer.
Step 7	remote-as <i>as-number</i> Example: RP/0/RSP0/CPU0:router(config-bgp-nbr)# remote-as 1	Creates a neighbor and assigns a remote autonomous system number to it.
Step 8	address-family { ipv4 ipv6 } sr-policy Example: RP/0/RSP0/CPU0:router(config-bgp-nbr)# address-family ipv4 sr-policy	Specifies either the IPv4 or IPv6 address family and enters address family configuration submode.
Step 9	route-policy <i>route-policy-name</i> { in out } Example: RP/0/RSP0/CPU0:router(config-bgp-nbr-af)# route-policy pass out	Applies the specified policy to IPv4 or IPv6 unicast routes.

Example: BGP SR-TE with BGPv4 Neighbor to BGP SR-TE Controller

The following configuration shows the an SR-TE head-end with a BGPv4 session towards a BGP SR-TE controller. This BGP session is used to signal both IPv4 and IPv6 SR policies.

```
router bgp 65000
bgp router-id 10.1.1.1
!
address-family ipv4 sr-policy
!
address-family ipv6 sr-policy
!
neighbor 10.1.3.1
remote-as 10
description *** eBGP session to BGP SRTE controller ***
address-family ipv4 sr-policy
route-policy pass in
route-policy pass out
!
address-family ipv6 sr-policy
route-policy pass in
route-policy pass out
!
!
```

Example: BGP SR-TE with BGPv6 Neighbor to BGP SR-TE Controller

The following configuration shows an SR-TE head-end with a BGPv6 session towards a BGP SR-TE controller. This BGP session is used to signal both IPv4 and IPv6 SR policies.

```
router bgp 65000
bgp router-id 10.1.1.1
address-family ipv4 sr-policy
!
address-family ipv6 sr-policy
!
neighbor 3001::10:1:3:1
remote-as 10
description *** eBGP session to BGP SRTE controller ***
address-family ipv4 sr-policy
route-policy pass in
route-policy pass out
!
address-family ipv6 sr-policy
route-policy pass in
route-policy pass out
!
!
```

Traffic Steering

Automated Steering

Automated steering (AS) allows service traffic to be automatically steered onto the required transport SLA path programmed by an SR policy.

With AS, BGP automatically steers traffic onto an SR Policy based on the next-hop and color of a BGP service route. The color of a BGP service route is specified by a color extended community attribute. This color is used as a transport SLA indicator, such as min-delay or min-cost.

When the next-hop and color of a BGP service route matches the end-point and color of an SR Policy, BGP automatically installs the route resolving onto the BSID of the matching SR Policy. Recall that an SR Policy on a head-end is uniquely identified by an end-point and color.

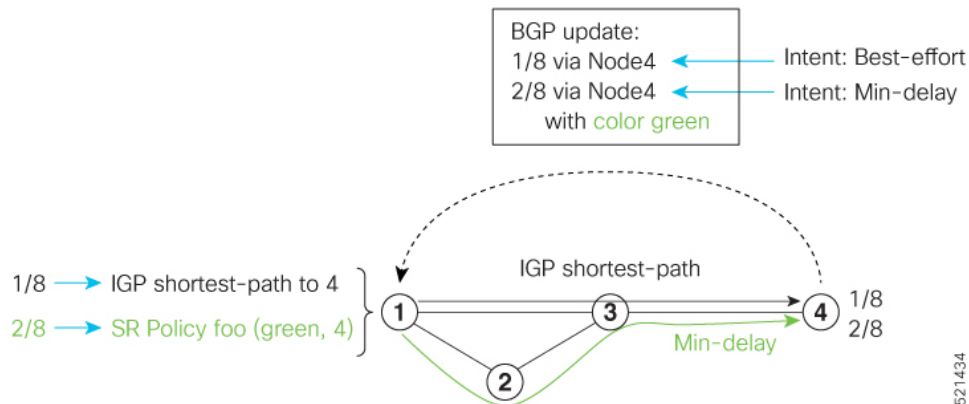

When a BGP route has multiple extended-color communities, each with a valid SR Policy, the BGP process installs the route on the SR Policy giving preference to the color with the highest numerical value.

The granularity of AS behaviors can be applied at multiple levels, for example:

- At a service level—When traffic destined to all prefixes in a given service is associated to the same transport path type. All prefixes share the same color.
- At a destination/prefix level—When traffic destined to a prefix in a given service is associated to a specific transport path type. Each prefix could be assigned a different color.
- At a flow level—When flows destined to the same prefix are associated with different transport path types

AS behaviors apply regardless of the instantiation method of the SR policy, including:

- On-demand SR policy
- Manually provisioned SR policy
- PCE-initiated SR policy

See the [Verifying BGP VRF Information, on page 15](#) and [Verifying Forwarding \(CEF\) Table, on page 16](#) sections for sample output that shows AS implementation.

Color-Only Automated Steering

Color-only steering is a traffic steering mechanism where a policy is created with given color, regardless of the endpoint.

You can create an SR-TE policy for a specific color that uses a NULL end-point (0.0.0.0 for IPv4 NULL, and ::0 for IPv6 NULL end-point). This means that you can have a single policy that can steer traffic that is based on that color and a NULL endpoint for routes with a particular color extended community, but different destinations (next-hop).



Note Every SR-TE policy with a NULL end-point must have an explicit path-option. The policy cannot have a dynamic path-option (where the path is computed by the head-end or PCE) since there is no destination for the policy.

You can also specify a color-only (CO) flag in the color extended community for overlay routes. The CO flag allows the selection of an SR-policy with a matching color, regardless of endpoint Sub-address Family Identifier (SAFI) (IPv4 or IPv6). See [Setting CO Flag, on page 81](#).

Configure Color-Only Steering

```
Router# configure
Router(config)# segment-routing
Router(config-sr)# traffic-eng
Router(config-sr-te)# policy P1
Router(config-sr-te-policy)# color 1 end-point ipv4 0.0.0.0
```

```
Router# configure
Router(config)# segment-routing
Router(config-sr)# traffic-eng
Router(config-sr-te)# policy P2
Router(config-sr-te-policy)# color 2 end-point ipv6 ::0
```

```
Router# show running-configuration
segment-routing
 traffic-eng
  policy P1
    color 1 end-point ipv4 0.0.0.0
  !
  policy P2
    color 2 end-point ipv6 ::
  !
  !
  !
end
```

Setting CO Flag

The BGP-based steering mechanism matches BGP color and next-hop with that of an SR-TE policy. If the policy does not exist, BGP requests SR-PCE to create an SR-TE policy with the associated color, end-point, and explicit paths. For color-only steering (NULL end-point), you can configure a color-only (CO) flag as part of the color extended community in BGP.



Note See [Color-Only Automated Steering, on page 80](#) for information about color-only steering (NULL end-point).

The behavior of the steering mechanism is based on the following values of the CO flags:

co-flag 00	<ol style="list-style-type: none"> 1. The BGP next-hop and color <N, C> is matched with an SR-TE policy of same <N, C>. 2. If a policy does not exist, then IGP path for the next-hop N is chosen.
-------------------	----------------------------------------------------------------------------------------------------------------------------------------------------------------------------------------------------------------------------------------

co-flag 01	<ol style="list-style-type: none"> 1. The BGP next-hop and color <N, C> is matched with an SR-TE policy of same <N, C>. 2. If a policy does not exist, then an SR-TE policy with NULL end-point with the same address-family as N and color C is chosen. 3. If a policy with NULL end-point with same address-family as N does not exist, then an SR-TE policy with any NULL end-point and color C is chosen. 4. If no match is found, then IGP path for the next-hop N is chosen.
-------------------	------------------------------------------------------------------------------------------------------------------------------------------------------------------------------------------------------------------------------------------------------------------------------------------------------------------------------------------------------------------------------------------------------------------------------------------------------------------------------------------------------------------------------------------

Configuration Example

```

Router(config)# extcommunity-set opaque overlay-color
Router(config-ext)# 1 co-flag 01
Router(config-ext)# end-set
Router(config)#
Router(config)# route-policy color
Router(config-rpl)# if destination in (5.5.5.1/32) then
Router(config-rpl-if)# set extcommunity color overlay-color
Router(config-rpl-if)# endif
Router(config-rpl)# pass
Router(config-rpl)# end-policy
Router(config)#

```

Address-Family Agnostic Automated Steering

Address-family agnostic steering uses an SR-TE policy to steer both labeled and unlabeled IPv4 and IPv6 traffic. This feature requires support of IPv6 encapsulation (IPv6 caps) over IPv4 endpoint policy.

IPv6 caps for IPv4 NULL end-point is enabled automatically when the policy is created in Segment Routing Path Computation Element (SR-PCE). The binding SID (BSID) state notification for each policy contains an "ipv6_caps" flag that notifies SR-PCE clients (PCC) of the status of IPv6 caps (enabled or disabled).

An SR-TE policy with a given color and IPv4 NULL end-point could have more than one candidate path. If any of the candidate paths has IPv6 caps enabled, then all of the remaining candidate paths need IPv6 caps enabled. If IPv6 caps is not enabled on all candidate paths of same color and end-point, traffic drops can occur.

You can disable IPv6 caps for a particular color and IPv4 NULL end-point using the **ipv6 disable** command on the local policy. This command disables IPv6 caps on all candidate paths that share the same color and IPv4 NULL end-point.

Disable IPv6 Encapsulation

```

Router# configure
Router(config)# segment-routing
Router(config-sr)# traffic-eng
Router(config-sr-te)# policy P1
Router(config-sr-te-policy)# color 1 end-point ipv4 0.0.0.0
Router(config-sr-te-policy)# ipv6 disable

```

Per-Flow Automated Steering

Table 10: Feature History Table

Feature Name	Release Information	Feature Description
Per-Flow Automated Steering	Release 7.3.1	<p>This feature lets you auto-steer traffic on an SR policy based on the attributes of incoming packets, called Per-flow policy (PFP).</p> <p>Packets are classified and marked using forward classes (FCs). A Per-Flow Policy (PFP) steers the marked packets based on the mapping between an FC and its path. In effect, the feature auto-steers traffic with SR PFP based on its markings, and then switches the traffic to an appropriate path based on the packet FCs.</p>
Per-Flow Automated Steering: L2 EVPN BGP Services	Release 7.4.1	<p>This feature introduces support for the following:</p> <ul style="list-style-type: none"> • BGP EVPN (single-home/multi-homed) over a per-flow policy (PFP) • Packet classification using Layer 2 class of service (CoS) values

The steering of traffic through a Segment Routing (SR) policy is based on the candidate paths of that policy. For a given policy, a candidate path specifies the path to be used to steer traffic to the policy's destination. The policy determines which candidate path to use based on the candidate path's preference and state. The candidate path that is valid and has the highest preference is used to steer all traffic using the given policy. This type of policy is called a Per-Destination Policy (PDP).

Per-Flow Automated Traffic Steering using SR-TE Policies introduces a way to steer traffic on an SR policy based on the attributes of the incoming packets, called a Per-Flow Policy (PFP).

A PFP provides up to 8 "ways" or options to the endpoint. With a PFP, packets are classified by a classification policy and marked using internal tags called forward classes (FCs). The FC setting of the packet selects the "way". For example, this "way" can be a traffic-engineered SR path, using a low-delay path to the endpoint. The FC is represented as a numeral with a value of 0 to 7.

A PFP defines an array of FC-to-PDP mappings. A PFP can then be used to steer traffic into a given PDP based on the FC assigned to a packet.

As with PDPs, PFPs are identified by a {headend, color, endpoint} tuple. The color associated with a given FC corresponds to a valid PDP policy of that color and same endpoint as the parent PFP. So PFP policies contain mappings of different FCs to valid PDP policies of different colors. Every PFP has an FC designated

as its default FC. The default FC is associated to packets with a FC undefined under the PFP or for packets with a FC with no valid PDP policy.

The following example shows a per-flow policy from Node1 to Node4:

Figure 3: PFP Example

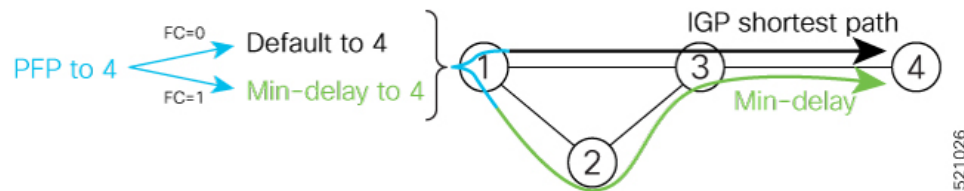

- FC=0 -> shortest path to Node4
 - IGP shortest path = 16004
- FC=1 -> Min-delay path to Node4
 - SID list = {16002,16004}

The same on-demand instantiation behaviors of PDPs apply to PFPs. For example, an edge node automatically (on demand) instantiates Per-Flow SR Policy paths to an endpoint by service route signaling. Automated Steering steers the service route in the matching SR Policy.

Figure 4: PFP with ODN Example

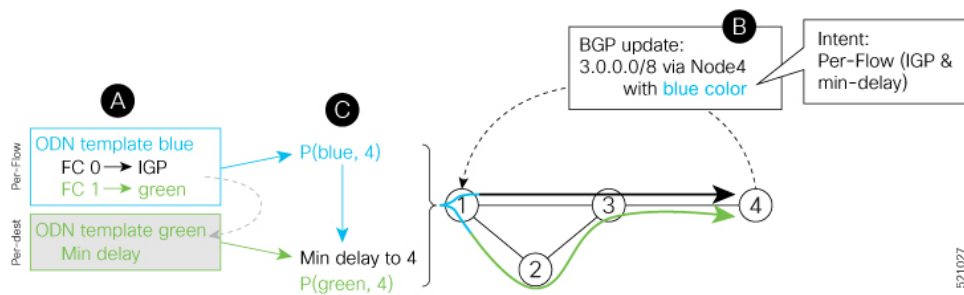

Like PDPs, PFPs have a binding SID (BSID). Existing SR-TE automated steering (AS) mechanisms for labeled traffic (via BSID) and unlabeled traffic (via BGP) onto a PFP is similar to that of a PDP. For example, a packet having the BSID of a PFP as the top label is steered onto that PFP. The classification policy on the ingress interface marks the packet with an FC based on the configured class-map. The packet is then steered to the PDP that corresponds to that FC.

Usage Guidelines and Limitations

The following guidelines and limitations apply to the platform when acting as a head-end of a PFP policy:

- BGP IPv4 unicast over PFP (steered via ODN/AS) is supported
- BGP IPv6 unicast (with IPv4 next-hop [6PE]) over PFP (steered via ODN/AS) is supported
- BGP IPv6 unicast (with IPv6 next-hop) over PFP (steered via ODN/AS) is supported
- BGP VPNv4 over PFP (steered via ODN/AS) is supported
- BGP VPNv6 (6VPE) over PFP (steered via ODN/AS) is supported

- BGP EVPN (single-home/multi-homed) over PFP (steered via ODN/AS) is supported
- Pseudowire and VPLS over PFP (steered with preferred-path) are supported
- BGP multipath is supported
- BGP PIC is not supported
- Labeled traffic (Binding SID as top-most label in the stack) steered over PFP is supported
- When not explicitly configured, FC 0 is the default FC.
- A PFP is considered valid as long as its default FC has a valid PDP.
- An ingress PBR policy applied to an input interface is used to classify flows and set corresponding forward class (FC) values.
- The following counters are supported:
 - PFP's BSID counter (packet, bytes)
 - Per-FC counters (packet, byte)
 - Collected from the PDP's segment-list-per-path egress counters
 - If an SR policy is used for more than one purpose (as a regular policy as well as a PDP under one or more PFPs), then the collected counters will represent the aggregate of all contributions. To preserve independent counters, it is recommended that an SR policy be used only for one purpose.
- Inbound packet classification, based on the following fields, is supported:
 - IP precedence
 - IP DSCP
 - L3 ACL-based (L3 source/destination IP; L4 source/destination port)
 - MPLS EXP
 - Layer 2 CoS
 - MAC ACL
- A color associated with a PFP SR policy cannot be used by a non-PFP SR policy. For example, if a per-flow ODN template for color 100 is configured, then the system will reject the configuration of any non-PFP SR policy using the same color. You must assign different color value ranges for PFP and non-PFP SR policies.

Configuring ODN Template for PFP Policies: Example

The following example depicts an ODN template for PFP policies that includes three FCs.

The example also includes the corresponding ODN templates for PDPs as follows:

- FC0 (default FC) mapped to color 10 = Min IGP path
- FC1 mapped to color 20 = Flex Algo 128 path

- FC2 mapped to color 30 = Flex Algo 129 path

```

segment-routing
traffic-eng
  on-demand color 10
    dynamic
      metric
        type igp
    !
  !
  on-demand color 20
    constraints
      segments
        sid-algorithm 128
    !
  !
  on-demand color 30
    constraints
      segments
        sid-algorithm 129
    !
  !
  on-demand color 1000
    per-flow
      forward-class 0 color 10
      forward-class 1 color 20
      forward-class 2 color 30

```

Manually Configuring a PFP and PDPs: Example

The following example depicts a manually defined PFP that includes three FCs and corresponding manually defined PDPs.

The example also includes the corresponding PDPs as follows:

- FC0 (default FC) mapped to color 10 = Min IGP path
- FC1 mapped to color 20 = Min TE path
- FC2 mapped to color 30 = Min delay path

```

segment-routing
traffic-eng
  policy MyPerFlow
    color 1000 end-point ipv4 10.1.1.4
    candidate-paths
      preference 100
    per-flow
      forward-class 0 color 10
      forward-class 1 color 20
      forward-class 2 color 30
    !
  policy MyLowIGP
    color 10 end-point ipv4 10.1.1.4
    candidate-paths
      preference 100
    dynamic
      metric type igp

```

```

!
policy MyLowTE
  color 20 end-point ipv4 10.1.1.4
  candidate-paths
  preference 100
  dynamic
  metric type te
!
policy MyLowDelay
  color 30 end-point ipv4 10.1.1.4
  candidate-paths
  preference 100
  dynamic
  metric type delay

```

Configuring Ingress Classification: Example

An PBR policy is used to classify and mark traffic to a corresponding forwarding class.

The following shows an example of such ingress classification policy:

```

class-map type traffic match-any MinDelay
  match dscp 46
end-class-map
!
class-map type traffic match-any PremiumHosts
  match access-group ipv4 PrioHosts
end-class-map
!
!
policy-map type pbr MyPerFlowClassificationPolicy
  class type traffic MinDelay
    set forward-class 2
  !
  class type traffic PremiumHosts
    set forward-class 1
  !
  class type traffic class-default
  !
end-policy-map
!
interface GigabitEthernet0/0/0/0
  description PE_Ingress_Interface
  service-policy type pbr input MyPerFlowClassificationPolicy
!

```

Determining Per-Flow Policy State

A PFP is brought down for the following reasons:

- The PDP associated with the default FC is in a down state.
- All FCs are associated with PDPs in a down state.
- The FC assigned as the default FC is missing in the forward class mapping.

Scenario 1—FC 0 (default FC) is not configured in the FC mappings below:

```

policy foo
  color 1 end-point ipv4 10.1.1.1
  per-flow
  forward-class 1 color 10

```

```
forward-class 2 color 20
```

Scenario 2—FC 1 is configured as the default FC, however it is not present in the FC mappings:

```
policy foo
  color 1 end-point ipv4 10.1.1.1
  per-flow
    forward-class 0 color 10
    forward-class 2 color 20
    forward-class default 1
```

Using Binding Segments

The binding segment is a local segment identifying an SR-TE policy. Each SR-TE policy is associated with a binding segment ID (BSID). The BSID is a local label that is automatically allocated for each SR-TE policy when the SR-TE policy is instantiated.



Note In Cisco IOS XR 6.3.2 and later releases, you can specify an explicit BSID for an SR-TE policy. See the following **Explicit Binding SID** section.

BSID can be used to steer traffic into the SR-TE policy and across domain borders, creating seamless end-to-end inter-domain SR-TE policies. Each domain controls its local SR-TE policies; local SR-TE policies can be validated and rerouted if needed, independent from the remote domain's head-end. Using binding segments isolates the head-end from topology changes in the remote domain.

Packets received with a BSID as top label are steered into the SR-TE policy associated with the BSID. When the BSID label is popped, the SR-TE policy's SID list is pushed.

BSID can be used in the following cases:

- Multi-Domain (inter-domain, inter-autonomous system)—BSIDs can be used to steer traffic across domain borders, creating seamless end-to-end inter-domain SR-TE policies.
- Large-Scale within a single domain—The head-end can use hierarchical SR-TE policies by nesting the end-to-end (edge-to-edge) SR-TE policy within another layer of SR-TE policies (aggregation-to-aggregation). The SR-TE policies are nested within another layer of policies using the BSIDs, resulting in seamless end-to-end SR-TE policies.
- Label stack compression—If the label-stack size required for an SR-TE policy exceeds the platform capability, the SR-TE policy can be seamlessly stitched to, or nested within, other SR-TE policies using a binding segment.
- BGP SR-TE Dynamic—The head-end steers the packet into a BGP-based FIB entry whose next hop is a binding-SID.

Explicit Binding SID

Use the **binding-sid mpls label** command in SR-TE policy configuration mode to specify the explicit BSID. Explicit BSIDs are allocated from the segment routing local block (SRLB) or the dynamic range of labels. A best-effort is made to request and obtain the BSID for the SR-TE policy. If requested BSID is not available (if it does not fall within the available SRLB or is already used by another application or SR-TE policy), the policy stays down.

Use the **binding-sid explicit {fallback-dynamic | enforce-srlb}** command to specify how the BSID allocation behaves if the BSID value is not available.

- Fallback to dynamic allocation – If the BSID is not available, the BSID is allocated dynamically and the policy comes up:

```
Router# configure
Router(config)# segment-routing
Router(config-sr)# traffic-eng
Router(config-sr-te)# binding-sid explicit fallback-dynamic
```

- Strict SRLB enforcement – If the BSID is not within the SRLB, the policy stays down:

```
Router# configure
Router(config)# segment-routing
Router(config-sr)# traffic-eng
Router(config-sr-te)# binding-sid explicit enforce-srlb
```

This example shows how to configure an SR policy to use an explicit BSID of 1000. If the BSID is not available, the BSID is allocated dynamically and the policy comes up.

```
segment-routing
traffic-eng
binding-sid explicit fallback-dynamic
policy goo
binding-sid mpls 1000
!
!
!
```

Stitching SR-TE Polices Using Binding SID: Example

In this example, three SR-TE policies are stitched together to form a seamless end-to-end path from node 1 to node 10. The path is a chain of SR-TE policies stitched together using the binding-SIDs of intermediate policies, providing a seamless end-to-end path.

Figure 5: Stitching SR-TE Polices Using Binding SID

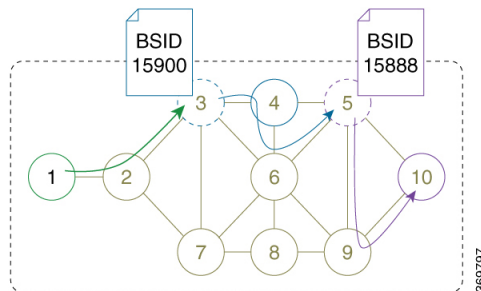

Table 11: Router IP Address

Router	Prefix Address	Prefix SID/Adj-SID
3	Loopback0 - 10.1.1.3	Prefix SID - 16003

Router	Prefix Address	Prefix SID/Adj-SID
4	Loopback0 - 10.1.1.4 Link node 4 to node 6 - 10.4.6.4	Prefix SID - 16004 Adjacency SID - dynamic
5	Loopback0 - 10.1.1.5	Prefix SID - 16005
6	Loopback0 - 10.1.1.6 Link node 4 to node 6 - 10.4.6.6	Prefix SID - 16006 Adjacency SID - dynamic
9	Loopback0 - 10.1.1.9	Prefix SID - 16009
10	Loopback0 - 10.1.1.10	Prefix SID - 16010

Step 1

On node 5, do the following:

- Define an SR-TE policy with an explicit path configured using the loopback interface IP addresses of node 9 and node 10.
- Define an explicit binding-SID (**mpls label 15888**) allocated from SRLB for the SR-TE policy.

Example:**Node 5**

```
segment-routing
traffic-eng
segment-list PATH-9_10
index 10 address ipv4 10.1.1.9
index 20 address ipv4 10.1.1.10
!
policy foo
binding-sid mpls 15888
color 777 end-point ipv4 10.1.1.10
candidate-paths
preference 100
explicit segment-list PATH5-9_10
!
!
!
!
!
```

```
RP/0/RSP0/CPU0:Node-5# show segment-routing traffic-eng policy color 777
```

```
SR-TE policy database
-----
```

```
Color: 777, End-point: 10.1.1.10
Name: srte_c_777_ep_10.1.1.10
Status:
Admin: up Operational: up for 00:00:52 (since Aug 19 07:40:12.662)
Candidate-paths:
Preference: 100 (configuration) (active)
Name: foo
Requested BSID: 15888
PCC info:
Symbolic name: cfg_foo_discr_100
PLSP-ID: 70
```

```

    Explicit: segment-list PATH-9_10 (valid)
    Weight: 1, Metric Type: TE
    16009 [Prefix-SID, 10.1.1.9]
    16010 [Prefix-SID, 10.1.1.10]
Attributes:
  Binding SID: 15888 (SRLB)
  Forward Class: 0
  Steering BGP disabled: no
  IPv6 caps enable: yes

```

Step 2 On node 3, do the following:

a) Define an SR-TE policy with an explicit path configured using the following:

- Loopback interface IP address of node 4
- Interface IP address of link between node 4 and node 6
- Loopback interface IP address of node 5
- Binding-SID of the SR-TE policy defined in Step 1 (**mpls label 15888**)

Note This last segment allows the stitching of these policies.

b) Define an explicit binding-SID (**mpls label 15900**) allocated from SRLB for the SR-TE policy.

Example:

Node 3

```

segment-routing
traffic-eng
segment-list PATH-4_4-6_5_BSID
index 10 address ipv4 10.1.1.4
index 20 address ipv4 10.4.6.6
index 30 address ipv4 10.1.1.5
index 40 mpls label 15888
!
policy baa
binding-sid mpls 15900
color 777 end-point ipv4 10.1.1.5
candidate-paths
preference 100
explicit segment-list PATH-4_4-6_5_BSID
!
!
!
!
!
RP/0/RSP0/CPU0:Node-3# show segment-routing traffic-eng policy color 777

SR-TE policy database
-----

Color: 777, End-point: 10.1.1.5
Name: srte_c_777_ep_10.1.1.5
Status:
  Admin: up Operational: up for 00:00:32 (since Aug 19 07:40:32.662)
Candidate-paths:
  Preference: 100 (configuration) (active)
  Name: baa
  Requested BSID: 15900

```

```

PCC info:
  Symbolic name: cfg_baa_discr_100
  PLSP-ID: 70
Explicit: segment-list PATH-4_4-6_5_BSID (valid)
  Weight: 1, Metric Type: TE
    16004 [Prefix-SID, 10.1.1.4]
    80005 [Adjacency-SID, 10.4.6.4 - 10.4.6.6]
    16005 [Prefix-SID, 10.1.1.5]
    15888
Attributes:
  Binding SID: 15900 (SRLB)
  Forward Class: 0
  Steering BGP disabled: no
  IPv6 caps enable: yes

```

Step 3 On node 1, define an SR-TE policy with an explicit path configured using the loopback interface IP address of node 3 and the binding-SID of the SR-TE policy defined in step 2 (**mpls label 15900**). This last segment allows the stitching of these policies.

Example:

Node 1

```

segment-routing
traffic-eng
  segment-list PATH-3_BSID
  index 10 address ipv4 10.1.1.3
  index 20 mpls label 15900
!
policy bar
  color 777 end-point ipv4 10.1.1.3
  candidate-paths
  preference 100
  explicit segment-list PATH-3_BSID
!
!
!
!
!
!
!

```

```
RP/0/RSP0/CPU0:Node-1# show segment-routing traffic-eng policy color 777
```

```
SR-TE policy database
```

```

-----
Color: 777, End-point: 10.1.1.3
Name: srte_c_777_ep_10.1.1.3
Status:
  Admin: up Operational: up for 00:00:12 (since Aug 19 07:40:52.662)
Candidate-paths:
  Preference: 100 (configuration) (active)
  Name: bar
  Requested BSID: dynamic
  PCC info:
    Symbolic name: cfg_bar_discr_100
    PLSP-ID: 70
  Explicit: segment-list PATH-3_BSID (valid)
    Weight: 1, Metric Type: TE
      16003 [Prefix-SID, 10.1.1.3]
      15900
Attributes:
  Binding SID: 80021

```

```
Forward Class: 0
Steering BGP disabled: no
IPv6 caps enable: yes
```

L2VPN Preferred Path

EVPN VPWS Preferred Path over SR-TE Policy feature allows you to set the preferred path between the two end-points for EVPN VPWS pseudowire (PW) using SR-TE policy.

L2VPN VPLS or VPWS Preferred Path over SR-TE Policy feature allows you to set the preferred path between the two end-points for L2VPN Virtual Private LAN Service (VPLS) or Virtual Private Wire Service (VPWS) using SR-TE policy.

Refer to the [EVPN VPWS Preferred Path over SR-TE Policy](#) and [L2VPN VPLS or VPWS Preferred Path over SR-TE Policy](#) sections in the "L2VPN Services over Segment Routing for Traffic Engineering Policy" chapter of the *L2VPN and Ethernet Services Configuration Guide*.

Static Route over Segment Routing Policy

This feature allows you to specify a Segment Routing (SR) policy as an interface type when configuring static routes for MPLS data planes.

For information on configuring static routes, see the "Implementing Static Routes" chapter in the *Routing Configuration Guide for Cisco ASR 9000 Series Routers*.

Configuration Example

The following example depicts a configuration of a static route for an IPv4 destination over an SR policy.

```
Router(config)# router static
Router(config-static)# address-family ipv4 unicast
Router(config-static-afi)# 10.1.100.100/32 sr-policy sample-policy
```

Running Configuration

```
Router# show run segment-routing traffic-eng

segment-routing
 traffic-eng
  segment-list sample-SL
  index 10 mpls adjacency 10.1.1.102
  index 20 mpls adjacency 10.1.1.103
  !
 policy sample-policy
  color 777 end-point ipv4 10.1.1.103
  candidate-paths
  preference 100
  explicit segment-list sample-SL

Router# show run segment-routing traffic-eng

router static
 address-family ipv4 unicast
  10.1.1.4/32 sr-policy srte_c_200_ep_10.1.1.4
  !
```

!

Verification

```
Router# show segment-routing traffic-eng policy candidate-path name sample-policy
```

```
SR-TE policy database
```

```
-----
```

```
Color: 777, End-point: 10.1.1.103
Name: srte_c_777_ep_10.1.1.103
Status:
  Admin: up Operational: up for 00:06:35 (since Jan 17 14:34:35.120)
Candidate-paths:
  Preference: 100 (configuration) (active)
  Name: sample-policy
  Requested BSID: dynamic
  PCC info:
    Symbolic name: cfg_sample-policy_discr_100
    PLSP-ID: 5
  Constraints:
    Protection Type: protected-preferred
    Maximum SID Depth: 9
  Explicit: segment-list sample-SL (valid)
    Weight: 1, Metric Type: TE
    SID[0]: 100102 [Prefix-SID, 10.1.1.102]
    SID[1]: 100103 [Prefix-SID, 10.1.1.103]
Attributes:
  Binding SID: 24006
  Forward Class: Not Configured
  Steering labeled-services disabled: no
  Steering BGP disabled: no
  IPv6 caps enable: yes
  Invalidation drop enabled: no
  Max Install Standby Candidate Paths: 0
```

```
Router# show static sr-policy sample-policy
```

```
SR-Policy-Name      State  Binding-label Interface      ifhandle  VRF
Paths
sample-policy      Up    24006      srte_c_777_ep_10.1.1.103  0x2000803c default
10.1.100.100/32
Reference count=1, Internal flags=0x0
Last Policy notification was Up at Jan 17 13:39:46.478
```

```
Router# show route 10.1.100.100/32
```

```
Routing entry for 10.1.100.100/32
  Known via "static", distance 1, metric 0
  Installed Jan 17 14:35:40.969 for 00:06:38
  Routing Descriptor Blocks
    directly connected, via srte_c_777_ep_10.1.1.103
    Route metric is 0
  No advertising protos.
```

```
Router# show route 10.1.100.100/32 detail
```

```
Routing entry for 10.1.100.100/32
  Known via "static", distance 1, metric 0
  Installed Jan 17 14:35:40.969 for 00:06:44
  Routing Descriptor Blocks
```

```

directly connected, via srte_c_777_ep_10.1.1.103
  Route metric is 0
  Label: None
  Tunnel ID: None
  Binding Label: 0x5dc6 (24006)
  Extended communities count: 0
  NHID: 0x0 (Ref: 0)
Route version is 0x1 (1)
No local label
IP Precedence: Not Set
QoS Group ID: Not Set
Flow-tag: Not Set
Fwd-class: Not Set
Route Priority: RIB_PRIORITY_STATIC (9) SVD Type RIB_SVD_TYPE_LOCAL
Download Priority 3, Download Version 3169
No advertising protos.

```

```
Router# show cef 10.1.100.100/32
```

```

10.1.100.100/32, version 3169, internal 0x1000001 0x30 (ptr 0x8b1b95d8) [1], 0x0 (0x0), 0x0
(0x0)
Updated Jan 17 14:35:40.971
Prefix Len 32, traffic index 0, precedence n/a, priority 3
gateway array (0x8a92f228) reference count 1, flags 0x2010, source rib (7), 0 backups
[1 type 3 flags 0x48441 (0x8a9d1b68) ext 0x0 (0x0)]
LW-LDI[type=0, refc=0, ptr=0x0, sh-ldi=0x0]
gateway array update type-time 1 Jan 17 14:35:40.971
LDI Update time Jan 17 14:35:40.972
via local-label 24006, 3 dependencies, recursive [flags 0x0]
path-idx 0 NHID 0x0 [0x8ac59f30 0x0]
recursion-via-label
next hop via 24006/1/21

Load distribution: 0 (refcount 1)

Hash OK Interface Address
0 Y recursive 24006/1

```

Autoroute Include

You can configure SR-TE policies with Autoroute Include to steer specific IGP (IS-IS, OSPF) prefixes, or all prefixes, over non-shortest paths and to divert the traffic for those prefixes on to the SR-TE policy.

The **autoroute include all** option applies Autoroute Announce functionality for all destinations or prefixes.

The **autoroute include ipv4 address** option applies Autoroute Destination functionality for the specified destinations or prefixes. This option is supported for IS-IS only; it is not supported for OSPF.

The Autoroute SR-TE policy adds the prefixes into the IGP, which determines if the prefixes on the endpoint or downstream of the endpoint are eligible to use the SR-TE policy. If a prefix is eligible, then the IGP checks if the prefix is listed in the Autoroute Include configuration. If the prefix is included, then the IGP downloads the prefix route with the SR-TE policy as the outgoing path.

Usage Guidelines and Limitations

- Autoroute Include supports three metric types:
 - Default (no metric): The path over the SR-TE policy inherits the shortest path metric.

- Absolute (constant) metric: The shortest path metric to the policy endpoint is replaced with the configured absolute metric. The metric to any prefix that is Autoroute Included is modified to the absolute metric. Use the **autoroute metric constant** *constant-metric* command, where *constant-metric* is from 1 to 2147483647.
- Relative metric: The shortest path metric to the policy endpoint is modified with the relative value configured (plus or minus). Use the **autoroute metric relative** *relative-metric* command, where *relative-metric* is from -10 to +10.



Note To prevent load-balancing over IGP paths, you can specify a metric that is lower than the value that IGP takes into account for autorouted destinations (for example, **autoroute metric relative -1**).

- LDP to SR-TE interworking is not supported.

Configuration Examples

The following example shows how to configure autoroute include for all prefixes:

```
Router# configure
Router(config)# segment-routing
Router(config-sr)# traffic-eng
Router(config-sr-te)#policy P1
Router(config-sr-te-policy)# color 20 end-point ipv4 10.1.1.2
Router(config-sr-te-policy)# autoroute include all
Router(config-sr-te-policy)# candidate-paths
Router(config-sr-te-policy-path)# preference 100
Router(config-sr-te-pp-index)# explicit segment-list Plist-1
```

The following example shows how to configure autoroute include for the specified IPv4 prefixes:



Note This option is supported for IS-IS only; it is not supported for OSPF.

```
Router# configure
Router(config)# segment-routing
Router(config-sr)# traffic-eng
Router(config-sr-te)#policy P1
Router(config-sr-te-policy)# color 20 end-point ipv4 10.1.1.2
Router(config-sr-te-policy)# autoroute include ipv4 10.1.1.21/32
Router(config-sr-te-policy)# autoroute include ipv4 10.1.1.23/32
Router(config-sr-te-policy)# autoroute metric constant 1
Router(config-sr-te-policy)# candidate-paths
Router(config-sr-te-policy-path)# preference 100
Router(config-sr-te-pp-index)# explicit segment-list Plist-1
```

Policy-Based Tunnel Selection for SR-TE Policy

Policy-Based Tunnel Selection (PBTS) is a mechanism that lets you direct traffic into specific SR-TE policies based on different classification criteria. PBTS benefits Internet service providers (ISPs) that carry voice and data traffic through their networks, who want to route this traffic to provide optimized voice service.

PBTS works by selecting SR-TE policies based on the classification criteria of the incoming packets, which are based on the IP precedence, experimental (EXP), differentiated services code point (DSCP), or type of service (ToS) field in the packet. Default-class configured for paths is always zero (0). If there is no TE for a given forward-class, then the default-class (0) will be tried. If there is no default-class, then the packet is dropped. PBTS supports up to seven (exp 1 - 7) EXP values associated with a single SR-TE policy.

For more information about PBTS, refer to the "Policy-Based Tunnel Selection" section in the *MPLS Configuration Guide for Cisco ASR 9000 Series Routers* and *MPLS Configuration Guide*.

Configure Policy-Based Tunnel Selection for SR-TE Policies

The following section lists the steps to configure PBTS for an SR-TE policy.



Note Steps 1 through 4 are detailed in the "Implementing MPLS Traffic Engineering" chapter of the *MPLS Configuration Guide for Cisco ASR 9000 Series Routers* and *MPLS Configuration Guide*.

1. Define a class-map based on a classification criteria.
2. Define a policy-map by creating rules for the classified traffic.
3. Associate a forward-class to each type of ingress traffic.
4. Enable PBTS on the ingress interface, by applying this service-policy.
5. Create one or more egress SR-TE policies (to carry packets based on priority) to the destination and associate the egress SR-TE policy to a forward-class.

Configuration Example

```
Router(config)# segment-routing traffic-eng
Router(config-sr-te)# policy POLICY-PBTS
Router(config-sr-te-policy)# color 1001 end-point ipv4 10.1.1.20
Router(config-sr-te-policy)# autoroute
Router(config-sr-te-policy-autoroute)# include all
Router(config-sr-te-policy-autoroute)# forward-class 1
Router(config-sr-te-policy-autoroute)# exit
Router(config-sr-te-policy)# candidate-paths
Router(config-sr-te-policy-path)# preference 1
Router(config-sr-te-policy-path-pref)# explicit segment-list SIDLIST1
Router(config-sr-te-policy-path-pref)# exit
Router(config-sr-te-policy-path-pref)# exit
Router(config-sr-te-policy-path-pref)# exit
Router(config-sr-te-policy-path-pref)# exit
Router(config-sr-te-policy-path-pref)# preference 2
Router(config-sr-te-policy-path-pref)# dynamic
Router(config-sr-te-policy-path-pref)# metric
Router(config-sr-te-policy-path-pref)# type te
Router(config-sr-te-policy-path-pref)# commit
```

Running Configuration

```
segment-routing
traffic-eng
policy POLICY-PBTS
  color 1001 end-point ipv4 10.1.1.20
  autoroute
  include all
  forward-class 1
  !
candidate-paths
  preference 1
  explicit segment-list SIDLIST1
  !
  !
  preference 2
  dynamic
  metric
  type te
```

SR-TE Automated Steering Without BGP Prefix Path Label

Table 12: Feature History Table

Feature Name	Release Information	Feature Description
SR-TE Automated Steering Without BGP Prefix Path Label	Release 7.9.1	<p>This feature allows traffic to a BGP service route to be steered over an SR-TE policy using automated-steering principles without imposing the service route's prefix label.</p> <p>This feature allows you to deploy a centralized BGP EPE solution for 6PE in an SR-MPLS network.</p> <p>This feature introduces the bgp prefix-path-label ignore command.</p>

This feature allows traffic to a BGP service route to be steered over an SR-TE policy using automated-steering principles without imposing the service route's prefix label (see [Automated Steering](#)). BGP ignores the programming of the label associated with a prefix path (for example, 6PE/VPN label) when recursing onto the BSID of an SR-TE policy with this feature enabled.

This feature allows you to deploy a [Use Case: Centralized BGP EPE for 6PE in an SR-MPLS Network](#).

Usage Guidelines and Limitations

This functionality applies to local/manually configured SR-TE candidate-paths.

This functionality does not apply to on-demand SR-TE candidate-paths triggered by ODN.

This functionality does not apply to SR-TE candidate-paths instantiated via PCEP (PCE-initiated) or BGP-TE.

Configuration

Use the **bgp prefix-path-label ignore** command in SR-TE policy steering config mode to indicate BGP ignores the programming of the label associated with a prefix path (for example, 6PE/VPN label) when recursing onto the BSID of an SR-TE policy with this feature enabled.

```
Router(config)# segment-routing
Router(config-sr)# traffic-eng
Router(config-sr-te)# policy FOO
Router(config-sr-te-policy)# steering
Router(config-sr-te-policy-steering)# bgp prefix-path-label ignore
Router(config-sr-te-policy-steering)# exit
Router(config-sr-te-policy)# color 100 end-point ipv4 0.0.0.0
Router(config-sr-te-policy)# candidate-paths
Router(config-sr-te-policy-path)# preference 100
Router(config-sr-te-policy-path-pref)# explicit segment-list sample-sl
```

Verification

The following output displays the SR-TE policy (SR policy color 100, IPv4 null end-point) details showing the ignore prefix label steering behavior:

```
Router# show segment-routing traffic-eng policy candidate-path name FOO private
```

```
SR-TE policy database
-----

Color: 100, End-point: 0.0.0.0 ID: 3
  Name: srte_c_100_ep_0.0.0.0
  Status:
    Admin: up Operational: up for 00:10:07 (since Feb  2 12:58:43.554)
  Candidate-paths:
    Preference: 100 (configuration) (active)
    Originator: ASN 0 node-address <None> discriminator: 100
    Name: FOO
    Requested BSID: dynamic
    Constraints:
      Protection Type: protected-preferred
      Maximum SID Depth: 10
    ID: 1
    Source: 20.1.0.100
    Stale: no
    Checkpoint flags: 0x00000000
  Steering:
    Client: BGP
      Disabled: no
      Ignore prefix label: yes
    Explicit: segment-list sample-sl (valid)
    Weight: 1, Metric Type: TE
    IGP area: 2
      SID[0]: 16102 [Prefix-SID: 20.1.0.102, Algorithm: 0]
      SID[1]: 16103 [Prefix-SID: 20.1.0.103, Algorithm: 0]
      SID[2]: 24008 [Adjacency-SID, 15:15:15::4 - 15:15:15::5]
  LSPs:
  . . .

  Attributes:
    Binding SID: 24030
    Forward Class: Not Configured
    Steering labeled-services disabled: no
    Steering BGP disabled: no
    IPv6 caps enable: yes
```

```

Invalidation drop enabled: no
Max Install Standby Candidate Paths: 0
Notification to clients:
  Binding SID: 24030
  Bandwidth : 0 Kbps (0 Kbps)
  State: UP
  Flags: [add] [ipv6_caps] [ignore_prefix_label]
  Metric Type: NONE
  Metric Value: 2147483647
  Admin Distance: 100
ifhandle: 0x00000170
Source: 20.1.0.100
Transition count: 1
LSPs created count: 1
Reoptimizations completed count: 1
Retry Action Flags: 0x00000000, ()
Last Retry Timestamp: never (0 seconds ago)
Policy reference: 0x1f81e50

```

The following output shows that BGP received the ignore prefix label steering behavior for an SR policy color 100 and IPv4 null end-point:

```

Router# show bgp nexthops 0.0.0.0 color 100 | include "BGP prefix label"

    BGP prefix label: [No]

```

The following output shows the details for a IPv6 BGP global route (151:1::/64) learned from an IPv4 next-hop (6PE) that is steered over an SR policy (BSID 24030). BGP programs the prefix path ignoring its label.

```

Router# show bgp ipv6 labeled-unicast 151:1::/64 detail

BGP routing table entry for 151:1::/64
Versions:
  Process          bRIB/RIB  SendTblVer
  Speaker          2003      2003
    Local Label: 81718 (no rewrite);
    Flags: 0x003e1001+0x30010000;
Last Modified: Nov 23 16:59:17.891 for 00:00:03
Paths: (400 available, best #1)
  Advertised IPv6 Unicast paths to update-groups (with more than one peer):
    0.2
  Advertised IPv6 Labeled-unicast paths to update-groups (with more than one peer):
    0.3
  Path #1: Received by speaker 0
  Flags: 0xa480000001060205+0x01, import: 0x020
  Advertised IPv6 Unicast paths to update-groups (with more than one peer):
    0.2
  Advertised IPv6 Labeled-unicast paths to update-groups (with more than one peer):
    0.3
  300, (Received from a RR-client)
    5.5.3.1 C:100 (bsid:24030) (admin 100) (metric 2147483647) from 4.4.4.1 (5.5.5.5),
if-handle 0x00000170
    Prefix Label not imposed due to SR policy config

```

Use Case: Centralized BGP EPE for 6PE in an SR-MPLS Network

In this use case, an operator wants to control the egress peering router/egress transit autonomous system (AS) used by selected Internet IPv6 prefixes. To achieve this, SR policies with explicit paths are used to steer traffic to an intended egress peering router and intended egress transit AS. BGP-EPE SIDs are used in order to force traffic onto an intended egress transit AS. Traffic steering follows SR-TE automated-steering principles.

The following key features enable the use-case:

- **SR-TE Policy with Explicit Path** — Allows the last segment of an SR policy's SID list to be associated with an EPE-enabled BGPv6 neighbor.
- **SR-TE Automated Steering Without BGP Prefix Path Label** — Allows traffic to an Internet IPv6 prefix to be steered over an SR-TE policy without imposing the 6PE label learned from the original advertising router.

Topology

The below topology shows a single-stack IPv4 SR-MPLS and BGP-free network that delivers Internet IPv6 connectivity using 6PE.

Peering routers 2 and 3 learn IPv6 reachability through transit AS's (ASBR routers 4, 5, 6) via eBGPv6 neighbors.

BGP EPE SIDs are enabled on external BGPv6 neighbors at router 2 (for example, EPE label 24024) and router 3 (for example, EPE labels 24035 and 24036).

Figure 6: Network Setup

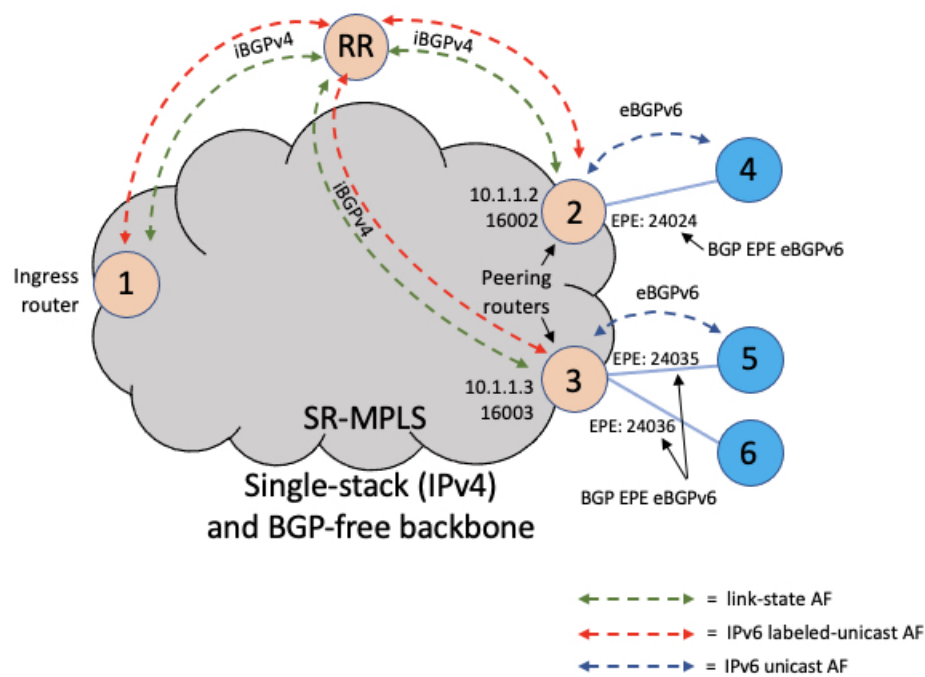

BGP EPE Propagation via BGP-LS

Peering routers 2 and 3 advertise their EPE-enabled neighbors via BGP-LS. As a result, ingress router node 1 learns those EPE-enabled neighbors via BGP-LS. This allows the SR-TE database at the ingress router to include the external links.

Figure 7: BGP-LS

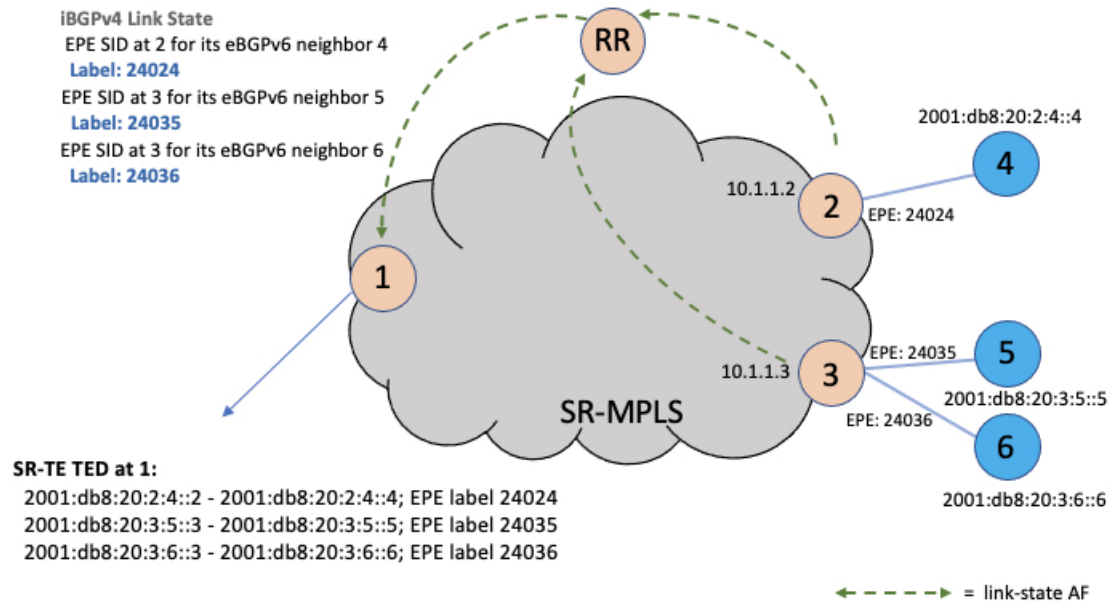
**Steady State (Non-Traffic-Engineered)**

At steady state, router 1 selects (as BGP best-path) the path from router 2 for IPv6 prefix 2001:db8:abcd::/48. Traffic to this prefix is sent over the SR-native LSP associated with router 2 (prefix SID 16002) along side the advertised 6PE label.

Figure 8: Steady State

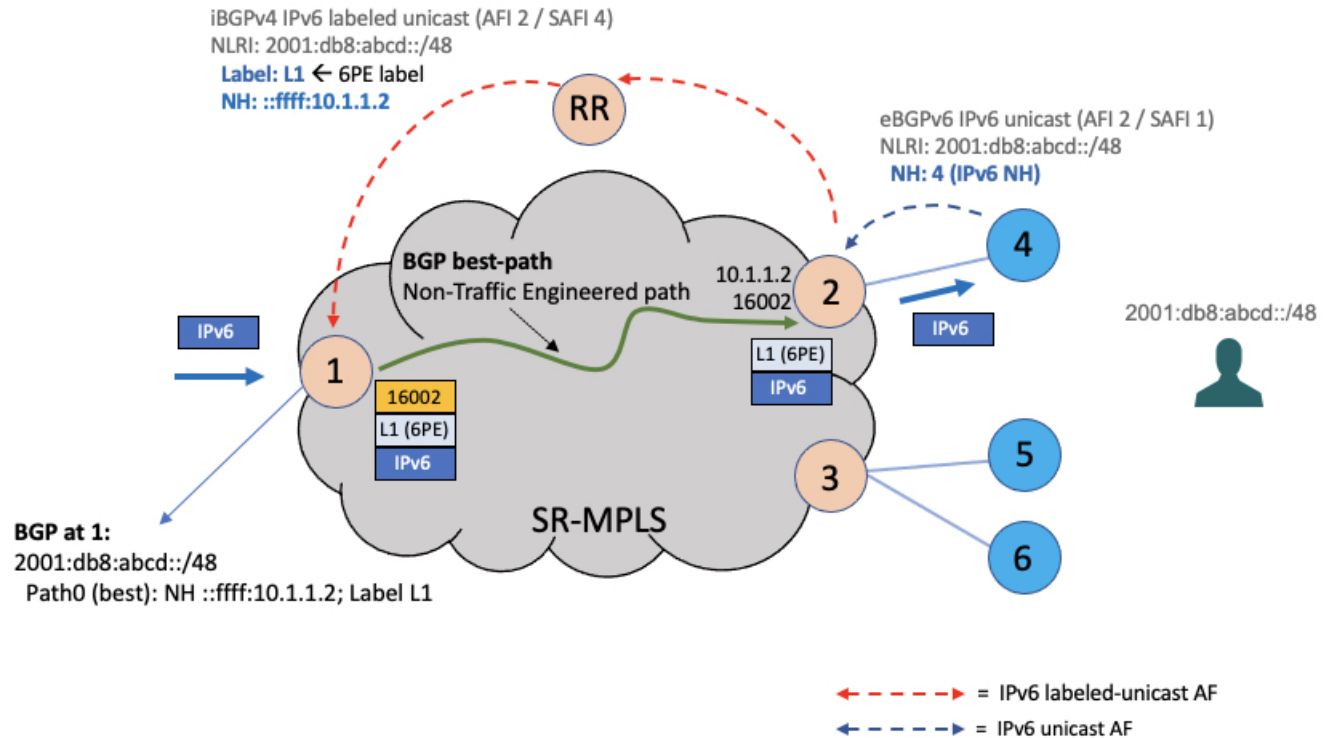

EPE Traffic-Engineered Path

To create a traffic-engineered path that steers traffic to an intended egress peering router/egress transit AS (for example, node 3/ASBR node 6), an SR policy can be configured at ingress border router 1 with the following:

- An IPv4 null (0.0.0.0) end-point, in order to perform color-only automated steering (see [Color-Only Automated Steering](#), on page 80).
- An explicit segment list with SIDs corresponding to the intended egress node (for example, node 3) and the intended egress peering link (for example, ASBR node 6).
- The **bgp prefix-label ignore** steering command in order to indicate BGP to ignore the programming of the 6PE label associated with the prefix path.

```
segment-routing
 traffic-eng
  segment-list s1-to_3-epe_36
    index 10 mpls adjacency 10.1.1.3
    index 20 mpls adjacency 2001:db8:20:3:6::3
  !
 policy FOO
  steering
    bgp prefix-path-label ignore
  !
  color 10 end-point ipv4 0.0.0.0
 candidate-paths
  preference 100
```

```
explicit segment-list s1-to_3-epe_36
```

When a given IPv6 Internet destination needs to be steered over an intended egress peering router/egress AS, the operator can perform one of the following:

- Advertise a new BGP prefix path from a Route Server that includes a color extended community value equal to the color of the SR-TE policy for the intended egress peering router/egress AS, or
- Apply a color extended community value equal to the color of the SR-TE policy for the intended egress peering router/egress AS at the peering router advertising the best path (for example, node 2), as shown below.



Note The BGP color includes the color-only flag value of 01 in order to allow for color-only automated steering.

Figure 9: EPE Traffic-Engineered Path

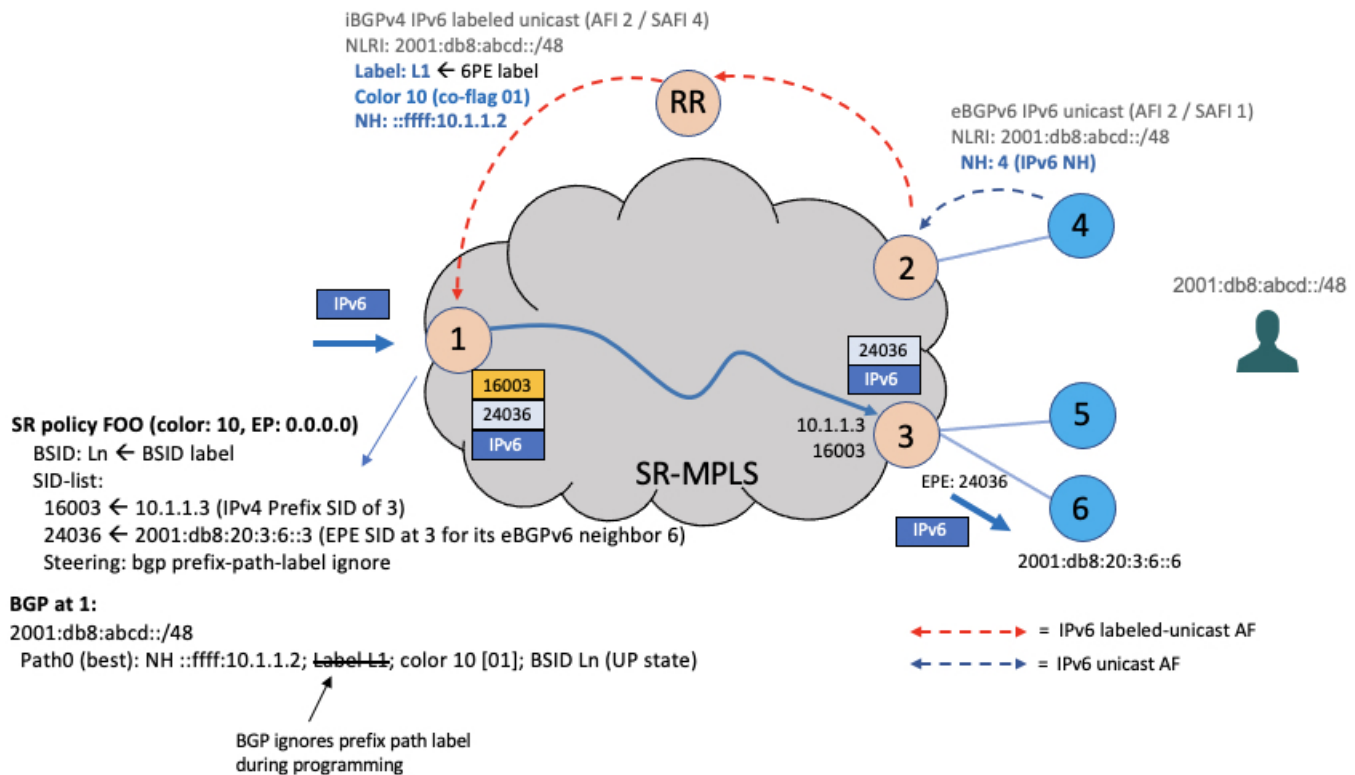

The following output depicts the details of the SR-TE policy programmed at the ingress border router node 1 used to send traffic to the egress peering router node 3 and egress AS behind ASBR node 6:

```
Router1# show segment-routing traffic-eng policy candidate-path name FOO private

SR-TE policy database
-----

Color: 10, End-point: 0.0.0.0 ID: 3
```



```

Name: srte_c_10_ep_0.0.0.0
Status:
  Admin: up Operational: up for 00:10:07 (since Feb  2 12:58:43.554)
Candidate-paths:
  Preference: 100 (configuration) (active)
  Originator: ASN 0 node-address <None> discriminator: 100
  Name: FOO
  Requested BSID: dynamic
  Constraints:
    Protection Type: protected-preferred
    Maximum SID Depth: 10
  ID: 1
  Source: 10.1.1.1
  Stale: no
  Checkpoint flags: 0x00000000
  Steering:
    Client: BGP
    Disabled: no
    Ignore prefix label: yes
  Explicit: segment-list sl-to_3-epe_36 (valid)
  Weight: 1, Metric Type: TE
  IGP area: 2
    SID[0]: 16003 [Prefix-SID: 10.1.1.3, Algorithm: 0]
    SID[1]: 24036 [Adjacency-SID, 2001:db8:20:3:6::3 - 2001:db8:20:3:6::6]
LSPs:
. . .

Attributes:
  Binding SID: 24030
  Forward Class: Not Configured
  Steering labeled-services disabled: no
  Steering BGP disabled: no
  IPv6 caps enable: yes
  Invalidation drop enabled: no
  Max Install Standby Candidate Paths: 0
Notification to clients:
  Binding SID: 24030
  Bandwidth : 0 Kbps (0 Kbps)
  State: UP
  Flags: [add] [ipv6_caps] [ignore_prefix_label]
  Metric Type: NONE
  Metric Value: 2147483647
  Admin Distance: 100
  ifhandle: 0x00000170
  Source: 10.1.1.1
  Transition count: 1
  LSPs created count: 1
  Reoptimizations completed count: 1
  Retry Action Flags: 0x00000000, ()
  Last Retry Timestamp: never (0 seconds ago)
  Policy reference: 0x1f81e50

```

The following output depicts the details of the IPv6 BGP global route (2001:db8:abcd::/48) being steered over the binding SID of the previously shown SR-TE policy (24030):

```

Router1# show bgp ipv6 labeled-unicast 2001:db8:abcd::/48 detail

BGP routing table entry for 2001:db8:abcd::/48
Versions:
  Process          bRIB/RIB  SendTblVer
  Speaker          2003      2003
  Local Label: 81718 (no rewrite);

```

```

Flags: 0x003e1001+0x30010000;
Last Modified: Nov 23 16:59:17.891 for 00:00:03
Paths: (1 available, best #1)
  Advertised IPv6 Unicast paths to update-groups (with more than one peer):
    0.2
  Advertised IPv6 Labeled-unicast paths to update-groups (with more than one peer):
    0.3
  Path #1: Received by speaker 0
  Flags: 0xa480000001060205+0x01, import: 0x020
  Advertised IPv6 Unicast paths to update-groups (with more than one peer):
    0.2
  Advertised IPv6 Labeled-unicast paths to update-groups (with more than one peer):
    0.3
  300, (Received from a RR-client)
    10.1.1.2 C:10 (bsid:24030) (admin 100) (metric 2147483647) from 10.1.1.100 (10.1.1.2),
  if-handle 0x00000170
    Prefix Label not imposed due to SR policy config

```

Miscellaneous

SR Policy Liveness Monitoring

SR Policy liveness monitoring allows you to verify end-to-end traffic forwarding over an SR Policy candidate path by periodically sending performance monitoring (PM) packets. The head-end router sends PM packets to the SR policy's endpoint router, which sends them back to the head-end without any control-plane dependency on the endpoint router.

For more information about this feature, see [SR Policy Liveness Monitoring](#).

Programming Non-Active Candidate Paths of an SR Policy

Table 13: Feature History Table

Feature Name	Release Information	Feature Description
Programming Non-Active Candidate Paths of an SR Policy	Release 7.6.1	<p>By programming non-active candidate paths (CPs) in the forwarding plane, you ensure that if the existing active CP is unavailable, the traffic switches quickly to the new CP, thus minimizing loss of traffic flow.</p> <p>In earlier releases, instantiating a non-active CP to the forwarding plane after the unavailability of the active CP could take a few seconds, resulting in potential loss of traffic flow.</p> <p>This feature introduces the following command:</p> <ul style="list-style-type: none"> • max-install-standby-cpaths

An SR Policy is associated with one or more candidate paths (CP). A CP is selected as the active CP when it is valid and it has the highest preference value among all the valid CPs of the SR Policy. By default, only the active CP is programmed in the forwarding plane.

This feature allows the programming of multiple CPs of an SR policy in the forwarding plane. This minimizes traffic loss when a new CP is selected as active.

Usage Guidelines and Limitations

Observe the following usage guidelines and limitations:

- Up to three non-active CPs can be programmed in the forwarding plane.
- Manually configured CPs are supported. This includes CPs with explicit paths or dynamic (head-end computed or PCE-delegated) paths.
- On-Demand instantiated CPs (ODN) are supported.
- BGP-initiated CPs are supported.
- PCE-initiated CPs via PCEP are not supported. This applies to policies created via CLI or via north-bound HTTP-based API.
- Programming of non-active CPs is not supported with SRv6-TE policies, Per-Flow Policies (PFP), or point-to-multipoint SR policies (Tree-SID)
- PCEP reporting of additional CPs is supported, but the PCEP reporting does not distinguish between active and non-active CPs.

- Programming of non-active CPs can be enabled for all SR policies (global), for a specific policy (local), or ODN template.

If enabled globally and also locally or on ODN template, the local or ODN configuration takes precedence over the global configuration.

- Programming of non-active CPs under global SR-TE and configuring policy path protection of an SR policy is supported. In this case, policy path protection takes precedence.
- Programming of non-active CPs for a specific SR policy and configuring policy path protection of an SR policy is not supported.
- The number of policies supported could be impacted by the number of non-active CPs per policy. Programming non-active CPs in the forwarding plane consumes hardware resources (such as local label and ECMP FEC) when more candidate paths are pre-programmed in forwarding than are actually carrying traffic.
- The active CP will be in programmed state. The remaining CPs will be in standby programmed state.
- We recommend that you create separate PM sessions for active and standby candidate paths to monitor the health of the paths end-to-end.

The recommended PM timers should be different for active and standby PM profiles. The PM timers should be less aggressive for the standby PM profile compared to the active PM profile. See [Configure Performance Measurement](#) for information about configuring PM sessions.



Note PM sessions for BGP-TE policies are not supported. PM profiles can be configured only under configured policies at the head-end.

- The protected paths for each CP is programmed in the respective LSPs. The protected paths of active CPs are programmed in the active LSP, and the protected paths of standby CPs are programmed in the standby LSP.
- If a candidate path with higher preference becomes available, the traffic will switch to it in Make-Before-Break (MBB) behavior.

Configuration

Programming of non-active CPs can be enabled for all SR policies (global), for a specific policy (local), or ODN template. If enabled globally, the local or ODN configuration takes precedence over the global configuration.

Global SR-TE

Use the **max-install-standby-cpaths** *value* command to configure standby candidate paths for all SR policies, for a specific policy, or for an ODN template. The range for *value* is from 1 to 3. Use **no max-install-standby-cpaths** command to return to the default behavior.

The following example shows how to configure standby candidate paths globally:

```
Router(config)# segment-routing traffic-eng
Router(config-sr-te)# max-install-standby-cpaths 2
Router(config-sr-te)#
```

Running Config

```
segment-routing
 traffic-eng
  max-install-standby-cpaths 2
```

Local SR Policy

Use the **max-install-standby-cpaths** *value* command to configure standby candidate paths for a specific policy. The range for *value* is from 0 (disable) to 3.

If programming of non-active CPs is enabled for all SR policies (global), you can disable programming of non-active CPs for a specific policy using the **max-install-standby-cpaths 0** command.

The following example shows how to configure standby candidate paths for a specific SR policy:

```
Router(config)# segment-routing traffic-eng
Router(config-sr-te)# policy MyBackupPolicy
Router(config-sr-te-policy)# max-install-standby-cpaths 2
Router(config-sr-te-policy)#
```

Running Config

```
segment-routing
 traffic-eng
  policy MyBackupPolicy
  max-install-standby-cpaths 2
```

SR ODN

When you create an ODN template, two CPs are created by default (PCE-delegated and head-end computed) with preference 100 and preference 200. You can use the **max-install-standby-cpaths 1** command to program the non-active CP in forwarding. If programming of non-active CPs is enabled for all SR policies (global), you can disable programming of non-active CPs on ODN template using the **max-install-standby-cpaths 0** command.

The following example shows how to configure standby candidate paths for an SR ODN template:

```
Router(config)# segment-routing traffic-eng
Router(config-sr-te)# on-demand color 10
Router(config-sr-te-color)# max-install-standby-cpaths 1
Router(config-sr-te-color)#
```

Running Config

```
segment-routing
 traffic-eng
  on-demand color 10
  max-install-standby-cpaths 1
```

The following example shows how to enable three standby CPs globally and disable standby CPs on local SR policy and ODN template:

```
Router(config)# segment-routing traffic-eng
Router(config-sr-te)# max-install-standby-cpaths 3
Router(config-sr-te)# policy MyBackupPolicy
Router(config-sr-te-policy)# max-install-standby-cpaths 0
```

```
Router(config-sr-te-policy)# exit
Router(config-sr-te)# on-demand color 10
Router(config-sr-te-color)# max-install-standby-cpaths 0
Router(config-sr-te-color)#
```

Verification

The following output shows the status of active and backup CPs:

```
Router# show segment-routing traffic-eng policy

SR-TE policy database
-----

Color: 50, End-point: 1.1.1.4
Name: srte_c_50_ep_1.1.1.4
Status:
  Admin: up   Operational: up for 08:17:32 (since Sep  9 13:16:02.818)
Candidate-paths:
  Preference: 100 (configuration) (active)
    Name: NCP_STATIC
    Requested BSID: 5000
    PCC info:
      Symbolic name: cfg_NCP_STATIC_discr_100
      PLSP-ID: 2
      Protection Type: protected-preferred
      Maximum SID Depth: 10
    Explicit: segment-list WORKING (valid)
    Reverse: segment-list REVERSE_WORKING
    Weight: 1, Metric Type: TE
      24010
      24012
  Preference: 80 (configuration) (standby)
    Name: NCP_STATIC
    Requested BSID: 5000
    PCC info:
      Symbolic name: cfg_NCP_STATIC_discr_80
      PLSP-ID: 3
      Protection Type: protected-preferred
      Maximum SID Depth: 10
    Explicit: segment-list STANDBY1 (valid)
    Reverse: segment-list REVERSE_STANDBY1
    Weight: 1, Metric Type: TE
      24018
      24010
  Preference: 60 (configuration) (standby)
    Name: NCP_STATIC
    Requested BSID: 5000
    PCC info:
      Symbolic name: cfg_NCP_STATIC_discr_60
      PLSP-ID: 4
      Protection Type: protected-preferred
      Maximum SID Depth: 10
    Explicit: segment-list STANDBY2 (valid)
    Reverse: segment-list REVERSE_STANDBY2
    Weight: 1, Metric Type: TE
      24014
  Preference: 40 (configuration)
    Name: NCP_STATIC
    Requested BSID: 5000
    PCC info:
      Symbolic name: cfg_NCP_STATIC_discr_40
      PLSP-ID: 5
      Protection Type: protected-preferred
```

```

        Maximum SID Depth: 10
    Dynamic (valid)
        Metric Type: TE, Path Accumulated Metric: 10
        24005 [Adjacency-SID, 13.13.13.1 - 13.13.13.4]
Preference: 30 (configuration)
Name: NCP_STATIC
Requested BSID: 5000
PCC info:
    Symbolic name: cfg_NCP_STATIC_discr_30
    PLSP-ID: 1
    Protection Type: protected-preferred
    Maximum SID Depth: 10
    Dynamic (pce 1.1.1.4) (valid)
        Metric Type: TE, Path Accumulated Metric: 10
        24015 [Adjacency-SID, 13.13.13.1 - 13.13.13.4]
Preference: 20 (configuration)
Name: NCP_STATIC
Requested BSID: 5000
PCC info:
    Symbolic name: cfg_NCP_STATIC_discr_20
    PLSP-ID: 6
    Protection Type: protected-preferred
    Maximum SID Depth: 10
    Explicit: segment-list WORKING2 (valid)
    Reverse: segment-list REVERSE_WORKING2
    Weight: 1, Metric Type: TE
    24012
    24012
Preference: 10 (configuration)
Name: NCP_STATIC
Requested BSID: 5000
PCC info:
    Symbolic name: cfg_NCP_STATIC_discr_10
    PLSP-ID: 7
    Protection Type: protected-preferred
    Maximum SID Depth: 10
    Explicit: segment-list WORKING3 (valid)
    Reverse: segment-list REVERSE_WORKING3
    Weight: 1, Metric Type: TE
    24010
    24014
    24010
Attributes:
    Binding SID: 5000
    Forward Class: Not Configured
    Steering labeled-services disabled: no
    Steering BGP disabled: no
    IPv6 caps enable: yes
    Invalidation drop enabled: no
Max Install Standby CPaths: 2

```

```
Router# show segment-routing traffic-eng forwarding policy
```

```
SR-TE Policy Forwarding database
```

```
-----
```

```

Color: 50, End-point: 1.1.1.4
Name: srte_c_50_ep_1.1.1.4
Binding SID: 5000
Active LSP:
Candidate path:
    Preference: 100 (configuration)
    Name: NCP_STATIC

```

```

Local label: 24021
Segment lists:
  SL[0]:
    Name: WORKING
    Switched Packets/Bytes: 0/0
    Paths:
      Path[0]:
        Outgoing Label: 24012
        Outgoing Interfaces: GigabitEthernet0/0/0/0
        Next Hop: 10.10.10.2
        Switched Packets/Bytes: 0/0
        FRR Pure Backup: No
        ECMP/LFA Backup: No
        Internal Recursive Label: Unlabelled (recursive)
        Label Stack (Top -> Bottom): { 24012 }
Standby LSP(s):
  LSP[0]:
    Candidate path:
      Preference: 80 (configuration)
      Name: NCP_STATIC
      Local label: 24024
      Segment lists:
        SL[0]:
          Name: STANDBY1
          Switched Packets/Bytes: 0/0
          Paths:
            Path[0]:
              Outgoing Label: 24010
              Outgoing Interfaces: GigabitEthernet0/0/0/2
              Next Hop: 12.12.12.3
              Switched Packets/Bytes: 0/0
              FRR Pure Backup: No
              ECMP/LFA Backup: No
              Internal Recursive Label: Unlabelled (recursive)
              Label Stack (Top -> Bottom): { 24010 }
  LSP[1]:
    Candidate path:
      Preference: 60 (configuration)
      Name: NCP_STATIC
      Local label: 24025
      Segment lists:
        SL[0]:
          Name: STANDBY2
          Switched Packets/Bytes: 0/0
          Paths:
            Path[0]:
              Outgoing Label: Pop
              Outgoing Interfaces: GigabitEthernet0/0/0/3
              Next Hop: 13.13.13.4
              Switched Packets/Bytes: 0/0
              FRR Pure Backup: No
              ECMP/LFA Backup: No
              Internal Recursive Label: Unlabelled (recursive)
              Label Stack (Top -> Bottom): { Pop }

Policy Packets/Bytes Switched: 2/136

```

LDP over Segment Routing Policy

The LDP over Segment Routing Policy feature enables an LDP-targeted adjacency over a Segment Routing (SR) policy between two routers. This feature extends the existing MPLS LDP address family neighbor configuration to specify an SR policy as the targeted end-point.

LDP over SR policy is supported for locally configured SR policies with IPv4 end-points.

For more information about MPLS LDP, see the "Implementing MPLS Label Distribution Protocol" chapter in the *MPLS Configuration Guide*.

For more information about Autoroute, see the *Autoroute Announce for SR-TE* section.



Note Before you configure an LDP targeted adjacency over SR policy name, you need to create the SR policy under Segment Routing configuration. The SR policy interface names are created internally based on the color and endpoint of the policy. LDP is non-operational if SR policy name is unknown.

The following functionality applies:

1. Configure the SR policy – LDP receives the associated end-point address from the interface manager (IM) and stores it in the LDP interface database (IDB) for the configured SR policy.
2. Configure the SR policy name under LDP – LDP retrieves the stored end-point address from the IDB and uses it. Use the auto-generated SR policy name assigned by the router when creating an LDP targeted adjacency over an SR policy. Auto-generated SR policy names use the following naming convention: **srte_c_color_val_ep_endpoint-address**. For example, **srte_c_1000_ep_10.1.1.2**

Configuration Example

```
/* Enter the SR-TE configuration mode and create the SR policy. This example corresponds
to a local SR policy with an explicit path. */
Router(config)# segment-routing
Router(config-sr)# traffic-eng
Router(config-sr-te)# segment-list sample-sid-list
Router(config-sr-te-sl)# index 10 address ipv4 10.1.1.7
Router(config-sr-te-sl)# index 20 address ipv4 10.1.1.2
Router(config-sr-te-sl)# exit
Router(config-sr-te)# policy sample_policy
Router(config-sr-te-policy)# color 1000 end-point ipv4 10.1.1.2
Router(config-sr-te-policy)# candidate-paths
Router(config-sr-te-policy-path)# preference 100
Router(config-sr-te-policy-path-pref)# explicit segment-list sample-sid-list
Router(config-sr-te-pp-info)# end

/* Configure LDP over an SR policy */
Router(config)# mpls ldp
Router(config-ldp)# address-family ipv4
Router(config-ldp-af)# neighbor sr-policy srte_c_1000_ep_10.1.1.2 targeted
Router(config-ldp-af)#
```



```

    Enabled via config: LDP interface
Interface TenGigE0/3/0/0/6 (0xa000400)
  VRF: 'default' (0x60000000)
    Enabled via config: LDP interface
Interface TenGigE0/3/0/0/7 (0xa000440)
  VRF: 'default' (0x60000000)
    Enabled via config: LDP interface
Interface TenGigE0/3/0/0/8 (0xa000480)
  VRF: 'default' (0x60000000)
  Disabled:
Interface TenGigE0/3/0/0/9 (0xa0004c0)
  VRF: 'default' (0x60000000)
  Disabled:
Interface srte_c_1000_ep_10.1.1.2 (0x520)
  VRF: 'default' (0x60000000)
  Enabled via config: LDP interface

```

```
Router# show segment-routing traffic-eng policy color 1000
```

```
SR-TE policy database
```

```

-----
Color: 1000, End-point: 10.1.1.2
Name: srte_c_1000_ep_10.1.1.2
Status:
  Admin: up Operational: up for 00:02:00 (since Jul  2 22:39:06.663)
Candidate-paths:
  Preference: 100 (configuration) (active)
  Name: sample_policy
  Requested BSID: dynamic
  PCC info:
    Symbolic name: cfg_sample_policy_discr_100
    PLSP-ID: 17
  Explicit: segment-list sample-sid-list (valid)
    Weight: 1, Metric Type: TE
      16007 [Prefix-SID, 10.1.1.7]
      16002 [Prefix-SID, 10.1.1.2]
Attributes:
  Binding SID: 80011
  Forward Class: 0
  Steering BGP disabled: no
  IPv6 caps enable: yes

```

```
Router# show mpls ldp neighbor 10.1.1.2 detail
```

```

Peer LDP Identifier: 10.1.1.2:0
TCP connection: 10.1.1.2:646 - 10.1.1.6:57473
Graceful Restart: No
Session Holdtime: 180 sec
State: Oper; Msgs sent/rcvd: 421/423; Downstream-Unsolicited
Up time: 05:22:02
LDP Discovery Sources:
  IPv4: (1)
    Targeted Hello (10.1.1.6 -> 10.1.1.2, active/passive)
  IPv6: (0)
Addresses bound to this peer:
  IPv4: (9)
    10.1.1.2          2.2.2.99          10.1.2.2          10.2.3.2
    10.2.4.2          10.2.22.2         10.2.222.2       10.30.110.132
    11.2.9.2
  IPv6: (0)
Peer holdtime: 180 sec; KA interval: 60 sec; Peer state: Estab

```

```

NSR: Disabled
Clients: LDP over SR Policy
Capabilities:
  Sent:
    0x508 (MP: Point-to-Multipoint (P2MP))
    0x509 (MP: Multipoint-to-Multipoint (MP2MP))
    0x50a (MP: Make-Before-Break (MBB))
    0x50b (Typed Wildcard FEC)
  Received:
    0x508 (MP: Point-to-Multipoint (P2MP))
    0x509 (MP: Multipoint-to-Multipoint (MP2MP))
    0x50a (MP: Make-Before-Break (MBB))
    0x50b (Typed Wildcard FEC)

```

Configure Seamless Bidirectional Forwarding Detection

Bidirectional forwarding detection (BFD) provides low-overhead, short-duration detection of failures in the path between adjacent forwarding engines. BFD allows a single mechanism to be used for failure detection over any media and at any protocol layer, with a wide range of detection times and overhead. The fast detection of failures provides immediate reaction to failure in the event of a failed link or neighbor.

In BFD, each end of the connection maintains a BFD state and transmits packets periodically over a forwarding path. Seamless BFD (SBFD) is unidirectional, resulting in faster session activation than BFD. The BFD state and client context is maintained on the head-end (initiator) only. The tail-end (reflector) validates the BFD packet and responds, so there is no need to maintain the BFD state on the tail-end.

Initiators and Reflectors

SBFD runs in an asymmetric behavior, using initiators and reflectors.

The following figure represents the roles of the SBFD initiator and reflector.

Figure 10: SBFD Initiator and Reflector

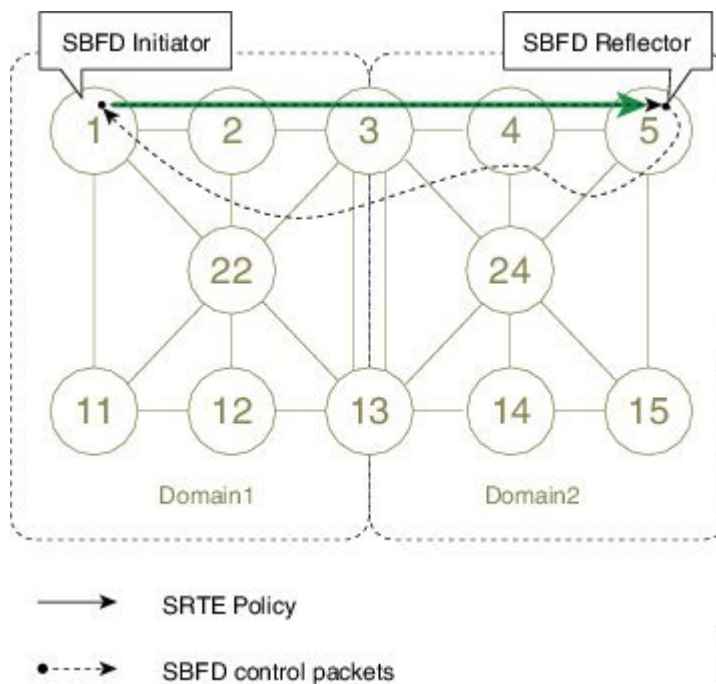

The initiator is an Sbfd session on a network node that performs a continuity test to a remote entity by sending Sbfd packets. The initiator injects the Sbfd packets into the segment-routing traffic-engineering (SRTE) policy. The initiator triggers the Sbfd session and maintains the Bfd state and client context.

The reflector is an Sbfd session on a network node that listens for incoming Sbfd control packets to local entities and generates response Sbfd control packets. The reflector is stateless and only reflects the Sbfd packets back to the initiator.

A node can be both an initiator and a reflector, if you want to configure different Sbfd sessions.

For SR-TE, Sbfd control packets are label switched in forward and reverse direction. For Sbfd, the tail-end node is the reflector node; other nodes cannot be a reflector. When using Sbfd with SR-TE, if the forward and return directions are label-switched paths, Sbfd need not be configured on the reflector node.

Discriminators

The Bfd control packet carries 32-bit discriminators (local and remote) to demultiplex Bfd sessions. Sbfd requires globally unique Sbfd discriminators that are known by the initiator.

The Sbfd control packets contain the discriminator of the initiator, which is created dynamically, and the discriminator of the reflector, which is configured as a local discriminator on the reflector.

Configure the Sbfd Reflector

To ensure the Sbfd packet arrives on the intended reflector, each reflector has at least one globally unique discriminator. Globally unique discriminators of the reflector are known by the initiator before the session starts. An Sbfd reflector only accepts Bfd control packets where "Your Discriminator" is the reflector discriminator.

This task explains how to configure local discriminators on the reflector.

Before you begin

Enable mpls oam on the reflector to install a routing information base (RIB) entry for 127.0.0.0/8.

```
Router_5# configure
Router_5(config)# mpls oam
Router_5(config-oam)#
```

SUMMARY STEPS

1. **configure**
2. **sbfd**
3. **local-discriminator** { *ipv4-address* | *32-bit-value* | **dynamic** | **interface** *interface* }
4. **commit**

DETAILED STEPS

	Command or Action	Purpose
Step 1	configure Example: RP/0/RSP0/CPU0:router# configure	Enters global configuration mode.

	Command or Action	Purpose
Step 2	sbfd Example: Router_5(config)# sbfd	Enters Sbfd configuration mode.
Step 3	local-discriminator { <i>ipv4-address</i> <i>32-bit-value</i> dynamic interface <i>interface</i> } Example: Router_5(config-sbfd)# local-discriminator 10.1.1.5 Router_5(config-sbfd)# local-discriminator 987654321 Router_5(config-sbfd)# local-discriminator dynamic Router_5(config-sbfd)# local-discriminator interface Loopback0	Configures the local discriminator. You can configure multiple local discriminators.
Step 4	commit	

Verify the local discriminator configuration.

Example

```
Router_5# show bfd target-identifier local

Local Target Identifier Table
-----
Discr      Discr Src  VRF      Status  Flags
-----  -
16843013   Local     default  enable  ----ia-
987654321  Local     default  enable  ----v--
2147483649 Local     default  enable  -----d

Legend: TID - Target Identifier
a - IP Address mode
d - Dynamic mode
i - Interface mode
v - Explicit Value mode
```

What to do next

Configure the Sbfd initiator.

Configure the Sbfd Initiator

Perform the following configurations on the Sbfd initiator.

Enable Line Cards to Host BFD Sessions

The SBFDF initiator sessions are hosted by the line card CPU.

This task explains how to enable line cards to host BFD sessions.

SUMMARY STEPS

1. **configure**
2. **bfd**
3. **multipath include location *node-id***

DETAILED STEPS

	Command or Action	Purpose
Step 1	configure Example: RP/0/RSP0/CPU0:router# <code>configure</code>	Enters global configuration mode.
Step 2	bfd Example: Router_1(config)# <code>bfd</code>	Enters BFD configuration mode.
Step 3	multipath include location <i>node-id</i> Example: Router_1(config-bfd)# <code>multipath include location 0/1/CPU0</code> Router_1(config-bfd)# <code>multipath include location 0/2/CPU0</code> Router_1(config-bfd)# <code>multipath include location 0/3/CPU0</code>	Configures BFD multiple path on specific line card. Any of the configured line cards can be instructed to host a BFD session.

What to do next

Map a destination address to a remote discriminator.

Map a Destination Address to a Remote Discriminator

The SBFDF initiator uses a Remote Target Identifier (RTI) table to map a destination address (Target ID) to a remote discriminator.

This task explains how to map a destination address to a remote discriminator.

SUMMARY STEPS

1. **configure**
2. **sbfd**
3. **remote-target ipv4 *ipv4-address***

4. remote-discriminator remote-discriminator

DETAILED STEPS

	Command or Action	Purpose
Step 1	configure Example: RP/0/RSP0/CPU0:router# configure	Enters global configuration mode.
Step 2	sbfd Example: Router_1(config)# sbfd	Enters SBFD configuration mode.
Step 3	remote-target ipv4 ipv4-address Example: Router_1(config-sbfd)# remote-target ipv4 10.1.1.5	Configures the remote target.
Step 4	remote-discriminator remote-discriminator Example: Router_1(config-sbfd-nnnn)# remote-discriminator 16843013	Maps the destination address (Target ID) to a remote discriminator.

Verify the remote discriminator configuration.

Example

```
Router_1# show bfd target-identifier remote

Remote Target Identifier Table
-----
Discr      Discr Src  VRF      TID Type  Status
Target ID  Name
-----  -----
16843013   Remote    default  ipv4      enable
          10.1.1.5
```

Legend: TID - Target Identifier

What to do next

Enable SBFD on an SR-TE policy.

Enable Seamless BFD Under an SR-TE Policy or SR-ODN Color Template

This example shows how to enable SBFD on an SR-TE policy or an SR on-demand (SR-ODN) color template.



Note Do not use BFD with disjoint paths. The reverse path might not be disjoint, causing a single link failure to bring down BFD sessions on both the disjoint paths.

Enable BFD

- Use the **bfd** command in SR-TE policy configuration mode to enable BFD and enters BFD configuration mode.

```
Router(config)# segment-routing traffic-eng
Router(config-sr-te)# policy POLICY1
Router(config-sr-te-policy)# bfd
Router(config-sr-te-policy-bfd)#
```

Use the **bfd** command in SR-ODN configuration mode to enable BFD and enters BFD configuration mode.

```
Router(config)# segment-routing traffic-eng
Router(config-sr-te)# on-demand color 10
Router(config-sr-te-color)# bfd
Router(config-sr-te-color-bfd)#
```

Configure BFD Options

- Use the **minimum-interval** *milliseconds* command to set the interval between sending BFD hello packets to the neighbor. The range is from 15 to 200. The default is 15.

```
Router(config-sr-te-policy-bfd)# minimum-interval 50
```

- Use the **multiplier** *multiplier* command to set the number of times a packet is missed before BFD declares the neighbor down. The range is from 2 to 10. The default is 3.

```
Router(config-sr-te-policy-bfd)# multiplier 2
```

- Use the **invalidation-action** {**down** | **none**} command to set the action to be taken when BFD session is invalidated.

- down**: LSP can only be operationally up if the BFD session is up
- none**: BFD session state does not affect LSP state, use for diagnostic purposes

```
Router(config-sr-te-policy-bfd)# invalidation-action down
```

- (SR-TE policy only)** Use the **reverse-path binding-label** *label* command to specify BFD packets return to head-end by using a binding label.

By default, the S-BFD return path (from tail-end to head-end) is via IPv4. You can use a reverse binding label so that the packet arrives at the tail-end with the reverse binding label as the top label. This label

is meant to point to a policy that will take the BFD packets back to the head-end. The reverse binding label is configured per-policy.

Note that when MPLS return path is used, BFD uses echo mode packets, which means the tail-end's BFD reflector does not process BFD packets at all.

The MPLS label value at the tail-end and the head-end must be synchronized by the operator or controller. Because the tail-end binding label should remain constant, configure it as an explicit BSID, rather than dynamically allocated.

```
Router(config-sr-te-policy-bfd) # reverse-path binding-label 24036
```

- Use the **logging session-state-change** command to log when the state of the session changes

```
Router(config-sr-te-policy-bfd) # logging session-state-change
```

Examples

This example shows how to enable SBFD on an SR-TE policy.

```
Router(config)# segment-routing traffic-eng
Router(config-sr-te)# policy POLICY1
Router(config-sr-te-policy)# bfd
Router(config-sr-te-policy-bfd)# invalidation-action down
Router(config-sr-te-policy-bfd)# minimum-interval 50
Router(config-sr-te-policy-bfd)# multiplier 2
Router(config-sr-te-policy-bfd)# reverse-path binding-label 24036
Router(config-sr-te-policy-bfd)# logging session-state-change
```

```
segment-routing
traffic-eng
policy POLICY1
bfd
  minimum-interval 50
  multiplier 2
  invalidation-action down
  reverse-path
  binding-label 24036
  !
  logging
  session-state-change
  !
!
!
!
```

This example shows how to enable SBFD on an SR-ODN color.

```
Router(config)# segment-routing traffic-eng
Router(config-sr-te)# on-demand color 10
Router(config-sr-te-color)# bfd
Router(config-sr-te-color-bfd)# minimum-interval 50
Router(config-sr-te-color-bfd)# multiplier 2
Router(config-sr-te-color-bfd)# logging session-state-change
Router(config-sr-te-color-bfd)# invalidation-action down
```

```
segment-routing
traffic-eng
```

```

on-demand color 10
bfd
  minimum-interval 50
  multiplier 2
  invalidation-action down
  logging
  session-state-change
!
!
!
!
!

```

SR-TE Head-End IPv4 Unnumbered Interface Support

This feature allows IPv4 unnumbered interfaces to be part of an SR-TE head-end router topology database.

An unnumbered IPv4 interface is not identified by its own unique IPv4 address. Instead, it is identified by the router ID of the node where this interfaces resides and the local SNMP index assigned for this interface.

This feature provides enhancements to the following components:

- IGPs (IS-IS and OSPF):
 - Support the IPv4 unnumbered interfaces in the SR-TE context by flooding the necessary interface information in the topology
- SR-PCE:



Note SR-PCE and path computation clients (PCCs) need to be running Cisco IOS XR 7.0.2 or later.

- Compute and return paths from a topology containing IPv4 unnumbered interfaces.
- Process reported SR policies from a head-end router that contain hops with IPv4 unnumbered adjacencies.

PCEP extensions for IPv4 unnumbered interfaces adhere to IETF RFC8664 “PCEP Extensions for Segment Routing” (<https://datatracker.ietf.org/doc/rfc8664/>). The unnumbered hops use a Node or Adjacency Identifier (NAI) of type 5. This indicates that the segment in the explicit routing object (ERO) is an unnumbered adjacency with an IPv4 ID and an interface index.

- SR-TE process at the head-end router:
 - Compute its own local path over a topology, including unnumbered interfaces.
 - Process PCE-computed paths that contain hops with IPv4 unnumbered interfaces.
 - Report a path that contains hops with IPv4 unnumbered interfaces to the PCE.

Configuration Example

The following example shows how to configure an IPv4 unnumbered interface:

```
RP/0/0/CPU0:rtrA(config)# interface GigabitEthernet0/0/0/0
RP/0/0/CPU0:rtrA(config-if)# ipv4 point-to-point
RP/0/0/CPU0:rtrA(config-if)# ipv4 unnumbered Loopback0
```

To bring up the IPv4 unnumbered adjacency under the IGP, configure the link as point-to-point under the IGP configuration. The following example shows how to configure the link as point-to-point under the IGP configuration:

```
RP/0/0/CPU0:rtrA(config)# router ospf one
RP/0/0/CPU0:rtrA(config-ospf)# area 0
RP/0/0/CPU0:rtrA(config-ospf-ar)# interface GigabitEthernet0/0/0/0
RP/0/0/CPU0:rtrA(config-ospf-ar-if)# network point-to-point
```

Verification

Use the **show ipv4 interface** command to display information about the interface:

```
RP/0/0/CPU0:rtrA# show ipv4 interface GigabitEthernet0/0/0/0 brief
Tue Apr  2 12:59:53.140 EDT
Interface                               IP-Address      Status          Protocol
GigabitEthernet0/0/0/0                 192.168.0.1    Up              Up
```

This interface shows the IPv4 address of Loopback0.

Use the **show snmp interface** command to find the SNMP index for this interface:

```
RP/0/0/CPU0:rtrA# show snmp interface
Tue Apr  2 13:02:49.190 EDT
ifName : Null0                ifIndex : 3
ifName : Loopback0            ifIndex : 10
ifName : GigabitEthernet0/0/0/0 ifIndex : 6
```

The interface is identified with the pair (IPv4:192.168.0.1, index:6).

Use the **show ospf neighbor** command to display the adjacency:

```
RP/0/0/CPU0:rtrA# show ospf neighbor gigabitEthernet 0/0/0/0 detail
...
Neighbor 192.168.0.4, interface address 192.168.0.4
  In the area 0 via interface GigabitEthernet0/0/0/0
  Neighbor priority is 1, State is FULL, 6 state changes
  ...
  Adjacency SIDs:
    Label: 24001,      Dynamic, Unprotected
  Neighbor Interface ID: 4
```

The output of the **show segment-routing traffic-eng ipv4 topology** command is enhanced to display the interface index instead of the IP address for unnumbered interfaces:

```
RP/0/0/CPU0:rtrA# show segment-routing traffic-eng ipv4 topology
...
Link[2]: Unnumbered local index 6, remote index 4
  Local node:
    OSPF router ID: 192.168.0.1 area ID: 0 ASN: 0
  Remote node:
    TE router ID: 192.168.0.4
    OSPF router ID: 192.168.0.4 area ID: 0 ASN: 0
  Metric: IGP 1, TE 1, Latency 1 microseconds
  Bandwidth: Total 125000000 Bps, Reservable 0 Bps
  Admin-groups: 0x00000000
```

```
Adj SID: 24001 (unprotected)
```

The output of the **show segment-routing traffic-eng policy detail** command includes unnumbered hops:

```
RP/0/0/CPU0:rtrA# show segment-routing traffic-eng policy detail
...
Dynamic (pce 192.168.0.5) (valid)
Metric Type: TE, Path Accumulated Metric: 3
24001 [Adjacency-SID, unnumbered 192.168.0.1(6) - 192.168.0.4(4)]
24002 [Adjacency-SID, unnumbered 192.168.0.4(7) - 192.168.0.3(7)]
24000 [Adjacency-SID, unnumbered 192.168.0.3(5) - 192.168.0.2(5)]
...
```

Path Invalidation Drop

Table 14: Feature History Table

Feature Name	Release Information	Feature Description
Path Invalidation Drop	Release 7.4.1	By default, if an SR Policy becomes invalid (for example, if there is no valid candidate path available), traffic falls back to the native SR forwarding path. In some scenarios, a network operator may require that certain traffic be only carried over the path associated with an SR policy and never allow the native SR LSP to be used. This feature allows the SR policy to stay up in the control plane (to prevent prefixes mapped to the SR policy from falling back to the native SR LSP) but drop the traffic sent on the SR policy.

By default, if an SR Policy becomes invalid, traffic would fall back to the native SR forwarding path.

In some scenarios, a network operator may require that certain traffic be only carried over the path associated with an SR policy and never allow the native SR LSP to be used. The SR-TE Path Invalidation Drop feature is introduced to meet this requirement.

With the Path Invalidation Drop feature enabled, an SR policy that would become invalid (for example, no valid candidate path available) is programmed to drop traffic. At the same time, the SR policy stays up in the control plane to prevent prefixes mapped to the SR policy from falling back to the native SR LSP.

When the SR policy becomes valid again, forwarding over the SR policy resumes.



Note This feature takes effect when an SR policy transitions from valid to invalid; it does not take effect when an SR policy has never been declared valid.

Enable Path Invalidation Drop for Manual SR Policy

Use the **segment-routing traffic-eng policy *name* steering path-invalidation drop** command to enable the dropping of traffic when an SR Policy becomes invalid.

```
segment-routing
traffic-eng
policy foo
steering
  path-invalidation drop
```

Enable Path Invalidation Drop for On-Demand SR Policy

Use the **segment-routing traffic-eng on-demand color *color* steering path-invalidation drop** command (where *color* is from 1 to 4294967295) to enable the dropping of traffic when an On-Demand SR Policy becomes invalid.

```
segment-routing
traffic-eng
on-demand color 10
steering
  path-invalidation drop
```

Enable Path Invalidation Drop for PCE-Initiated SR Policy

Use the **segment-routing traffic-eng pcc profile *profile* steering path-invalidation drop** command (where *profile* is from 1 to 65534) to enable the dropping of traffic when a PCE-Initiated SR Policy becomes invalid.

```
segment-routing
traffic-eng
pcc
profile 7
steering
  path-invalidation drop
```

Verification

Use the **show segment-routing traffic-eng policy** command to display SR policy information.

The following output shows an SR policy in the Up state with path-invalidation drop:

```
Router# show segment-routing traffic-eng policy

SR-TE policy database
-----

Color: 4, End-point: 10.1.1.4
Name: srte_c_4_ep_10.1.1.4
Status:
  Admin: up   Operational: up(path-invalidation drop) for 00:09:02 (since May 19
12:07:14.526)
Candidate-paths:
  Preference: 200 (BGP ODN) (shutdown)
  Requested BSID: dynamic
  Protection Type: protected-preferred
  Maximum SID Depth: 10
  Dynamic (invalid)
  Metric Type: TE,   Path Accumulated Metric: 0
  Preference: 100 (BGP ODN) (active)
  Requested BSID: dynamic
```

```

PCC info:
  Symbolic name: bgp_c_4_ep_10.1.1.4_discr_100
  PLSP-ID: 1
  Protection Type: protected-preferred
  Maximum SID Depth: 10
  Dynamic (pce) (invalid)
  Last error: No path
  Metric Type: TE, Path Accumulated Metric: 40
Attributes:
  Binding SID: 24015
  Forward Class: Not Configured
  Steering labeled-services disabled: no
  Steering BGP disabled: no
  IPv6 caps enable: yes
  Invalidation drop enabled: yes

Router# show segment-routing traffic-eng policy detail

SR-TE policy database
-----

Color: 4, End-point: 10.1.1.4
Name: srte_c_4_ep_10.1.1.4
Status:
  Admin: up Operational: up for 00:09:02 (since May 19 12:07:14.526)
Candidate-paths:
  Preference: 100 (BGP ODN) (active)
  Name: test1
  Requested BSID: dynamic
  Protection Type: protected-only
  Maximum SID Depth: 10
  Explicit: segment-list list1 (invalid)
  Last error: No path
  Weight: 1, Metric Type: TE
LSPs:
  LSP[0]:
    LSP-ID: 4 policy ID: 2 (active)
    Local label: 24025
    State: Invalidated traffic dropped
    Binding SID: 24029
Attributes:
  Binding SID: 24015
  Forward Class: Not Configured
  Steering labeled-services disabled: no
  Steering BGP disabled: no
  IPv6 caps enable: yes
  Invalidation drop enabled: yes

```

When the policy is in "Invalidated traffic dropped" state, as observed in the output above, use the **show mpls forwarding tunnels detail** command to display the forwarding information. The following output shows that the traffic is dropped with forwarding output indicating "Control plane programmed to drop".

```

Router# show mpls forwarding tunnels detail

Tunnel          Outgoing   Outgoing   Next Hop   Bytes
Name            Label      Interface  Next Hop   Switched
-----
srte_c_4_ep_10.1.1.4(SR)  ?          ?          ?          ?

Tunnel resolution: Incomplete (Control plane programmed to drop)
Interface:
  Name: srte_c_4_ep_10.1.1.4 (ifhandle 0x000040f0)
  Local Label: 24025, Forwarding Class: 0, Weight: 0

```

```
Packets/Bytes Switched: 0/0
```

Configuring Path Invalidation Drop with Performance Measurement Liveness Detection

The Path Invalidation Drop feature can work alongside the **invalidation-action down** configuration in the Performance Measurement Liveness Detection feature. The Performance Measurement Liveness Detection feature enables end-to-end SR policy liveness detection for all segment lists of the active and standby candidate paths that are in the forwarding table. When **invalidation-action down** is configured and a candidate path becomes invalid, the candidate path is immediately operationally brought down and becomes invalid.

See [SR Policy Liveness Monitoring](#) for information about configuring liveness detection and the invalidation action.

When both **path-invalidation drop** and **performance-measurement liveness-detection invalidation-action down** are enabled, the following behavior is observed:

1. If the PM liveness session goes down, the candidate path becomes invalid and is immediately operationally brought down.
2. SR-TE path re-optimization occurs to find a new valid candidate path.
3. If no valid candidate path is found, the SR policy is kept UP in the control plane, but the traffic sent on the SR policy is dropped.

SR-TE Reoptimization Timers

SR-TE path re-optimization occurs when the head-end determines that there is a more optimal path available than the one currently used. For example, in case of a failure along the SR-TE LSP path, the head-end could detect and revert to a more optimal path by triggering re-optimization.

Re-optimization can occur due to the following events:

- The explicit path hops used by the primary SR-TE LSP explicit path are modified
- The head-end determines the currently used path-option are invalid due to either a topology path disconnect, or a missing SID in the SID database that is specified in the explicit-path
- A more favorable path-option (lower index) becomes available

For event-based re-optimization, you can specify various delay timers for path re-optimization. For example, you can specify how long to wait before switching to a reoptimized path

Additionally, you can configure a timer to specify how often to perform reoptimization of policies. You can also trigger an immediate reoptimization for a specific policy or for all policies.

SR-TE Reoptimization

To trigger an immediate SR-TE reoptimization, use the **segment-routing traffic-eng reoptimization** command in Exec mode:

```
Router# segment-routing traffic-eng reoptimization {all | name policy}
```

Use the **all** option to trigger an immediate reoptimization for all policies. Use the **name policy** option to trigger an immediate reoptimization for a specific policy.

Configuring SR-TE Reoptimization Timers

Use these commands in SR-TE configuration mode to configure SR-TE reoptimization timers:

- **timers candidate-path cleanup-delay** *seconds*—Specifies the delay before cleaning up candidate paths, in seconds. The range is from 0 (immediate clean-up) to 86400; the default value is 120
- **timers cleanup-delay** *seconds*—Specifies the delay before cleaning up previous path, in seconds. The range is from 0 (immediate clean-up) to 300; the default value is 10.
- **timers init-verify-restart** *seconds* —Specifies the delay for topology convergence after the topology starts populating due to a restart, in seconds. The range is from 10 to 10000; the default is 40.
- **timers init-verify-startup** *seconds*—Specifies the delay for topology convergence after topology starts populating for due to startup, in seconds. The range is from 10 to 10000; the default is 300
- **timers init-verify-switchover** *seconds*—Specifies the delay for topology convergence after topology starts populating due to a switchover, in seconds. The range is from 10 to 10000; the default is 60.
- **timers install-delay** *seconds*—Specifies the delay before switching to a reoptimized path, in seconds. The range is from 0 (immediate installation of new path) to 300; the default is 10.
- **timers periodic-reoptimization** *seconds*—Specifies how often to perform periodic reoptimization of policies, in seconds. The range is from 0 to 86400; the default is 600.

Example Configuration

```
Router(config)# segment-routing traffic-eng
Router(config-sr-te)# timers
Router(config-sr-te-timers)# candidate-path cleanup-delay 600
Router(config-sr-te-timers)# cleanup-delay 60
Router(config-sr-te-timers)# init-verify-restart 120
Router(config-sr-te-timers)# init-verify-startup 600
Router(config-sr-te-timers)# init-verify-switchover 30
Router(config-sr-te-timers)# install-delay 60
Router(config-sr-te-timers)# periodic-reoptimization 3000
```

Running Config

```
segment-routing
 traffic-eng
  timers
   install-delay 60
   periodic-reoptimization 3000
   cleanup-delay 60
   candidate-path cleanup-delay 600
   init-verify-restart 120
   init-verify-startup 600
   init-verify-switchover 30
  !
 !
 !
```

Circuit-Style SR-TE Policies

Table 15: Feature History Table

Feature Name	Release Information	Feature Description
Circuit-Style SR-TE Policies	Release 7.8.1	<p>This solution allows Segment Routing to meet the requirements of a connection-oriented transport network, which was historically delivered over circuit-switched SONET/SDH networks.</p> <p>Circuit-style SR-TE policies allow a common network infrastructure to be used for both connection-oriented services and classic IP-based transport. This eliminates the need for multiple parallel networks, which greatly reduces both capital expenditures (CapEx) and operating expenditures (OpEx).</p>

Segment Routing provides an architecture that caters to both connectionless transport (such as IP) as well as connection-oriented transport (such as TDM). IP-centric transport uses the benefits of ECMP and automated/optimum protection from TI-LFA. On the other hand, connection-oriented transport, which was historically delivered over circuit-switched SONET/SDH networks, requires the following:

- End-to-end bidirectional transport that provides congruent forward and reverse paths, predictable latency, and disjointness
- Bandwidth commitment to ensure there is no impact on the SLA due to network load from other services
- Monitoring and maintenance of path integrity with end-to-end 50-msec path protection
- Persistent end-to-end paths regardless of control-plane state

An SR network can satisfy these requirements by leveraging Circuit-Style SR-TE policies (CS-SR policies).

Properties of Circuit-Style SR Policies

CS-SR policies have the following properties:

- **Guaranteed Latency over Non-ECMP Paths**

Consider the network below with three possible paths from node 1 to node 7. Of the three paths, the best end-to-end delay is provided by the blue path (1 -> 2 -> 3 -> 7). The chosen path is then encoded with Adj-SIDs corresponding to the traversed interfaces to avoid any ECMP, and therefore guarantee the latency over the path.

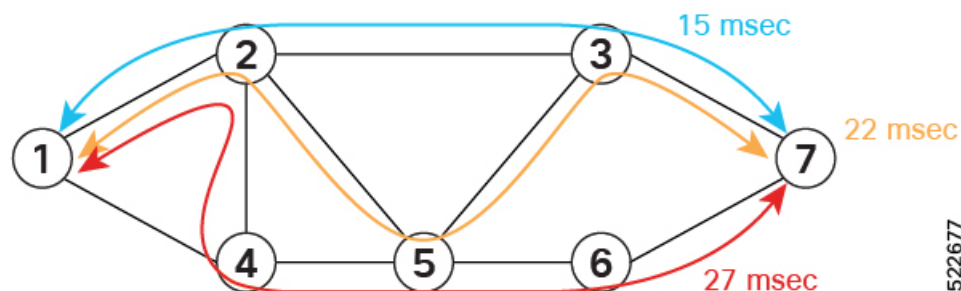

522677

• **Control-Plane Independent Persistency**

Adjacency SIDs can provide a persistent path independent from control-plane changes (such as IGP neighbor flaps), as well as network events (such as interface additions or interface flaps) and even the presence of IP on an interface. To achieve this, adjacency SIDs can be manually allocated to ensure persistent values, for example after a node reload event. In addition, adjacency SIDs can be programmed as non-protected to avoid any local TI-LFA protection.

With the Adj-SIDs depicted in the figure below, the path from node 1 to node 7 is encoded with the segment list of {24000, 24001, 24000}. By manually allocating the same Adj-SID values for other direction, the path from node 7 to node 1 is encoded with the same segment list of {24000, 24001, 24000}.

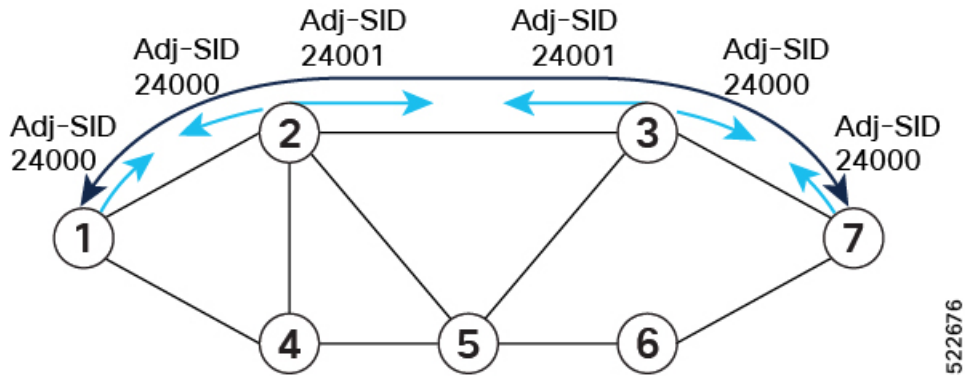

• **Co-Routed Bidirectional Path**

Forward and return SR Policies with congruent paths are routed along the same nodes/interfaces.

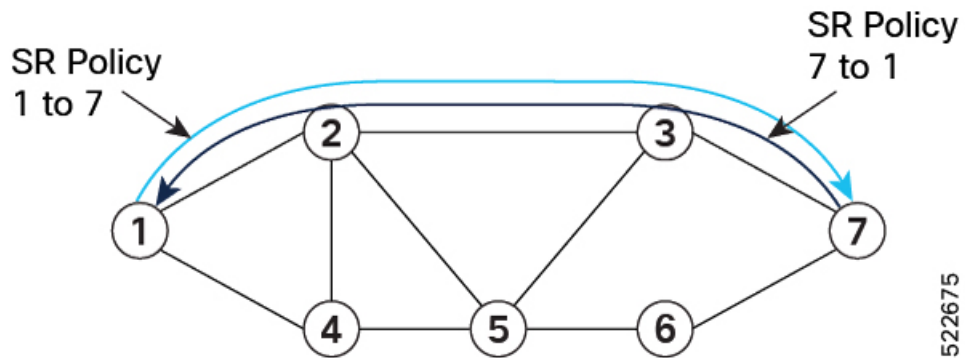

• **Liveness Monitoring with Path Protection Switching**

Bi-directional liveness monitoring on the working and protect paths ensures fast and consistent switchover, while a protect path is pre-programmed over disjoint facilities.

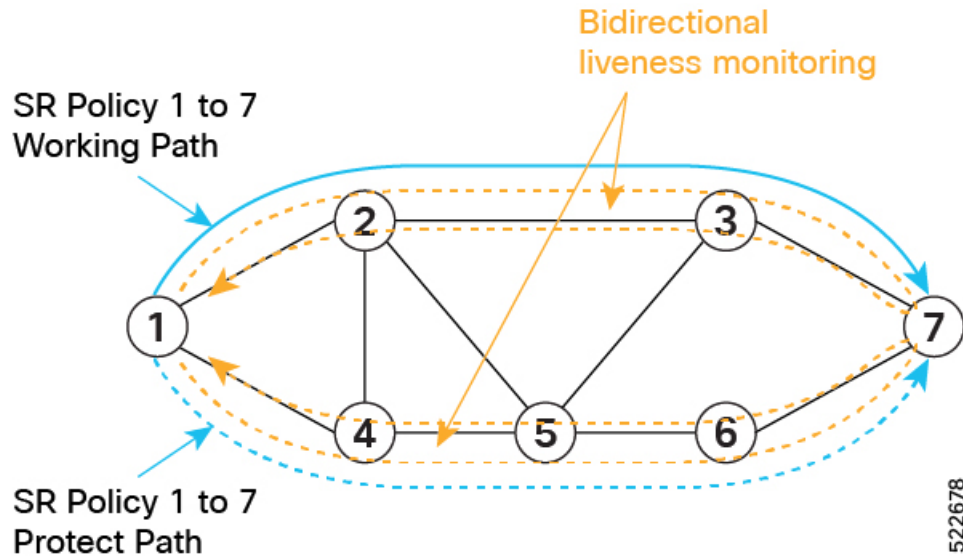

• **Guaranteed Bandwidth**

Most services carried over the CS-SR policy are constant-rate traffic streams. Any packet loss due to temporary congestion leads to bit errors at the service layer. Therefore, bandwidth must be managed very tightly and guaranteed to the services mapped to CS-SR policies.

A centralized controller manages the bandwidth reservation. The controller maintains the reserved bandwidth on each link based on the traffic usage:

- Monitors amount of traffic forwarded to each CS-SR policy in the network
- Uses knowledge of the active path used by the policy
- Computes the per-link reservable bandwidth accordingly

A per-hop behavior (as documented in [RFC3246](#) [Expedited Forwarding] or [RFC2597](#) [Assured Forwarding]) ensures that the specified bandwidth is available to CS-SR policies at all times independent of any other traffic.

Bandwidth is reserved on both the working and protect paths.

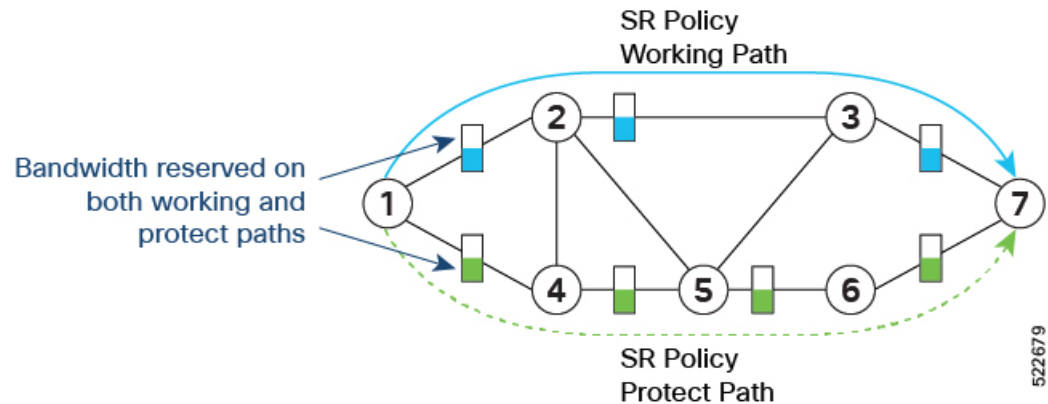

In addition, you can allocate one MPLS-EXP value for traffic steered over the CS SR-TE policies and use QoS (interface queuing) configuration to isolate the circuit traffic from the rest:

- QoS on headend nodes:
 - Define EXP value associated with CS services
 - Enforce rate limiting and perform EXP marking on service ingress interfaces
- QoS on transit nodes:
 - Classify incoming packets based on EXP value associated with CS services.
 - Enforce guaranteed bandwidth for the classified traffic on egress interfaces using bandwidth queues or priority queue with shaper.

Refer to [Configuring Modular QoS Service Packet Classification](#) chapter in the *Modular QoS Configuration Guide for Cisco ASR 9000 Series Routers*.

Components of the Circuit-Style Solution

CS-SR policy paths are computed and maintained by a stateful PCE. The stateful PCE has a centralized view of the network that it can leverage to compute the co-routed bidirectional end-to-end paths and perform bandwidth allocation control, as well as monitor capabilities to ensure SLA compliance for the life of the CS-SR Policy.

- Centralized Controller
 - Computes the path
 - Encodes the path in a list of Adj-SIDs
 - Monitors and controls bandwidth for SLA guarantee
- QoS configuration on every link to isolate guaranteed traffic

Usage Guidelines and Limitations

Observe the following guidelines and limitations:

- The maximum SID depth (MSD) is 10.
- CS SR policy end-point IP address must be the router-ID of the intended node.
- SR policy path protection is required for both directions.
- SR policy with dynamic path bandwidth constraint is required for both directions and must have the same value for both directions.
- Candidate path (CP) behavior:
 - The working path is associated with the candidate path of the highest preference value.
 - The protect path is associated with the candidate path of the second-highest preference value.

- The restore path is associated with the candidate path of the third-highest preference value and is configured as "backup ineligible".
- Candidate paths with the same role in both directions (working, protect, restore) must have the same preference value.
- Bi-directional path behavior:
 - All paths must be configured as co-routed.
 - All paths with the same role in both directions (working, protect, restore) must have the same bi-directional association ID value.
 - The bi-directional association ID value must be globally unique.
- Disjointness constraint:
 - The working and protect paths under the CS SR policy must be configured with a disjointness constraint using the same disjoint association ID and disjointness type.
 - The disjointness association ID for a working and protect path pair in one direction must be globally unique from the corresponding working and protect path pair in the opposite direction.
 - Node and link disjoint constraint types are supported.
 - The disjoint type used in both directions must be the same.
 - The restore path must not be configured with a disjointness constraint.
- Path optimization objectives supported are TE, IGP, and latency.
- The path optimization objective must match across working, protect, and restore paths in both directions.
- Segment type constraint:
 - Working, protect, and restore paths must all be configured with unprotected-only segment type constraint.
 - Working, protect, and restore paths must all be configured with Adj-SID-only segment type constraint.
 - To ensure persistency throughout link failure events, manual adjacency SIDs allocated from the SRLB range should be created on all interfaces used by CS policies.
- Revert/recovery behavior:
 - When both working and protect paths are down, the restore path becomes active.
 - The restore path remains active until the working or protect path recovers (partial recovery) and the lock duration timer expires.
 - The lock duration timer is configured under the protect and restore CPs.
- The following functionalities are not supported:
 - Affinity constraint
 - Flex-Algo constraint

- Metric-bounds constraint
- SR-TE Path Invalidation Drop

Configure Performance Measurement Liveness Profiles

Performance Measurement (PM) provides proper detection of candidate path liveness and effective path protection. See [SR Policy Liveness Monitoring](#).

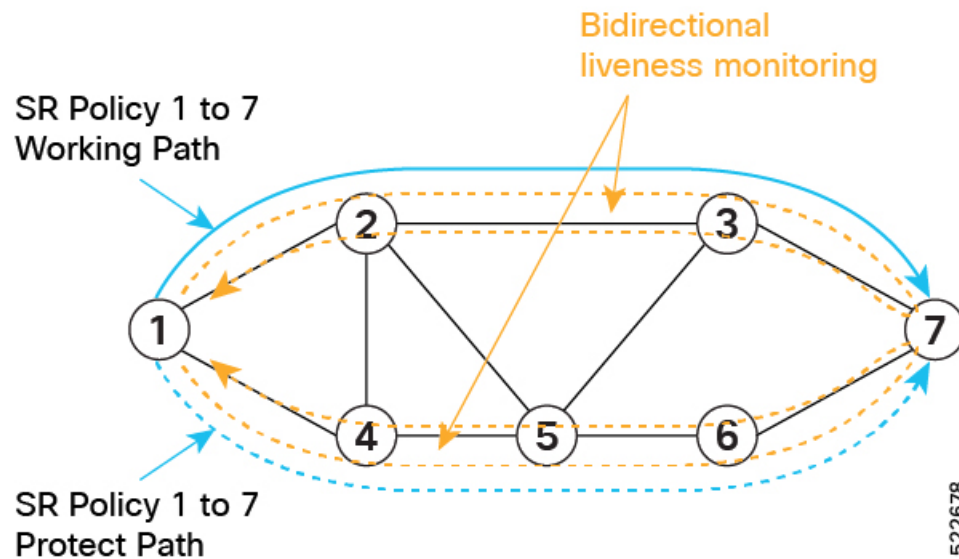

The following example shows how to create a liveness profile for the working and protect paths.

```
Router_1(config)# performance-measurement
Router_1(config-perf-meas)# liveness-profile name profile-WORKING
Router_1(config-pm-ld-profile)# liveness-detection
Router_1(config-pm-ld-profile-ld)# multiplier 3
Router_1(config-pm-ld-profile-ld)# exit
Router_1(config-pm-ld-profile)# probe
Router_1(config-pm-ld-probe)# tx-interval 30000
Router_1(config-pm-ld-probe)# exit
Router_1(config-pm-ld-profile)# exit
Router_1(config-perf-meas)# liveness-profile name profile-PROTECT
Router_1(config-pm-ld-profile)# liveness-detection
Router_1(config-pm-ld-profile-ld)# multiplier 3
Router_1(config-pm-ld-profile-ld)# exit
Router_1(config-pm-ld-profile)# probe
Router_1(config-pm-ld-probe)# tx-interval 100000
```

Configuring CS SR-TE Policy

The following example shows how to configure a circuit-style SR policy from node 1 to node 7 with three candidate paths: working, protect, and restore.

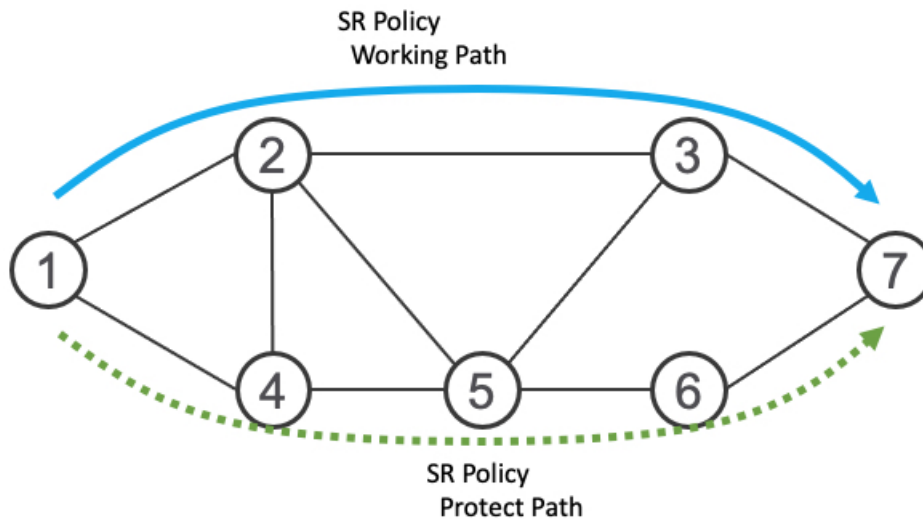

Create the SR-TE Policy

Configure the CS SR-TE policy.

Use the **bandwidth** *bandwidth* command in SR-TE policy configuration mode to configure the guaranteed reservable bandwidth for the policy. The range for *bandwidth* is from 1 to 4294967295 in kbps.

Use the **path-protection** command in SR-TE policy configuration mode to enable end-to-end path protection.

```
Router_1(config)# segment-routing
Router_1(config-sr)# traffic-eng
Router_1(config-sr-te)# policy cs-srte-to-node7
Router_1(config-sr-te-policy)# bandwidth 10000
Router_1(config-sr-te-policy)# color 10 end-point ipv4 10.1.1.7
Router_1(config-sr-te-policy)# path-protection
Router_1(config-sr-te-path-pref-protection)# exit
Router_1(config-sr-te-policy)#
```

Enable Liveness Monitoring Under SR Policy

The following example shows how to enable liveness monitoring under SR Policy and associate the working and protect (backup) liveness-profiles.

```
Router_1(config)# segment-routing
Router_1(config-sr)# traffic-eng
Router_1(config-sr-te)# policy cs-srte-to-node7
Router_1(config-sr-te-policy)# performance-measurement
Router_1(config-sr-te-policy-perf-meas)# liveness-detection
Router_1(config-sr-te-policy-live-detect)# liveness-profile name profile-WORKING
Router_1(config-sr-te-policy-live-detect)# liveness-profile backup name profile-PROTECT
Router_1(config-sr-te-policy-live-detect)# exit
Router_1(config-sr-te-policy-perf-meas)# exit
Router_1(config-sr-te-policy)#
```

Configure the Working Candidate Path

The working CP has the following characteristics:

- The working path is associated with the candidate path of the highest preference.
- The working CP uses unprotected-only Adj-SIDs in the segment list.
- The working CP is bidirectional and co-routed.
- The working CP in both directions must have the same bi-directional association ID value.
- The disjoint path constraint for the working CP must have the same group ID and disjoint type as the protect CP.

```

Router_1(config)# segment-routing
Router_1(config-sr)# traffic-eng
Router_1(config-sr-te)# policy cs-srte-to-node7
Router_1(config-sr-te-policy)# candidate-paths
Router_1(config-sr-te-policy-path)# preference 100
Router_1(config-sr-te-policy-path-pref)# dynamic
Router_1(config-sr-te-pp-info)# pcep
Router_1(config-sr-te-path-pcep)# exit
Router_1(config-sr-te-pp-info)# metric
Router_1(config-sr-te-path-metric)# type te
Router_1(config-sr-te-path-metric)# exit
Router_1(config-sr-te-pp-info)# exit
Router_1(config-sr-te-policy-path-pref)# constraints
Router_1(config-sr-te-path-pref-const)# segments
Router_1(config-sr-te-path-pref-const-seg)# protection unprotected-only
Router_1(config-sr-te-path-pref-const-seg)# adjacency-sid-only
Router_1(config-sr-te-path-pref-const-seg)# exit
Router_1(config-sr-te-path-pref-const)# disjoint-path group-id 3 type node
Router_1(config-sr-te-path-pref-const)# exit
Router_1(config-sr-te-policy-path-pref)# bidirectional
Router_1(config-sr-te-path-pref-bidir)# co-routed
Router_1(config-sr-te-path-pref-bidir)# association-id 1100
Router_1(config-sr-te-path-pref-bidir)# exit
Router_1(config-sr-te-policy-path-pref)# exit
Router_1(config-sr-te-policy-path)#

```

Configure the Protect Candidate Path

The protect CP has the following characteristics:

- The protect path is associated with the candidate path of the second-highest preference.
- The protect CP uses unprotected-only Adj-SIDs in the segment list.
- The protect CP is bidirectional and co-routed.
- The protect CP in both directions must have the same bi-directional association ID value.
- The disjoint path constraint for the protect CP must have the same group ID and disjoint type as the working CP.
- When the working path is invalid, the protect path becomes active. After the working path has recovered, the protect path remains active until the default lock duration (300 seconds) expires. You can configure a different lock duration using the **lock duration** *duration* command. The *duration* range is 0 (disabled) to 3000 seconds. If the lock duration is 0 (disabled), then the working path becomes active as soon as it recovers. If *duration* is not specified, the protect path remains active.

```

Router_1(config-sr-te-policy-path)# preference 50
Router_1(config-sr-te-policy-path-pref)# dynamic
Router_1(config-sr-te-pp-info)# pcep
Router_1(config-sr-te-path-pcep)# exit
Router_1(config-sr-te-pp-info)# metric
Router_1(config-sr-te-path-metric)# type te
Router_1(config-sr-te-path-metric)# exit
Router_1(config-sr-te-pp-info)# exit
Router_1(config-sr-te-policy-path-pref)# lock duration 30
Router_1(config-sr-te-policy-path-pref)# constraints
Router_1(config-sr-te-path-pref-const)# segments
Router_1(config-sr-te-path-pref-const-seg)# protection unprotected-only
Router_1(config-sr-te-path-pref-const-seg)# adjacency-sid-only
Router_1(config-sr-te-path-pref-const-seg)# exit
Router_1(config-sr-te-path-pref-const)# disjoint-path group-id 3 type node
Router_1(config-sr-te-path-pref-const)# exit
Router_1(config-sr-te-policy-path-pref)# bidirectional
Router_1(config-sr-te-path-pref-bidir)# co-routed
Router_1(config-sr-te-path-pref-bidir)# association-id 1050
Router_1(config-sr-te-path-pref-bidir)# exit
Router_1(config-sr-te-policy-path-pref)# exit
Router_1(config-sr-te-policy-path)#

```

Configure the Restore Candidate Path

The restore CP has the following characteristics:

- The restore path is associated with the candidate path of the the third-highest preference.
- The restore CP uses unprotected-only Adj-SIDs in the segment list.
- The restore CP is bidirectional and co-routed.
- The restore CP in both directions must have the same bidirectional association ID value.
- The restore CP must be configured with **backup-ineligible**. This configuration prevents the restore CP from being used as a fast reroute backup. The restore path is not computed until both working and protect paths become unavailable.
- Disjointness constraint is not configured on the restore CP.
- If both working and protect paths are unavailable, the restore path becomes active. After either the working or protect path has recovered, the restore path remains active until the default lock duration (300 seconds) expires. You can configure a different lock duration using the **lock duration duration** command. The *duration* range is 0 (disabled) to 3000 seconds. If the lock duration is 0 (disabled), then the working or protect path becomes active as soon as either recovers. If *duration* is not specified, the restore path remains active.

```

Router_1(config-sr-te-policy-path)# preference 10
Router_1(config-sr-te-policy-path-pref)# dynamic
Router_1(config-sr-te-pp-info)# pcep
Router_1(config-sr-te-path-pcep)# exit
Router_1(config-sr-te-pp-info)# metric
Router_1(config-sr-te-path-metric)# type te
Router_1(config-sr-te-path-metric)# exit
Router_1(config-sr-te-pp-info)# exit
Router_1(config-sr-te-policy-path-pref)# backup-ineligible
Router_1(config-sr-te-policy-path-pref)# lock duration 30

```

```

Router_1(config-sr-te-policy-path-pref)# constraints
Router_1(config-sr-te-path-pref-const)# segments
Router_1(config-sr-te-path-pref-const-seg)# protection unprotected-only
Router_1(config-sr-te-path-pref-const-seg)# adjacency-sid-only
Router_1(config-sr-te-path-pref-const-seg)# exit
Router_1(config-sr-te-path-pref-const)# exit
Router_1(config-sr-te-policy-path-pref)# bidirectional
Router_1(config-sr-te-path-pref-bidir)# co-routed
Router_1(config-sr-te-path-pref-bidir)# association-id 1010
Router_1(config-sr-te-path-pref-bidir)# exit
Router_1(config-sr-te-policy-path-pref)# exit
Router_1(config-sr-te-policy-path)#

```

Running Configuration

```

Router_1# show running-config

. . .
segment-routing
traffic-eng
policy cs-srte-to-node7
  bandwidth 10000
  color 10 end-point ipv4 10.1.1.7
  path-protection
  !
  candidate-paths
  preference 10
  dynamic
  pcep
  !
  metric
  type te
  !
  !
  lock
  duration 30
  !
  backup-ineligible
  !
  constraints
  segments
  protection unprotected-only
  adjacency-sid-only
  !
  !
  bidirectional
  co-routed
  association-id 1010
  !
  !
  preference 50
  dynamic
  pcep
  !
  metric
  type te
  !
  !
  lock
  duration 30
  !
  constraints

```

```

    segments
      protection unprotected-only
      adjacency-sid-only
    !
    disjoint-path group-id 3 type node
    !
    bidirectional
      co-routed
      association-id 1050
    !
  !
  preference 100
  dynamic
    pcep
    !
    metric
      type te
    !
    !
  constraints
    segments
      protection unprotected-only
      adjacency-sid-only
    !
    disjoint-path group-id 3 type node
    !
    bidirectional
      co-routed
      association-id 1100
    !
  !
  !
  performance-measurement
    liveness-detection
      liveness-profile backup name profile-PROTECT
      liveness-profile name profile-WORKING
      invalidation-action down
    !
  !
  !
  !
  root
  performance-measurement
    liveness-profile name profile-PROTECT
    liveness-detection
      multiplier 3
    !
    probe
      tx-interval 100000
    !
    !
    liveness-profile name profile-WORKING
    liveness-detection
      multiplier 3
    !
    probe
      tx-interval 30000
    !
  !
  !
  !

```

Verification

Use the **show segment-routing traffic-eng policy detail** command to display the details of the CS SR policy on node 1:

```
Router_1# show segment-routing traffic-eng policy detail

SR-TE policy database
-----

Color: 10, End-point: 10.1.1.7
Name: srte_c_10_ep_10.1.1.7
Status:
  Admin: up Operational: up for 00:02:24 (since Nov 30 08:03:36.588)
Candidate-paths:
  Preference: 100 (configuration) (active)
  Name: cs-srte-to-node7
  Requested BSID: 8000
  PCC info:
    Symbolic name: cfg_cs-srte-to-node7_discr_100
    PLSP-ID: 2
  Constraints:
    Protection Type: unprotected-only
    Maximum SID Depth: 10
    Adjacency SIDs Only: True
  Performance-measurement:
    Reverse-path Label: Not Configured
    Delay-measurement: Disabled
    Liveness-detection: Enabled
    Profile: profile-WORKING
    Invalidation Action: down
  Logging:
    Session State Change: No
  Statistics:
    Session Create      : 1
    Session Update     : 12
    Session Delete     : 4
    Session Up         : 8
    Session Down       : 3
    Delay Notification : 0
    Session Error      : 0
  Dynamic (pce 192.168.0.5) (valid)
  Metric Type: TE, Path Accumulated Metric: 10
  SID[0]: 24001 [Adjacency-SID, 10.10.10.1 - 10.10.10.2]
  Reverse path:
  SID[0]: 24000 [Adjacency-SID, 10.10.10.2 - 10.10.10.1]
  Protection Information:
    Role: WORKING
    Path Lock: Timed
    Lock Duration: 300(s)
  Preference: 50 (configuration) (protect)
  Name: cs-srte-to-node7
  Requested BSID: 8000
  PCC info:
    Symbolic name: cfg_cs-srte-to-node7_discr_50
    PLSP-ID: 1
  Constraints:
    Protection Type: unprotected-only
    Maximum SID Depth: 10
    Adjacency SIDs Only: True
  Performance-measurement:
    Reverse-path Label: Not Configured
    Delay-measurement: Disabled
    Liveness-detection: Enabled
```

```

Profile: profile-PROTECT
Invalidation Action: down
Logging:
  Session State Change: No
Statistics:
  Session Create      : 0
  Session Update     : 9
  Session Delete     : 0
  Session Up         : 1
  Session Down       : 0
  Delay Notification: 0
  Session Error      : 0
Dynamic (pce 192.168.0.5) (valid)
  Metric Type: TE, Path Accumulated Metric: 10
  SID[0]: 24002 [Adjacency-SID, 11.11.11.1 - 11.11.11.2]
  Reverse path:
  SID[0]: 24003 [Adjacency-SID, 11.11.11.2 - 11.11.11.1]
Protection Information:
  Role: PROTECT
  Path Lock: Timed
  Lock Duration: 30(s)
Preference: 10 (configuration) (inactive)
Name: cs-srte-to-node7
Requested BSID: 8000
Constraints:
  Protection Type: unprotected-only
  Maximum SID Depth: 10
  Adjacency SIDs Only: True
Performance-measurement:
  Reverse-path Label: Not Configured
  Delay-measurement: Disabled
  Liveness-detection: Enabled
  Profile: working
  Invalidation Action: down
  Logging:
  Session State Change: No
Statistics:
  Session Create      : 0
  Session Update     : 0
  Session Delete     : 0
  Session Up         : 0
  Session Down       : 0
  Delay Notification: 0
  Session Error      : 0
Dynamic (pce) (inactive)
  Metric Type: TE, Path Accumulated Metric: 0
Protection Information:
  Role: RESTORE
  Path Lock: Timed
  Lock Duration: 30(s)
LSPs:
LSP[0]:
  LSP-ID: 3 policy ID: 1 (standby)
  Local label: 24037
  State: Standby programmed state
Performance-measurement:
  Reverse-path Label: Not Configured
  Delay-measurement: Disabled
  Liveness-detection: Enabled
  Profile: profile-WORKING
  Invalidation Action: down
  Logging:
  Session State Change: No
  Session State: up, for 1d12h (since Nov 30 08:03:37.859)

```

```

LSP[1]:
  LSP-ID: 7 policy ID: 1 (active)
  Local label: 24036
  State: Programmed
  Binding SID: 8000
  Performance-measurement:
    Reverse-path Label: Not Configured
    Delay-measurement: Disabled
    Liveness-detection: Enabled
    Profile: profile-WORKING
    Invalidation Action: down
    Logging:
      Session State Change: No
      Session State: up, for 05:42:36 (since Dec 1 15:11:36.203)
Attributes:
  Binding SID: 8000
  Forward Class: Not Configured
  Steering labeled-services disabled: no
  Steering BGP disabled: no
  IPv6 caps enable: yes
  Bandwidth Requested: 10000 kbps
  Bandwidth Current: 10000 kbps
  Invalidation drop enabled: no
  Max Install Standby Candidate Paths: 0

```

Reporting of SR-TE Policies Using BGP- Link State

Table 16: Feature History Table

Feature Name	Release Information	Feature Description
Reporting of SR-TE Policies Using BGP-Link State for SRv6	Release 24.1.1	You can gather the Traffic Engineering Policy information that is locally available in a node and advertise it in BGP-LS for SRv6. The configuration procedures from previous releases, which supported only SR-MPLS, are the same and apply to this feature.

Feature Name	Release Information	Feature Description
Reporting of SR-TE Policies Using BGP-Link State for SR-MPLS	Release 7.10.1	<p>BGP- Link State (LS) is a mechanism by which LS and Traffic Engineering (TE) information can be collected from networks and shared with external components (such as, Segment Routing Path Computation Element (SR-PCE) or Crossword Optimization Engine (COE)) using the BGP routing protocol.</p> <p>This feature gathers the Traffic Engineering Policy information that is locally available in a node and advertises it in BGP-LS for SR-MPLS.</p> <p>The operators can now take informed decisions based on the information that is gathered on their network's path computation, reoptimization, service placement, network visualization, and so on.</p> <p>The feature introduces these changes:</p> <p>CLI:</p> <ul style="list-style-type: none"> • distribute link-state <p>YANG Data Model:</p> <ul style="list-style-type: none"> • New XPath for <code>module</code> <code>Cisco-IOS-XR-infra-xtc-agent-cfg.yang</code> (see GitHub, YANG Data Models Navigator)

This function is achieved using a BGP Network Layer Reachability Information (NLRI) encoding format. BGP-LS consumes structured IGP data (for example, router-id, remote-IP-address of a link, local-IP address of a link, link identifier, and so on). and creates BGP-LS (NLRI) or attributes that BGP or other components like Cisco IOS XR Traffic Controller (XTC) can consume. Current implementation of BGP-LS can report topology using Nodes, Links, and Prefixes.



- Note**
- Starting from Release 7.10.1 this feature supports MPLS.
 - Starting from Release 24.1.1 this feature supports SRv6.

Modern Segment Routing (SR) networks often use SR Traffic Engineering (SR-TE) to influence the path that each specific traffic takes over the network. SR-TE tunnels can be provisioned manually on the tunnel head, but often they are calculated and provisioned by the central controller. Often operator of the network wants the ability to force the traffic over specific nodes and links.

Now the operators have the option to collect reports of the SR-TE and Policy information that is locally available in a node and advertise it into BGP-LS updates, which can be used by external components. Refer the [IEFT](#) for examples. This feature is implemented so that the operators have control over their network's path computation, reoptimization, service placement, network visualization, and so on.



Note Circuit Style (CS) SR policies are reported but without the CS policies' specific attributes, like the bidirectional constraints, per-hop behavior, and so on.

Restrictions to Reporting of SRTE Policies using BGP-LS

Some important points to be aware related to this feature are as follows:

- This feature has high availability, ensuring BGP-LS reporting at all times.
- This feature works with PCE State Sync. The policy information learned via the state-sync channel is not advertised in BGP-LS by the PCE.
- The feature works with PCE redundancy. Both PCEs advertise the BGP-LS policy information. The consumers can select only one policy based on the BGP best path logic.

Configure Reporting of SRTE Policies using BGP-LS

The reporting of policies to BGP-LS is disabled by default. Configuring the **distribute link-state** under the SR-PCE or SR-TE configuration enables this feature. Once enabled, all the existing SR policies or Candidate Path (CPs) are encoded to BGP-LS. You can disable this feature by removing the configuration and all the SR policies or CPs are withdrawn from BGP which deletes all of the previously encoded SR policies or CPs.



Note When SR policies that are reporting in BGP-LS are enabled by the operator, the Head End only reports the Active Candidate Path (CPs) (CPs installed in the forwarding). There are monitoring use cases that require reporting of inactive CPs. The following CLI is needed to report inactive CPs.

For both SR-TE and SR-PCE, you need to use the global CLI to enable the reporting of policies or Circuit Style (CS) to BGP-LS:



Note

- Starting from Release 7.10.1 this feature supports MPLS.
- Starting from Release 24.1.1 this feature supports SRv6.

Configuration Example

Configure the following command to enable reporting and syncing of SR policies in BGP-LS at the Head End:

```
Router# config
Router(config)# segment-routing
Router(config-sr)# traffic-eng
Router(config-sr-te)# distribute link-state
Router(config-sr-te-distribute-ls)# report-candidate-path-inactive
Router(config-sr-te-distribute-ls)# commit
Router(config-sr-te-distribute-ls)# exit
```



Note The **report-candidate-path-inactive** command is an optional command to report inactive CPs.

Running Configuration

This is a sample running configuration which shows that you have configured BGP-LS reporting feature.

```
segment-routing
 traffic-eng
  distribute link-state
  report-candidate-path-inactive
 !
 !
 !
```

Verification

Use the **show pce segment-routing traffic-eng policy private** and **show pce distributed-ls events** to verify the configuration.

```
Router#show pce segment-routing traffic-eng policy private
```

```
PCE's policy database:
-----
PCC Address: 192.168.2.1
Color: 100, Endpoint: 192.0.2.1
Name: srte_c_100_ep_192.0.2.1
Self Pointer: 0x317d7f0
Active C-path Pointer: 0x317d9b0
Candidate-paths:
  Symbolic-name: cfg_foo_discr_100 (Active)
  PLSP-ID: 1
  NB-API Notification pending flag: 0
  Self Pointer: 0x317d9b0
  Tunnel Pointer: 0x317d4e0
  Policy Pointer: 0x317d7f0
  Cached distribute LS element:
    Sense: TRUE
    Refcount: 1
    Is on queue: FALSE
    Node identifiers:
      Protocol: 9 router ID: 192.0.2.1
    Policy identifiers:
      Color: 100 Endpoint: 192.0.2.1
      Flags: 0x00
    Candidate path identifiers:
      Originator: 0.0.0.0 protocol: 3 ASN: 0
      Flags: 0x00
      Discriminator: 100
    Candidate path attributes:
      Name: foo
      Policy name: srte_c_100_ep_192.0.2.1
      State:
        Priority: 0 flags: 0x5800 (active, evaluated, valid-sid-list)
        Preference: 100
      BSID:
        Flags: 0x4000 (alloc)
        BSID: 24021
        Specified BSID: 0
```

```

Constraints:
  Bitfield: 0x0020 flags: 0x4000 (protected-only) MT-ID: 0
  Algorithm: 0
  Bandwidth: 0 kbps
  Metric constraints[0]:
    Type: 0 flags: 0x80 (optimization)
    Margin: 0 bound: 0
  Metric constraints[1]:
    Type: 4 flags: 0x10 (bound)
    Margin: 0 bound: 10
Segment lists:
  Segment list[0]:
    Flags: 0x3800 (computed, verified, first-seg-resolved) MT-ID: 0 algorithm:
0 weight: 0
  Metric[0]:
    Type: 0 flags: 0x10 (value)
    Margin: 0 bound: 0 value: 10
  Segments:
    Segment[0]:
      Bitfield: 0x0000 type: 3 flags: 0x8000 (sid-present)
      SID: 102000
      Descriptor:
        Algorithm: 0
        Local address: 192.0.2.1 [0] remote address: 0.0.0.0 [0]

```

Router#show pce distribute-ls events

```

Distribute LS events:
-----
Event history (oldest first):
  Time          Event
  Apr 11 01:50:48.985 [UID: 0] SR CP NLRI: node ID: SR RID 192.0.2.1, ls_id 0, asn 0,
bitf 0x00000200 policy ID: endpoint: 192.168.0.2 color: 100 CP ID: originator: config 0.0.0.0
asn: 0 discriminator: 100 (oper: add)
  Apr 11 01:50:50.046 [UID: 1] SR CP NLRI: node ID: SR RID 192.0.2.1, ls_id 0, asn 0,
bitf 0x00000200 policy ID: endpoint: 192.168.0.2 color: 100 CP ID: originator: config 0.0.0.0
asn: 0 discriminator: 100 (oper: add)
RP/0/0/CPU0:rtrX#show pce distribute-ls summary
Tue Apr 11 02:03:36.289 PDT
Distribution enabled: yes
Connected to LS-LIB: yes
Encode queue size: 0
Estimated encoding rate: 17280/s
NLRIs encoded to LS-LIB:
  SR candidate path: 2 added, 0 removed, 0 errored, 0 replaced
Element stats:
  SR candidate path: 1 (watermark: 2)
Throttle timer:
  Running: no

```

Below is the example show output for SRv6.

```
Router# show segment-routing traffic-eng policy color 200 private
```

```

SR-TE policy database
-----
Color: 200, End-point: 192::2 ID: 2
Name: srte_c_200_ep_192::2
Status:
  Admin: up Operational: up for 00:01:07 (since Mar 6 11:17:42.580)
Candidate-paths:
  Preference: 100 (configuration) (active)
  Originator: ASN 0 node-address <None> discriminator: 100

```

```

Name: bar
Requested BSID: dynamic
PCC info:
  Symbolic name: cfg_bar_discr_100
  PLSP-ID: 2
  Is orphan: no
  State timer:
    Running: no
Constraints:
  Protection Type: protected-preferred
  Maximum SID Depth: 10
ID: 1
Source: 192::1
Stale: no
Checkpoint flags: 0x00000000
Path Type: SRV6
Performance-measurement:
  Reverse-path segment-list:
  Delay-measurement: Disabled
  Liveness-detection: Disabled
Dynamic (pce 192.168.0.3) (valid)
  Metric Type: IGP, Path Accumulated Metric: 10
  IGP area: 0
  SID[0]: fccc:cccl:2::/48 Behavior: uN (PSP/USD) (48)
    Format: f3216
    LBL:32 LNL:16 FL:0 AL:80
    Address: 192::2
SRv6 Information:
  Locator: loc1Algo0
  Binding SID requested: Dynamic
  Binding SID behavior: uB6 (Insert.Red)
Cached distribute LS element:
  Sense: TRUE
  Refcount: 1
  Is on queue: FALSE
  Node identifiers:
    Protocol: 9 router ID: 192::1
  Policy identifiers:
    Color: 200 Endpoint: 192::2
    Flags: 0x80 (endpoint-v6)
  Candidate path identifiers:
    Originator: 0.0.0.0 protocol: 3 ASN: 0
    Flags: 0x00
    Discriminator: 100
  Candidate path attributes:
    Name: bar
    Policy name: srte_c_200_ep_192::2
    State:
      Priority: 0 flags: 0x5A00 (active, evaluated, valid-sid-list, delegated)
      Preference: 100
  SRv6 BSID:
    Flags: 0x8000 (alloc)
    BSID: fccc:cccl:1:e018::
    Specified BSID: ::
    Endpoint:
      Endpoint function: 71 flags: 0x00 algorithm: 0
    Structure:
      Locator block length: 32 locator node length: 16 function length: 16 arguments
length: 0
Constraints:
  Bitfield: 0x0020 flags: 0xC000 (dataplane-v6, protected) MT-ID: 0
  Algorithm: 0
  Bandwidth: 0 kbps

```

```

Metric constraints[0]:
  Type: 0 flags: 0x80 (optimization)
  Margin: 0 bound: 0
Metric constraints[1]:
  Type: 4 flags: 0x10 (bound)
  Margin: 0 bound: 10
Segment lists:
  Segment list[0]:
    Flags: 0xB800 (dataplane-v6, computed, verified, first-seg-resolved) MT-ID:
0 algorithm: 0 weight: 1
  Metric[0]:
    Type: 0 flags: 0x10 (value)
    Margin: 0 bound: 0 value: 10
  Segments:
    Segment[0]:
      Bitfield: 0x0003 type: 9 flags: 0x8000 (sid-present)
      SID: fccc:cccl:2::
      Descriptor:
        Algorithm: 0
        Local address: 192::2 [0] remote address: :: [0]
      Endpoint:
        Endpoint function: 48 flags: 0x00 algorithm: 0
      Structure:
        Locator block length: 32 locator node length: 16 function length: 0
arguments length: 80
LSPs:
  LSP[0]:
    LSP-ID: 2 policy ID: 2 (active)
    State: Programmed
    Binding SID: fccc:cccl:1:e018::
    Install timer:
      Running: no
    Cleanup timer:
      Running: no
    Delete timer:
      Running: no
    Revert timer:
      Running: no
    SM chain:
      Init -> Egress paths
      Egress paths pending -> BSID RW
      BSID rewrite pending -> Success
    Forwarding flags: 0x00000008
    Candidate path ID: 1
    Flags:
    SL-ID:
      Sent/Received/Transferred: 1/1/0
    SLs:
      SL[0]:
        Name: dynamic
        Type: Dynamic PCE
        Checkpoint id: 1
        NH SRV6 SID: fccc:cccl:2::
        SL ID: 0xa000001
        Flags:
        Normalized Weight: 1
        ENS: 1
        Paths:
          Path[0]:
            Interface version: 1
            Flags:
            Outgoing interface: Gi0/2/0/0
            Weight: 1

```

```

        SID stack:
        Total SID count: 0
        Underlay Normalized Weight: 1
    Path[1]:
        Interface version: 1
        Flags:
        Outgoing interface: Gi0/2/0/1
        Weight: 1
        SID stack:
        Total SID count: 0
        Underlay Normalized Weight: 1
    Path[2]:
        Interface version: 1
        Flags:
        Outgoing interface: Gi0/2/0/2
        Weight: 1
        SID stack:
        Total SID count: 0
        Underlay Normalized Weight: 1
Attributes:
    Binding SID: fccc:cccl:1:e018::
    Forward Class: Not Configured
    Steering labeled-services disabled: no
    Steering BGP disabled: no
    IPv6 caps enable: yes
    Invalidation drop enabled: no
    Max Install Standby Candidate Paths: 0
    Path Type: SRV6
Notification to clients:
    Binding SID: fccc:cccl:1:e018::
    Bandwidth : 0 Kbps (0 Kbps)
    State: UP
    Flags: [add] [ipv6_caps]
    Metric Type: IGP
    Metric Value: 10
    Admin Distance: 30
ifhandle: 0x00000000
Source: 192::1
Transition count: 1
LSPs created count: 1
Reoptimizations completed count: 1
Retry Action Flags: 0x00000000, ()
Last Retry Timestamp: never (0 seconds ago)
Policy reference: 0x1222c10
Event history (oldest first):
    Time                Event
    Mar  6 11:17:40.563  POLICY CREATE
    Mar  6 11:17:40.564  (x3) CP PCRPT: 1 hops:
    Mar  6 11:17:41.071  CP PCUPD: CP-ID: 1, path change: true, notify: true, hops:
fccc:cccl:2::
    Mar  6 11:17:41.072  CP PCRPT: 1 hops: fccc:cccl:2::
    Mar  6 11:17:41.072  LSP CREATE: 2, need BSID RW: true, BSID: ::
    Mar  6 11:17:41.072  CP CHANGE: PREF: 100 [PROTO: 30, ORIGIN: 0/<None>, DISC: 100]
    Mar  6 11:17:42.579  SRv6 BSID RW REQ: ID 2
    Mar  6 11:17:42.580  SRv6 BSID RW RES: ID 2 Status: success
    Mar  6 11:17:42.580  LSP PCRPT: 2, hops: fccc:cccl:2::
    Mar  6 11:17:42.580  CP PCRPT REMOVE: 1
    Mar  6 11:17:42.580  IM STATE CHANGE: UNKNOWN to UP, count: 0

Router# show pce segment-routing traffic-eng policy private

PCE's policy database:

```

```

-----
PCC Address: 192.168.2.1
Color: 200, Endpoint: 192::2
Name: srte_c_200_ep_192::2
Self Pointer: 0x26cd890
Active C-path Pointer: 0x26cda00
Candidate-paths:
  Symbolic-name: cfg_bar_discr_100 (Active)
  PLSP-ID: 2
  NB-API Notification pending flag: 0
  Self Pointer: 0x26cda00
  Tunnel Pointer: 0x26cd580
  Policy Pointer: 0x26cd890
  Cached distribute LS element:
    Sense: TRUE
    Refcount: 1
    Is on queue: FALSE
    Node identifiers:
      Protocol: 9 router ID: 192::1
    Policy identifiers:
      Color: 200 Endpoint: 192::2
      Flags: 0x80 (endpoint-v6)
    Candidate path identifiers:
      Originator: 0.0.0.0 protocol: 3 ASN: 0
      Flags: 0x00
      Discriminator: 100
    Candidate path attributes:
      Name: bar
      Policy name: srte_c_200_ep_192::2
      State:
        Priority: 0 flags: 0x5A00 (active, evaluated, valid-sid-list, delegated)
        Preference: 100
      SRv6 BSID:
        Flags: 0x8000 (alloc)
        BSID: fccc:cccl:1:e018::
        Specified BSID: ::
        Endpoint:
          Endpoint function: 71 flags: 0x00 algorithm: 0
        Structure:
          Locator block length: 32 locator node length: 16 function length: 16 arguments
length: 0
    Constraints:
      Bitfield: 0x0020 flags: 0xC000 (dataplane-v6, protected) MT-ID: 0
      Algorithm: 0
      Bandwidth: 0 kbps
      Metric constraints[0]:
        Type: 0 flags: 0x80 (optimization)
        Margin: 0 bound: 0
      Metric constraints[1]:
        Type: 4 flags: 0x10 (bound)
        Margin: 0 bound: 10
    Segment lists:
      Segment list[0]:
        Flags: 0xB800 (dataplane-v6, computed, verified, first-seg-resolved) MT-ID:
0 algorithm: 0 weight: 0
        Metric[0]:
          Type: 0 flags: 0x10 (value)
          Margin: 0 bound: 0 value: 10
        Segments:
          Segment[0]:
            Bitfield: 0x0003 type: 9 flags: 0x8000 (sid-present)
            SID: fccc:cccl:2::

```

```

Descriptor:
  Algorithm: 0
  Local address: 192::2 [0] remote address: :: [0]
Endpoint:
  Endpoint function: 48 flags: 0x00 algorithm: 0
Structure:
  Locator block length: 32 locator node length: 16 function length: 0
arguments length: 80

```

```
Router# show bgp link-state link-state | i \[SP\]
```

```

*>i[SP][SR][IOx0][N[c100][b0.0.0.0][q192.168.0.1][te192::1]][C[po0x3][f0x80][e192::2][cl0xc8][as0][ca0.0.0.0][di100]]/792
*>
[SP][SR][IOx0][N[c100][b0.0.0.0][q192.168.0.3][te192::1]][C[po0x3][f0x80][e192::2][cl0xc8][as0][ca0.0.0.0][di100]]/792

```

```
Router# show bgp link-state link-state
```

```

[SP][SR][IOx0][N[c100][b0.0.0.0][q192.168.0.1][te192::1]][C[po0x3][f0x80][e192::2][cl0xc8][as0][ca0.0.0.0][di100]]/792
BGP routing table entry for
[SP][SR][IOx0][N[c100][b0.0.0.0][q192.168.0.1][te192::1]][C[po0x3][f0x80][e192::2][cl0xc8][as0][ca0.0.0.0][di100]]/792
Versions:
  Process          bRIB/RIB    SendTblVer
  Speaker          128         128
Last Modified: Mar  6 11:17:43.000 for 00:04:09
Last Delayed at: ---
Paths: (1 available, best #1)
  Not advertised to any peer
  Path #1: Received by speaker 0
  Not advertised to any peer
  Local
    192.168.2.1 (metric 20) from 192.168.2.1 (192.168.0.1)
    Origin IGP, localpref 100, valid, internal, best, group-best
    Received Path ID 0, Local Path ID 1, version 128
  Link-state:
    SRTE-CP-State: Priority: 0 Flags: 0x5a00 Preference: 100
    SR-Policy-CP-name: bar
    SR-Policy-name: srte_c_200_ep_192::2
    SRTE-CP-Constraints: Flags: 0xc000 Mtid: 0 Algorithm: 0
    SRTE-CP-Constraints-Metric: Type: 0 Flags: 0x80 Margin: 0
    Bound: 0
    SRTE-CP-Constraints-Metric: Type: 4 Flags: 0x10 Margin: 0
    Bound: 10
    SRTE-Segment-List: Flags: 0xb800 Mtid: 0 Algorithm: 0
    Weight: 1
    SRTE-Segment: Segment-Type: 9 Flags: 0x8000 SID: fccc:cccl:2:: Algorithm:
0
    Local-node: 192::2
    SRv6-Endpoint-Fn: 48 Flags: 0x0 Algo: 0
    SRv6-SID-Struct: LBL: 32 LNL: 16 FL: 0 AL: 80
    SRTE-Segment-List-Metric: Type: 0 Flags: 0x10 Margin: 0
    Bound: 0 Value: 10
    SRTE-CP-SRV6-BSID: Flags: 0x8000 BSID: fccc:cccl:1:e018::
    Specified BSID: ::
    SRv6-Endpoint-Fn: 71 Flags: 0x0 Algo: 0
    SRv6-SID-Struct: LBL: 32 LNL: 16 FL: 16 AL: 0

```

SR-TE Policy Path Protection

Table 17: Feature History Table

Feature Name	Release Information	Feature Description
SR-TE Policy Path Protection	Release 7.4.2	<p>You can now configure pre-programmed SR-TE policy Working and Protect candidate paths, and provide fast failure detection through SR Policy Liveness Monitoring probes. If there is a liveness failure on the Working candidate path, the headend triggers a switchover to the Protect candidate path.</p> <p>With this release, you can operate IP-centric (with ECMP and TI-LFA) and TDM-centric (with circuits and path protection) services over a common SR network. This eliminates the need for multiple parallel networks and reduces capital expenditures (CapEx) and operating expenditures (OpEx).</p> <p>For this feature, the following commands/keywords are added:</p> <ul style="list-style-type: none"> • policy candidate-paths preference lock duration • policy path-protection • backup keyword is added to the performance-measurement liveness-detection command.

To provide SR policy path protection, headend router and liveness monitoring functions are introduced. The functions are explained with the 1:1 (one-to-one) path protection with SR policy liveness monitoring use case for TDM-centric networks. Pointers:

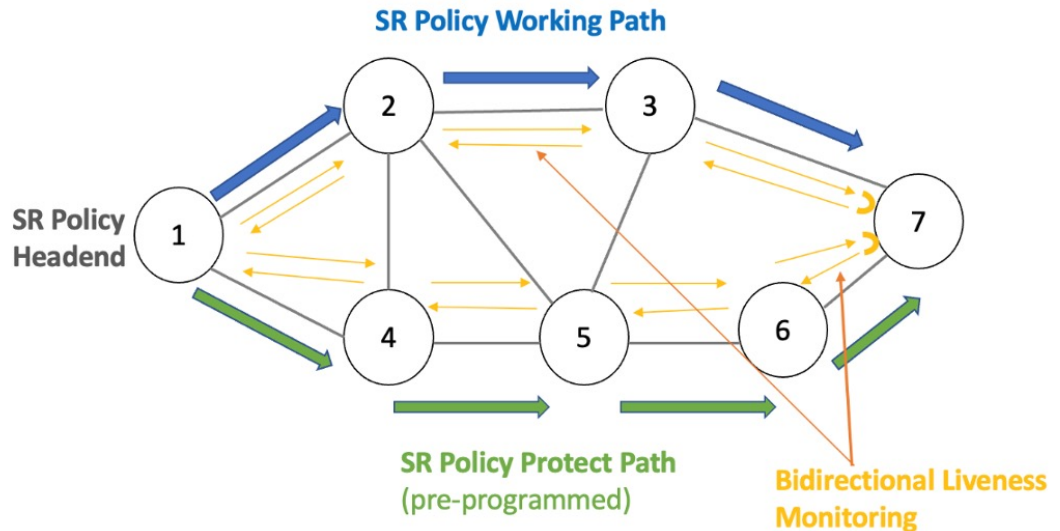



Note Path protection and local TI-LFA FRR are mutually exclusive functions.

- An SR-TE policy is enabled on the headend router. The headend router 1 sends traffic to endpoint router 7. The Working candidate path **Blue** spans routers 1-2-3-7, and the Protect candidate path **Green** spans routers 1-4-5-6-7.
- The headend Router maintains an independent liveness session on each candidate path using loopback measurement mode. After verifying liveness, it pre-programs Working and Protect paths in forwarding.
- The paths are manually configured in explicit segment lists using MPLS labels to ensure that unprotected adjacency SIDs are utilized.
- The headend router sends traffic over the Working candidate path, and detects any liveness failure. When there is a failure, it sends direct switchover notifications to the FIB, and triggers a switchover to the protected path.
- In 1:1 (*one-to-one*) path protection, when the Working candidate path fails, the Protect candidate path sends traffic.



Note SR-TE policy path protection and SR-TE path invalidation drop inter-working is not supported.

Liveness Monitoring

- SR PM Liveness probes are performed over Working and Protect candidate paths.
- TWAMP Light (RFC 5357) is used for performance measurement and liveness monitoring.
- Separate PM liveness monitoring sessions are created for working and protect candidate-paths.
- Independent PM sessions are created at both endpoints of the SR Policy.
- Loopback measurement-mode (timestamps t1/t4) is used for liveness monitoring. Probe packets are not punted on the responder node. Round-trip delay is computed as (t4 – t1).
- From headend router 1, PM probe query packets are sent with forward and reverse (7->3->2->1) direction paths of the SR Policy's candidate-path in the header of the probe packet. Similarly, PM probe query packets are sent along the Protect path.
- For liveness monitoring:
 - Liveness is declared UP as soon as one probe packet is received back on all segment-lists of the candidate-path.
 - Liveness failure is detected when last N (user-configured value) consecutive probe packets are lost on any segment-list.
 - Fault in the forward and reverse direction of the segment-list (co-routed path) triggers liveness failure notification to SRTE and FIB. FIB triggers protection switchover upon PM notification (running on high priority thread).

Configuration

- In this example, an SR-TE policy **foo** is created on the headend router and path-protection is enabled for the policy.

```
RP/0/RSP0/CPU0:ios# configure
RP/0/RSP0/CPU0:ios(config)# segment-routing traffic-eng policy foo
RP/0/RSP0/CPU0:ios(config-sr-te-policy)# color 10 end-point ipv4 192.168.0.3
RP/0/RSP0/CPU0:ios(config-sr-te-policy)# path-protection
RP/0/RSP0/CPU0:ios(config-sr-te-path-pref-protection)#exit
```

- Under **candidate-paths**, the Protect and Working paths are specified through explicit segment lists.
- The Protect path's preference is 50, and it is lower than the Working path preference of 100. The forward (1->4->5->6->7) and reverse (7->6->5->4->1) Protect paths, and the forward (1->2->3->7) and reverse (7->3->2->1) Working paths are enabled as explicit segment lists.
- When the Working path is invalid, the Protect path becomes active. After the Working path has recovered, the Protect path remains active until the default lock duration (of 300 seconds) expires. You can configure a different lock duration using the **lock duration** command.

The duration range is 0 (disabled) to 3000 seconds. If the lock duration is 0 (disabled), then the Working path becomes active as soon as it recovers. If the duration is not specified, the Protect path remains active.

```
RP/0/RSP0/CPU0:ios(config-sr-te-policy)# candidate-paths
RP/0/RSP0/CPU0:ios(config-sr-te-policy-path)#preference 50
RP/0/RSP0/CPU0:ios(config-sr-te-policy-path-pref)#lock duration 30
RP/0/RSP0/CPU0:ios(config-sr-te-policy-path-pref)# explicit segment-list sl-protect-fwd
```

Type **Exit** three times to go to the SR-TE policy configuration mode.

```
RP/0/RSP0/CPU0:ios(config-sr-te-policy)#candidate-paths
RP/0/RSP0/CPU0:ios(config-sr-te-policy-path)#preference 100
RP/0/RSP0/CPU0:ios(config-sr-te-policy-path-pref)# explicit segment-list sl-working-fwd
RP/0/RSP0/CPU0:ios(config-sr-te-pp-info)# commit
```

Working and Protect Segment Lists Configuration

Configure explicit segment lists for the candidate paths.



Note Segment lists must use only unprotected (dynamic or manual) Adjacency SID and BSIDs (as non-first-SID).

```
RP/0/RSP0/CPU0:ios# configure
RP/0/RSP0/CPU0:ios(config)# segment-routing traffic-eng
RP/0/RSP0/CPU0:ios(config-sr-te)# segment-list sl-working-fwd
RP/0/RSP0/CPU0:ios(config-sr-te-sl)# index 1 mpls label 24000
RP/0/RSP0/CPU0:ios(config-sr-te-sl)# index 2 mpls label 24004
RP/0/RSP0/CPU0:ios(config-sr-te-sl)# exit
RP/0/RSP0/CPU0:ios(config-sr-te)# segment-list sl-working-bck
RP/0/RSP0/CPU0:ios(config-sr-te-sl)# index 1 mpls label 24002
RP/0/RSP0/CPU0:ios(config-sr-te-sl)# index 2 mpls label 24006
RP/0/RSP0/CPU0:ios(config-sr-te-sl)# exit
RP/0/RSP0/CPU0:ios(config-sr-te)# segment-list sl-protect-fwd
RP/0/RSP0/CPU0:ios(config-sr-te-sl)# index 1 mpls label 24000
RP/0/RSP0/CPU0:ios(config-sr-te-sl)# index 2 mpls label 30201
RP/0/RSP0/CPU0:ios(config-sr-te-sl)# exit
RP/0/RSP0/CPU0:ios(config-sr-te)# segment-list sl-protect-bck
RP/0/RSP0/CPU0:ios(config-sr-te-sl)# index 1 mpls label 24002
RP/0/RSP0/CPU0:ios(config-sr-te-sl)# index 2 mpls label 30201
RP/0/RSP0/CPU0:ios(config-sr-te-sl)# commit
```

Performance Measurement Configuration For SR-TE Policy

- Enable SR-TE policy specific performance measurement configurations.
- Create a liveness profile for the Working and Protect paths.

```
RP/0/RSP0/CPU0:ios# configure
RP/0/RSP0/CPU0:ios(config)# segment-routing traffic-eng policy foo
RP/0/RSP0/CPU0:ios(config-sr-te-policy)# performance-measurement
RP/0/RSP0/CPU0:ios(config-sr-te-policy-perf-meas)# liveness-detection
RP/0/RSP0/CPU0:ios(config-sr-te-policy-live-detect)# liveness-profile backup name
profile-PROTECT
RP/0/RSP0/CPU0:ios(config-sr-te-policy-live-detect)# liveness-profile name profile-WORKING
```

- The default Invalidation action is Down and it triggers path protection switching. The other action is None, which is enabled here.

```
RP/0/RSP0/CPU0:ios(config-sr-te-policy-live-detect)# invalidation-action none
RP/0/RSP0/CPU0:ios(config-sr-te-policy-live-detect)# commit
```

Performance Measurement Global Profile Configuration

- Create a Working candidate path liveness profile.

```
RP/0/RSP0/CPU0:ios(config)# performance-measurement
RP/0/RSP0/CPU0:ios(config-perf-meas)# liveness-profile sr-policy name profile-WORKING
RP/0/RSP0/CPU0:ios(config-pm-ld-srpolicy)# probe
RP/0/RSP0/CPU0:ios(config-pm-ld-srpolicy-probe)# measurement-mode loopback
RP/0/RSP0/CPU0:ios(config-pm-ld-srpolicy-probe)# tx-interval 30000
RP/0/RSP0/CPU0:ios(config-pm-ld-srpolicy-probe)# commit
RP/0/RSP0/CPU0:ios(config-pm-ld-srpolicy-probe)# exit
RP/0/RSP0/CPU0:ios(config-pm-ld-srpolicy)# liveness-detection multiplier 4
RP/0/RSP0/CPU0:ios(config-pm-ld-srpolicy)# commit
```

Type **Exit** to access the Performance Measurement config mode.

- Create a Protect candidate path liveness profile.

```
RP/0/RSP0/CPU0:ios(config-perf-meas)# liveness-profile sr-policy name profile-PROTECT
RP/0/RSP0/CPU0:ios(config-pm-ld-srpolicy)# probe
RP/0/RSP0/CPU0:ios(config-pm-ld-srpolicy-probe)# measurement-mode loopback
RP/0/RSP0/CPU0:ios(config-pm-ld-srpolicy-probe)# tx-interval 100000
RP/0/RSP0/CPU0:ios(config-pm-ld-srpolicy-probe)# commit
RP/0/RSP0/CPU0:ios(config-pm-ld-srpolicy-probe)# exit
RP/0/RSP0/CPU0:ios(config-pm-ld-srpolicy)# liveness-detection multiplier 3
RP/0/RSP0/CPU0:ios(config-pm-ld-srpolicy)# commit
```

Verification

Use the **show segment-routing traffic-eng policy candidate-path** command to display Working and Protect candidate-path details.

```
RP/0/RSP0/CPU0:ios# show segment-routing traffic-eng policy candidate-path name foo

SR-TE policy database
-----

Color: 10, End-point: 192.168.0.3s
Name: srte_c_10_ep_192.168.0.3
Status:
  Admin: up   Operational: Up for 00:11:55 (since Dec 15 07:02:08.709)
```

```

Candidate-paths:
  Preference: 100 (configuration) (active)
  Name: foo
  Requested BSID: dynamic
  Protection Type: protected-preferred
  Maximum SID Depth: 10
  Explicit: segment-list sl-working-fwd (active)
  Weight: 1, Metric Type: TE
  24000
  24004
  Protection Information:
  Role: WORKING
  Path Lock: Timed
  Lock Duration: 300(s)
  Preference: 50 (configuration) (active)
  Name: foo
  Requested BSID: dynamic
  Protection Type: protected-preferred
  Maximum SID Depth: 10
  Explicit: segment-list sl-protect-fwd (active)
  Weight: 1, Metric Type: TE
  24000
  30201
  Protection Information:
  Role: PROTECT
  Path Lock: Timed
  Lock Duration: 30(s)
  ..

```

Sharing the Extended Label Switch Path Array

Table 18: Feature History Table

Feature Name	Release Information	Feature Description
Sharing the Extended Label Switch Path Array	Release 7.5.4	<p>The Cisco ASR 9000 series routers with third-generation and later line cards can experience scaling limitations with scaled labelled IPv6 prefixes.</p> <p>This feature enables the extended label switch path array (EXT_LSPA) resource to be shared per-path-list rather than per-prefix, which reduces the risk of an out-of-resources (OOR) condition.</p> <p>This feature introduces the following command:</p> <ul style="list-style-type: none"> • hw-module I3 feature sharedlspa enable

On third-generation Cisco ASR 9000 series line cards, a leaf node can store up to four per-prefix labels. On fourth-generation and fifth-generation ASR 9000 series line cards, a leaf node can store up to two per-prefix labels.



Note See the [Cisco ASR 9000 Series Aggregation Services Router Ethernet Line Card Installation Guide](#) for information about the different generations of ASR 9000 series line cards.

ASR 9000 series routers use extended label switch path array (EXT_LSPA) objects to store additional per-prefix labels. Each EXT_LSPA object stores four labels on third-generation line cards and six labels on fourth-generation and fifth-generation line cards.

There is a limited pool of EXT_LSPA objects in hardware. If per-prefix labels are allocated, then with prefix scale it is possible to run out of the EXT_LSPA hardware resource, resulting in an out of resources (OOR) condition.

This feature enables the EXT_LSPA resource to be shared per-path-list rather than per-prefix. If there is a path list that is shared across multiple prefixes, the same set of EXT_LSPA resources can be shared for all the prefixes.

Example

Consider the following scenario, where there are 24 SR-TE policy paths between nodes A and B, with each path having one next hop (NH).

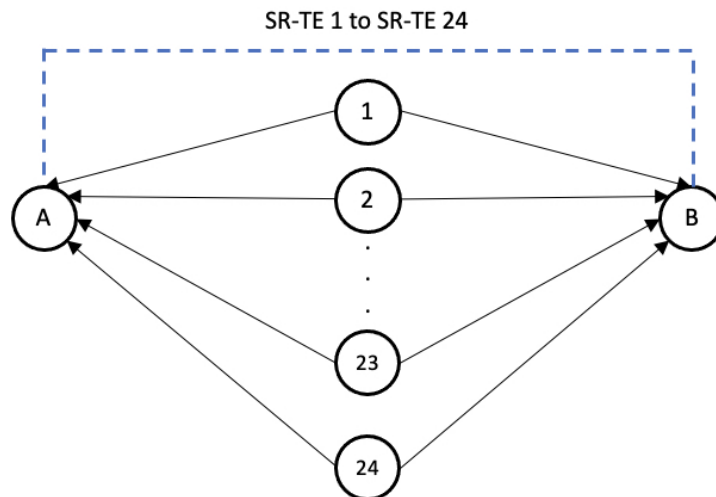

Each IPv6 prefix has a unique extended color community attribute, mapped to a different SR-TE policy. In this scenario, each IPv6 prefix has the same set of 24 labels from node A to node B. These labels are stored partly in the prefix leaf object and the rest are stored in the EXT_LSPA object.



Note The EXT_LSPA objects are allocated using the power of 2 (for example, 1, 2, 4, 8, etc).

For example:

- On third-generation line cards, four labels are stored on the leaf node. The remaining 20 labels are stored on EXT_LSPA object. Each EXT_LSPA object can store four labels, so five EXT_LSPA objects are needed (20 labels / 4 labels stored per EXT_LSPA object); however, eight EXT_LSPA objects are allocated. In our scenario, the number of EXT_LSPA objects required is 160 (20 labels x 8 EXT_LSPA objects).

- On fourth-generation and fifth-generation line cards, two labels are stored on the leaf node. The remaining 22 labels are stored on EXT_LSPA object. Each EXT_LSPA object can store six labels, so four EXT_LSPA objects are needed. In our scenario, the number of EXT_LSPA objects required is 88 (22 labels x 4 EXT_LSPA objects).

When you enable EXT_LSPA resource sharing, the EXT_LSPA resource is shared per-path-list rather than per-prefix. Since the path lists are shared across multiple prefixes, the same set of EXT_LSPA resources can be shared for all the prefixes.

For example, on third-generation line cards with 24 paths, only five EXT_LSPA objects are required:

- Paths 1 - 4: labels are stored on the leaf node
- Paths 5 - 8: labels are stored on EXT_LSPA_1
- Paths 9 - 12: labels are stored on EXT_LSPA_2
- Paths 13 - 16: labels are stored on EXT_LSPA_3
- Paths 17 - 20: labels are stored on EXT_LSPA_4
- Paths 21 - 24: labels are stored on EXT_LSPA_5

On fourth-generation and fifth-generation line cards with 24 paths, four different EXT_LSPA objects are allocated:

- Paths 1 - 2: labels are stored on the leaf node
- Paths 3 - 8: labels are stored on EXT_LSPA_1
- Paths 9 - 14: labels are stored on EXT_LSPA_2
- Paths 15 - 20: labels are stored on EXT_LSPA_3
- Paths 21 - 24: labels are stored on EXT_LSPA_4

Usage Guidelines and Limitations

Ensure that MPLS encapsulation sharing is not disabled (using the **cef encap-sharing disable** command). If MPLS encapsulation sharing is disabled, separate hardware resources (FEC/EEDB) are allocated for every prefix.

Configuration

To enable this feature, use the **hw-module l3 feature sharedlspa enable** command, then reload the router or line card.

```
Router(config)# hw-module l3 feature sharedlspa enable
Router(config)# commit
```

Verification

The following output shows the hardware EXT_LSPA usage on the linecard:

```
Router# show cef platform resource summary location 0/1/CPU0 | i EXT

OBJECT                USED                %                MAX                AVAILABLE                %
```

```
EXT_LSPA          26673          5.09          524288          497615          94.91
```

The following output shows LSPA object pointer for prefix 1 (23::1/128):

```
Router# show cef ipv6 23::1/128 internal location 0/1/CPU0

IPv6:default:0xe0800000, flags:[owner locked, global, default, initial converged]
obj-id:[0x1008802010000169][0x957e7ba0]:rib:23::1/128[ref:1 proto:ipv6 flags:0x5000001[owner
locked, inserted, svd remote] flags2:0x40[] src:rib ver:861]]
obj-id:[0x10148020280009c8][0x96693144]
  LSPA => [ref:1 count:4 src:rib flags:[imposition, updated] walk-idx:0 flags:0x208] ts:May
24 21:17:51.432] obj-id:[0x10448020100009f1][0x997dc0a8]
    0={
      LABEL_INFO => [default [o-label:ipv6-explicit-null l-label:no-label type:0
flags:[recursive, linked to ipv4, ipv6, pd create pending] ext-flags:[none]
stats-key:[0x10000100000000]]] obj-id:[0x10248020080009cf][0x9626f068]]]
      1={
        LABEL_INFO => [default [o-label:ipv6-explicit-null l-label:no-label type:0
flags:[recursive, linked to ipv4, ipv6, pd create pending] ext-flags:[none]
stats-key:[0x100001000000001]]] obj-id:[0x10248020080009ee][0x9626ef28]]]
        2={
          LABEL_INFO => [default [o-label:ipv6-explicit-null l-label:no-label type:0
flags:[recursive, linked to ipv4, ipv6, pd create pending] ext-flags:[none]
stats-key:[0x100001000000002]]] obj-id:[0x10248020080009ef][0x9626f2e8]]]
          3={
            LABEL_INFO => [default [o-label:ipv6-explicit-null l-label:no-label type:0
flags:[recursive, linked to ipv4, ipv6, pd create pending] ext-flags:[none]
stats-key:[0x100001000000003]]] obj-id:[0x10248020080009f0][0x9626f1a8]]]
            . . .
```

The following output shows LSPA object pointer for prefix 2 (24::1/128):

```
Router# show cef ipv6 24::1/128 internal location 0/1/CPU0

IPv6:default:0xe0800000, flags:[owner locked, global, default, initial converged]
obj-id:[0x1008802010000169][0x957e7ba0]:rib:24::1/128[ref:1 proto:ipv6 flags:0x5000001[owner
locked, inserted, svd remote] flags2:0x40[] src:rib ver:866]]
obj-id:[0x10148020280009cb][0x9669303c]
  LSPA => [ref:1 count:4 src:rib flags:[imposition, updated] walk-idx:0 flags:0x208] ts:May
24 21:17:51.432] obj-id:[0x10448020100009f7][0x997dc0a8]
    0={
      LABEL_INFO => [default [o-label:ipv6-explicit-null l-label:no-label type:0
flags:[recursive, linked to ipv4, ipv6, pd create pending] ext-flags:[none]
stats-key:[0x10000100000000]]] obj-id:[0x10248020080009d4][0x9626ede8]]]
      1={
        LABEL_INFO => [default [o-label:ipv6-explicit-null l-label:no-label type:0
flags:[recursive, linked to ipv4, ipv6, pd create pending] ext-flags:[none]
stats-key:[0x100001000000001]]] obj-id:[0x10248020080009f4][0x9626e8e8]]]
        2={
          LABEL_INFO => [default [o-label:ipv6-explicit-null l-label:no-label type:0
flags:[recursive, linked to ipv4, ipv6, pd create pending] ext-flags:[none]
stats-key:[0x100001000000002]]] obj-id:[0x10248020080009f5][0x9626e528]]]
          3={
            LABEL_INFO => [default [o-label:ipv6-explicit-null l-label:no-label type:0
flags:[recursive, linked to ipv4, ipv6, pd create pending] ext-flags:[none]
stats-key:[0x100001000000003]]] obj-id:[0x10248020080009f6][0x9626e668]]]
            . . .
```

Observe that the LSPA pointer for both prefixes is the same (**0x997dc0a8**). If LSPA sharing is not enabled, the pointer will be different for both prefixes.

SR Policy Path Computation for IPv6

Table 19: Feature History Table

Feature Name	Release Information	Feature Description
SR Policy Path Computation for IPv6	Release 24.1.1	We have introduced the capability for SR Policy to support segment lists with IPv6 addresses, which can be either dynamically computed or explicitly set at the SRTE headend.

You can now use this feature when you want SR Policy to support segment lists with IPv6 addressed.



Note It uses the exiting configurations outlined in *Chapter: Configure SR-TE Policies* in *Segment Routing Configuration Guide for Cisco ASR 9000 Series Routers*, with the supported features detailed in the Usage Guidelines section that follows.

Usage Guidelines and Limitations

The supported features are listed below in the same order as the Table of Contents within the *Chapter: Configure SR-TE Policies* in *Segment Routing Configuration Guide for Cisco ASR 9000 Series Routers*

Supported Features

- Instantiation of SR Policy
 - On-Demand SR Policy – SR On-Demand Next-Hop
 - Manually Provisioned SR Policy
- SR-TE BGP Soft Next-Hop Validation For ODN Policies
- SR-TE Policy Path Types
 - Dynamic Paths
 - Optimization Objectives
 - Constraints
 - Configure SR Policy with Dynamic Path
 - Explicit Paths
 - SR-TE Policy with Explicit Path
 - Explicit Path with Affinity Constraint Validation
 - Explicit Path with Segment Protection-Type Constraint
- Traffic Steering
 - Automated Steering

- Color-Only Automated Steering
- Static Route over Segment Routing Policy
- Services Supported
 - IPv4 BGP Global Routes
 - IPv6 BGP Global Routes
- Miscellaneous
 - SR-TE Reoptimization Timers
 - Sharing the Extended Label Switch Path Array