



## **MPLS Layer 3 VPN Configuration Guide for Cisco ASR 9000 Series Routers, IOS XR Release 6.2.x**

**First Published:** 2017-03-17

**Last Modified:** 2017-07-14

### **Americas Headquarters**

Cisco Systems, Inc.  
170 West Tasman Drive  
San Jose, CA 95134-1706  
USA  
<http://www.cisco.com>  
Tel: 408 526-4000  
800 553-NETS (6387)  
Fax: 408 527-0883

THE SPECIFICATIONS AND INFORMATION REGARDING THE PRODUCTS IN THIS MANUAL ARE SUBJECT TO CHANGE WITHOUT NOTICE. ALL STATEMENTS, INFORMATION, AND RECOMMENDATIONS IN THIS MANUAL ARE BELIEVED TO BE ACCURATE BUT ARE PRESENTED WITHOUT WARRANTY OF ANY KIND, EXPRESS OR IMPLIED. USERS MUST TAKE FULL RESPONSIBILITY FOR THEIR APPLICATION OF ANY PRODUCTS.

THE SOFTWARE LICENSE AND LIMITED WARRANTY FOR THE ACCOMPANYING PRODUCT ARE SET FORTH IN THE INFORMATION PACKET THAT SHIPPED WITH THE PRODUCT AND ARE INCORPORATED HEREIN BY THIS REFERENCE. IF YOU ARE UNABLE TO LOCATE THE SOFTWARE LICENSE OR LIMITED WARRANTY, CONTACT YOUR CISCO REPRESENTATIVE FOR A COPY.

The Cisco implementation of TCP header compression is an adaptation of a program developed by the University of California, Berkeley (UCB) as part of UCB's public domain version of the UNIX operating system. All rights reserved. Copyright © 1981, Regents of the University of California.

NOTWITHSTANDING ANY OTHER WARRANTY HEREIN, ALL DOCUMENT FILES AND SOFTWARE OF THESE SUPPLIERS ARE PROVIDED "AS IS" WITH ALL FAULTS. CISCO AND THE ABOVE-NAMED SUPPLIERS DISCLAIM ALL WARRANTIES, EXPRESSED OR IMPLIED, INCLUDING, WITHOUT LIMITATION, THOSE OF MERCHANTABILITY, FITNESS FOR A PARTICULAR PURPOSE AND NON-INFRINGEMENT OR ARISING FROM A COURSE OF DEALING, USAGE, OR TRADE PRACTICE.

IN NO EVENT SHALL CISCO OR ITS SUPPLIERS BE LIABLE FOR ANY INDIRECT, SPECIAL, CONSEQUENTIAL, OR INCIDENTAL DAMAGES, INCLUDING, WITHOUT LIMITATION, LOST PROFITS OR LOSS OR DAMAGE TO DATA ARISING OUT OF THE USE OR INABILITY TO USE THIS MANUAL, EVEN IF CISCO OR ITS SUPPLIERS HAVE BEEN ADVISED OF THE POSSIBILITY OF SUCH DAMAGES.

Any Internet Protocol (IP) addresses and phone numbers used in this document are not intended to be actual addresses and phone numbers. Any examples, command display output, network topology diagrams, and other figures included in the document are shown for illustrative purposes only. Any use of actual IP addresses or phone numbers in illustrative content is unintentional and coincidental.

All printed copies and duplicate soft copies of this document are considered uncontrolled. See the current online version for the latest version.

Cisco has more than 200 offices worldwide. Addresses and phone numbers are listed on the Cisco website at [www.cisco.com/go/offices](http://www.cisco.com/go/offices).

Cisco and the Cisco logo are trademarks or registered trademarks of Cisco and/or its affiliates in the U.S. and other countries. To view a list of Cisco trademarks, go to this URL: <https://www.cisco.com/c/en/us/about/legal/trademarks.html>. Third-party trademarks mentioned are the property of their respective owners. The use of the word partner does not imply a partnership relationship between Cisco and any other company. (1721R)

© 2017 Cisco Systems, Inc. All rights reserved.



## CONTENTS

---

### PREFACE

#### **Preface** xi

Changes to This Document xi

Obtaining Documentation and Submitting a Service Request xi

---

### CHAPTER 1

#### **New and Changed L3VPN Features** 1

New and Changed L3VPN Features 1

---

### CHAPTER 2

#### **Implementing MPLS Layer 3 VPNs** 3

Prerequisites for Implementing MPLS L3VPN 3

MPLS L3VPN Restrictions 4

Information About MPLS Layer 3 VPNs 5

MPLS L3VPN Overview 5

MPLS L3VPN Benefits 6

How MPLS L3VPN Works 6

Virtual Routing and Forwarding Tables 7

VPN Routing Information: Distribution 7

BGP Distribution of VPN Routing Information 7

MPLS Forwarding 8

Automatic Route Distinguisher Assignment 8

MPLS L3VPN Major Components 9

Inter-AS Support for L3VPN 9

Inter-AS Support: Overview 9

Inter-AS and ASBRs 10

Confederations 10

MPLS VPN Inter-AS BGP Label Distribution 12

Exchanging IPv4 Routes with MPLS labels 12

BGP Routing Information	13
BGP Messages and MPLS Labels	13
Sending MPLS Labels with Routes	14
Generic Routing Encapsulation Support for L3VPN	14
GRE Restriction for L3VPN	14
VPNv4 Forwarding Using GRE Tunnels	15
Ingress of Encapsulation Router	15
Egress of Encapsulation Router	15
Ingress of Decapsulation Router	15
Egress of Decapsulation Router	15
Carrier Supporting Carrier Support for L3VPN	15
CSC Prerequisites	16
CSC Benefits	16
Configuration Options for the Backbone and Customer Carriers	17
Customer Carrier: ISP with IP Core	17
Customer Carrier: MPLS Service Provider	17
How to Implement MPLS Layer 3 VPNs	18
Configuring the Core Network	18
Assessing the Needs of MPLS VPN Customers	18
Configuring Routing Protocols in the Core	19
Configuring MPLS in the Core	19
Determining if FIB Is Enabled in the Core	19
Configuring Multiprotocol BGP on the PE Routers and Route Reflectors	19
Connecting MPLS VPN Customers	21
Defining VRFs on the PE Routers to Enable Customer Connectivity	21
Configuring VRF Interfaces on PE Routers for Each VPN Customer	23
Configuring BGP as the Routing Protocol Between the PE and CE Routers	24
Configuring RIPv2 as the Routing Protocol Between the PE and CE Routers	28
Configuring Static Routes Between the PE and CE Routers	30
Configuring OSPF as the Routing Protocol Between the PE and CE Routers	32
Configuring EIGRP as the Routing Protocol Between the PE and CE Routers	34
Configuring EIGRP Redistribution in the MPLS VPN	37
Providing VPN Connectivity Across Multiple Autonomous Systems with MPLS VPN Inter-AS with ASBRs Exchanging IPv4 Routes and MPLS Labels	38

Configuring ASBRs to Exchange IPv4 Routes and MPLS Labels	39
Configuring the Route Reflectors to Exchange VPN-IPv4 Routes	41
Configuring the Route Reflector to Reflect Remote Routes in its AS	43
Providing VPN Connectivity Across Multiple Autonomous Systems with MPLS VPN Inter-AS with ASBRs Exchanging VPN-IPv4 Addresses	46
Configuring the ASBRs to Exchange VPN-IPv4 Addresses for IP Tunnels	46
Configuring a Static Route to an ASBR Peer	49
Configuring EBGW Routing to Exchange VPN Routes Between Subautonomous Systems in a Confederation	50
Configuring MPLS Forwarding for ASBR Confederations	53
Configuring a Static Route to an ASBR Confederation Peer	54
Configuring Carrier Supporting Carrier	55
Identifying the Carrier Supporting Carrier Topology	55
Configuring the Backbone Carrier Core	56
Configuring the CSC-PE and CSC-CE Routers	56
Configuring a Static Route to a Peer	57
Verifying the MPLS Layer 3 VPN Configuration	58
Configuring L3VPN over GRE	62
Creating a GRE Tunnel between Provider Edge Routers	62
Configuring IGP between Provider Edge Routers	63
Configuring LDP/GRE on the Provider Edge Routers	65
Configuring L3VPN	68
Configuration Examples for Implementing MPLS Layer 3 VPNs	73
Configuring an MPLS VPN Using BGP: Example	73
Configuring the Routing Information Protocol on the PE Router: Example	74
Configuring the PE Router Using EIGRP: Example	75
Configuration Examples for MPLS VPN CSC	75
Configuring the Backbone Carrier Core: Examples	75
Configuring the Links Between CSC-PE and CSC-CE Routers: Examples	75
Configuring a Static Route to a Peer: Example	76
Configuring L3VPN over GRE: Example	76

**CHAPTER 3****Implementing IPv6 VPN Provider Edge Transport over MPLS 81**

Prerequisites for Implementing 6PE/VPE	81
--	----

Information About 6PE/VPE	82
Overview of 6PE/VPE	82
Benefits of 6PE/VPE	82
IPv6 on the Provider Edge and Customer Edge Routers	83
IPv6 Provider Edge Multipath	83
OSPFv3 6VPE	84
Multiple VRF Support	84
OSPFv3 PE-CE Extensions	84
VRF Lite	84
How to Implement 6PE/VPE	85
Configuring 6PE/VPE	85
Configuring PE to PE Core	87
Configuring OSPFv3 as the Routing Protocol Between the PE and CE Routers	90
Configuration Examples for 6PE/VPE	93
Configuring 6PE on a PE Router: Example	93
Configuring 6VPE on a PE Router: Example	94

---

**CHAPTER 4**

<b>Implementing Generic Routing Encapsulation</b>	<b>95</b>
Prerequisites for Configuring Generic Routing Encapsulation	95
Information About Generic Routing Encapsulation	96
GRE Overview	96
GRE Features	96
MPLS/L3VPN over GRE	96
6PE/6VPE	98
6PE/6VPE over GRE	98
GRE Tunnel Key	99
GRE Tunnel Key-Ignore	100
GRE tunnel in VRF domains	100
Restrictions on a GRE tunnel	101
GRE IPv4/IPv6 Transport Over MPLS	102
How to Configure Generic Routing Encapsulation	102
Configuring a GRE Tunnel	102
Configuring the Tunnel Key	105
Configuring the Tunnel Key-Ignore	106

Configuring a VRF Interface	108
Configuring VRF Routing Protocol	109
Configuring IGP for Remote PE Reachability	111
Configuring LDP on GRE Tunnel	112
Configuring MP-iBGP to Exchange VPN-IPv4 Routes	113
Configuration Examples for Generic Routing Encapsulation	115
Configuring an IPv4 GRE Tunnel: Example	115
Configuring an IPv6 GRE Tunnel: Example	115
Verifying GRE tunnel Configuration: Example	115
Configuring Global VRF: Example	116
Configuring a VRF Interface: Example	116
Configuring VRF Routing Protocol: Example	116
Configuring IGP for Remote PE Reachability: Example	117
Configuring LDP on GRE Tunnel: Example	117
Configuring MP-iBGP to Exchange VPN-IPv4 Routes: Example	117

**CHAPTER 5****Implementing VXLAN 119**

Configuring a Layer 3 VXLAN gateway	119
Prerequisites	119
Restrictions	119
Creating and configuring the Network Virtualization Endpoint (NVE) interface	120
Configuring the L3 bridge virtual interface	121
Configuring a bridge domain	122
Configuration Example for Implementing Layer 3 VXLAN Gateway	123

**CHAPTER 6****Implementing IP in IP Tunnel 127**

IP in IP Tunneling	127
Restrictions	127
Configuring IP in IP Tunnel	128
IP in IP Tunneling: Examples	129

**CHAPTER 7****Implementing DCI VXLAN Layer 3 Gateway 133**

Prerequisites for Implementing Data Center Interconnect Layer 3 Gateway	133
Data Center Interconnect VXLAN Layer 3 Gateway	134

Route Targets	135
Route Re-origination	135
Route Address-Family and Encoded Address-Family	135
Local VPNv4 or VPNv6 Routes Advertisement	136
Data Center VXLAN with Support for MP-BGP	136
Default-Originate Forwarding to BGP EVPN Neighbor	136
Configure Data Center Interconnect Router	136
Configure VRF and route targets import/export rules	137
Configure Bridge Domain for DCI Gateway	138
Configure VTEP	140
Configure EVPN BGP neighbor and route advertisements	142
Configure L3VPN BGP neighbor relationship and route advertisements	144
Verification of Data Center Gateway Configuration	146
Example: Data Center Interconnection Layer 3 Gateway Configuration	155
OpFlex	157
OpFlex Topology	157
Restrictions	157
Configure OpFlex	158
Configure BGP	158
Configure BGP Session on the Fabric Side	159
Configure BGP Session on the WAN Side	160
Configure DCI Underlay for Fabric and WAN Interfaces	162
Configure IGP for ACI and WAN Reachability	163
Configure MPLS towards WAN	165
Configure FTI Auto-Configuration Parameters	166
Configure OpFlex Session	168
EVPN Default VRF Route Leaking	169
EVPN Default VRF Route Leaking on the DCI for Internet Connectivity	171
Leaking Routes from Default-VRF to Data Center-VRF	171
Leaking Routes to Default-VRF from Data Center-VRF	173
Sample Router Configuration	175
Sample Router Configuration: with default-originate	176
EVPN Service VRF Route Leaking	177
EVPN Service VRF Route Leaking on the DCI for Service Connectivity	179



Leaking Routes from Service VRF to Data Center VRF	179
Leaking Routes to Service VRF from Data Center VRF	181
Sample Router Configuration	183
Sample Router Configuration: with default-originate	185





## Preface



**Note** This product has reached end-of-life status. For more information, see the [End-of-Life and End-of-Sale Notices](#).

From Release 6.1.2 onwards, Cisco introduces support for the 64-bit Linux-based IOS XR operating system. Extensive feature parity is maintained between the 32-bit and 64-bit environments. Unless explicitly marked otherwise, the contents of this document are applicable for both the environments. For more details on Cisco IOS XR 64 bit, refer to the [Release Notes](#) for Cisco ASR 9000 Series Routers, Release 6.1.2 document.

This guide describes the Cisco ASR 9000 Series Router configurations. The preface for the *L2VPN and Ethernet Services Configuration Guide for Cisco ASR 9000 Series Routers* contains these sections:

- [Changes to This Document, on page xi](#)
- [Obtaining Documentation and Submitting a Service Request, on page xi](#)

## Changes to This Document

The following table lists the technical changes made to this document since it was first published.

Date	Change Summary
March 2017	Initial release of this document.
July 2017	Republished for Release 6.2.2.

## Obtaining Documentation and Submitting a Service Request

For information on obtaining documentation, submitting a service request, and gathering additional information, see the monthly What's New in Cisco Product Documentation, which also lists all new and revised Cisco technical documentation, at:

<http://www.cisco.com/en/US/docs/general/whatsnew/whatsnew.html>

Subscribe to the What's New in Cisco Product Documentation as a Really Simple Syndication (RSS) feed and set content to be delivered directly to your desktop using a reader application. The RSS feeds are a free service and Cisco currently supports RSS version 2.0.





# CHAPTER 1

## New and Changed L3VPN Features

- [New and Changed L3VPN Features, on page 1](#)

## New and Changed L3VPN Features

*Table 1: L3VPN Features Added or Modified in IOS XR Release 6.2.x*

Feature	Description	Changed in Release	Where Documented
EVPN Service VRF Route Leaking	The EVPN Service VRF Route Leaking feature enables connectivity to the services in the Service VRF to customers in EVPN Data Center VRF.	Release 6.2.2	<a href="#">EVPN Service VRF Route Leaking, on page 177</a>
EVPN Default VRF Route Leaking	The EVPN Default VRF Route Leaking feature leak routes between EVPN address-family and IPv4/IPv6 unicast address-family (Default-VRF), enabling the data center hosts to access the Internet.	Release 6.2.1	<a href="#">EVPN Default VRF Route Leaking , on page 169</a>





## CHAPTER 2

# Implementing MPLS Layer 3 VPNs

A Multiprotocol Label Switching (MPLS) Layer 3 Virtual Private Network (VPN) consists of a set of sites that are interconnected by means of an MPLS provider core network. At each customer site, one or more customer edge (CE) routers attach to one or more provider edge (PE) routers.

This module provides the conceptual and configuration information for MPLS Layer 3 VPNs on Cisco IOS XR software.



**Note** You must acquire an evaluation or permanent license in order to use MPLS Layer 3 VPN functionality. However, if you are upgrading from a previous version of the software, MPLS Layer 3 VPN functionality will continue to work using an implicit license for 90 days (during which time, you can purchase a permanent license). For more information about licenses, see the *Software Entitlement on the Cisco ASR 9000 Series Router* module in the *System Management Configuration Guide for Cisco ASR 9000 Series Routers*.

### Feature History for Implementing MPLS Layer 3 VPNs

- [Prerequisites for Implementing MPLS L3VPN, on page 3](#)
- [MPLS L3VPN Restrictions, on page 4](#)
- [Information About MPLS Layer 3 VPNs, on page 5](#)
- [Inter-AS Support for L3VPN, on page 9](#)
- [Carrier Supporting Carrier Support for L3VPN, on page 15](#)
- [How to Implement MPLS Layer 3 VPNs, on page 18](#)
- [Configuration Examples for Implementing MPLS Layer 3 VPNs, on page 73](#)

## Prerequisites for Implementing MPLS L3VPN

The following prerequisites are required to configure MPLS Layer 3 VPN:

- To perform these configuration tasks, your Cisco IOS XR software system administrator must assign you to a user group associated with a task group that includes the corresponding command task IDs. All command task IDs are listed in individual command references and in the *Cisco IOS XR Task ID Reference Guide*.
- If you suspect user group assignment is preventing you from using a command, contact your AAA administrator for assistance.
- You must be in a user group associated with a task group that includes the proper task IDs for:

- BGP commands
  - MPLS commands (generally)
  - MPLS Layer 3 VPN commands
- To configure MPLS Layer 3 VPNs, routers must support MPLS forwarding and Forwarding Information Base (FIB).

The following prerequisites are required for configuring MPLS VPN Inter-AS with autonomous system boundary routers (ASBRs) exchanging VPN-IPv4 addresses or IPv4 routes and MPLS labels:

- Before configuring external Border Gateway Protocol (eBGP) routing between autonomous systems or subautonomous systems in an MPLS VPN, ensure that all MPLS VPN routing instances and sessions are properly configured (see the [How to Implement MPLS Layer 3 VPNs](#), for procedures)
- These following tasks must be performed:
  - Define VPN routing instances
  - Configure BGP routing sessions in the MPLS core
  - Configure PE-to-PE routing sessions in the MPLS core
  - Configure BGP PE-to-CE routing sessions
  - Configure a VPN-IPv4 eBGP session between directly connected ASBRs

## MPLS L3VPN Restrictions

The following are restrictions for implementing MPLS Layer 3 VPNs:

- Multihop VPN-IPv4 eBGP is not supported for configuring eBGP routing between autonomous systems or subautonomous systems in an MPLS VPN.
- MPLS VPN supports only IPv4 address families.

The following restrictions apply when configuring MPLS VPN Inter-AS with ASBRs exchanging IPv4 routes and MPLS labels:

- For networks configured with eBGP multihop, a label switched path (LSP) must be configured between non adjacent routers.
- Inter-AS supports IPv4 routes only. IPv6 is not supported.



---

**Note** The physical interfaces that connect the BGP speakers must support FIB and MPLS.

---

The following restrictions apply to routing protocols OSPF and RIP:

- IPv6 is not supported on OSPF and RIP.



# Information About MPLS Layer 3 VPNs

To implement MPLS Layer 3 VPNs, you need to understand the following concepts:

## MPLS L3VPN Overview

Before defining an MPLS VPN, VPN in general must be defined. A VPN is:

- An IP-based network delivering private network services over a public infrastructure
- A set of sites that are allowed to communicate with each other privately over the Internet or other public or private networks

Conventional VPNs are created by configuring a full mesh of tunnels or permanent virtual circuits (PVCs) to all sites in a VPN. This type of VPN is not easy to maintain or expand, as adding a new site requires changing each edge device in the VPN.

MPLS-based VPNs are created in Layer 3 and are based on the peer model. The peer model enables the service provider and the customer to exchange Layer 3 routing information. The service provider relays the data between the customer sites without customer involvement.

MPLS VPNs are easier to manage and expand than conventional VPNs. When a new site is added to an MPLS VPN, only the edge router of the service provider that provides services to the customer site needs to be updated.

The components of the MPLS VPN are described as follows:

- Provider (P) router—Router in the core of the provider network. PE routers run MPLS switching and do not attach VPN labels to routed packets. VPN labels are used to direct data packets to the correct private network or customer edge router.
- PE router—Router that attaches the VPN label to incoming packets based on the interface or subinterface on which they are received, and also attaches the MPLS core labels. A PE router attaches directly to a CE router.
- Customer (C) router—Router in the Internet service provider (ISP) or enterprise network.
- Customer edge (CE) router—Edge router on the network of the ISP that connects to the PE router on the network. A CE router must interface with a PE router.

This following figure shows a basic MPLS VPN topology.

Figure 1: Basic MPLS VPN Topology

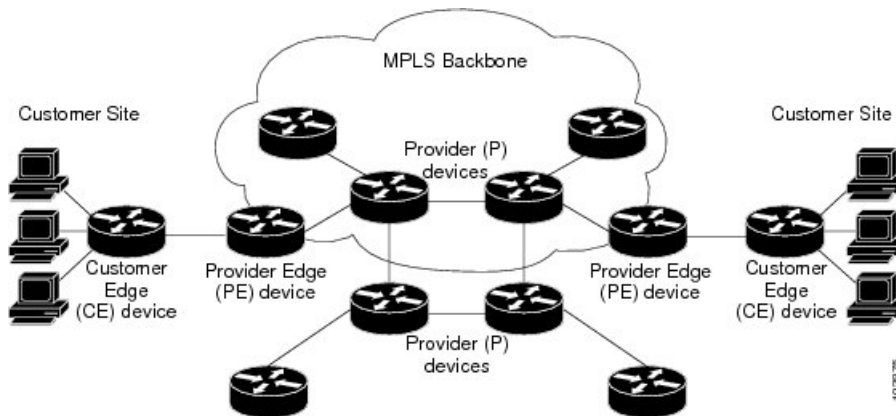

## MPLS L3VPN Benefits

MPLS L3VPN provides the following benefits:

- Service providers can deploy scalable VPNs and deliver value-added services.
- Connectionless service guarantees that no prior action is necessary to establish communication between hosts.
- Centralized Service: Building VPNs in Layer 3 permits delivery of targeted services to a group of users represented by a VPN.
- Scalability: Create scalable VPNs using connection-oriented, point-to-point overlays, Frame Relay, or ATM virtual connections.
- Security: Security is provided at the edge of a provider network (ensuring that packets received from a customer are placed on the correct VPN) and in the backbone.
- Integrated Quality of Service (QoS) support: QoS provides the ability to address predictable performance and policy implementation and support for multiple levels of service in an MPLS VPN.
- Straightforward Migration: Service providers can deploy VPN services using a straightforward migration path.
- Migration for the end customer is simplified. There is no requirement to support MPLS on the CE router and no modifications are required for a customer intranet.

## How MPLS L3VPN Works

MPLS VPN functionality is enabled at the edge of an MPLS network. The PE router performs the following tasks:

- Exchanges routing updates with the CE router
- Translates the CE routing information into VPN version 4 (VPNv4) routes.
- Exchanges VPNv4 and VPNv6 routes with other PE routers through the Multiprotocol Border Gateway Protocol (MP-BGP)

## Virtual Routing and Forwarding Tables

Each VPN is associated with one or more VPN routing and forwarding (VRF) instances. A VRF defines the VPN membership of a customer site attached to a PE router. A VRF consists of the following components:

- An IP version 4 (IPv4) unicast routing table
- A derived FIB table
- A set of interfaces that use the forwarding table
- A set of rules and routing protocol parameters that control the information that is included in the routing table

These components are collectively called a VRF instance.

A one-to-one relationship does not necessarily exist between customer sites and VPNs. A site can be a member of multiple VPNs. However, a site can associate with only one VRF. A VRF contains all the routes available to the site from the VPNs of which it is a member.

Packet forwarding information is stored in the IP routing table and the FIB table for each VRF. A separate set of routing and FIB tables is maintained for each VRF. These tables prevent information from being forwarded outside a VPN and also prevent packets that are outside a VPN from being forwarded to a router within the VPN.

## VPN Routing Information: Distribution

The distribution of VPN routing information is controlled through the use of VPN route target communities, implemented by BGP extended communities. VPN routing information is distributed as follows:

- When a VPN route that is learned from a CE router is injected into a BGP, a list of VPN route target extended community attributes is associated with it. Typically, the list of route target community extended values is set from an export list of route targets associated with the VRF from which the route was learned.
- An import list of route target extended communities is associated with each VRF. The import list defines route target extended community attributes that a route must have for the route to be imported into the VRF. For example, if the import list for a particular VRF includes route target extended communities A, B, and C, then any VPN route that carries any of those route target extended communities—A, B, or C—is imported into the VRF.

## BGP Distribution of VPN Routing Information

A PE router can learn an IP prefix from the following sources:

- A CE router by static configuration
- An eBGP session with the CE router
- A Routing Information Protocol (RIP) exchange with the CE router
- Open Shortest Path First (OSPF), Enhanced Interior Gateway Routing Protocol (EIGRP), and RIP as Interior Gateway Protocols (IGPs)

The IP prefix is a member of the IPv4 address family. After the PE router learns the IP prefix, the PE converts it into the VPN-IPv4 prefix by combining it with a 64-bit route distinguisher. The generated prefix is a member of the VPN-IPv4 address family. It uniquely identifies the customer address, even if the customer site is using

globally nonunique (unregistered private) IP addresses. The route distinguisher used to generate the VPN-IPv4 prefix is specified by the **rd** command associated with the VRF on the PE router.

BGP distributes reachability information for VPN-IPv4 prefixes for each VPN. BGP communication takes place at two levels:

- Within the IP domain, known as an autonomous system.
- Between autonomous systems.

PE to PE or PE to route reflector (RR) sessions are iBGP sessions, and PE to CE sessions are eBGP sessions. PE to CE eBGP sessions can be directly or indirectly connected (eBGP multihop).

BGP propagates reachability information for VPN-IPv4 prefixes among PE routers by the BGP protocol extensions (see RFC 2283, Multiprotocol Extensions for BGP-4), which define support for address families other than IPv4. Using the extensions ensures that the routes for a given VPN are learned only by other members of that VPN, enabling members of the VPN to communicate with each other.

## MPLS Forwarding

Based on routing information stored in the VRF IP routing table and the VRF FIB table, packets are forwarded to their destination using MPLS.

A PE router binds a label to each customer prefix learned from a CE router and includes the label in the network reachability information for the prefix that it advertises to other PE routers. When a PE router forwards a packet received from a CE router across the provider network, it labels the packet with the label learned from the destination PE router. When the destination PE router receives the labeled packet, it pops the label and uses it to direct the packet to the correct CE router. Label forwarding across the provider backbone is based on either dynamic label switching or traffic engineered paths. A customer data packet carries two levels of labels when traversing the backbone:

- The top label directs the packet to the correct PE router.
- The second label indicates how that PE router should forward the packet to the CE router.

More labels can be stacked if other features are enabled. For example, if traffic engineering (TE) tunnels with fast reroute (FRR) are enabled, the total number of labels imposed in the PE is four (Layer 3 VPN, Label Distribution Protocol (LDP), TE, and FRR).

## Automatic Route Distinguisher Assignment

To take advantage of iBGP load balancing, every network VRF must be assigned a unique route distinguisher. VRF is require a route distinguisher for BGP to distinguish between potentially identical prefixes received from different VPNs.

With thousands of routers in a network each supporting multiple VRFs, configuration and management of route distinguishers across the network can present a problem. Cisco IOS XR software simplifies this process by assigning unique route distinguisher to VRFs using the **rd auto** command.

To assign a unique route distinguisher for each router, you must ensure that each router has a unique BGP router-id. If so, the **rd auto** command assigns a Type 1 route distinguisher to the VRF using the following format: *ip-address:number*. The IP address is specified by the BGP router-id statement and the number (which is derived as an unused index in the 0 to 65535 range) is unique across the VRFs.

Finally, route distinguisher values are checkpointed so that route distinguisher assignment to VRF is persistent across failover or process restart. If an route distinguisher is explicitly configured for a VRF, this value is not overridden by the autoroute distinguisher.

## MPLS L3VPN Major Components

An MPLS-based VPN network has three major components:

- VPN route target communities—A VPN route target community is a list of all members of a VPN community. VPN route targets need to be configured for each VPN community member.
- Multiprotocol BGP (MP-BGP) peering of the VPN community PE routers—MP-BGP propagates VRF reachability information to all members of a VPN community. MP-BGP peering needs to be configured in all PE routers within a VPN community.
- MPLS forwarding—MPLS transports all traffic between all VPN community members across a VPN service-provider network.

A one-to-one relationship does not necessarily exist between customer sites and VPNs. A given site can be a member of multiple VPNs. However, a site can associate with only one VRF. A customer-site VRF contains all the routes available to the site from the VPNs of which it is a member

## Inter-AS Support for L3VPN

This section contains the following topics:

### Inter-AS Support: Overview

An autonomous system (AS) is a single network or group of networks that is controlled by a common system administration group and uses a single, clearly defined routing protocol.

As VPNs grow, their requirements expand. In some cases, VPNs need to reside on different autonomous systems in different geographic areas. In addition, some VPNs need to extend across multiple service providers (overlapping VPNs). Regardless of the complexity and location of the VPNs, the connection between autonomous systems must be seamless.

An MPLS VPN Inter-AS provides the following benefits:

- Allows a VPN to cross more than one service provider backbone.

Service providers, running separate autonomous systems, can jointly offer MPLS VPN services to the same end customer. A VPN can begin at one customer site and traverse different VPN service provider backbones before arriving at another site of the same customer. Previously, MPLS VPN could traverse only a single BGP autonomous system service provider backbone. This feature lets multiple autonomous systems form a continuous, seamless network between customer sites of a service provider.

- Allows a VPN to exist in different areas.

A service provider can create a VPN in different geographic areas. Having all VPN traffic flow through one point (between the areas) allows for better rate control of network traffic between the areas.

- Allows confederations to optimize iBGP meshing.

Internal Border Gateway Protocol (iBGP) meshing in an autonomous system is more organized and manageable. You can divide an autonomous system into multiple, separate subautonomous systems and then classify them into a single confederation. This capability lets a service provider offer MPLS VPNs across the confederation, as it supports the exchange of labeled VPN-IPv4 Network Layer Reachability Information (NLRI) between the subautonomous systems that form the confederation.

## Inter-AS and ASBRs

Separate autonomous systems from different service providers can communicate by exchanging IPv4 NLRI and IPv6 in the form of VPN-IPv4 addresses. The ASBRs use eBGP to exchange that information. Then an Interior Gateway Protocol (IGP) distributes the network layer information for VPN-IPv4 prefixes throughout each VPN and each autonomous system. The following protocols are used for sharing routing information:

- Within an autonomous system, routing information is shared using an IGP.
- Between autonomous systems, routing information is shared using an eBGP. An eBGP lets service providers set up an interdomain routing system that guarantees the loop-free exchange of routing information between separate autonomous systems.

The primary function of an eBGP is to exchange network reachability information between autonomous systems, including information about the list of autonomous system routes. The autonomous systems use EBGP border edge routers to distribute the routes, which include label switching information. Each border edge router rewrites the next-hop and MPLS labels.

Inter-AS configurations supported in an MPLS VPN can include:

- Interprovider VPN—MPLS VPNs that include two or more autonomous systems, connected by separate border edge routers. The autonomous systems exchange routes using eBGP. No IGP or routing information is exchanged between the autonomous systems.
- BGP Confederations—MPLS VPNs that divide a single autonomous system into multiple subautonomous systems and classify them as a single, designated confederation. The network recognizes the confederation as a single autonomous system. The peers in the different autonomous systems communicate over eBGP sessions; however, they can exchange route information as if they were iBGP peers.

## Confederations

A confederation is multiple subautonomous systems grouped together. A confederation reduces the total number of peer devices in an autonomous system. A confederation divides an autonomous system into subautonomous systems and assigns a confederation identifier to the autonomous systems. A VPN can span service providers running in separate autonomous systems or multiple subautonomous systems that form a confederation.

In a confederation, each subautonomous system is fully meshed with other subautonomous systems. The subautonomous systems communicate using an IGP, such as Open Shortest Path First (OSPF) or Intermediate System-to-Intermediate System (IS-IS). Each subautonomous system also has an eBGP connection to the other subautonomous systems. The confederation eBGP (CEBGP) border edge routers forward next-hop-self addresses between the specified subautonomous systems. The next-hop-self address forces the BGP to use a specified address as the next hop rather than letting the protocol choose the next hop.

You can configure a confederation with separate subautonomous systems two ways:

- Configure a router to forward next-hop-self addresses between only the CEBGP border edge routers (both directions). The subautonomous systems (iBGP peers) at the subautonomous system border do not forward the next-hop-self address. Each subautonomous system runs as a single IGP domain. However, the CEBGP border edge router addresses are known in the IGP domains.
- Configure a router to forward next-hop-self addresses between the CEBGP border edge routers (both directions) and within the iBGP peers at the subautonomous system border. Each subautonomous system runs as a single IGP domain but also forwards next-hop-self addresses between the PE routers in the domain. The CEBGP border edge router addresses are known in the IGP domains.



**Note** eBGP Connection Between Two Subautonomous Systems in a Confederation figure illustrates how two autonomous systems exchange routes and forward packets. Subautonomous systems in a confederation use a similar method of exchanging routes and forwarding packets.

The figure below illustrates a typical MPLS VPN confederation configuration. In this configuration:

- The two CEBGP border edge routers exchange VPN-IPv4 addresses with labels between the two autonomous systems.
- The distributing router changes the next-hop addresses and labels and uses a next-hop-self address.
- IGP-1 and IGP-2 know the addresses of CEBGP-1 and CEBGP-2.

**Figure 2: eBGP Connection Between Two Subautonomous Systems in a Confederation**

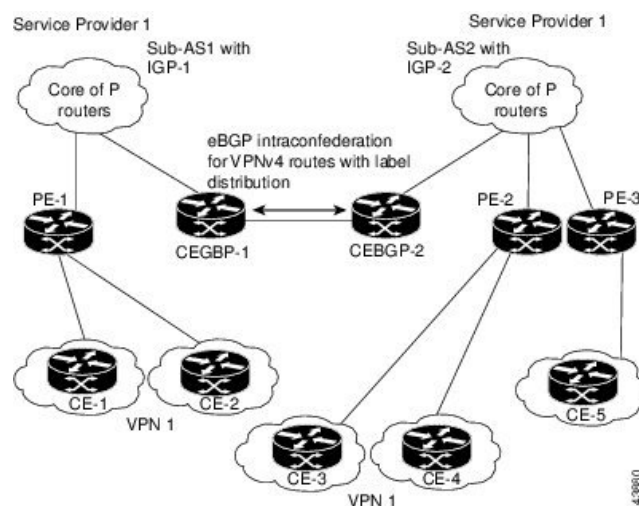

In this confederation configuration:

- CEBGP border edge routers function as neighboring peers between the subautonomous systems. The subautonomous systems use eBGP to exchange route information.
- Each CEBGP border edge router (CEBGP-1 and CEBGP-2) assigns a label for the router before distributing the route to the next subautonomous system. The CEBGP border edge router distributes the route as a VPN-IPv4 address by using the multiprotocol extensions of BGP. The label and the VPN identifier are encoded as part of the NLRI.

- Each PE and CEBGP border edge router assigns its own label to each VPN-IPv4 address prefix before redistributing the routes. The CEBGP border edge routers exchange IPV-IPv4 addresses with the labels. The next-hop-self address is included in the label (as the value of the eBGP next-hop attribute). Within the subautonomous systems, the CEBGP border edge router address is distributed throughout the iBGP neighbors, and the two CEBGP border edge routers are known to both confederations.
- For more information about how to configure confederations, see the .

## MPLS VPN Inter-AS BGP Label Distribution



**Note** This section is not applicable to Inter-AS over IP tunnels.

You can set up the MPLS VPN Inter-AS network so that the ASBRs exchange IPv4 routes with MPLS labels of the provider edge (PE) routers. Route reflectors (RRs) exchange VPN-IPv4 routes by using multihop, multiprotocol external Border Gateway Protocol (eBGP). This method of configuring the Inter-AS system is often called MPLS VPN Inter-AS BGP Label Distribution.

Configuring the Inter-AS system so that the ASBRs exchange the IPv4 routes and MPLS labels has the following benefits:

- Saves the ASBRs from having to store all the VPN-IPv4 routes. Using the route reflectors to store the VPN-IPv4 routes and distributes them to the PE routers results in improved scalability compared with configurations in which the ASBR holds all the VPN-IPv4 routes and distributes the routes based on VPN-IPv4 labels.
- Having the route reflectors hold the VPN-IPv4 routes also simplifies the configuration at the border of the network.
- Enables a non-VPN core network to act as a transit network for VPN traffic. You can transport IPv4 routes with MPLS labels over a non-MPLS VPN service provider.
- Eliminates the need for any other label distribution protocol between adjacent label switch routers (LSRs). If two adjacent LSRs are also BGP peers, BGP can handle the distribution of the MPLS labels. No other label distribution protocol is needed between the two LSRs.

## Exchanging IPv4 Routes with MPLS labels



**Note** This section is not applicable to Inter-AS over IP tunnels.

You can set up a VPN service provider network to exchange IPv4 routes with MPLS labels. You can configure the VPN service provider network as follows:

- Route reflectors exchange VPN-IPv4 routes by using multihop, multiprotocol eBGP. This configuration also preserves the next-hop information and the VPN labels across the autonomous systems.
- A local PE router (for example, PE1 in the figure below) needs to know the routes and label information for the remote PE router (PE2).



This information can be exchanged between the PE routers and ASBRs in one of two ways:

- Internal Gateway Protocol (IGP) and Label Distribution Protocol (LDP): The ASBR can redistribute the IPv4 routes and MPLS labels it learned from eBGP into IGP and LDP and from IGP and LDP into eBGP.
- Internal Border Gateway Protocol (iBGP) IPv4 label distribution: The ASBR and PE router can use direct iBGP sessions to exchange VPN-IPv4 and IPv4 routes and MPLS labels.

Alternatively, the route reflector can reflect the IPv4 routes and MPLS labels learned from the ASBR to the PE routers in the VPN. This reflecting of learned IPv4 routes and MPLS labels is accomplished by enabling the ASBR to exchange IPv4 routes and MPLS labels with the route reflector. The route reflector also reflects the VPN-IPv4 routes to the PE routers in the VPN. For example, in VPN1, RR1 reflects to PE1 the VPN-IPv4 routes it learned and IPv4 routes and MPLS labels learned from ASBR1. Using the route reflectors to store the VPN-IPv4 routes and forward them through the PE routers and ASBRs allows for a scalable configuration.

**Figure 3: VPNs Using eBGP and iBGP to Distribute Routes and MPLS Labels**

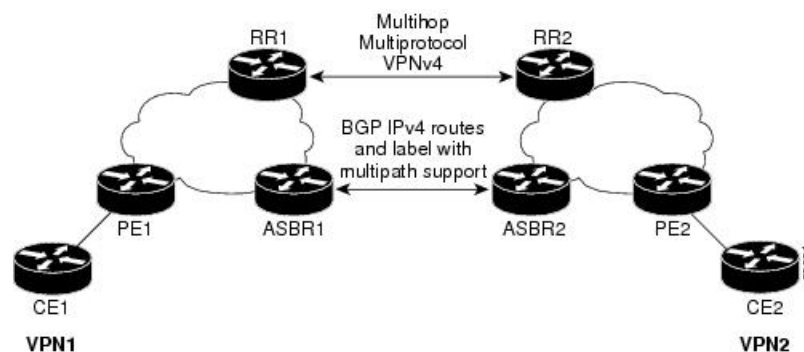

## BGP Routing Information

BGP routing information includes the following items:

- Network number (prefix), which is the IP address of the destination.
- Autonomous system (AS) path, which is a list of the other ASs through which a route passes on the way to the local router. The first AS in the list is closest to the local router; the last AS in the list is farthest from the local router and usually the AS where the route began.
- Path attributes, which provide other information about the AS path, for example, the next hop.

## BGP Messages and MPLS Labels

MPLS labels are included in the update messages that a router sends. Routers exchange the following types of BGP messages:

- Open messages—After a router establishes a TCP connection with a neighboring router, the routers exchange open messages. This message contains the number of the autonomous system to which the router belongs and the IP address of the router that sent the message.
- Update messages—When a router has a new, changed, or broken route, it sends an update message to the neighboring router. This message contains the NLRI, which lists the IP addresses of the usable routes. The update message includes any routes that are no longer usable. The update message also includes

path attributes and the lengths of both the usable and unusable paths. Labels for VPN-IPv4 routes are encoded in the update message, as specified in RFC 2858. The labels for the IPv4 routes are encoded in the update message, as specified in RFC 3107.

- Keepalive messages—Routers exchange keepalive messages to determine if a neighboring router is still available to exchange routing information. The router sends these messages at regular intervals. (Sixty seconds is the default for Cisco routers.) The keepalive message does not contain routing data; it contains only a message header.
- Notification messages—When a router detects an error, it sends a notification message.

## Sending MPLS Labels with Routes

When BGP (eBGP and iBGP) distributes a route, it can also distribute an MPLS label that is mapped to that route. The MPLS label mapping information for the route is carried in the BGP update message that contains the information about the route. If the next hop is not changed, the label is preserved.

When you issue the **show bgp neighbors ip-address** command on both BGP routers, the routers advertise to each other that they can then send MPLS labels with the routes. If the routers successfully negotiate their ability to send MPLS labels, the routers add MPLS labels to all outgoing BGP updates.

## Generic Routing Encapsulation Support for L3VPN

Generic Routing Encapsulation (GRE) is a tunneling protocol that can encapsulate many types of packets to enable data transmission using a tunnel. The GRE tunneling protocol enables:

- High assurance Internet Protocol encryptor (HAiPE) devices for encryption over the public Internet and nonsecure connections.
- Service providers (that do not run MPLS in their core network) to provide VPN services along with the security services.

GRE is used with IP to create a virtual point-to-point link to routers at remote points in a network. For detailed information about configuring GRE tunnel interfaces, see the <module-name> module of the *Cisco IOS XR Interfaces and Hardware Components Configuration Guide*.



---

**Note** GRE is used with IP to create a virtual point-to-point link to routers at remote points in a network. For detailed information about configuring GRE tunnel interfaces, refer to the *Cisco IOS XR Interfaces and Hardware Components Configuration Guide*. For a PE to PE (core) link, enable LDP (with implicit null) on the GRE interfaces for L3VPN.

---

## GRE Restriction for L3VPN

The following restrictions are applicable to L3VPN forwarding over GRE:

- Carrier Supporting Carrier (CsC) or Inter-AS is not supported.
- GRE-based L3VPN does not interwork with MPLS or IP VPNs.
- GRE tunnel is supported only as a core link (PE-PE, PE-P, P-P, P-PE). A PE-CE (edge) link is not supported.

- VPNv6 forwarding using GRE tunnels is not supported.

## VPNv4 Forwarding Using GRE Tunnels

This section describes the working of VPNv4 forwarding over GRE tunnels. The following description assumes that GRE is used only as a core link between the encapsulation and decapsulation provider edge (PE) routers that are connected to one or more customer edge (CE) routers.

### Ingress of Encapsulation Router

On receiving prefixes from the CE routers, Border Gateway Protocol (BGP) assigns the VPN label to the prefixes that need to be exported. These VPN prefixes are then forwarded to the Forwarding Information Base (FIB) using the Route Information Base (RIB) or the label switched database (LSD). The FIB then populates the prefix in the appropriate VRF table. The FIB also populates the label in the global label table. Using BGP, the prefixes are then relayed to the remote PE router (decapsulation router).

### Egress of Encapsulation Router

The forwarding behavior on egress of the encapsulation PE router is similar to the MPLS VPN label imposition. Regardless of whether the VPN label imposition is performed on the ingress or egress side, the GRE tunnel forwards a packet that has an associated label. This labeled packet is then encapsulated with a GRE header and forwarded based on the IP header.

### Ingress of Decapsulation Router

The decapsulation PE router learns the VPN prefixes and label information from the remote encapsulation PE router using BGP. The next-hop information for the VPN prefix is the address of the GRE tunnel interface connecting the two PE routers. BGP downloads these prefixes to the RIB. The RIB downloads the routes to the FIB and the FIB installs the routes in the hardware.

### Egress of Decapsulation Router

The egress forwarding behavior on the decapsulation PE router is similar to VPN disposition and forwarding, based on the protocol type of the inner payload.

## Carrier Supporting Carrier Support for L3VPN

This section provides conceptual information about MPLS VPN Carrier Supporting Carrier (CSC) functionality and includes the following topics:

- [CSC Prerequisites](#)
- [CSC Benefits](#)
- [Configuration Options for the Backbone and Customer Carriers](#)

Throughout this document, the following terminology is used in the context of CSC:

*backbone carrier*—Service provider that provides the segment of the backbone network to the other provider. A backbone carrier offers BGP and MPLS VPN services.

*customer carrier*—Service provider that uses the segment of the backbone network. The customer carrier may be an Internet service provider (ISP) or a BGP/MPLS VPN service provider.

*CE router*—A customer edge router is part of a customer network and interfaces to a provider edge (PE) router. In this document, the CE router sits on the edge of the customer carrier network.

*PE router*—A provider edge router is part of a service provider's network connected to a customer edge (CE) router. In this document, the PE router sits on the edge of the backbone carrier network.

*ASBR*—An autonomous system boundary router connects one autonomous system to another.

## CSC Prerequisites

The following prerequisites are required to configure CSC:

- You must be able to configure MPLS VPNs with end-to-end (CE-to-CE router) pings working.
- You must be able to configure Interior Gateway Protocols (IGPs), MPLS Label Distribution Protocol (LDP), and Multiprotocol Border Gateway Protocol (MP-BGP).
- You must ensure that CSC-PE and CSC-CE routers support BGP label distribution.



---

**Note** BGP is the only supported label distribution protocol on the link between CE and PE.

---

## CSC Benefits

This section describes the benefits of CSC to the backbone carrier and customer carriers.

### Benefits to the Backbone Carrier

- The backbone carrier can accommodate many customer carriers and give them access to its backbone.
- The MPLS VPN carrier supporting carrier feature is scalable.
- The MPLS VPN carrier supporting carrier feature is a flexible solution.

### Benefits to the Customer Carriers

- The MPLS VPN carrier supporting carrier feature removes from the customer carrier the burden of configuring, operating, and maintaining its own backbone.
- Customer carriers who use the VPN services provided by the backbone carrier receive the same level of security that Frame Relay or ATM-based VPNs provide.
- Customer carriers can use any link layer technology to connect the CE routers to the PE routers.
- The customer carrier can use any addressing scheme and still be supported by a backbone carrier.

### Benefits of Implementing MPLS VPN CSC Using BGP

The benefits of using BGP to distribute IPv4 routes and MPLS label routes are:

- BGP takes the place of an IGP and LDP in a VPN forwarding and routing instance (VRF) table.
- BGP is the preferred routing protocol for connecting two ISPs.

## Configuration Options for the Backbone and Customer Carriers

To enable CSC, the backbone and customer carriers must be configured accordingly:

- The backbone carrier must offer BGP and MPLS VPN services.
- The customer carrier can take several networking forms. The customer carrier can be:
  - An ISP with an IP core (see the “[Customer Carrier: ISP with IP Core](#)”).
  - An MPLS service provider with or without VPN services (see “[Customer Carrier: MPLS Service Provider](#)”).



**Note** An IGP in the customer carrier network is used to distribute next hops and loopbacks to the CSC-CE. IBGP with label sessions are used in the customer carrier network to distribute next hops and loopbacks to the CSC-CE.

### Customer Carrier: ISP with IP Core

The following figure shows a network configuration where the customer carrier is an ISP. The customer carrier has two sites, each of which is a point of presence (POP). The customer carrier connects these sites using a VPN service provided by the backbone carrier. The backbone carrier uses MPLS or IP tunnels to provide VPN services. The ISP sites use IP.

**Figure 4: Network: Customer Carrier Is an ISP**

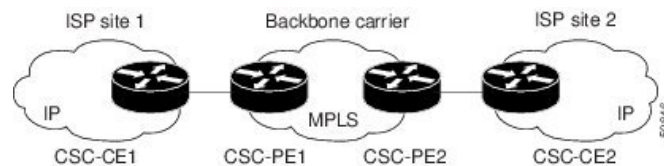

The links between the CE and PE routers use eBGP to distribute IPv4 routes and MPLS labels. Between the links, the PE routers use multiprotocol iBGP to distribute VPNv4 routes.

### Customer Carrier: MPLS Service Provider

The following figure shows a network configuration where the backbone carrier and the customer carrier are BGP/MPLS VPN service providers. The customer carrier has two sites. The customer carrier uses MPLS in its network while the backbone carrier may use MPLS or IP tunnels in its network.

Figure 5: Network: Customer Carrier Is an MPLS VPN Service Provider

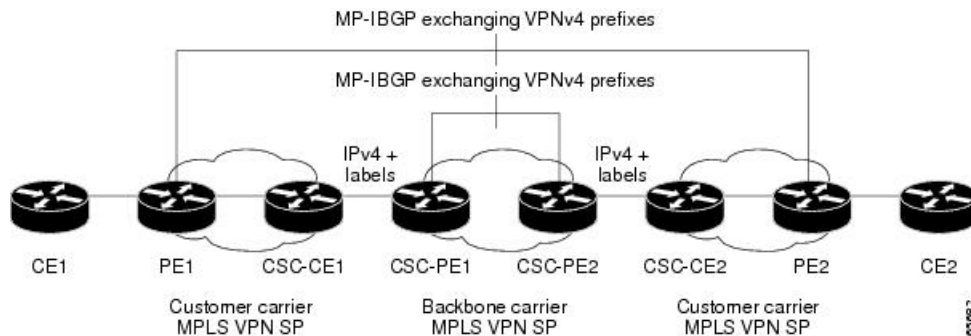

In Network: Customer Carrier Is an MPLS VPN Service Provider configuration, the customer carrier can configure its network in one of these ways:

- The customer carrier can run an IGP and LDP in its core network. In this case, the CSC-CE1 router in the customer carrier redistributes the eBGP routes it learns from the CSC-PE1 router of the backbone carrier to an IGP
- The CSC-CE1 router of the customer carrier system can run an IPv4 and labels iBGP session with the PE1 router.

## How to Implement MPLS Layer 3 VPNs

This section contains instructions for the following tasks:

### Configuring the Core Network

Configuring the core network includes the following tasks:

#### Assessing the Needs of MPLS VPN Customers

Before configuring an MPLS VPN, the core network topology must be identified so that it can best serve MPLS VPN customers. Perform this task to identify the core network topology.

#### SUMMARY STEPS

1. Identify the size of the network.
2. Identify the routing protocols in the core.
3. Determine if MPLS High Availability support is required.
4. Determine if BGP load sharing and redundant paths are required.

#### DETAILED STEPS

**Step 1** Identify the size of the network.

Identify the following to determine the number of routers and ports required:

- How many customers will be supported?
- How many VPNs are required for each customer?
- How many virtual routing and forwarding (VRF) instances are there for each VPN?

**Step 2** Identify the routing protocols in the core.

Determine which routing protocols are required in the core network.

**Step 3** Determine if MPLS High Availability support is required.

MPLS VPN nonstop forwarding and graceful restart are supported on select routers and Cisco IOS XR software releases.

**Step 4** Determine if BGP load sharing and redundant paths are required.

Determine if BGP load sharing and redundant paths in the MPLS VPN core are required.

---

## Configuring Routing Protocols in the Core

To configure a routing protocol, see the *Routing Configuration Guide for Cisco ASR 9000 Series Routers*.

## Configuring MPLS in the Core

To enable MPLS on all routers in the core, you must configure a Label Distribution Protocol (LDP). You can use either of the following as an LDP:

- MPLS LDP—See the *Implementing MPLS Label Distribution Protocol* chapter in the *MPLS Configuration Guide for Cisco ASR 9000 Series Routers* for configuration information.
- MPLS Traffic Engineering Resource Reservation Protocol (RSVP)—See *Implementing RSVP for MPLS-TE* module in the *MPLS Configuration Guide for Cisco ASR 9000 Series Routers* for configuration information.

## Determining if FIB Is Enabled in the Core

Forwarding Information Base (FIB) must be enabled on all routers in the core, including the provider edge (PE) routers. For information on how to determine if FIB is enabled, see the *Implementing Cisco Express Forwarding* module in the *IP Addresses and Services Configuration Guide for Cisco ASR 9000 Series Routers*.

## Configuring Multiprotocol BGP on the PE Routers and Route Reflectors

Perform this task to configure multiprotocol BGP (MP-BGP) connectivity on the PE routers and route reflectors.

### SUMMARY STEPS

1. **configure**
2. **router bgp** *autonomous-system-number*
3. **address-family vpnv4 unicast** or **address-family vpnv6 unicast**
4. **neighbor ip-address remote-as** *autonomous-system-number*
5. **address-family vpnv4 unicast** or **address-family vpnv6 unicast**
6. Use the **commit** or **end** command.

## DETAILED STEPS

---

### Step 1 **configure**

**Example:**

```
RP/0/RSP0/CPU0:router# configure
```

Enters the Global Configuration mode.

### Step 2 **router bgp *autonomous-system-number***

**Example:**

```
RP/0/RSP0/CPU0:router(config)# router bgp 120
```

Enters BGP configuration mode allowing you to configure the BGP routing process.

### Step 3 **address-family *vpn4 unicast*** or **address-family *vpn6 unicast***

**Example:**

```
RP/0/RSP0/CPU0:router(config-bgp)# address-family vpn4 unicast
```

Enters VPNv4 or VPNv6 address family configuration mode for the VPNv4 or VPNv6 address family.

### Step 4 **neighbor *ip-address* remote-as *autonomous-system-number***

**Example:**

```
RP/0/RSP0/CPU0:router(config-bgp)# neighbor 172.168.40.24 remote-as 2002
```

Creates a neighbor and assigns it a remote autonomous system number.

### Step 5 **address-family *vpn4 unicast*** or **address-family *vpn6 unicast***

**Example:**

```
RP/0/RSP0/CPU0:router(config-bgp-nbr)# address-family vpn4 unicast
```

Enters VPNv4 or VPNv6 address family configuration mode for the VPNv4 or VPNv6 address family.

### Step 6 Use the **commit** or **end** command.

**commit** - Saves the configuration changes and remains within the configuration session.

**end** - Prompts user to take one of these actions:

- **Yes** - Saves configuration changes and exits the configuration session.
  - **No** - Exits the configuration session without committing the configuration changes.
  - **Cancel** - Remains in the configuration mode, without committing the configuration changes.
-



## Connecting MPLS VPN Customers

To connect MPLS VPN customers to the VPN, perform the following tasks:

### Defining VRFs on the PE Routers to Enable Customer Connectivity

Perform this task to define VPN routing and forwarding (VRF) instances.

#### SUMMARY STEPS

1. **configure**
2. **vrf** *vrf-name*
3. **address-family ipv4 unicast**
4. **import route-policy** *policy-name*
5. **import route-target** [ *as-number:nn* | *ip-address:nn* ]
6. **export route-policy** *policy-name*
7. **export route-target** [ *as-number:nn* | *ip-address:nn* ]
8. **exit**
9. **exit**
10. **router bgp** *autonomous-system-number*
11. **vrf** *vrf-name*
12. **rd** { *as-number* | *ip-address* | **auto** }
13. Use the **commit** or **end** command.

#### DETAILED STEPS

---

##### Step 1 **configure**

###### Example:

```
RP/0/RSP0/CPU0:router# configure
Enters Global Configuration mode.
```

##### Step 2 **vrf** *vrf-name*

###### Example:

```
RP/0/RSP0/CPU0:router(config)# vrf vrf_1

Configures a VRF instance and enters VRF configuration mode.
```

##### Step 3 **address-family ipv4 unicast**

###### Example:

```
RP/0/RSP0/CPU0:router(config-vrf)# address-family ipv4 unicast

Enters VRF address family configuration mode for the IPv4 address family.
```

##### Step 4 **import route-policy** *policy-name*

**Example:**

```
RP/0/RSP0/CPU0:router(config-vrf-af)# import route-policy policy_A
```

Specifies a route policy that can be imported into the local VPN.

**Step 5** **import route-target** [ *as-number:nn* | *ip-address:nn* ]

**Example:**

```
RP/0/RSP0/CPU0:router(config-vrf-af)# import route-target 120:1
```

Allows exported VPN routes to be imported into the VPN if one of the route targets of the exported route matches one of the local VPN import route targets.

**Step 6** **export route-policy** *policy-name*

**Example:**

```
RP/0/RSP0/CPU0:router(config-vrf-af)# export route-policy policy_B
```

Specifies a route policy that can be exported from the local VPN.

**Step 7** **export route-target** [ *as-number:nn* | *ip-address:nn* ]

**Example:**

```
RP/0/RSP0/CPU0:router(config-vrf-af)# export route-target 120:2
```

Associates the local VPN with a route target. When the route is advertised to other provider edge (PE) routers, the export route target is sent along with the route as an extended community.

**Step 8** **exit**

**Example:**

```
RP/0/RSP0/CPU0:router(config-vrf-af)# exit
```

Exits VRF address family configuration mode and returns the router to VRF configuration mode.

**Step 9** **exit**

**Example:**

```
RP/0/RSP0/CPU0:router(config-vrf)# exit
```

Exits VRF configuration mode and returns the router to Global Configuration mode.

**Step 10** **router bgp** *autonomous-system-number*

**Example:**

```
RP/0/RSP0/CPU0:router(config)# router bgp 120
```

Enters BGP configuration mode allowing you to configure the BGP routing process.

**Step 11** `vrf vrf-name`

**Example:**

```
RP/0/RSP0/CPU0:router(config-bgp)# vrf vrf_1
```

Configures a VRF instance and enters VRF configuration mode for BGP routing.

**Step 12** `rd { as-number | ip-address | auto }`

**Example:**

```
RP/0/RSP0/CPU0:router(config-bgp-vrf)# rd auto
```

Automatically assigns a unique route distinguisher (RD) to vrf\_1.

**Step 13** Use the **commit** or **end** command.

**commit** - Saves the configuration changes and remains within the configuration session.

**end** - Prompts user to take one of these actions:

- **Yes** - Saves configuration changes and exits the configuration session.
- **No** - Exits the configuration session without committing the configuration changes.
- **Cancel** - Remains in the configuration mode, without committing the configuration changes.

## Configuring VRF Interfaces on PE Routers for Each VPN Customer

Perform this task to associate a VPN routing and forwarding (VRF) instance with an interface or a subinterface on the PE routers.



**Note** You must remove IPv4/IPv6 addresses from an interface prior to assigning, removing, or changing an interface's VRF. If this is not done in advance, any attempt to change the VRF on an IP interface is rejected.

### SUMMARY STEPS

1. **configure**
2. **interface** *type interface-path-id*
3. **vrf** *vrf-name*
4. **ipv4 address** *ipv4-address mask*
5. Use the **commit** or **end** command.

### DETAILED STEPS

**Step 1** **configure**

**Example:**

```
RP/0/RSP0/CPU0:router# configure
```

Enters Global Configuration mode.

**Step 2** `interface type interface-path-id`**Example:**

```
RP/0/RSP0/CPU0:router(config)# interface TenGigE 0/3/0/0
```

Enters interface configuration mode.

**Step 3** `vrf vrf-name`**Example:**

```
RP/0/RSP0/CPU0:router(config-if)# vrf vrf_A
```

Configures a VRF instance and enters VRF configuration mode.

**Step 4** `ipv4 address ipv4-address mask`**Example:**

```
RP/0/RSP0/CPU0:router(config-if)# ipv4 address 192.168.1.27 255.255.255.0
```

Configures a primary IPv4 address for the specified interface.

**Step 5** Use the **commit** or **end** command.

**commit** - Saves the configuration changes and remains within the configuration session.

**end** - Prompts user to take one of these actions:

- **Yes** - Saves configuration changes and exits the configuration session.
- **No** - Exits the configuration session without committing the configuration changes.
- **Cancel** - Remains in the configuration mode, without committing the configuration changes.

---

## Configuring BGP as the Routing Protocol Between the PE and CE Routers

Perform this task to configure PE-to-CE routing sessions using BGP.

**SUMMARY STEPS**

1. **configure**
2. **router bgp** *autonomous-system-number*
3. **bgp router-id** {*ip-address*}
4. **vrf** *vrf-name*
5. **label-allocation-mode per-ce**
6. **address-family ipv4 unicast**

7. Do one of the following:
  - **redistribute connected** [ **metric** *metric-value* ] [ **route-policy** *route-policy-name* ]
  - **redistribute isis** *process-id* [ **level** { **1** | **1-inter-area** | **2** } ] [ **metric** *metric-value* ] [ **route-policy** *route-policy-name* ]
  - **redistribute ospf** *process-id* [ **match** { **external** [ **1** | **2** ] | **internal** | **nssa-external** [ **1** | **2** ] } ] [ **metric** *metric-value* ] [ **route-policy** *route-policy-name* ]
  - **redistribute static** [ **metric** *metric-value* ] [ **route-policy** *route-policy-name* ]
8. **aggregate-address** *address/mask-length* [ **as-set** ] [ **as-confed-set** ] [ **summary-only** ] [ **route-policy** *route-policy-name* ]
9. **network** { *ip-address/prefix-length* | *ip-address mask* } [ **route-policy** *route-policy-name* ]
10. **exit**
11. **neighbor** *ip-address*
12. **remote-as** *autonomous-system-number*
13. **password** { **clear** | **encrypted** } *password*
14. **ebgp-multihop** [ *ttl-value* ]
15. **address-family** **ipv4** **unicast**
16. **allowas-in** [ *as-occurrence-number* ]
17. **route-policy** *route-policy-name* **in**
18. **route-policy** *route-policy-name* **out**
19. Use the **commit** or **end** command.

## DETAILED STEPS

### Step 1 **configure**

#### Example:

```
RP/0/RSP0/CPU0:router# configure
```

Enters Global Configuration mode.

### Step 2 **router bgp** *autonomous-system-number*

#### Example:

```
RP/0/RSP0/CPU0:router(config)# router bgp 120
```

Enters Border Gateway Protocol (BGP) configuration mode allowing you to configure the BGP routing process.

### Step 3 **bgp router-id** { *ip-address* }

#### Example:

```
RP/0/RSP0/CPU0:router(config-bgp)# bgp router-id 192.168.70.24
```

Configures the local router with a router ID of 192.168.70.24.

### Step 4 **vrf** *vrf-name*

**Example:**

```
RP/0/RSP0/CPU0:router(config-bgp)# vrf vrf_1
```

Configures a VPN routing and forwarding (VRF) instance and enters VRF configuration mode for BGP routing.

**Step 5 label-allocation-mode per-ce****Example:**

```
RP/0/RSP0/CPU0:router(config-bgp-vrf)# label-allocation-mode per-ce
```

Sets the MPLS VPN label allocation mode for each customer edge (CE) label mode allowing the provider edge (PE) router to allocate one label for every immediate next-hop.

**Step 6 address-family ipv4 unicast****Example:**

```
RP/0/RSP0/CPU0:router(config-bgp-vrf)# address-family ipv4 unicast
```

Enters VRF address family configuration mode for the IPv4 address family.

**Step 7** Do one of the following:

- **redistribute connected** [ **metric** *metric-value* ] [ **route-policy** *route-policy-name* ]
- **redistribute isis** *process-id* [ **level** { **1** | **1-inter-area** | **2** } ] [ **metric** *metric-value* ] [ **route-policy** *route-policy-name* ]
- **redistribute ospf** *process-id* [ **match** { **external** [ **1** | **2** ] | **internal** | **nssa-external** [ **1** | **2** ] } ] [ **metric** *metric-value* ] [ **route-policy** *route-policy-name* ]
- **redistribute static** [ **metric** *metric-value* ] [ **route-policy** *route-policy-name* ]

**Example:**

```
RP/0/RSP0/CPU0:router(config-bgp-vrf-af)# redistribute connected
```

Causes routes to be redistributed into BGP. The routes that can be redistributed into BGP are:

- Connected
- Intermediate System-to-Intermediate System (IS-IS)
- Open Shortest Path First (OSPF)
- Static

**Step 8 aggregate-address** *address/mask-length* [ **as-set** ] [ **as-confed-set** ] [ **summary-only** ] [ **route-policy** *route-policy-name* ]**Example:**

```
RP/0/RSP0/CPU0:router(config-bgp-vrf-af)# aggregate-address 10.0.0.0/8 as-set
```

Creates an aggregate address. The path advertised for this route is an autonomous system set consisting of all elements contained in all paths that are being summarized.

- The **as-set** keyword generates autonomous system set path information and community information from contributing paths.

- The **as-confed-set** keyword generates autonomous system confederation set path information from contributing paths.
- The **summary-only** keyword filters all more specific routes from updates.
- The **route-policy** *route-policy-name* keyword and argument specify the route policy used to set the attributes of the aggregate route.

**Step 9**     **network** { *ip-address/prefix-length* | *ip-address mask* } [ **route-policy** *route-policy-name* ]

**Example:**

```
RP/0/RSP0/CPU0:router(config-bgp-vrf-af)# network 172.20.0.0/16
```

Configures the local router to originate and advertise the specified network.

**Step 10**    **exit**

**Example:**

```
RP/0/RSP0/CPU0:router(config-bgp-vrf-af)# exit
```

Exits VRF address family configuration mode and returns the router to VRF configuration mode for BGP routing.

**Step 11**    **neighbor** *ip-address*

**Example:**

```
RP/0/RSP0/CPU0:router(config-bgp-vrf)# neighbor 172.168.40.24
```

Places the router in VRF neighbor configuration mode for BGP routing and configures the neighbor IP address 172.168.40.24 as a BGP peer.

**Step 12**    **remote-as** *autonomous-system-number*

**Example:**

```
RP/0/RSP0/CPU0:router(config-bgp-vrf-nbr)# remote-as 2002
```

Creates a neighbor and assigns it a remote autonomous system number.

**Step 13**    **password** { **clear** | **encrypted** } *password*

**Example:**

```
RP/0/RSP0/CPU0:router(config-bgp-vrf-nbr)# password clear pswd123
```

Configures neighbor 172.168.40.24 to use MD5 authentication with the password pswd123.

**Step 14**    **ebgp-multihop** [ *ttl-value* ]

**Example:**

```
RP/0/RSP0/CPU0:router(config-bgp-vrf-nbr)# ebgp-multihop
```

Allows a BGP connection to neighbor 172.168.40.24.

**Step 15**     **address-family ipv4 unicast****Example:**

```
RP/0/RSP0/CPU0:router(config-bgp-vrf-nbr)# address-family ipv4 unicast
```

Enters VRF neighbor address family configuration mode for BGP routing.

**Step 16**     **allowas-in [as-occurrence-number ]****Example:**

```
RP/0/RSP0/CPU0:router(config-bgp-vrf-nbr-af)# allowas-in 3
```

Replaces the neighbor autonomous system number (ASN) with the PE ASN in the AS path three times.

**Step 17**     **route-policy route-policy-name in****Example:**

```
RP/0/RSP0/CPU0:router(config-bgp-vrf-nbr-af)# route-policy In-Ipv4 in
```

Applies the In-Ipv4 policy to inbound IPv4 unicast routes.

**Step 18**     **route-policy route-policy-name out****Example:**

```
RP/0/RSP0/CPU0:router(config-bgp-vrf-nbr-af)# route-policy In-Ipv4 in
```

Applies the In-Ipv4 policy to outbound IPv4 unicast routes.

**Step 19**     Use the **commit** or **end** command.

**commit** - Saves the configuration changes and remains within the configuration session.

**end** - Prompts user to take one of these actions:

- **Yes** - Saves configuration changes and exits the configuration session.
- **No** - Exits the configuration session without committing the configuration changes.
- **Cancel** - Remains in the configuration mode, without committing the configuration changes.

---

## Configuring RIPv2 as the Routing Protocol Between the PE and CE Routers

Perform this task to configure provider edge (PE)-to-customer edge (CE) routing sessions using Routing Information Protocol version 2 (RIPv2).

**SUMMARY STEPS**

1. **configure**
2. **router rip**
3. **vrf vrf-name**



4. **interface** *type instance*
5. **site-of-origin** { *as-number : number* | *ip-address : number* }
6. **exit**
7. Do one of the following:
  - **redistribute bgp** *as-number* [ [ **external** | **internal** | **local** ] [ **route-policy name** ]
  - **redistribute connected** [ **route-policy name** ]
  - **redistribute isis** *process-id* [ **level-1** | **level-1-2** | **level-2** ] [ **route-policy name** ]
  - **redistribute eigrp** *as-number* [ **route-policy name** ]
  - **redistribute ospf** *process-id* [ **match** { **external** [ **1** | **2** ] | **internal** | **nssa-external** [ **1** | **2** ] } ] [ **route-policy name** ]
  - **redistribute static** [ **route-policy name** ]
8. Use the **commit** or **end** command.

## DETAILED STEPS

### Step 1 **configure**

#### Example:

```
RP/0/RSP0/CPU0:router# configure
```

Enters Global Configuration mode.

### Step 2 **router rip**

#### Example:

```
RP/0/RSP0/CPU0:router(config)# router rip
```

Enters the Routing Information Protocol (RIP) configuration mode allowing you to configure the RIP routing process.

### Step 3 **vrf vrf-name**

#### Example:

```
RP/0/RSP0/CPU0:router(config-rip)# vrf vrf_1
```

Configures a VPN routing and forwarding (VRF) instance and enters VRF configuration mode for RIP routing.

### Step 4 **interface type instance**

#### Example:

```
RP/0/RSP0/CPU0:router(config-rip-vrf)# interface TenGigE 0/3/0/0
```

Enters VRF interface configuration mode.

### Step 5 **site-of-origin** { *as-number : number* | *ip-address : number* }

#### Example:

```
RP/0/RSP0/CPU0:router(config-rip-vrf-if)# site-of-origin 200:1
```

Identifies routes that have originated from a site so that the re-advertisement of that prefix back to the source site can be prevented. Uniquely identifies the site from which a PE router has learned a route.

### Step 6 **exit**

#### **Example:**

```
RP/0/RSP0/CPU0:router(config-rip-vrf-if)# exit
```

Exits VRF interface configuration mode, and returns the router to VRF configuration mode for RIP routing.

### Step 7 Do one of the following:

- **redistribute bgp** *as-number* [ [ **external** | **internal** | **local** ] [ **route-policy name** ]
- **redistribute connected** [ **route-policy name** ]
- **redistribute isis** *process-id* [ **level-1** | **level-1-2** | **level-2** ] [ **route-policy name** ]
- **redistribute eigrp** *as-number* [ **route-policy name** ]
- **redistribute ospf** *process-id* [ **match** { **external** [ **1** | **2** ] | **internal** | **nssa-external** [ **1** | **2** ] } ] [ **route-policy name** ]
- **redistribute static** [ **route-policy name** ]

#### **Example:**

```
RP/0/RSP0/CPU0:router(config-rip-vrf)# redistribute connected
```

Causes routes to be redistributed into RIP. The routes that can be redistributed into RIP are:

- Border Gateway Protocol (BGP)
- Connected
- Enhanced Interior Gateway Routing Protocol (EIGRP)
- Intermediate System-to-Intermediate System (IS-IS)
- Open Shortest Path First (OSPF)
- Static

### Step 8 Use the **commit** or **end** command.

**commit** - Saves the configuration changes and remains within the configuration session.

**end** - Prompts user to take one of these actions:

- **Yes** - Saves configuration changes and exits the configuration session.
- **No** - Exits the configuration session without committing the configuration changes.
- **Cancel** - Remains in the configuration mode, without committing the configuration changes.

## Configuring Static Routes Between the PE and CE Routers

Perform this task to configure provider edge (PE)-to-customer edge (CE) routing sessions that use static routes.



**Note** You must remove IPv4/IPv6 addresses from an interface prior to assigning, removing, or changing an interface's VRF. If this is not done in advance, any attempt to change the VRF on an IP interface is rejected.

## SUMMARY STEPS

1. **configure**
2. **router static**
3. **vrf vrf-name**
4. **address-family ipv4 unicast**
5. *prefix/mask [ vrf vrf-name ] { ip-address | type interface-path-id }*
6. *prefix/mask [vrf vrf-name] bfd fast-detect*
7. Use the **commit** or **end** command.

## DETAILED STEPS

### Step 1 **configure**

**Example:**

```
RP/0/RSP0/CPU0:router# configure
```

Enters Global Configuration mode.

### Step 2 **router static**

**Example:**

```
RP/0/RSP0/CPU0:router(config)# router static
```

Enters static routing configuration mode allowing you to configure the static routing process.

### Step 3 **vrf vrf-name**

**Example:**

```
RP/0/RSP0/CPU0:router(config-static)# vrf vrf_1
```

Configures a VPN routing and forwarding (VRF) instance and enters VRF configuration mode for static routing.

### Step 4 **address-family ipv4 unicast**

**Example:**

```
RP/0/RSP0/CPU0:router(config-static-vrf)# address-family ipv4 unicast
```

Enters VRF address family configuration mode for the IPv4 address family.

### Step 5 *prefix/mask [ vrf vrf-name ] { ip-address | type interface-path-id }*

**Example:**

```
RP/0/RSP0/CPU0:router(config-static-vrf-afi)# 172.168.40.24/24 vrf vrf_1 10.1.1.1
```

Assigns the static route to vrf\_1.

**Step 6** *prefix/mask [vrf vrf-name] bfd fast-detect***Example:**

```
RP/0/RSP0/CPU0:router(config-static-vrf-afi)# 172.168.40.24/24 vrf vrf_1 bfd fast-detect
```

Enables bidirectional forwarding detection (BFD) to detect failures in the path between adjacent forwarding engines. This option is available is when the forwarding router address is specified in Step 5 .

**Step 7** Use the **commit** or **end** command.

**commit** - Saves the configuration changes and remains within the configuration session.

**end** - Prompts user to take one of these actions:

- **Yes** - Saves configuration changes and exits the configuration session.
- **No** - Exits the configuration session without committing the configuration changes.
- **Cancel** - Remains in the configuration mode, without committing the configuration changes.

---

## Configuring OSPF as the Routing Protocol Between the PE and CE Routers

Perform this task to configure provider edge (PE)-to-customer edge (CE) routing sessions that use Open Shortest Path First (OSPF).

**SUMMARY STEPS**

1. **configure**
2. **router ospf** *process-name*
3. **vrf** *vrf-name*
4. **router-id** {*router-id* | type interface-path-id}
5. Do one of the following:
  - **redistribute bgp** *process-id* [**metric** *metric-value*] [**metric-type** {1 | 2}] [**route-policy** *policy-name*] [**tag** *tag-value*]
  - **redistribute connected** [**metric** *metric-value*] [**metric-type** {1 | 2}] [**route-policy** *policy-name*] [**tag** *tag-value*]
  - **redistribute ospf** *process-id* [**match** {**external** [1 | 2] | **internal** | **nssa-external** [1 | 2]}] [**metric** *metric-value*] [**metric-type** {1 | 2}] [**route-policy** *policy-name*] [**tag** *tag-value*]
  - **redistribute static** [**metric** *metric-value*] [**metric-type** {1 | 2}] [**route-policy** *policy-name*] [**tag** *tag-value*]
  - **redistribute eigrp** *process-id* [**match** {**external** [1 | 2] | **internal** | **nssa-external** [1 | 2]}] [**metric** *metric-value*] [**metric-type** {1 | 2}] [**route-policy** *policy-name*] [**tag** *tag-value*]
  - **redistribute rip** [**metric** *metric-value*] [**metric-type** {1 | 2}] [**route-policy** *policy-name*] [**tag** *tag-value*]

6. **area** *area-id*
7. **interface** type interface-path-id
8. Use the **commit** or **end** command.

## DETAILED STEPS

### Step 1 **configure**

#### Example:

```
RP/0/RSP0/CPU0:router# configure
```

Enters Global Configuration mode.

### Step 2 **router ospf** *process-name*

#### Example:

```
RP/0/RSP0/CPU0:router(config)# router ospf 109
```

Enters OSPF configuration mode allowing you to configure the OSPF routing process.

### Step 3 **vrf** *vrf-name*

#### Example:

```
RP/0/RSP0/CPU0:router(config-ospf)# vrf vrf_1
```

Configures a VPN routing and forwarding (VRF) instance and enters VRF configuration mode for OSPF routing.

### Step 4 **router-id** {*router-id* | type interface-path-id}

#### Example:

```
RP/0/RSP0/CPU0:router(config-ospf-vrf)# router-id 172.20.10.10
```

Configures the router ID for the OSPF routing process.

### Step 5 Do one of the following:

- **redistribute bgp** *process-id* [**metric** *metric-value*] [**metric-type** {**1** | **2**}] [**route-policy** *policy-name*] [**tag** *tag-value*]
- **redistribute connected** [**metric** *metric-value*] [**metric-type** {**1** | **2**}] [**route-policy** *policy-name*] [**tag** *tag-value*]
- **redistribute ospf** *process-id* [**match** {**external** [**1** | **2**] | **internal** | **nssa-external** [**1** | **2**]}] [**metric** *metric-value*] [**metric-type** {**1** | **2**}] [**route-policy** *policy-name*] [**tag** *tag-value*]
- **redistribute static** [**metric** *metric-value*] [**metric-type** {**1** | **2**}] [**route-policy** *policy-name*] [**tag** *tag-value*]
- **redistribute eigrp** *process-id* [**match** {**external** [**1** | **2**] | **internal** | **nssa-external** [**1** | **2**]}] [**metric** *metric-value*] [**metric-type** {**1** | **2**}] [**route-policy** *policy-name*] [**tag** *tag-value*]
- **redistribute rip** [**metric** *metric-value*] [**metric-type** {**1** | **2**}] [**route-policy** *policy-name*] [**tag** *tag-value*]

#### Example:

```
RP/0/RSP0/CPU0:router(config-ospf-vrf)# redistribute connected
```

Causes routes to be redistributed into OSPF. The routes that can be redistributed into OSPF are:

- Border Gateway Protocol (BGP)
- Connected
- Enhanced Interior Gateway Routing Protocol (EIGRP)
- OSPF
- Static
- Routing Information Protocol (RIP)

**Step 6** `area area-id`

**Example:**

```
RP/0/RSP0/CPU0:router(config-ospf-vrf)# area 0
```

Configures the OSPF area as area 0.

**Step 7** `interface type interface-path-id`

**Example:**

```
RP/0/RSP0/CPU0:router(config-ospf-vrf-ar)# interface TenGigE 0/3/0/0
```

Associates interface TenGigE 0/3/0/0 with area 0.

**Step 8** Use the **commit** or **end** command.

**commit** - Saves the configuration changes and remains within the configuration session.

**end** - Prompts user to take one of these actions:

- **Yes** - Saves configuration changes and exits the configuration session.
- **No** - Exits the configuration session without committing the configuration changes.
- **Cancel** - Remains in the configuration mode, without committing the configuration changes.

## Configuring EIGRP as the Routing Protocol Between the PE and CE Routers

Perform this task to configure provider edge (PE)-to-customer edge (CE) routing sessions that use Enhanced Interior Gateway Routing Protocol (EIGRP).

Using EIGRP between the PE and CE routers allows you to transparently connect EIGRP customer networks through an MPLS-enabled Border Gateway Protocol (BGP) core network so that EIGRP routes are redistributed through the VPN across the BGP network as internal BGP (iBGP) routes.

### Before you begin

BGP is configured in the network. See the *Implementing BGP* module in the *Routing Configuration Guide for Cisco ASR 9000 Series Routers*



**Note** You must remove IPv4/IPv6 addresses from an interface prior to assigning, removing, or changing an interface's VRF. If this is not done in advance, any attempt to change the VRF on an IP interface is rejected.

## SUMMARY STEPS

1. **configure**
2. **router eigrp** *as-number*
3. **vrf** *vrf-name*
4. **address-family ipv4**
5. **router-id** *router-id*
6. **autonomous-system** *as-number*
7. **default-metric** *bandwidth delay reliability loading mtu*
8. **redistribute** { { **bgp** | **connected** | **isis** | **ospf** | **rip** | **static** } [ *as-number* | *instance-name* ] } [ **route-policy** *name* ]
9. **interface** *type interface-path-id*
10. **site-of-origin** { *as-number:number* | *ip-address : number* }
11. Use the **commit** or **end** command.

## DETAILED STEPS

**Step 1** **configure**

**Example:**

```
RP/0/RSP0/CPU0:router# configure
```

Enters Global Configuration mode.

**Step 2** **router eigrp** *as-number*

**Example:**

```
RP/0/RSP0/CPU0:router(config)# router eigrp 24
```

Enters EIGRP configuration mode allowing you to configure the EIGRP routing process.

**Step 3** **vrf** *vrf-name*

**Example:**

```
RP/0/RSP0/CPU0:router(config-eigrp)# vrf vrf_1
```

Configures a VPN routing and forwarding (VRF) instance and enters VRF configuration mode for EIGRP routing.

**Step 4** **address-family ipv4**

**Example:**

```
RP/0/RSP0/CPU0:router(config-eigrp-vrf)# address family ipv4
```

Enters VRF address family configuration mode for the IPv4 address family.

**Step 5** **router-id** *router-id*

**Example:**

```
RP/0/RSP0/CPU0:router(config-eigrp-vrf-af)# router-id 172.20.0.0
```

Configures the router ID for the Enhanced Interior Gateway Routing Protocol (EIGRP) routing process.

**Step 6** **autonomous-system** *as-number*

**Example:**

```
RP/0/RSP0/CPU0:router(config-eigrp-vrf-af)# autonomous-system 6
```

Configures the EIGRP routing process to run within a VRF.

**Step 7** **default-metric** *bandwidth delay reliability loading mtu*

**Example:**

```
RP/0/RSP0/CPU0:router(config-eigrp-vrf-af)# default-metric 100000 4000 200 45 4470
```

Sets the metrics for an EIGRP.

**Step 8** **redistribute** { { **bgp** | **connected** | **isis** | **ospf** | **rip** | **static** } [ *as-number* | *instance-name* ] } [ **route-policy** *name* ]

**Example:**

```
RP/0/RSP0/CPU0:router(config-eigrp-vrf-af)# redistribute connected
```

Causes connected routes to be redistributed into EIGRP.

**Step 9** **interface** *type interface-path-id*

**Example:**

```
RP/0/RSP0/CPU0:router(config-eigrp-vrf-af)# interface TenGigE 0/3/0/0
```

Associates interface TenGigE 0/3/0/0 with the EIGRP routing process.

**Step 10** **site-of-origin** { *as-number:number* | *ip-address : number* }

**Example:**

```
RP/0/RSP0/CPU0:router(config-eigrp-vrf-af-if)# site-of-origin 201:1
```

Configures site of origin (SoO) on interface TenGigE 0/3/0/0.

**Step 11** Use the **commit** or **end** command.



**commit** - Saves the configuration changes and remains within the configuration session.

**end** - Prompts user to take one of these actions:

- **Yes** - Saves configuration changes and exits the configuration session.
- **No** - Exits the configuration session without committing the configuration changes.
- **Cancel** - Remains in the configuration mode, without committing the configuration changes.

## Configuring EIGRP Redistribution in the MPLS VPN

Perform this task for every provider edge (PE) router that provides VPN services to enable Enhanced Interior Gateway Routing Protocol (EIGRP) redistribution in the MPLS VPN.

### Before you begin

The metric can be configured in the route-policy configuring using the **redistribute** command (or configured with the **default-metric** command). If an external route is received from another EIGRP autonomous system or a non-EIGRP network without a configured metric, the route is not installed in the EIGRP database. If an external route is received from another EIGRP autonomous system or a non-EIGRP network without a configured metric, the route is not advertised to the CE router. See the *Implementing EIGRP* module in the *Routing Configuration Guide for Cisco ASR 9000 Series Routers*.



**Restriction** Redistribution between native EIGRP VPN routing and forwarding (VRF) instances is not supported. This behavior is designed.

### SUMMARY STEPS

1. **configure**
2. **router eigrp** *as-number*
3. **vrf** *vrf-name*
4. **address-family ipv4**
5. **redistribute bgp** [*as-number*] [**route-policy** *policy-name*]
6. Use the **commit** or **end** command.

### DETAILED STEPS

**Step 1** **configure**

**Example:**

```
RP/0/RSP0/CPU0:router# configure
```

Enters Global Configuration mode.

**Step 2** **router eigrp** *as-number*

**Example:**

```
RP/0/RSP0/CPU0:router(config)# router eigrp 24
```

Enters EIGRP configuration mode allowing you to configure the EIGRP routing process.

**Step 3** `vrf vrf-name`

**Example:**

```
RP/0/RSP0/CPU0:router(config-eigrp)# vrf vrf_1
```

Configures a VRF instance and enters VRF configuration mode for EIGRP routing.

**Step 4** `address-family ipv4`

**Example:**

```
RP/0/RSP0/CPU0:router(config-eigrp-vrf)# address family ipv4
```

Enters VRF address family configuration mode for the IPv4 address family.

**Step 5** `redistribute bgp [as-number] [route-policy policy-name]`

**Example:**

```
RP/0/RSP0/CPU0:router(config-eigrp-vrf-af)# redistribute bgp 24 route-policy policy_A
```

Causes Border Gateway Protocol (BGP) routes to be redistributed into EIGRP.

**Step 6** Use the **commit** or **end** command.

**commit** - Saves the configuration changes and remains within the configuration session.

**end** - Prompts user to take one of these actions:

- **Yes** - Saves configuration changes and exits the configuration session.
- **No** - Exits the configuration session without committing the configuration changes.
- **Cancel** - Remains in the configuration mode, without committing the configuration changes.

## Providing VPN Connectivity Across Multiple Autonomous Systems with MPLS VPN Inter-AS with ASBRs Exchanging IPv4 Routes and MPLS Labels



---

**Note** This section is not applicable to Inter-AS over IP tunnels.

---

This section contains instructions for the following tasks:

## Configuring ASBRs to Exchange IPv4 Routes and MPLS Labels

Perform this task to configure the autonomous system boundary routers (ASBRs) to exchange IPv4 routes and MPLS labels.

### SUMMARY STEPS

1. **configure**
2. **router bgp** *autonomous-system-number*
3. **address-family ipv4 unicast**
4. **allocate-label all**
5. **neighbor** *ip-address*
6. **remote-as** *autonomous-system-number*
7. **address-family ipv4 labeled-unicast**
8. **route-policy** *route-policy-name* **in**
9. **route-policy** *route-policy-name* **out**
10. Use the **commit** or **end** command.

### DETAILED STEPS

---

#### Step 1 **configure**

**Example:**

```
RP/0/RSP0/CPU0:router# configure
```

Enters Global Configuration mode.

#### Step 2 **router bgp** *autonomous-system-number*

**Example:**

```
RP/0/RSP0/CPU0:router(config)# router bgp 120
RP/0/RSP0/CPU0:router(config-bgp)#
```

Enters Border Gateway Protocol (BGP) configuration mode allowing you to configure the BGP routing process.

#### Step 3 **address-family ipv4 unicast**

**Example:**

```
RP/0/RSP0/CPU0:router(config-bgp)# address-family ipv4 unicast
RP/0/RSP0/CPU0:router(config-bgp-af)#
```

Enters global address family configuration mode for the IPv4 unicast address family.

#### Step 4 **allocate-label all**

**Example:**

```
RP/0/CPU0:router(config-bgp-af)# allocate-label all
```

Allocates the MPLS labels for a specific IPv4 unicast or VPN routing and forwarding (VRF) IPv4 unicast routes so that the BGP router can send labels with BGP routes to a neighboring router that is configured for a labeled-unicast session.

**Step 5** `neighbor ip-address`

**Example:**

```
RP/0/RSP0/CPU0:router(config-bgp-af)# neighbor 172.168.40.24
RP/0/RSP0/CPU0:router(config-bgp-nbr)#
```

Places the router in neighbor configuration mode for BGP routing and configures the neighbor IP address 172.168.40.24 as a BGP peer.

**Step 6** `remote-as autonomous-system-number`

**Example:**

```
RP/0/RSP0/CPU0:router(config-bgp-nbr)# remote-as 2002
```

Creates a neighbor and assigns it a remote autonomous system number.

**Step 7** `address-family ipv4 labeled-unicast`

**Example:**

```
RP/0/RSP0/CPU0:router(config-bgp-nbr)# address-family ipv4 labeled-unicast
RP/0/RSP0/CPU0:router(config-bgp-nbr-af)
```

Enters neighbor address family configuration mode for the IPv4 labeled-unicast address family.

**Step 8** `route-policy route-policy-name in`

**Example:**

```
RP/0/RSP0/CPU0:router(config-bgp-nbr-af)# route-policy pass-all in
```

Applies a routing policy to updates that are received from a BGP neighbor.

- Use the *route-policy-name* argument to define the name of the of route policy. The example shows that the route policy name is defined as pass-all.
- Use the **in** keyword to define the policy for inbound routes.

**Step 9** `route-policy route-policy-name out`

**Example:**

```
RP/0/RSP0/CPU0:router(config-bgp-nbr-af)# route-policy pass-all out
```

Applies a routing policy to updates that are sent to a BGP neighbor.

- Use the *route-policy-name* argument to define the name of the of route policy. The example shows that the route policy name is defined as pass-all.
- Use the **out** keyword to define the policy for outbound routes.

**Step 10** Use the **commit** or **end** command.

**commit** - Saves the configuration changes and remains within the configuration session.

**end** - Prompts user to take one of these actions:

- **Yes** - Saves configuration changes and exits the configuration session.
- **No** - Exits the configuration session without committing the configuration changes.
- **Cancel** - Remains in the configuration mode, without committing the configuration changes.

---

## Configuring the Route Reflectors to Exchange VPN-IPv4 Routes

Perform this task to enable the route reflectors to exchange VPN-IPv4 routes by using multihop. This task specifies that the next-hop information and the VPN label are to be preserved across the autonomous system.

### SUMMARY STEPS

1. **configure**
2. **router bgp** *autonomous-system-number*
3. **neighbor** *ip-address*
4. **remote-as** *autonomous-system-number*
5. **ebgp-multihop** [*tth-value*]
6. **update-source** *type interface-path-id*
7. **address-family vpnv4 unicast**
8. **route-policy** *route-policy-name* **in**
9. **route-policy** *route-policy-name* **out**
10. **next-hop-unchanged**
11. Use the **commit** or **end** command.

### DETAILED STEPS

---

**Step 1** **configure**

**Example:**

```
RP/0/RSP0/CPU0:router# configure
```

Enters Global Configuration mode.

**Step 2** **router bgp** *autonomous-system-number*

**Example:**

```
RP/0/RSP0/CPU0:router(config)# router bgp 120
RP/0/RSP0/CPU0:router(config-bgp)#
```

Enters Border Gateway Protocol (BGP) configuration mode allowing you to configure the BGP routing process.

**Step 3** **neighbor** *ip-address*

**Example:**

```
RP/0/RSP0/CPU0:router(config-bgp)# neighbor 172.168.40.24
RP/0/RSP0/CPU0:router(config-bgp-nbr)#
```

Places the router in neighbor configuration mode for BGP routing and configures the neighbor IP address 172.168.40.24 as a BGP peer.

**Step 4** **remote-as** *autonomous-system-number*

**Example:**

```
RP/0/RSP0/CPU0:router(config-bgp-nbr)# remote-as 2002
```

Creates a neighbor and assigns it a remote autonomous system number.

**Step 5** **ebgp-multihop** [*ttl-value*]

**Example:**

```
RP/0/RSP0/CPU0:router(config-bgp-nbr)# ebgp-multihop
```

Enables multihop peerings with external BGP neighbors.

**Step 6** **update-source** *type interface-path-id*

**Example:**

```
RP/0/RSP0/CPU0:router(config-bgp-nbr)# update-source loopback0
```

Allows BGP sessions to use the primary IP address from a particular interface as the local address.

**Step 7** **address-family** *vpn4 unicast*

**Example:**

```
RP/0/RSP0/CPU0:router(config-bgp-nbr)# address-family vpn4 unicast
RP/0/RSP0/CPU0:router(config-bgp-nbr-af)#
```

Configures VPNv4 address family.

**Step 8** **route-policy** *route-policy-name in*

**Example:**

```
RP/0/RSP0/CPU0:router(config-bgp-nbr-af)# route-policy pass-all in
```

Applies a routing policy to updates that are received from a BGP neighbor.

- Use the *route-policy-name* argument to define the name of the of route policy. The example shows that the route policy name is defined as pass-all.
- Use the **in** keyword to define the policy for inbound routes.

**Step 9** **route-policy** *route-policy-name out*

**Example:**

```
RP/0/RSP0/CPU0:router(config-bgp-nbr-af)# route-policy pass-all out
```

Applies a routing policy to updates that are sent to a BGP neighbor.

- Use the *route-policy-name* argument to define the name of the of route policy. The example shows that the route policy name is defined as pass-all.
- Use the **out** keyword to define the policy for outbound routes.

#### Step 10 **next-hop-unchanged**

##### Example:

```
RP/0/RSP0/CPU0:router(config-bgp-nbr-af)# next-hop-unchanged
```

Disables overwriting of the next hop before advertising to external Border Gateway Protocol (eBGP) peers.

#### Step 11 Use the **commit** or **end** command.

**commit** - Saves the configuration changes and remains within the configuration session.

**end** - Prompts user to take one of these actions:

- **Yes** - Saves configuration changes and exits the configuration session.
- **No** - Exits the configuration session without committing the configuration changes.
- **Cancel** - Remains in the configuration mode, without committing the configuration changes.

## Configuring the Route Reflector to Reflect Remote Routes in its AS

Perform this task to enable the route reflector (RR) to reflect the IPv4 routes and labels learned by the autonomous system boundary router (ASBR) to the provider edge (PE) routers in the autonomous system. This task is accomplished by making the ASBR and PE route reflector clients of the RR.

### SUMMARY STEPS

1. **configure**
2. **router bgp** *autonomous-system-number*
3. **address-family ipv4 unicast**
4. **allocate-label all**
5. **neighbor** *ip-address*
6. **remote-as** *autonomous-system-number*
7. **update-source** *type interface-path-id*
8. **address-family ipv4 labeled-unicast**
9. **route-reflector-client**
10. **neighbor** *ip-address*
11. **remote-as** *autonomous-system-number*
12. **update-source** *type interface-path-id*
13. **address-family ipv4 labeled-unicast**
14. **route-reflector-client**
15. Use the **commit** or **end** command.

## DETAILED STEPS

---

**Step 1**      **configure****Example:**

```
RP/0/RSP0/CPU0:router# configure
```

Enters Global Configuration mode.

**Step 2**      **router bgp *autonomous-system-number*****Example:**

```
RP/0/RSP0/CPU0:router(config)# router bgp 120
```

Enters Border Gateway Protocol (BGP) configuration mode allowing you to configure the BGP routing process.

**Step 3**      **address-family ipv4 unicast****Example:**

```
RP/0/RSP0/CPU0:router(config-bgp)# address-family ipv4 unicast
RP/0/RSP0/CPU0:router(config-bgp-af)#
```

Enters global address family configuration mode for the IPv4 unicast address family.

**Step 4**      **allocate-label all****Example:**

```
RP/0/RSP0/CPU0:router(config-bgp-af)# allocate-label all
```

Allocates the MPLS labels for a specific IPv4 unicast or VPN routing and forwarding (VRF) IPv4 unicast routes so that the BGP router can send labels with BGP routes to a neighboring router that is configured for a labeled-unicast session.

**Step 5**      **neighbor *ip-address*****Example:**

```
RP/0/RSP0/CPU0:router(config-bgp-af)# neighbor 172.168.40.24
RP/0/RSP0/CPU0:router(config-bgp-nbr)#
```

Places the router in neighbor configuration mode for BGP routing and configures the neighbor IP address 172.168.40.24 as an ASBR eBGP peer.

**Step 6**      **remote-as *autonomous-system-number*****Example:**

```
RP/0/RSP0/CPU0:router(config-bgp-nbr)# remote-as 2002
```



Creates a neighbor and assigns it a remote autonomous system number.

**Step 7**      **update-source** *type interface-path-id*

**Example:**

```
RP/0/RSP0/CPU0:router(config-bgp-nbr)# update-source loopback0
```

Allows BGP sessions to use the primary IP address from a particular interface as the local address.

**Step 8**      **address-family ipv4 labeled-unicast**

**Example:**

```
RP/0/RSP0/CPU0:router(config-bgp-nbr)# address-family ipv4 labeled-unicast
RP/0/RSP0/CPU0:router(config-bgp-nbr-af)#
```

Enters neighbor address family configuration mode for the IPv4 labeled-unicast address family.

**Step 9**      **route-reflector-client**

**Example:**

```
RP/0/RSP0/CPU0:router(config-bgp-nbr-af)# route-reflector-client
```

Configures the router as a BGP route reflector and neighbor 172.168.40.24 as its client.

**Step 10**     **neighbor ip-address**

**Example:**

```
RP/0/RSP0/CPU0:router(config-bgp-nbr-af)# neighbor 10.40.25.2
RP/0/RSP0/CPU0:router(config-bgp-nbr)#
```

Places the router in neighbor configuration mode for BGP routing and configures the neighbor IP address .40.25.2 as an VPNv4 iBGP peer.

**Step 11**     **remote-as** *autonomous-system-number*

**Example:**

```
RP/0/RSP0/CPU0:router(config-bgp-nbr)# remote-as 2002
```

Creates a neighbor and assigns it a remote autonomous system number.

**Step 12**     **update-source** *type interface-path-id*

**Example:**

```
RP/0/RSP0/CPU0:router(config-bgp-nbr)# update-source loopback0
```

Allows BGP sessions to use the primary IP address from a particular interface as the local address.

**Step 13**     **address-family ipv4 labeled-unicast**

**Example:**

```
RP/0/RSP0/CPU0:router(config-bgp-nbr)# address-family ipv4 labeled-unicast
RP/0/RSP0/CPU0:router(config-bgp-nbr-af)#
```

Enters neighbor address family configuration mode for the IPv4 labeled-unicast address family.

**Step 14 route-reflector-client****Example:**

```
RP/0/RSP0/CPU0:router(config-bgp-nbr-af)# route-reflector-client
```

Configures the neighbor as a route reflector client.

**Step 15** Use the **commit** or **end** command.

**commit** - Saves the configuration changes and remains within the configuration session.

**end** - Prompts user to take one of these actions:

- **Yes** - Saves configuration changes and exits the configuration session.
- **No** - Exits the configuration session without committing the configuration changes.
- **Cancel** - Remains in the configuration mode, without committing the configuration changes.

## Providing VPN Connectivity Across Multiple Autonomous Systems with MPLS VPN Inter-AS with ASBRs Exchanging VPN-IPv4 Addresses

This section contains instructions for the following tasks:

### Configuring the ASBRs to Exchange VPN-IPv4 Addresses for IP Tunnels

Perform this task to configure an external Border Gateway Protocol (eBGP) autonomous system boundary router (ASBR) to exchange VPN-IPv4 routes with another autonomous system.

#### SUMMARY STEPS

1. **configure**
2. **router bgp** *autonomous-system-number*
3. **address-family** { **ipv4 tunnel** }
4. **address-family** { **vpn4 unicast** }
5. **neighbor** *ip-address*
6. **remote-as** *autonomous-system-number*
7. **address-family** { **vpn4 unicast** }
8. **route-policy** *route-policy-name* { **in** }
9. **route-policy** *route-policy-name* { **out** }
10. **neighbor** *ip-address*
11. **remote-as** *autonomous-system-number*
12. **update-source** *type interface-path-id*

13. **address-family { ipv4 tunnel }**
14. **address-family { vpnv4 unicast }**
15. Use the **commit** or **end** command.

## DETAILED STEPS

---

### Step 1 **configure**

**Example:**

```
RP/0/RSP0/CPU0:router# configure
```

Enters the Global Configuration mode.

### Step 2 **router bgp *autonomous-system-number***

**Example:**

```
RP/0/RSP0/CPU0:router(config)# router bgp 120
RP/0/RSP0/CPU0:router(config-bgp)#
```

Enters Border Gateway Protocol (BGP) configuration mode allowing you to configure the BGP routing process.

### Step 3 **address-family { ipv4 tunnel }**

**Example:**

```
RP/0/RSP0/CPU0:router(config-bgp)# address-family ipv4 tunnel
RP/0/RSP0/CPU0:router(config-bgp-af)#
```

Configures IPv4 tunnel address family.

### Step 4 **address-family { vpnv4 unicast }**

**Example:**

```
RP/0/RSP0/CPU0:router(config-bgp-af)# address-family vpnv4 unicast
```

Configures VPNv4 address family.

### Step 5 **neighbor *ip-address***

**Example:**

```
RP/0/RSP0/CPU0:router(config-bgp-af)# neighbor 172.168.40.24
RP/0/RSP0/CPU0:router(config-bgp-nbr)#
```

Places the router in neighbor configuration mode for BGP routing and configures the neighbor IP address 172.168.40.24 as an ASBR eBGP peer.

### Step 6 **remote-as *autonomous-system-number***

**Example:**

```
RP/0/RSP0/CPU0:router(config-bgp-nbr)# remote-as 2002
```

Creates a neighbor and assigns it a remote autonomous system number.

### Step 7 **address-family { vpnv4 unicast }**

**Example:**

```
RP/0/RSP0/CPU0:router(config-bgp-nbr)# address-family vpnv4 unicast
RP/0/RSP0/CPU0:router(config-bgp-nbr-af)#
```

Configures VPNv4 address family.

**Step 8** **route-policy** *route-policy-name* { **in** }**Example:**

```
RP/0/RSP0/CPU0:router(config-bgp-nbr-af)# route-policy pass-all in
```

Applies a routing policy to updates that are received from a BGP neighbor.

- Use the *route-policy-name* argument to define the name of the of route policy. The example shows that the route policy name is defined as pass-all.
- Use the **in** keyword to define the policy for inbound routes.

**Step 9** **route-policy** *route-policy-name* { **out** }**Example:**

```
RP/0/RSP0/CPU0:router(config-bgp-nbr-af)# route-policy pass-all out
```

Applies a routing policy to updates that are sent from a BGP neighbor.

- Use the *route-policy-name* argument to define the name of the route policy. The example shows that the route policy name is defined as pass-all.
- Use the **out** keyword to define the policy for outbound routes.

**Step 10** **neighbor** *ip-address***Example:**

```
RP/0/RSP0/CPU0:router(config-bgp-nbr-af)# neighbor 175.40.25.2
RP/0/RSP0/CPU0:router(config-bgp-nbr)#
```

Places the router in neighbor configuration mode for BGP routing and configures the neighbor IP address 175.40.25.2 as an VPNv4 iBGP peer.

**Step 11** **remote-as** *autonomous-system-number***Example:**

```
RP/0/RSP0/CPU0:router(config-bgp-nbr)# remote-as 2002
```

Creates a neighbor and assigns it a remote autonomous system number.

**Step 12** **update-source** *type interface-path-id***Example:**

```
RP/0/RSP0/CPU0:router(config-bgp-nbr)# update-source loopback0
```

Allows BGP sessions to use the primary IP address from a particular interface as the local address.

**Step 13** **address-family** { **ipv4 tunnel** }**Example:**

```
RP/0/RSP0/CPU0:router(config-bgp-nbr)# address-family ipv4 tunnel
RP/0/RSP0/CPU0:router(config-bgp-nbr-af)#
```

Configures IPv4 tunnel address family.

**Step 14** **address-family { vpnv4 unicast }**

**Example:**

```
RP/0/RSP0/CPU0:router(config-bgp-nbr-af)# address-family vpv4 unicast
```

Configures VPNv4 address family.

**Step 15** Use the **commit** or **end** command.

**commit** - Saves the configuration changes and remains within the configuration session.

**end** - Prompts user to take one of these actions:

- **Yes** - Saves configuration changes and exits the configuration session.
- **No** - Exits the configuration session without committing the configuration changes.
- **Cancel** - Remains in the configuration mode, without committing the configuration changes.

---

## Configuring a Static Route to an ASBR Peer

Perform this task to configure a static route to an ASBR peer.

### SUMMARY STEPS

1. **configure**
2. **router static**
3. **address-family ipv4 unicast**
4. **A.B.C.D/length next-hop**
5. Use the **commit** or **end** command.

### DETAILED STEPS

---

**Step 1** **configure**

**Example:**

```
RP/0/RSP0/CPU0:router# configure
```

Enters the Global Configuration mode.

**Step 2** **router static**

**Example:**

```
RP/0/RSP0/CPU0:router(config)# router static
RP/0/RSP0/CPU0:router(config-static)#
```

Enters router static configuration mode.

**Step 3** address-family ipv4 unicast**Example:**

```
RP/0/RSP0/CPU0:router(config-static)# address-family ipv4 unicast
RP/0/RSP0/CPU0:router(config-static-afi)#
```

Enables an IPv4 address family.

**Step 4** A.B.C.D/length next-hop**Example:**

```
RP/0/RSP0/CPU0:router(config-static-afi)# 10.10.10.10/32 10.9.9.9
```

Enters the address of the destination router (including IPv4 subnet mask).

**Step 5** Use the **commit** or **end** command.

**commit** - Saves the configuration changes and remains within the configuration session.

**end** - Prompts user to take one of these actions:

- **Yes** - Saves configuration changes and exits the configuration session.
- **No** - Exits the configuration session without committing the configuration changes.
- **Cancel** - Remains in the configuration mode, without committing the configuration changes.

## Configuring EBGW Routing to Exchange VPN Routes Between Subautonomous Systems in a Confederation

Perform this task to configure external Border Gateway Protocol (eBGW) routing to exchange VPN routes between subautonomous systems in a confederation.

**Note**

To ensure that host routes for VPN-IPv4 eBGW neighbors are propagated (by means of the Interior Gateway Protocol [IGP]) to other routers and PE routers, specify the **redistribute connected** command in the IGP configuration portion of the confederation eBGW (CEBGW) router. If you are using Open Shortest Path First (OSPF), make sure that the OSPF process is not enabled on the CEBGW interface in which the “redistribute connected” subnet exists.

**SUMMARY STEPS**

1. **configure**
2. **router bgp** *autonomous-system-number*
3. **bgp confederation peers** *peer autonomous-system-number*
4. **bgp confederation identifier** *autonomous-system-number*
5. **address-family vpnv4 unicast**
6. **neighbor** *ip-address*
7. **remote-as** *autonomous-system-number*

8. **address-family vpnv4 unicast**
9. **route-policy route-policy-name in**
10. **route-policy route-policy-name out**
11. **next-hop-self**
12. Use the **commit** or **end** command.

## DETAILED STEPS

---

### Step 1 **configure**

#### Example:

```
RP/0/RSP0/CPU0:router# configure
```

Enters Global Configuration mode.

### Step 2 **router bgp autonomous-system-number**

#### Example:

```
RP/0/RSP0/CPU0:router(config)# router bgp 120
RP/0/RSP0/CPU0:router(config-bgp)#
```

Enters BGP configuration mode allowing you to configure the BGP routing process.

### Step 3 **bgp confederation peers peer autonomous-system-number**

#### Example:

```
RP/0/RSP0/CPU0:router(config-bgp)# bgp confederation peers 8
```

Configures the peer autonomous system number that belongs to the confederation.

### Step 4 **bgp confederation identifier autonomous-system-number**

#### Example:

```
RP/0/RSP0/CPU0:router(config-bgp)# bgp confederation identifier 5
```

Specifies the autonomous system number for the confederation ID.

### Step 5 **address-family vpnv4 unicast**

#### Example:

```
RP/0/RSP0/CPU0:router(config-bgp)# address-family vpnv4 unicast
RP/0/RSP0/CPU0:router(config-bgp-af)#
```

Configures VPNv4 address family.

### Step 6 **neighbor ip-address**

#### Example:

```
RP/0/RSP0/CPU0:router(config-bgp-af)# neighbor 10.168.40.24
RP/0/RSP0/CPU0:router(config-bgp-nbr)#
```

Places the router in neighbor configuration mode for BGP routing and configures the neighbor IP address 10.168.40.24 as a BGP peer.

**Step 7** **remote-as** *autonomous-system-number*

**Example:**

```
RP/0/RSP0/CPU0:router(config-bgp-nbr)# remote-as 2002
```

Creates a neighbor and assigns it a remote autonomous system number.

**Step 8** **address-family vpnv4 unicast**

**Example:**

```
RP/0/RSP0/CPU0:router(config-bgp-nbr)# address-family vpnv4 unicast
RP/0/RSP0/CPU0:router(config-bgp-nbr-af)#
```

Configures VPNv4 address family.

**Step 9** **route-policy** *route-policy-name in*

**Example:**

```
RP/0/RSP0/CPU0:router(config-bgp-nbr-af)# route-policy In-Ipv4 in
```

Applies a routing policy to updates received from a BGP neighbor.

**Step 10** **route-policy** *route-policy-name out*

**Example:**

```
RP/0/RSP0/CPU0:router(config-bgp-nbr-af)# route-policy Out-Ipv4 out
```

Applies a routing policy to updates advertised to a BGP neighbor.

**Step 11** **next-hop-self**

**Example:**

```
RP/0/RSP0/CPU0:router(config-bgp-nbr-af)# next-hop-self
```

Disables next-hop calculation and let you insert your own address in the next-hop field of BGP updates.

**Step 12** Use the **commit** or **end** command.

**commit** - Saves the configuration changes and remains within the configuration session.

**end** - Prompts user to take one of these actions:

- **Yes** - Saves configuration changes and exits the configuration session.



- **No** - Exits the configuration session without committing the configuration changes.
- **Cancel** - Remains in the configuration mode, without committing the configuration changes.

---

## Configuring MPLS Forwarding for ASBR Confederations

Perform this task to configure MPLS forwarding for autonomous system boundary router (ASBR) confederations (in BGP) on a specified interface.



---

**Note** This configuration adds the implicit NULL rewrite corresponding to the peer associated with the interface, which is required to prevent BGP from automatically installing rewrites by LDP (in multihop instances).

---

### SUMMARY STEPS

1. **configure**
2. **router bgp** *as-number*
3. **mpls activate**
4. **interface** *type interface-path-id*
5. Use the **commit** or **end** command.

### DETAILED STEPS

---

#### Step 1 **configure**

**Example:**

```
RP/0/RSP0/CPU0:router# configure
```

Enters Global Configuration mode.

#### Step 2 **router bgp** *as-number*

**Example:**

```
RP/0/RSP0/CPU0:router(config)# router bgp 120
RP/0/RSP0/CPU0:router(config-bgp)
```

Enters BGP configuration mode allowing you to configure the BGP routing process.

#### Step 3 **mpls activate**

**Example:**

```
RP/0/RSP0/CPU0:router(config-bgp)# mpls activate
RP/0/RSP0/CPU0:router(config-bgp-mpls)#
```

Enters BGP MPLS activate configuration mode.

**Step 4** `interface type interface-path-id`

**Example:**

```
RP/0/RSP0/CPU0:router(config-bgp-mpls)# interface GigabitEthernet 0/3/0/0
```

Enables MPLS on the interface.

**Step 5** Use the **commit** or **end** command.

**commit** - Saves the configuration changes and remains within the configuration session.

**end** - Prompts user to take one of these actions:

- **Yes** - Saves configuration changes and exits the configuration session.
- **No** - Exits the configuration session without committing the configuration changes.
- **Cancel** - Remains in the configuration mode, without committing the configuration changes.

---

## Configuring a Static Route to an ASBR Confederation Peer

Perform this task to configure a static route to an Inter-AS confederation peer. For more detailed information, see [“Configuring a Static Route to a Peer”](#) section.

### SUMMARY STEPS

1. **configure**
2. **router static**
3. **address-family ipv4 unicast**
4. **A.B.C.D/length next-hop**
5. Use the **commit** or **end** command.

### DETAILED STEPS

**Step 1** `configure`

**Example:**

```
RP/0/RSP0/CPU0:router# configure
```

Enters Global Configuration mode.

**Step 2** `router static`

**Example:**

```
RP/0/RSP0/CPU0:router(config)# router static
RP/0/RSP0/CPU0:router(config-static)#
```

Enters router static configuration mode.

**Step 3** `address-family ipv4 unicast`

**Example:**

```
RP/0/RSP0/CPU0:router(config-static)# address-family ipv4 unicast
RP/0/RSP0/CPU0:router(config-static-afi)#
```

Enables an IPv4 address family.

**Step 4** **A.B.C.D/length** *next-hop***Example:**

```
RP/0/RSP0/CPU0:router(config-static-afi)# 10.10.10.10/32 10.9.9.9
```

Enters the address of the destination router (including IPv4 subnet mask).

**Step 5** Use the **commit** or **end** command.

**commit** - Saves the configuration changes and remains within the configuration session.

**end** - Prompts user to take one of these actions:

- **Yes** - Saves configuration changes and exits the configuration session.
- **No** - Exits the configuration session without committing the configuration changes.
- **Cancel** - Remains in the configuration mode, without committing the configuration changes.

## Configuring Carrier Supporting Carrier

Perform the tasks in this section to configure Carrier Supporting Carrier (CSC):

### Identifying the Carrier Supporting Carrier Topology

Before you configure the MPLS VPN CSC with BGP, you must identify both the backbone and customer carrier topology.



**Note** You can connect multiple CSC-CE routers to the same PE, or you can connect a single CSC-CE router to multiple CSC-PEs using more than one CSC-CE interface to provide redundancy and multiple path support in a CSC topology.

Perform this task to identify the carrier supporting carrier topology.

#### SUMMARY STEPS

1. Identify the type of customer carrier, ISP, or MPLS VPN service provider.
2. Identify the CE routers.
3. Identify the customer carrier core router configuration.
4. Identify the customer carrier edge (CSC-CE) routers.
5. Identify the backbone carrier router configuration.

## DETAILED STEPS

- 
- Step 1** Identify the type of customer carrier, ISP, or MPLS VPN service provider.  
Sets up requirements for configuration of carrier supporting carrier network.
- Step 2** Identify the CE routers.  
Sets up requirements for configuration of CE to PE connections.
- Step 3** Identify the customer carrier core router configuration.  
Sets up requirements for configuration between core (P) routers and between P routers and edge routers (PE and CSC-CE routers).
- Step 4** Identify the customer carrier edge (CSC-CE) routers.  
Sets up requirements for configuration of CSC-CE to CSC-PE connections.
- Step 5** Identify the backbone carrier router configuration.  
Sets up requirements for configuration between CSC core routers and between CSC core routers and edge routers (CSC-CE and CSC-PE routers).
- 

## Configuring the Backbone Carrier Core

Configuring the backbone carrier core requires setting up connectivity and routing functions for the CSC core and the CSC-PE routers. To do so, you must complete the following high-level tasks:

- Verify IP connectivity in the CSC core.
- Verify LDP configuration in the CSC core.



---

**Note** This task is not applicable to CSC over IP tunnels.

---

- Configure VRFs for CSC-PE routers.
- Configure multiprotocol BGP for VPN connectivity in the backbone carrier.

## Configuring the CSC-PE and CSC-CE Routers

Perform the following tasks to configure links between a CSC-PE router and the carrier CSC-CE router for an MPLS VPN CSC network that uses BGP to distribute routes and MPLS labels:

The following figure shows the configuration for the peering with directly connected interfaces between CSC-PE and CSC-CE routers. This configuration is used as the example in the tasks that follow.

**Figure 6: Configuration for Peering with Directly Connected Interfaces Between CSC-PE and CSC-CE Routers**



## Configuring a Static Route to a Peer

Perform this task to configure a static route to an Inter-AS or CSC-CE peer.

When you configure an Inter-AS or CSC peer, BGP allocates a label for a /32 route to that peer and performs a NULL label rewrite. When forwarding a labeled packet to the peer, the router removes the top label from the label stack; however, in such an instance, BGP expects a /32 route to the peer. This task ensures that there is, in fact, a /32 route to the peer.

Please be aware of the following facts before performing this task:

- A /32 route is not required to establish BGP peering. A route using a shorter prefix length will also work.
- A shorter prefix length route is not associated with the allocated label; even though the BGP session comes up between the peers, without the static route, forwarding will not work.



---

**Note** To configure a static route on a CSC-PE, you must configure the router under the VRF (as noted in the detailed steps).

---

### SUMMARY STEPS

1. **configure**
2. **router static**
3. **address-family ipv4 unicast**
4. **A.B.C.D/length** *next-hop*
5. Use the **commit** or **end** command.

### DETAILED STEPS

---

**Step 1**     **configure**

**Example:**

```
RP/0/RSP0/CPU0:router# configure
```

Enters the Global Configuration mode.

**Step 2**     **router static**

**Example:**

```
RP/0/RSP0/CPU0:router(config)# router static
```

Enters router static configuration mode.

**Step 3**     **address-family ipv4 unicast**

**Example:**

```
RP/0/RSP0/CPU0:router(config-static)# address-family ipv4 unicast
```

Enables an IPv4 address family.

**Note** To configure a static route on a CSC-PE, you must first configure the VRF using the **vrf** command before **address-family**.

**Step 4** **A.B.C.D/length next-hop**

**Example:**

```
RP/0/RSP0/CPU0:router(config-static-afi)# 10.10.10.10/32 10.9.9.9
```

Enters the address of the destination router (including IPv4 subnet mask).

**Step 5** Use the **commit** or **end** command.

**commit** - Saves the configuration changes and remains within the configuration session.

**end** - Prompts user to take one of these actions:

- **Yes** - Saves configuration changes and exits the configuration session.
- **No** - Exits the configuration session without committing the configuration changes.
- **Cancel** - Remains in the configuration mode, without committing the configuration changes.

## Verifying the MPLS Layer 3 VPN Configuration

Perform this task to verify the MPLS Layer 3 VPN configuration.

### SUMMARY STEPS

1. **show running-config router bgp** *as-number vrf vrf-name*
2. **show running-config routes**
3. **show ospf vrf** *vrf-name database*
4. **show running-config router bgp** *as-number vrf vrf-name neighbor ip-address*
5. **show bgp vrf** *vrf-name summary*
6. **show bgp vrf** *vrf-name neighbors ip-address*
7. **show bgp vrf** *vrf-name*
8. **show route vrf** *vrf-name ip-address*
9. **show bgp vpn unicast summary**
10. **show running-config router isis**
11. **show running-config mpls**
12. **show isis adjacency**
13. **show mpls ldp forwarding**
14. **show bgp vpnv4 unicast** or **show bgp vrf** *vrf-name*
15. **show bgp vrf** *vrf-name imported-routes*
16. **show route vrf** *vrf-name ip-address*
17. **show cef vrf** *vrf-name ip-address*
18. **show cef vrf** *vrf-name ip-address location node-id*
19. **show bgp vrf** *vrf-name ip-address*
20. **show ospf vrf** *vrf-name database*

## DETAILED STEPS

---

**Step 1** **show running-config router bgp** *as-number vrf vrf-name*

**Example:**

```
RP/0/RSP0/CPU0:router# show running-config router bgp 3 vrf vrf_A
```

Displays the specified VPN routing and forwarding (VRF) content of the currently running configuration.

**Step 2** **show running-config routes**

**Example:**

```
RP/0/RSP0/CPU0:router# show running-config routes
```

Displays the Open Shortest Path First (OSPF) routes table in the currently running configuration.

**Step 3** **show ospf vrf** *vrf-name database*

**Example:**

```
RP/0/RSP0/CPU0:router# show ospf vrf vrf_A database
```

Displays lists of information related to the OSPF database for a specified VRF.

**Step 4** **show running-config router bgp** *as-number vrf vrf-name neighbor ip-address*

**Example:**

```
RP/0/RSP0/CPU0:router# show running-config router bgp 3 vrf vrf_A neighbor 172.168.40.24
```

Displays the Border Gateway Protocol (BGP) VRF neighbor content of the currently running configuration.

**Step 5** **show bgp vrf** *vrf-name summary*

**Example:**

```
RP/0/RSP0/CPU0:router# show bgp vrf vrf_A summary
```

Displays the status of the specified BGP VRF connections.

**Step 6** **show bgp vrf** *vrf-name neighbors ip-address*

**Example:**

```
RP/0/RSP0/CPU0:router# show bgp vrf vrf_A neighbors 172.168.40.24
```

Displays information about BGP VRF connections to the specified neighbors.

**Step 7** **show bgp vrf** *vrf-name*

**Example:**

```
RP/0/RSP0/CPU0:router# show bgp vrf vrf_A
```

Displays information about a specified BGP VRF.

**Step 8**     **show route vrf vrf-name ip-address**

**Example:**

```
RP/0/RSP0/CPU0:router# show route vrf vrf_A 10.0.0.0
```

Displays the current routes in the Routing Information Base (RIB) for a specified VRF.

**Step 9**     **show bgp vpn unicast summary**

**Example:**

```
RP/0/RSP0/CPU0:router# show bgp vpn unicast summary
```

Displays the status of all BGP VPN unicast connections.

**Step 10**    **show running-config router isis**

**Example:**

```
RP/0/RSP0/CPU0:router# show running-config router isis
```

Displays the Intermediate System-to-Intermediate System (IS-IS) content of the currently running configuration.

**Step 11**    **show running-config mpls**

**Example:**

```
RP/0/RSP0/CPU0:router# show running-config mpls
```

Displays the MPLS content of the currently running-configuration.

**Step 12**    **show isis adjacency**

**Example:**

```
RP/0/RSP0/CPU0:router# show isis adjacency
```

Displays IS-IS adjacency information.

**Step 13**    **show mpls ldp forwarding**

**Example:**

```
RP/0/RSP0/CPU0:router# show mpls ldp forwarding
```

Displays the Label Distribution Protocol (LDP) forwarding state installed in MPLS forwarding.

**Step 14**    **show bgp vpnv4 unicast** or **show bgp vrf vrf-name**



**Example:**

```
RP/0/RSP0/CPU0:router# show bgp vpnv4 unicast
```

Displays entries in the BGP routing table for VPNv4 or VPNv6 unicast addresses.

**Step 15** **show bgp vrf *vrf-name* imported-routes****Example:**

```
RP/0/RSP0/CPU0:router# show bgp vrf vrf_A imported-routes
```

Displays BGP information for routes imported into specified VRF instances.

**Step 16** **show route vrf *vrf-name* ip-address****Example:**

```
RP/0/RSP0/CPU0:router# show route vrf vrf_A 10.0.0.0
```

Displays the current specified VRF routes in the RIB.

**Step 17** **show cef vrf *vrf-name* ip-address****Example:**

```
RP/0/RSP0/CPU0:router# show cef vrf vrf_A 10.0.0.1
```

Displays the IPv4 Cisco Express Forwarding (CEF) table for a specified VRF.

**Step 18** **show cef vrf *vrf-name* ip-address location *node-id*****Example:**

```
RP/0/RSP0/CPU0:router# show cef vrf vrf_A 10.0.0.1 location 0/1/cpu0
```

Displays the IPv4 CEF table for a specified VRF and location.

**Step 19** **show bgp vrf *vrf-name* ip-address****Example:**

```
RP/0/RSP0/CPU0:router# show bgp vrf vrf_A 10.0.0.0
```

Displays entries in the BGP routing table for VRF vrf\_A.

**Step 20** **show ospf vrf *vrf-name* database****Example:**

```
RP/0/RSP0/CPU0:router# show ospf vrf vrf_A database
```

Displays lists of information related to the OSPF database for a specified VRF.

---

## Configuring L3VPN over GRE

Perform the following tasks to configure L3VPN over GRE:

### Creating a GRE Tunnel between Provider Edge Routers

Perform this task to configure a GRE tunnel between provider edge routers.

#### SUMMARY STEPS

1. **configure**
2. **interface tunnel-ip** *number*
3. **ipv4 address** *ipv4-address subnet-mask*
4. **ipv6 address** *ipv6-prefix/prefix-length*
5. **tunnel mode gre ipv4**
6. **tunnel source** *type path-id*
7. **tunnel destination** *ip-address*
8. Use the **commit** or **end** command.

#### DETAILED STEPS

---

##### Step 1 **configure**

###### Example:

```
RP/0/RSP0/CPU0:router# configure
```

Enters the Global Configuration mode.

##### Step 2 **interface tunnel-ip** *number*

###### Example:

```
RP/0/RSP0/CPU0:router(config)# interface tunnel-ip 4000
```

Enters tunnel interface configuration mode.

- *number* is the number associated with the tunnel interface.

##### Step 3 **ipv4 address** *ipv4-address subnet-mask*

###### Example:

```
RP/0/RSP0/CPU0:router(config-if)# ipv4 address 10.1.1.1 255.255.255.0
```

Specifies the IPv4 address and subnet mask for the interface.

- `ipv4-address` specifies the IP address of the interface.
- `subnet-mask` specifies the subnet mask of the interface.

**Step 4** `ipv6 address` *ipv6-prefix/prefix-length***Example:**

```
RP/0/RSP0/CPU0:router(config-if)# ipv6 address 100:1:1:1::1/64
```

Specifies an IPv6 network assigned to the interface.

**Step 5** `tunnel mode gre ipv4`**Example:**

```
RP/0/RSP0/CPU0:router(config-if)# tunnel mode gre ipv4
```

Sets the encapsulation mode of the tunnel interface to GRE.

**Step 6** `tunnel source` *type path-id***Example:**

```
RP/0/RSP0/CPU0:router(config-if)# tunnel source TenGigE0/2/0/1
```

Specifies the source of the tunnel interface.

**Step 7** `tunnel destination` *ip-address***Example:**

```
RP/0/RSP0/CPU0:router(config-if)# tunnel destination 145.12.5.2
```

Defines the tunnel destination.

**Step 8** Use the **commit** or **end** command.

**commit** - Saves the configuration changes and remains within the configuration session.

**end** - Prompts user to take one of these actions:

- **Yes** - Saves configuration changes and exits the configuration session.
- **No** - Exits the configuration session without committing the configuration changes.
- **Cancel** - Remains in the configuration mode, without committing the configuration changes.

---

## Configuring IGP between Provider Edge Routers

Perform this task to configure IGP between provider edge routers.

### SUMMARY STEPS

1. **configure**

2. **router ospf** *process-name*
3. **nsr**
4. **router-id** { *router-id* }
5. **mpls ldp sync**
6. **dead-interval** *seconds*
7. **hello-interval** *seconds*
8. **area** *area-id*
9. **interface tunnel-ip** *number*
10. Use the **commit** or **end** command.

## DETAILED STEPS

### Step 1 **configure**

**Example:**

```
RP/0/RSP0/CPU0:router# configure
```

Enters the Global Configuration mode.

### Step 2 **router ospf** *process-name*

**Example:**

```
RP/0/RSP0/CPU0:router(config)# router ospf 1
```

Enables OSPF routing for the specified routing process and places the router in router configuration mode.

### Step 3 **nsr**

**Example:**

```
RP/0/RSP0/CPU0:router(config-ospf)# nsr
```

Activates BGP NSR.

### Step 4 **router-id** { *router-id* }

**Example:**

```
RP/0/RSP0/CPU0:router(config-ospf)# router-id 1.1.1.1
```

Configures a router ID for the OSPF process.

**Note** We recommend using a stable IP address as the router ID.

### Step 5 **mpls ldp sync**

**Example:**

```
RP/0/RSP0/CPU0:router(config-ospf)# mpls ldp sync
```

Enables MPLS LDP synchronization.

### Step 6 **dead-interval** *seconds*

**Example:**

```
RP/0/RSP0/CPU0:router(config-ospf)# dead-interval 60
```

Sets the time to wait for a hello packet from a neighbor before declaring the neighbor down.

**Step 7** **hello-interval** *seconds***Example:**

```
RP/0/RSP0/CPU0:router(config-ospf)# hello-interval 15
```

Specifies the interval between hello packets that OSPF sends on the interface.

**Step 8** **area** *area-id***Example:**

```
RP/0/RSP0/CPU0:router(config-ospf)# area 0
```

Enters area configuration mode and configures an area for the OSPF process.

**Step 9** **interface tunnel-ip** *number***Example:**

```
RP/0/RSP0/CPU0:router(config-ospf)# interface tunnel-ip 4
```

Enters tunnel interface configuration mode.

- *number* is the number associated with the tunnel interface.

**Step 10** Use the **commit** or **end** command.

**commit** - Saves the configuration changes and remains within the configuration session.

**end** - Prompts user to take one of these actions:

- **Yes** - Saves configuration changes and exits the configuration session.
- **No** - Exits the configuration session without committing the configuration changes.
- **Cancel** - Remains in the configuration mode, without committing the configuration changes.

---

## Configuring LDP/GRE on the Provider Edge Routers

Perform this task to configure LDP/GRE on the provider edge routers.

**SUMMARY STEPS**

1. **configure**
2. **mpls ldp**
3. **router-id** { *router-id* }
4. **discovery hello holdtime** *seconds*
5. **discovery hello interval** *seconds*
6. **nsr**
7. **graceful-restart**

8. **graceful-restart reconnect-timeout** *seconds*
9. **graceful-restart forwarding-state-holdtime** *seconds*
10. **holdtime** *seconds*
11. **neighbor** *ip-address*
12. **interface tunnel-ip** *number*
13. Use the **commit** or **end** command.

## DETAILED STEPS

---

### Step 1 **configure**

**Example:**

```
RP/0/RSP0/CPU0:router# configure
```

Enters the Global Configuration mode.

### Step 2 **mpls ldp**

**Example:**

```
RP/0/RSP0/CPU0:router(config)# mpls ldp
```

Enables MPLS LDP configuration mode.

### Step 3 **router-id** { *router-id* }

**Example:**

```
RP/0/RSP0/CPU0:router(config-ldp)# router-id 1.1.1.1
```

Configures a router ID for the OSPF process.

**Note** We recommend using a stable IP address as the router ID.

### Step 4 **discovery hello holdtime** *seconds*

**Example:**

```
RP/0/RSP0/CPU0:router(config-ldp)# discovery hello holdtime 40
```

Defines the period of time a discovered LDP neighbor is remembered without receipt of an LDP Hello message from the neighbor.

**Note** We recommend using a stable IP address as the router ID.

### Step 5 **discovery hello interval** *seconds*

**Example:**

```
RP/0/RSP0/CPU0:router(config-ldp)# discovery hello holdtime 20
```

Defines the period of time between the sending of consecutive Hello messages.

### Step 6 **nsr**

**Example:**

```
RP/0/RSP0/CPU0:router(config-ldp)# nsr
```

Activates BGP NSR.

**Step 7**      **graceful-restart**

**Example:**

```
RP/0/RSP0/CPU0:router(config-ldp)# graceful-restart
```

Enables graceful restart on the router.

**Step 8**      **graceful-restart reconnect-timeout** *seconds*

**Example:**

```
RP/0/RSP0/CPU0:router(config-ldp)# graceful-restart reconnect-timeout 180
```

Defines the time for which the neighbor should wait for a reconnection if the LDP session is lost.

**Step 9**      **graceful-restart forwarding-state-holdtime** *seconds*

**Example:**

```
RP/0/RSP0/CPU0:router(config-ldp)# graceful-restart forwarding-state-holdtime 300
```

Defines the time that the neighbor should retain the MPLS forwarding state during a recovery.

**Step 10**     **holdtime** *seconds*

**Example:**

```
RP/0/RSP0/CPU0:router(config-ldp)# holdtime 90
```

Configures the hold time for an interface.

**Step 11**     **neighbor** *ip-address*

**Example:**

```
RP/0/RSP0/CPU0:router(config-ldp)# neighbor 10.1.1.0
```

Defines a neighboring router.

**Step 12**     **interface tunnel-ip** *number*

**Example:**

```
RP/0/RSP0/CPU0:router(config-ldp)# interface tunnel-ip 4
```

Enters tunnel interface configuration mode.

- *number* is the number associated with the tunnel interface.

**Step 13**     Use the **commit** or **end** command.

**commit** - Saves the configuration changes and remains within the configuration session.

**end** - Prompts user to take one of these actions:

- **Yes** - Saves configuration changes and exits the configuration session.

- **No** - Exits the configuration session without committing the configuration changes.
- **Cancel** - Remains in the configuration mode, without committing the configuration changes.

## Configuring L3VPN

Perform this task to configure L3VPN.

### SUMMARY STEPS

1. **configure**
2. **vrf** *vrf-name*
3. **address-family** { **ipv4** | **ipv6** } **unicast**
4. **import route-target** [ *as-number:nn* | *ip-address:nn* ]
5. **export route-target** [ *as-number:nn* | *ip-address:nn* ]
6. **interface** *type interface-path-id*
7. **vrf** *vrf-name*
8. **ipv4 address** *ipv4-address subnet-mask*
9. **dot1q native vlan** *vlan-id*
10. **router bgp** *as-number*
11. **nsr**
12. **bgp router-id** *ip-address*
13. **address-family** { **vpn4** | **vpn6** } **unicast**
14. **neighbor** *ip-address*
15. **remote-as** *as-number*
16. **update-source** *type interface-path-id*
17. **address-family** { **vpn4** | **vpn6** } **unicast**
18. **route-policy** *route-policy-name* **in**
19. **route-policy** *route-policy-name* **out**
20. **vrf** *vrf-name*
21. **rd** { *as-number:nn* | *ip-address:nn* | **auto** }
22. **address-family** { **ipv4** | **ipv6** } **unicast**
23. **redistribute connected** [ *metric metric-value* ] [ *route-policy route-policy-name* ]
24. **redistribute static** [ *metric metric-value* ] [ *route-policy route-policy-name* ]
25. **neighbor** *ip-address*
26. **remote-as** *as-number*
27. **ebg-multihop** *ttl-value*
28. **address-family** { **ipv4** | **ipv6** } **unicast**
29. **route-policy** *route-policy-name* **in**
30. **route-policy** *route-policy-name* **out**
31. Use the **commit** or **end** command.

### DETAILED STEPS

**Step 1** **configure**



**Example:**

```
RP/0/RSP0/CPU0:router# configure
```

Enters the Global Configuration mode.

**Step 2** `vrf vrf-name`**Example:**

```
RP/0/RSP0/CPU0:router(config)# vrf vpn1
```

Configures a VRF instance.

**Step 3** `address-family { ipv4 | ipv6 } unicast`**Example:**

```
RP/0/RSP0/CPU0:router(config-vrf)# address-family { ipv4 | ipv6 } unicast
```

Specifies either the IPv4 or IPv6 address family and enters address family configuration submode.

**Step 4** `import route-target [ as-number:nn | ip-address:nn ]`**Example:**

```
RP/0/RSP0/CPU0:router(config-vrf)# import route-target 2:1
```

Specifies a list of route target (RT) extended communities. Only prefixes that are associated with the specified import route target extended communities are imported into the VRF.

**Step 5** `export route-target [ as-number:nn | ip-address:nn ]`**Example:**

```
RP/0/RSP0/CPU0:router(config-vrf)# export route-target 1:1
```

Specifies a list of route target extended communities. Export route target communities are associated with prefixes when they are advertised to remote PEs. The remote PEs import them into VRFs which have import RTs that match these exported route target communities.

**Step 6** `interface type interface-path-id`**Example:**

```
RP/0/RSP0/CPU0:router(config)# interface TenGigE0/2/0/0.1
```

Enters interface configuration mode and configures an interface.

**Step 7** `vrf vrf-name`**Example:**

```
RP/0/RSP0/CPU0:router(config-if)# vrf vpn1
```

Configures a VRF instance.

**Step 8** `ipv4 address ipv4-address subnet-mask`**Example:**

```
RP/0/RSP0/CPU0:router(config-if)# ipv4 address 150.1.1.1 255.255.255.0
```

Specifies the IPv4 address and subnet mask for the interface.

- `ipv4-address` specifies the IP address of the interface.
- `subnet-mask` specifies the subnet mask of the interface.

### Step 9 **dot1q native vlan** *vlan-id*

#### Example:

```
RP/0/RSP0/CPU0:router(config-if)# dot1q native
vlan 1
```

Assigns the native VLAN ID of a physical interface trunking 802.1Q VLAN traffic.

### Step 10 **router bgp** *as-number*

#### Example:

```
RP/0/RSP0/CPU0:router(config)# router bgp 1
```

Specifies the autonomous system number and enters the BGP configuration mode, allowing you to configure the BGP routing process.

### Step 11 **nsr**

#### Example:

```
RP/0/RSP0/CPU0:router(config-bgp)# nsr
```

Activates BGP NSR.

### Step 12 **bgp router-id** *ip-address*

#### Example:

```
RP/0/RSP0/CPU0:router(config-bgp)# bgp router-id 1.1.1.1
```

Configures the local router with a specified router ID.

### Step 13 **address-family {vpnv4 | vpnv6} unicast**

#### Example:

```
RP/0/RSP0/CPU0:router(config-bgp)# address-family vpnv4 unicast
```

Enters address family configuration submode for the specified address family.

### Step 14 **neighbor** *ip-address*

#### Example:

```
RP/0/RSP0/CPU0:router(config-bgp)# neighbor 4.4.4.4
```

Places the router in neighbor configuration mode for BGP routing and configures the neighbor IP address as a BGP peer.

**Step 15**     **remote-as** *as-number***Example:**

```
RP/0/RSP0/CPU0:router(config-bgp-nbr)#remote-as 1
```

Creates a neighbor and assigns a remote autonomous system number to it..

**Step 16**     **update-source** *type interface-path-id***Example:**

```
RP/0/RSP0/CPU0:router(config-bgp-nbr)#update-source Loopback0
```

Allows sessions to use the primary IP address from a specific interface as the local address when forming a session with a neighbor.

**Step 17**     **address-family** { *vpn4* | *vpn6* } **unicast****Example:**

```
RP/0/RSP0/CPU0:router(config-bgp-nbr)# address-family vpn4 unicast
```

Enters address family configuration submode for the specified address family.

**Step 18**     **route-policy** *route-policy-name* **in****Example:**

```
RP/0/RSP0/CPU0:router(config-bgp-nbr-af)#route-policy pass-all in
```

Defines a route policy and enters route policy configuration mode.

**Step 19**     **route-policy** *route-policy-name* **out****Example:**

```
RP/0/RSP0/CPU0:router(config-bgp-nbr-af)#route-policy pass-all out
```

Defines a route policy and enters route policy configuration mode.

**Step 20**     **vrf** *vrf-name***Example:**

```
RP/0/RSP0/CPU0:router(config)# vrf vpn1
```

Configures a VRF instance.

**Step 21**     **rd** { *as-number:nn* | *ip-address:nn* | **auto** }**Example:**

```
RP/0/RSP0/CPU0:router(config-vrf)#rd 1:1
```

Configures the route distinguisher.

**Step 22**     **address-family** { *ipv4* | *ipv6* } **unicast****Example:**

```
RP/0/RSP0/CPU0:router(config-vrf)# address-family ipv4 unicast
```

Specifies either the IPv4 or IPv6 address family and enters address family configuration submode.

**Step 23**     **redistribute connected** [ **metric** *metric-value* ] [ *route-policy route-policy-name* ]

**Example:**

```
RP/0/RSP0/CPU0:router(config-vrf-af)#
redistribute connected
```

Configures the local router with a specified router ID.

**Step 24**     **redistribute static** [ **metric** *metric-value* ] [ *route-policy route-policy-name* ]

**Example:**

```
RP/0/RSP0/CPU0:router(config-vrf-af)#
redistribute static
```

Causes routes from the specified instance to be redistributed into BGP.

**Step 25**     **neighbor** *ip-address*

**Example:**

```
RP/0/RSP0/CPU0:router(config-bgp)# neighbor 150.1.1.2
```

Places the router in neighbor configuration mode for BGP routing and configures the neighbor IP address as a BGP peer.

**Step 26**     **remote-as** *as-number*

**Example:**

```
RP/0/RSP0/CPU0:router(config-bgp-nbr)#remote-as 7501
```

Creates a neighbor and assigns a remote autonomous system number to it..

**Step 27**     **ebg-multihop** *ttl-value*

**Example:**

```
RP/0/RSP0/CPU0:router(config-bgp-nbr)
#ebgp-multihop 10
```

Configures the CE neighbor to accept and attempt BGP connections to external peers residing on networks that are not directly connected.

**Step 28**     **address-family** { **ipv4** | **ipv6** } **unicast**

**Example:**

```
RP/0/RSP0/CPU0:router(config-bgp-nbr)# address-family ipv4 unicast
```

Specifies either the IPv4 or IPv6 address family and enters address family configuration submode.

**Step 29**     **route-policy** *route-policy-name* **in**

**Example:**

```
RP/0/RSP0/CPU0:router(config-bgp-nbr-af)#route-policy
BGP_pass_all in
```

Configures the local router with a specified router.

**Step 30** **route-policy** *route-policy-name* **out**

**Example:**

```
RP/0/RSP0/CPU0:router(config-bgp-nbr-af)#route-policy BGP_pass_all out
```

Defines a route policy and enters route policy configuration mode.

**Step 31** Use the **commit** or **end** command.

**commit** - Saves the configuration changes and remains within the configuration session.

**end** - Prompts user to take one of these actions:

- **Yes** - Saves configuration changes and exits the configuration session.
- **No** - Exits the configuration session without committing the configuration changes.
- **Cancel** - Remains in the configuration mode, without committing the configuration changes.

## Configuration Examples for Implementing MPLS Layer 3 VPNs

The following section provides sample configurations for MPLS L3VPN features:

### Configuring an MPLS VPN Using BGP: Example

The following example shows the configuration for an MPLS VPN using BGP on “vrf vpn1”:

```
address-family ipv4 unicast
  import route-target
    100:1
  !
  export route-target
    100:1
  !
!
!
route-policy pass-all
  pass
end-policy
!
interface Loopback0
  ipv4 address 10.0.0.1 255.255.255.255
!
interface TenGigE 0/1/0/0
  vrf vpn1
  ipv4 address 10.0.0.2 255.0.0.0
!
interface TenGigE 0/1/0/1
  ipv4 address 10.0.0.1 255.0.0.0
!
router ospf 100
```

```

    area 100
      interface loopback0
      interface TenGigE 0/1/0/1
    !
  !
router bgp 100
  address-family vpnv4 unicast
  retain route-target route-policy policy1
  neighbor 10.0.0.3
    remote-as 100
    update-source Loopback0
  address-family vpnv4 unicast
  !
vrf vpn1
  rd 100:1
  address-family ipv4 unicast
    redistribute connected
  !
  neighbor 10.0.0.1
    remote-as 200
    address-family ipv4 unicast
      as-override
      route-policy pass-all in
      route-policy pass-all out
  !
  advertisement-interval 5
  !
!
!
mpls ldp
  route-id loopback0
  interface TenGigE 0/1/0/1
!

```

## Configuring the Routing Information Protocol on the PE Router: Example

The following example shows the configuration for the RIP on the PE router:

```

vrf vpn1
  address-family ipv4 unicast
    import route-target
      100:1
    !
    export route-target
      100:1
    !
  !
!
route-policy pass-all
  pass
end-policy
!

interface TenGigE 0/1/0/0
  vrf vpn1
  ipv4 address 10.0.0.2 255.0.0.0
!

router rip
  vrf vpn1
  interface TenGigE 0/1/0/0
  !
  timers basic 30 90 90 120

```

```

redistribute bgp 100
default-metric 3
route-policy pass-all in
!
```

## Configuring the PE Router Using EIGRP: Example

The following example shows the configuration for the Enhanced Interior Gateway Routing Protocol (EIGRP) on the PE router:

```

Router eigrp 10
vrf VRF1
address-family ipv4
router-id 10.1.1.2
default-metric 100000 2000 255 1 1500
as 62
redistribute bgp 2000
interface Loopback0
!
interface TenGigE 0/6/0/0
```

## Configuration Examples for MPLS VPN CSC

Configuration examples for the MPLS VPN CSC include:

### Configuring the Backbone Carrier Core: Examples

Configuration examples for the backbone carrier core included in this section are as follows:

#### Configuring VRFs for CSC-PE Routers: Example

The following example shows how to configure a VPN routing and forwarding instance (VRF) for a CSC-PE router:

```

config
vrf vpn1
address-family ipv4 unicast
import route-target 100:1
export route-target 100:1
end
```

### Configuring the Links Between CSC-PE and CSC-CE Routers: Examples

This section contains the following examples:

#### Configuring a CSC-PE: Example

In this example, a CSC-PE router peers with a PE router, 10.1.0.2, in its own AS. It also has a labeled unicast peering with a CSC-CE router, 10.0.0.1.

```

config
router bgp 2
address-family vpnv4 unicast
neighbor 10.1.0.2
remote-as 2
update-source loopback0
address-family vpnv4 unicast
```

```

vrf customer-carrier
 rd 1:100
  address-family ipv4 unicast
   allocate-label all
   redistribute static
 neighbor 10.0.0.1
  remote-as 1
  address-family ipv4 labeled-unicast
   route-policy pass-all in
   route-policy pass-all out
  as-override
end

```

### Configuring a CSC-CE: Example

The following example shows how to configure a CSC-CE router. In this example, the CSC-CE router peers CSC-PE router 10.0.0.2 in AS 2.

```

config
 router bgp 1
  address-family ipv4 unicast
   redistribute ospf 200
   allocate-label all
  neighbor 10.0.0.2
   remote-as 2
   address-family ipv4 labeled-unicast
    route-policy pass-all in
    route-policy pass-all out
end

```

### Configuring a Static Route to a Peer: Example

The following example shows how to configure a static route to an Inter-AS or CSC-CE peer:

```

config
 router static
  address-family ipv4 unicast
   10.0.0.2/32 40.1.1.1
end

```

## Configuring a Static Route to a Peer: Example

This example shows how to configure a static route to an Inter-AS or CSC-CE peer:

```

config
 router static
  address-family ipv4 unicast
   10.0.0.2/32 40.1.1.1
end

```

## Configuring L3VPN over GRE: Example

The following example shows how to configure L3VPN over GRE:

Sample configuration to create a GRE tunnel between PE1 and PE2:



```

RP/0/RSP0/CPU0:PE1#sh run int tunnel-ip 1
interface tunnel-ip1
  ipv4 address 100.1.1.1 255.255.255.0
  ipv6 address 100:1:1:1::1/64
  tunnel mode gre ipv4
  tunnel source TenGigE0/2/0/1
  tunnel destination 145.12.5.2
!
RP/0/RSP0/CPU0:PE2#sh run int tunnel-ip 1
interface tunnel-ip1
  ipv4 address 100.1.1.2 255.255.255.0
  ipv6 address 100:1:1:1::2/64
  tunnel mode gre ipv4
  tunnel source TenGigE0/1/0/2
  tunnel destination 145.12.1.1

```

### Configure IGP between PE1 and PE2:

Sample configuration for PE1 is given below. PE2 will also have a similar configuration.

```

RP/0/RSP0/CPU0:PE1#sh run router ospf 1
router ospf 1
  nsr
  router-id 1.1.1.1 <=== Loopback0
  mpls ldp sync
  mtu-ignore enable
  dead-interval 60
  hello-interval 15
  area 0
    interface TenGigE0/2/0/1
    !
RP/0/RSP0/CPU0:PE1#sh run router ospf 0
router ospf 0
  nsr
  router-id 1.1.1.1
  mpls ldp sync
  dead-interval 60
  hello-interval 15
  area 0
    interface Loopback0
    !
    interface tunnel-ip1
    !

```

\* Check for OSPF neighbors

```
RP/0/RSP0/CPU0:PE1#sh ospf neighbor
```

Neighbors for OSPF 0

Neighbor ID	Pri	State	Dead Time	Address	Interface	<==
4.4.4.4	1	FULL/ -	00:00:47	100.1.1.2	tunnel-ip1	<==

Neighbor PE2

Neighbor is up for 00:13:40

Neighbors for OSPF 1

Neighbor ID	Pri	State	Dead Time	Address	Interface	<==
2.2.2.2	1	FULL/DR	00:00:50	145.12.1.2	TenGigE0/2/0/1	<==

Neighbor P1

Neighbor is up for 00:13:43

**Configure LDP/GRE on PE1 and PE2:**

```
RP/0/RSP0/CPU0:PE1#sh run mpls ldp
mpls ldp
router-id 1.1.1.1 <=== Loopback0
discovery hello holdtime 45
discovery hello interval 15
nsr
graceful-restart
graceful-restart reconnect-timeout 180
graceful-restart forwarding-state-holdtime 300
holdtime 90
log
neighbor
!
```

\*Check for mpls forwarding

```
RP/0/RSP0/CPU0:PE1#sh mpls forwarding prefix 4.4.4.4/32
Local  Outgoing  Prefix      Outgoing  Next Hop      Bytes
Label  Label       or ID      Interface Next Hop      Switched
-----  -----  -
16003  Pop         4.4.4.4/32  ti1       100.4.1.2     0
```

**Configure L3VPN**

```
RP/0/RSP0/CPU0:PE1#sh run vrf vpn1
vrf vpn1
address-family ipv4 unicast
import route-target
2:1
!
export route-target
1:1
!
```

```
RP/0/RSP0/CPU0:PE1#sh run int tenGigE 0/2/0/0.1
interface TenGigE0/2/0/0.1
vrf vpn1
ipv4 address 150.1.1.1 255.255.255.0
encapsulation dot1q 1
!
```

```
RP/0/RSP0/CPU0:PE1#sh run router bgp
router bgp 1
nsr
bgp router-id 1.1.1.1 <===Loopback0
address-family vpnv4 unicast
!
neighbor 4.4.4.4 <===iBGP session with PE2
remote-as 1
update-source Loopback0
address-family vpnv4 unicast
route-policy pass-all in
route-policy pass-all out
!
```

```

!
vrf vpn1
 rd 1:1
  address-family ipv4 unicast
   redistribute connected
   redistribute static
  !
 neighbor 150.1.1.2 <=== VRF neighbor
  remote-as 7501
  ebgp-multihop 10
  address-family ipv4 unicast
   route-policy BGP_pass_all in
   route-policy BGP_pass_all out
  !

```

\* Check vrf ping to the 150.1.1.2.

```

RP/0/RSP0/CPU0:PE1#ping vrf vpn1 150.1.1.2
Type escape sequence to abort.
Sending 5, 100-byte ICMP Echos to 150.1.1.2, timeout is 2 seconds:
!!!!
Success rate is 100 percent (5/5), round-trip min/avg/max = 1/1/3 ms

```

\* Send traffic to vrf routes advertised and verify that mpls counters increase in tunnel interface accounting

```

RP/0/RSP0/CPU0:PE1#sh int tunnel-ip1 accounting
tunnel-ip1

```

Protocol	Pkts In	Chars In	Pkts Out	Chars Out
IPV4_MULTICAST	3	276	3	276
MPLS	697747	48842290	0	0





## CHAPTER 3

# Implementing IPv6 VPN Provider Edge Transport over MPLS

IPv6 Provider Edge or IPv6 VPN Provider Edge (6PE/VPE) uses the existing MPLS IPv4 core infrastructure for IPv6 transport. 6PE/VPE enables IPv6 sites to communicate with each other over an MPLS IPv4 core network using MPLS label switched paths (LSPs).

This feature relies heavily on multiprotocol Border Gateway Protocol (BGP) extensions in the IPv4 network configuration on the provider edge (PE) router to exchange IPv6 reachability information (in addition to an MPLS label) for each IPv6 address prefix. Edge routers are configured as dual-stack, running both IPv4 and IPv6, and use the IPv4 mapped IPv6 address for IPv6 prefix reachability exchange.

For detailed information about the commands used to configure 6PE/VPE, see the *VPN and Ethernet Services Command Reference for Cisco ASR 9000 Series Routers*.

### Feature History for Implementing 6PE/VPE Transport over MPLS

Release	Modification
Release 3.9.1	This feature was introduced.
Release 4.0.0	Support was added for the 6PE and 6VPE features for IPv6 L3VPN on A9K-SIP-700.  Support was added for the BGP per VRF/CE label allocation for 6PE feature.
Release 4.1.0	Support for the Open Shortest Path First version 3 (OSPFv3) IPv6 VPN Provider Edge (6VPE) feature was added.

- [Prerequisites for Implementing 6PE/VPE, on page 81](#)
- [Information About 6PE/VPE, on page 82](#)
- [How to Implement 6PE/VPE, on page 85](#)
- [Configuration Examples for 6PE/VPE, on page 93](#)

## Prerequisites for Implementing 6PE/VPE

The following prerequisites are required to implement 6PE/VPE:

- You must be in a user group associated with a task group that includes the proper task IDs. The command reference guides include the task IDs required for each command.

If you suspect user group assignment is preventing you from using a command, contact your AAA administrator for assistance.

- Familiarity with MPLS and BGP4 configuration and troubleshooting.

## Information About 6PE/VPE

To configure the 6PE/VPE feature, you should understand the concepts that are described in these sections:

### Overview of 6PE/VPE

Multiple techniques are available to integrate IPv6 services over service provider core backbones:

- Dedicated IPv6 network running over various data link layers
- Dual-stack IPv4-IPv6 backbone
- Existing MPLS backbone leverage

These solutions are deployed on service providers' backbones when the amount of IPv6 traffic and the revenue generated are in line with the necessary investments and the agreed-upon risks. Conditions are favorable for the introduction of native IPv6 services, from the edge, in a scalable way, without any IPv6 addressing restrictions and without putting a well-controlled IPv4 backbone in jeopardy. Backbone stability is essential for service providers that have recently stabilized their IPv4 infrastructure.

Service providers running an MPLS/IPv4 infrastructure follow similar trends because several integration scenarios that offer IPv6 services on an MPLS network are possible. Cisco Systems has specially developed Cisco 6PE or IPv6 Provider Edge Router over MPLS, to meet all those requirements.

Inter-AS support for 6PE requires support of Border Gateway Protocol (BGP) to enable the address families and to allocate and distribute PE and ASBR labels.



---

**Note** Cisco IOS XR displays actual IPv4 next-hop addresses for IPv6 labeled-unicast and VPNv6 prefixes. IPv4-mapped-to-IPv6 format is not supported.

---

### Benefits of 6PE/VPE

Service providers who currently deploy MPLS experience these benefits of Cisco 6PE/VPE:

- Minimal operational cost and risk—No impact on existing IPv4 and MPLS services.
- Provider edge routers upgrade only—A 6PE/VPE router can be an existing PE router or a new one dedicated to IPv6 traffic.
- No impact on IPv6 customer edge routers—The ISP can connect to any customer CE running Static, IGP or EGP.
- Production services ready—An ISP can delegate IPv6 prefixes.

- IPv6 introduction into an existing MPLS service—6PE/VPE routers can be added at any time.

## IPv6 on the Provider Edge and Customer Edge Routers

### Service Provider Edge Routers

6PE is particularly applicable to service providers who currently run an MPLS network. One of its advantages is that there is no need to upgrade the hardware, software, or configuration of the core network, and it eliminates the impact on the operations and the revenues generated by the existing IPv4 traffic. MPLS is used by many service providers to deliver services to customers. MPLS as a multiservice infrastructure technology is able to provide layer 3 VPN, QoS, traffic engineering, fast re-routing and integration of ATM and IP switching.

### Customer Edge Routers

Using tunnels on the CE routers is the simplest way to deploy IPv6 over MPLS networks. It has no impact on the operation or infrastructure of MPLS and requires no changes to the P routers in the core or to the PE routers. However, tunnel meshing is required as the number of CEs to connect increases, and it is difficult to delegate a global IPv6 prefix for an ISP.

The following figure illustrates the network architecture using tunnels on the CE routers.

**Figure 7: IPv6 Using Tunnels on the CE Routers**

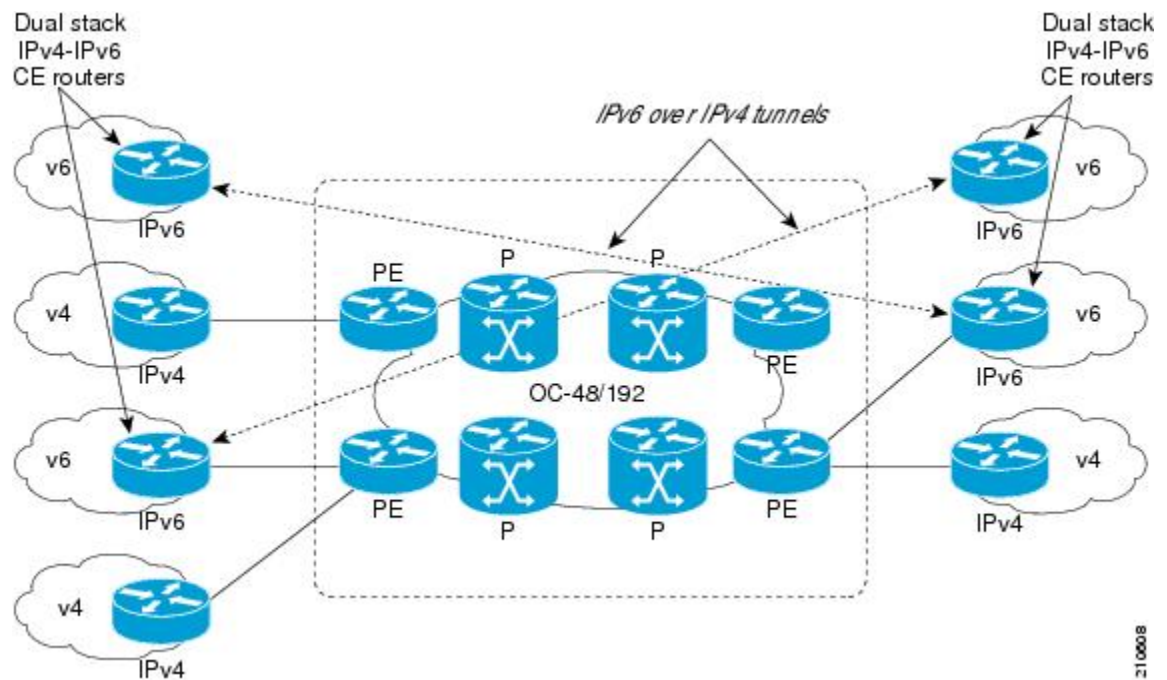

## IPv6 Provider Edge Multipath

Internal and external BGP multipath for IPv6 allows the IPv6 router to load balance between several paths (for example, same neighboring autonomous system (AS) or sub-AS, or the same metric) to reach its destination. The 6PE multipath feature uses multiprotocol internal BGP (MP-IBGP) to distribute IPv6 routes over the MPLS IPv4 core network and to attach an MPLS label to each route.

When MP-IBGP multipath is enabled on the 6PE router, all labeled paths are installed in the forwarding table with MPLS information (label stack) when MPLS information is available. This functionality enables 6PE to perform load balancing.

## OSPFv3 6VPE

The Open Shortest Path First version 3 (OSPFv3) IPv6 VPN Provider Edge (6VPE) feature adds VPN routing and forwarding (VRF) and provider edge-to-customer edge (PE-CE) routing support to Cisco IOS XR OSPFv3 implementation. This feature allows:

- Multiple VRF support per OSPFv3 routing process
- OSPFv3 PE-CE extensions

### Multiple VRF Support

OSPFv3 supports multiple VRFs in a single routing process that allows scaling to tens and hundreds of VRFs without consuming too much route processor (RP) resources.

Multiple OSPFv3 processes can be configured on a single router. In large-scale VRF deployments, this allows partition VRF processing across multiple RPs. It is also used to isolate default routing table or high impact VRFs from the regular VRFs. It is recommended to use a single process for all the VRFs. If needed, a second OSPFv3 process must be configured for IPv6 routing.



---

**Note** The maximum of four OSPFv3 processes are supported.

---

### OSPFv3 PE-CE Extensions

IPv6 protocol is being vastly deployed in today's customer networks. Service Providers (SPs) need to be able to offer Virtual Private Network (VPN) services to their customers for supporting IPv6 protocol, in addition to the already offered VPN services for IPv4 protocol.

In order to support IPv6, routing protocols require additional extensions for operating in the VPN environment. Extensions to OSPFv3 are required in order for OSPFv3 to operate at the PE-CE links.

### VRF Lite

VRF lite feature enables VRF deployment without BGP or MPLS based backbone. In VRF lite, the PE routers are directly connected using VRF interfaces. For OSPFv3, the following needs to operate differently in the VRF lite scenario, as opposed to the deployment with BGP or MPLS backbone:

- DN bit processing—In VRF lite environment, the DN bit processing is disabled.
- ABR status—In VRF context (except default VRF), OSPFv3 router is automatically set as an ABR, regardless to its connectivity to area 0. This automatic ABR status setting is disabled in the VRF lite environment.



---

**Note** To enable VRF Lite, issue the **capability vrf-lite** command in the OSPFv3 VRF configuration submode.

---



# How to Implement 6PE/VPE

This section includes these implementation procedures:

## Configuring 6PE/VPE

This task describes how to configure 6PE/VPE on PE routers to transport the IPv6 prefixes across the IPv4 cloud.

Ensure that you configure 6PE/VPE on PE routers participating in both the IPv4 cloud and IPv6 clouds.



**Note** For 6PE, you can use all routing protocols supported on Cisco IOS XR software such as BGP, OSPF, IS-IS, EIGRP, RIP, and Static to learn routes from both clouds. However, for 6VPE, you can use only the BGP, EIGRP and Static routing protocols to learn routes. Also, 6VPE supports OSPFv3 routing protocol between PE and CE routers.

### SUMMARY STEPS

1. **configure**
2. **router bgp** *as-number*
3. **neighbor** *ip-address*
4. **remote-as** *as-number*
5. **address-family ipv6** **labeled-unicast**
6. **exit**
7. **exit**
8. **address-family ipv6** **unicast**
9. **allocate-label** [**all** | **route-policy** *policy\_name*]
10. Use the **commit** or **end** command.

### DETAILED STEPS

**Step 1** **configure**

**Example:**

```
RP/0/RSP0/CPU0:router# configure
```

Enters the Global Configuration mode.

**Step 2** **router bgp** *as-number*

**Example:**

```
RP/0/RSP0/CPU0:router(config)# router bgp 1
```

Enters the number that identifies the autonomous system (AS) in which the router resides.

Range for 2-byte numbers is 1 to 65535. Range for 4-byte numbers is 1.0 to 65535.65535.

**Step 3** `neighbor ip-address`

**Example:**

```
RP/0/RSP0/CPU0:router(config-bgp) # neighbor 1.1.1.1
```

Enters neighbor configuration mode for configuring Border Gateway Protocol (BGP) routing sessions.

**Step 4** `remote-as as-number`

**Example:**

```
RP/0/RSP0/CPU0:router(config-bgp-nbr) # remote-as 100
```

Creates a neighbor and assigns a remote autonomous system number to it.

**Step 5** `address-family ipv6 labeled-unicast`

**Example:**

```
RP/0/RSP0/CPU0:router(config-bgp-nbr) # address-family ipv6 labeled-unicast
```

Specifies IPv6 labeled-unicast address prefixes.

**Note** This option is also available in IPv6 neighbor configuration mode and VRF neighbor configuration mode.

**Step 6** `exit`

**Example:**

```
RP/0/RSP0/CPU0:router(config-bgp-nbr-af) # exit
```

Exits BGP address-family submode.

**Step 7** `exit`

**Example:**

```
RP/0/RSP0/CPU0:router(config-bgp-nbr) # exit
```

Exits BGP neighbor submode.

**Step 8** `address-family ipv6 unicast`

**Example:**

```
RP/0/RSP0/CPU0:router(config-bgp) # address-family ipv6 unicast
```

Specifies IPv6 unicast address prefixes.

**Step 9** `allocate-label [all | route-policy policy_name]`

**Example:**

```
RP/0/RSP0/CPU0:router(config-bgp-af)# allocate-label all
```

Allocates MPLS labels for specified IPv4 unicast routes.

**Note** The **route-policy** keyword provides finer control to filter out certain routes from being advertised to the neighbor.

**Step 10** Use the **commit** or **end** command.

**commit** - Saves the configuration changes and remains within the configuration session.

**end** - Prompts user to take one of these actions:

- **Yes** - Saves configuration changes and exits the configuration session.
- **No** - Exits the configuration session without committing the configuration changes.
- **Cancel** - Remains in the configuration mode, without committing the configuration changes.

## Configuring PE to PE Core

This task describes how to configure a Provider Edge (PE) to PE Core.

For information on configuring VPN Routing and Forwarding (VRF), refer to the *Implementing BGP* module of the *Routing Configuration Guide for Cisco ASR 9000 Series Routers*.

### SUMMARY STEPS

1. **configure**
2. **router bgp**
3. **address-family vpnv6 unicast**
4. **bgp dampening** [ *half-life* [ *reuse suppress max-suppress-time* ] ] **route-policy** *route-policy-name* ]
5. **bgp client-to-client reflection** { **cluster-id** | **disable** }
6. **neighbor** *ip-address*
7. **remote-as** *as-number*
8. **description** *text*
9. **password** { **clear** | **encrypted** } *password*
10. **shutdown**
11. **timers** *keepalive hold-time*
12. **update-source type** *interface-id*
13. **address-family vpnv6 unicast**
14. **route-policy** *route-policy-name* { **in** | **out** }
15. **exit**
16. **vrf** *vrf-name*
17. **rd** { *as-number : nn* | *ip-address : nn* | **auto** }
18. Use the **commit** or **end** command.

## DETAILED STEPS

---

### Step 1 **configure**

**Example:**

```
RP/0/RSP0/CPU0:router# configure
```

Enters the Global Configuration mode.

### Step 2 **router bgp**

**Example:**

```
RP/0/RSP0/CPU0:router(config)# router bgp 10
```

Specifies the BGP AS number and enters the BGP configuration mode, allowing you to configure the BGP routing process.

### Step 3 **address-family vpnv6 unicast**

**Example:**

```
RP/0/RSP0/CPU0:router(config-bgp)# address-family vpnv6 unicast
```

Specifies the vpnv6 address family and enters address family configuration submode.

### Step 4 **bgp dampening [ half-life [ reuse suppress max-suppress-time ] | route-policy route-policy-name ]**

**Example:**

```
RP/0/RSP0/CPU0:router(config-bgp-af)# bgp dampening 30 1500 10000 120
```

Configures BGP dampening for the specified address family.

### Step 5 **bgp client-to-client reflection { cluster-id | disable }**

**Example:**

```
RP/0/RSP0/CPU0:router(config-bgp-af)# bgp client-to-client
reflection disable
```

Configures client to client route reflection.

### Step 6 **neighbor ip-address**

**Example:**

```
RP/0/RSP0/CPU0:router(config-bgp)# neighbor 10.1.1.1
```

Places the router in neighbor configuration mode for BGP routing and configures the neighbor IP address as a BGP peer.

### Step 7 **remote-as as-number**

**Example:**

```
RP/0/RSP0/CPU0:router(config-bgp-nbr)# remote-as 100
```

Creates a neighbor and assigns a remote autonomous system number to it.

**Step 8****description** *text***Example:**

```
RP/0/RSP0/CPU0:router(config-bgp-nbr)# description neighbor 172.16.1.1
```

Provides a description of the neighbor. The description is used to save comments and does not affect software function.

**Step 9****password** { **clear** | **encrypted** } *password***Example:**

```
RP/0/RSP0/CPU0:router(config-bgp-nbr)# password encrypted 123abc
```

Enables Message Digest 5 (MD5) authentication on the TCP connection between the two BGP neighbors.

**Step 10****shutdown****Example:**

```
RP/0/RSP0/CPU0:router(config-bgp-nbr)# router bgp 1
```

Terminates any active sessions for the specified neighbor and removes all associated routing information.

**Step 11****timers** *keepalive hold-time***Example:**

```
RP/0/RSP0/CPU0:router(config-bgp-nbr)# timers 12000 200
```

Set the timers for the BGP neighbor.

**Step 12****update-source type** *interface-id***Example:**

```
RP/0/RSP0/CPU0:router(config-bgp-nbr)# update-source TenGigE 0/1/5/0
```

Allows iBGP sessions to use the primary IP address from a specific interface as the local address when forming an iBGP session with a neighbor.

**Step 13****address-family vpnv6 unicast****Example:**

```
RP/0/RSP0/CPU0:router(config-bgp-nbr)# address-family vpnv6 unicast
```

Enters VPN neighbor address family configuration mode.

**Step 14** `route-policy route-policy-name { in | out }`

**Example:**

```
RP/0/RSP0/CPU0:router(config-bgp-nbr-af)# route-policy pe-pe-vpn-out out
```

Specifies a routing policy for an outbound route. The policy can be used to filter routes or modify route attributes.

**Step 15** `exit`

**Example:**

```
RP/0/RSP0/CPU0:router(config-bgp-nbr-af)# exit
```

Exits address family configuration and neighbor submode.

**Step 16** `vrf vrf-name`

**Example:**

```
RP/0/RSP0/CPU0:router(config-bgp)# vrf vrf-pe
```

Configures a VRF instance.

**Step 17** `rd { as-number : nn | ip-address : nn | auto }`

**Example:**

```
RP/0/RSP0/CPU0:router(config-bgp-vrf)# rd 345:567
```

Configures the route distinguisher.

Use the `auto` keyword if you want the router to automatically assign a unique RD to the VRF.

**Step 18** Use the `commit` or `end` command.

**commit** - Saves the configuration changes and remains within the configuration session.

**end** - Prompts user to take one of these actions:

- **Yes** - Saves configuration changes and exits the configuration session.
- **No** - Exits the configuration session without committing the configuration changes.
- **Cancel** - Remains in the configuration mode, without committing the configuration changes.

## Configuring OSPFv3 as the Routing Protocol Between the PE and CE Routers

Perform this task to configure provider edge (PE)-to-customer edge (CE) routing sessions that use Open Shortest Path First version 3 (OSPFv3).

### SUMMARY STEPS

1. `configure`
2. `router ospf process-name`

3. **vrf** *vrf-name*
4. **capability** *vrf-lite*
5. **router-id** {*router-id* | *type interface-path-id*}
6. **domain-id type** { 0005 | 0105 | 0205 | 8005 } **value** *domain-id*
7. Do one of the following:
  - **redistribute bgp** *process-id* [ **metric** *metric-value* ] [ **metric-type** {1 | 2} ] [ **route-policy** *route-policy policy-name* ] [ **tag** *tag-value* ]
  - **redistribute connected** [ **metric** *metric-value* ] [ **metric-type** {1 | 2} ] [ **route-policy** *policy-name* ] [ **tag** *tag-value* ]
  - **redistribute ospf** *process-id* [ **match** { **external** [1 | 2] | **internal** | **nssa-external** [1 | 2] } ] [ **metric** *metric-value* ] [ **metric-type** {1 | 2} ] [ **route-policy** *policy-name* ] [ **tag** *tag-value* ]
  - **redistribute static** [ **metric** *metric-value* ] [ **metric-type** {1 | 2} ] [ **route-policy** *policy-name* ] [ **tag** *policy-name* ] [ **tag** *tag-value* ]
  - **redistribute eigrp** *process-id* [ **match** { **external** [1 | 2] | **internal** | **nssa-external** [1 | 2] } ] [ **metric** *metric-value* ] [ **metric-type** {1 | 2} ] [ **route-policy** *policy-name* ] [ **tag** *tag-value* ]
  - **redistribute rip** [ **metric** *metric-value* ] [ **metric-type** {1 | 2} ] [ **route-policy** *policy-name* ] [ **tag** *tag-value* ]
8. **area** *area-id*
9. **interface** {*type interface-path-id*}
10. Use the **commit** or **end** command.

## DETAILED STEPS

### Step 1 **configure**

**Example:**

```
RP/0/RSP0/CPU0:router# configure
```

Enters the Global Configuration mode.

### Step 2 **router ospf** *process-name*

**Example:**

```
RP/0/RSP0/CPU0:router(config)# router ospf 109
```

Enters OSPF configuration mode allowing you to configure the OSPF routing process.

### Step 3 **vrf** *vrf-name*

**Example:**

```
RP/0/RSP0/CPU0:router(config-ospf)# vrf vrf_1
```

Configures a VPN routing and forwarding (VRF) instance and enters VRF configuration mode for OSPF routing.

### Step 4 **capability** *vrf-lite*

**Example:**

```
RP/0/RSP0/CPU0:router(config-ospf-vrf)# capability vrf-lite
```

Enables VRF Lite feature.

**Step 5** `router-id {router-id | type interface-path-id }`

**Example:**

```
RP/0/RSP0/CPU0:router(config-ospf-vrf)# router-id 172.20.10.10
```

Configures the router ID for the OSPF routing process.

**Note** Router ID configuration is required for each VRF.

**Step 6** `domain-id type { 0005 | 0105 | 0205 | 8005 } value domain-id`

**Example:**

```
RP/0/RSP0/CPU0:router(config-ospf-vrf)# domain-id type 0005 value CAFE00112233
```

Specifies the domain ID.

**Step 7** Do one of the following:

- **redistribute bgp** *process-id* [ **metric** *metric-value* ] [ **metric-type** {1 | 2} ] [ **route-policy**12*route-policy policy-name* ] [ **tag** *tag-value* ]
- **redistribute connected** [ **metric** *metric-value* ] [ **metric-type** {1 | 2} ] [ **route-policy***policy-name* ] [ **tag** *tag-value* ]
- **redistribute ospf** *process-id* [ **match** {**external** [1 | 2] | **internal** | **nssa-external** [1 | 2]} ] [ **metric** *metric-value* ] [ **metric-type** {1 | 2} ] [ **route-policy** *policy-name* ] [ **tag** *tag-value* ]
- **redistribute static** [ **metric** *metric-value* ] [ **metric-type** {1 | 2} ] [ **route-policy** *policy-name* ] [ **tag** *policy-name* ] [ **tag** *tag-value* ]
- **redistribute eigrp** *process-id* [ **match** {**external** [1 | 2] | **internal** | **nssa-external** [1 | 2]} ] [ **metric** *metric-value* ] [ **metric-type** {1 | 2} ] [ **route-policy** *policy-name* ] [ **tag** *tag-value* ]
- **redistribute rip** [ **metric** *metric-value* ] [ **metric-type** {1 | 2} ] [ **route-policy** *policy-name* ] [ **tag** *tag-value* ]

**Example:**

```
RP/0/RSP0/CPU0:router(config-ospf-vrf)# redistribute connected
```

Causes routes to be redistributed into OSPF. The routes that can be redistributed into OSPF are:

- Border Gateway Protocol (BGP)
- Connected
- Enhanced Interior Gateway Routing Protocol (EIGRP)
- OSPF
- Static
- Routing Information Protocol (RIP)

**Step 8** `area area-id`

**Example:**

```
RP/0/RSP0/CPU0:router(config-ospf-vrf)# area 0
```



Configures the OSPF area as area 0.

**Step 9** **interface** {*type interface-path-id*}

**Example:**

```
RP/0/RSP0/CPU0:router(config-ospf-vrf-ar)# interface GigabitEthernet 0/3/0/0
```

Associates interface GigabitEthernet 0/3/0/0 with area 0.

**Step 10** Use the **commit** or **end** command.

**commit** - Saves the configuration changes and remains within the configuration session.

**end** - Prompts user to take one of these actions:

- **Yes** - Saves configuration changes and exits the configuration session.
- **No** - Exits the configuration session without committing the configuration changes.
- **Cancel** - Remains in the configuration mode, without committing the configuration changes.

## Configuration Examples for 6PE/VPE

This section includes the following configuration example:

### Configuring 6PE on a PE Router: Example

This sample configuration shows the configuration of 6PE on a PE router:

```
interface TenGigE0/3/0/0
  ipv6 address 2001::1/64
  !
router isis ipv6-cloud
  net 49.0000.0000.0001.00
  address-family ipv6 unicast
    single-topology
  interface TenGigE0/3/0/0
    address-family ipv6 unicast
  !
!
router bgp 55400
  bgp router-id 54.6.1.1
  address-family ipv4 unicast
  !
  address-family ipv6 unicast
    network 55:5::/64
    redistribute connected
    redistribute isis ipv6-cloud
    allocate-label all
  !
neighbor 34.4.3.3
  remote-as 55400
  address-family ipv4 unicast
```

```
!
address-family ipv6 labeled-unicast
```

## Configuring 6VPE on a PE Router: Example

This sample configuration shows the configuration of 6VPE on a PE router:

```
vrf vpn1
address-family ipv6 unicast
import route-target
200:2
!
export route-target
200:2

interface Loopback0
ipv4 address 10.0.0.1 255.255.255.255

interface GigabitEthernet0/0/0/1
vrf vpn1
ipv6 address 2001:c003:a::2/64

router bgp 1
bgp router-id 10.0.0.1
bgp redistribute-internal
bgp graceful-restart
address-family ipv4 unicast
!

address-family vpnv6 unicast
!
neighbor 10.0.0.2 >>>> Remote peer loopback address.
remote-as 1
update-source Loopback0
address-family ipv4 unicast
!
address-family vpnv6 unicast
route-policy pass-all in
route-policy pass-all out
!

vrf vpn1
rd 100:2
bgp router-id 140.140.140.140
address-family ipv6 unicast
redistribute connected
!

neighbor 2001:c003:a::1
remote-as 6502
address-family ipv6 unicast
route-policy pass-all in
route-policy pass-all out
!
```



## CHAPTER 4

# Implementing Generic Routing Encapsulation

Generic Routing Encapsulation (GRE) is a tunneling protocol developed by Cisco Systems that encapsulates a wide variety of network layer protocols inside virtual point-to-point links over an Internet Protocol internetwork.

### Feature History for Configuring Link Bundling on Cisco IOS XR Software

Release	Modification
Release 4.3.0	These feature were supported on the Cisco ASR 9000 Series Aggregation Services Routers: <ul style="list-style-type: none"><li>• MPLS/L3VPNoGRE on ASR 9000 Enhanced Ethernet Line Card and Cisco ASR 9000 Series SPA Interface Processor-700</li><li>• RSVP/TEoGRE on ASR 9000 Enhanced Ethernet Line Card and Cisco ASR 9000 Series SPA Interface Processor-700</li><li>• VRF aware GRE on ASR 9000 Enhanced Ethernet Line Card and Cisco ASR 9000 Series SPA Interface Processor-700</li><li>• L2VPN (VPWS and VPLS) on GRE for ASR 9000 Enhanced Ethernet Line Card only</li></ul>
Release 5.1.1	Support for GRE Tunnel Key and Tunnel Key-Ignore was introduced.
Release 5.2.2	Support for GRE tunnel on an IPv6 transport network.
Release 5.3.2	Support for GRE IPv4 Transport Over MPLS was introduced.
Release 6.0.1	Support for GRE IPv6 Transport Over MPLS was introduced.

- [Prerequisites for Configuring Generic Routing Encapsulation, on page 95](#)
- [Information About Generic Routing Encapsulation, on page 96](#)
- [GRE IPv4/IPv6 Transport Over MPLS, on page 102](#)
- [How to Configure Generic Routing Encapsulation, on page 102](#)
- [Configuration Examples for Generic Routing Encapsulation, on page 115](#)

## Prerequisites for Configuring Generic Routing Encapsulation

Before configuring Link Bundling, be sure that these tasks and conditions are met:

- You must be in a user group associated with a task group that includes the proper task IDs. The command reference guides include the task IDs required for each command.

If you suspect user group assignment is preventing you from using a command, contact your AAA administrator for assistance.

## Information About Generic Routing Encapsulation

To implement the GRE feature, you must understand these concepts:

### GRE Overview

Generic Routing Encapsulation (GRE) tunneling protocol provides a simple generic approach to transport packets of one protocol over another protocol by means of encapsulation.

GRE encapsulates a payload, that is, an inner packet that needs to be delivered to a destination network inside an outer IP packet. GRE tunnel endpoints send payloads through GRE tunnels by routing encapsulated packets through intervening IP networks. Other IP routers along the way do not parse the payload (the inner packet); they only parse the outer IP packet as they forward it towards the GRE tunnel endpoint. Upon reaching the tunnel endpoint, GRE encapsulation is removed and the payload is forwarded to its ultimate destination.

MPLS networks provide VPN functionality by tunneling customer data through public networks using routing labels. Service Providers (SP) provide MPLS L3VPN, 6PE/6VPE and L2VPN services to their customers who have interconnected private networks.

MPLS and L3VPN are supported over regular interfaces on Cisco ASR 9000 Series Aggregation Services Routers through GRE tunnels over an IPv4 transport network. MPLS support is extended over IPv4 GRE tunnels between routers as the provider core may not be fully MPLS aware.

### GRE Features

The following sections list the GRE features:



---

**Note** An IPv6 GRE tunnel does not support features that involve transport of MPLS packets through a GRE tunnel.

---

### MPLS/L3VPN over GRE

The MPLS VPN over GRE feature provides a mechanism for tunneling Multiprotocol Label Switching (MPLS) packets over a non-MPLS network. This feature utilizes MPLS over generic routing encapsulation (MPLSoGRE) to encapsulate MPLS packets inside IP tunnels. The encapsulation of MPLS packets inside IP tunnels creates a virtual point-to-point link across non-MPLS networks.

L3VPN over GRE basically means encapsulating L3VPN traffic in GRE header and its outer IPv4 header with tunnel destination and source IP addresses after imposing zero or more MPLS labels, and transporting it across the tunnel over to the remote tunnel end point. The incoming packet can be a pure IPv4 packet or an MPLS packet. If the incoming packet is IPv4, the packet enters the tunnel through a VRF interface, and if the incoming packet is MPLS, then the packet enters through an MPLS interface. In the IPv4 case, before encapsulating in the outer IPv4 and GRE headers, a VPN label corresponding to the VRF prefix and any IGP

label corresponding to the IGP prefix of the GRE tunnel destination is imposed on the packet. In the case of MPLS, the top IGP label is swapped with any label corresponding to the GRE tunnel destination address.

### PE-to-PE Tunneling

The provider-edge-to-provider-edge (PE-to-PE) tunneling configuration provides a scalable way to connect multiple customer networks across a non-MPLS network. With this configuration, traffic that is destined to multiple customer networks is multiplexed through a single GRE tunnel.



**Note** A similar nonscalable alternative is to connect each customer network through separate GRE tunnels (for example, connecting one customer network to each GRE tunnel).

As shown in the following figure, the PE devices assign VPN routing and forwarding (VRF) numbers to the customer edge (CE) devices on each side of the non-MPLS network.

The PE devices use routing protocols such as Border Gateway Protocol (BGP), Open Shortest Path First (OSPF), or Routing Information Protocol (RIP) to learn about the IP networks behind the CE devices. The routes to the IP networks behind the CE devices are stored in the associated CE device's VRF routing table.

The PE device on one side of the non-MPLS network uses the routing protocols (that operate within the non-MPLS network) to learn about the PE device on the other side of the non-MPLS network. The learned routes that are established between the PE devices are then stored in the main or default routing table.

The opposing PE device uses BGP to learn about the routes that are associated with the customer networks that are behind the PE devices. These learned routes are not known to the non-MPLS network.

The following figure shows BGP defining a static route to the BGP neighbor (the opposing PE device) through the GRE tunnel that spans the non-MPLS network. Because routes that are learned by the BGP neighbor include the GRE tunnel next hop, all customer network traffic is sent using the GRE tunnel.

**Figure 8: PE-to-PE Tunneling**

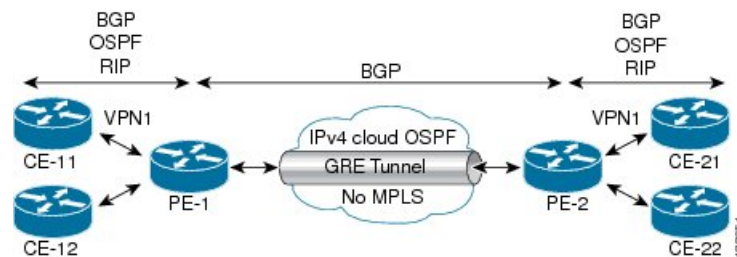

### P-to-PE Tunneling

As shown in the following figure, the provider-to-provider-edge (P-to-PE) tunneling configuration provides a way to connect a PE device (P1) to an MPLS segment (PE-2) across a non-MPLS network. In this configuration, MPLS traffic that is destined to the other side of the non-MPLS network is sent through a single GRE tunnel.

Figure 9: P-to-PE Tunneling

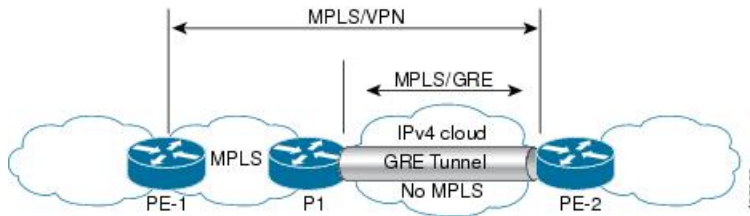

### P-to-P Tunneling

As shown in the following figure, the provider-to-provider (P-to-P) configuration provides a method of connecting two MPLS segments (P1 to P2) across a non-MPLS network. In this configuration, MPLS traffic that is destined to the other side of the non-MPLS network is sent through a single GRE tunnel.

Figure 10: P-to-P Tunneling

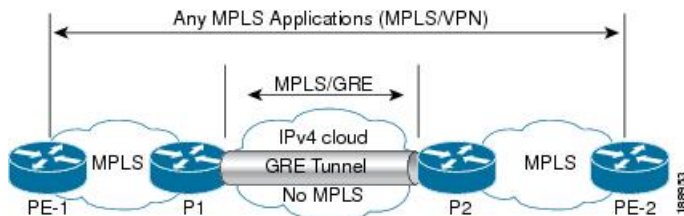

## 6PE/6VPE

Service Providers (SPs) use a stable and established core with IPv4/MPLS backbone for providing IPv4 VPN services. The 6PE/6VPE feature facilitates SPs to offer IPv6 VPN services over this backbone without an IPv6 core. The provide edge (PE) routers run MP-iBGP (Multi-Protocol iBGP) to advertise v6 reachability and v6 label distribution. For 6PE, the labels are allocated per IPv6 prefix learnt from connected customer edge (CE) routers and for 6VPE, the PE router can be configured to allocate labels on a per-prefix or per-CE/VRF level.

### 6PE/6VPE over GRE

While IPv4/MPLS allows SPs to transport IPv6 traffic across IPv4 core (IPv6 unaware), MPLS over GRE allows MPLS traffic to be tunneled through MPLS unaware networks. These two features together facilitate IPv6 traffic to be transported across IPv4 as well as MPLS unaware core segments. Only the PE routers need to be aware of MPLS and IPv6 (Dual stack).

The 6PE/6VPE over GRE feature allows the use of IPv4 GRE tunnels to provide IPv6 VPN over MPLS functionality to reach the destination v6 prefixes via the BGP next hop through MPLS & IPv6 unaware core.

### MPLS Forwarding

When IPv6 traffic is received from one customer site, the ingress PE device uses MPLS to tunnel IPv6 VPN packets over the backbone toward the egress PE device identified as the BGP next hop. The ingress PE device prefixes the IPv6 packets with the outer and inner labels before placing the packet on the egress interface.

Under normal operation, a P device along the forwarding path does not lookup the frame beyond the first label. The P device either swaps the incoming label with an outgoing one or removes the incoming label if the next device is a PE device. Removing the incoming label is called penultimate hop popping. The remaining

label (BGP label) is used to identify the egress PE interface toward the customer site. The label also hides the protocol version (IPv6) from the last P device, which it would otherwise need to forward an IPv6 packet.

A P device is ignorant of the IPv6 VPN routes. The IPv6 header remains hidden under one or more MPLS labels. When the P device receives an MPLS-encapsulated IPv6 packet that cannot be delivered, it has two options. If the P device is IPv6 aware, it exposes the IPv6 header, builds an Internet Control Message Protocol (ICMP) for IPv6 message, and sends the message, which is MPLS encapsulated, to the source of the original packet. If the P device is not IPv6 aware, it drops the packet.

### 6PE/6VPE over GRE

As discussed earlier, 6PE/6VPE over GRE basically means enabling IPv6/IPv6 VPN over MPLS over GRE.

The ingress PE device uses IPv4 generic routing encapsulation (GRE) tunnels combined with 6PE/6VPE over MPLS to tunnel IPv6 VPN packets over the backbone toward the egress PE device identified as the BGP next hop.

The PE devices establish MP-iBGP sessions and MPLS LDP sessions just as in the case of 6PE/6VPE. The difference here is that these sessions are established over GRE tunnels, which also means that the PEs are just one IGP hop away. The P routers in the tunnel path only need to forward the traffic to the tunnel destination, which is an IPv4 address.

This is how the IPv6 LSP is setup for label switching the IPv6 traffic:

- After the LDP and BGP sessions are established, the PEs exchange IPv6 prefixes that they learn from the CEs and the corresponding IPv6 labels, just as in the case of IPv4 VPN.
- The IPv6 labels occupy the inner most position in the label stack.
- The IPv4 labels corresponding to the PE IPv4 addresses occupy the outer position in the stack.
- When IPv6 traffic needs to be forwarded from PE1 to PE2, the outer PE2 IPv4 label is used to label switch the traffic to PE2, and the inner IPv6 label is used to send the packet out of the interface connected to the CE.

## GRE Tunnel Key

The GRE Tunnel Key feature enables the encapsulation router to add a four-byte key, as part of the GRE header, during encapsulation. In the decapsulation router, the GRE key of an incoming packet should match the key value configured under the GRE tunnel. During decapsulation, if a mismatch between the key value of the incoming GRE packet and the key value configured under the GRE tunnel is identified, the incoming packet is dropped.



### Note

- GRE tunnel key feature is supported only on Cisco ASR 9000 Enhanced Ethernet line cards. It is mandatory to have ingress and egress line cards as Enhanced Ethernet line cards.
- Either the same key or different keys can be configured under multiple GRE tunnels for a given router. However, more than one tunnel, having the same tunnel source and destination but a different tunnel key is not supported because the source and destination pair for various configured tunnels must be unique irrespective of the key value. Also, two tunnels with the same tunnel source and destination, but one tunnel being with key and the other tunnel being without key is not supported.
- Different traffic streams passing through the same GRE tunnel contains the same GRE key configured for that tunnel.
- Use the **tunnel key** command to configure the key value at both ends of a GRE tunnel.

The following figure shows a simple representation of the GRE tunnel key configuration:

**Figure 11: GRE Tunnel with Key**

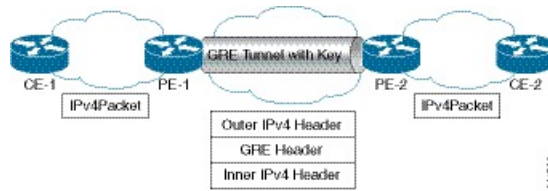

The following figure shows the complete format of the GRE header with the key field:

**Figure 12: GRE Header**

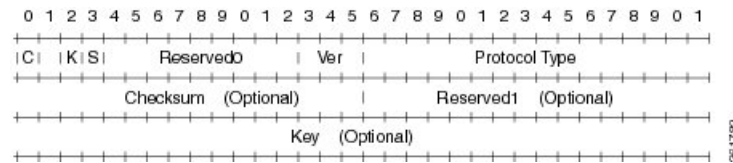

## GRE Tunnel Key-Ignore

If a GRE key is configured on only one endpoint router of a GRE tunnel, the other router that has no GRE key configured discards any incoming tunnel packet that has a GRE key. To enable this router to ignore GRE keys and accept incoming data plane packets on the GRE tunnel, run the **tunnel key-ignore** command. Control plane packets over a GRE tunnel are accepted only if there is no GRE tunnel key configured on both the tunnel endpoints or both the endpoints are configured with a GRE key and the control plane packet passes the GRE key validation. Hence, in the above scenario, both the routers discard any incoming control plane packets from the GRE tunnel.



**Note** Do not configure a GRE key on the GRE tunnel endpoint router if you have configured the router to ignore GRE keys. Configuring a GRE key overrides the **tunnel key-ignore** command and thus cancels the skipping of GRE key validation. This results in the router accepting from the incoming tunnel traffic only those packets that have the matching GRE key.

## GRE tunnel in VRF domains

You can configure an IPv4/IPv6 GRE tunnel between two interfaces that belong to a Virtual Forwarding and Routing (VRF) instance. This contains or limits the tunnel path within this specific VRF instance. For example, packets can be sent internally within a default or non-default VRF instance separated through an intermediate VRF that contains the GRE tunnel.



Figure 13: GRE tunnel in a VRF instance

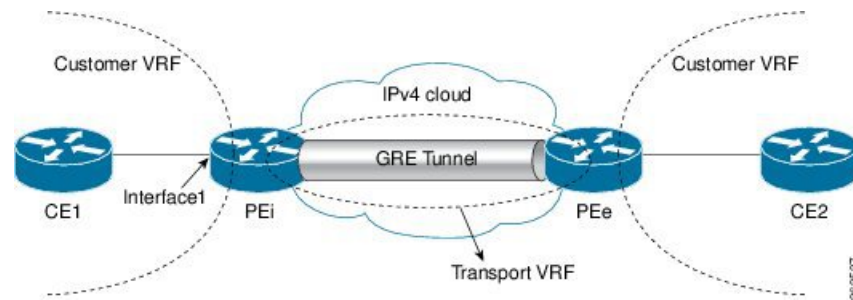

In the above topology, a GRE tunnel is configured in the core network, which is an IPv4 cloud. For packets entering through Interface1, the provider edge (PE) devices PEi and PEe are the tunnel head and tunnel exit respectively.

The VRF configured on Interface1 is the customer VRF. Packets entering this interface are routed using this customer VRF to the tunnel. The routing by the customer VRF is called inner IP packet routing. You can configure the tunnel to be visible to the customer VRF instance using the `vrf vrf-name` command. This enables only the configured VRF instance to use the tunnel, that is, forward traffic from PEi into this tunnel and also receive all incoming PEi tunnel packets.

The VRF configured on the tunnel using the `tunnel vrf` command is the transport VRF. The packet entering the tunnel is encapsulated with the tunnel source and destination addresses. The transport VRF routes this encapsulated payload between the tunnel endpoints. The routing by the transport VRF is the outer IP packet routing. If no transport VRF is configured for the tunnel, the PEi device looks up the tunnel endpoint addresses in the default VRF instance, that is, the global routing table.

## Restrictions on a GRE tunnel

The following restrictions are applicable for a GRE tunnel:

- GRE over BVI is not supported.
- MPLS packets cannot be transported within an IPv6 GRE tunnel. Therefore, the following features are not supported on an IPv6 GRE tunnel:
  - MPLS/L3VPN over GRE
  - 6PE/6VPE
  - 6PE/6VPE over GRE
- Multicast packets cannot be transported within an IPv6 GRE tunnel.
- Multicast packets cannot be transported within an IPv4 GRE tunnel that is configured in a transport VRF.
- Keep-Alive packets are not supported on an IPv6 GRE tunnel. You can use the Bidirectional Forwarding Detection (BFD) protocol to detect link failures in an IPv6 GRE tunnel.
- The IPv4 addresses are mandatory for configuring GRE tunnels under the VRF, as this would ensure the traffic flows through the tunnel in an expected manner. Use either an IP unnumbered interface or a loopback interface belonging to that VRF for establishing the GRE tunnels under a VRF. Though the tunnel may come up without the aforementioned configuration, the traffic may not pass over the GRE tunnel, since the IP information on the tunnel interface is not available for forwarding the traffic correctly.

Also, for the VRF information to be written in hardware database the IP information is required. Therefore, the IP unnumbered GRE tunnels may not work as expected as they may not forward traffic on the device.

## GRE IPv4/IPv6 Transport Over MPLS

The Generic Routing Encapsulation (GRE) IPv4/IPv6 transport over Multiprotocol Label Switching (MPLS) feature provides a mechanism to configure GRE tunnels, where the tunnel destination IPv4/IPv6 address is reachable through an MPLS label switched path (LSP). With this feature, IPv4, IPv6, routing protocols - OSPF, ISIS, and L2VPN and L3VPN packets are accepted as payload packets for GRE encapsulation. IPv4/IPv6 is supported as the GRE delivery protocol.

This feature overcomes the restriction of not being able to configure the tunnel destination endpoint through an MPLS LSP during tunnel configuration.

The GRE IPv4/IPv6 transport over MPLS feature facilitates creation of GRE tunnels over LSPs, through L3VPN inter-AS (autonomous system) options:

- External Border Gateway Protocol (EBGP) redistribution of labeled VPN IPv4/IPv6 routes from an AS to a neighboring AS.
- Multi-hop EBGP redistribution of labeled VPN IPv4/IPv6 routes between source and destination ASs, with EBGP redistribution of labeled IPv4/IPv6 routes from an AS to a neighboring AS.

Multipoint GRE IPv4/IPv6 transport over MPLS is also supported.

The GRE IPv4/IPv6 transport over MPLS feature is supported on the following types of Cisco ASR 9000 line cards:

- Cisco ASR 9000 Enhanced Ethernet line card
- Cisco ASR 9000 High Density 100GE Ethernet line card

### Limitations

- GRE IPv4/IPv6 transport over MPLS-TE tunnels is not supported.
- GREoMPLS with IP Fast Reroute (IPFRR).

## How to Configure Generic Routing Encapsulation

### Configuring a GRE Tunnel

Perform this task to configure a GRE tunnel.

#### SUMMARY STEPS

1. **configure**
2. **interface tunnel-ip** *number*
3. **vrf** *vrf-name*

4. **ipv4 address** *ipv4-address mask*
5. **tunnel mode gre** { *ipv4* | *ipv6* }
6. **tunnel source** { *ip-address* | **type** *path-id* }
7. **tunnel destination** *ip-address*
8. **tunnel vrf** *transport-vrf-name*
9. Use the **commit** or **end** command.

## DETAILED STEPS

---

### Step 1 **configure**

#### Example:

```
RP/0/RSP0/CPU0:router# configure
```

Enters the Global Configuration mode.

### Step 2 **interface tunnel-ip** *number*

#### Example:

```
RP/0/RSP0/CPU0:router(config)# interface tunnel-ip 4000
```

Enters tunnel interface configuration mode.

- *number* is the number associated with the tunnel interface.

### Step 3 **vrf** *vrf-name*

#### Example:

```
RP/0/RSP0/CPU0:router(config-if)# vrf vrf1
```

(Optional) Specifies the VRF domain that can route packets into and from the tunnel.

**Note** This step is not required if the tunnel is available for global routing and therefore, is not specific to a VRF.

### Step 4 **ipv4 address** *ipv4-address mask*

#### Example:

```
RP/0/RSP0/CPU0:router(config-if)# ipv4 address 10.1.1.1 255.255.255.0
```

Specifies the IPv4 address and subnet mask for the interface.

- *ipv4-address* specifies the IP address of the interface.
- *subnet-mask* specifies the subnet mask of the interface.

### Step 5 **tunnel mode gre** { *ipv4* | *ipv6* }

**Example:**

```
RP/0/RSP0/CPU0:router(config-if)# tunnel mode gre ipv4
```

Specify whether the transport network is an IPv4 or IPv6 network. The default GRE tunnel mode is IPv4.

**Note** The tunnel source and destination addresses should match the tunnel mode. A mismatch in configuration causes the tunnel to fail without any error message.

**Step 6** **tunnel source** { *ip-address* | **type** *path-id* }**Example:**

```
RP/0/RSP0/CPU0:router(config-if)# tunnel source TenGigE0/2/0/1
```

Specifies the source of the tunnel interface.

**Note** It is recommended that the tunnel source is identified using the interface ID and not the IP address. Using the interface ID enables the router to mark the tunnel as down when the interface is down and the routing protocol tries to find and use an alternate route to the tunnel route.

**Step 7** **tunnel destination** *ip-address***Example:**

```
RP/0/RSP0/CPU0:router(config-if)# tunnel destination 145.12.5.2
```

Defines the tunnel destination.

**Step 8** **tunnel vrf** *transport-vrf-name***Example:**

```
RP/0/RSP0/CPU0:router(config-if)# tunnel vrf vrf99
```

(Optional) Associates the transport VRF with the tunnel. The transport VRF contains the interfaces over which the tunnel sends as well as receives packets (outer IP packet routing).

**Note** This step is not required if the tunnel endpoints belong to the global routing table.

**Step 9** Use the **commit** or **end** command.

**commit** - Saves the configuration changes and remains within the configuration session.

**end** - Prompts user to take one of these actions:

- **Yes** - Saves configuration changes and exits the configuration session.
- **No** - Exits the configuration session without committing the configuration changes.
- **Cancel** - Remains in the configuration mode, without committing the configuration changes.

## Configuring the Tunnel Key

Perform this task to configure the tunnel key for the GRE encapsulated packets. You need to perform same configuration steps on the other endpoint router of the tunnel ensuring that the key value is the same at both the local and remote GRE interfaces.

### SUMMARY STEPS

1. **configure**
2. **interface tunnel-ip** *number*
3. **ipv4 address** *ipv4-address subnet-mask*
4. **tunnel key** *value*
5. (Optional) **tunnel tos** *tos-value*
6. **tunnel source** *type path-id*
7. **tunnel destination** *ip-address*
8. Use the **commit** or **end** command.

### DETAILED STEPS

---

**Step 1** **configure****Example:**

```
RP/0/RSP0/CPU0:router# configure
```

Enters the Global Configuration mode.

**Step 2** **interface tunnel-ip** *number***Example:**

```
RP/0/RSP0/CPU0:router(config)# interface tunnel-ip 10
```

Enters tunnel interface configuration mode.

- *number* is the number associated with the tunnel interface.

**Step 3** **ipv4 address** *ipv4-address subnet-mask***Example:**

```
RP/0/RSP0/CPU0:router(config-if)# ipv4 address 101.0.9.1 255.255.255.0
```

Specifies the IPv4 address and subnet mask for the interface.

- *ipv4-address* specifies the IP address of the interface.
- *subnet-mask* specifies the subnet mask of the interface.

**Step 4** **tunnel key** *value*

**Example:**

```
RP/0/RSP0/CPU0:router(config-if)# tunnel key 10
```

Enables tunnel key.

**Step 5** (Optional) **tunnel tos** *tos-value***Example:**

```
RP/0/RSP0/CPU0:router(config-if)# tunnel tos 96
```

Specifies the value of the TOS field in the tunnel encapsulating packets.

**Step 6** **tunnel source** *type path-id***Example:**

```
RP/0/RSP0/CPU0:router(config-if)# tunnel source Loopback10
```

Specifies the source of the tunnel interface.

**Step 7** **tunnel destination** *ip-address***Example:**

```
RP/0/RSP0/CPU0:router(config-if)# tunnel destination 33.0.9.33
```

Defines the tunnel destination.

**Step 8** Use the **commit** or **end** command.

**commit** - Saves the configuration changes and remains within the configuration session.

**end** - Prompts user to take one of these actions:

- **Yes** - Saves configuration changes and exits the configuration session.
- **No** - Exits the configuration session without committing the configuration changes.
- **Cancel** - Remains in the configuration mode, without committing the configuration changes.

## Configuring the Tunnel Key-Ignore

Perform this task to configure the tunnel key-ignore for the GRE encapsulated packets. You need to perform same configuration steps on the other endpoint router of the tunnel.

### SUMMARY STEPS

1. **configure**
2. **interface tunnel-ip** *number*
3. **ipv4 address** *ipv4-address subnet-mask*

4. **tunnel key-ignore**
5. *(Optional)* **tunnel tos tos-value**
6. **tunnel source type path-id**
7. **tunnel destination ip-address**
8. Use the **commit** or **end** command.

## DETAILED STEPS

---

### Step 1 **configure**

#### Example:

```
RP/0/RSP0/CPU0:router# configure
```

Enters the Global Configuration mode.

### Step 2 **interface tunnel-ip number**

#### Example:

```
RP/0/RSP0/CPU0:router(config)# interface tunnel-ip 10
```

Enters tunnel interface configuration mode.

- number is the number associated with the tunnel interface.

### Step 3 **ipv4 address ipv4-address subnet-mask**

#### Example:

```
RP/0/RSP0/CPU0:router(config-if)# ipv4 address 101.0.9.1 255.255.255.0
```

Specifies the IPv4 address and subnet mask for the interface.

- ipv4-address specifies the IP address of the interface.
- subnet-mask specifies the subnet mask of the interface.

### Step 4 **tunnel key-ignore**

#### Example:

```
RP/0/RSP0/CPU0:router(config-if)# tunnel key-ignore
```

Enables tunnel key-ignore.

### Step 5 *(Optional)* **tunnel tos tos-value**

#### Example:

```
RP/0/RSP0/CPU0:router(config-if)# tunnel tos 96
```

Specifies the value of the TOS field in the tunnel encapsulating packets.

**Step 6** `tunnel source` *type path-id***Example:**

```
RP/0/RSP0/CPU0:router(config-if)# tunnel source Loopback10
```

Specifies the source of the tunnel interface.

**Step 7** `tunnel destination` *ip-address***Example:**

```
RP/0/RSP0/CPU0:router(config-if)# tunnel destination 33.0.9.33
```

Defines the tunnel destination.

**Step 8** Use the **commit** or **end** command.

**commit** - Saves the configuration changes and remains within the configuration session.

**end** - Prompts user to take one of these actions:

- **Yes** - Saves configuration changes and exits the configuration session.
- **No** - Exits the configuration session without committing the configuration changes.
- **Cancel** - Remains in the configuration mode, without committing the configuration changes.

## Configuring a VRF Interface

Perform this task to configure a VRF interface.

### SUMMARY STEPS

1. **configure**
2. **interface** *type interface-path-id*
3. **vrf** *vrf-name*
4. **ipv4 address** *ipv4-address mask*
5. Use the **commit** or **end** command.

### DETAILED STEPS

**Step 1** `configure`**Example:**

```
RP/0/RSP0/CPU0:router# configure
```

Enters the Global Configuration mode.

**Step 2** `interface` *type interface-path-id***Example:**



```
RP/0/RSP0/CPU0:router(config)# interface tunnel-ip 100
```

Enters interface configuration mode.

**Step 3** `vrf vrf-name`

**Example:**

```
RP/0/RSP0/CPU0:router(config-if)# vrf vrf_A
```

Configures a VRF instance and enters VRF configuration mode.

**Step 4** `ipv4 address ipv4-address mask`

**Example:**

```
RP/0/RSP0/CPU0:router(config-if)# ipv4 address 192.168.1.27 255.255.255.0
```

Configures a primary IPv4 address for the specified interface.

**Step 5** Use the **commit** or **end** command.

**commit** - Saves the configuration changes and remains within the configuration session.

**end** - Prompts user to take one of these actions:

- **Yes** - Saves configuration changes and exits the configuration session.
- **No** - Exits the configuration session without committing the configuration changes.
- **Cancel** - Remains in the configuration mode, without committing the configuration changes.

---

## Configuring VRF Routing Protocol

Perform this task to configure the VRF routing protocol.

### SUMMARY STEPS

1. **configure**
2. **router ospf** *process-name*
3. **vrf** *vrf-name*
4. **router-id** {*router-id* | *type interface-path-id*}
5. **area** *area-id*
6. **interface** *type interface-path-id*
7. Use the **commit** or **end** command.

### DETAILED STEPS

---

**Step 1** **configure**

**Example:**

```
RP/0/RSP0/CPU0:router# configure
```

Enters the Global Configuration mode.

**Step 2** **router ospf** *process-name*

**Example:**

```
RP/0/RSP0/CPU0:router(config)# router ospf 109
```

Enters OSPF configuration mode allowing you to configure the OSPF routing process.

**Step 3** **vrf** *vrf-name*

**Example:**

```
RP/0/RSP0/CPU0:router(config-ospf)# vrf vrf_1
```

Configures a VPN routing and forwarding (VRF) instance and enters VRF configuration mode for OSPF routing.

**Step 4** **router-id** {*router-id* | *type interface-path-id*}

**Example:**

```
RP/0/RSP0/CPU0:router(config-ospf-vrf)# router-id 172.20.10.10
```

Configures the router ID for the OSPF routing process.

**Step 5** **area** *area-id*

**Example:**

```
RP/0/RSP0/CPU0:router(config-ospf-vrf)# area 0
```

Configures the OSPF area as area 0.

**Step 6** **interface** *type interface-path-id*

**Example:**

```
RP/0/RSP0/CPU0:router(config-ospf-vrf-ar)# interface GigabitEthernet 0/3/0/0
```

Associates interface GigabitEthernet 0/3/0/0 with area 0.

**Step 7** Use the **commit** or **end** command.

**commit** - Saves the configuration changes and remains within the configuration session.

**end** - Prompts user to take one of these actions:

- **Yes** - Saves configuration changes and exits the configuration session.
- **No** - Exits the configuration session without committing the configuration changes.

- **Cancel** - Remains in the configuration mode, without committing the configuration changes.

---

## Configuring IGP for Remote PE Reachability

Perform this task to configure IGP for remote PE reachability.

### SUMMARY STEPS

1. **configure**
2. **router ospf** *process-name*
3. **router-id** {*router-id*}
4. **area** *area-id*
5. **interface tunnel-ip** *number*
6. Use the **commit** or **end** command.

### DETAILED STEPS

---

#### Step 1 **configure**

**Example:**

```
RP/0/RSP0/CPU0:router# configure
```

Enters the Global Configuration mode.

#### Step 2 **router ospf** *process-name*

**Example:**

```
RP/0/RSP0/CPU0:router(config)# router ospf 1
```

Enables OSPF routing for the specified routing process and places the router in router configuration mode.

#### Step 3 **router-id** {*router-id*}

**Example:**

```
RP/0/RSP0/CPU0:router(config-ospf)# router-id 1.1.1.1
```

Configures a router ID for the OSPF process.

**Note** We recommend using a stable IP address as the router ID.

#### Step 4 **area** *area-id*

**Example:**

```
RP/0/RSP0/CPU0:router(config-ospf)# area 0
```

Enters area configuration mode and configures an area for the OSPF process.

**Step 5** `interface tunnel-ip number`**Example:**

```
RP/0/RSP0/CPU0:router(config-ospf-ar)# interface tunnel-ip 4
```

Enters tunnel interface configuration mode.

- number is the number associated with the tunnel interface.

**Step 6** Use the **commit** or **end** command.

**commit** - Saves the configuration changes and remains within the configuration session.

**end** - Prompts user to take one of these actions:

- **Yes** - Saves configuration changes and exits the configuration session.
- **No** - Exits the configuration session without committing the configuration changes.
- **Cancel** - Remains in the configuration mode, without committing the configuration changes.

## Configuring LDP on GRE Tunnel

Perform this task to configure LDP on a GRE tunnel.

### SUMMARY STEPS

1. **configure**
2. **mpls ldp**
3. **router-id** *{router-id}*
4. **interface tunnel-ip number**
5. Use the **commit** or **end** command.

### DETAILED STEPS

**Step 1** `configure`**Example:**

```
RP/0/RSP0/CPU0:router# configure
```

Enters the Global Configuration mode.

**Step 2** `mpls ldp`**Example:**

```
RP/0/RSP0/CPU0:router(config)# mpls ldp
```

Enables MPLS LDP configuration mode.

**Step 3** `router-id {router-id}`

**Example:**

```
RP/0/RSP0/CPU0:router(config-ldp)# router-id 1.1.1.1
```

Configures a router ID for the OSPF process.

**Note** We recommend using a stable IP address as the router ID.

**Step 4** **interface tunnel-ip** *number***Example:**

```
RP/0/RSP0/CPU0:router(config-ldp)# interface tunnel-ip 4
```

Enters tunnel interface configuration mode.

- *number* is the number associated with the tunnel interface.

**Step 5** Use the **commit** or **end** command.

**commit** - Saves the configuration changes and remains within the configuration session.

**end** - Prompts user to take one of these actions:

- **Yes** - Saves configuration changes and exits the configuration session.
- **No** - Exits the configuration session without committing the configuration changes.
- **Cancel** - Remains in the configuration mode, without committing the configuration changes.

---

## Configuring MP-iBGP to Exchange VPN-IPv4 Routes

Perform this task to configure MP-iBGP to exchange VPN-IPv4 routes.

### SUMMARY STEPS

1. **configure**
2. **router bgp** *as-number*
3. **router-id** *ip-address*
4. **neighbor** *ip-address*
5. **remote-as** *as-number*
6. **update-source** *type interface-path-id*
7. **address-family** { **vpn4** | **vpn6 unicast** }
8. Use the **commit** or **end** command.

### DETAILED STEPS

**Step 1** **configure****Example:**

```
RP/0/RSP0/CPU0:router# configure
```

Enters the Global Configuration mode.

**Step 2** `router bgp as-number`

**Example:**

```
RP/0/RSP0/CPU0:router(config)# router bgp 1
```

Specifies the autonomous system number and enters the BGP configuration mode, allowing you to configure the BGP routing process.

**Step 3** `router-id ip-address`

**Example:**

```
RP/0/RSP0/CPU0:router(config-bgp)# router-id 1.1.1.1
```

Configures the local router with a specified router ID.

**Step 4** `neighbor ip-address`

**Example:**

```
RP/0/RSP0/CPU0:router(config-bgp)# neighbor 4.4.4.4
```

Places the router in neighbor configuration mode for BGP routing and configures the neighbor IP address as a BGP peer.

**Step 5** `remote-as as-number`

**Example:**

```
RP/0/RSP0/CPU0:router(config-bgp-nbr)#remote-as 1
```

Creates a neighbor and assigns a remote autonomous system number to it.

**Step 6** `update-source type interface-path-id`

**Example:**

```
RP/0/RSP0/CPU0:router(config-bgp-nbr)#update-source Loopback0
```

Allows sessions to use the primary IP address from a specific interface as the local address when forming a session with a neighbor.

**Step 7** `address-family { vpn4 | vpn6 unicast }`

**Example:**

```
RP/0/RSP0/CPU0:router(config-bgp-nbr)# address-family vpn4 unicast
```

Enters address family configuration submode for the specified address family.

**Step 8** Use the `commit` or `end` command.

**commit** - Saves the configuration changes and remains within the configuration session.

**end** - Prompts user to take one of these actions:

- **Yes** - Saves configuration changes and exits the configuration session.
- **No** - Exits the configuration session without committing the configuration changes.
- **Cancel** - Remains in the configuration mode, without committing the configuration changes.

---

## Configuration Examples for Generic Routing Encapsulation

This section provides examples to configure GRE:

### Configuring an IPv4 GRE Tunnel: Example

This example shows how to configure an IPv4 GRE tunnel:

```
configure
interface tunnel-ip1
  ipv4 address 12.0.0.1 255.255.255.0
  tunnel source Loopback0
  tunnel destination 200.200.200.1
end
```

### Configuring an IPv6 GRE Tunnel: Example

```
interface tunnel-ip 1
  vrf RED
  ipv4 address 10.1.1.2/24
  ipv6 address 10::2/64
  tunnel mode gre ipv6
  tunnel source GigabitEthernet 0/0/0/0
  tunnel destination 100::1
  tunnel vrf BLUE
!
```

### Verifying GRE tunnel Configuration: Example

```
vrf blue
description connected to IXIA in blue VRF
address-family ipv4 unicast
  import route-target
  100:1
  !
  export route-target
100:1
!

vrf red
description connected to core interface in red VRF
address-family ipv4 unicast
  import route-target
  200:1
  !
  export route-target
200:1
```

```

!

interface tunnel-ip1
 vrf blue
 ipv4 address 10.10.10.1 255.255.255.0
 tunnel source Loopback0
 keepalive
 tunnel vrf red
 tunnel destination 12.12.12.12

RP/0/RSP0/CPU0:ios#ping vrf red 12.12.12.12
Type escape sequence to abort.
Sending 5, 100-byte ICMP Echos to 12.12.12.12, timeout is 2 seconds:
!!!!
Success rate is 100 percent (5/5), round-trip min/avg/max = 1/1/2 ms

RP/0/RSP0/CPU0:ios#ping vrf blue 10.10.10.1
Type escape sequence to abort.
Sending 5, 100-byte ICMP Echos to 10.10.10.1, timeout is 2 seconds:
!!!!
Success rate is 100 percent (5/5), round-trip min/avg/max = 1/4/19 ms

```

## Configuring Global VRF: Example

This example shows how to configure global VRF:

```

configure
 vrf VRF1
  address-family ipv4 unicast
  import route-target 120:1
  export route-target 120:2
exit
exit
router bgp120
 vrf VRF1
  rd auto
end

```

## Configuring a VRF Interface: Example

This example shows how to configure a VRF interface:

```

configure
 interface tunnel-ip 100
  vrf VRF1
  ipv4 address 1.1.1.1 255.255.255.0
  ipv6 address 100::2/64
end

```

## Configuring VRF Routing Protocol: Example

This example shows how to configure VRF routing protocol:



```
configure
router ospf109
vrf VRF1
router-id 172.20.10.10
area0
interface GigabitEthernet0/3/0/0
end
```

## Configuring IGP for Remote PE Reachability: Example

This example shows how to configure IGP for remote provider edge (PE) reachability:

```
configure
router ospf109
router-id 172.20.10.10
area0
interface tunnel-ipl
end
```

## Configuring LDP on GRE Tunnel: Example

This example shows how to configure LDP on a GRE tunnel:

```
configure
mpls ldp
router-id 172.20.10.10
interface tunnel-ipl
end
```

## Configuring MP-iBGP to Exchange VPN-IPv4 Routes: Example

This example shows how to configure MP-iBGP to exchange VPN-IPv4 routes:

```
configure
router bgp100
router-id 172.20.10.10
neighbor 2.2.2.2 remote-as 100
update-source Loopback0
address-family vpnv4 unicast
end
```





## CHAPTER 5

# Implementing VXLAN

This module provides configuration information for layer 3 VXLAN on Cisco ASR 9000 Series Router. For conceptual information on VXLAN, see *Implementing VXLAN* chapter in the *L2VPN and Ethernet Services Configuration Guide for Cisco ASR 9000 Series Routers*.

**Table 2: Feature History for VXLAN**

Release	Modification
Release 5.2.0	This feature was introduced on Cisco ASR 9000 Series Router.

- [Configuring a Layer 3 VXLAN gateway, on page 119](#)
- [Configuration Example for Implementing Layer 3 VXLAN Gateway, on page 123](#)

## Configuring a Layer 3 VXLAN gateway

A layer 3 VXLAN gateway provides routing between VXLAN segment and any other network segment such as VXLAN, VLAN or L3VPN. The following sections show how to configure an ASR 9000 series router as a Layer 3 VXLAN gateway between a VLAN and a VXLAN segment in different networks.

### Prerequisites

The following are the prerequisites to configuring a Cisco ASR 9000 series router as a VXLAN Layer 2 gateway:

- Configure a loopback interface. It serves as a source interface for the local VTEP.
- Configure unicast reachability to remote VTEPs.
- Configure Bidirectional Protocol Independent Multicast (Bidir PIM) or PIM Sparse Mode. For more information, see the *Multicast Configuration Guide for Cisco ASR 9000 Series Routers*.

### Restrictions

Consider the following restrictions while configuring VXLAN:

- You configure VXLAN only on Overlay Transport Virtualization (OTV) and VXLAN UDP ports.

- The source interface can only be a loopback interface.
- You cannot share a VNI or a multicast group or a source interface across multiple NVE interfaces.
- The VNI range and the multicast range both can only be specified contiguously. A non-contiguous range with comma separated values is not supported.
- The VNI to multicast group mapping can be only either 1:1 or N:1. For example,
  - The "member vni 5000 mcast-group 239.1.1.1" command configures a valid 1:1 mapping.
  - The "member vni 5000-5005 mcast-group 239.1.1.1" command configures a valid N:1 mapping.
- When a VNI is configured as a part of a VNI range, it can be modified or deleted only as part of the same range. For example, if the "member vni 5000-5002 mcast-group 239.1.1.1" command is configured, you cannot disassociate just the VNI 5001 from the NVE interface with a "no member vni 5001" command.
- Static MAC configuration is not supported.
- You can configure a maximum of 128k Layer 2 and Layer 3 sub-interfaces per system. The configuration can be a combination of both Layer 2 sub-interfaces and Layer 3 sub-interfaces; or either fully Layer 2 sub-interfaces or Layer 3 sub-interfaces.

Though the system allows you to configure more than 128k sub-interfaces per system, you cannot use this configuration for services. Though the system displays a warning message on reaching the threshold of 128k sub-interfaces, the configuration is still applied. However, you cannot use this configuration for services.

## Creating and configuring the Network Virtualization Endpoint (NVE) interface

Perform this task to create an NVE interface and configure it as a VXLAN Tunnel EndPoint (VTEP) for VXLAN.

### SUMMARY STEPS

1. **interface nve** *nve-identifier*
2. **source-interface loopback** *loopback-interface-identifier*
3. **member vni** *vni\_number* [ *-end\_vni\_range* ] **mcast-group** *ip\_address* [ *end\_ip\_address\_range* ]
4. Use the **commit** or **end** command.

### DETAILED STEPS

---

**Step 1** **interface nve** *nve-identifier*

**Example:**

```
RP/0/RSP0/CPU0:router(config)# interface nve 1
```

Creates the NVE interface and enters the NVE interface configuration sub-mode.

**Step 2** **source-interface loopback** *loopback-interface-identifier*

**Example:**

```
RP/0/RSP0/CPU0:router(config-if)# source-interface loopback 1
```

Sets a loopback interface as the source interface for the VTEP.

**Step 3** `member vni vni_number [ -end_vni_range ] mcast-group ip_address [ end_ip_address_range ]`

**Example:**

```
RP/0/RSP0/CPU0:router(config-if)# member vni 1-10 mcast-group 224.2.2.2
```

Associates a single VxLAN or a contiguous range of VxLANs with the NVE interface using their VxLAN Network Identifiers (VNIs) and specifies a multicast address or a contiguous multicast address range associated with these VNIs.

**Note** The mapping between the VNIs and the multicast groups is either one-to-one or many-to-one.

**Step 4** Use the **commit** or **end** command.

**commit** - Saves the configuration changes and remains within the configuration session.

**end** - Prompts user to take one of these actions:

- **Yes** - Saves configuration changes and exits the configuration session.
- **No** - Exits the configuration session without committing the configuration changes.
- **Cancel** - Remains in the configuration mode, without committing the configuration changes.

## Configuring the L3 bridge virtual interface

Perform this task to configure the IPv4 address for a bridge virtual interface for L3 routing.

### SUMMARY STEPS

1. `interface BVI BVI-identifier`
2. `ipv4 address ip-address {/prefix | subnet mask}`
3. Use the **commit** or **end** command.

### DETAILED STEPS

**Step 1** `interface BVI BVI-identifier`

**Example:**

```
RP/0/RSP0/CPU0:router(config)# interface BVI 1
```

Enters the bridge virtual interface configuration mode.

**Step 2** `ipv4 address ip-address {/prefix | subnet mask}`

**Example:**

```
RP/0/RSP0/CPU0:router(config-if)# ipv4 address 1.1.1.1 255.0.0.0
```

Sets the IPv4 address for the bridge virtual interface.

**Step 3** Use the **commit** or **end** command.

**commit** - Saves the configuration changes and remains within the configuration session.

**end** - Prompts user to take one of these actions:

- **Yes** - Saves configuration changes and exits the configuration session.
- **No** - Exits the configuration session without committing the configuration changes.
- **Cancel** - Remains in the configuration mode, without committing the configuration changes.

---

## Configuring a bridge domain

Perform this task to configure a bridge domain.

### SUMMARY STEPS

1. **l2vpn**
2. **bridge group** *bridge-group-name*
3. **bridge-domain** *bridge-domain-name*
4. **member vni** *vxlan-id*
5. **routed interface BVI** *BVI-id*
6. Use the **commit** or **end** command.

### DETAILED STEPS

---

#### Step 1 **l2vpn**

**Example:**

```
RP/0/RSP0/CPU0:router(config)# l2vpn
```

Enters the l2vpn configuration mode.

#### Step 2 **bridge group** *bridge-group-name*

**Example:**

```
RP/0/RSP0/CPU0:router(config-l2vpn)# bridge group bgroup1
```

Enters the bridge group configuration mode.

#### Step 3 **bridge-domain** *bridge-domain-name*

**Example:**

```
RP/0/RSP0/CPU0:router(config-l2vpn-bg)# bridge-domain bdomain1
```

Enters the bridge domain configuration mode.

#### Step 4 **member vni** *vxlan-id*

**Example:**

```
RP/0/RSP0/CPU0:router(config-l2vpn-bg-bd)# member vni 10
```

Associates a member VNI with the bridge domain.

#### Step 5 **routed interface BVI** *BVI-id*

**Example:**

```
RP/0/RSP0/CPU0:router(config-l2vpn-bg-bd)# routed interface BVI 1
```

Sets the bridge virtual interface for the bridge domain.

**Step 6** Use the **commit** or **end** command.

**commit** - Saves the configuration changes and remains within the configuration session.

**end** - Prompts user to take one of these actions:

- **Yes** - Saves configuration changes and exits the configuration session.
- **No** - Exits the configuration session without committing the configuration changes.
- **Cancel** - Remains in the configuration mode, without committing the configuration changes.

## Configuration Example for Implementing Layer 3 VXLAN Gateway

The following example shows layer 3 VXLAN gateway configuration on two Provider Edge (PE) routers, R1 and R2, from a sample network topology that has the core network simplified as a bundle link connection between the PE routers.

**Figure 14: Network with Layer 3 VXLAN Gateways**

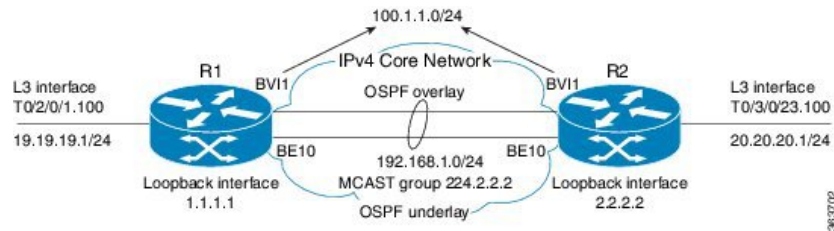

### Configuration at R1:

```
interface Bundle-Ether10
  ipv4 address 192.168.1.1/24
  !
interface Loopback0
  ipv4 address 1.1.1.1/32
  !
interface T0/2/0/1
  no shut
  !
interface T0/2/0/1.100
  encapsulation dot1q 100
  ipv4 address 19.19.19.1/24
  !
interface BVI1
  ipv4 address 100.1.1.1 255.255.255.0
  ipv6 address 100::1/64
  !
router ospf underlay
  router-id 1.1.1.1
  area 0
    interface Bundle-Ether10
    interface Loopback0
  !
Interface nve 1
  member vni 1 mcast-group 224.2.2.2 0.0.0.0
  overlay-encapsulation vxlan
```

```

    source-interface Loopback0
  !
router ospf overlay
  area 0
    interface bvi1
  interface T0/2/0/1.100
  !
l2vpn
  bridge group vxlan
  bridge-domain vxlan
    routed interface BVI1
  member vni 1
  !
multicast-routing
  address-family ipv4
    interface loopback0
      enable
    interface Bundle-Ether10
      enable
  !
router pim
  address-family ipv4
    rp-address 1.1.1.1 bidir

```

**Configuration at R2:**

```

interface Bundle-Ether10
  ipv4 address 192.168.1.2/24
  !
interface Loopback0
  ipv4 address 2.2.2.2/32
  !
interface T0/3/0/23
  no shut
  !
interface T0/3/0/23.100
  encapsulation dot1q 100
  ipv4 address 20.20.20.1/24
  !
interface BVI1
  ipv4 address 100.1.1.2 255.255.255.0
  ipv6 address 100::2/64
router ospf underlay
  router-id 2.2.2.2
  area 0
    interface Bundle-Ether10
    interface Loopback0
  !
Interface nve 1
  member vni 1 mcast-group 224.2.2.2 0.0.0.0
  overlay-encapsulation vxlan
  source-interface Loopback0
  !
router ospf overlay
  area 0
    interface bvi1
    interface T0/3/0/23.100
  !
l2vpn
  bridge group vxlan
  bridge-domain vxlan
    routed interface BVI1
  member vni 1
  !
multicast-routing

```



```
address-family ipv4
  interface loopback0
    enable
  interface Bundle-Ether10
    enable
!
router pim
  address-family ipv4
    rp-address 1.1.1.1 bidir
```





## CHAPTER 6

# Implementing IP in IP Tunnel

This chapter module provides conceptual and configuration information for IP in IP tunnels on Cisco ASR 9000 Series Router.



**Note** For a complete description of the IP in IP tunnel commands listed in this chapter, see the *VPN and Ethernet Services Command Reference for Cisco ASR 9000 Series Routers*.

**Table 3: Feature History for IP in IP tunnel**

Release	Modification
Release 5.3.1	This feature was introduced on Cisco ASR 9000 Series Router.

- [IP in IP Tunneling, on page 127](#)
- [Configuring IP in IP Tunnel, on page 128](#)
- [IP in IP Tunneling: Examples, on page 129](#)

## IP in IP Tunneling

IP in IP tunneling refers to the encapsulation of an IP packet as a payload in another IP packet. ASR9K routers support IP in IP tunnels with all possible combinations of IPv4 and IPv6; that is, IPv4 over IPv4, IPv6 over IPv4, IPv4 over IPv6, and IPv6 over IPv6. For example, an IPv4 over IPv6 refers to an IPv4 packet as a payload encapsulated within an IPv6 packet and routed across an IPv6 network to reach the destination IPv4 network, where it is decapsulated.

IP in IP tunneling does not require any additional header such as a GRE header used in the GRE tunnels. So, IP in IP tunneling is preferred over GRE tunnels if both the networks are IP networks.

## Restrictions

The following are not supported in IP in IP tunnels:

- MPLS
- Multicast packets

- Keep-Alive packets
- Path MTU (Maximum Transmission Unit) discovery
- DF (Do not Fragment) bit configuration in IPv6 tunnel mode.



**Note** If DF bit is configured for the tunnel interface, you cannot enable IPv6 tunnel mode.

## Configuring IP in IP Tunnel

Perform the following steps to configure an IP in IP tunnel.

### SUMMARY STEPS

1. **configure**
2. **interface tunnel-ip** *tunnel-id*
3. **{ipv4 | ipv6} address** *ip-address*
4. **tunnel mode** *{ipv4 | ipv6}*
5. **tunnel source** *{interface-id | ipv4/v6-address}*
6. **tunnel destination** *ipv4/v6-address*
7. (Optional) **tunnel df-bit** *{copy | disable}*
8. (Optional) **tunnel tos** *tos-value*
9. Use the **commit** or **end** command.

### DETAILED STEPS

	Command or Action	Purpose
<b>Step 1</b>	<b>configure</b> <b>Example:</b> RP/0/RSP0/CPU0:router# configure	Enters the Global Configuration mode.
<b>Step 2</b>	<b>interface tunnel-ip</b> <i>tunnel-id</i> <b>Example:</b> RP/0/RSP0/CPU0:router(config)# interface tunnel-ip 1	Creates a tunnel interface and enters the tunnel configuration sub-mode. The <i>tunnel-id</i> is the numeric identifier for the tunnel interface.
<b>Step 3</b>	<b>{ipv4   ipv6} address</b> <i>ip-address</i> <b>Example:</b> RP/0/RSP0/CPU0:router(config-if)# ipv6 address 10::1/64	Sets the IPv4 or IPv6 address, as required, for the tunnel interface.

	Command or Action	Purpose
Step 4	<b>tunnel mode</b> { <i>ipv4</i>   <i>ipv6</i> } <b>Example:</b> RP/0/RSP0/CPU0:router(config-if)# tunnel mode ipv6	Sets the tunnel mode as IPv4 or IPv6. This states the tunnel is in an IPv4 or IPv6 transport network.
Step 5	<b>tunnel source</b> { <i>interface-id</i>   <i>ipv4/v6-address</i> } <b>Example:</b> RP/0/RSP0/CPU0:router(config-if)# tunnel source GigabitEthernet0/0/0/0	Specifies an IP address or an interface that serves as the tunnel source. The encapsulated packet uses this IP address as the source address. If the tunnel mode is set to IPv4 or IPv6, an IPv4 or IPv6 address is selected as a tunnel source address from the specified source interface respectively.
Step 6	<b>tunnel destination</b> <i>ipv4/v6-address</i> <b>Example:</b> RP/0/RSP0/CPU0:router(config-if)# tunnel destination 100::2	Specifies the destination IP address for the tunnel. The encapsulated packet uses this IP address as the destination address.
Step 7	<i>(Optional)</i> <b>tunnel df-bit</b> { <i>copy</i>   <i>disable</i> } <b>Example:</b> RP/0/RSP0/CPU0:router(config-if)# tunnel df-bit disable	<p><b>Note</b> This is valid only for a tunnel that uses an IPv4 transport network.</p> <p>Configures the DF bit value for the outer IP packet. For details on this <b>tunnel df-bit</b> command, see the <i>VPN and Ethernet Services Command Reference for Cisco ASR 9000 Series Routers</i>.</p>
Step 8	<i>(Optional)</i> <b>tunnel tos</b> <i>tos-value</i> <b>Example:</b> RP/0/RSP0/CPU0:router(config-if)# tunnel tos 1	Sets the TOS value for the outer IP packet in the tunnel. For details on this <b>tunnel tos</b> command, see the <i>VPN and Ethernet Services Command Reference for Cisco ASR 9000 Series Routers</i> .
Step 9	Use the <b>commit</b> or <b>end</b> command.	<p><b>commit</b> —Saves the configuration changes and remains within the configuration session.</p> <p><b>end</b> —Prompts user to take one of these actions:</p> <ul style="list-style-type: none"> <li>• <b>Yes</b> — Saves configuration changes and exits the configuration session.</li> <li>• <b>No</b> —Exits the configuration session without committing the configuration changes.</li> <li>• <b>Cancel</b> —Remains in the configuration session, without committing the configuration changes.</li> </ul>

## IP in IP Tunneling: Examples

The following examples provide configurations for an IPv4 or IPv6 tunnel, with the transport VRF as the default VRF for the following simplified network topology.

Figure 15: IP in IP tunnel network topology

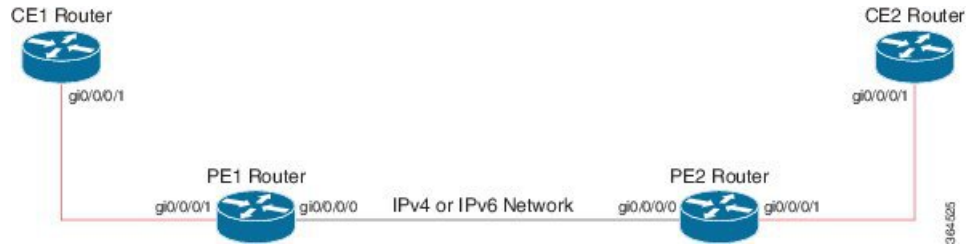

Configuration example for an IPv4 tunnel

<pre> PE1 Router Configuration interface GigabitEthernet0/0/0/0 !! Link between PE1-PE2 ipv4 address 100.1.1.1/64 ! interface GigabitEthernet0/0/0/1 !! Link between CE1-PE1 ipv4 address 20.1.1.1/24 ipv6 address 20::1/64 ! interface tunnel-ip 1 ipv4 address 10.1.1.1/24 ipv6 address 10::1/64 tunnel mode ipv4 tunnel source GigabitEthernet0/0/0/0 tunnel destination 100.1.1.2 !  router static address-family ipv4 unicast  30.1.1.0/24 tunnel-ip1 address-family ipv6 unicast  30::0/64 tunnel-ip1 ! ! !         </pre>	<pre> PE2 Router Configuration interface GigabitEthernet0/0/0/0 !! Link between PE1-PE2 ipv4 address 100.1.1.2/64 ! interface GigabitEthernet0/0/0/1 !! Link between PE2-CE2 ipv4 address 30.1.1.1/24 ipv6 address 30::1/64 ! interface tunnel-ip 1 ipv4 address 10.1.1.2/24 ipv6 address 10::2/64 tunnel mode ipv4 tunnel source GigabitEthernet0/0/0/0 tunnel destination 100.1.1.1 !  router static address-family ipv4 unicast  20.1.1.0/24 tunnel-ip1 address-family ipv6 unicast  20::0/64 tunnel-ip1 ! ! !         </pre>
<pre> CE1 Router Configuration interface GigabitEthernet0/0/0/1 !! Link between CE1-PE1 ipv4 address 20.1.1.2 255.255.255.0 ipv6 address 20::2/64 ! router static address-family ipv4 unicast  30.1.1.0/24 20.1.1.1 address-family ipv6 unicast  30::0/64 20::1 ! ! !         </pre>	<pre> CE2 Router Configuration interface GigabitEthernet0/0/0/1 !! Link between CE2-PE2 ipv4 address 30.1.1.2 255.255.255.0 ipv6 address 30::2/64 ! router static address-family ipv4 unicast  20.1.1.0/24 30.1.1.1 address-family ipv6 unicast  20::0/64 30::1 ! ! !         </pre>

Configuration example for an IPv6 tunnel

<pre> PE1 Router Configuration         </pre>	<pre> PE2 Router Configuration         </pre>
---	---

<pre> interface GigabitEthernet0/0/0/0 !! Link between PE1-PE2 ipv6 address 100::1/64 ! interface GigabitEthernet0/0/0/1 !! Link between CE1-PE1 vrf RED ipv4 address 20.1.1.1/24 ipv6 address 20::1/64 ! interface tunnel-ip 1 vrf RED ipv4 address 10.1.1.1/24 ipv6 address 10::1/64 tunnel mode ipv6 tunnel source GigabitEthernet0/0/0/0 tunnel destination 100::2 ! vrf RED address-family ipv6 unicast import route-target 2:1 ! export route-target 2:1 ! address-family ipv4 unicast import route-target 2:1 ! export route-target 2:1 ! router static vrf RED address-family ipv4 unicast 30.1.1.0/24 tunnel-ip1 address-family ipv6 unicast 30::0/64 tunnel-ip1 ! ! ! </pre>	<pre> interface GigabitEthernet0/0/0/0 !! Link between PE1-PE2 ipv6 address 100::2/64 ! interface GigabitEthernet0/0/0/1 !! Link between PE2-CE2 vrf RED ipv4 address 30.1.1.1/24 ipv6 address 30::1/64 ! interface tunnel-ip 1 vrf RED ipv4 address 10.1.1.2/24 ipv6 address 10::2/64 tunnel mode ipv6 tunnel source GigabitEthernet0/0/0/0 tunnel destination 100::1 ! vrf RED address-family ipv6 unicast import route-target 2:1 ! export route-target 2:1 ! address-family ipv4 unicast import route-target 2:1 ! export route-target 2:1 ! router static vrf RED address-family ipv4 unicast 20.1.1.0/24 tunnel-ip1 address-family ipv6 unicast 20::0/64 tunnel-ip1 ! ! ! </pre>
CE1 Router Configuration	CE2 Router Configuration
<pre> interface GigabitEthernet0/0/0/1 !! Link between CE1-PE1 ipv4 address 20.1.1.2 255.255.255.0 ipv6 address 20::2/64 ! router static address-family ipv4 unicast 30.1.1.0/24 20.1.1.1 address-family ipv6 unicast 30::0/64 20::1 ! ! ! </pre>	<pre> interface GigabitEthernet0/0/0/1 !! Link between CE2-PE2 ipv4 address 30.1.1.2 255.255.255.0 ipv6 address 30::2/64 ! router static address-family ipv4 unicast 20.1.1.0/24 30.1.1.1 address-family ipv6 unicast 20::0/64 30::1 ! ! ! </pre>







## CHAPTER 7

# Implementing DCI VXLAN Layer 3 Gateway

This chapter module provides conceptual and configuration information for Data Center Interconnect (DCI) VXLAN Layer 3 Gateway on Cisco ASR 9000 Series Router.

Release	Modification
Release 5.3.2	This feature was introduced.
Release 6.1.x	<ul style="list-style-type: none"><li>• OpFlex</li></ul>

- [Prerequisites for Implementing Data Center Interconnect Layer 3 Gateway](#), on page 133
- [Data Center Interconnect VXLAN Layer 3 Gateway](#), on page 134
- [Configure Data Center Interconnect Router](#), on page 136
- [Example: Data Center Interconnection Layer 3 Gateway Configuration](#), on page 155
- [OpFlex](#), on page 157
- [OpFlex Topology](#), on page 157
- [Restrictions](#), on page 157
- [Configure OpFlex](#), on page 158
- [EVPN Default VRF Route Leaking](#), on page 169
- [EVPN Service VRF Route Leaking](#), on page 177

## Prerequisites for Implementing Data Center Interconnect Layer 3 Gateway

- You must be in a user group associated with a task group that includes the proper task IDs. The command reference guides include the task IDs required for each command. If you suspect user group assignment is preventing you from using a command, contact your AAA administrator for assistance.
- You need to have understanding of the following features:
  - **VxLAN:** For detailed conceptual and configuration information, see the chapters *Implementing Layer 2 VxLAN Gateway* and *Implementing Layer 3 VxLAN Gateway* in *Cisco ASR 9000 Series Aggregation Services Router L2VPN and Ethernet Services Configuration Guide* and *Cisco ASR 9000 Series Aggregation Services Router MPLS Layer 3 VPN Configuration Guide*.

- MP-BGP: For detailed conceptual and configuration information, see the chapter *Implementing BGP* in the *Cisco ASR 9000 Series Aggregation Services Router Routing Configuration Guide*.
- MPLS L3VPN: For detailed conceptual and configuration information, see the *Cisco ASR 9000 Series Aggregation Services Router MPLS Layer 3 VPN Configuration Guide*.

## Data Center Interconnect VXLAN Layer 3 Gateway

The Cisco ASR 9000 Series Router can serve as a Data Center Interconnect (DCI) L3 Gateway to provide IP connectivity between multi-tenant remote Data Center sites. Consider the following network topology, which has two Data Center sites connected through the intermediate Service Provider network. The multi-tenant Data Centers use VXLAN encapsulation to carry separate tenant IP traffic. The VXLAN-enabled Data Center sites use MP-BGP EVPN control plane for distributing both Layer-2 and Layer-3 forwarding information within the site. The RFC 5512 and *draft-ietf-bess-evpn-inter-subnet-forwarding-00* define how MP-BGP Network Layer Reachability Information (NLRI) carries VXLAN encapsulation as well as L2/L3 forwarding information details to provide an integrated routing and bridging solution within the Data Center site. The Cisco ASR 9000 Series Router uses MPLS L3VPN application service over the Service Provider network to provide L3 connectivity between the two Data Center sites.



**Note** DCI Gateway does not provide layer 2 inter-connectivity across Data Centers.

**Figure 16: Data Center Interconnect Layer 3 Gateway**

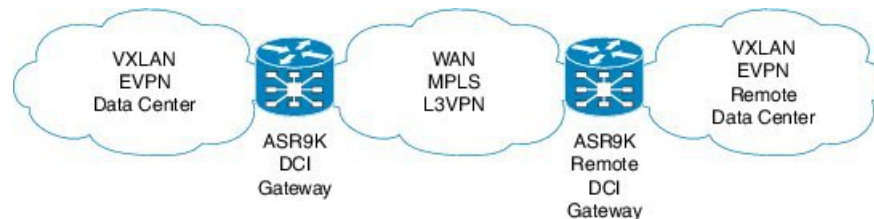

The Cisco ASR 9000 Series Router functions as a Data Center Interconnect (DCI) gateway by intermediating between the two MP-BGP control planes, one on the Data Center site and the other on the MPLS L3VPN network. To enable this exchange of forwarding information between the two MP-BGP control planes, the DCI router has a VRF instance configured with two sets of import and export route-targets. One set of import/export route targets is associated with the Data Center BGP neighbor router that uses MP-BGP EVPN with route type 5 NLRI to exchange VXLAN encapsulation and L3 routing information with the DCI router. The other set of import/export route-targets is associated with the L3VPN BGP neighbor in the service provider network that uses VPNv4 or VPNv6 address-family to exchange L3 and MPLS information. The DCI router exchanges the IP prefixes in VRF instance as L3VPN NLRIs with the L3VPN BGP neighbor and as EVPN NLRIs with the EVPN BGP neighbor and thus, effectively stitches these two sets of route targets. This enables the DCI router to convert the received Data Center EVPN forwarding information into VPNv4 or VPNv6 routes that, in turn, is to be forwarded to the remote DCI router and vice versa. The remote DCI router connected to the remote Data Center performs same functions. This enables L3 connectivity between two hosts located across remote Data Center sites. The DCI Gateway enables tenant Layer 3 data traffic movement across remote Data Centers by stitching the per-tenant VXLAN encapsulation in the DCI Gateway router to the per-tenant MPLS encapsulation in L3VPN service provider network.

The DCI L3 Gateway can be configured on the Provider Edge (PE) router or a Data Center router that connects to the WAN. The WAN network can be any VRF-deployed network configured with any control plane protocol. For example, a VRF-lite WAN network configured with an IGP.



**Note** In a DCI deployment, for route reoriginate with stitching-rt for a particular VRF, using the same Route Distinguisher (RD) between ASR9K DCI and MPLS-VPN PE or same RD between ASR9K DCI and VxLAN Top of Rack (ToR) is not supported.

## Route Targets

For each VRF on the DCI router, there are two sets of manually configured import and export route-targets. One set of import and export route-targets is associated with the Data Center BGP neighbor that uses EVPN address-family to exchange L3 information; the other set of import and export route-targets is associated with the L3VPN BGP neighbor that use VPNv4 or VPNv6 unicast address-family to exchange L3 information. This separation of route targets (RTs) enables the two sets of RTs to be independently configured. The DCI router effectively stitches the two set of RTs. The RTs associated with the EVPN BGP neighbor are labelled as stitching RTs. The RTs associated with the L3VPN BGP neighbor are normal RTs.

## Route Re-origination

Consider the case of control plane information propagation by the DCI from the L3VPN side to the Data Center side. Here, instead of advertising the remote Data Center's original BGP EVPN routes, you can configure the DCI router to advertise to its BGP EVPN neighbor the routes that are re-originated after importing them from the L3VPN BGP neighbor. For this case of VPNv4 or VPNv6 routes being propagated to the BGP EVPN neighbors (Data Center neighbors), re-originating the routes refers to replacing the normal route-targets with the local route-target values associated with the BGP EVPN neighbors. The converse holds true for the routing information traffic propagation from the BGP EVPN control plane to BGP L3VPN control plane. You can configure this re-origination by using the re-originate keyword in the **import re-originate** command. Configuring this command, by default, also enables advertisement of L2VPN EVPN prefixes to the EVPN BGP neighbors. You can suppress native L2VPN EVPN address-family NLRI advertisements towards the EVPN Neighbor using the **advertise l2vpn evpn disable** command under the EVPN BGP address-family configuration mode.

## Route Address-Family and Encoded Address-Family

When an address-family is configured for a BGP neighbor, it means that the specified address-family routes encoded with the NLRI for that address-family is advertised to the neighbor. This does not hold for data center BGP neighbors because they use only EVPN address-family. Here, BGP neighbors advertise VPNv4 or VPNv6 unicast routes using the EVPN NLRI encoding. Thus, here the encoded address-family and route address family can be possibly different. You can advertise the VPNv4 or VPNv6 address-family using the **advertise vpnv4 unicast** or **advertise vpnv6 unicast** command. For example, a EVPN address-family BGP neighbor configured with the **advertise vpnv4 unicast** command sends VPNv4 unicast routes in an EVPN encoded NLRI.

## Local VPNv4 or VPNv6 Routes Advertisement

On the DCI router, the locally sourced VPNv4 or VPNv6 routes can be advertised to the BGP EVPN neighbors with the normal route targets (RTs) configured for the VRF or the stitching RTs associated with the BGP EVPN neighbors. By default, these routes are advertised with the normal route targets. You can configure these local VPNv4 or VPNv6 route advertisements to be advertised with stitching RTs to the BGP EVPN neighbors by using the **advertise vpnv4 unicast local stitching-rt** or **advertise vpnv6 unicast local stitching-rt** command as required.

## Data Center VXLAN with Support for MP-BGP

The Data Center VXLAN uses MP-BGP for control-plane learning of end-host Layer 2 and Layer 3 reachability information. The DCI router is configured with a VXLAN Tunnel EndPoint (VTEP). For VTEP configuration details, see the chapter *Implementing Layer 3 VXLAN Gateway*. You also need to run the **host-reachability protocol bgp** command to specify that control-plane learning within Data center site is through BGP routing protocol.

The DCI Gateway router and the EVPN BGP neighbor (Data Center BGP neighbor) exchange BGP EVPN NLRIs of route type 5 that carry L3 routing information and associated VXLAN encapsulation information. Some of the VXLAN information is carried in the EVPN NLRI and the rest is carried in RFC 5512 Tunnel Type Encapsulation EXTCOMM and Router MAC EXTCOMM defined in *draft-ietf-bess-evpn-inter-subnet-forwarding-00*. BGP downloads VXLAN encapsulation as *RIB remote next hop opaque* attribute to L3RIB.

## Default-Originate Forwarding to BGP EVPN Neighbor

Instead of advertising the specific networks available in the remote Data Center, you can configure the DCI gateway to advertise a default route to the directly connected Data Center neighbor. To send the default route for a VRF instance to the Data Center BGP EVPN neighbor, the VPN default-originate information that is typically forwarded to the L3VPN BGP neighbor, is also configured to be forwarded to the BGP EVPN neighbor in the Data Center. To do so, you need to configure **allow vpn default-originate** command in the BGP VRF configuration mode and also configure **default-originate** command under EVPN BGP neighbor in L2VPN EVPN address-family configuration mode. This configures BGP to forward only one default route information for a VRF instance from the DCI Gateway to the BGP neighbor that has L2VPN EVPN address-family. This default route information is encoded in the EVPN "IP Prefix Route" NLRI.

With the advertisement of a default route to the connected Data Center, the DCI Gateway should not advertise specific prefixes of the remote Data Center to the BGP EVPN neighbor. To prevent forwarding of VRF prefixes, you need to configure the DCI gateway with a EVPN BGP neighbor policy that drops forwarding of all prefixes.

## Configure Data Center Interconnect Router

This section describes tasks to configure the Data Center Interconnect (DCI) router. Perform the following tasks to complete the configuration:

## Configure VRF and route targets import/export rules

Perform the following steps to configure VRF and define route targets to be used for import and export of forwarding information.

### SUMMARY STEPS

1. **configure**
2. **vrf** *vrf-name*
3. **address-family** { **ipv4** | **ipv6** } **unicast**
4. **import route-target** *route-target-id*
5. **export route-target** *route-target-id*
6. **import route-target** *route-target-id* **stitching**
7. **export route-target** *route-target-id* **stitching**
8. Use the **commit** or **end** command.

### DETAILED STEPS

	Command or Action	Purpose
Step 1	<b>configure</b> <b>Example:</b>  RP/0/RSP0/CPU0:router# configure	Enters global configuration mode.
Step 2	<b>vrf</b> <i>vrf-name</i> <b>Example:</b>  RP/0/RSP0/CPU0:router(config)# vrf data-center-10	Defines a VPN routing and forwarding (VRF) instance and enters VRF configuration mode.
Step 3	<b>address-family</b> { <b>ipv4</b>   <b>ipv6</b> } <b>unicast</b> <b>Example:</b>  RP/0/RSP0/CPU0:router(config-vrf-af)# address-family ipv4 unicast	Specifies either the IPv4 or IPv6 address family for the VRF instance and enters address family configuration submode.
Step 4	<b>import route-target</b> <i>route-target-id</i> <b>Example:</b>  RP/0/RSP0/CPU0:router(config-vrf-af)# import route-target 1:1	Configures importing of routes to the VRF from the L3VPN BGP NLRIs that have the matching route-target value.
Step 5	<b>export route-target</b> <i>route-target-id</i> <b>Example:</b>  RP/0/RSP0/CPU0:router(config-vrf-af)# export route-target 1:2	Configures exporting of routes from the VRF to the L3VPN BGP NLRIs and assigns the specified route-target identifiers to the L3VPN BGP NLRIs.

	Command or Action	Purpose
<b>Step 6</b>	<b>import route-target <i>route-target-id</i> stitching</b> <b>Example:</b> RP/0/RSP0/CPU0:router(config-vrf-af)# import route-target 10:1 stitching	Configures importing of routes from the EVPN BGP NLRI that have the matching route-target value.
<b>Step 7</b>	<b>export route-target <i>route-target-id</i> stitching</b> <b>Example:</b> RP/0/RSP0/CPU0:router(config-vrf-af)# export route-target 10:2 stitching	Configures exporting of routes from the VRF to the EVPN BGP NLRIs and assigns the specified route-target identifiers to the BGP EVPN NLRIs.
<b>Step 8</b>	Use the <b>commit</b> or <b>end</b> command.	<b>commit</b> —Saves the configuration changes and remains within the configuration session. <b>end</b> —Prompts user to take one of these actions: <ul style="list-style-type: none"> <li>• <b>Yes</b> — Saves configuration changes and exits the configuration session.</li> <li>• <b>No</b> —Exits the configuration session without committing the configuration changes.</li> <li>• <b>Cancel</b> —Remains in the configuration session, without committing the configuration changes.</li> </ul>

## Configure Bridge Domain for DCI Gateway

Perform the following steps to configure the bridge domain on the DCI Gateway.



### Note

For DCI VxLAN L3 Gateway, only "routed interface BVI" and "member vni" can be configured in the bridge-domain. All other L2 services such as EVI, PW, or AC are not supported in the bridge-domain.

### SUMMARY STEPS

1. **configure**
2. **interface bvi** *bvi-id*
3. **vrf** *vrf-id*
4. **ipv4 address** *ip-address subnet-mask*
5. **exit**
6. **l2vpn**
7. **bridge group** *bridge-group-identifier*
8. **bridge-domain** *bridge-group-identifier*
9. **routed interface** *interface-identifier*
10. **member vni** *vni-id*
11. Use the **commit** or **end** command.

## DETAILED STEPS

	Command or Action	Purpose
<b>Step 1</b>	<b>configure</b> <b>Example:</b>  RP/0/RSP0/CPU0:router# configure	Enters global configuration mode.
<b>Step 2</b>	<b>interface bvi</b> <i>bvi-id</i> <b>Example:</b>  RP/0/RSP0/CPU0:router(config)# interface bvi 1	Creates a BVI (Bridge Virtual Interface) with the user-defined identifier and enters the interface configuration mode.
<b>Step 3</b>	<b>vrf</b> <i>vrf-id</i> <b>Example:</b>  RP/0/RSP0/CPU0:router(config-if)# vrf cust1	Associates a VRF (Virtual Routing and Forwarding) instance to the BVI.
<b>Step 4</b>	<b>ipv4 address</b> <i>ip-address subnet-mask</i> <b>Example:</b>  RP/0/RSP0/CPU0:router(config-if)# ipv4 address 40.1.1.1 255.255.255.255	Creates an IPv4 address for the BVI.
<b>Step 5</b>	<b>exit</b> <b>Example:</b>  RP/0/RSP0/CPU0:router(config)# exit	Exits the interface configuration mode and returns to Global Configuration mode.
<b>Step 6</b>	<b>l2vpn</b> <b>Example:</b>  RP/0/RSP0/CPU0:router(config)# l2vpn	Enters the L2VPN configuration mode.
<b>Step 7</b>	<b>bridge group</b> <i>bridge-group-identifier</i> <b>Example:</b>  RP/0/RSP0/CPU0:router(config-l2vpn)# bridge group bg1	Configures a bridge group and enters the Bridge Group configuration mode.
<b>Step 8</b>	<b>bridge-domain</b> <i>bridge-group-identifier</i> <b>Example:</b>  RP/0/RSP0/CPU0:router(config-l2vpn-bg)# bridge-domain bd1	Configures a bridge domain and enters Bridge Domain configuration mode.
<b>Step 9</b>	<b>routed interface</b> <i>interface-identifier</i> <b>Example:</b>	Configures a BVI interface as a routing interface for the bridge domain.

	Command or Action	Purpose
	RP/0/RSP0/CPU0:router(config-l2vpn-bg-bd)# routed interface BVI1	
<b>Step 10</b>	<b>member vni</b> <i>vni-id</i>  <b>Example:</b>  RP/0/RSP0/CPU0:router(config-l2vpn-bg-bd)# member vni 5001	Assigns the bridge domain to a VxLAN segment.
<b>Step 11</b>	Use the <b>commit</b> or <b>end</b> command.	<b>commit</b> —Saves the configuration changes and remains within the configuration session.  <b>end</b> —Prompts user to take one of these actions: <ul style="list-style-type: none"> <li>• <b>Yes</b> — Saves configuration changes and exits the configuration session.</li> <li>• <b>No</b> —Exits the configuration session without committing the configuration changes.</li> <li>• <b>Cancel</b> —Remains in the configuration session, without committing the configuration changes.</li> </ul>

## Configure VTEP

Perform the following steps to configure VTEP (VxLAN Terminal EndPoint) on the DCI Gateway.

### SUMMARY STEPS

1. **configure**
2. **interface loopback** *loopback-id*
3. **ipv4 address** *ip-address subnet-mask*
4. **exit**
5. **interface nve** *nve-id*
6. **source interface loopback** *loopback-interface-identifier*
7. **member vni** *vni-id*
8. **vrf** *vrf-id*
9. **host reachability protocol bgp**
10. Use the **commit** or **end** command.

### DETAILED STEPS

	Command or Action	Purpose
<b>Step 1</b>	<b>configure</b>  <b>Example:</b>  RP/0/RSP0/CPU0:router# configure	Enters global configuration mode.



	Command or Action	Purpose
<b>Step 2</b>	<p><b>interface loopback</b> <i>loopback-id</i></p> <p><b>Example:</b></p> <pre>RP/0/RSP0/CPU0:router(config)# interface loopback 0</pre>	Creates a loopback interface with the user-defined loopback identifier and enters the interface configuration mode.
<b>Step 3</b>	<p><b>ipv4 address</b> <i>ip-address subnet-mask</i></p> <p><b>Example:</b></p> <pre>RP/0/RSP0/CPU0:router(config-if)# ipv4 address 40.1.1.1 255.255.255.255</pre>	Creates an IPv4 address for the loopback interface.
<b>Step 4</b>	<p><b>exit</b></p> <p><b>Example:</b></p> <pre>RP/0/RSP0/CPU0:router(config)# exit</pre>	Exits the interface configuration mode and returns to Global Configuration mode.
<b>Step 5</b>	<p><b>interface nve</b> <i>nve-id</i></p> <p><b>Example:</b></p> <pre>RP/0/RSP0/CPU0:router(config)# interface nve 1</pre>	Creates an NVE (Network Virtualization Endpoint) interface with the identifier and enters the interface configuration mode.
<b>Step 6</b>	<p><b>source interface loopback</b> <i>loopback-interface-identifier</i></p> <p><b>Example:</b></p> <pre>RP/0/RSP0/CPU0:router(config-if)# source interface loopback 0</pre>	Configures the loopback interface IP address as the source IP address for the NVE interface.
<b>Step 7</b>	<p><b>member vni</b> <i>vni-id</i></p> <p><b>Example:</b></p> <pre>RP/0/RSP0/CPU0:router(config-if)# member vni 5001</pre>	Configures the NVE interface under a VxLAN with VNI (VxLAN Network Identifier) 5001 and enters the NVE VNI configuration mode.
<b>Step 8</b>	<p><b>vrf</b> <i>vrf-id</i></p> <p><b>Example:</b></p> <pre>RP/0/RSP0/CPU0:router(config-nve-vni)# vrf cust1</pre>	Associates a VRF (Virtual Routing and Forwarding) instance to the VxLAN segment.
<b>Step 9</b>	<p><b>host reachability protocol bgp</b></p> <p><b>Example:</b></p> <pre>RP/0/RSP0/CPU0:router(config-nve-vni)# host reachability protocol bgp</pre>	Specifies BGP protocol as the control protocol for VxLAN VTEP end-host reachability.
<b>Step 10</b>	Use the <b>commit</b> or <b>end</b> command.	<p><b>commit</b> —Saves the configuration changes and remains within the configuration session.</p> <p><b>end</b> —Prompts user to take one of these actions:</p>

	Command or Action	Purpose
		<ul style="list-style-type: none"> <li>• <b>Yes</b> — Saves configuration changes and exits the configuration session.</li> <li>• <b>No</b> —Exits the configuration session without committing the configuration changes.</li> <li>• <b>Cancel</b> —Remains in the configuration session, without committing the configuration changes.</li> </ul>

## Configure EVPN BGP neighbor and route advertisements

Perform this task on the DCI router to configure BGP neighbor relationship and route advertisements with the EVPN BGP neighbor.

### SUMMARY STEPS

1. **configure**
2. **router bgp** *asn-id*
3. **address-family l2vpn evpn**
4. **exit**
5. **neighbor** *neighbor-ip-address*
6. **remote-as** *remote-as-id*
7. **address-family l2vpn evpn**
8. *(Optional)* **default-originate**
9. **import stitching-rt reoriginate**
10. **advertise { vpnv4 | vpnv6 } unicast re-originated**
11. **advertise { vpnv4 | vpnv6 } unicast local stitching-rt**
12. *(Optional)* **advertise l2vpn evpn disable**
13. Use the **commit** or **end** command.

### DETAILED STEPS

	Command or Action	Purpose
<b>Step 1</b>	<b>configure</b> <b>Example:</b> RP/0/RSP0/CPU0:router# configure	Enters global configuration mode.
<b>Step 2</b>	<b>router bgp</b> <i>asn-id</i> <b>Example:</b> RP/0/RSP0/CPU0:router(config)# router bgp 100	Specifies the BGP AS number and enters the BGP configuration mode, allowing you to configure the BGP routing process.

	Command or Action	Purpose
<b>Step 3</b>	<b>address-family l2vpn evpn</b>  <b>Example:</b> RP/0/RSP0/CPU0:router(config-bgp)# address-family l2vpn evpn	Enables EVPN address family globally under BGP routing process and enters EVPN address family configuration submode.
<b>Step 4</b>	<b>exit</b>  <b>Example:</b> RP/0/RSP0/CPU0:router(config-bgp-af)# exit	Exits the EVPN address family configuration and returns to the BGP router configuration mode.
<b>Step 5</b>	<b>neighbor neighbor-ip-address</b>  <b>Example:</b> RP/0/RSP0/CPU0:router(config-bgp)# neighbor 1.1.1.1	Configures the specified neighbor IP address as a BGP peer and enters neighbor configuration mode for BGP routing.
<b>Step 6</b>	<b>remote-as remote-as-id</b>  <b>Example:</b> RP/0/RSP0/CPU0:router(config-bgp-nbr)# remote-as 100	Specifies the autonomous system identifier of the BGP neighbor.
<b>Step 7</b>	<b>address-family l2vpn evpn</b>  <b>Example:</b> RP/0/RSP0/CPU0:router(config-bgp-nbr)# address-family l2vpn evpn	Enables EVPN address family under BGP routing process and enters EVPN address family configuration submode.
<b>Step 8</b>	<b>(Optional) default-originate</b>  <b>Example:</b> RP/0/RSP0/CPU0:router(config-bgp-nbr)# default-originate	<b>(Optional)</b> Configures advertisement of a default route instead of specific prefixes to the BGP EVPN neighbor.
<b>Step 9</b>	<b>import stitching-rt reoriginate</b>  <b>Example:</b> RP/0/RSP0/CPU0:router(config-bgp-nbr-af)# import stitching-rt reoriginate	Enables import of routing information from BGP EVPN NLRIs that has route target identifier matching the stitching route target identifier and exports this routing information after re-origination to the L3VPN BGP neighbor.
<b>Step 10</b>	<b>advertise { vpnv4   vpnv6 } unicast re-originated</b>  <b>Example:</b> RP/0/RSP0/CPU0:router(config-bgp-nbr-af)# advertise vpnv4 unicast re-originated	Configures advertisement of VPNv4 or VPNv6 unicast routes that are redistributed from the L3VPN BGP neighbor, to the EVPN BGP neighbor. The route targets are changed to the stitching route targets before advertising onto the EVPN BGP neighbor.

	Command or Action	Purpose
<b>Step 11</b>	<b>advertise { vpnv4   vpnv6 } unicast local stitching-rt</b>  <b>Example:</b> <pre>RP/0/RSP0/CPU0:router(config-bgp-nbr-af)# advertise vpnv4 unicast local stitching-rt</pre>	Configures the local VPNv4 or VPNv6 unicast routes to be advertised with stitching route target identifiers to the EVPN BGP neighbor.
<b>Step 12</b>	<i>(Optional)</i> <b>advertise l2vpn evpn disable</b>  <b>Example:</b> <pre>RP/0/RSP0/CPU0:router(config-bgp-nbr-af)# advertise</pre>	Suppresses the advertisement of the L2VPN EVPN routes to the EVPN BGP neighbor. The step 7 <b>address-family l2vpn evpn</b> command, by default, causes the L2VPN EVPN routes to be advertised along with the VPNv4 or VPNv6 unicast routes received from the L3VPN BGP neighbor.
<b>Step 13</b>	Use the <b>commit</b> or <b>end</b> command.	<b>commit</b> —Saves the configuration changes and remains within the configuration session.  <b>end</b> —Prompts user to take one of these actions: <ul style="list-style-type: none"> <li>• <b>Yes</b> — Saves configuration changes and exits the configuration session.</li> <li>• <b>No</b> —Exits the configuration session without committing the configuration changes.</li> <li>• <b>Cancel</b> —Remains in the configuration session, without committing the configuration changes.</li> </ul>

## Configure L3VPN BGP neighbor relationship and route advertisements

Perform the following steps to configure BGP neighbor relationship and route advertisements with the L3VPN BGP neighbor.

### SUMMARY STEPS

1. **configure**
2. **router bgp *asn-id***
3. **address-family { vpnv4 | vpnv6 }**
4. **exit**
5. **neighbor *neighbor-ipv4/6-address***
6. **remote-as *remote-as-id***
7. **address-family { vpnv4 | vpnv6 }**
8. **import reoriginate stitching-rt**
9. **advertise { vpnv4 | vpnv6 } unicast re-originated**
10. Use the **commit** or **end** command.

## DETAILED STEPS

	Command or Action	Purpose
<b>Step 1</b>	<b>configure</b> <b>Example:</b> RP/0/RSP0/CPU0:router# configure	Enters global configuration mode.
<b>Step 2</b>	<b>router bgp <i>asn-id</i></b> <b>Example:</b> RP/0/RSP0/CPU0:router(config)# router bgp 100	Specifies the BGP AS number and enters the BGP configuration mode, allowing you to configure the BGP routing process.
<b>Step 3</b>	<b>address-family { <i>vpn4</i>   <i>vpn6</i> }</b> <b>Example:</b> RP/0/RSP0/CPU0:router(config-bgp-nbr)# address-family vpn4	Configures VPNv4 or VPNv6 address family for the global BGP routing process and enters VPNv4 or VPNv6 address family configuration mode.
<b>Step 4</b>	<b>exit</b> <b>Example:</b> RP/0/RSP0/CPU0:router(config-bgp-af)# exit	Exits the VPNv4 or VPNv6 address family configuration and returns to the BGP router configuration mode.
<b>Step 5</b>	<b>neighbor <i>neighbor-ipv4/6-address</i></b> <b>Example:</b> RP/0/RSP0/CPU0:router(config-bgp)# neighbor 1.1.1.1	Configures the specified neighbor IP address as a BGP peer and enters neighbor configuration mode for BGP routing.
<b>Step 6</b>	<b>remote-as <i>remote-as-id</i></b> <b>Example:</b> RP/0/RSP0/CPU0:router(config-bgp-nbr)# remote-as 100	Specifies the autonomous system identifier of the BGP neighbor.
<b>Step 7</b>	<b>address-family { <i>vpn4</i>   <i>vpn6</i> }</b> <b>Example:</b> RP/0/RSP0/CPU0:router(config-bgp-nbr)# address-family vpn4	Configures VPNv4 or VPNv6 address family for the BGP neighbor and enters VPNv4 or VPNv6 address family configuration mode.
<b>Step 8</b>	<b>import reoriginate stitching-rt</b> <b>Example:</b> RP/0/RSP0/CPU0:router(config-bgp-nbr-af)# import reoriginate stitching-rt	Configures import of routing information from the L3VPN BGP NLRIs that has route target identifier matching the normal route target identifier and exports this routing information after re-origination that assigns it with stitching route target identifier, to the BGP EVPN neighbor.

	Command or Action	Purpose
<b>Step 9</b>	<b>advertise { vpnv4   vpnv6 } unicast re-originated</b> <b>Example:</b> RP/0/RSP0/CPU0:router(config-bgp-nbr-af)# advertise vpnv4 unicast re-originated	Configures advertisement of VPNv4 or VPNv6 unicast routes that are redistributed from the EVPN BGP neighbor, to the L3VPN BGP neighbor. The route targets are changed to the normal route targets before advertising onto the L3VPN BGP neighbor.
<b>Step 10</b>	Use the <b>commit</b> or <b>end</b> command.	<b>commit</b> —Saves the configuration changes and remains within the configuration session. <b>end</b> —Prompts user to take one of these actions: <ul style="list-style-type: none"> <li>• <b>Yes</b> — Saves configuration changes and exits the configuration session.</li> <li>• <b>No</b> —Exits the configuration session without committing the configuration changes.</li> <li>• <b>Cancel</b> —Remains in the configuration session, without committing the configuration changes.</li> </ul>

## Verification of Data Center Gateway Configuration

These show commands can be used to verify the DCI Gateway configurations:

### SUMMARY STEPS

1. **show bgp l2vpn evpn**
2. **show bgp l2vpn evpn rd rd-id l2vpn-evpn-prefix detail**
3. **show bgp l2vpn evpn neighbors neighbor-ip-address detail**
4. **show bgp sessions**
5. **show bgp vpnv4 unicast**
6. **show bgp vpnv4 unicast rd-id vpnv4-prefix detail**
7. **show bgp vrf foo**
8. **show bgp vrf foo ipv4 unicast 100.1.1.1/32 detail**
9. **show bgp vpnv4 unicast update-group**
10. **show bgp l2vpn evpn update-group**

### DETAILED STEPS

	Command or Action	Purpose
<b>Step 1</b>	<b>show bgp l2vpn evpn</b> <b>Example:</b> RP/0/RSP0/CPU0:router# <b>show bgp l2vpn evpn</b> Fri Aug 21 00:24:10.773 PDT BGP router identifier 30.30.30.30, local AS number 100	Displays a summary of the BGP information advertised from the EVPN BGP neighbor.

	Command or Action	Purpose
	<pre> BGP generic scan interval 60 secs Non-stop routing is enabled BGP table state: Active Table ID: 0x0   RD version: 0 BGP main routing table version 16 BGP NSR Initial initsync version 1 (Reached) BGP NSR/ISSU Sync-Group versions 16/0 BGP scan interval 60 secs  Status codes: s suppressed, d damped, h history, * valid, &gt; best                 i - internal, r RIB-failure, S stale, N Nexthop-discard Origin codes: i - IGP, e - EGP, ? - incomplete Network        Next Hop          Metric LocPrf Weight Path Route Distinguisher: 100:1 *&gt;i[2][10000][48][0226.51bd.c81c][32][200::1001]/232                 11.0.0.1     100          0 i *&gt;i[2][10000][48][0226.51bd.c81c][32][200:1::1001]/232                 11.0.0.1     100          0 i *&gt;i[2][10000][48][0226.51bd.c81c][32][200.1.1.1]/136                 11.0.0.1     100          0 i *&gt;i[2][10000][48][0226.51bd.c81c][32][200.1.1.2]/136                 11.0.0.1     100          0 i *&gt;i[5][4231][32][100.1.1.1]/80                 11.0.0.1     100          0 i *&gt;i[5][4231][32][100.1.1.2]/80                 11.0.0.1     100          0 i *&gt;i[5][4231][112][fec0::1001]/176                 11.0.0.1     100          0 i *&gt;i[5][4232][112][fec0::1:1001]/176                 11.0.0.1     100          0 i  Processed 8 prefixes, 8 paths                     </pre>	
<p><b>Step 2</b></p>	<pre> <b>show bgp l2vpn evpn rd rd-id l2vpn-evpn-prefix detail</b>  <b>Example:</b>  RP/0/RSP0/CPU0:router# <b>show bgp l2vpn evpn rd 100:1 [5][4231][112][fec0::1001]/176 detail</b>  Fri Aug 21 00:34:43.747 PDT BGP routing table entry for [5][4231][112][fec0::1001]/176, Route Distinguisher: 100:1 Versions:   Process                bRIB/RIB  SendTblVer                     </pre>	<p>Displays detailed information for a specific prefix advertised from an EVPN BGP neighbor.</p>

	Command or Action	Purpose
	<pre> Speaker                    5          5   Flags: 0x04040001+0x00000000; Last Modified: Aug 21 00:16:58.000 for 00:17:46 Paths: (1 available, best #1)   Not advertised to any peer   Path #1: Received by speaker 0   Flags: 0x4000600025060005, import: 0x3f   Not advertised to any peer Local   11.0.0.1 (metric 2) from 20.0.0.1 (11.0.0.1)   Received Label 16001   Origin IGP, localpref 100, valid, internal, best, group-best, import-candidate, reoriginate, not-in-vrf   Received Path ID 0, Local Path ID 1, version 5   Extended community: Flags 0x2: Encapsulation Type:8 Router MAC:aabb.ccdd.eeff RT:65540:1 RT:40.40.40.40:1 RT:100:1   Originator: 11.0.0.1, Cluster list: 20.20.20.20   EVPN ESI: ffff.ffff.ffff.ffff.ff01, Gateway Address : fec0::254 </pre>	
<b>Step 3</b>	<p><b>show bgp l2vpn evpn neighbors <i>neighbor-ip-address</i> detail</b></p> <p><b>Example:</b></p> <pre> RP/0/RSP0/CPU0:router# show bgp l2vpn evpn neighbors 20.0.0.1 detail  Fri Aug 21 00:25:37.383 PDT  BGP neighbor is 20.0.0.1   Remote AS 100, local AS 100, internal link   Remote router ID 20.20.20.20   BGP state = Established, up for 00:08:58   NSR State: NSR Ready   Last read 00:00:34, Last read before reset 00:00:00   Hold time is 180, keepalive interval is 60 seconds   Configured hold time: 180, keepalive: 60, min acceptable hold time: 3   Last write 00:00:36, attempted 19, written 19   Second last write 00:01:36, attempted 143, written 143   Last write before reset 00:00:00, attempted 0, written 0   Second last write before reset 00:00:00, attempted 0, written 0   Last write pulse rcvd Aug 21 00:25:03.667 last full not set pulse count 33   Last write pulse rcvd before reset 00:00:00   Socket not armed for io, armed for read, armed for write   Last write thread event before reset 00:00:00, second last 00:00:00   Last KA expiry before reset 00:00:00, second </pre>	Displays a detailed information of the specified L2VPN EVPN BGP neighbor.



	Command or Action	Purpose
	<pre> last 00:00:00   Last KA error before reset 00:00:00, KA not sent 00:00:00   Last KA start before reset 00:00:00, second last 00:00:00   Precedence: internet   Non-stop routing is enabled   Entered Neighbor NSR TCP mode:     TCP Initial Sync :           Aug 21 00:18:07.291     TCP Initial Sync Phase Two :  Aug 21 00:18:07.319     TCP Initial Sync Done :       Aug 21 00:18:08.334   Multi-protocol capability received   Neighbor capabilities:         Adv Rcvd   Route refresh:                 Yes Yes   4-byte AS:                     Yes Yes   Address family VPNv4 Unicast:  Yes No   Address family VPNv6 Unicast:  Yes No   Address family L2VPN EVPN:     Yes Yes   Message stats:     InQ depth: 0, OutQ depth: 0                                 Last_Sent      Sent   Last_Rcvd                      Rcvd   Open:                           Aug 21 00:16:38.087    1 Aug 21 00:16:40.123                1   Notification: ---                      0 ---                                0   Update:                          Aug 21 00:24:01.421    9 Aug 21 00:24:03.652                13   Keepalive:                       Aug 21 00:25:01.434    8 Aug 21 00:25:03.667                9   Route_Refresh:                   Aug 21 00:24:01.377    3 ---                                0   Total:                            21                                 23   Minimum time between advertisement runs is 0 secs   Inbound message logging enabled, 3 messages buffered   Outbound message logging enabled, 3 messages buffered  For Address Family: VPNv4 Unicast   BGP neighbor version 35   Update group: 0.3 Filter-group: 0.1 No Refresh request being processed   Advertise Reorigination Enabled   Advertise AFI EoR can be sent   Route refresh request: received 0, sent 0   0 accepted prefixes, 0 are bestpaths   Cumulative no. of prefixes denied: 0.   Prefix advertised 4, suppressed 0, withdrawn 0   Maximum prefixes allowed 2097152   Threshold for warning message 75%, restart                     </pre>	

Command or Action	Purpose
<pre> interval 0 min   AIGP is enabled   An EoR was not received during read-only mode   Last ack version 35, Last synced ack version 35    Outstanding version objects: current 0, max 1   Additional-paths operation: None   Send Multicast Attributes    For Address Family: VPNv6 Unicast   BGP neighbor version 29   Update group: 0.3 Filter-group: 0.1 No Refresh   request being processed   Advertise Reorigination Enabled   Advertise AFI EoR can be sent   Route refresh request: received 0, sent 0   0 accepted prefixes, 0 are bestpaths   Cumulative no. of prefixes denied: 0.   Prefix advertised 0, suppressed 0, withdrawn 0   Maximum prefixes allowed 1048576   Threshold for warning message 75%, restart interval 0 min   AIGP is enabled   An EoR was not received during read-only mode   Last ack version 29, Last synced ack version 29    Outstanding version objects: current 0, max 0   Additional-paths operation: None   Send Multicast Attributes   Advertise VPNv4 routes enabled with   Reoriginate,Local with stitching-RT option    For Address Family: L2VPN EVPN   BGP neighbor version 18   Update group: 0.2 Filter-group: 0.1 No Refresh   request being processed   Route refresh request: received 0, sent 3   8 accepted prefixes, 8 are bestpaths   Cumulative no. of prefixes denied: 0.   Prefix advertised 4, suppressed 0, withdrawn 6   Maximum prefixes allowed 2097152   Threshold for warning message 75%, restart interval 0 min   AIGP is enabled   An EoR was received during read-only mode   Last ack version 18, Last synced ack version 18    Outstanding version objects: current 0, max 2   Additional-paths operation: None   Send Multicast Attributes   Advertise VPNv4 routes enabled with Reoriginate,   option   Advertise VPNv6 routes is enabled with   Reoriginate, option   Import Stitching is enabled for this neighbor   address-family   Import Reoriginate is enabled for this neighbor   address-family    Connections established 1; dropped 0   Local host: 30.0.0.1, Local port: 59405, IF   Handle: 0x00000000 </pre>	

	Command or Action	Purpose
	Foreign host: 20.0.0.1, Foreign port: 179 Last reset 00:00:00	
<b>Step 4</b>	<p><b>show bgp sessions</b></p> <p><b>Example:</b></p> <pre>RP/0/RSP0/CPU0:router# show bgp sessions  Fri Aug 21 00:25:57.216 PDT  Neighbor          VRF                Spk    AS   InQ  OutQ  NBRState    NSRState 20.0.0.1          default            0    100    0    0  Established  NSR Ready[PP] 32.0.0.2          default            0    200    0    0  Established  NSR Ready</pre>	Displays current BGP sessions.
<b>Step 5</b>	<p><b>show bgp vpnv4 unicast</b></p> <p><b>Example:</b></p> <pre>RP/0/RSP0/CPU0:router# show bgp vpnv4 unicast  Fri Aug 21 00:28:41.253 PDT BGP router identifier 30.30.30.30, local AS number 100 BGP generic scan interval 60 secs Non-stop routing is enabled BGP table state: Active Table ID: 0x0  RD version: 0 BGP main routing table version 39 BGP NSR Initial initsync version 4 (Reached) BGP NSR/ISSU Sync-Group versions 39/0 BGP scan interval 60 secs  Status codes: s suppressed, d damped, h history, * valid, &gt; best                 i - internal, r RIB-failure, S stale, N Nexthop-discard Origin codes: i - IGP, e - EGP, ? - incomplete   Network          Next Hop          Metric   LocPrf Weight Path Route Distinguisher: 1:1 *&gt; 1.1.1.0/24          32.0.0.2            0 200 300 i *&gt; 1.1.2.0/24          32.0.0.2            0 200 300 i Route Distinguisher: 30.30.30.30:0 (default for vrf foo) *&gt; 1.1.1.0/24          32.0.0.2            0 200 300 i *&gt; 1.1.2.0/24          32.0.0.2            0 200 300 i *&gt;i100.1.1.1/32        11.0.0.1            100 0 i *&gt;i100.1.1.2/32        11.0.0.1            100 0 i *&gt;i200.1.1.1/32        11.0.0.1</pre>	Displays summary information of unicast BGP prefixes. The <b>show bgp vpnv6 unicast</b> provides similar output information for IPv6 prefixes.

	Command or Action	Purpose
	<pre> 100      0 i *&gt;i200.1.1.2/32      11.0.0.1 100      0 i </pre>	
<b>Step 6</b>	<p><b>show bgp vpnv4 unicast rd-id vpnv4-prefix detail</b></p> <p><b>Example:</b></p> <pre> RP/0/RSP0/CPU0:router# show bgp vpnv4 unicast rd 30.30.30.30:0 1.1.1.0/24 detail  Fri Aug 21 00:28:57.824 PDT BGP routing table entry for 1.1.1.0/24, Route Distinguisher: 30.30.30.30:0 Versions:   Process          bRIB/RIB  SendTblVer   Speaker          26       26   Flags: 0x04103001+0x00000000; Last Modified: Aug 21 00:24:01.000 for 00:04:58 Paths: (1 available, best #1)   Advertised to peers (in unique update groups):     20.0.0.1   Path #1: Received by speaker 0   Flags: 0x4000c00005060001, import: 0x80   Advertised to peers (in unique update groups):     20.0.0.1 200 300   32.0.0.2 from 32.0.0.2 (40.40.40.40)     Received Label 24001     Origin IGP, localpref 100, valid, external, best, group-best, import-candidate, imported, reoriginated with stitching-rt     Received Path ID 0, Local Path ID 1, version 26     Extended community: RT:100:2     Source AFI: VPNv4 Unicast, Source VRF: default, Source Route Distinguisher: 1:1 </pre>	<p>Displays detailed information of specified VPNv4 prefixes. The <b>show bgp vpnv6 unicast</b> provides similar output information for VPNv6 prefixes.</p>
<b>Step 7</b>	<p><b>show bgp vrf foo</b></p> <p><b>Example:</b></p> <pre> RP/0/RSP0/CPU0:router# show bgp vrf foo  Fri Aug 21 00:24:36.523 PDT BGP VRF foo, state: Active BGP Route Distinguisher: 30.30.30.30:0 VRF ID: 0x60000002 BGP router identifier 30.30.30.30, local AS number 100 Non-stop routing is enabled BGP table state: Active Table ID: 0xe0000011 RD version: 35 BGP main routing table version 35 BGP NSR Initial initsync version 4 (Reached) BGP NSR/ISSU Sync-Group versions 31/0  Status codes: s suppressed, d damped, h history, * valid, &gt; best </pre>	<p>Displays summary information of prefixes in the specified VRF instance BGP table.</p>

	Command or Action	Purpose
	<pre> i - internal, r RIB-failure, S stale, N Nexthop-discard Origin codes: i - IGP, e - EGP, ? - incomplete Network          Next Hop          Metric LocPrf Weight Path Route Distinguisher: 30.30.30.30:0 (default for vrf foo) *&gt; 1.1.1.0/24          32.0.0.2           0 200 300 i *&gt; 1.1.2.0/24          32.0.0.2           0 200 300 i *&gt;i100.1.1.1/32        11.0.0.1           100    0 i *&gt;i100.1.1.2/32        11.0.0.1           100    0 i *&gt;i200.1.1.1/32        11.0.0.1           100    0 i *&gt;i200.1.1.2/32        11.0.0.1           100    0 i  Processed 6 prefixes, 6 paths                     </pre>	
<p><b>Step 8</b></p>	<p><b>show bgp vrf foo ipv4 unicast 100.1.1.1/32 detail</b></p> <p><b>Example:</b></p> <pre> RP/0/RSP0/CPU0:router# show bgp vrf foo ipv4 unicast 100.1.1.1/32 detail  Mon Dec  8 23:24:50.243 PST BGP routing table entry for 100.1.1.1/32, Route Distinguisher: 30.30.30.30:0 Versions:   Process          bRIB/RIB  SendTblVer   Speaker          43        43   Local Label: 24001 (with rewrite);   Flags: 0x05081001+0x00000200; Last Modified: Dec  8 18:04:21.000 for 05:20:30 Paths: (1 available, best #1)   Advertised to PE peers (in unique update groups):     32.0.0.2   Path #1: Received by speaker 0   Flags: 0x400061000d060005, import: 0x80   Advertised to PE peers (in unique update groups):     32.0.0.2   Local     11.0.0.1 (metric 2) from 20.0.0.1 (11.0.0.1)     Received Label 1234     Origin IGP, localpref 100, valid, internal, best, group-best, import-candidate, imported, reoriginated     Received Path ID 0, Local Path ID 1, version 43     Extended community: Encapsulation Type:8 Router MAC:aabb.ccdd.eeff RT:1:2   Originator: 11.0.0.1, Cluster list: 20.20.20.20   RIB RNH: table_id 0xe0000011, Encap 8, VNI                     </pre>	<p>Displays detailed information for a specified prefix in the specified VRF instance BGP table.</p>

	Command or Action	Purpose
	<pre> 1234, MAC Address: aabb.ccdd.eeff, IP Address: 11.0.0.1, IP table_id 0xe0000000   Source AFI: L2VPN EVPN, Source VRF: default,   Source Route Distinguisher: 100:1 </pre>	
<b>Step 9</b>	<p><b>show bgp vpnv4 unicast update-group</b></p> <p><b>Example:</b></p> <pre> RP/0/RSP0/CPU0:router# show bgp vpnv4 unicast update-group  Fri Aug 21 00:27:57.910 PDT  Update group for VPNv4 Unicast, index 0.1:   Attributes:     Outbound policy: pass     First neighbor AS: 200     Send communities     Send GSHUT community if originated     Send extended communities     4-byte AS capable     Send Re-originated VPN routes     Send multicast attributes     Minimum advertisement interval: 30 secs   Update group desynchronized: 0   Sub-groups merged: 0   Number of refresh subgroups: 0   Messages formatted: 8, replicated: 8   All neighbors are assigned to sub-group(s)     Neighbors in sub-group: 0.2, Filter-Groups num:1     Neighbors in filter-group: 0.2(RT num: 0)     32.0.0.2  Update group for VPNv4 Unicast, index 0.3:   Attributes:     Neighbor sessions are IPv4     Internal     Common admin     First neighbor AS: 100     Send communities     Send GSHUT community if originated     Send extended communities     4-byte AS capable     Send AIGP     Send Re-originated VPN routes     Send multicast attributes     Minimum advertisement interval: 0 secs   Update group desynchronized: 0   Sub-groups merged: 0   Number of refresh subgroups: 0   Messages formatted: 2, replicated: 2   All neighbors are assigned to sub-group(s)     Neighbors in sub-group: 0.1, Filter-Groups num:1     Neighbors in filter-group: 0.1(RT num: 0)     20.0.0.1 </pre>	<p>Displays update-group details for BGP VPNv4 unicast address-family.</p>

	Command or Action	Purpose
Step 10	<p><b>show bgp l2vpn evpn update-group</b></p> <p><b>Example:</b></p> <pre>RP/0/RSP0/CPU0:router# show bgp l2vpn evpn update-group  Fri Aug 21 00:27:42.786 PDT  Update group for L2VPN EVPN, index 0.2:   Attributes:     Neighbor sessions are IPv4     Internal     Common admin     First neighbor AS: 100     Send communities     Send GSHUT community if originated     Send extended communities     4-byte AS capable     Send AIGP     Send multicast attributes     Minimum advertisement interval: 0 secs     Update group desynchronized: 0     Sub-groups merged: 0     Number of refresh subgroups: 0     Messages formatted: 4, replicated: 4     All neighbors are assigned to sub-group(s)     Neighbors in sub-group: 0.1, Filter-Groups num:1     Neighbors in filter-group: 0.1(RT num: 0)     20.0.0.1</pre>	Displays update-group details for BGP L2VPN EVPN address-family.

## Example: Data Center Interconnection Layer 3 Gateway Configuration

The following configurations provide an example Data Center Interconnection (DCI) Layer 3 Gateway configuration.

### VTEP-related configuration

```
interface Loopback1
  ipv4 address 40.1.1.1 255.255.255.255
  !

interface nve1
  source-interface Loopback1
  member vni 1
  vrf cust1
  host-reachabilty protocol bgp
  !
interface BVI1
  vrf cust1
  ipv4 address 10.99.1.30 255.255.255.0
  ipv6 address 10:99:1::30/64
  !
```

```

l2vpn
 bridge group bg1
   bridge-domain bd1
     routed interface BV11
     member vni 1
   !
 !

```

### VRF-related configuration

```

vrf data-center-10
 import route-target 1:1
 export route-target 1:2
 import route-target 10:10 stitching
 export route-target 10:20 stitching

```

### Data Center EVPN BGP neighbor-related configuration

```

router bgp 1
 neighbor 1.1.1.1
   address-family l2vpn evpn
     import stitching-rt reoriginate
     advertise vpnv4 unicast reoriginated
     advertise vpnv6 unicast reoriginated
     advertise vpnv4 unicast local stitching-rt
     advertise vpnv6 unicast local stitching-rt
     advertise l2vpn evpn disable

```

### L3VPN BGP neighbor-related configuration

```

router bgp 2
 neighbor 10.10.10.10
   address-family vpnv4
     import reoriginate stitching-rt
     advertise vpnv4 unicast reoriginated

```

The following example configuration shows how to configure the DCI router to forward default route to its Data Center neighbor.

```

router bgp 1
 address-family vpnv4 unicast
 address-family vpnv6 unicast
 address-family l2vpn evpn
 exit
 neighbor 1.1.1.1
   address-family l2vpn evpn
   default-originate
   exit
 vrf foo
   rd 2:1
   address-family ipv4 unicast
   allow vpn default-originate
   exit
   address-family ipv6 unicast
   allow vpn default-originate
   exit
 exit
 !

```



# OpFlex

OpFlex is an open and extensible policy protocol used for transferring the policy information between a network policy controller such as the Cisco Application Policy Infrastructure Controller (APIC) and network elements such as routers that are configured as Data Center Interconnect (DCI) gateway. The policies are distributed using the Cisco® Application Centric Infrastructure (ACI) infrastructure within the fabric to the spine nodes. The spine nodes send policies to the DCI gateway through the OpFlex framework. An OpFlex framework resides between the spines and the DCIs. It enables the distribution of the DCI policy model from the fabric to the DCI gateways. DCI gateway acts as an OpFlex agent and the spine acts a policy repository. Fabric tenant interconnect (FTI) is the OpFlex agent application that runs on the DCI to generate and apply the tenant device configuration on the DCI. Policies configure the DCI service for a given tenant on the DCI gateway.

## OpFlex Topology

Consider the topology where OpFlex framework is used between the DCI gateway and the Cisco ACI spine switches to automate fabric-facing tenant provisioning on the DCI gateway. When you configure a new external Layer 3 outside (L3Out) policy for a tenant on the Cisco Application Policy Infrastructure Controller (APIC), the controller programs all related information associated with that tenant, such as VRF instance name and BGP extended community route-target attributes for the Cisco ACI spine switches. The OpFlex framework running on the spine switches reads the L3Out managed object and converts it to the OpFlex model. This information is then pushed to the DCI gateway, which acts as a policy element for the OpFlex framework. On the DCI, the fabric facing configuration for the tenant VFR is auto-generated.

**Figure 17: OpFlex Topology**

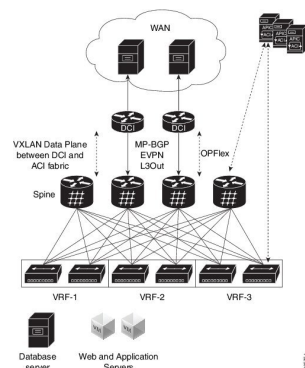

## Restrictions

The OpFlex feature is supported with the following restrictions:

- OpFlex feature is not supported on ASR9K with power PC based route-processor.
- FTI cannot generate configuration for multiple RTs of one address family in a tenant VRF provisioned in one fabric.

- On exhaustion of FTI configuration pools, the OpFlex notifications to add tenants are ignored. If existing tenants are deleted, the new tenants must be added again to enable OpFlex notifications to be re-sent to the DCI.
- FTI supports only Type 0 RT format: 2 byte ASN + 4 byte value. Type 1 and Type 2 RT formats are not supported.
- XML configuration and oper schema are not supported for FTI configuration and show commands.

## Configure OpFlex

Perform the following tasks to configure the OpFlex session to automate fabric-facing tenant provisioning on the DCI gateway. This includes the one-time configuration that must be done on the DCI to enable DCI hand-off from an ACI fabric.

## Configure BGP

Perform this task to enable address-family under BGP routing process for fabric and WAN peering.

### SUMMARY STEPS

1. **configure**
2. **router bgp** *as-number*
3. **bgp router-id** *ip-address*
4. **address-family {vpnv4 | vpnv6} unicast**
5. **address-family l2vpn evpn**
6. Use the **commit** or **end** command.

### DETAILED STEPS

	Command or Action	Purpose
<b>Step 1</b>	<b>configure</b> <b>Example:</b> RP/0/RSP0/CPU0:router# configure	Enters global configuration mode.
<b>Step 2</b>	<b>router bgp</b> <i>as-number</i> <b>Example:</b> RP/0/RSP0/CPU0:router(config)# router bgp 1234	Specifies the autonomous system number and enters the BGP configuration mode, allowing you to configure the BGP routing process.
<b>Step 3</b>	<b>bgp router-id</b> <i>ip-address</i> <b>Example:</b> RP/0/RSP0/CPU0:router(config-bgp)# bgp router-id 198.51.100.1	Configures the router with a specified router ID.
<b>Step 4</b>	<b>address-family {vpnv4   vpnv6} unicast</b> <b>Example:</b>	Specifies either the vpnv4 or vpnv6 address family.

	Command or Action	Purpose
	RP/0/RSP0/CPU0:router(config-bgp)# address-family vpv4 unicast	
<b>Step 5</b>	<b>address-family l2vpn evpn</b>  <b>Example:</b> RP/0/RSP0/CPU0:router(config-bgp-af)# address-family l2vpn evpn	Configures EVPN address family.
<b>Step 6</b>	Use the <b>commit</b> or <b>end</b> command.	<b>commit</b> - Saves the configuration changes and remains within the configuration session.  <b>end</b> - Prompts user to take one of these actions: <ul style="list-style-type: none"> <li>• <b>Yes</b> - Saves configuration changes and exits the configuration session.</li> <li>• <b>No</b> - Exits the configuration session without committing the configuration changes.</li> <li>• <b>Cancel</b> - Remains in the configuration mode, without committing the configuration changes.</li> </ul>

## Configure BGP Session on the Fabric Side

Perform this task to configure BGP session on the fabric side.

### SUMMARY STEPS

1. **configure**
2. **router bgp *asn\_id***
3. **neighbor *ip-address***
4. **remote-as *autonomous-system-number***
5. **update-source *loopback***
6. **address-family l2vpn evpn**
7. **import stitching-rt reoriginate**
8. **advertise {vpnv4 | vpv6} unicast re-originated**
9. Use the **commit** or **end** command.

### DETAILED STEPS

	Command or Action	Purpose
<b>Step 1</b>	<b>configure</b>  <b>Example:</b> RP/0/RSP0/CPU0:router# configure	Enters global configuration mode.
<b>Step 2</b>	<b>router bgp <i>asn_id</i></b>  <b>Example:</b> RP/0/RSP0/CPU0:router(config)# router bgp 200	Specifies the BGP AS number and enters the BGP configuration mode, allowing you to configure the BGP routing process.

	Command or Action	Purpose
<b>Step 3</b>	<b>neighbor</b> <i>ip-address</i> <b>Example:</b> RP/0/RSP0/CPU0:router(config-bgp)# neighbor 209.165.201.1	Places the router in neighbor configuration mode for BGP routing and configures the neighbor IP address 209.165.201.1 as a BGP peer.
<b>Step 4</b>	<b>remote-as</b> <i>autonomous-system-number</i> <b>Example:</b> RP/0/RSP0/CPU0:router(config-bgp-nbr)# remote-as 100	Creates a neighbor and assigns it a remote autonomous system number.
<b>Step 5</b>	<b>update-source</b> <i>loopback</i> <b>Example:</b> RP/0/RSP0/CPU0:router(config-bgp-nbr)# update-source loopback2	Allows BGP sessions to use the primary IP address from a particular interface as the local address.
<b>Step 6</b>	<b>address-family</b> <i>l2vpn evpn</i> <b>Example:</b> RP/0/RSP0/CPU0:router(config-bgp-nbr)# address-family l2vpn evpn	Configures EVPN address family.
<b>Step 7</b>	<b>import</b> <i>stitching-rt reoriginate</i> <b>Example:</b> RP/0/RSP0/CPU0:router(config-bgp-nbr-af)# import stitching-rt reoriginate	Enables import of routing information from BGP EVPN NLRIs that has route target identifier matching the stitching route target identifier and exports this routing information after re-origination to the L2VPN BGP neighbor.
<b>Step 8</b>	<b>advertise</b> { <i>vpn4   vpn6</i> } <i>unicast re-originated</i> <b>Example:</b> RP/0/RSP0/CPU0:router(config-bgp-nbr-af)# advertise vpn4 unicast re-originated	Configures advertisement of VPNv4 or VPNv6 unicast routes that are redistributed from the L2VPN BGP neighbor, to the EVPN BGP neighbor. The route targets are changed to the stitching route targets before advertising onto the EVPN BGP neighbor.
<b>Step 9</b>	Use the <b>commit</b> or <b>end</b> command.	<b>commit</b> - Saves the configuration changes and remains within the configuration session. <b>end</b> - Prompts user to take one of these actions: <ul style="list-style-type: none"> <li>• <b>Yes</b> - Saves configuration changes and exits the configuration session.</li> <li>• <b>No</b>- Exits the configuration session without committing the configuration changes.</li> <li>• <b>Cancel</b> - Remains in the configuration mode, without committing the configuration changes.</li> </ul>

## Configure BGP Session on the WAN Side

Perform this task to configure BGP session on the WAN side.

## SUMMARY STEPS

1. **configure**
2. **router bgp** *asn\_id*
3. **neighbor** *ip-address*
4. **remote-as** *autonomous-system-number*
5. **update-source** *loopback*
6. **address-family vpnv4 unicast**
7. **import re-originate stitching-rt**
8. **advertise {vpnv4 | vpnv6} unicast re-originated**
9. Use the **commit** or **end** command.

## DETAILED STEPS

	Command or Action	Purpose
Step 1	<b>configure</b> <b>Example:</b> RP/0/RSP0/CPU0:router# configure	Enters global configuration mode.
Step 2	<b>router bgp</b> <i>asn_id</i> <b>Example:</b> RP/0/RSP0/CPU0:router(config)# router bgp 200	Specifies the BGP AS number and enters the BGP configuration mode, allowing you to configure the BGP routing process.
Step 3	<b>neighbor</b> <i>ip-address</i> <b>Example:</b> RP/0/RSP0/CPU0:router(config-bgp)# neighbor 209.165.200.226	Places the router in neighbor configuration mode for BGP routing and configures the neighbor IP address 209.165.200.226 as a BGP peer.
Step 4	<b>remote-as</b> <i>autonomous-system-number</i> <b>Example:</b> RP/0/RSP0/CPU0:router(config-bgp-nbr)# remote-as 100	Creates a neighbor and assigns it a remote autonomous system number.
Step 5	<b>update-source</b> <i>loopback</i> <b>Example:</b> RP/0/RSP0/CPU0:router(config-bgp-nbr)# update-source loopback2	Allows BGP sessions to use the primary IP address from a particular interface as the local address.
Step 6	<b>address-family vpnv4 unicast</b> <b>Example:</b> RP/0/RSP0/CPU0:router(config-bgp-nbr)# address-family vpnv4 unicast	Enters VPNv4 address family configuration mode for the VPNv4 address family.
Step 7	<b>import re-originate stitching-rt</b> <b>Example:</b> RP/0/RSP0/CPU0:router(config-bgp-nbr-af)# import re-originate stitching-rt	Enables import of routing information from BGP EVPN NLRIs that has route target identifier matching the stitching route target identifier and exports this routing information after re-origination to the L2VPN BGP neighbor.

	Command or Action	Purpose
<b>Step 8</b>	<b>advertise {vpngv4   vpngv6} unicast re-originated</b> <b>Example:</b> RP/0/RSP0/CPU0:router(config-bgp-nbr-af)# advertise vpngv4 unicast re-originated	Configures advertisement of VPNv4 or VPNv6 unicast routes that are redistributed from the L2VPN BGP neighbor, to the EVPN BGP neighbor. The route targets are changed to the stitching route targets before advertising onto the EVPN BGP neighbor.
<b>Step 9</b>	Use the <b>commit</b> or <b>end</b> command.	<b>commit</b> - Saves the configuration changes and remains within the configuration session. <b>end</b> - Prompts user to take one of these actions: <ul style="list-style-type: none"> <li>• <b>Yes</b> - Saves configuration changes and exits the configuration session.</li> <li>• <b>No</b> - Exits the configuration session without committing the configuration changes.</li> <li>• <b>Cancel</b> - Remains in the configuration mode, without committing the configuration changes.</li> </ul>

## Configure DCI Underlay for Fabric and WAN Interfaces

Perform this task to configure DCI underlay for fabric facing interface and WAN facing interface. Perform this task on both the interfaces.

### SUMMARY STEPS

1. **configure**
2. **interface** *type interface-path-id*
3. **ipv4 address** *ipv4-address mask*
4. Use the **commit** or **end** command.

### DETAILED STEPS

	Command or Action	Purpose
<b>Step 1</b>	<b>configure</b> <b>Example:</b> RP/0/RSP0/CPU0:router# configure	Enters global configuration mode.
<b>Step 2</b>	<b>interface</b> <i>type interface-path-id</i> <b>Example:</b> RP/0/RSP0/CPU0:router(config)# interface GigabitEthernet 0/0/0/0	Configures Gigabit Ethernet interface.
<b>Step 3</b>	<b>ipv4 address</b> <i>ipv4-address mask</i> <b>Example:</b> RP/0/RSP0/CPU0:router(config-if)# ipv4 address 209.165.200.226 255.255.255.224	Specifies the IPv4 address and subnet mask for the interface.

	Command or Action	Purpose
Step 4	Use the <b>commit</b> or <b>end</b> command.	<p><b>commit</b> - Saves the configuration changes and remains within the configuration session.</p> <p><b>end</b> - Prompts user to take one of these actions:</p> <ul style="list-style-type: none"> <li>• <b>Yes</b> - Saves configuration changes and exits the configuration session.</li> <li>• <b>No</b> - Exits the configuration session without committing the configuration changes.</li> <li>• <b>Cancel</b> - Remains in the configuration mode, without committing the configuration changes.</li> </ul>

## Configure IGP for ACI and WAN Reachability

Perform this task to configure IGP for ACI and WAN reachability.

### SUMMARY STEPS

1. **configure**
2. **router ospf** *process-name*
3. **area** *area-id*
4. **interface** *type interface-path-id*
5. **exit**
6. **exit**
7. **area** *area-id*
8. **nssa**
9. **interface loopback** *loopback-id*
10. **exit**
11. **interface** *type interface-path-id*
12. Use the **commit** or **end** command.

### DETAILED STEPS

	Command or Action	Purpose
Step 1	<p><b>configure</b></p> <p><b>Example:</b></p> <pre>RP/0/RSP0/CPU0:router# configure</pre>	Enters global configuration mode.
Step 2	<p><b>router ospf</b> <i>process-name</i></p> <p><b>Example:</b></p> <pre>RP/0/RSP0/CPU0:router(config)# router ospf 100</pre>	Enables OSPF routing for the specified routing process and places the router in router configuration mode.
Step 3	<p><b>area</b> <i>area-id</i></p> <p><b>Example:</b></p>	Enters area configuration mode and configures an area for the OSPF process.

	Command or Action	Purpose
	<code>RP/0/RSP0/CPU0:router(config-ospf)# area 0</code>	
<b>Step 4</b>	<b>interface</b> <i>type interface-path-id</i> <b>Example:</b> <code>RP/0/RSP0/CPU0:router(config-ospf-ar)# interface GigabitEthernet 0/0/0/1</code>	Configures Gigabit Ethernet interface. Enables reachability to WAN.
<b>Step 5</b>	<b>exit</b> <b>Example:</b> <code>RP/0/RSP0/CPU0:router(config-ospf-ar-if)# exit</code>	Exits the interface submode and returns to area submode.
<b>Step 6</b>	<b>exit</b> <b>Example:</b> <code>RP/0/RSP0/CPU0:router(config-ospf-ar)# exit</code>	Exits the area submode and returns to router configuration mode.
<b>Step 7</b>	<b>area</b> <i>area-id</i> <b>Example:</b> <code>RP/0/RSP0/CPU0:router(config-ospf)# area 100</code>	Enters area configuration mode and configures an area for the OSPF process.
<b>Step 8</b>	<b>nssa</b> <b>Example:</b> <code>RP/0/RSP0/CPU0:router(config-ospf-ar)# nssa</code>	Specifies area as a NSSA area
<b>Step 9</b>	<b>interface loopback</b> <i>loopback-id</i> <b>Example:</b> <code>RP/0/RSP0/CPU0:router(config-ospf-ar)# interface loopback0</code>	Creates a loopback interface with the user-defined loopback identifier and enters the interface configuration mode.
<b>Step 10</b>	<b>exit</b> <b>Example:</b> <code>RP/0/RSP0/CPU0:router(config-ospf-ar-if)# exit</code>	Exits the interface submode and returns to area submode.
<b>Step 11</b>	<b>interface</b> <i>type interface-path-id</i> <b>Example:</b> <code>RP/0/RSP0/CPU0:router(config-ospf-ar)# interface GigabitEthernet 0/0/0/0</code>	Configures Gigabit Ethernet interface. Enables reachability to ACI.
<b>Step 12</b>	Use the <b>commit</b> or <b>end</b> command.	<b>commit</b> - Saves the configuration changes and remains within the configuration session. <b>end</b> - Prompts user to take one of these actions: <ul style="list-style-type: none"> <li>• <b>Yes</b> - Saves configuration changes and exits the configuration session.</li> <li>• <b>No</b> - Exits the configuration session without committing the configuration changes.</li> </ul>



	Command or Action	Purpose
		<ul style="list-style-type: none"> <li>• <b>Cancel</b> - Remains in the configuration mode, without committing the configuration changes.</li> </ul>

## Configure MPLS towards WAN

Perform this task to configure MPLS on the DCI.

### SUMMARY STEPS

1. **configure**
2. **mpls ldp**
3. **interface type interface-path-id**
4. **exit**
5. **exit**
6. **interface loopback instance**
7. **ipv4 address ipv4-address mask**
8. **exit**
9. **interface nve nve-identifier**
10. **source-interface loopback loopback-interface-identifier**
11. Use the **commit** or **end** command.

### DETAILED STEPS

	Command or Action	Purpose
<b>Step 1</b>	<b>configure</b> <b>Example:</b> RP/0/RSP0/CPU0:router# configure	Enters global configuration mode.
<b>Step 2</b>	<b>mpls ldp</b> <b>Example:</b> RP/0/RSP0/CPU0:router# mpls ldp	Enables MPLS LDP configuration mode.
<b>Step 3</b>	<b>interface type interface-path-id</b> <b>Example:</b> RP/0/RSP0/CPU0:router(config-ldp)# interface GigabitEthernet 0/0/0/1	Configures Gigabit Ethernet interface.
<b>Step 4</b>	<b>exit</b> <b>Example:</b> RP/0/RSP0/CPU0:router(config-ldp-if)# exit	Exits the interface submode and returns to MPLS LDP submode.
<b>Step 5</b>	<b>exit</b> <b>Example:</b> RP/0/RSP0/CPU0:router(config-ldp)# exit	Exits the MPLS LDP submode and returns to global configuration mode.

	Command or Action	Purpose
<b>Step 6</b>	<b>interface loopback</b> <i>instance</i> <b>Example:</b> RP/0/RSP0/CPU0:router(config)# interface Loopback0	Enters interface configuration mode and names the new loopback interface.
<b>Step 7</b>	<b>ipv4 address</b> <i>ipv4-address mask</i> <b>Example:</b> RP/0/RSP0/CPU0:router(config-if)# ipv4 address 209.165.200.227 255.255.255.224	Specifies the IPv4 address and subnet mask for the interface.
<b>Step 8</b>	<b>exit</b> <b>Example:</b> RP/0/RSP0/CPU0:router(config-if)# exit	Exits the interface submode and returns to global configuration mode.
<b>Step 9</b>	<b>interface nve</b> <i>nve-identifier</i> <b>Example:</b> RP/0/RSP0/CPU0:router(config)# interface nve 1	Creates the NVE interface and enters the NVE interface configuration sub-mode.
<b>Step 10</b>	<b>source-interface loopback</b> <i>loopback-interface-identifier</i> <b>Example:</b> RP/0/RSP0/CPU0:router(config-if)# source-interface loopback 0	Sets a loopback interface as the source interface for the VTEP.
<b>Step 11</b>	Use the <b>commit</b> or <b>end</b> command.	<b>commit</b> - Saves the configuration changes and remains within the configuration session. <b>end</b> - Prompts user to take one of these actions: <ul style="list-style-type: none"> <li>• <b>Yes</b> - Saves configuration changes and exits the configuration session.</li> <li>• <b>No</b> - Exits the configuration session without committing the configuration changes.</li> <li>• <b>Cancel</b> - Remains in the configuration mode, without committing the configuration changes.</li> </ul>

## Configure FTI Auto-Configuration Parameters

Perform this task to configure FTI auto-configuration parameters.

### SUMMARY STEPS

1. **configure**
2. **dci-fabric-interconnect**
3. **auto-configuration-pool**
4. **bgp-as** *AS number*
5. **bridge group** *bridge-group-name*

6. **vrf** *vrf name* **ipv4-address** *ipv4 address*
7. **bd-pool** *bd range minimum bd range maximum*
8. **bvi-pool** *bvi range minimum bvi range maximum*
9. **vni-pool** *vni minimum range vni maximum range*
10. **local-vtep nve index**
11. Use the **commit** or **end** command.

## DETAILED STEPS

	Command or Action	Purpose
Step 1	<b>configure</b> <b>Example:</b> RP/0/RSP0/CPU0:router# configure	Enters global configuration mode.
Step 2	<b>dci-fabric-interconnect</b> <b>Example:</b> RP/0/RSP0/CPU0:router(config)# dci-fabric-interconnect	Enters the fabric tenant interconnect submode.
Step 3	<b>auto-configuration-pool</b> <b>Example:</b> RP/0/RSP0/CPU0:router(config-fti)# auto-configuration-pool	Enters the auto configuration pool submode and enables to set the auto configuration pool parameters.
Step 4	<b>bgp-as</b> <i>AS number</i> <b>Example:</b> RP/0/RSP0/CPU0:router(config-fti-acp)# bgp-as 1234	Specifies the BGP AS number that is used when the configuration is generated. The BGP AS must be configured separately.
Step 5	<b>bridge group</b> <i>bridge-group-name</i> <b>Example:</b> RP/0/RSP0/CPU0:router(config-fti-acp)# bridge group bgl	Specifies the L2VPN bridge group to be used for generation of configuration.
Step 6	<b>vrf</b> <i>vrf name</i> <b>ipv4-address</b> <i>ipv4 address</i> <b>Example:</b> vrf vrf1 ipv4-address 198.51.100.1	Configures per-VRF BVI interface IP address. If the default IPv4 address from link-local range is not acceptable for tenant addressing, this IP address must be configured. If configured, this must match the WAN-side tenant VRF configuration.
Step 7	<b>bd-pool</b> <i>bd range minimum bd range maximum</i> <b>Example:</b> RP/0/RSP0/CPU0:router(config-fti-acp)# bd-pool 1 1000	Specifies the bridge domain range. The range is from 1 through 4000.
Step 8	<b>bvi-pool</b> <i>bvi range minimum bvi range maximum</i> <b>Example:</b> RP/0/RSP0/CPU0:router(config-fti-acp)# bvi-pool 1 1000	Specifies the bridge-group virtual interface (BVI) range. The range is from 1 through 4000.

	Command or Action	Purpose
<b>Step 9</b>	<b>vni-pool</b> <i>vni minimum range vni maximum range</i> <b>Example:</b> RP/0/RSP0/CPU0:router(config-fti-acp)# vni-pool 1 1000	Specifies the VNI range. The range is from 1 through 4000.
<b>Step 10</b>	<b>local-vtep</b> <i>nve index</i> <b>Example:</b> RP/0/RSP0/CPU0:router(config-fti-acp)# local-vtep nve 1	Specifies an NVE interface and configures it as VXLAN Tunnel EndPoint (VTEP) for the VXLAN.
<b>Step 11</b>	Use the <b>commit</b> or <b>end</b> command.	<b>commit</b> - Saves the configuration changes and remains within the configuration session. <b>end</b> - Prompts user to take one of these actions: <ul style="list-style-type: none"> <li>• <b>Yes</b> - Saves configuration changes and exits the configuration session.</li> <li>• <b>No</b> - Exits the configuration session without committing the configuration changes.</li> <li>• <b>Cancel</b> - Remains in the configuration mode, without committing the configuration changes.</li> </ul>

## Configure OpFlex Session

This task enables the fabric tenant interconnect to setup an OpFlex session with the spine.

### SUMMARY STEPS

1. **configure**
2. **dci-fabric-interconnect**
3. **fabric** *fabric identifier*
4. **opflex-peer** *spine IP address*
5. **exit**
6. **identity** *loopback IP address*
7. Use the **commit** or **end** command.

### DETAILED STEPS

	Command or Action	Purpose
<b>Step 1</b>	<b>configure</b> <b>Example:</b> RP/0/RSP0/CPU0:router# configure	Enters global configuration mode.
<b>Step 2</b>	<b>dci-fabric-interconnect</b> <b>Example:</b>	Enters the fabric tenant interconnect submode.

	Command or Action	Purpose
	RP/0/RSP0/CPU0:router(config)# dci-fabric-interconnect	
<b>Step 3</b>	<b>fabric</b> <i>fabric identifier</i>  <b>Example:</b> RP/0/RSP0/CPU0:router(config-fti)# fabric 1001	Enters the fabric submode and you can configure the fabric parameters. The fabric identifier range is from 1000 through 9999.
<b>Step 4</b>	<b>opflex-peer</b> <i>spine IP address</i>  <b>Example:</b> RP/0/RSP0/CPU0:router(config-fti-fabric)# opflex-peer 192.0.2.1	FTI sets up an OpFlex session with the spine.
<b>Step 5</b>	<b>exit</b>  <b>Example:</b> RP/0/RSP0/CPU0:router(config-fti-fabric)# exit	Exits the current configuration mode and returns to fti submode.
<b>Step 6</b>	<b>identity</b> <i>loopback IP address</i>  <b>Example:</b> RP/0/RSP0/CPU0:router(config-fti)# identity 203.0.113.1	Specifies the DCI's BGP loopback IP address.
<b>Step 7</b>	Use the <b>commit</b> or <b>end</b> command.	<b>commit</b> - Saves the configuration changes and remains within the configuration session.  <b>end</b> - Prompts user to take one of these actions: <ul style="list-style-type: none"> <li>• <b>Yes</b> - Saves configuration changes and exits the configuration session.</li> <li>• <b>No</b> - Exits the configuration session without committing the configuration changes.</li> <li>• <b>Cancel</b> - Remains in the configuration mode, without committing the configuration changes.</li> </ul>

## EVPN Default VRF Route Leaking

The EVPN Default VRF Route Leaking feature leak routes between EVPN address-family and IPv4/IPv6 unicast address-family (Default-VRF), enabling the data center hosts to access the Internet. This feature is an extension of Border Gateway Protocol (BGP) VRF Dynamic route leaking feature that provides connectivity between non-default VRF hosts and Default VRF hosts by exchanging routes between the non-default VRF and Default VRF. EVPN Default VRF Route Leaking feature extends the BGP VRF Dynamic leaking feature, by allowing EVPN/L3VPN hosts to communicate with Default VRF hosts.

The import process installs the Internet route in a VRF table or a VRF route in the Internet table, providing connectivity.

The BGP VRF Dynamic route leaking feature is enabled by:

- Importing from default-VRF to non-default-VRF using the following command in VRF address-family configuration mode.

**import from default-vrf route-policy** *route-policy-name* [**advertise-as-vpn**]

If the **advertise-as-vpn** keyword is used, the paths imported from the default-VRF to the non-default-VRF are advertised to the (EVPN/L3VPN) PEs as well as to the CEs. If the **advertise-as-vpn** keyword is not used, the paths imported from the default-VRF to the non-default-VRF are not advertised to the PEs. However, the paths are still advertised to the CEs.

The EVPN Default VRF Route Leaking feature with **advertise-as-vpn** keyword, enables to advertise the paths imported from default-VRF to non-default VRFs to EVPN PE peers as well.

A new command **advertise vpnv4/vpnv6 unicast imported-from-default-vrf disable** is added under neighbor address-family configuration mode for EVPN and VPNv4/VPNv6 unicast to disable advertisement of Default-VRF leaked routes to that neighbor.

- Importing from non-default-VRF to default-VRF using the following command in VRF address-family configuration mode.

**export to default-vrf route-policy** *route-policy-name* [**advertise-as-vpn**]

The Dynamic Route Leaking feature enables leaking of local and CE routes to Default-VRF.

A new optional keyword **allow-imported-vpn** is added to the above command, when configured, enables the leaking of EVPN and L3VPN imported/re-originated routes to the Default-VRF.

A route-policy is mandatory to filter the imported routes. This reduces the risk of unintended import of routes between the Internet table and the VRF tables and the corresponding security issues. There is no hard limit on the number of prefixes that can be imported. The import creates a new prefix in the destination VRF, which increases the total number of prefixes and paths.



#### Note

Each VRF importing global routes adds workload equivalent to a neighbor receiving the global table. This is true even if the user filters out all but a few prefixes.

### Scale Limitation of Default Route Leaking

Default VRF route leaking uses Dynamic Route Leaking feature to leak prefixes between the default VRF and the DC VRF. Do not use Dynamic Route Leaking feature to leak default VRF prefixes to large number of DC VRFs, even if you filter out all prefixes except a few that are to be leaked.

The following are the key factors that affect the performance:

- The default VRF prefix scale, which is approximately 0.7 million internet prefixes.
- The number of DC VRFs the default VRF prefixes that are to be imported.

To improve the scale, either the prefix scale or the number of VRFs whose prefixes that are to be imported must be reduced.

To manage the scale limitation, Cisco recommends you to do the following:

- Host the Internet prefixes on an adjacent PE with IPv4 unicast peering with DCI, and advertise a default route towards the DCI. On the DCI, import the default route from default VRF to DC VRFs.

- Host the Internet prefixes on an adjacent PE with IPv4 unicast peering with DCI. On the DCI, configure a static default route in the DC VRF with the next hop of the default VRF pointing to the adjacent PE address.
- Configure the static default route 0.0.0.0/0 on DC VRF with nexthop as “vrf default”.



**Note** If the static routes are re-distributed to BGP, make sure it is not unintentionally advertised out.

## EVPN Default VRF Route Leaking on the DCI for Internet Connectivity

The EVPN Default VRF Route Leaking feature leak routes between the Default-VRF and Data Center-VRF on the DCI to provide Internet access to data center hosts.

This feature is enabled by:

- Leaking routes from Default-VRF to Data Center-VRF
- Leaking routes to Default-VRF from Data Center-VRF

## Leaking Routes from Default-VRF to Data Center-VRF

This section explains the process of leaking Default-VRF routes to Data Center-VRF.

**Figure 18: Leaking Routes from Default-VRF to Data Center-VRF**

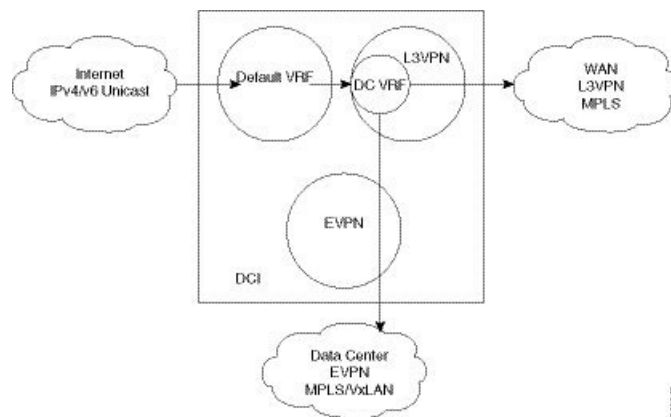

**Step 1** The Internet routes are present in the Default-VRF on the DCI.

**Note** A static default-route (0/0) can be configured under Default-VRF router static address-family configuration and redistributed to BGP.

**Step 2** A route-policy is configured to select the routes to be leaked from Default-VRF to Data Center-VRF.

**Example:**

```

route-policy import-from-default-policy
  if destination in (100.10.0.0/16, 100.20.0.0/16) then
    pass
  endif
end-policy
!

route-policy import-from-default-policy-v6
  if destination in (100:10::0/64, 100:20::0/64) then
    pass
  endif
end-policy
!

```

**Note** Instead of leaking the internet routes, you can leak the default-route 0/0 from Default-VRF to Data Center-VRF using the following policy.

```

route-policy import-from-default-policy
  if destination in (0.0.0.0/0) then
    pass
  endif
end-policy
!

route-policy import-from-default-policy-v6
  if destination in (0::0/0) then
    pass
  endif
end-policy
!

```

**Step 3** Leak Default-VRF routes specified in the route-policy to Data Center-VRF by configuring **import from default-vrf route-policy import-from-default-policy(-v6)** under Data Center VRF address-family configuration mode.

**Example:**

```

vrf data-center-vrf
  address-family ipv4 unicast
    import from default-vrf route-policy import-from-default-policy
  !
  address-family ipv6 unicast
    import from default-vrf route-policy import-from-default-policy-v6
  !

```

**Step 4** Advertise the leaked (Default-VRF) routes in the Data Center-VRF as EVPN routes towards Data Center routers by configuring **advertise-as-vpn** option.

**Example:**

```

vrf data-center-vrf
  address-family ipv4 unicast
    import from default-vrf route-policy import-from-default-policy advertise-as-vpn
  !
  address-family ipv6 unicast
    import from default-vrf route-policy import-from-default-policy-v6 advertise-as-vpn
  !

```

**Note** To advertise any routes from L3VPN address-family to EVPN peers, use **advertise vpv4/vpv6 unicast re-originated [stitching-rt]** command under neighbor address-family L2VPN EVPN.



### EVPN Default-originate

Instead of advertising the Default-VRF routes towards Data Center routers, default-originate can be configured under the EVPN neighbor address-family to advertise the default route. When default-originate is configured under the neighbor address-family for EVPN/L3VPN, there is no need to advertise the Default-VRF leaked routes to the data center and **advertise-as-vpn** need not be configured.

#### Example:

```
router bgp 100
  neighbor 40.0.0.1
    address-family l2vpn evpn
      default-originate

vrf data-center-vrf
  rd auto
  address-family ipv4 unicast
    allow vpn default-originate
!
  address-family ipv6 unicast
    allow vpn default-originate
```

**Step 5** To block advertisement of the Default-VRF leaked routes towards a particular EVPN/L3VPN peer, use **advertise vpnv4/vpnv6 unicast imported-from-default-vrf disable** command under respective neighbor address-family.

#### Example:

```
router bgp 100
  neighbor 40.0.0.1
    address-family l2vpn evpn
      advertise vpv4 unicast imported-from-default-vrf disable
      advertise vpv6 unicast imported-from-default-vrf disable
!
router bgp 100
  neighbor 60.0.0.1
    address-family vpv4 unicast
      advertise vpv4 unicast imported-from-default-vrf disable
    address-family vpv6 unicast
      advertise vpv6 unicast imported-from-default-vrf disable
```

---

## Leaking Routes to Default-VRF from Data Center-VRF

This section explains the process of leaking Data Center-VRF routes to Default-VRF.

Figure 19: Leaking Routes to Default-VRF from Data Center-VRF

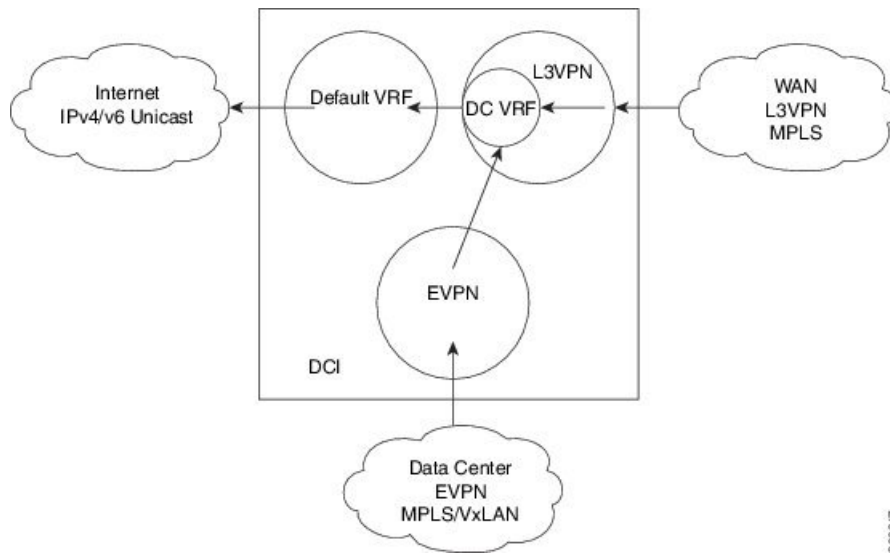

368247

**Step 1** Data Center routes are received on the DCI as EVPN Route-type 2 and Route-type 5 NLRI and imported to the Data Center VRFs.

**Step 2** A route-policy is configured to select the routes to be leaked from Data Center-VRF to Default-VRF.

**Example:**

```
route-policy export-to-default-policy
  if destination in (200.47.0.0/16, 200.168.0.0/16) then
    pass
  endif
end-policy
!

route-policy export-to-default-policy-v6
  if destination in (200:47::0/64, 200:168::0/64) then
    pass
  endif
end-policy
!
```

**Step 3** Leak Data Center-VRF routes specified in the above policy to Default-VRF by configuring **export to default-vrf route-policy export-to-default-policy(-v6) [allow-imported-vpn]** under Data Center-VRF address-family configuration mode.

Normally only local and CE VRF routes are allowed to be leaked to the Default-VRF, but **allow-imported-vpn** configuration enables leaking of EVPN/L3VPN imported routes to the Default-VRF.

**Example:**

```
vrf data-center-vrf
  address-family ipv4 unicast
    export to default-vrf route-policy export-to-default-policy [allow-imported-vpn]
  !
```

```

address-family ipv6 unicast
  export to default-vrf route-policy export-to-default-policy-v6 [allow-imported-vpn]
!
```

**Step 4** The Leaked routes in the Default VRF are advertised to the Internet.

**Note** Instead of advertising the leaked routes to the Internet, an aggregate can be configured and advertised to the Internet.

## Sample Router Configuration

The following sample configuration specifies how EVPN Default VRF Route Leaking feature is configured on a DCI router to provide Internet access to the data center hosts.

```

vrf data-center-vrf
  address-family ipv4 unicast
    import from default-vrf route-policy import-from-default-policy advertise-as-vpn
    export to default-vrf route-policy export-to-default-policy allow-imported-vpn
  !
  address-family ipv6 unicast
    import from default-vrf route-policy import-from-default-policy-v6 advertise-as-vpn
    export to default-vrf route-policy export-to-default-policy-v6 allow-imported-vpn
  !

route-policy import-from-default-policy
  if destination in (100.10.0.0/16, 100.20.0.0/16) then
    pass
  endif
end-policy
!

route-policy import-from-default-policy-v6
  if destination in (100:10::0/64, 100:20::0/64) then
    pass
  endif
end-policy
!

route-policy export-to-default-policy
  if destination in (200.47.0.0/16, 200.168.0.0/16) then
    pass
  endif
end-policy
!

route-policy export-to-default-policy-v6
  if destination in (200:47::0/64, 200:168::0/64) then
    pass
  endif
end-policy
!

router bgp 100
  neighbor 40.0.0.1
  address-family l2vpn evpn
    import stitching-rt re-originate
    advertise vpnv4 unicast re-originated stitching-rt
    advertise vpnv6 unicast re-originated stitching-rt
```

```

neighbor 60.0.0.1
 address-family vpnv4 unicast
   import re-originate stitching-rt
   advertise vpnv4 unicast re-originated
   advertise vpnv4 unicast imported-from-default-vrf disable

 address-family vpnv6 unicast
   import re-originate stitching-rt
   advertise vpnv6 unicast re-originated
   advertise vpnv6 unicast imported-from-default-vrf disable

```

## Sample Router Configuration: with default-originate

The following sample configuration specifies how EVPN Default VRF Route Leaking feature is configured along with default-originate on a DCI router to provide Internet access to data center hosts.

```

vrf data-center-vrf
 address-family ipv4 unicast
   import from default-vrf route-policy import-from-default-policy <= Remove
 advertise-as-vpn=>
   export to default-vrf route-policy export-to-default-policy allow-imported-vpn
   !
 address-family ipv6 unicast
   import from default-vrf route-policy import-from-default-policy-v6 <= Remove
 advertise-as-vpn=>
   export to default-vrf route-policy export-to-default-policy-v6 allow-imported-vpn
   !
 route-policy import-from-default-policy
   if destination in (100.10.0.0/16, 100.20.0.0/16) then
     pass
   endif
 end-policy
 !
 route-policy import-from-default-policy-v6
   if destination in (100:10::0/64, 100:20::0/64) then
     pass
   endif
 end-policy
 !
 route-policy export-to-default-policy
   if destination in (200.47.0.0/16, 200.168.0.0/16) then
     pass
   endif
 end-policy
 !
 route-policy export-to-default-policy-v6
   if destination in (200:47::0/64, 200:168::0/64) then
     pass
   endif
 end-policy
 !
router bgp 100
 neighbor 40.0.0.1
 address-family l2vpn evpn
   import stitching-rt re-originate
   advertise vpnv4 unicast re-originated stitching-rt
   advertise vpnv6 unicast re-originated stitching-rt
 default-originate <= Added=>

 neighbor 60.0.0.1
 address-family vpnv4 unicast

```

```

import re-originate stitching-rt
advertise vpnv4 unicast re-originated
advertise vpnv4 unicast imported-from-default-vrf disable

address-family vpnv6 unicast
import re-originate stitching-rt
advertise vpnv6 unicast re-originated
advertise vpnv6 unicast imported-from-default-vrf disable

vrf data-center-vrf
rd auto
address-family ipv4 unicast
  allow vpn default-originate <= Added=>
!
address-family ipv6 unicast
  allow vpn default-originate <= Added=>

```

## EVPN Service VRF Route Leaking

The EVPN Service VRF Route Leaking feature enables connectivity to the services in the Service VRF to customers in EVPN Data Center VRF. The Service VRF and Data Center VRF routes can be IPv4 and/or IPv6 addresses. The Services VRF is any L3 VRF providing services reachable through connected, static, re-distributed IGP or BGP routes.

This feature leaks routes between Data Center VRF and Service VRF, enabling the EVPN/L3VPN hosts to access the Services in the Service VRF. This feature rely on Border Gateway Protocol (BGP) VRF extranet feature that imports routes between two VRFs.

The import process installs the Data Center VRF routes in a Service VRF table or a Service VRF routes in the Data Center VRF table, providing connectivity.

The BGP Service VRF route leaking feature is enabled by:

- Importing routes from Service VRF to Data Center VRF and advertising it as EVPN/L3VPN route from Data Center VRF.
- Importing Service VRF routes to Data Center VRF by attaching Data Center VRF import RTs to Service VRF routes.

This can be achieved by configuring one or more Data Center VRF import RTs as export RT of Service VRF, or configuring a Service VRF export route-policy to attach import RT EXTCOMM to Service VRF routes matching the import RTs of Data Center VRF using the following command in Service VRF address-family configuration mode.

### **export route-policy service-vrf-export-route-policy-name**

Where the route-policy "service-vrf-export-route-policy-name" attaches the RT EXTCOMM matching the one or more import RTs of Data Center VRF to Service VRF routes.

- Advertising Data Center VRF imported routes that are exported from Service VRFs as EVPN/L3VPN NLRI from Data Center VRF using the following command in Data Center VRF address-family configuration mode.

### **import from vrf advertise-as-vpn**

If the **advertise-as-vpn** keyword is used, the paths imported from the Service VRF to the Data Center VRF are advertised to the (EVPN/L3VPN) PEs as well as to the CEs. If the **advertise-as-vpn** keyword is not used, the paths imported from the Service VRF to the Data Center VRF are not advertised to the PEs. However, the paths are still advertised to the CEs.

- Block advertising Data Center VRF leaked routes from being advertised to a neighbor using the following command in neighbor address-family configuration mode.

**advertise vpnv4/vpnv6 unicast imported-from-vrf disable**

A new command **advertise vpnv4/vpnv6 unicast imported-from-vrf disable** is added under neighbor address-family configuration mode for EVPN and VPNv4/VPNv6 unicast to disable advertisement of VRF to VRF leaked routes to that neighbor.

- Importing EVPN/L3VPN routes from Data Center VRF to Service VRF
  - Importing EVPN/L3VPN routes from Data Center VRF to Service VRF by attaching Service VRF import RTs.

This can be achieved by configuring one or more Service VRF import RTs as export RT of Data Center VRF, or configuring a Data Center VRF export route-policy to attach import RT EXTCOMM to Data Center VRF routes matching the import RTs of Service VRF using the following command in Data Center VRF address-family configuration mode.

**export route-policy data-center-vrf-export-route-policy-name**

The route-policy "data-center-vrf-export-route-policy-name" attaches the RT EXTCOMM matching one or more import RTs of Service VRF.

- Allow leaking of Data Center VRF routes to Service VRF by using the following command in Data Center VRF address-family configuration mode.

**export to vrf allow-imported-vpn**



---

**Note** In order to prevent un-intended import of routes to VRFs, select unique RT's to import routes between Service VRF and Data Center VRF, which are not used for normal import of VPN/EVPN routes to Data Center VRFs.

---

The Extranet Route Leaking feature enables leaking of local and CE routes from one VRF to another VRF. A new command **export to vrf allow-imported-vpn** is added to enable the leaking of EVPN and L3VPN imported/re-originated Data Center VRF routes to the Service VRF.



---

**Note** A route-policy is preferred to filter the imported routes. This reduces the risk of unintended import of routes between the Data Center VRF and the Service VRF, and the corresponding security issues. There is no hard limit on the number of prefixes that can be imported. The import creates a new prefix in the destination VRF, which increases the total number of prefixes and paths.

---



---

**Note** This feature does not advertise EVPN/L3VPN PE routes imported to Data Center VRF and leaked to Service VRF as EVPN/L3VPN PE route.

---

## EVPN Service VRF Route Leaking on the DCI for Service Connectivity

The EVPN Service VRF Route Leaking feature leaks routes between the Service VRF and Data Center VRF on the DCI to provide access to Services to data center hosts.

This feature is enabled by:

- Leaking routes from Service VRF to Data Center VRF
- Leaking routes to Service VRF from Data Center VRF

### Leaking Routes from Service VRF to Data Center VRF

This section explains the process of leaking Service VRF routes to Data Center VRF.

**Figure 20: Leaking Routes from Service VRF to Data Center VRF**

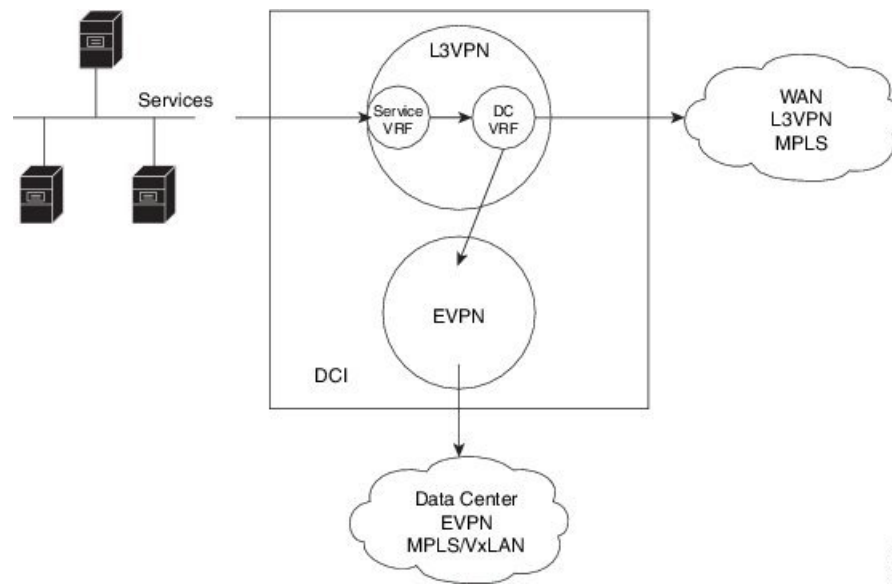

366244

**Step 1** The Service routes are present in the Service VRF on the DCI.

**Step 2** A route-policy is configured to select the routes to be leaked from Service VRF to Data Center VRF.

**Example:**

```
route-policy service-vrf-export-policy
  if destination in (100.10.0.0/16, 100.20.0.0/16) then
    set extcommunity rt (1:1) additive <--- matches import RT of Data Center-VRF
  endif
end-policy
!
route-policy service-vrf-export-policy-v6
  if destination in (100:10::0/64, 100:20::0/64) then
    set extcommunity rt (1:1) additive <--- matches import RT of Data Center-VRF
  endif
end-policy
!
```

**Step 3** Leak Service VRF routes specified in the route-policy to Data Center VRF by configuring **export route-policy service-vrf-export-policy(-v6)** under Service VRF address-family configuration mode.

**Example:**

```
vrf service-vrf
  address-family ipv4 unicast
    import route-target
      3:1
      4:1 stitching
    export route-policy service-vrf-export-policy
    export route-target
      3:1
      4:1 stitching
  !
  address-family ipv6 unicast
    import route-target
      3:1
      4:1 stitching
    export route-policy service-vrf-export-policy-v6
    export route-target
      3:1
      4:1 stitching
  !
```

**Step 4** Advertise the leaked (Service VRF) routes in the Data Center VRF as EVPN/L3VPN routes towards Data Center routers by configuring **import from vrf advertise-as-vpn** under Data Center VRF address-family configuration mode..

**Example:**

```
vrf data-center-vrf
  address-family ipv4 unicast
    import from vrf advertise-as-vpn
    import route-target
      1:1
      100:1
      200:1 stitching
    export route-target
      100:1
      200:1 stitching
  !
  address-family ipv6 unicast
    import from vrf advertise-as-vpn
    import route-target
      1:1
      100:1
      200:1 stitching
    export route-target
      100:1
      200:1 stitching
  !
```

**Note** To advertise any routes from L3VPN address-family to EVPN peers, use **advertise vpnv4/vpnv6 unicast re-originated [stitching-rt]** command under neighbor address-family L2VPN EVPN.

**EVPN Default-originate**

Instead of advertising the Service VRF routes towards Data Center routers, default-originate can be configured under the EVPN neighbor address-family to advertise the default route. When **allow vpn default-originate** is configured under



the Data Center VRF, there is no need to advertise the Service VRF leaked routes to the data center and **advertise-as-vpn** need not be configured.

**Example:**

```
router bgp 100
  neighbor 40.0.0.1
    address-family l2vpn evpn
      default-originate

vrf data-center-vrf
  rd auto
  address-family ipv4 unicast
    allow vpn default-originate
  !
  address-family ipv6 unicast
    allow vpn default-originate
```

**Step 5** To block advertisement of the Service VRF leaked routes towards a particular EVPN/L3VPN peer, use **advertise vpnv4/vpnv6 unicast imported-from-vrf disable** command under respective neighbor address-family.

**Example:**

```
router bgp 100
  neighbor 40.0.0.1
    address-family l2vpn evpn
      import stitching-rt re-originate
      advertise vpv4 unicast re-originated stitching-rt
      advertise vpv4 unicast imported-from-vrf disable
      advertise vpv6 unicast re-originated stitching-rt
      advertise vpv6 unicast imported-from-vrf disable
  !
router bgp 100
  neighbor 60.0.0.1
    address-family vpv4 unicast
      import re-originate stitching-rt
      advertise vpv4 unicast re-originated
      advertise vpv4 unicast imported-from-vrf disable
    address-family vpv6 unicast
      import re-originate stitching-rt
      advertise vpv6 unicast re-originated
      advertise vpv6 unicast imported-from-vrf disable
```

## Leaking Routes to Service VRF from Data Center VRF

This section explains the process of leaking Data Center VRF routes to Service VRF.

Figure 21: Leaking Routes to Service VRF from Data Center VRF

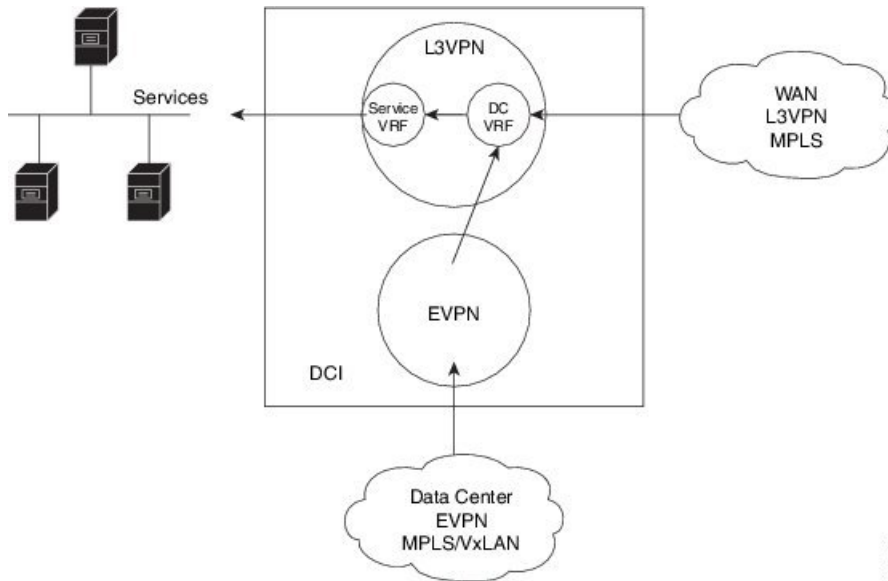

- Step 1** Data Center routes are received on the DCI as EVPN Route-type 2 and Route-type 5 NLRI and imported to the Data Center VRFs.
- Step 2** A route-policy is configured to select the routes to be leaked from Data Center VRF to Service VRF. The policy attaches RT EXTCOMM to Data Center VRF routes matching one or more import RT of the Service VRF.

**Example:**

```
route-policy data-center-vrf-export-policy
  if destination in (200.47.0.0/16) then <--- EVPN PE route
    set extcommunity rt (4:1) additive <--- matches import stitching-RT of service-VRF
  if destination in (200.168.0.0/16) then <--- VPNv4 PE route
    set extcommunity rt (3:1) additive <--- matches import RT of service-VRF
  endif
end-policy
!
route-policy data-center-vrf-export-policy-v6
  if destination in (200:47::0/64) then <--- EVPN PE route
    set extcommunity rt (4:1) additive <--- matches import stitching-RT of service-VRF
  elseif destination in (200:168::0/64) then <--- VPNv6 PE route
    set extcommunity rt (3:1) additive <--- matches import RT of service-VRF
  endif
end-policy
!
```

**Note** An EVPN/L3VPN route received from a neighbor configured locally with "import stitching-rt re-originate" is imported to Data Center VRF if the route's RT EXTCOMM matches with one or more Data Center VRF import stitching RTs, and is leaked to Service VRF if the Data Center VRF route's RT EXTCOMM matches with one or more Service VRF import stitching RTs.

- Step 3** Leak Data Center VRF routes specified in the above policy to Service VRF by configuring **export route-policy data-center-vrf-export-policy(-v6)** under Data Center VRF address-family configuration mode.

Normally only local and CE VRF routes are allowed to be leaked to the Service VRF, but **allow-imported-vpn** configuration enables leaking of EVPN/L3VPN imported routes to the Service VRF.

**Example:**

```
vrf data-center-vrf
  address-family ipv4 unicast
    import from vrf advertise-as-vpn
    import route-target
      1:1
      100:1
      200:1 stitching
    export route-policy data-center-vrf-export-policy
    export to vrf allow-imported-vpn
    export route-target
      100:1
      200:1 stitching
  !
address-family ipv6 unicast
  import from vrf advertise-as-vpn
  import route-target
    1:1
    100:1
    200:1 stitching
  export route-policy data-center-vrf-export-policy-v6
  export to vrf allow-imported-vpn
  export route-target
    100:1
    200:1 stitching
  !
```

**Step 4** The Data Center VRF leaked routes in the Service VRF are advertised to Service VRF CE peers.

## Sample Router Configuration

The following sample configuration specifies how EVPN Service VRF Route Leaking feature is configured on a DCI router providing access to data center hosts to Services in the Service VRF.

```
vrf data-center-vrf
  address-family ipv4 unicast
    import from vrf advertise-as-vpn
    import route-target
      1:1
      100:1
      200:1 stitching
    export route-policy data-center-vrf-export-policy
    export to vrf allow-imported-vpn
    export route-target
      100:1
      200:1 stitching
  !
address-family ipv6 unicast
  import from vrf advertise-as-vpn
  import route-target
    1:1
    100:1
    200:1 stitching
  export route-policy data-center-vrf-export-policy-v6
  export to vrf allow-imported-vpn
  export route-target
```

```

        100:1
        200:1 stitching
    !
vrf service-vrf
  address-family ipv4 unicast
    import route-target
      3:1
      4:1 stitching
    export route-policy service-vrf-export-policy
    export route-target
      3:1
      4:1 stitching
  !
  address-family ipv6 unicast
    import route-target
      3:1
      4:1 stitching
    export route-policy service-vrf-export-policy-v6
    export route-target
      3:1
      4:1 stitching
  !

route-policy data-center-vrf-export-policy
  if destination in (200.47.0.0/16) then
    set extcommunity rt (4:1) additive
  if destination in (200.168.0.0/16)
    set extcommunity rt (3:1) additive
  endif
end-policy
!

route-policy data-center-vrf-export-policy-v6
  if destination in (200:47::0/64) then
    set extcommunity rt (4:1) additive
  elseif destination in (200:168::0/64)
    set extcommunity rt (3:1) additive
  endif
end-policy
!

route-policy service-vrf-export-policy
  if destination in (100.10.0.0/16, 100.20.0.0/16) then
    set extcommunity rt (1:1) additive
  endif
end-policy
!

route-policy service-vrf-export-policy-v6
  if destination in (100:10::0/64, 100:20::0/64) then
    set extcommunity rt (1:1) additive
  endif
end-policy
!

route-policy pass-all
  pass
end-policy
!

router bgp 100
  neighbor 40.0.0.1
  remote-as 100

```

```

address-family l2vpn evpn
  import stitching-rt re-originate
  advertise vpnv4 unicast re-originated stitching-rt
  advertise vpnv6 unicast re-originated stitching-rt
!
neighbor 60.0.0.1
  remote-as 200
  address-family vpnv4 unicast
    import re-originate stitching-rt
    route-policy pass-all in
    route-policy pass-all out
    advertise vpnv4 unicast re-originated
    advertise vpnv4 unicast imported-from-vrf disable
  address-family vpnv6 unicast
    import re-originate stitching-rt
    route-policy pass-all in
    route-policy pass-all out
    advertise vpnv6 unicast re-originated
    advertise vpnv6 unicast imported-from-vrf disable

```

## Sample Router Configuration: with default-originate

The following sample configuration specifies how EVPN Service VRF Route Leaking feature is configured along with default-originate on a DCI router to provide data center hosts access to Services in the Service VRF..

```

vrf data-center-vrf
  address-family ipv4 unicast
    import from vrf advertise-as-vpn
    import route-target
      1:1
      100:1
      200:1 stitching
    export route-policy data-center-vrf-export-policy
    export to vrf allow-imported-vpn
    export route-target
      100:1
      200:1 stitching
  !
  address-family ipv6 unicast
    import from vrf advertise-as-vpn
    import route-target
      1:1
      100:1
      200:1 stitching
    export route-policy data-center-vrf-export-policy-v6
    export to vrf allow-imported-vpn
    export route-target
      100:1
      200:1 stitching
  !

vrf service-vrf
  address-family ipv4 unicast
    import route-target
      3:1
      4:1 stitching
    export route-policy service-vrf-export-policy
    export route-target
      3:1
      4:1 stitching
  !

```

```

address-family ipv6 unicast
  import route-target
    3:1
    4:1 stitching
  export route-policy service-vrf-export-policy-v6
  export route-target
    3:1
    4:1 stitching
!

route-policy data-center-vrf-export-policy
  if destination in (200.47.0.0/16) then
    set extcommunity rt (4:1) additive
  if destination in (200.168.0.0/16) then
    set extcommunity rt (3:1) additive
  endif
end-policy
!

route-policy data-center-vrf-export-policy-v6
  if destination in (200:47::0/64) then
    set extcommunity rt (4:1) additive
  elseif destination in (200:168::0/64) then
    set extcommunity rt (3:1) additive
  endif
end-policy
!

route-policy service-vrf-export-policy
  if destination in (100.10.0.0/16, 100.20.0.0/16) then
    set extcommunity rt (1:1) additive
  endif
end-policy
!

route-policy service-vrf-export-policy-v6
  if destination in (100:10::0/64, 100:20::0/64) then
    set extcommunity rt (1:1) additive
  endif
end-policy
!

route-policy pass-all
  pass
end-policy
!

router bgp 100
  neighbor 40.0.0.1
    remote-as 100
    address-family l2vpn evpn
      import stitching-rt re-originate
      advertise vpnv4 unicast re-originated stitching-rt
      advertise vpnv4 unicast imported-from-vrf disable
      advertise vpnv6 unicast re-originated stitching-rt
      advertise vpnv6 unicast imported-from-vrf disable
      default-originate <= Added=>
    !
  neighbor 60.0.0.1
    remote-as 200
    address-family vpnv4 unicast
      import re-originate stitching-rt
      route-policy pass-all in
      route-policy pass-all out

```

```
advertise vpnv4 unicast re-originated
advertise vpnv4 unicast imported-from-vrf disable
default-originate <= Added=>
address-family vpnv6 unicast
import re-originate stitching-rt
route-policy pass-all in
route-policy pass-all out
advertise vpnv6 unicast re-originated
advertise vpnv6 unicast imported-from-vrf disable
default-originate <= Added=>

vrf data-center-vrf
rd auto
address-family ipv4 unicast
  allow vpn default-originate <= Added=>
!
address-family ipv6 unicast
  allow vpn default-originate <= Added=>
```

