



Broadband Network Gateway Configuration Guide for Cisco ASR 9000 Series Routers, IOS XR Release 6.6.x

First Published: 2018-12-01

Last Modified: 2019-12-13

Americas Headquarters

Cisco Systems, Inc.
170 West Tasman Drive
San Jose, CA 95134-1706
USA
<http://www.cisco.com>
Tel: 408 526-4000
800 553-NETS (6387)
Fax: 408 527-0883

THE SPECIFICATIONS AND INFORMATION REGARDING THE PRODUCTS IN THIS MANUAL ARE SUBJECT TO CHANGE WITHOUT NOTICE. ALL STATEMENTS, INFORMATION, AND RECOMMENDATIONS IN THIS MANUAL ARE BELIEVED TO BE ACCURATE BUT ARE PRESENTED WITHOUT WARRANTY OF ANY KIND, EXPRESS OR IMPLIED. USERS MUST TAKE FULL RESPONSIBILITY FOR THEIR APPLICATION OF ANY PRODUCTS.

THE SOFTWARE LICENSE AND LIMITED WARRANTY FOR THE ACCOMPANYING PRODUCT ARE SET FORTH IN THE INFORMATION PACKET THAT SHIPPED WITH THE PRODUCT AND ARE INCORPORATED HEREIN BY THIS REFERENCE. IF YOU ARE UNABLE TO LOCATE THE SOFTWARE LICENSE OR LIMITED WARRANTY, CONTACT YOUR CISCO REPRESENTATIVE FOR A COPY.

The Cisco implementation of TCP header compression is an adaptation of a program developed by the University of California, Berkeley (UCB) as part of UCB's public domain version of the UNIX operating system. All rights reserved. Copyright © 1981, Regents of the University of California.

NOTWITHSTANDING ANY OTHER WARRANTY HEREIN, ALL DOCUMENT FILES AND SOFTWARE OF THESE SUPPLIERS ARE PROVIDED "AS IS" WITH ALL FAULTS. CISCO AND THE ABOVE-NAMED SUPPLIERS DISCLAIM ALL WARRANTIES, EXPRESSED OR IMPLIED, INCLUDING, WITHOUT LIMITATION, THOSE OF MERCHANTABILITY, FITNESS FOR A PARTICULAR PURPOSE AND NON-INFRINGEMENT OR ARISING FROM A COURSE OF DEALING, USAGE, OR TRADE PRACTICE.

IN NO EVENT SHALL CISCO OR ITS SUPPLIERS BE LIABLE FOR ANY INDIRECT, SPECIAL, CONSEQUENTIAL, OR INCIDENTAL DAMAGES, INCLUDING, WITHOUT LIMITATION, LOST PROFITS OR LOSS OR DAMAGE TO DATA ARISING OUT OF THE USE OR INABILITY TO USE THIS MANUAL, EVEN IF CISCO OR ITS SUPPLIERS HAVE BEEN ADVISED OF THE POSSIBILITY OF SUCH DAMAGES.

Any Internet Protocol (IP) addresses and phone numbers used in this document are not intended to be actual addresses and phone numbers. Any examples, command display output, network topology diagrams, and other figures included in the document are shown for illustrative purposes only. Any use of actual IP addresses or phone numbers in illustrative content is unintentional and coincidental.

All printed copies and duplicate soft copies of this document are considered uncontrolled. See the current online version for the latest version.

Cisco has more than 200 offices worldwide. Addresses and phone numbers are listed on the Cisco website at www.cisco.com/go/offices.

The documentation set for this product strives to use bias-free language. For purposes of this documentation set, bias-free is defined as language that does not imply discrimination based on age, disability, gender, racial identity, ethnic identity, sexual orientation, socioeconomic status, and intersectionality. Exceptions may be present in the documentation due to language that is hardcoded in the user interfaces of the product software, language used based on standards documentation, or language that is used by a referenced third-party product.

Cisco and the Cisco logo are trademarks or registered trademarks of Cisco and/or its affiliates in the U.S. and other countries. To view a list of Cisco trademarks, go to this URL: <https://www.cisco.com/c/en/us/about/legal/trademarks.html>. Third-party trademarks mentioned are the property of their respective owners. The use of the word partner does not imply a partnership relationship between Cisco and any other company. (1721R)

© 2019 Cisco Systems, Inc. All rights reserved.



CONTENTS

PREFACE

Preface xv

Changes to This Document xv

Communications, Services, and Additional Information xv

CHAPTER 1

New and Changed BNG Features 1

BNG Features Added or Modified in IOS XR Release 6.6.x 1

CHAPTER 2

Broadband Network Gateway Overview 5

Understanding BNG 5

BNG Architecture 6

BNG Role in ISP Network Models 8

BNG Packaging 9

Installing and Activating the BNG Pie on Cisco ASR 9000 Series Router 9

BNG Configuration Process 10

Hardware Requirements for BNG 11

BNG Interoperability 13

BNG Smart Licensing 14

BNG on Cisco IOS XR 64-bit ASR 9000 Series Routers 15

Hardware Support for Cisco IOS XR 64-bit BNG 16

Feature Support on Cisco IOS XR 64-bit BNG 18

Packaging of Cisco IOS XR 64-bit BNG 19

Call-model Support on Cisco IOS XR 64-bit BNG 21

CHAPTER 3

Configuring Authentication, Authorization, and Accounting Functions 25

Configuring Authentication, Authorization, and Accounting Functions 25

AAA Overview 26

Using RADIUS Server Group	27
Configuring RADIUS Server Group	27
Specifying Method List	30
Configuring Method Lists for AAA	30
Defining AAA Attributes	31
Creating Attributes of Specific Format	33
Configuring RADIUS Attribute List	38
Configuring RADIUS Attribute Format	39
Configuring RADIUS Attribute Nas-port-type	41
Configuring AAA Attribute Format Function	42
Suppressing Unassigned Attributes	43
Making RADIUS Server Settings	44
Configuring RADIUS Server Settings	44
Configuring Automated Testing	48
Setting IP DSCP for RADIUS Server	50
Balancing Transaction Load on the RADIUS Server	51
Configuring Load Balancing for Global RADIUS Server Group	51
Configuring Load Balancing for a Named RADIUS Server Group	52
Throttling of RADIUS Records	53
Configuring RADIUS Throttling Globally	54
Configuring RADIUS Throttling on a Server Group	56
RADIUS Change of Authorization (CoA) Overview	57
Multi-Action Change of Authorization	59
Generating Accounting Records	60
High Availability for MA-CoA	61
An Example with Verification Commands	61
Important Notes on Multi-Action Change of Authorization	65
User Authentication and Authorization in the Local Network	65
Policy Configurations for IPoE Sessions	66
Policy Configurations for PTA Sessions	69
Service Accounting	70
Configuring Service Accounting	72
Statistics Infrastructure	74
Configuring Statistics IDs (statsD)	74

Understanding Per-VRF AAA Function	75
RADIUS Double-Dip Feature	75
RADIUS over IPv6	76
Dynamic Policy Download over RADIUS Interface	76
Merge and Account Statistics	76
Software Functional Requirements	77
Limitations	78
Verifying Dynamic Policy Download over RADIUS Interface	78
Additional References	79

CHAPTER 4**Activating Control Policy 81**

Control Policy Overview	81
Creating Class-Map	83
Configuring a Class-Map	83
Creating Policy-Map	84
Control Policy Events	85
Configuring a Policy-Map	86
Activating Policy-Map	88
Enabling a Service-Policy on a Subscriber Interface	88
Defining Dynamic Templates	89
Additional References	90

CHAPTER 5**Establishing Subscriber Sessions 93**

Subscriber Session Overview	93
Establishing IPoE Session	96
Enabling IPv4 or IPv6 on an Access Interface	97
Creating Dynamic Template for IPv4 or IPv6 Subscriber Session	99
Creating a Policy-Map to Run During IPoE Session	101
Enabling IPoE Subscribers on an Access Interface	103
Routed Subscriber Sessions	106
DHCP-initiated Routed Subscriber Sessions	107
Packet-triggered Routed Subscriber Sessions	109
Deployment Model for IPv6 Routed Network	109
Call Flow of IPv6 Routed Subscriber Session	110

Restrictions for Routed Subscriber Sessions	111
Configuring Routed Subscriber Sessions	112
Prevent Default ARP Entry Creation for a Subscriber Interface	114
Unconditional Proxy ARP Response	114
Establishing PPPoE Session	115
Provisioning PPP PTA Session	116
Creating PPPoE Profiles	117
Creating a PPP Dynamic-Template	118
Creating a Policy-Map to Run During PPPoE Session	119
Applying the PPPoE Configurations to an Access Interface	122
Provisioning PPP LAC Session	123
Configuring the VPDN Template	125
Configuring Maximum Simultaneous VPDN Sessions	127
Activating VPDN Logging	128
Configuring Options to Apply on Calling Station ID	129
Configuring L2TP Session-ID Commands	130
Configuring L2TP Class Options	131
Configuring Softshut for VPDN	134
L2TP Access Concentrator Stateful Switchover	135
Local VPDN RADIUS Enhancement	138
PPPoE Smart Server Selection	141
Configuring PADO Delay	141
PPPoE Session Limit, Throttle and In-flight-window	143
PPPoE Session Limit	143
PPPoE Session Throttle	146
PPPoE In-flight-window	148
Activating IPv6 Router Advertisement on a Subscriber Interface When IPv4 Starts	148
Creating Dynamic Template for Enabling IPv6 Router Advertisement on an IPv4 Subscriber Interface	148
Making DHCP Settings	149
Enabling DHCP Proxy	150
Configuring DHCP IPv4 Profile Proxy Class	151
Configuring a Circuit-ID for an Interface	152
Configuring a Remote-ID	154

Configuring the Client Lease Time	155
Attaching a Proxy Profile to an Interface	156
DHCPv4 Server	157
Enabling DHCP Server	158
Configuring DHCPv4 Server Profile	158
DHCP L3 Routed Subscriber Snooping	161
Network Topology of DHCP L3 Snooping in BNG	161
Details for DHCP L3 Snooping in BNG	162
Call Flow of DHCP L3 Snooping in BNG	163
Configure DHCP L3 Snooping in BNG	164
RADIUS Attributes for DHCP L3 Snooping in BNG	168
Specifying DHCP Lease Limit	170
Specifying the Lease Limit for a Circuit-ID	170
Specifying the Lease Limit for a Remote-ID	172
Specifying the Lease Limit for an Interface	173
Understanding DHCP Option-82	174
Option 82 Relay Information Encapsulation	175
Configuring DHCPv4 Class of Service (CoS)	175
Send Rich DHCP Options from RADIUS to DHCP Server or Proxy	175
Configure Rich DHCP Option on RADIUS VSA	179
DHCP Option 60 Filtering	180
Configure DHCP Option 60 Filtering	181
Send DHCP Options to RADIUS	182
Configure Generic DHCP Option to RADIUS VSA Mapping	183
DHCP RADIUS Proxy	184
Subscriber Session-Restart	185
Allow-move for Simple IP Sessions	186
Restrictions for Simple IP Allow-move	186
DHCP Duplicate MAC Session	187
DHCP Duplicate MAC Session With Exclude VLAN Option	187
Configure DHCP Duplicate MAC Session	188
DHCP Lease From AAA Server	191
AAA Authorization on DHCP RENEW or REBIND	192
Enable AAA Authorization on DHCP RENEW or REBIND	193

IPoE Class-based DHCPv4 Mode Selection	194
DHCPv6 Overview	194
DHCPv6 Server and DHCPv6 Proxy	195
Enabling DHCPv6 for Different Configuration Modes	196
Setting Up DHCPv6 Parameters	199
PPP/IPoE Class-based DHCPv6 Mode Selection	201
DHCPv6 Features	202
High Availability Support for DHCPv6	202
DHCPv6 Prefix Delegation	202
IPv6 IPoE Subscriber Support	203
IPv6 PPPoE Subscriber Support	210
Ambiguous VLAN Support	216
DHCPv6 Address or Prefix Pool	219
DHCPv6 Dual-Stack Lite Support	225
VRF Awareness in DHCPv6	227
DHCP Options Support for BNG DHCPv6 Proxy Mode	228
Configurable DHCPv6 Option 17	230
DHCP IPv6 Lease from the AAA Server	230
DHCPv6 Lease Time for Class Profile	231
DHCPv6 Option 1 and Option 16 to Form Authentication Username	232
DHCPv6 Option 16 Filtering	233
Rapid commit	235
Packet Handling on Subscriber Interfaces	236
IPv6 Neighbor Discovery	238
Line Card Subscribers	238
External Interaction for LC Subscribers	239
Benefits and Restrictions of Line Card Subscribers	239
High Availability for Line Card Subscribers	240
Static Sessions	241
Restrictions for static sessions	242
Subscriber Session Limit	243
BNG Subscriber Templates	244
Feature Support for Subscriber Templates	244
Restrictions for BNG Subscriber Templates	245

Verification of BNG Subscriber Templates	245
eBGP over PPPoE	245
BNG over Pseudowire Headend	246
QoS on BNG Pseudowire Headend	246
Features Supported for BNG over Pseudowire Headend	247
Unsupported Features and Restrictions for BNG over Pseudowire Headend	248
PPPoE LAC Subscriber Over PWHE	248
Removing Access Interface Configuration	249
Additional References	252

CHAPTER 6**Deploying the Quality of Service (QoS) 253**

Quality of Service Overview	254
Configuring Service-policy and Applying Subscriber Settings Through RADIUS	255
Configuring Service-policy and Applying Subscriber Settings Through Dynamic Template	256
Parameterized QoS	259
Parameterized QoS Syntax	260
Configuring Parameterized QoS Policy Through RADIUS	265
Modifying Service Policy through CoA	268
Parameterized QoS for Line Card Subscribers	269
Configuring Parameterized QoS as Auto-service	270
Verifying PQoS Configuration	273
RADIUS Based Policing - QoS Shaper Parameterization	275
Sample Configuration and Use Cases for QoS Shaper Parameterization	276
Verification of QoS Shaper Parameterization Configurations	277
Supported Scenarios of QoS Shaper Parameterization	279
Restrictions of QoS Shaper Parameterization	280
QoS Accounting	280
Configuring QoS Accounting	281
Support for Shared Policy Instance	283
Configuring a Policy with SPI in the Input or Output Direction Using Dynamic Template	284
Configuring a Policy with SPI in the Input or Output Direction Using RADIUS	287
Merging QoS Policy-maps	289
Enabling Policy-maps Merge	290
QoS Features Supported on BNG	294

	VLAN Policy on Access Interface	298
	Configuring Policy on S-VLAN	299
	Configuring VLAN Policy on an Access Interface	300
	Multiple Class Support for Ingress Policing for Subscribers	302
	Group-based Grandparent Shaping	303
	Subscriber QoS on Main Interface	304
	Configure Subscriber QoS on Main Interface	304
	Additional References	305
<hr/>		
CHAPTER 7	Configuring Subscriber Features	307
<hr/>		
CHAPTER 8	BNG Geo Redundancy	393
	Geo Redundancy Overview	394
	Subscriber Redundancy Group (SRG)	395
	Session Distribution Across SRG	396
	Benefits of BNG Geo Redundancy	398
	Supported Features in BNG Geo Redundancy	399
	BNG Geo Redundancy Configuration Guidelines	401
	Setting up BNG Subscriber Redundancy Group	402
	Geographical Redundancy By Using a Session Redundancy Group (SERG)	406
	Configuring and Verifying Session Redundancy for DHCPv6 Clients	408
	Managing Session Redundancy Groups	415
	Configuring and Verifying Session Redundancy for IPv6 ND Clients	416
	Geo Redundancy for PPPoE Sessions	423
	PPPoE-LAC Session Switchover	424
	Verification of Geo Redundancy for PPPoE Sessions	425
	BNG Geo Redundancy with Satellite	426
	Configure BNG Geo Redundancy with Cisco NCS 5000 Series nV Satellite	428
	Geo Redundancy Features	429
	Peer Route Disable	429
	Active-active Session Support for Geo Redundancy	429
	Address Pool Usage Synchronisation in BNG Geo Redundant Active-Active Nodes	430
	Configure Address Pool Usage Synchronisation in BNG Geo Redundant Active-Active Nodes	431
	State Control Route for Geo Redundancy	433

Multiple State Control Routes for Each SRG	433
Configure State Control Route for Geo Redundancy	434
Subscriber Redundancy Group Revertive Timer	435
Subscriber Redundancy Group-aware IPv6 Neighbor Discovery	436
Peer-to-peer Traffic Flow with BNG Geo Redundancy	436
Accounting Trigger Cause for Geo Redundancy	437
SRG Support for BNG SLAAC Sessions	438
SRG Support for Static Sessions	439
Configure Subscriber Redundancy Group for Static Sessions	439
SRG Support for LC Subscribers	442
Configure Subscriber Redundancy Group for LC Subscriber Sessions	443
Subscriber Redundancy Group for Pseudowire Headend Subscribers	445
Link Failure Scenarios in BNG PWHE with SRG	446
Restrictions for SRG for PWHE subscribers on BNG	446
Configure SRG for Pseudowire Headend Subscribers on BNG	447
Deployment Models for BNG Geo Redundancy	451

CHAPTER 9**DIAMETER Support in BNG 453**

DIAMETER Overview	453
DIAMETER Interface in BNG	454
Supported DIAMETER Base Messages	455
DIAMETER NASREQ Application	456
DIAMETER Accounting	458
DIAMETER Gx and Gy Applications	458
DIAMETER DCCA Application	460
BNG DIAMETER Call Flow	460
Guidelines and Restrictions for DIAMETER Support in BNG	461
Configuring DIAMETER Peer in BNG	462
Configuring AAA for DIAMETER Peer in BNG	467
Verification of DIAMETER Configurations in BNG	470
BNG DIAMETER-Geo Redundancy Interworking	475
BNG DIAMETER-Geo Redundancy Call Flow	476
Verify BNG DIAMETER-Geo Redundancy	479
Additional References	482

CHAPTER 10	USH Support in BNG	485
	Overview of USH	485
	Restrictions for USH in BNG	486
	Configure USH for BNG	486

APPENDIX A	XML Support for BNG Features	491
	AAA XML Support	491
	DHCP XML Support	494
	Control Policy XML Support	497
	DAPS XML Support	500
	PPPoE XML Support	501
	Subscriber Database XML Support	503

APPENDIX B	RADIUS Attributes	509
	RADIUS IETF Attributes	509
	IETF Tagged Attributes on LAC	511
	RADIUS Vendor-Specific Attributes	512
	Vendor-Specific Attributes for Account Operations	518
	RADIUS ADSL Attributes	518
	RADIUS ASCEND Attributes	519
	RADIUS Microsoft Attributes	519
	RADIUS Disconnect-Cause Attributes	520

APPENDIX C	Action Handlers	525
-------------------	------------------------	------------

APPENDIX D	BNG Use Cases and Sample Configurations	527
	BNG over Pseudowire Headend	527
	Sample Topology for BNG over Pseudowire Headend	527
	Deployment Models for Subscribers on Pseudowire Headend	528
	Residential Subscribers on Pseudowire Headend	528
	Residential and Business Subscribers on Pseudowire Headend	529
	Configuration and Verification of BNG over Pseudowire Headend	530
	Sample Configurations for BNG over Pseudowire Headend	532

Dual-Stack Subscriber Sessions	534
IP Address Assignment for Clients	534
Sample IPv6 Addressing and Configurations	535
IPv6 Address Mapping	535
CPE Configurations	535
DHCPv6 Server Configuration	536
Operation and Call Flow of Dual-Stack Sessions	536
Generic Call Flow of Dual-Stack Session	536
Detailed Call Flows - PPPoE Dual-Stack	537
Detailed Call Flows - IPoE Dual-Stack	539
Sample Topology for Dual-Stack	540
Configuration Examples for Dual-Stack	540
Verification Steps for Dual-Stack	543
eBGP over PPPoE	543
Sample Topology for eBGP over PPPoE	543
Configuration and Verification of eBGP over PPPoE	544
Sample Configurations for eBGP over PPPoE	546
Routed Subscriber Sessions	552
Routed Subscriber Deployment Topology and Use Cases	552
Sample Configurations for Routed Subscriber Session	553
Verification of Routed Subscriber Session Configurations	555

APPENDIX E

DIAMETER Attributes	563
BNG DIAMETER Gx Application AVPs	563
BNG DIAMETER Gy Application AVPs	565
BNG DIAMETER NASREQ Application Cisco AVPs	566
DIAMETER Accounting AVP	569
DIAMETER Session-Id AVP	570
RADIUS Attributes in DIAMETER Messages	571
Sample Packets for BNG DIAMETER Messages	572



Preface

From Release 6.1.2 onwards, Cisco introduces support for the 64-bit Linux-based IOS XR operating system. Extensive feature parity is maintained between the 32-bit and 64-bit environments. Unless explicitly marked otherwise, the contents of this document are applicable for both the environments. For more details on Cisco IOS XR 64 bit, refer to the [Release Notes](#) for Cisco ASR 9000 Series Routers, Release 6.1.2 document.

This preface contains these sections:

- [Changes to This Document, on page xv](#)
- [Communications, Services, and Additional Information, on page xv](#)

Changes to This Document



Note *This software release has reached end-of-life status. For more information, see the [End-of-Life and End-of-Sale Notices](#).*

Date	Summary
April 2019	Initial release of this document.
December 2019	Republished for 6.6.3

Communications, Services, and Additional Information

- To receive timely, relevant information from Cisco, sign up at [Cisco Profile Manager](#).
- To get the business impact you're looking for with the technologies that matter, visit [Cisco Services](#).
- To submit a service request, visit [Cisco Support](#).
- To discover and browse secure, validated enterprise-class apps, products, solutions and services, visit [Cisco Marketplace](#).
- To obtain general networking, training, and certification titles, visit [Cisco Press](#).
- To find warranty information for a specific product or product family, access [Cisco Warranty Finder](#).

Cisco Bug Search Tool

[Cisco Bug Search Tool](#) (BST) is a web-based tool that acts as a gateway to the Cisco bug tracking system that maintains a comprehensive list of defects and vulnerabilities in Cisco products and software. BST provides you with detailed defect information about your products and software.



CHAPTER

1

New and Changed BNG Features

This table summarizes the new and changed feature information for the *Cisco ASR 9000 Series Aggregation Services Router Broadband Network Gateway Configuration Guide*, and tells you where they are documented.

- [BNG Features Added or Modified in IOS XR Release 6.6.x, on page 1](#)

BNG Features Added or Modified in IOS XR Release 6.6.x

For details of commands referred in this guide, see the *Cisco ASR 9000 Series Aggregation Services Router Broadband Network Gateway Command Reference*.

Feature	Description	Changed in Release	Where Documented
Subscriber Redundancy Group for PWHE BNG Sessions	This feature was introduced	Release 6.6.3	Subscriber Redundancy Group for Pseudowire Headend Subscribers, on page 445 For commands related to this feature, see the <i>Subscriber and Session Redundancy Commands</i> chapter.
Header Enrichment on PWHE over Sub-interface with SRG Switchover in Global	Header Enrichment feature was enhanced.	Release 6.6.3	HTTP Header Enrichment for BNG Subscribers, on page 380
HTTP Redirect on PWHE with SRG	HTTP redirect feature was enhanced.	Release 6.6.3	HTTP Redirect Using PBR, on page 361
Cisco IOS XR 64-bit BNG Support on RSP5	This feature was introduced	Release 6.6.3	Hardware Support for Cisco IOS XR 64-bit BNG, on page 16

Feature	Description	Changed in Release	Where Documented
Support to add options in DHCPv4 and DHCPv6 messages for BNG subscribers	This functionality was introduced	Release 6.6.2	Send DHCP Options to RADIUS, on page 182 and Send Rich DHCP Options from RADIUS to DHCP Server or Proxy, on page 175 See the <i>BNG DHCP Commands</i> chapter in the <i>Cisco ASR 9000 Series Aggregation Services Router Broadband Network Gateway Command Reference</i> , for information on the commands related to this feature.
Support to configure DHCPv6 base profile	This functionality was introduced	Release 6.6.2	PPP/IPoE Class-based DHCPv6 Mode Selection, on page 201 See the <i>BNG DHCP Commands</i> chapter in <i>Cisco ASR 9000 Series Aggregation Services Router Broadband Network Gateway Command Reference</i> , for information on the commands related to this feature.
Support to configure DHCPv4 base profile	This functionality was introduced	Release 6.6.2	IPoE Class-based DHCPv4 Mode Selection, on page 194 See the <i>BNG DHCP Commands</i> chapter in <i>Cisco ASR 9000 Series Aggregation Services Router Broadband Network Gateway Command Reference</i> , for information on the commands related to this feature.

Feature	Description	Changed in Release	Where Documented
Support for merge and accounting-statistics for configuring Parameterized QoS as auto-service	This functionality was introduced	Release 6.6.2	Configuring Parameterized QoS as Auto-service, on page 270
Support for DHCPv4 and DHCPv6 Options from Radius Server to DHCP Client	This functionality was introduced	Release 6.6.2	Send Rich DHCP Options from RADIUS to DHCP Server or Proxy, on page 175
Support for DHCPv4 and DHCPv6 to Handle VRF Name and IP Address from Radius Server	This functionality was introduced	Release 6.6.2	DHCP RADIUS Proxy, on page 184



CHAPTER 2

Broadband Network Gateway Overview

This chapter provides an overview of the Broadband Network Gateway (BNG) functionality implemented on the Cisco ASR 9000 Series Router.

For details on Cisco IOS XR 64-bit BNG, see [BNG on Cisco IOS XR 64-bit ASR 9000 Series Routers, on page 15](#)

Table 1: Feature History for Broadband Network Gateway Overview

- [Understanding BNG, on page 5](#)
- [BNG Architecture, on page 6](#)
- [BNG Role in ISP Network Models, on page 8](#)
- [BNG Packaging, on page 9](#)
- [BNG Configuration Process, on page 10](#)
- [Hardware Requirements for BNG, on page 11](#)
- [BNG Interoperability, on page 13](#)
- [BNG Smart Licensing, on page 14](#)
- [BNG on Cisco IOS XR 64-bit ASR 9000 Series Routers, on page 15](#)

Understanding BNG

Broadband Network Gateway (BNG) is the access point for subscribers, through which they connect to the broadband network. When a connection is established between BNG and Customer Premise Equipment (CPE), the subscriber can access the broadband services provided by the Network Service Provider (NSP) or Internet Service Provider (ISP).

BNG establishes and manages subscriber sessions. When a session is active, BNG aggregates traffic from various subscriber sessions from an access network, and routes it to the network of the service provider.

BNG is deployed by the service provider and is present at the first aggregation point in the network, such as the edge router. An edge router, like the Cisco ASR 9000 Series Router, needs to be configured to act as the BNG. Because the subscriber directly connects to the edge router, BNG effectively manages subscriber access, and subscriber management functions such as:

- Authentication, authorization and accounting of subscriber sessions
- Address assignment
- Security

- Policy management
- Quality of Service (QoS)

Some benefits of using BNG are:

- The BNG router not only performs the routing function but also communicates with authentication, authorization, and accounting (AAA) server to perform session management and billing functions. This makes the BNG solution more comprehensive.
- Different subscribers can be provided different network services. This enables the service provider to customize the broadband package for each customer based on their needs.

BNG Architecture

The goal of the BNG architecture is to enable the BNG router to interact with peripheral devices (like CPE) and servers (like AAA and DHCP), in order to provide broadband connectivity to subscribers and manage subscriber sessions. The basic BNG architecture is shown in this figure.

Figure 1: BNG Architecture

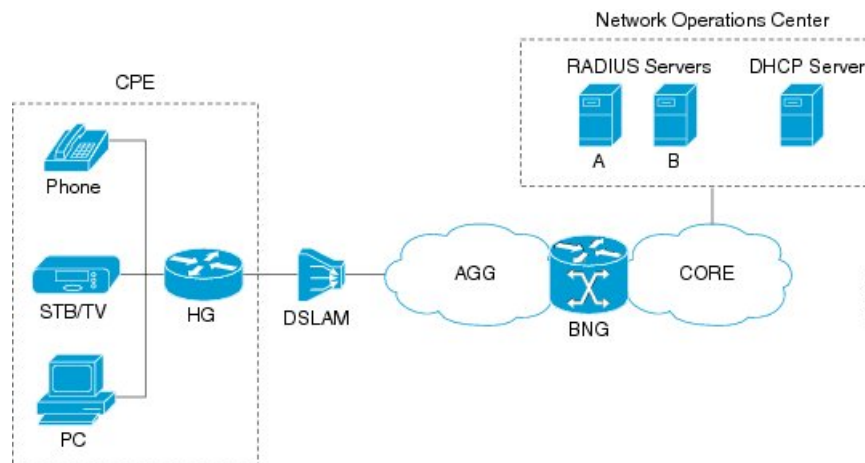

The BNG architecture is designed to perform these tasks:

- Connecting with the Customer Premise Equipment (CPE) that needs to be served broadband services.
- Establishing subscriber sessions using IPoE or PPPoE protocols.
- Interacting with the AAA server that authenticates subscribers, and keeps an account of subscriber sessions.
- Interacting with the DHCP server to provide IP address to clients.
- Advertising the subscriber routes.

The five BNG tasks are briefly explained in the following sections.

Connecting with the CPE

BNG connects to the CPE through a multiplexer and Home Gateway (HG). The CPE represents the triple play service in telecommunications, namely, voice (phone), video (set top box), and data (PC). The individual subscriber devices connect to the HG. In this example, the subscriber connects to the network over a Digital Subscriber Line (DSL) connection. Therefore, the HG connects into a DSL Access Multiplexer (DSLAM).

Multiple HGs can connect to a single DSLAM that sends the aggregated traffic to the BNG router. The BNG router routes traffic between the broadband remote access devices (like DSLAM or Ethernet Aggregation Switch) and the service provider network.

Establishing Subscriber Sessions

Each subscriber (or more specifically, an application running on the CPE) connects to the network by a logical session. Based on the protocol used, subscriber sessions are classified into two types:

- PPPoE subscriber session—The PPP over Ethernet (PPPoE) subscriber session is established using the point-to-point (PPP) protocol that runs between the CPE and BNG.
- IPoE subscriber session—The IP over Ethernet (IPoE) subscriber session is established using IP protocol that runs between the CPE and BNG; IP addressing is done using the DHCP protocol.

Interacting with the RADIUS Server

BNG relies on an external Remote Authentication Dial-In User Service (RADIUS) server to provide subscriber Authentication, Authorization, and Accounting (AAA) functions. During the AAA process, BNG uses RADIUS to:

- authenticate a subscriber before establishing a subscriber session
- authorize the subscriber to access specific network services or resources
- track usage of broadband services for accounting or billing

The RADIUS server contains a complete database of all subscribers of a service provider, and provides subscriber data updates to the BNG in the form of attributes within RADIUS messages. BNG, on the other hand, provides session usage (accounting) information to the RADIUS server. For more information about RADIUS attributes, see [RADIUS Attributes, on page 509](#).

BNG supports connections with more than one RADIUS server to have fail over redundancy in the AAA process. For example, if RADIUS server A is active, then BNG directs all messages to the RADIUS server A. If the communication with RADIUS server A is lost, BNG redirects all messages to RADIUS server B.

During interactions between the BNG and RADIUS servers, BNG performs load balancing in a round-robin manner. During the load balancing process, BNG sends AAA processing requests to RADIUS server A only if it has the bandwidth to do the processing. Else, the request is sent to RADIUS server B.

Interacting with the DHCP Server

BNG relies on an external Dynamic Host Configuration Protocol (DHCP) server for address allocation and client configuration functions. BNG can connect to more than one DHCP server to have fail over redundancy in the addressing process. The DHCP server contains an IP address pool, from which it allocates addresses to the CPE.

During the interaction between BNG and the DHCP server, BNG acts as a DHCP relay or DHCP proxy.

As the DHCP relay, BNG receives DHCP broadcasts from the client CPE, and forwards the request to the DHCP server.

As the DHCP proxy, BNG itself maintains the address pool by acquiring it from DHCP server, and also manages the IP address lease. BNG communicates on Layer 2 with the client Home Gateway, and on Layer 3 with the DHCP server.

The DSLAM modifies the DHCP packets by inserting subscriber identification information. BNG uses the identification information inserted by the DSLAM, as well as the address assigned by the DHCP server, to identify the subscriber on the network, and monitor the IP address lease.

Advertising Subscriber Routes

For optimal performance in design solutions where the Border Gateway Protocol (BGP) advertises the subscriber routes, the BNG advertises the entire subnet designated to the subscribers using the **network** command in the BGP configuration.

The BNG redistributes the individual subscriber routes only in scenarios where the Radius server assigns the IP address to a subscriber and there is no way to know to which BNG that particular subscriber will connect.

BNG Role in ISP Network Models

The role of BNG is to pass traffic from the subscriber to the ISP. The manner in which BNG connects to the ISP depends on the model of the network in which it is present. There are two types of network models:

- [Network Service Provider, on page 8](#)
- [Access Network Provider, on page 9](#)

Network Service Provider

The following figure shows the topology of a Network Service Provider model.

Figure 2: Network Service Provider Model

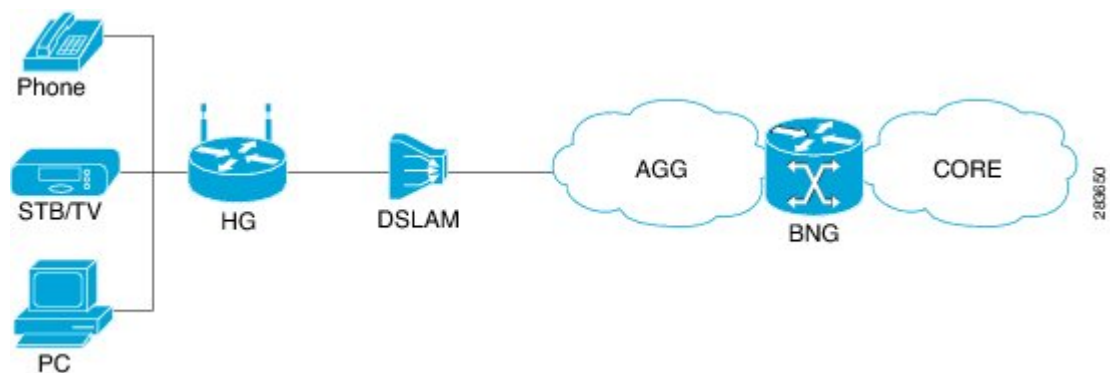

In the Network Service Provider model, the ISP (also called the retailer) directly provides the broadband connection to the subscriber. As shown in the above figure, BNG is at the edge router, and its role is to connect to the core network through uplinks.

Access Network Provider

The following figure shows the topology of a Access Network Provider model.

Figure 3: Access Network Provider Model

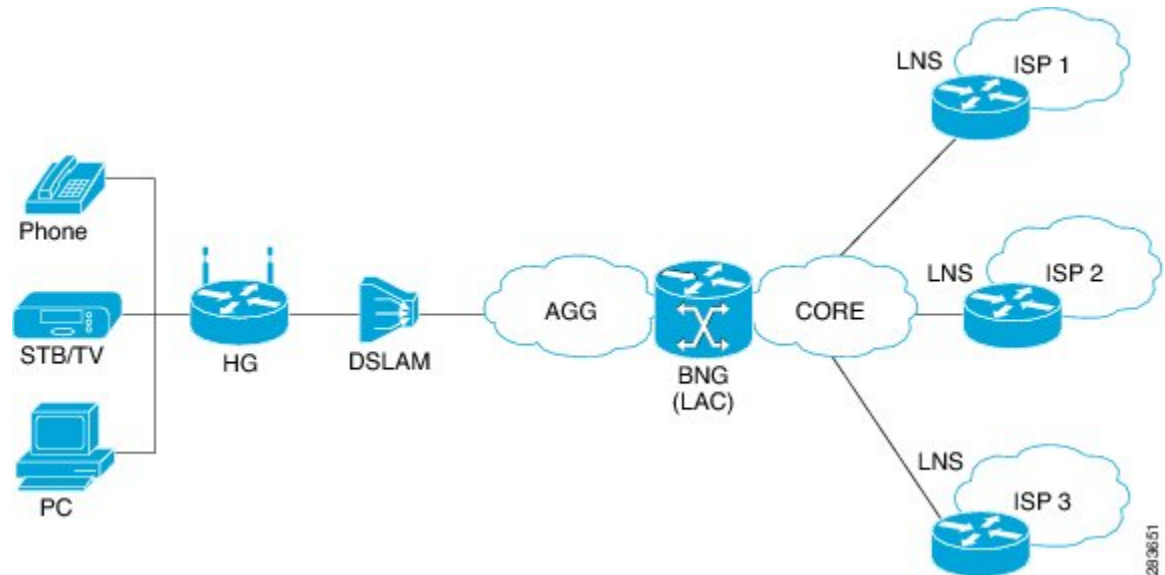

In the Access Network Provider model, a network carrier (also called the wholesaler) owns the edge network infrastructure, and provides the broadband connection to the subscriber. However, the network carrier does not own the broadband network. Instead, the network carrier connects to one of the ISPs that manage the broadband network.

BNG is implemented by the network carrier and its role is to hand the subscriber traffic off to one of several ISPs. The hand-off task, from the carrier to the ISP, is implemented by Layer 2 Tunneling Protocol (L2TP) or Layer 3 Virtual Private Networking (VPN). L2TP requires two distinct network components:

- L2TP Access Concentrator (LAC)—The LAC is provided by the BNG.
- L2TP Network Server (LNS)—The LNS is provided by the ISP.

BNG Packaging

The BNG pie, `asr9k-bng-px.pie` can be installed and activated on the Cisco ASR 9000 Series Router to access the BNG features. The install, uninstall, activate and deactivate operations can be performed without rebooting the router.

It is recommended that the relevant BNG configurations be removed from the running configuration of the router, before uninstalling or deactivating the BNG pie.

Installing and Activating the BNG Pie on Cisco ASR 9000 Series Router

Perform this task to install and activate the BNG pie on the Cisco ASR 9000 Series Router:

SUMMARY STEPS

1. **admin**
2. **install add** {*pie_location* | **source** | **tar**}
3. **install activate** {*pie_name* | **id**}

DETAILED STEPS

	Command or Action	Purpose
Step 1	admin Example: RP/0/RSP0/CPU0:router# admin	Enters the administration mode.
Step 2	install add { <i>pie_location</i> source tar }	Installs the pie from the tftp location, on to the Cisco ASR 9000 Series Router.
	Example: RP/0/RSP0/CPU0:router(admin)# install add tftp://223.255.254.254/softdir/asr9k-bng-px.pie	
Step 3	install activate { <i>pie_name</i> id }	Activates the installed pie on the Cisco ASR 9000 Series Router.
	Example: RP/0/RSP0/CPU0:router(admin)# install activate asr9k-bng-px.pie	

What to do next



Note During upgrade from Release 4.2.1 to Release 4.3.0, it is recommended that the Cisco ASR 9000 base image pie (asr9k-mini-px.pie) is installed prior to installing the BNG pie (asr9k-bng-px.pie).

After BNG pie is installed, you must copy BNG related configurations from the flash or tftp location to the router. If BNG pie is deactivated and activated again, then load the removed BNG configurations by executing the **load configuration removed** command from the configuration terminal.



Note Most of the BNG feature configurations are moved to a new namespace partition, and hence BNG features are not available by default now. To avoid inconsistent BNG configurations before, or after installing the BNG pie, run the **clear configuration inconsistency** command, in EXEC mode.

BNG Configuration Process

Configuring BNG on the Cisco ASR 9000 Series Router involves these stages:

- **Configuring RADIUS Server**—BNG is configured to interact with the RADIUS server for authentication, authorization, and accounting functions. For details, see [Configuring Authentication, Authorization, and Accounting Functions, on page 25](#).
- **Activating Control Policy**—Control policies are activated to determine the action that BNG takes when specific events occur. The instructions for the action are provided in a policy map. For details, see [Activating Control Policy, on page 81](#).
- **Establishing Subscriber Sessions**—Configurations are done to set up one or more logical sessions, from the subscriber to the network, for accessing broadband services. Each session is uniquely tracked and managed. For details, see [Establishing Subscriber Sessions, on page 93](#).
- **Deploying QoS**—Quality of Service (QoS) is deployed to provide control over a variety of network applications and traffic types. For example, the service provider can have control over resources (example bandwidth) allocated to each subscriber, provide customized services, and give priority to traffic belonging to mission-critical applications. For details, see [Deploying the Quality of Service \(QoS\), on page 253](#).
- **Configuring Subscriber Features**—Configurations are done to activate certain subscriber features that provide additional capabilities like policy based routing, access control using access list and access groups, and multicast services. For details, see [Configuring Subscriber Features, on page 307](#).
- **Verifying Session Establishment**—Established sessions are verified and monitored to ensure that connections are always available for use. The verification is primarily done using "show" commands. Refer to the *Cisco ASR 9000 Series Aggregation Services Router Broadband Network Gateway Command Reference* guide for the list of various "show" commands.

To use a BNG command, you must be in a user group associated with a task group that includes the proper task IDs. The *Cisco ASR 9000 Series Aggregation Services Router Broadband Network Gateway Command Reference* guide includes the task IDs required for each command. If you suspect that the user group assignment is preventing you from using a command, contact your AAA administrator for assistance.

Important

The Select VRF Download (SVD) must be disabled, when BNG is configured. For more information about SVD, see the *Cisco IOS XR Routing Configuration Guide for the Cisco XR 12000 Series Router*.

Hardware Requirements for BNG

For specific hardware requirements for Cisco IOS XR 64-bit BNG, see [Hardware Support for Cisco IOS XR 64-bit BNG, on page 16](#).

These hardwares support BNG:

- The Satellite Network Virtualization (nV) system.
- The route switch processors, RSP-440, RSP-880 and RSP-880-LT-SE.
- The route processor, A99-RP-SE, A99-RP2-SE, on the Cisco ASR 9912 and the Cisco ASR 9922 chassis.
- The route switch processor, A99-RSP-SE, on the Cisco ASR 9910 and the Cisco ASR 9906 chassis.
- The below table lists the Line Cards and Modular Port Adapters that support BNG.

Table 2: Line Cards and Modular Port Adapters Supported on BNG

Product Description	Part Number
24-Port 10-Gigabit Ethernet Line Card, Service Edge Optimized	A9K-24X10GE-SE
36-Port 10-Gigabit Ethernet Line Card, Service Edge Optimized	A9K-36X10GE-SE
40-Port Gigabit Ethernet Line Card, Service Edge Optimized	A9K-40GE-SE
4-Port 10-Gigabit Ethernet, 16-Port Gigabit Ethernet Line Card, 40G Service Edge Optimized	A9K-4T16GE-SE
<p>Cisco ASR 9000 High Density 100GE Ethernet line cards:</p> <ul style="list-style-type: none"> • Cisco ASR 9000 8-port 100GE "LAN-only" Service Edge Optimized Line Card, Requires CPAK optics • Cisco ASR 9000 8-port 100GE "LAN/WAN/OTN" Service Edge Optimized Line Card, Requires CPAK optics • Cisco ASR 9000 4-port 100GE "LAN/WAN/OTN" Service Edge Optimized Line Card, Requires CPAK optics 	<p>A9K-8X100G-LB-SE</p> <p>A9K-8x100GE-SE</p> <p>A9K-4x100GE-SE</p>
Cisco ASR 9000 Series 24-port dual-rate 10GE/1GE service edge-optimized line cards	A9K-24X10-1GE-SE
Cisco ASR 9000 Series 48-port dual-rate 10GE/1GE service edge-optimized line cards	A9K-48X10-1GE-SE
80 Gigabyte Modular Line Card, Service Edge Optimized	A9K-MOD80-SE
160 Gigabyte Modular Line Card, Service Edge Optimized	A9K-MOD160-SE
20-Port Gigabit Ethernet Modular Port Adapter (MPA)	A9K-MPA-20GE
ASR 9000 200G Modular Line Card, Service Edge Optimized, requires modular port adapters	A9K-MOD200-SE
ASR 9000 400G Modular Line Card, Service Edge Optimized, requires modular port adapters	A9K-MOD400-SE
2-port 10-Gigabit Ethernet Modular Port Adapter (MPA)	A9K-MPA-2X10GE

Product Description	Part Number
4-Port 10-Gigabit Ethernet Modular Port Adapter (MPA)	A9K-MPA-4X10GE
ASR 9000 20-port 10-Gigabit Ethernet Modular Port Adapter, requires SFP+ optics	A9K-MPA-20x10GE
2-port 40-Gigabit Ethernet Modular Port Adapter (MPA)	A9K-MPA-2X40GE
1-Port 40-Gigabit Ethernet Modular Port Adapter (MPA)	A9K-MPA-1X40GE
ASR 9000 1-port 100-Gigabit Ethernet Modular Port Adapter, requires CFP2-ER4 or CPAK optics	A9K-MPA-1x100GE
ASR 9000 2-port 100-Gigabit Ethernet Modular Port Adapter, requires CFP2-ER4 or CPAK optics	A9K-MPA-2x100GE

BNG Interoperability

The BNG interoperability allows BNG to exchange and use information with other larger heterogeneous networks. These are the key features:

- BNG Coexists with ASR9001:

ASR9001 is a standalone high processing capability router that comprises of a route switch processor (RSP), linecards (LC), and ethernet plugs (EPs). All BNG features are fully supported on the ASR9001 chassis.

- BNG Supports nV Satellite:

- The only topology that BNG supports with nV Satellite is bundle access on the CPE side with non-bundle ICL links, as shown below:

CPE --- Bundle --- [Satellite] --- Non Bundle ICL --- ASR9K

For details on nV Satellite configuration, see *nV System Configuration Guide for Cisco ASR 9000 Series Routers* located [here](#).

- BNG does not support nV Satellite with bundle ICL and bundle access links, as shown below:

CPE --- Bundle --- [Satellite] --- Bundle ICL --- ASR9K

- From Cisco IOS XR Software Release 6.1.2 and later, BNG supports the use of Cisco NCS 5000 Series satellite.
- From Cisco IOS XR Software Release 6.2.2 and later, Cisco IOS XR 32 bit operating system supports BNG geo redundancy with Cisco NCS 5000 Series satellite. Whereas, it does not support BNG geo redundancy with Cisco ASR 9000v satellite. For details, see *BNG Geo Redundancy* chapter in this guide..

- BNG interoperates with Carrier Grade NAT (CGN):

To address the impending threat from IPv4 address space depletion, it is recommended that the remaining or available IPv4 addresses be shared among larger numbers of customers. This is done by using CGN, which primarily pulls the address allocation to a more centralized NAT in the service provider network. NAT44 is a technology that uses CGN and helps manage depletion issues of the IPv4 address space. BNG supports the ability to perform NAT44 translation on IPoE and PPPoE-based BNG subscriber sessions.



Note For BNG and CGN interoperability, configure the BNG interface and the application service virtual interface (SVI) on the same VRF instance.

BNG Smart Licensing

BNG supports Cisco Smart Software Licensing that provides a simplified way for the customers to purchase licenses and to manage them across their network. Smart licensing provides a customizable consumption-based model that aligns to the network growth of the customer. It also provides the flexibility to quickly modify or upgrade software feature configurations to deploy new services over time.

For more information about Cisco Smart Software Licensing, see [Software Entitlement on the Cisco ASR 9000 Series Router](#) chapter of *System Management Configuration Guide for Cisco ASR 9000 Series Routers*.

BNG Smart Licensing supports Geo redundancy and non-Geo redundancy subscriber sessions. One license supports of 8000 subscribers or a fraction of it. For example, 9000 subscribers need two licenses.

The software license PIDs for BNG in the Cisco Smart Software Manager (CSSM) portal are as follows:

Table 3: BNG License PIDs in the CSSM portal

Product ID	Product Description
S-A9K-BNG-LIC-8K	BNG license unit for 8000 non geo- redundancy sessions.
S-A9K-BNG-ADV-8K	BNG license unit for advanced features i.e. geo-redundancy sessions.

You can use the **show sessionmon license statistics** command to display the highest number of subscriber sessions that are up in a 24-hour time period. In the event of an RP/LC reload or powercycle, the session count for the corresponding RP/LC resets to 0. As and when the BNG sessions come up, this counter changes and shows the highest number of sessions since the reload.

```
Router# show sessionmon license statistics
```

```

Active Standby
=====
Peak (24 hours) 32000 1
```

BNG on Cisco IOS XR 64-bit ASR 9000 Series Routers

The Broadband Network Gateway (BNG) functionality is supported on Cisco IOS XR 64-bit ASR 9000 Series Routers, in addition to the Cisco IOS XR 32-bit ASR 9000 Series Routers. This functionality is available on Cisco ASR 9000 Series Routers with RSP880, RSP 880-LT and Cisco ASR 9000 High Density 100GE Ethernet line cards (LCs) having more CPU cycles and per-process virtual memory, which in turn increases the scale and performance of the Cisco ASR 9000 Series Router as a BNG.

Pre-requisites for Using Cisco IOS XR 64-bit BNG

- Verify the supported hardware:

See [Hardware Support for Cisco IOS XR 64-bit BNG, on page 16](#).

- Install and activate the BNG RPM:

You must install the BNG route processor module (RPM) on the Cisco IOS XR 64-bit ASR 9000 Series Router, in order to use the BNG service package. For details, see [Packaging of Cisco IOS XR 64-bit BNG, on page 19](#).

- Fine tune physical memory resources of each line card:

The configuration procedures for the support of subscriber sessions on Cisco IOS XR 64-bit BNG remain the same as that of Cisco IOS XR 32-bit BNG. However, the following command must be used to fine tune the physical memory resources of each Cisco ASR 9000 High Density 100GE Ethernet line card in order to achieve full scale with Cisco IOS XR 64-bit BNG. The recommended value of memory is 20GB. This configuration reserves 20 GB of physical memory for each line card XR virtual machine (XR VM), out of which, 5.5 GB (approximately) is consumed by the kernel and only the remaining of 14.5GB (approximately) is available for applications.

```
sdr sdr-name resources card-type card-type vm-memory memory-value
```

or by disabling ISSU:

```
sdr default-sdr issu disable
```



Note

- To enable ISSU, use the **nosdr** *default-sdr* **issu** **disable** command.
- After you disable or re-enable ISSU, ensure to reload the SDR manually on all LCs using the **hw-module location all reload** command.

For example:

```
sysadmin-vm:0_RSP0# hw-module location all reload
```

You must configure these commands from System Admin Config (sysadmin-vm:0_RP0) mode. To enter System Admin Config mode, use the **admin** command in EXEC mode of the Cisco IOS XR 64-bit ASR 9000 Series Router, followed by the **config** command.



Note The `sdr resources` command enforces to reboot the LC XR VMs to adjust the requested resources (say, VM memory).

Use these commands to verify the memory utilization on each RSP880 and LC:

- `run show_memory_ng -a -S`
- `show memory summary detail location location`

Hardware Support for Cisco IOS XR 64-bit BNG

Supported Hardware for Cisco IOS XR 64-bit BNG

- The Satellite Network Virtualization (nV) system.
- Cisco IOS XR 64-bit BNG is supported only on the following Route Switch Processors (RSPs) and families of Cisco ASR 9000 High Density 100GE Ethernet line cards.

Supported RSPs for Cisco IOS XR 64-bit BNG are:

- A9K-RSP880-SE
- A9K-RSP880-LT-SE
- A99-RP-SE and A99-RP2-SE on the Cisco ASR 9912 and the Cisco ASR 9922 chassis.
- A99-RSP-SE on the Cisco ASR 9910 and the Cisco ASR 9906 chassis.
- A9K-RSP5-SE

Table 4: Supported Line Cards and Chassis for Cisco IOS XR 64-bit BNG

Line Cards / Chassis	Description
A9K-8X100G-LB-SE	Cisco ASR 9000 8-port 100GE “LAN-only” Service Edge Optimized Line Card
A9K-8X100GE-SE	Cisco ASR 9000 8-port 100GE “LAN/WAN/OTN” Service Edge Optimized Line Card
A9K-4X100GE-SE	Cisco ASR 9000 4-port 100GE “LAN/WAN/OTN” Service Edge Optimized Line Card
A9K-MOD200-SE	ASR 9000 200G Modular Line Card, Service Edge Optimized, requires modular port adapters
A9K-MOD400-SE	ASR 9000 400G Modular Line Card, Service Edge Optimized, requires modular port adapters
A99-8X100GE-SE	Cisco ASR 9900 8-port 100GE “LAN/WAN/OTN” Service Edge Optimized Line Card

Line Cards / Chassis	Description
A9K-8X100GE-CM	Cisco ASR 9000 8-Port 100GE Consumption Model Line Card
A9K-MOD400-CM	Cisco ASR 9000 Modular 400G Consumption Model Line Card
A9K-MOD200-CM	Cisco ASR 9000 Modular 200G Consumption Model Line Card
A9K-24X10-1GE-SE	Cisco ASR 9000 Series 24-port dual-rate 10GE/1GE service edge-optimized line cards
A9K-48X10-1GE-SE	Cisco ASR 9000 Series 48-port dual-rate 10GE/1GE service edge-optimized line cards
A99-48X10GE-1G-SE	Cisco ASR 9000 48-port dual-rate 10G/1G service edge line card

Table 5: Supported Modular Port Adapters for Cisco IOS XR 64-bit BNG

Modular Port Adapters (MPA)	Part Number
MOD400	<ul style="list-style-type: none"> • A9K-MPA-1X100GE • A9K-MPA-2X100GE • A9K-MPA-4X10GE • A9K-MPA-8X10GE • A9K-MPA-20X10GE • A9K-MPA-20X1GE • A9K-MPA-1X40GE • A9K-MPA-2X40GE
MOD200	The support list is same as that for MOD400.

Unsupported Hardware for Cisco IOS XR 64-bit BNG

Cisco IOS XR 64-bit BNG is not supported on these hardware:

- Packet Transport Optimised (TR) families of Cisco ASR 9000 High Density 100GE Ethernet line cards.
- A9K-RSP880-TR
- A9K-MPA-2X10GE

Feature Support on Cisco IOS XR 64-bit BNG

Table 6: Feature History Table

The following section describes the following :

- [Supported Features on Cisco IOS XR 64-bit BNG](#)
- [Unsupported Features on Cisco IOS XR 64-bit BNG](#)

Supported Features on Cisco IOS XR 64-bit BNG

The Cisco IOS XR 64-bit BNG functionality maintains parity with Cisco IOS XR 32-bit BNG. This section lists the BNG functionality and features supported on Cisco IOS XR 64-bit ASR 9000 Series Routers.

- RADIUS server interface - RADIUS server interaction to authorize the subscriber session and to download RADIUS attributes from the AAA server
- Access control lists (ACLs) or access control elements (ACEs)
- Routed subscriber sessions
- QoS features:
 - Shared policy instance (SPI)
 - Shared policy database (SPD)
 - Parameterized QoS (pQoS)
 - Policy-map merge
 - Hierarchical QoS (HQoS)
- Session accounting
- Services and service accounting – The limitations on the number of services enabled on subscriber sessions remain the same as that on Cisco IOS XR 32-bit BNG.
- Session timeout and static timeout in control policy
- SNMP, NetConf or Yang, XML
- RADIUS dynamic authorization
 - RADIUS change-of-authorization (CoA) for service-activation (SA), service-deactivation (SD), service-update (SU), accounting-query, session-query, and so on.
 - RADIUS packet of disconnect (PoD) feature for disconnecting subscriber session
- Stateful switchover (SSO) - Process restart and RP failover (RPFO)
- Subscriber redundancy group (SRG)
- Licensing
- Static sessions
- HTTP redirect (HTTPR) using policy-based routing (PBR)

- Pseudowire headend (PWHE)
- Ingress Lawful Intercept (LI) for all interface types (bundle and PWHE interfaces)
- Egress LI for bundle interfaces

Unsupported Features on Cisco IOS XR 64-bit BNG

This section lists the BNG functionality and features that are currently not supported on Cisco IOS XR 64-bit ASR 9000 Series Routers.

- PPPoE LAC SSO
- In-service software upgrade (ISSU)
- Egress LI for PWHE interfaces
- Multicast passive, QoS correlation
- DIAMETER-based Gx and Gy interfaces

BNG Support on Cisco ASR 9000 5th Generation High Density Ethernet Line Cards

Starting from Release 7.3.1 onwards, BNG features are supported on Cisco ASR 9000 5th generation High Density Ethernet line cards.

The following features are not supported on Cisco ASR 9000 5th generation High Density Ethernet line cards:

Table 7: Unsupported Features for Cisco ASR 9000 5th generation High Density Ethernet line cards

Packaging of Cisco IOS XR 64-bit BNG

Unlike the Cisco IOS XR 32-bit BNG, the Cisco IOS XR 64-bit BNG does not use the BNG pie, **asr9k-bng-px.pie**. Instead, it uses the **mini.iso** or the **full.iso** image that combines all service packages including the BNG service package for the Cisco IOS XR 64-bit ASR9000 Series Router. Also, a **.rpm** package is available separately for the BNG services.



Note In order to operate BNG services, it is mandatory to install the respective **.rpm** package for BNG, irrespective of having the **mini.iso** or the **full.iso** image installed on the router.

Install BNG RPM on Cisco ASR 9000 Series Routers

Installing BNG RPM on Cisco ASR 9000 Series Routers involves these steps:

- Download the **.rpm** package for BNG services from the source location to the router
- Activate the service package
- Commit the activated package
- Verify the activated package

Configuration Example

```

/* Download the .rpm file from the source location */
Router# install add source tftp://192.0.2.254 /user1/asr9k-bng-x64-1.0.0.0-r64104I.x86_64.rpm

/* Verify if the package is successfully added */
Router# show install inactive summary

/* Activate the inactive package listed in the above command output */
Router# install activate asr9k-bng-x64-1.0.0.0-r64104I

/* Verify the status of the install operation that proceeds in the background */
Router# show install log

/* Commit the activated package after the install operation is successfully completed */
Router# install commit

```

Verify the Installation of BNG RPM

Use this command to verify if the .rpm for BNG services is successfully installed:

```

Router# show install active summary
Thu Feb 18 13:32:17.643 IST
Label : 7.3.1.41I

Active Packages: 15
asr9k-xr-7.3.1.41I version=7.3.1.41I [Boot image]
asr9k-mgbl-x64-2.0.0.0-r73141I
asr9k-bng-supp-x64-1.0.0.0-r73141I
asr9k-bng-x64-1.0.0.0-r73141I
asr9k-9000v-nV-x64-1.0.0.0-r73141I
asr9k-mcast-x64-2.0.0.0-r73141I
asr9k-mpls-x64-2.0.0.0-r73141I
asr9k-isis-x64-1.1.0.0-r73141I
asr9k-ospf-x64-1.0.0.0-r73141I
asr9k-mpls-te-rsvp-x64-2.1.0.0-r73141I
asr9k-services-x64-1.0.0.0-r73141I
asr9k-li-x64-1.1.0.0-r73141I
asr9k-m2m-x64-2.0.0.0-r73141I
asr9k-optic-x64-1.0.0.0-r73141I
asr9k-bng-x64-1.0.0.4-r73141I

Router# show install active summary
Thu Aug 10 21:28:46.484 UTC
Active Packages: 5
asr9k-xr-6.3.1.04I version=6.3.1.04I [Boot image]
asr9k-mgbl-x64-2.0.0.0-r63104I
asr9k-mpls-x64-2.0.0.0-r63104I
asr9k-ospf-x64-1.0.0.0-r63104I
asr9k-bng-x64-1.0.0.0-r63104I

```

Related Topics

- [BNG on Cisco IOS XR 64-bit ASR 9000 Series Routers, on page 15](#)

Associated Commands

- `install add`

- install activate
- install commit
- show install {active | inactive} summary

Call-model Support on Cisco IOS XR 64-bit BNG

Supported Call-models on Cisco IOS XR 64-bit BNG

This table lists the call-models supported on Cisco IOS XR 64-bit BNG.

Call-model	Description
RP-based PPPoE PTA IPv4 sessions	Route Processor (RP)-based PPPoE PTA subscriber sessions by allocating IPv4 address for end user, with or without user authentication with the AAA server.
RP-based PPPoE PTA IPv6 or dual-stack sessions	<p>RP-based PPPoE PTA subscriber sessions by allocating IPv6 or dual subscriber address for end-user with or without user authentication with the AAA server.</p> <p>The IPv6 address allocation can be done using any of these:</p> <ul style="list-style-type: none"> • DHCPv6 procedures (using DHCPv6 server or proxy for address allocation) • IPv6 neighbor discovery (ND) procedures
RP-based PPPoE LAC sessions	<p>RP-based PPPoE LAC subscriber sessions with LNS server interaction for authenticating the user and by providing IPv4, IPv6 or dual-stack address allocation to the user.</p> <p>Note PPPoE LAC stateful switchover (SSO) is not supported.</p>
RP-based IPoE sessions	<p>RP-based IPoE subscriber sessions by providing IPv4, IPv6 or dual-stack address allocation for end-user with or without user authentication with the AAA server.</p> <p>The IPv4, IPv6 or dual-stack address allocation can be done using any of these:</p> <ul style="list-style-type: none"> • DHCPv4 procedures (using DHCPv4 server or proxy) • DHCPv6 procedures (using DHCPv6 server or proxy)

Call-model	Description
LC-based PPPoE PTA IPv4 sessions	Line Card (LC)-based PPPoE PTA subscriber sessions by allocating IPv4 address for end-user with or without user authentication with the AAA server.
LC-based PPPoE PTA IPv6 or dual-stack sessions	<p>LC-based PPPoE PTA Subscriber sessions by allocating IPv6 or dual-stack address for end-user with or without user authentication with the AAA server.</p> <p>The IPv6 address allocation can be done using any of these:</p> <ul style="list-style-type: none"> • DHCPv6 procedures (using DHCPv6 server or proxy for address allocation) • IPv6 ND procedures
LC-based IPoE sessions	<p>LC-based IPoE subscriber sessions by providing IPv4, IPv6 or dual-stack address allocation for end-user with or without user authentication with the AAA server.</p> <p>The IPv4, IPv6 or dual-stack address allocation can be done using any of these:</p> <ul style="list-style-type: none"> • DHCPv4 procedures (using DHCPv4 server or proxy) • DHCPv6 procedures (using DHCPv6 server or proxy)
RP PWHE-based PPPoE PTA IPv4 sessions	RP Pseudowire Headend (PWHE)-based PPPoE PTA subscriber sessions by allocating IPv4 address for end-user with or without user authentication with the AAA server.
RP PWHE-based PPPoE PTA IPv6 or dual-stack sessions	<p>RP PWHE-based PPPoE PTA subscriber sessions by allocating IPv6 or dual-stack address for end-user with or without user authentication with the AAA server.</p> <p>The IPv6 address allocation can be done using any of these:</p> <ul style="list-style-type: none"> • DHCPv6 procedures (using DHCPv6 server or proxy for address allocation) • IPv6 neighbor discovery (ND) procedures

Call-model	Description
RP PWHE-based IPoE sessions	<p data-bbox="963 296 1523 422">RP PWHE-based IPoE subscriber session by providing IPv4, IPv6 or dual-stack address allocation for end-user with or without user authentication with the AAA server.</p> <p data-bbox="963 436 1523 499">The IPv4, IPv6 or dual-stack address allocation can be done using any of these:</p> <ul data-bbox="995 514 1523 661" style="list-style-type: none"><li data-bbox="995 514 1523 577">• DHCPv4 procedures (using DHCPv4 server or proxy)<li data-bbox="995 592 1523 661">• DHCPv6 procedures (using DHCPv6 server or proxy)



CHAPTER 3

Configuring Authentication, Authorization, and Accounting Functions

This chapter provides information about configuring authentication, authorization, and accounting (AAA) functions on the BNG router. BNG interacts with the RADIUS server to perform AAA functions. A group of RADIUS servers form a server group that is assigned specific AAA tasks. A method list defined on a server or server group lists methods by which authorization is performed. Some of the RADIUS features include creating specific AAA attribute formats, load balancing of RADIUS servers, throttling of RADIUS records, Change of Authorization (CoA), and Service Accounting for QoS.

Table 8: Feature History for Configuring Authentication, Authorization, and Accounting Functions

This chapter covers these topics:

- [Configuring Authentication, Authorization, and Accounting Functions, on page 25](#)
- [AAA Overview, on page 26](#)
- [Using RADIUS Server Group, on page 27](#)
- [Specifying Method List, on page 30](#)
- [Defining AAA Attributes, on page 31](#)
- [Making RADIUS Server Settings, on page 44](#)
- [Balancing Transaction Load on the RADIUS Server, on page 51](#)
- [Throttling of RADIUS Records, on page 53](#)
- [RADIUS Change of Authorization \(CoA\) Overview, on page 57](#)
- [User Authentication and Authorization in the Local Network, on page 65](#)
- [Service Accounting, on page 70](#)
- [Understanding Per-VRF AAA Function, on page 75](#)
- [RADIUS over IPv6, on page 76](#)
- [Dynamic Policy Download over RADIUS Interface, on page 76](#)
- [Additional References, on page 79](#)

Configuring Authentication, Authorization, and Accounting Functions

This chapter provides information about configuring authentication, authorization, and accounting (AAA) functions on the BNG router. BNG interacts with the RADIUS server to perform AAA functions. A group of

RADIUS servers form a server group that is assigned specific AAA tasks. A method list defined on a server or server group lists methods by which authorization is performed. Some of the RADIUS features include creating specific AAA attribute formats, load balancing of RADIUS servers, throttling of RADIUS records, Change of Authorization (CoA), and Service Accounting for QoS.

Table 9: Feature History for Configuring Authentication, Authorization, and Accounting Functions

This chapter covers these topics:

AAA Overview

AAA acts as a framework for effective network management and security. It helps in managing network resources, enforcing policies, auditing network usage, and providing bill-related information. BNG connects to an external RADIUS server that provides the AAA functions.

The RADIUS server performs the three independent security functions (authentication, authorization, and accounting) to secure networks against unauthorized access. The RADIUS server runs the Remote Authentication Dial-In User Service (RADIUS) protocol. (For details about RADIUS protocol, refer to RFC 2865). The RADIUS server manages the AAA process by interacting with BNG, and databases and directories containing user information.

The RADIUS protocol runs on a distributed client-server system. The RADIUS client runs on BNG (Cisco ASR 9000 Series Router) that sends authentication requests to a central RADIUS server. The RADIUS server contains all user authentication and network service access information.

The AAA processes, the role of RADIUS server during these processes, and some BNG restrictions, are explained in these sections:

Authentication

The authentication process identifies a subscriber on the network, before granting access to the network and network services. The process of authentication works on a unique set of criteria that each subscriber has for gaining access to the network. Typically, the RADIUS server performs authentication by matching the credentials (user name and password) the subscriber enters with those present in the database for that subscriber. If the credentials match, the subscriber is granted access to the network. Otherwise, the authentication process fails, and network access is denied.

Authorization

After the authentication process, the subscriber is authorized for performing certain activity. Authorization is the process that determines what type of activities, resources, or services a subscriber is permitted to use. For example, after logging into the network, the subscriber may try to access a database, or a restricted website. The authorization process determines whether the subscriber has the authority to access these network resources.

AAA authorization works by assembling a set of attributes based on the authentication credentials provided by the subscriber. The RADIUS server compares these attributes, for a given username, with information contained in a database. The result is returned to BNG to determine the actual capabilities and restrictions that are to be applied for that subscriber.

Accounting

The accounting keeps track of resources used by the subscriber during network access. Accounting is used for billing, trend analysis, tracking resource utilization, and capacity planning activities. During the accounting

process, a log is maintained for network usage statistics. The information monitored include, but are not limited to - subscriber identities, applied configurations on the subscriber, the start and stop times of network connections, and the number of packets and bytes transferred to, and from, the network.

BNG reports subscriber activity to the RADIUS server in the form of accounting records. Each accounting record comprises of an accounting attribute value. This value is analyzed and used by the RADIUS server for network management, client billing, auditing, etc.

The accounting records of the subscriber sessions may timeout if the BNG does not receive acknowledgments from the RADIUS server. This timeout can be due to RADIUS server being unreachable or due to network connectivity issues leading to slow performance of the RADIUS server. If the sessions on the BNG are not acknowledged for their Account-Start request, loss of sessions on route processor fail over (RPFO) and other critical failures are reported. It is therefore recommended that a RADIUS server **deadtime** be configured on the BNG, to avoid loss of sessions. Once this value is configured, and if a particular session is not receiving an accounting response even after retries, then that particular RADIUS server is considered to be non-working and further requests are not sent to that server.

The **radius-server deadtime limit** command can be used to configure the **deadtime** for RADIUS server. For details, see [Configuring RADIUS Server Settings, on page 44](#).

**Note**

- On session disconnect, transmission of the Accounting-Stop request to RADIUS may be delayed for a few seconds while the system waits for the "final" session statistics to be collected from the hardware. The Event-Timestamp attribute in that Accounting-Stop request should, however, reflect the time the client disconnects, and not the transmission time.

Using RADIUS Server Group

A RADIUS server group is a named group of one or more RADIUS servers. Each server group is used for a particular service. For example, in an AAA network configuration having two RADIUS server groups, the first server group can be assigned the authentication and authorization task, while the second group can be assigned the accounting task.

Server groups can include multiple host entries for the same server. Each entry, however, must have a unique identifier. This unique identifier is created by combining an IP address and a UDP port number. Different ports of the server, therefore, can be separately defined as individual RADIUS hosts providing a specific AAA service. In other words, this unique identifier enables RADIUS requests to be sent to different UDP ports on the same server. Further, if two different host entries on the same RADIUS server are configured for the same service (like the authentication process), then the second host entry acts as a fail-over backup for the first one. That is, if the first host entry fails to provide authentication services, BNG tries with the second host entry. (The RADIUS host entries are tried in the order in which they are created.)

For assigning specific actions to the server group, see [Configuring RADIUS Server Group, on page 27](#).

Configuring RADIUS Server Group

Perform this task to define a named server group as the server host.

SUMMARY STEPS

1. **configure**
2. **aaa group server radius** *name*
3. **accounting accept** *radius_attribute_list_name*
4. **authorization reply accept** *radius_attribute_list_name*
5. **deadtime** *limit*
6. **load-balance method least-outstanding** *batch-size size ignore-preferred-server*
7. **server** *host_name acct-port accounting_port_number auth-port authentication_port_number*
8. **source-interface** *name value*
9. **vrf** *name*
10. Use the **commit** or **end** command.

DETAILED STEPS

	Command or Action	Purpose
Step 1	configure Example: RP/0/RSP0/CPU0:router# configure	Enters global configuration mode.
Step 2	aaa group server radius <i>name</i> Example: RP/0/RSP0/CPU0:router(config)# aaa group server radius r1	Configures the RADIUS server group named r1.
Step 3	accounting accept <i>radius_attribute_list_name</i> Example: RP/0/RSP0/CPU0:router(config-sg-radius)# accounting accept att_list	Configures the radius attribute filter for the accounting process to accept only the attributes specified in the list.
Step 4	authorization reply accept <i>radius_attribute_list_name</i> Example: RP/0/RSP0/CPU0:router(config-sg-radius)# authorization reply accept att_list1	Configures the radius attribute filter for the authorization process to accept only the attributes specified in the list.
Step 5	deadtime <i>limit</i> Example: RP/0/RSP0/CPU0:router(config-sg-radius)# deadtime 40	Configures the RADIUS server-group deadtime. The deadtime limit is configured in minutes. The range is from 1 to 1440, and the default is 0.
Step 6	load-balance method least-outstanding <i>batch-size size ignore-preferred-server</i> Example:	Configures load balancing batch size after which the next host is picked.

	Command or Action	Purpose
	<pre>RP/0/RSP0/CPU0:router(config-sg-radius)# load-balance method least-outstanding batch-size 50 ignore-preferred-server</pre>	
Step 7	<p>server <i>host_name acct-port accounting_port_number</i> auth-port <i>authentication_port_number</i></p> <p>Example:</p> <pre>RP/0/RSP0/CPU0:router(config-sg-radius)# server 1.2.3.4 acct-port 455 auth-port 567</pre>	<p>Specifies the radius server, and its IP address or host name. Configures the UDP port for RADIUS accounting and authentication requests. The accounting and authentication port number ranges from 0 to 65535. If no value is specified, then the default is 1645 for auth-port, and 1646 for acct-port.</p> <p>From Cisco IOS XR Software Release 5.3.1 and later, IPv6 address can also be configured for the RADIUS server. But, the host name option is supported only for IPv4 domain, and not for IPv6.</p>
Step 8	<p>source-interface <i>name value</i></p> <p>Example:</p> <pre>RP/0/RSP0/CPU0:router(config-sg-radius)# source-interface Bundle-Ether 455</pre>	<p>Configures the RADIUS server-group source-interface name and value for Bundle-Ether.</p>
Step 9	<p>vrf <i>name</i></p> <p>Example:</p> <pre>RP/0/RSP0/CPU0:router(config-sg-radius)# vrf vrf_1</pre>	<p>Configures the vrf to which the server radius group belongs.</p>
Step 10	<p>Use the commit or end command.</p>	<p>commit —Saves the configuration changes and remains within the configuration session.</p> <p>end —Prompts user to take one of these actions:</p> <ul style="list-style-type: none"> • Yes — Saves configuration changes and exits the configuration session. • No —Exits the configuration session without committing the configuration changes. • Cancel —Remains in the configuration session, without committing the configuration changes.

Configuring Radius Server-Group: An example

```
configure
aaa group server radius r1
accounting accept r1 r2
authorization reply accept a1 a2
deadtime 8
load-balance method least-outstanding batch-size 45 ignore-preferred-server
server host_name acct-port 355 auth-port 544
```

```
source-interface Bundle-Ether100.10
vrf vrf_1
!
end
```

Specifying Method List

Method lists for AAA define the methods using which authorization is performed, and the sequence in which these methods are executed. Before any defined authentication method is performed, the method list must be applied to the configuration mechanism responsible for validating user-access credentials. The only exception to this requirement is the default method list (named "default"). The default method list is automatically applied if no other method list is defined. A defined method list overrides the default method list.

On BNG, you have to specify the method list and the server group that will be used for AAA services. For specifying method lists, see [Configuring Method Lists for AAA, on page 30](#).

Configuring Method Lists for AAA

Perform this task to assign the method list to be used by the server group for subscriber authentication, authorization, and accounting.

SUMMARY STEPS

1. **configure**
2. **aaa authentication subscriber default** *method-list-name* **group** *server-group-name*
3. **aaa authorization subscriber default** *method-list-name* **group** *server-group-name* | **radius**
4. **aaa accounting subscriber default** *method-list-name* **group** *server-group-name*
5. Use the **commit** or **end** command.

DETAILED STEPS

	Command or Action	Purpose
Step 1	configure Example: RP/0/RSP0/CPU0:router# configure	Enters global configuration mode.
Step 2	aaa authentication subscriber default <i>method-list-name</i> group <i>server-group-name</i> Example: RP/0/RSP0/CPU0:router(config)# aaa authentication subscriber default method1 group group1 radius group group2 group group3 ...	Configures the method-list which will be applied by default for subscriber authentication. You can either enter 'default' or a user-defined name for the AAA method-list. Also, enter the name of the server group, on which the method list is applied.
Step 3	aaa authorization subscriber default <i>method-list-name</i> group <i>server-group-name</i> radius Example:	Configures the method-list which will be applied by default for subscriber authorization. You can either enter 'default' or a user-defined name for the AAA method-list. Also, enter

	Command or Action	Purpose
	RP/0/RSP0/CPU0:router(config)# aaa authorization subscriber default method1 group group1 radius group group2 group group3 ...	the name of the server group, on which the method list is applied.
Step 4	aaa accounting subscriber default <i>method-list-name</i> group <i>server-group-name</i> Example: RP/0/RSP0/CPU0:router(config)# aaa accounting subscriber default method1 group group1 radius group group2 group group3 ...	Configures the method-list which will be applied by default for subscriber accounting. You can either enter 'default' or a user-defined name for the AAA method-list. Also, enter the name of the server group, on which the method list is applied.
Step 5	Use the commit or end command.	commit —Saves the configuration changes and remains within the configuration session. end —Prompts user to take one of these actions: <ul style="list-style-type: none"> • Yes — Saves configuration changes and exits the configuration session. • No —Exits the configuration session without committing the configuration changes. • Cancel —Remains in the configuration session, without committing the configuration changes.

Configuring Method-list for AAA: An example

```

configure
aaa authentication subscriber default group radius group rad2 group rad3..
aaa authorization subscriber default group radius group rad1 group rad2 group rad3..
aaa accounting subscriber default group radius group rad1 group rad2 group rad3..
!
!
end

```

Defining AAA Attributes

The AAA attribute is an element of RADIUS packet. A RADIUS packet transfers data between a RADIUS server and a RADIUS client. The AAA attribute parameter, and its value - form a Attribute Value Pair (AVP). The AVP carries data for both requests and responses for the AAA transaction.

The AAA attributes either can be predefined as in Internet Engineering Task Force (IETF) attributes or vendor defined as in vendor-specific attributes (VSAs). For more information about the list of BNG supported attributes, see [RADIUS Attributes, on page 509](#).

The RADIUS server provides configuration updates to BNG in the form of attributes in RADIUS messages. The configuration updates can be applied on a subscriber during session setup through two typical methods— per-user attributes, which applies configuration on a subscriber as part of the subscriber's authentication Access

Accept, or through explicit domain, port, or service authorization Access Accepts. This is all controlled by the Policy Rule Engine's configuration on the subscriber.

When BNG sends an authentication or an authorization request to an external RADIUS server as an Access Request, the server sends back configuration updates to BNG as part of the Access Accept. In addition to RADIUS configuring a subscriber during setup, the server can send a change of authorization (CoA) message autonomously to the BNG during the subscriber's active session life cycle, even when the BNG did not send a request. These RADIUS CoA updates act as dynamic updates, referencing configured elements in the BNG and instructing the BNG to update a particular control policy or service policy.

BNG supports the concept of a "service", which is a group of configured features acting together to represent that service. Services can be represented as either features configured on dynamic-templates through CLI, or as features configured as RADIUS attributes inside Radius Servers. Services are activated either directly from CLI or RADIUS through configured "activate" actions on the Policy Rule Engine, or through CoA "activate-service" requests. Services can also be deactivated directly (removing all the involved features within the named service) through configured "deactivate" action on the Policy Rule Engine or through CoA "deactivate-service" requests.

The attribute values received from RADIUS interact with the subscriber session in this way:

- BNG merges the values received in the RADIUS update with the existing values that were provisioned statically by means of CLI commands, or from prior RADIUS updates.
- In all cases, values received in a RADIUS update take precedence over any corresponding CLI provisioned values or prior RADIUS updates. Even if you reconfigured the CLI provisioned values, the system does not override session attributes or features that were received in a RADIUS update.
- Changes made to CLI provision values on the dynamic template take effect immediately on all sessions using that template, assuming the template features have not already been overridden by RADIUS. Same applies to service updates made through CoA "service-update" requests.

AAA Attribute List

An attribute list is named list that contains a set of attributes. You can configure the RADIUS server to use a particular attribute list to perform the AAA function.

To create an attribute list, see [Configuring RADIUS Attribute List, on page 38](#).

AAA Attribute Format

It is possible to define a customized format for some attributes. The configuration syntax for creating a new format is:

```
aaa attribute format <format-name> format-string [length] <string> * [<Identity-Attribute>]
```

where:

- `format-name` — Specifies the name given to the attribute format. This name is referred when the format is applied on an attribute.
- `length` — (Optional) Specifies the maximum length of the formatted attribute string. If the final length of the attribute string is greater than the value specified in `LENGTH`, it is truncated to `LENGTH` bytes. The maximum value allowed for `LENGTH` is 255. If the argument is not configured, the default is also 255.
- `string` — Contains regular ASCII characters that includes conversion specifiers. Only the % symbol is allowed as a conversion specifier in the `STRING`. The `STRING` value is enclosed in double quotes.

- Identity-Attribute — Identifies a session, and includes user-name, ip-address, and mac-address. A list of currently-defined identity attributes is displayed on the CLI.

Once the format is defined, the FORMAT-NAME can be applied to various AAA attributes such as username, nas-port-ID, calling-station-ID, and called-station-ID. The configurable AAA attributes that use the format capability are explained in the section [Creating Attributes of Specific Format, on page 33](#).

To create a customized nas-port attribute and apply a predefined format to nas-port-ID attribute, see [Configuring RADIUS Attribute Format, on page 39](#).

Specific functions can be defined for an attribute format for specific purposes. For example, if the input username is "text@abc.com", and only the portion after "@" is required as the username, a function can be defined to retain only the portion after "@" as the username. Then, "text" is dropped from the input, and the new username is "abc.com". To apply username truncation function to a named-attribute format, see [Configuring AAA Attribute Format Function, on page 42](#).

Creating Attributes of Specific Format

BNG supports the use of configurable AAA attributes. The configurable AAA attributes have specific user-defined formats. The following sections list some of the configurable AAA attributes used by BNG.

Username

BNG has the ability to construct AAA username and other format-supported attributes for subscribers using MAC address, circuit-ID, remote-ID, and DHCP Option-60 (and a larger set of values available in CLI). The DHCP option-60 is one of the newer options that is communicated by the DHCP client to the DHCP server in its requests; it carries Vendor Class Identifier (VCI) of the DHCP client's hardware.

The MAC address attribute is specified in the CLI format in either of these forms:

- mac-address: for example, 0000.4096.3e4a
- mac-address-ietf: for example, 00-00-40-96-3E-4A
- mac-address-raw: for example, 000040963e4a
- mac-address-custom1: for example, 01.23.45.67.89.AB

(This particular MAC address format is available only from Cisco IOS XR Software Release 6.2.1 and later).

An example of constructing a username in the form "mac-address@vendor-class-ID" is:

```
aaa attribute format USERNAME-FORMAT format-string "%s@%s" mac-address dhcp-vendor-class
```

NAS-Port-ID

The NAS-Port-ID is constructed by combining BNG port information and access-node information. The BNG port information consists of a string in this form:

```
"eth phy_slot/phy_subslot/phy_port:XPI.XCI"
```

For 802.1Q tunneling (QinQ), XPI is the outer VLAN tag and XCI is the inner VLAN tag.

If the interface is QinQ, the default format of nas-port-ID includes both the VLAN tags; if the interface is single tag, it includes a single VLAN tag.

In the case of a single VLAN, only the outer VLAN is configured, using this syntax:

```
<slot>/<subslot>/<port>/<outer_vlan>
```

In the case of QinQ, the VLAN is configured using this syntax:

```
<slot>/<subslot>/<port>/<inner_vlan>.<outer_vlan>
```

In the case of a bundle-interface, the phy_slot and the phy_subslot are set to zero (0); whereas the phy_port number is the bundle number. For example, 0/0/10/30 is the NAS-Port-ID for a Bundle-Ether10.41 with an outer VLAN value 30.

The nas-port-ID command is extended to use the 'nas-port-type' option so that the customized format (configured with the command shown above) can be used on a specific interface type (nas-port-type). The extended nas-port-ID command is:

```
aaa radius attribute nas-port-id format <FORMAT_NAME> [type <NAS_PORT_TYPE>]
```

If 'type' option is not specified, then the nas-port-ID for all interface types is constructed according to the format name specified in the command. An example of constructing a maximum 128 byte NAS-Port-ID, by combining the BNG port information and Circuit-ID is:

```
aaa attribute format NAS-PORT-ID-FORMAT1 format-string length 128 "eth %s/%s/%s:%s.%s %s"
physical-slot physical-subslot physical-port outer-vlan-Id inner-vlan-id circuit-id-tag
```

An example of constructing the NAS-Port-ID from just the BNG port information, and with "0/0/0/0/0" appended at the end for circuit-ID, is:

```
aaa attribute format NAS-PORT-ID-FORMAT2 format-string "eth %s/%s/%s:%s.%s 0/0/0/0/0/0"
physical-slot physical-subslot physical-port outer-vlan-Id inner-vlan-id
```

An example of constructing the NAS-Port-ID from just the Circuit-ID is:

```
aaa attribute format NAS-PORT-ID-FORMAT3 format-string "%s" circuit-id-tag
```

The NAS-Port-ID formats configured in the above examples, can be specified in the nas-port-ID command, thus:

For IPoEoQINQ interface:-

```
aaa radius attribute nas-port-id format NAS-PORT-ID-FORMAT1 type 41
```

For Virtual IPoEoQINQ interface:-

```
aaa radius attribute nas-port-id format NAS-PORT-ID-FORMAT2 type 44
```

For IPOEoE interface:-

```
aaa radius attribute nas-port-id format NAS-PORT-ID-FORMAT3 type 39
```

NAS-Port-Type on Interface or VLAN Sub-interface

In order to have different production models for subscribers on the same BNG router, but different physical interfaces of same type, the NAS-Port-Type is made configurable for each physical interface, or VLAN sub-interface. With a different NAS-Port-Type value configured on the interface, the NAS-Port and NAS-Port-ID gets formatted according to the formats defined globally for the new NAS-Port-Type configured on the interface, instead of the actual value of NAS-Port-Type that the interface has. This in turn sends different formats of NAS-Port, NAS-Port-ID and NAS-Port-Type to the RADIUS server for the subscribers under different production models.

In the case of sub-interfaces, the hierarchy to be followed in deciding the format of NAS-Port-Type to be sent to the RADIUS server is:

1. Verify whether the NAS-Port-Type is configured on the sub-interface in which the subscriber session arrives.

2. If NAS-Port-Type is not configured on the sub-interface, verify whether it is configured on the main physical interface.
The format of NAS-Port or NAS-Port-ID is based on the NAS-Port-Type retrieved in [Step 1](#) or [Step 2](#).
3. If NAS-Port-Type is configured on neither the sub-interface nor the main physical interface, the format of NAS-Port or NAS-Port-ID is based on the format of the default NAS-Port-Type of the sub-interface.
4. If a NAS-Port or NAS-Port-ID format is not configured for the NAS-Port-Type retrieved in steps 1, 2 or 3, the format of NAS-Port or NAS-Port-ID is based on the default formats of NAS-Port or NAS-Port-ID.

Use this command to configure NAS-Port-Type per interface or VLAN sub-interface:

```
aaa radius attribute nas-port-type <nas-port-type>
```

where:

<nas-port-type> is either a number ranging from 0 to 44, or a string specifying the nas-port-type.

Refer [Configuring RADIUS Attribute Nas-port-type, on page 41](#).

Calling-Station-ID and Called-Station-ID

BNG supports the use of configurable calling-station-ID and called-station-ID. The calling-station-ID is a RADIUS attribute that uses Automatic Number Identification (ANI), or similar technology. It allows the network access server (NAS) to send to the Access-Request packet, the phone number from which the call came from. The called-station-ID is a RADIUS attribute that uses Dialed Number Identification (DNIS), or similar technology. It allows the NAS to send to the Access-Request packet, the phone number that the user called from.

The command used to configure the calling-station-ID and called-station-ID attributes is:

```
aaa radius attribute calling-station-id format <FORMAT_NAME>
```

```
aaa radius attribute called-station-id format <FORMAT_NAME>
```

Examples of constructing calling-station-ID from mac-address, remote-ID, and circuit-ID are:

```
aaa radius attribute calling-station-id format CLID-FORMAT
```

```
aaa attribute format CLID-FORMAT format-string "%s:%s:%s" client-mac-address-ietf
remote-id-tag circuit-id-tag
```

Examples of constructing called-station-ID from mac-address, remote-ID, and circuit-ID are:

```
aaa radius attribute called-station-id format CLDID-FORMAT
```

```
aaa attribute format CLDID-FORMAT format-string "%s:%s" client-mac-address-raw circuit-id-tag
```

NAS-Port Format

NAS-Port is a 4-byte value that has the physical port information of the Broadband Remote Access Server (BRAS), which connects the Access Aggregation network to BNG. It is used both by Access-Request packets and Accounting-Request packets. To uniquely identify a physical port on BRAS, multiple pieces of information such as shelf, slot, adapter, and so on is used along with the port number. A configurable format called format-e

is defined to allow individual bits or group of bits in 32 bits of NAS-Port to represent or encode various pieces that constitute port information.

Individual bits in NAS-Port can be encoded with these characters:

- Zero: 0
- One: 1
- PPPoX slot: S
- PPPoX adapter: A
- PPPoX port: P
- PPPoX VLAN Id: V
- PPPoX VPI: I
- PPPoX VCI: C
- Session-Id: U
- PPPoX Inner VLAN ID: Q

```
aaa radius attribute nas-port format e [string] [type {nas-port-type}]
```

The above command is used to configure a format-e encode string for a particular interface of NAS-Port type (RADIUS attribute 61). The permissible nas-port type values are:

Nas-port-types	Values	Whether value can be derived from associated interface	Whether value can be configured on the interface configuration mode
ASYNC	0	No	Yes
SYNC	1	No	Yes
ISDN	2	No	Yes
ISDN_V120	3	No	Yes
ISDN_V110	4	No	Yes
VIRTUAL	5	No	Yes
ISDN_PIAFS	6	No	Yes
X75	9	No	Yes
ETHERNET	15	No	Yes
PPPATM	30	No	Yes
PPPOEOA	31	No	Yes
PPPOEOE	32	Yes	Yes
PPPOEOVLAN	33	Yes	Yes

Nas-port-types	Values	Whether value can be derived from associated interface	Whether value can be configured on the interface configuration mode
PPPOEQINQ	34	Yes	Yes
VIRTUAL_PPPOEOE	35	Yes	Yes
VIRTUAL_PPPOEOVLAN	36	Yes	Yes
VIRTUAL_PPPOEQINQ	37	Yes	Yes
IPSEC	38	No	Yes
IPOEOE	39	Yes	Yes
IPOEOVLAN	40	Yes	Yes
IPOEQINQ	41	Yes	Yes
VIRTUAL_IPOEOE	42	Yes	Yes
VIRTUAL_IPOEOVLAN	43	Yes	Yes
VIRTUAL_IPOEQINQ	44	Yes	Yes

Examples:

For non-bundle: GigabitEthernet0/1/2/3.11.pppoe5

where:

PPPoEoQinQ (assuming 2 vlan tags): interface-type

1: slot

2: adapter

3: port

vlan-ids: whatever the outer and inner vlan-ids received in the PADR were

5: session-id

```
aaa radius attribute nas-port format e SSAAPPPPPQQQQQQQQVVVVVVVVUUUUU type 34
Generated NAS-Port:      01100011QQQQQQQQVVVVVVVVV0101
```

For bundle: Bundle-Ether17.23.pppoe8

where:

Virtual-PPPoEoQinQ (assuming 2 vlan tags): interface-type

0: slot

0: adapter

17 (bundle-id): port

Vlan-Ids: whatever the outer and inner vlan-ids received in the PADR were.

8: session-id

```
aaa radius attribute nas-port format e PPPPPPPQQQQQQQQVVVVVVVVUUUUU type 37
Generated NAS-Port:      010001QQQQQQQQVVVVVVVVV000101
```

NAS-port format for IP/DHCP sessions are represented in these examples:

For IPoEoVLAN interface type:

```
aaa radius attribute nas-port format e SSAAAPPPPPVVVVVVVVVVVVVVVVVV type 40
```

For IPoEoQinQ:
 aaa radius attribute nas-port format e SSAAAPPPPPQQQQQQQQQQVVVVVVVVVV type 41

For virtual IPoEoVLAN:
 aaa radius attribute nas-port format e PPPPPPPVVVVVVVVVVVVVVVVUUUUUUUU type 43

NAS-port format for PPPoE sessions are represented in these examples:

For PPPoEoVLAN interface type:
 aaa radius attribute nas-port format e SSAAAPPPPPVVVVVVVVVVVVVVVVUUUU type 33

For Virtual PPPoEoVLAN:.
 aaa radius attribute nas-port format e PPPPPPPVVVVVVVVVVVVVVVVUUUUUUUU type 36



Note If a NAS-Port format is not configured for a NAS-Port-Type, the system looks for a default CLI configuration for the NAS-Port format. In the absence of both these configurations, for sessions with that particular NAS-Port-Type, the NAS-Port attribute is not sent to the RADIUS server.

Configuring RADIUS Attribute List

Perform this task to create a RADIUS attribute list that is used for filtering authorization and accounting attributes.

SUMMARY STEPS

1. **configure**
2. **radius-server attribute list** *listname*
3. **attribute** *list_of_radius_attributes*
4. **attribute vendor-id** *vendor-type number*
5. **vendor-type** *vendor-type-value*
6. Use the **commit** or **end** command.

DETAILED STEPS

	Command or Action	Purpose
Step 1	configure Example: RP/0/RSP0/CPU0:router# configure	Enters global configuration mode.
Step 2	radius-server attribute list <i>listname</i> Example: RP/0/RSP0/CPU0:router(config)# radius-server attribute list l1	Defines the name of the attribute list.
Step 3	attribute <i>list_of_radius_attributes</i> Example:	Populates the list with radius attributes.

	Command or Action	Purpose
	RP/0/RSP0/CPU0:router(config-attribute-filter)# attribute a1, a2	Note For more information about supported attributes, see RADIUS Attributes, on page 509 .
Step 4	attribute vendor-id <i>vendor-type number</i> Example: RP/0/RSP0/CPU0:router(config)# attribute vendor-id 6456	Configures the attribute filtering to be applied to vendor specific attributes (VSAs) by allowing vendor specific information for VSAs to be specified in radius attribute list CLI. Vendor specific information comprises of vendor-id, vendor-type, and optional attribute name in case of Cisco generic VSA. The vendor-id ranges from 0 to 4294967295.
Step 5	vendor-type <i>vendor-type-value</i> Example: RP/0/RSP0/CPU0:router(config-attribute-filter-vsa)# vendor-type 54	Configures the vendor specific information such as the vendor-type to be specified in radius attribute list. The range of the vendor-type value is from 1 to 254.
Step 6	Use the commit or end command.	commit —Saves the configuration changes and remains within the configuration session. end —Prompts user to take one of these actions: <ul style="list-style-type: none"> • Yes — Saves configuration changes and exits the configuration session. • No —Exits the configuration session without committing the configuration changes. • Cancel —Remains in the configuration session, without committing the configuration changes.

Configuring RADIUS Attribute List: An example

```
configure
radius-server attribute list list_! attribute B C
attribute vendor-id vendor-type 10
vendor-type 30
!
end
```

Configuring RADIUS Attribute Format

Perform this task to the define RADIUS attribute format for the nas-port attribute, and apply a predefined format on nas-port-ID attribute.

SUMMARY STEPS

1. **configure**
2. **aaa radius attribute**
3. **nas-port format e string type nas-port-type value**

4. **nas-port-id format** *format name*
5. Use the **commit** or **end** command.

DETAILED STEPS

	Command or Action	Purpose
Step 1	configure Example: RP/0/RSP0/CPU0:router# configure	Enters global configuration mode.
Step 2	aaa radius attribute Example: RP/0/RSP0/CPU0:router(config)# aaa radius attribute	Configures the AAA radius attribute.
Step 3	nas-port format e string type nas-port-type value Example: RP/0/RSP0/CPU0:router(config)# nas-port format e format1 type 30	Configures the format for nas-port attribute. The string represents a 32 character string representing the format to be used. The nas-port-value ranges from 0 to 44.
Step 4	nas-port-id format format name Example: RP/0/RSP0/CPU0:router(config)# nas-port-id format format2	Applies a predefined format to the nas-port-ID attribute.
Step 5	Use the commit or end command.	commit —Saves the configuration changes and remains within the configuration session. end —Prompts user to take one of these actions: <ul style="list-style-type: none"> • Yes — Saves configuration changes and exits the configuration session. • No —Exits the configuration session without committing the configuration changes. • Cancel —Remains in the configuration session, without committing the configuration changes.

Configuring RADIUS Attribute Format: An example

```
configure
aaa radius attribute
nas-port format e abcd type 40
nas-port-id format ADEF
!
end
```

Configuring RADIUS Attribute Nas-port-type

Perform this task to configure RADIUS Attribute nas-port-type on a physical interface or VLAN sub-interface:

SUMMARY STEPS

1. **configure**
2. **interface** *type interface-name*
3. **aaa radius attribute nas-port-type** {*value* | *name*}
4. Use the **commit** or **end** command.

DETAILED STEPS

	Command or Action	Purpose
Step 1	configure Example: RP/0/RSP0/CPU0:router# configure	Enters global configuration mode.
Step 2	interface <i>type interface-name</i> Example: RP/0/RSP0/CPU0:router(config)# interface gigabitEthernet 0/0/0/0	Enters the interface configuration mode.
Step 3	aaa radius attribute nas-port-type { <i>value</i> <i>name</i> } Example: RP/0/RSP0/CPU0:router(config-if)# aaa radius attribute nas-port-type 30 or RP/0/RSP0/CPU0:router(config-if)# aaa radius attribute nas-port-type Ethernet	Configures the RADIUS Attribute nas-port-type value. The range of <i>value</i> is from 0 to 44. See table in NAS-Port Format, on page 35 , for permissible nas-port-type values within this range.
Step 4	Use the commit or end command.	commit —Saves the configuration changes and remains within the configuration session. end —Prompts user to take one of these actions: <ul style="list-style-type: none"> • Yes — Saves configuration changes and exits the configuration session. • No —Exits the configuration session without committing the configuration changes. • Cancel —Remains in the configuration session, without committing the configuration changes.

Configuring RADIUS Attribute Nas-port-type: An example

```
configure
```

```
interface gigabitEthernet 0/0/0/0
  aaa radius attribute nas-port-type Ethernet
!
end
```

Configuring AAA Attribute Format Function

Perform this task to configure a function for the AAA attribute format. The function is for stripping the user-name till the delimiter.

SUMMARY STEPS

1. **configure**
2. **aaa attribute format** *format-name*
3. **username-strip prefix-delimiter** *prefix_delimiter*
4. Use the **commit** or **end** command.

DETAILED STEPS

	Command or Action	Purpose
Step 1	configure Example: RP/0/RSP0/CPU0:router# configure	Enters global configuration mode.
Step 2	aaa attribute format <i>format-name</i> Example: RP/0/RSP0/CPU0:router(config)# aaa attribute format red	Specifies the format name for which the function is defined.
Step 3	username-strip prefix-delimiter <i>prefix_delimiter</i> Example: RP/0/RSP0/CPU0:router(config-id-format)# username-strip prefix-delimiter @	Configures the function to strip the username preceding the prefix delimiter, which is @.
Step 4	Use the commit or end command.	commit —Saves the configuration changes and remains within the configuration session. end —Prompts user to take one of these actions: <ul style="list-style-type: none"> • Yes — Saves configuration changes and exits the configuration session. • No —Exits the configuration session without committing the configuration changes. • Cancel —Remains in the configuration session, without committing the configuration changes.

Configuring AAA Attribute Format Function: An example

```
configure
aaa attribute format red
username-strip prefix-delimiter @
!
!
end
```

Suppressing Unassigned Attributes

You can suppress unassigned (experimental) attributes like 196 that are sent during access-request by the BNG router to the RADIUS.

Configuration Example

To suppress unassigned (experimental) attributes like 196 that are sent during access-request by the BNG router to the RADIUS, you must complete the following configurations:

1. Create an attribute list to filter an attribute, for example attribute 196.
2. Configure the radius server host in the AAA group.
3. Filter and reject the attribute list containing attribute 196 from being sent to RADIUS.
4. (Optional) Configure the IP address of the private RADIUS server for the group server
5. (Optional) Configure the radius-server key.

Configuration

```
/* Enter the global configuration mode and then create an attribute list to filter an
attribute. */
Router# configure
Router(configure)# radius-server attribute list <name-of-the-filter-list>
Router(config-attribute-filter)# attribute <attribute-number>
Router(config-attribute-filter)# commit
Router(config-attribute-filter)# exit

/* Enter the global configuration mode and then configure the radius server host in the AAA
group. */
Router(configure)# aaa group server radius <name-of-the-RADIUS-server>

/* Filter and reject the attribute list containing attribute 196 from being sent to RADIUS.
*/
Router(config-sg-radius)# authorization request reject <name-of-the-filter-list>

/* (Optional) Configure the IP address of the private RADIUS server for the group server.
*/
Router(config-sg-radius)# server-private <ip-address-of-the-radius-server> auth-port
<auth-port-number> acct-port <acct-port-number>

/* (Optional) Configure the radius-server key. */
Router(config-sg-radius-private)# key <key-secret-for-the-radius>
Router(config-sg-radius-private)# commit
```

Running Configuration

```

Router# show running configuration
radius-server attribute list FILTER-mm
      attribute 196
!
aaa group server radius TEST.
  authorization request reject FILTER-mm
  server-private 192.0.2.0 auth-port 1 acct-port 2
  key 7

```

Making RADIUS Server Settings

In order to make BNG interact with the RADIUS server, certain server specific settings must be made on the BNG router. This table lists some of the key settings:

Settings	Description
Server host	Defines the RADIUS server details to which BNG will connect.
Attribute list	Defines which attribute list is to be used.
Server key	Defines the encryption status.
Dead criteria	Defines the criteria that is used to mark a RADIUS server as dead.
Retransmit value	Defines the number of retries the BNG makes to send data to RADIUS server.
Timeout value	Defines how long BNG waits for the RADIUS server to reply.
Automated testing	Defines the duration after which automated testing will start and the username to be tested.
IP DSCP	Allows RADIUS packets to be marked with a specific Differentiated Services Code Point (DSCP) value.

For more making RADIUS server settings, see [Configuring RADIUS Server Settings, on page 44](#).

For more making specific automated testing settings, see [Configuring Automated Testing, on page 48](#).

For more making specific IP DSCP settings, see [Setting IP DSCP for RADIUS Server, on page 50](#).



Note The service profile push or asynchronously pushing a profile to the system is not supported. To download a profile from Radius, the profile must be requested initially as part of the subscriber request. Only service-update is supported and can be used to change a service that was previously downloaded.

Configuring RADIUS Server Settings

Perform this task to make RADIUS server specific settings on the BNG router.

SUMMARY STEPS

1. **configure**

2. **radius-server host** *ip-address acct-port accounting_port_number auth-port authentication_port_number*
3. **radius-server attribute list** *list_name attribute_list*
4. **radius-server key** *7 encrypted_text*
5. **radius-server disallow null-username**
6. **radius-server dead-criteria time** *value*
7. **radius-server dead-criteria tries** *value*
8. **radius-server deadtime** *limit*
9. **radius-server ipv4 dscp** *codepoint_value*
10. **radius-server load-balance method least-outstanding ignore-preferred-server batch-size** *size*
11. **radius-server retransmit** *retransmit_value*
12. **radius-server source-port extended**
13. **radius-server timeout** *value*
14. **radius-server vsa attribute ignore unknown**
15. **radius source-interface Loopback** *value vrf vrf_name*
16. Use the **commit** or **end** command.

DETAILED STEPS

	Command or Action	Purpose
Step 1	configure Example: RP/0/RSP0/CPU0:router# configure	Enters global configuration mode.
Step 2	radius-server host <i>ip-address acct-port accounting_port_number auth-port authentication_port_number</i> Example: RP/0/RSP0/CPU0:router(config)# radius-server host 1.2.3.4 acct-port 455 auth-port 567	<p>Specifies the radius server and its IP address. Configures the UDP port for RADIUS accounting and authentication requests. The accounting and authentication port numbers range from 0 to 65535. If no value is specified, then the default is 1645 for the auth-port and 1646 for the acct-port.</p> <p>From Cisco IOS XR Software Release 5.3.1 and later, IPv6 address can also be configured for the RADIUS server host.</p>
Step 3	radius-server attribute list <i>list_name attribute_list</i> Example: RP/0/RSP0/CPU0:router(config)# radius-server attribute list rad_list a b	Specifies the radius server attributes list, and customizes the selected radius attributes.
Step 4	radius-server key <i>7 encrypted_text</i> Example: RP/0/RSP0/CPU0:router(config-radius-host)# radius-server key 7 rngiry	Specifies the per-server encryption key that overrides the default, and takes the value 0 or 7, which indicates that the unencrypted key will follow.

	Command or Action	Purpose
Step 5	radius-server disallow null-username Example: <pre>RP/0/RSP0/CPU0:router(config)# radius-server disallow null-username</pre>	Specifies that the null-username is disallowed for the radius server.
Step 6	radius-server dead-criteria time value Example: <pre>RP/0/RSP0/CPU0:router(config)# radius-server dead-criteria time 40</pre>	Specifies the dead server detection criteria for a configured RADIUS server. The time (in seconds) specifies the minimum time that must elapse since a response is received from this RADIUS server.
Step 7	radius-server dead-criteria tries value Example: <pre>RP/0/RSP0/CPU0:router(config)# radius-server dead-criteria tries 50</pre>	Specify the value for the number of consecutive timeouts that must occur on the router before the RADIUS server is marked as dead. The value ranges from 1 to 100.
Step 8	radius-server deadtime limit Example: <pre>RP/0/RSP0/CPU0:router(config)# radius-server deadtime 67</pre>	Specifies the time in minutes for which a RADIUS server is marked dead. The deadtime limit is specified in minutes and ranges from 1 to 1440. If no value is specified, the default is 0.
Step 9	radius-server ipv4 dscp codepoint_value Example: <pre>RP/0/RSP0/CPU0:router(config)# radius-server ipv4 dscp 45</pre>	Allows radius packets to be marked with a specific differentiated services code point (DSCP) value. This code point value ranges from 0 to 63.
Step 10	radius-server load-balance method least-outstanding ignore-preferred-server batch-size size Example: <pre>RP/0/RSP0/CPU0:router(config)# radius-server load-balance method least-outstanding ignore-preferred-server batch-size 500</pre>	Configures the radius load-balancing options by picking the server with the least outstanding transactions. This load-balancing method uses the batch-size for the selection of the server. The size ranges from 1 to 1500. If no value is specified, the default is 25.
Step 11	radius-server retransmit retransmit_value Example: <pre>RP/0/RSP0/CPU0:router(config)# radius-server retransmit 45</pre>	Specifies the number of retries to the active server. The retransmit value indicates the number of retries in numeric and ranges from 1 to 100. If no value is specified, then the default is 3.
Step 12	radius-server source-port extended Example: <pre>RP/0/RSP0/CPU0:router(config)# radius-server source-port extended</pre>	Configures BNG to use a total of 200 ports as the source ports for sending out RADIUS requests.

	Command or Action	Purpose
Step 13	<p>radius-server timeout <i>value</i></p> <p>Example:</p> <pre>RP/0/RSP0/CPU0:router(config)# radius-server timeout</pre>	Specifies the time to wait for a radius server to reply. The value is in seconds and ranges from 1 to 1000. The default is 5.
Step 14	<p>radius-server vsa attribute ignore unknown</p> <p>Example:</p> <pre>RP/0/RSP0/CPU0:router(config)# radius-server vsa attribute ignore unknown</pre>	Ignores the unknown vendor-specific attributes for the radius server.
Step 15	<p>radius source-interface Loopback <i>value</i> vrf <i>vrf_name</i></p> <p>Example:</p> <pre>RP/0/RSP0/CPU0:router(config)# radius source-interface Loopback 655 vrf vrf_1</pre>	Specifies loopback interface for source address in RADIUS packets. The value ranges from 0 to 65535.
Step 16	Use the commit or end command.	<p>commit —Saves the configuration changes and remains within the configuration session.</p> <p>end —Prompts user to take one of these actions:</p> <ul style="list-style-type: none"> • Yes — Saves configuration changes and exits the configuration session. • No —Exits the configuration session without committing the configuration changes. • Cancel —Remains in the configuration session, without committing the configuration changes.

Configuring RADIUS Server Settings: Examples

```
\\Configuring RADIUS Server Options
configure
radius-server attribute list list1 a b
radius-server dead-criteria time 100
radius-server deadtime 30
radius-server disallow null-username
radius-server host 1.2.3.4 acct-port 655 auth-port 566
radius-server ipv4 dscp 34
radius-server key 7 ERITY$
radius-server load-balance method least-outstanding ignore-preferred-server batch-size 25
radius-server retransmit 50
radius-server source-port extended
radius-server timeout 500
radius-server vsa attribute ignore unknown
!
!
end

\\Configuring RADIUS Attribute List
```

```
radius-server attribute list list_! attribute B C
attribute vendor-id vendor-type 10
vendor-type 30
!
end

\\Configuring RADIUS Server Host
configure
radius-server host 1.3.5.7 acct-port 56 auth-port 66
idle-time 45
ignore-acct-port
ignore-auth-port 3.4.5.6
key 7 ERWQ
retransmit 50
test username username
timeout 500
!
end

\\Configuring RADIUS Server Key
configure
radius-server key 7 ERWQ
!
end

\\Configuring Load Balancing for RADIUS Server
configure
radius-server load-balance method least-outstanding batch-size 25
radius-server load-balance method least-outstanding ignore-preferred-server batch-size 45
!
end

\\Ignoring Unknown VSA Attributes in RADIUS Server
configure
radius-server vsa attribute ignore unknown
!
end

\\Configuring Dead Criteria for RADIUS Server
configure
radius-server dead-criteria time 60
radius-server dead-criteria tries 60
!
end

\\Configuring Disallow Username
configure
radius-server disallow null-username
!
end

\\Setting IP DSCP for RADIUS Server
configure
radius-server ipv4 dscp 43
radius-server ipv4 dscp default
!
end
```

Configuring Automated Testing

Perform this task to test if the external RADIUS server is UP or not.

SUMMARY STEPS

1. **configure**
2. **radius-server idle-time** *idle_time*
3. **radius-server test username** *username*
4. Use the **commit** or **end** command.

DETAILED STEPS

	Command or Action	Purpose
Step 1	configure Example: RP/0/RSP0/CPU0:router# configure	Enters global configuration mode.
Step 2	radius-server idle-time <i>idle_time</i> Example: RP/0/RSP0/CPU0:router(config-radius-host)# radius-server idle-time 45	Specifies the idle-time after which the automated test should start. The idle time is specified in minutes, and ranges from 1 to 60.
Step 3	radius-server test username <i>username</i> Example: RP/0/RSP0/CPU0:router(config-radius-host)# radius-server test username user1	Specifies the username to be tested for the automated testing functionality.
Step 4	Use the commit or end command.	commit —Saves the configuration changes and remains within the configuration session. end —Prompts user to take one of these actions: <ul style="list-style-type: none"> • Yes — Saves configuration changes and exits the configuration session. • No —Exits the configuration session without committing the configuration changes. • Cancel —Remains in the configuration session, without committing the configuration changes.

Configuring Automated Testing: An example

```
configure
radius-server idle-time 60
radius-server test username user_1
!
end
```

Setting IP DSCP for RADIUS Server

Perform this task to set IP differentiated services code point (DSCP) for RADIUS server.

SUMMARY STEPS

1. **configure**
2. **radius-server ipv4 dscp** *codepoint_value*
3. **radius-server ipv4 dscp default**
4. Use the **commit** or **end** command.

DETAILED STEPS

	Command or Action	Purpose
Step 1	configure Example: RP/0/RSP0/CPU0:router# <code>configure</code>	Enters global configuration mode.
Step 2	radius-server ipv4 dscp <i>codepoint_value</i> Example: RP/0/RSP0/CPU0:router(config)# <code>radius-server ipv4 dscp 45</code>	Allows radius packets to be marked with a specific differentiated services code point (DSCP) value that replaces the outdated IP precedence, a 3-bit field in the Type of Service byte of the IP header originally used to classify and prioritize types of traffic. This code point value ranges from 0 to 63.
Step 3	radius-server ipv4 dscp default Example: RP/0/RSP0/CPU0:router(config)# <code>radius-server ipv4 dscp default</code>	Matches the packets with default dscp (000000).
Step 4	Use the commit or end command.	commit —Saves the configuration changes and remains within the configuration session. end —Prompts user to take one of these actions: <ul style="list-style-type: none"> • Yes — Saves configuration changes and exits the configuration session. • No —Exits the configuration session without committing the configuration changes. • Cancel —Remains in the configuration session, without committing the configuration changes.

Setting IP DSCP for RADIUS Server: An example

```
configure
radius-server ipv4 dscp 43
```

```
radius-server ipv4 dscp default
!
end
```

Balancing Transaction Load on the RADIUS Server

The RADIUS load-balancing feature is a mechanism to share the load of RADIUS access and accounting transactions, across a set of RADIUS servers. Each AAA request processing is considered to be a transaction. BNG distributes batches of transactions to servers within a server group.

When the first transaction for a new is received, BNG determines the server with the lowest number of outstanding transactions in its queue. This server is assigned that batch of transactions. BNG keeps repeating this determination process to ensure that the server with the least-outstanding transactions always gets a new batch. This method is known as the least-outstanding method of load balancing.

You can configure the load balancing feature either globally, or for RADIUS servers that are part of a server group. In the server group, if a preferred server is defined, you need to include the keyword "ignore-preferred-server" in the load-balancing configuration, to disable the preference.

For configuring the load balancing feature globally, see [Configuring Load Balancing for Global RADIUS Server Group, on page 51](#).

For configuring the load balancing feature on RADIUS servers that are part of a named server group, see [Configuring Load Balancing for a Named RADIUS Server Group, on page 52](#).

Configuring Load Balancing for Global RADIUS Server Group

Perform this task to activate the load balancing function for the global RADIUS server group. As an example, in this configuration the preferred server is set to be ignored.

SUMMARY STEPS

1. **configure**
2. **radius-server load-balance method least-outstanding batch-size *size***
3. **radius-server load-balance method least-outstanding ignore-preferred-server batch-size *size***
4. Use the **commit** or **end** command.

DETAILED STEPS

	Command or Action	Purpose
Step 1	configure Example: RP/0/RSP0/CPU0:router# <code>configure</code>	Enters global configuration mode.
Step 2	radius-server load-balance method least-outstanding batch-size <i>size</i> Example: RP/0/RSP0/CPU0:router(config)# <code>radius-server</code>	Configures the radius load-balancing options by picking the server with the least-outstanding transactions. This load-balancing method uses the batch-size for the selection of the server. The size ranges from 1 to 1500. If no value is specified, the default is 25.

	Command or Action	Purpose
	<code>load-balance method least-outstanding batch-size 500</code>	
Step 3	<p>radius-server load-balance method least-outstanding ignore-preferred-server batch-size size</p> <p>Example:</p> <pre>RP/0/RSP0/CPU0:router(config)# radius-server load-balance method least-outstanding ignore-preferred-server batch-size 500</pre>	Configures the radius load-balancing options by disabling the preferred server for this Server Group. This load-balancing method uses the batch-size for the selection of the server. The size ranges from 1 to 1500. If no value is specified, the default is 25.
Step 4	Use the commit or end command.	<p>commit —Saves the configuration changes and remains within the configuration session.</p> <p>end —Prompts user to take one of these actions:</p> <ul style="list-style-type: none"> • Yes — Saves configuration changes and exits the configuration session. • No —Exits the configuration session without committing the configuration changes. • Cancel —Remains in the configuration session, without committing the configuration changes.

Configuring Load Balancing for RADIUS Server: An example

```
configure
radius-server load-balance method least-outstanding batch-size 25
radius-server load-balance method least-outstanding ignore-preferred-server batch-size 45
!
end
```

Configuring Load Balancing for a Named RADIUS Server Group

Perform this task to activate the load balancing function for a named RADIUS server group. As an example, in this configuration the preferred server is set to be ignored.

SUMMARY STEPS

1. **configure**
2. **aaa group server radius** *server_group_name* **load-balance method least-outstanding batch-size size**
3. **aaa group server radius** *server_group_name* **load-balance method least-outstanding ignore-preferred-server batch-size size**
4. Use the **commit** or **end** command.

DETAILED STEPS

	Command or Action	Purpose
Step 1	configure Example: RP/0/RSP0/CPU0:router# configure	Enters global configuration mode.
Step 2	aaa group server radius <i>server_group_name</i> load-balance method least-outstanding batch-size <i>size</i> Example: RP/0/RSP0/CPU0:router(config)# aaa group server radius sg1 load-balance method least-outstanding batch-size 500	Configures the radius load-balancing options by picking the server with the least-outstanding transactions. This load-balancing method uses the batch-size for the selection of the server. The size ranges from 1 to 1500. If no value is specified, the default is 25.
Step 3	aaa group server radius <i>server_group_name</i> load-balance method least-outstanding ignore-preferred-server batch-size <i>size</i> Example: RP/0/RSP0/CPU0:router(config)# aaa group server radius sg1 load-balance method least-outstanding ignore-preferred-server batch-size 500	Configures the radius load-balancing options by disabling the preferred server for this Server Group. This load-balancing method uses the batch-size for the selection of the server. The size ranges from 1 to 1500. If no value is specified, the default is 25.
Step 4	Use the commit or end command.	commit —Saves the configuration changes and remains within the configuration session. end —Prompts user to take one of these actions: <ul style="list-style-type: none"> • Yes — Saves configuration changes and exits the configuration session. • No —Exits the configuration session without committing the configuration changes. • Cancel —Remains in the configuration session, without committing the configuration changes.

Throttling of RADIUS Records

The Throttling of AAA (RADIUS) records is a mechanism to avoid RADIUS congestion and instability. This function is useful in situations when there is insufficient bandwidth to accommodate a sudden burst of AAA requests generated by the BNG for the RADIUS server.

While configuring throttling, a threshold rate, which corresponds to the maximum number of outstanding requests, is defined. It is possible to configure independent throttling rates for access (authentication and authorization) and accounting requests. After a threshold value is reached for a server, no further requests of that type are sent to the server. However, for the pending requests, a retransmit timer is started, and if the outstanding request count (which is checked after every timer expiry), is less than the threshold, then the request is sent out.

As a session may timeout due to throttle on the access requests, a limit is set for the number of retransmit attempts. After this limit is reached, further access requests are dropped. Throttled accounting requests, however, are processed through the server-group failover process.

The throttling feature can be configured globally, or for a server-group. However, the general rule of configuration preference is that the server-group configuration overrides global configuration, if any.

The syntax for the throttling CLI command is:

```
radius-server throttle {[accounting THRESHOLD] [access THRESHOLD [access-timeout
NUMBER_OF-TIMEOUTS]]}
```

where:

- **accounting THRESHOLD**—Specifies the threshold for accounting requests. The range is from 0 to 65536. The default is 0, and indicates that throttling is disabled for accounting requests.
- **access THRESHOLD**—Specifies the threshold for access requests. The range is from 0 to 65536. The default is 0, and indicates that throttling is disabled for accounting requests.
- **access-timeout NUMBER_OF-TIMEOUTS**—Specifies the number of consecutive timeouts that must occur on the router, after which access-requests are dropped. The range of is from 0 to 10. The default is 3.



Note By default, the throttling feature is disabled on BNG.

For activating throttling globally, see [Configuring RADIUS Throttling Globally, on page 54](#).

For activating throttling on a server group, see [Configuring RADIUS Throttling on a Server Group, on page 56](#).

Configuring RADIUS Throttling Globally

Perform this task to activate RADIUS throttling globally.

SUMMARY STEPS

1. **configure**
2. **radius-server throttle access** *threshold_value*
3. **radius-server throttle access** *threshold_value* **access-timeout** *value*
4. **radius-server throttle access** *threshold_value* **access-timeout** *value* **accounting** *threshold_value*
5. **radius-server throttle accounting** *threshold_value* **access** *value* **access-timeout** *value*
6. Use the **commit** or **end** command.

DETAILED STEPS

	Command or Action	Purpose
Step 1	configure Example:	Enters global configuration mode.

	Command or Action	Purpose
	RP/0/RSP0/CPU0:router# configure	
Step 2	<p>radius-server throttle access <i>threshold_value</i></p> <p>Example:</p> <pre>RP/0/RSP0/CPU0:router(config)# radius-server throttle access 10</pre>	Controls the number of access requests sent to a RADIUS server. The threshold value denotes the number of outstanding access requests after which throttling should be performed. The range is from 0 to 65535, and the preferred value is 100.
Step 3	<p>radius-server throttle access <i>threshold_value</i> access-timeout <i>value</i></p> <p>Example:</p> <pre>RP/0/RSP0/CPU0:router(config)# radius-server throttle access 10 access-timeout 5</pre>	Specifies the number of timeouts, after which a throttled access request is dropped. The value denotes the number of timeouts for a transaction. The range is from 1 to 10, and the default is 3.
Step 4	<p>radius-server throttle access <i>threshold_value</i> access-timeout <i>value</i> accounting <i>threshold_value</i></p> <p>Example:</p> <pre>RP/0/RSP0/CPU0:router(config)# radius-server throttle access 10 access-timeout 5 accounting 10</pre>	Controls the number of access timeout requests sent to a RADIUS server. The threshold value denotes the number of outstanding accounting transactions after which throttling should be performed. The range is from 0 to 65535, and the preferred value is 100.
Step 5	<p>radius-server throttle accounting <i>threshold_value</i> access <i>value</i> access-timeout <i>value</i></p> <p>Example:</p> <pre>RP/0/RSP0/CPU0:router(config)# radius-server throttle accounting 56 access 10 access-timeout 5</pre>	Controls the number of accounting requests sent to a RADIUS server. The threshold value denotes the number of outstanding accounting transactions after which throttling should be performed. The value ranges between 0 to 65535 and the preferred value is 100.
Step 6	Use the commit or end command.	<p>commit —Saves the configuration changes and remains within the configuration session.</p> <p>end —Prompts user to take one of these actions:</p> <ul style="list-style-type: none"> • Yes — Saves configuration changes and exits the configuration session. • No —Exits the configuration session without committing the configuration changes. • Cancel —Remains in the configuration session, without committing the configuration changes.

Configuring RADIUS Throttling Globally: An example

```
configure
radius-server throttle access 10 access-timeout 5 accounting 10
!
end
```

Configuring RADIUS Throttling on a Server Group

Perform this task to activate RADIUS throttling on a server group.

SUMMARY STEPS

1. **configure**
2. **aaa group server radius** *server_group_name*
3. **server** *hostname* **acct-port** *acct_port_value* **auth-port** *auth_port_value*
4. **throttle access** *threshold_value* **access-timeout** *value* **accounting** *threshold_value*
5. Use the **commit** or **end** command.

DETAILED STEPS

	Command or Action	Purpose
Step 1	configure Example: RP/0/RSP0/CPU0:router# configure	Enters global configuration mode.
Step 2	aaa group server radius <i>server_group_name</i> Example: RP/0/RSP0/CPU0:router(config)# aaa group server radius SG1	Configures the AAA (RADIUS) server-group definition.
Step 3	server <i>hostname</i> acct-port <i>acct_port_value</i> auth-port <i>auth_port_value</i> Example: RP/0/RSP0/CPU0:router(config-sg-radius)# server 99.1.1.10 auth-port 1812 acct-port 1813	Configures a RADIUS server accounting or authentication port with either the IP address or hostname (as specified). The accounting port number and the authentication port number ranges from 0 to 65535.
Step 4	throttle access <i>threshold_value</i> access-timeout <i>value</i> accounting <i>threshold_value</i> Example: RP/0/RSP0/CPU0:router(config-sg-radius)# radius-server throttle access 10 access-timeout 5 accounting 10	Configures the RADIUS throttling options to control the number of access and accounting requests sent to a RADIUS server. The threshold value denotes the number of outstanding access requests or accounting transactions after which throttling should be performed. The range is from 0 to 65535, and for both access and accounting requests the preferred value is 100.
Step 5	Use the commit or end command.	commit —Saves the configuration changes and remains within the configuration session. end —Prompts user to take one of these actions: <ul style="list-style-type: none"> • Yes — Saves configuration changes and exits the configuration session. • No —Exits the configuration session without committing the configuration changes.

	Command or Action	Purpose
		<ul style="list-style-type: none"> • Cancel —Remains in the configuration session, without committing the configuration changes.

Configuring RADIUS Throttling on a Server Group: An example

```

configure
aaa group server radius SG1
server 99.1.1.10 auth-port 1812 acct-port 1813
radius-server throttle access 10 access-timeout 5 accounting 10
!
end

```

RADIUS Change of Authorization (CoA) Overview

The Change of Authorization (CoA) function allows the RADIUS server to change the authorization settings for a subscriber who is already authorized. CoA is an extension to the RADIUS standard that allows sending asynchronous messages from RADIUS servers to a RADIUS client, like BNG.



Note A CoA server can be a different from the RADIUS server.

To identify the subscriber whose configuration needs to be changed, a RADIUS CoA server supports and uses a variety of keys (RADIUS attributes) such as Accounting-Session-ID, Username, IP-Address, and ipv4:vrf-id.

The RADIUS CoA supports:

- **account-logon** — When a user logs into a network, an external web portal that supports CoA sends an account-logon request to BNG with the user's credentials (username and password). Account-logon on BNG then attempts to authenticate the user through RADIUS with those credentials.
- **account-logoff**— BNG processes the account-logoff request as a disconnect event for the subscriber and terminates the session.



Note The RADIUS CoA server does not differentiate between originators of the disconnect event. Hence, when the BNG receives an account-logoff request from the RADIUS CoA server, for both a user-initiated and an administrator-initiated request, the Acct-Terminate-Cause to be sent to the RADIUS server is always set as Admin-Reset.

- **account-update** — BNG parses and applies the attributes received as part of the CoA profile. Only subscriber-specific attributes are supported and applied on the user profile.

- activate-service — BNG starts a predefined service on a subscriber. The service settings can either be defined locally by a dynamic template, or downloaded from the RADIUS server.
- deactivate-service — BNG stops a previously started service on the subscriber, which is equivalent to deactivating a dynamic-template.

For a list of supported Vendor-Specific Attributes for account operations, see [Vendor-Specific Attributes for Account Operations](#), on page 518.

Note

In order for BNG to enable interim accounting, it is mandatory for the CoA request to have both accounting method list from the dynamic-template and Acct-Interim-Interval attribute from the user profile. This behavior is applicable for accounting enabled through dynamic-template.

Service Activate from CoA

BNG supports activating services through CoA requests. The CoA **service-activate** command is used for activating services. The CoA request for the service activate should contain these attributes:

- "subscriber:command=activate-service" Cisco VSA
- "subscriber:service-name=<service name>" Cisco VSA
- Other attributes that are part of the service profile

The "<subscriber:sa=<service-name>" can also be used to activate services from CoA and through RADIUS.

Duplicate service activate requests can be sent to BNG from the CoA server. BNG does not take any action on services that are already activated. BNG sends a CoA ACK message to the CoA server under these scenarios:

- When a duplicate request with identical parameters comes from the CoA for a service that is already active.
- When a duplicate request with identical parameters comes from the CoA to apply a parameterized service.

BNG sends a CoA NACK message to the CoA server with an error code as an invalid attribute under these scenarios:

- When a request comes from the CoA to deactivate a non-parameterized service that is not applied to the session.
- When a request comes from the CoA to deactivate a parameterized service that is not applied to the session.
- When a duplicate request to apply a parameterized service is made with non-identical parameters from the CoA.
- When a request with non-identical parameters comes from CoA to deactivate a parameterized service.

Service Update from CoA

The service update feature allows an existing service-profile to be updated with a new RADIUS attribute list representing the updated service. This impacts any subscriber who is already activated with the service and new subscriber who activate the service in the future. The new CoA **service-update** command is used for activating this feature. The CoA request for the service update should have these attributes:

- "subscriber:command=service-update" Cisco VSA
- "subscriber:service-name=<service name>" Cisco VSA
- Other attributes that are part of the service profile

A service update CoA should have a minimum of these attributes:

- vsa cisco generic 1 string "subscriber:command=service-update"
- vsa cisco generic 1 string "subscriber:service-name=<service name>"

Web Logon with RADIUS Based CoA

To support Web Logon, a set of Policy Rule Events need to be configured in an ordered manner. These events are as follows:

- session-start:
 - On the start of a session, a subscriber is setup to get internet connectivity. The service is activated to redirect HTTP traffic to a Web portal for web-based logon.
 - Start the timer with duration for the maximum waiting period for authentication.
- account-logon — The Web portal collects the user credentials such as username and password and triggers a CoA account-logon command. When this event is triggered, subscriber username and password are authenticated by the RADIUS server. Once the authentication is successful, the HTTP redirect service is deactivated, granting user access to already connected internet setup. Also, the timer established in session-start must be stopped. However, if the authentication fails during account-logon, BNG sends a NAK CoA request, allowing for further authentication attempts to take place.
- timer expiry — When the timer expires, the subscriber session is disconnected based on the configuration.

Multi-Action Change of Authorization

BNG supports multi-action Change of Authorization (CoA) wherein service providers can activate and deactivate multiple services using a single CoA request. Multi-action CoA is supported for **Service-Logon** and **Service-Logoff** CoA commands. The Service-Logon command can contain one or more **Service-Activate** attributes, and optionally **Service-Deactivate** attributes, for multi-action CoA to specify service(s) to be activated or deactivated. Similarly, the **Service-Logoff** command can contain one or more **Service-Deactivate** attributes, and optionally **Service-Activate** attributes, for multi-action CoA to specify service(s) to be deactivated or activated.

MA-CoA supports up to a maximum of 10 service activations or deactivations per MA-CoA request, however, it is recommended to issue six activations or deactivations per MA-CoA request.

During the multi-action CoA request, if any of the COA requests fail to activate or deactivate, then any of the services which have been activated or deactivated as part of that CoA request is rolled back to its previous state. The session restores back to the its pre-MA-CoA state upon failure to activation or deactivation.

A rollback-failure event, exception, can be configured to specify what action to be taken when a service rollback fails following a failed MA-CoA request (that is, a case of a double-failure condition). The default action to be taken when the rollback fails is to preserve the session, however, you can configure to terminate the session.

The following example details on the rollback failure exception.

```

policy-map type control subscriber PL1
  event session-start match-first
    class type control subscriber class-default do-all
      1 activate dynamic-template pkt-trigl
    !
  !
  event exception match-first
    class type control subscriber coa-rollback-failure do-all
      10 disconnect
    !
  !
  !

```

An Example of a Multi-Action Change of Authorization Use Case

The following example lists the sequence of events that occur in the case of a PTA session initiation.

1. PTA session's web traffic redirected to a service portal (HTTP Redirect)
2. The user activates the first level of service through the service portal. A multi-action COA request is initiated in the following sequence.
 - a. Deactivate redirection
 - b. Activate Turbo Button 1
 - c. Activate VoIP with two channels
3. The user activates the second level of service through the service portal. A multi-action COA request is initiated in the following sequence.
 - a. Deactivate Turbo Button 1
 - b. Activate Turbo Button 2
 - c. Deactivate VoIP with two channels
 - d. Activate VoIP with 4 channels

Interworking with Service-Level Accounting

BNG supports Service-Level Accounting, where a service is a collection of features that are activated and deactivated as a group. Service-Level Accounting and MA-CoA features are independent, that is, they can be applied separately. However, MA-CoA accounts for services that are activated or deactivated that have Service-Level Accounting enabled through the dynamic template configuration.

Generating Accounting Records

The following cases describes how the multi-action CoA records are generated for accounting purposes.

MA-CoA ACK Case

- If MA-CoA request contains only service activate commands, then START accounting record for those services are generated after the CoA Ack is sent out.

- If MA-CoA request contains only deactivate services or combination of activate and deactivate services, then for those services START or STOP accounting records are generated after the CoA Ack is sent out.

MA-CoA NAK Case (Rollback scenario)

- If MA-CoA request fails due to presence of invalid command formats or due to internal software failure or due to presence of invalid service names, that are not defined in the box, in such cases the accounting START or STOP messages are not generated upon rollback.
- If MA-CoA request fails due to internal feature programming failure, then the Service-START or Service-STOP accounting records may be generated for the services that were activated or deactivated before the failure. After the failure, the rollback is initiated and appropriate Service-START or Service-STOP records are generated for these services.

High Availability for MA-CoA

If an high availability event other than a line card online insertion and removal (LC-OIR), such as a process restart or an RP failover occurs while an MA-CoA request is being processed, then the affected session is restored to its pre-MA-CoA state. The policy plane does not make an attempt to automatically recover the MA-CoA message or to resume processing. Instead, the CoA Client times out and re-sends the MA-CoA request to the BNG router.

An Example with Verification Commands

The following example shows the profile of a subscriber with existing services, modified with a MA-CoA request, and the subscriber profile with the changed services invoked by the MA-CoA request.

Multi-Action Change of Authorization - Verification Commands

Session with an Existing Service -----[1]

```
show subsscriber session all detail internal

Interface:                Bundle-Ether1.1.ip1
Circuit ID:                Unknown
Remote ID:                Unknown
Type:                    IP: DHCP-trigger
IPv4 State:                Up, Wed Jul  9 14:25:40 2014
IPv4 Address:              12.1.0.2, VRF: default
IPv4 Up helpers:          0x00000040 {IPSUB}
IPv4 Up requestors:       0x00000040 {IPSUB}
Mac Address:               0000.0c00.0001
Account-Session Id:       00000001
Nas-Port:                 Unknown
User name:                 0000.0c00.0001
Outer VLAN ID:            10
Subscriber Label:         0x00000040
Created:                  Wed Jul  9 14:25:37 2014
State:                    Activated
Authentication:           unauthenticated
Authorization:            authorized
Ifhandle:                 0x020001a0
Session History ID:       1
Access-interface:         Bundle-Ether1.1
Policy Executed:

event Session-Start match-first [at Wed Jul  9 14:25:37 2014]
```

```

class type control subscriber ISN_CM do-all [Succeeded]
  1 activate dynamic-template ISN_TEMPLATE_1 [cerr: No error][aaa: Success]
  2 authorize aaa list default [cerr: No error][aaa: Success]
  1001 activate dynamic-template svcQoSacct2 [cerr: No error][aaa: Success]
  1002 activate dynamic-template svcQoSacct3 [cerr: No error][aaa: Success]
Session Accounting: disabled
Last COA request received: unavailable
User Profile received from AAA:
Attribute List: 0x1000eb24
  1: ipv4-mtu          len= 4  value= 1500(5dc)
Services:
  Name       : ISN_TEMPLATE_1
  Service-ID : 0x4000002
  Type       : Template
  Status     : Applied
-----
  Name       : svcQoSacct1
  Service-ID : 0x400000a
  Type       : Multi Template
  Status     : Applied
-----
  Name       : svcQoSacct2
  Service-ID : 0x400000b
  Type       : Template
  Status     : Applied
-----
  Name       : svcQoSacct3
  Service-ID : 0x400000c
  Type       : Template
  Status     : Applied
-----
[Event History]
  Jul  9 14:29:41.056 IPv4 Start
  Jul  9 14:29:44.384 SUBDB produce done
  Jul  9 14:29:44.384 IPv4 Up

```

RP/0/RSP1/CPU0:BNB#show subscriber database association

Location 0/RSP1/CPU0

```

Bundle-Ether1.1.ip1, subscriber label 0x40
  Name                               Template Type
  -----
  U00000040                          User profile
  svcQoSacct3                         Service
  svcQoSacct2                         Service
  svcQoSacct1                         Service
  ISN_TEMPLATE_1                      IP subscriber

```

MA-CoA Request Initiated From RADIUS Client -----

[2]

```

exec /bin/echo
"Cisco-AVPair='subscriber:sd=svcQoSacct1',Cisco-AVPair='subscriber:sd=svcQoSacct2',
Cisco-AVPair='subscriber:sd=svcQoSacct3',Cisco-AVPair='subscriber:sa=qosin_coa',
Cisco-AVPair='subscriber:sa=qosout_coa',Acct-Session-Id=00000001" | /usr/local/bin/radclient
-r 1 -x 5.11.17.31:1700 coa coa

```

RP/0/RSP1/CPU0:BNB#show subscriber manager statistics AAA COA location 0/rsp1/cpu0

```
[ CHANGE OF AUTHORIZATION STATISTICS ]
```

```
CoA Requests:
```

Type	Received	Acked	NAKed
====	=====	=====	=====
Account Logon	0	0	0
Account Logoff	0	0	0
Account Update	0	0	0
Disconnect	0	0	0
Single Service Logon	0	0	0
Single Service Logoff	0	0	0
Single Service Modify	0	0	0
Multiple Service	1	1	0

```
Errors:
```

```
None
```

```
RP/0/RSP1/CPU0:BNB#show subscriber session all detail internal
```

```
Interface: Bundle-Ether1.1.ip1
Circuit ID: Unknown
Remote ID: Unknown
Type: IP: DHCP-trigger
IPv4 State: Up, Wed Jul 9 14:25:40 2014
IPv4 Address: 12.1.0.2, VRF: default
IPv4 Up helpers: 0x00000040 {IPSUB}
IPv4 Up requestors: 0x00000040 {IPSUB}
Mac Address: 0000.0c00.0001
Account-Session Id: 00000001
Nas-Port: Unknown
User name: 0000.0c00.0001
Outer VLAN ID: 10
Subscriber Label: 0x00000040
Created: Wed Jul 9 14:25:37 2014
State: Activated
Authentication: unauthenticated
Authorization: authorized
Ifhandle: 0x020001a0
Session History ID: 1
Access-interface: Bundle-Ether1.1
Policy Executed:
```

```
event Session-Start match-first [at Wed Jul 9 14:25:37 2014]
class type control subscriber ISN_CM do-all [Succeeded]
  1 activate dynamic-template ISN_TEMPLATE_1 [cerr: No error][aaa: Success]
  2 authorize aaa list default [cerr: No error][aaa: Success]
  1001 activate dynamic-template svcQoSacct2 [cerr: No error][aaa: Success]
  1002 activate dynamic-template svcQoSacct3 [cerr: No error][aaa: Success]
```

```
Session Accounting: disabled
```

```
Last COA request: Wed Jul 9 14:27:37 2014
```

```
COA Request Attribute List: 0x1000f0c4
```

1:	sd	len= 11	value= svcQoSacct1
2:	command	len= 18	value= deactivate-service
3:	service-info	len= 11	value= svcQoSacct1
4:	service-name	len= 11	value= svcQoSacct1
5:	sd	len= 11	value= svcQoSacct2
6:	command	len= 18	value= deactivate-service
7:	service-info	len= 11	value= svcQoSacct2
8:	service-name	len= 11	value= svcQoSacct2
9:	sd	len= 11	value= svcQoSacct3
10:	command	len= 18	value= deactivate-service
11:	service-info	len= 11	value= svcQoSacct3

```

12: service-name   len= 11  value= svcQoSacct3
13: sa             len=  9  value= qosin_coa
14: command       len= 16  value= activate-service
15: service-info  len=  9  value= qosin_coa
16: service-name  len=  9  value= qosin_coa
17: sa            len= 10  value= qosout_coa
18: command       len= 16  value= activate-service
19: service-info  len= 10  value= qosout_coa
20: service-name  len= 10  value= qosout_coa
Last COA response: Result ACK
COA Response Attribute List: 0x1000f4e4
1: sd             len= 11  value= svcQoSacct1
2: sd             len= 11  value= svcQoSacct2
3: sd             len= 11  value= svcQoSacct3
4: sa             len=  9  value= qosin_coa
5: sa            len= 10  value= qosout_coa
User Profile received from AAA:
Attribute List: 0x1000f6f4
1: ipv4-mtu       len=  4  value= 1500(5dc)
Services:
  Name           : ISN_TEMPLATE_1
  Service-ID    : 0x4000002
  Type          : Template
  Status        : Applied
-----
  Name           : qosin_coa
  Service-ID    : 0x4000006
  Type          : Multi Template
  Status        : Applied
-----
  Name           : qosout_coa
  Service-ID    : 0x4000008
  Type          : Multi Template
  Status        : Applied
-----
[Event History]
  Jul  9 14:29:41.056 IPv4 Start
  Jul  9 14:29:44.384 IPv4 Up
  Jul  9 14:31:41.504 CoA request
  Jul  9 14:31:41.632 SUBDB produce done [many]

```

Changed Subscriber Profile after the MA-CoA Request is Processed from RADIUS

-----[3]

```
RP/0/RSP1/CPU0:BNG#show subscriber database association
```

```
Location 0/RSP1/CPU0
```

```
Bundle-Ether1.1.ip1, subscriber label 0x40
  Name           Template Type
  -----
  U00000040      User profile
  qosout_coa     Service
  qosin_coa      Service
  ISN_TEMPLATE_1 IP subscriber

```

In the above example, the subscriber profile existing services are defined by [1], the changes initiated by the MA-CoA request is represented by [2], and the changes that are impacted by the MA-CoA request is shown in [3].

Important Notes on Multi-Action Change of Authorization

The following are the details of Multi-Action Change of Authorization:

- **Service-Activate and Service-Deactivate commands only:** Only the Service-Activate and Service-Deactivate commands are supported in the MA-CoA requests. If a MA-CoA request containing account-logon, account-logoff, account-update, session-query, or disconnect-request commands is received, the request is rejected.
- Cisco VSAs of format "**subscriber:command= activate-service**" and "**subscriber:service-name=Svc1**" are not supported in MA-COA. If requests containing these VSA formats are received, a NAK is sent. Only formats of the "**subscriber:sa/sd=svcname**" type is supported.
- Event **service-logon** and **service-logoff** actions are not supported under policy map for services activated or deactivated through MA-CoA (same as service activation done as part of Access-Accept).
- MA-CoA with QoS Shaper Parameterization is not supported.
- **CoA Account-Update messages must not contain any Service-Activate or Deactivate VSAs:** MA-CoA does not restrict or detect Service-Activate or Service-Deactivate VSAs within the CoA Account-Update messages, however, the support is not available.
- **Scale, Performance, Boundary Conditions:** The following are the conditions for MA-CoA:
 - MA-CoA does not impose any significant limitations on scaling, in terms of the total number of sessions or the number of services applied per session.
 - MA-CoA supports up to a maximum of 10 service activations or deactivations per MA-CoA request. If the number of action requests exceeds the limit of 10, a NAK is initiated for the last request received.
 - MA-CoA can handle a maximum of 30 CoA messages per second.

User Authentication and Authorization in the Local Network

The user authentication and authorization in the local network feature in BNG provides the option to perform subscriber authorization locally (in a subscriber's network), instead of both remote authentication and authorization that occurs in RADIUS servers. With the User Authentication and Authorization in the Local Network feature, you can run the RADIUS server locally in your network, manage, and configure the RADIUS server locally in your network to the profile that is required for the environment. In the case of a remote RADIUS server, the RADIUS server is maintained by an external regulatory body (not within the subscriber's network) and subscriber will not be able to manage or configure the server.

Figure 4: User Authentication and Authorization in the Local Network

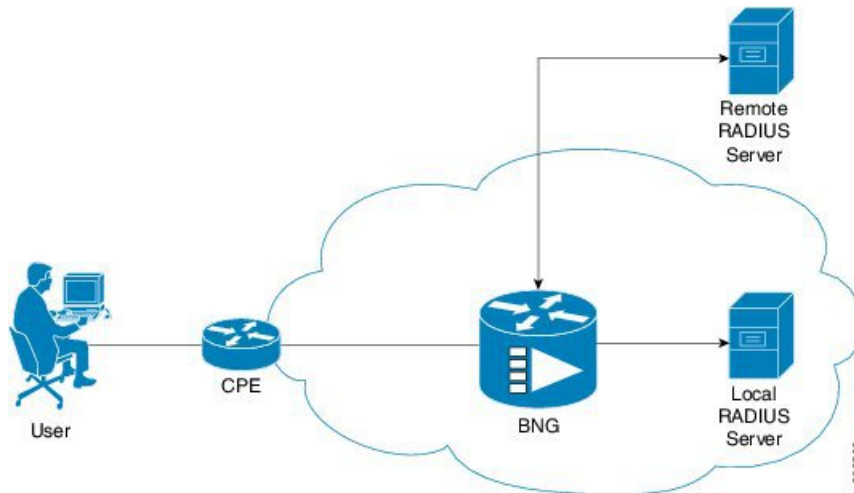

User Authentication and Authorization in the Local Network feature is used in a case when a user wants to perform a two-level authentication or authorization, first, a remote authentication (or authorization) followed by a local authorization (or authentication).



Note All the debug commands applicable to AAA server are applicable on User Authentication and Authorization in the Local Network feature.

For IPoE subscribers, User Authentication and Authorization in the Local Network is a two-level authorization process as a part of the session-start event. For PTA subscribers, User Authentication and Authorization in the Local Network is a remote server authentication process, followed by a local server authorization process.

Policy Configurations for IPoE Sessions

The following policy configuration explains how the authentication and authorization process occurs in IPoE subscriber sessions. The authentication and authorization processes are performed using two RADIUS servers (one located remotely and the other located locally). At first, the authentication request is routed to the remotely located RADIUS server, which is not in the user's control. Then, to authorize the session, the authorization request is routed to the local RADIUS server, where the subscriber profile for the service provider is maintained.

As a first step in the authorization process, you can configure the authentication process to download the authorization profile from the local RADIUS server. However, when both RADIUS servers have the same authorization profiles, either partially or completely, that part of the authorization profile that is the same is overridden by the one downloaded from the local RADIUS server, and the other part of the authorization profile is merged.

Case 1: Subscriber session created by applying the user profile downloaded from the local RADIUS server.

```
Radius Server1 (located remotely, profile not controlled by the operator
```

```
    0000.0000.0001 Cleartext-Password := "shootme"
    Fall-Through = no
```

Radius Server2 (located locally, profile controlled by the operator)

```
0000.0000.0001 Cleartext-Password := "shootme"
Class = "IPSUB",
Cisco-avpair += "ip:sub-qos-policy-in=12MUp",
Cisco-avpair += "ip:sub-qos-policy-out=12MDown",
Fall-Through = no
```

Case 2: Subscriber session created by applying the user profile downloaded from the remote RADIUS server, and in this case, the policy attribute values are overridden by the local RADIUS server profile.

Radius Server1 (located remotely, profile not controlled by the operator)

```
0000.0000.0001 Cleartext-Password := "shootme"
Cisco-avpair += "ip:sub-qos-policy-in=6MUp",
Cisco-avpair += "ip:sub-qos-policy-out=6MDown",
Fall-Through = no
```

Radius Server2 (located locally, profile controlled by the operator)

```
0000.0000.0001 Cleartext-Password := "shootme"
Class = "IPSUB",
Cisco-avpair += "ip:sub-qos-policy-in=12MUp",
Cisco-avpair += "ip:sub-qos-policy-out=12MDown",
Fall-Through = no
```

Profile Created by the Attribute Merging of both the Local and Remote Server Profiles

```
RP/0/RSP0/CPU0:BNG#sh run aaa
radius-server host 10.105.236.46 auth-port 1812 acct-port 1813
key 7 111B1801464058
!
radius-server host 10.105.236.237 auth-port 1812 acct-port 1813
key 7 095E4F0D485744
!
aaa group server radius local_server
server 10.105.236.237 auth-port 1812 acct-port 1813
!
aaa group server radius remote_server
server 10.105.236.46 auth-port 1812 acct-port 1813
!
aaa accounting subscriber acct_meth broadcast group local_server group remote_server
aaa authorization subscriber local_server group local_server
aaa authorization subscriber remote_server group remote_server

RP/0/RSP0/CPU0:BNG#

RP/0/RSP0/CPU0:BNG#sh run policy-map type control subscriber ISN_CNTRL_1
policy-map type control subscriber ISN_CNTRL_1
event session-start match-all
  class type control subscriber ISN_CM do-all
    10 activate dynamic-template ISN_TEMPLATE_1
    11 authorize aaa list remote_server identifier source-address-mac password shootme
    12 authorize aaa list local_server identifier source-address-mac password shootme
  !
!
end-policy-map
!
```

```

RP/0/RSP0/CPU0:BN#
Remote User Profile
0000.0c00.0001 Cleartext-Password := "shootme"
    cisco-avpair += "subscriber:accounting-list=acct_meth", -- [(A) Same attribute on both
profile]
    Session-Timeout += 1000, ----- [(B) Attribute defined in
remote profile only]
    Acct-Interim-Interval = 3600 ----- [(C) Same attribute on both
profiles with diff value]

```

```

Local User profile
0000.0c00.0001 Cleartext-Password := "shootme"
    cisco-avpair += "subscriber:accounting-list=acct_meth", -- [(A) Same attribute on both
profile]
    cisco-avpair += "sub-qos-policy-in=12MUp",----- [(D) Attribute defined in
local profile only]
    cisco-avpair += "sub-qos-policy-out=12MDown",----- [(E) Attribute defined in
local profile only]
    cisco-avpair += "ipv4:inacl=innet", ----- [(F) Attribute defined in
local profile only]
    cisco-avpair += "ipv4:outacl=outnet", ----- [(G) Attribute defined in
local profile only]
    Acct-Interim-Interval = 3000 ----- [(H) Same attributes on both
profiles with diff value]

```

```

RP/0/RSP0/CPU0:BN#sh subscriber session all detail internal
Interface:          Bundle-Ether1.1.ip22
Circuit ID:         Unknown
Remote ID:          Unknown
Type:               IP: DHCP-trigger
IPv4 State:         Up, Wed Jun 18 16:56:25 2014
IPv4 Address:       12.16.0.24, VRF: default
IPv4 Up helpers:    0x00000040 {IPSUB}
IPv4 Up requestors: 0x00000040 {IPSUB}
Mac Address:        0000.0c00.0001
Account-Session Id: 000000bb
Nas-Port:           Unknown
User name:          0000.0c00.0001
Outer VLAN ID:     10
Subscriber Label:   0x00000075
Created:            Wed Jun 18 16:56:15 2014
State:              Activated
Authentication:     unauthenticated
Authorization:       authorized
Ifhandle:           0x000012a0
Session History ID: 11
Access-interface:   Bundle-Ether1.1
Policy Executed:

```

```

event Session-Start match-all [at Wed Jun 18 16:56:15 2014]
class type control subscriber ISN_CM do-all [Succeeded]
  10 activate dynamic-template ISN_TEMPLATE_1 [cerr: No error][aaa: Success]
  11 authorize aaa list remote_server [cerr: No error][aaa: Success]
  12 authorize aaa list local_server [cerr: No error][aaa: Success]

```

```

Session Accounting:
Acct-Session-Id:    000000bb
Method-list:        acct_meth
Accounting started: Wed Jun 18 16:56:25 2014
Interim accounting: On, interval 50 mins
  Last successful update: Never
  Next update in:   00:46:48 (dhms)

```

```

Last update sent:      Never
Updates sent:         0
Updates accepted:     0
Updates rejected:     0
Update send failures: 0
Last COA request received: unavailable
User Profile received from AAA:
Attribute List: 0x1000e764
1: session-timeout len= 4 value= 1000(3e8) ----- [(B) Attribute value fetched from
the remote profile]
2: accounting-list len= 9 value= acct_meth ----- [(A) Attribute common to both the
profiles]
3: sub-qos-policy-in len= 5 value= 12MUp ----- [(D) Attribute defined in the local
profile]
4: sub-qos-policy-out len= 7 value= 12MDown ----- [(E) Attribute defined in the local
profile]
5: inacl len= 5 value= inet ----- [(F) Attribute defined in the local
profile]
6: outacl len= 6 value= outnet ----- [(G) Attribute defined in the local
profile]
7: acct-interval len= 4 value= 3000(bb8) ----- [(I) Attribute value fetched from
the local profile]
Services:
Name       : ISN_TEMPLATE_1
Service-ID : 0x4000002
Type      : Template
Status    : Applied
-----

```

In the above example, the server profile attributes are defined in both the Local RADIUS and the Remote RADIUS servers. Attributes (A), (B), and (C) are defined in remote RADIUS server profile, and attributes (A), (D), (E), (F), (G), and (H) are defined in the local RADIUS server profile. The subscriber session created by applying the user profile downloaded from the local RADIUS server contains attributes (B), (A), (D), (E), (F), (G), and (I), where the attribute (B) is fetched from the remote RADIUS server profile; the attribute (A) is common to both the RADIUS server profiles; the attributes (D), (E), (F), and (G) are the attributes fetched from the local RADIUS server profile; and attribute (I) is common to both the profiles, however, the attribute value differs on both the profiles. In this case, the value of the attribute (I) is fetched from the local RADIUS server profile.

Policy Configurations for PTA Sessions

The following policy configuration explains how the authentication and authorization processes occur in PTA subscriber sessions. In the case of PTA subscriber sessions, the authentication and authorization processes consists of two steps:

1. Domain Authorization on LAC: Achieved through the local RADIUS server where the domain authorization occurs.

```

policy-map type control subscriber vpdn_ipv4_pmap
event session-start match-first
  class type control subscriber vpdn_ipv4_cmap do-until-failure
    ! activate dynamic-template vpdn_v4
    !
event session-activate match-first
  class type control subscriber vpdn_ipv4_cmap do-until-failure
    10 authorize aaa list vpdn-author-list format vpdn_domain password cisco

```

```
20 authenticate aaa list vpdn-authen-list
!
```

2. User Authentication before forwarding on LAC: Achieved using two RADIUS servers: one local RADIUS server for domain authorization and another remote RADIUS server for user authentication.

```
radius-server vsa attribute ignore unknown

radius-server host 5.8.23.156 auth-port 1812 acct-port 1813
key 7 02050D480809
!
radius-server host 5.8.23.160 auth-port 1812 acct-port 1813
key 7 030752180500
!
radius-server key 7 0214055F5A545C
aaa attribute format vpdn_domain
username-strip prefix-delimiter @
!
aaa accounting network default start-stop group radius
aaa group server radius vpdn-authen
server 5.8.23.160 auth-port 1812 acct-port 1813
!
aaa group server radius vpdn-author
server 5.8.23.156 auth-port 1812 acct-port 1813
!
aaa accounting subscriber default group radius
aaa authorization subscriber vpdn-author-list group vpdn-author
aaa authentication subscriber vpdn-authen-list group vpdn-authen
!
```

Service Accounting

Accounting records for each service enabled on a subscriber can be sent to the configured RADIUS server. These records can include service-start, service-stop, and service-interim records containing the current state of the service and any associated counters. This feature is the Service Accounting feature. Service accounting records are consolidated accounting records that represent the collection of features that make up a service as part of a subscriber session.

Service accounting starts when a subscriber session comes up with a service enabled on it. This can happen through a dynamic template applied through a control policy, through access-accept (AA) messages when the session is authorized, or through a change of authorization (CoA), when a new service is applied on a subscriber session. Service accounting stops either when the session is terminated, or a service is removed from the session through CoA, or some other event that deactivates the service. Start records have no counters; interim and stop records with QoS counters are generated when service accounting is enabled for QoS. Interim accounting records can be generated, in between start and stop accounting, as an option with a pre-defined periodic interval. When the interim period is zero, interim accounting records are not created. Different interim intervals are based on every service for each session. Service accounting is enabled on each template, based on the configuration.

Service Accounting is supported on bundle subscriber interfaces as well as line card subscriber interfaces.



Note The policy-map associated to a dynamic template can be edited to change the service parameters. However, this does not update the accounting records. Therefore, to generate all the accounting records accurately, it is recommended that a new service with all the required service parameters be created and associated to the new service, through a CoA.

For service accounting, statistics for ingress and egress QoS policies, which are applied under each service for a given subscriber, may need to be reported as part of the accounting interim and stop records. For each service, these QoS counters can be reported as part of the accounting records:

- BytesIn — Aggregate of bytes matching all classes of the ingress QoS policy for the service minus the policer drops.
- PacketsIn — Aggregate of packets matching all classes of the ingress QoS policy for the service minus the policer drops.
- BytesOut — Aggregate of bytes matching all classes of the egress QoS policy for the service minus the queuing drops.
- PacketsOut — Aggregate of packets matching all classes of the egress QoS policy for the service minus the queuing drops

Dynamic template features that support accounting statistic collection and require that their statistics be reported in the AAA service accounting records can enable accounting statistics on their features using the newly-introduced optional **acct-stats** configuration option. This option is not available for the features that do not support statistic collection. By default, QoS accounting statistics are disabled to optimize performance.



Note The QoS counters for each direction is reported only if a QoS policy is applied for that service in the given direction. For example, if a service does not have an ingress policy applied, BytesIn and PacketsIn counters are reported as being 0.

Pre-requisites

- Subscriber accounting, the parent accounting record for service accounting, must be configured to enable the service accounting feature to work.
- The keyword **acct-stats** must be configured in service-policy configuration to enable the service accounting feature to report feature counter information as part of the records.



Note

- IPv4 and IPv6 subscriber sessions has a single set of service accounting records. They are merged into one set of bytes_in, bytes_out, packets_in, packets_out counters.
- Service accounting is not supported for static sessions.

Configuring Service Accounting

Perform this task to configure service accounting through the dynamic template:

Before you begin

You must configure subscriber accounting before performing this task. Refer [Creating Dynamic Template for IPv4 or IPv6 Subscriber Session, on page 99](#) for configuring procedure.

SUMMARY STEPS

1. **configure**
2. **aaa accounting service** *{list_name | default}* **{broadcast group** *{group_name | radius}* **|group** *{group_name | radius}* }
3. **aaa service-accounting** [**extended** | **brief**]
4. **dynamic-template**
5. **type service** *dynamic-template-name*
6. **accounting aaa list** *{method_list_name | default}* **type service** [**periodic-interval** *time*]
7. **{ipv4 | ipv6}** **access-group** *access-list-name*
8. **service-policy** **{input | output | type}** *service-policy_name* [**acct-stats**]
9. Use the **commit** or **end** command.

DETAILED STEPS

	Command or Action	Purpose
Step 1	configure Example: RP/0/RSP0/CPU0:router# configure	Enters global configuration mode.
Step 2	aaa accounting service <i>{list_name default}</i> {broadcast group <i>{group_name radius}</i> group <i>{group_name radius}</i> } Example: RP/0/RSP0/CPU0:router(config)# aaa accounting service ll group srGroup1	Creates an accounting list for service accounting
Step 3	aaa service-accounting [extended brief] Example: RP/0/RSP0/CPU0:router(config)# aaa service-accounting brief	(Optional) Sets accounting parameters for service to select the level of subscriber accounting state and to identity attribute reporting in brief or extended form. Note The default setting is extended.
Step 4	dynamic-template Example: RP/0/RSP0/CPU0:router(config)# dynamic-template	Enters the dynamic-template configuration mode.

	Command or Action	Purpose
Step 5	<p>type service <i>dynamic-template-name</i></p> <p>Example:</p> <pre>RP/0/RSP0/CPU0:router(config-dynamic-template)# type service s1</pre>	Creates a dynamic-template with a user-defined name for a service.
Step 6	<p>accounting aaa list {<i>method_list_name</i> default}</p> <p>type service [periodic-interval <i>time</i>]</p> <p>Example:</p> <pre>RP/0/RSP0/CPU0:router(config-dynamic-template-type)# accounting aaa list l1 type service periodic-interval 1000</pre>	Configures the service accounting feature.
Step 7	<p>{ipv4 ipv6} access-group <i>access-list-name</i></p> <p>Example:</p> <pre>RP/0/RSP0/CPU0:router(config-dynamic-template-type)# ipv4 access-group ACL1 RP/0/RSP0/CPU0:router(config-dynamic-template-type)# ipv6 access-group ACL2</pre>	Sets IPv4 or IPv6 access list to an interface.
Step 8	<p>service-policy {input output type}</p> <p><i>service-policy_name</i> [acct-stats]</p> <p>Example:</p> <pre>RP/0/RSP0/CPU0:router(config-dynamic-template-type)# service-policy input QoS1 acct-stats RP/0/RSP0/CPU0:router(config-dynamic-template-type)# service-policy output QoS2 acct-stats</pre>	Associates a service-policy to the dynamic template, and enables service accounting feature using acct-stats keyword.
Step 9	Use the commit or end command.	<p>commit —Saves the configuration changes and remains within the configuration session.</p> <p>end —Prompts user to take one of these actions:</p> <ul style="list-style-type: none"> • Yes — Saves configuration changes and exits the configuration session. • No —Exits the configuration session without committing the configuration changes. • Cancel —Remains in the configuration session, without committing the configuration changes.

Configuring Service Accounting: Example

```
configure
aaa accounting service S1 group SG1
```

```

aaa service-accounting brief
dynamic-template
type service s1
accounting aaa list S1 type service periodic-interval 600
ipv4 access-group ACL1
service-policy input QOS1 acct-stats
service-policy output QOS2 acct-stats
!
!
end

```

Statistics Infrastructure

The accounting counters are maintained by the service accounting statistics IDs (statsD) infrastructure. Service accounting interacts with the statistics infrastructure in this manner:

- Each feature has a statistics collector process that is responsible for returning statistics counters for that feature.
- A single collector can handle counters for multiple features.
- An accounting process, the service accounting management agent, uses the access library to register for notifications and request statistics, and pushes to a radius server.

There is a polling period to pull the data from statsD. To support sub-second accuracy on stop records, the statistics are immediately pulled when the session is terminated, without waiting for any polling method to get accurate data. The same method is followed by session accounting and service accounting. Sub-second accuracy is not supported for data reported in interim records, because no data is pulled while sending interim accounting records.

Configuring Statistics IDs (statsD)

The statsD is configured to poll feature statistics by default every 900 seconds (that is, every 15 minutes). Perform this task to change the default figure to either increase or decrease the polling interval.

SUMMARY STEPS

1. **configure**
2. **statistics period service-accounting** *{period | disable}*
3. Use the **commit** or **end** command.

DETAILED STEPS

	Command or Action	Purpose
Step 1	configure Example: RP/0/RSP0/CPU0:router# configure	Enters global configuration mode.
Step 2	statistics period service-accounting <i>{period disable}</i> Example:	Sets collection period for statistics collectors for the service accounting feature.

	Command or Action	Purpose
	RP/0/RSP0/CPU0:router(config)# statistics period service-accounting 1800	
Step 3	Use the commit or end command.	<p>commit —Saves the configuration changes and remains within the configuration session.</p> <p>end —Prompts user to take one of these actions:</p> <ul style="list-style-type: none"> • Yes — Saves configuration changes and exits the configuration session. • No —Exits the configuration session without committing the configuration changes. • Cancel —Remains in the configuration session, without committing the configuration changes.

Configuring Service Accounting: Example

```
configure
 statistics period service-accounting 1800
end
```

Understanding Per-VRF AAA Function

The Per VRF AAA function allows authentication, authorization, and accounting (AAA) on the basis of virtual routing and forwarding (VRF) instances. This feature permits the Provider Edge (PE) or Virtual Home Gateway (VHG) to communicate directly with the customer's RADIUS server, (which is associated with the customer's Virtual Private Network (VPN)), without having to go through a RADIUS proxy.

ISPs must be able to define operational parameters such as AAA server groups, method lists, system accounting, and protocol-specific parameters, and associate those parameters to a particular VRF instance.

The Per VRF AAA feature is supported with VRF extensions to server-group, RADIUS, and system accounting commands. The list of servers in server groups is extended to include definitions of private servers, in addition to references to the hosts in the global configuration. This allows simultaneous access to both customer servers and global service provider servers. The syntax for the command used to configure per-vrf AAA globally is:

```
radius source-interface subinterface-name [vrf vrf-name]
```

RADIUS Double-Dip Feature

BNG supports the RADIUS double-dip feature, where BNG sends the first authentication or authorization request to a service provider's RADIUS server, which in turn responds with the correct VRF associated with the subscriber session. Subsequently, the BNG redirects the original request, and sends it as a second request, to the correct RADIUS server that is associated with the designated VRF.

RADIUS over IPv6

From Cisco IOS XR Software Release 5.3.1 and later, RADIUS over IPv6 is supported in BNG, thereby allowing IPv6 address also for various RADIUS configurations and CoA client configurations.

These commands are extended to support IPv6 address:

- **radius-server host** (global configuration mode)
- **radius server** (radius server group configuration mode)
- **radius server-private** (radius server group configuration mode)
- **aaa server radius dynamic-author client** (global configuration mode)

For details on configuring RADIUS server group and settings, see [Configuring RADIUS Server Group, on page 27](#) and [Configuring RADIUS Server Settings, on page 44](#).

Dynamic Policy Download over RADIUS Interface

Starting with Cisco IOS XR Software Release 6.6.3, in BNG with dynamic policy push, a complete service definition is downloaded over the RADIUS interface. When a subscriber accesses a BNG with service, BNG triggers the service download from RADIUS, if that service definition does not exist on the BNG box.

RADIUS sends input policy, output policy, or both, along with service accounting enable information. Merge accounting statistics is a subset of Dynamic Policy Download, and more information about it can be found in [Merge and Account Statistics, on page 76](#).

Merge and Account Statistics

The merge and account statistics feature provides support for H-QoS parameters as a service download from CPS to BNG for dynamic policy download.

```
1_Mbps CLeartext-Password:="cisco"
      Cisco-AVPair += "qos-policy-out=add-class(sub,(class-default),shape(12000))"
      Cisco-AVPair += "qos-policy-out=add-class(sub,(class-default,voice),shape(5000))"
      Cisco-AVPair += "qos-policy-in=add-class(sub,(class-default),police(12000))"
      Cisco-AVPair += "qos-policy-in=add-class(sub,(class-default,voice),police(5000))"
```

Here, 1_Mbps is the service which is downloaded from RADIUS. PQoS is defined inside this service. The policy manager generates qos-policy-in and qos-policy-out based on pQoS inside the 1_Mbps service.

Starting with Cisco IOS XR Software Release 6.6.3, BNG supports PQoS as auto-service with merge and accounting statistics, in the QoS VSAs. The user must configure merge and accounting-statistics only after add-class. The PQoS inside 1_Mbps service looks like this:

```
1_Mbps CLeartext-Password:="cisco"
      Cisco-AVPair += "qos-policy-out=add-class(sub,(class-default),shape(12000))"
      Cisco-AVPair += "qos-policy-out=add-class(sub,(class-default,voice),shape(5000))"
      Cisco-AVPair += "qos-policy-in=add-class(sub,(class-default),police(12000))"
      Cisco-AVPair += "qos-policy-in=add-class(sub,(class-default,voice),police(5000))"
      Cisco-avpair = "ip:qos-policy-in=(merge(60),acct-stats)"
      Cisco-avpair = "ip:qos-policy-out=(merge(60),acct-stats)"
```



Note merge CLI should always be the last one to be configured.

Software Functional Requirements

- Dynamic Policy Download is supported only over RADIUS Interface.
- During session-bring up: Access-Accept carries `service-activate` and `method-list` for the service, which has to be downloaded. `Method-list` is a mandatory attribute for service download. For example:

```
Cisco-AVPair += "subscriber:sa=A0F0100M100M000030MQ"
Cisco-AVPair += "Method-List=default"
```

- Access-Accept carries other Cisco-AVP attributes along with downloadable `service-activate` attributes.
- BNG triggers access-request for the service to be downloaded, if the service definition does not exist in BNG service-profile cache. Below is an example of Access-Request for service download:

```
User-Name = "A0F0100M100M000030MQ"
User-Password = "cisco"
Service-Type = Outbound-User
NAS-Identifier = "bng-primary"
NAS-IP-Address = 5.8.23.76
```

- RADIUS responds back with service definition in Access-Response. Access-Response contains the service definition, which is being downloaded to BNG. Below is an example of Access-Response. The example contains service-accounting enable and input or output QoS policies, formed into Cisco-AVP attributes. QoS policies are built using parameterized-QoS (pQoS) commands.

```
Cisco-avpair += "subscriber:acct-interval=1800",
Cisco-avpair += "subscriber:service-acct-list=default",
Cisco-AVPair += "ip:qos-policy-in=add-class(sub, (class-default), police(1085))",
Cisco-AVPair +=
"ip:qos-policy-in=add-class(sub, (class-default, BROADBAND_VOZ), police(512, transmit, drop), set-mpls-exp-imp-imp(5))",
Cisco-AVPair +=
"ip:qos-policy-in=add-class(sub, (class-default, BROADBAND_CRITICOS), set-mpls-exp-imp-imp(1))",
Cisco-AVPair +=
"ip:qos-policy-in=add-class(sub, (class-default, BROADBAND_BUSINESS), set-mpls-exp-imp-imp(1))",
Cisco-AVPair +=
"ip:qos-policy-in=add-class(sub, (class-default, class-default), set-mpls-exp-imp-imp(0), set-ip-dscp(0))",
Cisco-AVPair += "ip:qos-policy-out=add-class(sub, (class-default), shape(1064))",
Cisco-AVPair +=
"ip:qos-policy-out=add-class(sub, (class-default, BROADBAND_VOZ), police(512, transmit, drop), pri-level(1), set-cos(5))",
Cisco-AVPair +=
"ip:qos-policy-out=add-class(sub, (class-default, BROADBAND_CRITICOS), bw-rpct(50), set-cos(1))",
Cisco-AVPair +=
"ip:qos-policy-out=add-class(sub, (class-default, BROADBAND_BUSINESS), bw-rpct(35), set-cos(1))",
Cisco-AVPair +=
"ip:qos-policy-out=add-class(sub, (class-default, class-default), bw-rpct(15), set-cos(0))"
```

- CoA-Request contains `service-deactivate` and `service-activate` in one request.

- BNG does not trigger Access-Request to download service, if service already exists in BNG service-profile cache.
- BNG service-profile cache should be cleared by using the `clear subscriber manager service-profile location <location-value>` command, if BNG has to trigger Access-Request to download service.
- Performance of Change of Authorization (CoA) or Multi-Action Change of Authorization (MACoA) depends on how many services are downloaded during CoA or MACoA. If multiple services are downloaded, then it takes time to get processed at BNG. The following extra parameters are added:
 - Round-trip time (RTT) for service download. This is a variable factor and depends on network traffic and RADIUS performance.
 - Time taken to create a policy from service parameters downloaded from RADIUS. It is 2 milliseconds per policy creation. This means that each service download feature introduces RTT in milliseconds (service downloaded from RADIUS) + 2 milliseconds to create policy in policy manager.

Limitations

This list described the limitations of dynamic policy download via RADIUS interface for BNG subscriber:

- The Dynamic Policy Download does not support downloading PBR policies from RADIUS.
- Four services per BNG subscriber can be downloaded from RADIUS.
- p-QoS attributes values are supported only in kbps.

Verifying Dynamic Policy Download over RADIUS Interface

The following example shows how to verify Dynamic Policy Download over RADIUS Interface:

```
RP/0/RSP0/CPU0:router#show subscriber database configuration brief service-profile location
0/RSP0/CPU0

Location 0/RSP0/CPU0

ServiceName:MethodList          In Use By Subscriber
-----
A0F0200M100M000030MQ_1:default True
JHV_VOICE:default              True
LIVE_TV:default                True

RP/0/RSP0/CPU0:router#
show policy-map applied interface Bundle-Ether1.1.ip62 input

Input policy-map applied to Bundle-Ether1.1.ip62:
 policy-map type merge __merge_67da4456
  class class-default
  service-policy type merge __merge_fffffb83affffff97fffff8f
  police rate 102400 kbps burst 1250000 kbytes
  !
  !
Child policy-map(s) of policy-map __merge_67da4456:
 policy-map type merge __merge_fffffb83affffff97fffff8f
  class JHV-VIDEO-IN
```

```

police rate 20480 kbps burst 500000 kbytes
!
set mpls experimental imposition 4
!
class LIVE-TV-IN-IPv4
  police rate 40960 kbps burst 100 kbytes
  !
  set mpls experimental imposition 4
  !
class LIVE-TV-IN-IPv6
  police rate 40960 kbps burst 100 kbytes
  !
  set mpls experimental imposition 4
  !
class JHV-VOICE-IN
  police rate 128 kbps burst 3200 kbytes
  !
  set mpls experimental imposition 5
  !
class JHV-SIGNALLING-IN
  police rate 256 kbps burst 6400 kbytes
  !
  set mpls experimental imposition 7
  !
class class-default
  police rate 102400 kbps burst 1250000 kbytes
  !
  set mpls experimental imposition 0
  !

```

RP/0/RSP0/CPU0:router#

Additional References

These sections provide references related to implementing RADIUS.

RFCs

Standard/RFC - AAA	
RFC-2865	Remote Authentication Dial In User Service (RADIUS)
RFC-2866	RADIUS Accounting
RFC-2867	RADIUS Accounting Modifications for Tunnel Protocol Support
RFC-2868	RADIUS Attributes for Tunnel Protocol Support
RFC-2869	RADIUS Extensions
RFC-3575	IANA Considerations for RADIUS
RFC-4679	DSL Forum Vendor-Specific RADIUS Attributes
RFC-5176	Dynamic Authorization Extensions to RADIUS

MIBs

MIBs	MIBs Link
—	To locate and download MIBs for selected platforms, Cisco IOS releases, and feature sets, use Cisco MIB Locator found at the following URL: http://www.cisco.com/go/mibs

Technical Assistance

Description	Link
The Cisco Technical Support website contains thousands of pages of searchable technical content, including links to products, technologies, solutions, technical tips, and tools. Registered Cisco.com users can log in from this page to access even more content.	http://www.cisco.com/cisco/web/support/index.html



CHAPTER 4

Activating Control Policy

A control policy enables the service provider to define certain actions that are performed during various subscriber life-cycle events. This chapter provides information about activating control policy on the BNG router. A control policy is defined using a policy-map. The policy-map contains a set of events - events during which certain actions are performed. The condition for performing an action is defined in a class-map. After a class-map is created, it is included in the policy-map. The policy-map is then activated on the router interface for the policy to take effect. One of the actions that can be performed by the policy map is activating dynamic template. The dynamic template is a container used to group a set of configuration items to be applied to a group of subscribers. This chapter covers the following topics:

- [Control Policy Overview, on page 81](#)
- [Creating Class-Map, on page 83](#)
- [Creating Policy-Map, on page 84](#)
- [Activating Policy-Map, on page 88](#)
- [Defining Dynamic Templates, on page 89](#)
- [Additional References, on page 90](#)

Control Policy Overview

A control policy enables the service provider to define actions that must be performed during various subscriber lifecycle events, such as creation of a session, connectivity loss, and so on. For the complete list of events, see [Control Policy Events, on page 85](#).

Different actions can be executed for different subscribers based on various match criteria. Some actions that can be specified in the control policy are:

- Authenticating or authorizing a subscriber by an external AAA server
- Starting subscriber accounting
- Activating specific configurations on the subscriber using dynamic templates

A control policy is deployed using policy-map and class-map. Each policy-map contains a list of events that the service provider considers applicable to the subscriber lifecycle. The policy-map also defines the actions that will be performed during these events. However, these actions are performed only when certain conditions are met. These conditions are called match criteria. The match criteria are defined in class-maps, which is included within the policy-map. It is possible to have different match criteria for different subscribers.

For example, a control policy can be created to start the "subscriber authentication" action, when a "session start" event occurs, for a specific "MAC address" match criteria. After this control policy is deployed, when the device having the specified MAC address starts a new session, BNG initiates the subscriber authentication process.

The actions defined in the policy-map are executed by action handlers. For more information about supported action handlers, see [Action Handlers, on page 525](#).

The following figure shows the structure of control policy. It illustrates that for each policy there can be multiple events; for each event, there can be multiple classes; and for each class, there can be multiple actions. As a result, a single policy map can be used to trigger multiple actions, when a match is found for a single or several criteria, during one or many events.

Figure 5: Control Policy

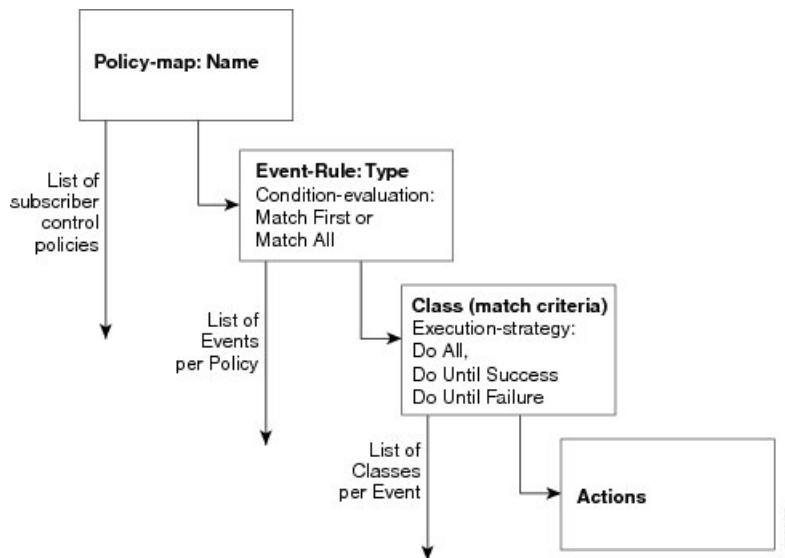

The following sample configuration shows the control policy structure:

```
policy-map type control subscriber policy-map-name
  event <event-type> [match-all|match-first]
  class type control subscriber <class-map-name>
    <seq#> <action-type> <action_options>
```



Note From Cisco IOS XR Software Release 5.2.2 and later, you can edit the class associated with the subscriber policy even while the sessions are active. Prior to this, new class map actions were not editable if the sessions were up, and any such dynamic policy-map changes resulted in clearing off the subscriber sessions.



Note Limit the `policy-map type control subscriber` number to 100.

Creating Class-Map

The class-map is used to define traffic class. The traffic is classified based on match criteria defined in the class-map. The parameter for match criteria can be protocol, MAC address, input interface, access group, and so on.

If more than one match criteria is listed in a single class-map, then instructions must be included defining how the match criteria are to be evaluated. The evaluation instruction are of two types:

- Match-any—A positive match is made if the traffic being evaluated matches any one of the specified criteria.
- Match-all—A positive match is made only if the traffic being evaluated matches all specified criteria.

Once a match is made, the traffic is considered as a member of the class.

Each class-map is assigned a name for identification. The class-map name is specified within the policy-map.

For creating a class-map, see [Configuring a Class-Map, on page 83](#).

Configuring a Class-Map

Perform this task to configure a class-map for control policies. As an example, this class-map is created with the evaluation instruction, "match-any". The match criteria is "protocol" with value "PPP". As a result, a positive match is made when the session is uses PPP protocol.

SUMMARY STEPS

1. **configure**
2. **class-map type control subscriber match-any** *class-map-name*
3. **match protocol ppp**
4. **end-class-map**
5. Use the **commit** or **end** command.

DETAILED STEPS

	Command or Action	Purpose
Step 1	configure Example: RP/0/RSP0/CPU0:router# <code>configure</code>	Enters global configuration mode.
Step 2	class-map type control subscriber match-any <i>class-map-name</i> Example: RP/0/RSP0/CPU0:router(config)# <code>class-map type control subscriber match-any clmap1</code>	Creates a new subscriber control class-map with a user defined name. Enters the class-map mode. Defines the match evaluation instruction to be "match-any".
Step 3	match protocol ppp	Defines the match-criteria to be PPP protocol.

	Command or Action	Purpose
	Example: RP/0/RSP0/CPU0:router(config-cmap)# match protocol PPP	Note More than one match statement can be applied per class-map.
Step 4	end-class-map Example: RP/0/RSP0/CPU0:router(config-cmap)# end-class-map	Ends the class map configuration.
Step 5	Use the commit or end command.	commit —Saves the configuration changes and remains within the configuration session. end —Prompts user to take one of these actions: <ul style="list-style-type: none"> • Yes — Saves configuration changes and exits the configuration session. • No —Exits the configuration session without committing the configuration changes. • Cancel —Remains in the configuration session, without committing the configuration changes.

Configuring a Class-Map: An example

```
class-map type control subscriber match-any DHCP_class
match protocol dhcpv4
end-class-map
!
!
end
```

Creating Policy-Map

The policy-map is used to define the events for which a set of actions are executed when a match, based on the class-map definitions, is made. For more information about the supported BNG events, see [Control Policy Events, on page 85](#).

A policy-map lists a set of events. For each event, a set of class-maps are defined. For each class-map, a series of actions are listed sequentially. After the policy-map is applied on the BNG router interface, when the traffic matches the criteria mentioned in the class-map, the actions are performed.

If more than one class-map is listed in the policy-map, then instruction has to be specified that defines which class-maps should be applied. The evaluation instruction are of two types:

- **First-match**—Actions are performed only when a match is made for the first class-map.
- **Match-all**—Actions are performed for all matching classes.

Like with a class-map, each policy-map is assigned a name for identification. The policy-map name is specified when activating the policy-map on the router interface.

For creating a policy-map, see [Configuring a Policy-Map, on page 86](#).

Control Policy Events

Control policy on BNG supports the events listed here. These events need to be defined while creating a policy-map using the task [Configuring a Policy-Map, on page 86](#).

- **Session-Start**—This event is used by the PPPoE and DHCP access protocols to create a subscriber in the policy plane. The operator may configure the AAA actions and activate dynamic templates, suitable for subscriber.
- **Session-Activate**—Some access protocols require a two-stage session bring-up; for example, with PPPoE subscribers, the PPPoE Access protocol calls the Session-Start event for first sign of life (FSOL), followed by Session-Activate during PPP negotiation and authentication. The operator configures the AAA actions and activates the dynamic templates as suitable for the subscriber.
- **Service-Stop**—CoA is responsible for generating this event. The BNG operator configures the activate or deactivate actions, to put the subscriber in a default state when a service is stopped.
- **Authentication-No-Response**—If configured, this event is triggered when there is no response from the AAA server(s) for an authentication request. This event allows the network access server (NAS) operators to define how the failure should be handled. If the authentication-no-response event is not configured, then the authentication failure result is propagated to the access protocol for default handling.
- **Authorization-No-Response**—If configured, this event is triggered when there is no response from the AAA server(s) for an authorization request. This event allows the NAS operators to define how the failure should be handled. If the authorization-no-response event is not configured, then the authorization results are propagated to the access protocol for default handling, which causes the client who triggered the authorization to disconnect the subscriber session.
- **Authentication-Failure**—If configured and if the RADIUS server returns an authentication failure, then the Policy Rule Engine returns an "Authentication-Success" to the client that originated the request, in order to prevent it from disconnecting the subscriber. Furthermore, instead of depending on the client to provide the necessary behavior, the actions within the configured Authentication-Failure event are applied on the subscriber.
- **Authorization-Failure**—The authorization failure event indicates a RADIUS server rejection for the access request. If configured, the service provider overrides the default handling of the failure from the client.
- **Timed-Policy-Expiry**—If configured, this event is triggered as a result of a policy set-timer action that is configured and set on a subscriber session. This event allows NAS operators to define a timer for a number of possible scenarios. The set timer indicates that certain subscriber state changes have taken place. If sessions are not in the desired state, the NAS operators can disconnect or terminate the session through a configured disconnect action, or impose a different user policy.
- **Account-Logon**—If configured, this event provides an override behavior to the default account-logon processing. The default behavior only triggers authentication with provided credentials. However, if you override the default account-logon event, then you must explicitly configure the authentication action, and any additional action you require.

- **Account-Logoff**—If configured, this event provides an override behavior for the default account-logoff processing. The default behavior of the account-logoff processing is to disconnect the subscriber. Being able to override the default behavior is useful. Instead of disconnecting the subscriber, the service provider can perform a re-authentication. The re-authentication is done through a new account-logon by enabling HTTP Redirect feature on the subscriber.
- **Idle-Timeout**—If configured, this event terminates the IPoE and PPPoE subscriber sessions when the timeout period expires. The default behavior of the Idle-Timeout event is to disconnect the session. You can configure a **monitor** action under the idle timeout event for a subscriber policy, to prevent the termination of the subscriber session when the idle timeout period expires.

Configuring a Policy-Map

Perform this task to configure policy map for control policies. As an example, this policy-map is created for the Session-Start and Session-Activate events. For the Session-Start event, a dynamic template is activated. For the Session-Activate event, an authentication process is invoked. For more information about the supported events, see [Control Policy Events, on page 85](#).

SUMMARY STEPS

1. **configure**
2. **policy-map type control subscriber** *policy-map-name*
3. **event session-start match-all**
4. **class type control subscriber** *class_name* **do-until-failure**
5. *sequence_number* **activate dynamic-template** *dynamic-template_name*
6. **event session-activate match-all**
7. **class type control subscriber** *class_name* **do-until-failure**
8. *sequence_number* **authenticate aaa list** **default**
9. **end-policy-map**
10. Use the **commit** or **end** command.

DETAILED STEPS

	Command or Action	Purpose
Step 1	configure Example: RP/0/RSP0/CPU0:router# configure	Enters global configuration mode.
Step 2	policy-map type control subscriber <i>policy-map-name</i> Example: RP/0/RSP0/CPU0:router(config)# policy-map type control subscriber plmap1	Creates a new policy-map with user-defined name. Enters the policy-map mode.
Step 3	event session-start match-all Example:	Defines an event (session start) for which actions will be performed.

	Command or Action	Purpose
	RP/0/RSP0/CPU0:router(config-pmap)# event session-start match-all	Defines the match instruction to be "match-all", which executes actions for all matched classes.
Step 4	<p>class type control subscriber <i>class_name</i> do-until-failure</p> <p>Example:</p> <pre>RP/0/RSP0/CPU0:router(config-pmap-e)# class type control subscriber CL1 do-until-failure</pre>	<p>Associates a class-map with the event. The class-map name has to be specified.</p> <p>Instructs that the actions will be performed until a failure occurs.</p>
Step 5	<p><i>sequence_number</i> activate dynamic-template <i>dynamic-template_name</i></p> <p>Example:</p> <pre>RP/0/RSP0/CPU0:router(config-pmap-c)# 1 activate dynamic-template template1</pre>	<p>Defines the action to be performed. In this case, it activates a dynamic-template.</p> <p>Note This command can be repeated to define multiple actions.</p>
Step 6	<p>event session-activate match-all</p> <p>Example:</p> <pre>RP/0/RSP0/CPU0:router(config-pmap)# event session-activate match-all</pre>	<p>Defines an event (activate session) for which actions will be performed.</p> <p>Defines the match instruction to be "match-all", which executes actions for all matched classes.</p>
Step 7	<p>class type control subscriber <i>class_name</i> do-until-failure</p> <p>Example:</p> <pre>RP/0/RSP0/CPU0:router(config-pmap-e)# class type control subscriber CL1 do-until-failure</pre>	<p>Associates a class-map with the event. The class-map name needs to be specified.</p> <p>Instructs that the actions will be performed until a failure occurs.</p>
Step 8	<p><i>sequence_number</i> authenticate aaa list default</p> <p>Example:</p> <pre>RP/0/RSP0/CPU0:router(config-pmap-c)# 2 authenticate aaa list default</pre>	Defines the action to be performed. In this case, it initiates the authentication of AAA list.
Step 9	<p>end-policy-map</p> <p>Example:</p> <pre>RP/0/RSP0/CPU0:router(config-pmap)# end-policy-map</pre>	Ends the policy map configuration.
Step 10	Use the commit or end command.	<p>commit —Saves the configuration changes and remains within the configuration session.</p> <p>end —Prompts user to take one of these actions:</p> <ul style="list-style-type: none"> • Yes — Saves configuration changes and exits the configuration session.

	Command or Action	Purpose
		<ul style="list-style-type: none"> • No —Exits the configuration session without committing the configuration changes. • Cancel —Remains in the configuration session, without committing the configuration changes.

Configuring a Policy-Map: An example

```

policy-map type control subscriber PL1
  event session-start match-first
  class type control subscriber DHCP_class do-until-failure
    1 activate dynamic-template dhcp
  class type control subscriber class-default do-until-failure
! Packet trigger is default
  1 activate dynamic-template packet-trigger
end-policy-map
!
!
end

\\Configuring a Policy-Map with idle-timeout event and monitor action

policy-map type control subscriber PL2
  event idle-timeout
  class type control subscriber DHCP_class
    1 monitor

```

Activating Policy-Map

After a policy-map is created, it needs to be activated on a router interface. The policies are implemented only after the policy-map activation is completed. One or more policy-maps will constitute the service-policy. To enable the service-policy, see [Enabling a Service-Policy on a Subscriber Interface, on page 88](#).

Enabling a Service-Policy on a Subscriber Interface

Perform this task to enable a service-policy on a subscriber interface. The process involves attaching a previously created policy-map with an interface. Once this process is complete, the actions defined in the class-map will take effect for the traffic coming on the interface on which service-policy is enabled.

SUMMARY STEPS

1. **configure**
2. **interface** *type interface-path-id*
3. **service-policy** **type control subscriber** *policy_name*
4. Use the **commit** or **end** command.

DETAILED STEPS

	Command or Action	Purpose
Step 1	configure Example: RP/0/RSP0/CPU0:router# configure	Enters global configuration mode.
Step 2	interface <i>type interface-path-id</i> Example: RP/0/RSP0/CPU0:router(config)# interface Bundle-Ether100.10	Enters the interface configuration mode for the bundle-ether access interface. Note For IPoE sessions, it is recommended that Dynamic ARP learning be disabled in the access-interface, using the arp learning disable command.
Step 3	service-policy type control subscriber <i>policy_name</i> Example: RP/0/RSP0/CPU0:router(config-if)# service-policy type control subscriber plmap1	Applies a pre-defined policy-map named 'plmap1' to an access interface.
Step 4	Use the commit or end command.	commit —Saves the configuration changes and remains within the configuration session. end —Prompts user to take one of these actions: <ul style="list-style-type: none"> • Yes — Saves configuration changes and exits the configuration session. • No —Exits the configuration session without committing the configuration changes. • Cancel —Remains in the configuration session, without committing the configuration changes.

Defining Dynamic Templates

A dynamic template is a container used to group a set of configuration settings, and apply them to the subscriber sessions. A dynamic template is globally configured through CLI. However, defining the dynamic template does not immediately cause the configuration to be applied to a subscriber interface. The configuration within a dynamic template is applied to a subscriber interface, only when the dynamic template is activated using a control policy. Similarly, the applied configurations are stopped, only when the dynamic template is deactivated using a control policy.

There are three basic types of dynamic-templates:

- PPP templates—It contains specific configurations related to the PPPoE protocol.
- IP Subscriber templates—It contains specific configurations that are activated on IP subscriber sessions.

- Service templates—It contains service-related configuration that are activated in response to session life-cycle events. Service templates are precluded from containing interface or media-specific commands.

A dynamic template can either be configured on the CLI, or downloaded from the AAA server. In the following sample configuration, the policy map activates an IP Subscriber dynamic template that is defined on the CLI.

```
dynamic-template
type ipsubscriber ipsub
ipv4 unnumbered Loopback400
policy-map type control subscriber PL2
event session-start match-first
class type control subscriber class-default do-all
1 activate dynamic-template ipsub
```

There are two types of dynamic templates that are downloaded from the AAA server—user profiles and service profiles. User profiles are applied to a single subscriber, whereas, service profiles can be applied to multiple subscribers. In the following sample configuration, the policy map downloads a service template from the AAA server.

```
Radius Config:
service1 Password="xxxxxx"
Cisco-avpair = "ipv4:ipv4-unnumbered=Loopback400"
```

```
Router Config:
policy-map type control subscriber PL2
event session-start match-first
class type control subscriber class-default do-all
1 activate dynamic-template service1 aaa list default
```

In the above example, the "aaa list default" keyword specifies that the template "service1" be downloaded from the AAA server. A template is downloaded only once. If there are multiple control policies referring to service1, then those will get the previously downloaded version.

It is possible to activate more than one dynamic template on the same subscriber interface, for the same event or different events. If the configurations for a particular functionality is defined in multiple dynamic templates, the configurations are derived from all the templates on a certain order of precedence. This order is based on the type of dynamic template, and whether it is being applied from CLI or AAA. The order is:

- Template applied by the user profile from AAA
- Template applied by the service profile from AAA
- IP Subscriber template applied from CLI
- PPP template applied from CLI
- Service template applied from CLI

The tasks involving the use of dynamic templates to define specific feature configurations are included in their corresponding feature topics.

Additional References

These sections provide references related to implementing control policy.

MIBs

MB	MIBs Link
	<p>To locate and download MIBs for selected platforms, Cisco IOS releases, and feature sets, use Cisco MIB Locator found at the following URL:</p> <p>http://www.cisco.com/go/mibs</p>

Technical Assistance

Description	Link
<p>The Cisco Support website provides extensive online resources, including documentation and tools for troubleshooting and resolving technical issues with Cisco products and technologies.</p> <p>To receive security and technical information about your products, you can subscribe to various services, such as the Product Alert Tool (accessed from Field Notices), the Cisco Technical Services Newsletter, and Really Simple Syndication (RSS) Feeds.</p> <p>Access to most tools on the Cisco Support website requires a Cisco.com user ID and password.</p>	<p>http://www.cisco.com/cisco/web/support/index.html</p>



CHAPTER 5

Establishing Subscriber Sessions

A subscriber accesses network resources through a logical connection known as subscriber session. This chapter provides information about various types of subscriber sessions, namely IPoE and PPPoE, and IP addressing by DHCP.

Table 10: Feature History for Establishing Subscriber Sessions

This chapter covers these topics:

- [Subscriber Session Overview, on page 93](#)
- [Establishing IPoE Session, on page 96](#)
- [Establishing PPPoE Session, on page 115](#)
- [Activating IPv6 Router Advertisement on a Subscriber Interface When IPv4 Starts, on page 148](#)
- [Making DHCP Settings, on page 149](#)
- [IPoE Class-based DHCPv4 Mode Selection, on page 194](#)
- [DHCPv6 Overview, on page 194](#)
- [Packet Handling on Subscriber Interfaces, on page 236](#)
- [IPv6 Neighbor Discovery, on page 238](#)
- [Line Card Subscribers, on page 238](#)
- [Static Sessions, on page 241](#)
- [Subscriber Session Limit , on page 243](#)
- [BNG Subscriber Templates, on page 244](#)
- [eBGP over PPPoE, on page 245](#)
- [BNG over Pseudowire Headend , on page 246](#)
- [Removing Access Interface Configuration, on page 249](#)
- [Additional References, on page 252](#)

Subscriber Session Overview

A session represents the logical connection between the customer premise equipment (CPE) and the network resource. To enable a subscriber access the network resources, the network has to establish a session with the subscriber. Each session establishment comprises of these phases:



Note When packets arrive on an access interface, an attempt is made to link that packet to a subscriber context.

- For PPPoE sessions the Source MAC of the CPE, Access interface and PPPoE Session ID are used to match the remote peer to a subscriber interface.
- For IPoE sessions the Source MAC, Access interface and IP address are verified against the DHCP binding to find a matching subscriber interface.

If there is no match, the packet is mapped against the access (sub-)interface. Considering that the access interface in IPoE designs is IP enabled (eg via an IP-Unnumbered configuration) that packets are processed like regular IP. In order to secure your BNG access interface, you will want to apply either uRPF or an Access-List blocking everything but DHCP incoming on the access interface to limit remote subscribers for which we don't have an interface created from accessing network resources.

- Establishing a connection—in this phase CPE finds the BNG with which to communicate.
- Authenticating and authorizing the subscriber—in this phase, BNG authenticates the subscribers and authorizes them to use the network. This phase is performed with the help of the RADIUS server.
- Giving subscriber an identity—in this phase, the subscriber is assigned an identity, the IP address.
- Monitoring the session—in this phase, BNG ascertains that the session is up and running.

The subscribers are not configured directly on BNG. Instead, a framework is created on which subscriber features and subscriber sessions are started and stopped dynamically. The framework consists of control policies and dynamic templates, which perform these functions:

- Control policy determines the action BNG takes when specific events, such as receipt of a session start request, or failure of authentication, occurs. The action is determined by the class-map defined in the control policy. The action involves activating dynamic templates.
- Dynamic template contains a set of CLI commands that are applied to a subscriber session. Multiple dynamic templates can be activated, one at a time, on the same subscriber interface. Also, the same dynamic template can be activated on multiple subscriber interfaces through different control policies.

Service providers can deploy subscribers over VLAN in these ways:

- 1:1 VLAN model—This model depicts a scenario where one dedicated VLAN is available for each customer. Each VLAN is an q-in-q VLAN where the inner VLAN tag represents the subscriber and the outer VLAN tag represents the DSLAM.
- N:1 VLAN model—This model depicts a scenario where multiple subscribers are available on a shared VLAN. The VLAN tags represent the DSLAM or the aggregation device.
- Ambiguous VLANs —This model allows the operator to specify a large number of VLANs in a single CLI line. Using ambiguous VLAN, a range of inner or outer tags (or both) can be configured on a VLAN sub-interface. This is particularly useful for the 1:1 model, where every subscriber has a unique value for the set of VLAN tags. For more information about ambiguous VLANs, see [Subscriber Session on Ambiguous VLANs](#), on page 331.

The subscriber sessions are established over the subscriber interfaces, which are virtual interfaces. It is possible to create only one interface for each subscriber session. A port can contain multiple VLANs, each of which can support multiple subscribers. BNG creates subscriber interfaces for each kind of session. These interfaces

are named based on the parent interface, such as bundle-ether 2.100.pppoe312. The subscribers on bundles (or bundle-VLANs) interfaces allow redundancy, and are managed on the BNG route processor (RP).

For details on subscriber session limit, see [Subscriber Session Limit](#), on page 243.

To provide network redundancy and load balancing, the service provider can deploy multiple links between the DSLAM and the BNG. The individual links can be grouped into ether-bundles, including VLANs over ether-bundles, or link aggregation groups (LAGs). The subscriber sessions can be active on any link within the bundle or group. If a BNG is deployed in a LAG configuration, all traffic for one subscriber should be configured to traverse one link of the ether-bundle. Load-balancing is achieved by putting different subscribers on different links.

There are two mechanisms to establish a subscriber session, namely, IPoE and PPPoE. These are discussed next in the next topics.

Line card (LC) subscribers are supported in BNG. For details, see [Line Card Subscribers](#), on page 238.

BNG supports interface based static sessions, where all traffic belonging to a particular VLAN sub-interface is treated as a single session. For details, see [Static Sessions](#), on page 241.

**Note**

- If a **clear subscriber session all** command is issued with the intent to clear all the subscriber sessions and if a route processor fail over (RPFO) occurs while the session bring down is in progress, then it is recommended to re-run the same command post RPFO, to ensure all the remaining sessions, if any, are brought down.
- Do not add or delete any Virtual Routing and Forwarding (VRF) configuration when the subscriber sessions are being brought up or brought down. Otherwise, there can be issues while creating new subscriber sessions that can lead to system instability.
- With packet-triggered session initiator configured, new sessions (for subscriber session with already activated state or subscriber sessions which are duplicating the credentials of already activated subscribers) are attempted even before clearing the previous session. This happens while clearing a subscriber session (either using CoA or using **clear subscriber session** command) when the user is sending traffic. From Cisco IOS XR Software Release 5.2.2 and later, if a packet-triggered session gets to an error state (Access-Reject or feature programming error) during session establishment procedure, then a penalty of two minutes is applied to that subscriber. That is, BNG does not accept a new session from the same subscriber for a time period of two minutes. This avoids hogging of system resources by a DoS attack. The penalty remains the same if the session was cleared either using CoA or using clear subscriber session command. For IP-initiated sessions, the subscribers can disconnect either based on the idle timeout or based on the portal logout. For idle timeout scenario, the penalty does not have any impact, because the penalty is applicable only if the subscriber sends traffic while the session is being cleared. In a portal logout scenario, a CoA is triggered by the portal. If subscriber sends traffic when the CoA is received, then the two-minute penalty is applied to that subscriber; else there is no penalty.

From Cisco IOS XR Software Release 5.3.0 and later, the penalty is reduced to 10 seconds only for scenarios where the previous session of the same subscriber is in **disconnecting** state. For other scenarios, the penalty remains as two minutes.

Restrictions

- If the subscriber's VRF is taken from the access interface's VRF value, then the VRF, configured in the dynamic template used by the subscriber, must match. If the two VRFs do not match, then the session would not work properly.
- ACL logging on BNG dynamic template is not supported.

Establishing IPoE Session

In an IPoE subscriber session, subscribers run IPv4 or IPv6 on the CPE device and connect to the BNG through a Layer-2 aggregation or Layer-3 routed network. IP subscriber sessions that connect through a Layer-2 aggregation network are called L2-connected and sessions that connect through routed access network are called L3-connected or routed subscriber sessions. IPoE subscriber sessions are always terminated on BNG and then routed into the service provider network. IPoE relies on DHCP to assign IP address. A typical IPoE session is depicted in the following figure.

Figure 6: IPoE Session

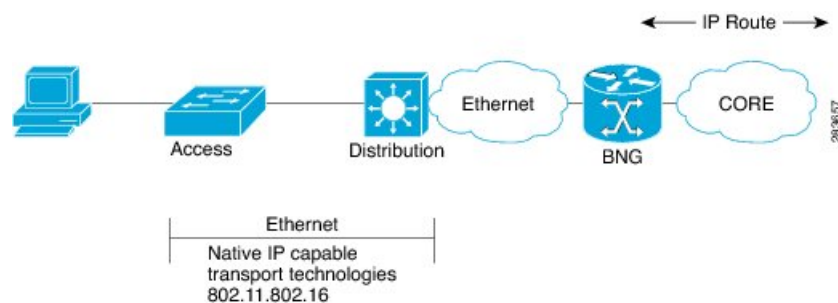

The process of provisioning an IPoE session involves:

- Enabling the processing of IPv4 or IPv6 protocol on an access interface. See [Enabling IPv4 or IPv6 on an Access Interface, on page 97](#).



Note For subscriber deployments, it is recommended that Dynamic ARP learning be disabled in the access-interface, using the **arp learning disable** command in the access-interface configuration mode.

- Creating dynamic template that contains the settings for the IPoE sessions. See [Creating Dynamic Template for IPv4 or IPv6 Subscriber Session, on page 99](#).
- Creating policy-map to activate dynamic template. See [Creating a Policy-Map to Run During IPoE Session, on page 101](#).
- Enabling IPoE subscriber creation on access interface by activating service-policy. The service-policy will apply the policy-map on the access interface. See [Enabling IPoE Subscribers on an Access Interface, on page 103](#).

For details on routed subscriber sessions, see [Routed Subscriber Sessions, on page 106](#).

BNG supports IPoE subscriber session-restart. For details, see [Subscriber Session-Restart, on page 185](#).

To limit the default ARP entry creations, see [Prevent Default ARP Entry Creation for a Subscriber Interface, on page 114](#).



Note If an access interface in BNG is configured to support only packet (PKT) triggered sessions, or both DHCP and PKT triggered sessions, then a burst of traffic with unique flows can affect the BNG router in terms of processing each packet to determine if it is an IPoE (PKT triggered) packet. New subscriber sessions cannot be established in these scenarios and this can in turn lead to system instability. Therefore, it is mandatory to configure static lpts policer for **unclassified rsp** protocol, on each of the line cards (LCs), such that the traffic rate does not exceed 150 pps per LC. The rate configured is applied at network processor (NP). Therefore, for an LC with 4 NPs, the rate should be configured as 38 (150/4), to achieve a traffic rate of 150 pps. For example, `lpts punt police location 0/RSP0/CPU0 protocol unclassified rsp rate 38`.

Restrictions

Enabling IPoE subscribers on an access-interface is subjected to a restriction that packet-triggered L2 sessions (**initiator unclassified-source**) are not supported for IPv6.

Enabling IPv4 or IPv6 on an Access Interface

Perform these tasks to enable IPv4 and IPv6 processing on an access interface. In this example, the IPv4 is being provisioned on an unnumbered bundle-interface.

SUMMARY STEPS

1. **configure**
2. **interface** *type interface-path-id*
3. **arp learning disable**
4. **ipv4 unnumbered** *interface-type interface-instance*
5. **ipv6 enable**
6. Use the **commit** or **end** command.

DETAILED STEPS

	Command or Action	Purpose
Step 1	configure Example: RP/0/RSP0/CPU0:router# <code>configure</code>	Enters global configuration mode.
Step 2	interface <i>type interface-path-id</i> Example: RP/0/RSP0/CPU0:router(config)# <code>interface Bundle-Ether100.10</code>	Enters interface configuration mode for the bundle-interface.
Step 3	arp learning disable Example:	Disables arp learning for the access-interface.

	Command or Action	Purpose
	RP/0/RSP0/CPU0:router(config-if)# arp learning disable	
Step 4	<p>ipv4 unnumbered <i>interface-type interface-instance</i></p> <p>Example:</p> <pre>RP/0/RSP0/CPU0:router(config-if)# ipv4 unnumbered loopback 5</pre>	Enables IPv4 processing on a unnumbered interface without assigning an explicit IPv4 address to that interface. Instead, the IP address is borrowed from the loopback interface. For the "ipv4 unnumbered" command, you must specify another interface in the same router that has been assigned an IP address and whose status is displayed as "up" for the show interfaces command.
Step 5	<p>ipv6 enable</p> <p>Example:</p> <pre>RP/0/RSP0/CPU0:router(config-if)# ipv6 enable</pre>	<p>Enables IPv6 processing on an unnumbered interface that has not been assigned an explicit IPv6 address.</p> <p>Note This step not only enables IPv6 processing on the interface, but also assigns an IPv6 link-local unicast address to it.</p>
Step 6	Use the commit or end command.	<p>commit —Saves the configuration changes and remains within the configuration session.</p> <p>end —Prompts user to take one of these actions:</p> <ul style="list-style-type: none"> • Yes — Saves configuration changes and exits the configuration session. • No —Exits the configuration session without committing the configuration changes. • Cancel —Remains in the configuration session, without committing the configuration changes.

Enabling IPv4 or IPv6 on an Access Interface: Examples

```
//Enabling IPv4 on an Access Interface
```

```
configure
interface Bundle-Ether100.10
arp learning disable
ipv4 unnumbered loopback 5
!
!
end
```

```
//Enabling IPv6 on an Access Interface
```

```
configure
interface Bundle-Ether100.10
arp learning disable
ipv6 enable
```

```

!
!
end

```

Creating Dynamic Template for IPv4 or IPv6 Subscriber Session

Perform this task to create a dynamic template for IPv4 or IPv6 subscriber session. As an example, in this dynamic template you will specify the MTU value for the IPv4 or IPv6 session and enable uRPF. The uRPF ensures that the traffic from malformed or forged IPv4 source addresses are not accepted on the subscriber interface. For more information about uRPF feature, see [uRPF, on page 337](#).

SUMMARY STEPS

1. **configure**
2. **dynamic-template**
3. **type { ipsubscriber | ppp | service } *dynamic-template-name***
4. **timeout idle *value* [*threshold duration*][**traffic {both | inbound | outbound}**]**
5. **accounting aaa list default type session periodic-interval *value* dual-stack-delay *value***
6. **{ipv4 | ipv6} mtu *mtu-bytes***
7. **{ipv4 | ipv6}verify unicast source reachable-via rx**
8. Use the **commit** or **end** command.

DETAILED STEPS

	Command or Action	Purpose
Step 1	configure Example: RP/0/RSP0/CPU0:router# configure	Enters global configuration mode.
Step 2	dynamic-template Example: RP/0/RSP0/CPU0:router(config)# dynamic-template	Enters the dynamic-template configuration mode.
Step 3	type { ipsubscriber ppp service } <i>dynamic-template-name</i> Example: RP/0/RSP0/CPU0:router(config-dynamic-template)# type ipsubscriber ipsub1	Creates a dynamic-template with an user-defined name for IP subscriber.
Step 4	timeout idle <i>value</i> [<i>threshold duration</i>][traffic {both inbound outbound}] Example: RP/0/RSP0/CPU0:router(config-dynamic-template-type)# timeout idle 600 threshold 2 traffic both	IPv4 or IPv6 or Dual-stack Subscribers support idle timeout feature. Note You can configure a monitor action under the idle timeout event for a subscriber policy, to prevent the termination of subscriber sessions when the idle timeout period expires.

	Command or Action	Purpose
Step 5	<p>accounting aaa list default type session periodic-interval value dual-stack-delay value</p> <p>Example:</p> <pre>RP/0/RSP0/CPU0:router(config-dynamic-template)# accounting aaa list default type session periodic-interval 60 dual-stack-delay 1</pre>	Configures the subscriber accounting feature.
Step 6	<p>{ipv4 ipv6} mtu mtu-bytes</p> <p>Example:</p> <pre>RP/0/RSP0/CPU0:router(config-dynamic-template-type)# ipv4 mtu 678 RP/0/RSP0/CPU0:router(config-dynamic-template-type)# ipv6 mtu 548</pre>	Sets IPv4 or IPv6 maximum transmission unit (MTU). The range is from 68 to 65535 bytes. The MTU value defines the largest packet size that can be transmitted during the subscriber session.
Step 7	<p>{ipv4 ipv6} verify unicast source reachable-via rx</p> <p>Example:</p> <pre>RP/0/RSP0/CPU0:router(config-dynamic-template-type)# ipv4 verify unicast source reachable-via rx RP/0/RSP0/CPU0:router(config-dynamic-template-type)# ipv6 verify unicast source reachable-via rx</pre>	Enables uRPF for packet validation that performs source address reachability check.
Step 8	Use the commit or end command.	<p>commit —Saves the configuration changes and remains within the configuration session.</p> <p>end —Prompts user to take one of these actions:</p> <ul style="list-style-type: none"> • Yes — Saves configuration changes and exits the configuration session. • No —Exits the configuration session without committing the configuration changes. • Cancel —Remains in the configuration session, without committing the configuration changes.

Creating Dynamic Template for IPv4 or IPv6 Subscriber Session: Examples

```
//Creating Dynamic Template for IPv4 Subscriber Session

configure
dynamic-template
type ipsubscriber ipsub1
timeout idle 600
accounting aaa list default type session periodic-interval 60 dual-stack-delay 1
ipv4 mtu 678
ipv4 verify unicast source reachable-via rx
```

```

!
!
end

//Creating Dynamic Template for IPv6 Subscriber Session

configure
dynamic-template
type ipsubscriber ipsub1
timeout idle 600 threshold 2 traffic both
accounting aaa list default type session periodic-interval 60 dual-stack-delay 1
ipv6 mtu 678
ipv6 verify unicast source reachable-via rx
!
!
end

```

Creating a Policy-Map to Run During IPoE Session

Perform this task to create a policy-map that will activate a predefined dynamic-template during an IPoE subscriber session. As an example, this policy-map activates a dynamic template, and applies a locally defined authorization setting, during a session-start event.

SUMMARY STEPS

1. **configure**
2. **policy-map type control subscriber** *policy_name*
3. **event session-start match-first**
4. **class type control subscriber** *class_name* **do-until-failure**
5. *sequence_number* **activate dynamic-template** *dynamic-template_name*
6. *sequence_number* **authorize aaa list default format** *format_name* **password** *password*
7. Use the **commit** or **end** command.

DETAILED STEPS

	Command or Action	Purpose
Step 1	configure Example: RP/0/RSP0/CPU0:router# configure	Enters global configuration mode.
Step 2	policy-map type control subscriber <i>policy_name</i> Example: RP/0/RSP0/CPU0:router(config)# policy-map type control subscriber IPoE_policy	Creates a new policy map of the type "control subscriber" with the name "IPoE_policy".
Step 3	event session-start match-first Example:	Defines an event (session start) for which actions will be performed.

	Command or Action	Purpose
	RP/0/RSP0/CPU0:router(config-pmap)# event session-start match-first	
Step 4	<p>class type control subscriber <i>class_name</i> do-until-failure</p> <p>Example:</p> <pre>RP/0/RSP0/CPU0:router(config-pmap-e)# class type control subscriber class-default do-until-failure</pre>	Configures the class to which the subscriber has to be matched. When there is a match, executes all actions until a failure is encountered.
Step 5	<p><i>sequence_number</i> activate dynamic-template <i>dynamic-template_name</i></p> <p>Example:</p> <pre>RP/0/RSP0/CPU0:router(config-pmap-c)# 1 activate dynamic-template ipsub1</pre>	Allows authentication of the subscriber to be triggered using the complete structure username.
Step 6	<p><i>sequence_number</i> authorize aaa list default format <i>format_name</i> password <i>password</i></p> <p>Example:</p> <pre>RP/0/RSP0/CPU0:router(config-pmap-c)# 1 authorize aaa list default format RM_User password Cisco</pre>	Allows authorization of the subscriber to be triggered using the domain name of the subscriber. Also, provides domain format-rule, which helps to parse the domain from a complete structured username.
Step 7	Use the commit or end command.	<p>commit —Saves the configuration changes and remains within the configuration session.</p> <p>end —Prompts user to take one of these actions:</p> <ul style="list-style-type: none"> • Yes — Saves configuration changes and exits the configuration session. • No —Exits the configuration session without committing the configuration changes. • Cancel —Remains in the configuration session, without committing the configuration changes.

Creating a Policy-Map to Run During IPoE Session: An example

```
configure
policy-map type control subscriber IPoE_policy
event session-start match-first
class type control subscriber class-default do-until-failure
1 activate dynamic-template ipsub1
1 authorize aaa list default format RM_User password Cisco
!
!
end
```

Enabling IPoE Subscribers on an Access Interface

Perform this task to enable IPoE subscriber creation on an access interface.

SUMMARY STEPS

1. **configure**
2. **interface** *interface-type interface-path-id*
3. **arp learning disable**
4. **{ipv4 | ipv6} address** {*ipv4_address | ipv6_address*} *ipsubnet_mask*
5. **service-policy type control subscriber** *policy-name*
6. **encapsulation dot1q** *value*
7. **ipsubscriber {ipv4 | ipv6}I2-connected**
8. **initiator dhcp**
9. **initiator unclassified-source** [**address-unique**]
10. Use the **commit** or **end** command.

DETAILED STEPS

	Command or Action	Purpose
Step 1	configure Example: RP/0/RSP0/CPU0:router# <code>configure</code>	Enters global configuration mode.
Step 2	interface <i>interface-type interface-path-id</i> Example: RP/0/RSP0/CPU0:router(config)# <code>interface Bundler-Ether400.12</code>	Configures an interface and enters interface configuration mode. <ul style="list-style-type: none"> • The type argument specifies an interface type. For more information on interface types, use the question mark (?) online help function. • The instance argument specifies either a physical interface instance or a virtual instance. <ul style="list-style-type: none"> • The naming notation for a physical interface instance is rack/slot/module/port. The slash (/) between values is required as part of the notation. • The number range for a virtual interface instance varies depending on the interface type.
Step 3	arp learning disable Example: RP/0/RSP0/CPU0:router(config-if)# <code>arp learning disable</code>	Disables arp learning for the access-interface.
Step 4	{ipv4 ipv6} address { <i>ipv4_address ipv6_address</i> } <i>ipsubnet_mask</i>	Sets the IPv4 address or an IPv6 address for an interface.

	Command or Action	Purpose
	<p>Example:</p> <pre>RP/0/RSP0/CPU0:router(config-subif)# ipv4 address 3.5.1.1 255.255.0.0</pre> <p>or</p> <p>Example:</p> <pre>RP/0/RSP0/CPU0:router(config-subif)# ipv6 address 1144:11</pre>	
Step 5	<p>service-policy type control subscriber <i>policy-name</i></p> <p>Example:</p> <pre>RP/0/RSP0/CPU0:router(config-subif)# service-policy type control subscriber PL4</pre>	<p>Associates a subscriber control service policy to the interface.</p> <p>Note Refer to the "Configuring a Subscriber Policy Map" procedure to create a PL4 policy-map.</p>
Step 6	<p>encapsulation dot1q <i>value</i></p> <p>Example:</p> <pre>RP/0/RSP0/CPU0:router(config-subif)# encapsulation dot1q 40</pre>	<p>Defines the matching criteria to map 802.1Q frames ingress on an interface to the appropriate service instance. The value ranges from 1 to 4094.</p>
Step 7	<p>ipsubscriber {ipv4 ipv6}l2-connected</p> <p>Example:</p> <pre>RP/0/RSP0/CPU0:router(config-subif)# ipsubscriber ipv4 l2-connected</pre> <p>or</p> <p>Example:</p> <pre>RP/0/RSP0/CPU0:router(config-subif)# ipsubscriber ipv6 l2-connected</pre>	<p>Enables creations of L2-connected IPv4 or IPv6 subscribers on the sub-interface.</p> <p>Note It is not recommended to remove these call flow-initiated configurations, after subscriber sessions are active:</p> <ul style="list-style-type: none"> • For an IPoE subscriber session, you must not delete the ipsubscriber ipv4 l2-connected initiator dhcp command from the sub-interface • For a packet-triggered subscriber session, you must not delete the ipsubscriber ipv4 l2-connected initiator unclassified-source command from the sub-interface.
Step 8	<p>initiator dhcp</p> <p>Example:</p> <pre>RP/0/RSP0/CPU0:router(config-subif-ipsub-ipv4-l2conn)# initiator dhcp</pre> <p>or</p> <p>Example:</p> <pre>RP/0/RSP0/CPU0:router(config-subif-ipsub-ipv6-l2conn)# initiator dhcp</pre>	<p>Configures DHCP as the first-sign-of-life (FSOL) protocol for IP subscriber.</p>
Step 9	<p>initiator unclassified-source [address-unique]</p> <p>Example:</p>	<p>Configures unclassified packets as the first-sign-of-life (FSOL) for IPv4 subscriber.</p>

	Command or Action	Purpose
	RP/0/RSP0/CPU0:router(config-subif-ipsub-ipv4-l2conn)# initiator unclassified-source	<p>The address-unique option enables subscriber IP uniqueness check during FSOL processing, thereby preventing invalid sessions from creating interfaces. This option is available from Cisco IOS XR Software Release 5.2.2 and later.</p> <p>Note</p> <ul style="list-style-type: none"> • The initiator unclassified-source option is not supported for IPv6. • If multiple initiators are used, use a policy or class map to prevent overlap of the IP addresses for the different sources.
Step 10	Use the commit or end command.	<p>commit —Saves the configuration changes and remains within the configuration session.</p> <p>end —Prompts user to take one of these actions:</p> <ul style="list-style-type: none"> • Yes — Saves configuration changes and exits the configuration session. • No —Exits the configuration session without committing the configuration changes. • Cancel —Remains in the configuration session, without committing the configuration changes.

Enabling IPoE Subscribers on an Access Interface: Examples

```

configure
interface Bundler-Ether400.12
arp learning disable
ipv4 address 3.5.1.1 255.255.0.0
service-policy type control subscriber PL4
encapsulation dot1q 40
ipsubscriber ipv4 l2-connected
initiator dhcp
initiator unclassified-source
!
!
end

```

```

configure
interface Bundler-Ether400.12
arp learning disable
ipv6 address 4444:34
service-policy type control subscriber PL4
encapsulation dot1q 40
ipsubscriber ipv6 l2-connected
initiator dhcp
!
!
end

```

Routed Subscriber Sessions

BNG supports L3 or routed subscriber sessions (DHCP-initiated and Packet-triggered), where IP subscribers are connected through a routed access network. The policies and services on the routed subscriber sessions are applied in a similar manner as with L2 subscriber sessions.

This figure shows a typical routed subscriber session network model:

Figure 7: Routed Subscriber Session Network Model

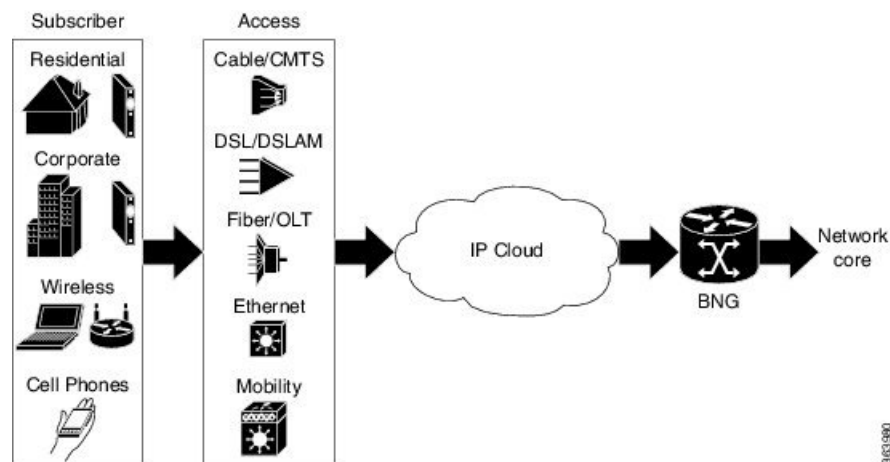

L2-connected subscribers are either directly attached to the physical interfaces of BNG or connected to BNG through a Layer 2 access network, such as a bridged or a switched network. Each user device here is a unique subscriber session. In case there is a routed CPE, the CPE owns the subscriber session on the BNG, and all devices behind the CPE performs NAT. The CPE holds the start of the session to BNG. The subscriber is keyed on the MAC address. Because there is a switched network, the BNG directly sees the MAC address of the device.

This figure shows a typical L2-connected subscriber session:

Figure 8: L2-connected Subscriber Session

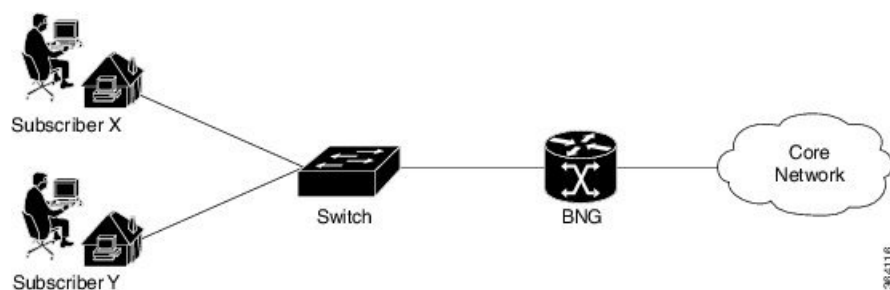

Whereas, routed subscribers are connected to BNG through routed device(s). The devices behind the CPE's MAC address are not visible to BNG. The subscriber is no longer keyed on MAC address. Instead, ip-address is used to key the subscriber session of the device.

In a typical L3 routed aggregation model, the CPE uses NAT to cover up the devices behind the routed CPE. The BNG sees a subscriber session that is initiated and linked to the WAN interface of the routed CPE.

With this routed subscriber session functionality, you can connect devices and create subscriber sessions that are behind a routed CPE.

This figure shows a typical routed subscriber session:

Figure 9: Routed Subscriber Session

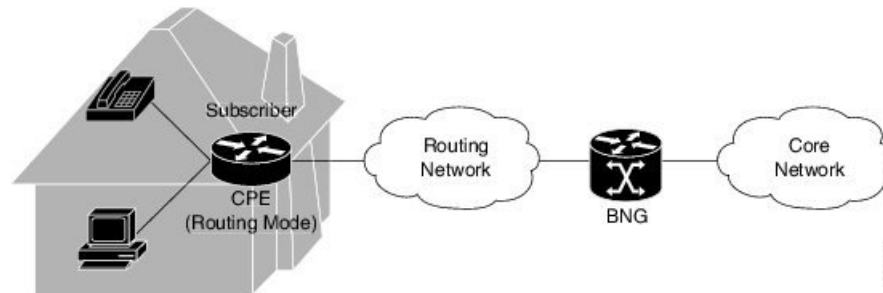

To configure an access-interface to host routed subscriber sessions, see [Configuring Routed Subscriber Sessions, on page 112](#).

Routed subscriber sessions come up only if a summary route is added on BNG. The summary route can be either statically configured, or created through some of the routing protocols like OSPF or EIGRP. The summary route VRF must be same as the access-interface VRF in BNG. Modifying or deleting a summary route that is pointing to the subscriber access-interface, while the subscriber sessions are active, may cause a minimal traffic disruption due to route re-convergence. Therefore, it is recommended that the summary route pointing to the subscriber access-interface be modified or deleted only after deleting the sessions that are using that static summary route.

DHCP-initiated Routed Subscriber Sessions

BNG supports DHCPv4-initiated routed subscriber sessions.

DHCP Interaction

The DHCP pool IP address range in BNG must be in compliance with the summary route address range. This DHCP pool IP address range must also match the IP address subnet of the first hop router, which acts as the DHCP relay or proxy. The route for this particular address range must be configured in BNG, so that BNG can reach the subnet of the first hop router, and eventually reach the subscriber.

The subscriber route need not be explicitly added. It is added internally by the BNG process, when the subscriber session is up.

For routed subscriber sessions, the DHCP server should be configured locally on ASR9K router itself, or a DHCP radius proxy should be used. Proxy mode to an external DHCP server is not supported. For details on the call flow of a DHCPv4-initiated session, see [Call Flow of DHCPv4-initiated Routed Subscriber Sessions, on page 108](#).

Session Initiator and Session Identifier

Routed sessions should use IP-based session in-band initiator; whereas L2 connected sessions can have **unclassified-mac** as session in-band initiator. Only DHCPv4 initiated sessions are supported.

Access Interface Features

Although features like ACL and Netflow may be configured on the access-interface, they do not get applied on the subscriber traffic under the respective access-interface. Which features get applied on the subscriber interface is decided based on the dynamic-template configurations under the interface or through RADIUS profile.

VRF Mapping

Routed subscriber sessions support VRF mapping, which allows subscriber to be in a different VRF other than the access-interface VRF. The DHCP pool VRF in BNG must be same as the subscriber VRF, whereas the summary route VRF must be same as the access-interface VRF in BNG. During subscriber creation, information from the dynamic-template or RADIUS is used to set the subscriber VRF. Because access-interface is not used to classify subscriber traffic, the IP address given to subscriber in a given access-interface must be a non-overlapping address.

Non-Subscriber Traffic

Because DHCP is the only session initiator for a routed subscriber, a non-subscriber packet is routed as a normal packet on an access-interface. For such packets, the features on access interface are applicable as normal. To prevent such traffic, you should deploy ACL on the access interface.

Call Flow of DHCPv4-initiated Routed Subscriber Sessions

This figure shows a call flow of DHCPv4-initiated routed subscriber session:

Figure 10: Call Flow of DHCPv4-initiated Routed Subscriber Session



These are the detailed steps involved in the DHCPv4 call flow :

1. The subscriber connects to the network and sends a DHCPDISCOVER broadcast packet on the network. The first hop router, configured as a DHCP relay or a DHCP proxy, processes the DHCPDISCOVER message and unicasts it to the BNG that acts as a DHCP server.
2. The BNG creates the subscriber session in its policy plane, and executes the policy rules on the session.
3. As per the policy rule, the BNG sends an AAA authorization request based on Option-82 and Option-60 to the RADIUS server.
4. The RADIUS server replies to the BNG with an Access-Accept message containing DHCP class information that is used for the subscriber IP address assignment.
5. The DHCP server on the BNG uses the DHCP class information in the Access-Accept message to allocate an IP address from an appropriate address pool, and sends a DHCP OFFER message to the subscriber.
6. The subscriber accepts the IP address and sends a DHCP REQUEST message back to the BNG.
7. The BNG assigns IPv4 address to the subscriber; from this point onwards, the session on the BNG starts accepting traffic from the subscriber.
8. The BNG sends a DHCP ACK message to the subscriber.

The first hop router can act as either a DHCP relay or a DHCP proxy. In the case of a DHCP proxy, the first hop router maintains the DHCP binding, and it also acts as a DHCP server to the subscriber.

When a DHCP binding is deleted, the BNG session associated with it is also deleted. Because DHCPv4 is the only session initiator, IP address changes cannot happen without having the DHCP server run on BNG. Therefore, in the case of an IP address change, the DHCP deletes the previous session and creates a new session.

Packet-triggered Routed Subscriber Sessions

BNG supports packet-triggered IPv4 and IPv6 routed subscriber sessions. Also, packet-triggered FSOL IPv4 and IPv6 on the same access interface are supported.



Note This feature is available from Cisco IOS XR Software Release 5.2.2 and later.

Session Initiator and Session Identifier

The **unclassified-ip** is used as the initiator for packet-triggered IPv4 and IPv6 routed subscriber sessions. The routed session is identified by subscriber-prefix and prefix-length.

In the case of dual-stack (that is, if both address-families are enabled on a CPE), two separate sessions are created on BNG - one for IPv4 and another for IPv6. Also, if RADIUS profile has dual-stack configuration, the entire configuration does not take effect; only the profile for the address-family takes effect.

The access interface features and VRF mapping for packet-triggered routed subscriber sessions remain the same as that for DHCP-initiated sessions.

For IPv6 packet-triggered routed subscribers, you can perform CoA using session identifier as standard **Framed-IPv6-Prefix** or AVpair **addrv6** RADIUS attribute.

Configuring Packet-triggered Routed Subscriber Sessions

This command is configured on the access interface, to make all the subscribers coming on that interface to routed subscribers:

```
ipsubscriber ipv4 routed
    initiator unclassified-ip

ipsubscriber ipv6 routed
    initiator unclassified-ip [prefix-len]
```

Here, *prefix-len* is the prefix-length of subscriber route. By default, this value is 32 and 128 for IPv4 and IPv6 subscribers respectively.

For a sample deployment topology and use-case scenario of packet-triggered routed subscriber sessions, see [Routed Subscriber Deployment Topology and Use Cases, on page 552](#).

Deployment Model for IPv6 Routed Network

This figure depicts a typical TR-177 routed IPv6 residential gateway deployment:

Figure 11: TR-177 Routed IPv6 Residential Gateway Deployment

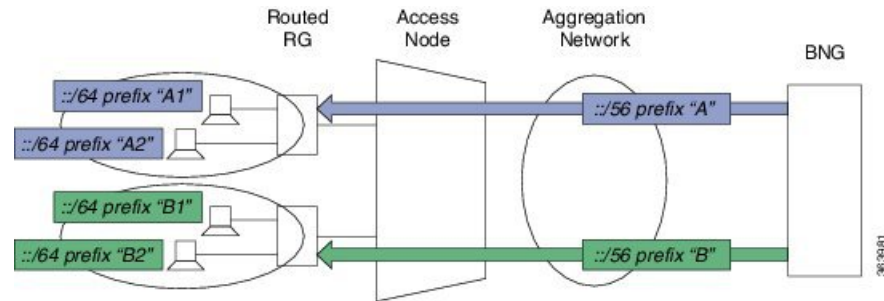

Here, the BNG router acts as a DHCPv6 server, proxy or relay (the DHCP functions can be off-box also) with IA-NA and IA-PD option enabled. BNG allocates both IA-NA and IA-PD non-shared different prefix (/56) for different access networks. Routed Residential Gateway (RG) uses the IA-NA address for itself. Again, Routed RG uses the IA-PD prefix (/56) to distribute different delegated prefixes (/64) to different LAN segments attached to it, using SLAAC or DHCPv6. When the end subscriber starts sending packets, the subscriber session is triggered on BNG.

In another deployment scenario, CPEs with /128 prefix-Len are terminated on BNG. Here, each subscriber is individually authenticated on BNG.

Call Flow of IPv6 Routed Subscriber Session

This figure depicts a typical call flow of web-logout packet-triggered IPv6 routed subscriber session in BNG:

Figure 12: Call Flow of Web-logon IPv6 Routed Subscriber Session

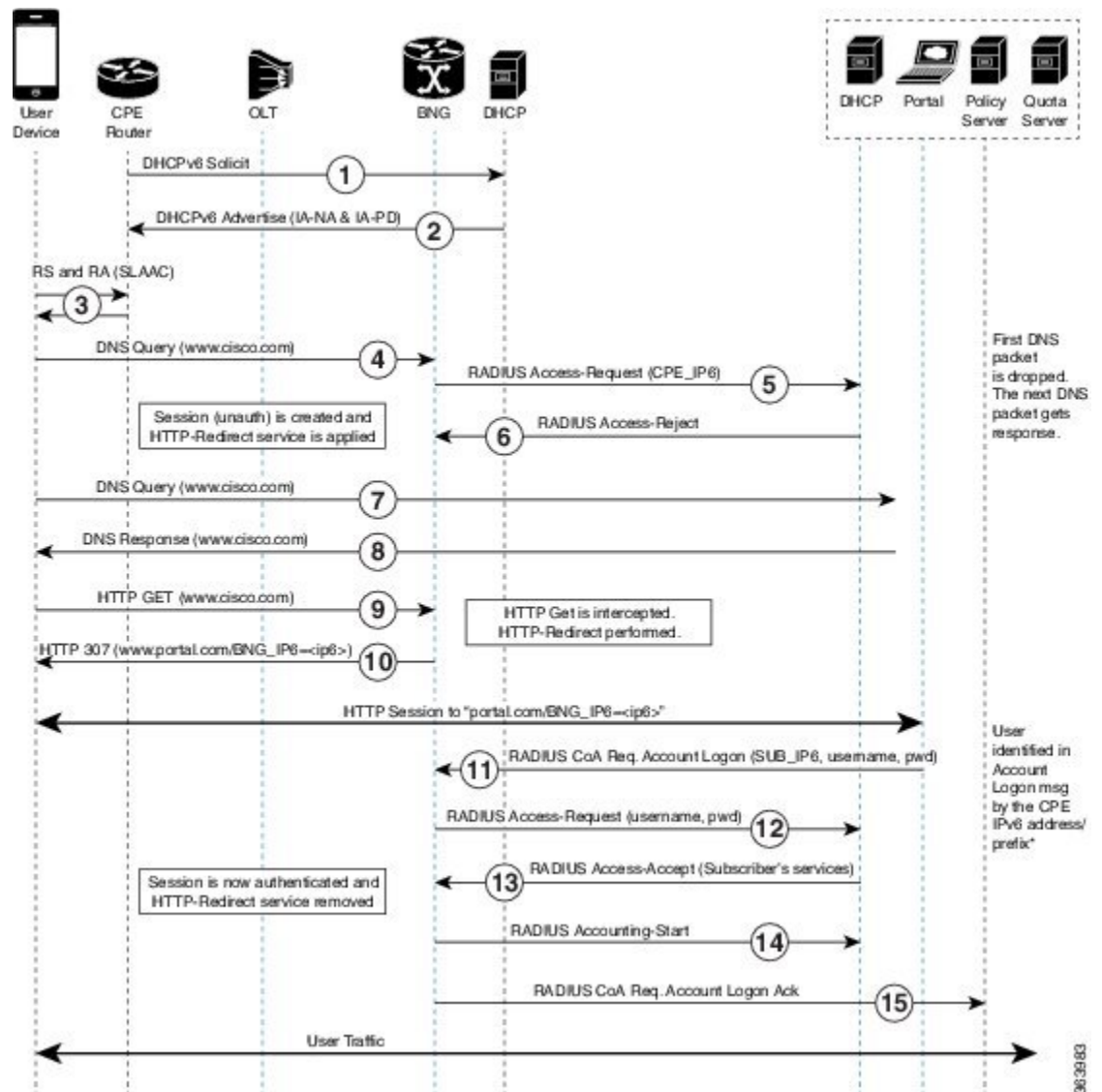

Restrictions for Routed Subscriber Sessions

Support for BNG routed subscriber sessions is subjected to these restrictions:

- Overlapping IP addresses are not supported on the same access-interface.
- Overlapping IP addresses are not supported on the same VRF.
- DHCP-initiated IPv6 sessions are not supported.
- Dual-stack sessions are not supported.
- DHCP lease query is not supported.
- Line card subscribers are not supported.
- For IPv4, BNG cannot be used as DHCP server or proxy to lease IPv4 addresses to IPv4-routed packet-triggered subscribers.

- For IPv6, on-box DHCPv6 server or DHCPv6 proxy can be used to lease IPv6 PD addresses to CPE; but not to end subscribers.
- Because Neighbor Discovery (ND) is point-to-point, ND-triggered sessions (Router Solicitation) are not supported.
- From Cisco IOS XR Software Release 6.2.2 and later, the maximum limit of ECMP path supported for each covering route is 8.

Configuring Routed Subscriber Sessions

Perform this task to configure routed subscriber sessions on an access-interface:

Before you begin

Configuring routed subscriber session in BNG is subjected to these guidelines:

- You must configure dynamic or static routes on the router for subscriber IP addresses. These routes should be configured in such a way that they are synchronized with the way DHCP assigns the IP addresses.

For DHCP-initiated sessions:

- To authorize the subscriber on session-start, you must configure policy-map with a policy having Option-82 (**circuit-id** and **remote-id**) and Option-60 as identifiers.

For Packet-triggered sessions:

- While creating the route (also called as cover route), the route prefix must be smaller than the subscriber prefix. Else, the subscriber route does not install, and the session fails. The cover route must be installed in the access-vrf.

SUMMARY STEPS

1. **configure**
2. **interface** *type interface-path-id*
3. **ipsubscriber** {**ipv4** | **ipv6**} **routed**
4. **initiator** {**dhcp** | **unclassified-ip** [**prefix-len** *prefix-len*]}
5. Use the **commit** or **end** command.

DETAILED STEPS

	Command or Action	Purpose
Step 1	configure Example: RP/0/RSP0/CPU0:router# <code>configure</code>	Enters global configuration mode.
Step 2	interface <i>type interface-path-id</i> Example: RP/0/RSP0/CPU0:router(config)# <code>interface bundle-ether101.201</code>	Specifies an access-interface and enters the interface configuration mode.

	Command or Action	Purpose
Step 3	ipsubscriber {ipv4 ipv6} routed Example: <pre>RP/0/RSP0/CPU0:router(config-if)# ipsubscriber ipv4 routed</pre>	Configures the access-interface to accept routed subscriber sessions.
Step 4	initiator {dhcp unclassified-ip [prefix-len prefix-len]} Example: <pre>RP/0/RSP0/CPU0:router(config-if)# initiator dhcp or RP/0/RSP0/CPU0:router(config-if)# initiator unclassified-ip</pre>	Configures the session initiator as DHCP or unclassified-ip, for routed subscribers. Note <ul style="list-style-type: none"> • DHCP-initiated IPv6 sessions are not supported. • prefix-len option is applicable only for packet-triggered (initiator unclassified-ip) IPv6 sessions.
Step 5	Use the commit or end command.	commit —Saves the configuration changes and remains within the configuration session. end —Prompts user to take one of these actions: <ul style="list-style-type: none"> • Yes — Saves configuration changes and exits the configuration session. • No —Exits the configuration session without committing the configuration changes. • Cancel —Remains in the configuration session, without committing the configuration changes.

Configuring Routed Subscriber Sessions: An example

DHCP-initiated routed subscriber sessions:

```
interface Bundle-Ether101.201
vrf vpn1
ipv4 address 10.1.1.1 255.255.255.0
service-policy type control subscriber ROUTED_POLICY
encapsulation dot1q 201 second-dot1q 301
ipsubscriber ipv4 routed
  initiator dhcp
!
!

//Configuring static summary route
!
router static
address-family ipv4 unicast
  14.0.0.0/16 12.0.0.2
!

//Configuring DHCP address pool
!
```

```
pool vrf default ipv4 ROUTED_POOL1
network 14.0.0.0/16
exclude 14.0.0.1 0.0.0.0
!
```

Packet-triggered routed subscriber sessions:

```
interface Bundle-Ether1.201
ipv4 address 15.15.15.1 255.255.255.0
ipv6 address 15:15:15::1/64
service-policy type control subscriber PL
encapsulation dot1q 201
ipsubscriber ipv4 routed
  initiator unclassified-ip
!
ipsubscriber ipv6 routed
  initiator unclassified-ip
!
!
```

Prevent Default ARP Entry Creation for a Subscriber Interface

In certain deployment scenarios, the subscriber access-interfaces are unnumbered and the associated loopback interface may have multiple secondary IP addresses. These unnumbered interfaces inherit all attributes, including the secondary IP addresses, from the loopback interface. This creates multiple local ARP entries per subscriber interface and the ARP table may extend beyond the supported scale in such scenarios. You can now prevent such default ARP entry creations by using the **subscriber arp scale-mode-enable** command. This functionality does not impact the existing ARP behavior for the subscribers.

Configuration Example

```
Router(config)# subscriber arp scale-mode-enable
```

Unconditional Proxy ARP Response

Unconditional proxy ARP response in BNG is an enhancement where the BNG router responds to all ARP requests coming over the subscriber interface. This feature is beneficial for scenarios like static IP subscribers, where the network operator does not intend to configure any subnet on the loopback.

Prior to this, the BNG router responded only to such ARP requests where the requested IP address was in the configured subnet of the attached loopback. This caused a lot of challenge in static IP address subscriber management and in dynamic pool migration scenarios (refer [DHCP Soft Pool Migration, on page 224](#)), where it was required to update the loopback for each pool migration.

Enable Unconditional Proxy ARP Response

You can enable unconditional proxy ARP feature by configuring **subscriber arp uncond-proxy-arp-enable** command in the Global Configuration mode.

```
Router(config)#subscriber arp uncond-proxy-arp-enable
```

Verify Unconditional Proxy ARP Response

Use the **show arp traffic** command to verify if ARP requests are responded on subscriber interfaces. The **Subscriber Interface** field in the command output displays the respective statistics.

```
Router# show arp traffic location 0/0/CPU0
ARP statistics:
Recv: 0 requests, 0 replies
  Sent: 0 requests, 0 replies (0 proxy, 0 local proxy, 0 gratuitous)
Subscriber Interface:
    10 requests recv, 10 replies sent, 0 gratuitous replies sent

Resolve requests rcvd: 0
  Resolve requests dropped: 0
  Errors: 0 out of memory, 0 no buffers, 0 out of sunbet
ARP cache:
  Total ARP entries in cache: 0
  Dynamic: 0, Interface: 0, Standby: 0
  Alias: 0, Static: 0, DHCP: 0
  IP Packet drop count for node 0/0/CPU0: 0
  Total ARP-IDB:0
```

Establishing PPPoE Session

The PPP protocol is mainly used for communications between two nodes, like a client and a server. The PPP protocol provides a standard method for transporting multi-protocol diagrams over point-to-point links. It defines an encapsulation scheme, a link layer control protocol (LCP), and a set of network control protocols (NCPs) for different network protocols that can be transmitted over the PPP link. The LCP is used to configure and maintain the data link. PPP peers can use the LCP to negotiate various link layer properties or characteristics. The NCP is used to establish and configure the associated network protocol before data packets for the protocol can be transmitted.

One of the methods to establish PPP connection is by the use of PPP over Ethernet (PPPoE). In a PPPoE session, the Point-to-Point (PPP) protocol runs between the CPE and BNG. The Home Gateway (which is part of the CPE) adds a PPP header (encapsulation) that is terminated at the BNG.

CPE detects and interacts with BNG using various PPPoE Active Discovery (PAD) messages listed here:

- PPPoE Active Discovery Initiation (PADI)—The CPE broadcasts to initiate the process to discover BNG.
- PPPoE Active Discovery Offer (PADO)—The BNG responds with an offer.
- PPPoE Active Discovery Request (PADR)—The CPE requests to establish a connection.
- PPPoE Active Discovery Session confirmation (PADS)—BNG accepts the request and responds by assigning a session identifier (Session-ID).
- PPPoE Active Discovery Termination (PADT)—Either CPE or BNG terminates the session.

In redundant BNG setups, where the PPPoE client is connected to multiple BNGs, the PADI message sent by the CPE is received on all BNGs. Each BNG, in turn, replies with a PADO message. You must configure Smart Server Selection on BNG to allow subscribers to select one of the BNGs in a multi-BNG setup. Refer [PPPoE Smart Server Selection, on page 141](#)

The BNG provides configuration flexibility to limit and throttle the number of PPPoE sessions requests, based on various parameters. For details, see [PPPoE Session Limit, on page 143](#) and [PPPoE Session Throttle, on page 146](#).

The PPPoE session are of two types, PPP PTA and PPP LAC. For the functioning of PPP PTA and PPP LAC session, the RADIUS server must be set up to authenticate and forward sessions as necessary. There is no local authentication available on BNG. The PPP PTA and PPP LAC sessions are explained in the sections, [Provisioning PPP PTA Session, on page 116](#) and [Provisioning PPP LAC Session, on page 123](#).



Note If the Interface on BNG is configured as only IPv4 or IPv6, the PPPoE sessions created by CPE for the other type stay down.

For example, If BNG is configured with IPv6 as the interface type, the IPv4 session stays down.

And, If the interface type is configured as dual stack and the CPE only initiates the IPv6 session, the IPv4 sessions stay in the *Up Pending* state.

Provisioning PPP PTA Session

In a PPP Termination and Aggregation (PTA) session, the PPP encapsulation is terminated on BNG. After it is terminated, BNG routes the traffic to the service provider using IP routing. A typical PTA session is depicted in this figure.

Figure 13: PTA Session

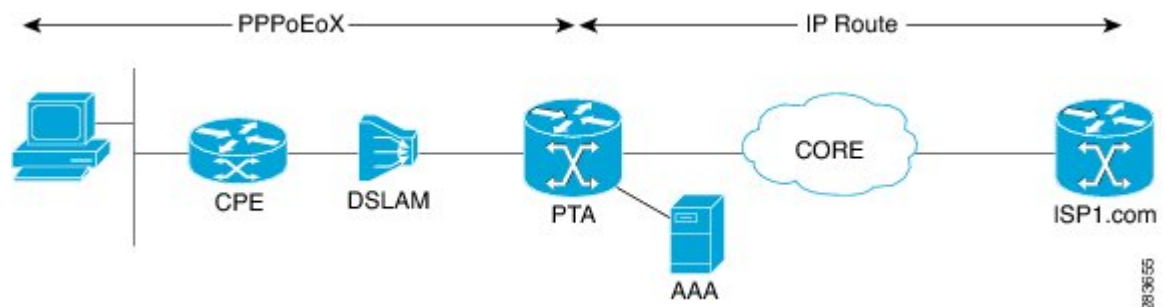

PPPoE session configuration information is contained in PPPoE profiles. After a profile has been defined, it can be assigned to an access interface. Multiple PPPoE profiles can be created and assigned to multiple interfaces. A global PPPoE profile can also be created; the global profile serves as the default profile for any interface that has not been assigned a specific PPPoE profile.

The PPP PTA session is typically used in the Network Service Provider (retail) model where the same service operator provides the broadband connection to the subscriber and also manages the network services.

The process of provisioning a PPP PTA session involves:

- Creating a PPPoE profile for PPPoE session. See, [Creating PPPoE Profiles, on page 117](#).
- Creating dynamic template that contains the various settings for the PPPoE sessions. See, [Creating a PPP Dynamic-Template, on page 118](#).
- Creating policy-map to activate the dynamic template. See, [Creating a Policy-Map to Run During PPPoE Session, on page 119](#).

- Enabling subscriber creation, and apply the PPPoE profile and service-policy on the access interface. See, [Applying the PPPoE Configurations to an Access Interface, on page 122](#).

The subscriber creation function must be explicitly enabled on BNG. Unless this function is enabled, the system will not attempt subscriber classification. As a result, the packets get forwarded based on the incoming interface mode.



Note Up to 8k PTA sessions should be configured with a 60 seconds keepalive timeout value. For every additional 8K sessions, you should increase the keepalive timeout by 60 seconds. Keepalive timeout is the multiple of keepalive interval and retry count. For example:

```
Router(config-dynamic-template-type)# keepalive 20 3
```

Creating PPPoE Profiles

Perform this task to create PPPoE profiles. The PPPoE profile will later be applied to an access interface.

SUMMARY STEPS

1. **configure**
2. **pppoe bba-group** *bba-group name*
3. **service name** *service_name*
4. Use the **commit** or **end** command.

DETAILED STEPS

	Command or Action	Purpose
Step 1	configure Example: RP/0/RSP0/CPU0:router# <code>configure</code>	Enters global configuration mode.
Step 2	pppoe bba-group <i>bba-group name</i> Example: RP/0/RSP0/CPU0:router(config)# <code>pppoe bba-group bba_1</code>	Creates a PPPoE profile with an user-specified name.
Step 3	service name <i>service_name</i> Example: RP/0/RSP0/CPU0:router(config-bbgroup)# <code>service name service_1</code>	Indicates the service that is requested by the subscriber. Repeat this step for each service name that you want to add to the subscriber profile.
Step 4	Use the commit or end command.	commit —Saves the configuration changes and remains within the configuration session. end —Prompts user to take one of these actions:

	Command or Action	Purpose
		<ul style="list-style-type: none"> • Yes — Saves configuration changes and exits the configuration session. • No —Exits the configuration session without committing the configuration changes. • Cancel —Remains in the configuration session, without committing the configuration changes.

Creating PPPoE Profiles: An example

```
configure
pppoe bba-group bba_1
service name service_1
!
!
end
```

Creating a PPP Dynamic-Template

Perform this task to create a PPP dynamic-template. As an example, this dynamic-template is created to apply PAP and CHAP authentication methods.

SUMMARY STEPS

1. **configure**
2. **dynamic-template type ppp** *dynamic_template_name*
3. **ppp authentication pap**
4. **ppp authentication chap**
5. Use the **commit** or **end** command.

DETAILED STEPS

	Command or Action	Purpose
Step 1	configure Example: RP/0/RSP0/CPU0:router# configure	Enters global configuration mode.
Step 2	dynamic-template type ppp <i>dynamic_template_name</i> Example: RP/0/RSP0/CPU0:router(config)# dynamic-template type ppp ppp_pta_template	Creates a dynamic-template with user-defined name for PPP session.
Step 3	ppp authentication pap Example:	Enables the use of PAP type authentication during link negotiation by Link Control Protocol (LCP).

	Command or Action	Purpose
	RP/0/RSP0/CPU0:router(config-dynamic-template-type)# ppp authentication pap	
Step 4	<p>ppp authentication chap</p> <p>Example:</p> <pre>RP/0/RSP0/CPU0:router(config-dynamic-template-type)# ppp authentication chap</pre>	Enables the use of CHAP type authentication during link negotiation by Link Control Protocol (LCP).
Step 5	Use the commit or end command.	<p>commit —Saves the configuration changes and remains within the configuration session.</p> <p>end —Prompts user to take one of these actions:</p> <ul style="list-style-type: none"> • Yes — Saves configuration changes and exits the configuration session. • No —Exits the configuration session without committing the configuration changes. • Cancel —Remains in the configuration session, without committing the configuration changes.

Creating a PPP Dynamic-Template: An example

```
configure
dynamic-template type ppp ppp_pta_template
ppp authentication pap
ppp authentication pap chap
!
!
end
```

Creating a Policy-Map to Run During PPPoE Session

Perform this task to create a policy-map that will activate a PPP dynamic-template during a PPPoE subscribers session. As an example, this policy-map activates a dynamic template during a session-start event. Also, this policy-map applies a locally-defined authorization setting during a session-activate event.

SUMMARY STEPS

1. **configure**
2. **policy-map type control subscriber** *policy_name*
3. **event session-start match-all**
4. **class type control subscriber** *class_name* **do-until-failure**
5. *sequence_number* **activate dynamic-template** *dynamic-template_name*
6. **event session-activate match-all**
7. **class type control subscriber** *class_name* **do-until-failure**
8. *sequence_number* **authenticate aaa list default**
9. Use the **commit** or **end** command.

DETAILED STEPS

	Command or Action	Purpose
Step 1	configure Example: RP/0/RSP0/CPU0:router# configure	Enters global configuration mode.
Step 2	policy-map type control subscriber <i>policy_name</i> Example: RP/0/RSP0/CPU0:router(config)# policy-map type control subscriber PPPoE_policy	Creates a new policy map of the type "control subscriber" with the user-defined name "PPPoE_policy".
Step 3	event session-start match-all Example: RP/0/RSP0/CPU0:router(config-pmap)# event session-start match-all	Defines an event (session start) for which actions will be performed.
Step 4	class type control subscriber <i>class_name</i> do-until-failure Example: RP/0/RSP0/CPU0:router(config-pmap-e)# class type control subscriber pta_class do-until-failure	Configures the class to which the subscriber is to be matched. When there is a match, executes all actions until a failure is encountered.
Step 5	<i>sequence_number</i> activate dynamic-template <i>dynamic-template_name</i> Example: RP/0/RSP0/CPU0:router(config-pmap-c)# 1 activate dynamic-template ppp_pta_template	Activates the dynamic-template with the specified dynamic template name.
Step 6	event session-activate match-all Example: RP/0/RSP0/CPU0:router(config-pmap)# event session-activate match-all	Defines an event (session activate) for which actions are performed.
Step 7	class type control subscriber <i>class_name</i> do-until-failure Example: RP/0/RSP0/CPU0:router(config-pmap-e)# class type control subscriber PPP_class do-until-failure	Configures the class to which the subscriber is to be matched. When there is a match, executes all actions until a failure is encountered.
Step 8	<i>sequence_number</i> authenticate aaa list default Example:	Allows authentication of the subscriber to be triggered using the complete structure username.

	Command or Action	Purpose
	RP/0/RSP0/CPU0:router(config-pmap-c)# 1 authenticate aaa list default	
Step 9	Use the commit or end command.	<p>commit —Saves the configuration changes and remains within the configuration session.</p> <p>end —Prompts user to take one of these actions:</p> <ul style="list-style-type: none"> • Yes — Saves configuration changes and exits the configuration session. • No —Exits the configuration session without committing the configuration changes. • Cancel —Remains in the configuration session, without committing the configuration changes.

Creating a Policy-Map to Run During PPPoE Session: An example

```

configure
policy-map type control subscriber policy1
event session-start match-all
class type control subscriber pta_class do-until-failure
1 activate dynamic-template template1
!
!
event session-activate match-all
class type control subscriber pta_class1 do-until-failure
1 activate dynamic-template ppp_pta_template
end-policy-map

```

Modifying VRF for PPPoE Sessions

BNG does not support modification of VRF using single dynamic template activated on session start. In order to change the VRF for PPPoE sessions from RADIUS, you must split the dynamic template. One dynamic template must be activated in session-start (for PPP parameters). The other dynamic template must contain L3 parameters and it must be enabled on session-activate event after the authenticate step.

This example shows a sample dynamic template configuration and a policy-map configuration for such a VRF transfer scenario, where some PPPoE users must be terminated in a different VRF than the normal user VRF. In order to do so, the user sends two AV-Pairs through RADIUS.

```

dynamic-template
type ppp PPP_TPL                               ==> Layer 3 interface
ppp authentication chap
ppp ipcp peer-address pool IPv4
ipv4 unnumbered Loopback100                   ==> Loopback in Global Routing Table
type ppp PPP_TPL_NO_LO                         ==> Layer 2 interface
ppp authentication chap

policy-map type control subscriber BNG_PPPOE
event session-activate match-first
class type control subscriber PPP do-until-failure
10 authenticate aaa list default
20 activate dynamic-template PPP_TPL

```

```

event session-start match-first
class type control subscriber PPP do-until-failure
10 activate dynamic-template PPP_TPL_NO_LO

```

Here, the Layer 2 dynamic template is created first, and only PPP authentication is done on it. Therefore, the RADIUS request is sent. The RADIUS returns the attributes and then the BNG proceeds to the next step, that is, session-activate. In session-activate, another dynamic template interface which has layer 3 configuration is used. But, because the BNG has already received the RADIUS attribute for the user, it uses the ipv4 unnumbered contained in the RADIUS profile, rather than the one configured directly under the Layer 3 dynamic template.

Applying the PPPoE Configurations to an Access Interface

Perform this task to apply the PPPoE profiles and the policy-maps to an access interface. The completion of this task enables the receiving of PPPoE traffic on the interface.

Before you begin

You must perform this task after performing the [Creating PPPoE Profiles, on page 117](#).

SUMMARY STEPS

1. **configure**
2. **interface** *type interface-path-id*
3. **service-policy type control subscriber** *policy_name*
4. **pppoe enable bba-group** *bbagroup_name*
5. Use the **commit** or **end** command.

DETAILED STEPS

	Command or Action	Purpose
Step 1	configure Example: RP/0/RSP0/CPU0:router# configure	Enters global configuration mode.
Step 2	interface <i>type interface-path-id</i> Example: RP/0/RSP0/CPU0:router(config)# interface Bundle-Ether 5.1	Enters interface configuration mode for the bundle-interface.
Step 3	service-policy type control subscriber <i>policy_name</i> Example: RP/0/RSP0/CPU0:router(config-if)# service-policy type control subscriber PL1	Associates a subscriber control service policy to the interface.
Step 4	pppoe enable bba-group <i>bbagroup_name</i> Example:	Enables PPPoE on the bundle-ether interface and specifies the PPPoE profile named bba_1 to be used on this interface.

	Command or Action	Purpose
	RP/0/RSP0/CPU0:router(config-if)# pppoe enable bba-group bba_1	Note It is not recommended to remove the call flow-initiated configurations, after subscriber sessions are active. Therefore, you must not delete the pppoe enable command from the sub-interface, while the PPPoE sessions are up.
Step 5	Use the commit or end command.	commit —Saves the configuration changes and remains within the configuration session. end —Prompts user to take one of these actions: <ul style="list-style-type: none"> • Yes — Saves configuration changes and exits the configuration session. • No —Exits the configuration session without committing the configuration changes. • Cancel —Remains in the configuration session, without committing the configuration changes.

Applying the PPPoE Configurations to an Access Interface: An example

```
configure
interface Bundle-Ether100.10
service-policy type control subscriber PL1
pppoe enable bba-group bba_1
!
!
end
```

Provisioning PPP LAC Session

In a PPP LAC session, the PPP session is tunneled to a remote network server by BNG, using Layer 2 Tunneling Protocol (L2TP). BNG performs the role of L2TP Access Concentrator (LAC), as it puts the subscriber session in the L2TP tunnel. The device on which the tunnel terminates is called L2TP Network Server (LNS). During a PPP LAC session, the PPPoE encapsulation terminates on BNG; however, the PPP packets travel beyond BNG to LNS through the L2TP tunnel. A typical LAC session is depicted in Figure 1.

Figure 14: LAC Session

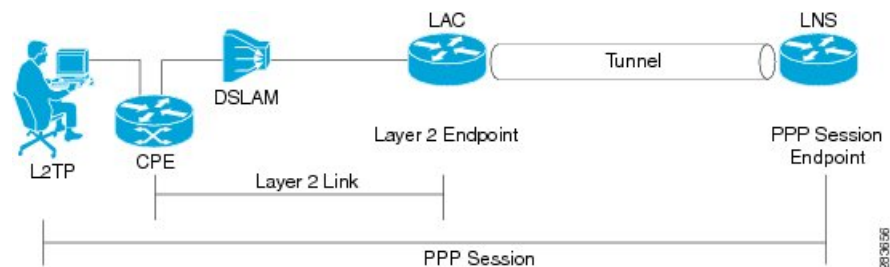

The PPP LAC session is used in the Access Network Provider (wholesale) model, where the network service provider (NSP) is a separate entity from the local access network provider (ANP). NSPs perform access

authentication, manage and provide IP addresses to subscribers, and are responsible for overall service. The ANP is responsible for providing the last-mile digital connectivity to the customer, and for passing on the subscriber traffic to the NSP. In this kind of setup, the ANP owns the LAC and the NSP owns the LNS.

A PPP LAC session establishes a virtual point-to-point connection between subscriber device and a node in the service provider network. The subscriber dials into a nearby L2TP access connector (LAC). Traffic is then securely forwarded through the tunnel to the LNS, which is present in service provider network. This overall deployment architecture is also known as Virtual Private Dial up Network (VPDN).

The process of provisioning a PPP LAC session involves:

- Defining a template with specific settings for the VPDN. See, [Configuring the VPDN Template, on page 125](#).
- Defining the maximum number of VPDN sessions that can be established simultaneously. See, [Configuring Maximum Simultaneous VPDN Sessions, on page 127](#).
- Activating the logging of VPDN event messages. See, [Activating VPDN Logging, on page 128](#).
- Specifying the method to apply calling station-ID. See, [Configuring Options to Apply on Calling Station ID, on page 129](#).
- Specifying the session-ID. See, [Configuring L2TP Session-ID Commands, on page 130](#).
- Defining specific settings for the L2TP class. See, [Configuring L2TP Class Options, on page 131](#).
- Preventing creation of additional VPDN sessions. See, [Configuring Softshut for VPDN, on page 134](#).

This is a sample user-profile for L2TP LAC:

```
abc_xyz@domain.com Password="abc"
  Service-Type = Outbound-User,
  Tunnel-Type = L2TP,
  Tunnel-Medium-Type = IP,
  Cisco-avpair = "vpdn:ip-addresses=3.3.3.3",
  Cisco-avpair = "vpdn:source-ip=1.1.1.1"
```



Note For L2TP LAC session to be up, the user-profile coming from the RADIUS server to the BNG must have **Service-Type = Outbound-User** configured for the user.

A PPP LAC session supports stateful switchover (SSO) along with non-stop routing (NSR) to reduce traffic loss during RP failover. For more information, see [L2TP Access Concentrator Stateful Switchover, on page 135](#)



Note PPPoE LAC sessions are supported on LC based VLAN interfaces from Cisco IOS XR Software Release 6.4.2 onwards.

Restrictions for PPP LAC

- A maximum of 19 LNS IP address can be configured in the user-profile for L2TP LAC sessions. This means there can be up to 19 IP addresses assigned to the Tunnel-Server-Endpoint argument for traffic to be securely forwarded through the L2TP tunnel.



Note If there are more than 19 LNS IP addresses, they are rejected, which means the previous 19 addresses are not overwritten with the new addresses.

Configuring the VPDN Template

Perform this task to configure the vpdn template:

SUMMARY STEPS

1. **configure**
2. **vpdn template**
3. **l2tp-class** *class_name*
4. **tunnel busy timeout** *timeout_value*
5. **caller-id mask-method remove match** *match_substring*
6. **dsl-line-info-forwarding**
7. **ip tos** *type_of_service_value*
8. **vpn id** *value*
9. **vpn vrf** *vrf_name*
10. Use the **commit** or **end** command.

DETAILED STEPS

	Command or Action	Purpose
Step 1	configure Example: RP/0/RSP0/CPU0:router# <code>configure</code>	Enters global configuration mode.
Step 2	vpdn template Example: RP/0/RSP0/CPU0:router(config)# <code>vpdn template</code>	Enters the VPDN template sub-mode.
Step 3	l2tp-class <i>class_name</i> Example: RP/0/RSP0/CPU0:router(config-vpdn-template)# <code>l2tp-class class_temp</code>	Configures the l2tp class command.

	Command or Action	Purpose
Step 4	tunnel busy timeout <i>timeout_value</i> Example: <pre>RP/0/RSP0/CPU0:router(config-vpdn-template)# tunnel busy timeout 456</pre>	Configure l2tp tunnel busy list commands. The busy timeout value ranges from 60-65535.
Step 5	caller-id mask-method remove match <i>match_substring</i> Example: <pre>RP/0/RSP0/CPU0:router(config-vpdn-template)# caller-id mask-method remove match m1</pre>	Configures options to apply on calling station id by masking the characters by the match substring specified.
Step 6	dsl-line-info-forwarding Example: <pre>RP/0/RSP0/CPU0:router(config-vpdn-template)# dsl-line-info-forwarding</pre>	Forwards the DSL Line Info attributes.
Step 7	ip tos <i>type_of_service_value</i> Example: <pre>RP/0/RSP0/CPU0:router(config-vpdn-template)# ip tos 56</pre>	Sets IP ToS value for tunneled traffic. The service value ranges from 0 to 255.
Step 8	vpn id <i>value</i> Example: <pre>RP/0/RSP0/CPU0:router(config-vpdn-temp)# vpn id 3333:33</pre>	Specifies tunnel for a vpn and configures the vpn id with the value 3333:33. The value ranges from 0-ffff in hexadecimal.
Step 9	vpn vrf <i>vrf_name</i> Example: <pre>RP/0/RSP0/CPU0:router(config-vpdn-template)# vpn vrf vrf_1</pre>	Configures the vpn vrf name.
Step 10	Use the commit or end command.	commit —Saves the configuration changes and remains within the configuration session. end —Prompts user to take one of these actions: <ul style="list-style-type: none"> • Yes — Saves configuration changes and exits the configuration session. • No —Exits the configuration session without committing the configuration changes. • Cancel —Remains in the configuration session, without committing the configuration changes.

Configuring the VPDN Template: An example

```

configure
l2tp-class class hello-interval 100
vpdn
template l2tp-class class //template default will be used and display in show run
template tunnel busy timeout 567
l2tp-class class

vpdn
template default
l2tp-class class
!
end

```

Configuring Maximum Simultaneous VPDN Sessions

Perform this task to configure the maximum simultaneous vpdn sessions for session limiting per tunnel:

SUMMARY STEPS

1. **configure**
2. **vpdn**
3. **session-limit** *number_of_sessions*
4. Use the **commit** or **end** command.

DETAILED STEPS

	Command or Action	Purpose
Step 1	configure Example: RP/0/RSP0/CPU0:router# configure	Enters global configuration mode.
Step 2	vpdn Example: RP/0/RSP0/CPU0:router(config)# vpdn	Enables VPDN and enters the VPDN sub-mode.
Step 3	session-limit <i>number_of_sessions</i> Example: RP/0/RSP0/CPU0:router(config-vpdn)# session-limit 200	Configures the maximum simultaneous VPDN sessions. The range is from 1 to 131072. Note If limit is configured after a number of sessions are up, then those sessions remain up irrespective of the limit.
Step 4	Use the commit or end command.	commit —Saves the configuration changes and remains within the configuration session. end —Prompts user to take one of these actions:

	Command or Action	Purpose
		<ul style="list-style-type: none"> • Yes — Saves configuration changes and exits the configuration session. • No —Exits the configuration session without committing the configuration changes. • Cancel —Remains in the configuration session, without committing the configuration changes.

Configuring Maximum Simultaneous VPDN Sessions: An example

```
configure
vpdn
session-limit 200
!
end
```

Activating VPDN Logging

Perform this task to activate logging of VPDN event information. When VPDN event logging is enabled, VPDN event messages are logged as the events occur.



Note Tunnel start and stop records are generated without any tunnel statistics.

SUMMARY STEPS

1. **configure**
2. **vpdn**
3. **logging** [**cause** | **cause-normal** | **dead-cache** | **local** | **tunnel-drop** | **user**]
4. **history failure**
5. Use the **commit** or **end** command.

DETAILED STEPS

	Command or Action	Purpose
Step 1	configure Example: RP/0/RSP0/CPU0:router# configure	Enters global configuration mode.
Step 2	vpdn Example: RP/0/RSP0/CPU0:router(config)# vpdn	Enters the VPDN sub-mode.

	Command or Action	Purpose
Step 3	<p>logging [cause cause-normal dead-cache local tunnel-drop user]</p> <p>Example:</p> <pre>RP/0/RSP0/CPU0:router(config-vpdn)# logging local RP/0/RSP0/CPU0:router(config-vpdn)# logging user RP/0/RSP0/CPU0:router(config-vpdn)# logging cause RP/0/RSP0/CPU0:router(config-vpdn)# logging tunnel-drop</pre>	Enables the logging of generic VPDN events.
Step 4	<p>history failure</p> <p>Example:</p> <pre>RP/0/RSP0/CPU0:router(config-vpdn)# history failure</pre>	Enables logging of VPDN failure events to the history failure table.
Step 5	Use the commit or end command.	<p>commit —Saves the configuration changes and remains within the configuration session.</p> <p>end —Prompts user to take one of these actions:</p> <ul style="list-style-type: none"> • Yes — Saves configuration changes and exits the configuration session. • No —Exits the configuration session without committing the configuration changes. • Cancel —Remains in the configuration session, without committing the configuration changes.

Activating VPDN Logging: An example

```
configure
vpdn
history failure
logging local
logging user
logging cause-normal
logging tunnel-drop
logging dead-cache
!
end
```

Configuring Options to Apply on Calling Station ID

Perform this task to configure options to apply on calling station ID. The calling station ID provides detailed information about the originator of the session, such as the phone number of the originator, the Logical Line ID (LLID) used to make the connection on the LAC, or the MAC address of the PC connecting to the network.

SUMMARY STEPS

1. **configure**

2. **vpdn**
3. **caller-id mask-method remove match match_name**
4. Use the **commit** or **end** command.

DETAILED STEPS

	Command or Action	Purpose
Step 1	configure Example: RP/0/RSP0/CPU0:router# configure	Enters global configuration mode.
Step 2	vpdn Example: RP/0/RSP0/CPU0:router(config)# vpdn	Enters the VPDN sub-mode.
Step 3	caller-id mask-method remove match match_name Example: RP/0/RSP0/CPU0:router(config-vpdn)# caller-id mask-method remove match match_class	Suppresses the calling station ID for all users. If there is a 'match' option, then calling station ID only for users which have the 'match-string' in their username is suppressed. Note This command can also be run under the vpdn template configuration mode.
Step 4	Use the commit or end command.	commit — Saves the configuration changes and remains within the configuration session. end — Prompts user to take one of these actions: <ul style="list-style-type: none"> • Yes — Saves configuration changes and exits the configuration session. • No — Exits the configuration session without committing the configuration changes. • Cancel — Remains in the configuration session, without committing the configuration changes.

Configuring Options to Apply on Calling Station ID: An example

```
configure
vpdn //or vpdn template
caller-id mask-method remove match match_call
!
end
```

Configuring L2TP Session-ID Commands

Perform this task to configure L2TP session-id commands.

SUMMARY STEPS

1. **configure**
2. **vpdn**
3. **l2tp session-id space hierarchical**
4. Use the **commit** or **end** command.

DETAILED STEPS

	Command or Action	Purpose
Step 1	configure Example: RP/0/RSP0/CPU0:router# configure	Enters global configuration mode.
Step 2	vpdn Example: RP/0/RSP0/CPU0:router(config)# vpdn	Configures vpdn.
Step 3	l2tp session-id space hierarchical Example: RP/0/RSP0/CPU0:router(config-vpdn)# l2tp session-id space hierarchical	Enables the hierarchical session-ID allocation algorithm.
Step 4	Use the commit or end command.	commit —Saves the configuration changes and remains within the configuration session. end —Prompts user to take one of these actions: <ul style="list-style-type: none"> • Yes — Saves configuration changes and exits the configuration session. • No —Exits the configuration session without committing the configuration changes. • Cancel —Remains in the configuration session, without committing the configuration changes.

Configuring L2TP Session-ID Commands: An example

```
configure
vpdn
l2tp session-id space hierarchical
!
end
```

Configuring L2TP Class Options

Perform this task to configure the various options for L2TP class.

SUMMARY STEPS

1. **configure**
2. **l2tp-class** *class_name*
3. **authentication** [**disable** | **enable**]
4. **congestion control**
5. **digest** [**check disable** | **hash** { **MD5** | **SHA1** } | **secret** { **0** | **7** | **LINE** }]
6. **hello-interval** *interval_duration*
7. **hostname** *host_name*
8. **receive-window** *size*
9. **retransmit initial** [**retries** | *retries_number* | **timeout** { **max** *max_seconds* | **min** *min_seconds* }]
10. **timeout** [**no-user** { *timeout_value* | **never** } | **setup** *setup_value*]
11. **tunnel accounting** *accounting_method_list_name*
12. Use the **commit** or **end** command.

DETAILED STEPS

	Command or Action	Purpose
Step 1	configure Example: RP/0/RSP0/CPU0:router# configure	Enters global configuration mode.
Step 2	l2tp-class <i>class_name</i> Example: RP/0/RSP0/CPU0:router(config)# l2tp-class class1	Configures the L2TP class command.
Step 3	authentication [disable enable] Example: RP/0/RSP0/CPU0:router(config-l2tp-class)# authentication disable	Enables the tunnel authentication. The Enable and Disable options enables or disables the L2TP tunnel authentication.
Step 4	congestion control Example: RP/0/RSP0/CPU0:router(config-l2tp-class)# congestion control	Enables L2TP congestion control.
Step 5	digest [check disable hash { MD5 SHA1 } secret { 0 7 LINE }] Example: RP/0/RSP0/CPU0:router(config-l2tp-class)# digest check disable RP/0/RSP0/CPU0:router(config-l2tp-class)# digest hash MD5	Messages the Digest configuration for L2TPv3 control connection.

	Command or Action	Purpose
	RP/0/RSP0/CPU0:router(config-l2tp-class)# digest secret 0	
Step 6	<p>hello-interval <i>interval_duration</i></p> <p>Example:</p> <pre>RP/0/RSP0/CPU0:router(config-l2tp-class)# hello-interval 45</pre>	Sets HELLO message interval for specified amount of seconds.
Step 7	<p>hostname <i>host_name</i></p> <p>Example:</p> <pre>RP/0/RSP0/CPU0:router(config-l2tp-class)# hostname local_host</pre>	Sets the local hostname for control connection authentication.
Step 8	<p>receive-window <i>size</i></p> <p>Example:</p> <pre>RP/0/RSP0/CPU0:router(config-l2tp-class)# receive-window 56</pre>	Receives window size for the control connection. The range is from 1 to 16384.
Step 9	<p>retransmit initial [retries <i>retries_number</i> timeout {max <i>max_seconds</i> min <i>min_seconds</i> }]</p> <p>Example:</p> <pre>RP/0/RSP0/CPU0:router(config-l2tp-class)# retransmit initial retries 58 RP/0/RSP0/CPU0:router(config-l2tp-class)# retransmit initial timeout max 6</pre>	Receives window size for the control connection. The range is from 1 to 16384.
Step 10	<p>timeout [no-user { <i>timeout_value</i> never } setup <i>setup_value</i>]</p> <p>Example:</p> <pre>RP/0/RSP0/CPU0:router(config-l2tp-class)# timeout no-user 56 RP/0/RSP0/CPU0:router(config-l2tp-class)# retransmit setup 60</pre>	Receives window size for the control connection. The timeout value range, in seconds, is from 0 to 86400. The setup value range is from 60 to 6000.
Step 11	<p>tunnel accounting <i>accounting_method_list_name</i></p> <p>Example:</p> <pre>RP/0/RSP0/CPU0:router(config-l2tp-class)# tunnel accounting acc_tunn</pre>	Configures the AAA accounting method list name.
Step 12	Use the commit or end command.	<p>commit —Saves the configuration changes and remains within the configuration session.</p> <p>end —Prompts user to take one of these actions:</p>

	Command or Action	Purpose
		<ul style="list-style-type: none"> • Yes — Saves configuration changes and exits the configuration session. • No —Exits the configuration session without committing the configuration changes. • Cancel —Remains in the configuration session, without committing the configuration changes.

Configuring L2TP Class Options: An example

```

configure
l2tp-class class1
authentication enable
congestion-control
digest check disable
hello-interval 876
hostname l2tp_host
receive-window 163
retransmit initial timeout 60
timeout no-user 864
tunnel accounting aaa_l2tp
!
end

```

Configuring Softshut for VPDN

Perform this task to configure softshut for vpdn.

SUMMARY STEPS

1. **configure**
2. **vpdn**
3. **softshut**
4. Use the **commit** or **end** command.

DETAILED STEPS

	Command or Action	Purpose
Step 1	configure Example: RP/0/RSP0/CPU0:router# configure	Enters global configuration mode.
Step 2	vpdn Example: RP/0/RSP0/CPU0:router(config)# vpdn	Enters the VPDN sub-mode.

	Command or Action	Purpose
Step 3	softshut Example: RP/0/RSP0/CPU0:router(config-vpdn)# softshut	Ensures that no new sessions are allowed.
Step 4	Use the commit or end command.	commit —Saves the configuration changes and remains within the configuration session. end —Prompts user to take one of these actions: <ul style="list-style-type: none"> • Yes — Saves configuration changes and exits the configuration session. • No —Exits the configuration session without committing the configuration changes. • Cancel —Remains in the configuration session, without committing the configuration changes.

Configuring Softshut for VPDN: An example

```
configure
vpdn
softshut
!
end
```

L2TP Access Concentrator Stateful Switchover

The L2TP Access Concentrator Stateful Switchover (LAC SSO) feature establishes one of the RPs as the active processor, designates the other RP as the standby processor, and then synchronizes critical state information between them. In specific Cisco networking devices that support dual RPs, LAC SSO takes advantage of RP redundancy to increase network availability.

LAC SSO supports non-stop routing (NSR) for VPDN and L2TP protocols in the event of a RP failover. The NSR provides the ability to guarantee reliable L2TP and VPDN synchronization between active and standby RPs. In case of RP fail-over, all VPDN and L2TP tunnels and sessions information are preserved without impacting the L2TP network peer. Also, peer networking devices do not experience routing flaps, and therefore reduce loss of service outages for customers. When VPDN and LAC SSO are enabled, all the tunnels and sessions are mirrored to the backup RP.

Enabling LAC SSO

Perform this task to enable LAC/VPDN SSO feature:

SUMMARY STEPS

1. **configure**
2. **vpdn**
3. **redundancy**
4. Use the **commit** or **end** command.

5. `show vpdn redundancy`
6. `show vpdn redundancy mirroring`
7. `show l2tpv2 redundancy`
8. `show l2tpv2 redundancy mirroring`

DETAILED STEPS

	Command or Action	Purpose
Step 1	configure Example: RP/0/RSP0/CPU0:router# <code>configure</code>	Enters global configuration mode.
Step 2	vpdn Example: RP/0/RSP0/CPU0:router(config)# <code>vpdn</code>	Enters vpdn configuration mode.
Step 3	redundancy Example: RP/0/RSP0/CPU0:router(config-vpdn)# <code>redundancy</code>	Enters vpdn redundancy configuration mode.
Step 4	Use the commit or end command.	commit —Saves the configuration changes and remains within the configuration session. end —Prompts user to take one of these actions: <ul style="list-style-type: none"> • Yes — Saves configuration changes and exits the configuration session. • No —Exits the configuration session without committing the configuration changes. • Cancel —Remains in the configuration session, without committing the configuration changes.
Step 5	show vpdn redundancy Example: RP/0/RSP0/CPU0:router# <code>show vpdn redundancy</code>	Displays all vpdn redundancy related information.
Step 6	show vpdn redundancy mirroring Example: RP/0/RSP0/CPU0:router# <code>show vpdn redundancy mirroring</code>	Displays vpdn related mirroring statistics.
Step 7	show l2tpv2 redundancy Example:	Displays L2TP redundancy related information.

	Command or Action	Purpose
	RP/0/RSP0/CPU0:router# show l2tpv2 redundancy	
Step 8	show l2tpv2 redundancy mirroring Example: RP/0/RSP0/CPU0:router# show l2tpv2 redundancy mirroring	Displays L2TP related mirroring statistics.

Enabling LAC SSO: Example

```
configure
 vpdn
  redundancy
    process-failures switchover
end
```

Enabling RPFO on Process-failures

In the event of an application or process crash, if VPDN NSR is enabled, an RP failover is triggered and a new primary RP process restarts without traffic loss.

The VPDN NSR is disabled by default. Perform these steps to enable RPFO:

SUMMARY STEPS

1. **configure**
2. **nsr process-failures switchover**
3. **vpdn**
4. **redundancy**
5. **process-failures switchover**
6. Use the **commit** or **end** command.

DETAILED STEPS

	Command or Action	Purpose
Step 1	configure Example: RP/0/RSP0/CPU0:router# configure	Enters global configuration mode.
Step 2	nsr process-failures switchover Example: RP/0/RSP0/CPU0:router(config)# l2tp nsr process-failures switchover	Enables VPDN non-stop routing.

	Command or Action	Purpose
Step 3	vpdn Example: RP/0/RSP0/CPU0:router(config)# vpdn	Enters vpdn configuration mode.
Step 4	redundancy Example: RP/0/RSP0/CPU0:router(config-vpdn)# redundancy	Enters vpdn redundancy configuration mode.
Step 5	process-failures switchover Example: RP/0/RSP0/CPU0:router(config-vpdn-redundancy)# process-failures switchover	Forces a switchover in case of a process failure.
Step 6	Use the commit or end command.	commit —Saves the configuration changes and remains within the configuration session. end —Prompts user to take one of these actions: <ul style="list-style-type: none"> • Yes — Saves configuration changes and exits the configuration session. • No —Exits the configuration session without committing the configuration changes. • Cancel —Remains in the configuration session, without committing the configuration changes.

Local VPDN RADIUS Enhancement

From Cisco IOS XR Software Release 6.2.1 and later, BNG router supports local VPDN configuration that is capable of working with locally stored user profiles, for LAC tunneling. Prior to this, BNG supported only external VPDN configuration through RADIUS server.

Configure Local VPDN for LAC

SUMMARY STEPS

1. **configure**
2. **radius-server host** *server-IP-address* **auth-port** *port number* **acct-port** *port number*
3. **key** *encryption key*
4. **exit**
5. **interface** *type interface-path-id*
6. **ip address** *ip-address mask*
7. **exit**
8. **vpdn**
9. **local secret** *password profile-dir directory path* [**cache-disabled port** *port number*]

10. Use the **commit** or **end** command.

DETAILED STEPS

	Command or Action	Purpose
Step 1	configure Example: RP/0/RSP0/CPU0:router# configure	Enters the global configuration mode.
Step 2	radius-server host <i>server-IP-address</i> auth-port <i>port number</i> acct-port <i>port number</i> Example: RP/0/RSP0/CPU0:router(config)# radius-server host 9.9.9.1 auth-port 1645 acct-port 1646	Specifies the RADIUS server IP address, authorization port, and accounting port.
Step 3	key <i>encryption key</i> Example: RP/0/RSP0/CPU0:router(config-radius-host)# key cisco	Specifies the per-server encryption key.
Step 4	exit Example: RP/0/RSP0/CPU0:router(config-radius-host)# exit	Exits configuration mode for the radius host and returns to global configuration mode.
Step 5	interface <i>type interface-path-id</i> Example: RP/0/RSP0/CPU0:router(config)# interface Loopback9	Enters configuration mode for loopback interface.
Step 6	ip address <i>ip-address mask</i> Example: RP/0/RSP0/CPU0:router(config-if)# ip address 9.9.9.1 255.255.255.255	Sets the IP address and subnet mask for the loopback interface.
Step 7	exit Example: RP/0/RSP0/CPU0:router(config-if)# exit	Exits configuration mode for the loopback interface and returns to global configuration mode.
Step 8	vpdn Example: RP/0/RSP0/CPU0:router(config)# vpdn	Enters vpdn configuration mode.
Step 9	local secret <i>password</i> profile-dir <i>directory path</i> [cache-disabled port <i>port number</i>] Example:	Configures the following parameters under VPDN: <ul style="list-style-type: none"> • Profile-directory: It is the local path in the router where the user-profile is saved.

	Command or Action	Purpose
	<pre>RP/0/RSP0/CPU0:router(config-vpdn)# local secret abc profile-dir /users/test/</pre>	<ul style="list-style-type: none"> • Cache-Disabled: It disables the cached configuration file. • Port-number: It is the udp port number. The default is 1645.
Step 10	Use the commit or end command.	<p>commit - Saves the configuration changes and remains within the configuration session.</p> <p>end - Prompts user to take one of these actions:</p> <ul style="list-style-type: none"> • Yes - Saves configuration changes and exits the configuration session. • No - Exits the configuration session without committing the configuration changes. • Cancel - Remains in the configuration mode, without committing the configuration changes.

Example

Sample Domain Profile:

```
address=1.2.3.4
password=abcd
client-name=user
identification=l2tp
local-interface=loopback9
ip-router-name=r1
```

The supported fields in the user profile with their respective attribute is given below :

- address: Tunnel server endpoint.
- password: Tunnel-password.
- local-interface-Source IP address.
- identification: Tunnel assignment ID.
- ip-router-name:VPN vrf.
- client-name: Tunnel client auth id.

Restrictions for Local VPDN for LAC

Local VPDN for LAC tunnelling in BNG is subjected to these restrictions:

- Change of Authorization (CoA) is not supported.
- The maximum number of user-profile cache entries supported is 16.
- BNG processes the packets only if an Access-Request message is received from the client. Else, packets are discarded.

- Password in CLI and user-profile are saved in clear text format.
- The loopback interface name and IP address are internally hardcoded to 127.0.0.x where x is the Loopback interface number that is defined. The loopback interface in the configuration should match the one used in user-profile.

PPPoE Smart Server Selection

The PPPoE Smart Server Selection (PADO delay) feature in BNG allows the PPPoE client to control the selection of BNG for session establishment, in a multi-BNG setup. The feature provides the option for configuring a delay in sending PADO messages from BNG, in response to the PADI messages received from the PPPoE clients. This, in turn, helps in establishing a priority order and load balancing across all BNGs.

When establishing a PPPoE session in a multi-BNG setup, the clients broadcast their PADI messages to all BNGs. When the BNGs reply with a PADO message, the subscriber selects a BNG, and sends a PADR message to the BNG with which a session needs to be established. Most PPPoE clients send a PADR message to the BNG from which it received the first PADO message. By configuring the Smart Server Selection feature on BNG, a delay is added to the PADO messages sent from the BNG, based on the properties of the PADI messages received from the PPPoE clients. This delay in receiving the PADO packets, in turn, gives the PPPoE client the flexibility of effectively selecting the appropriate BNG to which the PADR message is to be sent.

Configuration options for Smart Server Selection

- Allows configuring a specific delay for the PADO message sent from BNG.
- Allows configuring a delay for the PADO message sent from BNG, based on the Circuit-ID, Remote-ID and Service-Name contained in the incoming PADI message.
- Allows Circuit-ID and Remote-ID tag matching, with strings up to 64 characters in length.
- Allows partial matching on Circuit-ID, Remote-ID, and Service-Name contained in the incoming PADI message.

For configuring the delay for a PADO message, see [Configuring PADO Delay, on page 141](#).

Configuring PADO Delay

Perform this task to configure a delay for PPPoE Active Discovery Offer (PADO) message, or in other words, enabling Smart Server Selection feature for a PPPoE BBA-Group in BNG.



Note If multiple delays match a particular subscriber, Circuit-ID matches are preferred to Remote-ID matches, which, in turn, are preferred to Service-Name matches.

SUMMARY STEPS

1. **configure**
2. **pppoe bba-group** *bba-group-name*
3. Use these commands to configure the PADO delay based on a specific delay value, Circuit-ID, Remote-ID, and Service-Name respectively:
 - **pado delay** *delay*

- **pado delay circuit-id** *{delay | {string | contains} string delay}*
- **pado delay remote-id** *{delay | {string | contains} string delay}*
- **pado delay service-name** *{string | contains} string delay*

4. Use the **commit** or **end** command.

DETAILED STEPS

	Command or Action	Purpose
Step 1	configure Example: <pre>RP/0/RSP0/CPU0:router# configure</pre>	Enters global configuration mode.
Step 2	pppoe bba-group <i>bba-group-name</i> Example: <pre>RP/0/RSP0/CPU0:router(config)# pppoe bba-group bba_1</pre>	Enters the PPPoE BBA-Group configuration mode.
Step 3	<p>Use these commands to configure the PADO delay based on a specific delay value, Circuit-ID, Remote-ID, and Service-Name respectively:</p> <ul style="list-style-type: none"> • pado delay <i>delay</i> • pado delay circuit-id <i>{delay {string contains} string delay}</i> • pado delay remote-id <i>{delay {string contains} string delay}</i> • pado delay service-name <i>{string contains} string delay</i> <p>Example:</p> <pre>RP/0/RSP0/CPU0:router(config-bbagroup)# pado delay 500 RP/0/RSP0/CPU0:router(config-bbagroup)# pado delay circuit-id 200 RP/0/RSP0/CPU0:router(config-bbagroup)# pado delay remote-id string circuit4 RP/0/RSP0/CPU0:router(config-bbagroup)# pado delay service-name contains service 9950</pre>	<p>Sets the PADO delay in milliseconds based on:</p> <ul style="list-style-type: none"> • A specific <i>delay</i> value • Circuit-ID received in PADI • Remote-ID received in PADI • Service-Name received in PADI <p>The <i>delay</i> range is from 0 to 10000.</p> <p>The string option delays the PADO message, when the Circuit-ID (or Remote-ID or Service-Name) received in the PADI message matches the configured <i>string</i> value.</p> <p>The contains option delays the PADO message, when the Circuit-ID (or Remote-ID or Service-Name) received in the PADI message contains the configured <i>string</i> value.</p>
Step 4	Use the commit or end command.	<p>commit — Saves the configuration changes and remains within the configuration session.</p> <p>end — Prompts user to take one of these actions:</p> <ul style="list-style-type: none"> • Yes — Saves configuration changes and exits the configuration session. • No — Exits the configuration session without committing the configuration changes.

	Command or Action	Purpose
		<ul style="list-style-type: none"> • Cancel —Remains in the configuration session, without committing the configuration changes.

Configuring PPPoE PADO delay : An example

```

pppoe bba-group bba_1
pado delay 500
pado delay remote-id 100
pado delay circuit-id string circuit4 8000
pado delay service-name contains service 9950
!
end

```

PPPoE Session Limit, Throttle and In-flight-window

PPPoE Session Limit

The PPPoE Session Limit support limits the number of PPPoE sessions that can be created on a BNG router. As a result, it reduces excessive memory usage by the BNG router for virtual access.

This offers additional configuration flexibility on the BNG router by limiting the number of PPPoE sessions for each:

- Line card
- Parent interface
- Peer MAC address
- Peer MAC address under individual access interface
- Circuit-ID
- Remote-ID
- Combination of Circuit-ID and Remote ID
- Access interface using the same Inner VLAN tag
- Access interface using the same Outer VLAN tag.
- Access interface using the same Inner and Outer VLAN tags

The PPPoE Session Limit support also limits the number of Inter Working Function (IWF) sessions for each peer MAC address and for each peer MAC address under individual access interface.

From Cisco IOS XR Software Release 6.2.1 and later, you can set a global PPPoE sessions limit in a BNG router. This limit is configured under the global BBA-Group (using **pppoe bba-group** global command) and sets the maximum session limit on the node

**Note**

- For RP subscribers, the node is the complete chassis.
- For LC subscribers, the node is the LC. For LC subscribers, each LC considers the maximum limit set by the global limit. But with multiple LC in the chassis, the session count in the chassis can be multiplied by the number of active LC.

To use a BNG-wide limit for LC based subscribers, you can use either bundles or pre authentication.

- For a single member, when you are using bundles, the sessions are maintained on the RP and the control is moved to the RP for all sessions. The bba group limit applies to all sessions regardless to the number of line cards carrying subscribers:

```
interface GigabitEthernet0/0/0/0
bundle id 100 mode on
```

- In a pre authentication method, when PADI is received, an authorization request is sent to AAA . An authorisation request determines the session count on radius for it to accept or reject the request. When the request is accepted, a PADO is sent. When the request is rejected the PADI is discarded and ignored.

See, [Configuring PPPoE Session Limit, on page 144](#).

Configuring PPPoE Session Limit

Perform this task to configure PPPoE session limit for a PPPoE BBA-Group or to set a global session limit in BNG.

**Note**

The **global** BBA-Group is not valid for subscriber redundancy group (SRG) in BNG, and hence the **pppoe bba-group global** command must not be used in BNG geo redundancy scenarios. Because **global** is a reserved keyword for IOS XR PPPoE call flow, you must use a different keyword for SRG.

SUMMARY STEPS

1. **configure**
2. **pppoe bba-group** {*bba-group name* | **global**}
3. **sessions** {*access-interface* | *circuit-id* | *circuit-id-and-remote-id* | *inner-vlan* | {{*mac* | *mac-iwf*} [*access-interface*] }} | **max** | *outer-vlan* | *remote-id* | *vlan*} **limit** *limit-count* [**threshold** *threshold-count*]
4. Use the **commit** or **end** command.

DETAILED STEPS

	Command or Action	Purpose
Step 1	configure Example: RP/0/RSP0/CPU0:router# configure	Enters global configuration mode.

	Command or Action	Purpose
Step 2	<p>pppoe bba-group {<i>bba-group name</i> global}</p> <p>Example:</p> <pre>RP/0/RSP0/CPU0:router(config)# pppoe bba-group bba_1</pre> <p>OR</p> <pre>RP/0/RSP0/CPU0:router(config)# pppoe bba-group global</pre>	Enters the specific PPPoE BBA-Group or global PPPoE BBA-Group configuration mode.
Step 3	<p>sessions {access-interface circuit-id circuit-id-and-remote-id inner-vlan {{mac mac-iwf} [access-interface] }} max outer-vlan remote-id vlan} limit <i>limit-count</i> [threshold <i>threshold-count</i>]</p> <p>Example:</p> <pre>RP/0/RSP0/CPU0:router(config-bbagroup)# sessions access-interface limit 1000 RP/0/RSP0/CPU0:router(config-bbagroup)# sessions mac access-interface limit 5000 threshold 4900 RP/0/RSP0/CPU0:router(config-bbagroup)# sessions circuit-id limit 8000 threshold 7500</pre>	<p>Configures the PPPoE session limits.</p> <p>If the optional argument, threshold is configured, a log message is generated when the PPPoE session limit exceeds the <i>threshold-count</i> value.</p> <p>The <i>limit-count</i> value and <i>threshold-count</i> value ranges from 1 to 65535. The default value is 65535.</p> <p>If max limit is configured under pppoe bba-group global mode, it sets the PPPoE session limit for the entire router.</p>
Step 4	Use the commit or end command.	<p>commit —Saves the configuration changes and remains within the configuration session.</p> <p>end —Prompts user to take one of these actions:</p> <ul style="list-style-type: none"> • Yes — Saves configuration changes and exits the configuration session. • No —Exits the configuration session without committing the configuration changes. • Cancel —Remains in the configuration session, without committing the configuration changes.

Configuring PPPoE Session Limit: An example

```
configure
pppoe bba-group bba1
  sessions circuit-id limit 8000 threshold 7500
  sessions access-interface limit 1000
  sessions mac access-interface limit 5000 threshold 900
!
end
```

This example shows how to configure a global PPPoE session limit in BNG. As per this, a maximum of only 250 sessions can come up in the router. If 100 sessions are already created under bba1, then only the remaining number of sessions (250-100 = 150) can come up in bba2.

```

configure
pppoe bba-group global
  sessions max limit 250
!
pppoe bba-group bba1
  sessions max limit 100
!
pppoe bba-group bba2
  sessions max limit 200
!
end

```

PPPoE Session Throttle

The PPPoE Session Throttle support on BNG limits the number of PPPoE session requests coming to BNG within a specified period of time. This, in turn, ensures that the session establishment of other client requests coming to the BNG server is not impacted.

This offers configuration flexibility in the BNG router by throttling the number of session requests based on one of these:

- Peer MAC address
- Peer MAC address under individual access interface
- Circuit-ID
- Remote-ID
- A combination of Circuit-ID and Remote ID
- Inner VLAN tag under individual access interface
- Outer VLAN tag under individual access interface
- Inner and Outer VLAN tag under individual access interface

The PPPoE session throttle support also throttles the number of Inter Working Function (IWF) session requests for each peer MAC address under an individual access interface.

See, [Configuring PPPoE Session Throttle, on page 146](#).

Configuring PPPoE Session Throttle

Perform this task to configure PPPoE session throttle for a PPPoE BBA-Group in BNG.

SUMMARY STEPS

1. **configure**
2. **pppoe bba-group** *bba-group name*
3. **sessions** {**circuit-id** | **circuit-id-and-remote-id** | **inner-vlan** | {**mac** [**access-interface**] } | {**mac-iwf** {**access-interface**}} | **outer-vlan** | **remote-id** | **vlan**} **throttle** *request-count request-period blocking-period*
4. Use the **commit** or **end** command.

DETAILED STEPS

	Command or Action	Purpose
Step 1	configure Example: RP/0/RSP0/CPU0:router# configure	Enters global configuration mode.
Step 2	pppoe bba-group <i>bba-group name</i> Example: RP/0/RSP0/CPU0:router(config)# pppoe bba-group bba_1	Enters the PPPoE BBA-Group configuration mode.
Step 3	sessions { circuit-id circuit-id-and-remote-id inner-vlan { mac [access-interface] } { mac-iwf { access-interface }} outer-vlan remote-id vlan } throttle <i>request-count request-period blocking-period</i> Example: RP/0/RSP0/CPU0:router(config-bbagroup)# sessions circuit-id throttle 1000 50 25 RP/0/RSP0/CPU0:router(config-bbagroup)# sessions mac-iwf access-interface throttle 5000 100 50	Configures the PPPoE session throttles. The <i>request-count</i> value ranges from 1 to 65535. The <i>request-period</i> value ranges from 1 to 100. The <i>blocking-period</i> value ranges from 1 to 100.
Step 4	Use the commit or end command.	commit —Saves the configuration changes and remains within the configuration session. end —Prompts user to take one of these actions: <ul style="list-style-type: none"> • Yes — Saves configuration changes and exits the configuration session. • No —Exits the configuration session without committing the configuration changes. • Cancel —Remains in the configuration session, without committing the configuration changes.

Configuring PPPoE Session Throttle: An example

```
configure
pppoe bba-group bba1
  sessions circuit-id throttle 1000 50 25
  sessions mac-iwf access-interface throttle 5000 100 50
!
```

PPPoE In-flight-window

PPPoE in-flight-window is an enhancement to limit the number of PPPoE sessions in BNG that are in progression towards established state. The in-flight-window option sets the PPPoE process queue to a particular limit per LC and per RP, thereby providing a better control of incoming PPPoE sessions to BNG.

To enable this feature, use **pppoe in-flight-window** command in the global configuration mode.



Note The recommended in-flight-window *size* for RP-based subscribers is 200, and that for LC-based subscribers is 50. Values higher than these are not recommended for production deployment, as it can lead to system instability.

Configuration Example for PPPoE In-flight-window

```
Router# configure
Router(config)# pppoe in-flight-window 200
Router(config)#commit
```

Activating IPv6 Router Advertisement on a Subscriber Interface When IPv4 Starts

BNG introduces the ability to automatically trigger an IPv6 router advertisement on an IPv4 subscriber interface. This feature can be used by subscriber interfaces that are on a dual stack network and are enabled for IPv6 processing.

To configure this feature you can either use dynamic templates through CLI or configure RADIUS user profile attributes. This feature is only supported for subscriber sessions that use the IPoE protocol.

In a BNG dual stack network, an IPv4 session is initiated first followed by an IPv6 session request. After receiving the DHCP IPv6 request, the DHCP server allocates an IPv6 address.

Creating Dynamic Template for Enabling IPv6 Router Advertisement on an IPv4 Subscriber Interface

Perform this task to create a dynamic template to enable IPv6 router advertisements on a subscriber interface:

SUMMARY STEPS

1. **configure**
2. **dynamic-template**
3. **type ipsubscriber** *dynamic template name*
4. **ipv6 nd start-ra-on-ipv6-enable**
5. **show ipv6 nd idb interface** *subscriber interface detail location member location*

DETAILED STEPS

Step 1 **configure**

Step 2 **dynamic-template**

Enters the dynamic template configuration.

Example:

```
RP/0/RSP0/CPU0:router(config)#dynamic-template
```

Step 3 **type ipsubscriber** *dynamic template name*

Creates a dynamic template with a user-defined name for an ipsubscriber service.

Example:

```
RP/0/RSP0/CPU0:router(config-dynamic-template)#type ipsubscriber ipoe_ipv6
```

Step 4 **ipv6 nd start-ra-on-ipv6-enable**

Enables IPv6 router advertisement capability if ipv6-enable is already configured, instead of waiting for the dual stack to boot up.

Example:

```
RP/0/RSP0/CPU0:router(config-dynamic-template)#type ipsubscriber ipoe_ipv6 start-ra-on-ipv6-enable
```

Step 5 **show ipv6 nd idb interface** *subscriber interface* **detail location** *member location*

Example:

```
RP/0/RSP0/CPU0:router##show ipv6 nd idb interface bundle-ether 50.11.ip3 d
RA flag: 0x1, Unicast RA send: FALSE, Initial RA count: 3, RA pkts sent count: 4
```

Displays the RA packets sent from the subscriber interface.

Making DHCP Settings



Note For detailed information on the DHCP features and configurations supported on ASR9K router, refer to the *Implementing the Dynamic Host Configuration Protocol* chapter in the *IP Addresses and Services Configuration Guide for Cisco ASR 9000 Series Routers*. For a complete list of DHCP commands supported on ASR9K router, refer to the *DHCP Commands* chapter in the *IP Addresses and Services Command Reference for Cisco ASR 9000 Series Routers*.

The Dynamic Host Configuration Protocol (DHCP) is a network protocol used to configure network devices so that they can communicate on an IP network. There are three distinct elements in a DHCP network:

- DHCP client—It is the device that seeks IP configuration information, such as IP address.
- DHCP server—It allocates IP address from its address pool to the DHCP client.
- DHCP relay or DHCP proxy—It passes IP configuration information between the client and server. It is used when DHCP client and DHCP server are present on different networks.

Initially, the DHCP client (which is a CPE) does not possess an IP address. As a result, it sends a L2 broadcast request to get an IP address. Acting as the relay agent, BNG processes the request and forwards it to the DHCP server. BNG also forwards responses from the DHCP server back to the DHCP client, ensuring that the end device gets correct IP configuration information. A typical DHCP layout is depicted in this figure.

Figure 15: DHCP Network

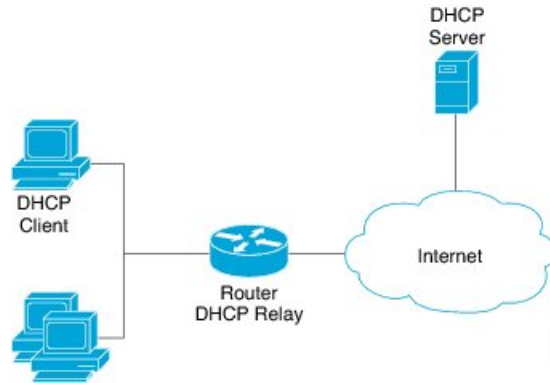

The DHCP server allocates IP addresses for only a configurable period of time known as the lease period. If a client device needs to retain the IP address for a period longer than the lease period, then the client must renew the lease before it expires. To renew the lease, the client sends a unicast request to the DHCP server. On receiving the request message, the server responds with an acknowledgment, and the client's lease is extended by the lease time specified in the acknowledgment message.

When a control policy is applied to an access interface, it becomes a subscriber access interface. Otherwise, it is a DHCP standalone interface. For the standalone interface, DHCP adds routes to RIB and populates ARP entries, based on the configuration.

For the subscriber access interface, DHCP uses the policy-plane to determine whether the IP subscriber session should be created for a client binding. This is determined based on whether a valid control policy is applied to the access-interface on which the client binding is created. If a subscriber session is created, then a route is added for the subscriber interface, but no ARP requests are sent out from that subscriber interface.

BNG can be configured to either act as DHCP proxy or DHCP server in the DHCP network.



Note DHCP relay is not supported for BNG.

Enabling DHCP Proxy

As the DHCP proxy, BNG performs all the functions of a relay and also provides some additional functions. In the proxy mode, BNG conceals DHCP server details from DHCP clients. BNG modifies the DHCP replies such that the client considers the proxy to be the server. In this state the client interacts with BNG as if it is the DHCP server.

BNG procures IP leases from the DHCP server and keeps it in its pool. When the client needs to renew its lease, it unicasts the lease renewal request directly to the BNG, assuming it to be the server. BNG renews the lease by allocating the lease from its lease pool.

This way the DHCP proxy splits the lease management process into two phases:

- Server to Proxy (Proxy Lease)
- Proxy to Client (Client lease)

The two phase lease management has these features:

- Shorter client lease times and longer proxy lease times.
- High frequency lease management (renews) at network edge.
- Low frequency lease management (renews) at centralized server.

The benefits of DHCP proxy are:

- Reduced traffic between BNG and DHCP server.
- Quicker client response to network outages.

Configuring DHCP proxy on BNG involves these phases:

- Creating a proxy profile. The profile contains various proxy settings. These settings are applied when the profile is attached to an interface. To create a proxy profile, see [Configuring DHCP IPv4 Profile Proxy Class, on page 151](#)
 - Specifying client lease period. The client should renew the lease before the completion of this time period, otherwise the lease expires. To specify the client lease period within a proxy profile, see [Configuring the Client Lease Time, on page 155](#).
 - Specifying remote-ID. The remote-ID is used by the proxy to identify the host that had sent the DHCP request. To define a remote-id within a proxy profile, see [Configuring a Remote-ID, on page 154](#).
- Specifying circuit-ID for an interface. The circuit-ID is used by the proxy to identify the circuit in which the DHCP request was received. Later, DHCP proxy uses it for relaying DHCP responses back to the proper circuit. The circuit-ID is defined for an interface. To define it, see [Configuring a Circuit-ID for an Interface, on page 152](#).
- Attaching proxy profile to an interface. See, [Attaching a Proxy Profile to an Interface, on page 156](#)

Configuring DHCP IPv4 Profile Proxy Class

Perform this task to define DHCP.

SUMMARY STEPS

1. **configure**
2. **dhcp ipv4**
3. **profile** *profile-name* **proxy**
4. **class** *class-name*
5. Use the **commit** or **end** command.
6. **show dhcp ipv4 proxy profile name** *name*

DETAILED STEPS

	Command or Action	Purpose
Step 1	configure Example: RP/0/RSP0/CPU0:router# configure	Enters global configuration mode.
Step 2	dhcp ipv4 Example: RP/0/RSP0/CPU0:router(config)# dhcp ipv4	Enters the IPv4 DHCP configuration mode.
Step 3	profile profile-name proxy Example: RP/0/RSP0/CPU0:router(config-dhcpv4)# profile profile1 proxy	Enters the proxy profile configuration mode. The DHCP Proxy makes use of the class information to select a subset of parameters in a given profile.
Step 4	class class-name Example: RP/0/RSP0/CPU0:router(config-dhcpv4-profile)# class blue	Creates a DHCP proxy profile class and enters the proxy profile class mode.
Step 5	Use the commit or end command.	commit —Saves the configuration changes and remains within the configuration session. end —Prompts user to take one of these actions: <ul style="list-style-type: none"> • Yes — Saves configuration changes and exits the configuration session. • No —Exits the configuration session without committing the configuration changes. • Cancel —Remains in the configuration session, without committing the configuration changes.
Step 6	show dhcp ipv4 proxy profile name name Example: RP/0/RSP0/CPU0:router# show dhcp ipv4 proxy profile name profile1	(Optional) Displays the details proxy profile information.

Configuring a Circuit-ID for an Interface

Perform this task to configure a circuit-id for an interface.

SUMMARY STEPS

1. **configure**
2. **dhcp ipv4**
3. **interface type interface-path-id**

4. **proxy information option format-type circuit-id** *value*
5. Use the **commit** or **end** command.

DETAILED STEPS

	Command or Action	Purpose
Step 1	configure Example: RP/0/RSP0/CPU0:router# configure	Enters global configuration mode.
Step 2	dhcp ipv4 Example: RP/0/RSP0/CPU0:router(config)# dhcp ipv4	Enters DHCP IPv4 configuration submenu.
Step 3	interface <i>type interface-path-id</i> Example: RP/0/RSP0/CPU0:router(config-dhcpv4)# interface Bundle-Ether 355	Configures the interface and enters the interface configuration mode.
Step 4	proxy information option format-type circuit-id <i>value</i> Example: RP/0/RSP0/CPU0:router(config-dhcpv4)# proxy information option format-type circuit-id 7	Configures the circuit-id for this interface.
Step 5	Use the commit or end command.	commit —Saves the configuration changes and remains within the configuration session. end —Prompts user to take one of these actions: <ul style="list-style-type: none"> • Yes — Saves configuration changes and exits the configuration session. • No —Exits the configuration session without committing the configuration changes. • Cancel —Remains in the configuration session, without committing the configuration changes.

Configuring a Circuit-ID for an Interface: An example

```
configure
dhcp ipv4
interface Bundle-Ether100.10
proxy information option format-type circuit-id 7
!
!
end
```

Configuring a Remote-ID

Perform this task to configure a remote-ID.

SUMMARY STEPS

1. **configure**
2. **dhcp ipv4**
3. **profile** *profile-name* **proxy**
4. **relay information option remote-id** *value*
5. Use the **commit** or **end** command.

DETAILED STEPS

	Command or Action	Purpose
Step 1	configure Example: RP/0/RSP0/CPU0:router# <code>configure</code>	Enters global configuration mode.
Step 2	dhcp ipv4 Example: RP/0/RSP0/CPU0:router(config)# <code>dhcp ipv4</code>	Enters the IPv4 DHCP configuration mode.
Step 3	profile <i>profile-name</i> proxy Example: RP/0/RSP0/CPU0:router(config-dhcpv4)# <code>profile profile1 proxy</code>	Creates a DHCP proxy profile.
Step 4	relay information option remote-id <i>value</i> Example: RP/0/RSP0/CPU0:router(config-if)# <code>relay information option remote-id 9</code>	Inserts relay agent information for remote id suboptions such as remote-ID value.
Step 5	Use the commit or end command.	<p>commit —Saves the configuration changes and remains within the configuration session.</p> <p>end —Prompts user to take one of these actions:</p> <ul style="list-style-type: none"> • Yes — Saves configuration changes and exits the configuration session. • No —Exits the configuration session without committing the configuration changes. • Cancel —Remains in the configuration session, without committing the configuration changes.

Configuring a Remote-ID: An example

```

configure
dhcp ipv4
profile profile1 proxy
relay information option remote-id 9
!
!
end

```

Configuring the Client Lease Time

Perform this task to configure the client lease time. It defines the time period after which the client lease expires.

SUMMARY STEPS

1. **configure**
2. **dhcp ipv4**
3. **profile** *profile-name* **proxy**
4. **lease proxy client-lease-time** *value*
5. Use the **commit** or **end** command.

DETAILED STEPS

	Command or Action	Purpose
Step 1	configure Example: RP/0/RSP0/CPU0:router# configure	Enters global configuration mode.
Step 2	dhcp ipv4 Example: RP/0/RSP0/CPU0:router(config)# dhcp ipv4	Enters the IPv4 DHCP configuration mode.
Step 3	profile <i>profile-name</i> proxy Example: RP/0/RSP0/CPU0:router(config-dhcpv4)# profile profile1 proxy	Creates a DHCP profile.
Step 4	lease proxy client-lease-time <i>value</i> Example: RP/0/RSP0/CPU0:router(config-dhcpv4-proxy-profile)# lease proxy client-lease-time 600	Configures a client lease time for each profile. The minimum value of the lease proxy client time is 300 seconds.
Step 5	Use the commit or end command.	commit —Saves the configuration changes and remains within the configuration session. end —Prompts user to take one of these actions:

	Command or Action	Purpose
		<ul style="list-style-type: none"> • Yes — Saves configuration changes and exits the configuration session. • No —Exits the configuration session without committing the configuration changes. • Cancel —Remains in the configuration session, without committing the configuration changes.

Configuring the Client Lease Time: An example

```
configure
dhcp ipv4
profile profile1 proxy
lease proxy client-lease-time 600
!
!
end
```

Attaching a Proxy Profile to an Interface

Perform this task to attach a proxy profile to an interface. After it is attached, the various settings specified in the proxy profile take effect on the interface.

SUMMARY STEPS

1. **configure**
2. **dhcp ipv4**
3. **interface** *type interface-path-id* **proxy profile** *profile-name*
4. Use the **commit** or **end** command.
5. **show dhcp ipv4 proxy profile name** *name*

DETAILED STEPS

	Command or Action	Purpose
Step 1	configure Example: RP/0/RSP0/CPU0:router# configure	Enters global configuration mode.
Step 2	dhcp ipv4 Example: RP/0/RSP0/CPU0:router(config)# dhcp ipv4	Enters the IPv4 DHCP configuration mode.
Step 3	interface <i>type interface-path-id</i> proxy profile <i>profile-name</i> Example:	Enters the Interface configuration mode and assigns a proxy profile to an interface.

	Command or Action	Purpose
	RP/0/RSP0/CPU0:router(config-dhcpv4)# interface Bundle-Ether 344 proxy profile profile1	
Step 4	Use the commit or end command.	<p>commit —Saves the configuration changes and remains within the configuration session.</p> <p>end —Prompts user to take one of these actions:</p> <ul style="list-style-type: none"> • Yes — Saves configuration changes and exits the configuration session. • No —Exits the configuration session without committing the configuration changes. • Cancel —Remains in the configuration session, without committing the configuration changes.
Step 5	<p>show dhcp ipv4 proxy profile name <i>name</i></p> <p>Example:</p> <pre>RP/0/RSP0/CPU0:router# show dhcp ipv4 proxy profile name profile1</pre>	(Optional) Displays the details proxy profile information.

Attaching a Proxy Profile to an Interface: An example

```
configure
dhcp ipv4
interface Bundle-Ether100.10 proxy profile profile1
proxy information option format-type circuit-id 7
!
!
end
```

DHCPv4 Server

DHCP server accepts address assignment requests and renewals and assigns the IP addresses from predefined groups of addresses contained within Distributed Address Pools (DAPS). DHCP server can also be configured to supply additional information to the requesting client such as the IP address of the DNS server, the default router, and other configuration parameters. DHCP server can accept broadcasts from locally attached LAN segments or from DHCP requests that have been forwarded by other DHCP relay agents within the network.

The DHCP proxy performs all the functions of a relay and also provides some additional functions. The DHCP proxy conceals DHCP server details from DHCP clients. The DHCP proxy modifies the DHCP replies such that the client considers the proxy to be the server. In this state, the client interacts with the proxy as if it is the DHCP server.

The pool is configured under server-profile-mode and server-profile-class-sub-mode. The class-based pool selection is always given priority over profile pool selection.

Enabling DHCP Server

BNG can be configured to act as a DHCPv4 Server. To create a DHCPv4 Server profile, see [Configuring DHCPv4 Server Profile, on page 158](#).

For more information on DHCPv4 Server configuration, see *Implementing the Dynamic Host Configuration Protocol* chapter in the *IP Addresses and Services Configuration Guide for Cisco ASR 9000 Series Routers*.

Configuring DHCPv4 Server Profile

Perform this task to configure the DHCPv4 Server.

SUMMARY STEPS

1. **configure**
2. **dhcp ipv4**
3. **profile** *profile-name* **server**
4. **bootfile** *boot-file-name*
5. **broadcast-flag policy** *unicast-always*
6. **class** *class-name*
7. **exit**
8. **default-router** *address1 address2 ... address8*
9. **lease** { **infinite** | *days minutes seconds* }
10. **limit lease** { **per-circuit-id** | **per-interface** | **per-remote-id** } *value*
11. **netbios-name server** *address1 address2 ... address8*
12. **netbios-node-type** { **number** | **b-node** | **h-node** | **m-node** | **p-node** }
13. **option** *option-code* { **ascii** *string* | **hex** *string* | **ip** *address* }
14. **pool** *pool-name*
15. **requested-ip-address-check** **disable**
16. **commit**

DETAILED STEPS

	Command or Action	Purpose
Step 1	configure	
Step 2	dhcp ipv4 Example: RP/0/RSP0/CPU0:router(config) # dhcp ipv4 RP/0/RSP0/CPU0:router(config-dhcpv4) #	Enables DHCP for IPv4 and enters DHCP IPv4 configuration mode.
Step 3	profile <i>profile-name</i> server Example: RP/0/RSP0/CPU0:router(config-dhcpv4) # profile TEST server	Enters the server profile configuration mode.

	Command or Action	Purpose
	RP/0/RSP0/CPU0:router (config-dhcpv4-server-profile)#	
Step 4	bootfile <i>boot-file-name</i> Example: RP/0/RSP0/CPU0:router (config-dhcpv4-server-profile)# bootfile b1	Configures the boot file.
Step 5	broadcast-flag policy <i>unicast-always</i> Example: RP/0/RSP0/CPU0:router (config-dhcpv4-server-profile)# broadcast-flag policy unicast-always	Configures the broadcast-flag policy to unicast-always.
Step 6	class <i>class-name</i> Example: RP/0/RSP0/CPU0:router (config-dhcpv4-server-profile)# class Class_A RP/0/RSP0/CPU0:router (config-dhcpv4-server-profile-class)	Creates and enters server profile class configuration submode.
Step 7	exit Example: RP/0/RSP0/CPU0:router (config-dhcpv4-server-profile-class)# exit RP/0/RSP0/CPU0:router (config-dhcpv4-server-profile)#	Exits the server profile class submode.
Step 8	default-router <i>address1 address2 ... address8</i> Example: RP/0/RSP0/CPU0:router (config-dhcpv4-server-profile)# default-router 10.20.1.2	Configures the name of the default-router or the IP address.
Step 9	lease { infinite <i>days minutes seconds</i> } Example: RP/0/RSP0/CPU0:router (config-dhcpv4-server-profile)#	Configures the lease for an IP address assigned from the pool.

	Command or Action	Purpose
	<code>lease infinite</code>	
Step 10	<p>limit lease { per-circuit-id per-interface per-remote-id } <i>value</i></p> <p>Example:</p> <pre>RP/0/RSP0/CPU0:router(config-dhcpv4-server-profile)# limit lease per-circuit-id 23</pre>	Configures the limit on a lease per-circuit-id, per-interface, or per-remote-id.
Step 11	<p>netbios-name server <i>address1 address2 ... address8</i></p> <p>Example:</p> <pre>RP/0/RSP0/CPU0:router(config-dhcpv4-server-profile)# netbios-name-server 10.20.3.5</pre>	Configures the NetBIOS name servers.
Step 12	<p>netbios-node-type { number b-node h-node m-node p-node }</p> <p>Example:</p> <pre>RP/0/RSP0/CPU0:router(config-dhcpv4-server-profile)# netbios-node-type p-node</pre>	Configures the type of NetBIOS node.
Step 13	<p>option <i>option-code</i> { ascii string hex string ip address }</p> <p>Example:</p> <pre>RP/0/RSP0/CPU0:router(config-dhcpv4-server-profile)# option 23 ip 10.20.34.56</pre>	Configures the DHCP option code.
Step 14	<p>pool <i>pool-name</i></p> <p>Example:</p> <pre>RP/0/RSP0/CPU0:router(config-dhcpv4-server-profile)# pool pool1</pre>	Configures the Distributed Address Pool Service (DAPS) pool name.
Step 15	<p>requested-ip-address-check disable</p> <p>Example:</p> <pre>RP/0/RSP0/CPU0:router(config-dhcpv4-server-profile)#</pre>	Validates a requested IP address.

	Command or Action	Purpose
	<code>requested-ip-address-check disable</code>	
Step 16	commit	

DHCP L3 Routed Subscriber Snooping

From Cisco IOS XR Software Release 6.3.2 and later, the Cisco ASR 9000 BNG router supports DHCPv4 and DHCPv6 L3 routed subscriber snooping on Cisco ASR 9000 High Density 100GE Ethernet line cards. This feature introduces the support for DHCP L3 snoop mode in addition to the existing DHCPv4 and DHCPv6 proxy and server modes in BNG. This feature helps you to create DHCP-initiated routed subscriber sessions on main (that is, non-VLAN) interfaces. This feature is supported only on Cisco IOS XR 64-bit operating system.

The DHCP L3 routed subscriber snooping feature brings in the support for these functionalities as well in BNG:

- Subscriber session creation on untagged or main line card (LC) interfaces.
- MAC-gateway address combination-based authentication for IPv4 address family interface (AFI) for BNG in proxy mode.
- DHCP unique identifier (DUID)-based authentication for IPv6 AFI for BNG in proxy mode.
- Delayed authentication for BNG in proxy mode. That is, ACCESS-REQUEST message to the AAA server is based on the DHCP REQUEST message, rather than the DHCP DISCOVER message, from the client.
- Support for multiple sessions based on the same MAC address, but with different gateway addresses. The duplicate MAC feature in BNG is extended to support gateway address as the key for allowing duplicate MAC-based session. Prior to this, VLAN and access-interfaces were part of the client key.

For a set of new attributes introduced as part of DHCP L3 snooping in BNG, see [RADIUS Attributes for DHCP L3 Snooping in BNG, on page 168](#).

Network Topology of DHCP L3 Snooping in BNG

Figure 16: Network Topology of DHCP L3 Snooping in Cisco ASR 9000 BNG Router

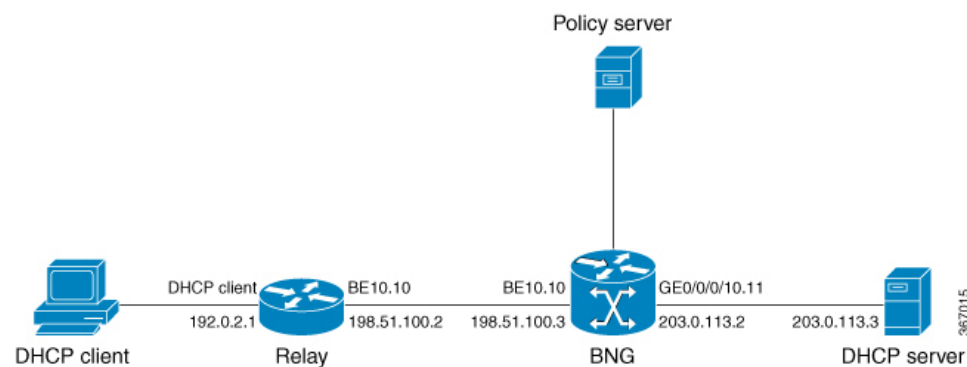

DHCP L3 snooping functionality is achieved by snooping the DHCP control packets which are not destined for the BNG router, instead destined for the DHCP server located external to the BNG router.

In this deployment model, the BNG router is placed between the relay agent and the DHCP server in the network. The relay agent sends the DHCP control packets to the DHCP server (with helper address 203.0.113.3, in this example) which is located external to the BNG. Although these packets are not destined for the BNG router, the BNG router snoops these packets, authenticates the subscriber, creates the subscriber session, applies the subscriber policy and collects accounting information for the subscriber.

Details for DHCP L3 Snooping in BNG

The support for DHCP L3 snooping in BNG is subjected to these restrictions:

- Supported only on Cisco ASR 9000 High Density 100GE Ethernet line cards.
- IPv4 and IPv6 sessions are not simultaneously supported.
- Only LC and bundle RP subscribers are supported; pseudowire ethernet interfaces are not supported.
- Supported only on main interfaces; not on VLAN interfaces.
- Although dual-stack configuration is supported, only one AFI (IPv4 or IPv6) can be brought UP at a time for a CPE.
- Routed subscriber DHCP-initiated and routed DHCP snoop-initiated sessions cannot co-exist on BNG.
- Routed subscriber packet-triggered and routed DHCP snoop-initiated sessions cannot co-exist on BNG.
- DHCP client and DHCP L3 snoop configuration cannot co-exist on BNG.
- Delayed authentication is not supported for DHCPv6.
- DHCP L3 snooping is applicable only for default VRF.
- Subscriber redundancy group (SRG) is not supported.
- Modification of duplicate MAC configuration is not supported while sessions are present on the router. If modified, it might lead to system inconsistency.
- **Allow move** command configuration is not relevant along with the **duplicate-mac include-giaddr** configuration.
- With the duplicate-mac include-giaddr command configured, the client reboot is supported only using the **allow-client-id-change** command.
- Only one prefix-length is supported on an access-interface. Sessions do not come up if the prefix-length of IAPD is not matching the prefix-length configured on the router.
- IAPD and IANA cannot be simultaneously supported on the same access interface (even for different CPEs on the same access interface).
- Only the below listed configurations are effective under the DHCPv4 profile mode for DHCP L3 snoop deployments. Other features such as proxy lease, relay information option setting and so on are not supported.
 - **authentication username**
 - **delayed authentication**
 - **giaddr policy keep**

Call Flow of DHCP L3 Snooping in BNG

This figure depicts the call flow of a successful subscriber authentication scenario with DHCP L3 snooping in BNG.

Figure 17: Call Flow of DHCP L3 Snooping in BNG

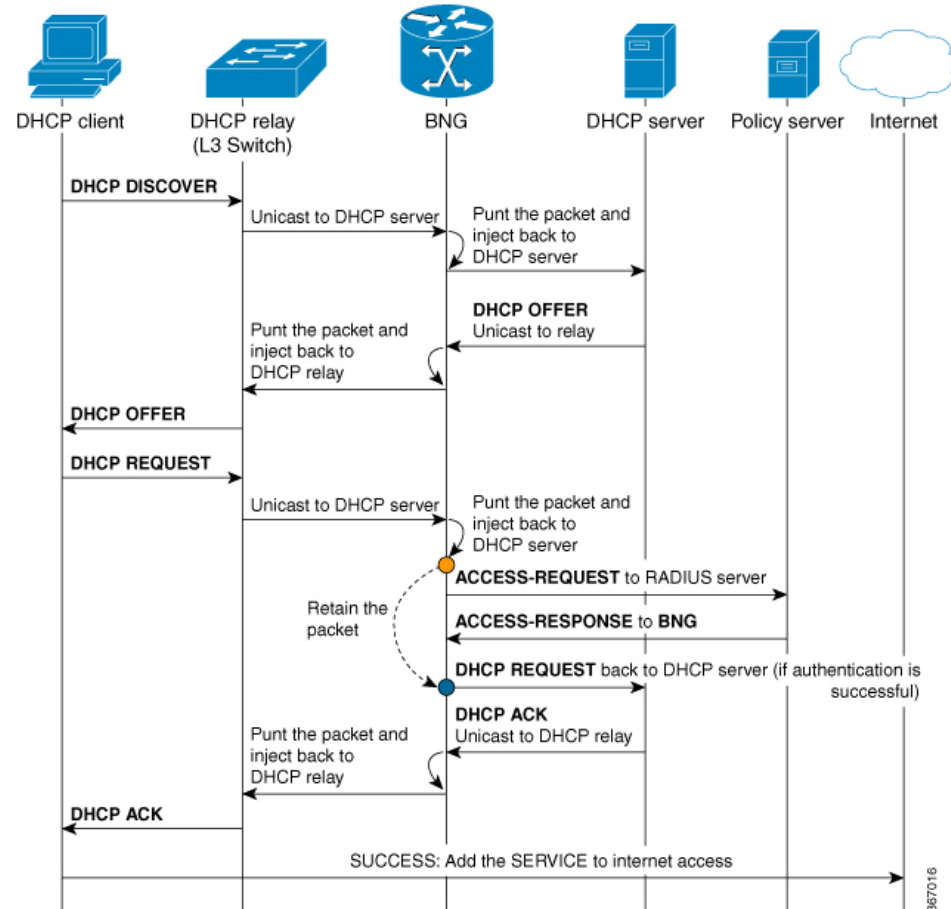

The subscriber sends the DHCP DISCOVER packet to the DHCP server. The packets reaches DHCP relay which in turn unicasts the packet to the DHCP server. The BNG router snoops this packet which is not destined for it. The BNG router punts the packet and injects it back to the DHCP server which is located external to it. The DHCP server unicasts the DHCP OFFER packet to the DHCP relay, through the BNG router. Later, the subscriber sends the DHCP REQUEST packet to the DHCP server, which in turn reaches the BNG router. It is only after receiving this DHCP REQUEST packet from the subscriber that the BNG router initiates the authentication of the subscriber with the AAA server. BNG sends an ACCESS-REQUEST message to the AAA server and the server replies back with an ACCESS-RESPONSE message if the subscriber authentication is successful. This delayed authentication ensures that subscribers sending multiple DISCOVER packets without subsequent REQUEST packets (after successful authentication and DHCP OFFER messages), do not load the AAA server. Once BNG receives the ACCESS-RESPONSE message, it sends the DHCP REQUEST packet from the client to the DHCP server. The DHCP server unicasts the DHCP ACK packet to the DHCP relay, which in turn sends it to the subscriber. This establishes a successful subscriber session in DHCP L3 snooping scenario.

Configure DHCP L3 Snooping in BNG

Configuring DHCPv4 L3 snooping in BNG involves these tasks:

- Enable subscriber session creation based on the DHCP control packets that are not destined for the BNG router.
- While in proxy mode, retain the gateway address (*gi-address*) in the DHCP control packets received from the relay agent as it is. Usually, the *gi-address* value received at BNG while in proxy mode, is modified and a new value is set based on the router configuration.
- Delay the DHCP-AAA server interaction (for a new session request) until the DHCP REQUEST message is received from the client.
- Specify the MAC-gateway address combination as the username for authorization. This helps in authorization in the case of multiple sessions for the same MAC address, but having different *gi-address* values.
- Enable support for duplicate sessions with the same MAC address having different *gi-address* values, mainly in the case of routed sessions.



Note Delayed authentication is supported only for DHCPv4; not for DHCPv6.

Configuration Example for DHCPv4 L3 Snooping

```

/* Configure the interface and the service-policy */
Router#configure
Router(config)#interface TenGigE 0/2/0/3
Router(config-if)#ipv4 address 192.0.2.1 255.255.255.0
Router(config-if)#proxy-arp
Router(config-if)#service-policy type control subscriber policy-map-IPSUBV4

/* Enable subscriber creation based on snooped DHCP packets */
Router(config-if)#ipsubscriber ipv4 routed
Router(config-if-ipsub-ipv4-routed)#initiator dhcp-snoop
Router(config-if-ipsub-ipv4-routed)#commit

/* Retain gateway address */
Router(config)#dhcp ipv4
Router(config-dhcpv4)#profile example-profile proxy
Router(config-dhcpv4-proxy-profile)#giaddr policy keep

/* Configure delayed authentication */
Router(config-dhcpv4-proxy-profile)#delayed authentication

/* Use MAC-giaddr as the username for authorization */
Router(config-dhcpv4-proxy-profile)#authentication username mac giaddr
Router(config-dhcpv4-proxy-profile)#exit

/* Attach the profile to the interface */
Router(config-dhcpv4)#interface TenGigE 0/2/0/3 proxy profile example-profile

/* Enable support for duplicate session */
Router(config-dhcpv4)#duplicate-mac-allowed include-giaddr
Router(config-dhcpv4)#commit

```

Running Configuration

```
interface TenGigE 0/2/0/3
  ipv4 address 192.0.2.1 255.255.255.0
  proxy-arp
  service-policy type control subscriber policy-map-IPSUBV6
  ipsubscriber ipv4 routed
    initiator dhcp-snoop
  !
!
dhcp ipv4
  profile example-profile proxy
  giaddr policy keep
  delayed authentication
  authentication username mac giaddr
  !
interface TenGigE 0/2/0/3 proxy profile example-profile
duplicate-mac-allowed include-giaddr
!
```

Configuring DHCPv6 L3 snooping in BNG involves the following tasks:

- Enable subscriber session creation based on the DHCP control packets that are not destined for the BNG router.
- Use DUID as the username for authorization so that the client authorization is based on the DUID value. This helps mainly for routed DHCPv6-initiated sessions in case the MAC information is not available to BNG through DHCP option 79.
- Use the **prefix-length** to determine the mask to be used for traffic classification. If **prefix-length** is configured, only the IAPD-based session and classification are supported. If **prefix-length** is not configured, the value is considered as 128, by default. In that case, the IANA-based session and classification are supported.

Configuration Example for DHCPv6 L3 Snooping

```
/* Configure the interface and the service-policy */
Router#configure
Router(config)#interface TenGigE 0/2/0/3
Router(config-if)#ipv4 address 192.0.2.1 255.255.255.0
Router(config-if)#proxy-arp
Router(config-if)#service-policy type control subscriber policy-map-IPSUBV6

/* Enable subscriber creation based on snooped DHCPv6 packets */
Router(config-if)#ipsubscriber ipv6 routed
Router(config-if-ipsub-ipv6-routed)#initiator dhcp-snoop prefix-len 64
Router(config-if-ipsub-ipv6-routed)#commit

/* Configure the proxy profile */
Router(config)#dhcp ipv6
Router(config-dhcpv6)#profile example-profile proxy
/* Use DUID as the username for authorization */
Router(config-dhcpv6-proxy-profile)#authentication username DUID
Router(config-dhcpv6-proxy-profile)#exit

/* Attach the profile to the interface */
Router(config-dhcpv6)#interface TenGigE 0/2/0/3 proxy profile example-profile
```

Running Configuration

```
interface TenGigE 0/2/0/3
  ipv4 address 192.0.2.1 255.255.255.0
  proxy-arp
  service-policy type control subscriber policy-map-IPSUBV6
  ipsubscriber ipv6 routed
  initiator dhcp-snoop prefix-len 64
!
!
dhcp ipv6
  profile example-profile proxy
  authentication username DUID
!
interface TenGigE 0/2/0/3 proxy profile example-profile
!
```

Verify DHCP L3 Snooping Configuration

- Verify if the DHCP statistics from the clients (RX) and the ones sent towards the DHCP server (TX) match. If it matches, it indicates that the BNG router received the requests from the clients and forwarded them to the server.

```
Router# show dhcp ipv4 proxy statistics location 0/0/CPU0
Wed Jan 23 18:07:12.386 IST
```

VRF	RX	TX	DR
default	4000	4000	
**nVSatellite	0	0	

- Verify the detailed DHCP statistics. The below output is for 1000 successful IPv4 subscriber sessions.

```
Router# show dhcp vrf default ipv4 proxy statistics location 0/0/CPU0
Wed Jan 10 20:24:05.628 EDT
```

DHCP IPv4 Proxy/Server Statistics for VRF default:

TYPE	RECEIVE	TRANSMIT	DROP
DISCOVER	1000	1000	0
OFFER	1000	1000	0
REQUEST	1000	1000	0
DECLINE	0	0	0
ACK	1000	1000	0
NAK	0	0	0
RELEASE	0	0	0
INFORM	0	0	0
LEASEQUERY	0	0	0
LEASEUNASSIGNED	0	0	0
LEASEUNKNOWN	0	0	0
LEASEACTIVE	0	0	0
BOOTP-REQUEST	0	0	0
BOOTP-REPLY	0	0	0

- Verify RADIUS authorization information mainly on the statistics of access requests, access accepts, access rejects and so on.

```
Router# show radius authentication
Wed Jan 23 18:07:12.386 IST

Server: 203.0.113.3, port: 1812/ default
  9 requests, 0 pending, 0 retransmits
  9 accepts, 0 rejects, 0 challenges
  0 timeouts, 0 bad responses, 0 bad authenticators
  0 unknown types, 0 dropped, 27 ms latest rtt
  Throttled: 0 transactions, 0 timeout, 0 failures
  Estimated Throttled Access Transactions: 0
  Maximum Throttled Access Transactions: 0

Automated TEST Stats:
  0 requests, 0 timeouts, 0 response, 0 pending
```

- Verify information about the number of accounting requests and responses transacted. In this example, each sessions is configured with sessions accounting as well as service accounting. So there are two requests for each session when it is set up. From then onwards, accounting requests are sent at every interim interval.

```
Router# show subscriber manager statistics AAA accounting location 0/0/CPU0
Wed Jan 23 18:07:12.386 IST
[ AAA ACCOUNTING STATISTICS ]

Sessions Active = 0
  Started       = 0
  Stopped      = 0

AAA Requests:
      Requests      Errors      Sent      Succeeded      Failed
      =====      =====      =====      =====      =====
      Start        2000          0          2000          2000           0
      Stop          0             0           0             0             0
      Interim       0             0           0             0             0
      Passthru      0             0           0             0             0
      Update        0             0           -             -             -

Interim Inflight Quota = 2000
  Remaining             = 2000
  Low Water Mark        = 2000
  Requests Accepted     = 0
  Requests Denied       = 0
  Quota Exhausts        = 0

Errors:
  None
```

In addition to the above commands, you can also use these commands to verify details on subscriber sessions, the reason for session disconnect, the QoS policy applied on the subscriber interface and so on:

- **show subscriber session all summary**
- **show ipsubscriber summary**
- **show subscriber manager disconnect-history**

- **show dhcp ipv4 proxy disconnect-history**
- **show subscriber database association**
- **show policy-map**

Related Topics

- [DHCP L3 Routed Subscriber Snooping, on page 161](#)
- [RADIUS Attributes for DHCP L3 Snooping in BNG, on page 168](#)

Associated Commands

- [authentication username](#)
- [delayed authentication](#)
- [duplicate-mac-allowed](#)
- [giaddress policy keep](#)
- [initiator dhcp-snoop](#)

RADIUS Attributes for DHCP L3 Snooping in BNG

This section describes the changes made to the BNG interface towards the AAA server, as part of the DHCP L3 snooping feature. A new attribute-value pair (AVP) encoding format and a set of new Cisco AVPs are introduced as part of this feature.

For example, prior to introducing DHCP L3 snoop feature, vendor-ID (DHCP option 60) attribute was encoded as a Cisco AVP in the below format:

```
AVP: l = 35   t = Vendor-Specific(26)  v =ciscoSystems(9)
VSA: l=29   t = Cisco-AVPair(1): dhcp-vendor-class=\xExample
```

With the introduction of DHCP L3 snoop feature, the same attribute can also be encoded in the following format using a new AVP, *Cisco-DHCP-Vendor-Class*. BNG supports both old and new formats.

```
AVP: l = 17   t = Vendor-Specific(26)  v =ciscoSystems(9)
VSA: l=11   t = Cisco-DHCP-Vendor-Class(48): \xExample
```

Likewise, a set of unique AVPs are introduced as part of DHCP L3 snooping feature, for the below mentioned DHCP attributes:

- *remote-id and circuit-id (DHCPv4 option 82)*
- *vendor-id (DHCPv4 option 60, DHCPv6 option 16)*
- *user-class (DHCPv4 option 77, DHCPv6 option 15)*
- *gi-address (DHCPv4 relay agent address)*
- *subscriber-id (DHCPv6 relay agent subscriber-ID or DHCPv6 option 38)*
- *link-address (DHCPv6 relay header link-address)*

- *subscriber:sub-qos-policy-in*
- *subscriber:sub-qos-policy-out*
- *ipv4:inacl*
- *ipv4:outacl*
- *ipv6:inacl*
- *ipv6:outacl*
- *subscriber:sub-pbr-policy-in*
- *subscriber:sa*
- *subscriber:sd*
- *service-name*
- *parent-session-id*

The new AVPs corresponding to the above DHCP options and attributes are listed below. These attributes are sent in the AAA Access-Request message or in the change-of-authorization (CoA) message in the respective direction, in both the new and the old formats.

Direction: BNG to AAA server

DHCPv4 Option	Cisco AVP	Type
82	cisco-relay-information-option	46
77	cisco-dhcp-user-class	47
60	cisco-dhcp-vendor-class	48
-	cisco-dhcp-relay-giaddr	50

Direction: BNG to AAA server

DHCPv6 Option	Cisco AVP	Type
15	cisco-dhcp-user-class	47
38	cisco-dhcp-subscriber-id	65
60	cisco-dhcpv6-link-address	66

Direction: AAA server to BNG

Attribute	Cisco AVP	Type
service-name	cisco-vs-a-service-name	51
parent-session-id	cisco-vs-a-parent-session-id	52

Attribute	Cisco AVP	Type
subscriber:sub-qos-policy-in	cisco-vsa-sub-qos-pol-in	55
subscriber:sub-qos-policy-out	cisco-vsa-sub-qos-pol-out	56
ipv4:inacl=ALL_DENY	cisco-vsa-in-acl	57
ipv4:outacl=ALL_DENY	cisco-vsa-out-acl	58
subscriber:sub-pbr-policy-in	cisco-vsa-sub-pbr-policy-in	59
subscriber:sa	cisco-vsa-sub-activate-service	60
ipv6:inacl	cisco-vsa-ipv6-in-acl	61
ipv6:outacl	cisco-vsa-ipv6-out-acl	62
subscriber:sd	cisco-vsa-sub-deactivate-service	63

For a list of Cisco VSAs, see [RADIUS Vendor-Specific Attributes, on page 512](#).

Specifying DHCP Lease Limit

The DHCP lease limit feature allows you to limit the number of DHCP bindings on an interface. A binding represents the mapping between the MAC address of the client and the IP address allocated to it. The lease limit can be specified for each Circuit-ID, or Remote-ID, or interface.

The lease limit can be configured through a DHCP proxy profile. When this profile is attached to an interface, bindings up to the configured limit on that interface are allowed. For example, if a profile with a per-circuit lease limit of 10 bindings is assigned to four interfaces, then for each unique Circuit-ID, there would be 10 bindings allowed for each interface.

If the lease limit is lowered below the current number of existing bindings, then the existing bindings are allowed to persist, but no new bindings are allowed to be created until the number of bindings drops below the new lease limit.

If the lease limit is specified from the AAA server, as part of Change of Authorization (CoA) or Access-Accept message, then the DHCP lease limit configured through the proxy profile is overridden. In this case, the most recent session limit, received from the AAA server, is taken as the current lease limit for the particular Circuit-ID. The lease limit set from the AAA server is cleared when there are no more client bindings associated with the Circuit-ID for which the lease limit is applied.

To specify the lease limit, see these procedures:

- [Specifying the Lease Limit for a Circuit-ID, on page 170](#)
- [Specifying the Lease Limit for a Remote-ID, on page 172](#)
- [Specifying the Lease Limit for an Interface, on page 173](#)

Specifying the Lease Limit for a Circuit-ID

Perform this task to specify the lease limit for each Circuit-ID.

SUMMARY STEPS

1. **configure**
2. **dhcp ipv4**
3. **profile** *profile-name* **proxy**
4. **limit lease per-circuit-id** *value*
5. Use the **commit** or **end** command.

DETAILED STEPS

	Command or Action	Purpose
Step 1	configure Example: RP/0/RSP0/CPU0:router# configure	Enters global configuration mode.
Step 2	dhcp ipv4 Example: RP/0/RSP0/CPU0:router(config)# dhcp ipv4	Enters the IPv4 DHCP configuration mode.
Step 3	profile <i>profile-name</i> proxy Example: RP/0/RSP0/CPU0:router(config-dhcpv4)# profile profile1 proxy	Creates a DHCP profile.
Step 4	limit lease per-circuit-id <i>value</i> Example: RP/0/RSP0/CPU0:router(config-dhcpv4-proxy-profile)# limit lease per-circuit-id 1000	Specifies the lease limit for a Circuit-ID that is applied to an interface.
Step 5	Use the commit or end command.	commit —Saves the configuration changes and remains within the configuration session. end —Prompts user to take one of these actions: <ul style="list-style-type: none"> • Yes — Saves configuration changes and exits the configuration session. • No —Exits the configuration session without committing the configuration changes. • Cancel —Remains in the configuration session, without committing the configuration changes.

Specifying the Lease Limit for a Circuit-ID: An example

```
configure
dhcp ipv4
profile profile1 proxy
limit lease per-circuit-id 1000
```

```

!
!
end

```

Specifying the Lease Limit for a Remote-ID

Perform this task to specify the lease limit for each Remote-ID.

SUMMARY STEPS

1. **configure**
2. **dhcp ipv4**
3. **profile** *profile-name* **proxy**
4. **limit lease per-remote-id** *value*
5. Use the **commit** or **end** command.

DETAILED STEPS

	Command or Action	Purpose
Step 1	configure Example: RP/0/RSP0/CPU0:router# configure	Enters global configuration mode.
Step 2	dhcp ipv4 Example: RP/0/RSP0/CPU0:router(config)# dhcp ipv4	Enters the IPv4 DHCP configuration mode.
Step 3	profile <i>profile-name</i> proxy Example: RP/0/RSP0/CPU0:router(config-dhcpv4)# profile profile1 proxy	Creates a DHCP profile.
Step 4	limit lease per-remote-id <i>value</i> Example: RP/0/RSP0/CPU0:router(config-dhcpv4-proxy-profile)# limit lease per-remote-id 1340	Specifies the lease limit for a Remote-ID that is applied to an interface.
Step 5	Use the commit or end command.	<p>commit —Saves the configuration changes and remains within the configuration session.</p> <p>end —Prompts user to take one of these actions:</p> <ul style="list-style-type: none"> • Yes — Saves configuration changes and exits the configuration session. • No —Exits the configuration session without committing the configuration changes. • Cancel —Remains in the configuration session, without committing the configuration changes.

Specifying the Lease Limit for a Remote-ID: An example

```
configure
dhcp ipv4
profile profile1 proxy
limit lease per-remote-id 1340
!
!
end
```

Specifying the Lease Limit for an Interface

Perform this task to specify the lease limit for each interface.

SUMMARY STEPS

1. **configure**
2. **dhcp ipv4**
3. **profile** *profile-name* **proxy**
4. **limit lease per-interface** *value*
5. Use the **commit** or **end** command.

DETAILED STEPS

	Command or Action	Purpose
Step 1	configure Example: RP/0/RSP0/CPU0:router# configure	Enters global configuration mode.
Step 2	dhcp ipv4 Example: RP/0/RSP0/CPU0:router(config)# dhcp ipv4	Enters the IPv4 DHCP configuration mode.
Step 3	profile <i>profile-name</i> proxy Example: RP/0/RSP0/CPU0:router(config-dhcpv4)# profile profile1 proxy	Creates a DHCP profile.
Step 4	limit lease per-interface <i>value</i> Example: RP/0/RSP0/CPU0:router(config-dhcpv4-proxy-profile)# limit lease per-interface 2400	Specifies the lease limit for each interface.
Step 5	Use the commit or end command.	commit —Saves the configuration changes and remains within the configuration session. end —Prompts user to take one of these actions:

	Command or Action	Purpose
		<ul style="list-style-type: none"> • Yes — Saves configuration changes and exits the configuration session. • No —Exits the configuration session without committing the configuration changes. • Cancel —Remains in the configuration session, without committing the configuration changes.

Specifying the Lease Limit for an Interface: An example

```

configure
dhcp ipv4
profile profile1 proxy
limit lease per-interface 2400
!
!
end

```

Understanding DHCP Option-82

DHCP Option 82 allows the DHCP server to generate IP addresses based on the location of the client device. This option defines these sub-options:

- **Agent Circuit ID Sub-option**—This sub-option is inserted by DSLAM and identifies the subscriber line in the DSLAM.
- **Agent Remote ID Sub-option**—This sub-option is inserted by DSLAM or BNG in an I2-connected topology. It is the client MAC address, but can be overridden. With the DHCP proxy or relay, the client MAC address is lost by the time the packet gets to the DHCP server. This is a mechanism that preserves the client MAC when the packet gets to the server.
- **VPN identifier sub-option**—This sub-option is used by the relay agent to communicate the VPN for every DHCP request that is sent to the DHCP server, and it is also used to forward any DHCP reply that the DHCP server sends back to the relay agent.
- **Subnet Selection Sub-option**—This sub-option allows the separation of the subnet from the IP address and is used to communicate with the relay agent. In a DHCP processing, the gateway address specifies both the subnet on which a DHCP client resides, and the IP address that the server uses to communicate with the relay agent.
- **Server Identifier Override Sub-option**—This sub-option value is copied in the reply packet from the DHCP server, instead of the normal server ID address. This sub-option contains the incoming interface IP address, which is the IP address on the relay agent that is accessible from the client. Using this information, the DHCP client sends all renew and release packets to the relay agent, which in turn adds all of the VPN sub-options and forwards the renew and release packets to the original DHCP server.



Note The VPN Identifier, Subnet Selection, and Server Identifier Override sub-options are used by DHCP relay/proxy for supporting MPLS VPNs.

Option 82 Relay Information Encapsulation

When two relay agents are relaying messages between the DHCP client and DHCP server, the second relay agent (closer to the server), by default, replaces the first option 82 information with its own option 82. The remote ID and circuit ID information from the first relay agent is lost. In some deployment scenarios, it is necessary to maintain the initial option 82 from the first relay agent, in addition to the option 82 from the second relay agent.

The DHCP option 82 relay information encapsulation feature allows the second relay agent to encapsulate option 82 information in a received message from the first relay agent, if it is also configured to add its own option 82 information. This configuration allows the DHCP server to use option 82 information from both the relay agents.

Configuring DHCPv4 Class of Service (CoS)

BNG supports manual reset of Class of Service (CoS) value of DHCPv4 control packets sent on subscriber interfaces. By default, the outer and inner CoS values are set to 6. This feature allows to set or modify these CoS values sent by BNG.

The inner and outer Class of Service (CoS) values can be configured for DHCPv4 control packets. For broadcast packets, both the **inner-cos** and **outer-cos** commands can be used to configure CoS values. For unicast packets, the **inner-cos** command cannot be directly used. The outer CoS value configured using the **outer-cos** command is also set as the inner CoS value.

To reset the CoS values, use the **dhcp ipv4 [inner-cos | outer-cos] value** command.

For more information about configuring the CoS values, see the *BNG DHCP Commands* chapter in the *Cisco ASR 9000 Series Aggregation Services Router Broadband Network Gateway Command Reference*.

Send Rich DHCP Options from RADIUS to DHCP Server or Proxy

Rich DHCP options are options derived from the RADIUS and some of these options enable customisation of benefits or services available to subscribers on a per-subscriber basis.

Rich DHCP option enhances the DHCPv4 server profile whereby BNG provides subscriber-based DHCP options to the client through DHCP messages. These options are retrieved by BNG as Cisco attribute-value pairs (AVPs) from the AAA server. Cisco AVP, **dhcpv4-option**, is used to send various DHCPv4 option types from the AAA server to the DHCP server.



Note Rich DHCP options are supported only on DHCP server profile and DHCP proxy profile.

Each AVP carries a generic DHCPv4 option. If DHCP server profile is configured on BNG, the per-subscriber-based DHCP options get preference over the generic DHCP options.

Apart from sending Rich DHCPv4 options, from Release 6.4.1, BNG routers acting as DHCP servers are enabled to send Rich DHCPv6 options as well through RADIUS VSA. Cisco AVP, **dhcpv6-option**, is used to send various DHCPv6 option types from the AAA server to the DHCP server.

The following figure illustrates that when multiple clients send DHCP requests to the DHCP server, unique and subscriber-based Rich DHCP Options are sent from the AAA server to the DHCP server.

Figure 18: Flow of Rich Options From AAA Server to DHCP Server

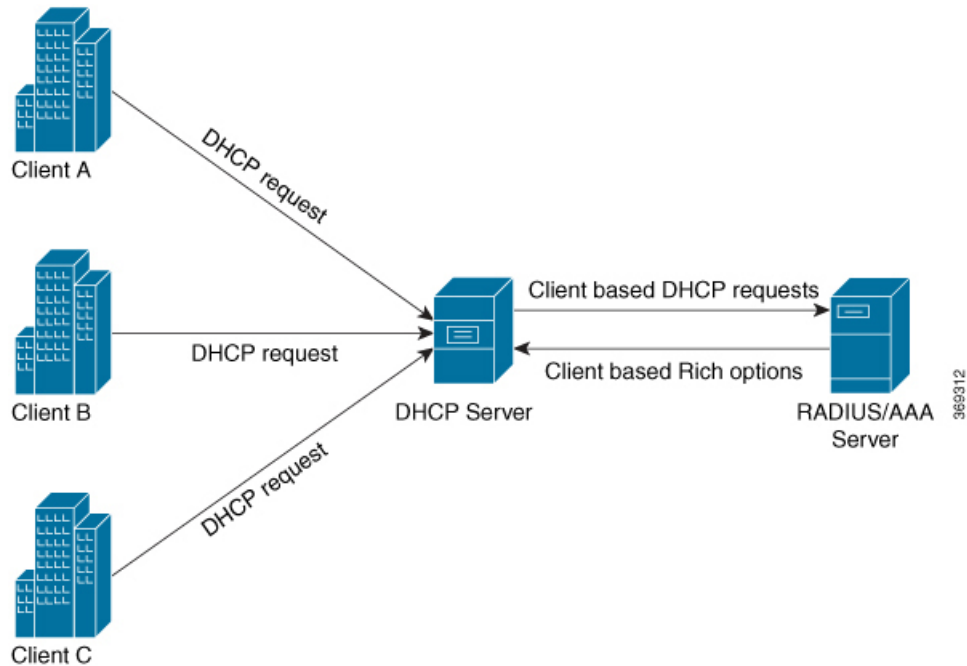

Apart from the DHCP server profile, from Release 6.6.2, Rich DHCP options enhances the DHCPv4 and DHCPv6 proxy profiles as well whereby the BNG router acts as the DHCP proxy. DHCP proxy downloads RADIUS configured Rich options from the AAA server and appends them in the packets while forwarding them to the DHCP server.

The following figure illustrates that when multiple clients send DHCP requests to the DHCP proxy, unique and subscriber-based Rich DHCP Options are sent from the AAA server to the DHCP proxy. DHCP proxy sends the options to the DHCP server.

Figure 19: Flow of Rich Options From AAA Server to DHCP Proxy

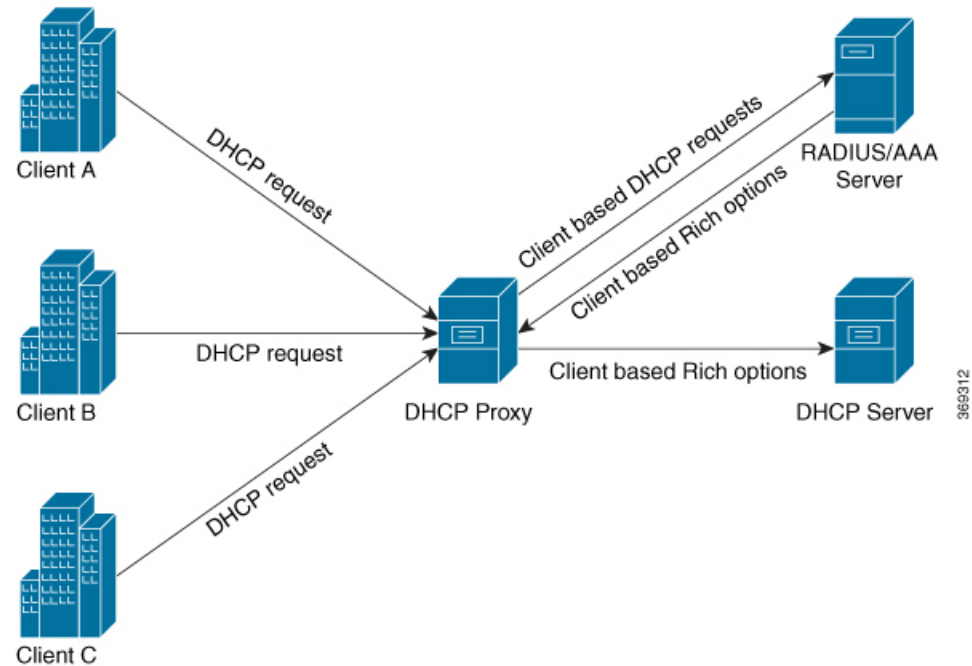

RADIUS sends the following DHCPv4 and DHCPv6 options to the DHCP Server and these options can influence DHCP server while allocating IP addresses to clients:



Note The numbers mentioned in parenthesis represent Option IDs.

- DHCPv4 options
 - Relay Agent Information (82)
 - Client Id (61)
 - Address Request (50)
- DHCPv6 options
 - Subscriber-ID (38)
 - Interface-ID (18)

Restrictions for Supporting Rich DHCPv6 Option on RADIUS VSA for DHCPv6 Servers

Supporting Rich DHCP option on RADIUS through AVPs for DHCPv6 servers is subjected to these restrictions:

- A maximum of only eight DHCPv6 options can be configured for each user profile.
- A maximum of only 120 hexadecimal bytes and 240 ASCII characters (approximately) can be sent from the AAA server to the BNG router.

- Flexibility of encoding the data in ASCII or hexadecimal format is available if the characters are printable. However, if you have to encode a non-printable character, the only option is to encode it as hexadecimal. This encoding in turn limits the available data length (considering that 2 bytes are required to encode one character).

Use Cases for Rich DHCP Option on RADIUS VSA

This table lists some of the use cases and expected behavior of rich DHCP option on RADIUS VSA.

Use Case Description	Expected Behavior
Create a basic BNG IPoE session without including Cisco AVP (DHCP options) in Access-Accept message while authorizing the subscriber.	BNG creates the IPoE session successfully and verifies that it includes DHCP options which are configured under the DHCP server profile.
Create a basic BNG IPoE session by processing Cisco AVP (DHCP options) in Access-Accept message while authorizing the subscriber.	BNG creates the IPoE session successfully by parsing the Cisco-AVP values and by fetching the DHCP options from each Cisco-AVP. BNG also includes the successfully parsed or identified DHCP option values in the DHCP Offer or DHCP Ack messages toward the end-user.
Renew BNG IPoE session by processing DHCP Request message.	BNG successfully renews the IPoE session by including the DHCP options (previously received from the AAA server) along with appropriate lease time, in the DHCP Ack message.
Generate an information request for BNG IPoE session by processing the DHCP Inform message.	BNG replies with Ack message for the IPoE session, by including previously received DHCP options from the AAA server.
A packet sent by a client already has a RADIUS option.	DHCP proxy server replaces it with the downloaded RADIUS option before forwarding the packet to the DHCP server.

This table lists some of the error conditional use cases and the expected behavior.

Use Case Description	Expected Behavior
An invalid Cisco-AVP present in the Access-Accept message while authorizing the subscriber	BNG drops the session and the session does not come up.
An invalid DHCP option present in Cisco-AVP of the received Access-Accept message while authorizing the subscriber	BNG drops the session and the session does not come up.
Access-Accept message with maximum number of Cisco-AVPs for DHCP options	BNG sets maximum supported Cisco-AVP attributes for carrying DHCP options and ignores the attributes exceeding this limit.
Fragmented Access-Accept message	BNG handles fragmented Access-Accept messages, waits for re-assembling the packet and processes the reassembled packet as per the functionality.

Use Case Description	Expected Behavior
(Access-Accept message is fragmented at source or intermediate router because of MTU issues. This is because of more number of of Cisco-AVPs.)	



Note Through the **aaa dhcp-option force-insert** command you can send DHCP options while replying to the DHCP client, regardless of the request from the DHCP host.

Configure Rich DHCP Option on RADIUS VSA

To enable rich DHCP option on RADIUS VSA, use **aaa dhcp-option force-insert** command in dhcpv4 or dhcpv6 server profile configuration mode. When it is configured, BNG mandatorily inserts the DHCP option while replying to the DHCP client, regardless of whether DHCP host requested it in the DHCP-request packet or not.

Configuration Example: DHCPv4 Server

```
Router#configure
Router(config)#dhcp ipv4
Router(config-dhcpv4)#profile DHCPV4_EXAMPLE_PROFILE server
Router(config-dhcpv4-server-profile)#aaa dhcp-option force-insert
```

Configuration Example: DHCPv6 Server

```
Router#configure
Router(config)#dhcp ipv6
Router(config-dhcpv6)#profile DHCPV6_EXAMPLE_PROFILE server
Router(config-dhcpv6-server-profile)#aaa dhcp-option force-insert
```

RADIUS Interface to Support Rich DHCP Option on RADIUS VSA

The existing vendor-specific attribute (VSA) of type 26 is used to process Cisco AVPs with DHCP options.

The usage format of the **dhcpv4-option** AVP is:

```
Cisco-avpair = "dhcpv4-option = DHCP-option-type, DHCP-option-length,
DHCP-option-data-format, DHCP-option-data"
```

The usage format of the **dhcpv6-option** AVP is:

```
Cisco-avpair = "dhcpv6-option = DHCP-option-type, DHCP-option-length,
DHCP-option-data-format, DHCP-option-data"
```

where,

- *DHCP-option-type* is the type of DHCP option, in decimal.
- *DHCP-option-length* is the length of DHCP option, in decimal.

- *DHCP-option-data-format* is the format in which DHCP option is encoded, in decimal. The format is 1 for IP address, 2 for ASCII and 3 for hexadecimal.
- *DHCP-option-data* is the DHCP option as specified by the data format.

For example,

```
Cisco-avpair = "dhcpv4-option=1, 4, 3, fffffff0"
```

```
Cisco-avpair = "dhcpv6-option=64,16,2,example.com"
```

If you want to include sub-options, then the full sub-option encoding (including type, length, format and data of sub-option) must be done in the AVP DHCP option data. Options having sub-option must be configured only in hexadecimal format.

Verification

You can use **show subscriber session** command to get details of the BNG subscriber session:

```
Router#show subscriber session all detail internal
Mon Feb 15 23:00:59.833 IST
Interface:                GigabitEthernet0/1/0/0.100.ipl
Circuit ID:                Unknown
Remote ID:                Unknown
=====
=====
1:  service-type          len=  4  value= Outbound
2:  ipv4-mtu              len=  4  value= 806(326)
3:  dhcpv4-option        len= 12  value= 1,4,3,ffffff0
4:  dhcpv4-option        len= 20  value= 3,8,3,0a0a0a0a0b0b0e
5:  dhcpv4-option        len= 13  value= 44,4,3,0c0c0c0c
6:  dhcpv4-option        len= 29  value= 4,12,3,010203040a0a0a0a0b0b0e
=====
=====
```

Related Topics

- [Send Rich DHCP Options from RADIUS to DHCP Server or Proxy, on page 175](#)

Associated Commands

[aaa dhcp-option force-insert](#)

DHCP Option 60 Filtering

DHCP option 60 filtering in BNG provides support to either block or allow subscribers based on the DHCPv4 option 60 (Vendor-Id or Class-Id) field. This feature provides administrator the flexibility to drop illegal clients (with Vendor-Id in the blocked list) at an early stage of DHCP session handling.

A list of allowed or blocked clients is created using specific configuration in DHCP. Every incoming DHCP packet is filtered based on the prevailing configuration. The feature kicks in only for DISCOVER packets that have option 60 field available. The DISCOVER packet from a blocked client is not treated as a first-sign-of-life (FSOL).

To enable DHCP option 60 filtering, use **match option 60** command in dhcpv4 profile (server or proxy or base/dynamic profile) configuration mode. We can specify either an **allow** or **drop** action. In the case of dynamic mode, the preference is given to the base profile filter list over proxy or server mode filter list, if available.

You can also configure a global filter in case any Vendor-Id specific option 60 filter is not configured. This default action is applied only for the packets where a Vendor-Id option 60 field is available, but without a matching option 60 filter.

Configure DHCP Option 60 Filtering

Configuration Example

For server and proxy profile:

```
RP/0/RSP0/CPU0:router#configure
RP/0/RSP0/CPU0:router(config)#dhcp ipv4
RP/0/RSP0/CPU0:router(config-dhcpv4)#profile DHCPV4_SAMPLE_PROFILE server
RP/0/RSP0/CPU0:router(config-dhcpv4-server-profile)#match option 60 hex FFFF action allow
```

For base or dynamic profile:

```
RP/0/RSP0/CPU0:router(config-dhcpv4)#profile DHCPV4_SAMPLE_BASE_PROFILE base
RP/0/RSP0/CPU0:router(config-dhcpv4-base-profile)#match option 60 FFFF action allow
```

To define a default behavior for any profile:

```
RP/0/RSP0/CPU0:router(config-dhcpv4)#profile DHCPV4_SAMPLE_PROFILE server
RP/0/RSP0/CPU0:router(config-dhcpv4-server-profile)#match option 60 default action allow
```

Use Cases of DHCP Option 60 Filtering

This table lists some of the use cases and expected behavior of DHCP Option 60 filtering.

Use Case Description	Expected Behavior
Configure blocked list of Vendor-Id values in server or proxy profile and bring up BNG IPoE session. match option 60 hex <hex-string> action drop match option 60 default action allow	BNG allows all DISCOVER packets by default except the ones that are explicitly configured to be dropped. Session comes up for all, except for blocked list of clients.
Configure allowed list of Vendor-Id values in server or proxy profile and bring up BNG IPoE session. match option 60 hex <hex-string> action allow match option 60 default action drop	BNG drops all DISCOVER packets by default except the ones that are explicitly configured to be allowed. Session comes up for allowed list of clients.
Configure blocked list of Vendor-Id values in base or dynamic profile and bring up BNG IPoE session. match option 60 hex <hex-string> action drop match option 60 default action allow	BNG allows all DISCOVER packets by default except the ones that are explicitly configured to be dropped. Session comes up for all, except for blocked list of clients.

Use Case Description	Expected Behavior
Configure allowed list of Vendor-Id values in base or dynamic profile and bring up BNG IPoE session. <pre>match option 60 hex <hex-string> action allow match option 60 default action drop</pre>	BNG drops all DISCOVER packets by default except the ones that are explicitly configured to be allowed. Session comes up for allowed list of clients.
Block all DISCOVER packets by default. <pre>match option 60 default action drop</pre>	BNG drops all DISCOVER packets provided Option 60 field is available. If not, the DISCOVER packets are always allowed.
Allow all DISCOVER packets by default. <pre>match option 60 default action allow</pre>	BNG allows all DISCOVER packets. The same behavior is observed when this feature is not configured.

Verification

Use this command to see the DHCP option 60 drop count.

```
RP/0/RSP0/CPU0:router#show dhcp ipv4 server/proxy statistics raw include-zeroes all | inc
packet_option_60_drop
```

Use this command to see the table of received, transmitted and dropped packets mapped with the DHCP option 60 drop count.

```
RP/0/RSP0/CPU0:router#show dhcp vrf default ipv4 server/proxy statistics
```

Send DHCP Options to RADIUS

DHCP options are sent as Cisco attribute-value pairs (AV pairs) to the RADIUS. There is an option to send all or specific incoming DHCPv4 and DHCPv6 option values in the DHCP client messages to the AAA server. This additional control facilitates advanced authorization options of the client. One of the examples of advanced authorization options available is that a particular IP address requested by a client can be allocated to that client against a random IP address allocation, if that particular IP address is not already allocated to some other client.

In the following figure, the DHCP request from client asks for a particular IP address to be allocated and therefore a particular DHCP option is configured to be sent to the RADIUS or AAA server, for example Option 1 enables allocation of a particular IP address to the client.

Figure 20: Flow of DHCP Options from DHCP Server or DHCP Proxy to the AAA Server

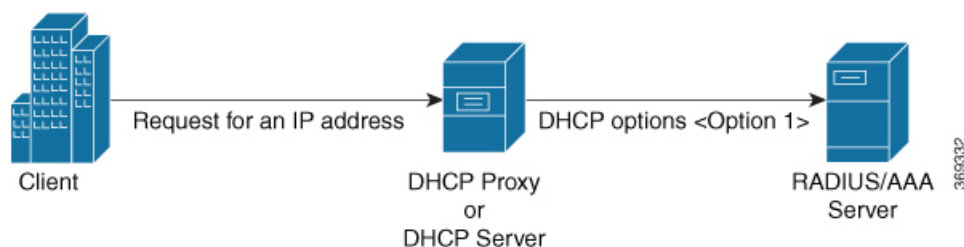

To send DHCPv4 and DHCPv6 options to the AAA server, **cisco-dhcpv4-option-to-aaa** and **cisco-dhcpv6-option-to-aaa** AV pairs are used by the BNG router.

The AVP format is:

```
"AVP: l=17 t = Vendor-Specific(26) v =ciscoSystems(9)
  VSA: l=11 t = cisco-dhcpv4-option-to-aaa(90):
  DHCP-option-type,DHCP-option-length,DHCP-option-data"
```

where,

- *DHCP-option-type* is the type of the DHCP option, in decimal.
- *DHCP-option-length* is the length of the DHCP option, in decimal.
- *DHCP-option-data* is the opaque data that is received from the client.

An AVP example is,

```
VSA: l=11 t = cisco-dhcpv4-option-to-aaa(90): 50,4,a1a2a3a4
```

To select the DHCPv4 or DHCPv6 options to be sent to the AAA server, use the **dhcp-to-aaa option list** or **dhcpv6-to-aaa option list** command in the DHCPv4 or DHCPv6 server profile configuration mode. The selected DHCP options are sent by the **cisco-dhcpv4-option-to-aaa** and **cisco-dhcpv6-option-to-aaa** AVPs through the AAA messages.

DHCP Option to RADIUS VSA Mapping

The new Cisco AVPs, **cisco-dhcpv4-option-to-aaa** and **cisco-dhcpv6-option-to-aaa**, send the DHCPv4 and DHCPv6 options as opaque values in the Access-Request message. For each DHCPv4 or DHCPv6 option that is configured, a separate instance of this AV pair is added to the AAA record.

It is not required to use the **cisco-dhcpv4-option-to-aaa** or **cisco-dhcpv6-option-to-aaa** AVP for the following DHCPv4 or DHCPv6 options, because they are already sent to the AAA server as part of the AAA messages.

- Client-ID
- Remote-ID
- Circuit-ID
- Vendor-ID
- User-class

These options continue to be encoded the way it was prior to the introduction of **cisco-dhcpv4-option-to-aaa** or **cisco-dhcpv6-option-to-aaa** AVP. However, these options are sent to the AAA server in both the new and old formats if **dhcp-to-aaa list all** or **dhcpv6-to-aaa list all** command is configured on BNG.

Configure Generic DHCP Option to RADIUS VSA Mapping

The command, **dhcp-to-aaa option list**, controls the subscriber DHCP options to be sent to the AAA server. It is available in DHCP profile mode to control the DHCP option list for each profile.



Note The command, **dhcp-to-aaa option list**, is currently available only in DHCPv4 server and proxy profile modes.

Configuring generic DHCP option to RADIUS VSA mapping in BNG involves these steps:

Configuration Example

```
Router#configure
Router(config)#dhcp ipv4
Router(config-dhcpv4)#profile server-profile server
Router(config-dhcpv4-server-profile)#dhcp-to-aaa option list 90 50
Router(config-dhcpv4-server-profile)#commit
```

Running Configuration

```
dhcp ipv4
  profile server-profile server
  dhcp-to-aaa option list 90 50
!
```

Related Topics

[Send DHCP Options to RADIUS, on page 182](#)

Associated Commands

[dhcp-to-aaa option list](#)

DHCP RADIUS Proxy

BNG supports DHCP IPv4 RADIUS proxy for RADIUS-based authorization of DHCP leases. This is a RADIUS-based address assignment mechanism in which a DHCP server authorizes remote clients and allocates IP addresses, based on replies from a RADIUS server. For DHCP RADIUS proxy to work, you must configure the DHCPv4 server profile on the BNG interface.

These are the steps involved in the address assignment mechanism:

- The DHCP server sends DHCP client information to the RADIUS server.
- The RADIUS server returns all required information, primarily IPV4 address and subnet mask, to the DHCP server, in the form of RADIUS attributes.
- The DHCP server translates the RADIUS attributes into DHCP options and sends this information back in a DHCP OFFER message to the DHCP client.
- The DHCP binding is synchronized after the RADIUS server authorizes the client session.

If DHCPv4 IETF attributes: **Framed-IP-Address** and **Framed-IP-Netmask** are received from the RADIUS server, then they are preferred and used instead of allocating the IP address from the local pool.

Example:

```
Framed-IP-Address = 10.10.10.81,
Framed-IP-Netmask = 255.255.255.0,
```

If Cisco attribute: **VRF-ID** is received from the RADIUS server and configured on BNG, then it is used and preferred over local configuration.

Example:

```
Cisco-avpair = "vrf-id=RED"
```

If Cisco attributes: **ipv6:addrv6** and **delegated-prefix** are received from the RADIUS server, then they are preferred and used instead of allocating the IP address from the local pool.

Example:

```
Cisco-avpair = "ipv6:addrv6=2000:4:4::1",
Cisco-avpair = "delegated-prefix=3405:100:1015:2::/64"
```

Apart from these attributes, if the RADIUS server sends the **dhcp-class** attribute to the DHCP server, then that attribute value is used to decide other configuration parameters in the reply that is to be sent to the DHCP client. For example, if the DHCPv4 server profile has both Class A and Class B in it, and if RADIUS server sends a reply to the DHCP server with the class name as 'B', then instead of Class A, Class B is used to send the options back to the DHCP client.

Additional RADIUS server attributes are allowed, but not mandatory. The DHCP server ignores additional attributes that it does not recognize. If a RADIUS server user profile contains a required attribute that is empty, the DHCP server does not generate the DHCP options.

Subscriber Session-Restart

BNG supports IPoE subscriber session-restart, where the DHCP binding for a subscriber session is retained even after the session is deleted. The DHCP client still holds the initial IP address issued by BNG. Later, when the client sends data packets or a DHCP renew request, the session is re-created in BNG. This behavior applies to DHCPv4 sessions on RP or LC.

At the time of session deletion, the DHCP binding moves from the BOUND to the DISCONNECT state. The subscriber label is reset to 0x0 when the binding moves to the DISCONNECT state. Later, when the session is re-created, the binding state then moves back from the DISCONNECT to the BOUND. This re-created session has a new subscriber label and a new subscriber interface.

The binding stays in the DISCONNECT state, only till the lease time. If a data packet or renew request does not come before the lease time expires, then the session is cleared.

Session-restart behavior is applicable to session deletions triggered by idle timeout, or by an account-logoff procedure, where the trigger for deletion is any action other than the DHCP release from the client.

Session-restart is not applicable to session deletions done by the execution of the **clear subscriber session all** command. The DHCP bindings are removed in such cases.

For session deletion triggered by the DHCP client, both the session and the DHCP binding are deleted.



Note For session-restart to work, you must configure dual initiators (**initiator dhcp** and **initiator unclassified-source**) under the access-interface.

Allow-move for Simple IP Sessions

Allow-move feature supports roaming of simple IP subscribers associated with an access-interface in BNG. If a new first sign of life (FSOL) for an existing IPoE subscriber comes on a different access-interface or on a different VLAN (in the case of ambiguous VLAN) in BNG, then this new FSOL is processed and a new subscriber session is created. The old session is deleted after creating the new session. Allow-move is supported for L2 subscriber sessions and IPv4 sessions only.

To enable allow-move, you must configure **allow-move** for that particular access-interface.

Only simple roaming is supported; mobile roaming is not supported. Compared to wire-line BNG, a number of additional FSOL events such as DHCP discover, DHCP renew request and IPv4 data packets are supported in the case of roaming subscribers.

This table summarizes the BNG system behavior when a simple IP subscriber roams and re-connects:

FSOL	Expected behavior (for DHCP session initiator)	Expected behavior (for Packet session initiator)
DHCP DISCOVER	Old session is deleted. Subsequent DHCP discover message creates a new session on the new access-interface. IP address retention is not guaranteed for the new session.	New Session is created on the new access-interface and old session is deleted. DHCP binding is added and ACK is sent for the next DHCP renew request.
DHCP RENEW	NACK is sent for the DHCP renew request. Subsequent DHCP discover message creates a new session.	NACK is sent for the DHCP renew request. Subsequent DHCP discover message creates a new session.



Note

- When a DHCP discover comes on a new access-interface or on the same access-interface, it is assumed that the client is requesting for a new address or that client is rebooted. IP address retention is not guaranteed in this scenario.
- If the access-interface is configured only with DHCP initiator, then only DHCP discover message brings up the new session. This is because NACK is sent for the DHCP renew request on a new interface.

Restrictions for Simple IP Allow-move

The allow-move feature for simple IP subscribers are subjected to these restrictions:

- Not supported for IPv6 Sessions
- Not supported for routed subscribers
- Walk-by lite sessions are not supported as part of simple IP roaming
- Not supported for PPPoE sessions
- ARP DNAv4 is not supported as a trigger for simple IP roaming
- Movement of sessions between nodes is not supported

- Not supported with subscriber redundancy group (SRG)

DHCP Duplicate MAC Session

Duplicate MAC Session is an enhancement in DHCP where BNG supports IPoE subscribers with the same MAC address, but with different VLANs or interfaces.

To enable DHCP duplicate MAC session feature, use the **duplicate-mac-allowed** command in the DHCP IPv4 configuration mode.

This feature is not supported with subscriber redundancy group (SRG).

DHCP Duplicate MAC Session With Exclude VLAN Option

From Cisco IOS XR Software Release 6.1.2 onwards, DHCP duplicate MAC session feature is enhanced with an option to exclude inner and outer VLANs from the client key. Only MAC and interface are used to form the client key. The **exclude-vlan** option is added to the **duplicate-mac-allowed** command to exclude the VLANs.

Use Case of DHCP Duplicate MAC Session

Use Case Description	Expected Behavior
<ul style="list-style-type: none"> • Configure duplicate-mac-allowed exclude-vlan command in BNG with access-interface having ambiguous configuration. • Configure allow-move in the profile. • Create two BNG IPoE sessions for a CPE (Voice and Video). • Change the DSLAM port for the CPE. • DSLAM port adds SVLAN, CPE adds CVLAN . The change in DSLAM port is equivalent to change in VLAN, but with same interface. 	<p>The movement of a session terminates the previous session and bring up the new one. So the initial two sessions (the ones before the movement) go down and the new sessions come up. Although seamless movement is not guaranteed, after the movement, the subscriber need not wait for the lease expiry of the session before movement.</p>

Behavior of duplicate-mac-allowed and allow-move Commands Configuration

The duplicate-mac-allowed command allows to determine the key selection for clients. This key selection for client determines how the **allow-move** configuration takes effect. The key includes MAC, interface and VLANs. The VLANs are excluded from the key if **exclude-vlan** option is configured.

The actions corresponding to the BOOTREQUEST packets for **duplicate-mac-allowed** and **allow-move** commands combinations are listed in the table below.

Interface or VLAN Change for Subscriber Movement	duplicate-mac-allowed Command Configured (Yes or No)	Behavior When allow-move Command is Not Configured	Behavior When allow-move Command is Configured
Interface change or Same interface, but VLAN change	No	Drops BOOTREQUEST	DISCOVER: Deletes session (sends release for proxy mode) REQUEST: NAK (sends release for proxy mode with new parameters, Deletes session) DECLINE: Deletes session RELEASE: Deletes session INFORM: DROP
Interface change or Same interface, but VLAN change	Yes (without exclude-option)	Treats BOOTREQUEST as new session	No effect. Treats BOOTREQUEST as new session
Interface change	Yes (with exclude-option)	Treats BOOTREQUEST as new session	No effect. Treats BOOTREQUEST as new session
Same interface, but VLAN change	Yes (with exclude-option)	Drops BOOTREQUEST	DISCOVER: Deletes session (sends release for proxy mode) REQUEST: NAK (sends release for proxy mode with new parameters, Deletes session) DECLINE: Deletes session RELEASE: Deletes session INFORM: DROP

Configure DHCP Duplicate MAC Session

Configuration Example

```
RP/0/RSP0/CPU0:router#configure
RP/0/RSP0/CPU0:router(config)#dhcp ipv4
```

```
RP/0/RSP0/CPU0:router(config-dhcpv4)#interface bundle-Ether 1.1 proxy profile p1
RP/0/RSP0/CPU0:router(config-dhcpv4)#duplicate-mac-allowed exclude-vlan
```

Running Configuration

```
dhcp ipv4
  profile p1 proxy
    helper-address vrf default 1.1.1.1 giaddr 0.0.0.0
  !
interface Bundle-Ether1.1 proxy profile PROXY
  duplicate-mac-allowed exclude-vlan
```

Verification

```
RP/0/RSP0/CPU0:router#show dhcp ipv4 proxy binding detail
Wed Feb 24 14:32:14.476 IST
MAC Address:          XXXX.YYY0.000Z
VRF:                  default
Server VRF:          default
IP Address:           198.51.100.101
Giaddr from client:   0.0.0.0
Giaddr to server:     192.0.2.1
Server IP Address to client: 198.51.100.151
Server IP Address:    203.0.113.1
ReceivedCircuit ID:   -
InsertedCircuit ID:  -
ReceivedRemote ID:   -
InsertedRemote ID:   -
ReceivedVSISO:       -
InsertedVSISO:       -
Auth. on received relay info:FALSE
ParamRequestOption:  -
SavedOptions:        -
Profile:              TEST
State:                BOUND
Lease:                1000 secs (00:16:40)
Lease remaining:     991 secs (00:16:31)
Client ID:            0xXX-0xXX-0xYY-0xY0-0x00-0x0Z
Access Interface:    Bundle-Ether1.1
Access VRF:          default
VLAN Id:              102
Subscriber Label:     0x42
Subscriber Interface: Bundle-Ether1.1.ip3
Srg State:            NONE
Event History:
Session Start:       Feb 24 14:32:01.925
PACKET_DISCOVER      :    0.001s
DPM_SUCCESS          :    0.094s
PACKET_OFFER         :    1.020s
PACKET_REQUEST       :    2.058s
PACKET_ACK           :    3.059s
LEASE_DPM_SUCCESS    :    3.544s
MAC Address:          XXXX.YYY0.000Z
VRF:                  default
Server VRF:          default
IP Address:           198.51.100.102
Giaddr from client:   0.0.0.0
Giaddr to server:     192.0.2.1
Server IP Address to client: 198.51.100.151
Server IP Address:    203.0.113.1
```

```

ReceivedCircuit ID:      -
InsertedCircuit ID:     -
ReceivedRemote ID:      -
InsertedRemote ID:      -
ReceivedVSISO:          -
InsertedVSISO:          -
Auth. on received relay info:FALSE
ParamRequestOption:     -
SavedOptions:           -
Profile:                TEST
State:                  BOUND
Lease:                  1000 secs (00:16:40)
Lease remaining:        991 secs (00:16:31)
Client ID:              0xXX-0xXX-0xYY-0xY0-0x00-0x0Z
Access Interface:       Bundle-Ether1.2
Access VRF:             default
VLAN Id:                101
Subscriber Label:       0x42
Subscriber Interface:   Bundle-Ether1.2.ip1
Srg State:              NONE
Event History:
Session Start:          Feb 24 14:32:00.925
PACKET_DISCOVER        :    0.001s
DPM_SUCCESS            :    0.094s
PACKET_OFFER           :    1.020s
PACKET_REQUEST         :    2.058s
PACKET_ACK             :    3.059s
LEASE_DPM_SUCCESS      :    3.544s

```

```
RP/0/RSP0/CPU0:router# show subscriber session all detail internal
```

```

Wed Feb 24 14:39:20.084 IST
Interface:              Bundle-Ether1.1.ip3
Circuit ID:             Unknown
Remote ID:              Unknown
Type:                  IP: DHCP-trigger
IPv4 State:            Up, Wed Feb 24 14:32:05 2016
IPv4 Address:          198.51.100.101, VRF: default
IPv4 Up helpers:       0x00000040 {IPSUB}
IPv4 Up requestors:    0x00000040 {IPSUB}
Mac Address:           XXXX.YYY0.000Z
Account-Session Id:    00000003
Nas-Port:              Unknown
User name:             unknown
Formatted User name:   unknown
Client User name:      unknown
Outer VLAN ID:         102
Subscriber Label:      0x00000042
Created:               Wed Feb 24 14:32:01 2016
State:                 Activated
Authentication:        unauthenticated
Authorization:         unauthorized
Ifhandle:              0x00000f80
Session History ID:    1
Access-interface:     Bundle-Ether1.1
SRG Flags:             0x00000000
Policy Executed:

    event Session-Start match-first [at Wed Feb 24 14:32:01 2016]
    class type control subscriber CLASS_SUB_PROT_DHCP do-all [Succeeded]
    1 activate dynamic-template DYN_TEMPL_IPSUB [cerr: Success][aaa: Success]
Session Accounting: disabled
Last COA request received: unavailable

```

```

User Profile received from AAA: None
Services:
  Name       : DYN_TEMPL_IPSUB
  Service-ID : 0x4000007
  Type       : Template
  Status     : Applied
-----
[Event History]
  Feb 24 14:32:01.856 IPv4 Start
  Feb 24 14:32:05.312 SUBDB produce done
  Feb 24 14:32:05.440 IPv4 Up

Interface:          Bundle-Ether1.2.ip1
Circuit ID:         Unknown
Remote ID:          Unknown
Type:               IP: DHCP-trigger
IPv4 State:         Up, Wed Feb 24 14:32:05 2016
IPv4 Address:       198.51.100.102, VRF: default
IPv4 Up helpers:   0x00000040 {IPSUB}
IPv4 Up requestors: 0x00000040 {IPSUB}
Mac Address:        XXXX.YYY0.000Z
Account-Session Id: 00000003
Nas-Port:           Unknown
User name:          unknown
Formatted User name: unknown
Client User name:   unknown
Outer VLAN ID:     101
Subscriber Label:   0x00000042
Created:            Wed Feb 24 14:32:01 2016
State:              Activated
Authentication:     unauthenticated
Authorization:      unauthorized
Ifhandle:           0x00000f80
Session History ID: 1
Access-interface:   Bundle-Ether1.1
SRG Flags:          0x00000000
Policy Executed:

  event Session-Start match-first [at Wed Feb 24 14:32:01 2016]
    class type control subscriber CLASS_SUB_PROT_DHCP do-all [Succeeded]
      1 activate dynamic-template DYN_TEMPL_IPSUB [cerr: Success][aaa: Success]
Session Accounting: disabled
Last COA request received: unavailable
User Profile received from AAA: None
Services:
  Name       : DYN_TEMPL_IPSUB
  Service-ID : 0x4000007
  Type       : Template
  Status     : Applied
-----
[Event History]
  Feb 24 14:32:01.856 IPv4 Start
  Feb 24 14:32:05.312 SUBDB produce done
  Feb 24 14:32:05.440 IPv4 Up

```

DHCP Lease From AAA Server

From Cisco IOS XR Software Release 6.4.1 and later, BNG supports the assignment of the subscriber DHCP lease values using the RADIUS profile. The Cisco attribute-value pairs (AVPs), **dhcipv4-ip-lease** and

dhcpv6-ip-lease, are used to specify the client IP address and lease values for DHCPv4 and DHCPv6 respectively.

RADIUS Attribute for Setting DHCP IPv4 Lease from the AAA Server

The existing RADIUS vendor-specific attribute (VSA) 26 is used to process the Cisco AVP with DHCP Options.

The format of the **dhcpv4-ip-lease** AVP is:

```
Cisco-avpair = "dhcpv4-ip-lease=ip-address, T, T1, T2"
```

where,

- *ip-address* is the IPv4 address, in the dotted-decimal notation.
- *T* is the lease time, in seconds.
- *T1* is the renewal time, in seconds.
- *T2* is the rebind time, in seconds.

For example,

```
Cisco-avpair = "dhcpv4-ip-lease=192.0.2.1,360,180,72",
```

For details on DHCPv6 lease from the AAA server, see [DHCP IPv6 Lease from the AAA Server, on page 230](#).

AAA Authorization on DHCP RENEW or REBIND

From Cisco IOS XR Software Release 6.4.1 and later, you can set new session attributes for the subscriber session even at the time of session lease renewal. The BNG router triggers an authorization process with the AAA server both at the time of starting the subscriber session as well as at the time of lease renewal. The main purpose of the BNG-AAA server interaction during the lease renewal is to control the IP address allocation and to change the lease time of the session. The AAA server can modify the lease values during the renewal. With this feature, the AAA server can have more control on the DHCP timers of each session, thereby controlling the burst of renewals from each DHCP client. This feature is supported only for DHCPv4; not for DHCPv6. As part of this feature, a new Cisco attribute-value pair (AVP), **dhcpv4-ip-lease**, is introduced in BNG to specify the client IPv4 address and lease values.

With this feature enabled, the BNG router triggers an Access-Request message to the AAA server, when it receives the DHCP RENEW or REBIND message from the DHCP client. Prior to this, the message was triggered only when the DHCP client sends the DHCP DISCOVER message to the BNG router. The AVP, **dhcpv4-ip-lease**, helps in modifying the lease during session renewal.

To enable this feature, use the **subscriber feature dhcp-renew-auth** command in Global Configuration mode. Also, configure the new event, **authenticate-dhcp-renew**, under policy-map configuration mode, to specify the action to be taken on session renewal.

For more details on AAA authorization, see the *Configuring Authentication, Authorization, and Accounting Functions* chapter.

Enable AAA Authorization on DHCP RENEW or REBIND

Perform these main tasks to enable AAA Authorization on DHCP RENEW or REBIND in BNG:

- Configure respective policy-maps and class-profiles.
- Define the action to be taken on session renewal.
- Configure the subscriber feature to set new attributes for the subscriber session during session lease renewal.

Configuration Example

```
/* Configure the respective policy-map and class profiles */
Router#configure
Router(config)#policy-map type control subscriber dhcpv4_policy
Router(config-pmap)#event session-start match-first
Router(config-pmap-e)#class type control subscriber dhcpv4_class do-all
Router(config-pmap-c)#1 authorize aaa list default format username password example
Router(config-pmap-c)#exit
Router(config-pmap-e)#exit

/* Configure the respective event that defines the action to be taken on session renewal
*/
Router(config-pmap)#event authenticate-dhcp-renew match-all
Router(config-pmap-c)#1 authorize aaa list default format username password example
Router(config-pmap-c)#commit

/* Configure the subscriber feature to set new attributes during session lease renewal */
Router#configure
Router(config)#subscriber feature dhcp-renew-author
Router(config-subscriber)#commit
```

Running Configuration

```
policy-map type control subscriber dhcpv4_policy
  event session-start match-first
    class type control subscriber dhcpv4_class do-all
      2 authorize aaa list default format username password example
    !
  !
  event authorize-dhcp-renew match-all
    class type control subscriber dhcpv4_class do-until-failure
      1 authorize aaa list default format username password cisco
    !
  !
end-policy-map
!
subscriber feature dhcp-renew-author
!
```

Related Topics

[AAA Authorization on DHCP RENEW or REBIND, on page 192](#)

Associated Commands

- [event](#)
- [subscriber featurette dhcp-renew-author](#)

IPoE Class-based DHCPv4 Mode Selection

IPoE Class-based DHCPv4 mode selection is a functionality where BNG provides IPv4 prefix allocation mechanism for IPoE subscribers, based on their IPoE Class information. BNG does this by selecting the corresponding DHCPv4 profile to perform DHCPv4 server or proxy functionality. This feature helps service providers to change the IPv4 address allocation mechanism only for a specific class of users, rather than allocating IPv4 address for their whole user base through the DHCPv4 server.

BNG receives the IPoE Class information as part of Access-Accept message sent from the AAA server while authorizing the subscriber or as part of Vendor Class Option (DHCPv4 Option 16) sent from the client. It is based on this IPoE Class information that the BNG selects the corresponding DHCPv4 profile to perform DHCPv4 Server or Proxy functionality for IPv4 prefix allocation to the end user. The IPoE Class information provided by AAA server is given preference over the one provided by IPoE negotiation.

The **base** profile option in DHCPv4 configuration mode, and IPoE Class **match** sub-options under the **base** profile are introduced in order to enable this IPoE Class-based DHCPv4 mode selection feature.

Running Configuration

```
/* Creating base profile */
dhcp ipv4
profile BASE_PROFILE base
  match mode-class SERVER_CLASS profile SERVER_PROFILE server
  match mode-class PROXY_CLASS profile PROXY_PROFILE proxy
  match-default profile DEFAULT_SERVER server
  dhcp-to-aaa option list 12 55 60 61 124
!
/* Attaching base profile to the interfaces */
interface bundle-ether1.10 base profile BASE_PROFILE
interface pw-ether25000.10 base profile BASE_PROFILE
!
```

DHCPv6 Overview

The Dynamic Host Configuration Protocol for IPv6 (DHCPv6) enables DHCP servers to pass configuration parameters, such as IPv6 network addresses, to IPv6 nodes. It enables automatic allocation of reusable network addresses to the requesting clients, using the stateful address-configuration. Along with address and prefix allocation, DHCPv6 also offers additional configuration flexibility by assigning other configuration parameters such as DNS address, DNS domain name, AFTR address to IPv6 nodes in a network.

The basic DHCPv6 client-server concept is similar to using DHCP for IPv4 (DHCPv4). If a client wishes to receive configuration parameters, it sends out a request on the attached local network to detect the available DHCPv6 servers. Although DHCPv6 assigns IPv6 addresses or prefixes, name servers, and other configuration information very similar to that of DHCP for IPv4, these are certain key differences between DHCPv4 and DHCPv6. For example, unlike DHCPv4, address allocation in DHCPv6 is handled using a message option,

DHCPv6 clients can request multiple addresses and prefixes in a single request, and DHCPv6 can request different lease times for the addresses and prefixes. These significant advantages of DHCPv6 make it a preferred protocol for address assignment.

IPv6 hosts use Stateless Address Auto-Configuration (SLAAC), a model in which the hosts generate their own addresses using a combination of local and router-advertised information.

The DHCPv6 has been standardized by the IETF through RFC 3315. This DHCPv6 protocol is a stateful counterpart to IPv6 Stateless Address Auto-Configuration (RFC 4862), and can be used separately, or concurrently with SLAAC, to obtain configuration parameters.



Note Prior to configuring DHCPv6, IPv6 must be enabled on the interface on which DHCPv6 is servicing and enable Neighbor Discovery (ND).

For more information about Neighbor Discovery (ND), refer to the "Implementing Network Stack IPv4 and IPv6" section in the *Cisco IOS XR IP Addresses and Services Configuration Guide*.

Restrictions

- DHCPv6 Proxy supports to a maximum of eight external DHCPv6 servers per proxy profile.
- Bulk lease query is not supported.
- DHCPv6 server is supported only with BNG configuration.

DHCPv6 Server and DHCPv6 Proxy

The DHCPv6 server always uses stateful address assignment. On receiving a valid request, the DHCPv6 server assigns IPv6 address or prefix and other configuration attributes such as domain name, domain name server (DNS) address to requesting clients.

A DHCPv6 Relay or Proxy forwards a DHCPv6 message from a client to a server. A DHCPv6 Relay can use either stateless or stateful address assignment. The DHCPv6 Stateless Relay agent acts as an intermediary to deliver DHCPv6 messages between clients and servers. The Relay does not store or keep track of information such as client addresses or the lease time. The DHCPv6 Relay is also known as a Stateless Relay. On the other hand, the DHCPv6 Stateful Relay agent, also known as DHCP proxy, not only forwards a DHCPv6 message from a client to the server, but also keeps track of the client's addresses and lease time. Hence, DHCPv6 Proxy is also known as Stateful Relay. DHCPv6 supports a standalone proxy.

DHCPv6 Proxy enables inserting remote-ID and interface-ID options. The DHCPv6 Proxy uses the interface-ID in addition to remote-ID to choose the interface on which to send the response towards client.

DHCPv6 can be enabled on different configuration modes. For more information about configuring DHCPv6 on different configuring modes, see [Enabling DHCPv6 for Different Configuration Modes, on page 196](#). For more information about setting the DHCPv6 parameters, see [Setting Up DHCPv6 Parameters, on page 199](#).



Note DHCP relay is not supported for BNG.

Enabling DHCPv6 for Different Configuration Modes

Perform this task to enable DHCPv6 for different configuration modes such as global, server profile, proxy profile configuration modes, and server profile class and proxy profile class sub-configuration modes.

SUMMARY STEPS

1. **configure**
2. **dhcp ipv6**
3. **profile** *server_profile_name* **server**
4. **class** *class-name*
5. **dns-server** *address*
6. **domain-name** *name*
7. **prefix-pool** *pool_name*
8. **address-pool** *pool_name*
9. Use the **commit** or **end** command.
10. **interface** *type interface-path-id* **server profile** *profile_name*
11. **profile** *proxy_profile_name* **proxy**
12. **link-address** *ipv6_address*
13. **class** *class-name*
14. **helper-address** **vrf** *vrf_name* *ipv6_address*
15. Use the **commit** or **end** command.
16. **interface** *type interface-path-id* **proxy profile** *profile_name*
17. Use the **commit** or **end** command.

DETAILED STEPS

	Command or Action	Purpose
Step 1	configure Example: RP/0/RSP0/CPU0:router# configure	Enters global configuration mode.
Step 2	dhcp ipv6 Example: RP/0/RSP0/CPU0:router(config)# dhcp ipv6	Configures DHCP for IPv6 and enters the DHCPv6 configuration mode.
Step 3	profile <i>server_profile_name</i> server Example: RP/0/RSP0/CPU0:router(config-dhcpv6)# profile my-server-profile server	Creates a DHCPv6 server profile and enters the DHCPv6 server profile sub-configuration mode.
Step 4	class <i>class-name</i> Example: RP/0/RSP0/CPU0:router(config-dhcpv6-server-profile)# class server-green	Defines a class in a server profile and enters the server profile class sub-mode.

	Command or Action	Purpose
Step 5	dns-server <i>address</i> Example: RP/0/RSP0/CPU0:router(config-dhcpv6-server-profile)# dns-server 1111::1	Defines a dns-server and the corresponding address in a server profile.
Step 6	domain-name <i>name</i> Example: RP/0/RSP0/CPU0:router(config-dhcpv6-server-profile)# domain-name www.xyz.com	Defines a domain name in a server profile.
Step 7	prefix-pool <i>pool_name</i> Example: RP/0/RSP0/CPU0:router(config-dhcpv6-server-profile)# prefix_pool p1	Configures a prefix pool in a server profile.
Step 8	address-pool <i>pool_name</i> Example: RP/0/RSP0/CPU0:router(config-dhcpv6-server-profile)# address_pool p1	Configures an address pool in a server profile.
Step 9	Use the commit or end command.	commit —Saves the configuration changes and remains within the configuration session. end —Prompts user to take one of these actions: <ul style="list-style-type: none"> • Yes — Saves configuration changes and exits the configuration session. • No —Exits the configuration session without committing the configuration changes. • Cancel —Remains in the configuration session, without committing the configuration changes.
Step 10	interface <i>type interface-path-id server profile profile_name</i> Example: RP/0/RSP0/CPU0:router(config-dhcpv6)# interface Bundle-Ether1.1 server profile my-server-profile	Associates a DHCPv6 server configuration profile with an IPv6 interface.
Step 11	profile <i>proxy_profile_name proxy</i> Example: RP/0/RSP0/CPU0:router(config-dhcpv6)# profile my-proxy-profile proxy	Creates a DHCPv6 profile proxy and enters the DHCPv6 proxy sub-configuration mode.
Step 12	link-address <i>ipv6_address</i> Example: RP/0/RSP0/CPU0:router(config-dhcpv6)# link-address 5:6::78	Specifies the IPv6 address to be filled in the link-address field of the Relay Forward message.

	Command or Action	Purpose
Step 13	class <i>class-name</i> Example: RP/0/RSP0/CPU0:router(config-dhcpv6-proxy-profile)# class proxy-red	Defines a class in a proxy profile and enters the proxy profile class sub-mode.
Step 14	helper-address vrf <i>vrf_name</i> <i>ipv6_address</i> Example: RP/0/RSP0/CPU0:router(config-dhcpv6-proxy-profile)# helper-address vrf my-server-vrf 1:1:1::1	Configures DHCPv6 address as a helper address to the proxy. Note The helper address can be configured only under the proxy profile and proxy profile class sub-modes.
Step 15	Use the commit or end command.	commit —Saves the configuration changes and remains within the configuration session. end —Prompts user to take one of these actions: <ul style="list-style-type: none"> • Yes — Saves configuration changes and exits the configuration session. • No —Exits the configuration session without committing the configuration changes. • Cancel —Remains in the configuration session, without committing the configuration changes.
Step 16	interface <i>type interface-path-id</i> proxy profile <i>profile_name</i> Example: RP/0/RSP0/CPU0:router(config-dhcpv6)# interface BundleEther100.1 proxy profile my-proxy-profile	Associates a DHCPv6 proxy configuration profile to an IPv6 interface.
Step 17	Use the commit or end command.	commit —Saves the configuration changes and remains within the configuration session. end —Prompts user to take one of these actions: <ul style="list-style-type: none"> • Yes — Saves configuration changes and exits the configuration session. • No —Exits the configuration session without committing the configuration changes. • Cancel —Remains in the configuration session, without committing the configuration changes.

Enabling DHCPv6 for Different Configuration Modes: An example

```
configure
dhcp ipv6
```

```

profile my-server-profile server
link-address 5:6::78
class server-green
dns-server 1111::1
domain-name www.cisco.com
prefix-pool POOL_P6_2
address-pool POOL_A6_1

end
!!
configure
dhcp ipv6
interface GigabitEthernet 0/2/0/0 server profile my-server-profile
profile my-proxy-profile proxy
link-address 5:6::78
class proxy-red
helper-address 5661:11
end
!!
configure
dhcp ipv6
interface GigabitEthernet 0/2/0/0 proxy profile my-proxy-profile
end
!!

```

Setting Up DHCPv6 Parameters

Perform this task to set up DHCPv6 parameters such as address pool name, prefix pool name, DNS server, domain name, lease time, and helper address.

SUMMARY STEPS

1. **configure**
2. **dhcp ipv6**
3. **profile** *server_profile_name* **server**
4. **dns-server** *ipv6_address*
5. **domain-name** *domain_name*
6. **lease**
7. **helper-address vrf** *vrf_name* *ipv6_address*
8. **prefix-pool** *prefix-pool-name*
9. **address-pool** *address-pool-name*
10. Use the **commit** or **end** command.

DETAILED STEPS

	Command or Action	Purpose
Step 1	configure Example: RP/0/RSP0/CPU0:router# configure	Enters global configuration mode.

	Command or Action	Purpose
Step 2	dhcp ipv6 Example: RP/0/RSP0/CPU0:router(config)# dhcp ipv6	Configures DHCP for IPv6 and enters the DHCPv6 configuration mode.
Step 3	profile server_profile_name server Example: RP/0/RSP0/CPU0:router(config-dhcpv6)# profile my-server-profile server	Configures DHCPv6 server profile and enters the DHCPv6 server profile sub-configuration mode.
Step 4	dns-server ipv6_address Example: RP/0/RSP0/CPU0:router(config-dhcpv6-server-profile)# dns-server 1:1:1::1	Configures the DNS server for DHCPv6 server profile. Note The DNS server name is defined in the class mode. If the same parameters are defined in the profile mode too, then the values defined in the class mode takes precedence.
Step 5	domain-name domain_name Example: RP/0/RSP0/CPU0:router(config-dhcpv6-server-profile)# domain-name my.domain.name	Configures the DNS domain name for DHCPv6 server profile. Note The DNS server name is defined in the class mode. If the same parameters are defined in the profile mode too, then the values defined in the class mode takes precedence.
Step 6	lease Example: RP/0/RSP0/CPU0:router(config-dhcpv6-server-profile)# lease 1 6 0	Configures the lease time for a duration of 1 day, 6 hours, and 0 minutes.
Step 7	helper-address vrf vrf_name ipv6_address Example: RP/0/RSP0/CPU0:router(config-dhcpv6-proxy-profile)# helper-address vrf my-server-vrf 1:1:1::1	Configures DHCPv6 address as a helper address to the proxy. Note The helper address can be configured only under the proxy profile and proxy profile class sub-modes.
Step 8	prefix-pool prefix-pool-name Example: RP/0/RSP0/CPU0:router(config-dhcpv6-server-profile-class)# prefix-pool my-server-delegated-prefix-pool	Configures the prefix pool under the DHCPv6 server profile class sub-mode.
Step 9	address-pool address-pool-name Example: RP/0/RSP0/CPU0:router(config-dhcpv6-server-profile-class)# address-pool my-server-address-pool	Configures the address pool under the DHCPv6 server profile class sub-mode.
Step 10	Use the commit or end command.	commit —Saves the configuration changes and remains within the configuration session.

	Command or Action	Purpose
		<p>end —Prompts user to take one of these actions:</p> <ul style="list-style-type: none"> • Yes — Saves configuration changes and exits the configuration session. • No —Exits the configuration session without committing the configuration changes. • Cancel —Remains in the configuration session, without committing the configuration changes.

Setting Up DHCPv6 Parameters: An example

```

configure
dhcp ipv6
profile my-server-profile server
dns-server 1:1:1::1
domain-name my.domain.name
lease 1 6 0
class class1
prefix-pool my-server-delegated-prefix-pool
address-pool my-server-address-pool
end
!!

```

PPP/IPoE Class-based DHCPv6 Mode Selection

PPP/IPoE Class-based DHCPv6 mode selection is a functionality where BNG provides IPv6 prefix allocation mechanism for PPP/IPoE subscribers, based on their PPP/IPoE Class information. BNG does this by selecting the corresponding DHCPv6 profile to perform DHCPv6 server or proxy functionality. This feature helps service providers to change the IPv6 address allocation mechanism only for a specific class of users, rather than allocating IPv6 address for their whole user base through the DHCPv6 server.

BNG receives the PPP/IPoE Class information as part of Access-Accept message sent from the AAA server while authorizing the subscriber or as part of Vendor Class Option (DHCPv6 Option 16) sent from the client. It is based on this PPP/IPoE Class information that the BNG selects the corresponding DHCPv6 profile to perform DHCPv6 Server or Proxy functionality for IPv6 prefix allocation to the end user. The PPP/IPoE Class information provided by AAA server is given preference over the one provided by PPP/IPoE negotiation.

The **base** profile option in DHCPv6 configuration mode, and PPP/IPoE Class **match** sub-options under the **base** profile are introduced in order to enable this PPP/IPoE Class-based DHCPv6 mode selection feature.

Running Configuration

```

/* Creating base profile */
dhcp ipv6
profile BASE_PROFILE base
match mode-class SERVER_CLASS profile SERVER_PROFILE server
match mode-class PROXY_CLASS profile PROXY_PROFILE proxy
match-default profile DEFAULT_SERVER server
dhcpv6-to-aaa option list all

```

```

!
/* Attaching base profile to the interfaces */
interface bundle-ether1.10 base profile BASE_PROFILE
interface pw-ether25000.10 base profile BASE_PROFILE
!

```

DHCPv6 Features

DHCPv6 is widely used in LAN environments to dynamically assign host IP addresses from a centralized server. This dynamic assignment of addresses reduces the overhead of administration of IP addresses. DHCPv6 also helps conserve the limited IP address space. This is because IP addresses no longer need to be permanently assigned to hosts; only those hosts that are connected to the network consume IP addresses.

The DHCPv6 features supported in BNG are:

High Availability Support for DHCPv6

High availability support for DHCPv6 includes:

Linecard Online Insertion and Removal

Linecard Online Insertion and Removal (OIR) enables you to replace faulty parts without affecting the system's operations. When a card is inserted, power is available on the card, and it initializes itself to start being operational.



Note DHCPv6 bindings are not affected by Linecard OIR.

Checkpoint and Shadow Database

The checkpoint and shadow database are actively maintained on the RSP and contains a copy of all bindings from all linecards. The checkpoint database has client or subscriber bindings from the subscribers over interfaces in its scope. The shadow database on the active RSP updates the standby shadow database.

DHCPv6 Hot Standby

DHCPv6 Hot Standby is a process that is supported only on RSPs. Whenever the active RSP stops responding, it is instantly replaced by a standby RSP. The standby RSP takes over processing when it becomes active.

DHCPv6 Prefix Delegation

The DHCPv6 prefix delegation is a mechanism of delegating IPv6 prefixes to a client. The prefix delegation feature can be used to manage link, subnet, and site addressing changes.

An Internet Service Provider (ISP) assigns prefix to a customer for use within the customer's network. Prefix delegation occurs between a provider edge (PE) device and customer premises equipment (CPE), using the DHCPv6 prefix delegation option. After the ISP has delegated prefixes to a customer, the customer may further subnet and assign prefixes to the links in the customer's network.

By default, the prefix delegation feature is always enabled.

IPv6 IPoE Subscriber Support

An IPv6 subscriber transmits IPv6 address that is created using the DHCPv6 protocol. The IPv6 subscribers run IPv6 on the CPE device and are connected to BNG through a Layer-2 network or through Layer-2 aggregation. The IPv6 subscribers are supported when they are directly connected to the BNG or through a Layer-2 aggregator.

To enable IPv6 IPoE subscriber support, the DHCPv6 profile needs to be explicitly configured on the subscriber interface. For more information, see [Configuring IPv6 IPoE Subscriber Interface, on page 203](#).

FSOL Handling

The DHCPv6 First Sign of Life (FSOL) handling is only supported for IPoE sessions. DHCPv6 handles SOLICIT packet from client as FSOL packet for IPoE session validation and creation. The IPoE session gets created, as long as the configuration exists and the subscriber information is validated successfully.

Configuring IPv6 IPoE Subscriber Interface

Perform this task to configure IPoE subscriber interface.

SUMMARY STEPS

1. **configure**
2. **pool vrf name ipv6 pool_name**
3. **address-range first_ipv6_address last_ipv6_address**
4. **pool vrf name ipv6 pool_name**
5. **prefix-length length**
6. **prefix-range first_ipv6_address last_ipv6_address**
7. Use the **commit** or **end** command.
8. **dhcp ipv6**
9. **interface type interface-path-id server profile profile_name**
10. **profile server_profile_name server**
11. **prefix-pool pool_name**
12. **address-pool pool_name**
13. Use the **commit** or **end** command.
14. **dhcp ipv6**
15. **interface type interface-path-id proxy profile profile_name**
16. **profile server_profile_name proxy**
17. **helper-address vrf vrf_name ipv6_address**
18. Use the **commit** or **end** command.
19. **dynamic-template type ipsubscriber dynamic_template_name**
20. **ipv6 enable**
21. **dhcpv6 address-pool pool_name**
22. **dhcpv6 delegated-prefix-pool pool_name**
23. Use the **commit** or **end** command.
24. **class-map type control subscriber match-all class-map_name**
25. **match protocol dhcpv6**
26. **end-class-map**
27. **policy-map type control subscriber class-map_name**

28. **event session-start match-first**
29. **class type control subscriber** *class_name* **do-all**
30. *sequence_number* **activate dynamic-template** *dynamic-template_name*
31. **end-policy-map**
32. Use the **commit** or **end** command.
33. **interface type** *interface-path-id*
34. **ipv4 address** *ipv4_address*
35. **ipv6 address** *ipv6_address*
36. **ipv6 enable**
37. **service-policy type control subscriber** *name*
38. **ipsubscriber ipv6 l2-connected**
39. **initiator dhcp**
40. Use the **commit** or **end** command.

DETAILED STEPS

	Command or Action	Purpose
Step 1	configure Example: RP/0/RSP0/CPU0:router# configure	Enters global configuration mode.
Step 2	pool vrf name ipv6 <i>pool_name</i> Example: RP/0/RSP0/CPU0:router(config)# pool vrf default ipv6 pool1	Configures the distributed address pool service.
Step 3	address-range <i>first_ipv6_address last_ipv6_address</i> Example: RP/0/RSP0/CPU0:router(config-pool-ipv6)# address-range 2201:abcd:1234:2400:f800::1 2201:abcd:1234:2400:f800::fff	Configures the address-range.
Step 4	pool vrf name ipv6 <i>pool_name</i> Example: RP/0/RSP0/CPU0:router(config)# pool vrf default ipv6 pool2	Configures the distributed address pool service.
Step 5	prefix-length <i>length</i> Example: RP/0/RSP0/CPU0:router(config-pool-ipv6)# prefix-length 92	Specifies the prefix-length to be used.
Step 6	prefix-range <i>first_ipv6_address last_ipv6_address</i> Example:	Specifies the prefix-range for allocation.

	Command or Action	Purpose
	<pre>RP/0/RSP0/CPU0:router(config-pool-ipv6)# prefix-range 3301:1ab7:2345:1200:f800:: 3301:1ab7:2345:1200:f800:fff0::</pre>	
Step 7	Use the commit or end command.	<p>commit —Saves the configuration changes and remains within the configuration session.</p> <p>end —Prompts user to take one of these actions:</p> <ul style="list-style-type: none"> • Yes — Saves configuration changes and exits the configuration session. • No —Exits the configuration session without committing the configuration changes. • Cancel —Remains in the configuration session, without committing the configuration changes.
Step 8	<p>dhcp ipv6</p> <p>Example:</p> <pre>RP/0/RSP0/CPU0:router(config)# dhcp ipv6</pre>	Configures DHCP for IPv6 and enters the DHCPv6 configuration mode.
Step 9	<p>interface <i>type interface-path-id server profile profile_name</i></p> <p>Example:</p> <pre>RP/0/RSP0/CPU0:router(config-dhcpv6)# interface Bundle-Ether1.1 server profile foo</pre>	Associates a DHCPv6 proxy configuration profile to an IPv6 interface.
Step 10	<p>profile <i>server_profile_name server</i></p> <p>Example:</p> <pre>RP/0/RSP0/CPU0:router(config-dhcpv6)# profile foo server</pre>	Creates a DHCPv6 server profile and enters the DHCPv6 server profile sub-configuration mode.
Step 11	<p>prefix-pool <i>pool_name</i></p> <p>Example:</p> <pre>RP/0/RSP0/CPU0:router(config-dhcpv6-server-profile)# prefix-pool pool2</pre>	Configures a prefix pool in a server profile.
Step 12	<p>address-pool <i>pool_name</i></p> <p>Example:</p> <pre>RP/0/RSP0/CPU0:router(config-dhcpv6-server-profile)# address-pool pool1</pre>	Configures an address pool in the server profile.
Step 13	Use the commit or end command.	<p>commit —Saves the configuration changes and remains within the configuration session.</p> <p>end —Prompts user to take one of these actions:</p> <ul style="list-style-type: none"> • Yes — Saves configuration changes and exits the configuration session.

	Command or Action	Purpose
		<ul style="list-style-type: none"> • No —Exits the configuration session without committing the configuration changes. • Cancel —Remains in the configuration session, without committing the configuration changes.
Step 14	dhcp ipv6 Example: RP/0/RSP0/CPU0:router(config)# dhcp ipv6	Configures DHCP for IPv6 and enters the DHCPv6 configuration mode.
Step 15	interface type interface-path-id proxy profile profile_name Example: RP/0/RSP0/CPU0:router(config-dhcpv6)# interface Bundle-Ether1.1 proxy profile foo	Associates a DHCPv6 proxy configuration profile to an IPv6 interface.
Step 16	profile server_profile_name proxy Example: RP/0/RSP0/CPU0:router(config-dhcpv6)# profile foo proxy	Creates a DHCPv6 server profile and enters the DHCPv6 server profile sub-configuration mode.
Step 17	helper-address vrf vrf_name ipv6_address Example: RP/0/RSP0/CPU0:router(config-dhcpv6-proxy-profile)# helper-address vrf my-server-vrf 1:1:1::1	Configures DHCPv6 address as a helper address to the proxy. Note The helper address can be configured only under the proxy profile and proxy profile class sub-modes.
Step 18	Use the commit or end command.	commit —Saves the configuration changes and remains within the configuration session. end —Prompts user to take one of these actions: <ul style="list-style-type: none"> • Yes — Saves configuration changes and exits the configuration session. • No —Exits the configuration session without committing the configuration changes. • Cancel —Remains in the configuration session, without committing the configuration changes.
Step 19	dynamic-template type ipsubscriber dynamic_template_name Example: RP/0/RSP0/CPU0:router(config)# dynamic-template type ipsubscriber dhcpv6_temp	Configures the dynamic template of type ipsubscriber and enters the dynamic template type configuration mode.
Step 20	ipv6 enable Example:	Enables IPv6 on an interface.

	Command or Action	Purpose
	RP/0/RSP0/CPU0:router(config-dynamic-template-type)# ipv6 enable	
Step 21	dhcpv6 address-pool <i>pool_name</i> Example: RP/0/RSP0/CPU0:router(config-dynamic-template-type)# dhcpv6 address-pool pool3	Configures DHCPv6 address pool.
Step 22	dhcpv6 delegated-prefix-pool <i>pool_name</i> Example: RP/0/RSP0/CPU0:router(config-dynamic-template-type)# dhcpv6 delegated-prefix-pool pool4	Configures DHCPv6 delegated prefix pool.
Step 23	Use the commit or end command.	commit —Saves the configuration changes and remains within the configuration session. end —Prompts user to take one of these actions: <ul style="list-style-type: none"> • Yes — Saves configuration changes and exits the configuration session. • No —Exits the configuration session without committing the configuration changes. • Cancel —Remains in the configuration session, without committing the configuration changes.
Step 24	class-map type control subscriber match-all <i>class-map_name</i> Example: RP/0/RSP0/CPU0:router(config)# class-map type control subscriber match-all dhcpv6_class	Configures the class map control subscriber with a match-any criteria.
Step 25	match protocol dhcpv6 Example: RP/0/RSP0/CPU0:router(config-cmap)# match protocol dhcpv6	Configures match criteria for the class configured in the earlier step.
Step 26	end-class-map Example: RP/0/RSP0/CPU0:router(config-cmap)# end-class-map	Configures the end class map.
Step 27	policy-map type control subscriber <i>class-map_name</i> Example: RP/0/RSP0/CPU0:router(config)# policy-map type control subscriber dhcpv6-policy	Configures the subscriber control policy map.
Step 28	event session-start match-first Example:	Configures the policy event with the match-first criteria.

	Command or Action	Purpose
	RP/0/RSP0/CPU0:router(config-pmap)# event session-start match-first	
Step 29	<p>class type control subscriber <i>class_name</i> do-all</p> <p>Example:</p> <pre>RP/0/RSP0/CPU0:router(config-pmap-e)# class type control subscriber dhcpv6_class do-all</pre>	Configures the class map control subscriber with a match-any criteria.
Step 30	<p><i>sequence_number</i> activate dynamic-template <i>dynamic-template_name</i></p> <p>Example:</p> <pre>RP/0/RSP0/CPU0:router(config-pmap-c)# 20 activate dynamic-template dhcpv6_temp</pre>	Activates actions related to dynamic template.
Step 31	<p>end-policy-map</p> <p>Example:</p> <pre>RP/0/RSP0/CPU0:router(config-pmap-c)# end-policy-map</pre>	Configures the end policy map.
Step 32	Use the commit or end command.	<p>commit —Saves the configuration changes and remains within the configuration session.</p> <p>end —Prompts user to take one of these actions:</p> <ul style="list-style-type: none"> • Yes — Saves configuration changes and exits the configuration session. • No —Exits the configuration session without committing the configuration changes. • Cancel —Remains in the configuration session, without committing the configuration changes.
Step 33	<p>interface <i>type interface-path-id</i></p> <p>Example:</p> <pre>RP/0/RSP0/CPU0:router(config)# interface Bundle-Ether1.1</pre>	Configures an interface and enters the interface configuration mode.
Step 34	<p>ipv4 address <i>ipv4_address</i></p> <p>Example:</p> <pre>RP/0/RSP0/CPU0:router(config-if)# ipv4 address 11.11.11.2 255.255.255.0</pre>	Configures the ipv4 address on an interface.
Step 35	<p>ipv6 address <i>ipv6_address</i></p> <p>Example:</p> <pre>RP/0/RSP0/CPU0:router(config-if)# ipv6 address 11:11:11::2/64</pre>	Configures the ipv6 address on an interface.
Step 36	<p>ipv6 enable</p> <p>Example:</p>	Enables IPv6 on an interface.

	Command or Action	Purpose
	RP/0/RSP0/CPU0:router(config-if)# ipv6 enable	
Step 37	service-policy type control subscriber <i>name</i> Example: RP/0/RSP0/CPU0:router(config-if)# service-policy type control subscriber dhcpv6_policy	Associates a subscriber control service policy to the interface.
Step 38	ipsubscriber ipv6 l2-connected Example: RP/0/RSP0/CPU0:router(config-if)# ipsubscriber ipv6 l2-connected	Enables l2-connected IPv6 subscriber.
Step 39	initiator dhcp Example: RP/0/RSP0/CPU0:router(config-if-ipsub-ipv6-l2conn)# initiator dhcp	Configures IPv6 subscriber initiator.
Step 40	Use the commit or end command.	commit —Saves the configuration changes and remains within the configuration session. end —Prompts user to take one of these actions: <ul style="list-style-type: none"> • Yes — Saves configuration changes and exits the configuration session. • No —Exits the configuration session without committing the configuration changes. • Cancel —Remains in the configuration session, without committing the configuration changes.

Configuring IPv6 IPoE Subscriber Interface: An example

```

configure
pool vrf default ipv6 pool1
  address-range 2201:abcd:1234:2400:f800::1 2201:abcd:1234:2400:f800::fff

pool vrf default ipv6 pool2
prefix-length 92
prefix-range 3301:1ab7:2345:1200:f800:: 3301:1ab7:2345:1200:f800:fff0::

dhcp ipv6
  interface GigabitEthernet0/3/0/0 server profile foo
  profile foo server
  prefix-pool pool2
  address-pool pool1
!
!
end

configure
dhcp ipv6
  interface GigabitEthernet0/3/0/0 proxy profile foo

```

```

profile foo proxy
  helper address <v6 address of the server
!
!
dynamic-template type ipsubscriber dhcpv6_temp
  ipv6 enable
  dhcpv6 address-pool pool3
  dhcpv6 delegated-prefix-pool pool4
!
!
class-map type control subscriber match-all dhcpv6_class
  match protocol dhcpv6
end-class-map
!
policy-map type control subscriber dhcpv6_policy
  event session-start match-first
  class type control subscriber dhcpv6_class do-all
    20 activate dynamic-template dhcpv6_temp
!
!
end

configure
interface GigabitEthernet0/3/0/0
  ipv4 address 11.11.11.2 255.255.255.0
  ipv6 address 11:11:11::2/64
  ipv6 enable
  service-policy type control subscriber dhcpv6_policy
  ipsubscriber ipv6 l2-connected
  initiator dhcp
!
!
end
end

```

IPv6 PPPoE Subscriber Support

The PPPoE subscriber interfaces establish a PPP link with the subscriber, which is used for authentication and address assignment. The DHCPv6 server assigns the address or prefix to the PPPoE subscriber. Because the PPPoE subscriber interfaces are created dynamically, the DHCPv6 profile is applied to all the PPPoE interfaces created on the router, and not just a single PPPoE interface.

To enable PPPoE subscriber support, you have to configure the DHCPv6 profile globally or on all PPPoE interfaces. For more information, see [Configuring IPv6 PPPoE Subscriber Interfaces, on page 210](#).

Configuring IPv6 PPPoE Subscriber Interfaces

Perform this task to configure PPPoE subscriber interfaces.

SUMMARY STEPS

1. **configure**
2. **dynamic-template type ppp** *dynamic_template_name*
3. **ppp authentication chap**
4. **ppp ipcp peer-address pool** *pool_name*
5. **ipv4 unnumbered** *interface-type interface-path-id*
6. **ipv6 enable**

7. Use the **commit** or **end** command.
8. **class-map type control subscriber match-any** *class-map_name*
9. **match protocol ppp**
10. **end-class-map**
11. Use the **commit** or **end** command.
12. **class-map type control subscriber match-all** *class-map_name*
13. **match protocol dhcpv6**
14. **end-class-map**
15. Use the **commit** or **end** command.
16. **policy-map type control subscriber** *policy_name*
17. **event session-start match-first**
18. **class type control subscriber name do-all**
19. *sequence_number* **activate dynamic-template** *dynamic-template_name*
20. **end-policy-map**
21. **policy-map type control subscriber** *policy_name*
22. **event session-start match-all**
23. **class type control subscriber name do-all**
24. *sequence_number* **activate dynamic-template** *dynamic-template_name*
25. **end-policy-map**
26. Use the **commit** or **end** command.
27. **interface type interface-path-id**
28. **description** *LINE*
29. **ipv6 enable**
30. **service-policy type control subscriber name**
31. **encapsulation dot1q 801**
32. **ipsubscriber ipv6 l2-connected**
33. **initiator dhcp**
34. Use the **commit** or **end** command.

DETAILED STEPS

	Command or Action	Purpose
Step 1	configure Example: RP/0/RSP0/CPU0:router# <code>configure</code>	Enters global configuration mode.
Step 2	dynamic-template type ppp <i>dynamic_template_name</i> Example: RP/0/RSP0/CPU0:router(config)# <code>dynamic-template type ppp ppp_pta_template</code>	Configures the dynamic template of type ppp and enters the dynamic template type configuration mode.
Step 3	ppp authentication chap Example:	Configures challenge handshake authentication protocol (chap) and sets PPP link authentication method.

	Command or Action	Purpose
	RP/0/RSP0/CPU0:router(config-dynamic-template-type)# ppp authentication chap	
Step 4	ppp ipcp peer-address pool <i>pool_name</i> Example: RP/0/RSP0/CPU0:router(config-dynamic-template-type)# ppp ipcp peer-address pool p1	Sets ipcp negotiation options and sets the peer address configuration option for the peer-address pool.
Step 5	ipv4 unnumbered <i>interface-type interface-path-id</i> Example: RP/0/RSP0/CPU0:router(config-dynamic-template-type)# ipv4 unnumbered Loopback 1	Enables IPv4 processing without an explicit address for an interface.
Step 6	ipv6 enable Example: RP/0/RSP0/CPU0:router(config-dynamic-template-type)# ipv6 enable	Enables IPv6 on an interface.
Step 7	Use the commit or end command.	commit —Saves the configuration changes and remains within the configuration session. end —Prompts user to take one of these actions: <ul style="list-style-type: none"> • Yes — Saves configuration changes and exits the configuration session. • No —Exits the configuration session without committing the configuration changes. • Cancel —Remains in the configuration session, without committing the configuration changes.
Step 8	class-map type control subscriber match-any <i>class-map_name</i> Example: RP/0/RSP0/CPU0:router(config)# class-map type control subscriber match-any pta_class	Configures the class map control subscriber with a match-any criteria.
Step 9	match protocol ppp Example: RP/0/RSP0/CPU0:router(config-cmap)# match protocol ppp	Configures match criteria for the class configured in the earlier step.
Step 10	end-class-map Example: RP/0/RSP0/CPU0:router(config-cmap)# end-class-map	Configures the end class map.
Step 11	Use the commit or end command.	commit —Saves the configuration changes and remains within the configuration session. end —Prompts user to take one of these actions:

	Command or Action	Purpose
		<ul style="list-style-type: none"> • Yes — Saves configuration changes and exits the configuration session. • No — Exits the configuration session without committing the configuration changes. • Cancel — Remains in the configuration session, without committing the configuration changes.
Step 12	class-map type control subscriber match-all <i>class-map_name</i> Example: RP/0/RSP0/CPU0:router(config)# class-map type control subscriber match-all ipoe_test	Configures the class map control subscriber with a match-all criteria.
Step 13	match protocol dhcpv6 Example: RP/0/RSP0/CPU0:router(config-cmap)# match protocol dhcpv6	Configures match criteria for the class configured in the earlier step.
Step 14	end-class-map Example: RP/0/RSP0/CPU0:router(config-cmap)# end-class-map	Configures the end class map.
Step 15	Use the commit or end command.	commit — Saves the configuration changes and remains within the configuration session. end — Prompts user to take one of these actions: <ul style="list-style-type: none"> • Yes — Saves configuration changes and exits the configuration session. • No — Exits the configuration session without committing the configuration changes. • Cancel — Remains in the configuration session, without committing the configuration changes.
Step 16	policy-map type control subscriber policy_name Example: RP/0/RSP0/CPU0:router(config)# policy-map type control subscriber policy1	Configures the subscriber control policy map.
Step 17	event session-start match-first Example: RP/0/RSP0/CPU0:router(config-pmap)# event session-start match-first	Configures the policy event with the match-first criteria.
Step 18	class type control subscriber name do-all Example:	Configures the policy event with the match-first criteria.

	Command or Action	Purpose
	RP/0/RSP0/CPU0:router(config-pmap)# class type control subscriber ipoe_test1 do-all	
Step 19	<p><i>sequence_number</i> activate dynamic-template <i>dynamic-template_name</i></p> <p>Example: RP/0/RSP0/CPU0:router(config-pmap-c)# 24 activate dynamic-template v6_test1</p>	Activates actions related to dynamic template.
Step 20	<p>end-policy-map</p> <p>Example: RP/0/RSP0/CPU0:router(config-pmap-c)# end-policy-map</p>	Configures the end policy map.
Step 21	<p>policy-map type control subscriber <i>policy_name</i></p> <p>Example: RP/0/RSP0/CPU0:router(config)# policy-map type control subscriber policy1</p>	Configures the subscriber control policy map.
Step 22	<p>event session-start match-all</p> <p>Example: RP/0/RSP0/CPU0:router(config-pmap)# event session-start match-all</p>	Configures the policy event with the match-all criteria.
Step 23	<p>class type control subscriber <i>name</i> do-all</p> <p>Example: RP/0/RSP0/CPU0:router(config-pmap)# class type control subscriber pta_class do-all</p>	Configures the policy event with the match-first criteria.
Step 24	<p><i>sequence_number</i> activate dynamic-template <i>dynamic-template_name</i></p> <p>Example: RP/0/RSP0/CPU0:router(config-pmap-c)# 1 activate dynamic-template ppp_pta_template</p>	Activates actions related to dynamic template.
Step 25	<p>end-policy-map</p> <p>Example: RP/0/RSP0/CPU0:router(config-pmap-c)# end-policy-map</p>	Configures the end policy map.
Step 26	Use the commit or end command.	<p>commit —Saves the configuration changes and remains within the configuration session.</p> <p>end —Prompts user to take one of these actions:</p> <ul style="list-style-type: none"> • Yes — Saves configuration changes and exits the configuration session. • No —Exits the configuration session without committing the configuration changes.

	Command or Action	Purpose
		<ul style="list-style-type: none"> • Cancel —Remains in the configuration session, without committing the configuration changes.
Step 27	interface <i>type interface-path-id</i> Example: RP/0/RSP0/CPU0:router(config)# interface BundleEther1.1	Configures an interface and enters the interface configuration mode.
Step 28	description <i>LINE</i> Example: RP/0/RSP0/CPU0:router(config-if)# description IPoE	Sets the description for the above configured interface.
Step 29	ipv6 enable Example: RP/0/RSP0/CPU0:router(config-if)# ipv6 enable	Enables IPv6 on an interface.
Step 30	service-policy type control subscriber <i>name</i> Example: RP/0/RSP0/CPU0:router(config-if)# service-policy type control subscriber ipoe1	Associates a subscriber control service policy to the interface.
Step 31	encapsulation dot1q 801 Example: RP/0/RSP0/CPU0:router(config-if)# encapsulation dot1q 801	Enables encapsulated 802.1Q VLAN configuration.
Step 32	ipsubscriber ipv6 l2-connected Example: RP/0/RSP0/CPU0:router(config-if)# ipsubscriber ipv6 l2-connected	Enables l2-connected IPv6 subscriber.
Step 33	initiator dhcp Example: RP/0/RSP0/CPU0:router(config-if-ipsub-ipv6-l2conn)# initiator dhcp	Configures IPv6 subscriber initiator.
Step 34	Use the commit or end command.	commit —Saves the configuration changes and remains within the configuration session. end —Prompts user to take one of these actions: <ul style="list-style-type: none"> • Yes — Saves configuration changes and exits the configuration session. • No —Exits the configuration session without committing the configuration changes. • Cancel —Remains in the configuration session, without committing the configuration changes.

Configuring IPv6 PPPoE Subscriber Interfaces: An example

```

configure
dynamic-template
type ppp PPP_PTA_TEMPLATE
ppp authentication chap
ppp ipcp peer-address pool ADDRESS_POOL
ipv4 unnumbered Loopback0
ipv6 enable
!
type ipsubscriber v6_test1
ipv6 enable
!
!
class-map type control subscriber match-any PTA_CLASS
match protocol ppp
end-class-map
!
class-map type control subscriber match-all ipoe_test1
match protocol dhcpv6
end-class-map
!
policy-map type control subscriber ipoe1
event session-start match-first
class type control subscriber ipoe_test1 do-all
24 activate dynamic-template v6_test1
!
!
end-policy-map
!
policy-map type control subscriber POLICY1
event session-start match-all
class type control subscriber PTA_CLASS do-all
1 activate dynamic-template PPP_PTA_TEMPLATE
!
!
end-policy-map
!
interface Bundle-Ether2.801
description IPoE
ipv6 enable
service-policy type control subscriber ipoe1
encapsulation dot1q 801
ipsubscriber ipv6 l2-connected
initiator dhcp

```

Ambiguous VLAN Support

An Ambiguous VLAN is configured with a range or group of VLAN IDs. The subscriber sessions created over ambiguous VLANs are identical to subscribers over regular VLANs that support all regular configurations such as policy-map, VRFs, QoS, and ACL. Multiple subscribers can be created on a particular VLAN ID as long as they contain a unique MAC address. Ambiguous VLANs enhance scalability by reducing the need for configuring multiple access interfaces.

To enable DHCPv6 support, ambiguous VLANs are unnumbered on top of the bundle interface.



Note The ambiguous VLANs are named exactly the same way as regular VLANs. The ambiguous VLANs are considered Layer 3 interfaces in contrast to EFP ranges allowed for l2transport interface.

When DHCPv6 Server receives a SOLICIT message on the ambiguous VLAN interface, the VLAN IDs are extracted from the received packet and used for authenticating the subscriber with the client related information.

When an interface configuration is changed from ambiguous to non-ambiguous or vice-versa or Ambiguous VLAN range is changed, then all existing client bindings for the Ambiguous VLAN are cleared.

For more information on configuring ambiguous VLAN, see [Configuring Ambiguous VLANs, on page 217](#).

Configuring Ambiguous VLANs

Perform this task to configure ambiguous vlans.



Note There is no DHCP-specific configuration required for ambiguous VLANs.

SUMMARY STEPS

1. **configure**
2. **interface** *type interface-path-id*
3. Use any of these encapsulations to configure encapsulated ambiguous VLANs:
 - **encapsulation ambiguous { dot1q | dot1ad } { any | vlan-range }**
 - **encapsulation ambiguous dot1q vlan-id second-dot1q { any | vlan-range }**
 - **encapsulation ambiguous dot1q any second-dot1q { any | vlan-id }**
 - **encapsulation ambiguous dot1ad vlan-id dot1q { any | vlan-range }**
 - **encapsulation ambiguous dot1q vlan-range second-dot1q any**
 - **encapsulation ambiguous dot1ad vlan-range dot1q any**
4. **ipv4 | ipv6address** *source-ip-address destination-ip-address*
5. **service-policy type control subscriber** *policy_name*
6. **ipsubscriber { ipv4 | ipv6 } l2-connected**
7. **initiator dhcp**
8. Use the **commit** or **end** command.

DETAILED STEPS

	Command or Action	Purpose
Step 1	configure Example: RP/0/RSP0/CPU0:router# configure	Enters global configuration mode.
Step 2	interface <i>type interface-path-id</i> Example:	Configures the interface and enters the interface configuration mode.

	Command or Action	Purpose
	RP/0/RSP0/CPU0:router(config)# interface Bundle-Ether100.12	
Step 3	<p>Use any of these encapsulations to configure encapsulated ambiguous VLANs:</p> <ul style="list-style-type: none"> • encapsulation ambiguous { dot1q dot1ad } {any vlan-range } • encapsulation ambiguous dot1q vlan-id second-dot1q { any vlan-range } • encapsulation ambiguous dot1q any second-dot1q { any vlan-id } • encapsulation ambiguous dot1ad vlan-id dot1q { any vlan-range } • encapsulation ambiguous dot1q vlan-range second-dot1q any • encapsulation ambiguous dot1ad vlan-range dot1q any <p>Example:</p> <pre>RP/0/RSP0/CPU0:router(config-if)# encapsulation ambiguous dot1q any RP/0/RSP0/CPU0:router(config-if)# encapsulation ambiguous dot1q 14 second-dot1q 100-200 RP/0/RSP0/CPU0:router(config-if)# encapsulation ambiguous dot1q any second-dot1q any RP/0/RSP0/CPU0:router(config-if)# encapsulation ambiguous dot1ad 14 dot1q 100,200,300-400 RP/0/RSP0/CPU0:router(config-if)# encapsulation ambiguous dot1q 1-1000 second-dot1q any</pre>	<p>Configures IEEE 802.1Q VLAN configuration.</p> <p>The <i>vlan-range</i> can be given in comma-separated, or hyphen-separated format, or a combination of both, as shown in the examples.</p> <p>Note Although encapsulation ambiguous dot1ad is supported, it is not commonly used in BNG deployments.</p>
Step 4	<p>ipv4 ipv6address <i>source-ip-address destination-ip-address</i></p> <p>Example:</p> <pre>RP/0/RSP0/CPU0:router(config-if)# ipv4 address 2.1.12.1 255.255.255.0 RP/0/RSP0/CPU0:router(config-if)# ipv6 address 1:2:3::4 128</pre>	Configures the IPv4 or IPv6 protocol address.
Step 5	<p>service-policy type control subscriber <i>policy_name</i></p> <p>Example:</p> <pre>RP/0/RSP0/CPU0:router(config-if)# service-policy type control subscriber PL1</pre>	Applies a policy-map to an access interface where the policy-map was previously defined with the specified PL1 <i>policy_name</i> .
Step 6	<p>ipsubscriber { ipv4 ipv6 } l2-connected</p> <p>Example:</p> <pre>RP/0/RSP0/CPU0:router(config-if)# ipsubscriber ipv4 l2-connected</pre>	Enables l2-connected IPv4 or IPv6 IP subscriber.

	Command or Action	Purpose
	RP/0/RSP0/CPU0:router(config-if)# ipsubscriber ipv6 l2-connected	
Step 7	initiator dhcp Example: RP/0/RSP0/CPU0:router(config-if)# initiator dhcp	Enables initiator DHCP on the IP subscriber.
Step 8	Use the commit or end command.	commit —Saves the configuration changes and remains within the configuration session. end —Prompts user to take one of these actions: <ul style="list-style-type: none"> • Yes — Saves configuration changes and exits the configuration session. • No —Exits the configuration session without committing the configuration changes. • Cancel —Remains in the configuration session, without committing the configuration changes.

Configuring Ambiguous VLANs: An example

```

configure
interface Bundle-Ether100.12
encapsulation ambiguous dot1q 14 second-dot1q any
ipv4 address 2.1.12.1 255.255.255.0
service-policy type control subscriber PL1
ipsubscriber ipv4 l2-connected
initiator dhcp
!
!
end

```

DHCPv6 Address or Prefix Pool

An address or prefix pool represents a pool of available address or prefixes from which a delegating router assigns an address or delegates a prefix to the requesting router. The Distributed Address Pool Service (DAPS) manages and maintains address or prefix pools for DHCPv6.

DHCPv6 Prefix Delegation involves a delegating router selecting a prefix and delegating it on a temporary basis to a requesting router. The delegating router assigns the address or delegates the prefix from the address pool or prefix pool to the requesting router.

For more information about configuring DHCPv6 address or prefix pool, see [Configuring IPv6 Address or Prefix Pool Name](#), on page 219.

Configuring IPv6 Address or Prefix Pool Name

Perform this task to configure IPv6 address or prefix pool name under dynamic template configuration mode.

SUMMARY STEPS

1. **configure**
2. **dynamic-template**
3. **type ipsubscriber** *dynamic-template_name*
4. **dhcpv6 delegated-prefix-pool** *pool-name*
5. Use the **commit** or **end** command.
6. **type ppp** *dynamic-template_name*
7. **dhcpv6 address-pool** *pool-name*
8. Use the **commit** or **end** command.
9. **type ipsubscriber** *dynamic-template_name*
10. **dhcpv6 address-pool** *pool-name*
11. Use the **commit** or **end** command.
12. **ipv6 nd framed-prefix-pool** *pool-name*
13. Use the **commit** or **end** command.

DETAILED STEPS

	Command or Action	Purpose
Step 1	configure Example: RP/0/RSP0/CPU0:router# configure	Enters global configuration mode.
Step 2	dynamic-template Example: RP/0/RSP0/CPU0:router(config)# dynamic-template	Enables dynamic template configuration.
Step 3	type ipsubscriber <i>dynamic-template_name</i> Example: RP/0/RSP0/CPU0:router(config-dynamic-template)# type ipsubscriber ipv6-sub-template	Configures dynamic template of type ipsubscriber and enters the dynamic-template type configuration mode.
Step 4	dhcpv6 delegated-prefix-pool <i>pool-name</i> Example: RP/0/RSP0/CPU0:router(config-dynamic-template-type)# dhcpv6 delegated-prefix-pool mypool	Configures IPv6 subscriber dynamic template with prefix-delegation pool.
Step 5	Use the commit or end command.	commit —Saves the configuration changes and remains within the configuration session. end —Prompts user to take one of these actions: <ul style="list-style-type: none"> • Yes — Saves configuration changes and exits the configuration session. • No —Exits the configuration session without committing the configuration changes.

	Command or Action	Purpose
		<ul style="list-style-type: none"> • Cancel —Remains in the configuration session, without committing the configuration changes.
Step 6	type ppp <i>dynamic-template_name</i> Example: RP/0/RSP0/CPU0:router(config-dynamic-template)# type ppp ipv6-sub-template	Configures dynamic template of type ppp.
Step 7	dhcpv6 address-pool <i>pool-name</i> Example: RP/0/RSP0/CPU0:router(config-dynamic-template-type)# dhcpv6 address-pool my-pppoe-addr-pool	Configures IPv6 address pool for PPPoE subscribers.
Step 8	Use the commit or end command.	commit —Saves the configuration changes and remains within the configuration session. end —Prompts user to take one of these actions: <ul style="list-style-type: none"> • Yes — Saves configuration changes and exits the configuration session. • No —Exits the configuration session without committing the configuration changes. • Cancel —Remains in the configuration session, without committing the configuration changes.
Step 9	type ipsubscriber <i>dynamic-template_name</i> Example: RP/0/RSP0/CPU0:router(config-dynamic-template)# type ipsubscriber my-ipv6-template	Configures dynamic template of type ipsubscriber and enters the dynamic-template type configuration mode.
Step 10	dhcpv6 address-pool <i>pool-name</i> Example: RP/0/RSP0/CPU0:router(config-dynamic-template-type)# dhcpv6 address-pool my-ipsub-addr-pool	Configures IPv6 address pool for IPoE subscribers.
Step 11	Use the commit or end command.	commit —Saves the configuration changes and remains within the configuration session. end —Prompts user to take one of these actions: <ul style="list-style-type: none"> • Yes — Saves configuration changes and exits the configuration session. • No —Exits the configuration session without committing the configuration changes. • Cancel —Remains in the configuration session, without committing the configuration changes.

	Command or Action	Purpose
Step 12	ipv6 nd framed-prefix-pool <i>pool-name</i> Example: RP/0/RSP0/CPU0:router(config-dynamic-template-type) # framed-prefix-pool my-slaac-pool	Configures prefix pool to be used by SLAAC only.
Step 13	Use the commit or end command.	commit —Saves the configuration changes and remains within the configuration session. end —Prompts user to take one of these actions: <ul style="list-style-type: none"> • Yes — Saves configuration changes and exits the configuration session. • No —Exits the configuration session without committing the configuration changes. • Cancel —Remains in the configuration session, without committing the configuration changes.

Configuring IPv6 Address or Prefix Pool Name: An example

```

configure
dynamic-template
type ipsubscriber ipv6-sub-template
dhcpv6 delegated-prefix-pool mypool
end
dynamic-template
type ppp ipv6-sub-template
dhcpv6 address-pool my-pppoe-addr-pool
!
type ipsubscriber my-ipv6-template
dhcpv6 address-pool my-ipsub-addr-pool
!!
ipv6 nd framed-prefix-pool my-slaac-pool
end
!!

```

Enabling DHCPv6 Proxy Mode PPPoE Session to Send the Link Local Address

Perform this task to configure Dynamic Host Configuration Protocol (DHCP) IPv6 proxy mode for Point-to-Point Protocol over Ethernet (PPPoE) sessions. The configuration enables PPPoE session to send the link local address for SOLICIT message and renew request message with the Router Advertisement (RA) prefix allocated by Neighbor Discovery (ND) or Broadband Network Gateway (BNG) routers.

SUMMARY STEPS

1. **configure**
2. **dhcp ipv6**
3. **profile** *proxy_profile_name* **proxy**
4. **helper-address vrf** *vrf_name* *ipv6_address*
5. **linkaddress-from-ra-enable**

6. Use the **commit** or **end** command.

DETAILED STEPS

	Command or Action	Purpose
Step 1	configure Example: RP/0/RSP0/CPU0:router# configure	Enters global configuration mode.
Step 2	dhcp ipv6 Example: RP/0/RSP0/CPU0:router(config)# dhcp ipv6	Configures DHCP for IPv6 and enters the DHCPv6 configuration mode.
Step 3	profile proxy_profile_name proxy Example: RP/0/RSP0/CPU0:router(config-dhcpv6)# profile my-proxy-profile proxy	Creates a DHCPv6 profile proxy and enters the DHCPv6 proxy sub-configuration mode.
Step 4	helper-address vrf vrf_name ipv6_address Example: RP/0/RSP0/CPU0:router(config-dhcpv6-proxy-profile)# helper-address vrf my-server-vrf 1:1:1::1	Configures DHCPv6 address as a helper address to the proxy. Note The helper address can be configured only under the proxy profile and proxy profile class sub-modes.
Step 5	linkaddress-from-ra-enable Example: RP/0/RSP0/CPU0:router(config-dhcpv6-proxy-profile)# linkaddress-from-ra-enable	Enable DHCPv6 relay message to include the link local address with router advertisement prefix. Note The link address configured in proxy profile or class level will take precedence over the link address while using the linkaddress-from-ra-enable command.
Step 6	Use the commit or end command.	commit —Saves the configuration changes and remains within the configuration session. end —Prompts user to take one of these actions: <ul style="list-style-type: none"> • Yes — Saves configuration changes and exits the configuration session. • No —Exits the configuration session without committing the configuration changes. • Cancel —Remains in the configuration session, without committing the configuration changes.

DHCP Soft Pool Migration

DHCP soft pool migration feature in BNG allows blocking networks within the IP address pool. These migrations can be performed on the complete pool or on the networks within the pool. Because IPv4 pool is a limited resource for internet service provider(ISP), this feature helps ISPs to manage their available IPv4 pools automatically and migrate pools on demand between BNGs.

To enable dynamic pool blocking, use the **block** option for **address-range** command in pool IPv4 or IPv6 configuration mode.

Once the pool is marked as blocked, DAPS does not release any more IP address from that particular network. On every RENEW request from the client, the DHCP server checks with DAPS whether the IP address range of that particular IP address is blocked or available. And, if that particular address range is blocked in the pool, the RENEW request is rejected, thereby forcing the client to re-negotiate for a new IP address.

DHCP validates the IP address with DAPS only if the identity change feature is enabled using **subscriber feature identity-change** command.

Configure DHCP Soft Pool Migration

Configuration Example

```
RP/0/RSP0/CPU0:router#config
RP/0/RSP0/CPU0:router#pool vrf default ipv4 dhcp_192
RP/0/RSP0/CPU0:router#address-range 192.0.2.1 192.0.2.7 block
RP/0/RSP0/CPU0:router#address-range 192.0.2.11 192.0.2.20
```

Verify DHCP Soft Pool Migration

Before blocking the pool:

```
RP/0/RSP0/CPU0:router#show run pool ipv4
pool vrf default ipv4 dhcp_192
  address-range 192.0.2.1 192.0.2.7
  address-range address-range 192.0.2.11 192.0.2.20
```

```
RP/0/RSP0/CPU0:router#show pool ipv4 name dhcp_192 verbose
```

```
...
Range Start      : 192.0.2.1
Range End        : 192.0.2.7
Default Router   : 0.0.0.0
Used Addresses   : 5
Excluded Addresses : 0
Free Addresses   : 1
Range Start      : 192.0.2.11
Range End        : 192.0.2.20
Default Router   : 0.0.0.0
Used Addresses   : 0
Excluded Addresses : 0
Free Addresses   : 10
...
```

After blocking the pool:

```
RP/0/RSP0/CPU0:router#show run pool ipv4
pool vrf default ipv4 dhcp_192
```



```
address-range 192.0.2.1 192.0.2.7 blocked
address-range 192.0.2.11 192.0.2.20
```

```
RP/0/RSP0/CPU0:router#show pool ipv4 name dhcp_192 verbose
```

```
...
Range Start      : 192.0.2.1
Range End        : 192.0.2.7
Default Router   : 0.0.0.0
Used Addresses   : 0
Excluded Addresses : 0
Free Addresses   : 6
Range Start      : 192.0.2.11
Range End        : 192.0.2.20
Default Router   : 0.0.0.0
Used Addresses   : 5
Excluded Addresses : 0
Free Addresses   : 5
...
```

DAPS generates a log message when all the IP addresses that were previously released from the blocked-address range are recovered back. This is one such sample log:

```
RP/0/RSP1/CPU0:Feb 25 15:18:12.810 : daps[178]: %IP-DAPS-6-POOL_BLK_TRP_DONE :
Ip release TRAP generated for pool dhcp_192 start 192.0.2.1 end 192.0.2.7
```

DHCPv6 Dual-Stack Lite Support

Dual-Stack Lite (DS-Lite) is a technique for providing complete support for both IPv4 and IPv6 internet protocols, both in hosts and router. Dual-Stack Lite enables a broadband service provider to share IPv4 addresses among customers by combining two technologies: IP in IP (IPv4- in-IPv6) and Network Address Translation (NAT).

The DS-Lite feature contains two components: Basic Bridging Broad Band (B4) and Address Family Transition Router (AFTR).

The B4 element is a function implemented on a dual-stack-capable node, either a directly connected device or a CPE that creates a tunnel to an Address Family Transition Router (AFTR). On the other hand, an AFTR element is the combination of an IPv4-in-IPv6 tunnel endpoint and an IPv4-IPv4 NAT implemented on the same node. A DS-Lite B4 element uses a DHCPv6 option to discover the IPv6 address of its corresponding AFTR location.

For more information about configuring AFTR for DS-Lite, see [Configuring AFTR Fully Qualified Domain Name for DS-Lite, on page 225](#).

Configuring AFTR Fully Qualified Domain Name for DS-Lite

Perform this task to configure AFTR fully qualified domain name for DS-Lite.

SUMMARY STEPS

1. **configure**
2. **dhcp ipv6**
3. **profile** *server_profile_name* **server**
4. **aftr-name** *aftr_name*

- Use the **commit** or **end** command.

DETAILED STEPS

	Command or Action	Purpose
Step 1	configure Example: RP/0/RSP0/CPU0:router# configure	Enters global configuration mode.
Step 2	dhcp ipv6 Example: RP/0/RSP0/CPU0:router(config)# dhcp ipv6	Configures DHCP for IPv6 and enters the DHCPv6 configuration mode.
Step 3	profile <i>server_profile_name</i> server Example: RP/0/RSP0/CPU0:router(config-dhcpv6)# profile my-server-profile server	Configures DHCPv6 server profile and enters the DHCPv6 server profile sub-configuration mode.
Step 4	aftr-name <i>aftr_name</i> Example: RP/0/RSP0/CPU0:router(config-dhcpv6-server-profile)# aftr-name aftr-server.example.com	Configures the AFTR Fully Qualified Domain Name option, in the server profile mode, for the DS-Lite support.
Step 5	Use the commit or end command.	commit —Saves the configuration changes and remains within the configuration session. end —Prompts user to take one of these actions: <ul style="list-style-type: none"> • Yes — Saves configuration changes and exits the configuration session. • No —Exits the configuration session without committing the configuration changes. • Cancel —Remains in the configuration session, without committing the configuration changes.

Configuring AFTR Fully Qualified Domain Name for DS-Lite: An example

```
configure
dhcp ipv6
profile my-server-profile server
aftr-name aftr-server.example.com
end
!!
```

VRF Awareness in DHCPv6

VRF Awareness is the ability of DHCPv6 Server or Proxy to support multiple clients in different VPNs where the same IP address is assigned to clients on differing VPNs. The IPv6 addresses in a VRF is independent from IPv6 addresses in an another VRF. It is not mandatory to have same prefix/address in multiple VRFs.

For more information about defining VRF in a dynamic template, see [Defining VRF in a Dynamic Template](#), on page 227.

Defining VRF in a Dynamic Template

Perform this task for defining VRF in a dynamic template. The IPv6 addresses in a VRF is independent from IPv6 addresses in an another VRF. It is not mandatory to have same prefix or address in multiple VRFs.

SUMMARY STEPS

1. **configure**
2. **dynamic-template**
3. **type ipsubscriber** *dynamic-template_name*
4. **vrf** *vrf_name*
5. Use the **commit** or **end** command.

DETAILED STEPS

	Command or Action	Purpose
Step 1	configure Example: RP/0/RSP0/CPU0:router# configure	Enters global configuration mode.
Step 2	dynamic-template Example: RP/0/RSP0/CPU0:router(config)# dynamic-template	Enables dynamic template configuration.
Step 3	type ipsubscriber <i>dynamic-template_name</i> Example: RP/0/RSP0/CPU0:router(config-dynamic-template)# type ipsubscriber ipv6-sub-template	Configures dynamic template of type ipsubscriber and enters the dynamic template type configuration mode.
Step 4	vrf <i>vrf_name</i> Example: RP/0/RSP0/CPU0:router(config-dynamic-template-type)# vrf vrf1	Sets the VRF in which the interface operates.
Step 5	Use the commit or end command.	commit —Saves the configuration changes and remains within the configuration session. end —Prompts user to take one of these actions: <ul style="list-style-type: none"> • Yes — Saves configuration changes and exits the configuration session.

	Command or Action	Purpose
		<ul style="list-style-type: none"> • No —Exits the configuration session without committing the configuration changes. • Cancel —Remains in the configuration session, without committing the configuration changes.

Defining VRF in a Dynamic Template: An example

```
configure
dynamic-template
type ipsubscriber ipv6-sub-template
vrf vrf1
end
!!
```

DHCP Options Support for BNG DHCPv6 Proxy Mode

This is a DHCP enhancement where BNG DHCPv6 proxy supports addition of PPPoE attributes like Remote-Id, Circuit-Id and Username as DHCPv6 options in the Relay-forward message sent to the external DHCPv6 server. The DHCPv6 options are sent as Remote-Id, Interface-Id and Relay-Agent-Subscriber-Id respectively. The MAC-address can also be included as Link-layer Address option in Relay-forward message. These fields can then be used by the external DHCPv6 server while performing IPv6 prefix allocation for the end user. This feature helps in identifying subscribers based on the Interface-Id and Remote-Id attributes in PPPoE.

The DHCPv6 options 18 (Interface-Id), 37 (Remote-Id) and 38 (Relay-Agent-Subscriber-Id) are valid only for PPPoE subscriber sessions. Option 79 (Link-layer Address) is valid for IPoE and PPPoE sessions.

To enable this feature, use the **relay option** command in DHCP IPv6 proxy profile configuration mode.

Configuration Example

```
RP/0/RSP0/CPU0:router#configure
RP/0/RSP0/CPU0:router(config)#dhcp ipv6
RP/0/RSP0/CPU0:router(config-dhcpv6)#profile P1 proxy
RP/0/RSP0/CPU0:router(config-dhcpv6-proxy-profile)#relay option remote-id pppoe
RP/0/RSP0/CPU0:router(config-dhcpv6-proxy-profile)#relay option interface-id insert pppoe
RP/0/RSP0/CPU0:router(config-dhcpv6-proxy-profile)#relay option subscriber-id pppoe
RP/0/RSP0/CPU0:router(config-dhcpv6-proxy-profile)#relay option link-layer-address set
```

Use Cases of DHCP Options in BNG DHCPv6 Proxy

This table lists some of the use cases of DHCP options in BNG DHCPv6 proxy mode.

Use Case Number	Description	Expected Behavior
1	<p>Configure relay option command with remote-id, interface-id, link-layer-addr and subscriber-id options in BNG DHCPv6 proxy.</p> <p>Create BNG PPPoE session with Username, Circuit-Id and Remote-Id attributes set for PPPoE.</p>	<p>BNG DHCPv6 proxy reads the Username, Circuit-Id and Remote-Id attributes from PPPoE session and sets them as DHCPv6 options 38, 18 and 37 (Subscriber-Id, Interface-Id and Remote-Id) respectively in the Relay-forward message (of SOLICIT or REQUEST) sent to the external DHCPv6 server.</p> <p>The client MAC address is set as option 39 (Link-layer Address) in the Relay-forward message.</p>
2	<p>Remove the relay option configuration mentioned in use case 1.</p> <p>Create BNG PPPoE session with Username, Circuit-Id and Remote-Id attributes set for PPPoE.</p>	<p>BNG DHCPv6 proxy sets the default Remote-Id and default Interface-Id in the Relay-forward message (of SOLICIT or REQUEST) sent to the external DHCPv6 server.</p> <p>The Link-layer Address option and Subscriber-Id option is not set in the Relay-forward message.</p>
3	<p>Create BNG session with configurations mentioned above in use case 1 and renew the DHCP lease with a REQUEST message.</p>	<p>The behavior remains same as in use case 1, except that the options are set in the Relay-forward message (of RENEW request) sent to the external DHCPv6 server.</p>
4	<p>Create BNG session with configurations mentioned above in use case 1 and tear down the session with RELEASE message.</p>	<p>The behavior remains same as in use case 1, except that the options are set in the Relay-forward message (of RELEASE request) sent to the external DHCPv6 server.</p>
5	<p>Create BNG session with configurations mentioned above in use case 1 and get information for binding with Information-Request message.</p>	<p>The behavior remains same as in use case 1, except that the options are set in the Relay-forward message (of Information-Request) sent to the external DHCPv6 server.</p>
6	<p>Handle DHCP Messages from LDRA which is placed between client and BNG.</p> <p>Create BNG session with configurations mentioned above in use case 1.</p>	<p>The behavior remains same as in use case 1. BNG forwards the received messages from LDRA by including it in the Relay-forward message sent to the external DHCPv6 server.</p>

This table lists an error conditional use case and the expected behavior.

Use Case Number	Description	Expected Behavior
1	<p>Configure relay option command with remote-id, interface-id, link-layer-addr and subscriber-id options in BNG DHCPv6 proxy.</p> <p>Create BNG PPPoE session with Username, Circuit-Id and Remote-Id attributes not set for PPPoE.</p>	<p>BNG DHCPv6 proxy sets the default Remote-Id and default Interface-Id in the Relay-forward message sent to the DHCPv6 server. The Link-layer Address option and Subscriber-Id option is not set in the Relay-forward message (of SOLICIT or REQUEST).</p>

Configurable DHCPv6 Option 17

BNG provides an option to specify the URL for self configuration of CPEs, through DHCPv6 Option 17. This way, the required configuration can be loaded on to the CPEs from the back end database itself.

To specify the URL, use the **option 17** command in DHCP IPv6 server profile configuration mode. The URL is to be specified in the form of an encoded string in hexadecimal format, without exceeding the maximum length of 1000 hex nibbles or 500 characters.

Configuration Example

```
Router#dhcp ipv6
Router(config-dhcpv6)#profile DHCP6_SERVER1 server
Router(config-dhcpv6-server-profile)#option 17 hex
0000168b0001002068747470733a2f2f6f70657261746f722e636f6d2f6465766963652f61636d70
```

The value used as encoded string in this example represents these:

- 0x0000de9—enterprise number=3561—The Broadband Forum
- 0x0001—opt-code=1
- 0x0020—option-len=32
- 0x68747470733a2f2f6f70657261746f722e636f6d2f6465766963652f61636d70—option-data=
https://operator.com/device/acmp

DHCP IPv6 Lease from the AAA Server

Cisco ASR 9000 BNG routers introduce the support for assigning DHCPv6 IP address and the lease values of the subscriber using the RADIUS profile. With this feature enabled, it is no more mandatory to configure the DHCPv6 lease values on the BNG router itself. When the first address family interface (AFI) comes up, the BNG router downloads and stores the IPv6 address and lease values of the user profile from the AAA server. If IPv6 AFI comes up with a delay, then the BNG router assigns the absolute lease value that is downloaded from the AAA server, to the client. As part of this feature, a new Cisco attribute-value pair (AVP), **dhcpv6-ip-lease**, is introduced to specify the client IPv6 address and lease values.

RADIUS Attribute for Setting DHCP IPv6 Lease from the AAA Server

The existing RADIUS vendor-specific attribute (VSA) 26 is used to process the Cisco AVP with DHCP Options.

The AVP format of **dhcpv6-ip-lease** is:

```
Cisco-avpair = "dhcpv6-ip-lease=IA-type, ip-address, prefix-length, T, T1, T2"
```

where,

- *IA-type* can be IANA or IAPD; 0 for IANA and 1 for IAPD.
- *ip-address* is the IPv6 address.
- *prefix-length* is the prefix length for IAPD. BNG ignores this value for IANA.
- *T* is the lease time, in seconds.
- *T1* is the renewal time, in seconds.
- *T2* is the rebind time, in seconds.

For example,

```
Cisco-avpair = "dhcpv6-ip-lease=0,2001:DB8::1,128,360,180,190",
```

For details on the RADIUS attribute for setting the DHCPv4 lease from the AAA server, see [DHCP Lease From AAA Server, on page 191](#).

DHCPv6 Lease Time for Class Profile

From Cisco IOS XR Software Release 6.4.1 and later, Cisco ASR 9000 BNG routers support lease time at the class profile level for DHCPv6 server mode. This feature helps to apply the same timer value to all the clients belonging to a particular class profile. Prior to this, the DHCPv6 lease time was supported only at global server profile level. If lease timer is configured for both global and class profiles, then the timer for the class profile takes precedence, provided the client belongs to that particular class profile.

Configure Lease Timer for Class Profile

Configuring lease time for class profile in DHCPv6 server mode in BNG involves these steps:

Configuration Example

```
Router#configure
Router(config)#dhcp ipv6
Router(config-dhcpv6)#profile server-profile server
Router(config-dhcpv6-server-profile)#class class1
Router(config-dhcpv6-server-profile-c)#lease 0 0 20
Router(config-dhcpv6-server-profile-c)#address-pool poolv6
Router(config-dhcpv6-server-profile-c)#dns-server 2001:DB8::1
Router(config-dhcpv6-server-profile-c)#commit
```

Running Configuration

```
dhcp ipv6
```

```

profile server-profile server
class class1
  lease 0 0 20
  address-pool poolv6
  dns-server 2001:DB8::1
!

```

Related Topics

[DHCPv6 Lease Time for Class Profile, on page 231](#)

Associated Commands

[lease](#)

DHCPv6 Option 1 and Option 16 to Form Authentication Username

This feature gives the flexibility to choose the format of the username that the BNG router sends to the AAA server as part of user authentication. The username is formed using DHCPv6 option 1 and option 16 present in the DHCP SOLICIT message. BNG uses the **Identifier** field of DHCP unique identifier (DUID) type 2 from the DHCP option 1, and the **vendor-class-data** from the DHCP option 16, to form the username.

The username must be in the following string format:

```
DHCP-option-1@DHCP-option-16
```

For example,

```
123456@example-vendor-class-data
```

Restrictions

Forming the authentication username from DHCPv6 option 1 and option 16 in BNG is subjected to these restrictions:

- The maximum length of DUID is 128 octets.
- The maximum limit of **Identifier** and **vendor-class-data** fields is 240 characters.
- The BNG router discards any DHCP SOLICIT message having a DUID type other than type 2 for DHCP option 1.

Enable AAA Username Formation Using DHCP Option 1 and Option 16

Configuration Example: DHCPv4

```

Router#configure
Router(config)#aaa attribute format format_v4
Router(config-id-format)#format-string length 233 "%s@s" dhcpv4-client-id-spl
dhcpv4-vendor-class
Router(config-id-format)#commit

```

Configuration Example: DHCPv6

```
Router#configure
Router(config)#aaa attribute format format_v6
Router(config-id-format)#format-string length 233 "%s@s%"
dhcpv6-client-id-enterprise-identifier dhcpv6-vendor-class-string
Router(config-id-format)#commit
```

Configuration Example: Dual-stack

```
Router#configure
Router(config)#aaa attribute format format_v4
Router(config-id-format)#format-string length 233 "%s@s%" dhcpv4-client-id-spl
dhcpv4-vendor-class
Router(config-id-format)#exit
Router(config)#aaa attribute format format_v6
Router(config-id-format)#format-string length 233 "%s@s%"
dhcpv6-client-id-enterprise-identifier dhcpv6-vendor-class-string
Router(config-id-format)#commit
```

Running Configuration

```
/* For dual-stack */
aaa attribute format format_v4
  format-string length 233 "%s@s%" dhcpv4-client-id-spl dhcpv4-vendor-class
!
aaa attribute format format_v6
  format-string length 233 "%s@s%" dhcpv6-client-id-enterprise-identifier
  dhcpv6-vendor-class-string
!
```

Related Topics

[DHCPv6 Option 1 and Option 16 to Form Authentication Username, on page 232](#)

Associated Commands

[aaa attribute format](#)

DHCPv6 Option 16 Filtering

The DHCPv6 option 16 filtering feature in Cisco ASR 9000 BNG routers controls the DHCP SOLICIT packets from the clients based on the DHCP option 16 information such as vendor-class data and enterprise-ID. This feature provides administrator, the flexibility to allow or drop block listed of clients as early as during DHCP session handling, that is, even before the interaction with the RADIUS server begins.

Enable DHCPv6 Option 16 Filtering

You must perform these tasks to enable DHCPv6 option 16 filtering feature in BNG:

- Specify the permitted DUID type for the DHCP SOLICIT packets, using the **duid allowed-type** command in DHCPv6 server profile configuration mode.

- Specify the match options as **vendor-class** and **enterprise-id** along with the respective action (**allow** or **drop**) to be taken for each incoming packet.

Configuration Example

```
Router#configure
Router(config)#dhcp ipv6
Router(config-dhcpv6)#profile server-profile server
Router(config-dhcpv6-server-profile)#duid allowed-type 1
Router(config-dhcpv6-server-profile)#commit

Router(config-dhcpv6-server-profile)#match option enterprise-id hex ABCD action allow
Router(config-dhcpv6-server-profile)#match option vendor-class string "example" action allow
Router(config-dhcpv6-server-profile)#match option enterprise-id default action allow
Router(config-dhcpv6-server-profile)#match option vendor-class default action drop
Router(config-dhcpv6-server-profile)#commit
```

Running Configuration

```
dhcp ipv6
  profile server-profile server
    duid allowed-type 1
    !
    match option enterprise-id hex ABCD action allow
    match option vendor-class string "example" action allow
    match option enterprise-id default action allow
    match option vendor-class default action drop
    !
```

Related Topics

[DHCPv6 Option 16 Filtering, on page 233](#)

Associated Commands

[duid-allowed-type](#)

[match option](#)

Use Cases of DHCPv6 Option 16 Filtering

This table lists some of the use cases and expected behavior of DHCP option 16 filtering feature in BNG.

Use Case Description	Expected Behavior
Bring up a BNG IPoE session after creating a server profile with a blocked list of vendor-class data and enterprise-ID. <pre>match vendor-class-data string "ABC*" action drop match enterprise-ID hex FFF action drop</pre>	The BNG router allows all the DHCP SOLICIT packets by default, except the ones that are explicitly configured to be dropped. Session comes up for all other clients.

Use Case Description	Expected Behavior
<p>Bring up a BNG IPoE session after creating a server profile with an allowed list of vendor-class data and enterprise-ID.</p> <pre>match vendor-class-data string "ABC*" action allow allow match enterprise-ID hex FFF action allow match vendor-class-data default action drop match enterprise-ID default action drop</pre>	<p>The BNG router drops all the DHCP SOLICIT packets by default, except the ones that are explicitly configured to be allowed. Session comes up for the allowed list of clients.</p>
<p>Bring up a BNG IPoE session after creating a server profile having an action to block all DHCP SOLICIT packets, by default.</p> <pre>match vendor-class-data default action drop match enterprise-ID default action drop</pre>	<p>The BNG router drops all DHCP SOLICIT packets if option 16 field is present in them. If not, the packets are always allowed.</p>
<p>Bring up a BNG IPoE session after creating a server profile having an action to allow all DHCP SOLICIT packets, by default.</p> <pre>match vendor-class-data default action allow match enterprise-ID default action allow</pre>	<p>The BNG router allows all DHCP SOLICIT packets if option 16 field is present in them. If not, the packets are always allowed.</p>
<p>Bring up a BNG IPoE session after creating a server profile with a blocked list of vendor-class data and an allowed list of enterprise-ID.</p> <pre>match vendor-class-data string "ABC*" action drop drop match enterprise-ID hex FFF action allow match vendor-class-data default action drop match enterprise-ID default action allow</pre>	<p>The BNG router drops all the DHCP SOLICIT packets having the specific blocked list (string with "ABC*", in this example) of vendor-class data . And, it allows the ones having the specific allowed list (FFF, in this example) of enterprise-ID .</p>

Rapid commit

The **rapid-commit** command aids to enable or disable the rapid commit option of the DHCP server. Enabling it renders the DHCPv6 server to use the two message exchange feature to address/prefix an assignment. Including the rapid commit option in the SOLICIT message and enabling the same in the server profile, enables the server to respond with the REPLY message. Else, it follows the normal four message exchange procedure to assign address/prefix an assignment.



Note By default, the rapid commit option is disabled.

Example:

```
RP/0/RSP0/CPU0:router(config)# dhcp ipv6
RP/0/RSP0/CPU0:router(config-dhcpv6)# profile my-server-profile server
RP/0/RSP0/CPU0:router(config-dhcpv6-server-profile)# rapid-commit
```

Packet Handling on Subscriber Interfaces

This section describes how subscriber interfaces are supported in certain special cases. These special cases include L3 forwarded interfaces. As a result, this support is applicable only to PPP over Ethernet PPP Termination and Aggregation (PPPoE PTA) and IPoE sessions.

Most subscriber data packets are forwarded directly by the network processing unit (NPU). There are certain special cases where the NPU does not completely handle the data packet. These special cases are handled by the CPU, and go through an internal interface created for this purpose. This internal interface is named the Subscriber Interface or SINT. SINT is an aggregate interface, which is used by all packets punted on subscriber interfaces. There is one SINT for each node. When the BNG package is installed, by default the SINT is created. The SINT interfaces are needed for punt-inject of packets on subscriber interfaces.

These special cases are supported for both IPoE and PPPoE PTA:



Note These special cases do not apply to PPPoE L2TP, because it is an L2 service.

- Ping to and from subscriber

BNG allows the receiving of a ping request from both IPoE and PPPoE PTA subscriber interfaces; this is consistent with other non-BNG interface types as well. Similarly, BNG also allows the sending of a ping request to both IPoE and PPPoE PTA subscriber interfaces. This includes:

- various lengths of ping packets including lengths exceeding the subscribers MTU size
- subscriber in the default and private VRFs
- various ping options such as type of service, DF set, and verbose

BNG also supports receiving a ping request from both IPv4 and IPv6 subscribers.



Note Excessive Punt Flow Trap feature should be disabled when sending a high rate of pings to, or from subscriber interfaces.

- Option Handling

BNG supports handling IP options; this is consistent with non-BNG interface types. These are punted from the NPU to the CPU. These go through the SINT interface and are handled by the appropriate application.

- Support for traceroute, PMTU discovery, ICMP unreachable
 - BNG supports sending ICMP for packets that are received from or destined to a PPPoE or IP subscriber interface that cannot be forwarded. This functionality is similar to other non-BNG subscriber interfaces.
 - BNG supports PMTU, in which BNG sends ICMPs, when a packet is destined to a subscriber interface, but the packet exceeds the subscriber MTU and the DF bit is set.
 - BNG supports sending ICMPs when packets to (egress ACL) or from (ingress ACL) the subscriber interface are denied due to the ACL. If the ACL is configured do both deny and log, then the packets get dropped, but no ICMP is generated.
 - BNG supports traceroute functionality that enables sending an ICMP when the time to live (TTL) of the packet is exceeded.
 - BNG supports traceroute functionality for both IPv4 and IPv6 subscribers.
- Fragmentation

BNG does not support fragmentation of packets destined to the PPPoE or IP subscriber interfaces.



Caution In Cisco IOS XR, fragmentation is handled by linecard (LC) CPU or route processor (RP) CPU. All packets requiring fragmentation are policed by local packet transport service (LPTS), to a maximum of 2500 packets per second (pps) for each network processing unit (NPU).

The fragmentation path is supported only in software, and fragmented packets skip all features, including subscriber features, QoS, ACL and so on. Therefore, irrespective of BNG, it should not be used as a general forwarding path.

BNG over Pseudowire Headend does not support fragmentation.

Restrictions

These restrictions apply to implementing subscriber interfaces:

- During an ACL logging, packets are punted to CPU, and BNG interfaces are directed to the SINT interface. The SINT interface drops these log packets because the system does not support ACL Logging on BNG interfaces.
- IPv6 Ping and traceroute functions should use both the CPE and BNG routers global addresses. IPv6 Ping and traceroute functions using link local address does not work in all cases.
- Logging on subscriber ACLs is not supported.

IPv6 Neighbor Discovery

The IPv6 Neighbor Discovery (ND) process uses Internet Control Message Protocol (ICMP) messages and solicited-node multicast addresses to determine the link-layer address of a neighbor on the same network (local link), verify the reachability of a neighbor, and track neighboring routers.

The IPv6 static cache entry for neighbor discovery feature allows static entries to be made in the IPv6 neighbor cache. Static routing requires that an administrator manually enters IPv6 addresses, subnet masks, gateways, and corresponding Media Access Control (MAC) addresses for each interface of each device into a table. Static routing enables more control but involves more work in maintaining the table. The table must be updated each time routes are added or changed.

The different message types in neighbor discovery are:

- **IPv6 Neighbor Solicitation Message:** A value of 135 in the Type field of the ICMP packet header identifies a neighbor solicitation message. Neighbor solicitation messages are sent on the local link when a node wants to determine the link-layer address of another node on the same local link.
- **IPv6 Router Advertisement Message:** Router advertisement (RA) messages, which have a value of 134 in the Type field of the ICMP packet header, are periodically sent out of each configured interface of an IPv6 device.

Ambiguous VLAN does not have association with any particular VLAN; therefore, a unicast router advertisement message has to be sent out for ambiguous VLAN interfaces. To enable IPv6 unicast router advertisement, use the **ipv6 nd ra-unicast** command in the dynamic template configuration mode.



Note From Cisco IOS XR Release 5.1.0 and later, it is mandatory to configure the **ipv6 enable** command under the bundle access-interface, in order to send RA messages out of BNG.

- **IPv6 Neighbor Redirect Message:** A value of 137 in the type field of the ICMP packet header identifies an IPv6 neighbor redirect message. Devices send neighbor redirect messages to inform hosts of better first-hop nodes on the path to a destination.

In BNG, IPv6 ND supports both IPoE and PPPoE sessions. IPv6 ND provides Stateless Address autoconfiguration (SLAAC), which is used for assigning a prefix to the PPPoE subscriber.

Line Card Subscribers

BNG supports line card (LC) subscribers which are based on physical access interfaces. This support is in addition to supporting route processor (RP) subscribers, which are based on bundle access-interfaces. Apart from route switch processor (RSP), line cards also support session termination and control plane protocols. For LC subscribers, both control and data planes run on the same node and share the same CPU resource. In contrast, for bundle subscribers, the control plane runs completely on RSP, and the data plane runs completely on LC.

The number of LC subscribers sessions scales linearly with the number of line cards in the system. The maximum number of sessions for each LC is 64000. As more line cards are added to the system, the maximum

number of sessions in the system reaches a multiple of 64000 subscribers, the multiplier being the number of line cards.

The calls-per-second (CPS) achieved for each chassis scales almost linearly with the number of line cards in the system. Linearity is not achieved for CPS because of the congestion in the communication channel, arising out of the large number of notifications sent out from LC to RSP.

From Cisco IOS XR Software Release 6.5.1 onwards, Subscriber Redundancy Group (SRG) is supported for LC subscriber sessions. For more information on this feature, see the chapter *BNG Geo Redundancy* in this guide.

External Interaction for LC Subscribers

As part of LC subscriber support, there are various interactions directly between LC and external servers such as RADIUS and DHCP servers. These interactions change the way how load balancing is done and the way CoA is handled.

Load Balancing

Because each LC control plane functions independently, with LC subscribers, any global configuration of RADIUS and DHCP servers does not result in load-balanced usage. It is possible that all LCs end up using the same RADIUS server. As a result, the user needs to carry out manual load balancing. This is done by creating different AAA groups and method lists using different sets of RADIUS servers, then assigning the AAA groups to different service profiles, and finally assigning these different service profiles to the access interfaces on different LCs. Similarly, for DHCP servers, the access interfaces on different LCs should have different profiles, each pointing to different DHCP servers.

Interaction with RADIUS Server

With the distributed model of interacting with RADIUS, the RADIUS client on BNG can be configured in two different ways. Either the entire BNG router shows up as one BNG to the RADIUS server (**NAS-IP-Address**), or each LC appears as a different router. Currently, the CoAs can be handled only by the iEdge on the RSP. Each LC appearing as its NAS is not supported.

Address Pools

It is preferable to provide different address pools to different LCs so that they work completely independent of each other, without the need to perform significant messaging across nodes.

Benefits and Restrictions of Line Card Subscribers

Benefits of line card subscribers

These are some of the benefits of LC subscribers:

- Subscribers built on bundle interfaces and line card physical interfaces can co-exist on the same router.
- Significant gain in performance because the control plane is distributed to multiple LCs. In aggregate, the entire chassis reaches much higher scale and performance than RSP-based subscribers.
- Higher fault isolation on the router. The control plane runs in a distributed manner and therefore, failure of certain LCs does not affect subscriber sessions on other LCs in the system. In such cases, only the subscriber sessions built on that particular LC is lost.

- Although the CPS achieved on a single LC is lower than the CPS achieved for RSP or Bundle subscribers, LC subscribers overcome the memory usage limit and CPS limit of RSP-based subscribers.
- Provide enhanced multi-service edge (MSE) capability for the ASR9K router, by freeing up the CPU and memory resources on the centralized route processor (RP).

Restrictions of line card subscribers

LC subscriber support in BNG is subjected to these restrictions:

- Bundles are not supported with LC subscribers.
- LC subscribers support features that are available on bundle subscribers, except for multicast. If this feature is required for specific subscribers, then those subscribers must be built on bundle interfaces.
- Routed subscriber sessions are not supported on LC subscribers.
- Local DHCPv4 Server feature is not supported over LC.

High Availability for Line Card Subscribers

The high availability (HA) for line card subscribers is different from that for subscribers built on bundle interfaces because the subscribers are built on LCs. This table details the HA features of LC subscribers and bundle subscribers:

Table 11: High Availability for LC Subscribers and Bundle Subscribers

HA Feature	Plane	Bundle Subscribers	Line Card Subscribers
Process restart	control	Subscriber session state is maintained. New subscriber bring up is delayed by a short time, depending on the component being restarted.	Behavior is the same as for bundle subscribers.
	data	No impact to traffic.	No impact to traffic.

HA Feature	Plane	Bundle Subscribers	Line Card Subscribers
LC online insertion and removal (OIR)	control	No impact with multi-member bundles. Because control packet is not received, control plane cannot function with single member bundles. Session state is not lost because it is stored in RSP.	Control plane is down for new sessions, and all session states are lost for existing sessions. After LC OIR, the LC sessions are restored using DHCP shadow bindings in RP.
	data	No impact with multi-member bundles. Data traffic is lost with single member bundles. Session state is not lost.	All traffic is lost
RP failover	control	Significant quiet time (currently more than 10 minutes) is expected before new sessions can be setup. Existing session state is not lost.	Very small impact (approximately 10 seconds) before new sessions can be setup; the delay is in connecting to RSP based servers, like RIB. Existing session state is not lost.
	data	No impact to traffic.	No impact to traffic.

Static Sessions

BNG supports interface-based static sessions, where all traffic belonging to a particular VLAN sub-interface is treated as a single session. These sessions are created or deleted, based on the configuration of static session on the sub-interface (access-interface). The session establishment is triggered by creating a static subscriber configuration on a sub-interface; the session termination is triggered by removing that configuration.

The number of static sessions that can be created in a router is the same as the number of Bundle VLAN interfaces that can be present in the router.

Static sessions are present only in the control plane, mainly to provide access to AAA, CoA, and dynamic templates. These sessions have the same flexibility as other kinds of sessions (such as DHCP-triggered sessions and packet-triggered sessions) from the perspective of AAA, CoA, and other dynamic configuration changes.

All forwarding and routing features for static sessions are programmed directly on the access-interface. Features such as Access Control List (ACL), Hierarchical Quality of Service (H-QoS), and Session Accounting are allowed to be configured through RADIUS or through dynamic template.

The IP address (and VRF, if used) for a static session is recommended to be configured on the access-interface itself (See the note below for the behavior of feature modification using BNG static sessions). All subnet interface addresses can be assigned to the subscribers in the case of switched Customer Premises Equipment (CPE). The Unicast Reverse Path Forwarding (uRPF) is also configured on the access-interface itself. Because

the access-interface is like any other Layer 3 interface, it allows PE-CE routing protocols such as OSPF and BGP.



Note If any feature configured on the access-interface is modified using BNG, the existing configurations get removed from the access-interface, and they do not get restored automatically on removing the static session. For example, if an ACL is already present on the access-interface, and if another ACL is applied by BNG using the static session, the ACL on the access-interface does not get restored when the static session is removed. You must reconfigure the access-interface and add the ACL again, in such scenarios.

Another example of feature modification by BNG is, if a VRF (say, *vrf-blue*) is present on the access-interface, and if another VRF (say, *vrf-green*) is applied on the access-interface by BNG using the static session, *vrf-blue* on the access-interface is not restored when the static session is removed. The interface is set to the default VRF. You must reconfigure the access-interface and add the *vrf-blue* again, in such scenarios.

A static session is similar to a subscriber session, except for these differences:

- The CoA should explicitly have an account session ID because static session does not have MAC address or IP address identity attribute associated with it.
- The statistics of static session is the same as that of the access-interface on which it is configured.

From Cisco IOS XR Software Release 6.5.1 onwards, the following BNG features are supported for static sessions:

- HTTP Redirect for static sessions - For more information, see the chapter *Configuring Subscriber Features* in this guide.
- SRG support for static sessions - For more information, see the chapter *BNG Geo Redundancy* in this guide.

Restrictions for static sessions

The interface-based static session in BNG is subject to these restrictions:

- Because all features are applied on the access-interface itself, all restrictions for feature programming on access-interface applies to static session too.
- Static interface sessions are not supported on ambiguous VLAN interfaces.
- VRF, Unnumbered loopback, IPv6 enable or IPv6-ND configuration through dynamic-template or RADIUS are not supported on static sessions.
- Multiple access-interfaces cannot be unnumbered to a single loopback interface for static sessions.
- Parameterized QoS (PQoS) is not supported for static sessions.
- The Change of Authorization (CoA) should explicitly have an account session ID because the static session does not have MAC address or IP address identity attribute associated with it.
- Once the static session is created, adding or removing IPv4 address or IPv6 address is not supported. You need to remove the static subscriber configuration, change the address, then add configuration back.
- Static sessions cannot be deleted by **clear subscriber session**.

Subscriber Session Limit

The subscriber session limit feature limits the total number of subscriber sessions in a BNG router. If a new subscriber session comes up after the router reaches the overall session limit, then the earliest un-authenticated session is deleted. If the router reaches the overall subscriber session limit and if all the sessions present in the router are authenticated sessions, then the request for a new session is rejected.

Typically sessions belonging to subscribers who do not have the intent of accessing the network services are typically un-authenticated sessions. Per-subscriber features do not apply to such sessions. Instead, they have the same set of features applied to all users. Generally, if the un-authenticated subscriber sessions do not authenticate themselves within a specific time, they are deleted using the un-auth timer mechanism.

The **subscriber session limit** command is used to apply the overall subscriber session limit in the BNG router.

This figure shows the scenario where a long-lived un-authenticated session is deleted, when a new un-authenticated session ($m + 1$) comes up after the router reaches the overall session limit. In this example, $m+n$ is the overall session limit, where m is the number of un-authenticated sessions and n is the number of authenticated sessions. The behavior is the same for a new authenticated session ($n + 1$) too.

Figure 21: Subscriber Session Limit

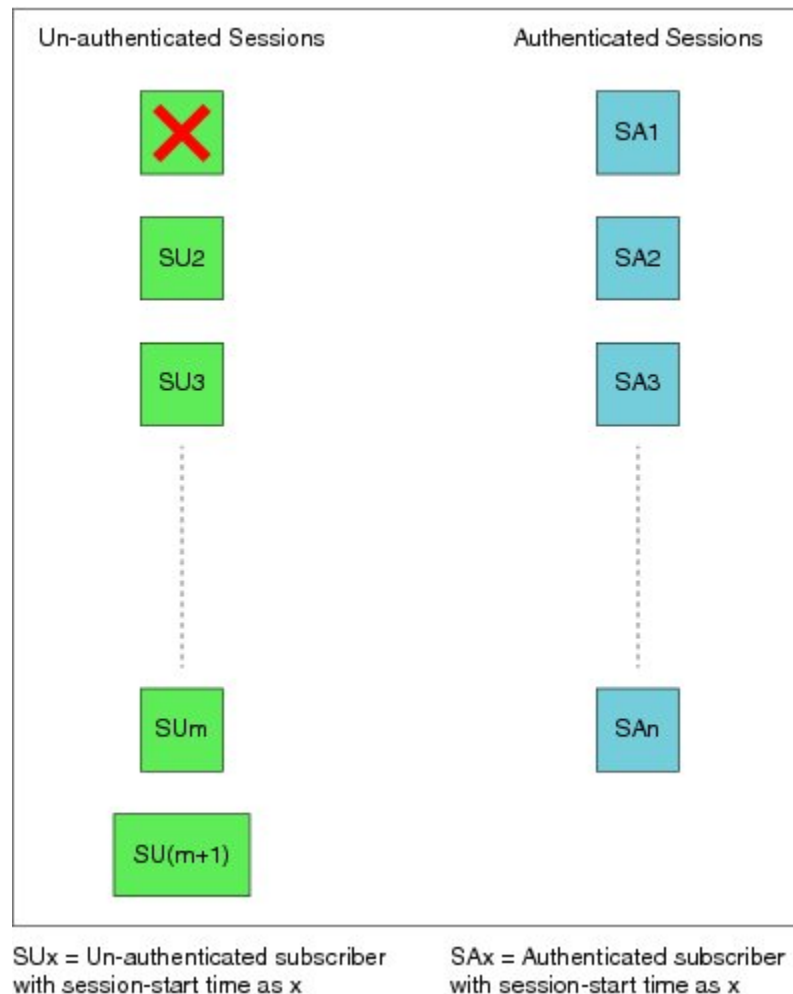

361752

BNG Subscriber Templates

BNG supports template interface based subscriber provisioning that defines an internal template interface for storing the feature information of each unique subscriber configuration, and reuses that information for feature programming of other subscribers having the same configuration. This reduces the inter-process communications (IPC), memory usage and CPU usage inside the system, thereby providing significant scale and performance improvements in BNG. The free memory available in the system can thus be utilized for enabling more services or for improving existing services on BNG, with full scale stability.

BNG subscriber templates feature is more beneficial in scale scenarios such as Service Provider Wi-Fi (SP Wi-Fi). Template interfaces are not recommended for scenarios where the configuration of template interface based feature is different for each subscriber, or in scenarios where only a few hundreds of subscribers use the similar configuration. Templates must be used or provisioned only if there are a few thousands of subscribers using similar configurations of template interface based features. There is no restriction on individual subscribers having different configurations for non-template interface based features.

Enabling BNG Subscriber Templates

Subscriber templates are enabled per access-interface in BNG. Use this command in interface configuration mode, to enable subscriber templates:

```
ipsubscriber subscriber-templates max-templates
```

Here, *max-templates* is the maximum number of templates on an access-interface.

This is an example of enabling subscriber templates on an access-interface in BNG:

```
interface Bundle-Ether1.10
 ipsubscriber subscriber-templates 5
!
```

You must clear all subscriber sessions on an access-interface before disabling the subscriber templates or before modifying the number of subscriber templates on that access-interface.

Feature Support for Subscriber Templates

These features are supported with subscriber templates:

- IPv4, IPv4-ACL, IPv6, IPv6-ACL.
- DHCP and packet-triggered sessions.
- RP subscribers.
- LC subscribers.
- High Availability - process restart and route processor fail over (RPFO).
- Scale scenarios.

These features are not supported with subscriber templates:

- PPPoE sessions.
- QoS and PBR.

Restrictions for BNG Subscriber Templates

The support for subscriber templates in BNG is subjected to these restrictions:

- Modifying the number of templates or removing the template configuration is not supported with subscribers provisioned on the access- interface.
- Modifying the encapsulation is not supported on access-interface having subscriber templates configured.
- Each line card (LC) has a micro-interface database (UIDB) limitation of 16 bits (that is, 65535 entries). For an expected scale of 64K subscriber interfaces on an LC, 1535 interfaces are remaining for the access-interfaces and template-interfaces. Provisioning of template-interfaces must be planned within these limits.

Verification of BNG Subscriber Templates

This table lists the verification commands for BNG subscriber templates configuration:

Command	Description
show ipsubscriber interface internal	Displays the internal information such as, <i>Template ID</i> (the template interface-handle referred by the subscriber session), of the IP subscriber interfaces.
show ipsubscriber template-interface [access-interface <i>interface-type interface-instance</i>] [internal]	Displays IP subscriber template interface information (brief, detailed or filtered based on the access-interface) such as template subscriber name, template subscriber ifhandle and so on.
show subscriber database session subscriber-label <i>subscriber-label</i>	Displays the subscriber database session information that includes the <i>Template Interface Id</i> field (this field indicates the subscriber template that is used by the session with the specified subscriber-label).
show subscriber database template [parent-if-handle <i>if-handle</i> parent-if-name <i>interface-type interface-instance</i>]	Displays subscriber database information such as template ifhandle, session count and so on.
show subscriber running-config subscriber-label <i>label</i>	Displays the subscriber running configuration in BNG.

Along with these commands, the existing subscriber show commands can also be used to verify the configurations.

eBGP over PPPoE

The eBGP over PPPoE feature provides eiBGP multi-path support over BNG subscriber interfaces. This feature also provides load-balancing and allows service providers to offer L3VPN service with dynamic service provisioning. The label allocation mode used for this feature is **per-prefix**. The feature is supported for IPv4 and IPv6.

Benefits of eBGP over PPPoE

The eBGP over PPPoE feature provides eBGP multi-path support with **per-prefix** label allocation mode. Currently, Cisco IOS XR supports three label allocation modes - per prefix, per-CE and per-VRF. The per-VRF mode does not provide multi-path support, and it may also cause forwarding loops during local traffic diversion. The per-CE mode does not support eBGP load balancing and BGP PIC functionality. Therefore, the per-prefix mode is chosen for this feature.

For sample topology and sample configurations for eBGP over PPPoE, see [Sample Topology for eBGP over PPPoE, on page 543](#).

BNG over Pseudowire Headend

BNG provides subscriber support over Pseudowire Headend (PWHE). PWHE provides L3 connectivity to customer edge nodes through a pseudowire connection. PWHE terminates the L2VPN circuits that exists between the access-provider edge (A-PE) nodes, to a virtual interface, and performs routing on the native IP packet. Each virtual interface can use one or more physical interfaces towards the access cloud to reach customer routers through the A-PE nodes. This feature is supported for PPPoE PTA, PPPoE LAC and IPoE subscribers.

For basic PWHE, the access pseudowire (PW) is terminated on an interface in the Services-PE (S-PE) box. The pseudowire in the access network can be of VC type 4 (tagged), type 5 (raw) and type 11 (inter-working). VC type 4 and VC type 5 pseudowires are represented by pw-ether interfaces. VC type 11 pseudowire is represented by a pw-iw interface. The physical interfaces that the pw-ether or pw-iw interface use is decided through a pin-down list, which is also called as generic-interface-list or a Tx-list. The access P nodes must ensure that the pseudowire traffic is sent to the S-PE box, on only one of the interfaces in the pin-down list. If not, the traffic is dropped on S-PE.

QoS on BNG Pseudowire Headend

Subscriber support over Pseudowire Headend (PWHE) interface was introduced in Cisco IOS XR Software Release 5.2.0. Further support for QoS features for subscribers on PWHE was introduced in Cisco IOS XR Software Release 5.2.2 as follows:

- Support for PPPoE or IPoE subscribers on PWHE sub-interface (with or without SVLAN policy).
- QoS support at different levels:
 - QoS on per-session PPPoE.
 - QoS on multiple PPPoE sessions associated to the same subscriber line, that is shared policy instance (SPI).
 - QoS at pseudowire level.
 - QoS at physical port-level.
- Support for features such as service accounting and pQoS for PWHE subscribers.
- Support for MPLS EXP marking for PWHE subscriber interfaces.

You can configure same SPI instance (with different policy-maps attached) on the sub-interface of PWHE pin-down members as well as on the subscriber interface. In this scenario, the subscriber sessions come up in spite of having the same SPI instance on the pin-down member of PWHE.

For ASR 9000 Enhanced Ethernet Line Card, there are 4 chunks per network processor (NP), and physical interfaces are mapped to a particular NP and chunk. The SE model of this line card (LC) supports 8K subscribers per chunk. To support this, these guidelines must be followed:

- Pin-down members must be distributed so that they are not from the same NP and chunk.
- The **resource-id** option in **service-policy** command must be used to change the chunk mapping of the physical interface.
- The target chunk must not be used by any other interface or sub-interface policy-map.
- The scale is expected to reduce if service accounting is enabled.



Note For BNG PWHE with QoS, an extra 4 bytes per packet get added if service accounting is enabled. This is because of the internal VC label that gets added when the packet enters the ingress LC. This is applicable only for egress direction.

Features Supported for BNG over Pseudowire Headend

These are supported for BNG over PWHE:

- Features such as http-r, Access-Control List (ACL), Accounting, Change of Authorization (CoA) and Lawful-Intercept.
- 64K dual stack and 128K IPv4 subscribers.
- Ambiguous VLANs on PWHE sub-interfaces.
- RFC-3107, for basic PWHE forwarding path from the core to the subscriber direction.
- QoS for the subscribers.
- Other features as applicable for the subscriber.

The supported control protocols for BNG over PWHE are DHCPv4, DHCPv6, IPv6 ND, PPP and PPPoE.

The pw-ether sub-interfaces are also supported in BNG. Ideally, the VC type for the PW can be negotiated as Type 4 or Type 5, for pw-ether interfaces. The pw-ether sub-interfaces are only supported for VC type 5.

These are the supported behavioral models of PWHE for the VC type and the sub-interface:

- According to the standards, the VC type 4 mandates that the SP-VLAN be carried along with the C-VLAN, in the PW. The VC type 5 mandates that the SP-VLAN be removed, and only the C-VLAN be carried in the PW.
- There are implementation differences (mainly in the number of VLANs that are transported in the PW) between Cisco 7600 Series Routers and Cisco ASR 9000 Series Aggregation Services Routers, and Cisco 12000 Series Routers based platforms. However, this does not impact the behavior of A-PE and S-PE.

- Because pw-ether sub-interfaces are supported only for VC type 5, the packet in the PW does not have the SP-VLAN. Therefore, when the subscriber connection enters the S-PE (BNG router), it finds a match with a pw-ether sub-interface VLAN and the C-VLAN in the packet.
- When VC type 4 is configured, it is always matched with the pw-ether main interface. Even if sub-interfaces are configured with VC type 4, they are not used. The system does not restrict the configuration of sub-interfaces.

The hardware support for BNG over PWHE is same as that for the bundle subscriber support. The RSP types supported are RSP-440-SE and RSP-880-SE.

Unsupported Features and Restrictions for BNG over Pseudowire Headend

These are the unsupported features and restrictions for BNG over PWHE feature:

- Subscribers on VC type-4 and VC type-11 pseudowires are not supported (that is, untagged subscribers cannot be terminated on a BNG PWHE interface and they are restricted in CLI on the main pw-ether interface).
- Egress subscriber Lawful-Intercept is not supported.
- Multicast for PPPoE is not supported.
- SPAN is not supported.
- IPoE L3 connected or routed subscribers are not supported.
- Because subscribers on PWHE are based out of RP, linecard (LC) subscribers are not supported.
- Because satellite is not supported on PWHE, it is not supported on PWHE over BNG too.
- BNG over PWHE does not support IPv4 fragmentation.

The support for QoS on BNG PWHE is subjected to these restrictions:

- PWHE subscribers are supported only in Co-existence disabled mode of line card (LC).
- ATM overhead accounting is not supported.
- Because multicast is not supported on PWHE subscriber, IGMP shaper co-relation is not supported.

PPPoE LAC Subscriber Over PWHE

The PPPoE LAC session over Pseudowire Headend (PWHE) feature enables LAC session to be established on PWHE interface. The PWHE technology allows termination of Access Pseudowire into a Layer 3 (VRF or global) domain or into a Layer 2 domain. PWHE infrastructure enables an easy and scalable mechanism for tunneling or backhauling traffic into a common IP, MPLS, or L2 network.

Supported Features

- Lawful Intercept (LI)
- uRPF
- Subscriber Control Plane Policing (CoPP)

- HTTP-Redirect (HTTPr)

Restrictions

- Routing protocols cannot be run on the subscriber interfaces
- L2TP is not supported for IP subscribers
- L2TP limitations are applicable with respect to sequencing, fragmentation, and checksums as applied to bundle-based LAC sessions
- L2TP imposition is not supported on A9K-SIP-700 Line Cards or Cisco ASR 9000 Series SPA Interface Processor-700
- VC type 4 and 11 are not supported for hosting subscribers
- For ingress L2TP packets, the negotiated UDP destination port is 1701 and the source port is defined by the LNS

Unsupported Features

- Routed subscriber session is not supported
- Multicast is not supported for PPPoE sessions over PWHE
- Cluster, satellite, and geo-redundancy are not supported
- SPAN is not supported
- ACL is not applicable on BNG sessions, as the incoming and outgoing traffic flow through MPLS routing
- Quality of Service (QoS)
- Layer 2 Tunnel Protocol Version 3 (L2tpv3)

Removing Access Interface Configuration



Note BNG does not support removing of interfaces with active subscriber sessions.

If you want to remove an access interface to clear unnecessary configuration or migrate it, perform the following steps:

1. Clear all subscriber sessions for the access interface, and then wait for all subscriber cleanup.
2. Shut down the access interface.
3. Perform the following instructions based on the subscriber details:

Subscribers	Instructions to perform
For PPP/ PPPoE subscribers	Remove the pppoe enable command to disable processing of PPPoE packets on the access interface.

Subscribers	Instructions to perform
For IPoE subscribers	Remove the ipsubscriber l2-connected command to disable creation of packet-triggered L2 sessions on the access interface.

4. Remove control policy attached under access interface by removing the **service-policy type control subscriber** command .
5. Remove the access interface configuration.

The below example shows the initial configuration of Bundle-Ether100.10 access interface with active PPP/PPPoE subscribers and Bundle-Ether100.20 access interface with active IPoE subscribers:

```
!
interface Bundle-Ether100.10
 vrf BNG
  service-policy type control subscriber BNG-PPPoE
  pppoe enable bba-group PPPoE
  encapsulation ambiguous dot1q 10 second-dot1q any
!

interface Bundle-Ether100.20
 vrf BNG
  ipv4 point-to-point
  ipv4 unnumbered Loopback100
  arp learning disable
  service-policy type control subscriber BNG-IPoE
  ipsubscriber ipv4 l2-connected
  initiator dhcp
  initiator unclassified-source
!
 encapsulation ambiguous dot1q 20 second-dot1q any
!
```

```
Router#show subscriber session filter access-interface bundle-ether 100.10
Codes: IN - Initialize, CN - Connecting, CD - Connected, AC - Activated,
      ID - Idle, DN - Disconnecting, ED - End
```

Type	Interface	State	Subscriber IP Addr / Prefix LNS Address (Vrf)
PPPoE:PTA	BE100.10.pppoe6	AC	172.172.0.24 (BNG)
PPPoE:PTA	BE100.10.pppoe7	AC	172.172.0.25 (BNG)
PPPoE:PTA	BE100.10.pppoe8	AC	172.172.0.26 (BNG)
PPPoE:PTA	BE100.10.pppoe9	AC	172.172.0.27 (BNG)
PPPoE:PTA	BE100.10.pppoe10	AC	172.172.0.28 (BNG)

```
Router#show subscriber session filter access-interface bundle-ether 100.20
Codes: IN - Initialize, CN - Connecting, CD - Connected, AC - Activated,
      ID - Idle, DN - Disconnecting, ED - End
```

Type	Interface	State	Subscriber IP Addr / Prefix LNS Address (Vrf)
IP:DHCP	BE100.20.ip1	AC	172.172.0.13 (BNG)
IP:DHCP	BE100.20.ip2	AC	172.172.0.14 (BNG)
IP:DHCP	BE100.20.ip3	AC	172.172.0.15 (BNG)
IP:DHCP	BE100.20.ip4	AC	172.172.0.16 (BNG)
IP:DHCP	BE100.20.ip6	AC	172.172.0.23 (BNG)

```
Router#
```

Clear all subscriber sessions for the access interfaces then wait for all subscriber cleanup.

```
Router#clear subscriber session identifier access-interface bundle-ether 100.10
Please allow for some processing time as subscriber(s)
may be on hold completing existing transactions.
```

```
Router#clear subscriber session identifier access-interface bundle-ether 100.20
Please allow for some processing time as subscriber(s)
may be on hold completing existing transactions.
Router#
```

Shut down the access interface.

```
Router#configure terminal
Router(config)#interface Bundle-Ether100.10
Router(config-subif)#shut
Router(config-subif)#commit
Router(config-subif)#exit
```

```
Router(config)#interface Bundle-Ether100.20
Router(config-subif)#shut
Router(config-subif)#commit
Router(config-subif)#exit
```

For PPP/PPPoE subscribers, disable processing of PPPoE packets on this access interface by removing the **pppoe enable** command.

```
Router(config)#interface Bundle-Ether100.10
Router(config-subif)#no pppoe enable bba-group PPPoE
Router(config-subif)#commit
Router(config-subif)#exit
```

For IPoE subscribers, disable creation of packet-triggered L2 sessions by removing the **ipsubscriber l2-connected** command.

```
Router(config)#interface Bundle-Ether100.20
Router(config-subif)#no ipsubscriber ipv4 l2-connected
Router(config-subif)#commit
Router(config-subif)#exit
```

Remove control policy attached under access interface.

```
Router(config)#interface Bundle-Ether100.10
Router(config-subif)#no service-policy type control subscriber BNG-PPPoE
WARNING: Removal of this service policy will result in clearing of existing subscribers on
this interface.
Enter clear to erase cached configuration or commit to continue.
Router(config-subif)#commit
Router(config-subif)#exit
```

```
Router(config)#interface Bundle-Ether100.20
Router(config-subif)#no service-policy type control subscriber BNG-IPoE
WARNING: Removal of this service policy will result in clearing of existing subscribers on
this interface.
Enter clear to erase cached configuration or commit to continue.
Router(config-subif)#commit
Router(config-subif)#exit
```

Remove configuration of the access interfaces.

```
Router(config)#no interface Bundle-Ether100.10
Router(config)#commit
```

```
Router(config)#no interface Bundle-Ether100.20
Router(config)#commit
```

Additional References

These sections provide references related to implementing PPP, PPPoE, L2TP, and DHCP.

RFCs

Standard/RFC - PPP	Title
RFC-1332	The PPP Internet Protocol Control Protocol (IPCP)
RFC-1570	PPP LCP Extensions
RFC-1661	The Point-to-Point Protocol (PPP)
RFC-1994	PPP Challenge Handshake Authentication Protocol (CHAP)

Standard/RFC - PPPoE	Title
RFC-2516	A Method for Transmitting PPP Over Ethernet (PPPoE)
RFC-4679	DSL Forum Vendor-Specific RADIUS Attributes

Standard/RFC - L2TP	Title
RFC-2661	Layer two tunneling protocol "L2TP"

MIBs

MIBs	MIBs Link
—	To locate and download MIBs for selected platforms, Cisco IOS releases, and feature sets, use Cisco MIB Locator found at the following URL: http://www.cisco.com/go/mibs

Technical Assistance

Description	Link
The Cisco Technical Support website contains thousands of pages of searchable technical content, including links to products, technologies, solutions, technical tips, and tools. Registered Cisco.com users can log in from this page to access even more content.	http://www.cisco.com/cisco/web/support/index.html



CHAPTER 6

Deploying the Quality of Service (QoS)

The Quality of Service (QoS) feature ensures that traffic to and from priority applications gets preference in using network resources. QoS actions are defined by service-policies that are deployed using policy-maps. During the QoS process, packets are encapsulated with QoS information. The encapsulation is monitored and accounted by the QoS accounting function.

Parameterized QoS (PQoS) is another form of QoS in which the traffic priority is based on the characteristic of the data being carried by the traffic.

BNG supports merging of multiple QoS policy-maps applied through multiple dynamic templates and implementing them on a single subscriber.

Table 12: Feature History for Configuring Subscriber Features

Release	Modification
Release 6.3.2	Introduced the feature, Subscriber QoS on Main Interface.
Release 6.2.1	These new features were introduced: <ul style="list-style-type: none">• Multiple Class Support for Ingress Policing for Subscribers• Group-based Grandparent Shaping
Release 4.2.0	Initial release of this document.
6.6.3	PQoS along with Merge option for Acct-Stats.

This chapter explains deploying QoS, and covers the following topics:

- [Quality of Service Overview, on page 254](#)
- [Parameterized QoS, on page 259](#)
- [RADIUS Based Policing - QoS Shaper Parameterization, on page 275](#)
- [QoS Accounting, on page 280](#)
- [Support for Shared Policy Instance, on page 283](#)
- [Merging QoS Policy-maps, on page 289](#)
- [QoS Features Supported on BNG, on page 294](#)
- [Additional References, on page 305](#)

Quality of Service Overview

Quality of Service (QoS) is the technique of prioritizing network traffic for time-sensitive and mission-critical applications such as VoIP services, live streaming of videos, priority accesses to database, and so on. Functions that QoS provides ensure that such applications receive sufficient bandwidth at low latency, with reduced data loss.

QoS functions perform preferential forwarding of high-priority packets. To do so, the packet is identified, classified, and then prioritized on all routers along the data-forwarding path throughout the network. As a result, priority applications get the resources they require, while other applications access the network, simultaneously.

QoS functions provide service providers cost benefits by enabling them to use existing resources efficiently and ensure the required level of service without reactively expanding, or over-provisioning their networks. QoS also improves customer experience when they get reliable services from a variety of network applications.

It is ideal to deploy QoS on BNG because BNG is present at the edge router, and subscriber directly connects to it. One of the unique features of BNG is QoS accounting. This feature enables BNG to collect and report QoS encapsulation information to the RADIUS server. For details, see [QoS Accounting, on page 280](#).

The deployment of QoS involves three components:

- **Class-map** — Classifies different forms of traffic, like video, data, VOIP and so on, based on matching rules.
- **Policy-map** — Defines the QoS actions to be applied to the classified traffic. It references the classes previously defined in the class-map. These policy-maps are also called QoS maps. The actions defined in the policy-map perform traffic prioritization and bandwidth allocation.
- **Service policy** — Associates a previously defined policy-map with a attachment point and direction, on BNG. The attachment points are listed in the section [QoS Attachment Points, on page 297](#). The two directions possible for a policy is input and output. The policy direction is relative to the attachment point.

BNG supports two-level hierarchical policy (parent policy and child policy) for deploying QoS. Based on the preference of service provider, the QoS policies are defined and applied on BNG in these ways:

- Define and apply the QoS policy from CLI. See, [Configuring Service-policy and Applying Subscriber Settings Through Dynamic Template, on page 256](#).
- Define the QoS policy in CLI, but apply it from RADIUS. See, [Configuring Service-policy and Applying Subscriber Settings Through RADIUS, on page 255](#).
- Define and apply the QoS policy from RADIUS. It is also called [Parameterized QoS, on page 259](#).

Restriction

- If the subscriber ingress or egress QoS includes policing, shaping, bandwidth, or WRED actions, it is recommended that only active:standby bundle interfaces be used. Load-sharing should be avoided.
- Users can configure only 7 class-maps (both ingress and egress, excluding the class-default map) to achieve a higher scale configuration per node processor.

Configuring Service-policy and Applying Subscriber Settings Through RADIUS

Perform this task to deploy the QoS policy using CLI commands. In this task, subscriber settings are applied from the RADIUS server.

SUMMARY STEPS

1. **configure**
2. **policy-map type qos *q_in***
3. **class class-default**
4. **service-policy *q_child_in***
5. **policy-map type qos *q_out***
6. **class class-default**
7. **service-policy *q_child_out***
8. Use the **commit** or **end** command.

DETAILED STEPS

	Command or Action	Purpose
Step 1	configure Example: RP/0/RSP0/CPU0:router# configure	Enters global configuration mode.
Step 2	policy-map type qos <i>q_in</i> Example: RP/0/RSP0/CPU0:router(config)# policy-map type qos <i>q_in</i>	Configures the policy-map for the type qos.
Step 3	class class-default Example: RP/0/RSP0/CPU0:router(config-pmap)# class class-default	Configures or modifies the parent class-default class. Note You can configure only the class-default class in a parent policy. Do not configure any other traffic class.
Step 4	service-policy <i>q_child_in</i> Example: RP/0/RSP0/CPU0:router(config-pmap-c)# service-policy <i>q_child_in</i>	Applies a bottom-level policy to the top-level class-default class.
Step 5	policy-map type qos <i>q_out</i> Example: RP/0/RSP0/CPU0:router(config)# policy-map type qos <i>q_out</i>	Configures the policy-map for the type qos.
Step 6	class class-default	Configures or modifies the parent class-default class.

	Command or Action	Purpose
	<p>Example:</p> <pre>RP/0/RSP0/CPU0:router(config-pmap)# class class-default</pre>	<p>Note You can configure only the class-default class in a parent policy. Do not configure any other traffic class.</p>
Step 7	<p>service-policy <i>q_child_out</i></p> <p>Example:</p> <pre>RP/0/RSP0/CPU0:router(config-pmap-c)# service-policy q_child_out</pre>	Applies a bottom-level policy to the top-level class-default class.
Step 8	Use the commit or end command.	<p>commit —Saves the configuration changes and remains within the configuration session.</p> <p>end —Prompts user to take one of these actions:</p> <ul style="list-style-type: none"> • Yes — Saves configuration changes and exits the configuration session. • No —Exits the configuration session without committing the configuration changes. • Cancel —Remains in the configuration session, without committing the configuration changes.

Configuring Subscriber Policy through CLI and Applying through RADIUS: Examples

```
configure
policy-map type qos q_in
class class-default
end
```

```
\\the following procedure is ran in RADIUS
Service-Type = Outbound-User
Cisco-avpair = "ipv4:ipv4-mtu=750",
Cisco-avpair = "ipv4:ipv4-unnumbered=Loopback0",
Cisco-avpair = "subscriber:sub-qos-policy-in=q_in",
Cisco-avpair = "subscriber:sub-qos-policy-out=q_out",
Idle-Timeout = 1000,
Session-Timeout = 5000
```

Configuring Service-policy and Applying Subscriber Settings Through Dynamic Template

Perform this task to deploy the QoS policy using CLI commands. In this task, subscriber settings are applied using a dynamic template.

SUMMARY STEPS

1. **configure**

2. **policy-map type qos** *q_in*
3. **class class-default**
4. **service-policy** *q_child_in*
5. **policy-map type qos** *q_out*
6. **class class-default**
7. **service-policy** *q_child_out*
8. **dynamic-template type ppp** *dynamic_config*
9. **service-policy input** *q_in*
10. **service-policy output** *q_out*
11. Use the **commit** or **end** command.

DETAILED STEPS

	Command or Action	Purpose
Step 1	configure Example: RP/0/RSP0/CPU0:router# configure	Enters global configuration mode.
Step 2	policy-map type qos <i>q_in</i> Example: RP/0/RSP0/CPU0:router(config)# policy-map type qos <i>q_in</i>	Configures the policy-map in the input direction.
Step 3	class class-default Example: RP/0/RSP0/CPU0:router(config-pmap)# class class-default	Configures or modifies the parent class-default class. Note You can configure only the class-default class in a parent policy. Do not configure any other traffic class.
Step 4	service-policy <i>q_child_in</i> Example: RP/0/RSP0/CPU0:router(config)# service-policy <i>q_child_in</i>	Configures the service policy for the input direction. Note The <i>q_in</i> and <i>q_out</i> policy maps are parent policy maps.
Step 5	policy-map type qos <i>q_out</i> Example: RP/0/RSP0/CPU0:router(config)# policy-map type qos <i>q_out</i>	Configures the policy-map for the output direction. Note The <i>q_in</i> and <i>q_out</i> policy maps are parent policy maps.
Step 6	class class-default Example: RP/0/RSP0/CPU0:router(config-pmap)# class class-default	Configures or modifies the parent class-default class. Note You can configure only the class-default class in a parent policy. Do not configure any other traffic class.

	Command or Action	Purpose
Step 7	service-policy <i>q_child_out</i> Example: RP/0/RSP0/CPU0:router(config)# service-policy q_child_out	Applies a bottom-level policy to the top-level class-default class. Note The q_in and q_out policy maps are parent policy maps.
Step 8	dynamic-template type ppp <i>dynamic_config</i> Example: RP/0/RSP0/CPU0:router(config)# dynamic-template type ppp dynamic_config	Configures dynamic-template of the type ppp and applies the configuration through dynamic-template.
Step 9	service-policy input <i>q_in</i> Example: RP/0/RSP0/CPU0:router(config-dynamic-template-type)# service-policy input q_in	Configures the service-policy in the input direction.
Step 10	service-policy output <i>q_out</i> Example: RP/0/RSP0/CPU0:router(config-dynamic-template-type)# service-policy output q_out	Configures the service-policy in the output direction.
Step 11	Use the commit or end command.	commit —Saves the configuration changes and remains within the configuration session. end —Prompts user to take one of these actions: <ul style="list-style-type: none"> • Yes — Saves configuration changes and exits the configuration session. • No —Exits the configuration session without committing the configuration changes. • Cancel —Remains in the configuration session, without committing the configuration changes.

Configuring Subscriber Policy through CLI and Applying to Subscriber through Dynamic-Template: Examples

```
configure
policy-map type qos q_in // policy-map input direction
class class-default
end
```

```
configure
policy-map type qos q_out // policy-map output direction
class class-default
end
```

```
// applying configuration through dynamic-template
configure
dynamic-template type ppp dynamic_policy
service-policy input q_in
service-policy output q_out
end
```

Parameterized QoS

Parameterized Quality of Service (PQoS) guarantees reliable performance of a network application by reserving for it the required network bandwidth. In this case, the prioritization is based on the type of data being carried by the packet.

In the standard QoS, the importance of a packet is based on the priority level that is defined for it. It is possible that in once case a video packet and an asynchronous data transfer packet have the same priority level defined. In such a case, the router gives equal importance to both packets. As a result, because of bandwidth conflict, there can be video degradation.

On the other hand, in PQoS, packet importance is based on the characteristics or parameters of the data that is carried by the packet. For example, it is possible to have PQoS provide dedicated bandwidth for video packets. Even at times when heavy loads of asynchronous data traffic are introduced into the network, PQoS guarantees that video packets have priority over other data streams that do not require real-time streaming.

Parameterized QoS has the ability to define, modify, or delete QoS policy-map based Vendor Specific Attributes (VSAs). VSAs are downloaded through the RADIUS server. The attributes from the parameterized QoS policies are filtered and passed on to the policy object library; the latter parses and translates them into policy objects. The VSAs define a two-level hierarchical policy to be applied on the subscriber session. The format of the QoS VSAs is:

```
AVPair: qos-policy-in=add-class(sub,<parent-class, child-class>,<action-list>)
AVPair: qos-policy-out=add-class(sub,<parent-class, child-class>,<action-list>)
AVPair: qos-policy-in=remove-class(sub,<parent-class, child-class>)
AVPair: qos-policy-out=remove-class(sub,<parent-class, child-class>)
```

where:

- “sub”, is a constant string, signifies that the current policy on the subscriber is to be modified
- <class-list> gives the hierarchy of the class to be added or removed (i.e. parent-class, child-class)
- <action-list> gives the QoS actions to be applied under the class being added

For more information about QoS parameters and its syntax, see *Parameterized QoS Syntax* in the [Configuring Parameterized QoS Policy Through RADIUS, on page 265](#).

When a parameterized QoS policy for a subscriber is downloaded from the RADIUS server for the first time, the VSAs are used to build the policy from scratch. After the policy is applied on the subscriber, any new or modified VSAs downloaded for that subscriber from the RADIUS server automatically modifies the already applied policy.

For deploying a Parameterized QoS policy from the RADIUS server, see [Configuring Parameterized QoS Policy Through RADIUS, on page 265](#).

Using Change of Authorization (CoA), it is possible to update the service-policy by modifying the class-maps that were previously configured by the parameterized QoS. Modifying can involve removing existing classes, or adding new classes. To make updates to the service-policy, see [Modifying Service Policy through CoA](#), on page 268.

Parameterized QoS Syntax

Parameterized QoS Syntax

QoS Action Parameter	Qualifiers	Commands
Shape (Variant 1)	QoS Action	shape(<rate-in-kbps>)
	CLI Equivalent	shape average <shape-rate> <kbps>
	RADIUS Equivalent - Example	qos-policy-out:add-class(sub,(class-default),shape(14700))
Shape (Variant 2)	QoS Action	shape(<rate-in-kbps>, <exceed-burst-in-kbytes>)
	CLI Equivalent	shape average <shape-rate> <kbps> exceed-burst <exceed-burst>
	RADIUS Equivalent - Example	qos-policy-out:add-class(sub,(class-default),shape(14700, 2000))
Shape in percentage (Variant 1)	QoS Action	Shape-rpct(<rate-in-pct>)
	CLI Equivalent	shape average percent < rate-in-pct >
	RADIUS Equivalent - Example	qos-policy-out:add-class(sub,(class-default),shape-pct(25))
Shape in percentage (Variant 2)	QoS Action	Shape-rpct(<rate-in-pct>, <exceed-burst-in-us>)
	CLI Equivalent	shape average percent < rate-in-pct > exceed-burst < exceed-burst >
	RADIUS Equivalent - Example	qos-policy-out:add-class(sub,(class-default),shape-pct(25, 40))

QoS Action Parameter	Qualifiers	Commands
Police (Variant 1)	QoS Action	police(<conform-rate-in-kbps>, <conform-burst-in-kBytes>, <exceed-rate-in-kbps>, <exceed-burst-in-kbytes>, <conform-action>, <exceed-action>, <violate-action>)
	CLI Equivalent	police rate <conform-rate> <kbps> burst <conform-burst> <kbps> peak-rate <exceed-rate> exceed-burst <exceed-burst> conform-action <action> exceed-action <action> violate-action <action>
	RADIUS Equivalent - Example	qos-policy-in:add-class(sub,(class-default, voip),police(2000,2000, 4000, 4000,transmit, set-ipprec(<precedence>), drop))
Police (Variant 2)	QoS Action	Police (<conform-rate-in-kbps>)
	CLI Equivalent	police rate <kbps>
	RADIUS Equivalent - Example	qos-policy-in:add-class(sub,(class-default, voip), police(200000))
Police in percentage (Variant 1)	QoS Action	police-rpct(<conform-rate-in-pct>, <conform-burst-in-us>, <exceed-rate-in-pct>, <exceed-burst-in-us>, <conform-action>, <exceed-action>, <violate-action>)

QoS Action Parameter	Qualifiers	Commands
	CLI Equivalent	police rate percentage <pct> burst <conform-burst> < us> peak-rate percentage<pct> exceedburst <exceed-burst> conform-action <action> exceed-action <action> violate-action <action>
	RADIUS Equivalent - Example	qos-policy-in:add-class(sub,(class-default, voip),police-rpct(20,20, 40, 40,transmit, set-ipprec(<precedence>), drop))
Police in percentage (Variant 2)	QoS Action	Police-rpct(<conform-rate-in-pct>
	CLI Equivalent	police rate percentage <pct>
	RADIUS Equivalent - Example	qos-policy-in:add-class(sub,(class-default, voip), police-rpct(20))
Set IP Precedence	QoS Action	set-ip-prec(<precedence>)
	CLI Equivalent	set precedence <precedence>
	RADIUS Equivalent - Example	qos-policy-out:add-class(sub,(class-default,voip), set-ip-prec(5))
Set CoS	QoS Action	set-cos(<cos-val>)
	CLI Equivalent	set cos <cos-val>
	RADIUS Equivalent - Example	qos-policy-out:add-class(sub,(class-default,voip), set-cos(5))
Minimum Bandwidth	QoS Action	bw-abs(<bw-in-kbps>)
	CLI Equivalent	bandwidth <bw-in-kbps>
	RADIUS Equivalent - Example	qos-policy-out:add-class(sub,(class-default,video),bw-abs(2000))
Minimum bandwidth percentage	QoS Action	bw-pct(<bw-in-pct>)

QoS Action Parameter	Qualifiers	Commands
	CLI Equivalent	bandwidth percent <pct>
	RADIUS Equivalent - Example	qos-policy-out:add-class(sub,(class-default,video),bw-abs(2000))
Bandwidth Remaining Percentage	QoS Action	bw-rpct(<pct>)
	CLI Equivalent	bandwidth remaining percent <pct>
	RADIUS Equivalent - Example	qos-policy-out:add-class(sub,(class-default,voip),bw-rpct(33))
Set IP DSCP	QoS Action	set-ip-dscp(<dscp-val>)
	CLI Equivalent	Set dscp <dscp-val>
	RADIUS Equivalent - Example	qos-policy-out:add-class(sub,(class-default,voip), set-ip-dscp(46))
Queue Limit in packets	QoS Action	queue-limit(<qlimit-in-packets>)
	CLI Equivalent	queue-limit <val> < packets>
	RADIUS Equivalent - Example	qos-policy-out:add-class(sub,(class-default,voip),queue-limit(64))
Queue Limit in us	QoS Action	queue-limit-us(<qlimit-in-us>)
	CLI Equivalent	queue-limit <val> <us>
	RADIUS Equivalent - Example	qos-policy-out:add-class(sub,(class-default,voip),queue-limit-us(240))
DSCP based WRED	QoS Action	random-detect-dscp(<dscp>, <min-threshold>, <max-threshold>, <probability>)
	CLI Equivalent	random-detect dscp <dscp-val> < Min-thresh> <Kbytes> <max-thresh> <Kbytes> probability < probability-val>
	RADIUS Equivalent - Example	qos-policy-out:add-class(sub,(class-default,voip), random-detect-dscp (24, 25000, 35000))

QoS Action Parameter	Qualifiers	Commands
Precedence based WRED	QoS Action	random-detect-prec (<precedence>, <min-threshold>, <max-threshold>, <probability>)
	CLI Equivalent	random-detect precedence <prec-val> <Min-thresh> <Kbytes> <max-thresh> <Kbytes> probability < probability-val>
	RADIUS Equivalent - Example	qos-policy-out:add-class(sub,(class-default,voip), random-detect- (24, 25000, 35000))
Set qos group	QoS Action	set-qos-grp(<group-val>)
	CLI Equivalent	set qos-group <qos-group-val>
	RADIUS Equivalent - Example	qos-policy-out:add-class(sub,(class-default,voip), set-qos-grp (24))
Priority Level	QoS Action	pri-level(<priority-level>)
	CLI Equivalent	priority level <priority-level>
	RADIUS Equivalent - Example	qos-policy-out:add-class(sub,(class-default, voip), pri_level(1))
Set discard class	QoS Action	set-dclass(<discard-class-val>)
	CLI Equivalent	set discard-class <discard-class-val>
	RADIUS Equivalent - Example	qos-policy-out:add-class(sub,(class-default,voip), set-dclass (4))
Set MPLS exp topmost bit	QoS Action	set-mpls-exp-topmost (<mpls-exp- topmost-val>)
	CLI Equivalent	set mpls experimental topmost <mpls-exp- topmost-val>
	RADIUS Equivalent - Example	qos-policy-out:add-class(sub,(class-default,voip), set-mpls-exp-topmost (4))
Set MPLS exp imposition bit	QoS Action	set-mpls-exp- imposition (<mpls-exp-imposition-val>)
	CLI Equivalent	set mpls experimental imposition <mpls-exp- imposition-val>
	RADIUS Equivalent - Example	qos-policy-out:add-class(sub,(class-default,voip), set-mpls-exp-imposition (4))

QoS Action Parameter	Qualifiers	Commands
Set Tunnel precedence	QoS Action	set-tunnel-prec(<prec-val>)
	CLI Equivalent	set precedence tunnel <precedence-val>
	RADIUS Equivalent - Example	qos-policy-out:add-class(sub,(class-default,voip), set-tunnel-prec(4))
Set Tunnel DSCP	QoS Action	set-tunnel-dscp (<dscp-val>)
	CLI Equivalent	set dscp tunnel <dscp-val>
	RADIUS Equivalent - Example	qos-policy-out:add-class(sub,(class-default,voip), set-tunnel-dscp(4))
Ingress QoS Merge with Accounting	QoS Action	Enables merge operation on QoS input policy from the service and enables accounting for the same.
	Radius Example	qos-policy-in=(merge(130),acct-stats)
	CLI example	service-policy input <name> merge 130 acct
Egress QoS Merge with Accounting	QoS Action	Enables merge operation on QoS output policy from the service and enables accounting for the same.
	Radius Example	qos-policy-out=(merge(110),acct-stats)
	CLI Example	service-policy output <name> merge 110 acct

Configuring Parameterized QoS Policy Through RADIUS

Perform this task to deploy parameterized QoS policy and apply subscriber settings through the RADIUS server. These steps are performed on the RADIUS server for each subscriber.



Note

- Parameterized QoS configuration through the RADIUS server is applicable only for user-profiles; not for service-profiles.
- In parameterized QoS configuration, the policy-map is not defined on the CLI. It is dynamically created based on the configuration passed through RADIUS. This procedure applies to the RADIUS server as part of RADIUS user configurations. The policy-map results are applied to the subscriber when that user profile is downloaded after executing a control policy authentication or authorization action. The class-map must be configured through CLI. For this task, the *classes voice_in, video_in, data_in, video_out, voice_out, and data_out* are configured separately.

SUMMARY STEPS

1. **Cisco-AVPair** = *"ip:qos-policy-in=add-class(sub, (class-default),police(2000))"*
2. **Cisco-AVPair** += *"ip:qos-policy-in=add-class(sub, (class-default,voice_in), pri-level(1), police(256))"*
3. **Cisco-AVPair** += *ip:qos-policy-in=add-class(sub, (class-default,video_in), pri-level(2), police(1000))"*
4. **Cisco-AVPair** += *"ip:qos-policy-in=add-class(sub, (class-default,data_in), set-qos-grp(4))"*
5. **Cisco-AVPair** += *"ip:qos-policy-in=add-class(sub, (class-default,class-default), set-qos-grp(7))"*
6. **Cisco-AVPair** += *"ip:qos-policy-out=add-class(sub, (class-default), shape(4000))"*
7. **Cisco-AVPair** += *"ip:qos-policy-out=add-class(sub, (class-default,voice_out), pri-level(1),queue-limit-us(10000))"*
8. **Cisco-AVPair** += *"ip:qos-policy-out=add-class(sub, (class-default,video_out),queue-limit-us(30000), shape(2000))"*
9. **Cisco-AVPair** += *"ip:qos-policy-out=add-class(sub, (class-default,data_out), bw-rpct(20))"*
10. **Cisco-AVPair** += *"ip:qos-policy-out=add-class(sub, (class-default,class-default))"*

DETAILED STEPS

	Command or Action	Purpose
Step 1	Cisco-AVPair = <i>"ip:qos-policy-in=add-class(sub, (class-default),police(2000))"</i> Example: Cisco-AVPair = "ip:qos-policy-in=add-class (sub, (class-default) ,police (2000)) "	Configures the cisco-avpair class-map in input direction for police action parameter.
Step 2	Cisco-AVPair += <i>"ip:qos-policy-in=add-class(sub, (class-default,voice_in), pri-level(1), police(256))"</i> Example: Cisco-AVPair = "ip:qos-policy-in=add-class (sub, (class-default,voice_in) , pri-level (1) , police (256)) "	Configures the cisco-avpair class-map in input direction for the police action parameter.
Step 3	Cisco-AVPair += <i>ip:qos-policy-in=add-class(sub, (class-default,video_in), pri-level(2), police(1000))"</i> Example: Cisco-AVPair = ip:qos-policy-in=add-class (sub, (class-default,video_in) , pri-level (2) , police (1000)) "	Configures the cisco-avpair class-map in input direction for the police action parameter.
Step 4	Cisco-AVPair += <i>"ip:qos-policy-in=add-class(sub, (class-default,data_in), set-qos-grp(4))"</i> Example: Cisco-AVPair = "ip:qos-policy-in=add-class (sub, (class-default,data_in) , set-qos-grp (4)) "	Configures the cisco-avpair class-map in input direction for the police action parameter.

	Command or Action	Purpose
Step 5	<p>Cisco-AVPair += "ip:qos-policy-in=add-class(sub, (class-default,class-default), set-qos-grp(7))"</p> <p>Example:</p> <pre>Cisco-AVPair = "ip:qos-policy-in=add-class(sub, (class-default,class-default), set-qos-grp(7))"</pre>	Configures the cisco-avpair class-map in input direction for the set qos action parameter.
Step 6	<p>Cisco-AVPair += "ip:qos-policy-out=add-class(sub, (class-default), shape(4000))"</p> <p>Example:</p> <pre>Cisco-AVPair = "ip:qos-policy-out=add-class(sub, (class-default), shape(4000))"</pre>	Configures the cisco-avpair class-map in output direction for the shape action parameter.
Step 7	<p>Cisco-AVPair += "ip:qos-policy-out=add-class(sub, (class-default,voice_out), pri-level(1),queue-limit-us(10000))"</p> <p>Example:</p> <pre>Cisco-AVPair = "ip:qos-policy-out=add-class(sub, (class-default,voice_out), pri-level(1),queue-limit-us(10000))"</pre>	Configures the cisco-avpair class-map in output direction for the queue-limit-us action parameter.
Step 8	<p>Cisco-AVPair += "ip:qos-policy-out=add-class(sub, (class-default,video_out),queue-limit-us(30000), shape(2000))"</p> <p>Example:</p> <pre>Cisco-AVPair = "ip:qos-policy-out=add-class(sub, (class-default,video_out), queue-limit-us(30000), shape(2000))"</pre>	Configures the cisco-avpair class-map in output direction for the queue-limit-us and the shape action parameters.
Step 9	<p>Cisco-AVPair += "ip:qos-policy-out=add-class(sub, (class-default,data_out), bw-rpct(20))"</p> <p>Example:</p> <pre>Cisco-AVPair = "ip:qos-policy-out=add-class(sub, (class-default,data_out), bw-rpct(20))"</pre>	Configures the cisco-avpair class-map in output direction for the bandwidth action parameter.
Step 10	<p>Cisco-AVPair += "ip:qos-policy-out=add-class(sub, (class-default,class-default))"</p> <p>Example:</p> <pre>Cisco-AVPair = "ip:qos-policy-out=add-class(sub, (class-default,class-default))"</pre>	<p>Configures the cisco-avpair class-map in output direction for the class action parameter.</p> <p>Note For the complete list of QoS action parameters that can be configured and applied through RADIUS, see <i>Parameterized QoS Syntax</i> section in Parameterized QoS Syntax, on page 260.</p>

Configuring Parameterized Subscriber Policy Defined and Applied through RADIUS: An example

Modifying Service Policy through CoA

Perform this task to modify service-policy through CoA.



Note The Web Portal or Radius server that supports CoA should be configured to generate a CoA request with Cisco VSA corresponding to the steps in this task.

SUMMARY STEPS

1. **qos-policy-out** *remove-class(sub, (class-default, voip))*
2. **qos-policy-out** *add-class(sub, (class-default, video), bw-rpct(50), pri-level(2))*
3. **qos-policy-out** *add-class(sub, (class-default, data), shape(400),set-ip-prec(1))*

DETAILED STEPS

	Command or Action	Purpose
Step 1	qos-policy-out <i>remove-class(sub, (class-default, voip))</i> Example: <pre>qos-policy-out=remove-class(sub, (class-default, voip))</pre>	Removes the class map, where voip is the class to be removed from a previously configured parameterized QoS for a subscriber.
Step 2	qos-policy-out <i>add-class(sub, (class-default, video), bw-rpct(50), pri-level(2))</i> Example: <pre>qos-policy-out=add-class(sub, (class-default, video), bw-rpct(50), pri-level(2))</pre>	Adds a class map, where video is the class to be added to a previously configured parameterized QoS for a subscriber.
Step 3	qos-policy-out <i>add-class(sub, (class-default, data), shape(400),set-ip-prec(1))</i> Example: <pre>qos-policy-out=add-class(sub, (class-default, data), shape(400),set-ip-prec(1))</pre>	Configures the qos-policy-out for shape, set ip precedence parameters.

Modifying Service Policy through CoA : Examples

```
//Policy-map configuration before CoA
policy-map __sub_5e311c4f_child1
class voip
  priority level 1
```

```

    police rate 10000 kbps burst 8 kbytes
    !
class video
    priority level 1
    police rate 10000 kbps burst 16 kbytes
    !
!
class data
    shape average 80000 kbps
    !
class class-default
    !
end-policy-map
!
policy-map __sub_5e311c4f
    class class-default
        service-policy __sub_5e311c4f_child1
        shape average 100000 kbps
    !
end-policy-map
!

//Modifying Service Policy through CoA
qos-policy-out=remove-class(sub, (class-default, voip))
qos-policy-out=add-class(sub, (class-default, video), bw-rpct(50), pri-level(2))
qos-policy-out=add-class(sub, (class-default, data), shape(400),set-ip-prec(1))

//Policy-map configuration after CoA looks like:
    policy-map __sub_fffffecla37f_child1
class video
priority level 2
    bandwidth percent 50
    police rate 10000 kbps burst 16 kbytes
    !
!
class data
    shape average 400 kbps
    set precedence 1
    !
class class-default
    !
end-policy-map
!
policy-map __sub_fffffecla37f
class class-default
    service-policy __sub_fffffecla37f_child1
    shape average 100000 kbps
    !
end-policy-map
!

```

Parameterized QoS for Line Card Subscribers

From Cisco IOS XR Release 5.3.2 and later, parameterized QoS (PQoS) as auto-service is supported for LC subscribers, along with RP subscribers. For PQoS as auto-service, all the PQoS attributes are defined as VSAs in the service profile, and activated as auto-service from the user profile. The regular mode of PQoS, where the attributes are defined in user profile and activated by a service logon CoA request, is not supported for LC subscribers. Whereas, RP subscribers support both modes of PQoS.

In user profile-based PQoS, the entire set of Cisco-AVPairs needs to be downloaded every time a new session comes up. Whereas, for PQoS as auto-service, the attributes need to be downloaded only for the first session. If the same service is to be activated for the next session, the attributes that were downloaded earlier for the previous session can be used from the BNG router itself. This reduces the processing time considerably and provides more flexibility in activating and deactivating a service.

To deactivate a PQoS service, use the service-logout request irrespective of the way it was activated. To modify the PQoS feature per subscriber session, send a multi-action CoA request with a deactivation command for the active service (`cisco-avpair += "subscriber:sd=<old-service>"`) and an activation command for the new service (`cisco-avpair += "subscriber:sa=<new-service>"`). To modify the service definitions which are currently used by the session, send the service update CoA request with new parameters.

Configuring Parameterized QoS as Auto-service

Configuration Guidelines

- For each service in the user profile, there must be a corresponding **Method-List** specified. Else, the BNG router considers that the service profile is defined locally.
- Once you download pqos as auto-service from the RADIUS server, the only way to change the service definition in the router, is through a CoA service-update request.
- The CoA account status query might not reply the **echo-strings** for the service.
- While a session starts, the user might want to apply default QoS service apart from the PQoS service. In such cases, ensure that the default QoS profile is applied as service template and activated after the authentication action. This avoids multiple instances of apply and undo apply during session bring-up, thereby providing good bring-up calls-per-second (CPS). It also avoids unnecessary feature installation for access-rejected users as well.
- From Release 6.6.3 onwards, BNG supports PQoS as auto-service with merge and accounting statistics, in the QoS VSAs. The user must configure merge and accounting-statistics only after **add-class**
- BNG does not support unconfiguring the merge and accounting-statistics attributes in COA cases. The user must deactivate the service to unconfigure merge and accounting-statistics.
- BNG does not support a CoA service-update request if the merge option is enabled.
- Any modification on the radius policy-map ensure that policy need to be cleared on the router, and then freshly need to be downloaded.

Configuration of PQoS as Auto-service: Example

This example shows a sample user profile and service profile, to activate the services 1_Mbps_IN and 1_Mbps_OUT as auto-service:

User Profile:

```
BNGuser1@bngtm.com Cleartext-Password := cisco
service-Type=Framed-User,
Cisco-AVPair += "echo-string-1=1_Mbps_IN",
Cisco-AVPair += "echo-string-2=1_Mbps_OUT",
Framed-Filter-Id = ACL_VOZ_CONTROL_IN.in,
Cisco-avpair += "subscriber:sa=1_Mbps_IN",
Cisco-AVPair += "Method-List=default"
Cisco-avpair += "subscriber:sa=1_Mbps_OUT",
```

```
Cisco-AVPair += "Method-List=default"
```

Service Profile:

```
1_Mbps_IN Cleartext-Password := "cisco"
    Cisco-AVPair += "ip:qos-policy-in=add-class(sub,(class-default),police(1085))",
    Cisco-AVPair +=
"ip:qos-policy-in=add-class(sub,(class-default,BROADBAND_VOZ),police(512,transmit,drop),set-mpls-exp-imp-osition(5))",

    Cisco-AVPair +=
"ip:qos-policy-in=add-class(sub,(class-default,BROADBAND_CRITICOS),set-mpls-exp-imp-osition(1))",

    Cisco-AVPair +=
"ip:qos-policy-in=add-class(sub,(class-default,BROADBAND_BUSINESS),set-mpls-exp-imp-osition(1))",

    Cisco-AVPair +=
"ip:qos-policy-in=add-class(sub,(class-default,class-default),set-mpls-exp-imp-osition(0),set-ip-dscp(0))"

1_Mbps_OUT Cleartext-Password := "cisco"
    Cisco-AVPair += "ip:qos-policy-out=add-class(sub,(class-default),shape(1064))",
    Cisco-AVPair +=
"ip:qos-policy-out=add-class(sub,(class-default,BROADBAND_VOZ),police(512,transmit,drop),pri-level(1),set-cos(5))",

    Cisco-AVPair +=
"ip:qos-policy-out=add-class(sub,(class-default,BROADBAND_CRITICOS),bw-rpct(50),set-cos(1))",

    Cisco-AVPair +=
"ip:qos-policy-out=add-class(sub,(class-default,BROADBAND_BUSINESS),bw-rpct(35),set-cos(1))",

    Cisco-AVPair +=
"ip:qos-policy-out=add-class(sub,(class-default,class-default),bw-rpct(15),set-cos(0))"
```

Single CoA Request: Example

This example shows a single CoA request to activate a PQoS service:

```
echo "Acct-Session-Id=08000001,Cisco-avpair+='subscriber:sa=pQOS_SVC_1MIN',
Cisco- AVPair+='Method-List=default'" | /usr/local/bin/radclient -x 6.6.6.18:1500 coa cisco
-r 1
Sending CoA-Request of id 134 to 6.6.6.18 port 1500 Acct-Session-Id = "08000001"
Cisco-AVPair += "subscriber:sa=pQOS_SVC_1MIN"
Cisco-AVPair += "Method-List=default"
rad_recv: CoA-ACK packet from host 6.6.6.18 port 1500, id=134, length=50
Cisco-AVPair = "sa=pQOS_SVC_1MIN"
```

This example shows a single CoA request to deactivate a PQoS service:

```
echo "Acct-Session-Id=08000001,Cisco-avpair+='subscriber:sd=pQOS_SVC_1MIN',
Cisco- AVPair+='Method-List=default'" | /usr/local/bin/radclient -x 6.6.6.18:1500 coa cisco
-r 1
Sending CoA-Request of id 21 to 6.6.6.18 port 1500 Acct-Session-Id = "08000001"
Cisco-AVPair += "subscriber:sd=pQOS_SVC_1MIN"
Cisco-AVPair += "Method-List=default"
rad_recv: CoA-ACK packet from host 6.6.6.18 port 1500, id=21, length=50
Cisco-AVPair = "sd=pQOS_SVC_1MIN"
```

Multi-action CoA Request: Example

This example shows a sample multi-action CoA request used to deactivate the service, pQOS_SVC_1MOUT and to activate the service, pQOS_SVC_2MOUT. It also updates the corresponding echo-string in single CoA request:

```
echo "Acct-Session-Id=080043e5,Cisco-Avpair+='subscriber:sd=pQOS_SVC_1MOUT',cisco-avpair+='Method-List=default',Cisco-AVPair+='echo-string-2=2_Mbps_OUT',Cisco-avpair+='subscriber:sa=pQOS_SVC_2MOUT',cisco-avpair+='Method-List=default'" | /usr/local/bin/radclient -x 6.6.6.18:1500 coa cisco

Sending CoA-Request of id 77 to 6.6.6.18 port 1500 Acct-Session-Id = "080043e5"

Cisco-AVPair += "subscriber:sd=pQOS_SVC_1MOUT" Cisco-AVPair += "Method-List=default"
Cisco-AVPair += "echo-string-1=1_Mbps_OUT"
Cisco-AVPair += "echo-string-2=2_Mbps_OUT" Cisco-AVPair += "subscriber:sa=pQOS_SVC_2MOUT"
Cisco-AVPair += "Method-List=default"
rad_recv: CoA-ACK packet from host 6.6.6.18 port 1500, id=77, length=80 Cisco-AVPair = "sd=pQOS_SVC_1MOUT" Cisco-AVPair = "sa=pQOS_SVC_2MOUT"
```

Service-update CoA Request: Example

This example shows a sample service-update CoA request to modify the parameters of a policy-map that is active on the BNG router:

```
echo "cisco-avpair+='subscriber:command=service-update',Cisco-avpair+='subscriber:service-name=pQOS_SVC_1MIN',Cisco-AVPair+='Method-List=default',Cisco-AVPair+='ip:qos-policy-in=add-class(sub,(class-default),police(1085))',Cisco-AVPair+='ip:qos-policy-in=add-class(sub,(class-default,BROADBAND_VOZ),police(512,transmit,drop),set-mpls-exp-imp-osition(4))',Cisco-AVPair+='ip:qos-policy-in=add-class(sub,(class-default,BROADBAND_CRITICOS),set-mpls-exp-imp-osition(2))',Cisco-AVPair+='ip:qos-policy-in=add-class(sub,(class-default,BROADBAND_BUSINESS),set-mpls-exp-imp-osition(2))',Cisco-AVPair+='ip:qos-policy-in=add-class(sub,(class-default,class-default),set-mpls-exp-imp-osition(0),set-ip-dscp(0))'" | /usr/local/bin/radclient -x 6.6.6.18:1500 coa cisco

Sending CoA-Request of id 173 to 6.6.6.18 port 1500 Cisco-AVPair += "subscriber:command=service-update"

Cisco-AVPair += "subscriber:service-name=pQOS_SVC_1MIN" Cisco-AVPair += "Method-List=default"
Cisco-AVPair += "ip:qos-policy-in=add-class(sub,(class-default),police(1085))"
Cisco-AVPair += "ip:qos-policy-in=add-class(sub,(class-default,BROADBAND_VOZ),police(512,transmit,drop),set-mpls-exp-imp-osition(5))"
Cisco-AVPair += "ip:qos-policy-in=add-class(sub,(class-default,BROADBAND_CRITICOS),set-mpls-exp-imp-osition(1))"
Cisco-AVPair += "ip:qos-policy-in=add-class(sub,(class-default,BROADBAND_BUSINESS),set-mpls-exp-imp-osition(1))"
Cisco-AVPair += "ip:qos-policy-in=add-class(sub,(class-default,class-default),set-mpls-exp-imp-osition(0),set-ip-dscp(1))"

rad_recv: CoA-ACK packet from host 6.6.6.18 port 1500, id=173, length=20
```

Merge and Accounting Statistics: Example

This example shows the RADIUS configuration which can be downloaded from the RADIUS server:

```

1_Mbps_IN      Password="cisco"
  Cisco-avpair = "ip:qos-policy-in=add-class(sub,(class-default),police(2085))",
  Cisco-avpair =
"ip:qos-policy-in=add-class(sub,(class-default,BROADBAND_VOZ),police(512,transmit,drop),set-mpls-exp-imp(5))",

  Cisco-avpair =
"ip:qos-policy-in=add-class(sub,(class-default,BROADBAND_BUSINESS),set-mpls-exp-imp(1))",

  Cisco-avpair =
"ip:qos-policy-in=add-class(sub,(class-default,class-default),set-mpls-exp-imp(0),set-ip-dscp(0))",

  Cisco-avpair = "ip:qos-policy-in=(merge(60),acct-stats)"

1_Mbps_OUT      Password="cisco"
  Cisco-avpair = "ip:qos-policy-out=add-class(sub,(class-default),shape(1064))",
  Cisco-avpair =
"ip:qos-policy-out=add-class(sub,(class-default,BROADBAND_VOZ),police(512,transmit,drop),pri-level(1))",

  Cisco-avpair =
"ip:qos-policy-out=add-class(sub,(class-default,BROADBAND_BUSINESS),bw-rpct(35))",
  Cisco-avpair =
"ip:qos-policy-out=add-class(sub,(class-default,class-default),bw-rpct(15))"
  Cisco-avpair = "ip:qos-policy-out=(merge(120),acct-stats)"

merge_servicel Password = "cisco"
  Cisco-avpair = "echo-string-1=1_Mbps_IN",
  Cisco-avpair = "echo-string-2=1_Mbps_OUT",
  Cisco-avpair = "subscriber:sa=1_Mbps_IN",
  Cisco-avpair = "Method-List=default",
  Cisco-avpair = "subscriber:sa=1_Mbps_OUT",
  Cisco-avpair = "Method-List=default",

```

This example shows ingress and egress policies in the same service:

```

In_out_servicel Password = "cisco"
  Cisco-avpair = "subscriber:service-acct-list=default"
  Cisco-avpair =
"ip:qos-policy-in=add-class(sub,(class-default,BROADBAND_VOZ),police(20480,500000),set-mpls-exp-imp(4))"

  Cisco-avpair =
"ip:qos-policy-in=add-class(sub,(class-default),police(102400,1250000),set-mpls-exp-imp(0))"

  Cisco-avpair =
"ip:qos-policy-out=add-class(sub,(class-default,BROADBAND_BUSINESS),shape(20480),random-detect-dscp(26,375000,500000))"

  Cisco-avpair = "ip:qos-policy-out=add-class(sub,(class-default,
class-default),shape(102400),random-detect-dscp(0,937500,1250000))"
  Cisco-avpair = "ip:qos-policy-out=add-class(sub,(class-default),shape(102400))"
  Cisco-avpair = "ip:qos-policy-out=(merge(110),acct-stats)"
  Cisco-avpair = "ip:qos-policy-in=(merge(130),acct-stats)"

servicel Password = "cisco"
  Cisco-avpair = "echo-string-1= In_out_servicel ",
  Cisco-avpair = "subscriber:sa= In_out_servicel ",

```

Verifying PQoS Configuration

You can use these show commands to verify the PQoS configuration:

- Verify if all the policy parameters, like policer and shaper values received from the RADIUS server, are applied on the interface:

```
router# show policy-map applied interface GigabitEthernet0/0/0/0.1.pppoe4
```

```
Input policy-map applied to GigabitEthernet0/0/0/0.1.pppoe4:
```

```
policy-map __sub_655b501d
  class class-default
    service-policy __sub_655b501d_child1
    police rate 2085 kbps
  !
!
```

```
Child policy-map(s) of policy-map __sub_655b501d:
```

```
policy-map __sub_655b501d_child1
  class BROADBAND_VOZ
    police rate 512 kbps
    conform-action transmit
    exceed-action drop
  !
  set mpls experimental imposition 5
  !
  class BROADBAND_CRITICOS
    set mpls experimental imposition 1
  !
  class BROADBAND_BUSINESS
    set mpls experimental imposition 1
  !
  class class-default
    set mpls experimental imposition 0
    set dscp 0
  !
end-policy-map
!
```

- Verify the applied service(s) for the session:

```
router# show subscriber session all detail internal
```

```
Interface: GigabitEthernet0/0/0/0.1.pppoe4
```

```
- - -
- - -
```

Policy Executed:

```
event Session-Start match-first [at Wed May 13 10:40:43 2015]
  class type control subscriber PPP_CM do-until-success [Succeeded]
    10 activate dynamic-template PTA_TEMPLATE_1 [cerr: No error][aaa: Success]
event Session-Activate match-first [at Wed May 13 10:40:43 2015]
  class type control subscriber PPP_CM do-all [Succeeded]
    10 authenticate aaa list default [cerr: No error][aaa: Success]
    20 activate dynamic-template DEF_SEVICE [cerr: No error][aaa: Success]
```

Session Accounting:

```
Acct-Session-Id: 10000003
Method-list: default
```

```
- - -
- - -
```

```
Last COA request received: unavailable
```

```
User Profile received from AAA:
```

```
Attribute List: 0x1000f524
```

```
1: service-type len= 4 value= Framed
2: inacl len= 18 value= ACL_VOZ_CONTROL_IN
```

Services:

```
Name       : PTA_TEMPLATE_1
Service-ID : 0x4000002
Type       : Template
Status     : Applied
```

```
-----
Name       : 2_Mbps_IN
Service-ID : 0x400001d
Type       : Profile
Status     : Applied
```

- Verify the policy-download is proper from radius:

```
RP/0/RSP1/CPU0:SRG2#show subscriber database configuration brief service-profile
```

```
Location 0/RSP0/CPU0
```

```
ServiceName:MethodList      In Use By Subscriber
-----
```

```
Location 0/RSP1/CPU0
```

```
ServiceName:MethodList      In Use By Subscriber
-----
```

```
Location 0/0/CPU0
```

```
ServiceName:MethodList      In Use By Subscriber
-----
```

```
Location 0/1/CPU0
```

```
ServiceName:MethodList      In Use By Subscriber
-----
```

```
Location 0/2/CPU0
```

```
ServiceName:MethodList      In Use By Subscriber
```

- To remove any policy-name from the router:

```
clear subscriber manager service-profile service-name <>
```

RADIUS Based Policing - QoS Shaper Parameterization

Radius Based Policing (RaBaPol) allows customized parameters, instead of the default parameters, to be used to activate BNG subscriber services. BNG supports parameterization of QoS **shape-rate**. The shaper parameters can either be sent to BNG by the RADIUS server during connection establishment, as CISCO VSAs in an Access Accept message, or they can be sent to BNG as part of the CoA messages.

To configure QoS Shaper Parameterization, use the shape average `$var_name = value` command in policy-map class configuration mode.

According to RaBaPol, the dynamic template associated with the subscriber contains individual feature configuration. The syntax and semantics of parameterization is feature dependent. For QoS, a dollar sign (\$) is added as a prefix to the **shape-rate** variable, and the default value, along with the variables, is configured in the policy-map definition.

If the service that is to be activated is already associated to the subscriber, the incoming variable-list is compared with the exiting one. If the variable-list is the same, then this is a duplicate request and the request gets dropped.

Otherwise, the old variable-list is cached and the new variable-list is associated to the subscriber. After the service is successfully activated, the iEdge echoes the VSA that triggered the service-activate, as an acknowledgment back to the AAA server.

If any feature returns an error during its activation, the iEdge component rolls back all features to their previous states. If the feature or service has a variable-list associated with it, then that variable-list is also rolled back to the previous cached variable-list.

RaBaPol also supports policy merge, where QoS policies from multiple dynamic templates (configured through CLI or downloaded from AAA server) are merged for the subscriber.

High Availability - In the case of process restart, the session is re-established using the variable-list that is already associated with the service.

Sample Configuration and Use Cases for QoS Shaper Parameterization

Sample Configuration for QoS Shaper Parameterization

This is a sample configuration for QoS Shaper Parameterization:

```
dynamic-template type service SERVICE-POLICY-OUT
  service-policy output out-policy merge 10

policy-map out-policy
  class class-default
    shape average $shape-rate= 100000 Kbps
  service-policy output-child
policy-map output-child
  class class-default
```

In this example, the service named SERVICE-POLICY-OUT has QoS features enabled. This dynamic template has outgoing QoS policies configured, with a default value of **shape-rate** being 100 Mbps.

Use Cases for QoS Shaper Parameterization

These are some use cases for QoS Shaper Parameterization:

- User initiates a subscriber session with this user profile:

```
user-cpe-xyz1@abc.com      Password="abc"
  Framed-Protocol=PPP,
  Service-Type=Framed-User
  ...
Cisco-avpair = "subscriber:sa=SERVICE-POLICY-OUT(shape-rate=1203000)"
```

The AAA server sends to BNG an Access-accept message that contains the service name that is to be activated (SERVICE-POLICY-OUT, in this example), action type (subscriber:sa), and the variable list, along with its values. Now, the service name maps with the dynamic-template defined on BNG. The VSA contains QoS **shape-rate** value (For example, shape-rate=1203000) to override the default values locally configured on BNG. In BNG, the policy gets merged with default and customized values. For the variables that were not specified in the AAA message, default values are retained.

Alternatively, the new service activation can be performed using CoA. In this case, the old policy is removed and the new, merged policy gets configured in the hardware.

- User wants to change the QoS shaper value of the subscriber. This can be ideally be done in two ways:
 - Service-modify of same service - This is currently not supported.
 - Service-activate of the new service followed by Service-deactivate of the old service - At first, a new service is activated using the new shaper value sent through the Access-accept message. After that, a CoA message is sent from the AAA server to the BNG, to deactivate the old service.

Verification of QoS Shaper Parameterization Configurations

These show commands can be used to verify the QoS Shaper Parameterization configurations in BNG:

SUMMARY STEPS

1. **show policy-map interface all**
2. **show policy-map applied interface** *interface-type interface-name*
3. **show running-configuration policy-map**
4. **show qos-ea interface** *interface-type interface-name*

DETAILED STEPS

Step 1 **show policy-map interface all**

Displays the QoS shaper rate configured on the subscriber interface by the AAA server, either through an Access-Accept message or through a CoA message. The statistics rate field, transmitted, displays the shaper rate.

Example:

```
RP/0/RSP0/CPU0:router#
show policy-map interface all
node0_1_CPU0: Service Policy not installed
node0_0_CPU0: Service Policy not installed
node0_RSP1_CPU0: node0_RSP0_CPU0:
Bundle-Ether1.1.pppoe62151: policy-parent
Class class-default
  Classification statistics          (packets/bytes)      (rate - kbps)
  Matched                          :                   0/0                0
  Transmitted                       :                   0/0                0
  Total Dropped                     :                   0/0                0
  Queueing statistics
  Queue ID                          : 458
  High watermark                    : N/A
  Inst-queue-len (packets)          : 0
  Avg-queue-len                    : N/A
  Taildropped (packets/bytes)       : 0/0
  Queue (conform)                   :                   0/0                0
  Queue (exceed)                   :                   0/0                0
  RED random drops (packets/bytes)  : 0/0
```

Step 2 **show policy-map applied interface** *interface-type interface-name*

Displays the actual policy-map applied on the subscriber interface.

Example:

```

RP/0/RSP0/CPU0:router#
show policy-map applied interface Bundle-Ether1.1.pppoe62151
Output policy-map applied to Bundle-Ether1.1.pppoe62151:
  policy-map policy-parent
    class class-default
      service-policy policy-child
        shape average $shaperP = 500 mbps
    !
Child policy-map(s) of policy-map policy-parent:

  policy-map policy-child
    class prec2
      shape average $shaperC1 = 600 kbps
    !
    class prec3
      shape average $shaperC2 = 700 kbps
    !
    class class-default
      shape average $shaperC3 = 200 kbps
    !
  end-policy-map

```

Step 3 **show running-configuration policy-map**

Displays the details of the policy-map configured on BNG.

Example:

```

RP/0/RSP0/CPU0:router#
show running-configuration policy-map
policy-map policy-parent
class class-default
  service-policy policy-child
  shape average $shaperP = 500 mbps
!
end-policy-map
!

policy-map policy-child
class prec2
  shape average $shaperC1 = 600 kbps
!
class prec3
  shape average $shaperC2 = 700 kbps
!
class class-default
  shape average $shaperC3 = 200 kbps
!
end-policy-map
!

```

Step 4 **show qos-ea interface *interface-type interface-name***

Displays the QoS programmed in the hardware.

Example:

```

RP/0/RSP0/CPU0:router#
show qos-ea interface bundle-Ether 1.4 output member gigabitEthernet 0/1/0/0

```

```

Interface: GigabitEthernet0_1_0_0 output policy: vlan_policy_egress
Total number of classes: 1
Total number of UBRL classes: 0
Total number of CAC classes: 0
-----
Policy name: vlan_policy_egress
Hierarchical depth 1
Interface type VLAN Subif
Interface rate 1000000 kbps
Port Shaper rate 0 kbps
Interface handle 0x00096060
ul_ifh 0x060000C0, ul_id 0x00000000
uidb index 0x001B
qos_ifh 0x810800000001b
Local port 0, NP 0
Policy map id 0x2014, format 16, uidb index 0x001B
-----
Index 0 Level 0 Class name class-default service_id 0x0 Policy name vlan_policy_egress
Node flags: LEAF Q_LEAF DEFAULT DEFAULT-ALL
Stats flags: Queuing enabled
Node Config:
Shape: CIR/CBS/PIR/PBS: 0kbps/11250000B/900000kbps/11250000B
WFQ: BW/Sum of BW/Excess ratio: 0kbps/0kbps/1
Queue limit 11250000 Guarantee 0
Node Result: Class-based stats:Stat ID 0x005114F3
Queue: Q-ID 0x00030062 Stat ID(Commit/Excess/Drop): 0x006E01EA/0x00000000/0x006E01EB
-----

```

Supported Scenarios of QoS Shaper Parameterization

These scenarios are supported for QoS Shaper Parameterization:

- Merging of QoS policies through AAA server is supported - A subscriber session does not come up if only one of the policies (applied either through dynamic template control policy or through RADIUS server) has the **merge** keyword enabled. This is irrespective of whether the shaper parameterization is enabled, or not.

In the case of re-configuring through a CoA message:

- If only one of the policies has the **merge** keyword enabled, the policy is rejected irrespective of whether the shaper parameterization is enabled, or not.
- If none of the policies have the **merge** keyword enabled, the policy applied through the RADIUS server replaces the one applied through the control subscriber policy.
- If both the policies have the **merge** keyword enabled, the policy is accepted irrespective of whether the shaper parameterization is enabled, or not.
- These service policy replacement scenarios are supported:
 - A subscriber, with service policy A (applied through dynamic template) having default shaper parameterized values, which is replaced by service policy B having shaper parameterized values.
 - A subscriber, with service policy A (applied through dynamic template) having default shaper parameterized values, which is replaced by service policy B with no shaper parameterized values.

Restrictions of QoS Shaper Parameterization

The QoS Shaper Parameterization is subjected to these restrictions:

- Parameterization of only the QoS *shape-rate* feature associated with the subscriber service is supported; other features are not supported. The parameterization of rate units such as burst size is supported in kbytes for *shape* and in microsecond for *shape-rpct*. For the *shape-rate* variable, the parameterization of the value attribute and excess burst size is supported from Release 6.6.2.
- Linecard (LC) subscribers are not supported.
- The service profile downloaded from the RADIUS server is not supported.
- The addition or modification of the *shape-rate* variable field is rejected for any policy-map that is applied on an interface.
- The modification of the default *shape-rate* variable value is rejected for a policy-map that is applied on an interface.
- The variable names in the policy-map definition must be different across the system.
- A service which is defined on BNG, without parameterization enabled, does not accept parameters through CoA.
- Service modification of variable-list is not supported.
- Parameterized shapers are not supported with multi-action CoA.
- The maximum number of different variable-lists supported is 2000. This limit includes the already-active sessions wherein the previous variable-list is also stored.
- Only absolute shaper values is supported in the highest level of the policy. At the child level of the policy, the absolute and the percent-based shaper values can be configured.
- Shared Policy Instance (SPI) is not supported on parameterized shaper policies.
- Scenarios with Parameterized (PQoS) policy-map and CLI policy-map applied through the RADIUS server, are not supported.
- Service Accounting - For a subscriber with service policy A (applied through dynamic template), a service policy-replacement with service policy B, is not supported (irrespective of whether shaper parameterized variables are present in both A or B) for all these scenarios:
 - If service accounting is enabled either in service policy A or in service policy B.
 - If service accounting is enabled in both A and B.
- If more than one service with service accounting is configured for each subscriber session, one of the services must show aggregate traffic of all the services. To have proper per-service accounting, it is recommended to define a parent service in such scenarios, with all the other services defined as children.

QoS Accounting

The QoS overhead accounting feature enables BNG to account for various encapsulation types when applying QoS to packets. The ATM overhead accounting enables the BNG to account for the ATM encapsulation on

the subscriber line. It also accounts for the overhead added by cell segmentation. This accounting enables the service provider to prevent overruns on the subscriber line and ensures that the BNG executes QoS features on the actual bandwidth allocated to the subscriber traffic. The ATM overhead encapsulation details are listed in this table.

Table 13: ATM Overhead Encapsulation Details

DSLAM to CPE Encapsulation		ALE Tags (RFC 4679)		
CLI Option	Overhead (in bytes)	Data Link	Encapsulation1	Encapsulation2
snap-pppoa	12	AAL5	N/A	PPPoA LLC (1)
mux-pppoa	10	AAL5	N/A	PPPoA Null (2)
snap-1483routed	18	AAL5	Untagged Ethernet	IPoA LLC (3)
mux-1483routed	8	AAL5	Untagged Ethernet	IPoA NULL (4)
snap-rbe	28	AAL5	Untagged Ethernet	Ethernet over AAL5 LLC without FCS (6)
snap-dot1q-rbe	32	AAL5	Single-Tagged Ethernet	Ethernet over AAL5 LLC without FCS (6)
mux-rbe	24	AAL5	Untagged Ethernet	Ethernet over AAL5 Null without FCS (8)
mux-dot1q-rbe	28	AAL5	Single-Tagged Ethernet	Ethernet over AAL5 Null without FCS (8)

To enable QoS overhead accounting, see [Configuring QoS Accounting, on page 281](#).

Configuring QoS Accounting

Perform this task to enable QoS Layer2 overhead accounting.

SUMMARY STEPS

1. **configure**
2. **dynamic-template**
3. **type** [ppp | ip-subscriber | service] *name*
4. **qos-account** [AAL5 | user-defined] [mux-1483routed | mux-dot1q-rbe | mux-pppoa | mux-rbe | snap-1483routed | snap-dot1q-rbe | snap-pppoa | snap-rbe]
5. **exit**
6. Use the **commit** or **end** command.

DETAILED STEPS

	Command or Action	Purpose
Step 1	configure Example: RP/0/RSP0/CPU0:router# configure	Enters global configuration mode.
Step 2	dynamic-template Example: RP/0/RSP0/CPU0:router(config)# dynamic-template	Enters dynamic template configuration mode.
Step 3	type [ppp ip-subscriber service] <i>name</i> Example: RP/0/RSP0/CPU0:router(config-dynamic-template)# type ppp p1	Specifies the type of dynamic template that needs to be applied. Three type are: <ul style="list-style-type: none"> • PPP • IP-subscriber • Service
Step 4	qos-account [AAL5 user-defined] [mux-1483routed mux-dot1q-rbe mux-pppoa mux-rbe snap-1483routed snap-dot1q-rbe snap-pppoa snap-rbe] Example: RP/0/RSP0/CPU0:router(config-dynamic-template-type)# qos-account AAL5 snap-rbe	Defines the L2 QoS overhead accounting. Various keywords such as mux-1483routed, snap-rbe define different available encapsulations between the DSLAM and CPE. For details about keywords, see Table 13: ATM Overhead Encapsulation Details, on page 281 .
Step 5	exit Example: RP/0/RSP0/CPU0:router(config-dynamic-template-type)# exit	Exits from the current mode.
Step 6	Use the commit or end command.	commit —Saves the configuration changes and remains within the configuration session. end —Prompts user to take one of these actions: <ul style="list-style-type: none"> • Yes — Saves configuration changes and exits the configuration session. • No —Exits the configuration session without committing the configuration changes. • Cancel —Remains in the configuration session, without committing the configuration changes.

Configuring QoS Accounting: An example

```
configure
dynamic-template type ppp p1
qos account AAL5 mux-1483routed
service-policy input input_1
end
```

Support for Shared Policy Instance

Shared Policy Instance (SPI) allows allocation of a single set of QoS resources among groups of BNG sub-interfaces and bundle sub-interfaces, and shares them across a group of sub-interfaces, multiple Ethernet flow points (EFPs), or bundle interfaces.

Using SPI, a single instance of QoS policy can be shared across multiple sub-interfaces, allowing for aggregate shaping of the sub-interfaces to one rate. All sub-interfaces that share the instance of a QoS policy must belong to the same physical interface. The number of sub-interfaces sharing the QoS policy instance can range from 2 to the maximum number of sub-interfaces on the port.

For bundle interfaces, hardware resources are replicated per bundle member. All sub-interfaces that use a common shared policy instance and are configured on a Link Aggregation Control Protocol (LAG) bundle must be load-balanced to the same member link.

When a policy is configured on a bundle EFP, one instance of the policy is configured on each of the bundle member links. When using SPI across multiple bundle EFPs of the same bundle, one shared instance of the policy is configured on each of the bundle member links. By default, the bundle load balancing algorithm uses hashing to distribute the traffic (that needs to be sent out of the bundle EFPs) among its bundle members. The traffic for single or multiple EFPs can get distributed among multiple bundle members. If multiple EFPs have traffic that needs to be shaped or policed together using SPI, the bundle load balancing has to be configured to select the same bundle member (hash-select) for traffic to all the EFPs that belong the same shared instance of the policy. This ensures that traffic going out on all the EFPs with same shared instance of the policy use the same policer or shaper Instance.

BNG configures a complete hierarchical policy-map that includes parent and child policies. Optionally, the SPI name can be defined and attached to the appropriate dynamic template or downloaded from RADIUS, in this manner:

- Policy configured through a CLI and applied through a dynamic-template
- Policy configured through a CLI and applied through RADIUS



Note The SPI has to be used across subscriber interfaces, but all subscriber interfaces have to be under the same access-interface (that is, the parent interface has to be same).

Restrictions

These restrictions apply to the usage of shared policy instance:

- SPI is not supported for subscribers on non-bundle interfaces.

- SPI is not supported for Parameterized QoS (PQoS). In a PQoS configuration, if there exists a SPI name, then it is ignored.
- Prior to Cisco IOS XR Release 5.2.0, SPI modified through CoA is not supported on subscribers.
- The SPI name must be changed if the policy-map associated with it is changed.
 - Once an SPI policy has been applied on a subscriber, a new policy with same policy-map name and different SPI name is rejected.
 - Once an SPI policy has been applied on a subscriber, a new policy with different policy-map name and same SPI name is rejected.

Configuring a Policy with SPI in the Input or Output Direction Using Dynamic Template

Perform this task to configure a policy with shared policy instance in the input and output direction using dynamic template.

SUMMARY STEPS

1. **configure**
2. **policy-map** *policy_map_name*
3. **class** {*class_name* | **class-default** | } [**type qos**]
4. **service-policy** *service_policy_name*
5. Use the **commit** or **end** command.
6. **policy-map** *policy_map_name*
7. **class** {*class_name* | **class-default** | } [**type qos**]
8. **police rate** *value*
9. Use the **commit** or **end** command.
10. **dynamic-template type ipsubscriber** *dynamic_template_name*
11. **service-policy** {**input** | **output**}*policy_map_name* [**shared-policy-instance** *instance_name*]
12. **service-policy** {**input** | **output**}*policy_map_name* [**shared-policy-instance** *instance_name*]
13. Use the **commit** or **end** command.

DETAILED STEPS

	Command or Action	Purpose
Step 1	configure Example: RP/0/RSP0/CPU0:router# <code>configure</code>	Enters global configuration mode.
Step 2	policy-map <i>policy_map_name</i> Example: RP/0/RSP0/CPU0:router(config)# <code>policy-map policyl</code>	Creates or modifies a policy map that can be attached to one or more interfaces to specify a service policy, and enters the policy-map configuration submode.

	Command or Action	Purpose
Step 3	<p>class {<i>class_name</i> class-default } [type qos]</p> <p>Example:</p> <pre>RP/0/RSP0/CPU0:router(config-pmap)# class class-default</pre>	Specifies the name of the class whose policy you want to create or change and enters the policy map class configuration submenu. This example configures a traffic policy for the default class of the traffic policy policy1. The default class is named class-default.
Step 4	<p>service-policy <i>service_policy_name</i></p> <p>Example:</p> <pre>RP/0/RSP0/CPU0:router(config-pmap-c)# service-policy policy1_child</pre>	Attaches a policy map to an input or output interface.
Step 5	Use the commit or end command.	<p>commit —Saves the configuration changes and remains within the configuration session.</p> <p>end —Prompts user to take one of these actions:</p> <ul style="list-style-type: none"> • Yes — Saves configuration changes and exits the configuration session. • No —Exits the configuration session without committing the configuration changes. • Cancel —Remains in the configuration session, without committing the configuration changes.
Step 6	<p>policy-map <i>policy_map_name</i></p> <p>Example:</p> <pre>RP/0/RSP0/CPU0:router(config)# policy-map policy1_child</pre>	Creates or modifies a policy map that can be attached to one or more interfaces to specify a service policy, and enters the policy-map configuration submenu.
Step 7	<p>class {<i>class_name</i> class-default } [type qos]</p> <p>Example:</p> <pre>RP/0/RSP0/CPU0:router(config-pmap)# class class-default</pre>	Specifies the name of the class whose policy you want to create or change and enters the policy map class configuration submenu. This example configures a traffic policy for the default class of the traffic policy policy1. The default class is named class-default.
Step 8	<p>police rate <i>value</i></p> <p>Example:</p> <pre>RP/0/RSP0/CPU0:router(config-pmap-c)# police rate 1024</pre>	Configures traffic policing and enters policy map police configuration mode. The value represents the committed information rate and ranges from 1 to 4294967295.
Step 9	Use the commit or end command.	<p>commit —Saves the configuration changes and remains within the configuration session.</p> <p>end —Prompts user to take one of these actions:</p> <ul style="list-style-type: none"> • Yes — Saves configuration changes and exits the configuration session.

	Command or Action	Purpose
		<ul style="list-style-type: none"> • No —Exits the configuration session without committing the configuration changes. • Cancel —Remains in the configuration session, without committing the configuration changes.
Step 10	dynamic-template type ipsubscriber <i>dynamic_template_name</i> Example: RP/0/RSP0/CPU0:router(config)# dynamic-template type ppp PTA_TEMPLATE_1	Creates a dynamic template of type ipsubscriber.
Step 11	service-policy {input output}policy_map_name [shared-policy-instance instance_name] Example: RP/0/RSP0/CPU0:router(config)# service-policy input policy1 shared-policy-instance spi_1	Attaches a policy map to an input or output interface to be used as the service policy for that interface. In this example, the traffic policy evaluates all traffic entering into that interface.
Step 12	service-policy {input output}policy_map_name [shared-policy-instance instance_name] Example: RP/0/RSP0/CPU0:router(config)# service-policy output policy1 shared-policy-instance spi_2	Attaches a policy map to an input or output interface to be used as the service policy for that interface. In this example, the traffic policy evaluates all traffic leaving that interface.
Step 13	Use the commit or end command.	commit —Saves the configuration changes and remains within the configuration session. end —Prompts user to take one of these actions: <ul style="list-style-type: none"> • Yes — Saves configuration changes and exits the configuration session. • No —Exits the configuration session without committing the configuration changes. • Cancel —Remains in the configuration session, without committing the configuration changes.

Configuring a Policy with SPI in the Input or Output Direction Using Dynamic Template: Example

```

configure
policy-map policy1
class class-default
service-policy policy1_child
!!

policy-map policy1_child

```

```

class class-default
police rate 1024 kbps
!!

dynamic-template
type ppp PTA_TEMPLATE_1
service-policy input policy1 shared-policy-instance spi_1
service-policy output policy1 shared-policy-instance spi_2
commit

```

Configuring a Policy with SPI in the Input or Output Direction Using RADIUS

Perform this task to configure a policy with shared policy instance in the input or output direction using RADIUS.

SUMMARY STEPS

1. **configure**
2. **policy-map** *policy_map_name*
3. **class** {*class_name* | **class-default**} [**type qos**]
4. **service-policy** *service_policy_name*
5. Use the **commit** or **end** command.
6. **policy-map** *policy_map_name*
7. **class** {*class_name* | **class-default**} [**type qos**]
8. **police rate value**
9. Use the **commit** or **end** command.

DETAILED STEPS

	Command or Action	Purpose
Step 1	configure Example: RP/0/RSP0/CPU0:router# configure	Enters global configuration mode.
Step 2	policy-map <i>policy_map_name</i> Example: RP/0/RSP0/CPU0:router(config)# policy-map policy1	Creates or modifies a policy map that can be attached to one or more interfaces to specify a service policy, and enters the policy-map configuration submode.
Step 3	class { <i>class_name</i> class-default } [type qos] Example: RP/0/RSP0/CPU0:router(config-pmap)# class class-default	Specifies the name of the class whose policy you want to create or change and enters the policy map class configuration submode. This example configures a traffic policy for the default class of the traffic policy policy1. The default class is named class-default.
Step 4	service-policy <i>service_policy_name</i> Example:	Attaches a policy map to an input or output interface.

	Command or Action	Purpose
	RP/0/RSP0/CPU0:router(config-pmap-c)# service-policy policy1_child	
Step 5	Use the commit or end command.	<p>commit —Saves the configuration changes and remains within the configuration session.</p> <p>end —Prompts user to take one of these actions:</p> <ul style="list-style-type: none"> • Yes — Saves configuration changes and exits the configuration session. • No —Exits the configuration session without committing the configuration changes. • Cancel —Remains in the configuration session, without committing the configuration changes.
Step 6	<p>policy-map <i>policy_map_name</i></p> <p>Example:</p> <pre>RP/0/RSP0/CPU0:router(config)# policy-map policy1_child</pre>	Creates or modifies a policy map that can be attached to one or more interfaces to specify a service policy, and enters the policy-map configuration submenu.
Step 7	<p>class {<i>class_name</i> class-default} [type qos]</p> <p>Example:</p> <pre>RP/0/RSP0/CPU0:router(config-pmap)# class class-default</pre>	Specifies the name of the class whose policy you want to create or change and enters the policy map class configuration submenu. This example configures a traffic policy for the default class of the traffic policy policy1. The default class is named class-default.
Step 8	<p>police rate <i>value</i></p> <p>Example:</p> <pre>RP/0/RSP0/CPU0:router(config-pmap-c)# police rate 1024</pre>	Configures traffic policing and enters policy map police configuration mode. The value represents the committed information rate and ranges from 1 to 4294967295.
Step 9	Use the commit or end command.	<p>commit —Saves the configuration changes and remains within the configuration session.</p> <p>end —Prompts user to take one of these actions:</p> <ul style="list-style-type: none"> • Yes — Saves configuration changes and exits the configuration session. • No —Exits the configuration session without committing the configuration changes. • Cancel —Remains in the configuration session, without committing the configuration changes.

Configuring a Policy with SPI in the Input or Output Direction Using RADIUS: Example

```

configure
policy-map policy1
class class-default
service-policy policy1_child
!!

policy-map policy1_child
class class-default
police rate 1024 kbps
commit
!!

//In the USER file in RADIUS
RoadRunner_P1@Chasing1 Cleartext-Password := "LooneyTunes_P1"
cisco-avpair += "sub-qos-policy-in=policy1 shared-policy-instance spi_1",
cisco-avpair += "sub-qos-policy-out=policy1 shared-policy-instance spi_2",
Framed-Protocol += PPP,
Service-Type += Framed-User,
Fall-Through = no

```

What to do next

Run these steps in the USER file in RADIUS:

```

RoadRunner_P1@Chasing1 Cleartext-Password := "LooneyTunes_P1"
cisco-avpair += "sub-qos-policy-in=policy1 shared-policy-instance spi_1",
cisco-avpair += "sub-qos-policy-out=policy1 shared-policy-instance spi_2",
Framed-Protocol += PPP,
Service-Type += Framed-User,
Fall-Through = no

```

Merging QoS Policy-maps

Multiple QoS policies, applied through multiple dynamic templates, can be merged and implemented on a single subscriber. The order in which the policies are merged is important, and is determined by the value of the sequence number configured in the dynamic template. A policy is deployed using a policy-map. A new optional **merge** keyword is provided with the **service-policy** command under dynamic template sub mode to allow the merging of policy-maps applied through multiple dynamic templates.

When more than two policy-maps are to be merged, two policy-maps are first merged together based on their sequence number (using the rules listed below) to create a merged policy-map. Similarly, a third policy-map is merged with the first merged policy-map. This continues till all policy-maps that are to be merged are merged together. The sequence numbers of the policy-maps are significant only while merging the policy-maps and are not related to the priority of the classes.

For example, let's say that policy-maps *p1*, *p2*, *p3*, *p4* each with a specific sequence number, are to be merged in that order; *p1* and *p2* are merged first based on their sequence numbers (see the rules listed below). Next, *p3* is merged with the <p1-p2> merged policy-map. Finally, *p4* is merged with the <p1-p2-p3> merged policy-map, giving the final merged policy-map.

The rules for merging two policy-maps are:

- The policy-map with the lowest sequence number takes precedence over the other.

For example, if policy-maps *p1* with a sequence number 100 and *p2* with a sequence number 20 are to be merged, then *p2* overrides *p1*, as it has the lowest sequence number. Similarly, if policy-map *p3* with a sequence number 10 has to be merged with the policy-map *p2* having sequence number 20, then the policy-map *p3* takes precedence over the other, as it has the lowest sequence number.

- If the same class (except for the default class) is configured under both the policies, the instance of that class (including all actions configured under it) in the second policy is ignored.
- If the default class under the first policy contains any actions other than any child policy actions, then that default class is added to the end of the merged policy. If it contains any child policy actions, then the default class from the second policy is added at the end of the merged policy.
- If a child policy is configured under the default class of both policies, the two child policies are merged using the rules above. The merged child policy is then applied as the child policy under the default class of the merged parent policy.
- If a child policy is configured under the default class of either the first or second policy (but not both), then it is applied (as it is) as the child policy under the default class of the merged policy. Child policies under classes other than the default class are never merged together.

**Note**

If the sequence numbers of two policies to be merged are configured to be the same, the order in which they are merged with respect to each other is random, and may change after the process restarts. Such configurations must be avoided.

Merge and Accounting Statistics for QoS Policies from the RADIUS Server

From Cisco IOS XR Software Release 6.2.25 and later, the service profiles defined and downloaded from the RADIUS server also have an option to set the merge and accounting statistics. Prior to this, the functionality was available only for the services defined locally in the BNG router through dynamic templates.

The Cisco AVP syntax for this feature is:

```
Cisco-Avpair += "ip:sub-qos-policy-in=<policy-name> merge <sequence number> acct-stat"
```

For example:

```
Cisco-Avpair += "ip:sub-qos-policy-in=example_policy merge 100 acct-stat"
```

Enabling Policy-maps Merge

Perform this task to enable merging of multiple QoS policy-maps applied through multiple dynamic templates.

SUMMARY STEPS

1. **configure**
2. **dynamic-template**
3. **type service *dynamic-template-name***

4. **service-policy** {**input** | **output** | **type**} *service-policy_name* [**acct-stats**] [**merge** *seq_num*]
5. Use the **commit** or **end** command.

DETAILED STEPS

	Command or Action	Purpose
Step 1	configure Example: RP/0/RSP0/CPU0:router# configure	Enters global configuration mode.
Step 2	dynamic-template Example: RP/0/RSP0/CPU0:router(config)# dynamic-template	Enters the dynamic-template configuration mode.
Step 3	type service <i>dynamic-template-name</i> Example: RP/0/RSP0/CPU0:router(config-dynamic-template)# type service s1	Creates a dynamic-template with a user-defined name for a service.
Step 4	service-policy { input output type } <i>service-policy_name</i> [acct-stats] [merge <i>seq_num</i>] Example: RP/0/RSP0/CPU0:router(config-dynamic-template-type)# service-policy input QoS1 merge 10 RP/0/RSP0/CPU0:router(config-dynamic-template-type)# service-policy output QoS2 merge 20	Associates a service-policy to the dynamic template, and enables merging of multiple QoS policies.
Step 5	Use the commit or end command.	commit —Saves the configuration changes and remains within the configuration session. end —Prompts user to take one of these actions: <ul style="list-style-type: none"> • Yes — Saves configuration changes and exits the configuration session. • No —Exits the configuration session without committing the configuration changes. • Cancel —Remains in the configuration session, without committing the configuration changes.

Enabling Policy-maps Merge: Examples

```
dynamic-template type service default-service
  service-policy input default-policy-in merge 100
  service-policy output default-policy-out merge 100
!
```

```

dynamic-template type service voip-service
  service-policy input voip-policy-in merge 20
  service-policy output voip-policy-out merge 30
!
dynamic-template type service vod-service
  service-policy input vod-policy-in merge 30
  service-policy output vod-policy-out merge 50
!
dynamic-template type service turbo-button-service
  service-policy input turbo-button-policy-in merge 10
  service-policy output turbo-button-policy-out merge 10
!
end

\\the following configuration explains the merging behavior of egress qos policies
policy-map type qos default-policy-out
  class class-default
    shape average 2 mbps
    bandwidth 512 kbps
    service-policy default-policy-child-out
  !
end-policy-map

policy-map type qos default-policy-child-out
  class critical-data
    bandwidth percent 90
    set cos 3
    queue-limit 500 ms
  !
  class best-effort-data
    shape average percent 50
    random-detect 100 ms 200 ms
    set cos 5
  !
  class class-default
    shape average percent 20
    set cos 7
  !
end-policy-map

policy-map type qos voip-policy-out
  class class-default
    service-policy voip-policy-child-out
  !
end-policy-map

policy-map type qos voip-policy-child-out
  class voip-control
    priority level 1
    set cos 2
  !
  class voip-data
    priority level 2
    set cos 2
    random-detect 100 ms 200 ms
  !
  class class-default
  !
end-policy-map

policy-map type qos vod-policy-out
  class class-default
    service-policy vod-policy-child-out
  !

```

```

end-policy-map

policy-map type qos vod-policy-child-out
  class vod-control
    priority level 1
    set cos 1
  !
  class vod-data
    priority level 2
    queue-limit 100 ms
  !
  class class-default
  !
end-policy-map

policy-map type qos turbo-button-policy-out
  class class-default
    shape average 10 mbps
    bandwidth 2 mpbs
  !
end-policy-map

```

\\after the default and voip services are enabled on a subscriber session

```

policy-map type qos <merged-policy-1>  !! Name is generated internally. This is just an
example.
  class class-default
    shape average 2 mbps
    bandwidth 512 kbps
    service-policy <merged-child-policy-1>
  !
end-policy-map

policy-map type qos <merged-child-policy-1>
  class voip-control
    priority level 1
    set cos 2
  !
  class voip-data
    priority level 2
    set cos 2
    random-detect 100 ms 200 ms
  !
  class critical-data
    bandwidth percent 90
    set cos 3
    queue-limit 500 ms
  !
  class best-effort-data
    shape average percent 50
    random-detect 100 ms 200 ms
    set cos 5
  !
  class class-default
    shape average percent 20
    set cos 7
  !
end-policy-map

\\after the turbo-button service is enabled

policy-map type qos <merged-policy-2>

```

```

class class-default
  shape average 10 mbps
  bandwidth 2 mbps
  service-policy <merged-child-policy-1> !! <merged-child-policy-1> is the same as before
since the
any child policy
!
!! the turbo-button-policy-out does not have
!! to be merged.

\\after the vod service is enabled

policy-map type qos <merged-policy-3>
class class-default
  shape average 10 mbps
  bandwidth 2 mbps
  service-policy <merged-child-policy-2>
!
end-policy-map

policy-map type qos <merged-child-policy-1>
class voip-control
  priority level 1
  set cos 2
!
class voip-data
  priority level 2
  set cos 2
  random-detect 100 ms 200 ms
!
class vod-control
  priority level 1
  set cos 1
!
class vod-data
  priority level 2
  queue-limit 100 ms
!
class critical-data
  bandwidth percent 90
  set cos 3
  queue-limit 500 ms
!
class best-effort-data
  shape average percent 50
  random-detect 100 ms 200 ms
  set cos 5
!
class class-default
  shape average percent 20
  set cos 7
!
end-policy-map

```

QoS Features Supported on BNG

BNG supports these QoS features:

Policing and Queuing Support

BNG provides ingress and egress traffic policers. BNG also supports pre-existing traffic policing mechanisms per subscriber session. 1R2C and 2R3C policers with marking actions is supported at parent-level in subscriber policies. Only absolute police rates are supported at the parent-level of subscriber policies. 1R2C and 2R3C policers with marking actions are supported at the child-level in subscriber policies. Both absolute and percentage based police rates are supported at child-level of subscriber policies.

BNG supports traffic shaping at the physical port level, at the subscriber session level, at the class level, and at the VLAN level only in egress direction. The system supports all pre-existing queuing actions for subscriber sessions. The configuration of minimum-bandwidth at the parent-level in subscriber policies is blocked. If subscriber policies do not have a queuing action, the traffic on those subscribers is still subjected to S-VLAN shaping and the traffic goes out through S-VLAN policy queues if those are present; if not, the traffic goes through the interface default-queue. The shaping or bandwidth-remaining queuing action is mandatory in flat S-VLAN policies. Only absolute shape rates is supported in S-VLAN flat policies and the parent-level of subscriber policies. However, only shaping and bandwidth-remaining queuing actions are supported in the parent-level of subscriber policies and all queuing actions are supported in the child-level of subscriber policies.

These additional queuing features are supported in egress policies applied on subscribers:

- A policy can have 1 P1, 1 P2, 1 P3 and 5 normal priority queues.
- A policy can have 1 P1, 2 P2 and 5 normal priority queues. P1 and P3 queues can be shared by multiple classes whereas P2 queues are never shared.

Default Marking

BNG supports all pre-existing classification and marking options supported for L3 interfaces for use with subscriber sessions. BNG also supports L3 marking to L2 marking mapping. BNG also supports ToS to CoS mapping at LAC for downstream PPPoE frames and provides mechanisms to mark 802.1p and IP TOS fields. The system allows flexible IP TOS marking for L2TP packets based on ingress subscriber qos policy. Marking is supported at the parent-level in subscriber policies and at the child-level in subscriber policies.

QoS Policy Modification

BNG supports in-service QoS policy-modification. Modification of subscriber-policy (through Radius), S-VLAN policy (through CLI) and port sub-rate policy (through CLI) are also supported.

When subscriber sessions applying these policies are in the progression towards the established state or being brought down, it is recommended to keep the subscriber-policy unchanged on the router.

L2 Encapsulation

For PPPoE subscribers, the L2 encapsulation size used in QoS rate calculations must be adjustable based on the last mile encapsulation (DSLAM to subscriber home) signaled in the PPPoE tags.

Classification

The BNG supports all pre-existing classification and marking options supported for L3 interfaces for use with subscriber sessions. BNG also supports ingress classification based on 802.1P values for single and double tagged COS, classification based on DSCP in either direction, classification based on L3/L4 ACLs in either direction, and classification of L2TPv2 traffic based on the outer DSCP marking.

The classification of an incoming L2TP packet on the ingress core side interface is always based on the outer IP fields even if the packet arrives with an MPLS tag stack.

Policy Inheritance

This table is relevant for egress direction only, as in ingress direction sub-rate policy and S-VLAN policy is not supported:

Port	S-VLAN	Subscriber
Sub-rate policy	No policy is configured. Inheritance limited to traffic getting shaped by port sub-rate policy. This is done irrespective of whether a policy is configured on the S-VLAN, or not.	Subscriber policy , if present, is executed first; then, traffic is subjected to port-shaper.
Sub-rate policy	Policy is configured. Inheritance limited to traffic that gets shaped by port sub-rate policy. This is done irrespective of whether a policy is configured on the S-VLAN or not.	Subscriber policy is executed first, if present, and then, S-VLAN policy is executed. Finally traffic is subjected to port-shaper.
HQoS or policy with more than class-default	Policy configuration is blocked and port policy is inherited.	Policy configuration is blocked and port policy inherited through the S-VLAN.
No policy configured	Policy is configured.	Subscriber policy is executed first, if present, and then S-VLAN policy is executed.

Subscriber with No QoS

When QoS is not configured on a subscriber, the parent S-VLAN, or on the port, subscriber traffic goes out using the default-queue of its parent's physical port.

- The subscriber is subjected to the S-VLAN policy and goes out using S-VLAN policy queues, if those are present. If the S-VLAN policy does not have its own queues, then all the S-VLAN traffic, including the subscriber's, goes out through the default queue of the physical interface.
- The subscriber is subject to a port policy, but no S-VLAN policy. Similar to the S-VLAN case, the subscriber traffic is subject to it and uses its queues.
- If a non-port-shaper policy is applied on the port, the application of policy on S-VLAN and subscriber is blocked. In such a scenario, subscriber traffic is subjected to the policy applied on the port.

Control Packet Handling

BNG provides priority treatment in handling PPP Link Control Protocol (LCP) packets. The control packets are handled in high priority without the need of user configuration, and these packets are not subjected to QoS policies that are applied on both ingress and egress of the interface. In the case of LAC upstream direction, if user wants a trusted COS value, then a PPP command is provided to impose the core-side header based on the set trusted-COS. Thus, this ensures the priority treatment of these control packets in the network.

S-VLAN Shaping and Statistics

In the egress direction, the BNG supports the ability to have policies at three different levels: the subscriber interface level, the stacked virtual local area network (S-VLAN), and at the port level. The egress S-VLAN

and port-level policies are applied through CLI directly at the interface level. For applying a QoS policy on S-VLAN, see [Configuring Policy on S-VLAN, on page 299](#)

The subscriber policy can only be applied through a dynamic template or via RADIUS. The egress subscriber policy can be a two-level policy. The S-VLAN and port-level policies can only be flat policies, with only the class default, with the only action being a shaped rate. Essentially it provides a means to constrain the S-VLAN or port to a maximum rate via shaping.

In the ingress direction, the traffic is only subject to the subscriber input policy where the subscriber policies are applied through RADIUS or dynamic-template.

The traffic through the S-VLAN includes traffic to many subscribers that may have already been shaped by the subscriber policies. Providing statistics on that S-VLAN shaper is important in order to monitor whether it is reaching the maximum capacity. Unlike the subscriber QoS policies, the HW does not have the ability to directly track the usage or transmitted packets/bytes through this S-VLAN shaper. So unlike other statistics, the BNG provides the S-VLAN QoS policy-related statistics by aggregating the statistics of the underlying subscriber policies. The statistics are displayed via show commands (and MIBs as appropriate) consistent with all other interface types.

S-VLAN supports these conditions:

- Modification of QoS rates.
- Modification of S-VLAN policy to change number of levels in the policy is rejected.
- Modification of two-level S-VLAN policy to add or remove child-level classes is rejected.
- Modification of classification criteria in child-level classes, in two-level policy, is rejected.
- Addition or removal of actions, in both two-level and flat policy, is rejected.

QoS Attachment Points

This table lists the QoS attachment points, and modes for definition and application.

QoS Attachment Point	Definition	Application	Type of Policy
Port (sub-rate policy)	CLI/XML	CLI/XML	Flat – class-default only
S-VLAN	CLI/XML	CLI/XML	Flat – class-default only. 2 level, with parent class-default only and child any classification.
Subscriber	CLI/XML	Dynamic-Template	2 level, with parent class-default only and child any classification.
Subscriber	CLI/XML	RADIUS	2 level, with parent class-default only and child any classification.

QoS Attachment Point	Definition	Application	Type of Policy
Subscriber	RADIUS (parameterized QoS)	RADIUS	2 level, with parent class-default only and child any classification.

Un-supported configurations will not be blocked. In S-VLAN policies and subscriber policies, any configuration other than the ones listed in these tables will be blocked:

Table 14: Supported Configuration in Ingress Direction

	Classification	Action	Rates
Subscriber Parent Level Policy	Class-default only	police, marking	Absolute only
Subscriber Child Level Policy	Any, with baseline restrictions	police, marking	Absolute and percent

Table 15: Supported Configurations in Egress Direction

	Classification	Action	Rates
S-VLAN Flat Policy	Class-default only	Any, with mandatory shape action	Absolute only
S-VLAN Parent Level Policy	Class-default only	Any, with mandatory shape action	Absolute only
S-VLAN Child Level Policy	Any, with baseline restrictions	Any	Absolute and percent
Subscriber Parent Level Policy	Class-default only	shape, bandwidth remaining, police, marking	Absolute only
Subscriber Child Level Policy	Any, with baseline restrictions	Any	Absolute and percent

VLAN Policy on Access Interface

BNG supports ingress and egress VLAN policies on an access-interface. Unlike as in the case of S-VLAN (subscriber-parent) policy, the access-interface VLAN policy is not inherited by the session policy. The VLAN policy does not provide reference bandwidth to session policies. The VLAN policy statistics does not include session policy statistics. Only the access-interface traffic is subjected to the VLAN policy.

For details, see [Configuring VLAN Policy on an Access Interface, on page 300](#).

This table summarizes the support for VLAN and S-VLAN policies in ingress and egress directions:

Policy Direction	V-LAN policy (without subscriber-parent keyword)	S-VLAN policy(with subscriber-parent keyword)
Ingress	Supported	Not supported

Policy Direction	V-LAN policy (without subscriber-parent keyword)	S-VLAN policy(with subscriber-parent keyword)
Egress	Supported	Supported

Restrictions

These restrictions apply to the VLAN policy on the access-interface, when used without the **subscriber-parent** keyword:

- The VLAN policy needs to be attached to the access-interfaces, before bringing up the sessions with QoS policies.
- The restrictions specified for the in-place modification of S-VLAN policy, are applicable to VLAN policy as well. For instance, the in-place modification for the VLAN policy supports only rate-changes. This restriction also applies in adding a policer or shaper and in changing the policy-map to include more classes.

Configuring Policy on S-VLAN

Perform this task to apply a QoS policy on a S-VLAN.



Note

- S-VLAN policy has to be provisioned before any policies are installed on subscribers.
- Application of S-VLAN policy is rejected, if policies are already installed on subscribers.
- Removal of S-VLAN policy is rejected, if subscriber policies are present under that S-VLAN.

SUMMARY STEPS

1. **configure**
2. **interface** *type*
3. **service-policy output** *name* **subscriber-parent**
4. Use the **commit** or **end** command.

DETAILED STEPS

	Command or Action	Purpose
Step 1	configure Example: RP/0/RSP0/CPU0:router# <code>configure</code>	Enters global configuration mode.
Step 2	interface <i>type</i> Example: RP/0/RSP0/CPU0:router(config)# <code>interface Bundle-Ether1.1</code>	Configures the subscribers on the Bundle-Ether access interface.

	Command or Action	Purpose
Step 3	service-policy output <i>name</i> subscriber-parent Example: <pre>RP/0/RSP0/CPU0:router(config-if)# service-policy output svlan subscriber-parent</pre>	Configures the s-vlan policy with the subscriber-parent keyword.
Step 4	Use the commit or end command.	commit —Saves the configuration changes and remains within the configuration session. end —Prompts user to take one of these actions: <ul style="list-style-type: none"> • Yes — Saves configuration changes and exits the configuration session. • No —Exits the configuration session without committing the configuration changes. • Cancel —Remains in the configuration session, without committing the configuration changes.

Configuring Policy on S-VLAN: An example

```
configure
interface Bundle-Ether1.1
service-policy output svlan_pmap subscriber-parent
end
!
```

Configuring VLAN Policy on an Access Interface

Perform this task to apply an ingress and egress QoS VLAN policy on an access interface.

SUMMARY STEPS

1. **configure**
2. **interface** *type*
3. **service-policy input** *service-policy-name*
4. **service-policy output** *service-policy-name*
5. Use the **commit** or **end** command.

DETAILED STEPS

	Command or Action	Purpose
Step 1	configure Example:	Enters global configuration mode.

	Command or Action	Purpose
	RP/0/RSP0/CPU0:router# configure	
Step 2	interface <i>type</i> Example: RP/0/RSP0/CPU0:router(config)# interface Bundle-Ether18.203	Configures subscribers on the Bundle-Ether access interface.
Step 3	service-policy input <i>service-policy-name</i> Example: RP/0/RSP0/CPU0:router(config-subif)# service-policy input mark	Configures the ingress VLAN QoS policy on the access-interface.
Step 4	service-policy output <i>service-policy-name</i> Example: RP/0/RSP0/CPU0:router(config-subif)# service-policy output metering	Configures the egress VLAN QoS policy on the access-interface.
Step 5	Use the commit or end command.	commit —Saves the configuration changes and remains within the configuration session. end —Prompts user to take one of these actions: <ul style="list-style-type: none"> • Yes — Saves configuration changes and exits the configuration session. • No —Exits the configuration session without committing the configuration changes. • Cancel —Remains in the configuration session, without committing the configuration changes.

Configuring Ingress and Egress VLAN Policies on an Access Interface: Example

```
//Attaching Ingress and Egress VLAN Policies on an Access Interface
```

```
configure
interface Bundle-Ether1.1
service-policy input INGRESS_MARKING_POLICING_POLICY
service-policy output VLAN_POLICY
end
!
```

```
//Attaching Ingress VLAN Policy and Egress S-VLAN Policies on an Access Interface
```

```
configure
interface Bundle-Ether1.2
service-policy input INGRESS_MARKING_POLICING_POLICY
```

```

service-policy output S_VLAN_POLICY subscriber-parent
end
!
```

Multiple Class Support for Ingress Policing for Subscribers

From Cisco IOS XR Software Release 6.2.1 and later, BNG supports multiple classes at root level for subscriber policing in ingress direction. This enhancement helps to group subscriber traffic with specific CoS (Class of Service) value and apply separate policing for such traffic, thereby optimizing the traffic flow and priority management.

Restrictions

Multiple class support for ingress policing for subscribers is subjected to these restrictions:

- It is supported only in ingress direction
- Subscriber traffic is split at the interface level and hence, there is no aggregate policing for the entire traffic from the subscriber.

Configuration Example

```

/* Input policy-map applied to bundle-ether interface */
policy-map
parent_policy_ingress_10mb
  class CLASS_IN_1
    service-policy SET_EXP_INGRESS
    police rate 1 mbps
  !
  class CLASS_IN_2
    service-policy SET_EXP_INGRESS
    police rate 10 mbps
  !
  class class-default
  !

class-map match-any CLASS_IN_1:
  match cos 0 1
class-map match-any CLASS_IN_2:
  match cos 2 3 4 5 6 7

policy-map SET_EXP_INGRESS:
  class COS0
    set mpls experimental topmost 0
  class COS1
    set mpls experimental topmost 1
  class COS2
    set mpls experimental topmost 2
  class COS3
    set mpls experimental topmost 3
  class COS4
    set mpls experimental topmost 4
  class COS5
    set mpls experimental topmost 5
  class COS6
    set mpls experimental topmost 6
```

```

class COS7
  set mpls experimental topmost 7
class class-default
!
!

```

In this example, traffic with CoS 0 and 1 are grouped and get policed at 1Mbps; traffic with CoS 2,3,5 and 6 are grouped and get policed at 4Mbps; traffic with CoS 4 and 7 get classified to "class-default" and get policed at 10Mbps. There is no aggregate policing of all traffic from the subscriber at 10Mbps.

Group-based Grandparent Shaping

Group-based grandparent shaping feature in BNG is a functionality where subscribers are grouped and attached to an aggregate shaper based on a logical group-ID. The BNG router receives the group-ID in the Access-Accept message sent from the RADIUS server. This feature helps to provide a flexible load balancing in BNG routers. Prior to this functionality, the grouping was based on the access-interface. This feature provides aggregate shaping on a per-VLAN basis, even though the access-interface is not per VLAN (that is, access-interface is ambiguous).

The Cisco AV Pair associated with this feature is:

```
Cisco-avpair = "subscriber:sub-qos-group-identifier=<string>"
```

To enable this feature, use the **subscriber-group** option in the **service-policy output** command in interface configuration mode.

Configuration Example

```

Router#config
Router(config)#interface Bundle-Ether1.1234
Router(config-if)#encapsulation ambiguous dot1q 1-4
Router(config-if)#service-policy output P0 subscriber-parent subscriber-group G0
Router(config-if)#service-policy output P1 subscriber-parent subscriber-group G1
Router(config-if)#service-policy output P2 subscriber-parent subscriber-group G2
Router(config-if)#service-policy output P3 subscriber-parent subscriber-group G3

```

Here, subscriber is grouped and attached to an aggregate shaper based on a logical group-ID, and not on the subscriber VLAN.

Subscriber Group-based LAG Load Balancing

For interfaces with multiple members, BNG programs resources on each member link of the bundle. The traffic towards the subscriber is load balanced on these member links. Because subscribers belonging to the same group is load balanced to different member links, it is not feasible to have aggregate shaping per group. In order to overcome this limitation, the traffic from subscribers within the same group is pinned to one of the active member links.

BNG plays a role in the member link selection. If *member-hash* is present in the user profile, the AV Pair sent by the RADIUS server will be of this format:

```
Cisco-avpair += "subscriber:member-hash=<hash-value>"
```

If *member-hash* is not present in the user profile, it is auto-derived from the group-ID (*sub-qos-group-identifier*) returned by the RADIUS server in the Access-Accept message. This value is then injected into the subscriber configuration.

The *member-hash* works only for Bundle-Ethernet interfaces; not for pseudowire head end (PWHE) interfaces.

Restrictions for Group-based Load Balancing

Group-based load balancing is subjected to these restrictions:

- Policies with **subscriber-group** do not support **resource-id**.
- You cannot configure a normal policy (without subscriber group) on the same access-interface where a policy with **subscriber-group** is already configured. To add a policy without subscriber group, you must remove all group-based policies on that access interface.
- If groups are configured, the subscriber without group-ID cannot establish on the default queue, and that subscriber is rejected.
- Group-ID change through CoA is not supported. The subscriber has to disconnect and re-connect to use any new Group-Id.
- Only 32 groups are supported for each Traffic Manager (TM) to achieve a full scale of 32K per TM.

Subscriber QoS on Main Interface

From Cisco IOS XR Software Release 6.3.2 and later, Cisco ASR 9000 Series BNG routers support subscriber QoS on main interface. Prior to this, subscriber QoS was supported only on VLAN sub-interfaces. This feature offers a better QoS resource management, which in turn provides an increased subscriber scale support (along with QoS shaper for each traffic manager) over physical line card-based interfaces. This feature is available on Cisco ASR 9000 High Density 100GE Ethernet line cards, and is supported only on Cisco IOS XR 64-bit operating system.

Subscriber QoS Resource Management

Cisco ASR 9000 Series Routers have a traffic manager (TM) that handles QoS shaping and queuing. The TM holds all resources for queuing the infrastructure at the child level (that is, class level), parent level (that is, subscriber shaper level) and at the grandparent level (that is, the VLAN or the main interface level). The TM is divided into 4 segments with 8000 parent shapers (subscriber shapers) each. When a new access-interface is configured to terminate BNG sessions, one of those 4 segments is dynamically assigned to that interface. When 2 interfaces share the same resource segments, they also share the queuing resources. With the introduction of subscriber QoS resource management functionality, you can have a better control on the segment allocation for an access-interface.

Prior to introducing this feature, a larger scale (with egress shaping for each TM) over VLAN-tagged interfaces, was achieved by using resource-ID feature. In that case, a parent class-default queue (at level-2) is allocated on each chunk of the TM within a given NP. But, on a physical LC-based interface, the mapping between the NP, the TM and the chunk is fixed, by default. Also, the resource-ID feature does not take effect on physical interfaces. So, the existing group-ID feature is enhanced, in order to support a larger scale for each TM over physical LC-based interfaces.

Configure Subscriber QoS on Main Interface

To configure subscriber QoS on main interface and to achieve higher scale configuration, the existing group-ID feature configuration is used along with new reserved keywords such as **resourceid0**, **resourceid1**, **resourceid2** and **resourceid3**. These reserved keywords act as the group-IDs of the subscriber.

**Note**

- Reserved group-ID values are supported only on physical LC-based interfaces. On other interface types, these group-IDs would function the way it is that allows aggregate shaping for each sub-interface.
- The policy-maps applied along with the reserved subscriber-group ID values on the physical interface must be the same for each line card. This helps to maintain the subscriber's parent bandwidth across high availability scenarios.

Configuration Example

```
Router#configure
Router(config)#interface GigabitEthernet 0/1/0/10
Router(config-if)#service-policy output parent_policy subscriber-parent subscriber-group
resourceid0
Router(config-if)#service-policy output parent_policy subscriber-parent subscriber-group
resourceid1
Router(config-if)#service-policy output parent_policy subscriber-parent subscriber-group
resourceid2
Router(config-if)#service-policy output parent_policy subscriber-parent subscriber-group
resourceid3
```

Running Configuration

```
interface GigabitEthernet 0/1/0/10
service-policy output parent_policy subscriber-parent subscriber-group resourceid0
service-policy output parent_policy subscriber-parent subscriber-group resourceid1
service-policy output parent_policy subscriber-parent subscriber-group resourceid2
service-policy output parent_policy subscriber-parent subscriber-group resourceid3
!
```

Related Topics

- [Subscriber QoS on Main Interface, on page 304](#)
- [Group-based Grandparent Shaping, on page 303](#)

Associated Commands

- [service-policy \(QoS-BNG\)](#)

Additional References

These sections provide references related to implementing QoS.

MIBs

MB	MIBs Link
	<p>To locate and download MIBs for selected platforms, Cisco IOS releases, and feature sets, use Cisco MIB Locator found at the following URL:</p> <p>http://www.cisco.com/go/mibs</p>

Technical Assistance

Description	Link
<p>The Cisco Support website provides extensive online resources, including documentation and tools for troubleshooting and resolving technical issues with Cisco products and technologies.</p> <p>To receive security and technical information about your products, you can subscribe to various services, such as the Product Alert Tool (accessed from Field Notices), the Cisco Technical Services Newsletter, and Really Simple Syndication (RSS) Feeds.</p> <p>Access to most tools on the Cisco Support website requires a Cisco.com user ID and password.</p>	<p>http://www.cisco.com/cisco/web/support/index.html</p>



CHAPTER 7

Configuring Subscriber Features

Subscriber features that are configured on BNG enable service providers to deploy certain specific functionalities like restricting the use of certain network resources, allowing Law Enforcement Agencies (LEAs) to conduct electronic surveillance, providing multicast services to the subscriber, and so on.

Table 16: Feature History for Configuring Subscriber Features

Release	Modification
Release 6.0.1	Added activating IPv6 router advertisement on an IPv4 subscriber interface enhancements
Release 6.0.1	Added Linking to Subscriber Traffic in a Shared Policy Instance Group feature
Release 6.2.1	These new features were introduced: <ul style="list-style-type: none">• IGMP QoS Correlation for IPoE Subscribers• SNMP Lawful Intercept Using Circuit-Id• Controlling Subscriber Plans Using Protocol Options
Release 6.3.1	Added HTTP Redirect URL with Subscriber Information feature.
Release 6.5.1	These new features were introduced: <ul style="list-style-type: none">• HTTP-Redirect Support for Static sessions• HTTP Header Enrichment for BNG Subscribers
Release 6.6.3	Introduced these new features: <ul style="list-style-type: none">• Header enrichment on pseduowire headend with subscriber redundancy group support.• HTTP redirect on pseduowire headend with subscriber redundancy group support.

The subscriber features covered in this chapter are:

- [Excessive Punt Flow Trap, on page 308](#)

- [Access Control List and Access Control List-based Forwarding, on page 314](#)
- [Support for Lawful Intercept, on page 318](#)
- [TCP MSS Adjustment, on page 327](#)
- [Linking to Subscriber Traffic in a Shared Policy Instance Group, on page 330](#)
- [Subscriber Session on Ambiguous VLANs , on page 331](#)
- [uRPF, on page 337](#)
- [Multicast Services, on page 337](#)
- [DAPS Support, on page 350](#)
- [HTTP Redirect Using PBR, on page 361](#)
- [HTTP-Redirect Support for Static Sessions, on page 378](#)
- [HTTP Header Enrichment for BNG Subscribers, on page 380](#)
- [Idle Timeout for IPoE and PPPoE Sessions, on page 384](#)
- [Routing Support on Subscriber Sessions , on page 384](#)
- [Traffic Mirroring on Subscriber Session, on page 386](#)
- [Randomization of Interim Timeout of Sessions or Services, on page 388](#)
- [Controlling Subscriber Plans Using Protocol Options, on page 389](#)
- [Additional References, on page 390](#)

Excessive Punt Flow Trap

The Excessive Punt Flow Trap feature attempts to identify and mitigate control packet traffic from remote devices that send more than their allocated share of control packet traffic. A remote device can be a subscriber device, a device on a VLAN interface, or a device identified by its source MAC address.

When remote devices send control packet traffic to the router, the control packets are punted and policed by a local packet transport service (LPTS) queue to protect the router's CPU. If one device sends an excessive rate of control packet traffic, the policer queue fills up, causing many packets to be dropped. If the rate from one "bad actor" device greatly exceeds that of other devices, most of the other devices do not get any of their control packets through to the router. The Excessive Punt Flow Trap feature addresses this situation.



Note Even when the Excessive Punt Flow Trap feature is not enabled, the "bad actors" can affect services for only other devices; they cannot bring down the router.

The Excessive Punt Flow Trap feature is supported on both subscriber interfaces, and non-subscriber interfaces such as L2 and L3 VLAN sub-interfaces and bundle virtual interfaces (BVIs). If the source that floods the punt queue with packets is a device with an interface handle, then all punts from that bad actor interface are penalty policed. The default penalty rate, for each protocol, is 10 protocols per second (pps). Otherwise, if the source is a device that does not have an interface handle, then all packets from this bad actor are dropped.



Note In the 4.2.x releases, the Excessive Punt Flow Trap feature was called as "Subscriber Control Plane Policing (CoPP)" that only operated on subscriber interfaces.

Functioning of Excessive Punt Flow Trap Feature

The Excessive Punt Flow Trap feature monitors control packet traffic arriving from physical interfaces, sub-interfaces, BVI, and subscriber interfaces. It divides interfaces into two categories:

- "Parent" interfaces, which can have other interfaces under them.
- "Non-parent" interfaces, which have no interfaces under them.

A physical interface is always a parent interface because it has VLAN sub-interfaces. An L3 VLAN sub-interface can either be a parent or a non-parent interface. If the VLAN sub-interface is enabled for subscribers, then it is a parent interface, otherwise it is a non-parent interface. A subscriber interface (IPoE or PPPoE) is always a non-parent interface.

When a flow is trapped, the Excessive Punt Flow Trap feature tries to identify the source of the flow. The first thing it determines is from which interface the flow came. If this interface is not a "parent" interface, then the feature assumes that it is the end-point source of the flow and penalty policing is applied. The software applies a penalty-policer in the case of a BVI interface also. If the trapped interface is a "parent" interface, then instead of penalizing the entire interface (which would penalize all the interfaces under it), this feature takes the source MAC address of the bad flow and drops all packets from the MAC address under the parent. Due to platform limitation, the penalty policer cannot be applied on a MAC address; therefore all packets are dropped.

For more information about enabling the Excessive Punt Flow Trap feature, see [Enabling Excessive Punt Flow Trap Processing, on page 312](#).



Note The Excessive Punt Flow Trap feature monitors all punt traffic. There is no way to remove a particular interface from the initial monitoring, nor can an interface be prevented from being flagged as bad if it is the source of excessive flows.

Bad actors are policed for each protocol. The protocols that are supported by the Excessive Punt Flow Trap feature are Broadcast, Multicast, ARP, DHCP, PPP, PPPoE, ICMP, IGMP, L2TP and IP (covers many types of L3 based punts, both IPv4 and IPv6). Each protocol has a static punt rate and a penalty rate. For example, the sum total of all ICMP punts from remote devices is policed at 1500 packets per second (pps) to the router's CPU. If one remote device sends an excessive rate of ICMP traffic and is trapped, then ICMP traffic from that bad actor is policed at 10 pps. The remaining (non-bad) remote devices continue to use the static 1500 pps queue for ICMP.



Note The excessive rate required to cause an interface to get trapped has nothing to do with the static punt rate (e.g. 1500 pps for ICMP). The excessive rate is a rate that is significantly higher than the current average rate of other control packets being punted. The excessive rate is not a fixed rate, and is dependent on the current overall punt packet activity.

Once a bad actor is trapped, it is penalty policed on all its punted protocols (ARP, DHCP, PPP, etc.), irrespective of the protocol that caused it to be identified as a bad actor. A penalty rate of 10 pps is sufficient to allow the other protocols to function normally. However, if the bad actor is trapped by source MAC address, then all its packets are dropped.

When an interface is trapped, it is placed in a "penalty box" for a period of time (a default of 15 minutes). At the end of the penalty timeout, it is removed from penalty policing (or dropping). If there is still an excessive rate of control packet traffic coming from the remote device, then the interface is trapped again.

Restrictions

These restrictions apply to implementing Excessive Punt Flow Trap feature:

- The A9K-8x100G-LB-SE and A9K-8x100G-LB-TR line cards do not support BNG subscriber interfaces.
- This feature does not support interfaces on SIP-700 line cards and ASR 9000 Ethernet Line Card.
- This feature is non-deterministic. In some cases, the Excessive Punt Flow Trap feature can give a false positive, i.e. it could trap an interface that is sending legitimate punt traffic.
- The Excessive Punt Flow Trap feature traps flows based on the relative rate of different flows; thus, the behavior depends on the ambient punt rates. A flow that is significantly higher than other flows could be trapped as a bad actor. Thus the feature is less sensitive when there are many flows, and more sensitive when there are fewer flows present.
- Sometimes control packet traffic can occur in bursts. The Excessive Punt Flow Trap has safeguards against triggering on short bursts, but longer bursts could trigger a false positive trap.

MAC-based EPFT on Non-subscriber Interface

This feature supports dropping of the excessive punt packets from a bad actor flow, based on the source MAC address. Prior to Cisco IOS XR Release 5.3.1, EPFT on non-subscriber interfaces was only performed based on the *ifhandle* (interface handle) of the VLAN sub-interface, wherein all the ingress punt packets on the VLAN sub-interface are penalty policed, irrespective of their source MAC addresses.

In an aggregation scenario, packets may come from multiple source MAC addresses to a VLAN sub-interface. If one particular source MAC sends excessive punt packets, it drains the punt queue; punt packets of other source MAC addresses on that non-subscriber interface may get dropped. MAC-based EPFT on the non-subscriber interface feature performs EPFT (that is, it drops the packets) based on a source MAC address, if the flow is a bad actor flow sending excessive punt packets.

To enable MAC-based EPFT on non-subscriber interface, you must use this command in global configuration mode:

```
lpts punt excessive-flow-trap non-subscriber-interfaces [mac]
```



Note If the **mac** option is not configured, the default behavior is to perform EPFT, based on the *ifhandle* of the non-subscriber interface.

Tunable Sampler Parameters for Control Plane Policing

This feature allows configuring various EPFT sampler parameters to fine-tune the Elephant Trap algorithm, to achieve the best behavior for realistic traffic streams, and to reduce situations like false positives to a great extent. Before this release, these parameter values were fixed and read from a configuration file.

The commands available for this feature are privileged (Cisco-support) commands.

This table lists configurable EPFT sampler parameters:

EPFT Sampler Parameter	Description
Elephant Trap size	The maximum number of flows that is concurrently stored in Elephant Trap. The range is from 1 to 128; default is 64. The value must be a power of 2, that is 1, 2, 4, 8, 16, 32, 64 and 128 are the valid values.
Sampling probability	Sampling probability of Elephant Trap; that is, the probability value to sample any particular packet and feed it into the trap. This is a floating point number ranging from 0 to 1 enclosed in double quotes (""). By default, the value is "0.01", which means that 1 out of 100 packets is randomly picked for sampling.
Report threshold	Threshold at which a flow is reported as a bad actor. The range is from 1 to 65535; default is 5.
Eviction threshold	Threshold below which a flow can be evicted from the Elephant Trap. The range is from 1 to 65535; default is 2.
Eviction search limit	Maximum number of entries to check before cancelling an eviction search. The range is from 1 to 128; default is 64. Eviction search limit must not be more than the Elephant Trap size.
Maximum flow gap	The maximum time, in milliseconds, that the Elephant Trap allows between successive samples while incrementing the hit counter. The range is from 1 to 60000; default is 800.

False Positive Suppression

Due to the probabilistic nature of the Elephant Trap algorithm, there is possibility of good flows being trapped as bad flows. This probability is more in scenarios where the number of flows is less. Such false positives can be suppressed using these features:

- **Support of tunable sampler parameters for control plane policing**

For details, see [Tunable Sampler Parameters for Control Plane Policing](#), on page 310.

- **False positive suppression through dampening**

This feature allows trapping only repeated bad actor flows. The Flowtrap process maintains a trap similar to the Elephant Trap that stores information about each flow for which the bad actor notification is received by the sampler process. The bad actor notifications for penalty policing the flow, or dropping the packets from the flow, is carried out only if the notification is received twice within a specified time (a configurable time in seconds). Although it extends the duration before which a true bad actor is throttled, it also reduces false positives.

By default, the dampening feature is disabled. To enable this feature, you must use this command in global configuration mode:

```
lpts punt excessive-flow-trap dampening [time]
```

The range of *time* (in milliseconds) is from 1 to 60000. If the *time* option is not used after the **dampening** keyword, a default time value of 30 is used.

EPFT Support for Packet-Triggered Sessions

Before Cisco IOS XR Software Release 5.3.0, punt packets on a packet-triggered subscriber-interface and on a packet-triggered access-interface were policed as per the LPTS rates. The policing rate earlier was high (2000 packets per second) and system wide. With EPFT support for packet triggered sessions, punt packets on packet-triggered interfaces (subscriber and access) go through EPFT node. If identified as bad actor flows, they are penalty-policed according to the EPFT penalty rates (only 20 to 200 packets per second). This is the default behavior from Cisco IOS XR Software Release 5.3.0 and later.

This feature is enabled by default (users need not explicitly configure any command to enable this feature). However, you can use these commands to set the **penalty-rate** and **penalty-timeout** for punt packets of **unclassified-source** type:

lpts punt excessive-flow-trap penalty-rate unclassified rate

The range of rate (in pps - packets per second) is from 2 to 100, the default is 10.

lpts punt excessive-flow-trap penalty-timeout unclassified timeout

The range of timeout (in minutes) is from 1 to 1000, the default is 15.

Interface-based Flow

For the Elephant Trap sampler, the MAC address is one of the key fields used to uniquely identify a flow. Certain cases of DoS attacks have dynamically changing source MAC addresses. An individual flow does not cross the threshold in such cases, and hence the EPFT does not trap the flow. With the interface-based flow feature, Elephant Trap does not consider MAC addresses as a key for uniquely identifying a flow. Hence, all packets received on a non-subscriber interface (irrespective of the source MAC address) are considered to be a part of a single flow. When excessive punts are received on the interface, EPFT does *ifhandle*-based trap, thereby penalty policing the punt traffic on that particular interface.

To enable interface-based flow, you must use this command in global configuration mode:

lpts punt excessive-flow-trap interface-based-flow



Note You cannot enable this command if EPFT is turned on for the subscriber-interfaces and non-subscriber-interfaces MAC, or vice versa. This is because interface-based flow feature is mutually exclusive with MAC-based EPFT on non-subscriber interface feature.

Enabling Excessive Punt Flow Trap Processing

Perform this task to enable the Excessive Punt Flow Trap feature for both subscriber and non-subscriber interfaces. The task also enables you to set the penalty policing rate and penalty timeout for a protocol.

SUMMARY STEPS

1. **configure**

2. **lpts punt excessive-flow-trap subscriber-interfaces**
3. **lpts punt excessive-flow-trap non-subscriber-interfaces**
4. **lpts punt excessive-flow-trap penalty-rate *protocol penalty_policer_rate***
5. **lpts punt excessive-flow-trap penalty-timeout *protocol time***
6. Use the **commit** or **end** command.

DETAILED STEPS

	Command or Action	Purpose
Step 1	configure Example: RP/0/RSP0/CPU0:router# configure	Enters global configuration mode.
Step 2	lpts punt excessive-flow-trap subscriber-interfaces Example: RP/0/RSP0/CPU0:router(config)# lpts punt excessive-flow-trap subscriber-interfaces	Enables the Excessive Punt Flow Trap feature on subscriber interfaces.
Step 3	lpts punt excessive-flow-trap non-subscriber-interfaces Example: RP/0/RSP0/CPU0:router(config)# lpts punt excessive-flow-trap non-subscriber-interfaces	Enables the Excessive Punt Flow Trap feature on non-subscriber interfaces. Note If both Step 2 and Step 3 configurations are applied, the Excessive Punt Flow Trap feature is enabled for all interfaces.
Step 4	lpts punt excessive-flow-trap penalty-rate <i>protocol penalty_policer_rate</i> Example: RP/0/RSP0/CPU0:router(config)# lpts punt excessive-flow-trap penalty-rate icmp 10	Sets the penalty policing rate for a protocol. The penalty policer rate is in packets-per-second (pps) and ranges from 2 to 100. Note The penalty policing rate for a protocol consumes a policer rate profile.
Step 5	lpts punt excessive-flow-trap penalty-timeout <i>protocol time</i> Example: RP/0/RSP0/CPU0:router(config)# lpts punt excessive-flow-trap penalty-timeout igmp 10	Sets the penalty timeout value, which is a period of time that the interface trapped is placed in the penalty box, for a protocol. The penalty timeout value is in minutes and ranges from 1 to 1000. The default penalty timeout value is 15 minutes.
Step 6	Use the commit or end command.	commit —Saves the configuration changes and remains within the configuration session. end —Prompts user to take one of these actions: <ul style="list-style-type: none"> • Yes — Saves configuration changes and exits the configuration session. • No —Exits the configuration session without committing the configuration changes.

	Command or Action	Purpose
		<ul style="list-style-type: none"> • Cancel —Remains in the configuration session, without committing the configuration changes.

Enabling Excessive Punt Flow Trap Processing: Examples

This is an example for enabling the Excessive Punt Flow Trap for subscriber interfaces, using the default penalty timeout (15 minutes) and setting a penalty rate of 20 pps for PPP and PPPoE protocols.

```
configure
lpts punt excessive-flow-trap subscriber-interfaces
lpts punt excessive-flow-trap penalty-rate ppp 20
lpts punt excessive-flow-trap penalty-rate pppoe 20
end
!!
```

This is an example for enabling the Excessive Punt Flow Trap for non-subscriber interfaces, using the default penalty rate (10 pps) and setting the ARP penalty timeout to 2 minutes.

```
configure
lpts punt excessive-flow-trap non-subscriber-interfaces
lpts punt excessive-flow-trap penalty-timeout arp 2
end
!!
```

Access Control List and Access Control List-based Forwarding

An Access Control List (ACL) is used to define access rights for a subscriber. It is also used for filtering content, blocking access to various network resources, and so on.

Certain service providers need to route certain traffic be routed through specific paths, instead of using the path computed by routing protocols. For example, a service provider may require that voice traffic traverse through certain expensive routes, but data traffic to use the regular routing path. This is achieved by specifying the next-hop address in the ACL configuration, which is then used for forwarding packet towards its destination. This feature of using ACL for packet forwarding is called ACL-based Forwarding (ABF).

The ACL is defined through CLI or XML; however, it can be applied to a subscriber session either through a dynamic-template, or through VSAs from RADIUS. Deploying ABF (using ACL) involves these stages:

- Defining an ACL, see [Configuring Access-Control Lists, on page 315](#).
- Applying the ACL to an access-interface, see [Activating ACL, on page 316](#).



Note ACL is not supported for LAC sessions.

Configuring Access-Control Lists

Perform this task to create an access control list. As an example, this access list is created to deploy ABF; therefore, it defines the next hop address.

SUMMARY STEPS

1. **configure**
2. **{ipv4 | ipv6} access-list** *access-list-name*
3. *sequence-number* **permit tcp any any**
4. *sequence-number* **permit {ipv4 | ipv6} host** *source_address* **nexthop** *source_address* *destination_address*
5. Use the **commit** or **end** command.

DETAILED STEPS

	Command or Action	Purpose
Step 1	configure Example: RP/0/RSP0/CPU0:router# configure	Enters global configuration mode.
Step 2	{ipv4 ipv6} access-list <i>access-list-name</i> Example: RP/0/RSP0/CPU0:router(config)# ipv4 access-list foo_in OR RP/0/RSP0/CPU0:router(config)# ipv6 access-list foo_in	Configures the access-list.
Step 3	<i>sequence-number</i> permit tcp any any Example: RP/0/RSP0/CPU0:router(config)# 10 permit tcp any any	Enters an access control list rule to tcp traffic.
Step 4	<i>sequence-number</i> permit {ipv4 ipv6} host <i>source_address</i> nexthop <i>source_address</i> <i>destination_address</i> Example: RP/0/RSP0/CPU0:router(config)# 10 permit ipv4 host 9.8.8.9 nexthop 6.6.6.6 7.7.7.7 OR RP/0/RSP0/CPU0:router(config)# 10 permit ipv6 host 192:2:1:9 nexthop 192:2:6:8	Specifies packets to forward on ipv4 protocol from source IP address to destination IP address. Note Repeat steps 1 to 4 to configure the foo_out access-list.

	Command or Action	Purpose
Step 5	Use the commit or end command.	<p>commit —Saves the configuration changes and remains within the configuration session.</p> <p>end —Prompts user to take one of these actions:</p> <ul style="list-style-type: none"> • Yes — Saves configuration changes and exits the configuration session. • No —Exits the configuration session without committing the configuration changes. • Cancel —Remains in the configuration session, without committing the configuration changes.

Configuring Access-Control Lists: Examples

```
//For IPv4
configure
ipv4 access-list foo_in
10 permit tcp any any
10 permit ipv4 host 9.8.8.9 nexthop 6.6.6.6 7.7.7.7
!
!
end

//For IPv6
configure
ipv6 access-list foo_in
10 permit tcp any any
10 permit ipv4 host 192:2:1:9 nexthop 192:2:6:8
!
!
end
```

Activating ACL

Perform this task to define a dynamic-template that is used to activate an access-control list.

SUMMARY STEPS

1. **configure**
2. **dynamic-template**
3. **type** { **ipsubscriber** | **ppp** | **service** } *dynamic-template-name*
4. { **ipv4** | **ipv6** } **access-group** *access-list-name* **ingress**
5. Use the **commit** or **end** command.

DETAILED STEPS

	Command or Action	Purpose
Step 1	configure Example: RP/0/RSP0/CPU0:router# configure	Enters global configuration mode.
Step 2	dynamic-template Example: RP/0/RSP0/CPU0:router(config)# dynamic-template	Enters the dynamic-template configuration mode.
Step 3	type {ipsubscriber ppp service} <i>dynamic-template-name</i> Example: RP/0/RSP0/CPU0:router(config-dynamic-template)# type service foo	Creates a service dynamic-template type.
Step 4	{ipv4 ipv6} access-group access-list-name ingress Example: RP/0/RSP0/CPU0:router(config-dynamic-template-type)# ipv4 access-group foo_in ingress or RP/0/RSP0/CPU0:router(config-dynamic-template-type)# ipv6 access-group foo_in ingress	Specifies access-control for the incoming packets. Note Similarly, create another access-group for the outgoing packets called foo_out.
Step 5	Use the commit or end command.	commit —Saves the configuration changes and remains within the configuration session. end —Prompts user to take one of these actions: <ul style="list-style-type: none"> • Yes — Saves configuration changes and exits the configuration session. • No —Exits the configuration session without committing the configuration changes. • Cancel —Remains in the configuration session, without committing the configuration changes.

Activating ACL: Examples

```
//For IPv4
configure
dynamic-template
type service foo
```

```

ipv4 access-group foo_in ingress
!
!
end

//For IPv6
configure
dynamic-template
type service foo
ipv6 access-group foo_in ingress
!
!
end

```

Support for Lawful Intercept

Lawful Intercept allows Law Enforcement Agencies (LEAs) to conduct electronic surveillance as authorized by judicial or administrative order. Increasingly, legislation is being adopted and regulations are being enforced that require service providers (SPs) and Internet service providers (ISPs) to implement their networks to explicitly support authorized electronic surveillance. The types of SPs or ISPs that are subject to Lawful Intercept mandates vary greatly from country to country. Lawful Intercept compliance in the United States is specified by the Communications Assistance for Law Enforcement Act (CALEA).

Cisco ASR 9000 Series Router supports the Cisco Service Independent Intercept (SII) architecture and PacketCableTM¹ Lawful Intercept architecture. The Lawful Intercept components by themselves do not ensure customer compliance with applicable regulations but rather provide tools that can be used by SPs and ISPs to construct an Lawful Intercept compliant network.

BNG supports the [Per-session Lawful Intercept](#) and [Radius-based Lawful Intercept](#) for subscribers. Both, per-session and radius-based lawful intercepts are executed on IPoE, PPPoE, and PPPoE LAC subscriber sessions in BNG.



Caution

This guide does not address legal obligations for the implementation of lawful intercept. Service providers are responsible for ensuring that network complies with applicable lawful intercept statutes and regulations. It is recommended that legal advice be sought to determine obligations.



Note

By default, Lawful Intercept is not a part of the Cisco IOS XR software. To enable Lawful Intercept, you must install and activate the **asr9k-li-px.pie**.

For more information about Lawful Intercept-related router configuration, see *Implementing Lawful Intercept* chapter in *Cisco ASR 9000 Series Aggregation Services Router System Security Configuration Guide*.

Maximum supported Lawful Intercept scale depends on the number of Network Processors (NP) on a line card. For example,

- Line cards with one or two NPs: 511 sessions per line card.
- Line cards with more than two NPs: 1024 divided by the number of NPs on the line card.

¹ PacketCableTM architecture addresses device interoperability and product compliance issues using the PacketCableTM Specifications.

You can verify the number of NPs on a line card using the **show controllers np summary all location <location>** command.

Per-session Lawful Intercept

Lawful interception of all Layer 2 or Layer 3 traffic on a specified subscriber interface, on both ingress as well egress directions, and sending the replicated stream to mediation device, is called the per-session Lawful Intercept. This Lawful Intercept implements IPv4, IPv6, and multicast traffic interception using the Cisco-defined MIBs. By default, the SNMP-based Lawful Intercept feature is enabled on the Cisco ASR 9000 Series Router, which allows you to configure the taps. For more information about disabling SNMP-based Lawful Intercept, see [Disabling SNMP-based Lawful Intercept, on page 320](#).

The subscriber session is identified by Account-session-ID, which acts as a key in identifying the specified subscriber interface for the subscriber user, whose traffic is getting intercepted.

Lawful Intercept, in general, can be implemented using either SII architecture or PacketCable™ specifications. The Cisco IOS-XR implementation of SNMP-based Lawful Intercept is based on service-independent intercept (SII) architecture. SNMPv3 authenticates data origin and ensures that the connection from Cisco ASR 9000 Series Router to the mediation device is secure. This ensures that unauthorized parties cannot forge an intercept target.



Note To implement lawful intercept, you must understand how the SNMP server functions. For this reason, carefully review the information described in the module *Implementing SNMP* in *System Management Configuration Guide for Cisco ASR 9000 Series Routers*.

Lawful intercept must be explicitly disabled. It is automatically enabled on a provisioned router after installing and activating the **asr9k-li-px.pie**. However, you should not disable LI if there is an active tap in progress, because this deletes the tap.

Management plane must be configured to enable SNMPv3. Allows the management plane to accept SNMP commands, so that the commands go to the interface (preferably, a loopback) on the router. This allows the mediation device (MD) to communicate with a physical interface. For more information about Management Plane Protection feature, see [Configuring the Inband Management Plane Protection Feature, on page 320](#) and for more information about enabling the mediation device, see [Enabling the Mediation Device to Intercept VoIP and Data Sessions, on page 321](#).

Lawful Intercept MIBs

An external mediation device also known as collectors can create IPv4 or IPv6 address based TAPs using IP-TAP-MIB. The SNMPv3 protocol is used to provision the mediation device (defined by CISCO-TAP2-MIB) and the Taps(defined by CISCO-USER-CONNECTION-TAP-MIB). The Cisco ASR 9000 Series Router supports a total of 511 concurrent taps that includes both SNMP and Radius.

Lawful intercept uses these MIBs for interception:

- CISCO-TAP2-MIB—Used for lawful intercept processing. It contains SNMP management objects that control lawful intercepts on a Cisco ASR 9000 Series Router. The mediation device uses the MIB to configure and run lawful intercepts on targets sending traffic through the Cisco ASR 9000 Series Router. The CISCO-TAP2-MIB supports the SII feature and defines the provisioning of the mediation devices and generic Taps. It primarily consists of the mediation device table and a stream table. The mediation device table contains information about mediation devices with which the Cisco ASR 9000 Series Router

communicates; for example, the device's address, the interfaces to send intercepted traffic over, and the protocol to use to transmit the intercepted traffic. The stream table contains a list of generic Taps that are provisioned by the MD table entries.

- **CISCO-USER-CONNECTION-TAP-MIB**—Used for intercepting traffic for individual subscribers. The MIB contains SNMP management objects to configure and execute wiretaps on individual user connections on the Cisco ASR 9000 Series Router. This MIB contains information about the user connections, each identified by a unique session ID. The **CISCO-USER-CONNECTION-TAP-MIB** cannot be configured without configuring the **CISCO-TAP2-MIB**.



Note It is not possible to configure an SNMP tap and a Radius tap at the same time. Also, the same session cannot be tapped more than once at a time.

Disabling SNMP-based Lawful Intercept

Lawful Intercept is enabled by default on the Cisco ASR 9000 Series Router after installing and activating the **asr9k-li-px.pie**.

- To disable Lawful Intercept, enter the **lawful-intercept disable** command in global configuration mode.
- To re-enable it, use the **no** form of this command.

Disabling SNMP-based Lawful Intercept: An example

```
RP/0/RSP0/CPU0:router# configure
RP/0/RSP0/CPU0:router(config)# lawful-intercept disable
```



Note The **lawful-intercept disable** command is available only after installing and activating the **asr9k-li-px.pie**.

All SNMP-based taps are dropped when lawful intercept is disabled.

Configuring the Inband Management Plane Protection Feature

If MPP was not earlier configured to work with another protocol, then ensure that the MPP feature is also not configured to enable the SNMP server to communicate with the mediation device for lawful interception. In such cases, MPP must be configured specifically as an inband interface to allow SNMP commands to be accepted by the router, using a specified interface or all interfaces.



Note Ensure this task is performed, even if you have recently migrated to Cisco IOS XR Software from Cisco IOS, and you had MPP configured for a given protocol.

For lawful intercept, a loopback interface is often the choice for SNMP messages. If you choose this interface type, you must include it in your inband management configuration.

Enabling the Mediation Device to Intercept VoIP and Data Sessions

These SNMP server configuration tasks enable the Cisco SII feature on a router running Cisco IOS XR Software by allowing the MD to intercept VoIP or data sessions.

SUMMARY STEPS

1. **configure**
2. **snmp-server view** *view-name* **ciscoTap2MIB included**
3. **snmp-server view** *view-name* **ciscoUserConnectionTapMIB included**
4. **snmp-server group** *group-name* **v3auth read** *view-name* **write** *view-name* **notify** *view-name*
5. **snmp-server host** *ip-address* **traps version 3 auth** *username* **udp-port** *port-number*
6. **snmp-server user** *mduser-id* *groupname* **v3 auth md5** *md-password*
7. Use the **commit** or **end** command.
8. **show snmp users**
9. **show snmp group**
10. **show snmp view**

DETAILED STEPS

	Command or Action	Purpose
Step 1	configure Example: RP/0/RSP0/CPU0:router# <code>configure</code>	Enters global configuration mode.
Step 2	snmp-server view <i>view-name</i> ciscoTap2MIB included Example: RP/0//CPU0:router(config)# <code>snmp-server view TapName ciscoTap2MIB included</code>	Creates or modifies a view record and includes the CISCO-TAP2-MIB family in the view. The SNMP management objects in the CISCO-TAP2-MIB that controls lawful intercepts are included. This MIB is used by the mediation device to configure and run lawful intercepts on targets sending traffic through the router.
Step 3	snmp-server view <i>view-name</i> ciscoUserConnectionTapMIB included Example: RP/0//CPU0:router(config)# <code>snmp-server view TapName ciscoUserConnectionTapMIB included</code>	Creates or modifies a view record and includes the CISCO-USER-CONNECTION-TAP-MIB family, to manage the Cisco intercept feature for user connections. This MIB is used along with the CISCO-TAP2-MIB to intercept and filter user traffic.
Step 4	snmp-server group <i>group-name</i> v3auth read <i>view-name</i> write <i>view-name</i> notify <i>view-name</i> Example: RP/0//CPU0:router(config)# <code>snmp-server group TapGroup v3 auth read TapView write TapView notify TapView</code>	Configures a new SNMP group that maps SNMP users to SNMP views. This group must have read, write, and notify privileges for the SNMP view.

	Command or Action	Purpose
Step 5	<p>snmp-server host <i>ip-address</i> traps version 3 auth <i>username udp-port port-number</i></p> <p>Example:</p> <pre>RP/0//CPU0:router(config)# snmp-server host 223.255.254.224 traps version 3 auth bgreen udp-port 2555</pre>	Specifies SNMP trap notifications, the version of SNMP to use, the security level of the notifications, and the recipient (host) of the notifications.
Step 6	<p>snmp-server user <i>mduser-id groupname v3 auth md5</i> <i>md-password</i></p> <p>Example:</p> <pre>RP/0//CPU0:router(config)# snmp-server mduser-id TapGroup v3 auth md5 mdpassword</pre>	<p>Configures the MD user as part of an SNMP group, using the v3 security model and the HMAC MD5 algorithm, which you associate with the MD password.</p> <ul style="list-style-type: none"> • The <i>mduser-id</i> and <i>mdpassword</i> must match that configured on MD. Alternatively, these values must match those in use on the router. • Passwords must be eight characters or longer to comply with SNMPv3 security minimums. • Minimum Lawful Intercept security level is auth; The noauth option will not work, as it indicates noAuthnoPriv security level. The Lawful Intercept security level must also match that of the MD. • Choices other than MD5 are available on the router, but the MD values must match. <p>Most MDs default to or support only MD5.</p>
Step 7	Use the commit or end command.	<p>commit —Saves the configuration changes and remains within the configuration session.</p> <p>end —Prompts user to take one of these actions:</p> <ul style="list-style-type: none"> • Yes — Saves configuration changes and exits the configuration session. • No —Exits the configuration session without committing the configuration changes. • Cancel —Remains in the configuration session, without committing the configuration changes.
Step 8	<p>show snmp users</p> <p>Example:</p> <pre>RP/0//CPU0:router# show snmp users</pre>	Displays information about each SNMP username in the SNMP user table.
Step 9	<p>show snmp group</p> <p>Example:</p> <pre>RP/0//CPU0:router# show snmp group</pre>	Displays information about each SNMP group on the network.

	Command or Action	Purpose
Step 10	show snmp view Example: RP/0//CPU0:router# show snmp view	Displays information about the configured views, including the associated MIB view family name, storage type, and status.

Enabling the Mediation Device to Intercept VoIP and Data Sessions: An example

```

configure
snmp-server view TapName ciscoTap2MIB included
snmp-server view TapName ciscoUserConnectionTapMIB included
snmp-server group TapGroup v3 auth read TapView write TapView notify TapView
snmp-server host 223.255.254.224 traps version 3 auth bgreen udp-port 2555
snmp-server mduser-id TapGroup v3 auth md5 mdpasword
end
!
!

```

Radius-based Lawful Intercept

Radius-based Lawful Intercept feature provides mechanisms for interception of the BNG subscriber traffic by using the RADIUS attributes. This is a preferred method over SNMP user-connection MIB, as SNMP-based method prevents a session to be tapped until an IP address has been assigned to the session. In the Radius-based LI mechanism, tapping is possible as soon as a session is established.

A RADIUS-based Lawful Intercept solution enables intercept requests to be sent (through Access-Accept packets or Change of Authorization (CoA)-Request packets) to the network access server (NAS) or to the Layer 2 Tunnel Protocol access concentrator (LAC) from the RADIUS server. All traffic data going to or from a PPP or L2TP session is passed to a mediation device. Another advantage of RADIUS-based Lawful Intercept solution is to set the tap with Access-Accept packets that allows all target traffic to be intercepted simultaneously.

The RADIUS-based Lawful Intercept feature provides tap initiation support for these modes:

- Access-Accept based Lawful Intercept for the new session
- CoA based Lawful Intercept for existing session



Note By default, the Radius-based Lawful Intercept functionality is not enabled. For more information about enabling Radius-based Lawful Intercept, see [Enabling RADIUS-based Lawful Intercept, on page 323](#).

Enabling RADIUS-based Lawful Intercept

Perform this task to enable the Radius-based Lawful Intercept feature.

SUMMARY STEPS

1. **configure**

2. **aaa intercept**
3. **aaa server radius dynamic-author**
4. **port** *port_number*
5. **server-key** [0|7] *word*
6. **client** *hostname* { **vrf** *vrf_name* | **server-key** [0|7] *word* }
7. Use the **commit** or **end** command.

DETAILED STEPS

	Command or Action	Purpose
Step 1	configure Example: RP/0/RSP0/CPU0:router# configure	Enters global configuration mode.
Step 2	aaa intercept Example: RP/0/RSP0/CPU0:router(config)# aaa intercept	Enables the radius-based lawful intercept feature. Note This command is available only after installing and activating asr9k-li-px.pie . When you disable aaa intercept, all radius-based taps are removed from the Cisco ASR 9000 Series Router.
Step 3	aaa server radius dynamic-author Example: RP/0/RSP0/CPU0:router(config)# aaa server radius dynamic-author	Configures the lawful intercept as a AAA server and enters the dynamic authorization local server configuration mode.
Step 4	port <i>port_number</i> Example: RP/0/RSP0/CPU0:router(config-Dynamic Author)# port 1600	Specifies the RADIUS server port. The default port number is 1700.
Step 5	server-key [0 7] <i>word</i> Example: RP/0/RSP0/CPU0:router(config-Dynamic Author)# server-key cisco	Specifies the encryption key shared with the RADIUS client.
Step 6	client <i>hostname</i> { vrf <i>vrf_name</i> server-key [0 7] <i>word</i> } Example: RP/0/RSP0/CPU0:router(config-Dynamic Author)# client 3.0.0.28 vrf default server-key cisco	Specifies the client with which the AAA server will be communicating. Note You can configure the server key in a global mode and also as a per client type key.
Step 7	Use the commit or end command.	commit —Saves the configuration changes and remains within the configuration session. end —Prompts user to take one of these actions:

	Command or Action	Purpose
		<ul style="list-style-type: none"> • Yes — Saves configuration changes and exits the configuration session. • No —Exits the configuration session without committing the configuration changes. • Cancel —Remains in the configuration session, without committing the configuration changes.

Enabling RADIUS-based Lawful Intercept: An example

```

configure
aaa intercept
aaa server radius dynamic-author
port 1600
server-key cisco
client 3.0.0.28 vrf default server-key cisco
end
!
!

```

What to do next

These attributes need to be present in the user profile to configure the Radius-based Lawful Intercept.

```

xyz_user1@domain.com Password == "cisco"
Cisco-avpair = "md-ip-addr=192.1.1.4",
Cisco-avpair += "md-port=203",
Cisco-avpair += "md-dscp=3",
Cisco-avpair += "intercept-id=abcd0003",
Cisco-avpair += "li-action=1"

```

SNMP Lawful Intercept Using Circuit-Id

SNMP lawful intercept (LI) using Circuit-Id in BNG provides a way to intercept the subscriber traffic based on a static identifier rather than the interface name or accounting session ID that changes every time a subscriber logs in to the network. This feature reduces the constraints on the back end, thereby providing a seamless integration.

For more details on lawful intercept, refer *Implementing Lawful Intercept* chapter in *System Security Configuration Guide for Cisco ASR 9000 Series Routers*.

For more details on implementing SNMP, refer *Implementing SNMP* chapter in *System Management Configuration Guide for Cisco ASR 9000 Series Routers*.

Configuration Example

Execute these commands on SNMP server:

- Create lawful intercept-mediation device (LI-MD):

```
# Create LI-MD
# CDID : 11
# MD IP: 5.5.5.2
# UDP PORT: 1234
# TIME TILL: 2016 (07-E0), FEB (02), 29 (1D)

snmpset -v3 -u li-user -A cisco123 -l authNoPriv 25.25.25.1 \
  1.3.6.1.4.1.9.9.399.1.1.2.1.13.11 i 5 \
  1.3.6.1.4.1.9.9.399.1.1.2.1.2.11 i 1 \
  1.3.6.1.4.1.9.9.399.1.1.2.1.3.11 x "05 05 05 02" \
  1.3.6.1.4.1.9.9.399.1.1.2.1.4.11 u 1234 \
  1.3.6.1.4.1.9.9.399.1.1.2.1.5.11 i 0 \
  1.3.6.1.4.1.9.9.399.1.1.2.1.11.11 i 1 \
  1.3.6.1.4.1.9.9.399.1.1.2.1.10.11 x "07 E0 02 1D 00 00 00 00 2D 00 00" \
  1.3.6.1.4.1.9.9.399.1.1.2.1.13.11 i 4
```

- Create subscriber TAP stream:

```
# CREATE SUBSCRIBER TAP STREAM BASED ON CID
# STREAM INDEX: 22
# SUBS CID: cid101

snmpset -v3 -u li-user -A cisco123 -l authNoPriv 25.25.25.1 \
  1.3.6.1.4.1.9.9.400.1.1.2.1.3.11.22 s "cid101" \
  1.3.6.1.4.1.9.9.400.1.1.2.1.2.11.22 i 4
```

- Enable TAP:

```
# ENABLE TAP ON THE STREAM
# MD CCDI: 11
# TAP STREAM ID: 22
# STREAM TYPE: 3 (SUBS)

snmpset -v3 -u li-user -A cisco123 -l authNoPriv 25.25.25.1 \
  1.3.6.1.4.1.9.9.399.1.2.1.1.2.11.22 i 3 \
  1.3.6.1.4.1.9.9.399.1.2.1.1.3.11.22 i 1 \
  1.3.6.1.4.1.9.9.399.1.2.1.1.6.11.22 i 4
```

Verification

Execute this command on SNMP server to verify the statistics:

```
snmpwalk -v3 -u li-user -A cisco123 -l authNoPriv 25.25.25.1 1.3.6.1.4.1.9.9.399
```

```
SNMPv2-SMI::enterprises.9.9.399.1.1.1.0 = INTEGER: 54
SNMPv2-SMI::enterprises.9.9.399.1.1.2.1.2.11 = INTEGER: 1
SNMPv2-SMI::enterprises.9.9.399.1.1.2.1.3.11 = Hex-STRING: 05 05 05 02
SNMPv2-SMI::enterprises.9.9.399.1.1.2.1.4.11 = Gauge32: 1234
SNMPv2-SMI::enterprises.9.9.399.1.1.2.1.5.11 = INTEGER: 0
SNMPv2-SMI::enterprises.9.9.399.1.1.2.1.7.11 = INTEGER: 34
SNMPv2-SMI::enterprises.9.9.399.1.1.2.1.10.11 = Hex-STRING: 07 E0 02 1D 00 00 00 00 2D 00 00
SNMPv2-SMI::enterprises.9.9.399.1.1.2.1.11.11 = INTEGER: 1
SNMPv2-SMI::enterprises.9.9.399.1.1.2.1.12.11 = INTEGER: 1
SNMPv2-SMI::enterprises.9.9.399.1.1.2.1.13.11 = INTEGER: 1
SNMPv2-SMI::enterprises.9.9.399.1.1.3.0 = Hex-STRING: A0
SNMPv2-SMI::enterprises.9.9.399.1.2.1.1.2.11.22 = INTEGER: 3
SNMPv2-SMI::enterprises.9.9.399.1.2.1.1.3.11.22 = INTEGER: 1
```

```
SNMPv2-SMI::enterprises.9.9.399.1.2.1.1.4.11.22 = Counter32: 13921356
SNMPv2-SMI::enterprises.9.9.399.1.2.1.1.5.11.22 = Counter32: 0
SNMPv2-SMI::enterprises.9.9.399.1.2.1.1.6.11.22 = INTEGER: 1
SNMPv2-SMI::enterprises.9.9.399.1.3.1.0 = INTEGER: 600
SNMPv2-SMI::enterprises.9.9.399.1.3.2.0 = INTEGER: 10
```

TCP MSS Adjustment

The TCP MSS Adjustment feature allows the configuration of the maximum segment size (MSS) on transient packets that traverse a Cisco ASR 9000 Series Router.

When dealing with PPPoE or L2TP cases, an additional header that the client initiating a TCP session may not be aware of is added to the packet. This can result in lost packets, broken transmissions, or fragmentation when packet sizes exceed the maximum transmission units (MTUs) due to the added headers.

Here is a sample scenario that shows how the TCP MSS adjust feature works:

Figure 22: Sample TCP MSS Adjust

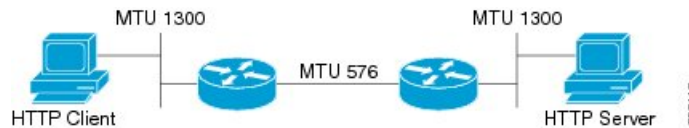

In this example, the HTTP client sends to the HTTP server a TCP synchronize (SYN) packet that signals an MSS value of 1300 (MTU) - 20 TCP - 20 IP header = 1260. On receiving it, the HTTP server acknowledges it with a SYN ACK message. The HTTP client confirms the TCP session with a single acknowledgment and opens up the TCP channel.



Note This is a sample scenario without PPPoE or L2TP.

When the HTTP server picks up a large file, it segments it into 1460 byte chunks (assuming that there are no http headers for now). When the HTTP server sends the packet, the first Cisco ASR 9000 Series Router (on the right) detects that the MTU is 576 downstream to the client and requires a 1300 byte packet to be fragmented.

If the server sets the DF ("don't fragment") bit, then the packet is dropped. And, if the packet does not have the DF bit set, then it gets fragmented, requiring the client to reassemble the packets. In digital subscriber line (DSL) or fibre-to-the-home (FTTH) like access, a CPE may block incoming fragments as a security mechanism, causing this transmission to be lost.

In a typical scenario, having packets that are dropped causes partial downloads, an obstruction, or a delay in displaying images in web pages. MSS adjust overcomes this scenario by intercepting the TCP SYN packet, reading the MSS option, and adjusting the value so that the server does not send packets larger than the configured size (plus headers).

Note that the TCP MSS value is only adjusted downward. If the clients request an MSS value lower than the configured value, then no action is taken.

In the case of PPPoE, an extra 8 bytes and in the case of L2TP, an extra 40 bytes is added to the packet. The recommended MSS adjust values are 1452 for PPPoE, and 1420 for L2TP scenarios, assuming a minimum MTU of 1500 end-to-end.

Separate unique global values for PTA and L2TP are supported, which once configured allows all future sessions to be TCP MSS adjustment; however, the sessions already established will not be TCP adjusted. If the global value is changed, then all new TCP subscriber sessions, will get the new global value.

For more information about configuring the TCP MSS value of packets, see [Configuring the TCP MSS Value of TCP Packets, on page 328](#).



Note To disable this on a session, you must first disable the global configuration, then delete the session and recreate it.

TCP encapsulated in both IPv4 and IPv6 are supported.

Restrictions

These restrictions are applicable for TCP MSS Adjustment:

- Because the MSS is TCP-specific, the TCP MSS Adjustment feature is applicable only to (transit) TCP packets and the UDP packets are unaffected.
- TCP MSS Adjustment configuration affects only the PPPoE PTA and LAC sessions types. It does not affect IP sessions or any non-BNG interfaces.
- The MSS option must be the first option in the TCP header.
- The router uses the MSS value that the user configures for checking TCP/IPV4 packets. When checking TCP/IPV6 packets, the router automatically adjusts the configured MSS value down by 20 bytes to account for the larger IPv6 header. For example, if the TCP MSS value is configured to 1450, then the router adjusts the TCP MSS in an IPV4 packet down to 1450 and down to 1430 for an IPv6 packet.

Configuring the TCP MSS Value of TCP Packets

Perform this task to configure the TCP MSS value of TCP packets in order to prevent TCP sessions from being dropped.

SUMMARY STEPS

1. **configure**
2. **subscriber**
3. **pta tcp mss-adjust** *max-segment-size*
4. Use the **commit** or **end** command.
5. **configure**
6. **vpdn**
7. **l2tp tcp-mss-adjust** *max-segment-size*
8. Use the **commit** or **end** command.

DETAILED STEPS

	Command or Action	Purpose
Step 1	configure Example: RP/0/RSP0/CPU0:router# configure	Enters global configuration mode.
Step 2	subscriber Example: RP/0/RSP0/CPU0:router(config)# subscriber	Enables the subscriber configuration mode.
Step 3	pta tcp mss-adjust max-segment-size Example: RP/0/RSP0/CPU0:router(config-subscriber)# pta tcp mss-adjust 1300	Sets the MSS value of TCP packets going through a Cisco ASR 9000 Series Router for a PTA subscriber. The TCP MSS Adjust maximum segment size ranges from 1280 to 1536 (in bytes). Note The value represents the global value for the PTA sessions, when the feature is enabled it applies to all sessions.
Step 4	Use the commit or end command.	commit —Saves the configuration changes and remains within the configuration session. end —Prompts user to take one of these actions: <ul style="list-style-type: none"> • Yes — Saves configuration changes and exits the configuration session. • No —Exits the configuration session without committing the configuration changes. • Cancel —Remains in the configuration session, without committing the configuration changes.
Step 5	configure Example: RP/0/RSP0/CPU0:router# configure	Enters global configuration mode.
Step 6	vpdn Example: RP/0/RSP0/CPU0:router(config)# vpdn	Enables the vpdn configuration mode.
Step 7	l2tp tcp-mss-adjust max-segment-size Example: RP/0/RSP0/CPU0:router(config-vpdn)# l2tp tcp-mss-adjust 1300	Sets the MSS value of TCP packets going through a Cisco ASR 9000 Series Router for a LAC subscriber. The TCP MSS Adjust maximum segment size ranges from 1280 to 1460 (in bytes).

	Command or Action	Purpose
Step 8	Use the commit or end command.	<p>commit —Saves the configuration changes and remains within the configuration session.</p> <p>end —Prompts user to take one of these actions:</p> <ul style="list-style-type: none"> • Yes — Saves configuration changes and exits the configuration session. • No —Exits the configuration session without committing the configuration changes. • Cancel —Remains in the configuration session, without committing the configuration changes.

Configuring the TCP MSS Value of TCP Packets: Examples

```
//Example for configuring the TCP MSS value of TCP packets for a PPPoE PTA subscriber session:
```

```
configure
subscriber
pta tcp mss-adjust 1280
!!
```

```
// Example for configuring the TCP MSS value of TCP packets for a PPPoE LAC subscriber session:
```

```
configure
vpdn
l2tp tcp-mss-adjust 1460
!!
```

Linking to Subscriber Traffic in a Shared Policy Instance Group

You can associate the subscriber traffic belonging to a Shared Policy Instance (SPI) group of multiple subinterfaces with a link using a Cisco Vendor-Specific Attribute (VSA). When you apply member hash Cisco:Avpair from RADIUS for a SPI group, traffic for that group will not spill across members. You can identify hash to member mapping based on the bundle's Link Ordering Number (LON).

To enable this feature, configure the following Cisco VSA in the RADIUS profile of the subscriber:

```
Cisco-avpair = "subscriber:member-hash=XX"
```

where XX is the hash value.

Supported Features

- IPoE and PPPoE call flows
- IPv4 and IPv6
- Member hash can be downloaded from RADIUS server

- Traffic is programmed when a new hash value is downloaded and also when a bundle member is modified
- High availability scenarios such as Flap, LC OIR, Process restart, and RPFO
- Only route processor subscribers and with maximum scale

Verifying Hash Value

To display the hash value programmed for the subscriber session, refer to Flow-tag value in the **show route address detail** command output:

```
RP/0/0/CPU0:server#show route 10.0.0.1/32 detail
Mon Mar  2 20:08:29.079 IST

Routing entry for 10.0.0.1/32
  Known via "subscriber", distance 2, metric 0 (connected)
  Installed Mar  2 20:07:35.448 for 00:00:54
Routing Descriptor Blocks
  directly connected, via GigabitEthernet0/0/0/0.pppoe1
    Route metric is 0
    Label: 0x300 (768)
    Tunnel ID: None
    Extended communities count: 0
    NHID:0x0(Ref:0)
  Route version is 0x1 (1)
  No local label
  IP Precedence: Not Set
  QoS Group ID: Not Set
Flow-tag: 33
  Route Priority: RIB_PRIORITY_RECURSIVE (9) SVD Type RIB_SVD_TYPE_LOCAL
  Download Priority 3, Download Version 5
  No advertising protos.
```

Subscriber Session on Ambiguous VLANs

Ambiguous VLAN enables you to create multiple subscriber sessions on a single access-interfaces. As a result, it increases the scalability of the access-interface. An ambiguous VLAN is an L3 interface on which either a VLAN ID range, or a group of individual VLAN IDs are specified. Instead of individually mapping each subscriber to a VLAN, an ambiguous VLAN configuration performs the mapping for a group. Multiple subscribers can be mapped on the ambiguous VLAN as long as they possess a unique MAC address. The subscriber sessions created over ambiguous VLANs are identical to the ones created over regular VLANs, and support all regular configurations such as policy-map, VRFs, QoS, access-control list, and so on.

For enabling IPoE subscriber session creation on an ambiguous VLAN, see [Establishing Subscriber Session on Ambiguous VLANs, on page 332](#).

From Cisco IOS XR Release 5.1.3 and later, the DHCP offer can be send as Unicast (or as per the broadcast policy flag in the DHCP request) for ambiguous VLANs. The ambiguous VLAN configuration in this case, must use a range of VLAN tags (For example, **encapsulation ambiguous dot1q 10, 100**).

For ambiguous VLAN dot1q configuration where the match criteria is explicitly configured for inner and outer VLAN tags or where a range is specified or where **any** is used for outer VLAN tag, the MTU is calculated by adding 8 bytes (2x dot1q tags) to the default MTU. That is, if default is 1514, the MTU is set to 1522 bytes in such scenarios. Whereas, for configurations where the match criteria for inner VLAN is specified as **any**, the MTU on the sub-interface is calculated by adding 4 (and not 8) bytes to the main interface MTU. That is, $1514 + 4 = 1518$ bytes. This behavior is applicable for both physical interfaces and bundle sub-interfaces.

Restriction

The use of **any** tag in the ambiguous VLAN configuration is not supported for Unicast DHCP offers. The DHCP offer packets are not forwarded to the subscriber if **any** tag is used in the configuration.

A DHCP proxy debug error message saying, ARP is not supported on ambiguous VLAN interface, is logged in such failure scenarios.

Establishing Subscriber Session on Ambiguous VLANs

Perform this task to define an ambiguous VLAN and enable creation of IP subscriber session on it.

**Note**

There is no DHCP-specific configuration required for ambiguous VLANs.

SUMMARY STEPS

1. **configure**
2. **interface** *type interface-path-id*
3. Use any of these commands to configure encapsulated ambiguous VLANs:
 - **encapsulation ambiguous** { **dot1q** | **dot1ad** } { **any** | *vlan-range* }
 - **encapsulation ambiguous dot1q** *vlan-id* **second-dot1q** { **any** | *vlan-range* }
 - **encapsulation ambiguous dot1q any** **second-dot1q** { **any** | *vlan-id* }
 - **encapsulation ambiguous dot1ad** *vlan-id* **dot1q** { **any** | *vlan-range* }
 - **encapsulation ambiguous dot1q** *vlan-range* **second-dot1q** **any**
 - **encapsulation ambiguous dot1ad** *vlan-range* **dot1q** **any**
4. **ipv4** | **ipv6address** *source-ip-address destination-ip-address*
5. **service-policy type control subscriber** *policy_name*
6. **ipsubscriber ipv4 l2-connected**
7. **initiator dhcp**
8. Use the **commit** or **end** command.

DETAILED STEPS

	Command or Action	Purpose
Step 1	configure Example: RP/0/RSP0/CPU0:router# <code>configure</code>	Enters global configuration mode.
Step 2	interface <i>type interface-path-id</i> Example: RP/0/RSP0/CPU0:router(config)# <code>interface GigabitEthernet0/1/0/0.12</code>	Configures the interface and enters the interface configuration mode.
Step 3	Use any of these commands to configure encapsulated ambiguous VLANs:	Configures IEEE 802.1Q VLAN configuration.

	Command or Action	Purpose
	<ul style="list-style-type: none"> • encapsulation ambiguous { dot1q dot1ad } {any vlan-range } • encapsulation ambiguous dot1q vlan-id second-dot1q { any vlan-range } • encapsulation ambiguous dot1q any second-dot1q { any vlan-id } • encapsulation ambiguous dot1ad vlan-id dot1q { any vlan-range } • encapsulation ambiguous dot1q vlan-range second-dot1q any • encapsulation ambiguous dot1ad vlan-range dot1q any <p>Example:</p> <pre>RP/0/RSP0/CPU0:router(config-if)# encapsulation ambiguous dot1q any RP/0/RSP0/CPU0:router(config-if)# encapsulation ambiguous dot1q 14 second-dot1q 100-200 RP/0/RSP0/CPU0:router(config-if)# encapsulation ambiguous dot1q any second-dot1q any RP/0/RSP0/CPU0:router(config-if)# encapsulation ambiguous dot1ad 14 dot1q 100,200,300-400 RP/0/RSP0/CPU0:router(config-if)# encapsulation ambiguous dot1q 1-1000 second-dot1q any</pre>	<p>The <i>vlan-range</i> is given in comma-separated, or hyphen-separated format, or a combination of both, as shown in the examples.</p> <p>Note Although encapsulation ambiguous dot1ad is supported, it is not commonly used in BNG deployments.</p> <p>encapsulation ambiguous dot1q any is not supported for unicast DHCP offers. You must use encapsulation ambiguous dot1q vlan-range for such scenarios.</p>
Step 4	<p>ipv4 ipv6address <i>source-ip-address destination-ip-address</i></p> <p>Example:</p> <pre>RP/0/RSP0/CPU0:router(config-if)# ipv4 address 2.1.12.1 255.255.255.0 RP/0/RSP0/CPU0:router(config-if)# ipv6 address 1:2:3::4 128</pre>	Configures the IPv4 or IPv6 protocol address.
Step 5	<p>service-policy type control subscriber <i>policy_name</i></p> <p>Example:</p> <pre>RP/0/RSP0/CPU0:router(config-if)# service-policy type control subscriber PL1</pre>	Applies a policy-map to an access interface where the policy-map was previously defined with the specified PL1 <i>policy_name</i> .
Step 6	<p>ipsubscriber ipv4 l2-connected</p> <p>Example:</p> <pre>RP/0/RSP0/CPU0:router(config-if)# ipsubscriber ipv4 l2-connected</pre>	Enables l2-connected IPv4 IP subscriber.
Step 7	<p>initiator dhcp</p> <p>Example:</p> <pre>RP/0/RSP0/CPU0:router(config-if)# initiator dhcp</pre>	Enables initiator DHCP on the IP subscriber.

	Command or Action	Purpose
Step 8	Use the commit or end command.	<p>commit —Saves the configuration changes and remains within the configuration session.</p> <p>end —Prompts user to take one of these actions:</p> <ul style="list-style-type: none"> • Yes — Saves configuration changes and exits the configuration session. • No —Exits the configuration session without committing the configuration changes. • Cancel —Remains in the configuration session, without committing the configuration changes.

Establishing Subscriber Session on Ambiguous VLANs: An example

```

configure
interface Bundle-Ether100.10
encapsulation ambiguous dot1q 14 second-dot1q any
ipv4 address 2.1.12.12 55.255.255.0
service-policy type control subscriber PL1
ipsubscriber ipv4 12-connected
!
!
end

```

Outer VLAN Range

The Outer VLAN range is a BNG-specific feature that provides a more advanced VLAN encapsulation option of double-tagged VLANs, where the outer VLAN is specified as a range and the inner VLAN is specified as **any**.

The current BNG implementation supports a high scale of subscriber interface. However, due to QoS hardware limitation, the number of subscribers with QoS policies attached under a single L3 ambiguous VLAN sub-interface is limited to 8K. Therefore, in a large scale scenario, if QoS policies are to be attached to each of the subscribers and if the maximum scale per port is to be achieved, you must configure multiple L3 ambiguous VLAN sub-interfaces per port, with encapsulations that partition the subscribers among the VLAN sub-interfaces. The encapsulations used in such scenarios are:

- Single-tagged VLAN range encapsulations.
- Double-tagged encapsulation, with an inner VLAN range.
- Double-tagged encapsulations, with a fixed outer VLAN-ID and an inner VLAN match for **any**.

In certain scenarios, depending on how the VLAN-IDs are allocated for the subscribers, none of the above partitioning schemes may be suitable. In such scenarios, the L3 ambiguous encapsulation double tag that matches an outer VLAN range and **any** inner VLAN can be used.

The configuration options available for the Outer VLAN range feature are:

- **encapsulation ambiguous dot1q *vlan range* second-dot1q any**

- **encapsulation ambiguous dot1ad *vlan range* dot1q any**

Sample Configuration for Outer VLAN Range

The sample configuration listed in this section shows how to configure 32K subscribers for each physical interface, using a double-tagged encapsulation to partition the subscribers across four sub-interfaces. Here, 8K subscribers, each with a separate QoS policy applied, are configured for each VLAN sub-interface. Further, a total of four VLAN sub-interfaces are configured to support 32K subscribers for each physical interface.

Option 1: Four VLAN sub-interfaces

```
interface GigabitEthernet0/0/0/0.1
encapsulation ambiguous dot1q 1-1000 second-dot1q any
!
interface GigabitEthernet0/0/0/0.2
encapsulation ambiguous dot1q 1001-2000 second-dot1q any
!
interface GigabitEthernet0/0/0/0.3
encapsulation ambiguous dot1q 2001-3000 second-dot1q any
!
interface GigabitEthernet0/0/0/0.4
encapsulation ambiguous dot1q 3001-4000 second-dot1q any
!
```

Option 2: Nine VLAN configuration ranges

```
interface GigabitEthernet0/0/0/0.1
encapsulation ambiguous dot1q 9-18, 19-25, 26, 27-30, 32, 33-40, 42, 43-50, 52 second-dot1q
any
!
```

Verification of Outer VLAN Range Configurations

These show commands can be used to verify the outer VLAN range configurations in BNG:

SUMMARY STEPS

1. **show interface***VLAN sub-interface*
2. **show ethernet tags** *VLAN sub-interface*
3. **show ethernet tags** *VLAN sub-interface detail*

DETAILED STEPS

Step 1 **show interface***VLAN sub-interface*

Displays VLAN sub-interface details, including encapsulations.

Example:

```
RP/0/RSP0/CPU0:router#
show interfaces GigabitEthernet 0/1/0/10.12
GigabitEthernet0/1/0/10.12 is up, line protocol is up
  Interface state transitions: 1
  Hardware is VLAN sub-interface(s), address is 0022.bde2.b222
```

```

Internet address is Unknown
MTU 1518 bytes, BW 1000000 Kbit (Max: 1000000 Kbit)
  reliability 255/255, txload 0/255, rxload 0/255
Encapsulation 802.1Q Virtual LAN,
  Outer Match: Dot1Q VLAN 11-20,21-30,31-60,61-100,101-140,141-180,181-220,221-260,261-300
  Inner Match: Dot1Q VLAN any
  Ethertype Any, MAC Match src any, dest any
loopback not set,
Last input never, output never
Last clearing of "show interface" counters never
5 minute input rate 0 bits/sec, 0 packets/sec
- - - - -
- - - - -

```

Step 2 `show ethernet tags VLAN sub-interface`

Displays VLAN sub-interface outer tag information, including outer VLAN ranges.

Example:

```

RP/0/RSP0/CPU0:router#
show ethernet tags tengigE 0/0/0/0.1
St:   AD - Administratively Down, Dn - Down, Up - Up
Ly:   L2 - Switched layer 2 service, L3 = Terminated layer 3 service,
Xtra  C - Match on Cos, E - Match on Ethertype, M - Match on source MAC
-,+:  Ingress rewrite operation; number of tags to pop and push respectively

Interface          St  MTU  Ly  Outer          Inner          Xtra -,+
Te0/0/0/0.1        Up  1522 L3  .1Q:10         .1Q:100-200   -   0 0
- - - - -
- - - - -

```

Step 3 `show ethernet tags VLAN sub-interface detail`

Displays VLAN sub-interface outer tag information, including outer VLAN ranges, in detail.

Example:

```

RP/0/RSP0/CPU0:router#
show ethernet tags GigabitEthernet 0/0/0/0.1 detail
GigabitEthernet0/1/0/10.12 is up, service is L3
  Interface MTU is 1518
  Outer Match: Dot1Q VLAN 11-20,21-30,31-60,61-100,101-140,141-180,181-220,221-260,261-300
  Inner Match: Dot1Q VLAN any
  Local traffic encap: -
  Pop 0 tags, push none

```

Limitations of Outer VLAN Range

The Outer VLAN Range feature is subjected to these restrictions:

- It is specific to BNG.
- The double-tagged L3 ambiguous encapsulation that matches an outer VLAN range and **any** inner VLAN, and an overlapping single tag encapsulation must not be configured at the same time under the same parent trunk interface. For example, the configurations listed here shows a double-tagged encapsulation configured under one sub-interface and a single-tagged encapsulation configured under another

sub-interface of the same parent interface. Although it is not a valid configuration, the system does not reject it.

```
interface Bundle-ether 1.1
encapsulation ambiguous dot1q 2-100 second any
!
interface Bundle-ether 1.2
encapsulation ambiguous dot1q 3
```

- Network layer protocols must not be configured on L3 VLAN sub-interfaces configured with VLAN ranges or the **any** keyword. If they are configured in that manner, then any layer 3 traffic may be dropped. This is a limitation of generic ambiguous VLANs, and is applicable to BNG-specific outer VLAN range feature too.

uRPF

Unicast Reverse Path Forwarding (uRPF) is a feature in BNG that verifies whether the packets that are received on a subscriber interface are sent from a valid subscriber. uRPF only applies to subscribers using an L3 service.

For PPPoE subscribers, the uRPF check ensures that the source address in the arriving packet matches the set of addresses associated with the subscriber. The subscriber addresses are the IPCP assigned addresses, or any framed routed assigned through RADIUS. PPPoE subscribers are identified by session ID and VLAN keys. BNG performs the uRPF check to ensure that the source IP address in the arriving packets matches the expected session IDs and VLAN keys.

For IPoE subscribers, the subscriber addresses are the ones assigned through DHCP. IPoE subscribers are identified by the incoming MAC address. The uRPF check ensures that the source IP address is the one allocated by DHCP to the source MAC address.

uRPF is supported on both IPv4 and IPv6 subscribers and is enabled using a dynamic template. To define a dynamic template for enabling uRPF, see [Creating Dynamic Template for IPv4 or IPv6 Subscriber Session](#), on page 99.

Multicast Services

Multicast services enable multiple subscribers to be recipients of a single transmission from one source. For example, real-time audio and video conferencing makes good use of a multicast service. The multicast features applied on the PPPoE interfaces of BNG includes:

Multicast Coexistence

On BNG, the multicast services coexist with regular unicast services. The multicast feature on BNG is the same as the existing L3 multicast feature already supported on the Cisco ASR 9000 Series Routers. On BNG, multicast is enabled on the trunk interfaces, and the VLANs created over physical interfaces and bundles. Multicast co-existence works for PPPoE PTA subscriber sessions. For more details on multicast implementation on ASR9k, see *Implementing Layer-3 Multicast Routing on Cisco IOS XR Software* chapter in *Multicast Configuration Guide for Cisco ASR 9000 Series Routers*.

To enable multicast function on BNG, see [Enabling Address Family for the VRF](#), on page 338.

Enabling Address Family for the VRF

Perform this task to enable multicast functions for the required address family.

SUMMARY STEPS

1. **configure**
2. **multicast-routing**
3. **vrf** *vrf_name*
4. **address-family ipv4**
5. Use the **commit** or **end** command.

DETAILED STEPS

	Command or Action	Purpose
Step 1	configure Example: RP/0/RSP0/CPU0:router# configure	Enters global configuration mode.
Step 2	multicast-routing Example: RP/0/RSP0/CPU0:router(config)# multicast routing	Configures multicast-routing.
Step 3	vrf <i>vrf_name</i> Example: RP/0/RSP0/CPU0:router(config)# vrf vrf1	Configures the vrf name.
Step 4	address-family ipv4 Example: RP/0/RSP0/CPU0:router(config)# address-family ipv4	Enables the multicast functions in the ipv4 address family.
Step 5	Use the commit or end command.	<p>commit —Saves the configuration changes and remains within the configuration session.</p> <p>end —Prompts user to take one of these actions:</p> <ul style="list-style-type: none"> • Yes — Saves configuration changes and exits the configuration session. • No —Exits the configuration session without committing the configuration changes. • Cancel —Remains in the configuration session, without committing the configuration changes.

Enabling Address Family for the VRF: An example

```
multicast-routing
vrf vrf1
address-family ipv4
!
!
end
```

Multicast Replication

BNG supports the multicast packet replication on PPPoE interfaces. It also supports multicast forwarding on subscriber interfaces, and transmission of multicast IP video content. When the multicast replication is enabled for a subscriber, BNG performs IGMP statistics gathering for that subscriber, and has the ability to export them. Multicast replication is supported on subscriber interfaces, which are configured in the passive mode.

HQoS Correlation

The Hierarchical quality of service (HQoS) correlation feature monitors every subscriber's multicast bandwidth usage through IGMP reports received on each subscriber's PPPoE session, and limits the unicast bandwidth usage, to leave enough bandwidth for multicast traffic. This is useful when the multicast traffic and unicast traffic share the same physical link to the subscriber in the last mile, when the multicast and unicast traffic are forwarded onto the last mile link by different devices. This feature is configured on BNG that forwards the unicast traffic to the subscriber. Based on the IGMP reports received, BNG informs the unicast QoS shaper on the PPPoE session to alter the bandwidth limit allowed for unicast traffic flows. Using this HQoS correlation feature, a service provider can protect the multicast traffic to the PPPoE subscriber from bursty unicast traffic. The bandwidth profiles for multicast flows need to be configured on BNG.

To define the bandwidth profile, see [Configuring Minimum Unicast Bandwidth, on page 339](#).

To specify the mode for Multicast HQoS, see [Configuring Multicast HQoS Correlation Mode or Passive Mode, on page 341](#).

Configuring Minimum Unicast Bandwidth

A minimum unicast bandwidth can be configured, to prevent unicast traffic from being completely cut off by oversubscribed multicast traffic. Perform this task to set the guaranteed minimum unicast bandwidth for a subscriber using QoS.

SUMMARY STEPS

1. **configure**
2. **dynamic-template**
3. **type** [**ppp** | **ip-subscriber** | **service**] *name*
4. **qos output minimum-bandwidth** *range*
5. **exit**
6. Use the **commit** or **end** command.

DETAILED STEPS

	Command or Action	Purpose
Step 1	configure Example: RP/0/RSP0/CPU0:router# configure	Enters global configuration mode.
Step 2	dynamic-template Example: RP/0/RSP0/CPU0:router(config)# dynamic-template	Enters dynamic template configuration mode.
Step 3	type [ppp ip-subscriber service] <i>name</i> Example: RP/0/RSP0/CPU0:router(config-dynamic-template)# type ppp p1	. Specifies the type of dynamic template that needs to be applied. Three available types are: <ul style="list-style-type: none"> • PPP • IP-subscriber • Service
Step 4	qos output minimum-bandwidth <i>range</i> Example: RP/0/RSP0/CPU0:router(config-dynamic-template-type)# qos output minimum-bandwidth 10	Sets the guaranteed minimum bandwidth, in kbps, for a subscriber. Range is from 1 to 4294967295.
Step 5	exit Example: RP/0/RSP0/CPU0:router(config-dynamic-template-type)# exit	Exits from the current mode.
Step 6	Use the commit or end command.	commit —Saves the configuration changes and remains within the configuration session. end —Prompts user to take one of these actions: <ul style="list-style-type: none"> • Yes — Saves configuration changes and exits the configuration session. • No —Exits the configuration session without committing the configuration changes. • Cancel —Remains in the configuration session, without committing the configuration changes.

Configuring Minimum Bandwidth: An example

```
configure
dynamic-template
type ppp p1
service-policy output pmap
multicast ipv4 qos-correlation
qos output minimum-bandwidth 10
end
```

Configuring Multicast HQoS Correlation Mode or Passive Mode

Perform this task to configure multicast in HQoS correlation mode or passive mode to enable multicast replication over PPPoE interfaces.

SUMMARY STEPS

1. **configure**
2. **dynamic-template**
3. **type ppp** *dynamic-template name*
4. **multicast ipv4** <qos-correlation | passive>
5. Use the **commit** or **end** command.

DETAILED STEPS

	Command or Action	Purpose
Step 1	configure Example: RP/0/RSP0/CPU0:router# configure	Enters global configuration mode.
Step 2	dynamic-template Example: RP/0/RSP0/CPU0:router(config)# dynamic-template	Enter the dynamic-template configuration mode.
Step 3	type ppp <i>dynamic-template name</i> Example: RP/0/RSP0/CPU0:router(config-dynamic-template)# type ppp foo	Enters the ppp type mode to configure igmp for subscriber interfaces.
Step 4	multicast ipv4 <qos-correlation passive> Example: RP/0/RSP0/CPU0:router(config-dynamic-template-type)# multicast ipv4 qos-correlation	Configures the subscriber either in the QoS-correlation mode (IGMP-HQoS correlation), or passive mode (multicast forwarding).
Step 5	Use the commit or end command.	commit —Saves the configuration changes and remains within the configuration session. end —Prompts user to take one of these actions:

	Command or Action	Purpose
		<ul style="list-style-type: none"> • Yes — Saves configuration changes and exits the configuration session. • No —Exits the configuration session without committing the configuration changes. • Cancel —Remains in the configuration session, without committing the configuration changes.

Configuring Multicast HQoS Correlation Mode: An example

```
dynamic-template type ppp foo
multicast ipv4 qos-correlation
!
!
end
```

IGMP to Unicast QoS Shaper Correlation

The Unicast QoS Shaper correlation feature configures the bandwidth profiles for the multicast flows and allows the IGMP messages to derive the multicast bandwidth usage for each subscriber. On the PPPoE subscriber sessions, the amount of multicast bandwidth that a subscriber uses is deducted from the unicast QoS shaper until a minimum threshold is reached.

For more information about configuring the IGMP QoS shaper, see [Configuring the IGMP to HQoS Correlation Feature in a VRF, on page 342](#). For more information about configuring the IGMP for subscriber interfaces, see [Configuring IGMP Parameters for Subscriber Interfaces, on page 345](#).

IGMP uses route-policies to distribute the absolute rate for all multicast flows. For more information for configuring the route-policy for unicast QoS shaper, see [Configuring route-policy for Unicast QoS Shaper, on page 344](#).

Configuring the IGMP to HQoS Correlation Feature in a VRF

Perform this task to configure the IGMP to HQoS Correlation Feature in a VRF.

SUMMARY STEPS

1. **configure**
2. **router igmp**
3. **unicast-qos-adjust adjustment-delay** *time*
4. **unicast-qos-adjust download-interval** *time*
5. **unicast-qos-adjust holdoff** *time*
6. **vrf** *vrf-name*
7. **traffic profile** *profile-name*
8. Use the **commit** or **end** command.

DETAILED STEPS

	Command or Action	Purpose
Step 1	configure Example: RP/0/RSP0/CPU0:router# configure	Enters global configuration mode.
Step 2	router igmp Example: RP/0/RSP0/CPU0:router(config)# router igmp	Enters the router process for IGMP configuration mode.
Step 3	unicast-qos-adjust adjustment-delay time Example: RP/0/RSP0/CPU0:router(config-igmp)# unicast-qos-adjust adjustment-delay 1	Configures the time to wait before programming rate in IGMP QoS shaper for subscriber unicast traffic. The time to wait ranges from 0 to 10 seconds.
Step 4	unicast-qos-adjust download-interval time Example: RP/0/RSP0/CPU0:router(config-igmp)# unicast-qos-adjust download-interval 10	Configures the time before downloading a batch of interfaces to IGMP QoS shaper for subscriber unicast traffic. The download interval time ranges from 10 to 500 milliseconds.
Step 5	unicast-qos-adjust holdoff time Example: RP/0/RSP0/CPU0:router(config-igmp)# unicast-qos-adjust holdoff 5	Configures the hold-off time before QoS clears the stale entries for the IGMP QoS shaper. The hold-off time ranges from 5 to 1800 seconds.
Step 6	vrf vrf-name Example: RP/0/RSP0/CPU0:router(config-igmp)# vrf vrf1	Enters the VRF configuration mode.
Step 7	traffic profile profile-name Example: RP/0/RSP0/CPU0:router(config-igmp-vrf1)# traffic profile routepolicy1	Configures the route-policy to be used to map the bandwidth profile.
Step 8	Use the commit or end command.	commit —Saves the configuration changes and remains within the configuration session. end —Prompts user to take one of these actions: <ul style="list-style-type: none"> • Yes — Saves configuration changes and exits the configuration session. • No —Exits the configuration session without committing the configuration changes. • Cancel —Remains in the configuration session, without committing the configuration changes.

Configuring the IGMP QoS Shaper: An Example

```
configure
router igmp
unicast-qos-adjust adjustment-delay 1
unicast-qos-adjust download-interval 10
unicast-qos-adjust holdoff 5
vrf vrf1
traffic profile routepolicy1
!
!
end
```

Configuring route-policy for Unicast QoS Shaper

Perform this task to configure route-policy for unicast QoS shaper.

SUMMARY STEPS

1. **configure**
2. **router igmp**
3. **vrf** *vrf-name*
4. **traffic profile** *profile-name*
5. Use the **commit** or **end** command.
6. **show igmp unicast-qos-adjust statistics**
7. **show igmp unicast-qos-adjust statistics interface** *interface-name*

DETAILED STEPS

	Command or Action	Purpose
Step 1	configure Example: RP/0/RSP0/CPU0:router# configure	Enters global configuration mode.
Step 2	router igmp Example: RP/0/RSP0/CPU0:router(config)# router igmp	Enter the router process for igmp configuration mode.
Step 3	vrf <i>vrf-name</i> Example: RP/0/RSP0/CPU0:router(config-igmp)# vrf vrf1	Enters the vrf configuration mode.
Step 4	traffic profile <i>profile-name</i> Example: RP/0/RSP0/CPU0:router(config-igmp-vrf1)# traffic profile routepolicy1	Configures the route-policy to be used to map the bandwidth profile.

	Command or Action	Purpose
Step 5	Use the commit or end command.	<p>commit —Saves the configuration changes and remains within the configuration session.</p> <p>end —Prompts user to take one of these actions:</p> <ul style="list-style-type: none"> • Yes — Saves configuration changes and exits the configuration session. • No —Exits the configuration session without committing the configuration changes. • Cancel —Remains in the configuration session, without committing the configuration changes.
Step 6	<p>show igmp unicast-qos-adjust statistics</p> <p>Example:</p> <pre>RP/0/RSP0/CPU0:router# show igmp unicast-qos-adjusted statistics</pre>	(Optional) Displays the internal statistics of the feature, such as total number of interface groups under adjustment, uptime since last clear command, and total number of rate adjustment calls for unicast QoS shaper.
Step 7	<p>show igmp unicast-qos-adjust statistics interface interface-name</p> <p>Example:</p> <pre>RP/0/RSP0/CPU0:router# show igmp unicast-qos-adjusted statistics interface interface1</pre>	(Optional) Displays the interface name, number of flows adjusted, total rate adjusted, uptime after first adjustment for unicast QoS shaper.

Configuring route-policy for Unicast QoS Shaper: Examples

```
#Adding a route-policy for profile1

route-policy profile1
if destination in (239.0.0.0/8 le 32) then
set weight 1000
endif
end-policy

# Configuring profile1 for Unicast QoS Shaper
router igmp
vrf vrf1
traffic profile profile1
!
!
end
```

Configuring IGMP Parameters for Subscriber Interfaces

Perform this task to configure IGMP parameters for subscriber interfaces.

SUMMARY STEPS

1. **configure**
2. **dynamic-template**

3. **type ppp** *dynamic-template name*
4. **igmp explicit-tracking**
5. **igmp query-interval** *value*
6. **igmp query-max-response-time** *query-response-value*
7. Use the **commit** or **end** command.

DETAILED STEPS

	Command or Action	Purpose
Step 1	configure Example: RP/0/RSP0/CPU0:router# configure	Enters global configuration mode.
Step 2	dynamic-template Example: RP/0/RSP0/CPU0:router(config)# dynamic-template	Enter the dynamic-template configuration mode.
Step 3	type ppp <i>dynamic-template name</i> Example: RP/0/RSP0/CPU0:router(config-dynamic-template)# type ppp foo	Enters the ppp type mode to configure igmp for subscriber interfaces.
Step 4	igmp explicit-tracking Example: RP/0/RSP0/CPU0:router(config-dynamic-template-type)# igmp explicit-tracking	Enables IGMPv3 explicit host tracking.
Step 5	igmp query-interval <i>value</i> Example: RP/0/RSP0/CPU0:router(config-dynamic-template-type)# igmp query-interval 60	Sets the query-interval in seconds for igmp. Note The igmp query-interval value, in seconds, should be in the range from 1 to 3600. With 16000 PPPoE subscribers or less, the recommended value, that also the default, is 60 seconds.
Step 6	igmp query-max-response-time <i>query-response-value</i> Example: RP/0/RSP0/CPU0:router(config-dynamic-template-type)# igmp query-max-response-time 4	Sets the query-max-response-time in seconds for igmp. Note The igmp query-interval value, in seconds, is in the range from 1 to 12.
Step 7	Use the commit or end command.	commit —Saves the configuration changes and remains within the configuration session. end —Prompts user to take one of these actions:

	Command or Action	Purpose
		<ul style="list-style-type: none"> • Yes — Saves configuration changes and exits the configuration session. • No — Exits the configuration session without committing the configuration changes. • Cancel — Remains in the configuration session, without committing the configuration changes.

Configuring IGMP for Subscriber Interfaces: An example

```
dynamic-template type ppp foo
igmp explicit-tracking
igmp query-interval 60
igmp query-max-response-time 4
!
end
```

IGMP QoS Correlation for IPoE Subscribers

From Cisco IOS XR Software Release 6.2.1 and later, the IGMP QoS correlation feature is extended to IPoE subscribers, in addition to PPPoE subscribers.

Use **multicast ipv4 qos-correlation** command to enable IGMP QoS correlation feature.

Running Configuration

```
/* IGMP configuration */
router igmp
 traffic profile MCAST_QOS_CVLAN
 maximum groups-per-interface 32000
 version 2
 query-timeout 60
 query-interval 600
 query-max-response-time 10
 maximum groups 75000
 unicast-qos-adjust holdoff 5
 unicast-qos-adjust download-interval 500
 unicast-qos-adjust adjustment-delay 1

/* Route policy configuration */
route-policy MCAST_QOS_CVLAN
  if destination in (225.0.0.0/8 le 32) then
    set weight 2000
  endif
end-policy

/* Dynamic Template Configuration for IP subscriber*/
ipv4 unnumbered Loopback4
ipv6 enable
```

multicast ipv4 qos-correlation

```

/* Input policy-map applied to Bundle-Ether1.1.ip199 */

policy-map parent_policy_ingress_10mb
  class CLASS_IN_1
    service-policy SET_EXP_INGRESS
    police rate 1 mbps
  !
  class CLASS_IN_2
    service-policy SET_EXP_INGRESS
    police rate 10 mbps
  !
  class class-default
  !

/* Output policy-map applied to Bundle-Ether1.1.ip199 */

policy-map parent_policy_egress_10mb
  class class-default
    service-policy child_policy_egress_1mb
    shape average 10 mbps
  !

/* Child policy-map(s) of policy-map parent_policy_egress_10mb */

policy-map child_policy_egress_1mb
  class class-default
    bandwidth 1 mbps
  !

```

Verification

```
RP/0/RSP0/CPU0:router#show qos interface bundle-Ether 1.1.ip199 output
```

```

Bandwidth configured: 10000 kbps Bandwidth programed: 10000 kbps
ANCP user configured: 0 kbps ANCP programed in HW: 0 kbps
Port Shaper programed in HW: 0 kbps
Policy: parent_policy_egress_10mb Total number of classes: 2
-----
Level: 0 Policy: parent_policy_egress_10mb Class: class-default
QueueID: N/A
Shape CIR : NONE

```

```
Shape PIR Profile : 0/3(S) Scale: 156 PIR: 9984 kbps PBS: 124800 bytes
```

```

WFQ Profile: 0/9 Committed Weight: 10 Excess Weight: 10
Bandwidth: 0 kbps, BW sum for Level 0: 0 kbps, Excess Ratio: 1

```

```

Level: 1 Policy: child_policy_egress_1mb Class: class-default
Parent Policy: parent_policy_egress_10mb Class: class-default
QueueID: 650 (Priority Normal)
Queue Limit: 126 kbytes Abs-Index: 29 Template: 0 Curve: 0
Shape CIR Profile: INVALID
WFQ Profile: 0/81 Committed Weight: 101 Excess Weight: 101

```

```
Bandwidth: 1000 kbps, BW sum for Level 1: 1000 kbps, Excess Ratio: 1
```

After IGMP join happens:

```
RP/0/RSP0/CPU0:router#show qos interface bundle-Ether 1.1.ip199 output

Bandwidth configured: 10000 kbps Bandwidth programed: 10000 kbps
- - -
- - -
Shape CIR : NONE

Shape PIR Profile : 0/3(S) Scale: 156 PIR: 7984 kbps PBS: 124800 bytes

WFQ Profile: 0/9 Committed Weight: 10 Excess Weight: 10
- - -
- - -
WFQ Profile: 0/81 Committed Weight: 101 Excess Weight: 101

Bandwidth: 1000 kbps, BW sum for Level 1: 1000 kbps, Excess Ratio: 1
```

IGMP Accounting

The Internet Group Management Protocol (IGMP) accounting feature enables BNG to maintain a statistics file to log the instances of subscriber joining, or leaving a multicast group. The file's format is:

```
harddisk:/usr/data/igmp/accounting.dat.<Node ID>.<YYMMDD>
```

where

- Node ID is the name of the node that generates the file; for example, RP/0/RSP0/CPU0.
- YY is the year, MM is the month, and DD is the day.

An example of the statistics file name is:

```
harddisk:/usr/data/igmp/accounting.dat.RP_0_RSP0_CPU0.101225
```

The statistics file is stored on the route processor (RP) that is active. If a failover event occurs, then a new file is created on the new active RP, and no attempt is made to mirror the data between the active and the standby RP. Thus, the statistics files must be retrieved from both the active and standby RPs.

By default, the IGMP Accounting feature adds one file each day. To avoid exhausting disk space, you can specify in how many files, or for how many days, data should be retained, see [Configuring IGMP Accounting, on page 349](#). Files older than the specified period are deleted, and the data is discarded from BNG. The maximum size of each file should be no more than 250 MB.

Configuring IGMP Accounting

Perform this task to configure the IGMP accounting.

SUMMARY STEPS

1. **configure**
2. **router igmp**
3. **accounting [max-history] days**
4. Use the **commit** or **end** command.
5. **show igmp interface**

DETAILED STEPS

	Command or Action	Purpose
Step 1	configure Example: RP/0/RSP0/CPU0:router# configure	Enters global configuration mode.
Step 2	router igmp Example: RP/0/RSP0/CPU0:router(config)# router igmp	Enter the router process for IGMP configuration mode.
Step 3	accounting [max-history] days Example: RP/0/RSP0/CPU0:router(config-igmp-vrf1)# accounting max-history 50	Configures the IGMP accounting. The max-history parameter is optional and specifies how many files are kept; this number is equivalent to the number of days in the history.
Step 4	Use the commit or end command.	commit —Saves the configuration changes and remains within the configuration session. end —Prompts user to take one of these actions: <ul style="list-style-type: none"> • Yes — Saves configuration changes and exits the configuration session. • No —Exits the configuration session without committing the configuration changes. • Cancel —Remains in the configuration session, without committing the configuration changes.
Step 5	show igmp interface Example: RP/0/RSP0/CPU0:router# show igmp interface	(Optional) Displays IGMP interface information.

Configuring IGMP Accounting: An example

```
configure
router igmp
accounting max-history 45
!
!
end
```

DAPS Support

A Distributed Address Pool Service (DAPS) allows address pools to be shared between DHCP processes that run on a line card (LC) and the route processor (RP). The DHCP Server and PPPoE subscribers are clients to

DAPS, and are known as the DAPS client. DAPS is used to return IP address to clients only when the RADIUS attributes contain the attribute "Pool Name". If the RADIUS attribute for a subscriber contains a fixed address, then the client does not contact DAPS for its IP address.

DAPS runs in two forms, as DAPS server on the RP, and as DAPS-Proxy on the LC. The RP has an in-built DAPS-Proxy module. This model ensures that all DAPS clients always talk to the DAPS-Proxy. The DAPS-Proxy instances talk to the central DAPS-Server on the RP for address assignments and other requests. DAPS-Proxy runs on all the LCs in the system. The DAPS-Proxy running on an LC can service multiple clients, from that LC; for example, PPP, DHCPv6, IPv6ND. DAPS serves multiple DAPS clients on two or more nodes. A separate DAPS-Proxy process runs on each node and connects locally to each DAPS Client.

DAPS supports dynamic IPv4 and IPv6 address allocation by pool name. For more information about configuring IPv4 DAPS, see [Configuring IPv4 Distributed Address Pool Service, on page 351](#). To create a configuration pool for IPv6, see [Creating a Configuration Pool Submode, on page 352](#).

You can configure various DAPS IPv6 parameters in the IPv6 configuration submode. You can configure the subnet number and mask for an IPv6 address pool, for more information, see [Configuring the Subnet Number and Mask for an Address Pool, on page 354](#). You can specify parameters such as a range of IPv6 addresses. For more information, see [Specifying a Range of IPv6 Addresses, on page 355](#). To specify a utilization threshold, see [Specifying a Utilization Threshold, on page 357](#). To specify a set of prefixes or addresses inside a subnet, see [Specifying a Set of Addresses or Prefixes Inside a Subnet, on page 359](#). You can also specify the length of a prefix. For more information, see [Specifying the Length of the Prefix, on page 358](#).

Configuring IPv4 Distributed Address Pool Service

Perform this task to configure IPv4 distributed address pool service (DAPS).

SUMMARY STEPS

1. **configure**
2. **pool ipv4** *ipv4-pool-name*
3. **address-range** *first_address second_address*
4. **pool vrf** *vrf-name* **ipv4** *ipv4-pool-name* {**address-range** *address-range*}
5. Use the **commit** or **end** command.

DETAILED STEPS

	Command or Action	Purpose
Step 1	configure Example: RP/0/RSP0/CPU0:router# configure	Enters global configuration mode.
Step 2	pool ipv4 <i>ipv4-pool-name</i> Example: RP/0/RSP0/CPU0:router(config)# pool ipv4 pool1	Configures IPv4 pool name.
Step 3	address-range <i>first_address second_address</i> Example:	Configures the address range for allocation.

	Command or Action	Purpose
	RP/0/RSP0/CPU0:router(config-pool-ipv4)# address-range 1.1.1.1 9.8.9.8	
Step 4	<p>pool vrf vrf-name ipv4 ipv4-pool-name { address-range address-range }</p> <p>Example:</p> <pre>RP/0/RSP0/CPU0:router(config)# pool vrf vrf1 ipv4 pool1 address-range 1.1.1.1 9.8.9.8</pre>	Configures IPv4 pool name.
Step 5	Use the commit or end command.	<p>commit —Saves the configuration changes and remains within the configuration session.</p> <p>end —Prompts user to take one of these actions:</p> <ul style="list-style-type: none"> • Yes — Saves configuration changes and exits the configuration session. • No —Exits the configuration session without committing the configuration changes. • Cancel —Remains in the configuration session, without committing the configuration changes.

Configuring IPv4 Distributed Address Pool Service: An example

```
pool ipv4 pool1
address-range 1.1.1.1 9.8.9.8
pool vrf vrf1 ipv4 pool1 address-range 1.1.1.1 9.8.9.8
!
!
end
```

Creating a Configuration Pool Submode

Perform this task to create and enable an IPv6 configuration pool submode for a default VRF and for a specific VRF.

SUMMARY STEPS

1. **configure**
2. **pool ipv6 ipv6-pool-name**
3. Use the **commit** or **end** command.
4. **configure**
5. **pool vrf vrf_name ipv6 ipv6-pool-name**
6. Use the **commit** or **end** command.

DETAILED STEPS

	Command or Action	Purpose
Step 1	configure Example: RP/0/RSP0/CPU0:router# configure	Enters global configuration mode.
Step 2	pool ipv6 <i>ipv6-pool-name</i> Example: RP/0/RSP0/CPU0:router(config)# pool ipv6 pool1	Creates the IPv6 pool name for a default VRF and enters the pool IPv6 configuration submode.
Step 3	Use the commit or end command.	commit —Saves the configuration changes and remains within the configuration session. end —Prompts user to take one of these actions: <ul style="list-style-type: none"> • Yes — Saves configuration changes and exits the configuration session. • No —Exits the configuration session without committing the configuration changes. • Cancel —Remains in the configuration session, without committing the configuration changes.
Step 4	configure Example: RP/0/RSP0/CPU0:router# configure	Enters global configuration mode.
Step 5	pool vrf <i>vrf_name</i> ipv6 <i>ipv6-pool-name</i> Example: RP/0/RSP0/CPU0:router(config)# pool vrf vrf1 ipv6 pool1	Creates the IPv6 pool name for a specific VRF and enters the pool IPv6 configuration submode.
Step 6	Use the commit or end command.	commit —Saves the configuration changes and remains within the configuration session. end —Prompts user to take one of these actions: <ul style="list-style-type: none"> • Yes — Saves configuration changes and exits the configuration session. • No —Exits the configuration session without committing the configuration changes. • Cancel —Remains in the configuration session, without committing the configuration changes.

Creating a Configuration Pool Submode: An example

```
configure
pool ipv6 pool1 (default vrf)
!
!
configure
pool vrf vrf1 ipv6 pool1 (for a specific vrf)
!
!
end
```

Configuring the Subnet Number and Mask for an Address Pool

Perform this task to create the subnet number and mask for an IPv6 address pool.

SUMMARY STEPS

1. **configure**
2. **pool vrf** *vrf_name* **ipv6** *ipv6-pool-name*
3. **prefix-length** *value*
4. **network** *subnet*
5. **utilization-mark** **high** *value* **low** *value*
6. **exclude** *low_ip_address* *high_ip_address*
7. Use the **commit** or **end** command.

DETAILED STEPS

	Command or Action	Purpose
Step 1	configure Example: RP/0/RSP0/CPU0:router# configure	Enters global configuration mode.
Step 2	pool vrf <i>vrf_name</i> ipv6 <i>ipv6-pool-name</i> Example: RP/0/RSP0/CPU0:router(config)# pool vrf default ipv6 test	Creates the IPv6 pool name for a specific VRF and enters the pool IPv6 configuration submode.
Step 3	prefix-length <i>value</i> Example: RP/0/RSP0/CPU0:router(config-pool-ipv6)# prefix-length 120	Specifies the length of the prefix that is assigned to the clients. The value of the prefix length ranges from 1 to 128.
Step 4	network <i>subnet</i> Example:	Specifies a set of addresses or prefixes inside a subnet.

	Command or Action	Purpose
	RP/0/RSP0/CPU0:router(config-pool-ipv6)# network 1101:1::/114	Note The prefix-length command must be mandatorily configured whenever the network command is used.
Step 5	<p>utilization-mark high value low value</p> <p>Example:</p> <pre>RP/0/RSP0/CPU0:router(config-pool-ipv6)# utilization-mark high 70 low 30</pre>	Specifies a utilization threshold in the pool IPv6 submode. The high and low values are represented as percentages between 0 and 100.
Step 6	<p>exclude low_ip_address high_ip_address</p> <p>Example:</p> <pre>RP/0/RSP0/CPU0:router(config-pool-ipv6)# exclude 1101:1::100 ::</pre>	<p>Specifies a range of IPv6 addresses or prefixes that DAPS must not assign to clients. The high and low values are represented as percentages between 0 and 100.</p> <p>Note Multiple exclude commands are allowed within a pool. To exclude a single address, <i><high_ip_address></i> can be omitted.</p>
Step 7	Use the commit or end command.	<p>commit —Saves the configuration changes and remains within the configuration session.</p> <p>end —Prompts user to take one of these actions:</p> <ul style="list-style-type: none"> • Yes — Saves configuration changes and exits the configuration session. • No —Exits the configuration session without committing the configuration changes. • Cancel —Remains in the configuration session, without committing the configuration changes.

Configuring the Subnet Number and Mask for an Address Pool: An example

```
configure
pool vrf default ipv6 test
prefix-length 120
network 1101:1::/114
utilization-mark high 70 low 30
exclude 1101:1::100 ::
!
!
end
```

Specifying a Range of IPv6 Addresses

Perform this task to specify a range of IPv6 addresses within a pool.

SUMMARY STEPS

1. **configure**
2. **pool vrf** *vrf_name* **ipv6** *ipv6-pool-name*
3. **address-range** *low_ip_address* *high_ip_address*
4. Use the **commit** or **end** command.

DETAILED STEPS

	Command or Action	Purpose
Step 1	configure Example: RP/0/RSP0/CPU0:router# <code>configure</code>	Enters global configuration mode.
Step 2	pool vrf <i>vrf_name</i> ipv6 <i>ipv6-pool-name</i> Example: RP/0/RSP0/CPU0:router(config)# <code>pool vrf vrf1 ipv6 addr_vrf</code>	Creates the IPv6 pool name for a specific VRF and enters the pool IPv6 configuration submenu.
Step 3	address-range <i>low_ip_address</i> <i>high_ip_address</i> Example: RP/0/RSP0/CPU0:router(config-pool-ipv6)# <code>address-range 1234::2 1234::3e81</code>	Specifies the range of IPv6 addresses within a pool. Multiple address-ranges are allowed within a pool.
Step 4	Use the commit or end command.	commit —Saves the configuration changes and remains within the configuration session. end —Prompts user to take one of these actions: <ul style="list-style-type: none"> • Yes — Saves configuration changes and exits the configuration session. • No —Exits the configuration session without committing the configuration changes. • Cancel —Remains in the configuration session, without committing the configuration changes.

Specifying a Range of IPv6 Addresses: An example

```
configure
pool vrf vrf1 ipv6 addr_vrf
address-range 1234::2 1234::3e81
!
!
end
```

Specifying a Utilization Threshold

Perform this task to specify a utilization threshold for a specific VRF in the pool IPv6 submode.

SUMMARY STEPS

1. **configure**
2. **pool vrf** *vrf_name* **ipv6** *ipv6-pool-name*
3. **prefix-length** *value*
4. **network** *subnet*
5. **utilization-mark** **high** *value* **low** *value*
6. Use the **commit** or **end** command.

DETAILED STEPS

	Command or Action	Purpose
Step 1	configure Example: RP/0/RSP0/CPU0:router# configure	Enters global configuration mode.
Step 2	pool vrf <i>vrf_name</i> ipv6 <i>ipv6-pool-name</i> Example: RP/0/RSP0/CPU0:router(config)# pool vrf default ipv6 test	Creates the IPv6 pool name for a specific VRF and enters the pool IPv6 configuration submode.
Step 3	prefix-length <i>value</i> Example: RP/0/RSP0/CPU0:router(config-pool-ipv6)# prefix-length 120	Specifies the length of the prefix that is assigned to the clients. The value of the prefix length ranges from 1 to 128.
Step 4	network <i>subnet</i> Example: RP/0/RSP0/CPU0:router(config-pool-ipv6)# network 1101:1::/114	Specifies a set of addresses or prefixes inside a subnet. Note The prefix-length command should be mandatorily configured whenever the network command is used.
Step 5	utilization-mark high <i>value</i> low <i>value</i> Example: RP/0/RSP0/CPU0:router(config-pool-ipv6)# utilization-mark high 70 low 30	Specifies a utilization threshold in the pool IPv6 submode. The high and low values are represented as percentages between 0 and 100.
Step 6	Use the commit or end command.	commit —Saves the configuration changes and remains within the configuration session. end —Prompts user to take one of these actions:

	Command or Action	Purpose
		<ul style="list-style-type: none"> • Yes — Saves configuration changes and exits the configuration session. • No —Exits the configuration session without committing the configuration changes. • Cancel —Remains in the configuration session, without committing the configuration changes.

Specifying a Utilization Threshold: An example

```

configure
pool vrf default ipv6 test
prefix-length 120
network 1101:1::/114
utilization-mark high 70 low 30
!
!
end

```

Specifying the Length of the Prefix

Perform this task to specify the length of the prefix that is assigned to the clients.

SUMMARY STEPS

1. **configure**
2. **pool vrf** *vrf_name* **ipv6** *ipv6-pool-name*
3. **prefix-length** *value*
4. **prefix-range** *low_ipv6_prefix* *high_ipv6_prefix*
5. Use the **commit** or **end** command.

DETAILED STEPS

	Command or Action	Purpose
Step 1	configure Example: RP/0/RSP0/CPU0:router# configure	Enters global configuration mode.
Step 2	pool vrf <i>vrf_name</i> ipv6 <i>ipv6-pool-name</i> Example: RP/0/RSP0/CPU0:router(config)# pool vrf vrf1 ipv6 prefix_vrf	Creates the IPv6 pool name for a specific VRF and enters the pool IPv6 configuration submenu.

	Command or Action	Purpose
Step 3	<p>prefix-length <i>value</i></p> <p>Example:</p> <pre>RP/0/RSP0/CPU0:router(config-pool-ipv6)# prefix-length 64</pre>	Specifies the length of the prefix that is assigned to the clients. The value of the prefix length ranges from 1 to 128.
Step 4	<p>prefix-range <i>low_ipv6_prefix high_ipv6_prefix</i></p> <p>Example:</p> <pre>RP/0/RSP0/CPU0:router(config-pool-ipv6)# prefix-range 9fff:1:: 9fff:1:0:3e7f::</pre>	<p>Specifies a range of IPv6 address prefixes for a specific VRF in the pool IPv6 configuration mode.</p> <p>Note The prefix-length must be mandatorily configured whenever prefix-range is configured.</p>
Step 5	Use the commit or end command.	<p>commit —Saves the configuration changes and remains within the configuration session.</p> <p>end —Prompts user to take one of these actions:</p> <ul style="list-style-type: none"> • Yes — Saves configuration changes and exits the configuration session. • No —Exits the configuration session without committing the configuration changes. • Cancel —Remains in the configuration session, without committing the configuration changes.

Specifying the Length of the Prefix that is Assigned to the Clients: An example

```
configure
pool vrf vrf1 ipv6 prefix_vrf
prefix-length 64
prefix-range 9fff:1:: 9fff:1:0:3e7f::
!
!
end
```

Specifying a Set of Addresses or Prefixes Inside a Subnet

Perform this task to specify a set of addresses or prefixes inside a subnet in the pool IPv6 configuration submode.

SUMMARY STEPS

1. **configure**
2. **pool vrf** *vrf_name* **ipv6** *ipv6-pool-name*
3. **prefix-length** *value*
4. **network** *subnet*
5. **utilization-mark** **high** *value* **low** *value*

6. **exclude** *low_ip_address high_ip_address*
7. Use the **commit** or **end** command.

DETAILED STEPS

	Command or Action	Purpose
Step 1	configure Example: RP/0/RSP0/CPU0:router# configure	Enters global configuration mode.
Step 2	pool vrf vrf_name ipv6 ipv6-pool-name Example: RP/0/RSP0/CPU0:router(config)# pool vrf default ipv6 test	Creates the IPv6 pool name for a specific VRF and enters the pool IPv6 configuration submenu.
Step 3	prefix-length value Example: RP/0/RSP0/CPU0:router(config-pool-ipv6)# prefix-length 120	Specifies the length of the prefix that is assigned to the clients. The value of the prefix length ranges from 1 to 128.
Step 4	network subnet Example: RP/0/RSP0/CPU0:router(config-pool-ipv6)# network 1101:1::/114	Specifies a set of addresses or prefixes inside a subnet. Note The prefix-length command should be mandatorily configured whenever the network command is used.
Step 5	utilization-mark high value low value Example: RP/0/RSP0/CPU0:router(config-pool-ipv6)# utilization-mark high 70 low 30	Specifies a utilization threshold in the pool IPv6 submenu. The high and low values are represented as percentages between 0 and 100.
Step 6	exclude low_ip_address high_ip_address Example: RP/0/RSP0/CPU0:router(config-pool-ipv6)# exclude 1101:1::100 ::	Specifies a range of IPv6 addresses or prefixes that DAPS must not assign to clients. The high and low values are represented as percentages between 0 and 100. Note Multiple exclude commands are allowed within a pool. To exclude a single address, <high_ip_address> can be omitted.
Step 7	Use the commit or end command.	commit —Saves the configuration changes and remains within the configuration session. end —Prompts user to take one of these actions: <ul style="list-style-type: none">• Yes — Saves configuration changes and exits the configuration session.

	Command or Action	Purpose
		<ul style="list-style-type: none"> • No —Exits the configuration session without committing the configuration changes. • Cancel —Remains in the configuration session, without committing the configuration changes.

Specifying a Set of Addresses or Prefixes Inside a Subnet: An example

```

configure
pool vrf default ipv6 test
prefix-length 120
network 1101:1::/114
utilization-mark high 70 low 30
exclude 1101:1::100 ::
!
!
end

```

HTTP Redirect Using PBR

The HTTP Redirect (HTTTPR) feature is used to redirect subscriber traffic to a destination other than the one to which it was originally destined. The HTTTPR feature is implemented using Policy Based Routing (PBR) that makes packet forwarding decisions based on the policy configuration, instead of routing protocols. The HTTTPR feature is implemented by sending an HTTP redirect response, which contains the redirect URL, back to the HTTP client that originally sent the request. Thereafter, the HTTP client sends requests to the redirected URL. HTTTPR is supported for both IPv4 and IPv6 subscribers.

The most common use of HTTTPR feature is for initial logon. In some cases, it is not possible to uniquely identify a subscriber and authorize them. This happens when the subscriber is using a shared network access medium to connect to the network. In such cases, the subscriber is allowed to access the network but restricted to what is known as an "open-garden". An open-garden is a collection of network resources that subscribers can access as long as they have physical access to the network. Subscribers do not have to provide authentication information before accessing the web sites in an open-garden.

When subscribers try to access resources outside the open-garden (which is called the "walled-garden"), they are redirected to a web logon portal. The walled-garden refers to a collection of web sites or networks that subscribers can access after providing minimal authentication information. The web logon portal requires the subscriber to login using a username and password. Thereafter, the web logon portal sends an account-logon CoA to BNG with user credentials. On successful authentication of these credentials, BNG disables the redirect and applies the correct subscriber policies for direct network access. Other uses of HTTTPR include periodic redirection to a web portal for advertising reasons, redirection to a billing server, and so on.

The PBR function is configured in its own dynamic template. If the dynamic template contains other functions too, then the PBR policy that redirects packets must be deactivated using a CoA.

BNG maintains HTTP redirect statistics counters that track the number of packets that are being either redirected or dropped. The HTTP protocol uses some status codes to implement HTTTPR. Currently, the redirect codes 302 (for HTTP version 1.0) and 307 (for HTTP version 1.1) are supported on BNG.

From Cisco IOS XR Software Release 6.6.3 onwards, the HTTP redirect feature on BNG is enhanced to support pseudowire headend (PWHE) subscriber sessions as well. This enhancement is available along with subscriber redundancy group (SRG) support, thereby providing geographical redundancy for such sessions.

**Note**

- HTTP redirect applies only to HTTP packets. As a result, other services such as SMTP, FTP are not affected by this feature. Nevertheless, if these other services are part of the redirect classification rules, then the packets are dropped and not forwarded.
- HTTPS is not supported.
- Destination URL-based classification is not supported.

The process of configuring HTTPR involves these stages:

- Creating access lists that define the redirected and open-garden permissions. See, [Identifying HTTP Destinations for Redirection, on page 362](#).
- Creating the class-maps that uses the access list to classify the traffic as redirected, or permitted to access open-garden. See, [Configuring Class Maps for HTTP Redirection, on page 365](#).
- Creating the policy-map to define the action to be performed on the traffic classified using class-maps. See, [Configuring Policy Map for HTTP Redirect, on page 368](#).
- Creating the dynamic template to apply the service policy. See [Configuring Dynamic Template for Applying HTTPR Policy, on page 370](#).

To configure a web logon that specifies a time limit to perform the authentication, see [Configuring Web Logon, on page 371](#).

Identifying HTTP Destinations for Redirection

Perform this task to define access lists that identify http destinations that require redirection or are part of an open garden:

SUMMARY STEPS

1. **configure**
2. **{ipv4 | ipv6}access-list** *redirect_acl_name*
3. Do one of the following:
 - `[sequence-number] {permit | deny} source source-wildcard destination destination-wildcard [precedence precedence] [dscp dscp] [fragments] [packet-length operator packet-length value] [log | log-input]`
 - `[sequence-number] {permit | deny} protocol {source-ipv6-prefix/prefix-length | any | host source-ipv6-address} [operator {port | protocol-port}] {destination-ipv6-prefix/prefix-length | any | host destination-ipv6-address} [operator {port | protocol-port}] [dscp value] [routing] [authen] [destopts] [fragments] [packet-length operator packet-length value] [log | log-input]`
4. Repeat Step 3 as necessary, adding statements by sequence number. Use the **no** *sequence-number* command to delete an entry.
5. **{ipv4 | ipv6}access-list** *open_garden_acl*

6. Do one of the following:

- [*sequence-number*] { **permit** | **deny** } *source source-wildcard destination destination-wildcard* [**precedence precedence**] [**dscp dscp**] [**fragments**] [*packet-length operator packet-length value*] [**log** | **log-input**]
- [*sequence-number*] { **permit** | **deny** } *protocol {source-ipv6-prefix/prefix-length | any | host source-ipv6-address} [operator {port | protocol-port}] {destination-ipv6-prefix/prefix-length | any | host destination-ipv6-address} [operator {port | protocol-port}] [dscp value] [routing] [authen] [destopts] [fragments] [packet-length operator packet-length value] [log | log-input]*

7. Repeat Step 6 as necessary, adding statements by sequence number. Use the **no sequence-number** command to delete an entry.

8. Use the **commit** or **end** command.

DETAILED STEPS

	Command or Action	Purpose
Step 1	<p>configure</p> <p>Example:</p> <pre>RP/0/RSP0/CPU0:router# configure</pre>	<p>Enters global configuration mode.</p>
Step 2	<p>{ipv4 ipv6} access-list <i>redirect_acl_name</i></p> <p>Example:</p> <pre>RP/0/RSP0/CPU0:router(config)# ipv4 access-lists redirect_acl</pre> <p>or</p> <pre>RP/0/RSP0/CPU0:router(config)# ipv6 access-lists redirect_acl</pre>	<p>Enters either IPv4 or IPv6 access list configuration mode and configures the named access list.</p>
Step 3	<p>Do one of the following:</p> <ul style="list-style-type: none"> • [<i>sequence-number</i>] { permit deny } <i>source source-wildcard destination destination-wildcard</i> [precedence precedence] [dscp dscp] [fragments] [<i>packet-length operator packet-length value</i>] [log log-input] • [<i>sequence-number</i>] { permit deny } <i>protocol {source-ipv6-prefix/prefix-length any host source-ipv6-address} [operator {port protocol-port}] {destination-ipv6-prefix/prefix-length any host destination-ipv6-address} [operator {port protocol-port}] [dscp value] [routing] [authen] [destopts] [fragments] [packet-length operator packet-length value] [log log-input]</i> <p>Example:</p> <pre>RP/0/RSP0/CPU0:router(config-ipv4-acl)# 10 permit 172.16.0.0 0.0.255.255</pre>	<p>Specifies one or more conditions allowed or denied in IPv4 or IPv6 access list <i>redirect_acl</i>.</p> <ul style="list-style-type: none"> • The optional log keyword causes an information logging message about the packet that matches the entry to be sent to the console. • The optional log-input keyword provides the same function as the log keyword, except that the logging message also includes the input interface. <p>or</p> <p>Specifies one or more conditions allowed or denied in IPv6 access list <i>redirect_acl</i>.</p> <ul style="list-style-type: none"> • Refer to the deny (IPv6) and permit (IPv6) commands for more information on filtering IPv6 traffic based on based on IPv6 option headers and optional, upper-layer protocol type information.

	Command or Action	Purpose
	<pre>RP/0/RSP0/CPU0:router(config-ipv4-acl)# 20 deny 192.168.34.0 0.0.0.255</pre> <p>or</p> <pre>RP/0/RSP0/CPU0:router(config-ipv6-acl)# 20 permit icmp any any RP/0/RSP0/CPU0:router(config-ipv6-acl)# 30 deny tcp any any gt 5000</pre>	<p>Note Every IPv6 access list has an implicit deny ipv6 any any statement as its last match condition. An IPv6 access list must contain at least one entry for the implicit deny ipv6 any any statement to take effect.</p>
Step 4	Repeat Step 3 as necessary, adding statements by sequence number. Use the no sequence-number command to delete an entry.	Allows you to revise an access list.
Step 5	<p>{ipv4 ipv6}access-list open_garden_acl</p> <p>Example:</p> <pre>RP/0/RSP0/CPU0:router(config)# ipv4 access-lists open_garden_acl</pre> <p>or</p> <pre>RP/0/RSP0/CPU0:router(config)# ipv6 access-lists open_garden_acl</pre>	Enters either IPv4 or IPv6 access list configuration mode and configures the named access list for open garden.
Step 6	<p>Do one of the following:</p> <ul style="list-style-type: none"> • [<i>sequence-number</i>] { permit deny } <i>source source-wildcard destination destination-wildcard</i> [precedence <i>precedence</i>] [dscp <i>dscp</i>] [fragments] [<i>packet-length operator packet-length value</i>] [log log-input] • [<i>sequence-number</i>] { permit deny } <i>protocol {source-ipv6-prefix/prefix-length any host source-ipv6-address} [operator {port protocol-port}] {destination-ipv6-prefix/prefix-length any host destination-ipv6-address} [operator {port protocol-port}] [dscp value] [routing] [authen] [destopts] [fragments] [packet-length operator packet-length value] [log log-input]</i> <p>Example:</p> <pre>RP/0/RSP0/CPU0:router(config-ipv4-acl)# 10 permit 172.16.0.0 0.0.255.255 RP/0/RSP0/CPU0:router(config-ipv4-acl)# 20 deny 192.168.34.0 0.0.0.255</pre> <p>or</p> <pre>RP/0/RSP0/CPU0:router(config-ipv6-acl)# 20 permit icmp any any RP/0/RSP0/CPU0:router(config-ipv6-acl)# 30 deny tcp any any gt 5000</pre>	<p>Specifies one or more conditions allowed or denied in IPv4 access list open_garden_acl.</p> <ul style="list-style-type: none"> • The optional log keyword causes an information logging message about the packet that matches the entry to be sent to the console. • The optional log-input keyword provides the same function as the log keyword, except that the logging message also includes the input interface. <p>or</p> <p>Specifies one or more conditions allowed or denied in IPv6 access list open_garden_acl.</p> <ul style="list-style-type: none"> • Refer to the deny (IPv6) and permit (IPv6) commands for more information on filtering IPv6 traffic based on based on IPv6 option headers and optional, upper-layer protocol type information. <p>Note Every IPv6 access list has an implicit deny ipv6 any any statement as its last match condition. An IPv6 access list must contain at least one entry for the implicit deny ipv6 any any statement to take effect.</p>

	Command or Action	Purpose
Step 7	Repeat Step 6 as necessary, adding statements by sequence number. Use the no sequence-number command to delete an entry.	Allows you to revise an access list.
Step 8	Use the commit or end command.	<p>commit —Saves the configuration changes and remains within the configuration session.</p> <p>end —Prompts user to take one of these actions:</p> <ul style="list-style-type: none"> • Yes — Saves configuration changes and exits the configuration session. • No —Exits the configuration session without committing the configuration changes. • Cancel —Remains in the configuration session, without committing the configuration changes.

Identifying HTTP Destinations for Redirection: An example

```

configure
  ipv4 access-list <redirect-acl>
    10 permit tcp any any syn eq www
    20 permit tcp any any ack eq www
    30 permit tcp any any eq www
  ipv4 access-group <allow-acl>
    10 permit tcp any 10.1.1.0 0.0.0.255 eq www
    20 permit tcp any 20.1.1.0 0.0.0.255 eq www
    30 permit tcp any 30.1.1.0 0.0.0.255 eq www
    40 permit udp any any eq domain
  !
  !
  !
end

configure
  ipv6 access-list <redirect-acl>
    10 permit tcp any any syn eq www
    20 permit tcp any any ack eq www
    30 permit tcp any any eq www
  ipv6 access-group <allow-acl>
    10 permit tcp any 10.1.1.0 0.0.0.255 eq www
    20 permit tcp any 20.1.1.0 0.0.0.255 eq www
    30 permit tcp any 30.1.1.0 0.0.0.255 eq www
    40 permit udp any any eq domain
  !
  !
  !
end

```

Configuring Class Maps for HTTP Redirection

Perform this task to configure the class maps for HTTP redirection. It makes use of previously defined ACLs.

Before you begin

The configuration steps mentioned in [Identifying HTTP Destinations for Redirection, on page 362](#) has to be completed before performing the configuration of the HTTP class maps.

SUMMARY STEPS

1. **configure**
2. **class-map type traffic match-all** *open-garden-class_name*
3. **match [not] access-group**{**ipv4 | ipv6**} *open_garden_acl*
4. **end-class-map**
5. **class-map type traffic match-all** *http_redirect-class_name*
6. **match [not] access-group** {**ipv4 | ipv6**} *redirect_acl*
7. **end-class-map**
8. Use the **commit** or **end** command.

DETAILED STEPS

	Command or Action	Purpose
Step 1	configure Example: RP/0/RSP0/CPU0:router# configure	Enters global configuration mode.
Step 2	class-map type traffic match-all <i>open-garden-class_name</i> Example: RP/0/RSP0/CPU0:router(config)# class-map type traffic match-all CL1	Defines a traffic class and the associated rules that match packets to the class for a open garden class.
Step 3	match [not] access-group { ipv4 ipv6 } <i>open_garden_acl</i> Example: RP/0/RSP0/CPU0:router(config-cmap)# match not access-group ipv4 open_garden_acl or RP/0/RSP0/CPU0:router(config-cmap)# match not access-group ipv6 open_garden_acl	Identifies a specified access control list (ACL) number as the match criteria for a class map. Note The redirect acl name provided in this step is the one configured in the configuration step mentioned in the prerequisites.
Step 4	end-class-map Example: RP/0/RSP0/CPU0:router(config-cmap)# end-class-map	Ends the configuration of match criteria for the class and exits the class map configuration mode.

	Command or Action	Purpose
Step 5	<p>class-map type traffic match-all <i>http_redirect-class_name</i></p> <p>Example:</p> <pre>RP/0/RSP0/CPU0:router(config)# class-map type traffic match-all RCL1</pre>	<p>Defines a traffic class and the associated rules that match packets to the class for an open garden class.</p>
Step 6	<p>match [not] access-group {ipv4 ipv6} redirect_acl</p> <p>Example:</p> <pre>RP/0/RSP0/CPU0:router(config-cmap)# match not access-group ipv4 redirect_acl</pre> <p>or</p> <pre>RP/0/RSP0/CPU0:router(config-cmap)# match not access-group ipv6 redirect_acl</pre>	<p>Identifies a specified access control list (ACL) number as the match criteria for a class map.</p> <p>Note The redirect acl name provided in this step is the one configured in the configuration step mentioned in the prerequisites.</p>
Step 7	<p>end-class-map</p> <p>Example:</p> <pre>RP/0/RSP0/CPU0:router(config-cmap)# end-class-map</pre>	<p>Ends the configuration of match criteria for the class and exits the class map configuration mode.</p>
Step 8	<p>Use the commit or end command.</p>	<p>commit —Saves the configuration changes and remains within the configuration session.</p> <p>end —Prompts user to take one of these actions:</p> <ul style="list-style-type: none"> • Yes — Saves configuration changes and exits the configuration session. • No —Exits the configuration session without committing the configuration changes. • Cancel —Remains in the configuration session, without committing the configuration changes.

Configuring Class Maps for HTTP Redirection: An example

```
configure
class-map type traffic [match-any | match-all] <open-garden-class>
match [not] access-group ipv4 allow-acl
end-class-map

class-map type traffic [match-any | match-all] <http-redirect-class>
match [not] access-group ipv4 redirect-acl
end-class-map
!
!
!
end
```

```

configure
class-map type traffic [match-any | match-all] <open-garden-class>
match [not] access-group ipv6 allow-acl
end-class-map

class-map type traffic [match-any | match-all] <http-redirect-class>
match [not] access-group ipv6 redirect-acl
end-class-map
!
!
!
end

```

Configuring Policy Map for HTTP Redirect

Perform this task to configure policy maps for http redirect.

Before you begin

The configuration steps mentioned in [Identifying HTTP Destinations for Redirection, on page 362](#) and [Configuring Class Maps for HTTP Redirection, on page 365](#) have to be completed before performing the configuration of the policy-map for HTTPR.

SUMMARY STEPS

1. **configure**
2. **policy-map type pbr** *http-redirect_policy_name*
3. **class type traffic** *open_garden_class_name*
4. **transmit**
5. **class type traffic** *http_redirect-class_name*
6. **http-redirect** *redirect_url*
7. **class class-default**
8. **drop**
9. **end-policy-map**
10. Use the **commit** or **end** command.

DETAILED STEPS

	Command or Action	Purpose
Step 1	configure Example: RP/0/RSP0/CPU0:router# configure	Enters global configuration mode.
Step 2	policy-map type pbr <i>http-redirect_policy_name</i> Example: RP/0/RSP0/CPU0:router(config)# policy-map type pbr RPL1	Creates a policy map of type policy-based routing that can be attached to one or more interfaces to specify a service policy.

	Command or Action	Purpose
Step 3	<p>class type traffic <i>open_garden_class_name</i></p> <p>Example:</p> <pre>RP/0/RSP0/CPU0:router(config-pmap)# class type traffic CL1</pre>	<p>Specifies the name of the class whose policy you want to create or change.</p> <p>Note The open garden acl name provided in this step is the one configured in the configuration step mentioned in the prerequisites.</p>
Step 4	<p>transmit</p> <p>Example:</p> <pre>RP/0/RSP0/CPU0:router(config-pmap)# transmit</pre>	Forwards the packet to the original destination.
Step 5	<p>class type traffic <i>http_redirect-class_name</i></p> <p>Example:</p> <pre>RP/0/RSP0/CPU0:router(config-pmap)# class type traffic RCL1</pre>	<p>Specifies the name of the class whose policy you want to create or change.</p> <p>Note The open garden acl name provided in this step is the one configured in the configuration step mentioned in the prerequisites.</p>
Step 6	<p>http-redirect <i>redirect_url</i></p> <p>Example:</p> <pre>RP/0/RSP0/CPU0:router(config-pmap-c)# http-redirect redirect_url</pre>	Specifies the URL to which the HTTP requests should be redirected.
Step 7	<p>class class-default</p> <p>Example:</p> <pre>RP/0/RSP0/CPU0:router(config-pmap)# class class-default</pre>	Configures default classes that cannot be used with user-defined classes.
Step 8	<p>drop</p> <p>Example:</p> <pre>RP/0/RSP0/CPU0:router(config-pmap)# drop</pre>	Drops the packet.
Step 9	<p>end-policy-map</p> <p>Example:</p> <pre>RP/0/RSP0/CPU0:router(config-cmap)# end-policy-map</pre>	Ends the configuration of a policy map and exits the policy map configuration mode.
Step 10	Use the commit or end command.	<p>commit —Saves the configuration changes and remains within the configuration session.</p> <p>end —Prompts user to take one of these actions:</p> <ul style="list-style-type: none"> • Yes — Saves configuration changes and exits the configuration session.

	Command or Action	Purpose
		<ul style="list-style-type: none"> • No —Exits the configuration session without committing the configuration changes. • Cancel —Remains in the configuration session, without committing the configuration changes.

Configuring Policy Map for HTTP Redirect: An example

```

configure
policy-map type pbr <http-redirect-policy>
class type traffic <open-garden-class>
transmit
!
class type traffic <http-redirect-class>
http-redirect <redirect-url>
!
class class-default
drop
!
end-policy-map
!
!
end

```

Configuring Dynamic Template for Applying HTTPR Policy

Perform this task to configure dynamic template for applying the HTTPR policy to subscriber sessions.

Before you begin

The configuration steps mentioned in [Configuring Policy Map for HTTP Redirect, on page 368](#) have to be completed before defining the dynamic template that uses a previously defined policy-map.



Note Ensure that the Dynamic template contains only the Policy Based Routing policy, so it can be easily deactivated after web login.

SUMMARY STEPS

1. **configure**
2. **dynamic-template type ipsubscriber** *redirect_template_name*
3. **service-policy type pbr** *http-redirect-policy*
4. Use the **commit** or **end** command.

DETAILED STEPS

	Command or Action	Purpose
Step 1	configure Example: RP/0/RSP0/CPU0:router# configure	Enters global configuration mode.
Step 2	dynamic-template type ipsubscriber <i>redirect_template_name</i> Example: RP/0/RSP0/CPU0:router(config)# dynamic-template type ipsubscriber RDL1	Creates a dynamic template of type "ipsubscriber".
Step 3	service-policy type pbr <i>http-redirect-policy</i> Example: RP/0/RSP0/CPU0:router(config-pmap)# service-policy type pbr RPL1	Attaches the service policy as a pbr type within a policy map created in the earlier configuration. Note The http redirect policy name provided in this step is the one configured in the configuration step mentioned in the prerequisites.
Step 4	Use the commit or end command.	commit —Saves the configuration changes and remains within the configuration session. end —Prompts user to take one of these actions: <ul style="list-style-type: none"> • Yes — Saves configuration changes and exits the configuration session. • No —Exits the configuration session without committing the configuration changes. • Cancel —Remains in the configuration session, without committing the configuration changes.

Configuring Dynamic Template for Applying HTTPR Policy: An example

```

configure
dynamic-template type ip <redirect-template>
service-policy type pbr <http-redirect-policy>
!
!
!
end

```

Configuring Web Logon

Perform this task to configure Web Logon. As an example, a timer defines the maximum time permitted for authentication.

SUMMARY STEPS

1. **configure**
2. **class-map type control subscriber match-all** *classmap_name*
3. **match timer** *name*
4. **match authen-status authenticated**
5. **policy-map type control subscriber** *polycymap_name*
6. **event session-start match-all**
7. **class type control subscriber** *class_name* **do-until-failure**
8. *sequence_number* **activate dynamic-template** *dt_name*
9. *sequence_number* **activate dynamic-template** *dt_name*
10. *sequence_number* **set-timer** *timer_name* *value*
11. **event account-logon match-all**
12. **class type control subscriber** *class_name* **do-until-failure**
13. *sequence_number* **authenticate aaa list default**
14. *sequence_number* **deactivate dynamic-template** *dt_name*
15. *sequence_number* **stop-timer** *timer_name*
16. **event time-expiry match-all**
17. **class type control subscriber** *class_name* **do-all**
18. *sequence_number* **disconnect**
19. Use the **commit** or **end** command.

DETAILED STEPS

	Command or Action	Purpose
Step 1	configure Example: RP/0/RSP0/CPU0:router# configure	Enters global configuration mode.
Step 2	class-map type control subscriber match-all <i>classmap_name</i> Example: RP/0/RSP0/CPU0:router(config)# class-map type control subscriber match-all IP_UNAUTH_COND	Configures a subscriber control class-map with the match-all match criteria.
Step 3	match timer <i>name</i> Example: RP/0/RSP0/CPU0:router(config-cmap)# match timer AUTH_TIMER	Configures a match criteria for the class along with timer details.
Step 4	match authen-status authenticated Example: RP/0/RSP0/CPU0:router(config-cmap)# match timer AUTH_TIMER	Configures a match criteria for the class along with authentication status details.

	Command or Action	Purpose
Step 5	policy-map type control subscriber <i>polycymap_name</i> Example: RP/0/RSP0/CPU0:router(config)# class-map type control subscriber match-all RULE_IP_WEBSESSION	Configures a subscriber control policy-map.
Step 6	event session-start match-all Example: RP/0/RSP0/CPU0:router(config-pmap)# event session-start match-all	Configures the session start policy event that runs all the matched classes.
Step 7	class type control subscriber <i>class_name</i> do-until-failure Example: RP/0/RSP0/CPU0:router(config-pmap-e)# class type control subscriber class-default do-until-failure	Configures the class to which the subscriber is to be matched. When there is a match, execute all actions that follow until a failure is encountered.
Step 8	<i>sequence_number</i> activate dynamic-template <i>dt_name</i> Example: RP/0/RSP0/CPU0:router(config-pmap-c)# 10 activate dynamic-template DEFAULT_IP_SERVICE	Activates the dynamic-template defined locally on the CLI with the specified dynamic template name.
Step 9	<i>sequence_number</i> activate dynamic-template <i>dt_name</i> Example: RP/0/RSP0/CPU0:router(config-pmap-c)# 10 activate dynamic-template HTTP_REDIRECT	Activates the dynamic-template defined locally on the CLI with the specified dynamic template name.
Step 10	<i>sequence_number</i> set-timer <i>timer_name</i> <i>value</i> Example: RP/0/RSP0/CPU0:router(config-pmap-c)# 10 set-timer AUTH_TIMER 4567	Sets a timer to run a rule on its expiry. The timer value, specified in minutes, ranges from 0 to 4294967295.
Step 11	event account-logon match-all Example: RP/0/RSP0/CPU0:router(config-pmap)# event session-start match-all	Configures the account logon policy event that runs all matched classes.
Step 12	class type control subscriber <i>class_name</i> do-until-failure Example: RP/0/RSP0/CPU0:router(config-pmap-e)# class type control subscriber class-default do-until-failure	Configures the class to which the subscriber is to be matched. When there is a match, execute all actions that follow, until a failure is encountered.
Step 13	<i>sequence_number</i> authenticate aaa list default Example: RP/0/RSP0/CPU0:router(config-pmap-c)# 10 authenticate aaa list default	Specifies and authenticates the default AAA method list.

	Command or Action	Purpose
Step 14	<i>sequence_number</i> deactivate dynamic-template <i>dt_name</i> Example: RP/0/RSP0/CPU0:router(config-pmap-c)# 10 deactivate dynamic-template HTTP_REDIRECT	Disables the timer before it expires.
Step 15	<i>sequence_number</i> stop-timer <i>timer_name</i> Example: RP/0/RSP0/CPU0:router(config-pmap-c)# 20 stop-timer AUTH_TIMER	Disables the timer before it expires.
Step 16	event time-expiry match-all Example: RP/0/RSP0/CPU0:router(config-pmap)# event session-start match-all	Configures the timer expiry policy event that runs all the matched classes.
Step 17	class type control subscriber <i>class_name</i> do-all Example: RP/0/RSP0/CPU0:router(config-pmap-e)# class type control subscriber IP_UNAUTH_COND do-all	Configures the class to which the subscriber has to be matched. When there is a match, execute all actions.
Step 18	<i>sequence_number</i> disconnect Example: RP/0/RSP0/CPU0:router(config-pmap-c)# 10 disconnect	Disconnects the session.
Step 19	Use the commit or end command.	commit —Saves the configuration changes and remains within the configuration session. end —Prompts user to take one of these actions: <ul style="list-style-type: none"> • Yes — Saves configuration changes and exits the configuration session. • No —Exits the configuration session without committing the configuration changes. • Cancel —Remains in the configuration session, without committing the configuration changes.

Configuring Web Logon: An example

This example illustrates an IP session that is HTTP-redirected to an authentication web-portal for credentials. On successful authentication, the timer is unset. Otherwise, the subscriber gets disconnected when the timer window expires:

```
class-map type control subscriber match-all IP_UNAUTH_COND
  match timer AUTH_TIMER
  match authen-status unauthenticated
```

```

policy-map type control subscriber RULE_IP_WEBSESSION
  event session-start match-all
    class type control subscriber class-default do-until-failure
      10 activate dynamic-template DEFAULT_IP_SERVICE
      20 activate dynamic-template HTTP_REDIRECT
      30 set-timer AUTH_TIMER 5

  event account-logon match-all
    class type control subscriber class-default do-until-failure
      10 authenticate aaa list default
      15 deactivate dynamic-template HTTP_REDIRECT
      20 stop-timer AUTH_TIMER

  event timer-expiry match-all
    class type control subscriber IP_UNAUTH_COND do-all
      10 disconnect

```

HTTP Redirect URL with Subscriber Information

The existing HTTP Redirect feature in BNG is enhanced to provide subscriber information in addition to the redirect portal address in the redirect URL. This information includes the user name of the subscriber (in a Cisco Attribute-Value-Pair named *parsed-user-name*), the IP address of the subscriber and the source-identifier of the BNG. This functionality provides a mechanism to authenticate the subscriber as well as to enhance the web server, which in turn can be used in multiple use cases of redirect scenarios. One such use case is, providing a subscriber-specific web page to the subscriber in a redirect scenario. This feature works with both RADIUS and DIAMETER protocols.

Cisco AVP for HTTP Redirect URL with Subscriber Information

A new Cisco Attribute-Value-Pair (AVP) named, *parsed-user-name*, is introduced in order to enable this feature. This AVP must be sent by the AAA server as part of the user profile in an Access-Accept message to BNG. The presence of this AVP in the Access-Accept message indicates whether the redirect URL to be send out from BNG must append the subscriber's username, subscriber's IP address and the BNG source-identifier or not.

Extension Format for Redirect URL

The redirect URL with subscriber information uses this format:

```
<portal address>/index.php?u=<username>&uip=<user-ip-address>&source=<BNG source-identifier>
```

Here, *portal address* is the domain name or IP address of the redirect web server. **u** denotes the username, **uip** denotes the IP address of subscriber and **source** denotes the BNG source-identifier. Currently, the *BNG source-identifier* is mentioned as 'bng' for all BNG routers.

Restrictions

The HTTP redirect URL with subscriber information feature is subjected to these restrictions:

- Only IPv4 address of the subscriber is supported in the redirect URL; IPv6 address is not supported.
- Only one portal or web server is supported in the redirect URL.
- The maximum size of redirect URL cannot be greater than 256 bytes (characters).

- The redirect URL includes both original and extension information of portal web server or IP address packed in the defined format.

Use Cases of HTTP Redirect URL with Subscriber Information

In general, HTTP redirect feature can be activated dynamically or in authorization or authentication failure scenarios. This section covers various redirect scenarios for the subscriber and the expected feature behavior of HTTP redirect URL with subscriber information.

1. Redirect triggered by DIAMETER GX Re-Auth-Request (RAR) or RADIUS Change-of-Authorization (CoA) message

This is a use case of dynamically activating HTTP redirect feature which is observed in scenarios such as:

- A DSL subscriber who is present in the AAA database with `Treatment Status` as `redirect`.
- A Fiber to the home (FTTH) subscriber who is present in the AAA database, but without having a privileged user profile, and with 'Treatment Status' as 'redirect'.

Once the subscriber session is created by the BNG router, it sends a Credit-Control-Request-Initial (CCR-I) message to the Policy and charging rule function (PCRF) server, which is the DIAMETER server. In response to this, the PCRF server sends the Credit-Control-Answer-Initial (CCA-I) message to the BNG, along with the policy to be applied for the subscriber. Later, for example, when the user exceeds the usage quota, the PCRF server sends a RAR message whereby the redirect policies are applied dynamically for the subscriber.

2. Redirect triggered by GX Credit-Control-Answer Initial (CCA-I) message during the bring-up of the subscriber session

Here, the CCR-I and CCA-I message exchange happens as mentioned in use case 1 above. The redirect service policy for the subscriber which is carried in the CCA-I message is then downloaded by the BNG and applied to the subscriber profile. Whenever the subscriber tries to access a web portal, it is redirected by the BNG to the respective web server as per the redirect URL configured for that subscriber. The communication then happens between the subscriber and the redirect web server.

3. Redirect in Access-Accept message scenario

The redirect URL with subscriber information feature is enabled if the Access-Accept message sent from the AAA server to the BNG contains the Cisco AVP **parsed-user-name** as part of the user profile.

4. Redirect in authentication failure scenarios

The redirect URL with subscriber information feature is not enabled in access reject scenarios such as:

- A subscriber who is not provisioned in the AAA database
- A DSL subscriber with incorrect DHCP Option 82
- An FTTH subscriber with incorrect DHCP Option 82

The subscriber username, subscriber IP address and BNG source-identifier are not present in these scenarios. The AAA server sends the Access-Reject message without the *parsed-user-name* attribute to the BNG which results in subscriber authentication failure in the above scenarios. A default string with value as `NOTAVAILABLE` is sent in the Access-Reject message in such scenarios. The BNG redirects such subscribers

to a portal server using a pre-configured `authentication-failed-redirect` URL. The subscriber accounting can be decided by enabling or disabling **accounting** on the BNG.

Configure HTTP Redirect URL with Subscriber Information

The configuration steps remain the same for redirect URL with and without subscriber information. For detailed steps, see [HTTP Redirect Using PBR, on page 361](#).

Running Configuration

```
/* Access List Configuration */
ipv4 access-list http-acl-example
 10 permit tcp any any eq www syn
 20 permit tcp any any eq www ack
 30 permit tcp any any eq www
!

/* Class Map Configuration */
class-map type traffic match-any http-class-example
 match access-group ipv4 http-acl-example
end-class-map
!
policy-map type pbr http-policy-example
 class type traffic http-class-example
  http-redirect http://example.com/index.php
!
class type traffic class-default
!
end-policy-map
!

/* Service Policy Configuration */
dynamic-template
 type service http-service-example
  service-policy type pbr http-policy-example
!
!
```

Verification

Use this command to verify if the subscriber policy is applied or not:

```
Router# show policy-map type pbr interface Bundle-Ether1.1
Sun Feb 19 22:19:32.289 EDT
Bundle-Ether1.1 input: http-policy-example
Policy Name: http-policy-example
Class http-class-example
  Classification statistics                (packets)
  Matched                                :          26
  Http statistics                         (packets)
  Requests Received                       :          26
  Responses Sent                           :           0
  Redirect drops                           :          26
Class class-default
  Classification statistics                (packets/bytes) (May be 10secs old)
  Matched                                :         10/940
```

Associated Commands

- class-map
- dynamic-template
- http-redirect
- policy-map
- show policy-map

HTTP-Redirect Support for Static Sessions

From Cisco IOS XR Software Release 6.5.1 onwards, BNG extends the HTTP redirect feature support for static sessions.

For a detailed information on HTTP Redirect feature, refer to the section [HTTP Redirect Using PBR, on page 361](#).

Restrictions for HTTP Redirect for Static Sessions

HTTP redirect for static sessions in BNG is subjected to the below restrictions:

- The maximum size of the redirect URL cannot be greater than 256 bytes (or characters). The redirect URL includes both the original information, such as the portal webserver or the IP address information, as well as the extension information which is packed in a defined format.

Configure HTTP Redirect for Static Sessions

Configuration Steps

The below section shows the steps to configure a redirect policy in which an authentication failure results in the subscriber being redirected to a portal server.

For instructions on creating access lists that define the redirected and open-garden permissions. See, [Identifying HTTP Destinations for Redirection, on page 362](#).

For instructions on Creating the class-maps that uses the access list to classify the traffic as redirected, or permitted to access open-garden. See, [Configuring Class Maps for HTTP Redirection, on page 365](#).

```
Router# config terminal
Router(config)# ipv4 access-list httppr-acl-cfg
Router(config-ipv4-acl)# 10 permit tcp any any eq www syn
Router(config-ipv4-acl)# 20 permit tcp any any eq www ack
Router(config-ipv4-acl)# 30 permit tcp any any eq www
Router(config-ipv4-acl)# exit
Router(config)# class-map type traffic match-any httppr-class-cfg
Router(config-cmap)# match access-group ipv4 httppr-acl-cfg
Router(config-cmap)# end-class-map
Router(config)# policy-map type pbr httppr-policy-cfg
Router(config-pmap)# class type traffic httppr-class-cfg
Router(config-pmap-c)# http-redirect http://203.0.113.103/index.php
Router(config-pmap-c)# exit
Router(config-pmap)# class type traffic class-default
Router(config-pmap-c)# drop
```

```

Router(config-pmap-c) # exit
Router(config-pmap) # end-policy-map
Router(config) # dynamic-template
Router(config-dynamic-template) # type ipsubscriber http-service-cfg
Router(config-dynamic-template-type) # service-policy type pbr http-policy-cfg
Router(config-dynamic-template-type) # exit
Router(config-dynamic-template) # exit
Router(config) # policy-map type control subscriber POLICY1
Router(config-pmap) # service-policy type pbr http-policy-cfg
Router(config-pmap-e) # event authentication-failure match-first
Router(config-pmap-e) # class type control subscriber CL1 do-until-failure
Router(config-pmap-c) # 2 activate dynamic-template http-service-cfg
Router(config-pmap-c) # exit
Router(config-pmap-e) # exit
Router(config-pmap) # end-policy-map
Router(config) # interface gigabitEthernet 0/0/0/0
Router(config-if) # bundle id 1 mode on
Router(config-if) # exit
Router(config) # interface bundle-ether 1
Router(config-if) # mac-address a1.b1.c1
Router(config-if) # exit
Router(config) # interface bundle-ether 1.100
Router(config-subif) # ipv4 address 192.0.2.10 255.255.255.0
Router(config-subif) # ipv6 address 2001:DB8::10/32
Router(config-subif) # ipv6 nd dad attempts 0
Router(config-subif) # encapsulation dot1q 100
Router(config-subif) # service-policy type control subscriber POLICY1
Router(config-subif) # ipsubscriber interface
Router(config-subif) # commit

```

Running Configuration

The below example shows the running configuration for a redirect policy in which an authentication failure results in the subscriber being redirected to a portal server.

```

ipv4 access-list http-acl-cfg
 10 permit tcp any any eq www syn
 20 permit tcp any any eq www ack
 30 permit tcp any any eq www
!
class-map type traffic match-any http-class-cfg
 match access-group ipv4 http-acl-cfg
end-class-map
!
policy-map type pbr http-policy-cfg
 class type traffic http-class-cfg
   http-redirect http://203.0.113.103/index.php
!
 class type traffic class-default
   drop
!
end-policy-map
!
dynamic-template
 type ipsubscriber http-service-cfg
   service-policy type pbr http-policy-cfg
!
!
policy-map type control subscriber POLICY1
 event authentication-failure match-first
   class type control subscriber CL1 do-until-failure
     2 activate dynamic-template http-service-cfg

```

```

end-policy-map
!
interface GigabitEthernet0/0/0/0
 bundle id 1 mode on
!
interface Bundle-Ether 1
 mac-address a1.b1.c1
!
interface Bundle-Ether 1.100
 ipv4 address 192.0.2.10 255.255.255.0
 ipv6 address 2001:DB8::10/32
 ipv6 nd dad attempts 0
 encapsulation dot1q 100
 service-policy type control subscriber POLICY1
 ipsubscriber interface

```

HTTP Header Enrichment for BNG Subscribers

This feature enables you to intercept the HTTP GET request packet sent by a broadband subscriber, add custom HTTP headers to it and then forward the enriched HTTP GET request to the original destination server. This provides the capability to add information within the HTTP header, such as subscriber and BNG information, which the server can decode in order to decide whether to allow or deny the request.

From Cisco IOS XR Software Release 6.6.3 onwards, the HTTP header enrichment feature on BNG is enhanced to support pseudowire headend (PWHE) subscriber sessions as well. This enhancement is available along with subscriber redundancy group (SRG) support, thereby providing geographical redundancy for such sessions.

Figure 23: Example of an enriched HTTP header

```

Hypertext Transfer Protocol
GET /index.html HTTP/1.1\r\n
Host: [2001:DB8:1::1] \r\n
Connection: Keep-Alive\r\n
x-mac: 1222.c0a8.0001\r\n
x-ip4: 203.0.113.1
x-ip6: 2001:DB8:ABCD::1
x-bng: IPOE\r\n
x-bngip4: 209.165.201.1
x-bngip6: 2001:DB8:100::1
\r\n
[Full request URI: http:// [2001:DB8:1::1]/index.html]
[HTTP request 1/1]
[Response in frame: 12]

```

367582

Restrictions for HTTP Header Enrichment

HTTP header enrichment in BNG is subjected to the below restrictions:

- The core-facing interface should have a PBR policy for punting the HTTP response packet from the server. And the enrichment parameter list on the core-facing interface should be the same as that on the access-facing interface.

- An HTTP request or response of length greater than 2000 bytes cannot be processed.
- This feature is not supported in cases where the HTTP request or response is fragmented.
- Only the first HTTP request packet from the client is enriched. After a SUCCESS response is obtained, no further HTTP packets will be received from subscriber for the entire duration of the timeout period, which is around 8 hours.
- The state of the BNG identifier interface will not be considered. In other words, even if the BNG identifier interface is shutdown the configured IP address will be used for enrichment.
- There can be additional spaces in encoded x-headers.
- IP options are not supported with HTTP header enrichment.
- HTTPS enrichment is not supported.
- The HTTP server or proxy need to be using TCP connection.
- In the case of high availability scenarios, the in-progress HTTP transactions will be dropped and the client will have to retry.
- HTTP header enrichment based on destination URL is not supported.
- This feature is supported only for IPoE and PWHE sessions.
- In the scenario where the hostname of the BNG is changed, the new hostname is used for both the new and existing subscribers. However, randomly changing the hostname of the router when there are existing subscribers present, is not recommended.
- This feature does not support random changes in the subscriber attributes such as IP address and MAC address.
- If the BNG interface is changed, the HTTP header enrichment feature uses the IP address of the new BNG interface for existing and new subscribers. However, randomly changing the BNG interface when existing subscribers are present on the router, is not recommended.
- In the scenario where the BNG interface is not configured, the HTTP header enrichment features uses 0.0.0.0 as the IPv4 address and 0::0 as the IPv6 address. This is a misconfiguration and is not recommended.
- It is not recommended to configure extra parameters in the **http-enrichment parameter-list** that is not mentioned in **subscriber http-enrichment parameter-list**. This is a misconfiguration and results in incorrect encoding.

Configure HTTP Header Enrichment for BNG Subscribers

Configuration Steps

The below section shows how to configure a PBR based policy-map with http-enrichment enabled on one of the classes:

```
Router# config terminal
Router(config)# policy-map type pbr http-enrichment-policy
Router(config-pmap)# class type traffic open-garden-class
Router(config-pmap-c)# transmit
```

```

Router(config-pmap-c)# exit
Router(config-pmap)# class type traffic http-enrich-class1
Router(config-pmap-c)# http-enrichment parameter-list subscriber-mac hostname bng-interface
Router(config-pmap-c)# exit
Router(config-pmap)# class class-default
Router(config-pmap-c)# drop
Router(config-pmap-c)# commit

```

The configuration steps for configuring a primary-list of http-enrichment parameters that are used in http-enrichment actions configured across all class-maps is shown below:

```

Router(config)# subscriber
Router(config-subscriber)# http-enrichment parameter-list subscriber-mac hostname
bng-interface
Router(config-subscriber)# commit

```

The configuration steps to set the bng identifier interface is shown below:

```

Router(config)# subscriber
Router(config-subscriber)# bng-interface Loopback8
Router(config-subscriber)# commit

```

Running Configuration

An example of the running configuration for the policy-map with HTTP enrichment action is shown below:

```

policy-map type pbr http-enrichment-policy
  class type traffic open-garden-class
    transmit
  !
  class type traffic http-enrich-class1
    http-enrichment parameter-list subscriber-mac hostname bng-interface
  !
  class class-default
    drop
  !
!
end-policy-map

```

The running configuration for the subscriber enrichment parameter list is shown below:

```

subscriber
  http enrichment parameter-list subscriber-mac subscriber-ip hostname bng-interface
!

```

The running configuration for the subscriber BNG identifier interface is shown below:

```

subscriber
  bng-interface Loopback8
!

```

Verification

The HTTP header enrichment statistics can be obtained using the commands **show policy-map type pbr interface all** and **show pbr internal statistics**.

```

Router# show policy-map type pbr interface all
node0_3_CPU0: (null): Service Policy not installed
node0_2_CPU0: (null): Service Policy not installed
node0_1_CPU0: (null): Service Policy not installed
node0_0_CPU0: (null): Service Policy not installed
node0_RSPO_CPU0:

```

```
Bundle-Ether20.1.ip296 input: http-policy-pldt
Policy Name: http-policy-pldt
```

Class http-class-pldt

```
Classification statistics (packets)
Matched : 13
Http enrichment statistics (packets)
HTTP Responses Sent : 13
HTTP Request Sent : 6
TCP packets Sent : 7
Enrichment drops : 0
```

Class class-default

```
Classification statistics (packets/bytes) (May be 10secs old)
Matched : 308/31094
```

Router# **show pbr internal statistics location 0/1/cpU0**

PBR EA Internal Statistics:

RSI Replay End Pending: 0

Database:

```
IFH Add: 1
IFH Delete: 1
IFH Total: 0
Mutex Block: 0
```

IM:

```
Caps Add: 1
Caps Add Error: 0
Caps Remove: 1
Caps Remove Error: 0
DPC: 4
DPC Error: 0
Init Data Update: 0
Init Data Update Error: 0
```

Switching:

```
Rx HTTPR TCP SYN: 0
Rx HTTPR TCP ACK: 0
Rx HTTPR TCP FIN: 0
Rx HTTPR HTTP GET: 0
Rx HTTPR HTTP HEAD: 0
Rx HTTPR HTTP POST: 0
Tx HTTPR TCP SYN ACK: 0
Tx HTTPR TCP FIN ACK: 0
Tx HTTPR HTTP Redirect: 0
```

Tx HTTP Enrichment TCP ACK: 8

Tx HTTP Enrichment TCP FIN: 0

Tx HTTP Enrichment TCP SYN: 2

Tx HTTP Enrichment TCP RST: 3

Tx HTTP Enrichment TCP SYN ACK: 0

Tx HTTP Enrichment TCP FIN ACK: 0

Tx HTTP Enrichment TCP RST ACK: 1

Tx HTTP Enrichment Response: 0

Tx HTTP Enrichment Request: 10

DROP IFH Class ID Inval: 0

DROP API Error: 0

DROP No Connection: 0

DROP HTTPR Fragment: 0

DROP HTTPR IP Options: 0

DROP HTTPR TCP ACK: 0

DROP HTTPR TCP Parse: 0

DROP HTTPR HTTP Parse: 0

DROP HTTP Enrichment Fragment: 0

DROP HTTP Enrichment IP Option: 0

DROP HTTP Enrichment TCP ACK: 14

```
DROP HTTP Enrichment TCP Parse 0
```

```
DROP HTTP Enrichment HTTP Parse:0
```

Idle Timeout for IPoE and PPPoE Sessions

The Idle Timeout feature for IPoE and PPPoE sessions allows users to configure a maximum period of time that the subscriber sessions may remain idle. The subscriber sessions are terminated when this timeout period expires. The BNG monitors both the ingress and egress traffic for the determination of the idle time for the subscriber sessions. Control packets are not considered while determining session inactivity.

You can configure a threshold rate, and if packets sent or received by BNG in that interval is less than this threshold rate, then that particular session is considered idle. The threshold option allows you to consider low traffic rates as being idle and to exclude DHCP lease renewal packets from the statistics used for idle time determination. For instance, if you want to discount the DHCP short lease of 5 minutes, then you must configure the threshold as 5 packets per minute.

The dynamic template configuration of idle timeout is extended to also support **type ppp** templates. If idle timeout is enabled and if **monitor** action is not specified under the idle timeout event for a subscriber policy, then, by default, the sessions are disconnected. You can prevent the sessions from getting disconnected, by setting, for that particular subscriber policy, the policy action under the idle timeout event as **monitor**.

These Cisco VSAs are used to configure or update the idle timeout threshold and traffic direction from the RADIUS server:

```
idlethreshold = <mins/pkt>
idle-timeout-direction = <inbound | outbound | both>
```

For details on configuring idle timeout, see [Creating Dynamic Template for IPv4 or IPv6 Subscriber Session, on page 99](#).

For details on configuring a policy-map with the idle-timeout event, see [Configuring a Policy-Map, on page 86](#).

Routing Support on Subscriber Sessions

Routing support on subscriber sessions allows dynamic routes to be added on an individual subscriber basis for IPoE and PPPoE sessions. This allows forwarding traffic to a subscriber subnet that resides behind the customer premise equipment (CPE).

Here is a typical scenario:

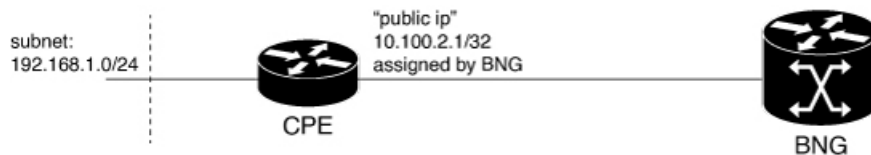

BNG has a subscriber connected route:
10.200.2.1/32 for this subscriber

BNG can download a per user static route
pointing the subnet behind the CPE if it doesn't do NAT:

```
192.168.1.0/24 nexthop 10.200.2.1
```

520580

Typically, a CPE provides NAT support and uses the public IP address provided during the session establishment through DHCP or PPPoE. This process doesn't require for the BNG to understand or know what subnet is behind the CPE.

In some cases, the CPE doesn't perform NAT. In such cases, an operator is required to provision a route on the BNG to point to the subnet behind the CPE using a next hop of the CPE.

To achieve this, you can do one of the following. But, neither of them are easy to manage.

- Use static route on the BNG router static configuration.
- Use a dynamic routing protocol to advertise and learn networks between CPE and BNG.

With RADIUS attribute value pairs, you can easily provide the subnet routing for such cases. The routes are dynamically downloaded from RADIUS and are added for each subscriber and the routes are configured as part of the RADIUS profile of the subscriber. The subscriber sessions are not disconnected even if the dynamic route insertion fails.

You can use the IETF defined (per user static routes) through the following attributes that exist in `Cisco:Avpair` format as well.

- Framed-Route for IPv4
- Framed-IPv6-Route for IPv6

The format of the `Cisco:Avpair` used for configuring the dynamic routes is:

For IPv4,

```
Cisco:Avpair = "ipv4:ipv4-route = {<prefix>} {<mask>} {<next_hop_ip_address>} [<metric>]
[tag <tag_value>]"
```

For example :

```
Cisco:Avpair = "ipv4:ipv4-route = 10.121.3.0 255.255.255.0 10.212.1.254 30 tag 12"
```

In this example, the route for 10.121.3.0 255.255.255.0 is added to the subscriber vrf with a next hop of 10.212.1.254. The route has a metric of 30 and a route tag value of 12.

For IPv6,

```
Framed-IPv6-Route + = "ipv6:ipv6-route = {<prefix>} {<mask>} {<next_hop_ip_address>}
[<metric>] [tag <tag_value>]"
```

For example,

```
Framed-IPv6-Route + = "ipv6:ipv6-route = 2000:18c8:1111::1111/128 :: 4 tag 1000"
```

In this example, the next hop is the subscriber interface and the route is installed with a metric of 4 and tag 1000.

Where,

- `prefix mask`: Specifies the IP route prefix and prefix mask for the destination.
- `next_hop_ip_address`: Specifies the next hop IP address.
- `metric`: Specifies the route metric. Range is 1 to 254. Default value is 2.
- `tag tag_value`: Specifies a tag value that can be used as a match for controlling redistribution using route policies. Range is 1 to 4294967295.

Restrictions

- For IPv6 when a next hop and tag values are defined, you need to configure the metric value for the subscriber to be connected. If not defined, the subscriber fails to connect.
- For IPv6 when only the tag value is set and no metric is configured, the value is interpreted as a metric. The route fails to install if the tag is greater than 254, but the subscriber will be able to connect.

Benefits of Routing Support on Subscriber Sessions

These are some of the benefits of routing support on subscriber sessions:

- Multiple dynamic routes for each subscriber are supported.
- The user can specify the next hop and metric for each route to be added, If the destination VRF isn't specified, the VRF of the subscriber is taken as the default. If the next hop VRF isn't specified, the same VRF as that of the destination prefix is taken as the default.
- Dynamic routes are the CoA attribute and therefore, they can be changed while the subscriber is connected to the BNG router.

Traffic Mirroring on Subscriber Session

BNG supports the Traffic Mirroring feature on subscriber session. Traffic mirroring, also known as Switched Port Analyzer (SPAN), enables a user to monitor Layer 2 network traffic passing in or out of a set of Ethernet interfaces. This allows the mirroring of packets that pass through a source interface to a specified destination interface. The destination interface may then be attached to a network analyzer for debugging.

Traffic Mirroring or Switched Port Analyzer (SPAN) has these two distinct sets of configurations:

- Global configuration to create monitor sessions - A session is configured by specifying a session type and a destination that can be a local interface or a pseudo-wire interface.
- Source interface attachment configuration - This specifies how an interface should be attached to a monitor session.

For BNG, the source interface attachment configuration to a monitor session is through the use of dynamic templates. The subscriber is attached to the monitor session only when the template is applied to the subscriber. The template is applied or removed using the **activate-service** or **deactivate-service** CoA command sent from the RADIUS server or using the **test radius coa [activate | deactivate]** command.

For more information on Traffic Mirroring feature, see *Configuring Traffic Mirroring on the Cisco ASR 9000 Series Router* chapter in the *Interface and Hardware Component Configuration Guide for Cisco ASR 9000 Series Routers*. For complete command reference of the SPAN commands, see the *Traffic Mirroring Commands on the Cisco ASR 9000 Series Router* chapter in the *Interface and Hardware Component Command Reference for Cisco ASR 9000 Series Routers*.

For configuring traffic mirroring on BNG subscriber session, see [Enabling Traffic Mirroring on Subscriber Session, on page 387](#).

**Note**

- It is recommended that a dynamic template is dedicated to SPAN configuration, so that SPAN can be enabled or disabled on a subscriber without any adverse impact.
- Modifications to SPAN configuration under a dynamic template, including the removal of configuration, have an immediate effect on all the subscribers to which that template is currently applied.

Enabling Traffic Mirroring on Subscriber Session

Perform this task to enable traffic mirroring on BNG subscriber session. These steps describe how to configure a dynamic template that references the monitor session and to associate or dis-associate it with a specific subscriber to enable or disable SPAN.

Before you begin

Create monitor sessions in global configuration mode using **monitor-session** command. Refer, [Traffic Mirroring on Subscriber Session, on page 386](#)

SUMMARY STEPS

1. **configure**
2. **dynamic-template type** {ipsubscriber | ppp | service} *dynamic-template-name*
3. Configure **monitor-session**, with optional **direction**, **acl** and **mirror first** options
4. Use the **commit** or **end** command.
5. **test radius coa** {activate | deactivate} **service name acct-ses-id name**

DETAILED STEPS

	Command or Action	Purpose
Step 1	configure Example: RP/0/RSP0/CPU0:router# configure	Enters global configuration mode.
Step 2	dynamic-template type {ipsubscriber ppp service} <i>dynamic-template-name</i> Example: RP/0/RSP0/CPU0:router(config)# dynamic-template type ppp ppp_template	Creates a dynamic-template of type ppp .
Step 3	Configure monitor-session , with optional direction , acl and mirror first options Example: RP/0/RSP0/CPU0:router (config-dynamic-template-type)# monitor-session mon1 direction rx-only RP/0/RSP0/CPU0:router (config-dynamic-template-type)# acl	Configures a dynamic template that references the monitor session. Note This syntax of monitor-session command for dynamic templates is same as the syntax for regular interfaces.

	Command or Action	Purpose
	RP/0/RSP0/CPU0:router (config-dynamic-template-type)# mirror first 100	
Step 4	Use the commit or end command.	<p>commit —Saves the configuration changes and remains within the configuration session.</p> <p>end —Prompts user to take one of these actions:</p> <ul style="list-style-type: none"> • Yes — Saves configuration changes and exits the configuration session. • No —Exits the configuration session without committing the configuration changes. • Cancel —Remains in the configuration session, without committing the configuration changes.
Step 5	<p>test radius coa {activate deactivate} service name acct-ses-id name</p> <p>Example:</p> <pre>RP/0/RSP0/CPU0:router# test radius coa activate acct-ses-id 0x00000001 service service1</pre>	<p>If activate keyword is used, this command enables SPAN by associating a dynamic template with a specific subscriber.</p> <p>If deactivate keyword is used, this command disables SPAN by dis-associating a dynamic template with a specific subscriber.</p>

Enabling Traffic Mirroring on Subscriber Session: An example

```
//Global configuration to create monitor sessions
configure
monitor-session mon1
destination interface gigabitethernet0/0/0/1
ethernet-services access-list tm_filter
 10 deny 0000.1234.5678 0000.abcd.abcd any capture
!
!

//Configuring a dynamic template that references the monitor session
configure
dynamic-template type ppp ppp_template
monitor-session mon1 direction rx-only
acl
mirror first 100
!
!

//Associating a dynamic-template with a specific subscriber to enable SPAN
test radius coa activate acct-ses-id 0x00000001 service service1
```

Randomization of Interim Timeout of Sessions or Services

The randomization feature distributes the interim timeouts in a relatively uniform manner and prevents accumulation of timeouts for interim accounts of sessions or services. This prevents a cycle where all messages

are sent at once (this occurs if a primary link was recently restored and many dial-up users were directed to the same BNG at once). This is useful in scenarios such as churn scenarios of session bring up (that is, a small spurt with very high session bring up rate), subscriber redundancy group (SRG) subordinate to primary switchover in BNG geo redundancy and so on.

For example, if a session is brought up at time 0, and it has an interim interval of 10 minutes (600 seconds), the first interim message is sent at time $t_1 = 600$ seconds (this is without randomization enabled). With randomization enabled, a random number x which is less than 600 is selected and the first interim message is sent at that time, x . Use this command to specify the maximum variance allowed:

accounting interim variation

Sample configuration:

```
subscriber
manager
  accounting interim variation 10
```

Controlling Subscriber Plans Using Protocol Options

The BNG router supports identity change for DHCP Remote-Id parameter, thereby allowing modification of the subscriber service. This functionality of controlling subscriber plans using protocol options helps to deactivate an old service and activate a new service for the subscriber, based on the new service name received in Remote-Id parameter.

BNG does this by extracting the username and the service name from Remote-Id parameter. The DHCP server compares the Remote-Id received in the packet against the Remote-Id that was stored earlier. If there is a data mismatch, DHCP triggers an identity change event. DHCP adds the new Remote-Id in identity parameters to be added and places the old Remote-Id in identity parameters to be removed. On successful execution of the event, the new service gets activated.

How to Control Subscriber Plans Using Protocol Options

To enable identity change handling across BNG router, use **subscriber feature identity-change** command in the global configuration mode. A new event, **session-identity-change**, is introduced to specify an identity change event. In order to decode the service encoded in the DHCP Remote-Id parameter, as per the defined AAA attribute format, use **decode** command in the policy-map event class configuration mode. The **activate** command in the class-map sub-configuration mode is also enhanced to include an option **service-from-line** to activate the service encoded in the DHCP Remote-Id parameter.

Consider an example where the Remote-Id parameter received by BNG is in the format '*Username|Service-Name*', say, *bng_user/service1*. At session start stage, DHCP passes this Remote-Id in the 'parameters-to-add' list. The 'parameters-to-remove' list is empty at that point of time. The decode instruction decodes the Remote-Id based on the defined AAA attribute format (my-format in this example), extracts Username (*bng_user*) and Service-Name (*service1*) from it, and adds these parameters to the system. The **service-from-line** parameter refers to this particular Service-Name. The extracted Service-Name is added to AAA_AT_SUBSCRIBER_ACTIVATE_SERVICE attribute in the transaction context and it gets activated.

FSOL clients trigger an event when they want to change an identity parameter. DHCP triggers this event only if identity-change feature is enabled. In this event, DHCP passes the new Remote-Id (say, *bng_user/service2*) in parameters-to-add list and passes the old Remote-Id as part of parameters-to-remove list. The new Service-Name to be activated (*service2*) and the old Service-Name (*service1*) to be deactivated are decoded,

extracted and added to AAA_AT_SUBSCRIBER_ACTIVATE_SERVICE and AAA_AT_SUBSCRIBER_DEACTIVATE_SERVICE attributes respectively, in the transaction context. The old Service-Name gets deactivated and the new Service-Name gets activated.

Running Configuration

```
configure

/* This configuration defines the format of Remote-Id from which BNG can derive the Username
and Service-Name */
aaa attribute format my-format format-string length 253 "%[^\]|%[^\]|" username service-name

!

/* Enable identity change feature */
subscriber
feature enable identity-change
!
!

policy-map type control subscriber pm-dtmpl-1
event session-start match-first
class type control subscriber CL1 do-until-failure
  1 decode remote-id format my-format
  2 activate dynamic-template service-from-line
  3 authorize aaa list default identifier remote-id password blank

event session-identity-change match-first
class type control subscriber CL1 do-until-failure
  1 decode remote-id format my-format
  2 deactivate dynamic-template service-from-line
  3 activate dynamic-template service-from-line
  4 authorize aaa list default identifier remote-id password blank
```

Whenever the **deactivate dynamic-template service-from-line** is used after the **decode** instruction, it has to be placed before **activate** or **authorize** commands.

Verification

Use these commands to verify the activation and deactivation of old and new services for the subscriber:

- **show subscriber session all detail**
- **show dhcp ipv6 server binding detail**
- **show policy-map applied interface bundle-ether *interface-name***

Additional References

These sections provide references related to implementing BNG subscriber features.

MIBs

MB	MIBs Link
	<p>To locate and download MIBs for selected platforms, Cisco IOS releases, and feature sets, use Cisco MIB Locator found at the following URL:</p> <p>http://www.cisco.com/go/mibs</p>

Technical Assistance

Description	Link
<p>The Cisco Support website provides extensive online resources, including documentation and tools for troubleshooting and resolving technical issues with Cisco products and technologies.</p> <p>To receive security and technical information about your products, you can subscribe to various services, such as the Product Alert Tool (accessed from Field Notices), the Cisco Technical Services Newsletter, and Really Simple Syndication (RSS) Feeds.</p> <p>Access to most tools on the Cisco Support website requires a Cisco.com user ID and password.</p>	<p>http://www.cisco.com/cisco/web/support/index.html</p>



CHAPTER 8

BNG Geo Redundancy

This chapter provides information about support of geographical redundancy through subscriber redundancy groups (SRGs) and session redundancy groups (SERGs).

Table 17: Feature History for Establishing Geo Redundancy

Release	Modification
Release 5.2.2	Introduced BNG geo redundancy.
Release 5.3.1	Geo redundancy support for PPPoE sessions was added.
Release 5.3.3	Peer route disable functionality was added.
Release 6.1.2	These geo redundancy enhancements were added: <ul style="list-style-type: none"> • Active-active session support • State Control Route • Subscriber Redundancy Group Revertive Timer • Subscriber Redundancy Group-aware IPv6 Neighbor Discovery • Peer-to-peer Traffic Flow • Accounting Trigger Cause
Release 6.2.1	Session Redundancy Groups (SERGs) were introduced for DHCPv6 and IPv6 ND clients.
Release 6.2.2	Added the support for BNG Geo Redundancy over Cisco NCS 5000 Series nV satellite.
Release 6.3.1	Added Multiple State Control Routes for Each SRG feature.
Release 6.3.1	Added SRG Support for BNG SLAAC Sessions.

Release	Modification
Release 6.5.1	<p>These new features were introduced:</p> <ul style="list-style-type: none"> • Address pool usage synchronisation in BNG geo redundant active-active nodes • SRG support for static sessions • SRG for line card subscribers (12-connected IPoE only on QinQ based access interfaces)

This chapter covers these topics:

- [Geo Redundancy Overview](#), on page 394
- [Supported Features in BNG Geo Redundancy](#), on page 399
- [BNG Geo Redundancy Configuration Guidelines](#), on page 401
- [Setting up BNG Subscriber Redundancy Group](#), on page 402
- [Geographical Redundancy By Using a Session Redundancy Group \(SERG\)](#), on page 406
- [Geo Redundancy for PPPoE Sessions](#), on page 423
- [BNG Geo Redundancy with Satellite](#), on page 426
- [Geo Redundancy Features](#), on page 429
- [Deployment Models for BNG Geo Redundancy](#), on page 451

Geo Redundancy Overview

To provide redundancy for the subscriber sessions, BNG supports Geographical Redundancy across multiple BNGs, without having any L1 or L2 connectivity between them. The BNG routers may be located in multiple geographical locations, and they have L3 connectivity over a shared core network through IP or MPLS routing.

Geo redundancy feature is supported for IPoE DHCP-triggered (IPv4, IPv6 and dual-stack) sessions and PPPoE (PTA and LAC) sessions.



Note PPPOE LAC geo redundancy is supported only with Multi-chassis Link Aggregation (MC-LAG) based access networks (active-standby mode) and RFC4951 compliant L2TP Network Server (LNS).

This figure depicts a BNG geo redundancy deployment network model:

Figure 24: BNG Geo Redundancy Deployment Network Model

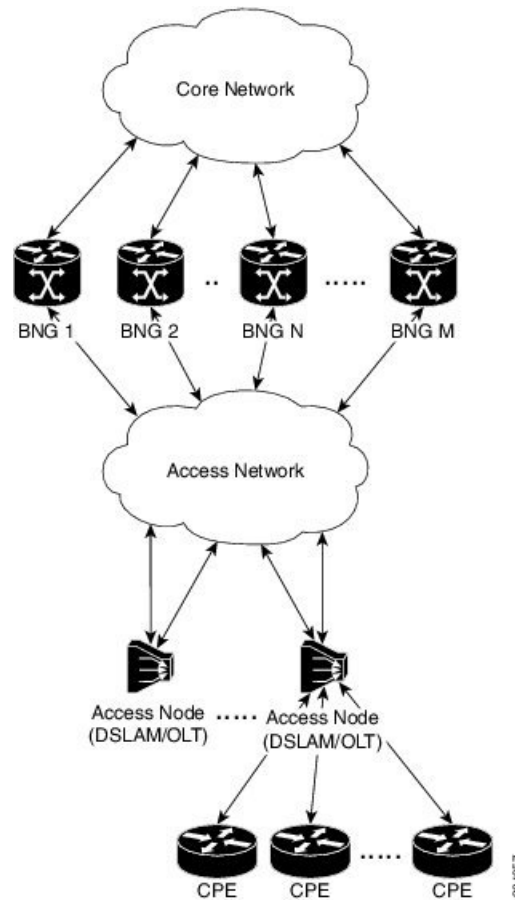

The redundancy pairing between BNG routers work by synchronizing the state from the primary (active) to the subordinate (backup).

Geo redundancy works in conjunction with any of the access technologies. The CPEs are agnostic to redundancy; they see only one BNG or gateway. The access nodes are dual or multi-homed for redundancy using a variety of technologies based on the service provider network design and choices. Multi-chassis Link Aggregation (MC-LAG), dual-homed (Multiple Spanning Tree - Access Gateway or MST-AG), Ring (MST-AG or G.8032), xSTP and seamless MPLS (pseudowires) are a few such access networks.

Subscriber Redundancy Group (SRG)

Geo redundancy for subscribers is delivered by transferring the relevant session state from primary BNG to subordinate BNG which can then help in failover (FO) or planned switchover (SO) of sessions from one BNG to another. Subscriber Redundancy Group (SRG) which is a set of access-interface (or a single access-interface) is introduced in BNG, and all subscribers in an SRG would FO or SO as a group.

The SRG has two modes of operation:

- Hot-standby
- Warm-standby

Currently BNG geo redundancy supports only the hot-standby subordinate mode. This is achieved by a 1:1 mirroring of subscriber session state from the primary to the subordinate where the entire provisioning is done before the FO or SO. The sessions provisioned on subordinate is in sync with the set up on the primary. Because the data plane is already set up for sub-second traffic impact, there is minimal action on switchover in the case of hot-standby mode and therefore, it is suitable for subscribers requiring high service level agreement (SLA). With appropriate capacity planning, the sessions can also be distributed across multiple BNGs to achieve an M: N model. The primary-subordinate terminology is always in the context of a specific SRG; not for the BNG device as a whole.



Note Even after the Subscriber Redundancy Group (SRG) configuration is removed from the subordinate node, the CPE continues to receive ARP replies from both the primary node and the subordinate node. This results in the network functioning in an uncertain manner. In order to avoid this uncertainty, shut down the access interface (that which corresponds to the subordinate node from which the configuration is removed) before removing the SRG configuration from the subordinate.

This figure depicts a typical BNG subscriber redundancy group (SRG):

Figure 25: BNG Subscriber Redundancy Group

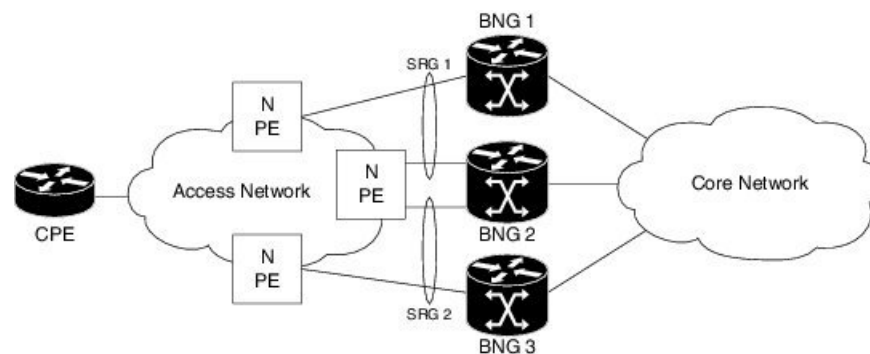

SRG Virtual MAC

For seamless switchover between two BNGs, the L2-connected CPE devices must not detect change in gateway MAC and IPv4 or IPv6 addresses. The access technology like MC-LAG uses the same MAC address on both BNGs with active-standby roles, providing seamless switchover. Where MAC sharing is not provided by the access technology or protocol (like MST-AG, G.8032), the BNG SRG virtual MAC (vMAC) must be used. vMAC is configured as global MAC prefix or per SRG. This is integrated with BNG's dynamic primary or subordinate role negotiation; additional protocols like VRRP or HSRP is not needed. vMAC (and its derived IPv6 link-local address) is used for control protocol exchanges (for example, ARP, ND, DHCP, PPPOE and so on) and data traffic for subscriber sessions or services only. It allows real port MAC to be used for Ethernet protocols (like E-OAM, xSTP, G.8032 and so on) that are leveraged by the SRG for doing failure detection, recovery and MAC Flush.

Session Distribution Across SRG

The session distribution across SRGs can be in either of these modes:

- Active-standby mode:

In this mode, a dedicated backup BNG can be a subordinate for multiple SRGs from different active BNGs which are primaries for those respective SRGs.

This figure shows an active-standby mode of session distribution across SRGs:

Figure 26: Active-standby Mode of Session Distribution

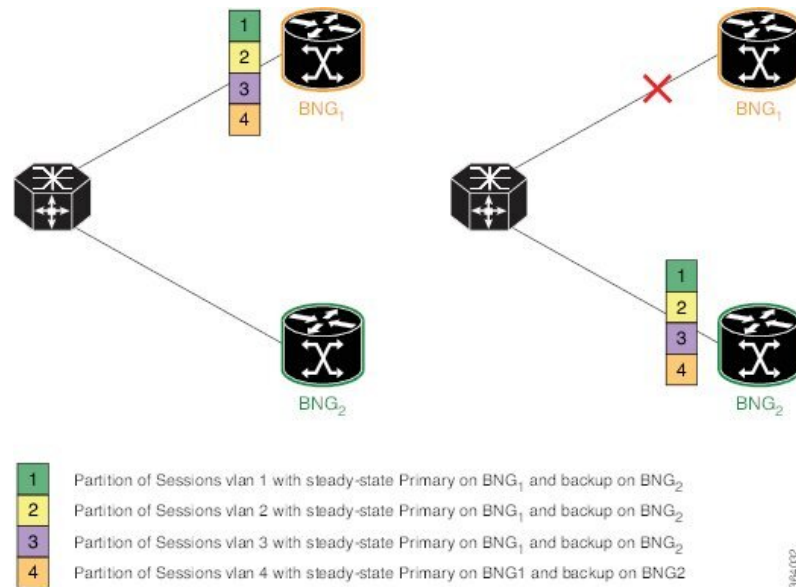

In figure a:

- Sessions are associated with partitions (VLAN 1, 2, 3 and 4) on BNG₁, with each VLAN mapped to separate SRG configured as primary role.
- BNG₂ acts as backup for all VLANs.
- Each VLAN has 8K sessions terminated on it.

In figure b:

- An interface failure gets detected (using object-tracking of the access-interface) through MC-LAG.
- MC-LAG and SRG for each VLAN on BNG₂ gets the primary role.
- All 32K sessions are switched to BNG₂.
- BNG₂ sees a session termination count of 32K.

- Active-active mode:

In this mode, a BNG can be primary for one SRG and a subordinate for another SRG at the same time.

This figure shows an active-active mode of session distribution across SRGs:

Figure 27: Active-active Mode of Session Distribution

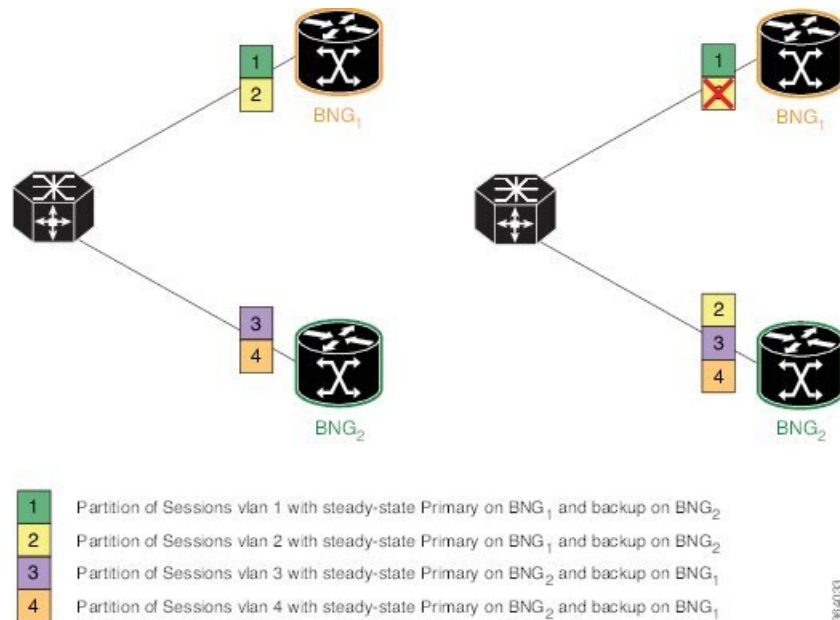

In figure a:

- Sessions are associated with partitions (VLAN 1, 2) on BNG₁, with each VLAN mapped to separate SRG configured as primary role.
- Sessions are associated with partitions (VLAN 3, 4) on BNG₂, with each VLAN mapped to separate SRG configured as primary role.
- Each VLAN has 8K sessions terminated on it.
- Each BNG has 16K sessions terminated on it.

In figure b:

- The interface associated with VLAN 2 on BNG₁ goes down.
- Sessions associated with partitions (VLAN 2) on BNG₁ are switched to BNG₂.
- BNG₁ sees a session termination count of 8K and BNG₂ sees a session termination count of 24K.

Benefits of BNG Geo Redundancy

Major benefits of BNG Geo Redundancy include:

- Supports various redundancy models such as 1:1 (active-active) and M:N, including M:1.
- Provides flexible redundancy pairing on access-link basis.
- Works with multiple access networks such as MC-LAG, dual-home and OLT rings.
- Supports various types of subscribers such as IPv4, IPv6 and dual-stack IPoE sessions.
- Works for RP (bundle and virtual access-links) based subscribers.

- Provides failure protection to access link failures, LC failures, RP failures and chassis failures.
- Performs automatic switchovers during dynamic failures or planned events such as maintenance, upgrades and transitions.
- Co-exists with other high availability (HA) or redundancy mechanisms.
- Does switchover of the impacted session group only; other session groups remain on the same BNG.
- Provides fast convergence and rapid setup of sessions, with minimal subscriber impact during switchover.
- Provides automatic routing convergence towards core and efficient address pool management.
- Provides seamless switchover for subscriber CPE without the need for any signaling.
- Integrates with RADIUS or policy and charging rule function (PCRF) systems.
- Provides minimal to zero incremental load on back end servers and PCRFs during normal operations and switchover.
- Does not impact session scale and call-per-second (CPS) during normal operation.

Supported Features in BNG Geo Redundancy

Supported Features in BNG Geo Redundancy

These access topologies are supported:

- SRG active-active mode without any access protocol.
- MC-LAG topology (recommended only for IPv4 BNG sessions).
- Dual-home bundle interfaces with SRG vMAC using CFM or EFD fault detection and MST-AG for blocking.
- Ring bundle interfaces with SRG vMAC using CFM or EFD fault detection and MST-AG for blocking.
- Other access topologies and design variations may also be used for this feature.

These base geo redundancy features are supported:

- RP subscribers.
- LC subscribers (only for dual-stack IPoE sessions with BNG as DHCPv4 or DHCPv6 proxy), No PPPoE supported.
- Multiple SRG groups to different peer routers.
- Setting up peering statically through IPv4 or IPv6 TCP sessions.
- Hot-standby mode for subordinate (that is, subscribers provisioned in hardware on the subordinate as they are synchronized).
- Dynamic role negotiation between peers.
- Manual SRG switchover through command line interface (CLI).
- Dynamic failure detection using object tracking (link up-down, route and IPSLA tracking).

- Hold timer for dynamic switchover or switchback.
- Protocol bindings alone synchronized to subordinate; whereas AAA authorization for subscriber profile download performed by subordinate.
- Full BNG scale support (that is, half the scale number with redundancy).
- G.8032 (dual-home and ring) access technologies.
- PPPOE LAC geo redundancy only with Multi-chassis Link Aggregation (MC-LAG) based access networks (active-standby mode) and RFC4951 compliant L2TP Network Server (LNS).

These DHCP features are supported:

- DHCPv6 IA-NA and IA-PD support for L2 connected sessions.
- DHCPv4 support for L2 connected sessions.
- DHCPv4 or DHCPv6 dual-stack support.
- DHCP proxy mode.
- Session initiation through DHCPv4 or DHCPv6 protocol.

Unsupported Features and Restrictions for BNG Geo Redundancy

This section lists the unsupported features and restrictions for BNG geo redundancy.

These are not supported in BNG geo redundancy:

- IPoE packet-triggered sessions.
- Routed (L3 connected) sessions
- Multicast
- SRG for ambiguous VLAN BNG sessions.
- SRG between Cisco IOS XR 64-bit BNG node and 32-bit BNG node.
- Both RP and LC subscribers do not support enabling fast switchover for subscriber framed-routes.
- PPPoE is not supported for LC subscriber sessions with SRG.
- Excessive Punt Flow Trap (EPFT)
- IPoE and PPPoE sessions do not support `idle-timeout` configuration for both RP and LC-based subscribers.
-

These are planned to be fully qualified only in future releases of Cisco IOS XR Software:

- Warm-standby subordinate mode.
- DHCP server mode.

BNG Geo Redundancy Configuration Guidelines

While configuring BNG geo redundancy, certain guidelines must be followed in these areas:

- BNG Configuration Consistency
- Access-link Integration
- Core Routing Integration
- RADIUS-PCRF Integration

BNG Configuration Consistency

- Geo redundancy feature infrastructure synchronizes individual subscriber session state from primary to subordinate. But, it does not synchronize the BNG related configurations (namely dynamic-template, DHCP profiles, policy-maps, access-interface configurations, external RADIUS or DHCP server and so on).
- For successful synchronization and setup of subscriber sessions between the two BNGs, it is mandatory that the relevant BNG configurations must be identical on the two routers and on the access-interfaces pairs in the SRG.
- While the access-interfaces or their types (or both) may vary between the paired BNGs, their outer-VLAN tag (that is, S-VLAN imposed by the access or aggregation devices) must be identical.
- Inconsistencies in base BNG or SRG configurations may result in synchronization failure and improper setup of sessions on the subordinate.

Access-link Integration

- You must use only those dual-homing techniques where one side is up or active, and the other side is down or standby. Both sides must not be up and forwarding traffic at the same time.
- You must use access-tracking mechanism under the SRG to ensure that its BNG role is always in synchronization with its access-link. Without this, the data or control traffic may get dropped.
- The access-tracking object used by the SRG must be same as the one used in the routing configuration for conditional advertisement of the subscriber summary route(s) corresponding to that SRG's subscriber address or subnet pool(s).
- Including multiple access-links (which do not fail or switchover their roles) together into a single SRG may be challenging, unless mechanisms are implemented to ensure that all these links change state even when one of them fails.
- Synchronisation of the framed IPv6 prefix addresses in SRG or SERG scenario is not supported on satellite bundle access interfaces in dual-homed satellite topology.

IPv6 Neighbour Discovery process maintains the synchronisation of a framed-prefix-pool. For the Neighbour Discovery process to work, the interface must be up. Bundle state is up only on the active host in a dual-homed satellite scenario.

Core Routing Integration

- Redistribution of individual subscriber routes into the routing protocol is not recommended because it slows convergence in failure or switchover events.
- Recommended design option is to conditionally advertise the summary static route for the subscriber address/subnet pool(s) of the SRG into the core routing protocol, through access-tracking.
- You can also advertise from both routers with different preferences and use various fast-reroute techniques.
- To avoid core routing changes in certain failure conditions, there are options to re-route the traffic from the subordinate to the primary (for example, a tunnel or inter-chassis link) for transient or prolonged intervals.
- Routing convergence and its correlation with access failures or convergence is a key to overall end-to-end service impact for subscribers. Multiple options exist to achieve sub-second intervals.

RADIUS-PCRF Integration

The backend policy and charging rule function (PCRF) system must send the CoA message to both primary and subordinate nodes. The message can be sent to the subordinate either at the same time as it is sent to primary, or it can be sent after the subordinate takes over the primary role and sends the Accounting START message.

From Cisco IOS XR Software Release R5.3.1 and later, the backend PCRF system need to send the CoA message only to the primary node.

Session Sync

Once the session is up on the primary node, the entire session information gets synced to the subordinate node. This includes dynamic synchronization of updates such as CoA or service logon. This is applicable from Cisco IOS XR Software Release R5.3.1 and later.

Setting up BNG Subscriber Redundancy Group

Guidelines in setting up SRG

Setting up SRG is subjected to these guidelines:

- The configurations and subscriber policies applied on the two routers (where the SRG access-interfaces are dual homing) must be identical to ensure seamless session mirroring and switchover.
 - SRG IDs (group IDs) must be same across BNGs.
 - Access-interface names or types need not be the same across routers.
 - Interface mapping-IDs must be same for the access-interfaces across BNGs.
 - Server configurations (namely, RADIUS and DHCP configurations), IP pools, subscriber policies and templates must be identical across routers.
- The database of SRGs is scoped to a particular control plane instance (that is, at RP or LC node level). Therefore, you cannot form a single SRG with member links across LCs or with a mix of virtual interfaces (for example, bundles) and physical ports.

- The **global** BBA-Group is not valid for SRG, and hence the **pppoe bba-group global** command must not be used in BNG geo redundancy scenarios. Because **global** is a reserved keyword for IOS XR PPPoE call flow, you must use a different keyword for SRG.

Setting up a BNG subscriber redundancy group (SRG) involves these steps:

- Enable BNG Geo-Redundancy:

```
subscriber redundancy
source-interface loopback1
```

- Setup SRG and specify peer IPv4 or IPv6 address:

```
subscriber redundancy
group 1
peer 1.1.1.2
```

- Specify access-interfaces or VLANs, and mapping IDs:

```
subscriber redundancy
group 1
interface-list
interface Bundle-Ether1.10 id 210
```

- Set up access object tracking for SRG and summary subscriber route:

```
track mclag-bel
type line-protocol state
interface bundle-ether1

subscriber redundancy
group 1
access-tracking mc-lag-bel

router static
address-family ipv4 unicast
200.0.0.0/16 Null0 track mc-lag-bel
```

Some optional configurations such as **preferred-role**, **slave-mode** and **hold-timer** also exist for SRG.

**Note**

Subscriber sessions should always be in sync between the SRG primary and subordinate. Don't clear all the SRG subscriber sessions manually. In an exceptional situation, follow the recommended steps for safe clearing of all SRG subscriber sessions.

To clear the subscriber sessions manually, perform the following:

To Clear SRG subordinate sessions:

1. Shut down the subordinate access interface.

For example,

```
RP/0/RSP0/CPU0# configure
RP/0/RSP0/CPU0(config)# interface Hu0/0/0/1
RP/0/RSP0/CPU0(config-if)# shutdown
```

2. Disable SRG (in global SRG configuration or SRG group level configuration).

For example,

```
Disable SRG in global configuration
RP/0/RSP0/CPU0:router# configure
RP/0/RSP0/CPU0:router(config)# subscriber redundancy disable

Disable SRG in group level configuration
RP/0/RSP0/CPU0:router# configure
RP/0/RSP0/CPU0:router(config)# subscriber redundancy group 1 disable
```

3. Clear subscriber sessions using the **clear subscriber srg slave session all** command.

For example,

```
RP/0/RSP0/CPU0:router#clear subscriber srg slave session all
```

4. Re-enable SRG (in global SRG configuration or SRG group level configuration).

For example,

```
Re-enable SRG in the global configuration:
RP/0/RSP0/CPU0:router# configure
RP/0/RSP0/CPU0:router(config)# session redundancy

Re-enable SRG in the group configuration:
RP/0/RSP0/CPU0:router# configure
RP/0/RSP0/CPU0:router(config)# session redundancy group 1
```

5. Bring up the subordinate access interface.

For example,

```
RP/0/RSP0/CPU0# configure
RP/0/RSP0/CPU0(config)# interface Hu0/0/0/1
RP/0/RSP0/CPU0(config-if)# no shutdown
```

Clearing SRG primary sessions:

1. Perform SRG switchover using the **subscriber redundancy switchover [group <group>]** command.

For example,

```
RP/0/RSP0/CPU0# configure
RP/0/RSP0/CPU0:router(config)# subscriber redundancy switchover group 1
```

2. Shut down the primary access interface.

For example,

```
RP/0/RSP0/CPU0# configure
RP/0/RSP0/CPU0(config)# interface Hu0/0/0/1
RP/0/RSP0/CPU0(config-if)# shutdown
```

3. Disable SRG (in global SRG configuration or SRG group level configuration).

For example,

```
Disable SRG in global configuration
RP/0/RSP0/CPU0:router# configure
RP/0/RSP0/CPU0:router(config)# subscriber redundancy
RP/0/RSP0/CPU0:router(config-subscr-red)# disable

Disable SRG in group level configuration
RP/0/RSP0/CPU0:router# configure
RP/0/RSP0/CPU0:router(config)# subscriber redundancy group 1 disable
```

4. Clear subscriber sessions using the **clear subscriber srg master session all** command.

For example,

```
RP/0/RSP0/CPU0:router#clear subscriber srg master session all
```

5. Re-enable SRG (in global SRG configuration or SRG group level configuration).

For example,

```
RP/0/RSP0/CPU0:router# configure
RP/0/RSP0/CPU0:router(config)# session redundancy

RP/0/RSP0/CPU0:router# configure
RP/0/RSP0/CPU0:router(config)# session redundancy group 1
```

6. Bring up the primary access interface.

For example,

```
RP/0/RSP0/CPU0# configure
RP/0/RSP0/CPU0(config)# interface Hu0/0/0/1
RP/0/RSP0/CPU0(config-if)# no shutdown
```

Geographical Redundancy By Using a Session Redundancy Group (SERG)

In large scale network implementations, it becomes essential to have redundancy between routers that share the same core network (IP and MPLS), but are geographically apart. A redundancy thus achieved is known as geographical redundancy, and often consists of a switchover (SO) from the active (primary) router to the standby (subordinate) router.

To achieve geographical redundancy for IPv6 Neighbor Discovery (ND) entries, or for DHCPv6 bindings, we use a Session Redundancy Group (SERG). A SERG comprises of sessions mapped to the access interfaces on the active RP of the router. If a single SERG is configured on the active RPs of the primary and subordinate

routers, then the router hosting the primary SERG serves as the primary, and the router hosting the subordinate SERG serves as the subordinate. This is illustrated in the following figure.

Figure 28: Geo Redundancy with a Single SERG

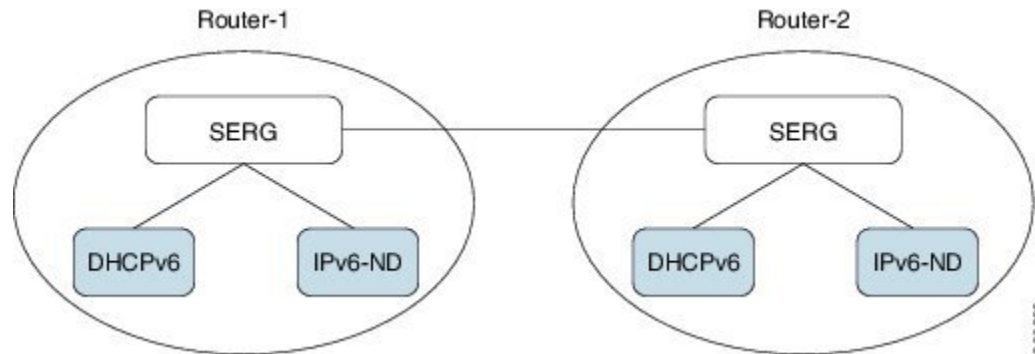

When multiple SERGs are configured on the active RPs, you could have both primary and subordinate SERGs on a single router. This is illustrated in the following figure.

Figure 29: Geo Redundancy with Multiple SERGs

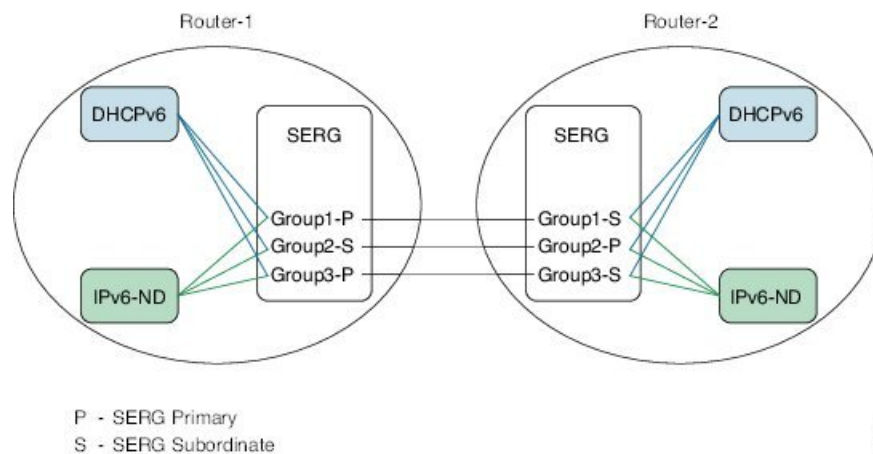

Each router has an inbuilt redundancy between the RPs. When the active RP fails, the session (s) is transferred to the standby RP. This is known as a failover (FO).



Note When a SERG peering is down, the communication between the SERG agents is lost. So the role of the subordinate routers automatically switches to the primary role. The routers on both sides act as a primary router, but only the SERG group configured with the preferred role as primary can provide addresses to subscribers establishing sessions.

The Session Redundancy Manager (SERM) runs on the active RP of both primary and subordinate routers. The SR clients running on the routers interact with the Session Redundancy Infrastructure (Session Redundancy Agent (SRA) and the Session Redundancy Library (SRL)).

The various components and their functions are briefly described as follows:

- **Session Redundancy Manager (SERM):** The SERM runs as a separate process on the active RP and manages the SERG configuration. The SERM peers with other routers that need to form a redundancy

relationship, and establishes a point-to-multipoint communication channel to Session Redundancy Agents (SRAs) on the RP.

- **Session Redundancy Agent (SRA):** One or more SRAs run as a separate process on the active RP and supported line cards. A SRA acts on the SERG configuration, setting up operational context and database tables. The SRA implements the state machine for primary/subordinate selection and role change and orchestrates it using the TCP channel and provided APIs. The SRA receives the session entries on the primary router and updates its database prior to synchronizing with the database on the subordinate router. The SRA orchestrates the session context setup on the subordinate router during the FO or SO. The SRA maintains a separate session database for each session client configured in the SERG.



Note The SRA works only on specific, defined keys, such as the IPv6 address, DHCPv6 client ID, and so on. Any undefined session data is handled as opaque data by the SRA. The respective session components must provide their access library to the SRA for handling any transformation or data retrieval.

- **Session Redundancy Library (SRL):** The SRL is used by session components for communicating with the SRA. The SRL uses IPC semantics for communicating with the SRA. SERG clients use an asynchronous API for storing and retrieving the session state from the SRL.

You can configure object tracking for one or more access interfaces in the SERG to enable automatic switchovers when an interface goes down. For more information on this configuration, see the *BNG Command Reference Guide for Cisco ASR 9000 Series Routers*.

Configuring and Verifying Session Redundancy for DHCPv6 Clients

Use the following procedure to configure geo-redundancy through session redundancy for DHCPv6 clients.

In this example, we configure Router 1 as Primary and Router 2 as Subordinate.

1. On Routers R1 and R2, enter the global configuration mode and configure session redundancy by specifying Loopback 0 as the source interface.

```
RP/0/RSP0/CPU0:router# configure
RP/0/RSP0/CPU0:router(config)# session redundancy
RP/0/RSP0/CPU0:router(config-session-red)# hold-timer 5
RP/0/RSP0/CPU0:router(config-session-red)# source-interface loopback0
```



Note The hold timer values on Routers R1 and R2 must match for them to peer with each other.

2. Configure the session redundancy group by specifying the preferred role as Primary for Router R1 using the **master** keyword, and as subordinate for Router R2 using the **slave** keyword.

Router R1:

```
RP/0/RSP0/CPU0:router(config)# session redundancy group 1
RP/0/RSP0/CPU0:router(config-session-red-group)# preferred-role master
RP/0/RSP0/CPU0:router(config-session-red-group)# hold-timer 7
RP/0/RSP0/CPU0:router(config-session-red-group)# peer 2.2.2.2
```



```
RP/0/RSP0/CPU0:router(config-session-red-group)# revertive-timer 5 maximum 15
RP/0/RSP0/CPU0:router(config-session-red-group)# interface-list
RP/0/RSP0/CPU0:router(config-session-red-grp-intf)# interface GigabitEthernet0/1/0/0 id
1
```

Router R2:

```
RP/0/RSP0/CPU0:router(config)# session redundancy group 1
RP/0/RSP0/CPU0:router(config-session-red-group)# preferred-role slave
RP/0/RSP0/CPU0:router(config-session-red-group)# hold-timer 7
RP/0/RSP0/CPU0:router(config-session-red-group)# peer 1.1.1.1
RP/0/RSP0/CPU0:router(config-session-red-group)# revertive-timer 5 maximum 15
RP/0/RSP0/CPU0:router(config-session-red-group)# interface-list
RP/0/RSP0/CPU0:router(config-session-red-grp-intf)# interface GigabitEthernet0/1/0/0 id
1
```



Note The hold timer, revertive timer, and interface ID values on Routers R1 and R2 must match for them to peer with each other.

- Exit to the global configuration mode and commit your configuration on Routers R1 and R2.

```
RP/0/RSP0/CPU0:router(config)# commit
```

- Confirm your configuration on Router R1.

```
RP/0/RSP0/CPU0:router# show running-config session-redundancy
...
session-redundancy
source-interface Loopback0
hold-timer 5
group 1
  preferred-role master
  hold-timer 7
  peer 2.2.2.2
  revertive-timer 5 maximum 15
  interface-list
    interface GigabitEthernet0/1/0/0 id 1
  !
!
```

- Confirm your configuration on Router R2.

```
RP/0/RSP0/CPU0:router# show running-config session-redundancy
...
session-redundancy
source-interface Loopback0
hold-timer 5
group 1
  preferred-role slave
  hold-timer 7
  peer 1.1.1.1
  revertive-timer 5 maximum 15
  interface-list
    interface GigabitEthernet0/1/0/0 id 1
  !
!
```

- Verify the session redundancy group on the routers by running the following show commands.

```
RP/0/RSP0/CPU0:router# show session-redundancy group
```

```
...
Session Redundancy Agent Group Summary
Flags      : E - Enabled, D - Disabled, M - Preferred Master, S - Preferred Slave
            H - Hot Mode, W - Warm Mode, T - Object Tracking Enabled
P/S        : Peer Status
            I - Initialize, Y - Retry, X - Cleanup, T - Connecting
            L - Listening, R- Registered, C - Connected, E - Established
I/F Count: Interface Count
SS Count  : Session Count
```

Node Name	Group ID	Role	Flags	Peer Address	P/S	I/F Count
0/1/CPU0	1	Master	EMH-	2.2.2.2	E	
1	0	0				

```
Session Summary Count(Master/Slave/Total): 0/0/0
```

```
RP/0/RSP0/CPU0:router# show session-redundancy group 1
```

```
...
Session Redundancy Group ID: 1
Description      : <<not-configured>>
Status          : Enabled

Init-Role       : Master
Negotiated-Role : Master
Current-Role    : Master

Hold Time       : 7
Revert Time     : 5

Tracking Status : Enabled
Core-Tracking   : <<not-configured>>
Status          : n/a
Access-Tracking : <<not-configured>>
Status          : n/a

Peer:
IP-address     : 2.2.2.2
Status         : Established
Role(Init/Neg/Cur): Slave/Slave/Slave
Tracking Status : Up

Last Neg-Time   : 2017 Mar 2 18:14:42
Last Up-Time    : 2017 Mar 2 18:14:42
Last Down-Time  : 2017 Mar 2 18:14:26

Switchover:
Last Switchover : 2017 Mar 2 18:14:42      Reason       : Peer Up
Switchover Count : 1
Hold Time       : Not-Running
Revert Time     : Not-Running

Session Statistics:
Count           : 0
Pending Update  : 0
Client:
  IPv6ND        : 0
  DHCPv6        : 0
Slave-Upd-Fail : 0
Pending Delete  : 0
```

```
Interface Count      : 1
GigabitEthernet0/1/0/0      Map-ID      : 1
```

```
RP/0/RSP0/CPU0:router# show session-redundancy summary interface
```

```
...
Session Redundancy Interface Summary
Status: E - Exists, F - Forward Reference
-----
```

Interface Name	Status	Group ID	Map ID	Role
GigabitEthernet0/1/0/0	E	1	1	Master

```
-----
```

7. Verify the SRG session information on the routers.

```
RP/0/RSP0/CPU0:router# show session-redundancy group 1 session verbose
```

```
...
Session Redundancy Agent Group Session
  Flags: M-Master, V-Valid MAC, N-Neg Ack
  Comp: SA-Agent, ND-ipv6nd, D6-dhcpv6
  Comp Flags: U-Update, D-Delete, S-InSync, F-TxListFail, T-Dirty, C-Cleanup
  Err Info: X-xxxx-ec - H/S - Hard/Soft, xxxx - No. of Times, ec - Error Code
-----
```

Parent Interface	Key index	Flags
Comp Flags	Synchronization Error Info	
GigabitEthernet0/1/0/0	00030001ca011bba00000000000000000000000000000000	M-SA{S} D6{S}
	-	

```
-----
```

8. Verify the SRA information and statistics.

```
RP/0/RSP0/CPU0:router# show session-redundancy agent interface
```

```
...
Session Redundancy Agent Interface
Status : F - Forward Referenced, S - Stale, R - Registered,
        A - CAPS Added, O - Resource Owned, P - EOMS Pending
        C - Pending CAPS Remove, U - Pending Reg Disable
Err Stats: Enable - Disable - Caps Add - Caps Remove - Attr Updated
-----
```

Interface Name	ID	Group ID	Role	Status	Oper	Err Stats
GigabitEthernet0/1/0/0	1	1	Master	--RA----	-----	0-0-0-0-0

```
-----
```

```
RP/0/RSP0/CPU0:router# show session-redundancy agent statistics
```

```
...
Session Redundancy Agent Summary - Node 0/0/CPU0
  Process State      : Active

  Source Interface   : Loopback0
  VRF Name           : default
  IPv4 Address       : 1.1.1.1
  IPv6 Address       : 192::2

Restart Client Sync In Progress : No
```

```

Client Init Sync TimeStamp      : -
Restart Peer Sync In Progress  : No
Peer Init Sync TimeStamp       : -
Sync in Progress                : No
Peer Action Timer               : Not-Running
Retry Timer                     : Not-Running
Interface Status Statistics
  Bound to group                 : 1
  Non stale                      : 0
  Pending caps remove            : 0
  Pending reg disable            : 0
  Pending other batch oper       : 0
  Sync in Progress               : No

```

Client Statistics:

Status: U - Connection UP, S - Init-Sync Pending, E - Sync EOD Pending

Comp	Status	Up Timestamp	Down Timestamp	Cleanup Timer
SERGAGT	---	-	-	0
IPv6ND	U--	2017 Mar 2 18:14:25	-	0
DHCPv6	U--	2017 Mar 2 18:14:25	-	0

TxList Statistics:

```

Ok      Part-Write      Clean
-----
Marker Encode           :           4           0           4
Command Encode          :           0           0           0
Negotiation Encode     :           0           0           0

```

Client Statistics:

```

Ok      NotOk
-----
Invalid Registration    :           0
Invalid DeRegistration  :           0
Connection Up Count     :           2
Connection Down Count   :           0
Message CallBack Count :           2
Message Received        :           4           0
Command Message Received :           0           0
Session Message Received :           4           0
Peer Done               :           2

```

Peer Statistics:

```

Ok      NotOk
-----
Timer Handler           :           0
Invalid Registration    :           0
Invalid DeRegistration  :           0
Message CallBack Count :           0           0
Command Connection Up   :           0           0
Command Connection Down :           0           0
Session Connection Up   :           0           0
Session Connection Down :           0           0
Peer Done               :           0

```

9. Verify the DHCPv6 SR client information on the routers.

```

RP/0/RSP0/CPU0:router#show session-redundancy agent client dhcpv6
...
Session Redundancy Agent Client Statistics - Node 0/0/CPU0
Component - DHCPv6
Statistics:                                     Ok      NotOk
-----

```

```

Sent To Client:
Command
  Start of Download - SOD          :          1          0
  End of Download   - EOD          :          1          0
  End of Master Sync - EOMS        :          0          0
  Clear             - All           :          0          0
  Clear             - Selected      :          0          0
  Replay           - All           :          0          0
  Replay           - Selected      :          0          0
Session
  Update           :          0          0
  Delete           :          0          0

TxList Operation:
Encode - Complete Write          :          0
Encode - Partial Write           :          0
Cleanup CallBack                 :          0
Last Replay Count                :          0

Received From Client:
Command
  Start of Download - SOD - All    :          1
  Start of Download - SOD - Selected :          0
  End of Download   - EOD - All    :          1
  End of Download   - EOD - Selected :          0
  End of Master Sync - EOMS        :          0
  Clear             - All           :          0
  Clear             - Selected      :          0
  Replay           - All           :          0
  Replay           - Selected      :          0
Session
  Update           :          0          0
  Delete           :          0          0
  Negative Acknowledgement        :          0          0

Client Activity Statistics:
Active                :          1          0
Deactive              :          0          0
Registration          :          1          0
DeRegistration        :          0
Connection Down       :          0
Cleanup               :          0

```

Session Redundancy Agent Client Statistics - Node 0/1/CPU0

Component - DHCPv6

Statistics: Ok NotOk

```

Sent To Client:
Command
  Start of Download - SOD          :          1          0
  End of Download   - EOD          :          1          0
  End of Master Sync - EOMS        :          1          0
  Clear             - All           :          0          0
  Clear             - Selected      :          0          0
  Replay           - All           :          0          0
  Replay           - Selected      :          0          0
Session
  Update           :          0          0
  Delete           :          0          0

TxList Operation:
Encode - Complete Write          :          0
Encode - Partial Write           :          0

```

```

Cleanup CallBack          :          0
Last Replay Count        :          0

Received From Client:
Command
  Start of Download - SOD - All      :          1
  Start of Download - SOD - Selected :          0
  End of Download   - EOD - All      :          1
  End of Download   - EOD - Selected :          0
  End of Master Sync - EOMS          :          0
  Clear             - All             :          0
  Clear             - Selected        :          0
  Replay           - All             :          0
  Replay           - Selected        :          0
Session
  Update           :          0          3
  Delete           :          0          2
Negative Acknowledgement :          0          0

Client Activity Statistics:
Active             :          1          0
Deactive          :          0          0
Registration       :          1          0
DeRegistration    :          0
Connection Down   :          0
Cleanup           :          0

```

Session Redundancy Agent Client Statistics - Node 0/2/CPU0

Component - DHCPv6

Statistics:	Ok	NotOk
-------------	----	-------

Sent To Client:

```

Command
  Start of Download - SOD          :          1          0
  End of Download   - EOD          :          1          0
  End of Master Sync - EOMS        :          0          0
  Clear             - All          :          0          0
  Clear             - Selected     :          0          0
  Replay           - All          :          0          0
  Replay           - Selected     :          0          0
Session
  Update           :          0          0
  Delete           :          0

```

TxList Operation:

```

Encode - Complete Write :          0
Encode - Partial Write  :          0
Cleanup CallBack       :          0
Last Replay Count      :          0

```

Received From Client:

```

Command
  Start of Download - SOD - All      :          1
  Start of Download - SOD - Selected :          0
  End of Download   - EOD - All      :          1
  End of Download   - EOD - Selected :          0
  End of Master Sync - EOMS          :          0
  Clear             - All             :          0
  Clear             - Selected        :          0
  Replay           - All             :          0
  Replay           - Selected        :          0
Session
  Update           :          0          0

```

```

Delete : 0 0
Negative Acknowledgement : 0 0

Client Activity Statistics:
Active : 1 0
Deactive : 0 0
Registration : 1 0
DeRegistration : 0
Connection Down : 0
Cleanup : 0

```

You have successfully configured and verified geo redundancy using session redundancy groups for DHCPv6 clients.

Managing Session Redundancy Groups

After you have configured and verified the session redundancy groups (SERGs), you can use the commands in this section to trigger a manual switchover, trigger a manual synchronization, or clear sessions for all or a specific SERG.

Triggering a Manual Switchover

After you have configured SERGs on the primary and subordinate routers, if you want to remove/replace the primary router, you can trigger a manual switchover from the primary to the subordinate by running the following commands.



Note The following commands can be executed only on the primary router.

- To trigger a redundancy switchover for all SERGs, run the following command.

```
RP/0/RSP0/CPU0:router# session redundancy switchover
```

- To trigger a redundancy switchover for a specific SERG, run the following command.

```
RP/0/RSP0/CPU0:router# session redundancy switchover group 210
```

Triggering Manual Synchronization

If the sessions between the primary and subordinate routers are not getting synchronized, either because of some change in the network topology, or some network latency, you can trigger synchronization manually by running the following commands.



Note The following commands can be executed on either the Primary or the Subordinate router.

- To trigger a redundancy synchronization for all SERGs, run the following command.

```
RP/0/RSP0/CPU0:router# session redundancy synchronize
```

- To trigger a redundancy synchronization for a specific SERG, run the following command.

```
RP/0/RSP0/CPU0:router# session redundancy synchronize group 210
```

Clearing Sessions in a SERG

If you want to clear the existing sessions on the primary and subordinate routers, either because of a switchover, or a change in network topology, you can run the following commands.



Note

The following commands can be executed on either the primary or the subordinate router.

When issued on the subordinate, the session context is deleted from the router and a synchronization is requested with the primary. If the router is in hot-standby mode, the sessions are deleted on the subordinate.

When issued on the primary, the session entries are deleted first on the primary and later on the subordinate. The SRA then requests a fresh session from the SR client, which is eventually synchronized with the subordinate.

- To clear sessions for all SERGs, run the following command.

```
RP/0/RSP0/CPU0:router# clear session-redundancy
```

- To clear sessions for a specific SERG, run the following command.

```
RP/0/RSP0/CPU0:router# clear session-redundancy group 1
```

Configuring and Verifying Session Redundancy for IPv6 ND Clients

Use the following procedure to configure geo-redundancy through session redundancy for IPv6 ND clients.

In this example, we configure Router 1 as Primary and Router 2 as Subordinate.

1. On Routers R1 and R2, enter the global configuration mode and configure session redundancy by specifying Loopback 0 as the source interface.

```
RP/0/RSP0/CPU0:router# configure
RP/0/RSP0/CPU0:router(config)# session redundancy
RP/0/RSP0/CPU0:router(config-session-red)# hold-timer 5
RP/0/RSP0/CPU0:router(config-session-red)# source-interface loopback0
```



Note The hold timer values on Routers R1 and R2 must match for them to peer with each other.

- Configure the session redundancy group by specifying the preferred role as Primary for Router R1 using the **master** keyword, and as subordinate for Router R2 using the **slave** keyword.

Router R1 :

```
RP/0/RSP0/CPU0:router(config)# session redundancy group 1
RP/0/RSP0/CPU0:router(config-session-red-group)# preferred-role master
RP/0/RSP0/CPU0:router(config-session-red-group)# hold-timer 7
RP/0/RSP0/CPU0:router(config-session-red-group)# peer 2.2.2.2
RP/0/RSP0/CPU0:router(config-session-red-group)# revertive-timer 5 maximum 15
RP/0/RSP0/CPU0:router(config-session-red-group)# interface-list
RP/0/RSP0/CPU0:router(config-session-red-grp-intf)# interface GigabitEthernet0/1/0/0 id
1
```

Router R2:

```
RP/0/RSP0/CPU0:router(config)# session redundancy group 1
RP/0/RSP0/CPU0:router(config-session-red-group)# preferred-role slave
RP/0/RSP0/CPU0:router(config-session-red-group)# hold-timer 7
RP/0/RSP0/CPU0:router(config-session-red-group)# peer 1.1.1.1
RP/0/RSP0/CPU0:router(config-session-red-group)# revertive-timer 5 maximum 15
RP/0/RSP0/CPU0:router(config-session-red-group)# interface-list
RP/0/RSP0/CPU0:router(config-session-red-grp-intf)# interface GigabitEthernet0/1/0/0 id
1
```



Note The hold timer, revertive timer, and interface ID values on Routers R1 and R2 must match for them to peer with each other.

- Exit to the global configuration mode and commit your configuration on Routers R1 and R2.

```
RP/0/RSP0/CPU0:router(config)# commit
```

- Confirm your configuration on Router R1 (Primary).

```
RP/0/RSP0/CPU0:router# show running-config session-redundancy
...
session-redundancy
 source-interface Loopback0
 hold-timer 5
 group 1
   preferred-role master
   hold-timer 7
   peer 2.2.2.2
   revertive-timer 5 maximum 15
   interface-list
     interface GigabitEthernet0/1/0/0 id 1
   !
 !
 !
```

- Confirm your configuration on Router R2.

```
RP/0/RSP0/CPU0:router# show running-config session-redundancy
...
session-redundancy
 source-interface Loopback0
 hold-timer 5
 group 1
   preferred-role slave
   hold-timer 7
   peer 1.1.1.1
```

```

revertive-timer 5 maximum 15
interface-list
interface GigabitEthernet0/1/0/0 id 1
!
!
!

```

6. Verify the session redundancy group on the routers by running the following show commands.

```
RP/0/RSP0/CPU0:router# show session-redundancy group
```

```

...
Session Redundancy Agent Group Summary
Flags      : E - Enabled, D - Disabled, M - Preferred Master, S - Preferred Slave
            H - Hot Mode, W - Warm Mode, T - Object Tracking Enabled
P/S       : Peer Status
            I - Initialize, Y - Retry, X - Cleanup, T - Connecting
            L - Listening, R- Registered, C - Connected, E - Established
I/F Count: Interface Count
SS Count  : Session Count

```

Node Name	Group ID	Role	Flags	Peer Address	P/S	I/F Count
SS Count	Sync Pending					
0/1/CPU0	1	Master	EMH-	2.2.2.2	E	
1	0	0				

```
Session Summary Count(Master/Slave/Total): 0/0/0
```

```
RP/0/RSP0/CPU0:router# show session-redundancy group 1
```

```

...
Session Redundancy Group ID: 1
Description      : <<not-configured>>
Status           : Enabled

Init-Role        : Master
Negotiated-Role  : Master
Current-Role     : Master

Hold Time        : 7
Revert Time      : 5

Tracking Status  : Enabled
Core-Tracking    : <<not-configured>>
Status           : n/a
Access-Tracking  : <<not-configured>>
Status           : n/a

Peer:
IP-address       : 2.2.2.2
Status           : Established
Role(Init/Neg/Cur): Slave/Slave/Slave
Tracking Status  : Up

Last Neg-Time    : 2017 Mar 2 18:14:42
Last Up-Time     : 2017 Mar 2 18:14:42
Last Down-Time   : 2017 Mar 2 18:14:26

Switchover:
Last Switchover  : 2017 Mar 2 18:14:42      Reason      : Peer Up
Switchover Count : 1
Hold Time        : Not-Running

```

 ...

9. Verify the IPv6 ND SR client information on the routers.

RP/0/RSP0/CPU0:router# **show session-redundancy client ipv6nd**
Session Redundancy Client Statistics - Node 0/0/CPU0

```

Config      : True
Status     : Enabled
Active      : True

Connection Status      : Connected
Last Connection Up Time : 2017 Mar  7 10:28:03
Last Connection Down Time : 1970 Jan  1 05:30:00

TxList Operation:
Message CallBack           :           2
Encode - Complete Write    :           7
Encode - Partial Write     :           0
Cleanup CallBack           :           0
Decode Message Error       :           0
Unknown Operation Error    :           0

TxList Statistics:
-----
Marker Encode              :           2           0           2
Command Encode              :           0           0           0
Negotiation Encode         :           0           0           0

Statistics:
-----
Ok           NotOk

Sent To Agent:
Command
  Start of Download - SOD           :           1           0
  End of Download   - EOD           :           1           0
  End of Master Sync - EOMS         :           0           0
  Clear             - All            :           0           0
  Clear             - Selected       :           0           0
  Replay           - All            :           0           0
  Replay           - Selected       :           0           0
Session
  Add               :           7           0
  Delete            :           7           0
Negative Acknowledgement
  Synchronous       :           0           0
  Asynchronous      :           0           0

Received From Agent:
Message
Command
  Start of Download - SOD - All      :           1
  Start of Download - SOD - Selected :           0
  End of Download   - EOD - All      :           1
  End of Download   - EOD - Selected :           0
  End of Master Sync - EOMS          :           7
  Clear             - All            :           0
  Clear             - Selected       :           0
  Replay           - All            :           1
  Replay           - Selected       :           0
Session
  Update            :           0           0
  Delete            :           0           0

```

Agent Activity Statistics:

```

Active           :           1           0
Deactive         :           0           0
Connection Up    :           1           0
Connection Down  :           0
Peer Done        :           8

```

...

RP/0/RSP0/CPU0:router# show ipv6 nd statistics

Service	Attrib	Oper	Success#	Failure#	MinTime (usec)	MaxTime (usec)	AvgTime (usec)
AIB	IDB	Init	1	0	84110	84110	84110
AIB	IDB	Reg	1	0	295	295	295
CHKPT	IDB	Init	1	0	73	73	73
CHKPT	IDB	Update	47	0	23	100	27
CHKPT	NBR	Create	4	0	68	110	80
CHKPT	NBR	Del	2	0	150	1475	812
CHKPT	NBR	Init	1	0	232	232	232
CHKPT	NBR	Update	4	0	54	166	120
GSP	BATCH	Sent	4	32	0	2411	68
GSP	IDB	Init	1	0	5197	5197	5197
GSP	IDB	Reg	1	0	1816	1816	1816
GSP	IDB	Sent	24	0	13	104	15
GSP	MNODE	Sent	8	0	14	2482	322
GSP	PING	Recv	4	0	0	0	0
GSP	PING	Sent	4	0	76	1476	475
GSP	Ucast	Recv	5	0	0	0	0
IM	IDB	Create	10	0	0	0	0
IM	IDB	Init	2	0	670	4831	2750
IM	IDB	Reg	1	0	465	465	465
IM	MAC	Recv	8	0	0	0	0
IM	MAC	Reg	1	0	134	134	134
IM	MTU	Recv	8	0	0	0	0
IM	MTU	Reg	1	0	121	121	121
IM	VLAN	Recv	7	0	0	0	0
IM	VLAN	Reg	1	0	144	144	144
IM	MEMBER	Recv	24	0	0	0	0
IM	MEMBER	Reg	1	0	1603	1603	1603
LPTS	IDB	Add	8	0	2	174	25
LPTS	IDB	Init	1	0	4545	4545	4545
LPTS	IDB	Update	10	0	0	1	0
IPV6-MA	BATCH	Recv	3	0	0	0	0
NETIO	IDB	Init	1	0	244787	244787	244787
NETIO	RA	Recv	14	0	0	0	0
NETIO	NA	Recv	4	0	0	0	0
NETIO	NS	Recv	4	0	0	0	0
STATS	IDB	Init	1	0	21410	21410	21410
STATS	IDB	Reg	8	0	2	19532	2449

Session Redundancy Stats

```

-----
Type                               Success  Error
-----
serg_init                           1         0
serg_shutdown                        0         0

```

```

serg_activate           1      0
serg_active_txlist_add 0      0
serg_active_txlist_del 0      0
serg_active_txlist_encode 6     0
serg_active_txlist_clean 6     0
serg_active_replay     1      0
serg_active_cleanup    0      0
serg_standby_receive   0      0
serg_standby_sess_update 0     0
serg_standby_sess_delete 0     0
serg_standby_sess_nack 0      0
serg_standby_sess_mark 1      0
serg_standby_sess_sweep 1     0
serg_standby_cleanup   0      0

```

You have successfully configured and verified geo redundancy using session redundancy groups for IPv6 ND clients.

For information on managing SERGs, see [Managing Session Redundancy Groups, on page 415](#).

Geo Redundancy for PPPoE Sessions

BNG supports geo redundancy for PPPoE-PPP Termination and Aggregation (PPPoE-PTA) and PPPoE-L2TP Access Concentrator (PPPoE-LAC) sessions.

PPPoE-PTA Geo Redundancy

Geo redundancy behavior for the PPPoE-PTA sessions remains the same as for basic geo redundancy set up, except that the keepalives are disabled on the subordinate BNG node. The keepalives are sent only after the subordinate switches its role to primary.

PPPoE-LAC Geo Redundancy

This figure shows a PPPoE-LAC Geo Redundancy set up with BNG

Figure 30: PPPoE-LAC Geo Redundancy Topology

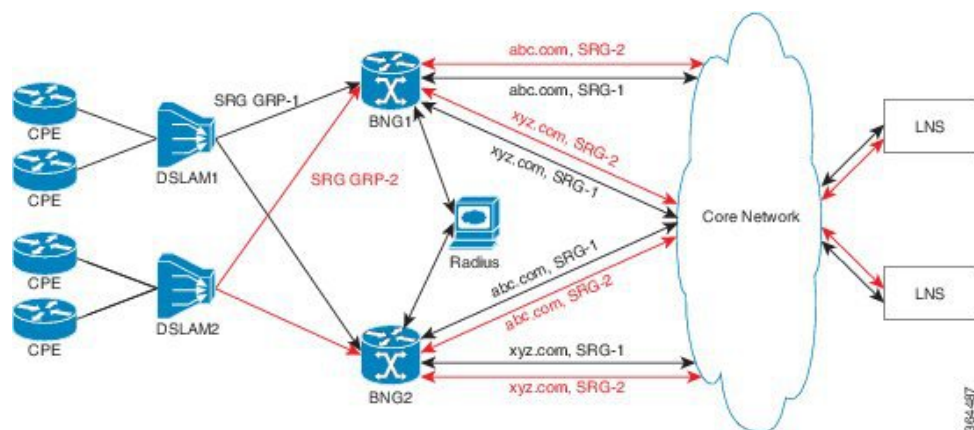

For a PPPoE-LAC geo redundancy setup, the SRG is formed by grouping together the access-links on which LAC sessions are to arrive (co-exists with PTA). To enable SRG level redundancy switchover, tunnels for each SRG for each L2TP network server (LNS) must be setup. L2TP ensures that sessions belonging to

different SRGs do not share the same tunnel even if they are going to the same LNS. The tunnel is set up on both primary and subordinate nodes. By default, the tunnel is down on subordinate and it gets activated upon switchover. The BNG sync takes care of both tunnel and session-state sync from the primary to the subordinate. The L2TP tunnel attributes and negotiated parameters are also synchronized through the BNG sync.

You must use this command in subscriber redundancy group configuration mode, to configure the source IP used for L2TP tunnel for subscribers coming under an SRG group:

l2tp-source-ip *ipv4-address*

This ensures that there is a separate tunnel from each SRG group, in spite of having the same LNS.

PPPoE-LAC Session Switchover

This figure shows the call flow of PPPoE-LAC session switchover.

Figure 31: PPPoE-LAC Session Switchover

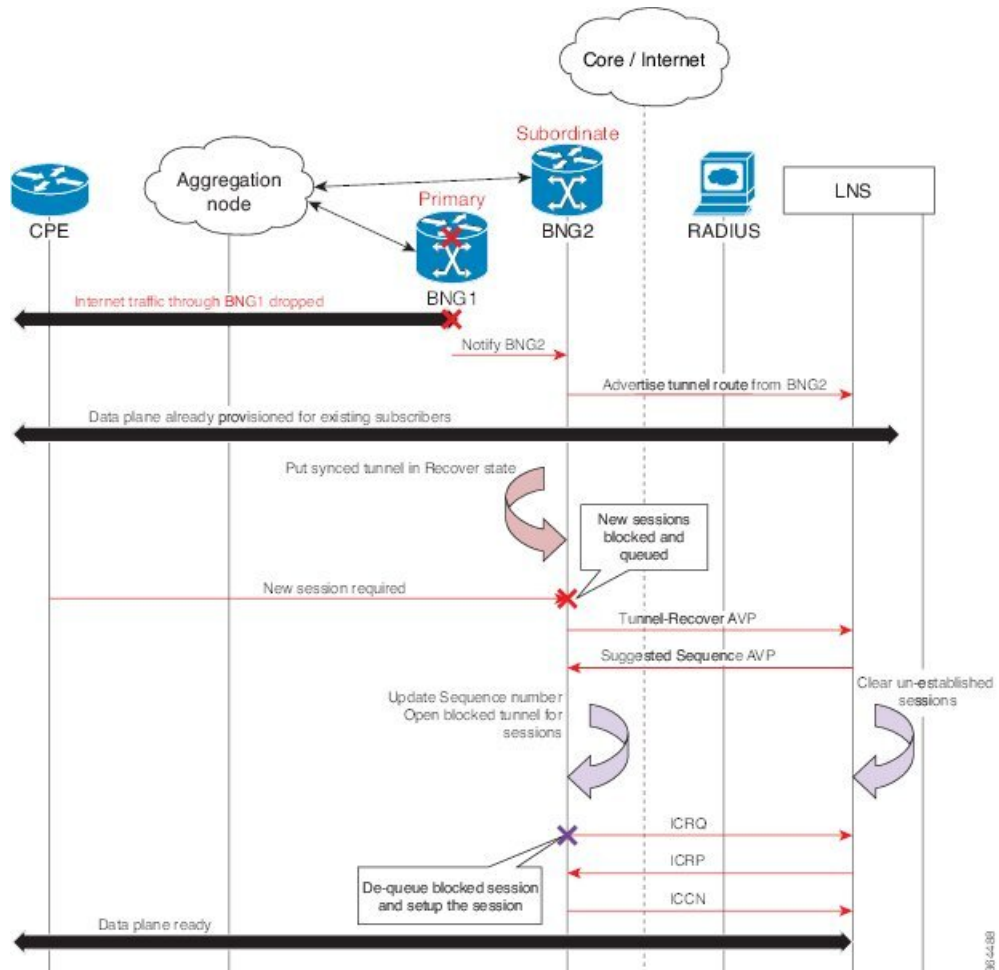

During switchover, the tunnel endpoint switches from the primary (BNG1) to subordinate (BNG2) node as soon as the routing converges, and advertises the loopback address of subordinate (BNG2) to the LNS. The sessions and tunnels that are already provisioned on the data path on subordinate (BNG2) then seamlessly take over. The L2TP control plane on subordinate (BNG2) places the tunnel in re-sync state to recover the

tunnel sequence number (Ns and Nr) during which only control messages are queued up for further processing. After the tunnel recovery, the LAC gets the sequence number from the LNS. The existing tunnels or sessions are not lost as the subordinate (BNG2) takes over. The signaling for the new session resumes and the queued requests also get processed. The unestablished sessions are then cleared off. For LNS, this switchover appears to be a convergence event where the tunnel has flapped.

Verification of Geo Redundancy for PPPoE Sessions

Listed below are some of the show commands that can be used to verify the Geo Redundancy configuration in BNG. For complete command reference, see the *Subscriber Commands*, *PPPoE Commands* and *PPPoE LAC-Specific Commands*, chapters in the *Cisco ASR 9000 Series Aggregation Services Router Broadband Network Gateway Command Reference*.

- **show subscriber redundancy group 210**

```
Subscriber Redundancy Group ID: 210
Description : <<not-configured>>

Status : Enabled
Init-Role      : Master
Negotiated-Role : Master           Current-Role : Master

Slave-mode      : Hot                Hold Time : 15
- - -
- - -
Peer:
  11::2                Status : Established
  Role(Init/Neg/Cur) : Slave/Slave/Slave
  Tracking Status    : Down
- - -
- - -
Switchover:
  Last Switchover    : 2014 Sep 12 07:12:11      Reason : Object Tracking Status
Change
- - -
- - -
Subscriber Session Statistics:
  Count              : 8000                Slave-Upd-Fail : 0
  Pending Update     : 0                  Pending Delete : 0
  Tunnel Count       : 0

Interface Count      : 1
  Bundle-Ether1.10   Map-ID              : 210
```

- **show ppp interfaces**

```
Bundle-Ether2.1.pppoe16534 is up, line protocol is up
SRG Role: Slave
LCP: Open
  Keepalives enabled (60 sec, retry count 5)
  Local MRU: 1492 bytes
  Peer MRU: 65531 bytes
Authentication
  Of Peer: PAP (Completed as user1@domain.com)
  Of Us: <None>
IPCP: Open
  Local IPv4 address: 12.16.0.1
  Peer IPv4 address: 12.0.250.23
```

```
IPv6CP: Initial
  Local IPv6 address: fe80::
  Peer IPv6 address: fe80::
```

- **show pppoe interfaces**

```
Bundle-Ether2.1.pppoe16534 is Complete
  Session id: 16534
  Parent interface: Bundle-Ether2.1
  BBA-Group: BBA1
  Local MAC address: 0002.0003.0004
  Remote MAC address: 0000.6201.0103
  Outer VLAN ID: 10
  Tags:
    Service name: AGILENT
    Host-Uniq: 4 bytes, (000e0000)
  SRG-state: SRG-Standby
```

- **show vpdn**

```
RP/0/RSP0/CPU0:router# show vpdn session

SRG Role: Master
Subscriber label: 0x42, interface name: Bundle-Ether1.10.pppoe3
  user name: user1@lms2.com
  parent interface: Bundle-Ether1.10
  state: est last change: 00:01:01
  time to setup session: 0:2 (s:msec)
  conditional debug flags: 0
L2TP data
  local end point: 11.1.1.1 remote end point: 19.9.9.2
  call serial number: 1970100002
  local tunnel id: 46813 remote tunnel id: 40849
  local session id: 36198 remote session id: 33437 remote port: 1701
  tunnel assigned id:
  tunnel client authentication id: LAC
  tunnel server authentication id: LNS
  tunnel authentication: disabled
  class attribute mask:
Subscriber data
  NAS port id: 0/0/1/10
  NAS port type: Virtual PPPoE over VLAN
  physical channel id: 0
  Rx speed: 1000000000, Tx speed: 1000000000
Configuration data
  table id: 0xe0000000, VRF id: 0x60000000, VPN id: 0:0
  VRF name: default
  dsl line info forwarding: disabled, l2tp busy timeout: 60
  TOS mode: default
```

BNG Geo Redundancy with Satellite

From Cisco IOS XR Software Release 6.2.2 and later, the BNG geo redundancy feature in Cisco ASR 9000 Series Routers is enhanced to provide a satellite-based solution. The satellite box provides high density 10-Gigabit ports to terminate optical line terminals (OLTs) which works seamlessly with BNG geo redundancy

solution for loss-of-signal (LOS) based detection and failover. Currently, this feature is supported only on Cisco IOS XR 32 bit IOS XR operating system, and only with the Cisco NCS 5000 Series nV satellite.

Sample Topology of BNG Geo Redundancy with Cisco NCS 5000 Series nV Satellite

Figure 32: BNG Geo Redundancy with Cisco NCS 5000 Series nV Satellite

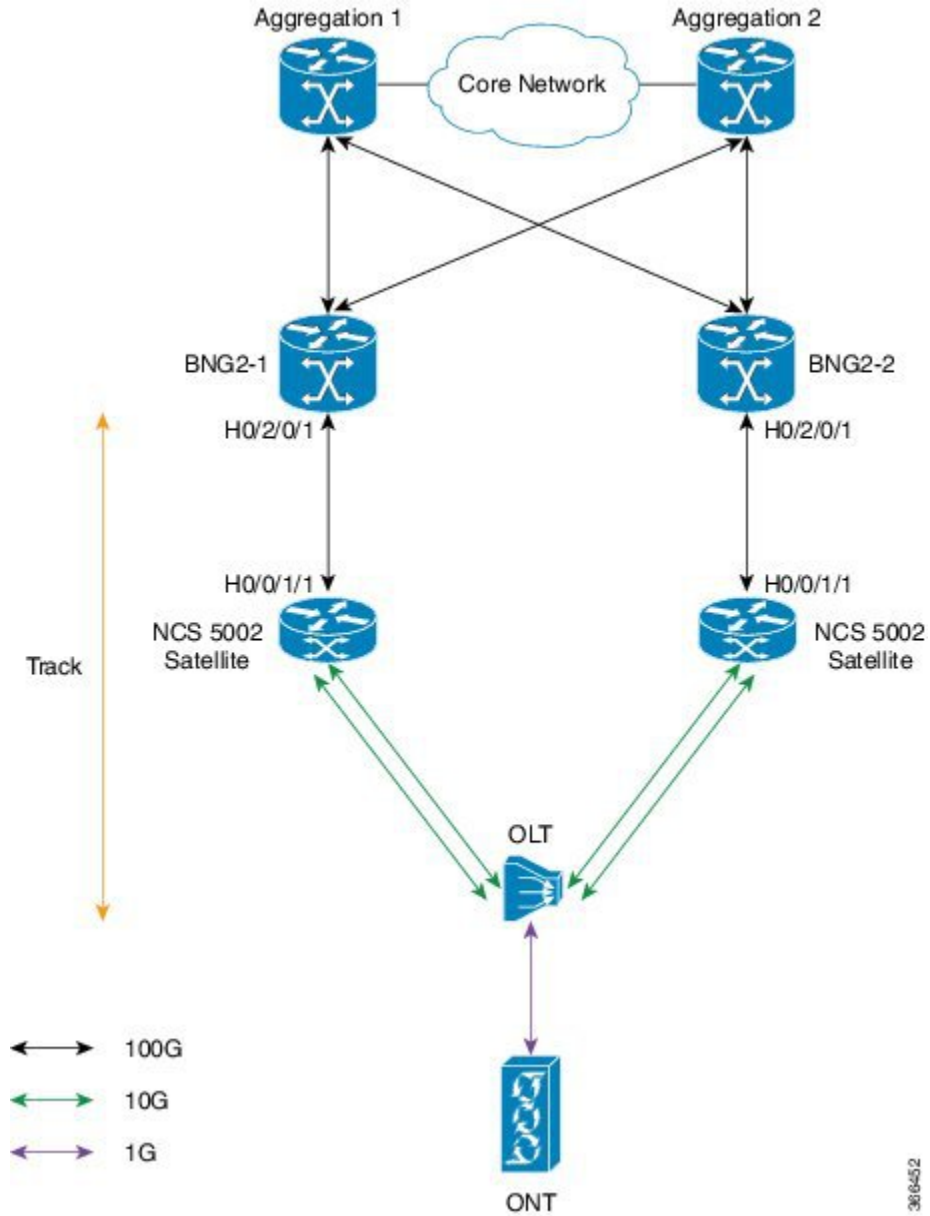

The Cisco NCS 5000 Series (NCS 5001 or NCS 5002) nV satellite which is used in this topology, provides the functionality of an extended or virtual line card for BNG, thereby increasing the access ports on BNG.

Configure BNG Geo Redundancy with Cisco NCS 5000 Series nV Satellite

You have to accomplish the following in order to configure BNG Geo Redundancy with Cisco NCS 5000 Series nV satellite:

- Global satellite configuration
- ICL configuration
- Access-tracking configuration

Except for the additional configurations related to satellite, all other configurations on BNG remain unchanged in order to interwork with Cisco NCS 5000 Series (NCS 5002, in this example) nV satellite.

For information on nV satellite configuration, see the *Configuring the Satellite Network Virtualization* chapter in the *nV System Configuration Guide for Cisco ASR 9000 Series Routers* located [here](#).

Configuration Example

The configurations given here for access-tracking in BNG2-1 are to be repeated for BNG2-2 as well.

```
RP/0/RSP0/CPU0:router(config)# interface TenGigE100/0/0/1
RP/0/RSP0/CPU0:router(config-if)# bundle id 100 mode on
RP/0/RSP0/CPU0:router(config-if)# commit

RP/0/RSP0/CPU0:router(config)# track ACCESS100
RP/0/RSP0/CPU0:router(config-track)# type line-protocol state
RP/0/RSP0/CPU0:router(config-track-line-prot)# interface Bundle-Ether100
RP/0/RSP0/CPU0:router(config-satellite)# commit
```

You must also configure BNG on the sub-interfaces of Bundle-Ether100 and add the BNG access-interface under the SRG group.

Running Configuration

```
interface TenGigE100/0/0/1
 bundle id 100 mode on

track ACCESS100
 type line-protocol state
 interface Bundle-Ether100
 !
```

Related Topics

- [Geo Redundancy Overview, on page 394](#)
- [Setting up BNG Subscriber Redundancy Group, on page 402](#)
- [BNG Interoperability, on page 13](#)

Geo Redundancy Features

Peer Route Disable

Peer route disable is an enhancement in BNG geo redundancy whereby the user can disable the route on geo redundancy hot-standby peer. This disabling is so that the subscriber routes are not installed in the RIB even when the subscriber sessions are brought up on the standby peer. The subscriber routes are inserted into the RIB only when the BNG Geo-Redundancy state of peer changes to active. This ensures that only the primary BNG, and not the subordinate BNG, routes the subscriber traffic in a scenario where access-interface is up on the standby peer. By disabling the routes, the hot-standby mode in BNG geo redundancy does not mandate the access-interface to be down on the standby peer any more.

To enable this feature, use the **peer route disable** command in subscriber redundancy group configuration mode.

Configuration Example

```
RP/0/RSP0/CPU0:router(config)# subscriber redundancy group 110
RP/0/RSP0/CPU0:router(config-subscr-red-group)# peer route-disable
```

Active-active Session Support for Geo Redundancy

Active-active session support for BNG geo redundancy is an enhancement where a subscriber redundancy group (SRG) can be primary on a BNG node while being subordinate on the pair BNG node, and simultaneously another SRG can be primary on the pair BNG node while being subordinate on the primary BNG node. So, a BNG node can be a primary for one SRG and at the same time subordinate for another SRG. This feature provides better load balancing for subscriber sessions across both BNG nodes.

In the case of an active-active scenario, the L2 path from the subscriber CPE towards both BNG nodes is ready to forward packets. Or in other words, the access interface protocol is UP at both BNG nodes.

Figure 33: Active-active Session for BNG Geo Redundancy

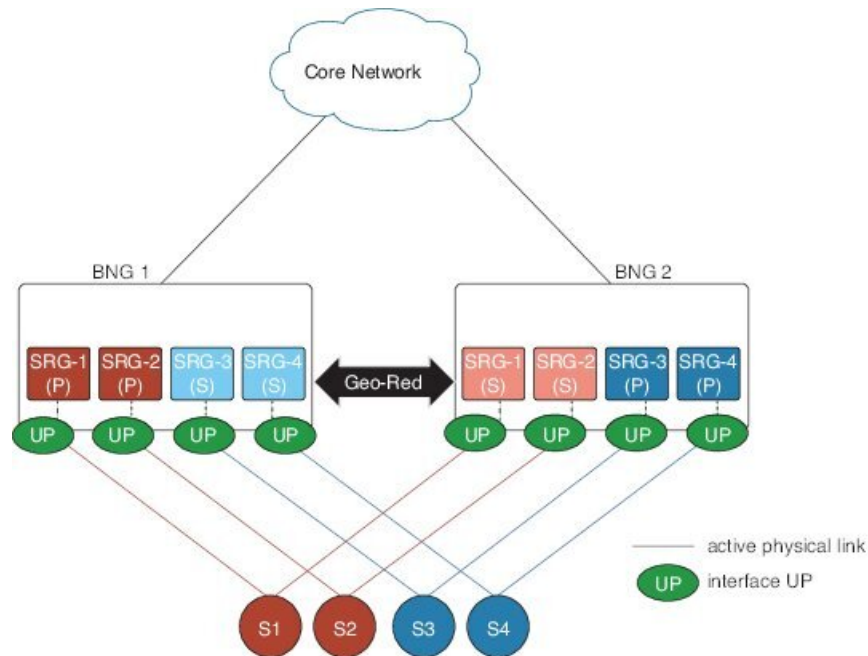

Note The pool name and the address range must be unique for each SRG group in both BNGs for the active-active configuration.

Address Pool Usage Synchronisation in BNG Geo Redundant Active-Active Nodes

The BNG geo redundancy active-active topology contains multiple SRG groups between a pair of BNG nodes. Since each BNG node will be in Primary role for some SRG groups and Subordinate role for the remaining SRG groups, it provides a load balancing of subscribers across BNG nodes.

But this mechanism brings in a lot of complexity when the IP address pool is locally configured on the BNGs, such as in the case of PPPoE, DHCP Server & ND Slaac configuration. The same address pool cannot be shared by multiple interfaces that belong to different SRG groups running in different roles. As a result, the operational overhead is high and you need to manage multiple address pools and address ranges, which might also result in an inefficient address usage.

To overcome this problem, BNG introduces address pool usage synchronisation in geo redundant active-active nodes. This feature enables the use of the same address-pool for a two BNG geo redundant topology. The pool-server running in the SERG Primary BNG assigns the IP addresses for the SRG Primary subscribers. The pool-server running in SERG Subordinate BNG acts as the proxy.

Restrictions for Address Pool Usage Synchronisation in BNG Geo Redundant Active-Active Nodes

Address pool usage synchronisation in BNG geo redundant active-active nodes is subjected to the below restrictions:

- An SERG group cannot have both the interface configuration and pool configuration. Only one of the configurations can be applied on a specific group.
- A specific address pool should be configured only under one SERG group.

Configure Address Pool Usage Synchronisation in BNG Geo Redundant Active-Active Nodes

Configuration Steps

Consider two BNG geo redundant active-active nodes. The configuration steps for configuring pools, on both the SERG primary and SERG subordinate BNG nodes, are shown below:

```
Router# configure terminal
Router(config)# pool vrf default ipv4 p1
Router(config-pool-ipv4)# network 10.10.0.1/16
Router(config-pool-ipv4)# exit
Router(config)# pool vrf default ipv6 p2
Router(config-pool-ipv4)# address-range 2001::10 2001::ffff
Router(config-pool-ipv4)# commit
```

The configuration steps for the BNG node in the SERG primary role is shown below:

```
Router(config)# session-redundancy
Router(config-sess-red)# source-interface mgmtEth 0/RP0/CPU0/0
Router(config-sess-red)# group 100
Router(config-sess-red-group)# preferred-role master
Router(config-sess-red-group)# peer 10.10.10.2
Router(config-sess-red-group)# pool-list pool-name p1
Router(config-sess-red-group)# pool-list pool-name p2
Router(config-sess-red-group)# commit
```

The configuration steps for the BNG node in the SERG subordinate role is shown below:

```
Router(config)# session-redundancy
Router(config-sess-red)# source-interface mgmtEth 0/RP0/CPU0/0
Router(config-sess-red)# group 100
Router(config-sess-red-group)# preferred-role slave
Router(config-sess-red-group)# peer 10.10.10.1
Router(config-sess-red-group)# pool-list pool-name p1
Router(config-sess-red-group)# pool-list pool-name p2
Router(config-sess-red-group)# commit
```

Running Configuration

The running configuration for the pools on both the SERG primary and SERG subordinate BNG nodes is shown below:

```
pool vrf default ipv4 p1
  network 10.10.0.1/16
!
pool vrf default ipv6 p2
  address-range 2001::10 2001::ffff
!
```

The running configuration for the BNG node in the SERG primary role is as follows:

```
session-redundancy
  source-interface MgmtEth0/RP0/CPU0/0
```

```

group 100
  preferred-role master
  peer 10.10.10.2
  pool-list pool-name p1
  pool-list pool-name p2
!
!

```

The running configuration for the BNG node in the SERG subordinate role is as follows:

```

session-redundancy
  source-interface MgmtEth0/RP0/CPU0/0
  group 100
    preferred-role slave
    peer 10.10.10.1
    pool-list pool-name p1
    pool-list pool-name p2
!
!

```

Verification

Pool specific information can be verified using the below command:

```
Router# show pool ipv4 name p1 remote-info
```

```
SERG Info:-
```

```
-----
```

```
Role           : Master
PeerDown       : False
```

```
Addresses allocated to Remote:-
```

```
-----
```

```

150.0.5.100 PPP *
150.0.5.101 PPP *
150.0.5.103 PPP *
150.0.5.104 PPP *
150.0.5.105 PPP *

```

```
Addresses received from Remote:-
```

```
-----
```

```
NONE
```

Pool information for the SERG can be verified using the below command:

```
Router# show session-redundancy group
```

```
Session Redundancy Agent Group Summary
```

```
Flags      : E - Enabled, D - Disabled, M - Preferred Master, S - Preferred Slave
            H - Hot Mode, W - Warm Mode, T - Object Tracking Enabled
```

```
P/S       : Peer Status
```

```
            I - Initialize, Y - Retry, X - Cleanup, T - Connecting
```

```
            L - Listening, R- Registered, C - Connected, E - Established
```

```
I/F-P Count: Interface or Pool Count
```

```
SS Count : Session Count
```

```
-----
```

Node Name	Group ID	Role	Flags	Peer Address	P/S	I/F-P Count
SS Count	Sync Pending					
0/RP0/CPU0	100	Master	EMH-	10.10.10.2	T	1
1	0					

```
-----
```

```
Session Summary Count(Master/Slave/Total): 1/0/1
```

State Control Route for Geo Redundancy

State control route is a loss-of-signal (LOS) based solution for Broadband Network Gateway (BNG) geo redundancy, where the route advertisement to the core network is controlled based on the role of the subscriber redundancy group (SRG). Only a summary of subscriber routes from the primary SRG group get advertised to the core network with the help of routing protocols. The routes from the subordinate SRG are not advertised. When a switchover happens, the new subordinate SRG withdraws the previously advertised routes from the core. This solution provides a sub-second traffic convergence and prevents traffic back hole. This feature is mainly useful in BNG deployments where optical line terminals (OLTs) do not support access protocols (like BFDs, CFM, and so on) to detect link failures in the access or core network.

A tag value is used in order to filter out the summary route from the subscriber routes. So, only the routes having that particular tag get redistributed through the routing protocol and get advertised to the core. The remaining routes are filtered out.

Figure 34: State Control Route for BNG Geo Redundancy

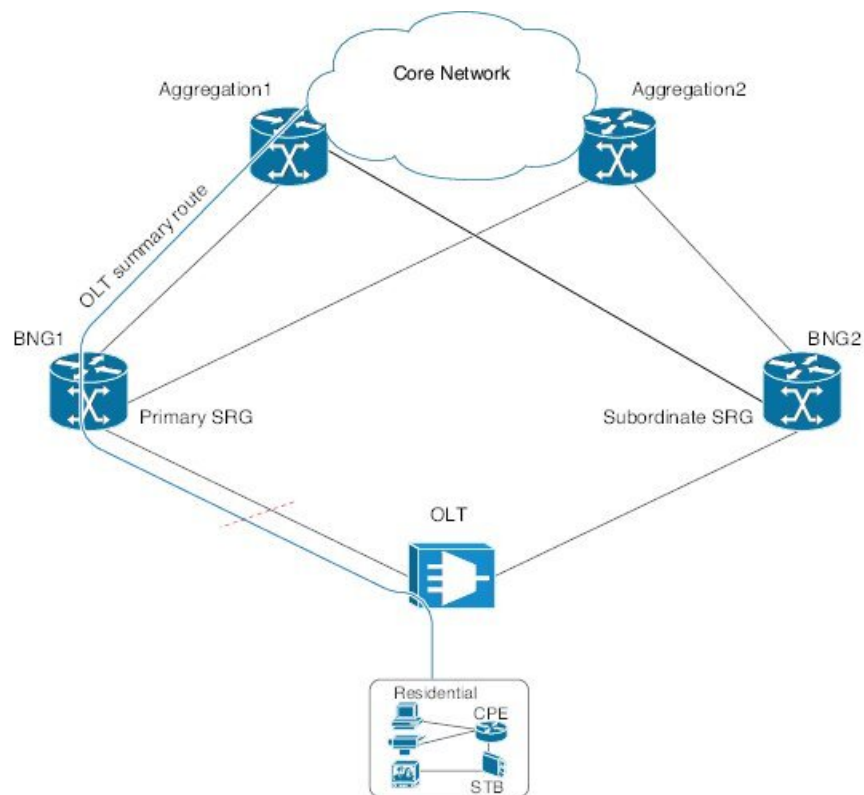

Multiple State Control Routes for Each SRG

The state control route feature in BNG is extended to have multiple state control routes for each subscriber redundancy group (SRG), as opposed to allowing only single state control route for each SRG. This functionality is available for PPPoE and IPoE subscribers. Users can also add summary route for a subscriber for a specific VRF, rather than limiting it to a default VRF. This feature thereby allows service providers to terminate multiple subnets of subscribers in a particular SRG.

Configure State Control Route for Geo Redundancy

To enable state control route for BNG geo redundancy, use **state-control-route** command in subscriber redundancy group configuration mode.

To enable multiple state control routes for each subscriber redundancy group, use this command along with the **vrf** option which is available only from Cisco IOS XR Software Release 6.3.1 and later.

The **vrf** and **tag** keywords are optional parameters. If the **vrf** option is not specified, then the routes are added in the default VRF, that is, global routing table.

A maximum of 30 state control routes can be added in each subscriber redundancy group (SRG), with a limit of 10 state control routes for each route type. That is, user can have a maximum 10 IPv4 routes, 10 IANA routes and 10 IAPD routes in each SRG. In these 30 routes, user can have routes in either the default or the non-default VRF.

The route-policy with the respective tag (that is, tag 1 in this example) must be defined prior to configuring the **state-control-route**.

Configuration Example for State Control Route with Default VRF

```
RP/0/RSP0/CPU0:router#configure
RP/0/RSP0/CPU0:router(config)#subscriber redundancy group 110
RP/0/RSP0/CPU0:router(config-subscr-red-group)#state-control-route ipv4 192.0.2.0/9 tag 1
RP/0/RSP0/CPU0:router(config-subscr-red-group)#state-control-route ipv6 iana 2001:DB8::/32
tag 1
RP/0/RSP0/CPU0:router(config-subscr-red-group)#state-control-route ipv6 iapd 2001:DB8:1::1/32
tag 1
RP/0/RSP0/CPU0:router(config-subscr-red-group)#commit
```

Running Configuration for State Control Route with Default VRF

```
/* State control route configuration */
subscriber redundancy group 110
state-control-route ipv4 192.0.2.0/9 tag 1
state-control-route ipv6 iana 2001:DB8::/32 tag 1
state-control-route ipv6 iapd 2001:DB8:1::1/32 tag 1
!

/* Route-policy configuration */
route-policy SUB_ROUTES
if tag is 1 then
    pass
done
endif
end-policy

/* Routing protocol configuration */
router ospf core
router-id 11.11.11.11
redistribute subscriber route-policy SUB_ROUTES
address-family ipv4 unicast
area 0
interface Loopback2
!
interface GigabitEthernet0/0/0/10
!
!
```

Configuration Example for Multiple State Control Routes with Specific VRF

```
RP/0/RSP0/CPU0:router#configure
RP/0/RSP0/CPU0:router(config)#subscriber redundancy group 110
RP/0/RSP0/CPU0:router(config-subscr-red-group)#state-control-route ipv4 192.0.2.0/9 vrf
vrf1 tag 1
RP/0/RSP0/CPU0:router(config-subscr-red-group)#state-control-route ipv6 iana 2001:DB8::/32
vrf vrf1 tag 1
RP/0/RSP0/CPU0:router(config-subscr-red-group)#state-control-route ipv6 iapd 2001:DB8:1::1/32
vrf vrf1 tag 1
RP/0/RSP0/CPU0:router(config-subscr-red-group)#commit
```

Running Configuration for Multiple State Control Routes with Specific VRF

```
/* Multiple State control route configuration with VRF, vrf1 */
subscriber redundancy group 110
state-control-route ipv4 192.0.2.0/9 vrf vrf1 tag 1
state-control-route ipv6 iana 2001:DB8::/32 vrf vrf1 tag 1
state-control-route ipv6 iapd 2001:DB8:1::1/32 vrf vrf1 tag 1
!
```

Verification

Use this command to display the summary routes:

```
RP/0/RSP0/CPU0:router#show route subscriber

A    192.0.2.0/9 [1/0] via 0.0.0.0, 1w4d
```

Subscriber Redundancy Group Revertive Timer

The subscriber redundancy group (SRG) revertive timer feature is an enhancement in BNG geo redundancy where, based on certain conditions, the primary BNG node for which the preferred role is set as primary, automatically regains the primary role (from subordinate role) after an SRG fail-over. An auto-revertive timer starts when the preferred primary BNG becomes subordinate due to SRG fail-over and when access-tracking and core-tracking are restored. When the timer expires, the preferred primary BNG regains the primary role. This switch back to the preferred primary role is required, as the new primary SRG may not be equipped to handle the entire subscriber load in the case of a fail-over.

The SRG revertive timer starts only if all these conditions are met:

- The preferred-role of the BNG is set as primary.
- The current role of the BNG node is subordinate.
- Access-tracking is UP.
- Subscriber Redundancy Group (SRG) peering is UP.

If SRG peering is down, the role of the BNG node automatically switches back from subordinate to primary, without even starting the SRG revertive timer.

To set the SRG revertive timer, use the **revertive-timer** command in subscriber redundancy configuration mode.

Running Configuration

```
subscriber
  redundancy
    revertive-timer 5 maximum 20
!
```

Subscriber Redundancy Group-aware IPv6 Neighbor Discovery

Subscriber Redundancy Group-aware (SRG-aware) IPv6 Neighbor Discovery (ND) is an enhancement in BNG geo redundancy where, the Router Advertisement (RA) message in response to the IPv6 ND message for IPv6 deployments, is sent based on the SRG role of the parent interface. Only the primary node sends out RA message in response to the IPv6 ND message and brings up the session. The RS (Router Solicitation) or Neighbor Solicitation (NS) message is dropped on the subordinate node, but the sessions still come up in that subordinate node. That way, the routes are not advertised to the core from the standby node.

IPv6 ND sends RA on every subscriber interface. It listens to the SRG state and then stops generating protocol messages based on the SRG state. When SRG state is primary, periodic RA is performed and when SRG state is back to subordinate, the periodic RA is stopped.

Verification

```
Router# show ipv6 nd idb interface <> detail location 0/RSP0/CPU0
...
Subscriber status flag: 0x18, Supressed cache learning: FALSE
BNG nud: Disabled, Master Node: 0/1/CPU0(0x10)
Global Mac Accounting: Disabled, IDB Mac Accounting : Disabled, Marked: No
Notfn sent to iedge - Up: Yes (Apr 4 18:12:07), Down: No
                               Update: No
                               Last notif reason:No prefix available

SRG Stby Role : TRUE
```

Peer-to-peer Traffic Flow with BNG Geo Redundancy

Peer-to-peer traffic flow is an enhancement in BNG Geo Redundancy where subscribers in different subscriber redundancy groups (SRGs) in the primary and subordinate nodes can send traffic to each other through the BNG nodes. This is feasible as the primary SRGs from both the BNG nodes advertise the respective summary routes to the core.

Figure 35: Peer-to-peer Traffic Flow with BNG Geo Redundancy

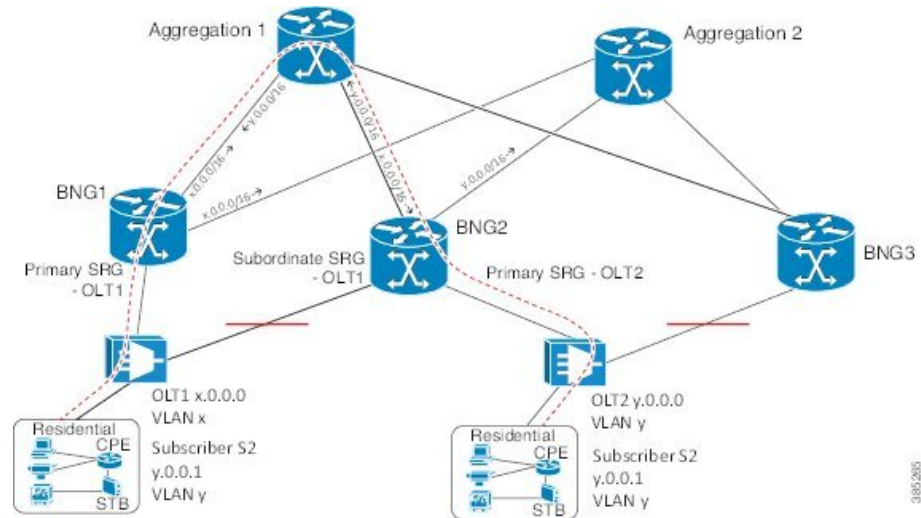

Suppose, subscriber S1 is connected to BNG1 and BNG2 through OLT1. Similarly, subscriber S2 is connected to BNG1 and BNG2 through OLT2. S1 is associated with SRG1 and S2 is associated with SRG2. SRG1 is primary in BNG1 and subordinate in BNG2. Similarly, SRG2 is primary in BNG2 and subordinate in BNG1.

In this scenario, the subscriber routes are added to the main table as well as to SRG VRF table in the primary node. Whereas, in the subordinate, the routes are added only to the SRG VRF table. The primary SRG1 in BNG1 advertises the summary route of S1 to the core. Similarly, the primary SRG2 in BNG2 advertises the summary route of S2 to the core. That way, both routes are reachable by each other through the BNG peer nodes.

To enable this feature, use the **enable-fast-switchover** command in subscriber redundancy group configuration mode.

Running Configuration

```
subscriber
 redundancy
  group 110
  enable-fast-switchover
  !
  !
  !
end
```

Accounting Trigger Cause for Geo Redundancy

A new Cisco-Attribute Value Pair (AVP), **Acct-Trigger-Cause**, is introduced to send the reason of accounting start and accounting stop messages triggered during an SRG switchover. The accounting stop record, sent from the old primary BNG node, and the accounting start record, sent from the new primary BNG node, specify the Acct-Trigger-Cause to be **nas-switchover**. This, in turn, helps the backend servers to identify the reason for the new accounting trigger thereby preventing the existing accounting records of the subscriber sessions from getting deleted.

This is a sample output of the session accounting stop record on old primary BNG node:

```

RADIUS: Vendor,Cisco      [26]  41
RADIUS: Cisco AVpair      [1]   35      acct-trigger-cause=nas-switchover
RADIUS: Acct-Status-Type  [40]  6       Start[1]

```

This is a sample output of the session accounting start record on new primary BNG node:

```

RADIUS: Vendor,Cisco      [26]  41
RADIUS: Cisco AVpair      [1]   35      acct-trigger-cause=nas-switchover
RADIUS: Acct-Status-Type  [40]  6       Stop[2]

```

SRG Support for BNG SLAAC Sessions

BNG introduces the support for subscriber redundancy group (SRG) for Stateless Address Auto-Configuration (SLAAC) sessions, wherein the subordinate BNG router allocates the same Neighbor Discovery (ND) prefix as that of primary BNG router to the subscriber. This feature ensures a seamless traffic flow for SLAAC sessions in the event of a BNG switchover.

SLAAC is an IP address-assignment model in which the hosts generate their own addresses using a combination of local and router-advertised information. Routers advertise prefixes that identify the subnet(s) associated with a link. Hosts generate a unique identifier for the interface on a subnet. These two combine to form an IP address. For more details on geo redundancy on PPPoE sessions, IPv6 address assignment and SLAAC, see the *Related Topics* section below.

When the SLAAC session comes up with IPv6 prefix from ND prefix pool on subordinate SRG, IPv6 ND reserves the prefix from DAPS pool. Once the prefix reservation is successful, SLAAC session comes up on the subordinate SRG.

When SRG peer route disable feature is enabled, IPv6-ND brings up SLAAC session on the subordinate SRG without adding the subscriber IPv6 route to RIB. When the SRG role of the parent interface changes from subordinate to primary, IPv6-ND adds the subscriber IPv6 route to RIB. When the SRG role of the parent interface changes from primary to subordinate, IPv6-ND removes the subscriber IPv6 route from RIB.



Note For the seamless working of SRG for BNG SLAAC sessions, you must ensure that the configurations and IP addresses are similar on both primary and subordinate BNG routers, as it is for generic SRG functionality.

Related Topics

- [Geo Redundancy for PPPoE Sessions, on page 423](#)
- [DHCPv6 Address or Prefix Pool, on page 219](#)
- [IP Address Assignment for Clients, on page 534](#)
- [Scenario 1: SLAAC-Based Address Assignment, on page 537](#)

SRG Support for Static Sessions

BNG introduces the support for subscriber redundancy group (SRG) for static sessions, wherein all traffic belonging to a particular VLAN sub-interface is treated as a single session. This feature ensures a seamless traffic flow for static sessions in the event of a BNG switchover.

Restrictions for SRG Support for Static Sessions

SRG support for static sessions in BNG is subjected to these restrictions:

- The bundle mac-address which is configured on the primary and subordinate BNG must be the same in order for SRG to work for static interface sessions. SRG virtual MAC address (vMAC) functionality is not supported with static interface sessions.
- IPv6-ND DAD must be disabled on the access interface for SRG to work for IPv6 static interface sessions.
- The command **clear subscriber session** is not supported on the subordinate SRG.
- SRG disable and enable operations are not supported for static interface sessions.
- SRG enable-fast-switchover and peer route-disable are not supported for static interface sessions.
- SRG support for static sessions is applicable for both RP and LC based subscribers.
- RPFO is not supported on primary BNG when static sessions are coming up on subordinate BNG.
- RPFO can lead to an SRG peering flap.
- Restart of the `srg_agt` process is not supported if some of the groups are disabled or if some of the groups do not have a peering group.

Configure Subscriber Redundancy Group for Static Sessions

Configuration Steps

The below section shows how to configure SRG for static sessions.

```
Router# config terminal
Router(config)# interface GigabitEthernet0/0/0/0
Router(config-if)# bundle id 1 mode on
Router(config-if)# exit
Router(config)# interface Bundle-Ether 1
Router(config-if)# mac-address a1.b1.c1
Router(config-if)# exit
Router(config)# policy-map type control subscriber POLICY1
Router(config-pmap)# event session-start match-all
Router(config-pmap-e)# class type control subscriber class-default do-all
Router(config-pmap-c)# 1 activate dynamic-template IPSUB_TEMPLATE
Router(config-pmap-c)# exit
Router(config-pmap)# end-policy-map
Router(config)# interface Bundle-Ether 1.100
Router(config-subif)# ipv4 address 20.1.1.1 255.255.255.0
Router(config-subif)# ipv6 address 1001::2/128
Router(config-subif)# ipv6 nd dad attempts 0
Router(config-subif)# encapsulation dot1q 100
Router(config-subif)# service-policy type control subscriber POLICY1
Router(config-subif)# ipsubscriber interface
Router(config-subif)# exit
Router(config)# track abc
```

```

Router(config-track)# type line-protocol state
Router(config-track-line-prot)# interface GigabitEthernet0/0/0/0
Router(config-track-line-prot)# exit
Router(config-track)# exit
Router(config)# subscriber
Router(config-subscriber)# redundancy
Router(config-subscr-red)# source-interface GigabitEthernet0/0/0/10
Router(config-subscr-red)# group 1
Router(config-subscr-red-group)# preferred-role master
Router(config-subscr-red-group)# slave-mode hot
Router(config-subscr-red-group)# peer 10.1.1.2
Router(config-subscr-red-group)# access-tracking abc
Router(config-subscr-red-group)# interface-list
Router(config-subscr-red-grp-intf)# interface Bundle-Ether1.100 id 1
Router(config-subscr-red-grp-intf)# commit

```

When bringing up scaled static sessions on subordinate SRG, below procedure must be followed:

1. Shutdown the bundle interface.
2. Configure the access-interfaces with dot1q encapsulation, IP address, subscriber control policy and ipsubscriber interface. All the vlan interfaces should be in ready state.
3. Configure the SRG with interface-list.
4. Bring up the bundle interface

Running Configuration

```

interface GigabitEthernet0/0/0/0
 bundle id 1 mode on
!
interface Bundle-Ether 1
 mac-address a1.b1.c1
!
policy-map type control subscriber POLICY1
 event session-start match-all
 class type control subscriber class-default do-all
  1 activate dynamic-template IPSUB_TEMPLATE
!
end-policy-map
!
interface Bundle-Ether 1.100
 ipv4 address 20.1.1.1 255.255.255.0
 ipv6 address 1001::2/128
 ipv6 nd dad attempts 0
 encapsulation dot1q 100
 service-policy type control subscriber POLICY1
 ipsubscriber interface
!
track abc
 type line-protocol state
 interface GigabitEthernet0/0/0/0
!
!
subscriber
 redundancy
 source-interface GigabitEthernet0/0/0/10
 group 1
 preferred-role master
 slave-mode hot

```



```

peer 10.1.1.2
access-tracking abc
interface-list
interface Bundle-Ether1.100 id 1
!

```

Verification

Router#**show subscriber session all**

Codes: IN - Initialize, CN - Connecting, CD - Connected, AC - Activated,
ID - Idle, DN - Disconnecting, ED - End

Type	Interface	State	Subscriber IP Addr / Prefix	LNS Address (Vrf)
------	-----------	-------	-----------------------------	-------------------

```

-----
IP:STATIC    BE1.100                AC        20.1.1.1 (default)

```

```

RP/0/RSP0/CPU0:server-1#

```

```

RP/0/RSP0/CPU0:server-1#sh subscriber session all detail

```

```

Sat Oct 28 21:30:11.303 IST

```

```

Interface:          Bundle-Ether1.100
Circuit ID:         Unknown
Remote ID:          Unknown
Type:               IP: Static
IPv4 State:         Up, Sat Oct 28 21:24:06 2017
IPv4 Address:       20.1.1.1, VRF: default
Mac Address:        Unknown
Account-Session Id: 00000001
Nas-Port:           Unknown
User name:          unknown
Formatted User name: unknown
Client User name:  unknown
Outer VLAN ID:     100
Subscriber Label:   0x00000040
Created:            Sat Oct 28 21:24:06 2017
State:              Activated
Authentication:     unauthenticated
Authorization:      unauthorized
Access-interface:   Bundle-Ether1.100
Policy Executed:
policy-map type control subscriber POLICY1
  event Session-Start match-all [at Sat Oct 28 21:24:06 2017]
  class type control subscriber class-default do-all [Succeeded]
  1 activate dynamic-template IPSUB_TEMPLATE [Succeeded]
Session Accounting: disabled
Last COA request received: unavailable

```

Router#**show ipsubscriber interface**

```

Interface: Bundle-Ether1.100

```

```

Type: Static

```

```

Access Interface: Bundle-Ether1.100

```

```

Subscriber Label: 0x40

```

```

IPv4 Initiator: Packet-Trigger

```

```

VLAN ID: 100

```

```

Created: Oct 28 21:24:06 (age 00:00:31)

```

```

IPv4 State: Up (old: Session features applied)

```

```

Last state change: Oct 28 21:24:06 (00:00:31 in current state)

```

Router#**show subscriber redundancy group**

```

Subscriber Redundancy Agent Group Summary

```

```

Flags      : E - Enabled, D - Disabled, M - Preferred Master, S - Preferred Slave

```

```

            H - Hot Mode, W - Warm Mode, T - Object Tracking Enabled

```

```

P/S        : Peer Status

```

```

I - Initialize, Y - Retry, X - Cleanup, T - Connecting
L - Listening, R- Registered, C - Connected, E - Established
I/F Count: Interface Count
SS Count : Subscriber Session Count

```

```

-----
Node Name | Group ID | Role | Flags | Peer Address | P/S | I/F Count
| SS Count | Sync Pending
-----
0/RSP0/CPU0 | 1 | Master | EMHT | 10.1.1.2 | E | 1
| 1 | 0
-----

```

```
Session Summary Count(Master/Slave/Total): 1/0/1
```

```
Router#show subscriber redundancy group 1 session
Subscriber Redundancy Agent Group Session
```

```

-----
Parent Interface | MAC Address | In/Out VLAN | PPPoE/L2TP ID
-----
Bundle-Ether1.100 | 0000.0000.0000 | 0/100 | 0/0
-----

```

SRG Support for LC Subscribers

BNG introduces the support for subscriber redundancy group (SRG) for LC subscriber sessions. This feature ensures that if there is any access link failure or a complete LC node failure, the end user services are not impacted.

Restrictions for SRG Support for LC Subscribers

SRG support for LC subscribers in BNG is subjected to these restrictions:

- SRG is not supported for ambiguous VLAN LC subscriber sessions.
- PQoS is not supported for LC subscriber sessions with SRG.
- LC subscriber sessions cannot be cleared on the subordinate SRG.
- Clearing DHCP or DHCPv6 bindings is not supported on the subordinate SRG.
- Changing the MAC address of the interface with active sessions is not supported.
- The command **clear subscriber redundancy session group** *group-id* is not supported.
- Changing the SRG vMAC which has active sessions associated with it, is not supported.
- Configuring or unconfiguring the command **peer route-disable** with active sessions is not supported.
- Configuring or unconfiguring the command **enable-fast-switchover** with active sessions is not supported.
- If the line card is removed and re-inserted, the session accounting records for the primary line card sessions is sent with 0 statistics.
- Enabling fast switchover is not supported for subscriber framed-routes.
- Restart of the process `srg_agt` or an RSP failover can trigger SRG switchover for some groups.
- Core link failure with active sessions on both SRG nodes is not supported.
- Traffic for the primary LC sessions can drop for 30 seconds when the LC is removed and re-inserted.

- If SRG is disabled for group, then you need to wait for all the routes and sessions of that group to be deleted before SRG is enabled for that group again.
- Avoid the restart of any of the IOS XR processes simultaneously on both primary and subordinate nodes.
- The configuration for idle-timeout is not supported for SRG sessions.
- Clear all the sessions on LC before replacing the card with the new one.
- When both the primary and subordinate SRG nodes are being configured simultaneously, all the groups taking preferred role is not guaranteed.
- Access switch reload which results in the access links going down on both SRG nodes is not supported.
- Removing the SRG configuration on the primary node with active sessions is not supported.
- The command **admin srg switchover** is meant to be used for planned upgrades when subscriber churn is very less.
- If there is an inconsistency on the primary and subordinate nodes after SRG switchover, execute the command **subscriber redundancy synchronize group group-id** command on new primary in order to clear the inconsistency. If the subordinate node has more sessions compared to primary, execute the same command on the subordinate node. If inconsistency is still not cleared, clients will reconnect after the lease timer expires.
- Session state mismatch cannot be handled by **subscriber redundancy synchronize** command. If there is mismatch, clear the sessions administratively on the primary node. Clients will reconnect due to the lease timer expiry.

Configure Subscriber Redundancy Group for LC Subscriber Sessions

Configuration Steps

The below section shows how to configure SRG for LC subscriber sessions.

```

Router# config terminal
Router(config)# interface GigabitEthernet0/0/0/0.100
Router(config-subif)# ipv4 point-to-point
Router(config-subif)# ipv4 unnumbered Loopback0
Router(config-subif)# ipv6 enable
Router(config-subif)# service-policy type control subscriber POLICY1
Router(config-subif)# encapsulation dot1q 100
Router(config-subif)# ipsubscriber ipv4 12-connected
Router(config-if-ipsub-ipv4-l2conn)# initiator dhcp
Router(config-if-ipsub-ipv4-l2conn)# exit
Router(config-subif)# ipsubscriber ipv6 12-connected
Router(config-if-ipsub-ipv6-l2conn)# initiator dhcp
Router(config-if-ipsub-ipv6-l2conn)# exit
Router(config-subif)# exit
Router(config)# track access-link1
Router(config-track)# type line-protocol state
Router(config-track-line-prot)# interface GigabitEthernet0/0/0/0
Router(config-track-line-prot)# exit
Router(config-track)# exit
Router(config)# subscriber
Router(config-subscriber)# redundancy
Router(config-subscr-red)# source-interface GigabitEthernet0/1/0/10
Router(config-subscr-red)# group 1
Router(config-subscr-red-group)# preferred-role master

```

```

Router(config-subscr-red-group)# virtual-mac 00a1.00b1.00c1
Router(config-subscr-red-group)# peer 55.1.0.1
Router(config-subscr-red-group)# access-tracking access-link1
Router(config-subscr-red-group)# state-control-route ipv4 192.0.2.0/8 tag 1
Router(config-subscr-red-group)# state-control-route ipv6 iana 2001:DB8::/32 tag 1
Router(config-subscr-red-group)# state-control-route ipv6 iapd 2001:DB8:1::1/32 tag 1
Router(config-subscr-red-group)# interface-list
Router(config-subscr-red-grp-intf)# interface GigabitEthernet0/0/0/0.100 id 1
Router(config-subscr-red-grp-intf)# commit

```

Running Configuration

```

interface GigabitEthernet0/0/0/0.100
  ipv4 point-to-point
  ipv4 unnumbered Loopback0
  ipv6 enable
  service-policy type control subscriber POLICY1
  encapsulation dot1q 100
  ipsubscriber ipv4 l2-connected
    initiator dhcp
  !
  ipsubscriber ipv6 l2-connected
    initiator dhcp
  !
!
track access-link1
  type line-protocol state
  interface GigabitEthernet0/0/0/0
  !
!
subscriber
  redundancy
    source-interface GigabitEthernet0/1/0/10
    group 1
      preferred-role master
      virtual-mac 00a1.00b1.00c1
      peer 55.1.0.1
      access-tracking access-link1
      state-control-route ipv4 192.0.2.0/8 tag 1
      state-control-route ipv6 iana 2001:DB8::/32 tag 1
      state-control-route ipv6 iapd 2001:DB8:1::1/32 tag 1
      interface-list
        interface GigabitEthernet0/0/0/0.100 id 1
    !
  !
!
!
!

```

Verification

Router# **show ipsubscriber access-interface brief**

Codes: UP - Up, DOWN - Down, DELETED - Deleted State, UNKNOWN - Unknown State,
 PKT - Packet Trigger Initiation, DHCP - DHCP Initiation,
 PKTV6 - Packet Trigger Initiation for IPv6, DHCPv6 - DHCPv6 Initiation

Interface State	Proto	DHCP	Pkt Trigger DHCPv6	PktTrigIPv6
----- Gi0/0/0/0.100 0 UP	DHCP, DHCPv6		1 0	1

```

Router# show subscriber redundancy group
Subscriber Redundancy Agent Group Summary
Flags      : E - Enabled, D - Disabled, M - Preferred Master, S - Preferred Slave
            H - Hot Mode, W - Warm Mode, T - Object Tracking Enabled
P/S       : Peer Status
            I - Initialize, Y - Retry, X - Cleanup, T - Connecting
            L - Listening, R- Registered, C - Connected, E - Established
I/F Count: Interface Count
SS Count  : Subscriber Session Count
    
```

Node Name	Group ID	Role	Flags	Peer Address	P/S	I/F Count
0/0/CPU0	1	Master	EMHT	55.1.0.1	E	1
1	0					

Session Summary Count(Master/Slave/Total): 1/0/1

Subscriber Redundancy Group for Pseudowire Headend Subscribers

Cisco IOS XR Software Release 6.6.3 introduces the support for subscriber redundancy group (SRG) for pseudowire headend (PWHE) subscribers on BNG routers. The geographical redundancy feature helps in failover or planned switchover of subscriber sessions from one BNG router to another. This feature in turn allows service providers to support geographical redundancy for PWHE subscriber sessions on BNG. Currently, the SRG feature for PWHE subscribers is supported for BNG IPoE sessions.

Figure 36: Sample Network Topology of SRG for PWHE Subscriber Sessions on BNG

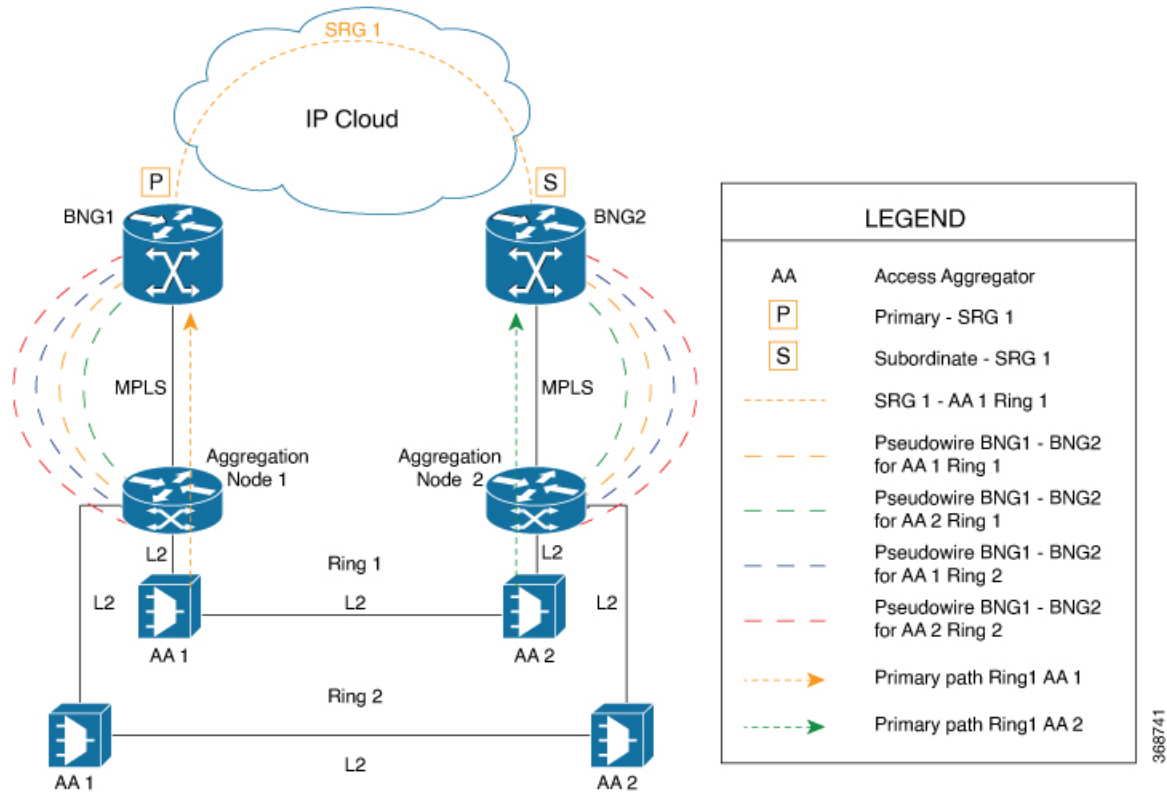

The geo redundancy solution exists at the BNG nodes, BNG1 and BNG2, in this topology. These BNG nodes terminate IPoE subscriber sessions in primary or subordinate mode. The access aggregation nodes (AA 1 and AA 2, in this topology) are connected to BNG nodes through PWHE. The PWHE provides Layer 2 loop avoidance technologies in case the link between the aggregation nodes is to be utilized for failure scenarios. The PWHE terminates access PW into a Layer 2 domain from aggregation node to the BNG. Each PW-Ethernet sub-interface on the BNG represents a ring of access aggregation. The Virtual Private Wire Service (VPWS)-Ethernet transport solution (virtual connection type 5 cross-connect) exists between the BNG and the aggregation node. The SRG is configured to track PW-Ether interface on primary and subordinate modes. When PW-Ether interface goes down on primary, the SRG triggers the switchover to the subordinate.

Link Failure Scenarios in BNG PWHE with SRG

This section illustrates some of the access link failure scenarios in BNG PWHE topology with SRG. Scenario 1 depicts a link failure between aggregation node 1 and BNG1. Scenario 2 depicts a link failure between the access aggregator 1 and aggregation node 1. In these scenarios, the SRG 1 is in primary mode on BNG1 and at the same time in subordinate mode on BNG2. In both these cases, the PWHE interface goes down on BNG1. The SRG 1 then does a switchover to BNG2.

The handling of core link failure scenarios with PWHE sessions remain the same as in regular SRG scenarios.

Figure 37: Link Failure Scenarios in BNG PWHE topology with SRG

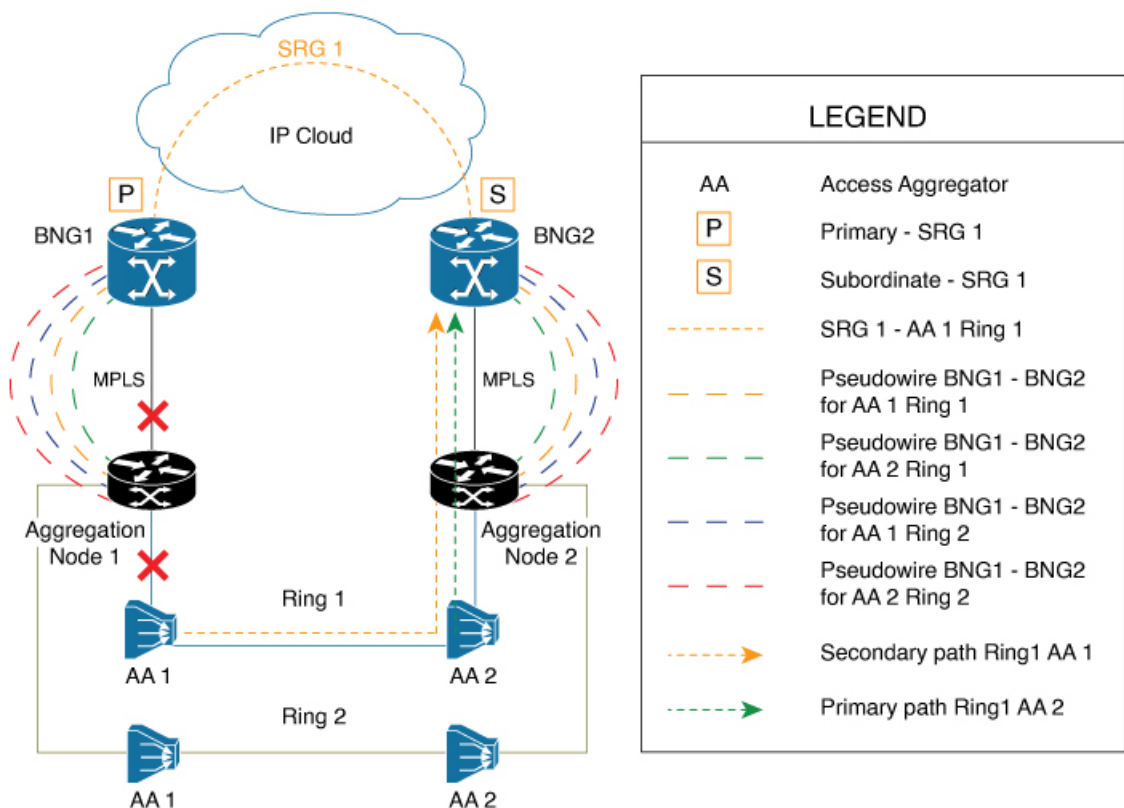

Restrictions for SRG for PWHE subscribers on BNG

The SRG support for PWHE subscribers on BNG is subjected to these restrictions:

- Supported only on the SE variants of Cisco ASR 9000 Enhanced Ethernet Line Cards and Cisco ASR 9000 High Density 100GE Ethernet Line Cards, with RSP880, RSP880-LT, and RSP5.
- Supported only for DHCP-initiated IPoE (IPv4, IPv6 or dual-stack) L2-connected sessions with BNG as DHCPv4 or DHCPv6 proxy.
- Not supported for BNG sessions over ambiguous VLAN PWHE sub-interfaces.
- Once SRG switchover is triggered, the next SRG switchover must not be triggered within the recommended value of revertive timer (approximately 10 to 12 minutes). If back-to-back switchover happens, the primary and subordinate sessions might go out of sync.
- Not supported for L2VPN hot-standby pseudowire (HSPW) deployment model solution.
- Scale limit is subjected to the number of interfaces in the generic interface list of PWHE.

Configure SRG for Pseudowire Headend Subscribers on BNG

Configuration Example

You must perform these tasks in order to configure SRG for pseudowire headend subscribers on BNG:

- Configure L2VPN
- Configure MPLS
- Configure OSPF
- Configure PWHE
- Configure subscriber redundancy

The below example shows the configuration steps done on the primary BNG router. Repeat these steps on the subordinate BNG router as well with the respective values.

```

/* Configure L2VPN */
Router#configure
Router(config)#l2vpn
Router(config-l2vpn)#pw-class atom
Router(config-l2vpn-pwc)#encapsulation mpls
Router(config-l2vpn-pwc-mpls)#exit
Router(config-l2vpn-pwc)#exit
Router(config-l2vpn)#xconnect group pwhe
Router(config-l2vpn-xc)#p2p bng-pwhe
Router(config-l2vpn-xc-p2p)#interface PW-Ether 1
Router(config-l2vpn-xc-p2p)#neighbor ipv4 192.0.2.1 pw-id 101
Router(config-l2vpn-xc-p2p-pw)#pw-class atom
Router(config-l2vpn-xc-p2p-pw)#commit

/* Configure MPLS */
Router(config)#mpls ldp
Router(config-ldp)#log
Router(config-ldp-log)#neighbor
Router(config-ldp-log)#nsr
Router(config-ldp-log)#graceful-restart
Router(config-ldp-log)#exit
Router(config-ldp)#router-id 203.0.113.1
Router(config-ldp)#interface TenGigE 0/1/0/10
Router#commit

```

```

/* Configure OSPF */
Router(config)#router ospf srg_pw_test
Router(config-ospf)#router-id 203.0.113.1
Router(config-ospf)#address-family ipv4 unicast
Router(config-ospf)#area 0
Router(config-ospf-ar)#interface Loopback 101
Router(config-ospf-ar-if)#exit
Router(config-ospf-ar)#interface TenGigE 0/1/0/10
Router(config-ospf-ar-if)#commit

/* Configure PWHE */
Router(config)#generic-interface-list pwhel
Router(config-gen-if-list)#interface TenGigE 0/1/0/10
Router(config-gen-if-list)#commit

Router(config)#interface PW-Ether1
Router(config-if)#attach generic-interface-list pwhel
Router(config-if)#exit
Router(config)#interface PW-Ether1.1
Router(config-subif)#ipv4 unnumbered Loopback1
Router(config-subif)#ipv6 address 2001:DB8::1/64
Router(config-subif)#ipv6 enable
Router(config-subif)#service-policy type control subscriber TEST_POLICY
Router(config-subif)#encapsulation dot1q 1
Router(config-subif)#ipsubscriber ipv4 l2-connected
Router(config-if-ipsub-ipv4-l2conn)#initiator dhcp
Router(config-if-ipsub-ipv4-l2conn)#exit
Router(config-subif)#ipsubscriber ipv6 l2-connected
Router(config-if-ipsub-ipv6-l2conn)#initiator dhcp
Router(config-if-ipsub-ipv6-l2conn)#commit

Router(config)#track access1
Router(config-track)#type line-protocol state
Router(config-track-line-prot)#interface PW-Ether1.1
Router(config-track-line-prot)#commit

/* Configure Subscriber Redundancy */
Router(config)#subscriber
Router(config-subscriber)#redundancy
Router(config-subscr-red)#source-interface Loopback500
Router(config-subscr-red)#hold-timer 5
Router(config-subscr-red)#group 1
Router(config-subscr-red-group)#virtual-mac 0000.0000.0001
Router(config-subscr-red-group)#peer 203.0.113.2
Router(config-subscr-red-group)#core-tracking core
Router(config-subscr-red-group)#access-tracking access1
Router(config-subscr-red-group)#enable-fast-switchover
Router(config-subscr-red-group)#state-control-route ipv4 198.51.100.0/21 vrf default tag
10
Router(config-subscr-red-group)#state-control-route ipv6 iana 2001:DB8:A:B::1/64 vrf default
tag 10
Router(config-subscr-red-group)#state-control-route ipv6 iapd 2001:DB8:A:B:ABCD::1/64 vrf
default tag 10
Router(config-subscr-red-group)#interface-list
Router(config-subscr-red-grp-intf)#interface PW-Ether1.1 id 1
Router(config-subscr-red-grp-intf)#commit

Router(config)#ipsubscriber ipv4 l2-connected
Router(config-gen-if-list)#interface TenGigE 0/1/0/10
Router(config-gen-if-list)#commit

```



```
Router(config)#interface PW-Ether1
Router(config-l2vpn-xc-p2p-pw)#attach generic-interface-list pwhe1
```



Note For efficient tracking, it is recommended to track the member links under the generic interface list (GIL) rather than the parent PW interface itself, as it gives faster convergence.

Running Configuration

```
l2vpn
 pw-class atom
   encapsulation mpls
   protocol ldp
   transport-mode ethernet
 !
 !
 xconnect group pwhe
   p2p bng-pwhe
     interface PW-Ether1
       neighbor ipv4 192.0.2.1 pw-id 101
       pw-class atom
     !
   !
 !
 !
 mpls ldp
 log
 neighbor
 nsr
 graceful-restart
 !
 router-id 203.0.113.1
 interface Bundle-Ether1
 !
 interface TenGigE0/1/0/10
 !
 !
 router ospf srg_pw_test
 router-id 203.0.113.1
 address-family ipv4 unicast
 area 0
   interface Bundle-Ether1
   !
   interface Loopback101
   !
   interface TenGigE0/1/0/10
   !
 !
 !
 generic-interface-list pwhe1
 interface Bundle-Ether1
 interface TenGigE0/1/0/10
 !
 interface PW-Ether1
 mtu 1514
 attach generic-interface-list pwhe1
 !
 interface PW-Ether1.1
 service-policy output spd subscriber-parent resource-id 0
 ipv4 unnumbered Loopback1
 ipv6 address 2001:DB8::1/64
```

```

ipv6 enable
service-policy type control subscriber TEST_POLICY
encapsulation dot1q 1
ipsubscriber ipv4 l2-connected
  initiator dhcp
!
ipsubscriber ipv6 l2-connected
  initiator dhcp
!
!
track access1
  type line-protocol state
  interface PW-Ether1.1
!
!
subscriber
  redundancy
    source-interface Loopback500
    hold-timer 5
    group 1
      preferred-role master
      virtual-mac 0000.0000.0001
      peer 203.0.113.2
      core-tracking core
      access-tracking access1
      enable-fast-switchover
      state-control-route ipv4 198.51.100.0/21 vrf default tag 10
      state-control-route ipv6 iana 2001:DB8:A:B::1/64 vrf default tag 10
      state-control-route ipv6 iapd 2001:DB8:A:B:ABCD::1/64 vrf default tag 10
      interface-list
        interface PW-Ether1.1 id 1
!
!
!

```

Verification

```

Router#show subscriber redundancy group
Thu Jan 24 11:57:03.766 UTC
Subscriber Redundancy Agent Group Summary
Flags      : E - Enabled, D - Disabled, M - Preferred Master, S - Preferred slave
             H - Hot Mode, W - Warm Mode, T - Object Tracking Enabled
P/S        : Peer Status
             I - Initialize, Y - Retry, X - Cleanup, T - Connecting
             L - Listening, R- Registered, C - Connected, E - Established
I/F Count: Interface Count
SS Count  : Subscriber Session Count

```

```

-----
Node Name   | Group ID | Role | Flags | Peer Address | P/S | I/F Count | SS Count |
Sync Pending
-----
Router      | 1        | Master | EMHT | 203.0.113.2 | E   | 1         | 0        |
0

```

Related Topics

[Subscriber Redundancy Group for Pseudowire Headend Subscribers, on page 445](#)

Associated Commands

- [access-tracking](#)
- [state-control-route](#)
- [subscriber redundancy](#)
- [virtual-mac](#)

Deployment Models for BNG Geo Redundancy

Multiple access networks are considered for BNG geo redundancy deployment scenarios. Some of the sample use cases are:

- Multi-chassis Link Aggregation (MC-LAG) - Two BNG boxes that are point-of-attachment (POA) devices, connected through MC-LAG either to a single Dual Homed Device (DHD) or to a DHD-pair using MC-LAG.
- Multiple Spanning Tree - Access Gateway (MST-AG):
 - Dual Homed Device using Bundle Interfaces - A single DHD with one bundle interface each to the two BNGs in active-active mode.
 - Ethernet Access Network-Ring - A physical ring (open or closed) that connects multiple OLTs (or L2 devices in general) to the two BNGs in active-active mode.



CHAPTER 9

DIAMETER Support in BNG

DIAMETER provides a base protocol that can be extended in order to provide authentication, authorization, and accounting (AAA) services to new access technologies. This chapter provides information about DIAMETER protocol and its support in BNG.

Table 18: Feature History for DIAMETER Support in BNG

Release	Modification
Release 6.1.2	Added DIAMETER-Geo redundancy interworking.
Release 5.3.0	This chapter was introduced for DIAMETER support feature in BNG.

This chapter covers these topics:

- [DIAMETER Overview, on page 453](#)
- [DIAMETER Interface in BNG, on page 454](#)
- [Supported DIAMETER Base Messages, on page 455](#)
- [DIAMETER NASREQ Application, on page 456](#)
- [DIAMETER Gx and Gy Applications, on page 458](#)
- [DIAMETER DCCA Application, on page 460](#)
- [BNG DIAMETER Call Flow, on page 460](#)
- [Guidelines and Restrictions for DIAMETER Support in BNG, on page 461](#)
- [Configuring DIAMETER Peer in BNG, on page 462](#)
- [Configuring AAA for DIAMETER Peer in BNG, on page 467](#)
- [Verification of DIAMETER Configurations in BNG, on page 470](#)
- [BNG DIAMETER-Geo Redundancy Interworking, on page 475](#)
- [Additional References, on page 482](#)

DIAMETER Overview

DIAMETER is a peer-to-peer protocol that is composed of a base protocol and a set of applications that allow it to extend its services to provide AAA services to new access technologies. The base protocol provides basic mechanisms for reliable transport, message delivery, and error handling and the base protocol must be used in conjunction with a DIAMETER application. Each application relies on the services of the base protocol to support a specific type of network access. Each application is defined by an application identifier and associated

with commands. Each command is defined with mandatory Attribute Value Pairs (AVPs) and non-mandatory AVPs including vendor-specific AVPs.

DIAMETER allows peers to exchange a variety of messages. The DIAMETER client generates DIAMETER messages to the DIAMETER server to perform the AAA actions for the user. This protocol also supports server-initiated messages, such as a request to cancel service to a particular user.

DIAMETER Interface in BNG

BNG supports the DIAMETER base protocol, along with applications such as DIAMETER Credit Control Application (DCCA) and Network Access Server Requirements (NASREQ), which is used for policy control and charging, and real-time credit control of pre-paid users. BNG acts as NASREQ and DCCA client to perform AAA NAS related functionality, policy provisioning, quota request and usage reporting function. With this DIAMETER interface, BNG provides service-aware billing functionality and policy provisioning for post-paid and pre-paid users.

This figure shows the network of the DIAMETER interface in BNG:

Figure 38: DIAMETER Interface in BNG

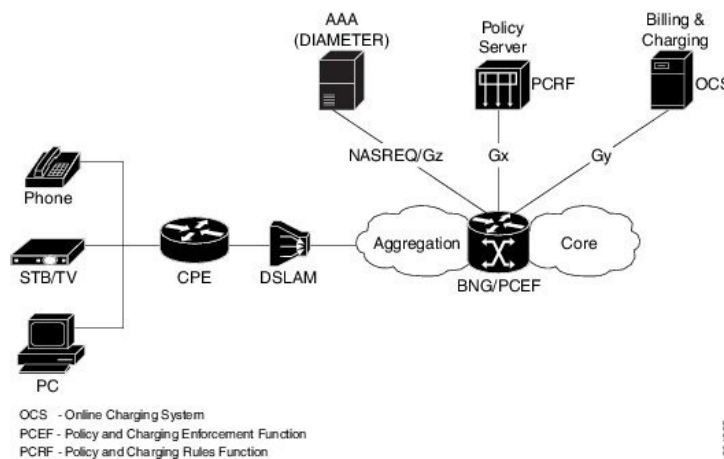

Along with the DIAMETER base protocol, these DIAMETER applications are also supported in BNG:

- Diameter Credit Control Application (DCCA)
- Gx interface for Policy Control and Charging
- Gy interface for online charging
- Gz interface for offline charging

This table lists IANA-assigned application IDs for DIAMETER applications:

DIAMETER Application	DIAMETER Application ID
DIAMETER common message	0x00000000
DIAMETER NASREQ message	0x00000001
DIAMETER base accounting	0x00000003

DIAMETER Application	DIAMETER Application ID
DIAMETER DCCA application(Gy)	0x00000004
DIAMETER policy interface(Gx)	0x01000016 (16777224)

Features supported for BNG with DIAMETER

These base protocol features are supported in BNG with DIAMETER:

- TCP as the transport protocol for DIAMETER messages
- TLS support over TCP for secure communication
- IPv4 and IPv6 transport stack to the back end DIAMETER server

These base protocol features are not supported in BNG with DIAMETER:

- Communication with diameter peers that act as proxy, relay or a redirection agent
- Diameter peer discovery
- SCTP as the transport protocol for DIAMETER messages
- Internet Protocol Security (IPSec)

Supported DIAMETER Base Messages

BNG supports these DIAMETER base messages:

DIAMETER Base Messages	Abbreviation	Command Code	Description
Capabilities-Exchange-Request	CER	257	Sent from the client to the server to determine the capabilities of the server.
Capabilities-Exchange-Answer	CEA	257	Sent from the server to the client in response to a CER message.
Disconnect-Peer-Request	DPR	282	Sent to the peer to inform about the termination of the connection. The client or server may initiate the termination.
Disconnect-Peer-Answer	DPA	282	Sent as a response to a DPR message.
Device-Watchdog-Request	DWR	280	Sent from the client to the server to monitor the health of the connection. This happens if, for a while, there is no traffic between peers, after CER and CEA messages are exchanged.
Device-Watchdog-Answer	DWA	280	Sent as response to a DWR message.

For details of DIAMETER attributes and sample packets of DIAMETER messages, see Appendix E, [DIAMETER Attributes, on page 563](#).

DIAMETER NASREQ Application

The NASREQ application is used for Authentication, Authorization and Accounting (AAA) in the Network Access Server (NAS) environment. For subscriber authentication or authorization, as part of the session creation, a DIAMETER AA-Request message is sent to the DIAMETER NASREQ server and the response may be an AA-Answer message. Subscriber accounting for sessions and services is done using AC-Request and AC-Answer messages of the NASREQ application. BNG supports the NASREQ application for network access related functionality; the admin access requests (such as Telnet, SSH, rlogin, and so on) must not be transported using the DIAMETER protocol. Because Extensible Authentication Protocol (EAP) authentication is not required in BNG, the support for DIAMETER EAP application is not considered.

If the user deploys a separate Offline Charging Server (OFCS) with the AAA method list configuration, the NASREQ application forwards the messages accordingly.

No new application-specific AVPs are sent for the NASREQ application, except DIAMETER-specific common set of AVPs and RADIUS prohibited AVPs for accounting.

This table lists the DIAMETER NAS messages supported by BNG:

DIAMETER NAS Messages	Abbreviation	Command Code	Description
AA-Request	AAR	265	Used to request authentication or authorization (or both) for a given NAS user. Admin user related AVPs are not applicable for BNG deployment with DIAMETER NASREQ application.
AA-Answer	AAA	265	Sent in response to the AAR message. If authorization was requested, a successful response includes the authorization AVPs appropriate for the service being provided. For backward compatibility and also based on the session type if it is IPoE or PPPoE, a few additional DIAMETER Cisco VSAs may also be present in this message.
Re-Auth-Request	RAR	258	Sent by a DIAMETER server when it initiates a re-authentication or re-authorization (or both) service for a particular session.
Re-Auth-Answer	RAA	258	Sent in response to the RAR message. The Result-Code AVP must be present in the RAA message and it indicates the disposition of the request. A successful RAA transaction must be followed by an AAR message.

DIAMETER NAS Messages	Abbreviation	Command Code	Description
Session-Termination-Request	STR	275	<p>Sent by NAS to inform DIAMETER server that an authenticated or authorized (or both) session is being terminated.</p> <p>This is required only if NASREQ application is stateful.</p>
Session-Termination-Answer	STA	275	<p>Sent by DIAMETER server to acknowledge the session termination notification sent by NAS.</p> <p>The Result-Code AVP must be present in this STA message, and it may also contain an indication that an error occurred while the STR was being serviced. Upon sending or receiving the STA, the DIAMETER server must release all resources for the session indicated by the Session-ID AVP.</p>
Abort-Session-Request	ASR	274	<p>Sent by DIAMETER server to NAS to stop the session identified by the Session-ID AVP.</p> <p>This is similar to RADIUS CoA Session-disconnect request or POD. In the case of stateless application, the DIAMETER session with the particular Session-ID does not exist on BNG. Therefore, instead of Session-ID, another BNG subscriber identity such as Acct-Session-ID, <Framed-IP-Address, VRF> may be sent as one of the AVPs.</p>
Abort-Session-Answer	ASA	274	<p>Sent in response to the ASR message.</p> <p>These are the possible result codes:</p> <ul style="list-style-type: none"> • DIAMETER_SUCCESS - If the session identified by Session-ID was successfully terminated. • DIAMETER_UNKNOWN_SESSION_ID - If the session is not currently active. • DIAMETER_UNABLE_TO_COMPLY - If the access device does not stop the session for some reason.
Accounting-Request	ACR	271	<p>Sent by a DIAMETER node that is acting as a client, in order to exchange accounting information with a peer.</p> <p>In addition to the standard AVPs, ACR messages must also include service-specific accounting AVPs.</p>

DIAMETER NAS Messages	Abbreviation	Command Code	Description
Accounting-Answer	ACA	271	To acknowledge an ACR message. The ACA message contains the same Session-ID as the corresponding request.

DIAMETER Accounting

The session accounting and service accounting functionality provided by BNG, remain unchanged with the introduction of the DIAMETER interface. BNG uses accounting messages defined in the DIAMETER base protocol. The DIAMETER NASREQ application is used for regular AAA services over DIAMETER. The DIAMETER accounting message construction and transport is supported as part of this application.

The DIAMETER applications in BNG have the option of using either or both of these accounting application extension models:

- Split Accounting Service - The accounting message carries the Application-ID of the DIAMETER base accounting application (0x00000003). The respective diameter nodes advertise the DIAMETER base accounting Application ID during capabilities exchanges (CER and CEA).
- Coupled Accounting Service - The accounting message carries the Application-ID of the application that is using it (for example, NASREQ). The application itself processes the received accounting records or forwards them to an accounting server. The accounting application advertisement is not required during capabilities exchange, and the accounting messages are routed the same way as any of the other application messages. In the case of BNG, where an application does not define its own accounting service, the use of the split accounting model is preferred.

The Gz interface between PCEF and OFCS use DIAMETER base accounting application for offline charging. Because BNG supports session based and service based accounting, the split accounting model in which the accounting Application-ID is inserted in all the accounting messages, is preferable.

BNG does not support persistence of accounting records when the DIAMETER server is down.

DIAMETER Accounting Messages

Accounting-Request (ACR) and Accounting-Answer (ACA) are the typical DIAMETER accounting NASREQ messages. The possible ACR types are:

1. EVENT_RECORD - sent if a session fails to start, along with the reason for the failure.
2. START_RECORD - sent if the first authentication or authorization transaction is successfully completed.
3. INTERIM_RECORD - sent if additional authentications or authorizations occur.
4. STOP_RECORD - sent upon termination of the session context.

DIAMETER Gx and Gy Applications

The Gx reference point (based on 3GPP TS 129 212 V11.10.0), that is located between Policy and Charging Rules Function (PCRF) and Policy and Charging Enforcement Function (PCEF), is used for provisioning and

removal of policy and charging control (PCC) rules from the PCRF to the PCEF and for the transmission of traffic plane events from PCEF to PCRF. BNG acts as a PCEF in the current deployment. The PCRF acts as a DIAMETER server with respect to the DIAMETER protocol defined over the Gx interface. That is, it is the network element that handles PCC rule requests for a particular realm. The PCEF acts as the DIAMETER client. That is, it is the network element that requests PCC rules in the transport plane network resources. Currently BNG supports the Gx interface for PCC rules provisioning, but the usage monitoring feature on Gx interface (3GPP RLS9) is not supported.

The Gy reference point (based on 3GPP TS 132 299 V11.9.1), that is located between OCS and PCEF, is used for reporting and online charging.

The required AVPs for broadband deployment and for Cisco ASR 9000 Series Aggregation Services Router use cases are derived out of the Gx and Gy reference points.



Note When there is a DIAMETER process restart, all the ongoing or transient Gy sessions corresponding established Gx sessions are dropped for the sessions between a customer premise equipment (CPE) and the network resource.

Supported Gx Messages

This table lists the DIAMETER Gx messages supported by BNG:

DIAMETER Gx Messages	Abbreviation	Command Code	Description
Credit-Control-Request	CCR	272	Sent by the traffic plane function (TPF) to the charging rules function (CRF) in order to request charging rules for a bearer, and also to indicate the termination of the subscriber session.
Credit-Control-Answer	CCA	272	Sent by the PCRF to the PCEF in response to the CCR command. It is used to provision PCC rules and event triggers for the bearer or session, and to provide the selected bearer control mode for the IP connectivity access network (IP-CAN) session.
Re-Auth-Request	RAR	258	Sent by the PCRF to the PCEF in order to provision unsolicited PCC rules using the PUSH procedure.
Re-Auth-Answer	RAA	258	Sent by the PCEF to the PCRF in response to the RAR command.
Abort Session Request	ASR	274	Sent by any server to the access device providing session service, requesting it to stop the session identified by the Session-Id.
Abort Session Answer	ASA	274	Sent in response to the ASR. The Result-Code AVP that indicates the disposition of the request must be present.

Supported Gy Messages

BNG supports these DIAMETER Gy messages:

- CCR-Initial
- CCA-Initial
- CCR-Update message with tariff change units
- CCA-Update
- CCR-Final
- CCA-Final

DIAMETER DCCA Application

DCCA interface implementation is based on the RFC 4006. The 3GPP Gx and Gy applications use the DCCA framework and AVPs to provide the respective functions.

BNG supports these DCCA messages:

- Credit Control Request (CCR)
- Credit Control Answer (CCA)

Every single CCR must be responded with a separate CCA.

DCCA Session and Services

Each BNG subscriber session is associated with a DIAMETER CC-Session (Credit Control-Session) when Gx or Gy, or both applications, are enabled. Multiple services may be active in a BNG subscriber session. The quota management and usage reporting for each service is performed by using MSCC AVP in the CCR-CCA messages. The Service-Identifier and Rating-Group AVP inside the MSCC identifies the service of a subscriber session. Quota for a service is granted within one Granted-Service-Unit AVP (GSU). Quota usage reporting is done in one or more Used-Service-Unit (USU) AVP.

A CC-Session is uniquely identified by a Diameter Session-ID. The same format is used for the construction of Session-ID.

BNG DIAMETER Call Flow

This figure shows a call flow sequence of BNG DIAMETER, for DHCP-initiated IPoE sessions (this is based on one of the BNG DIAMETER use cases and the BNG call flow):

Figure 39: BNG DIAMETER Call Flow

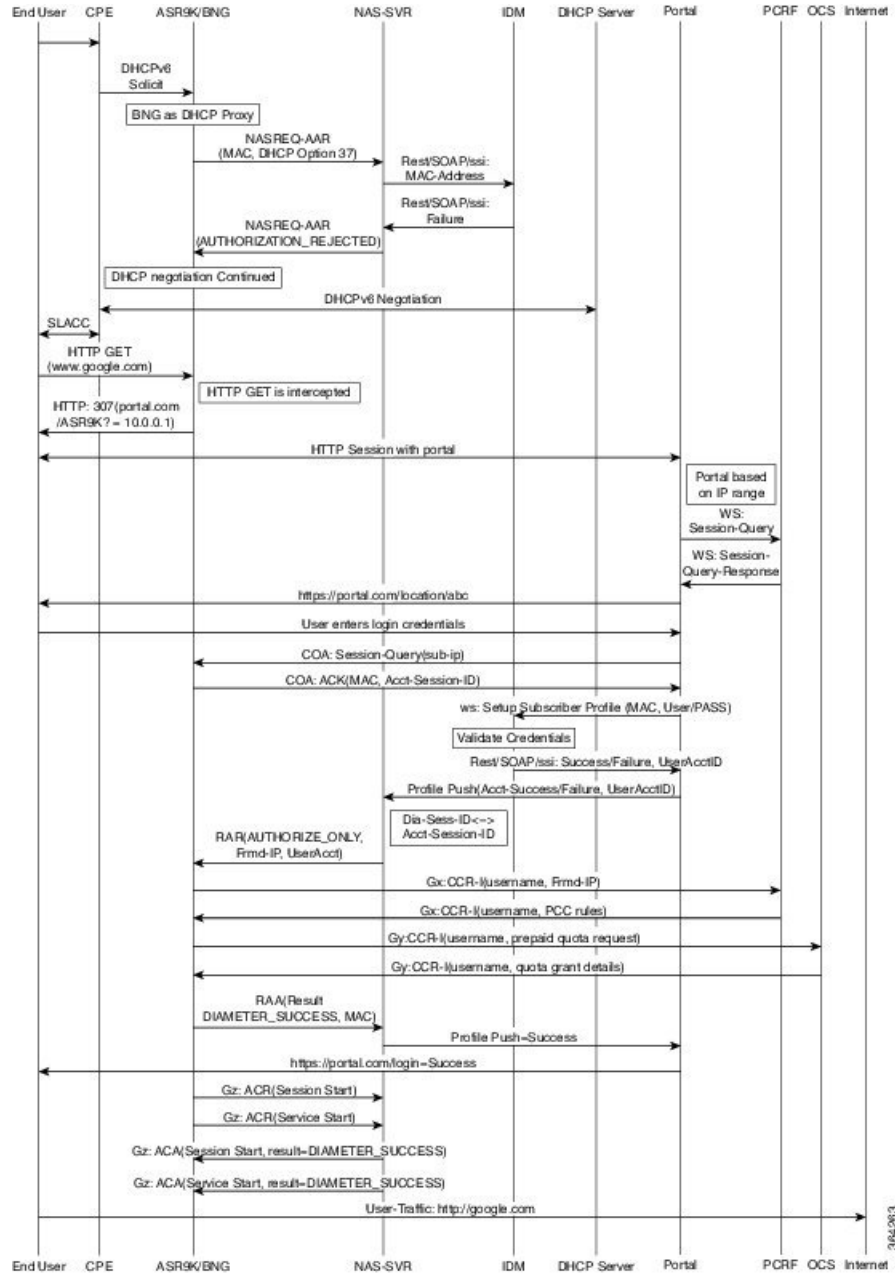

394-263

Guidelines and Restrictions for DIAMETER Support in BNG

Guidelines for DIAMETER AVPs in BNG

These guidelines must be taken into consideration for the DIAMETER AVPs in BNG:

- Because BNG is deployed in wire-line scenario, Subscription-ID (443) AVP is not required. Instead, the subscriber identifier is carried using DIAMETER User-Name (1) AVP. If a provider likes to use the common subscriber identity, BNG can include Subscription-ID(443) Grouped AVP with the appropriate value for Subscription-ID-Type (450).
- To bring up a BNG session, a few Cisco VSAs are also needed as part of the subscriber authorization profile. Since the profile is provided by the PCRF, you must ensure the support of those DIAMETER Cisco AVPs.
- The network access details are sent from BNG in the request packet using the existing RADIUS equivalent of DIAMETER AVPs, such as NAS-Port-ID (87), NAS-Identifier (32) and NAS-IP-Address (4).
- The user must define the subscriber service on the BNG router as part of the dynamic template. The configurations on BNG router defines the service definitions that are part of a prepaid set. Hence, from the Gx interface perspective, only the Service-name is expected to come from PCRF. More than one service-name instance may come in CCA and RAR messages from PCRF. BNG receives these instances using Charging-Rule-Install (1001) 3GPP Grouped AVP, Charging-Rule-Name (1005) 3GPP AVP, Service-Identifier (439) IETF AVP and Rating-Group (432) 3GPP AVP, to be part of this grouped AVP to represent the one logical service construct.
- Currently BNG does not support service definition coming from PCRF. Therefore, the Charging-Rule-Definition(1003) 3GPP Grouped AVP, with containers to denote the flow-description, is not required.

Restrictions for DIAMETER in BNG

The DIAMETER support in BNG is subjected to these restrictions:

- BNG does not support Origin-State-Id AVP. Therefore, if this AVP is received from the DIAMETER server, it is ignored.
- The Session-Binding AVP is ignored by BNG router. BNG uses the value of Origin-Host AVP, received in the latest CCA message, for the Destination-Host AVP of the next request and the termination request as well.
- The use of In-band-Security-Id AVP, that is used to advertise the support of security portion of the application is not recommended in CER and CEA messages. Instead, discovery of a DIAMETER entity's security capabilities can be done through static configuration.

Configuring DIAMETER Peer in BNG

Perform this task to configure the DIAMETER connection on a BNG router.

The selection of DIAMETER server is mostly based on the AAA method list configuration. These are the various selection options:

- For regular AAA services (NASREQ), it is completely based on the AAA configuration on the router.
- For Gx, it can be based on the Gx realm selection.
- For prepaid, it is based on the charging profile associated with the subscriber session on BNG.

For details on configuring AAA for DIAMETER, see [Configuring AAA for DIAMETER Peer in BNG](#), on page 467.

SUMMARY STEPS

1. **configure**
2. **diameter {gx | gy}**
3. **diameter peer** *peer name*
4. **transport security-type** **tls**
5. **transport tcp port** *port_num*
6. **destination host** *host_string*
7. **destination realm** *realm_string*
8. **address [ipv4 | ipv6]** *ip_addr*
9. **ip vrf forwarding** *vrf_table_name*
10. **source-interface** *intf-type intf-name*
11. **peer-type** **server**
12. **root**
13. **diameter origin host** *host-name*
14. **diameter origin realm** *realm-string*
15. **diameter timer** [**connection** | **transaction** | **watchdog**] *timer-value*
16. **diameter vendor supported** [**cisco** | **etsi** | **threegpp** | **vodafone**]
17. **diameter tls trustpoint** *label*
18. **diameter {gx | gy}** [**retransmit** *retansmit-timer-val* | **tx-timer** *tx-timer-val*]
19. Use the **commit** or **end** command.

DETAILED STEPS

	Command or Action	Purpose
Step 1	configure Example: RP/0/RSP0/CPU0:router# <code>configure</code>	Enters global configuration mode.
Step 2	diameter {gx gy} Example: RP/0/RSP0/CPU0:router(config)# <code>diameter gx</code>	Configures Gx interface for policy control and charging. Similarly, configures the Gy interface for online (prepaid) charging.
Step 3	diameter peer <i>peer name</i> Example: RP/0/RSP0/CPU0:router(config)# <code>diameter peer</code> <code>GX_SERVER</code>	Configures DIAMETER peer.
Step 4	transport security-type tls Example: RP/0/RSP0/CPU0:router(config-dia-peer)# <code>transport</code> <code>security-type tcp</code>	[Optional] Configures the DIAMETER security type as TLS .

	Command or Action	Purpose
Step 5	transport tcp port <i>port_num</i> Example: <pre>RP/0/RSP0/CPU0:router(config-dia-peer)# transport tcp port 3868</pre>	<p>Configures the DIAMETER transport protocol used for establishing the connection with the peer, along with the port number (Optional) that the remote peer uses for DIAMETER messages.</p> <p>Currently only TCP is supported as DIAMETER transport protocol.</p>
Step 6	destination host <i>host_string</i> Example: <pre>RP/0/RSP0/CPU0:router(config-dia-peer)# destination host dcal.cisco.com</pre>	<p>Configures the hostname of the peer in Fully Qualified Domain Name (FQDN) format.</p> <p>This value is sent in various messages so that intermediate proxies can correctly route the packets.</p>
Step 7	destination realm <i>realm_string</i> Example: <pre>RP/0/RSP0/CPU0:router(config-dia-peer)# destination realm GX_REALM</pre>	<p>[Optional] Configures the realm to which the peer belongs to.</p> <p>The destination realm is added by AAA clients while sending a request to AAA server, using the AAA_AT_DESTINATION_REALM attribute. If this attribute is not present, then the realm information is retrieved using the User name field. If the clients do not add the attribute, then the value configured in the peer mode is used while sending messages to the destination peer.</p>
Step 8	address [<i>ipv4</i> <i>ipv6</i>] <i>ip_addr</i> Example: <pre>RP/0/RSP0/CPU0:router(config-dia-peer)# address ipv4 2.2.2.2</pre>	<p>Configures IP address of the DIAMETER peer.</p>
Step 9	ip vrf forwarding <i>vrf_table_name</i> Example: <pre>RP/0/RSP0/CPU0:router(config-dia-peer)# ip vrf forwarding VRF1</pre>	<p>[Optional] Configures the VRF associated with the peer, to establish connections with the peers immediately after configuring the peers.</p> <p>If this command is not configured, then the global routing table is used for establishing the connection with the peer.</p> <p>If the VRF associated with the name is not configured, then an error message mentioning that is displayed, and this command does not have any effect.</p>
Step 10	source-interface <i>intf-type intf-name</i> Example: <pre>RP/0/RSP0/CPU0:router(config-dia-peer)# source-interface Bundle-Ether 1</pre>	<p>[Optional] Configures the source-interface to be used for the DIAMETER connection. The diameter client uses this source address and port to initiate the TCP connection to the peer.</p> <p>This command is also available in global configuration mode, when used with diameter keyword.</p>

	Command or Action	Purpose
Step 11	<p>peer-type server</p> <p>Example:</p> <pre>RP/0/RSP0/CPU0:router(config-dia-peer)# peer-type server</pre>	Configures the peer type. By default, the peer type is, server .
Step 12	<p>root</p> <p>Example:</p> <pre>RP/0/RSP0/CPU0:router(config-dia-peer)# root</pre>	Returns the configuration mode back to the global configuration mode.
Step 13	<p>diameter origin host <i>host-name</i></p> <p>Example:</p> <pre>RP/0/RSP0/CPU0:router(config)# diameter origin host 1.1.1.1</pre>	<p>Configures the origin host information.</p> <p>The origin host information is sent in different requests to the DIAMETER peer and it maps to multiple IP addresses. If this value is not configured, then a NULL string is sent. Therefore, this is a mandatory configuration.</p>
Step 14	<p>diameter origin realm <i>realm-string</i></p> <p>Example:</p> <pre>RP/0/RSP0/CPU0:router(config)# diameter origin realm cisco.com</pre>	<p>[Optional] Configures the origin realm information.</p> <p>The origin realm information is sent in each request to the DIAMETER peer. If this value is not configured, then a NULL string is sent. Therefore, this is a mandatory configuration.</p>
Step 15	<p>diameter timer [connection transaction watchdog] <i>timer-value</i></p> <p>Example:</p> <pre>RP/0/RSP0/CPU0:router(config)# diameter timer watchdog 300</pre>	<p>Configures global timers for DIAMETER.</p> <ul style="list-style-type: none"> • Connection timer is used to delay the connection establishment or re-establishment of client with the DIAMETER server. It determines the frequency of transport connection attempts with the peer when there is no active connection with the peer. • Transaction timer is used for setting the frequency of transaction attempts. That is, the duration for which the client waits for any response message from the peer. • Watchdog timer is used to periodically send the Device-Watch-Dog to the DIAMETER server to test the link status. <p>Note These timers can also be configured at the peer level (in diameter peer configuration mode). By default, the peers inherit the globally configured timer values. But, if the timer values are configured at peer level as well, then the peer level timer values take precedence over the globally configured timer values.</p>

	Command or Action	Purpose
Step 16	<p>diameter vendor supported [cisco etsi threagpp vodafone]</p> <p>Example:</p> <pre>RP/0/RSP0/CPU0:router(config)# diameter vendor supported cisco</pre>	Advertises the various vendor AVPs that the DIAMETER node understands. This information is passed to the peer in capability exchange messages.
Step 17	<p>diameter tls trustpoint <i>label</i></p> <p>Example:</p> <pre>RP/0/RSP0/CPU0:router(config)# diameter tls trustpoint DIAMETER_TRUSTPOINT</pre>	Specifies the trustpoint name to be used in the certificate to be used for DIAMETER TLS exchange. If a trustpoint name is not provided, then the default trustpoint is used.
Step 18	<p>diameter {gx gy} [retransmit <i>retransmit-timer-val</i> tx-timer <i>tx-timer-val</i>]</p> <p>Example:</p> <pre>RP/0/RSP0/CPU0:router(config)# diameter gx retransmit 5 RP/0/RSP0/CPU0:router(config)# diameter gx tx-timer 100</pre>	Configures the re-transmit and the transaction timers for Gx and Gy applications.
Step 19	Use the commit or end command.	<p>commit —Saves the configuration changes and remains within the configuration session.</p> <p>end —Prompts user to take one of these actions:</p> <ul style="list-style-type: none"> • Yes — Saves configuration changes and exits the configuration session. • No —Exits the configuration session without committing the configuration changes. • Cancel —Remains in the configuration session, without committing the configuration changes.

Configuring DIAMETER Connection in BNG: Example

DIAMETER-specific configurations:

```
diameter gx
diameter gy
diameter peer GX_SERVER
  destination realm GX_REALM
  address ipv4 2.2.2.2
!
diameter peer GY_SERVER
  transport tcp port 3869
  destination realm GY_REALM
  address ipv4 2.2.2.2
!
diameter peer NASREQ_SERVER
```

```

address ipv4 1.1.1.2
!
diameter timer watchdog 300
diameter origin host 1.1.1.1
diameter origin realm cisco.com
diameter vendor supported threegpp
diameter vendor supported cisco
diameter vendor supported vodafone

```

Configuring AAA for DIAMETER Peer in BNG

Perform this task to configure AAA for DIAMETER NASREQ application in BNG router.

Before you begin

Prior to this task, you must set up the DIAMETER peer in BNG router. For details, see [Configuring DIAMETER Peer in BNG, on page 462](#).

SUMMARY STEPS

1. **configure**
2. **aaa group server** {diameter | radius} *server-group-name*
3. **server** *peer_name*
4. **aaa authentication subscriber** {list-name | default} **group** {*server-group-name* | diameter | radius}
5. **aaa authorization subscriber** {list-name | default} **group** {*server-group-name* | diameter | radius}
6. **aaa accounting subscriber** {list-name | default} **group** {*server-group-name* | diameter | radius}
7. **aaa accounting service** {list-name | default} **group** {*server-group-name* | diameter | radius}
8. **aaa authorization policy-if** {list-name | default} **group** {*server-group-name* | diameter | radius}
9. **aaa authorization prepaid** {list-name | default} **group** {*server-group-name* | diameter | radius}
10. Use the **commit** or **end** command.

DETAILED STEPS

	Command or Action	Purpose
Step 1	configure Example: RP/0/RSP0/CPU0:router# <code>configure</code>	Enters global configuration mode.
Step 2	aaa group server {diameter radius} <i>server-group-name</i> Example:	Configures the named server group for DIAMETER, and enters the server group sub-mode.

	Command or Action	Purpose
	RP/0/RSP0/CPU0:router(config)# aaa group server diameter GX_SG	
Step 3	server peer_name Example: RP/0/RSP0/CPU0:router(config-sg-diameter)# server GX_SERVER	Attaches the globally configured DIAMETER server (configured using diameter peer command) having the same name, to the server group. If a server is not configured with the same name, then an error message mentioning that is displayed. Unlike for RADIUS, DIAMETER does not have private servers. DIAMETER considers a server that does not have a VRF name configured, as a global server, and it uses global routing table for that particular server.
Step 4	aaa authentication subscriber {list-name default} group {server-group-name diameter radius} Example: RP/0/RSP0/CPU0:router(config)# aaa authentication subscriber default group diameter	Configures subscriber authentication with DIAMETER protocol using NASREQ application.
Step 5	aaa authorization subscriber {list-name default} group {server-group-name diameter radius} Example: RP/0/RSP0/CPU0:router(config)# aaa authorization subscriber default group diameter	Configures subscriber authorization with DIAMETER protocol using NASREQ application.
Step 6	aaa accounting subscriber {list-name default} group {server-group-name diameter radius} Example: RP/0/RSP0/CPU0:router(config)# aaa accounting subscriber default group diameter	Configures subscriber session accounting to DIAMETER server using Base Accounting Application.
Step 7	aaa accounting service {list-name default} group {server-group-name diameter radius} Example: RP/0/RSP0/CPU0:router(config)# aaa accounting service default group diameter	Configures to carry subscriber service accounting records to DIAMETER server using Base Accounting Application.
Step 8	aaa authorization policy-if {list-name default} group {server-group-name diameter radius} Example: RP/0/RSP0/CPU0:router(config)# aaa authorization policy-if policy_meth group GX_SG	Configures authorization lists for policy interface (Gx interface).

	Command or Action	Purpose
Step 9	aaa authorization prepaid { <i>list-name</i> default } group { <i>server-group-name</i> diameter radius } Example: RP/0/RSP0/CPU0:router(config)# aaa authorization prepaid prepaid_meth group GY_SG	Configures authorization lists for prepaid (Gy interface).
Step 10	Use the commit or end command.	commit —Saves the configuration changes and remains within the configuration session. end —Prompts user to take one of these actions: <ul style="list-style-type: none"> • Yes — Saves configuration changes and exits the configuration session. • No —Exits the configuration session without committing the configuration changes. • Cancel —Remains in the configuration session, without committing the configuration changes.

Configuring AAA for DIAMETER Connection in BNG: Example

AAA configurations:

```

aaa group server diameter GX_SG
  server GX_SERVER
!
aaa group server diameter GY_SG
  server GY_SERVER
!
aaa group server diameter NASREQ_SG
  server NASREQ_SERVER
!
aaa authorization network default group radius
aaa accounting service default group radius
aaa accounting subscriber default group radius
aaa accounting subscriber nasreq_acct_list group NASREQ_SG
aaa authorization subscriber default group radius
aaa authorization subscriber nasreq_author_list group NASREQ_SG
aaa authorization policy-if policy_meth group GX_SG
aaa authentication subscriber default group radius
aaa authorization prepaid prepaid_meth group GY_SG

```

Prepaid Service:

```

dynamic-template
  type service prepaid
  service-policy input qos_in_parent1 merge 10 acct-stats
  service-policy output qos_out_parent1 merge 10 acct-stats
  accounting aaa list default type service periodic-interval 30
  prepaid-config prepaid_config

```

Prepaid Template:

```

subscriber
  accounting prepaid prepaid_config
  threshold volume 100
  method-list authorization prepaid_meth
  threshold time 100
  password cisco

Policy Map:

policy-map type control subscriber diam_policy
  event session-start match-first
  class type control subscriber dual-stack do-until-failure
    10 activate dynamic-template DYN_TEMP_IPSUB_DUAL
    20 authorize aaa list default identifier source-address-mac password welcome
    30 authorize aaa list policy_meth identifier username password welcome
  !
!
end-policy-map
!

```

Verification of DIAMETER Configurations in BNG

These show commands can be used to verify the DIAMETER configurations in BNG:

SUMMARY STEPS

1. **show tcp brief**
2. **show diameter peer**
3. **show diameter gx statistics**
4. **show diameter gy statistics**
5. **show diameter gx session** *session-id-string*
6. **show diameter gy session** *session-id-string*
7. **show diameter nas session** [**checkpoint** | **session** | **summary**]
8. **show checkpoint dynamic process diameter**

DETAILED STEPS

Step 1 show tcp brief

Example:

```
RP/0/RSP0/CPU0:router# show tcp brief
```

PCB	VRF-ID	Recv-Q	Send-Q	Local Address	Foreign Address	State
0x1016cc7c	0x60000000	0	0	2.2.2.1:28691	2.2.2.2:3869	ESTAB
0x1016bbc8	0x60000000	0	0	2.2.2.1:24698	2.2.2.2:3868	ESTAB
0x1013ccc0	0x60000000	0	0	0.0.0.0:23	0.0.0.0:0	LISTEN
0x10138db8	0x00000000	0	0	0.0.0.0:23	0.0.0.0:0	LISTEN

Displays a summary of the TCP connection table.

Step 2 show diameter peer

Example:

```
RP/0/RSP0/CPU0:router# show diameter peer

Origin Host :
Origin Realm :
Source Interface :
TLS Trustpoint :
Connection timer value : 30 seconds
Watchdog timer value : 300 seconds
Transaction timer value : 30 seconds
Number of Peers:3

Peer name : GX_SERVER
  type : SERVER
  Address/port : 2.2.2.2/3868
  Transport protocol : TCP
  Peer security protocol : NONE
  connection timer : 30 seconds
  watchdog timer value : 300 seconds
  transaction timer value : 30 seconds
  VRF name : default
  Source-interface :
  Destination realm : GX_REALM
  Destination host name :
  Peer connection status : Open
```

```
Peer Statistics
-----
          IN    /    OUT
-----
ASR      0      /      0
ASA      0      /      0
ACR      0      /      0
ACA      0      /      0
CER      0      /      1
CEA      1      /      0
DWR      0      /      0
DWA      0      /      0
DPR      0      /      0
DPA      0      /      0
RAR      0      /      0
RAA      0      /      0
STR      0      /      0
STA      0      /      0
AAR      0      /      0
AAA      0      /      0
CCR      0      /      0
CCA      0      /      0
Malformed Rcvd   : 0
Prot. Errs Sent  : 0
Trans. Errs Sent : 0
Perm. Errs Sent  : 0
Prot. Errs Rcvd  : 0
Trans. Errs Rcvd : 0
Perm. Errs Rcvd  : 0
```

Displays DIAMETER peer information.

Step 3 show diameter gx statistics**Example:**

```
RP/0/RSP0/CPU0:router# show diameter gx statistics
CCR Initial Messages : 1
```

```

CCR Initial Messages Sent Failed      : 0
CCR Initial Messages Timed Out        : 0
CCR Initial Messages Retry            : 0
CCR Update Messages                   : 0
CCR Update Messages Sent Failed        : 0
CCR Update Messages Timed Out         : 0
CCR Update Messages Retry              : 0
CCR Terminate Messages                : 0
CCR Terminate Messages Sent Failed     : 0
CCR Terminate Messages Timed Out      : 0
CCR Terminate Messages Retry          : 0
CCA Initial Messages                  : 1
CCA Initial Messages Error             : 0
CCA Update Messages                   : 0
CCA Update Messages Error             : 0
CCA Terminate Messages                : 0
CCA Terminate Messages Error          : 0
RAR Received Messages                 : 0
RAR Received Messages Error           : 0
RAA Sent Messages                     : 0
RAA Sent Messages Error               : 0
ASR Received Messages                 : 0
ASR Received Messages Error           : 0
ASA Sent Messages                     : 0
ASA Sent Messages Error               : 0
Session Termination Messages Recvd    : 0
Unknown Request Messages              : 0
Restored Sessions                     : 0
Total Opened Sessions                  : 1
Total Closed Sessions                  : 0
Total Active Sessions                  : 1

```

Displays DIAMETER gx statistics.

Step 4 show diameter gy statistics

Example:

```
RP/0/RSP0/CPU0:router# show diameter gy statistics
```

```

CCR Initial Messages                  : 1
CCR Initial Messages Sent Failed      : 0
CCR Initial Messages Timed Out        : 0
CCR Initial Messages Retry            : 0
CCR Update Messages                   : 4
CCR Update Messages Sent Failed        : 0
CCR Update Messages Timed Out         : 0
CCR Update Messages Retry              : 0
CCR Terminate Messages                : 1
CCR Terminate Messages Sent Failed     : 0
CCR Terminate Messages Timed Out      : 0
CCR Terminate Messages Retry          : 0
CCA Initial Messages                  : 1
CCA Initial Messages Error             : 0
CCA Update Messages                   : 4
CCA Update Messages Error             : 0
CCA Terminate Messages                : 1
CCA Terminate Messages Error          : 0
RAR Received Messages                 : 0
RAR Received Messages Error           : 0
RAA Sent Messages                     : 0
RAA Sent Messages Error               : 0
ASR Received Messages                 : 0

```



```

ASR Received Messages Error      : 0
ASA Sent Messages                : 0
ASA Sent Messages Error          : 0
Unknown Request Messages         : 0
Restored Sessions                : 0
Total Opened Sessions            : 2
Total Closed Sessions            : 1
Total Active Sessions             : 1

```

Displays DIAMETER gy statistics.

Step 5 **show diameter gx session** *session-id-string*

Example:

```
RP/0/RSP0/CPU0:router# show diameter gx session 461419
```

```

Gx Session Status for [461419]
  Session Status      : ACTIVE
  Diameter Session ID : 1.1.1.1;4;461419;1185991
  Gx Session State    : OPEN
  Request Number      : 0
  Request Type        : INITIAL REQUEST
  Request Retry Count : 0

```

Displays DIAMETER gx session information.

Step 6 **show diameter gy session** *session-id-string*

Example:

```
RP/0/RSP0/CPU0:router# show diameter gy session 461421
```

```

Gy Session Status for [461421]
  Session Status      : ACTIVE
  Diameter Session ID : 1.1.1.1;4;461421;1186625
  Gy Session State    : OPEN
  Request Number      : 1
  Request Type        : UPDATE REQUEST
  Request Retry Count : 0

```

Displays DIAMETER gy session information.

Step 7 **show diameter nas session** [**checkpoint** | **session** | **summary**]

Example:

```
RP/0/RSP0/CPU0:router# show diameter nas session
```

```

Gy Session Status for [461421]
  Session Status      : ACTIVE
  Diameter Session ID : 1.1.1.1;4;461421;1186625
  Gy Session State    : OPEN
  Request Number      : 1
  Request Type        : UPDATE REQUEST
  Request Retry Count : 0

```

```
RP/0/RSP0/CPU0:router# show diameter nas session 00070a6f
```

```
Nas Session status for [00070a6f]
```

```

Session Status           : Active
Diameter Session ID     : 1.1.1.1;4;461423;1187179

Authentication Status   : NA
Authorization Status    : SUCCESS
Accounting Status (Start) : NA
Accounting Status (Stop) : NA
Disconnect status       : NA

```

```

Peer Information :
Server group     : NASREQ_SG
Server Used      : NASREQ_SERVER

```

RP/0/RSP0/CPU0:router# **show diameter nas summary**

NAS Statistics :

NAS Initiated msgs :

```

Authentication      ::
  In                 :           0  Out                 :           0
  Requests received  :           0  Requests send     :           0
  Response received  :           0  Result forwarded  :           0
  Transaction Succeeded:         0  Transactions Failed :           0

Authorization       ::
  In                 :           1  Out                 :           1
  Requests received  :           1  Requests send     :           1
  Response received  :           1  Result forwarded  :           1
  Transaction Succeeded:         1  Transactions Failed :           0

Accounting (Start)  ::
  In                 :           0  Out                 :           0
  Requests received  :           0  Requests send     :           0
  Response received  :           0  Result forwarded  :           0
  Transaction Succeeded:         0  Transactions Failed :           0

Accounting (Stop)   ::
  In                 :           0  Out                 :           0
  Requests received  :           0  Requests send     :           0
  Response received  :           0  Result forwarded  :           0
  Transaction Succeeded:         0  Transactions Failed :           0

Accounting (Interim) ::
  In                 :           0  Out                 :           0
  Requests received  :           0  Requests send     :           0
  Response received  :           0  Result forwarded  :           0
  Transaction Succeeded:         0  Transactions Failed :           0

Disconnect          ::
  In                 :           0  Out                 :           0
  Requests received  :           0  Requests send     :           0
  Response received  :           0  Result forwarded  :           0
  Transaction Succeeded:         0  Transactions Failed :           0

```

Server Initiated msgs :

```

Coa (RAR)      ::
    In          :          0 Out          :          0
    Requests received :      0 Requests send :      0
    Response received :      0 Result forwarded :      0
    Transaction Succeeded:      0 Transactions Failed :      0

POD (ASR)      ::
    In          :          0 Out          :          0
    Requests received :      0 Requests send :      0
    Response received :      0 Result forwarded :      0
    Transaction Succeeded:      0 Transactions Failed :      0
Diameter NAS summary

```

Displays DIAMETER NAS information.

Step 8 show checkpoint dynamic process diameter

Example:

```
RP/0/RSP0/CPU0:router# show checkpoint dynamic process diameter
```

Name	Version	ID	Seg	#Objects	Length	InfoLen	Flags
0x00000003	0, 0, 0	0x40001c00	M	0	292	4	I M
0x00000004	0, 0, 0	0x40001d00	M	1	264	4	I M
0x00000002	0, 0, 0	0x40001e00	M	1	24	4	I M
0x00000001	0, 0, 0	0x40001f00	M	1	24	4	I M

```
Segment 0: Number of pages allocated: 4
Segment 0: Number of pages free: 3
```

```
Segment 1: Number of pages allocated: 9
Segment 1: Number of pages free: 3
```

Displays checkpoint information of DIAMETER process.

BNG DIAMETER-Geo Redundancy Interworking

BNG extends the geo redundancy feature to support DIAMETER protocol for the northbound interfaces. DIAMETER being a stateful protocol, unlike RADIUS which is a stateless protocol, the northbound interface convergence with respect to the NASREQ, Gx and Gy applications is taken care in the case of BNG switchovers. This functionality is mainly useful for the back end servers to seamlessly maintain the subscriber accounting information of prepaid customers in the case of node fail overs.

This figure shows a topology of DIAMETER-Geo redundancy interworking.

Figure 40: DIAMETER-Geo Redundancy Interworking

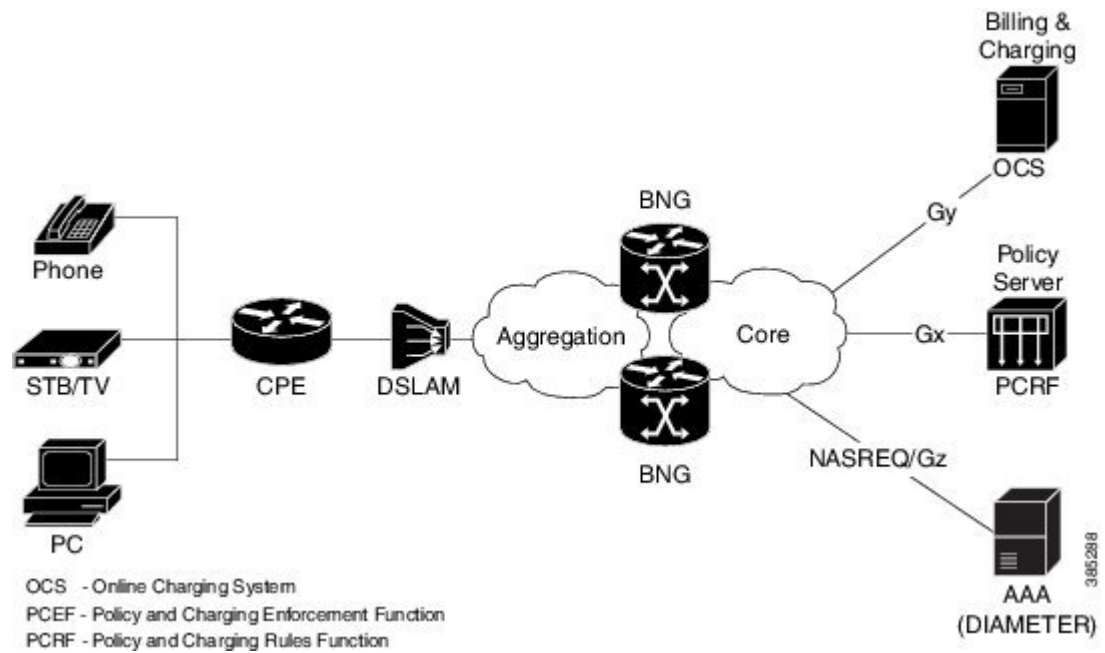

See more details about geo redundancy and DIAMETER at [BNG Geo Redundancy](#), on page 393 and [DIAMETER Support in BNG](#), on page 453.

BNG DIAMETER-Geo Redundancy Call Flow

This figure shows the call flow of subscriber session establishment with BNG DIAMETER-Geo redundancy:

Figure 41: Call Flow of Subscriber Session Establishment With BNG DIAMETER-Geo Redundancy

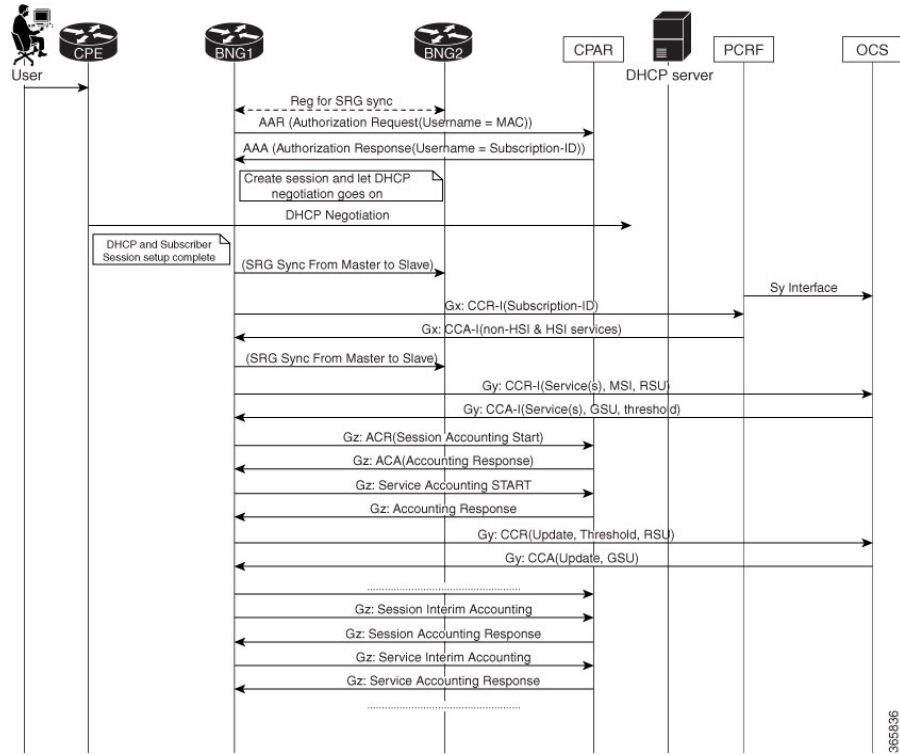

This figure shows the call flow of subscriber sessions during SRG switch over:

Figure 42: Call Flow of Subscriber Sessions During SRG Switch Over

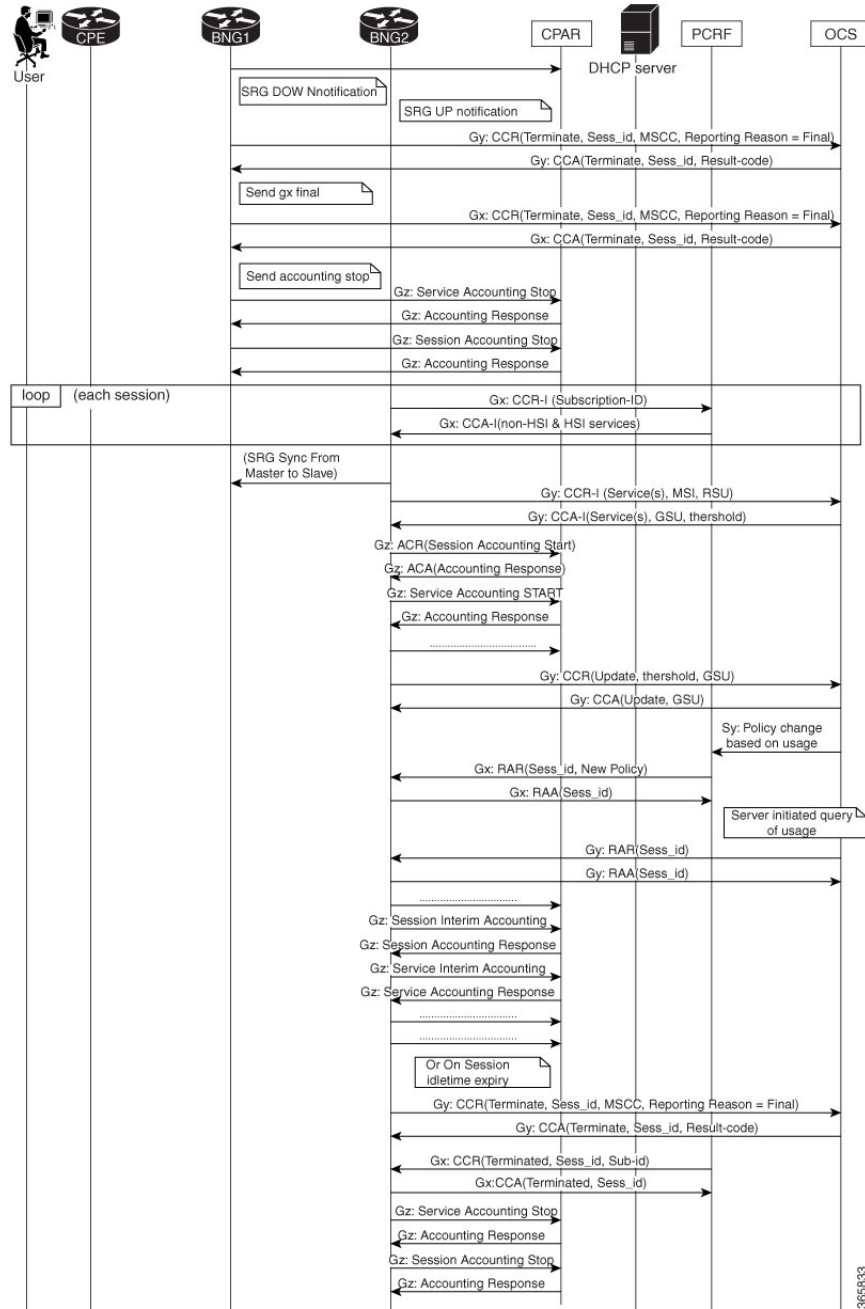

When sessions move from active to standby state in the case of a switchover, the old SRG primary BNG node stops the prepaid accounting by sending a CCR-Final message from DIAMETER Gy application to the OCS server. Similarly, the old SRG primary BNG node sends a CCR-Terminate message from DIAMETER Gx application to gracefully close the session with PCRF. The NASREQ application handles the accounting start, stop and interim messages. This application sends Accounting STOP messages from primary BNG node to NASREQ server.

When the sessions are switched from standby state to active state, the new SRG primary BNG node re-establishes the state with the PCRF for subsequent communication by sending a CCR-Initial message from the Gx application. Similarly, the new SRG primary BNG node sends a CCR-Initial message to OCS server so that the Gy application starts the new prepaid service. After SRG switchover, the Gy application on the new SRG primary node creates a new context after receiving the Prepaid Start (Authorization) request.

DIAMETER NAS application on the router needs the diameter session context in order to process requests from the client. This context is created for every new request received from the client, except the Accounting Stop and Session-Termination-Request messages. When the sessions are coming up on the new SRG primary node, the NAS application receives Accounting Start messages from the client. DIAMETER sessions are created on receiving the Accounting Start messages. These accounting START messages are sent from the NASREQ application to the NASREQ server, to maintain the continuity of the interim accounting.

Verify BNG DIAMETER-Geo Redundancy

Verify the Statistics From the New Subordinate BNG Node

- Check the accounting records and STR record counters, if authentication is done with the NASREQ server:

```
Router#show diameter nas summary
NAS Statistics :

    NAS Initiated msgs :

        Authentication      ::

            In              :          0   Out              :          0
            Requests received :          0   Requests send       :          0
            Response received :          0   Result forwarded   :          0
            Transaction Succeeded:          0   Transactions Failed :          0

        Authorization      ::

            In              :          0   Out              :          0
            Requests received :          0   Requests send       :          0
            Response received :          0   Result forwarded   :          0
            Transaction Succeeded:          0   Transactions Failed :          0

        Accounting (Start)  ::

            In              :          0   Out              :          0
            Requests received :          0   Requests send       :          0
            Response received :          0   Result forwarded   :          0
            Transaction Succeeded:          0   Transactions Failed :          0

        Accounting (Stop)  ::

            In              :        64000   Out              :        64000
            Requests received :        64000   Requests send       :        64000
            Response received :        64000   Result forwarded   :        64000
            Transaction Succeeded:        64000   Transactions Failed :          0

        Accounting (Interim) ::

            In              :          0   Out              :          0
            Requests received :          0   Requests send       :          0
            Response received :          0   Result forwarded   :          0
```

```

Transaction Succeeded:          0  Transactions Failed :          0
Disconnect                ::
In                               :    32000  Out                       :    32000
Requests received               :    32000  Requests send                :    32000
Response received               :    32000  Result forwarded             :    32000
Transaction Succeeded:          32000  Transactions Failed :          0

```

- Check the Gx-specific statistics:

```

Router#show diameter gx statistics
Tue Mar 15 16:37:36.545 UTC
CCR Initial Messages                : 0
CCR Initial Messages Sent Failed    : 0
CCR Initial Messages Timed Out      : 0
CCR Initial Messages Retry          : 0
CCR Update Messages                 : 0
CCR Update Messages Sent Failed     : 0
CCR Update Messages Timed Out       : 0
CCR Update Messages Retry           : 0
CCR Terminate Messages          : 32000
CCR Terminate Messages Sent Failed  : 0
CCR Terminate Messages Timed Out    : 0
CCR Terminate Messages Retry        : 0
CCA Initial Messages                : 0
CCA Initial Messages Error          : 0
CCA Update Messages                 : 0
CCA Update Messages Error           : 0
CCA Terminate Messages          : 32000
CCA Terminate Messages Error        : 0
RAR Received Messages               : 0
RAR Received Messages Error         : 0
RAA Sent Messages                   : 0
RAA Sent Messages Error             : 0
ASR Received Messages               : 0
ASR Received Messages Error         : 0
ASA Sent Messages                   : 0
ASA Sent Messages Error             : 0
Session Termination Messages Recvd  : 0
Unknown Request Messages            : 0
Restored Sessions                   : 0
Total Opened Sessions               : 0
Total Closed Sessions               : 32000
Total Active Sessions               : 0

```

- Check the Gy-specific statistics:

```

Router#show diameter gy statistics
Tue Mar 15 16:37:36.545 UTC
CCR Initial Messages                : 0
CCR Initial Messages Sent Failed    : 0
CCR Initial Messages Timed Out      : 0
CCR Initial Messages Retry          : 0
CCR Update Messages                 : 0
CCR Update Messages Sent Failed     : 0
CCR Update Messages Timed Out       : 0
CCR Update Messages Retry           : 0
CCR Terminate Messages          : 32000
CCR Terminate Messages Sent Failed  : 0

```



```

CCR Terminate Messages Timed Out      : 0
CCR Terminate Messages Retry          : 0
CCA Initial Messages                  : 0
CCA Initial Messages Error            : 0
CCA Update Messages                   : 0
CCA Update Messages Error             : 0
CCA Terminate Messages                : 32000
CCA Terminate Messages Error          : 0
RAR Received Messages                 : 0
RAR Received Messages Error           : 0
RAA Sent Messages                     : 0
RAA Sent Messages Error               : 0
ASR Received Messages                 : 0
ASR Received Messages Error           : 0
ASA Sent Messages                     : 0
ASA Sent Messages Error               : 0
Session Termination Messages Recvd    : 0
Unknown Request Messages              : 0
Restored Sessions                     : 0
Total Opened Sessions                 : 0
Total Closed Sessions                 : 32000
Total Active Sessions                  : 0

```

Verify the Statistics From the New Primary BNG Node

```

•
Router#show diameter nas summary
NAS Statistics :

NAS Initiated msgs :

    Authentication      ::
        In              :          0   Out              :          0
        Requests received :          0   Requests send      :          0
        Response received :          0   Result forwarded  :          0
        Transaction Succeeded:          0   Transactions Failed :          0

    Authorization       ::
        In              :          0   Out              :          0
        Requests received :          0   Requests send      :          0
        Response received :          0   Result forwarded  :          0
        Transaction Succeeded:          0   Transactions Failed :          0

    Accounting (Start)  ::
        In              :        64000   Out              :        64000
        Requests received :        64000   Requests send      :        64000
        Response received :        64000   Result forwarded  :        64000
        Transaction Succeeded:        64000   Transactions Failed :          0

•
Router#show diameter gx statistics

Tue Mar 15 16:36:29.875 UTC
CCR Initial Messages          : 32000
CCR Initial Messages Sent Failed : 0
CCR Initial Messages Timed Out   : 0
CCR Initial Messages Retry       : 0
CCR Update Messages              : 0

```

```

CCR Update Messages Sent Failed      : 0
CCR Update Messages Timed Out        : 0
CCR Update Messages Retry            : 0
CCR Terminate Messages               : 0
CCR Terminate Messages Sent Failed   : 0
CCR Terminate Messages Timed Out     : 0
CCR Terminate Messages Retry        : 0
CCA Initial Messages                : 32000
CCA Initial Messages Error           : 0
CCA Update Messages                  : 0
CCA Update Messages Error            : 0
CCA Terminate Messages               : 0
CCA Terminate Messages Error         : 0
RAR Received Messages                : 0
RAR Received Messages Error          : 0
RAA Sent Messages                    : 0
RAA Sent Messages Error              : 0
ASR Received Messages                : 0

```

•

```

Router#show diameter gy statistics

Tue Mar 15 16:36:34.342 UTC
CCR Initial Messages                : 32000
CCR Initial Messages Sent Failed     : 0
CCR Initial Messages Timed Out      : 0
CCR Initial Messages Retry           : 0
CCR Update Messages                  : 0
CCR Update Messages Sent Failed     : 0
CCR Update Messages Timed Out       : 0
CCR Update Messages Retry            : 0
CCR Terminate Messages               : 0
CCR Terminate Messages Sent Failed   : 0
CCR Terminate Messages Timed Out     : 0
CCR Terminate Messages Retry        : 0
CCA Initial Messages                : 32000
CCA Initial Messages Error           : 0
CCA Update Messages                  : 0
CCA Update Messages Error            : 0
CCA Terminate Messages               : 0
CCA Terminate Messages Error         : 0
RAR Received Messages                : 0
RAR Received Messages Error          : 0
RAA Sent Messages                    : 0
RAA Sent Messages Error              : 0
ASR Received Messages                : 0
ASR Received Messages Error          : 0
ASA Sent Messages                    : 0
ASA Sent Messages Error              : 0
Unknown Request Messages             : 0
Restored Sessions                    : 0
Total Opened Sessions                 : 32000
Total Closed Sessions                 : 0
Total Active Sessions                 : 32000

```

Additional References

These sections provide references related to implementing DIAMETER.

RFCs and Standards

Standard/RFC	
RFC-6733	Diameter Base Protocol
RFC-4006	Diameter Credit-Control Application
RFC-4005	Diameter Network Access Server Application (NASREQ)
RFC-3046	DHCP Relay Agent Information Option
RFC-3539	Authentication, Authorization and Accounting (AAA) Transport Profile
3GPP TS 129 212 V11.10.0	Universal Mobile Telecommunications System (UMTS); LTE; Policy and Charging Control (PCC); Reference Points for Gx interface support.
3GPP TS 132 299 V11.9.1	Technical Specification on Diameter charging applications used for Gx and Gy interface support.

MIBs

MB	MIBs Link
	To locate and download MIBs for selected platforms, Cisco IOS releases, and feature sets, use Cisco MIB Locator found at the following URL: http://www.cisco.com/go/mibs

Technical Assistance

Description	Link
<p>The Cisco Support website provides extensive online resources, including documentation and tools for troubleshooting and resolving technical issues with Cisco products and technologies.</p> <p>To receive security and technical information about your products, you can subscribe to various services, such as the Product Alert Tool (accessed from Field Notices), the Cisco Technical Services Newsletter, and Really Simple Syndication (RSS) Feeds.</p> <p>Access to most tools on the Cisco Support website requires a Cisco.com user ID and password.</p>	http://www.cisco.com/support



CHAPTER 10

USH Support in BNG

Unified Session History (USH) is a flow based event logging and correlating framework. This chapter provides information about USH support in BNG.

Table 19: Feature History for USH Support in BNG

Release	Modification
Release 6.5.1	This feature is introduced.

This chapter covers these topics:

- [Overview of USH, on page 485](#)
- [Restrictions for USH in BNG, on page 486](#)
- [Configure USH for BNG, on page 486](#)

Overview of USH

Unified Session History (USH) is a flow based event logging and correlating framework. It provides the infrastructure to store the events that occurs on a subscriber session lifecycle in a central storage, correlating multiple keys of the subscriber, such as, subscriber label, MAC address, IPv4 address, IPv6 address, interface handle etc. It also identifies the normal or errored events in show commands and thereby helps narrow down the reason behind problematic subscriber sessions.

For BNG, MAC address of the subscriber is the primary key. The secondary keys used are:

- Interface handle
- Subscriber label
- IPv4 address and VRF id
- IPv6 address and VRF id

USH enables processing and storing the events on a per-subscriber basis. New show commands have been introduced to display the events based on the key provided.

Restrictions for USH in BNG

The following restrictions are applicable to this feature:

- This feature will not work for routed subscribers as the subscriber MAC address is not unique in the case.
- When the subscriber is successfully disconnected, only the key events are saved to reduce memory footprint.

Configure USH for BNG

Configuration Steps

The USH feature for BNG is not enabled by default. This is enabled on demand by the following configuration:

```
Router# configure terminal
Router(config)# subscriber ush enable
Router(config)# interface Bundle-Ether 1.1
Router(config)# interface Bundle-Ether 1.2
Router(config)# commit
```



Note

The maximum number of access interfaces configured as filter for USH is two. Configuring more than two interfaces shows the following error:

```
!!% Max number of monitored interfaces reached: exceeded USH_MAX_FILTER_COUNT interfaces
```

Verification

In order to view the event history for an active subscriber, use the show command **show subscriber session history subscriber-mac** command as shown below:

```
Router# show subscriber session history subscriber-mac 0020.9400.000c
/oper/ush/%%/key path mac/0020.9400.000c/0
```

```

          STAF event history

Subscriber state: Active

SubscriberMAC:0020.9400.000c

ifhandle: 0x0000cba0

sublabel: 0x00000052

ipv4 Address:192.168.1.42

ipv6 Address: No IPv6 address

vrf:0x60000000 (default)

Time stamp                comp_name                event
```

```

-----
11/07/2018 16:34:52:743135      dhcp      Discover pkt procsd
11/07/2018 16:34:52:743135      iedge     IPv4 Start
11/07/2018 16:34:52:747135      aaa       Radiusd recieved Authorization request
11/07/2018 16:34:52:748134      aaa       Radiusd successfully built Access-Request
packet
11/07/2018 16:34:52:750134      aaa       Radiusd Successfully sent packet and started
timeout handler
11/07/2018 16:34:52:753134      aaa       Radiusd recieved Access-Accept
11/07/2018 16:34:52:753134      aaa       Decode radius packet success
11/07/2018 16:34:52:753134      aaa       Radiusd sending reply back to client
11/07/2018 16:34:52:759133      dhcp      Session Created      - Init state
11/07/2018 16:34:52:760133      dhcp      IP allocated          - Init state
11/07/2018 16:34:52:764132      dhcp      Request pkt procsd   - Post Offer sent
11/07/2018 16:34:52:764132      ipsub     IPSub intf creation started
11/07/2018 16:34:52:764132      ipsub     IPSub init callback from Ifmg
11/07/2018 16:34:52:764132      ipsub     IPSub session start event to iEdge
11/07/2018 16:34:52:764132      ipsub     IPSub init to Ifmgr
11/07/2018 16:34:52:884114      ipsub     IPSub received VRF details
11/07/2018 16:34:52:951103      iedge     SUBDB produce done
11/07/2018 16:34:52:976099      ipsub     IPSub RIB details added
11/07/2018 16:34:53:078084      ipsub     IPSub session up
11/07/2018 16:34:53:079084      iedge     IPv4 Up
11/07/2018 16:34:53:079084      dhcp      Session DPM success

```

Information about the last instance of the subscriber session can be displayed using the **show subscriber session history subscriber-mac *subscriber MAC address* disconnected** command.

Router# **show subscriber session history subscriber-mac 0010.9400.0094 disconnected**

```

STAF event history
Subscriber state: Successfully disconnected
SubscriberMAC:0010.9400.0094
ifhandle: 0x00000260
sublabel: 0x000025d7
ipv4 Address:200.0.0.29
ipv6 Address:
vrf:0x60000000 (default)
Time stamp                comp_name      event
-----
05/12/2016 12:45:35:328697  dhcp          Discover pkt procsd
05/12/2016 12:45:35:328697  iedge         IPv4 Start
05/12/2016 12:45:38:412225  ipsub        IPSub session up
05/12/2016 12:45:38:417224  iedge         IPv4 Up

```

```
05/12/2016 12:45:38:422223    iedge    SUBDB produce done
06/12/2016 07:07:12:330971    dhcp     Lease expired for client
```

If the subscriber session is errored, the complete event information is stored for further reference. This information can be retrived by using the **show subscriber session history subscriber-mac *subscriber MAC address* errored** command.

```
Router# show subscriber session history subscriber-mac 0020.9400.000c errored
```

```
/oper/ush/%%/key path mac/0020.9400.000c/2
```

```
STAF event history
```

```
Subscriber state: Errored
```

```
SubscriberMAC:0020.9400.000c
```

```
ifhandle: 0x00000000
```

```
sublabel: 0x00000051
```

```
ipv4 Address: No IPv4 address
```

```
ipv6 Address: No IPv6 address
```

Time stamp	comp_name	event
11/07/2018 16:32:28:386225	dhcp	Discover pkt procsd
11/07/2018 16:32:28:386225	iedge	IPv4 Start
11/07/2018 16:32:28:389225	aaa	Radiusd recieved Authorization request
11/07/2018 16:32:28:391224	aaa	Radiusd successfully built Access-Request packet
11/07/2018 16:32:28:392224	aaa	Radiusd Successfully sent packet and started timeout handler
11/07/2018 16:32:33:783399	aaa	Radiusd Successfully sent packet and started timeout handler
11/07/2018 16:32:38:790633	aaa	Radiusd Successfully sent packet and started timeout handler
11/07/2018 16:32:43:801866	aaa	Radiusd Successfully sent packet and started timeout handler
11/07/2018 16:32:48:808100	aaa	Radius packet sending failed Reason: 'RADIUS' detected the 'fatal' condition 'No server information is available'
11/07/2018 16:32:48:808100	iedge	policy rule failed Reason: 'AAA_BASE' detected the 'fatal' condition 'Invalid state (aaa base lib error)'
11/07/2018 16:32:48:809100	iedge	Disconnect session

When USH is enabled, it keeps track of the statistics of sessions that are created, destroyed and errored in the system, over a 10 minute interval. This can be viewed using the command **show subscriber session history analytics**.

```
Router# show subscriber session history analytics
```



```
+++++
[28/01/2017 00:46:15:716111 - 28/01/2017 00:46:58:576552]
-----
Flows Created   :      43
Flows Completed:      42
Error Summary:
-----
[ 0]: 0x45349600 - 'qos-ma' detected the 'warning' condition 'Multiple policies configured
on an interface/direction without specifying the merge option'
Count:      42
Last Instance:      28/01/2017 00:46:58:162811
                MAC:0000:0000:0001, SUBLBL:0x61, IFH:0x2c10
```



APPENDIX **A**

XML Support for BNG Features

Most BNG features, such as AAA, DHCP, Policy Plane, PPPoE, DAPS, and Subscriber Database support XML based router configuration. The Cisco XML API can be used to configure routers or request information about configuration, management, and operation of the routers. For details about using the Cisco XML API, see the latest release of *Cisco IOS XR XML API Guide* listed at http://www.cisco.com/en/US/products/ps9853/products_programming_reference_guides_list.html.

The Cisco XML API uses XML commands to configure the router. The following sections list the supported XML commands for the BNG features.

- [AAA XML Support, on page 491](#)
- [DHCP XML Support, on page 494](#)
- [Control Policy XML Support, on page 497](#)
- [DAPS XML Support, on page 500](#)
- [PPPoE XML Support, on page 501](#)
- [Subscriber Database XML Support, on page 503](#)

AAA XML Support

The support for XML is available for RADIUS that retrieves the accounting and authorization request statistics. The mapping between CLI and XML entries for the AAA commands are as follows:

CLI	XML
radius-server dead-criteria time	AAA.RADIUS. DeadCriteria.Time
radius-server dead-criteria tries	AAA.RADIUS. DeadCriteria.Tries
radius-server ipv4 dscp <value>	AAA.RADIUS. IPv4.DSCP
radius-server key {0 7 LINE}	AAA.RADIUS.Key
radius-server retransmit <limit>	AAA.RADIUS.Retransmit

CLI	XML
radius-server timeout <number>	AAA.RADIUS.Timeout
radius-server source-port extended	AAA.RADIUS.SourcePort.Extended
radius-server deadtime	AAA.RADIUS.DeadTime
radius-server load-balance method least-outstanding	AAA.RADIUS.LoadBalance.Method.LeastOutstanding
radius-server attribute list <attribute-name>	AAA.RADIUS.AttributeListTable.AttributeList.Enable
radius-server attribute list <attribute-name> attribute <radius-attributes>	AAA.RADIUS.AttributeListTable.AttributeList.Attribute
radius-server vsa attribute ignore unknown	AAA.RADIUS.VSA.Attribute.Ignore.Unknown
Radius-server host <> retransmit	AAA.RADIUS.HostTable.Host.Retransmit
Radius-server host <> timeout	AAA.RADIUS.HostTable.Host.Timeout
radius-server host <> key {0 7 LINE}	AAA.RADIUS.HostTable.Host.Key
aaa server radius dynamic-author client <ip-address> vrf <vrf-name> server-key {0 7 LINE}	AAA.RADIUS.DynamicAuthorization.ClientTable.Client.ServerKey
aaa server radius dynamic-author ignore {server key session key }	AAA.RADIUS.DynamicAuthorization.Ignore
aaa server radius dynamic-author port <port num>	AAA.RADIUS.DynamicAuthorization.Port

CLI	XML
aaa accounting system default start-stop [broadcast] {group {radius NAME1}} [group NAME2..] aaa accounting system rp-failover default start-stop [broadcast] {group {radius NAME1}} [group NAME2..]	AAA.AccountingTable.Accounting
aaa radius attribute nas-port-id format FORMAT_NAME	AAA.RADIUSAttribute.NASPortID.Format
aaa group server radius <group-name> { authorization } { reply reject } <name>	AAA.ServerGroups.RADIUSServerGroupTable.RADIUSServerGroup.Authorization.Reply
aaa group server radius <group-name> { authorization } { accept request } <name>	AAA.ServerGroups.RADIUSServerGroupTable.RADIUSServerGroup.Authorization.Request
aaa group server radius <group-name> { accounting } { accept request } <name>	AAA.ServerGroups.RADIUSServerGroupTable.RADIUSServerGroup.Accounting.Request
aaa group server radius <group-name> { accounting } { reply reject } <name>	AAA.ServerGroups.RADIUSServerGroupTable.RADIUSServerGroup.Accounting.Reply
aaa group server radius <group-name> load-balance	AAA.ServerGroups.RADIUSServerGroupTable.RADIUSServerGroup.LoadBalance.Method.LeastBounding

CLI	XML
method least-bounding	
aaa group server radius group1 source-interface	AAA.ServerGroups.RADIUSServerGroupTable.RADIUSServerGroup.SourceInterface
aaa group server radius <radius-group> vrf <>	AAA.ServerGroups.RADIUSServerGroupTable.RADIUSServerGroup.VRF
aaa group server radius <radius-group> deadtime <>	AAA.ServerGroups.RADIUSServerGroupTable.RADIUSServerGroup.DeadTime
aaa group server radius <> server-private <host>	AAA.ServerGroups.RADIUSGroupTable.RADIUSGroup.PrivateServerTable.PrivateServer
show radius accounting	RADIUS.Accounting
show radius authentication	RADIUS.Authentication
show radius client	RADIUS.Client
show radius dynamic-author	RADIUS.DynamicAuthorization
show radius dead-criteria host <ip>	RADIUS.DeadCriteria.HostTable.Host
show radius server-groups	RADIUS.ServerGroups

DHCP XML Support

The support for XML is available for DHCP that retrieves the client bindings, profile information, and DHCPv4 proxy statistics. It allows the management clients to perform client bindings based on Circuit-ID, Remote-ID, Mac-Address, user profile information, and DHCPv4 proxy statistics. The mapping between CLI and XML entries for the DHCP commands are as follows:

CLI	XML
dhcp ipv4 profile <name> proxy relay information check	DHCPv4.ProfileTable.Profile.Proxy.RelayInformation.Check

CLI	XML
dhcp ipv4 profile <name>proxy relay information option[vpn allow-untrusted remote-id <name>]	DHCPv4.ProfileTable.Profile.Proxy.RelayInformation.AllowUntrusted DHCPv4.ProfileTable.Profile.Proxy.RelayInformation.VPN DHCPv4.ProfileTable.Profile.Proxy.RelayInformation.RemoteID
dhcp ipv4 interface GigabitEthernet <interface-name> proxy profile <name>	DHCPv4.InterfaceTable.Interface.Proxy.Profile
dhcp ipv4 profile <name>proxy relay information policy [drop keep replace]	DHCPv4.ProfileTable.Profile.Proxy.RelayInformation.Policy
dhcp ipv4 profile <name>proxy helper-address [vrf <name>] <server-ip-addr> [giaddr <ip-addr>]	DHCPv4.ProfileTable.Profile.Proxy.VRFTTable.VRF.HelperAddressTable.HelperAddress
dhcp ipv4 profile <name> proxy broadcast-flag policy check	DHCPv4.ProfileTable.Profile.Proxy.BroadcastFlag.Policy
dhcp ipv4 profile <name>proxy class <class-name> helper-address [vrf <name>] <server-ip-addr> [giaddr <ip-addr>] match vrf <name> match option [124 125 60 77] hex <value> [mask <value>]	DHCPv4.ProfileTable.Profile.Proxy.ClassTable.Class DHCPv4.ProfileTable.Profile.Proxy.ClassTable.Class.VRFTTable.VRF.HelperAddressTabl DHCPv4.ProfileTable.Profile.Proxy.ClassTable.Class.Match.VRF DHCPv4.ProfileTable.Profile.Proxy.ClassTable.Class.Match.Option
dhcp ipv4 interface <interface> none	DHCPv4.InterfaceTable.Interface.None

CLI	XML
dhcp ipv4 interface <interface> proxy [information option format-type circuit-id <cir-id>]	DHCPv4.InterfaceTable.Interface.Proxy.CircuitID
dhcp ipv4 vrf vrfname proxy profile <name>	DHCPv4.VRFTable.VRF
show dhcp ipv4 proxy binding circuit-id <cid> location <locationSpecifier>	DHCPv4.NodeTable.Node.Proxy.Binding.ClientTable[DHCPv4ProxyCircuitIDFilter (Naming C
show dhcp ipv4 proxy binding remote-id <rid> location <locationSpecifier>	DHCPv4.NodeTable.Node.Proxy.Binding.ClientTable[DHCPv4ProxyRemoteIDFilter (Naming Re
show dhcp ipv4 proxy binding interface <ifSpecifier>	DHCPv4.NodeTable.Node.Proxy.Binding.ClientTable[DHCPv4ProxyInterfaceFilter (Naming Int
show dhcp ipv4 proxy binding mac-address <addr> location <locationSpecifier>	DHCPv4.NodeTable.Node.Proxy.Binding.ClientTable[DHCPv4ProxyMACAddressFilter (Naming
show dhcp ipv4 proxy binding location <locationSpecifier>	DHCPv4.NodeTable.Node.Proxy.Binding.ClientTable[DHCPv4ProxyBriefFilter]
show dhcp ipv4 proxy binding detail location <locationSpecifier>	DHCPv4.NodeTable.Node.Proxy.Binding.ClientTable.Client
show dhcp ipv4 proxy binding summary location <locationSpecifier>	DHCPv4.NodeTable.Node.Proxy.Binding.Summary
show dhcp ipv4 proxy binding vrf <vrfname>	DHCPv4.NodeTable.Node.Proxy.Binding.ClientTable[DHCPv4PProxyVRFFilter (Naming VRFName

CLI	XML
show dhcp ipv4 proxy profile name <profile-name> location <locationSpecifier>	DHCPv4.NodeTable.Node.Proxy.ProfileTable.Profile
show dhcp vrf <name> ipv4 proxy statistics location <locationSpecifier>	DHCPv4.NodeTable.Node.Proxy.VRFTable.VRF.Statistics
show dhcp ipv4 proxy statistics [location < loc >]	DHCPv4.NodeTable.Node.Proxy.Statistics

Control Policy XML Support

The support for XML is available for policy plane that retrieves subscriber management and subscriber session related information. The mapping between CLI and XML entries for the control policy commands are as follows:

CLI	XML
interface <intf> service-policy type control subscriber <policy-name>	InterfaceConfigurationTable.InterfaceConfiguration.ControlSubscriber.ServicePolicy
sh sub sess all loc <loc>	Subscriber.Session.NodeTable.Node.SessionTable
sh sub sess all detail loc <loc>	Subscriber.Session.NodeTable.Node.SessionTable (SubscriberDetailAllSessionFilter)
sh sub sess all summary loc <loc>	Subscriber.Session.NodeTable.Node.Summary
sh sub sess all username loc <loc>	Subscriber.Session.NodeTable.Node.SessionTable (SubscriberAllUsernameFilter)
sh sub sess filter interface	Subscriber.Session.NodeTable.Node.SessionTable (SubscriberInterfaceBriefFilter) {Naming InterfaceName}

CLI	XML
<intf-name> loc <loc>	
sh sub sess filter interface <intf-name> detail loc <loc>	Subscriber.Session.NodeTable.Node.SessionTable (SubscriberInterfaceDetailFilter) {Naming InterfaceName}
sh sub sess filter ipv4-address <IPv4-addr> loc <loc>	Subscriber.Session.NodeTable.Node.SessionTable (SubscriberIPv4AddressVRFDetailFilter) {Naming VRF Name, Address}
sh sub sess filter ipv4-address <IPv4-addr> detail loc <loc>	Subscriber.Session.NodeTable.Node.SessionTable (SubscriberIPv4AddressVRFBriefFilter) {Naming VRF Name, Address}
sh sub sess filter mac-address <mac-addr> loc <loc>	Subscriber.Session.NodeTable.Node.SessionTable (SubscriberMACAddressBriefFilter) {Naming MACAddress}
sh sub sess filter mac-address <mac-addr> detail loc <loc>	Subscriber.Session.NodeTable.Node.SessionTable (SubscriberMACAddressDetailFilter) {Naming MACAddress}
sh sub sess filter state <state> loc <loc>	Subscriber.Session.NodeTable.Node.SessionTable (SubscriberStateBriefFilter) {Naming State}
sh sub sess filter state <state> detail loc <loc>	Subscriber.Session.NodeTable.Node.SessionTable (SubscriberStateDetailFilter) {Naming State}
sh sub sess filter username <uname> loc <loc>	Subscriber.Session.NodeTable.Node.SessionTable (SubscriberUsernameBriefFilter) {Naming Username}
sh sub sess filter	Subscriber.Session.NodeTable.Node.SessionTable (SubscriberUsernameDetailFilter) {Naming Username}

CLI	XML
username <uname> detail loc <loc>	
sh sub sess filter ipv4-address <IPv4 addr> vrf <vrf> loc <loc>	Subscriber.Session.NodeTable.Node.SessionTable(SubscriberIPv4AddressVRFBriefFilter) {Naming VRF Name, Address}
sh sub sess filter ipv4-address <IPv4-addr> vrf <vrf> detail loc <loc>	Subscriber.Session.NodeTable.Node.SessionTable(SubscriberIPv4AddressVRFDetailFilter) {Naming VRF Name, Address}
sh sub sess filter vrf <vrf-name> loc <loc>	Subscriber.Session.NodeTable.Node.SessionTable(SubscriberIPv4AddressVRFBriefFilter) {Naming VRF Name, Address }
sh sub sess filter vrf <vrf-name> detail loc <loc>	Subscriber.Session.NodeTable.Node.SessionTable(SubscriberIPv4AddressVRFDetailFilter) {Naming VRF Name, Address }
sh sub sess sub-label <0-ffffff> loc <loc>	Subscriber.Session.NodeTable.Node.SessionTable.Session{Naming SessionID}
sh sub man stat AAA accounting loc <loc>	Subscriber.Manager.NodeTable.Node.Statistics.AAA.Accounting
sh sub man stat AAA accounting total loc <loc>	Subscriber.Manager.NodeTable.Node.Statistics.AAA.AggregateAccounting
sh sub man stat AAA authentication loc <loc>	Subscriber.Manager.NodeTable.Node.Statistics.AAA.Authentication
sh sub man stat AAA	Subscriber.Manager.NodeTable.Node.Statistics.AAA.AggregateAuthentication

CLI	XML
authentication total loc <loc>	
sh sub man stat AAA authorization loc <loc>	Subscriber.Manager.NodeTable.Node.Statistics.AAA.Authorization
sh sub man stat AAA authorization total loc <loc>	Subscriber.Manager.NodeTable.Node.Statistics.AAA.AggregateAuthorization
sh sub man stat AAA COA loc <loc>	Subscriber.Manager.NodeTable.Node.Statistics.AAA.ChangeOfAuthorization
sh sub man stat AAA COA total loc <loc>	Subscriber.Manager.NodeTable.Node.Statistics.AAA.AggregateChangeOfAuthorization
sh sub man stat AAA all loc <loc>	Subscriber.Manager.NodeTable.Node.Statistics.AAA
sh sub man stat AAA all total loc <loc>	Subscriber.Manager.NodeTable.Node.Statistics.AAA
sh sub man stats summary total <loc>	Subscriber.Manager.NodeTable.Node.Statistics.AggregateSummary

DAPS XML Support

The support for XML is available for distributed address pool service (DAPS) that retrieves the pool parameters for distributed address pool services, and allows the management clients to get number of free, allocated and excluded addresses based on VRF and pool name. The mapping between CLI and XML entries for the DAPS commands are as follows:

CLI	XML
pool vrf <vrf-name> ipv4 <poolname>pool ipv4 <poolname>	PoolService.VRFTable.VRF.IPv4.Pool.Enable
pool vrf <VRFName> ipv4 <PoolName> * address-range <RangeStart> <RangeEnd>pool ipv4 <PoolName> * address-range <RangeStart> <RangeEnd>	PoolService.VRFTable.VRF.IPv4.Pool.AddressRangeTable.AddressRange

CLI	XML
pool vrf <VRFName> ipv4 <PoolName> * exclude <RangeStart> <RangeEnd> pool vrf <VRFName> ipv4 <PoolName> * exclude <RangeStart> <RangeEnd> pool ipv4 <PoolName> * exclude <RangeStart> <RangeEnd>	PoolService.VRFTable.VRF.IPv4.Pool.ExcludeTable.Exclude
Pool vrf <VRFName> ipv4 <PoolName> utilization-mark high <> pool ipv4 <PoolName> utilization-mark high <>	PoolService.VRFTable.VRF.IPv4.Pool.UtilizationMark.High
Pool vrf <VRFName> ipv4 <PoolName> utilization-mark low <> pool ipv4 <PoolName> utilization-mark low <>	PoolService.VRFTable.VRF.IPv4.Pool.UtilizationMark.Low
show pool vrf <vrf-name> ipv4	PoolService.NodeTable.Node.VRFTable.VRF.IPv4
show pool ipv4 name <poolname>	PoolService.NodeTable.Node.PoolTable.Pool.IPv4.Detail
show pool ipv4 name <poolname> verbose	PoolService.NodeTable.Node.PoolTable.Pool.IPv4.Verbose
show pool ipv4 show pool vrf all ipv4	PoolService.NodeTable.Node.VRFTable

PPPoE XML Support

XML support is available for PPP over Ethernet (PPPoE) sessions. The mapping between CLI and XML entries for the PPPoE feature commands are:

CLI	XML
pado delay {<delay>}	set PadoDelay.Default {<delay>}
pado delay circuit-id {<delay>}	set PadoDelay.CircuitId {<delay>}
pado delay remote-id {<delay>}	set PadoDelay.RemoteId {<delay>}
pado delay circuit-id string {<string>} {<delay>}	set PadoDelay.CircuitIdString{<string>} {<delay>}
pado delay circuit-id contains {<string>} {<delay>}	set PadoDelay.CircuitIdSubString{<string>} {<delay>}
pado delay remote-id string {<string>} {<delay>}	set PadoDelay.RemoteIdString{<string>} {<delay>}
pado delay remote-id contains {<string>} {<delay>}	set PadoDelay.RemoteIdSubString{<string>} {<delay>}
pado delay service-name string {<string>} {<delay>}	set PadoDelay.ServiceNameString{<string>} {<delay>}
pado delay service-name contains {<string>} {<delay>}	set PadoDelay.ServiceNameSubString{<string>} {<delay>}
pppoe session-id space flat	set SessionIDSpaceFlat {TRUE}
pppoe bba-group {<group-name>}	PPPoECfg.BBAGroup {<group-name>}

CLI	XML
pppoe enable bba-group {<group-name>}	set PPPoE.EnableBBAGroup {<group-name>}
ac name {<name>}	set Tags.ACName {<name>}
service name {<name>}	set Tags.ServiceName {<name>}.ServiceNameConfigured
service selection disable	set Tags.ServiceSelectionDisable
tag ppp-max-payload deny	set Tags.PPPMaxPayloadDeny
tag ppp-max-payload minimum {<min>} maximum {<max>}	set Tags.PPPMaxPayload {<min>,<max>}
mtu {<mtu>}	set MTU {<mtu>}
sessions max limit {limit} threshold {<threshold>}	set Sessions.MaxLimit {<limit>,<threshold>}
sessions access-interface limit {<count>} [threshold {<threshold>}]	set Sessions.AccessInterfaceLimit {<count>,<threshold>}
sessions mac limit {<count>} [threshold {<threshold>}]	set Sessions.MacLimit {<count>,<threshold>}
sessions mac-iwf limit {<count>} [threshold {<threshold>}]	set Sessions.MacIWFLimit {<count>,<threshold>}
sessions mac access-interface limit {<count>} [threshold {<threshold>}]	set Sessions.MacAccessInterfaceLimit {<count>,<threshold>}
sessions mac-iwf access-interface limit {<count>} [threshold {<threshold>}]	set Sessions.MacIWFAccessInterfaceLimit {<count>,<threshold>}
sessions circuit-id limit {<count>} [threshold {<threshold>}]	set Sessions.CircuitIDLimit {<count>,<threshold>}
sessions remote-id limit {<count>} [threshold {<threshold>}]	set Sessions.RemoteIDLimit {<count>,<threshold>}
sessions circuit-id-and-remote-id limit {<count>} [threshold {<threshold>}]	set Sessions.CircuitIDAndRemoteIDLimit {<count>,<threshold>,<radius-override>}
sessions inner-vlan limit {<count>} [threshold {<threshold>}]	set Sessions.InnerVLANLimit {<count>,<threshold>}
sessions mac throttle {<request-count> <request-period> <blocking-period>}	set Sessions.MacThrottle {<request-count>,<request-period>,<blocking-period>}
sessions mac access-interface throttle {<request-count> <request-period> <blocking-period>}	set Sessions.MacAccessInterfaceThrottle {<request-count>,<request-period>,<blocking-period>}
sessions mac-iwf access-interface throttle {<request-count> <request-period> <blocking-period>}	set Sessions.MacIWFAccessInterfaceThrottle {<request-count>,<request-period>,<blocking-period>}
sessions circuit-id throttle {<request-count> <request-period> <blocking-period>}	set Sessions.CircuitIDThrottle {<request-count>,<request-period>,<blocking-period>}

CLI	XML
sessions remote-id throttle {<request-count> <request-period> <blocking-period>}	set Sessions.RemoteIDThrottle {<request-count>,<request-period>,<blocking-period>}
sessions circuit-id-and-remote-id throttle {<request-count> <request-period> <blocking-period>}	set Sessions.CircuitIDAndRemoteIDThrottle {<request-count>,<request-period>,<blocking-period>}
sessions inner-vlan throttle {<request-count> <request-period> <blocking-period>}	set Sessions.InnerVLANThrottle {<request-count>,<request-period>,<blocking-period>}
control-packets priority {<cos>}	set ControlPackets.Priority {<cos>}
invalid-session-id drop	set InvalidSessionID {DROP}
invalid-session-id log	set InvalidSessionID {LOG}

Subscriber Database XML Support

The support for XML is available for subscriber database that retrieves the subscriber association and session information and allows the management clients to get subscriber session state, subscriber session information based on unique subscriber label, subscriber association information based on unique subscriber label or interface name or dynamic template name or type. The mapping between CLI and XML entries for the subscriber database commands are as follows:

CLI	XML
show subscriber database association br location <>	Subscriber.Database.NodeTable.Node.Association.LabelTable.Label {Naming SubscriberLabel}
show subscriber database association subscriber-label <> br location<>	Subscriber.Database.NodeTable.Node.Association.LabelTable.Label {Naming SubscriberLabel}
show subscriber database association location <>	Subscriber.Database.NodeTable.Node.Association (SubscriberDatabaseLabelDetailFilter)
show subscriber database association interface-name <> br location<>	Subscriber.Database.NodeTable.Node.Association (SubscriberDatabaseInterfaceBriefFilter) {Naming InterfaceName}
show subscriber database association interface-name <> location<>	Subscriber.Database.NodeTable.Node.Association (SubscriberDatabaseInterfaceFilter) {Naming InterfaceName}
show subscriber database association type < ipsubscriber ppp service-profile subscriber-service> br location <>	Subscriber.Database.NodeTable.Node.Association (SubscriberDatabaseTemplateTypeBriefFilter) {Naming TemplateType}

CLI	XML
show subscriber database association type < ipsubscriber ppp service-profile subscriber-service> location <>	Subscriber.Database.NodeTable.Node.Association(SubscriberDatabaseTemplateTypeFilter) {Naming TemplateType}
show subscriber database session state <all> cfgapply cfgdone cfggen cfgunapply destroying error fatgen init sync>	Subscriber.Database.NodeTable.Node.Session(SubscriberDatabaseSessionStateFilter) {Naming Session-State}
show subscriber database session subscriber-label <> location <>	Subscriber.Database.NodeTable.Node.Session.LabelTable.Label {Naming SubscriberLabel}
association subscriber-label <0x0-0xffffffff> brief location R/S/M	Subscriber.Database.NodeTable.Node.Association.LabelTable.Label
association subscriber-label <0x0-0xffffffff> brief	Subscriber.Database.NodeTable.Node.Association.LabelTable.Label
association subscriber-label <0x0-0xffffffff> location R/S/M	Subscriber.Database.NodeTable.Node.Association.LabelTable.Label
association subscriber-label <0x0-0xffffffff>	Subscriber.Database.NodeTable.Node.Association.LabelTable.Label
association interface-name <ifname> brief location R/S/M	Subscriber.Database.NodeTable.Node.Association[SubscriberInterfaceBriefFilter (Naming InterfaceName)]
association interface-name <ifname> brief	Subscriber.Database.NodeTable.Node.Association[SubscriberInterfaceBriefFilter (Naming InterfaceName)]
association interface-name <ifname> location R/S/M	Subscriber.Database.NodeTable.Node.Association[SubscriberInterfaceFilter (Naming InterfaceName)]
association interface-name <ifname>	Subscriber.Database.NodeTable.Node.Association[SubscriberInterfaceFilter (Naming InterfaceName)]
association type ppp brief location R/S/M	Subscriber.Database.NodeTable.Node.Association[SubscriberTemplateType (Naming TemplateType)]
association type ppp brief	Subscriber.Database.NodeTable.Node.Association[SubscriberTemplateType (Naming TemplateType)]
association type ppp location R/S/M	Subscriber.Database.NodeTable.Node.Association[SubscriberTemplateType (Naming TemplateType)]
association type ppp	Subscriber.Database.NodeTable.Node.Association[SubscriberTemplateType (Naming TemplateType)]

CLI	XML
association type ipsubscriber brief location R/S/M	Subscriber.Database.NodeTable.Node.Association[SubscriberTemplateType (Naming TemplateType)]
association type ipsubscriber brief	Subscriber.Database.NodeTable.Node.Association[SubscriberTemplateType (Naming TemplateType)]
association type ipsubscriber location R/S/M	Subscriber.Database.NodeTable.Node.Association[SubscriberTemplateType (Naming TemplateType)]
association type ipsubscriber	Subscriber.Database.NodeTable.Node.Association[SubscriberTemplateType (Naming TemplateType)]
association type subscriber-service brief location R/S/M	Subscriber.Database.NodeTable.Node.Association[SubscriberTemplateType (Naming TemplateType)]
association type subscriber-service brief	Subscriber.Database.NodeTable.Node.Association[SubscriberTemplateType (Naming TemplateType)]
association type subscriber-service location R/S/M	Subscriber.Database.NodeTable.Node.Association[SubscriberTemplateType (Naming TemplateType)]
association type subscriber-service	Subscriber.Database.NodeTable.Node.Association[SubscriberTemplateType (Naming TemplateType)]
association type service-profile brief location R/S/M	Subscriber.Database.NodeTable.Node.Association[SubscriberTemplateType (Naming TemplateType)]
association type service-profile brief	Subscriber.Database.NodeTable.Node.Association[SubscriberTemplateType (Naming TemplateType)]
association type service-profile location R/S/M	Subscriber.Database.NodeTable.Node.Association[SubscriberTemplateType (Naming TemplateType)]
association type service-profile	Subscriber.Database.NodeTable.Node.Association[SubscriberTemplateType (Naming TemplateType)]
association type user-profile brief location R/S/M	Subscriber.Database.NodeTable.Node.Association[SubscriberTemplateType (Naming TemplateType)]
association type user-profile brief	Subscriber.Database.NodeTable.Node.Association[SubscriberTemplateType (Naming TemplateType)]
association type user-profile location R/S/M	Subscriber.Database.NodeTable.Node.Association[SubscriberTemplateType (Naming TemplateType)]
association type user-profile	Subscriber.Database.NodeTable.Node.Association[SubscriberTemplateType (Naming TemplateType)]
association brief location R/S/M	Subscriber.Database.NodeTable.Node.Association.LabelTable.Label
association brief	Subscriber.Database.NodeTable.Node.Association.LabelTable.Label

CLI	XML
association location R/S/M	Subscriber.Database.NodeTable.Node.Association.LabelTable.Label
association	Subscriber.Database.NodeTable.Node.Association.LabelTable.Label
session subscriber-label <0x0-0xffffffff> location R/S/M	Subscriber.Database.NodeTable.Node.Session.LabelTable.Label
session subscriber-label <0x0-0xffffffff>	Subscriber.Database.NodeTable.Node.Session.LabelTable.Label
session state init location R/S/M	Subscriber.Database.NodeTable.Node.Session[SubscriberSessionStateFilter (Naming State)]
session state init	Subscriber.Database.NodeTable.Node.Session[SubscriberSessionStateFilter (Naming State)]
session state destroying location R/S/M	Subscriber.Database.NodeTable.Node.Session[SubscriberSessionStateFilter (Naming State)]
session state destroying	Subscriber.Database.NodeTable.Node.Session[SubscriberSessionStateFilter (Naming State)]
session state cfggen location R/S/M	Subscriber.Database.NodeTable.Node.Session[SubscriberSessionStateFilter (Naming State)]
session state cfggen	Subscriber.Database.NodeTable.Node.Session[SubscriberSessionStateFilter (Naming State)]
session state fatgen location R/S/M	Subscriber.Database.NodeTable.Node.Session[SubscriberSessionStateFilter (Naming State)]
session state fatgen	Subscriber.Database.NodeTable.Node.Session[SubscriberSessionStateFilter (Naming State)]
session state cfgapply location R/S/M	Subscriber.Database.NodeTable.Node.Session[SubscriberSessionStateFilter (Naming State)]
session state cfgapply	Subscriber.Database.NodeTable.Node.Session[SubscriberSessionStateFilter (Naming State)]
session state cfgdone location R/S/M	Subscriber.Database.NodeTable.Node.Session[SubscriberSessionStateFilter (Naming State)]
session state cfgdone	Subscriber.Database.NodeTable.Node.Session[SubscriberSessionStateFilter (Naming State)]
session state cfgunapply location R/S/M	Subscriber.Database.NodeTable.Node.Session[SubscriberSessionStateFilter (Naming State)]
session state cfgunapply	Subscriber.Database.NodeTable.Node.Session[SubscriberSessionStateFilter (Naming State)]
session state cfgerror location R/S/M	Subscriber.Database.NodeTable.Node.Session[SubscriberSessionStateFilter (Naming State)]
session state cfgerror	Subscriber.Database.NodeTable.Node.Session[SubscriberSessionStateFilter (Naming State)]

CLI	XML
session state error location R/S/M	Subscriber.Database.NodeTable.Node.Session[SubscriberSessionStateFilter (Naming State)]
session state error	Subscriber.Database.NodeTable.Node.Session[SubscriberSessionStateFilter (Naming State)]
session state sync location R/S/M	Subscriber.Database.NodeTable.Node.Session[SubscriberSessionStateFilter (Naming State)]
session state sync	Subscriber.Database.NodeTable.Node.Session[SubscriberSessionStateFilter (Naming State)]
session state all location R/S/M	Subscriber.Database.NodeTable.Node.Session[SubscriberSessionStateFilter (Naming State)]
session state all	Subscriber.Database.NodeTable.Node.Session[SubscriberSessionStateFilter (Naming State)]



APPENDIX **B**

RADIUS Attributes

Remote Authentication Dial-In User Service (RADIUS) attributes are used to define specific authentication, authorization, and accounting (AAA) elements in a user profile, which is stored on the RADIUS daemon.

This appendix describes the following types of RADIUS attributes supported in Broadband Network Gateway (BNG):

- [RADIUS IETF Attributes, on page 509](#)
- [RADIUS Vendor-Specific Attributes, on page 512](#)
- [RADIUS ADSL Attributes, on page 518](#)
- [RADIUS ASCEND Attributes, on page 519](#)
- [RADIUS Microsoft Attributes, on page 519](#)
- [RADIUS Disconnect-Cause Attributes, on page 520](#)

RADIUS IETF Attributes

IETF Attributes Versus VSAs

RADIUS Internet Engineering Task Force (IETF) attributes are the original set of 255 standard attributes that are used to communicate AAA information between a client and a server. Because IETF attributes are standard, the attribute data is predefined and well known; thus all clients and servers who exchange AAA information via IETF attributes must agree on attribute data such as the exact meaning of the attributes and the general bounds of the values for each attribute.

RADIUS vendor-specific attributes (VSAs) derived from one IETF attribute-vendor-specific (attribute 26). Attribute 26 allows a vendor to create an additional 255 attributes however they wish. That is, a vendor can create an attribute that does not match the data of any IETF attribute and encapsulate it behind attribute 26; thus, the newly created attribute is accepted if the user accepts attribute 26.

Table 20: Supported RADIUS IETF Attributes

Name	Value	Type
Acct-Authentic	integer	45
Acct-Delay-Time	integer	41
Acct-Input-Giga-Words	integer	52
Acct-Input-Octets	integer	42

Name	Value	Type
Acct-Input-Packets	integer	47
Acct-Interim-Interval	integer	85
Acct-Link-Count	integer	51
Acct-Output-Giga-Words	integer	53
Acct-Output-Octets	integer	43
Acct-Output-Packets	integer	48
Acct-Session-Time	integer	46
Acct-Status-Type	integer	40
Acct-Terminate-Cause	integer	49
CHAP-Challenge	binary	40
CHAP-Password	binary	3
Dynamic-Author-Error-Cause	integer	101
Event-Timestamp	integer	55
Filter-Id	binary	11
Framed-Protocol	integer	7
Framed-IP-Address	ipv4addr	8
Framed-Route	"string"	22
login-ip-addr-host	ipv4addr	14
Multilink-Session-ID	string	50
Nas-Identifier	string	32
NAS-IP-Address	ipv4addr	4
NAS-Port	integer	5
Reply-Message	binary	18
Service-Type	integer	6
Tunnel-Assignment-Id	string	32
Tunnel-Packets-Lost	integer	86
X-Ascend-Client-Primary-DNS	ipv4addr	135
X-Ascend-Client-Secondary-DNS	ipv4addr	136
NAS-IPv6-Address	string	95
Delegated-IPv6-Prefix	binary	123
Stateful-IPv6-Address-Pool	binary	123
Framed-IPv6-Prefix	binary	97

Name	Value	Type
Framed-Interface-Id	binary	96
Framed-IPv6-Pool	string	100
Framed-IPv6-Route	string	99
login-ip-addr-host	string	98

IETF Tagged Attributes on LAC

The IETF Tagged Attributes support on L2TP Access Concentrator (LAC) provides a means of grouping tunnel attributes referring to the same tunnel in an Access-Accept packet sent from the RADIUS server to the LAC. The Access-Accept packet can contain multiple instances of same RADIUS attributes, but with different tags. The tagged attributes support ensures that all attributes pertaining to a given tunnel contain the same value in their respective tag fields, and that each set includes an appropriately-valued instance of the Tunnel-Preference attribute. This conforms to the tunnel attributes that are to be used in a multi-vendor network environment, thereby eliminating interoperability issues among Network Access Servers (NASs) manufactured by different vendors.

For details of RADIUS Attributes for Tunnel Protocol Support, refer [RFC 2868](#).

These examples describe the format of IETF Tagged Attributes:

```
Tunnel-Type = :0:L2TP, Tunnel-Medium-Type = :0:IP, Tunnel-Server-Endpoint = :0:"1.1.1.1",
Tunnel-Assignment-Id = :0:"1", Tunnel-Preference = :0:1, Tunnel-Password = :0:"hello"
```

A tag value of 0 is used in the above example in the format of :0:, to group those attributes in the same packet that refer to the same tunnel. Similar examples are:

```
Tunnel-Type = :1:L2TP, Tunnel-Medium-Type = :1:IP, Tunnel-Server-Endpoint = :1:"2.2.2.2",
Tunnel-Assignment-Id = :1:"1", Tunnel-Preference = :1:1, Tunnel-Password = :1:"hello"
```

```
Tunnel-Type = :2:L2TP, Tunnel-Medium-Type = :2:IP, Tunnel-Server-Endpoint = :2:"3.3.3.3",
Tunnel-Assignment-Id = :2:"1", Tunnel-Preference = :2:2, Tunnel-Password = :2:"hello"
```

```
Tunnel-Type = :3:L2TP, Tunnel-Medium-Type = :3:IP, Tunnel-Server-Endpoint = :3:"4.4.4.4",
Tunnel-Assignment-Id = :3:"1", Tunnel-Preference = :3:2, Tunnel-Password = :3:"hello"
```

```
Tunnel-Type = :4:L2TP, Tunnel-Medium-Type = :4:IP, Tunnel-Server-Endpoint = :4:"5.5.5.5",
Tunnel-Assignment-Id = :4:"1", Tunnel-Preference = :4:3, Tunnel-Password = :4:"hello"
```

```
Tunnel-Type = :5:L2TP, Tunnel-Medium-Type = :5:IP, Tunnel-Server-Endpoint = :5:"6.6.6.6",
Tunnel-Assignment-Id = :5:"1", Tunnel-Preference = :5:3, Tunnel-Password = :5:"hello"
```

Table 21: Supported IETF Tagged Attributes

IETF Tagged Attribute Name	Value	Type
Tunnel-Type	integer	64
Tunnel-Medium-Type	integer	65
Tunnel-Client-Endpoint	string	66
Tunnel-Server-Endpoint	string	67

IETF Tagged Attribute Name	Value	Type
Tunnel-Password	string	69
Tunnel-Assignment-ID	string	82
Tunnel-Preference	integer	83
Tunnel-Client-Auth-ID	string	90
Tunnel-Server-Auth-ID	string	91

RADIUS Vendor-Specific Attributes

The Internet Engineering Task Force (IETF) draft standard specifies a method for communicating vendor-specific information between the network access server and the RADIUS server by using the vendor-specific attribute (attribute 26). Attribute 26 encapsulates vendor specific attributes, thereby, allowing vendors to support their own extended attributes otherwise not suitable for general use.

The Cisco RADIUS implementation supports one vendor-specific option using the format recommended in the specification. Cisco's vendor-ID is 9, and the supported option has vendor-type 1, which is named "cisco-avpair." The value is a string of this format:

```
protocol : attribute sep value *
```

"Protocol" is a value of the Cisco "protocol" attribute for a particular type of authorization; protocols that can be used include IP, IPX, VPDN, VOIP, SHELL, RSVP, SIP, AIRNET, OUTBOUND. "Attribute" and "value" are an appropriate attribute-value (AV) pair defined in the Cisco TACACS+ specification, and "sep" is "=" for mandatory attributes and "*" for optional attributes. This allows the full set of features available for TACACS+ authorization to also be used for RADIUS.

For example, the following AV pair causes Cisco's "multiple named ip address pools" feature to be activated during IP authorization (during PPP's IPCP address assignment):

```
cisco-avpair= "ip:addr-pool=first"
```

If you insert an "*", the AV pair "ip:addr-pool=first" becomes optional. Note that any AV pair can be made optional.

IETF Attribute 26 (Vendor-Specific) encapsulates vendor specific attributes, thereby, allowing vendors to support their own extended attributes otherwise not suitable for general use.

```
cisco-avpair= "ip:addr-pool*first"
```

The following example shows how to cause a user logging in from a network access server to have immediate access to EXEC commands:

```
cisco-avpair= "shell:priv-lvl=15"
```

The following example shows how to configure avpair aaa attribute to enable IPv6 router advertisements from an IPv4 subscriber interface:

```
Cisco-avpair= "ipv6:start-ra-on-ipv6-enable=1"
```

Attribute 26 contains these three elements:

- Type
- Length

- String (also known as data)
 - Vendor-ID
 - Vendor-Type
 - Vendor-Length
 - Vendor-Data



Note It is up to the vendor to specify the format of their VSA. The Attribute-Specific field (also known as Vendor-Data) is dependent on the vendor's definition of that attribute.

Table 22: Supported Cisco Vendor-Specific RADIUS Attributes

Name	Value	Type	Present in AAA message type
access-loop-encapsulation	binary	1	Access-accept, Accounting-request
accounting-list	string	1	Access-accept, CoA, Accounting-request
acct-input-gigawords-ipv4	integer	1	Accounting-request
acct-input-octets-ipv4	integer	1	Accounting-request
acct-input-packets-ipv4	integer	1	Accounting-request
acct-input-gigawords-ipv6	integer	1	Accounting-request
acct-input-octets-ipv6	integer	1	Accounting-request
acct-input-packets-ipv6	integer	1	Accounting-request
acct-output-gigawords-ipv4	integer	1	Accounting-request
acct-output-octets-ipv4	integer	1	Accounting-request
acct-output-packets-ipv4	integer	1	Accounting-request
acct-output-gigawords-ipv6	integer	1	Accounting-request
acct-output-octets-ipv6	integer	1	Accounting-request
acct-output-packets-ipv6	integer	1	Accounting-request
acct-policy-in	string	1	Access-request
acct-policy-map	string	1	Access-request
acct-policy-out	string	1	Access-request
actual-data-rate-downstream	integer	1	Access-accept, Accounting-request

Name	Value	Type	Present in AAA message type
actual-data-rate-upstream	integer	1	Access-accept, Accounting-request
actual-interleaving-delay-downstream	integer	1	Access-accept, Accounting-request
actual-interleaving-delay-upstream	integer	1	Access-accept, Accounting-request
addr-pool Note This is for IPv4 subscriber.	string	1	Access-accept
addrv6	string	1	Access-accept, Accounting-request
attainable-data-rate-downstream	integer	1	Access-accept, Accounting-request
attainable-data-rate-upstream	integer	1	Access-accept, Accounting-request
circuit-id-tag	string	1	Access-accept, Accounting-request
cisco-dhcp-relay-giaddr	string	50	Access-request
cisco-dhcp-subscriber-id	string	65	Access-request
cisco-dhcp-user-class	string	47	Access-request
cisco-dhcp-vendor-class	string	48	Access-request
cisco-dhcpv4-option-to-aaa	string	90	Access-request
cisco-dhcpv6-link-address	string	66	Access-request
cisco-nas-port	string	2	Access-accept, Accounting-request
cisco-relay-information-option	string	46	Access-request
cisco-vsa-in-acl	string	57	Access-accept, CoA
cisco-vsa-ipv6-in-acl	string	61	Access-accept, CoA
cisco-vsa-ipv6-out-acl	string	62	Access-accept, CoA
cisco-vsa-parent-session-id	string	52	Access-accept
cisco-vsa-out-acl	string	58	Access-accept, CoA
cisco-vsa-service-name	string	51	Access-accept
cisco-vsa-sub-activate-service	string	60	Access-accept, CoA
cisco-vsa-sub-deactivate-service	string	63	Access-accept, CoA
cisco-vsa-sub-pbr-policy-in	string	59	Access-accept, CoA

Name	Value	Type	Present in AAA message type
cisco-vsa-sub-qos-pol-in	string	55	Access-accept, CoA
cisco-vsa-sub-qos-pol-out	string	56	Access-accept, CoA
client-mac-address	string	1	Access-accept, Accounting-request
command	string	1	CoA
connect-progress	string	1	Accounting-request
connect-rx-speed	integer	1	Access-accept, Accounting-request
connect-tx-speed	integer	1	Access-accept, Accounting-request
delegated-ipv6-pool	string	1	Access-accept
dhcp-class	string	1	Access-accept
dhcp-client-id	string	1	Accounting-request
dhcp-vendor-class	string	1	Access-request, Accounting-request
dhcpv4-ip-lease	string	1	Access-accept
dhcpv4-option	string	1	Access-accept
dhcpv6-class	string	1	Access-accept
dhcpv6-ip-lease	string	1	Access-accept
dhcpv6-option	string	1	Access-accept
disc-cause-ext	string	1	Accounting-request
disconnect-cause	string	1	Accounting-request
dual-stack-delay	integer	1	Access-accept
idlethreshold	integer	1	Access-accept, CoA
idle-timeout	integer	1	Access-accept, CoA
idle-timeout-direction	string	1	Access-accept, CoA
if-handle	integer	1	Accounting-request
inacl	string	1	Access-accept
intercept-id	integer	1	Access-accept
ip-addresses	string	1	Access-request, Accounting-request

Name	Value	Type	Present in AAA message type
ipv4-unnumbered Note This attribute-value pair (AVP) is preferred for BNG in Cisco IOS XR Software, and it is equivalent to the ip-unnumbered AVP in Cisco IOS Software.	string	1	Access-accept
ipv6_inacl	string	1	Access-accept, CoA
ipv6_outacl	string	1	Access-accept, CoA
ipv6-addr-pool	string	1	Access-accept
ipv6-dns-servers-addr	string	1	Access-accept
ipv6-enable	integer	1	Access-accept
ipv6-mtu	integer	1	Access-accept
ipv6-strict-rpf	integer	1	Access-accept
ipv6-unreachable	integer	1	Access-accept
l2tp-tunnel-password	string	1	Access-accept
ipv6 nd start-ra-on-ipv6-enable	Integer	1	Access-accept
login-ip-host	string	1	Accounting-request
maximum-interleaving-delay-downstream	integer	1	Access-request, Accounting-request
maximum-interleaving-delay-upstream	integer	1	Access-request, Accounting-request
maximum-data-rate-downstream	integer	1	Access-request, Accounting-request
maximum-data-rate-upstream	integer	1	Access-request, Accounting-request
md-dscp	integer	1	Access-accept
md-ip-addr	ipaddr	1	Access-accept
md-port	integer	1	Access-accept
minimum-data-rate-downstream	integer	1	Access-request, Accounting-request
minimum-data-rate-downstream-low-power	integer	1	Access-request, Accounting-request
minimum-data-rate-upstream	integer	1	Access-request, Accounting-request

Name	Value	Type	Present in AAA message type
minimum-data-rate-upstream-low-power	integer	1	Access-request, Accounting-request
outacl	string	1	Access-accept
parent-if-handle	integer	1	Access-request, Accounting-request
parent-session-id	string	1	Accounting-request
parsed-user-attribute	string	1	Access-accept
pppoe_session_id	integer	1	Accounting-request
primary-dns	ipaddr	1	Access-accept
qos-policy-in	string	1	Access-accept, CoA
qos-policy-out	string	1	Access-accept, CoA
redirect-vrf	string	1	Access-accept
remote-id-tag	string	1	Access-request, Accounting-request
sa	string	1	Access-accept, CoA
sd	string	1	RADIUS CoA
secondary-dns	ipaddr	1	Access-accept
service-name	string	1	Accounting-request
Stateful-IPv6-Address-Pool	string	1	Access-accept
sub-pbr-policy-in	string	1	Access-accept, CoA
sub-qos-policy-in	string	1	Access-accept
sub-qos-policy-out	string	1	Access-accept
Tunnel-Client-endpoint	ipaddr	1	Access-accept, Accounting-request
tunnel-id	string	1	Access-accept
tunnel-medium-type	string	1	Access-accept
Tunnel-Server-endpoint	ipaddr	1	Access-accept, Accounting-request
tunnel-tos-reflect	string	1	Access-accept
tunnel-tos-setting	integer	1	Access-accept
tunnel-type	string	1	Access-accept
username	string	1	Access-request, Accounting-request

Name	Value	Type	Present in AAA message type
vpdn-template	string	1	Access-accept
vpn-id	string	1	Access-accept
vpn-vrf	string	1	Access-accept
vrf-id	integer	1	Access-accept, Accounting-request
wins-server	ipaddr	1	Access-accept

Vendor-Specific Attributes for Account Operations

Table 23: Supported Vendor-Specific Attributes for Account Operations

RADIUS AVP	Value	Type	Action
subscriber:command=account-logon	string	1	account logon
subscriber:command=account-logoff	string	1	account logoff
subscriber:command=account-update	string	1	account update
subscriber:sa=<service-name>	string	1	service activate
subscriber:sd=<service-name>	string	1	service de-activate

RADIUS ADSL Attributes

Table 24: Supported RADIUS ADSL Attributes

Name	Value	Type
Access-Loop-Encapsulation	binary	144
Actual-Interleaving-Delay-Downstream	integer	142
Actual-Interleaving-Delay-Upstream	integer	140
Actual-Data-Rate-Downstream	integer	130
Actual-Data-Rate-Upstream	integer	129
Attainable-Data-Rate-Downstream	integer	134
Attainable-Data-Rate-Upstream	integer	133
Agent-Circuit-Id	string	1
IWF-Session	boolean social	254
Maximum-Interleaving-Delay-Downstream	integer	141
Maximum-Interleaving-Delay-Upstream	integer	139

Name	Value	Type
Maximum-Data-Rate-Downstream	integer	136
Maximum-Data-Rate-Upstream	integer	135
Minimum-Data-Rate-Downstream	integer	132
Minimum-Data-Rate-Downstream-Low-Power	integer	138
Minimum-Data-Rate-Upstream	integer	131
Minimum-Data-Rate-Upstream-Low-Power	integer	137
Agent-Remote-Id	string	2

RADIUS ASCEND Attributes

Table 25: Supported RADIUS Ascend Attributes

Name	Value	Type
Ascend-Client-Primary-DNS	ipv4addr	135
Ascend-Client-Secondary-DNS	ipv4addr	136
Ascend-Connection-Progress	integer	196
Ascend-Disconnect-Cause	integer	195
Ascend-Multilink-Session-ID	integer	187
Ascend-Num-In-Multilink	integer	188

RADIUS Microsoft Attributes

Table 26: Supported RADIUS Microsoft Attributes

Name	Value	Type
MS-1st-NBNS-Server	ipv4addr	30
MS-2nd-NBNS-Server	ipv4addr	31
MS-CHAP-ERROR	binary	2
MS-Primary-DNS	ipv4addr	28
MS-Secondary-DNS	ipv4addr	29

RADIUS Disconnect-Cause Attributes

Disconnect-cause attribute values specify the reason a connection was taken offline. The attribute values are sent in Accounting request packets. These values are sent at the end of a session, even if the session fails to be authenticated. If the session is not authenticated, the attribute can cause stop records to be generated without first generating start records.

lists the cause codes, values, and descriptions for the Disconnect-Cause (195) attribute.



Note The Disconnect-Cause is incremented by 1000 when it is used in RADIUS AVPairs; for example, disc-cause 4 becomes 1004.

Table 27: Supported Disconnect-Cause Attributes

Cause Code	Value	Description
0	No-Reason	No reason is given for the disconnect.
1	No-Disconnect	The event was not disconnected.
2	Unknown	Reason unknown.
3	Call-Disconnect	The call has been disconnected.
4	CLID-Authentication-Failure	Failure to authenticate number of the calling-party.
9	No-Modem-Available	A modem in not available to connect the call.
10	No-Carrier	No carrier detected. Note Codes 10, 11, and 12 can be sent if there is a disconnection during initial modem connection.
11	Lost-Carrier	Loss of carrier.
12	No-Detected-Result-Codes	Failure to detect modem result codes.
20	User-Ends-Session	User terminates a session. Note Codes 20, 22, 23, 24, 25, 26, 27, and 28 apply to EXEC sessions.

Cause Code	Value	Description
21	Idle-Timeout	Timeout waiting for user input. Note Codes 21, 100, 101, 102, and 120 apply to all session types.
22	Exit-Telnet-Session	Disconnect due to exiting Telnet session.
23	No-Remote-IP-Addr	Could not switch to SLIP/PPP; the remote end has no IP address.
24	Exit-Raw-TCP	Disconnect due to exiting raw TCP.
25	Password-Fail	Bad passwords.
26	Raw-TCP-Disabled	Raw TCP disabled.
27	Control-C-Detected	Control-C detected.
28	EXEC-Process-Destroyed	EXEC process destroyed.
29	Close-Virtual-Connection	User closes a virtual connection.
30	End-Virtual-Connection	Virtual connected has ended.
31	Exit-Rlogin	User exists Rlogin.
32	Invalid-Rlogin-Option	Invalid Rlogin option selected.
33	Insufficient-Resources	Insufficient resources.
40	Timeout-PPP-LCP	PPP LCP negotiation timed out. Note Codes 40 through 49 apply to PPP sessions.
41	Failed-PPP-LCP-Negotiation	PPP LCP negotiation failed.
42	Failed-PPP-PAP-Auth-Fail	PPP PAP authentication failed.
43	Failed-PPP-CHAP-Auth	PPP CHAP authentication failed.
44	Failed-PPP-Remote-Auth	PPP remote authentication failed.
45	PPP-Remote-Terminate	PPP received a Terminate Request from remote end.
46	PPP-Closed-Event	Upper layer requested that the session be closed.
47	NCP-Closed-PPP	PPP session closed because there were no NCPs open.
48	MP-Error-PPP	PPP session closed because of an MP error.

Cause Code	Value	Description
49	PPP-Maximum-Channels	PPP session closed because maximum channels were reached.
50	Tables-Full	Disconnect due to full terminal server tables.
51	Resources-Full	Disconnect due to full internal resources.
52	Invalid-IP-Address	IP address is not valid for Telnet host.
53	Bad-Hostname	Hostname cannot be validated.
54	Bad-Port	Port number is invalid or missing.
60	Reset-TCP	TCP connection has been reset. Note Codes 60 through 67 apply to Telnet or raw TCP sessions.
61	TCP-Connection-Refused	TCP connection has been refused by the host.
62	Timeout-TCP	TCP connection has timed out.
63	Foreign-Host-Close-TCP	TCP connection has been closed.
64	TCP-Network-Unreachable	TCP network is unreachable.
65	TCP-Host-Unreachable	TCP host is unreachable.
66	TCP-Network-Admin Unreachable	TCP network is unreachable for administrative reasons.
67	TCP-Port-Unreachable	TCP port in unreachable.
100	Session-Timeout	Session timed out.
101	Session-Failed-Security	Session failed for security reasons.
102	Session-End-Callback	Session terminated due to callback.
120	Invalid-Protocol	Call refused because the detected protocol is disabled.
150	RADIUS-Disconnect	Disconnected by RADIUS request.
151	Local-Admin-Disconnect	Administrative disconnect.
152	SNMP-Disconnect	Disconnected by SNMP request.
160	V110-Retries	Allowed V.110 retries have been exceeded.
170	PPP-Authentication-Timeout	PPP authentication timed out.
180	Local-Hangup	Disconnected by local hangup.

Cause Code	Value	Description
185	Remote-Hangup	Disconnected by remote end hangup.
190	T1-Quiesced	Disconnected because T1 line was quiesced.
195	Call-Duration	Disconnected because the maximum duration of the call was exceeded.
600	VPN-User-Disconnect	Call disconnected by client (through PPP). Code is sent if the LNS receives a PPP terminate request from the client.
601	VPN-Carrier-Loss	Loss of carrier. This can be the result of a physical line going dead. Code is sent when a client is unable to dial out using a dialer.
602	VPN-No-Resources	No resources available to handle the call. Code is sent when the client is unable to allocate memory (running low on memory).
603	VPN-Bad-Control-Packet	Bad L2TP or L2F control packets. This code is sent when an invalid control packet, such as missing mandatory Attribute-Value pairs (AVP), from the peer is received. When using L2TP, the code will be sent after six retransmits; when using L2F, the number of retransmits is user configurable. Note VPN-Tunnel-Shut will be sent if there are active sessions in the tunnel.

Cause Code	Value	Description
604	VPN-Admin-Disconnect	Administrative disconnect. This can be the result of a VPN soft shutdown, which is when a client reaches maximum session limit or exceeds maximum hopcount. Code is sent when a tunnel is brought down by issuing the clear vpdn tunnel command.
605	VPN-Tunnel-Shut	Tunnel teardown or tunnel setup has failed. Code is sent when there are active sessions in a tunnel and the tunnel goes down. Note This code is not sent when tunnel authentication fails.
606	VPN-Local-Disconnect	Call is disconnected by LNS PPP module. Code is sent when the LNS sends a PPP terminate request to the client. It indicates a normal PPP disconnection initiated by the LNS.
607	VPN-Session-Limit	VPN soft shutdown is enabled. Code is sent when a call has been refused due to any of the soft shutdown restrictions previously mentioned.
608	VPN-Call-Redirect	VPN call redirect is enabled.



APPENDIX C

Action Handlers

An action handler performs specific tasks in response to certain events. The following action handlers are currently supported in BNG.

- [Authorization Action Handler, on page 525](#)
- [Authentication Action Handler, on page 525](#)
- [Disconnect Action Handler, on page 526](#)
- [Activate Action Handler, on page 526](#)
- [Deactivate Action Handler, on page 526](#)
- [Set Timer and Stop Timer Action Handlers, on page 526](#)

Authorization Action Handler

The authorization action handler obtains authorization data for a specific subscriber identity from external AAA servers. The authorization action handler is an asynchronous function. It collects identity information from Subscriber Attribute Database (SADB) as well as the user credential data based on the identifier type specified in the CLI. This information along with method list name is sent to the AAA authorization coordinator. Once the AAA processing is done, the control is returned to the Policy Rule Engine (PRE) action handler to complete the event processing. The configuration example is as follows:

```
1 authorize aaa list <list-name> [identifier <identifier-type> | format <format_name>
password ['use-from-line'] <user-cfg-password>
```



Note Password is a mandatory, regardless of whether the user selects use-from-line or provides a specific value to use for authorization.

Authentication Action Handler

The authentication action handler gathers information like protocol type, service type, authentication type, user name, chap attributes, and user password and passes them to the AAA coordinator along with the AAA method list name. The authentication action handler is an asynchronous function. Once the AAA processing is done, the control is returned to the PRE action handler to complete the event processing. The configuration example is as follows:

```
1 authenticate aaa list <list-name>
```

Disconnect Action Handler

The disconnect action handler is called to disconnect a subscriber. For a subscriber disconnect, the PRE informs the Policy Plane Session Manager (PPSM) to notify all clients about the subscriber disconnect. The PPSM reports back to the PRE to complete the disconnection. The PRE puts the subscriber in the disconnect state. The PRE also cleans-up the record history data that stores policy execution history and the control block containing the subscriber label. When PRE processing is done, control is returned to the PPSM for further processing.

Activate Action Handler

The activate action handler enables local dynamic templates or remote AAA services on the subscriber's configuration. The results of this action are either immediate or asynchronous. The PRE gathers information like the AAA method list name, template type, and template name and sends to the SVM for processing. The SVM returns the control after completing template processing, and the PRE resumes processing the action list from the place it had stopped. The configuration example is as follows:

```
1 activate dynamic-template <template-name> [aaa list <list-name>]
```

Deactivate Action Handler

The deactivate action handler disables local dynamic templates or remote AAA services from the subscriber's configuration. The result of this action is asynchronous. The PRE collects information like AAA list, template type, and template name and sends to the SVM. to request it to not apply the service. The AAA list is used to derive a key used in SVM. SVM returns control after completing template processing, and the PRE restarts processing the action list from where it had stopped. The configuration example is as follows:

```
1 deactivate dynamic-template <template-name> [aaa list <list-name>]
```

Set Timer and Stop Timer Action Handlers

The set timer action handler sets an active named timer for a defined time period on the subscriber session. The stop timer stops an active named timer on the subscriber session. Enabling the set timer action handler allows the service provider to have one or more timed-policy-expiry events to be triggered on a subscriber. This in turn provides better subscriber management over the subscriber life cycle. These action handlers provide functions like scheduled validation of subscriber state status (checking if the subscriber is authenticated or unauthenticated) and periodically changing subscriber policy (such as forcing re-authentication on a daily or hourly basis).



Note An action with a timer value of 0, triggers the action immediately.

There are two methods to stop an active timer:

- Allow the timer to expire.
- Stop the active running timer using the stop-timer action command.



APPENDIX **D**

BNG Use Cases and Sample Configurations

This appendix describes the various BNG use cases and sample configurations:

- [BNG over Pseudowire Headend](#) , on page 527
- [Dual-Stack Subscriber Sessions](#), on page 534
- [eBGP over PPPoE](#), on page 543
- [Routed Subscriber Sessions](#), on page 552

BNG over Pseudowire Headend

Sample Topology for BNG over Pseudowire Headend

For an overview of BNG over Pseudowire Headend, see [BNG over Pseudowire Headend](#) , on page 246.

This figure shows a sample topology for BNG over Pseudowire Headend:

Figure 43: Sample Topology for BNG over Pseudowire Headend

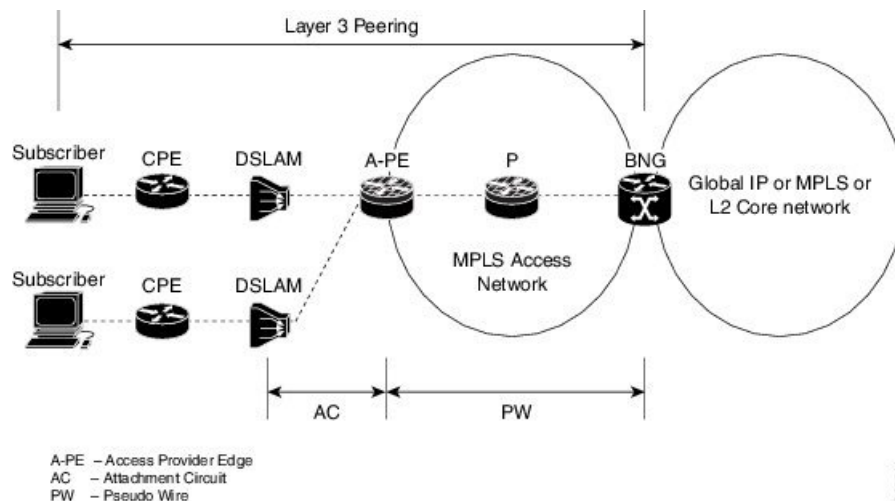

Deployment Models for Subscribers on Pseudowire Headend

Residential Subscribers on Pseudowire Headend

The deployment models available for residential subscribers on PWHE are:

N:1 model

This figure shows the n:1 deployment model for residential subscribers on PWHE:

Figure 44: N:1 deployment model for residential subscribers on PWHE

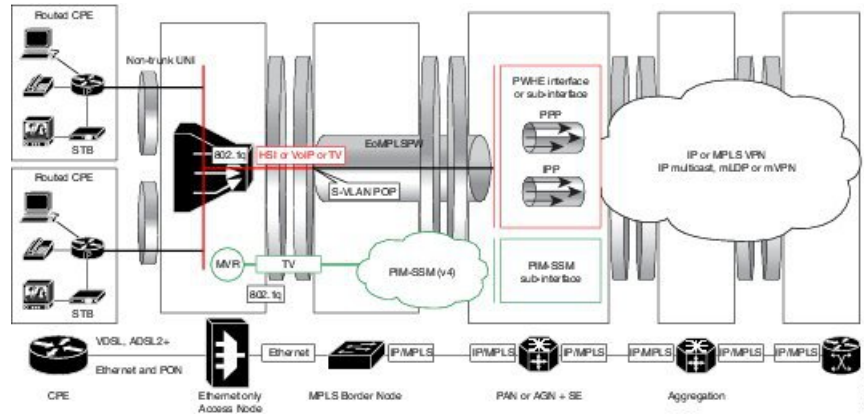

This model does not have subscriber VLANs. All subscribers connected to the DSLAM are aggregated into an S-VLAN and sent to the BNG, over a pseudowire. In most cases, there is only one pseudowire for each DSLAM in this deployment model. In this model, the pseudowire can be negotiated for VC type 4 and the subscriber can be terminated on the PWHE main interface. The pseudowire can also be negotiated for VC type 5 and be matched with the PWHE sub-interface that is configured for the S-VLAN (if VLAN is retained in the pseudowire).

1:1 model

This figure shows the 1:1 deployment model for residential subscribers on PWHE:

Figure 45: 1:1 deployment model for residential subscribers on PWHE

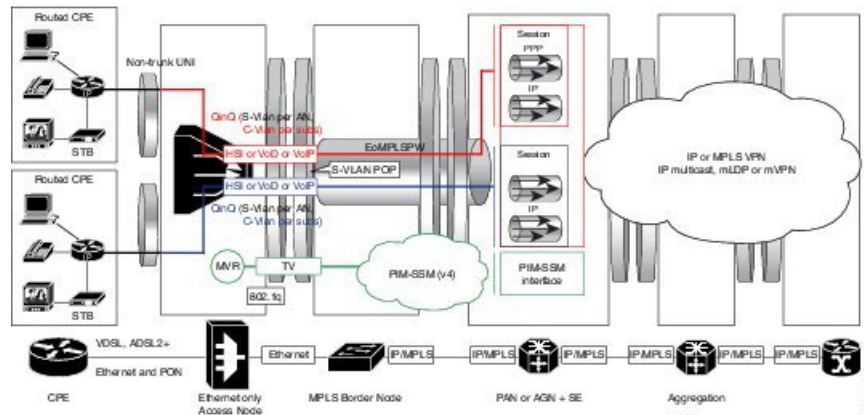

In this model, the subscriber traffic comes in VLANs to the DSLAM and one pseudowire is created per DSLAM. Here, the pseudowire is negotiated for VC type 5, and therefore, the S-VLAN is not retained in the pseudowire. The subscriber VLANs can be matched with the PWHE sub-interface configuration. There cannot be a matching sub-interface for each subscriber VLAN. As a result, ambiguous VLANs must be enabled on the PWHE sub-interfaces to accommodate multiple unique subscriber VLANs.

Residential and Business Subscribers on Pseudowire Headend

The deployment models available for residential and business subscribers on PWHE are:

Model 1

This figure shows the deployment model 1 for residential and business subscribers on PWHE:

Figure 46: Deployment Model 1 for Residential and Business Subscribers on PWHE

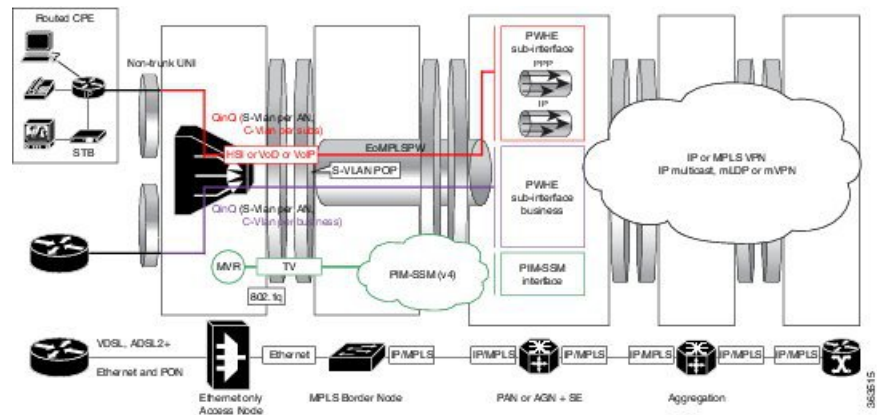

In this model, all services from the access network are enabled on different sub-interfaces on the same pseudowire. The PW is negotiated for VC type 5. This solution model provides up to service level aggregation; an aggregate shaper may not be applied on the main interface.

Model 2

This figure shows the deployment model 2 for residential and business subscribers on PWHE:

Figure 47: Deployment Model 2 for Residential and Business Subscribers on PWHE

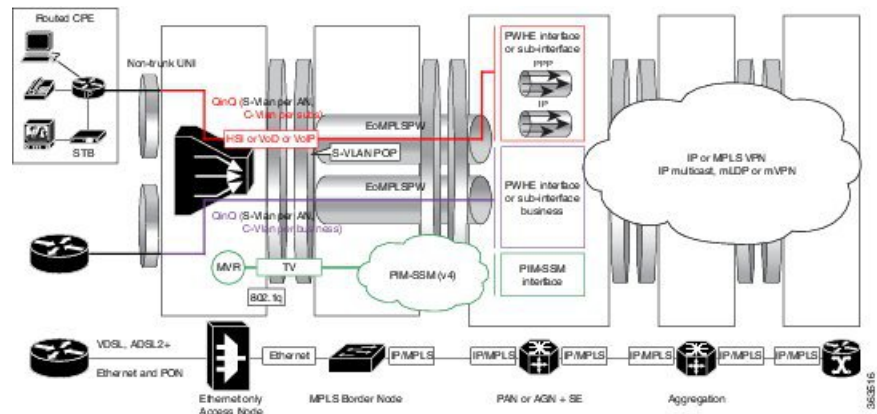

In this model, all services from the access network are enabled on PWHE sub-interfaces configured on different pseudowires. The PW is negotiated for VC type 5. An aggregate shaper can also be applied on both the PWHE interfaces.

Configuration and Verification of BNG over Pseudowire Headend

Configuration Commands for BNG over Pseudowire Headend

These are some of the common commands to be used to configure BNG over Pseudowire Headend:

Table 28: Configuration Commands for BNG over Pseudowire Headend

Command	Purpose
pw-class <i>class-name</i>	Configures the pseudowire class template name to use for the pseudowire.
encapsulation mpls	Configures the pseudowire encapsulation to MPLS.
protocol ldp	Sets pseudowire signaling protocol to LDP.
xconnect group <i>group-name</i>	Configures a cross-connect group name using a free-format 32-character string.
l2overhead <i>bytes</i>	Sets layer 2 overhead size.
generic-interface-list <i>bytes</i>	Configures a generic interface list.
attach generic-interface-list <i>interface_list_name</i>	Attaches the generic interface list to the PW-Ether or PW-IW interface.
encapsulation dot1q <i>vlan-id</i>	Assigns the matching VLAN-Id and Ethertype to the interface.
QoS Commands	
service-policy output <i>policy-name</i> [subscriber-parent resource-id <i>value</i>]	Configures egress SVLAN policy on PW-Ether sub interface.
service-policy output <i>policy-name</i> [shared-policy-instance <i>instance-name</i>]	Configures egress policy (with or without shared-policy-instance) on PWHE subscriber interface.



Note For more information about the PWHE feature and the related configuration procedures in Cisco ASR9K router, see the *Implementing Multipoint Layer 2 Services* chapter in the *L2VPN and Ethernet Services Configuration Guide for Cisco ASR 9000 Series Routers*. For complete command reference of the PWHE-specific commands in Cisco ASR9K router, see the *VPN and Ethernet Services Command Reference for Cisco ASR 9000 Series Routers*.

For more information about QoS features and the related configuration in Cisco ASR9K router, see the *Modular QoS Configuration Guide for Cisco ASR 9000 Series Routers*. For complete command reference of the QoS-specific commands in Cisco ASR9K router, see the *Modular Quality of Service Command Reference for Cisco ASR 9000 Series Routers*.

Verification Commands for BNG over Pseudowire Headend

This table lists the verification commands for BNG over Pseudowire Headend.

Command	Purpose
show run lvpn	Displays the running configuration of L2VPN.
show run interface PW-Ether <i>interface-name</i>	Displays the running configuration of pw-ether interface.
show run mpls ldp	Displays the running configuration of MPLS ldp.
show run generic-interface-list	Displays the running configuration of generic-interface-list.
show l2vpn xconnect detail	Displays the configuration details of L2VPN cross-connect.
show l2vpn xconnect detail include packet	Displays the configuration details of L2VPN cross-connect with lines that match <i>packet</i> .
show controller np counters all	Displays the counter statistics of network processors.
BNG-specific commands:	
show subscriber session all summary	Displays the summary of subscriber session information.
show subscriber manager disconnect history	Displays the disconnect history of subscriber manager.
show tech-support subscriber [ipoe memory pta]	Collects the output of relevant BNG subscriber related commands, and saves it to the local disk.
QoS commands:	
show policy-map interface	Displays the policy configuration information for all classes configured for all service policies on the specified interface.
show policy-map shared-policy-instance	Displays the statistics for all details of the shared policy instance.

Sample Configurations for BNG over Pseudowire Headend

This section provides the sample configurations for BNG over Pseudowire Headend (without QoS).

- PWHE Configuration

```
//l2vpn pw-class
l2vpn
pw-class deep
  encapsulation mpls
  protocol ldp
  control-word
  transport-mode vlan
!
!
!

//l2vpn xconnect group
l2vpn
xconnect group xc1
  p2p 101
  interface PW-Ether101
  neighbor 3.3.3.3 pw-id 2300
  pw-class deep

//Generic interface list configuration
generic-interface-list double1
  interface GigabitEthernet0/3/0/1
  interface Bundle-Ether 101
!

//pw-ether interface configuration
interface pw-ether101
  l2overhead 64
  attach generic-interface-list double1
  mac-address <mac-address>
!

interface pw-ether 101.1
  encapsulation dot1q 10
  ipv6 address 1001::1/64
  ipv4 address 162.162.1.2 255.255.255.0
!
```

- Subscriber Configuration on PWHE access-interface

```
//IPoE
interface PW-Ether1.1
  ipv4 unnumbered Loopback200
  service-policy type control subscriber ISN_CNTRL_1
  ipsubscriber ipv4 l2-connected
  initiator dhcp
  initiator unclassified-source
  encapsulation ambiguous dot1q 73 second-dot1q any
!

//PPPoE
interface PW-Ether1.4
  ipv6 enable
  pppoe enable
```

```

service-policy type control subscriber pppoe_pxy
encapsulation dot1q 104
!

```

This section provides the sample configurations for BNG over Pseudowire Headend (with QoS).

- Egress SVLAN policy configuration on PW-Ether sub interface:

```

interface pw-ether 2.1
  ipv4 address 11.11.11.11 255.255.255.0
  encapsulation dot1q 100
  service-policy output policy1 subscriber-parent
!

```

- Egress policy (with or without shared-policy-instance) on PWHE subscriber interface:

```

interface pw-ether 2.1
  service-policy output policy1 shared-policy-instance
!

```

- Policy application on PWHE subscriber interface, with service accounting enabled:

```

dynamic-template
type ppp ppp1
ppp ipcp peer-address pool ppp_pool
ipv4 unnumbered Loopback10
!
type service S1
service-policy output test acct-stats
accounting aaa list default type service
!
!

```

- Policy application on PWHE subscriber through Radius CoA (pQoS):

```

qos-policy-{in | out}={add-class | remove-class} (sub,<parent-class,
child-class>,<action-list>)
2 - level policy-map definition
Each vsa defines one class and its actions

CoA / Access-Accept {
qos-policy-out=add-class(sub, (class-default), shape(2000))
qos-policy-out=add-class(sub, (class-default, data), shape(500), bw-rpct(25))
qos-policy-out=add-class(sub, (class-default, class-default), queue-limit(20000))
}

policy-map type qos __policy1_out
class class-default
shape average 2000 kbps
service-policy child1
!
end-policy-map

policy-map type qos __policy1_child1
class data
shape average 500 kbps
bandwidth remaining percent 25

```

```

!
class class-default
queue-limit 20000 packets
!
end-policy-map

```

Dual-Stack Subscriber Sessions

The BNG supports dual-stack for subscriber sessions, whereby an IPv4 address and an IPv6 address can co-exist for the same subscriber.

The figure below shows a deployment model of dual-stack subscriber sessions.

Figure 48: Deployment Model of Dual-Stack Subscriber Sessions

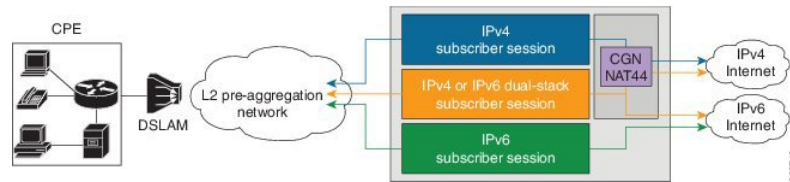

IP Address Assignment for Clients

The following figure shows various IP address assignment options available for IPv6 clients, and the supported local address assignment functions.

Figure 49: IPv6 Client Address Assignment Models

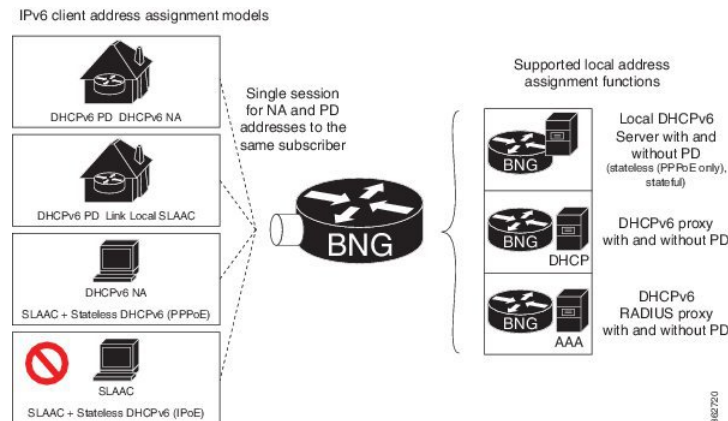

The **framed-ipv6-address** RADIUS attribute can also be used to provide an IP address from the RADIUS server to the subscriber. This address is then advertised through a Stateless Address Auto Configuration - Neighbor Advertisement or Neighbor Discovery (SLAAC - NA or ND) message for both PPPoE and IPoE sessions.

If DHCPv6 is not used for the IPoE sessions, an additional Vendor-Specific Attribute **ipv6:ipv6-default-gateway** is used to specify the default router.

Sample IPv6 Addressing and Configurations

IPv6 Address Mapping

The following figure shows the sample IPv6 address mapping with prefix-delegation in place, for the dual-stack subscriber. The respective sample CPE configurations and the sample DHCPv6 Server configurations are discussed in subsequent sections.

Figure 50: Sample IPv6 Address Mapping for Dual-Stack Subscriber

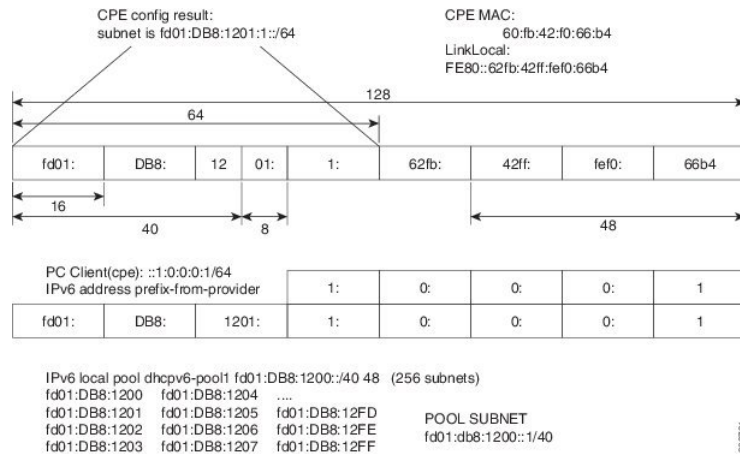

CPE Configurations

Sample Configuration for the Client Side of the CPE

This section provides the sample configurations for the client side of the Customer Premises Equipment (CPE).

```
interface GigabitEthernet0/2
description to switch fa0/15
ip address 192.168.1.1 255.255.255.0
no ip unreachable
ip nat inside
ip virtual-reassembly
duplex full
speed 100
media-type rj45
negotiation auto
ipv6 address prefix-from-provider ::1:0:0:1/64
ipv6 enable
```

Sample Configuration for the WAN Side of the CPE

This section provides the sample configurations for the WAN side of the Customer Premises Equipment (CPE).

```
interface FastEthernet2/0.50
encapsulation dot1Q 50
ipv6 address autoconfig default
ipv6 enable
```

```
ipv6 dhcp client pd prefix-from-provider
```

DHCPv6 Server Configuration

Sample Configuration for the DHCPv6 Server

This section gives the sample configurations for the DHCPv6 Server.

```
ipv6 unicast-routing
ipv6 dhcp pool dhcpv6
prefix-delegation pool dhcpv6-pool1 lifetime 6000 2000
ipv6 route 2001:60:45:28::/64 2005::1
ipv6 route 2001:DB8:1200::/40 2005::1
ipv6 route 200B::/64 2005::1
ipv6 route 2600:80A::9/128 4000::1
ipv6 local pool dhcpv6-pool1 2001:DB8:1200::/40 48
```



Note BNG supports only a single IA-NA and IA-PD for the subscribers. Therefore, if the ASR9K is configured as a DHCP server, and if the BNG subscriber sends a DHCPv6 SOLICIT message with more than one IA-NA and IA-PD, then the DHCP ADVERTISEMENT response from the ASR9K fails. And, the subscriber will not get the IPv6 address in such scenarios.

Operation and Call Flow of Dual-Stack Sessions

The ASR9K router considers the IPv4 and IPv6 stacks as a single subscriber. Therefore, only a single Access Request message and a single accounting record are generated for both the stacks. However, in scenarios such as the one where an accounting request is generated, the two stacks are considered as being two separate entities.



- Note**
- When the first address-family (AF) comes up, the Access Request message that is generated must contain, for the session, information about both the IPv4 and the IPv6. A second request is not generated for the other AF.
 - When the first AF comes up, the BNG router generates an Accounting Start message and sends it to the AAA server. The BNG waits for a pre-determined period of time and generates a single accounting start record for both address-families. As another option, an interim accounting record is triggered by the BNG when the second AF comes up.

Generic Call Flow of Dual-Stack Session

The figure below shows the generic call flow of dual-stack session. The interactions with other servers, such as the DHCP server, are not displayed in this figure.

Figure 51: Generic Call Flow of Dual-Stack Session

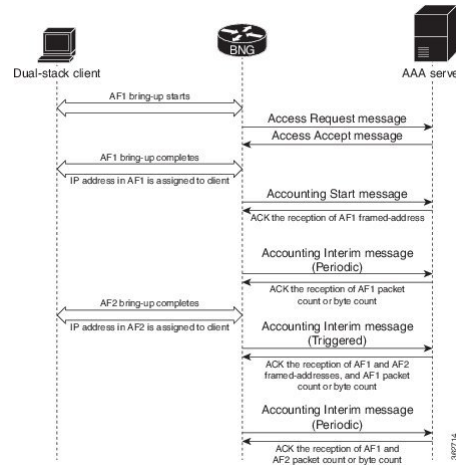

The details of the call flow between the BNG router and the AAA server are listed here:

- A single authentication process for the first and the second address-family (AF1 and AF2) is triggered when the first AF1 comes up.
- A single Accounting Start message is triggered when the AF1 is set up. The framed-address for the AF1 that is set up, is sent from the AAA server back to the BNG router.
- The statistics for the AF that is currently set up (AF1 in this case) is sent through periodic Accounting Interim messages.
- The AF2 is set up next, and the statistics for the AF2 is sent through triggered Accounting Interim messages.
- The statistics for each AF and the aggregated statistics for both the address-families that are set up are sent by periodic Accounting Interim messages.

Detailed Call Flows - PPPoE Dual-Stack

Scenario 1: SLAAC-Based Address Assignment

The figure below shows the detailed call flow of PPPoE dual-stack, where the address assignment is SLAAC-based.

Scenario 2: DHCPv6-Based Address Assignment

Figure 52: PPPoE Dual-Stack - SLAAC-Based Address Assignment

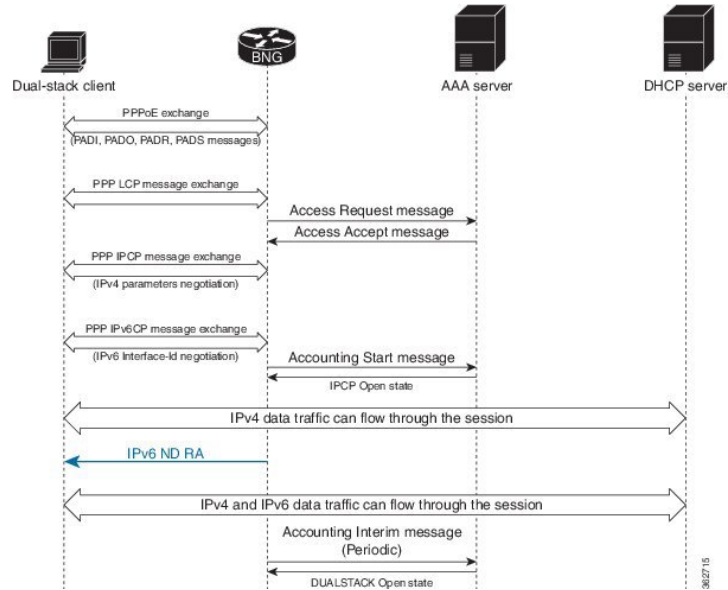

Scenario 2: DHCPv6-Based Address Assignment

The figure below shows the detailed call flow of PPPoE dual-stack, where the address assignment is DHCPv6-based.

Figure 53: Call Flow of PPPoE Dual-Stack - DHCPv6-Based Address Assignment

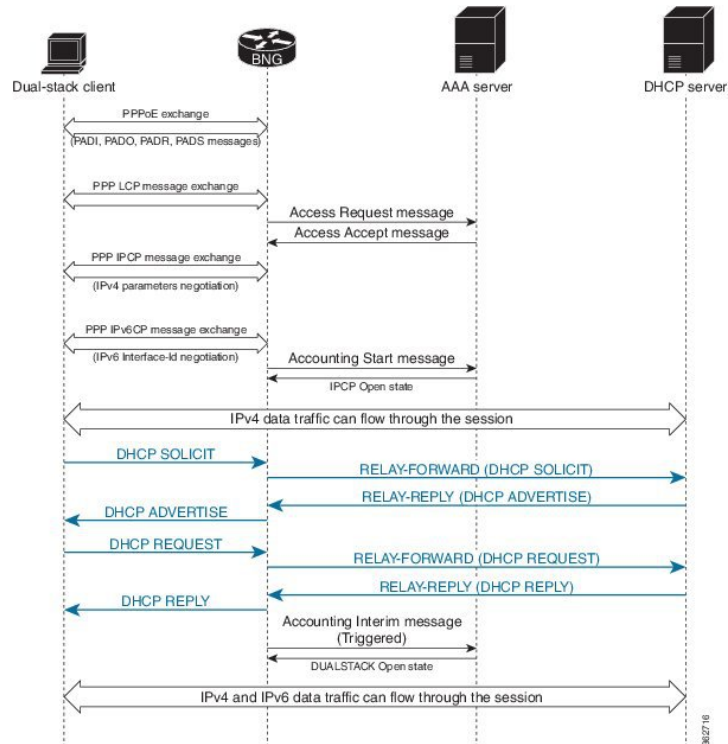

Detailed Call Flows - IPoE Dual-Stack

Scenario 1 - IPv4 Address-Family Starts First

The figure below shows the detailed call flow of IPoE dual-stack, where the IPv4 address-family (AF) starts first.

Figure 54: Call Flow of IPoE Dual-Stack - IPv4 Address-Family Starts First

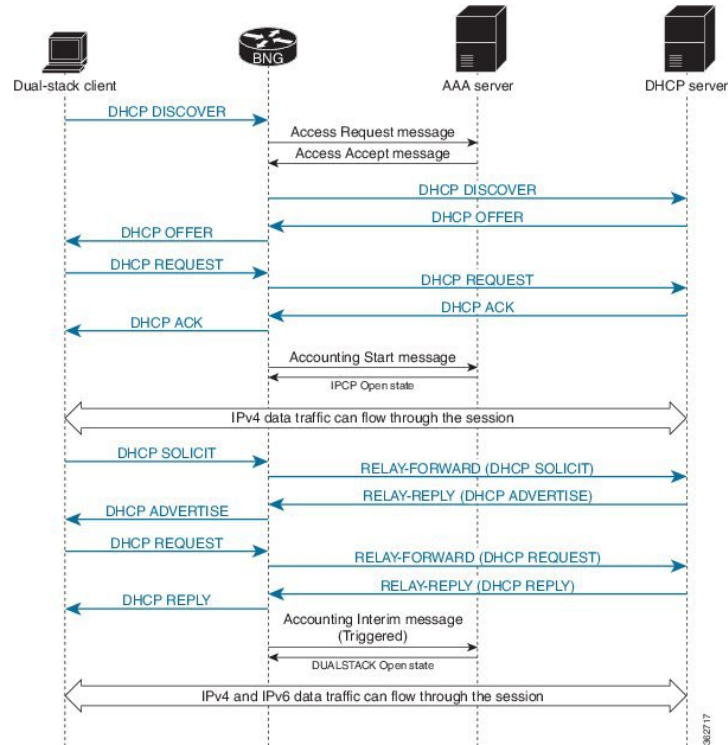

Scenario 2 - IPv6 Address-Family Starts First

The figure below shows the detailed call flow of IPoE dual-stack, where the IPv6 address-family (AF) starts first.

Figure 55: Call Flow of IPoE Dual-Stack - IPv6 Address-Family Starts First

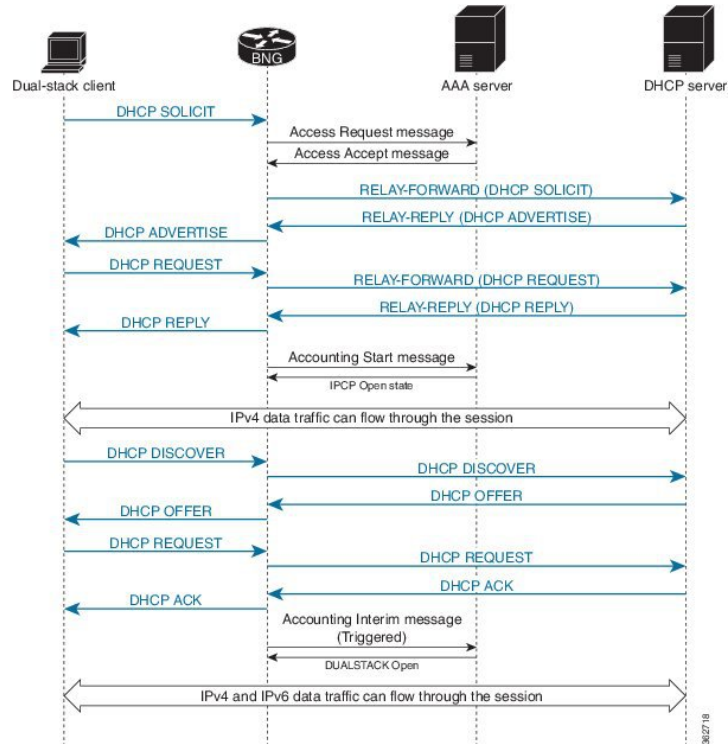

Sample Topology for Dual-Stack

The figure below shows a sample topology for the dual-stack.

Figure 56: Sample topology for Dual-Stack

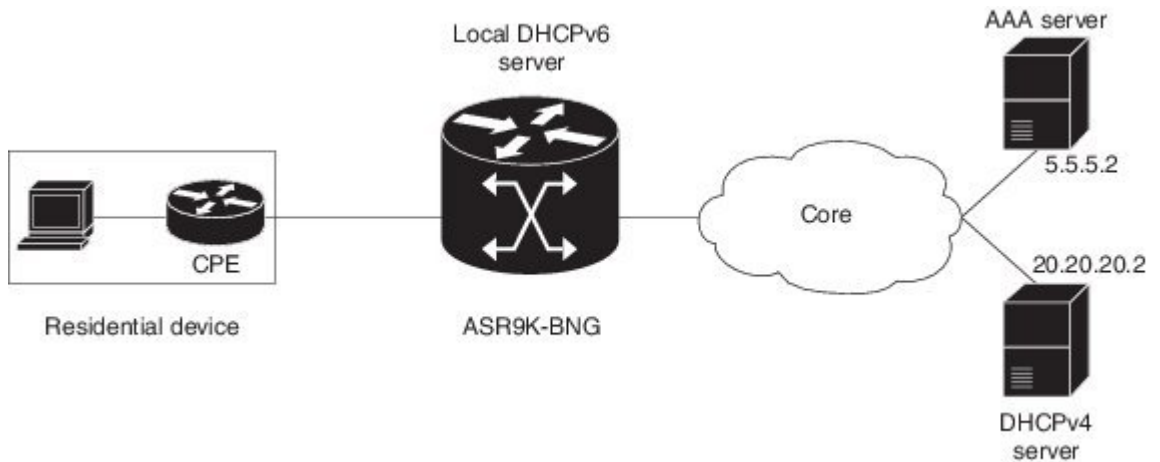

Configuration Examples for Dual-Stack

This section provides configuration examples for a dual-stack.

```
hostname bng
logging console debugging
```

The RADIUS server is configured with the server listening on the IP address 5.5.5.2 with **auth-port** on 1645 and **accounting-port** on 1646.

```
radius-server host 5.5.5.2 auth-port 1645 acct-port 1646
key 7 010107000A5955
!
```

The CoA server or policy-server with IP address 5.5.5.2 is configured.

```
aaa server radius dynamic-author
client 5.5.5.2 vrf default server-key 7 03165A0F575D72
!
aaa group server radius RADIUS
server 5.5.5.2 auth-port 1645 acct-port 1646
!
aaa accounting service default group radius
aaa accounting subscriber default group radius
aaa authorization subscriber default group radius
aaa authentication subscriber default group radius
!
```

The DHCPv6 address pool is defined locally within the BNG router and the local pool is used for IPv6 address assignment to the IPv6 BNG clients.

```
pool vrf default ipv6 ipv6_address_pool
address-range 2001::2 2001::7dff
!
```

The DHCPv4 server with IP address 20.20.20.2 is deployed externally and this IPv4 address must be reachable from the BNG router. The routing protocols must take care of the reachability of the IP address 20.20.20.2 from the BNG router. The DHCPv4 proxy is configured, thus:

```
dhcp ipv4
profile IPoEv4 proxy
helper-address vrf default 20.20.20.2 giaddr 10.10.10.1
```

The DHCPv4 proxy is enabled on the bundle sub-interface.

```
interface Bundle-Ether1.10 proxy profile IPoEv4
!
```

The DHCPv6 server is configured and the previously-configured DHCPv6 address pool is referred within the DHCPv6 server configuration. The DHCPv6 profile along with the address-pool is configured, thus:

```
dhcp ipv6
  profile IPoEv6 server
  address-pool ipv6_address_pool
!
```

The DHCPv6 address pool is referred on the bundle sub-interface.

```
interface Bundle-Ether1.10 server profile IPoEv6
!
interface Bundle-Ether1
bundle maximum-active links 1
!
```

The bundle sub-interface with the dot1q encapsulation is configured with a single tag. The subscriber traffic from the CPE should come with the single dot1q tag and this VLAN tag must match the VLAN-ID 10 configured under the bundle sub-interface. In Dual-Stack IPoE configuration, the **initiator dhcp** command is configured under the IPv4 or IPv6 l2-connected configuration mode. The name of the policy-map type control is referred with the service-policy.

```
interface Bundle-Ether1.10
ipv4 point-to-point
ipv4 unnumbered Loopback1
ipv6 enable
service-policy type control subscriber pm-src-mac
encapsulation dot1q 10
ipsubscriber ipv4 l2-connected
initiator dhcp
!

ipsubscriber ipv6 l2-connected
initiator dhcp
!
```

The IPv4 address 10.10.10.1 is the default-gateway IP address for the pool of IPv4 addresses allocated to the dual-stack BNG clients.

```
interface Loopback1
ipv4 address 10.10.10.1 255.255.255.0
ipv6 enable
!
```

The physical interface GigabitEthernet0/0/0/0 is configured as the bundle interface.

```
interface GigabitEthernet0/0/0/0
bundle id 1 mode on
negotiation auto
transceiver permit pid all
!
```

The dual-stack dynamic-template is configured for the dual-stack initiation. The IPv6 enable, IPv4 unnumbered address and IPv4 urpf are configured under the dual-stack template.

```
dynamic-template
type ipsubscriber Dual_stack_IPoE
accounting aaa list default type session periodic-interval 5
ipv4 verify unicast source reachable-via rx
ipv4 unnumbered Loopback1
ipv6 enable
!
```

!

The class-map is configured for the dual-stack scenario in order to match the DHCPv6 - SOLICIT and DHCPv4 - DISCOVER messages as the first-sign-of-life (FSOL) packets.

```
class-map type control subscriber match-any dual_stack_class_map
  match protocol dhcpv4 dhcpv6
end-class-map
!
```

The **dual_stack_class_map** class-map is referred within the policy-map. The event session-start is matched based on the DHCPv4 or DHCPv6 FSOL and the **Dual_stack_IPoE** dynamic-template is activated. The subscriber Mac-Address is used for subscriber identification, and this address is authorized with the AAA server.

```
policy-map type control subscriber pm-src-mac
event session-start match-all
  class type control subscriber dual_stack_class_map do-all
    1 activate dynamic-template Dual_stack_IPoE
    2 authorize aaa list default identifier source-address-mac password cisco
!
!
end-policy-map
!
end
```

Verification Steps for Dual-Stack

This section provides the list of commands that can be used for verifying dual-stack configuration. For details of these commands, see *Cisco ASR 9000 Series Aggregation Services Router Broadband Network Gateway Command Reference*.

Command	Purpose
show subscriber session all	Displays active IPv4 or IPv6 client sessions.
show subscriber session all detail	Displays details of active IPv4 or IPv6 client sessions.
show dhcp ipv4 proxy binding	Displays IPoEv4 clients created. It displays the ip-address , mac-address , the interface on which the IPoEv4 clients are created, the vrf-name , and so on.
show dhcp ipv4 proxy binding detail	Displays details of IPoEv4 clients created.
show dhcp ipv6 server binding	Displays IPv6 address allocated from the DHCPv6 local pool.

eBGP over PPPoE

Sample Topology for eBGP over PPPoE

This figure shows a sample topology for eBGP over PPPoE:

Figure 57: Sample topology for eBGP over PPPoE

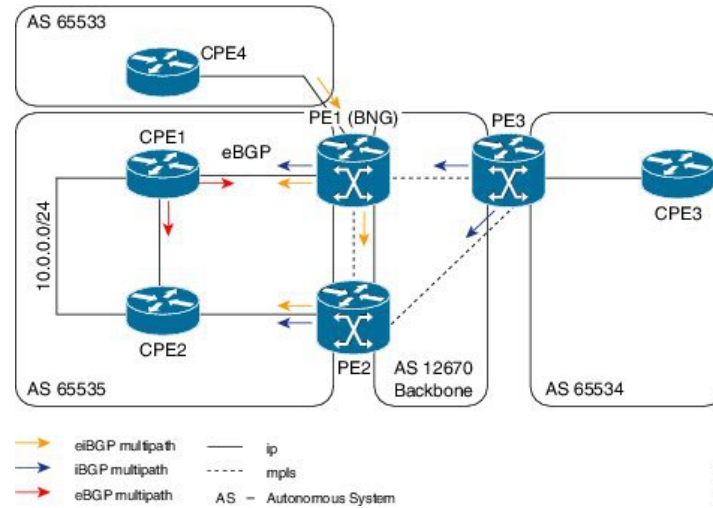

All Provide Edge (PE) routers shown in the figure, are in the service provider Autonomous System (AS), representing the core of the network. The CPE1 and CPE2 are in customer AS, peering with the PEs (PE1 and PE2 respectively) as eBGP neighbors. A statically-configured loopback address on CPE and PE, is used for BGP peering. There are networks behind the CPE, and the CPE advertises respective prefixes to the PE routers through eBGP.

PE1 and PE2 that are configured as BNG, provide reachability to the same CPE. Along with site bring-up, CPE1 and CPE2 tries to establish subscriber sessions with PE1 and PE2 respectively. These can be PPPoE PTA sessions. As part of authentication, BNG receives RADIUS attributes (through an Access-accept message) and brings-up subscribers on the respective customer VRF. The Access-accept message also contains a Framed-Route attribute that sets up a route to the CPE loopback through the subscriber interface.

When the subscriber session is up, the BGP on the CPE and the PE discover each other as neighbors and start exchanging prefixes. Based on the BGP configuration on the BNG, a label is allocated for each prefix that is advertised by the CPE. As CPE1 and CPE2 are advertising routes for the same network (For example, 10.0.0.0/24), both PE1 and PE2 allocate a label for the same prefix and distribute it to each other, and to PE3. All PEs have eBGP multi-path enabled through the configuration, and they keep multiple paths active in the FIB chain. For example, PE3 can reach 10.0.0.0/24 through PE1 or PE2. Similarly, PE1 can reach the network through CPE1 or through PE2-CPE1. The traffic is equally distributed across all available paths. The PE1 and PE2 must be configured such that when the same prefix is advertised, a loop does not occur due to multiple path creation. In that case, only PE1 accepts the route, and PE2 must be configured to reject multiple paths.

Configuration and Verification of eBGP over PPPoE

Configuration Commands

These are some of the common BGP and MPLS commands used to configure eBGP over PPPoE:

Table 29: Configuration Commands for eBGP over PPPoE

Command	Purpose
<code>maximum-paths eibgp num_path</code>	Configures the maximum number of eibgp multi-paths allowed under a VRF.

Command	Purpose
maximum-paths ibgp <i>num_path</i>	Configures the maximum number of ibgp paths allowed under a VRF.
ebgp-multihop <i>num_hop</i>	Sets the number of hops by which the ebgp neighbor is from the PE.
label mode per-prefix	Sets the label mode as per-prefix, for prefixes learnt over eBGP.
cef load-balancing	Configures the load-balancing functionality at each node.

For details on BGP configurations, see *Implementing BGP* chapter in *Routing Configuration Guide for Cisco ASR 9000 Series Routers*. For complete command reference of BGP Commands, see *Border Gateway Protocol Commands* chapter in *Routing Command Reference for Cisco ASR 9000 Series Routers*.

For details on MPLS configurations, see *Implementing MPLS Label Distribution Protocol* chapter in *MPLS Configuration Guide for Cisco ASR 9000 Series Routers*. For complete command reference of MPLS Commands, see *MPLS Command Reference for Cisco ASR 9000 Series Routers*.

Troubleshooting Steps for eBGP over PPPoE

As part of troubleshooting eBGP over PPPoE, verify these:

- Ensure that the **maximum-paths eibgp** command is configured for eiBGP multi-path.
- If iBGP multi-path is failing, verify the metric or cost. If they are unequal, configure the **maximum-paths ibgp num_path unequal-cost** command for iBGP.
- If traffic is not flowing on all paths, verify **cef load-balancing**. It must have at least L3 hash, and traffic must be sent with different source and destination IP addresses.
- If multi-path is not working, perform these:
 - Verify whether both Routing Information Base (RIB) and Cisco Express Forwarding (CEF) have two paths.
 - Verify BGP neighbors, whether routers do get exchanged.
 - Verify whether eBGP neighbor is reachable through static route, and ensure that **ebgp multi-hop** is configured in BGP configuration.

Verification Commands for eBGP over PPPoE

These show commands are used to verify the eBGP over PPPoE configurations:

Table 30: Verification Commands for eBGP over PPPoE

Command	Purpose
show route vrf <i>vrf_name network_IP</i> detail	Displays the current contents of the RIB. This can be used to verify whether both RIB and CEF have two paths, when multi-path is not working.

Command	Purpose
<code>show cef vrf vrf_name detail</code>	Displays the CEF-related information for a VRF.
<code>show bgp vpnv4 unicast network_IP</code>	Displays entries related to VPNv4 unicast address families in BGP routing table.
<code>show bgp vpnv4 unicast neighbors</code>	Displays detailed information on TCP and BGP neighbor connections.
<code>show bgp neighbors</code>	Displays information about BGP neighbors, including configuration inherited from neighbor groups, session groups, and address family groups.

Sample Configurations for eBGP over PPPoE

This section provides some sample configurations for eBGP over PPPoE:

- PE1 Configuration

```
//VRF Configuration

vrf CPE_1_VRF_1
address-family ipv4 unicast
  import route-target
    200:1
    200:3
    200:4
  !
  export route-target
    200:1
  !
!
!

vrf CPE_4_VRF_1
address-family ipv4 unicast
  import route-target
    200:1
    200:3
    200:4
  !
  export route-target
    200:4
  !
!
!

//BGP Configuration

route-policy EBGP_ROUTE_POLICY
pass
end-policy

router bgp 200
address-family ipv4 unicast
!
address-family vpnv4 unicast
!
```

```

neighbor 65.0.0.2 --->PE2
  remote-as 200
  update-source Loopback0
  address-family vpnv4 unicast
  !
!
neighbor 65.0.0.3 --->PE3
  remote-as 200
  update-source Loopback0
  address-family vpnv4 unicast
  !
!

//maximum-paths and per-prefix label mode configurations

vrf CPE_1_VRF_1
  rd 65001:1
  address-family ipv4 unicast
  maximum-paths eibgp 8
  label mode per-prefix
  !
  neighbor 101.0.0.1 --->CPE1
  remote-as 65535
  ebgp-multihop 5
  update-source Loopback1
  address-family ipv4 unicast
  route-policy EBG_ROUTE_POLICY in
  route-policy EBG_ROUTE_POLICY out
  !
!

vrf CPE_4_VRF_1
  rd 65004:1
  address-family ipv4 unicast
  maximum-paths eibgp 8
  label mode per-prefix
  !
  neighbor 104.0.0.1 --->CPE4
  remote-as 65533
  update-source Loopback5001
  address-family ipv4 unicast
  route-policy EBG_ROUTE_POLICY in
  route-policy EBG_ROUTE_POLICY out
  !
!

//RADIUS Configuration

DEFAULT Cleartext-Password :=cisco, Nas-Port-Id == "0/0/50/2"
  Framed-Protocol = PPP,
  Framed-IP-Address = 11.11.0.1,
  Framed-Route = "101.0.0.1 255.255.255.255 0.0.0.0 6 tag 7",
  Service-Type = Framed-User,
  Cisco-Avpair += "ipv4:ipv4-unnumbered=Loopback1",
  Cisco-avpair += "subscriber:vrf-id=CPE_1_VRF_1",

//MPLS Configuration

mpls ldp
router-id 65.0.0.1 --->Local IP
interface GigabitEthernet0/0/1/9
!
```

```

interface GigabitEthernet0/0/0/19
!
!
cef load-balancing --->For load-balancing
fields 13 global
!

router ospf MPLS_CORE
area 200
interface Loopback0
!
interface GigabitEthernet0/0/0/19
!
interface GigabitEthernet0/0/1/9
!
!
!

//BNG - PPPoE Configuration

pppoe bba-group PPPoE-BBA-GRP1
service selection disable
!
class-map type control subscriber match-all PPPOE_CLASS
match protocol ppp
end-class-map
!
!
policy-map type control subscriber PPPOE_POLICY
event session-start match-first
class type control subscriber PPPOE_CLASS do-all
1 activate dynamic-template PPPOE_TEMPLATE
!
!
event session-activate match-first
class type control subscriber PPPOE_CLASS do-until-failure
1 authenticate aaa list default
!
!
end-policy-map
!
end
dynamic-template
type ppp PPPOE_TEMPLATE
ppp chap hostname ASR9k_BNG_PE1
ppp authentication chap pap
keepalive 60
!
!
interface Bundle-Ether50
bundle maximum-active links 1
!
interface Bundle-Ether50.1
vrf CPE_1_VRF_1
service-policy type control subscriber PPPOE_POLICY
pppoe enable bba-group PPPoE-BBA-GRP1
encapsulation dot1q 2
!

```

- PE2 Configuration

```
//VRF Configuration
```

```
vrf CPE_1_VRF_1
  address-family ipv4 unicast
    import route-target
      200:1
      200:3
      200:4
    !
  export route-target
    200:1
  !
!
!

//BGP Configuration

router bgp 200
  address-family ipv4 unicast
    redistribute connected
  !
  address-family vpnv4 unicast
  !
  neighbor 65.0.0.1
    remote-as 200
    update-source Loopback0
    address-family vpnv4 unicast
  !
  !
  neighbor 65.0.0.3
    remote-as 200
    update-source Loopback0
    address-family vpnv4 unicast
  !
  !

//label-mode configuration

vrf CPE_1_VRF_1
  rd 65002:1
  address-family ipv4 unicast
    label mode per-prefix
    redistribute connected
  !
  neighbor 101.0.0.1
    remote-as 65535
    ebgp-multihop 5
    update-source Loopback1
    address-family ipv4 unicast
      route-policy EBG_ROUTE_POLICY in
      route-policy EBG_ROUTE_POLICY out
  !
  neighbor 102.0.0.1
    remote-as 65535
    ebgp-multihop 5
    update-source Loopback1
    address-family ipv4 unicast
      route-policy EBG_ROUTE_POLICY in
      route-policy EBG_ROUTE_POLICY out
  !
  !
!

//MPLS Configuration
mpls ldp
log
```

```

    neighbor
    !
    router-id 65.0.0.2 --->local
    interface GigabitEthernet0/2/1/1 --->connected to PE3
    !
    interface GigabitEthernet0/2/1/19 --->connected to PE1

    !
    !
    cef load-balancing
    fields 13 global
    !

    router ospf CORE
    area 200
    interface Loopback0
    !
    interface GigabitEthernet0/2/1/1
    !
    interface GigabitEthernet0/2/1/19
    !
    !
    !

//BNG - PPPoE Configuration

interface Bundle-Ether60
!
interface Bundle-Ether60.1
vrf CPE_1_VRF_1
service-policy type control subscriber PPPOE_POLICY
pppoe enable bba-group PPPoE-BBA-GRP1
encapsulation dot1q 2
!
pppoe bba-group PPPoE-BBA-GRP1
service selection disable
!
class-map type control subscriber match-all PPPOE_CLASS
match protocol ppp
end-class-map
!
!

policy-map type control subscriber PPPOE_POLICY
event session-start match-first
class type control subscriber PPPOE_CLASS do-all
1 activate dynamic-template PPPOE_TEMPLATE
!
!
event session-activate match-first
class type control subscriber PPPOE_CLASS do-until-failure
1 authenticate aaa list default
!
!
end-policy-map
!

```

• PE3 Configuration

```

//VRF Configuration

vrf CPE_3_VRF_1

```

```
address-family ipv4 unicast
import route-target
  200:1
  200:2
  200:4
!
export route-target
  200:4
!
!
!

//BGP Configuration

router bgp 200
address-family ipv4 unicast
!
address-family vpnv4 unicast
!
neighbor 65.0.0.1
  remote-as 200
  update-source Loopback0
address-family vpnv4 unicast
!
!
neighbor 65.0.0.2
  remote-as 200
  update-source Loopback0
address-family vpnv4 unicast
!
!

//maximum-paths and label-mode configuration

vrf CPE_3_VRF_1
rd 65003:1
address-family ipv4 unicast
  label mode per-prefix
  maximum-paths ibgp 8 unequal-cost
!
neighbor 103.0.0.1
  remote-as 102
  ebgp-multihop 5
  update-source Loopback1
address-family ipv4 unicast
  route-policy PASS_ALL_POLICY in
  route-policy PASS_ALL_POLICY out
!
!
!

//MPLS Configuration

mpls ldp
router-id 65.0.0.3
interface GigabitEthernet0/0/0/9
!
interface GigabitEthernet0/1/0/9
!
!
```

Routed Subscriber Sessions

Routed Subscriber Deployment Topology and Use Cases

This figure depicts a sample deployment topology for routed subscriber sessions:

Figure 58: Sample Deployment Topology for Routed Subscriber Sessions

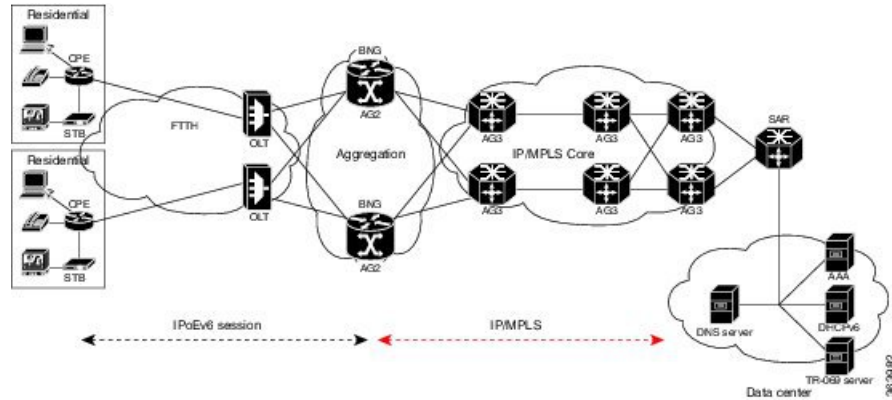

This table lists some of the use cases supported for routed subscriber sessions in BNG:

Description	Stack
Off-Box DHCP, with access and subscriber in the same VRF on BNG, and static cover route for the subscriber subnet.	IPv4 or IPv6
Off-Box DHCP, with access and subscriber in cross or different VRF on BNG, and static cover route for the subscriber subnet.	IPv4 or IPv6
Standalone DHCPv6 proxy on BNG, with access and subscriber in the default VRF, and cover route added by DHCPv6 for PD prefixes pointing to LL address of CPE.	IPv6
Standalone DHCPv6 proxy on BNG, with access in the default VRF, and subscriber in the non-default VRF; cover route added by DHCPv6 for PD prefixes pointing to LL address of CPE.	IPv6
Standalone DHCPv6 server on BNG, with access and subscriber in the default VRF; cover route added by DHCPv6 for PD prefixes pointing to LL address of CPE.	IPv6

Description	Stack
Standalone DHCPv6 server on BNG, with access in the default VRF, and subscriber in the non-default vrf; cover route added by DHCPv6 for PD prefixes pointing to LL address of CPE.	IPv6

These use cases are not supported for routed subscriber sessions in BNG:

Description	Stack
On-Box DHCP standalone proxy or server, with access in the default VRF, and subscriber in the non-default VRF on BNG; /32 cover route added by DHCP, and the first hop router is proxy or relay.	IPv4
On-Box DHCP standalone proxy or server, with access and subscriber in the same VRF (default or non-default) on BNG.	IPv4
Off-Box DHCP, with access and subscriber in the same VRF (default or non-default); subscriber prefix-length matching with cover-route prefix-length is not supported.	IPv4 or IPv6

Sample Configurations for Routed Subscriber Session

This section provides the sample configurations for a use case scenario of packet-triggered routed subscriber session in BNG.

These are the sample configurations:

```
//Interface Configuration:

interface Bundle-Ether1
 [bundle load-balancing hash src-ip] --->optional
 lacp switchover suppress-flaps 2500
 bundle wait-while 1
 dampening 4
 bundle maximum-active links 2
!
interface Bundle-Ether1.201
 ipv4 address 15.15.15.1 255.255.255.0
 ipv6 address 15:15:15::1/64
 service-policy type control subscriber PL
 encapsulation dot1q 201
 ipsubscriber ipv4 routed
   initiator unclassified-ip
!
 ipsubscriber ipv6 routed
   initiator unclassified-ip
!
!
```

```
//Class-map Configuration:
```

```

class-map type control subscriber match-any ISN_CM_V6_1
  match source-address ipv6 2004:1:1::/48
end-class-map
!
class-map type control subscriber match-any ISN_CM_V4_1
  match source-address ipv4 14.0.0.1 255.0.0.0
end-class-map
!

//Dynamic Template Configuration:
dynamic-template
  type ipsubscriber ISN_TEMPLATE_V6_4
    ipv6 enable
  !
  type ipsubscriber ISN_TEMPLATE_V4_1
    ipv4 unnumbered Loopback1
  !
  type service httppr_service_temp_coa
    service-policy type pbr httppr-redirect-policy
  !

//Policy-map Configuration:

policy-map type control subscriber p_map_cntl_1
  event session-start match-all
    class type control subscriber ISN_CM_V6_1 do-until-failure
      1 activate dynamic-template ISN_TEMPLATE_V6_1
      2 authorize aaa list default format VID password cisco123
    !
    class type control subscriber ISN_CM_V4_1 do-until-failure
      1 activate dynamic-template ISN_TEMPLATE_V4_1
      2 authorize aaa list default format VID password cisco123
    !
  !
  event authorization-failure match-all
    class type control subscriber ISN_CM_V6_1 do-until-failure
      1 activate dynamic-template httppr_service_temp_coa
      2 set-timer T1 60
    class type control subscriber ISN_CM_V4_1 do-until-failure
      1 activate dynamic-template httppr_service_temp_coa
      2 set-timer T1 60
    !
  !

event account-logon match-all
  class type control subscriber ISN_CM_V6_1 do-until-failure
    1 authenticate aaa list default
    2 stop-timer T1
    3 deactivate dynamic-template httppr_service_temp_coa
  !
  class type control subscriber ISN_CM_V4_1 do-until-failure
    1 authenticate aaa list default
    2 stop-timer T1
    3 deactivate dynamic-template httppr_service_temp_coa
  !

event account-logout match-all
  class type control subscriber ISN_CM_V6_1 do-until-failure
    1 disconnect
  !
  class type control subscriber ISN_CM_V4_1 do-until-failure
    1 disconnect
  !
!

```

```

event timer-expiry match-all
  class type control subscriber ISN_CM_V6_1 do-until-failure
    11 disconnect
  !
  class type control subscriber ISN_CM_V4_1 do-until-failure
    11 disconnect
  !
end-policy-map
!

lpts punt police location 0/0/CPU0
  protocol unclassified rate 75
!
lpts punt police location 0/1/CPU0
  protocol unclassified rate 75
!

//Static Route Configuration:

router static
  address-family ipv4 unicast
    8.0.0.0/8 8.44.0.1
  13.0.0.0/8 13.0.0.2
  14.0.0.0/16 12.0.0.2 ---> summary route to subscriber network

dhcp ipv6
  profile pf1 server
    lease 0 0 10
    prefix-pool p1
  !
  profile pf3 proxy
    helper-address vrf red 2003::2
  !
  interface Bundle-Ether1.1 server profile pf1
  interface Bundle-Ether2.1 proxy profile pf3
  !
pool vrf default ipv6 p1
  prefix-length 56
  prefix-range 2004:1:1:100:: 2004:1:1:100::
!

//RADIUS Configuration:

radius-server host 8.45.12.251 auth-port 1812 acct-port 1813
  key 7 094F471A1A0A
!
aaa server radius dynamic-author
  port 1700
  client 8.45.12.251 vrf default
  server-key 7 02050B5A
!
!
radius-server source-port extended
aaa accounting network default start-stop group radius
aaa accounting service default group radius
aaa accounting subscriber default group radius
aaa authorization subscriber default group radius
!

```

Verification of Routed Subscriber Session Configurations

These show commands can be used to verify the routed subscriber session configurations in BNG.

SUMMARY STEPS

1. **show ipsubscriber access-interface**
2. **show ipsubscriber summary**
3. **show ipsubscriber interface brief**
4. **show ipsubscriber interface**
5. **show ipsubscriber interface**
6. **show subscriber session all summary**
7. **show subscriber session filter**
8. **show subscriber session filter**

DETAILED STEPS

Step 1 show ipsubscriber access-interface

Displays the access-interface information for IP subscriber.

Example:

```
RP/0/RSP0/CPU0:router#
show ipsubscriber access-interface bundle-Ether 1.201

---
---
Mon Sep  1 18:05:15.899 UTC
Interface: Bundle-Ether1.201
  State: UP
  Type: Plain
  Interface Type: Routed
  Created Sep  1 17:54:17 (age 00:10:58)
  Initiator DHCP disabled
    Session count 0
    FSOL packets 0
    FSOL dropped packets 0
    FSOL flow rate dropped packets 0
    FSOL session limit dropped packets 0
  Initiator Packet-Trigger enabled
    Session count 1
    FSOL packets 3, bytes 300
    FSOL dropped packets 2, bytes 200
    FSOL flow rate dropped packets 0
    FSOL session limit dropped packets 0
  Initiator DHCPv6 disabled
    Session count 0
    FSOL packets 0
    FSOL dropped packets 0
    FSOL flow rate dropped packets 0
    FSOL session limit dropped packets 0
  Initiator Packet-Trigger-IPv6 enabled
    Session count 1
    FSOL packets 1, bytes 100
    FSOL dropped packets 0, bytes 0
    FSOL flow rate dropped packets 0
    FSOL session limit dropped packets 0
  Session limits per-vlan
    All sources 0
    Unclassified-source 0
```

Step 2 show ipsubscriber summary

Displays the summary information for IP subscriber interfaces.

Example:

```
RP/0/RSP0/CPU0:router#
show ipsubscriber summary
```

```
Mon Sep 1 18:05:48.610 UTC
IPSUB Summary for all nodes
```

Interface Counts:

	DHCP	Pkt Trigger
	-----	-----
Invalid:	0	0
Initialized:	0	0
Session creation started:	0	0
Control-policy executing:	0	0
Control-policy executed:	0	0
Session features applied:	0	0
VRF configured:	0	0
Adding adjacency:	0	0
Adjacency added:	0	0
Up:	0	1
Down:	0	0
Down AF:	0	0
Down AF Complete:	0	0
Disconnecting:	0	0
Disconnected:	0	0
Error:	0	0
Total:	0	1

	DHCPv6	PktTrig-IPv6
	-----	-----
Invalid:	0	0
Initialized:	0	0
Session creation started:	0	0
Control-policy executing:	0	0
Control-policy executed:	0	0
Session features applied:	0	0
VRF configured:	0	0
Adding adjacency:	0	0
Adjacency added:	0	0
Up:	0	1
Down:	0	0
Down AF:	0	0
Down AF Complete:	0	0
Disconnecting:	0	0
Disconnected:	0	0
Error:	0	0
Total:	0	1

Routes Per VRF (1 VRFs) [Packet-Trigger]:

	IPv4 Count	IPv6 Count
	-----	-----
default:	1	1

Access Interface Counts (1 interfaces):

	DHCP	Pkt Trigger
	-----	-----

```

FSOL Packets:      0          3
FSOL Bytes:       0          300

                DHCPv6 PktTrig-IPv6
                -----
FSOL Packets:      0          1
FSOL Bytes:       0          100

```

Step 3 show ipsubscriber interface brief

Displays the brief summary of IP Subscriber access-interface status and configuration.

Example:

```
RP/0/RSP0/CPU0:router#
show ipsubscriber interface brief
```

```

Mon Sep  1 18:06:33.713 UTC
Codes: INV - Invalid, INIT - Initialized, STRTD - Session Creation Started,
CPEXCTG - Control-Policy Executing, CPEXCTD - Control-Policy Executed,
FTAPPLD - Session Features Applied, VRFCFGD - VRF Configured,
ADJADDG - Adding Adjacency, ADJADDD - Adjacency Added, UP - Up,
DOWN - Down, DISCG - Disconnecting, DISCD - Disconnected, ERR - Error,
UNKWN - Unknown State, PKT - Packet Trigger Initiation,
PKTv6 - Packet Trigger Initiation for IPv6,
DHCP - DHCP Initiation, DHCPv6 - DHCPv6 Initiation

```

Interface	Proto	Subscriber IP	MAC Address	Sublabel	VRF	State
BE1.201.ip1	PKT	1.10.10.1	0000.0000.0003	0x41	default	UP
BE1.201.ip2	PKTv6		0001.0001.0000	0xc3	default	UP

Step 4 show ipsubscriber interface

Displays the interface information for the IP subscriber interfaces.

Example:

```
RP/0/RSP0/CPU0:router#
show ipsubscriber interface Bundle-Ether 1.201.ip1
```

```

Mon Sep  1 18:06:54.213 UTC
Interface: Bundle-Ether1.201.ip1
  Type: Routed
  Access Interface: Bundle-Ether1.201
  Subscriber IPv4: 1.10.10.1
  Subscriber Label: 0x41
  IPv4 Initiator: Packet-Trigger
  VLAN ID: 201
  Created: Sep  1 17:58:24 (age 00:08:30)
  VRF: default, IPv4 Table: default
  IPv4 State: Up (old: Adjacency added)
  Last state change: Sep  1 17:58:25 (00:08:29 in current state)

```

Step 5 show ipsubscriber interface

Displays the interface information for the IP subscriber interfaces.

Example:

```
RP/0/RSP0/CPU0:router#
show ipsubscriber interface Bundle-Ether 1.201.ip2

Mon Sep  1 18:06:57.846 UTC
Interface: Bundle-Ether1.201.ip2
  Type: Routed
  Access Interface: Bundle-Ether1.201
  Subscriber IPv6: 2001:0:1:1::1
  Subscriber IPv6 Prefix: 2001:0:1:1::/64
  Subscriber Label: 0xc3
  IPv6 Initiator: Packet-Trigger-IPv6
  VLAN ID: 201
  Created: Sep  1 17:58:59 (age 00:07:58)
  VRF: default, IPv6 Table: default
  IPv6 State: Up (old: Adjacency added)
    Last state change: Sep  1 17:59:00 (00:07:57 in current state)
```

Step 6 show subscriber session all summary

Displays the session summary information for all nodes.

Example:

```
RP/0/RSP0/CPU0:router#
show subscriber session all summary

Mon Sep  1 18:07:29.791 UTC

Session Summary Information for all nodes
```

Type	PPPoE	IPSub (DHCP)	IPSub (PKT)
====	=====	=====	=====
Session Counts by State:			
initializing	0	0	0
connecting	0	0	0
connected	0	0	0
activated	0	0	2
idle	0	0	0
disconnecting	0	0	0
end	0	0	0
Total:	0	0	2
Session Counts by Address-Family/LAC:			
in progress	0	0	0
ipv4-only	0	0	1
ipv6-only	0	0	1
dual-partial-up	0	0	0
dual-up	0	0	0
lac	0	0	0
Total:	0	0	2

Step 7 show subscriber session filter

Displays the subscriber management session information based on the filter criteria.

Example:

```

RP/0/RSP0/CPU0:router#
show subscriber session filter interface bundle-ether 1.201.ip1 detail

Mon Sep 1 18:09:51.381 UTC
Interface:          Bundle-Ether1.201.ip1
Circuit ID:         Unknown
Remote ID:          Unknown
Type:              IP: Packet-trigger
IPv4 State:         Up, Mon Sep 1 17:58:25 2014
IPv4 Address:       1.10.10.1, VRF: default
Mac Address:        Unknown
Account-Session Id: 0001137f
Nas-Port:           Unknown
User name:          unknown
Outer VLAN ID:     201
Subscriber Label:   0x00000041
Created:            Mon Sep 1 17:58:24 2014
State:              Activated
Authentication:     unauthenticated
Authorization:      unauthorized
Access-interface:   Bundle-Ether1.201
Policy Executed:
policy-map type control subscriber PL
  event Session-Start match-first [at Mon Sep 1 17:58:24 2014]
  class type control subscriber class-default do-all [Succeeded]
  10 activate dynamic-template ptrigger [Succeeded]
Session Accounting: disabled
Last COA request received: unavailable

```

Step 8 show subscriber session filter

Displays the subscriber management session information based on the filter criteria.

Example:

```

RP/0/RSP0/CPU0:router#
show subscriber session filter interface bundle-ether 1.201.ip2 detail

Mon Sep 1 18:10:45.883 UTC
Interface:          Bundle-Ether1.201.ip2
Circuit ID:         Unknown
Remote ID:          Unknown
Type:              IP: Packet-trigger
IPv6 State:         Up, Mon Sep 1 17:59:00 2014
IPv6 Address:       2001:0:1:1::1, VRF: default
IPv6 Interface ID: ..... (00 00 00 00 00 00 00 01)
Mac Address:        Unknown
Account-Session Id: 00011380
Nas-Port:           Unknown
User name:          unknown
Outer VLAN ID:     201
Subscriber Label:   0x000000c3
Created:            Mon Sep 1 17:58:59 2014
State:              Activated
Authentication:     unauthenticated
Authorization:      unauthorized
Access-interface:   Bundle-Ether1.201
Policy Executed:
policy-map type control subscriber PL
  event Session-Start match-first [at Mon Sep 1 17:58:59 2014]

```



```
class type control subscriber class-default do-all [Succeeded]
  10 activate dynamic-template ptrigger [Succeeded]
Session Accounting: disabled
Last COA request received: unavailable
```



APPENDIX **E**

DIAMETER Attributes

BNG Supports DIAMETER Gx interface for Policy and Charging Provisioning with the PCRF, and DIAMETER Gy interface for Online Charging Service with OCS.

This Appendix lists the applicable AVPs in each Diameter Request that is sent or received by BNG, and also some sample packets.

- [BNG DIAMETER Gx Application AVPs, on page 563](#)
- [BNG DIAMETER Gy Application AVPs, on page 565](#)
- [BNG DIAMETER NASREQ Application Cisco AVPs, on page 566](#)
- [DIAMETER Accounting AVP, on page 569](#)
- [DIAMETER Session-Id AVP, on page 570](#)
- [RADIUS Attributes in DIAMETER Messages, on page 571](#)
- [Sample Packets for BNG DIAMETER Messages, on page 572](#)

BNG DIAMETER Gx Application AVPs

The DIAMETER interface with BNG is based on the respective latest 3GPP specifications and Diameter Credit Control Application (RFC 4006) standard. The interface remains the same for any DIAMETER server vendor, but the user must be aware of the set of AVPs being used to address the BNG-DIAMETER deployments and use-cases. This topic lists the BNG DIAMETER Gx Application AVPs.

Table 31: BNG DIAMETER Gx Application AVPs

AVP Name	AVP Code	Vendor	AVP Format	Messages	Source	Flags
Session-ID	263	IETF	String	CCR, CCA	RFC 6733	M
Origin-Host-Name	264	IETF	String	CCR, CCA	RFC 6733	M
Origin-Realm	296	IETF	String	CCR, CCA	RFC 6733	M
Destination Realm	283	IETF	String	CCR, CCA	RFC 6733	M
CC-Request-Type	416	IETF	Ulong	CCR, CCA	RFC 4006	M
CC-Request-Number	415	IETF	Ulong	CCR, CCA	RFC 4006	M
Auth-Application-ID	258	IETF	Ulong	CCR, CCA	RFC 6733	M

AVP Name	AVP Code	Vendor	AVP Format	Messages	Source	Flags
ReAuth-Request-Type	285	IETF	Ulong	RAR	RFC 6733	M
Username	1	IETF	String	CCR, CCA	RFC 6733	M
Framed-IP-Address	8	IETF	Address	CCR, CCA	RFC 6733	M
Logical-Access-Id	302	ETSI	OctectString	CCR-I	TS 29.212	
Physical-Access-Id	313	ETSI	OctectString	CCR-I	TS 29.212	
*User-Equipment-Info	458	IETF	Grouped	CCR-I	RFC 6733	
User-Equipment-Info-Type	459	IETF	Enum	CCR-I	RFC 6733	M
User-Equipment-Info-Value	460	IETF	String	CCR-I	RFC 6733	M
Result-Code	268	IETF	Enum	CCA	RFC 6733	M
*Charging-Rule-Install	1001	3GPP	Grouped	CCA, RAR	TS 29.212	M, V
*Charging-Rule-Definition	1003	3GPP	Grouped	CCA, RAR	TS 29.212	M, V
Charging-Rule-Name	1004	3GPP	OctectString	CCA, RAR	TS 29.212	M, V
CC-Service-Identifier	439	IETF	Ulong	CCA, RAR	RFC 4006	M
Rating-Group	432	IETF	Ulong	CCA, RAR	RFC 4006	M
*Charging-Rule-Remove	1002	3GPP	Grouped	RAR	TS 29.212	
Session-Release-Cause	1045	3GPP	Enum	RAR	TS 29.212	M
Gx-Application-ID	14080	Cisco	Ulong	CCR		
Vrf-Id	14002	Cisco	Ulong	CCA-I		
IPv6-Enable	14056	Cisco	Ulong	CCA-I		
IP-Unnumbered	14055	Cisco	String	CCA-I		
Inacl	14009	Cisco	String	CCA-I		
Ipv6-inacl	14010	Cisco	String	CCA-I		
Outacl	14012	Cisco	String	CCA-I		
IPv6-outacl	14013	Cisco	String	CCA-I		
Sub-Qos-Policy-In	14014	Cisco	String	CCA-I		
Sub-Qos-Policy-Out	14015	Cisco	String	CCA-I		
Accounting-List	14016	Cisco	String	CCA-I		

BNG DIAMETER Gy Application AVPs

This table lists the BNG DIAMETER Gy application AVPs.

Table 32: BNG DIAMETER Gy Application AVPs

AVP Name	AVP Code	Vendor	AVP Format	Messages	Source	Flags
Session-ID	263	IETF	String	CCR, CCA	RFC 6733	M
Origin-Host-Name	264	IETF	String	CCR, CCA	RFC 6733	M
Origin-Realm	296	IETF	String	CCR, CCA	RFC 6733	M
Destination Realm	283	IETF	String	CCR, CCA	RFC 6733	M
CC-Request-Type	416	IETF	Ulong	CCR, CCA	RFC 4006	M
CC-Request-Number	415	IETF	Ulong	CCR, CCA	RFC 4006	M
Auth-Application-ID	258	IETF	Ulong	CCR, CCA	RFC 6733	M
ReAuth-Request-Type	285	IETF	Ulong	RAR	RFC 6733	M
Username	1	IETF	String	CCR, CCA	RFC 6733	M
Framed-IP-Address	8	IETF	Address	CCR, CCA	RFC 6733	M
*User-Equipment-Info	458	IETF	Grouped	CCR-I	RFC 6733	-
User-Equipment-Info-Type	459	IETF	Enum	CCR-I	RFC 6733	M
User-Equipment-Info-Value	460	IETF	String	CCR-I	RFC 6733	M
Result-Code	268	IETF	Enum	CCA	RFC 6733	M
Service-Context-Id	461	IETF	String	CCR	RFC 4006	M
Event-Time-Stamp	55	IETF	Ulong	CCR	RFC 6733	M
CC-Multiple-Service-Support	455	IETF	Enum	CCR	RFC 4006	M
*CC-Multiple-Service	456	IETF	Grouped	CCR, CCA	RFC 4006	M
CC-Service-Identifier	439	IETF	Ulong	CCA, RAR	RFC 4006	M
Rating-Group	432	IETF	Ulong	CCA, RAR	RFC 4006	M
*Requested-Service-Unit	437	IETF	Ulong	CCR-I	RFC 4006	-
CC-Session-Failover	418	IETF	Ulong	CCA	RFC 4006	-
*Granted-Service-Unit	431	IETF	Grouped	CCA	RFC 4006	M
CC-Tariff-Time-Change	451	IETF	Ulong	CCR-U, CCA	RFC 4006	M

AVP Name	AVP Code	Vendor	AVP Format	Messages	Source	Flags
CC-Time	420	IETF	Ulong	CCR, CCA	RFC 4006	M
CC-Input-Octets	412	IETF	Ulonglong	CCR, CCA	RFC 4006	M
CC-Output-Octets	414	IETF	Ulonglong	CCR, CCA	RFC 4006	M
CC-Total-Octets	421	IETF	Ulonglong	CCR, CCA	RFC 4006	M
CC-Tariff-Change-Units	446	IETF	Enum	CCR-U	RFC 4006	M
Reporting-Reason	872	IETF	Enum	CCR-U	RFC 4006	M
Volume-Quota-Threshold	869	3GPP	Ulong	CCA	TS 32.299	M, V
Time-Quota-Threshold	868	3GPP	Ulong	CCA	TS 32.2996	M, V
CC-Validity-Time	448	IETF	Ulong	CCA	RFC 4006	M
Quota-Holding-Time	871	3GPP	Ulong	CCA	RFC 4006	M
Credit-Control-Failure-Handling	427	IETF	Enum	CCA	RFC 4006	M
*Final-Unit-Indication	430	IETF	Grouped	CCA	RFC 4006	M
Final-Unit-Action	449	IETF	Enum	CCA	RFC 4006	M
Termination-Cause	295	IETF	Enum	CCR-Final	RFC 6733	M

BNG DIAMETER NASREQ Application Cisco AVPs

This table lists the BNG DIAMETER NASREQ application Cisco AVPs.

Table 33: BNG DIAMETER NASREQ Application Cisco AVPs

AVP Name	Value	Format	Type
Framed-IP-Address	8	ipv4addr	ietf
Framed-IP-Address/ Framed-IP-Netmask	9	ipv4addr	ietf
Filter-Id	11	binary	ietf
Framed-MTU	12	ulong	ietf
Framed-Compression	13	enum	ietf
Reply-Message	18	binary	ietf
Framed-Route	22	string	ietf
Session-Timeout	27	ulong	ietf

AVP Name	Value	Format	Type
Idle-Timeout	28	ulong	ietf
Framed-Pool	88	string	ietf
Framed-IPv6-Prefix	97	binary	ietf
Framed-IPv6-Route	99	string	ietf
Framed-IPv6-Pool	100	string	ietf
Delegated-IPv6-Prefix	123	binary	ietf
ip:primary-dns / ip:secondary-dns	135	address	ietf
addrv6	14001	address	cisco_vsa
vrf-id	14002	ulong	cisco_vsa
parent-session-id	14003	string	cisco_vsa
service-name	14004	string	cisco_vsa
disc-cause-ext	14005	enum	cisco_vsa
disconnect-cause	14006	string	cisco_vsa
Ascend-Connect-Progress	14007	ulong	cisco_vsa
Acct-Unique-Session-Id	14008	ulong	cisco_vsa
inacl	14009	string	cisco_vsa
ipv6_inacl	14010	string	cisco_vsa
cisco-nas-port	14011	string	cisco_vsa
outacl	14012	string	cisco_vsa
ipv6_outacl	14013	string	cisco_vsa
sub-qos-policy-in	14014	string	cisco_vsa
sub-qos-policy-out	14015	string	cisco_vsa
accounting-list	14016	string	cisco_vsa
parent-if-handle	14017	ulong	cisco_vsa
acct-input-gigawords-ipv4	14018	ulong	cisco_vsa
acct-input-octets-ipv4	14019	ulong	cisco_vsa
acct-input-packets-ipv4	14020	ulong	cisco_vsa
acct-output-gigawords-ipv4	14021	ulong	cisco_vsa

AVP Name	Value	Format	Type
acct-output-octets-ipv4	14022	ulong	cisco_vsa
acct-output-packets-ipv4	14023	ulong	cisco_vsa
acct-input-gigawords-ipv6	14024	ulong	cisco_vsa
acct-input-octets-ipv6	14025	ulong	cisco_vsa
acct-input-packets-ipv6	14026	ulong	cisco_vsa
acct-output-gigawords-ipv6	14027	ulong	cisco_vsa
acct-output-octets-ipv6	14028	ulong	cisco_vsa
acct-output-packets-ipv6	14029	ulong	cisco_vsa
subscriber:command=account-logon	14030	string	cisco_vsa
subscriber:sd=service1	14031	string	cisco_vsa
subscriber:sa=service1	14032	string	cisco_vsa
subscriber:sm= svc1(interim-interval=120)	14033	string	cisco_vsa
ip:ip-unnumbered=<loopback>	14038	string	cisco_vsa
ipv4:ipv4-multicast=Qos Correlation	14039	enum	cisco_vsa
ip:keepalive	14040	string	cisco_vsa
dual-stack-delay	14041	string	cisco_vsa
idle-timeout-direction	14042	string	cisco_vsa
idlethreshold	14043	ulong	cisco_vsa
ipv4:ipv4-mtu	14044	ulong	cisco_vsa
ipv6:ipv6-mtu	14045	ulong	cisco_vsa
md-ip-addr	14046	address	cisco_vsa
md-port	14047	ulong	cisco_vsa
md-dscp	14048	ulong	cisco_vsa
li-action	14049	ulong	cisco_vsa
intercept-id	14050	binary	cisco_vsa
cisco-mpc-protocol-interface=pmipv6	14051	enum	cisco_vsa
cisco-mobile-node-identifier	14052	string	cisco_vsa
cisco-mn-service	14053	enum	cisco_vsa

AVP Name	Value	Format	Type
home-lma	14054	string	cisco_vsa

DIAMETER Accounting AVP

This table lists the DIAMETER Accounting AVPs that describe accounting usage information related to a specific session and for a service.

AVP	Command Code	Description
Accounting-Record-Type	480	<p>Contains the type of accounting record being sent.</p> <p>This is similar to Acct-Status-Type RADIUS IETF AVP. These are the values currently defined for the Accounting-Record-Type AVP:</p> <ul style="list-style-type: none"> • 1 - EVENT_RECORD • 2 - START_RECORD • 3 - INTERIM_RECORD • 4 - STOP_RECORD
Accounting-Record-Number	485	<p>Identifies the record within one session.</p> <p>For a given BNG session, START_RECORD carries the value 0 (zero) and it increases for the subsequent Accounting-Request for the same BNG Session.</p>
Accounting-Sub-Session-Id	287	<p>Contains the accounting sub-session identifier.</p> <p>The combination of the Session-Id and this AVP must be unique for each sub-session, and the value of this AVP must be increased by one for all new sub-sessions.</p> <p>Note This is not supported in BNG.</p>

AVP Considerations

These AVPs are considered to be security-sensitive:

- Acct-Interim-Interval

- Accounting-Realtime-Required
- Acct-Multi-Session-Id
- Accounting-Record-Number
- Accounting-Record-Type
- Accounting-Session-Id
- Accounting-Sub-Session-Id
- Class
- Session-Id
- Session-Binding
- Session-Server-Failover
- User-Name

DIAMETER Session-Id AVP

The Session-Id AVP (AVP code 263) is of type UTF8String and is used to identify a specific diameter application session. All messages pertaining to a given BNG subscriber session have the same Session-Id and uses the same value throughout the life of the session. The Session-Id AVP must appear immediately after the DIAMETER header and it optimizes the session association while parsing the request or response. The Session-Id AVP includes a mandatory portion and an implementation-specific portion.

The syntax for this AVP is:

DiameterIdentity;high 32 bits;low 32 bits;optional value

Table 34: Syntax Description

<i>DiameterIdentity</i>	Used to identify either: <ul style="list-style-type: none"> • A DIAMETER node for the purpose of duplicate connection and routing loop detection. • A realm to determine whether the messages can be processed locally or whether they must be routed or redirected.
<i>high 32 bits</i> <i>low 32 bits</i>	Decimal representation of the high and low 32 bits of a increasing 64-bit value. BNG uses Session-Id (Acct-Session-ID) which is of 32 bits as of now and hence the high 32 bits is 0 (Zero) to start with. To make the DIAMETER Session-Id unique, the high 32 bits is increased every time after a router reload or in process restart scenarios (such as DIAMETER process restart) where the previous Session-Id is lost. This eliminates the possibility of overlapping Session-Ids in such scenarios.

<i>optional value</i>	This is implementation specific, and it may include a Layer 2 address, timestamp and so on. BNG uses the <i>timestamp</i> that is retrieved when the first request is being sent to the DIAMETER server for each application. The first message for NASREQ is AA-Request, and for DCCA application, it is CCR-Initial request. The subsequent messages carry the same timestamp for the given BNG subscriber session to ensure that the same Session-Id is used in the entire span of the respective DIAMETER application session.
-----------------------	--

This is an example of DIAMETER Session-Id AVP (with an optional value):

```
BNG1.example.com;1876543210;523;BNG1@10.0.0.1
```

This is an example of DIAMETER Session-Id AVP (without an optional value):

```
BNG1.example.com;1876543210;523
```

RADIUS Attributes in DIAMETER Messages

A DIAMETER message may include RADIUS attributes, except the ones listed in this table. These RADIUS attributes, if present, are translated internally to similar DIAMETER AVPs.

RADIUS Attribute	RADIUS Attribute Name	Nearest DIAMETER AVP
3	CHAP-Password	CHAP-Auth Group
26	Vendor-Specific	Vendor Specific AVP
29	Termination-Action	Authorization-Lifetime
40	Acct-Status-Type	Accounting-Record-Type
42	Acct-Input-Octets	Accounting-Input-Octets
43	Acct-Output-Octets	Accounting-Output-Octets
47	Acct-Input-Packets	Accounting-Input-Packets
48	Acct-Output-Packets	Accounting-Output-Packets
49	Acct-Terminate-Cause	Termination-Cause
52	Acct-Input-Gigawords	Accounting-Input-Octets
53	Acct-Output-Gigawords	Accounting-Output-Octets
80	Message-Authenticator	No corresponding DIAMETER AVP. If this attribute is present, it is checked and discarded.

Sample Packets for BNG DIAMETER Messages

This topic lists the sample packets for BNG DIAMETER messages.

GX - CCR-Initial Message from BNG to PCRF

Session-Id	[263]	"cisco123.com;3201010A;0"	(M)
Origin-host-name	[264]	"cisco123.com"	(M)
Origin-Realm	[296]	"cisco.com"	(M)
CC-request-type	[416]	ccr-initial	(M)
CC-request-number	[415]	0	(M)
Destination-Realm	[283]	"cisco.com"	(M)
Auth-Application-ID	[258]	16777238	(M)
User-name	[1]	"prepaid-user"	(M)
Framed-IP-Address	[8]	10.0.0.1	(M)
User-Equipment-Info	[458]		
User-Equipment-Info-Type	[459]	MAC (1)	(M)
User-Equipment-Info-Value	[460]	"0219.a220.e809"	(M)

GX - CCA-Initial Message from PCRF to BNG

Session-Id	[263]	"cisco123.com;3201010A;0"	(M)
Result-code	[268]	2001	(M)
Auth-Application-ID	[258]	16777238	(M)
Origin-host-name	[264]	"pcrf.cisco.com"	(M)
Origin-Realm	[296]	"cisco.com"	(M)
Destination-Realm	[283]	"cisco.com"	(M)
CC-request-type	[416]	ccr-initial	(M)
CC-request-number	[415]	0	(M)
Vendor, 3GENPP	[10415]		
Charging-Rule-Install	[1001]		(M)
Vendor, 3GENPP	[10415]		
Charging-Rule-Definition	[1003]		(M)
Vendor, 3GENPP	[10415]		
Charging Rule Name	[1005]	"HSI_10MB"	(M)
CC-service-identifier	[439]	5	(M)
Rating group	[432]	3	(M)

Gx - Application RA-Request Message

Session-Id	[263]	"cisco123.com;3201010A;0"	(M)
Origin-host-name	[264]	"cisco123.com"	(M)
Origin-Realm	[296]	"cisco.com"	(M)
Re-Auth-Request-Type	[285]	AUTHORIZE_ONLY (0)	(M)
CC-request-number	[415]	0	(M)
Destination-Realm	[283]	"cisco.com"	(M)
Auth-Application-ID	[258]	Gx (16777238)	
Vendor, 3GENPP	[10415]		(M)
Charging Rule Remove	[1002]		
Vendor, 3GENPP	[10415]		
Charging Rule Name	[1005]	"HSI_10MB"	(M)
Vendor, 3GENPP	[10415]		(M)
Charging Rule Install	[1001]		
Vendor, 3GENPP	[10415]		
Charging-Rule-Definition	[1003]		(M)
Vendor, 3GENPP	[10415]		

Charging Rule Name	[1005]	"LOW_BW128KB"	(M)
CC-service-identifier	[439]	6	(M)
Vendor, 3GENPP	[10415]		
Rating group	[432]	4	(M)

Gx - Application RA-Answer Message

Session-Id	[263]	"cisco123.com;3201010A;0"	(M)
Result-code	[268]	2001	(M)
Auth-Application-ID	[258]	Gx (16777238)	(M)
Origin-host-name	[264]	"pcrf.cisco.com"	(M)
Origin-Realm	[296]	"cisco.com"	(M)
Destination-Realm	[283]	"cisco.com"	(M)

Gx - RA-Request Message to Release the Session

Session-Id	[263]	"cisco123.com;3201010A;0"	(M)
Origin-host-name	[264]	"cisco123.com"	(M)
Origin-Realm	[296]	"cisco.com"	(M)
Re-Auth-Request-Type	[285]	AUTHORIZE_ONLY (0)	(M)
CC-request-number	[415]	0	(M)
Destination-Realm	[283]	"cisco.com"	(M)
Auth-Application-ID	[258]	Gx (16777238)	
Vendor, 3GENPP	[10415]		
Session-Release-Cause	[1045]	"UNSPECIFIED_REASON"	(M)

Gy - CCR-Initial Message

Session-Id	[263]	"cisco123.com;3201010A;0"	(M)
Origin-host-name	[264]	"cisco123.com"	(M)
Origin-Realm	[296]	"cisco.com"	(M)
CC-request-type	[416]	ccr-initial	(M)
CC-request-number	[415]	0	(M)
Destination-Realm	[283]	"cisco.com"	(M)
Auth-Application-ID	[258]	4	(M)
User-name	[1]	"prepaid-user"	(M)
Service_Context_Id	[461]	"32251@3gpp.org"	(M)
Framed-IP-Address	[8]	10.0.0.1	(M)
Event-Timestamp	[55]	3426644002	(M)
CC-Multiple-service-support	[455]	multiple-service-supported	(M)
CC-multiple-service	[456]		
CC-service-identifier	[439]	5	(M)
Rating group	[432]	3	(M)
CC-requested-service-unit	[437]		
User-Equipment-Info	[458]		
User-Equipment-Info-Type	[459]	MAC (1)	(M)
User-Equipment-Info-Value	[460]	"0219.a220.e809"	(M)

Gy - CCA-Initial Message

Session-Id	[263]	"cisco123.com;3201010A;0"	(M)
Result-code	[268]	2001	(M)
Origin-host-name	[264]	"cisco123.com"	(M)
Origin-Realm	[296]	"cisco.com"	(M)
CC-request-type	[416]	ccr-initial	(M)
CC-request-number	[415]	0	(M)

Destination-Realm	[283]	"cisco.com"	(M)
Auth-Application-ID	[258]	4	(M)
User-name	[1]	"prepaid-user"	(M)
Framed-IP-Address	[8]	10.0.0.1	(M)
Event-Timestamp	[55]	3426644002	(M)
CC-session-failover	[418]	NOT_SUPPORTED (0)	(M)
CC-multiple-service	[456]		
Granted-Service-Unit	[431]		
CC-Tariff-Time-Change	[451]	10:10:10 Thu Dec 28 2006	(M)
CC-Total-Octets	[414]	1000	(M)
Vendor, 3GENPP	[10415]		
Volume-Quota-threshold	[869]	10	
Rating-Group	[432]	3	(M)
Service-Identifier	[439]	5	(M)
CC-validity-time	[448]	1000	(M)
Result-code	[268]	2001	(M)
Vendor, 3GENPP	[10415]		
Quota-Holding-Time	[871]	10000	(M)
Credit-Control-Failure-Handling	[427]	CONTINUE (1)	(M)

Gy - CCR-Update Message

Session-Id	[263]	" cisco123.com;3201010A;0"	(M)
Origin-host-name	[264]	"cisco123.com"	(M)
Origin-Realm	[296]	"cisco.com"	(M)
Auth-Application-ID	[258]	4	(M)
CC-request-type	[416]	ccr-update	(M)
CC-request-number	[415]	1	(M)
Service_Context_Id	[461]	"bng1@cisco.com"	(M)
Framed-IP-Address	[8]	10.0.0.1	(M)
User-Name	[1]	"prepaid-user"	(M)
Event-Timestamp	[55]	3426644119	(M)
Destination-Realm	[283]	"cisco.com"	(M)
CC-multiple-service	[456]		
CC-rating-group	[432]	3	(M)
Service-Identifier	[439]	5	(M)
Used-Service-Unit	[446]		
CC-Time	[420]	1	(M)
Vendor, 3GENPP	[10415]		
Reporting- Reason	[872]	QUOTA_EXHAUSTED (3)	(M)
Used-Service-Unit	[446]		
CC-Total-Octets	[421]	2	(M)
Vendor, 3GENPP	[10415]		
Reporting-Reason	[872]	QUOTA_EXHAUSTED (3)	(M)
CC-Input-Octets	[412]	1	(M)
CC-Output-Octets	[414]	1	(M)
User-Equipment-Info	[458]		
User-Equipment-Info-Type	[459]	MAC (1)	(M)
User-Equipment-Info-Value	[460]	"0219.a220.e809"	(M)

CCR-Update Message with Tariff Change Units

CC-multiple-service	[456]		
CC-rating-group	[432]	3	(M)
Service-Identifier	[439]	5	(M)
CC-Service-Unit	[446]		
CC-Time	[420]	166	(M)
CC-tariff-change-units	[452]	units-before-tariff-change	(M)
CC-Service-Unit	[446]		
CC-Total-Octets	[421]	264	(M)

CC-Input-Octets	[412]	132	(M)
CC-Output-Octets	[414]	132	(M)
CC-tariff-change-units	[452]	units-before-tariff-change	(M)
CC-Service-Unit	[446]		
CC-Time	[420]	129	(M)
CC-tariff-change-units	[452]	units-after-tariff-change	(M)
CC-Service-Unit	[446]		
CC-Total-Octets	[421]	132	(M)
CC-Input-Octets	[412]	66	(M)
CC-Output-Octets	[414]	66	(M)
CC-tariff-change-units	[452]	units-after-tariff-change	(M)

Gy - CCA-Update Message

Session-Id	[263]	"cisco123.com;3201010A;0"	(M)
Result-code	[268]	2001	(M)
Origin-host-name	[264]	"cisco123.com"	(M)
Origin-Realm	[296]	"cisco.com"	(M)
CC-request-type	[416]	ccr-update	(M)
CC-request-number	[415]	0	(M)
Destination-Realm	[283]	"cisco.com"	(M)
Auth-Application-ID	[258]	4	(M)
CC-session-failover	[418]	NOT_SUPPORTED (0)	(M)
CC-multiple-service	[456]		
Granted-Service-Unit	[431]		
CC-Tariff-Time-Change	[451]	10:10:10 Thu Dec 28 2006	(M)
CC-Total-Octets	[414]	1000	(M)
CC-final-unit-indication	[430]		
Final-Unit-Action	[449]	0 (Terminate)	(M)
Vendor, 3GENPP	[10415]		
Volume-Quota-threshold	[869]	10	
Rating-Group	[432]	3	(M)
Service-Identifier	[439]	5	(M)
Result-code	[268]	2001	(M)
Vendor, 3GENPP	[10415]		
Quota-Holding-Time	[871]	10000	(M)
Quota-Validity-Time	[448]	10000	(M)
Credit-Control-Failure-Handling	[427]	CONTINUE (1)	(M)

Gy - Sample RAR Packet

Session-Id	[263]	"bng;167;1234567"	(M)
Origin-host-name	[264]	"diameter1.cisco.com"	(M)
Origin-Realm	[296]	"cisco.com"	(M)
Destination-Realm	[283]	"cisco.com"	(M)
Destination host name	[293]	"diamclient1.cisco.com"	(M)
Auth-Application-ID	[258]	4	(M)
Re-Auth-Request-Type	[285]	Authorize-Only	(M)

Gy - Sample RAA Packet

Session-Id	[263]	"bng;167;217443434"	(M)
Result-code	[268]	2001	(M)
Origin-Realm	[296]	"cisco.com"	(M)
Origin-host-name	[264]	"diamclient1.cisco.com"	(M)
Origin-host-name	[264]	"diamclient1.cisco.com"	(M)

Origin-Realm	[296]	"cisco.com"	(M)
--------------	-------	-------------	-----

Gy - CCR-Final Message

Session-Id	[263]	"63;3201010A;4294967295"	(M)
Origin-host-name	[264]	"cisco123.com"	(M)
Origin-Realm	[296]	"cisco.com"	(M)
Auth-Application-ID	[258]	4	(M)
CC-request-type	[416]	ccr-final	(M)
CC-request-number	[415]	3	(M)
Service_Context_Id	[461]	"bng1@cisco.com"	(M)
Framed-IP-Address	[8]	"10.0.0.1" (M)	(M)
User-Name	[1]	"prepaid-user"	(M)
Event-Timestamp	[55]	3426644295	(M)
Termination_Cause	[295]	Diameter Administrative	(M)
Destination-Realm	[283]	"cisco.com"	(M)
CC-multiple-service	[456]		
CC-rating-group	[432]	3	(M)
Service-Identifier	[439]	5	(M)
Used-Service-Unit	[446]		
Vendor, 3GENPP	[10415]		
Reporting-Reason	[872]	FINAL (2)	(M)
CC-Time	[420]	1	(M)
Used-Service-Unit	[446]		
Vendor, 3GENPP	[10415]		
Reporting-Reason	[872]	FINAL (2)	(M)
CC-Total-Octets	[421]	2	(M)
CC-Input-Octets	[412]	1	(M)
CC-Output-Octets	[414]	1	(M)

Gy - CCA-Final Message

Session-Id	[263]	"cisco123.com;3201010A;0"	(M)
Result-code	[268]	2001	(M)
Origin-host-name	[264]	"cisco123.com"	(M)
Origin-Realm	[296]	"cisco.com"	(M)
CC-request-type	[416]	ccr-final	(M)
CC-request-number	[415]	0	(M)
Destination-Realm	[283]	"cisco.com"	(M)
Auth-Application-ID	[258]	4	(M)
CC-session-failover	[418]	NOT_SUPPORTED(0)	(M)
Credit-Control-Failure-Handling	[427]	CONTINUE (1)	(M)