



Segment Routing Configuration Guide for Cisco ASR 9000 Series Routers, IOS XR Release 6.7.x

First Published: 2020-01-29

Last Modified: 2020-09-22

Americas Headquarters

Cisco Systems, Inc.
170 West Tasman Drive
San Jose, CA 95134-1706
USA
<http://www.cisco.com>
Tel: 408 526-4000
800 553-NETS (6387)
Fax: 408 527-0883

THE SPECIFICATIONS AND INFORMATION REGARDING THE PRODUCTS IN THIS MANUAL ARE SUBJECT TO CHANGE WITHOUT NOTICE. ALL STATEMENTS, INFORMATION, AND RECOMMENDATIONS IN THIS MANUAL ARE BELIEVED TO BE ACCURATE BUT ARE PRESENTED WITHOUT WARRANTY OF ANY KIND, EXPRESS OR IMPLIED. USERS MUST TAKE FULL RESPONSIBILITY FOR THEIR APPLICATION OF ANY PRODUCTS.

THE SOFTWARE LICENSE AND LIMITED WARRANTY FOR THE ACCOMPANYING PRODUCT ARE SET FORTH IN THE INFORMATION PACKET THAT SHIPPED WITH THE PRODUCT AND ARE INCORPORATED HEREIN BY THIS REFERENCE. IF YOU ARE UNABLE TO LOCATE THE SOFTWARE LICENSE OR LIMITED WARRANTY, CONTACT YOUR CISCO REPRESENTATIVE FOR A COPY.

The Cisco implementation of TCP header compression is an adaptation of a program developed by the University of California, Berkeley (UCB) as part of UCB's public domain version of the UNIX operating system. All rights reserved. Copyright © 1981, Regents of the University of California.

NOTWITHSTANDING ANY OTHER WARRANTY HEREIN, ALL DOCUMENT FILES AND SOFTWARE OF THESE SUPPLIERS ARE PROVIDED "AS IS" WITH ALL FAULTS. CISCO AND THE ABOVE-NAMED SUPPLIERS DISCLAIM ALL WARRANTIES, EXPRESSED OR IMPLIED, INCLUDING, WITHOUT LIMITATION, THOSE OF MERCHANTABILITY, FITNESS FOR A PARTICULAR PURPOSE AND NON-INFRINGEMENT OR ARISING FROM A COURSE OF DEALING, USAGE, OR TRADE PRACTICE.

IN NO EVENT SHALL CISCO OR ITS SUPPLIERS BE LIABLE FOR ANY INDIRECT, SPECIAL, CONSEQUENTIAL, OR INCIDENTAL DAMAGES, INCLUDING, WITHOUT LIMITATION, LOST PROFITS OR LOSS OR DAMAGE TO DATA ARISING OUT OF THE USE OR INABILITY TO USE THIS MANUAL, EVEN IF CISCO OR ITS SUPPLIERS HAVE BEEN ADVISED OF THE POSSIBILITY OF SUCH DAMAGES.

Any Internet Protocol (IP) addresses and phone numbers used in this document are not intended to be actual addresses and phone numbers. Any examples, command display output, network topology diagrams, and other figures included in the document are shown for illustrative purposes only. Any use of actual IP addresses or phone numbers in illustrative content is unintentional and coincidental.

All printed copies and duplicate soft copies of this document are considered uncontrolled. See the current online version for the latest version.

Cisco has more than 200 offices worldwide. Addresses and phone numbers are listed on the Cisco website at www.cisco.com/go/offices.

The documentation set for this product strives to use bias-free language. For purposes of this documentation set, bias-free is defined as language that does not imply discrimination based on age, disability, gender, racial identity, ethnic identity, sexual orientation, socioeconomic status, and intersectionality. Exceptions may be present in the documentation due to language that is hardcoded in the user interfaces of the product software, language used based on standards documentation, or language that is used by a referenced third-party product.

Cisco and the Cisco logo are trademarks or registered trademarks of Cisco and/or its affiliates in the U.S. and other countries. To view a list of Cisco trademarks, go to this URL: <https://www.cisco.com/c/en/us/about/legal/trademarks.html>. Third-party trademarks mentioned are the property of their respective owners. The use of the word partner does not imply a partnership relationship between Cisco and any other company. (1721R)

© 2020 Cisco Systems, Inc. All rights reserved.



CONTENTS

PREFACE

Preface ix

Changes to This Document **ix**

Communications, Services, and Additional Information **ix**

CHAPTER 1

About Segment Routing 1

Scope **1**

Need **2**

Benefits **2**

Workflow for Deploying Segment Routing **3**

CHAPTER 2

Configure Segment Routing over IPv6 (SRv6) 5

Segment Routing over IPv6 Overview **5**

Configuring SRv6 under IS-IS **13**

SRv6 Services: IPv4 L3VPN **14**

SRv6 Services: IPv4 L3VPN Active-Standby Redundancy using Port-Active Mode **18**

SRv6 Services for L3VPN Active-Standby Redundancy using Port-Active Mode: Operation **19**

Configure SRv6 Services L3VPN Active-Standby Redundancy using Port-Active Mode **19**

Configuration Example **19**

Running Configuration **20**

Verification **20**

CHAPTER 3

Configure Segment Routing Global Block and Segment Routing Local Block 23

About the Segment Routing Global Block **23**

About the Segment Routing Local Block **25**

Understanding Segment Routing Label Allocation **26**

Setup a Non-Default Segment Routing Global Block Range **29**

Setup a Non-Default Segment Routing Local Block Range 30

CHAPTER 4

Configure Segment Routing for IS-IS Protocol 33

- Enabling Segment Routing for IS-IS Protocol 33
- Configuring a Prefix-SID on the IS-IS Enabled Loopback Interface 35
- Configuring an Adjacency SID 38
 - Protected Adjacency SID Backup Timer 41
 - Manually Configure a Layer 2 Adjacency SID 42
- Configuring Bandwidth-Based Local UCMP 45
- IS-IS Prefix Attributes for Extended IPv4 and IPv6 Reachability 46
 - Prefix Attribute Flags 46
 - IPv4 and IPv6 Source Router ID 47
 - Configuring Prefix Attribute N-flag-clear 48
- IS-IS Multi-Domain Prefix SID and Domain Stitching: Example 49
 - Configure IS-IS Multi-Domain Prefix SID 50
 - Configure Common Router ID 51
 - Distribute IS-IS Link-State Data 51

CHAPTER 5

Configure Segment Routing for OSPF Protocol 53

- Enabling Segment Routing for OSPF Protocol 53
- Configuring a Prefix-SID on the OSPF-Enabled Loopback Interface 55
- Configuring an Adjacency SID 57

CHAPTER 6

Configure Segment Routing for BGP 61

- Segment Routing for BGP 61
- Configure BGP Prefix Segment Identifiers 62
- Segment Routing Egress Peer Engineering 63
 - Configure Segment Routing Egress Peer Engineering 63
- Configure BGP Link-State 65
- Use Case: Configuring SR-EPE and BGP-LS 69
- Configure BGP Proxy Prefix SID 71

CHAPTER 7

Configure SR-TE Policies 75

- SR-TE Policy Overview 75

Usage Guidelines and Limitations	76
Instantiation of an SR Policy	76
On-Demand SR Policy – SR On-Demand Next-Hop	76
SR-ODN/Automated Steering Support at ASBR for L3VPN Inter-AS Option B and L3VPN Inline Route Reflector	78
SR-ODN Configuration Steps	81
Configuring SR-ODN: Examples	83
Configuring SR-ODN for EVPN-VPWS: Use Case	89
Manually Provisioned SR Policy	109
PCE-Initiated SR Policy	109
SR-TE Policy Path Types	109
Dynamic Paths	110
Optimization Objectives	110
Constraints	111
Configure SR Policy with Dynamic Path	113
Explicit Paths	114
Configure SR-TE Policy with Explicit Path	114
Configuring Explicit Path with Affinity Constraint Validation	119
Explicit Path with Affinity Constraint Validation for Anycast SIDs	121
Protocols	123
Path Computation Element Protocol	123
Configure the Head-End Router as PCEP PCC	124
BGP SR-TE	127
Configure BGP SR Policy Address Family at SR-TE Head-End	128
Traffic Steering	130
Automated Steering	130
Color-Only Automated Steering	131
Setting CO Flag	132
Address-Family Agnostic Automated Steering	133
Using Binding Segments	133
Stitching SR-TE Polices Using Binding SID: Example	134
L2VPN Preferred Path	138
Static Route over Segment Routing Policy	138
Autoroute Include	141

Policy-Based Tunnel Selection for SR-TE Policy 143

Miscellaneous 144

 LDP over Segment Routing Policy 144

 SR-TE Reoptimization Timers 147

CHAPTER 8 **Segment Routing Tree Segment Identifier 151**

 Behaviors and Limitations 154

 Configure Segment Routing Tree-SID 154

 Running Config 156

CHAPTER 9 **Enabling Segment Routing Flexible Algorithm 159**

 Prerequisites for Flexible Algorithm 159

 Building Blocks of Segment Routing Flexible Algorithm 159

 Flexible Algorithm Definition 159

 Flexible Algorithm Membership 160

 Flexible Algorithm Definition Advertisement 160

 Flexible Algorithm Prefix-SID Advertisement 160

 Calculation of Flexible Algorithm Path 160

 Installation of Forwarding Entries for Flexible Algorithm Paths 161

 Configuring Flexible Algorithm 161

 Example: Configuring IS-IS Flexible Algorithm 163

 Example: Traffic Steering to Flexible Algorithm Paths 163

 BGP Routes on PE – Color Based Steering 163

CHAPTER 10 **Configure Segment Routing Path Computation Element 169**

 About SR-PCE 169

 Configure SR-PCE 170

 Configure the Disjoint Policy (Optional) 172

 PCE-Initiated SR Policies 174

 ACL Support for PCEP Connection 175

CHAPTER 11 **Configure Performance Measurement 177**

 Measurement Modes 178

 Link Delay Measurement 179

CHAPTER 12	Configure Topology-Independent Loop-Free Alternate (TI-LFA)	191
	Usage Guidelines and Limitations	193
	Configuring TI-LFA for IS-IS	194
	Configuring TI-LFA for OSPF	196
	TI-LFA Node and SRLG Protection: Examples	198
	Configuring Global Weighted SRLG Protection	199

CHAPTER 13	Configure Segment Routing Microloop Avoidance	203
	About Segment Routing Microloop Avoidance	203
	Configure Segment Routing Microloop Avoidance for IS-IS	205
	Configure Segment Routing Microloop Avoidance for OSPF	206

CHAPTER 14	Configure Segment Routing Mapping Server	209
	Segment Routing Mapping Server	209
	Usage Guidelines and Restrictions	210
	Segment Routing and LDP Interoperability	210
	Example: Segment Routing LDP Interoperability	210
	Configuring Mapping Server	213
	Enable Mapping Advertisement	215
	Configure Mapping Advertisement for IS-IS	215
	Configure Mapping Advertisement for OSPF	216
	Enable Mapping Client	217

CHAPTER 15	Using Segment Routing Traffic Matrix	219
	Segment Routing Traffic Matrix	219
	Traffic Collector Process	219
	Configuring Traffic Collector	220
	Displaying Traffic Information	222

CHAPTER 16	Using Segment Routing OAM	225
	MPLS Ping and Traceroute for BGP and IGP Prefix-SID	225
	Examples: MPLS Ping, Traceroute, and Tree Trace for Prefix-SID	226

MPLS LSP Ping and Traceroute Nil FEC Target **228**
Examples: LSP Ping and Traceroute for Nil_FEC Target **228**
Segment Routing Ping and Traceroute **230**
 Segment Routing Ping **230**
 Segment Routing Traceroute **232**
Segment Routing Policy Nil-FEC Ping and Traceroute **234**
Segment Routing over IPv6 OAM **236**



Preface



Note This release has reached end-of-life status. For more information, see the [End-of-Life and End-of-Sale Notices](#).

From Release 6.1.2 onwards, Cisco introduces support for the 64-bit Linux-based IOS XR operating system. Extensive feature parity is maintained between the 32-bit and 64-bit environments. Unless explicitly marked otherwise, the contents of this document are applicable for both the environments. For more details on Cisco IOS XR 64 bit, refer to the [Release Notes](#) for Cisco ASR 9000 Series Routers, Release 6.1.2 document.

The *Segment Routing Configuration Guide for Cisco ASR 9000 Series Aggregation Services Routers* preface contains these sections:

- [Changes to This Document, on page ix](#)
- [Communications, Services, and Additional Information, on page ix](#)

Changes to This Document

This table lists the changes made to this document since it was first printed.

Date	Change Summary
January 2020	Initial release of this document
September 2020	Republished for Release 6.7.2

Communications, Services, and Additional Information

- To receive timely, relevant information from Cisco, sign up at [Cisco Profile Manager](#).
- To get the business impact you're looking for with the technologies that matter, visit [Cisco Services](#).
- To submit a service request, visit [Cisco Support](#).
- To discover and browse secure, validated enterprise-class apps, products, solutions and services, visit [Cisco Marketplace](#).

- To obtain general networking, training, and certification titles, visit [Cisco Press](#).
- To find warranty information for a specific product or product family, access [Cisco Warranty Finder](#).

Cisco Bug Search Tool

[Cisco Bug Search Tool](#) (BST) is a web-based tool that acts as a gateway to the Cisco bug tracking system that maintains a comprehensive list of defects and vulnerabilities in Cisco products and software. BST provides you with detailed defect information about your products and software.



CHAPTER 1

About Segment Routing



Note Segment Routing is not supported on 1st generation Cisco ASR 9000 Ethernet Line Cards or the Cisco ASR 9000 SIP-700 SPA Interface Processor. Refer to the [Cisco ASR 9000 Ethernet Line Card Installation Guide](#) for details about 1st generation line cards.

This chapter introduces the concept of segment routing and provides a workflow for configuring segment routing.

- [Scope, on page 1](#)
- [Need, on page 2](#)
- [Benefits, on page 2](#)
- [Workflow for Deploying Segment Routing, on page 3](#)

Scope

Segment routing is a method of forwarding packets on the network based on the source routing paradigm. The source chooses a path and encodes it in the packet header as an ordered list of segments. Segments are an identifier for any type of instruction. For example, topology segments identify the next hop toward a destination. Each segment is identified by the segment ID (SID) consisting of a flat unsigned 20-bit integer.

Segments

Interior gateway protocol (IGP) distributes two types of segments: prefix segments and adjacency segments. Each router (node) and each link (adjacency) has an associated segment identifier (SID).

- A prefix SID is associated with an IP prefix. The prefix SID is manually configured from the segment routing global block (SRGB) range of labels, and is distributed by IS-IS or OSPF. The prefix segment steers the traffic along the shortest path to its destination. A node SID is a special type of prefix SID that identifies a specific node. It is configured under the loopback interface with the loopback address of the node as the prefix.

A prefix segment is a global segment, so a prefix SID is globally unique within the segment routing domain.

- An adjacency segment is identified by a label called an adjacency SID, which represents a specific adjacency, such as egress interface, to a neighboring router. An adjacency SID can be allocated dynamically from the dynamic label range or configured manually from the segment routing local block (SRLB) range

of labels. The adjacency SID is distributed by IS-IS or OSPF. The adjacency segment steers the traffic to a specific adjacency.

An adjacency segment is a local segment, so the adjacency SID is locally unique relative to a specific router.

By combining prefix (node) and adjacency segment IDs in an ordered list, any path within a network can be constructed. At each hop, the top segment is used to identify the next hop. Segments are stacked in order at the top of the packet header. When the top segment contains the identity of another node, the receiving node uses equal cost multipaths (ECMP) to move the packet to the next hop. When the identity is that of the receiving node, the node pops the top segment and performs the task required by the next segment.

Dataplane

Segment routing can be directly applied to the Multiprotocol Label Switching (MPLS) architecture with no change in the forwarding plane. A segment is encoded as an MPLS label. An ordered list of segments is encoded as a stack of labels. The segment to process is on the top of the stack. The related label is popped from the stack, after the completion of a segment.

Services

Segment Routing integrates with the rich multi-service capabilities of MPLS, including Layer 3 VPN (L3VPN), Virtual Private Wire Service (VPWS), Virtual Private LAN Service (VPLS), and Ethernet VPN (EVPN).

Segment Routing for Traffic Engineering

Segment routing for traffic engineering (SR-TE) takes place through a policy between a source and destination pair. Segment routing for traffic engineering uses the concept of source routing, where the source calculates the path and encodes it in the packet header as a segment. Each segment is an end-to-end path from the source to the destination, and instructs the routers in the provider core network to follow the specified path instead of the shortest path calculated by the IGP. The destination is unaware of the presence of the policy.

Need

With segment routing for traffic engineering (SR-TE), the network no longer needs to maintain a per-application and per-flow state. Instead, it simply obeys the forwarding instructions provided in the packet.

SR-TE utilizes network bandwidth more effectively than traditional MPLS-TE networks by using ECMP at every segment level. It uses a single intelligent source and relieves remaining routers from the task of calculating the required path through the network.

Benefits

- **Ready for SDN:** Segment routing was built for SDN and is the foundation for Application Engineered Routing (AER). SR prepares networks for business models, where applications can direct network behavior. SR provides the right balance between distributed intelligence and centralized optimization and programming.
- **Minimal configuration:** Segment routing for TE requires minimal configuration on the source router.

- **Load balancing:** Unlike in RSVP-TE, load balancing for segment routing can take place in the presence of equal cost multiple paths (ECMPs).
- **Supports Fast Reroute (FRR):** Fast reroute enables the activation of a pre-configured backup path within 50 milliseconds of path failure.
- **Plug-and-Play deployment:** Segment routing policies are interoperable with existing MPLS control and data planes and can be implemented in an existing deployment.

Workflow for Deploying Segment Routing

Follow this workflow to deploy segment routing.

1. Configure the Segment Routing Global Block (SRGB)
2. Enable Segment Routing and Node SID for the IGP
3. Configure Segment Routing for BGP
4. Configure the SR-TE Policy
5. Configure TI-LFA and Microloop Avoidance
6. Configure the Segment Routing Mapping Server
7. Collect Traffic Statistics



CHAPTER 2

Configure Segment Routing over IPv6 (SRv6)

Segment Routing for IPv6 (SRv6) is the implementation of Segment Routing over the IPv6 dataplane.

- [Segment Routing over IPv6 Overview, on page 5](#)
- [Configuring SRv6 under IS-IS, on page 13](#)
- [SRv6 Services: IPv4 L3VPN, on page 14](#)
- [SRv6 Services: IPv4 L3VPN Active-Standby Redundancy using Port-Active Mode, on page 18](#)

Segment Routing over IPv6 Overview

Segment Routing (SR) can be applied on both MPLS and IPv6 data planes. Segment Routing over IPv6 (SRv6) extends Segment Routing support with IPv6 data plane.

In an SR-MPLS enabled network, an MPLS label represents an instruction. The source nodes programs the path to a destination in the packet header as a stack of labels.

SRv6 introduces the Network Programming framework that enables a network operator or an application to specify a packet processing program by encoding a sequence of instructions in the IPv6 packet header. Each instruction is implemented on one or several nodes in the network and identified by an SRv6 Segment Identifier (SID) in the packet. The SRv6 Network Programming framework is defined in [IETF RFC 8986 SRv6 Network Programming](#).

In SRv6, an IPv6 address represents an instruction. SRv6 uses a new type of IPv6 Routing Extension Header, called the Segment Routing Header (SRH), in order to encode an ordered list of instructions. The active segment is indicated by the destination address of the packet, and the next segment is indicated by a pointer in the SRH.

Figure 1: Network Program in the Packet Header

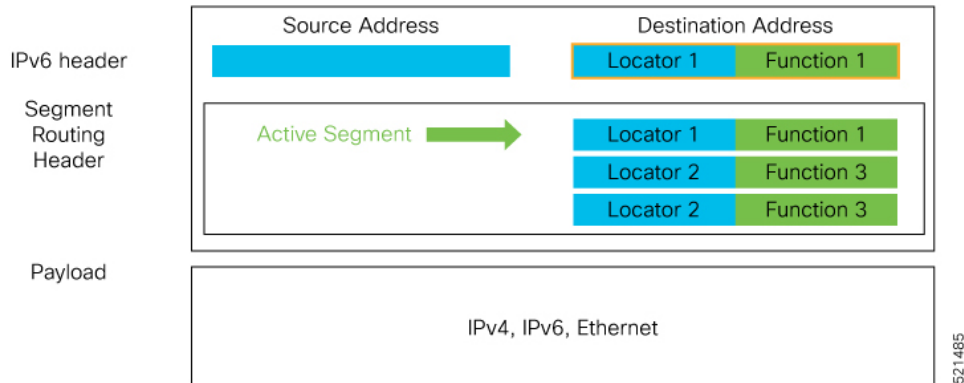

The SRv6 SRH is documented in IETF RFC [IPv6 Segment Routing Header \(SRH\)](#).

The SRH is defined as follows:

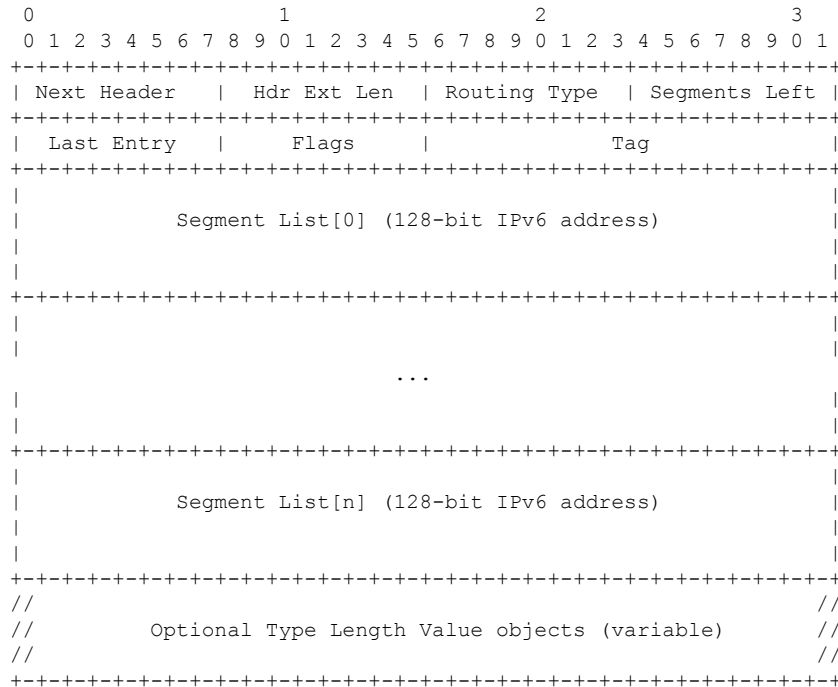

The following list explains the fields in SRH:

- Next header—Identifies the type of header immediately following the SRH.
- Hdr Ext Len (header extension length)—The length of the SRH in 8-octet units, not including the first 8 octets.
- Segments left—Specifies the number of route segments remaining. That means, the number of explicitly listed intermediate nodes still to be visited before reaching the final destination.
- Last Entry—Contains the index (zero based) of the last element of the segment list.

- Flags— Contains 8 bits of flags.
- Tag—Tag a packet as part of a class or group of packets like packets sharing the same set of properties.
- Segment list—128-bit IPv6 addresses representing the *n*th segment in the segment list. The segment list encoding starts from the last segment of the SR policy (path). That means the first element of the segment list (Segment list [0]) contains the last segment of the SR policy, the second element contains the penultimate segment of the SR policy and so on.

In SRv6, a SID represents a 128-bit value, consisting of the following three parts:

- Locator: This is the first part of the SID with most significant bits and represents an address of a specific SRv6 node.
- Function: This is the portion of the SID that is local to the owner node and designates a specific SRv6 function (network instruction) that is executed locally on a particular node, specified by the locator bits.
- Args: This field is optional and represents optional arguments to the function.

The locator part can be further divided into two parts:

- SID Block: This field is the SRv6 network designator and is a fixed or known address space for an SRv6 domain. This is the most significant bit (MSB) portion of a locator subnet.
- Node Id: This field is the node designator in an SRv6 network and is the least significant bit (LSB) portion of a locator subnet.

SRv6 Node Roles

Each node along the SRv6 packet path has a different functionality:

- Source node—A node that can generate an IPv6 packet with an SRH (an SRv6 packet), or an ingress node that can impose an SRH on an IPv6 packet.
- Transit node—A node along the path of the SRv6 packet (IPv6 packet and SRH). The transit node does not inspect the SRH. The destination address of the IPv6 packet does not correspond to the transit node.
- Endpoint node—A node in the SRv6 domain where the SRv6 segment is terminated. The destination address of the IPv6 packet with an SRH corresponds to the end point node. The segment endpoint node executes the function bound to the SID

SRv6 Head-End Behaviors

The SR Headend with Encapsulation behaviors are documented in the [IETF RFC 8986 SRv6 Network Programming](#).

The SR Headend with Insertion head-end behaviors are documented in the following IETF draft:

<https://datatracker.ietf.org/doc/draft-filsfils-spring-srv6-net-pgm-insertion/>

This section describes a set of SR Policy headend behaviors. The following list summarizes them:

- H.Encaps—SR Headend Behavior with Encapsulation in an SRv6 Policy
- H.Encaps.Red—H.Encaps with Reduced Encapsulation
- H.Insert—SR Headend with insertion of an SRv6 Policy

- H.Insert.Red—H.Insert with reduced insertion

SRv6 Endpoint Behaviors

The SRv6 endpoint behaviors are documented in the [IETF RFC 8986 SRv6 Network Programming](#).

The following is a subset of defined SRv6 endpoint behaviors that can be associated with a SID.

- End—Endpoint function. The SRv6 instantiation of a Prefix SID [[RFC8402](#)].
- End.X—Endpoint with Layer-3 cross-connect. The SRv6 instantiation of an Adj SID [[RFC8402](#)].
- End.DX6—Endpoint with decapsulation and IPv6 cross-connect (IPv6-L3VPN - equivalent to per-CE VPN label).
- End.DX4—Endpoint with decapsulation and IPv4 cross-connect (IPv4-L3VPN - equivalent to per-CE VPN label).
- End.DT6—Endpoint with decapsulation and IPv6 table lookup (IPv6-L3VPN - equivalent to per-VRF VPN label).
- End.DT4—Endpoint with decapsulation and IPv4 table lookup (IPv4-L3VPN - equivalent to per-VRF VPN label).
- End.DT46—Endpoint with decapsulation and specific IP table lookup (IP-L3VPN - equivalent to per-VRF VPN label).
- End.DX2—Endpoint with decapsulation and L2 cross-connect (L2VPN use-case).
- End.B6.Encaps—Endpoint bound to an SRv6 policy with encapsulation. SRv6 instantiation of a Binding SID.
- End.B6.Encaps.RED—End.B6.Encaps with reduced SRH. SRv6 instantiation of a Binding SID.

SRv6 Endpoint Behavior Variants

Depending on how the SRH is handled, different behavior variants are defined for the End and End.X behaviors. The End and End.X behaviors can support these variants, either individually or in combinations.

- **Penultimate Segment Pop (PSP) of the SRH variant**—An SR Segment Endpoint Nodes receive the IPv6 packet with the Destination Address field of the IPv6 Header equal to its SID address.

A penultimate SR Segment Endpoint Node is one that, as part of the SID processing, copies the last SID from the SRH into the IPv6 Destination Address and decrements the Segments Left value from one to zero.

The PSP operation takes place only at a penultimate SR Segment Endpoint Node and does not happen at non-penultimate endpoint nodes. When a SID of PSP-flavor is processed at a non-penultimate SR Segment Endpoint Node, the PSP behavior is not performed since Segments Left would not be zero.

The SR Segment Endpoint Nodes advertise the SIDs instantiated on them via control plane protocols. A PSP-flavored SID is used by the Source SR Node when it needs to instruct the penultimate SR Segment Endpoint Node listed in the SRH to remove the SRH from the IPv6 header.

- **Ultimate Segment Pop (USP) of the SRH variant**—The SRH processing of the End and End.X behaviors are modified as follows:

If Segments Left is 0, then:

1. Update the Next Header field in the preceding header to the Next Header value of the SRH
2. Decrease the IPv6 header Payload Length by $8 * (\text{Hdr Ext Len} + 1)$
3. Remove the SRH from the IPv6 extension header chain
4. Proceed to process the next header in the packet

One of the applications of the USP flavor is when a packet with an SRH is destined to an application on hosts with smartNICs implementing SRv6. The USP flavor is used to remove the consumed SRH from the extension header chain before sending the packet to the host.

- **Ultimate Segment Decapsulation (USD) variant**—The Upper-layer header processing of the End and End.X behaviors are modified as follows:

- **End** behavior: If the Upper-layer Header type is 41 (IPv6), then:
 1. Remove the outer IPv6 Header with all its extension headers
 2. Submit the packet to the egress IPv6 FIB lookup and transmission to the new destination
 3. Else, if the Upper-layer Header type is 4 (IPv4)
 4. Remove the outer IPv6 Header with all its extension headers
 5. Submit the packet to the egress IPv4 FIB lookup and transmission to the new destination
 6. Else, process as per Section 4.1.1 (Upper-Layer Header) of [IETF RFC 8986 SRv6 Network Programming](#)
- **End.X** behavior: If the Upper-layer Header type is 41 (IPv6) or 4 (IPv4), then:
 1. Remove the outer IPv6 Header with all its extension headers
 2. Forward the exposed IP packet to the L3 adjacency J
 3. Else, process as per Section 4.1.1 (Upper-Layer Header) of [IETF RFC 8986 SRv6 Network Programming](#)

One of the applications of the USD flavor is the case of TI-LFA in P routers with encapsulation with H.Encaps. The USD flavor allows the last Segment Endpoint Node in the repair path list to decapsulate the IPv6 header added at the TI-LFA Point of Local Repair and forward the inner packet.

Usage Guidelines and Limitations

General Guidelines and Limitations

- Cisco IOS XR supports the following SRv6 SID behaviors and variants:
 - END with PSP
 - END.X with PSP
 - END.DT4
 - END.DT6
- SRv6 Underlay support includes:

- IGP redistribution/leaking between levels
- Prefix Summarization on ABR routers
- IS-IS TI-LFA
- Microloop Avoidance
- Flex-algo

Configuring SRv6

To enable SRv6 globally, you should first configure a locator with its prefix. The IS-IS protocol announces the locator prefix in IPv6 network and SRv6 applications (like ISIS, BGP) use it to allocate SIDs.

The following usage guidelines and restrictions apply while configuring SRv6.

- All routers in the SRv6 domain should have the same SID block (network designator) in their locator.
- The locator length should be 64-bits long.
 - The SID block portion (MSBs) cannot exceed 40 bits. If this value is less than 40 bits, user should use a pattern of zeros as a filler.
 - The Node Id portion (LSBs) cannot exceed 24 bits.
- You can configure up to 8 locators to support SRv6 Flexible Algorithm. All locators prefix must share the same SID block (first 40-bits).

Enabling SRv6 with Locator

This example shows how to globally enable SRv6 and configure locator.

```
Router(config)# segment-routing srv6
Router(config-srv6)# locators
Router(config-srv6-locators)# locator myLoc1
Router(config-srv6-locator)# prefix 2001:db8:0:a2::/64
```

Optional: Configuring Encapsulation Parameters

This example shows how to configure encapsulation parameters when configuring SRv6. These optional parameters include:

- Source Address of outer encapsulating IPv6 header: The default source address for encapsulation is one of the loopback addresses.
- The hop limit of outer-encapsulating IPv6 header. The range is from 1 to 255; the default value for hop-limit is 255.

```
Router(config)# segment-routing srv6
Router(config-srv6)# encapsulation source-address 1::1
Router(config-srv6)# hop-limit 60
```

Optional: Enabling Syslog Logging for Locator Status Changes

This example shows how to enable the logging of locator status.

```
Router(config)# segment-routing srv6
Router(config-srv6)# logging locator status
```

Verifying SRv6 Manager

This example shows how to verify the overall SRv6 state from SRv6 Manager point of view. The output displays parameters in use, summary information, and platform specific capabilities.

```

Router# show segment-routing srv6 manager
Parameters:
  Parameters:
    SRv6 Enabled: Yes
    SRv6 Operational Mode:
      Base:
        SID Base Block: 2001:db8::/40
  Encapsulation:
    Source Address:
      Configured: 1::1
      Default: 5::5
    Hop-Limit: Default
    Traffic-class: Default
Summary:
  Number of Locators: 1 (1 operational)
  Number of SIDs: 4 (0 stale)
  Max SIDs: 64000
  OOR:
    Thresholds: Green 3200, Warning 1920
    Status: Resource Available
      History: (0 cleared, 0 warnings, 0 full)
    Block 2001:db8:0:a2::/64:
      Number of SIDs free: 65470
      Max SIDs: 65470
      Thresholds: Green 3274, Warning 1965
      Status: Resource Available
      History: (0 cleared, 0 warnings, 0 full)
Platform Capabilities:
  SRv6: Yes
  TILFA: Yes
  Microloop-Avoidance: Yes
  Endpoint behaviors:
    End (PSP)
    End.X (PSP)
    End.DX6
    End.DX4
    End.DT6
    End.DT4
    End.DX2
    End.OP
    uN (PSP/USD)
    uA (PSP/USD)
    uDT6
    uDT4
    uDX2
    uB6 (Insert.Red)
  Headend behaviors:
    T
    H.Insert.Red
    H.Encaps.Red
  Security rules:
    SEC-1
    SEC-2
    SEC-3
  Counters:
    CNT-1
    CNT-3
  Signaled parameters:

```

```

Max-SL          : 3
Max-End-Pop-SRH : 3
Max-H-Insert    : 3 sids
Max-H-Encap     : 3 sids
Max-End-D       : 4
Configurable parameters (under srv6):
Encapsulation:
  Source Address: Yes
  Hop-Limit     : value=Yes, propagate=No
  Traffic-class : value=Yes, propagate=Yes
Max SIDs: 64000
SID Holdtime: 3 mins

```

Verifying SRv6 Locator

This example shows how to verify the locator configuration and its operational status.

```

Router# show segment-routing srv6 locator myLoc1 detail
Name          ID      Prefix          Status
-----
myLoc1*       5      2001:db8:0:a2::/64  Up
  (*): is-default
  Interface:
    Name: srv6-myLoc1
    IFH : 0x00000170
    IPv6 address: 2001:db8:0:a2::/64
    Chkpt Obj ID: 0x2fc8
    Created: Apr 25 06:21:57.077 (00:03:37 ago)

```

Verifying SRv6 SIDs

This example shows how to verify the allocation of SRv6 local SIDs off locator(s).

```

Router# show segment-routing srv6 locator myLoc1 sid

SID          State  RW          Function      Context          Owner
-----
2001:db8:0:a2:1::      InUse  Y          End (PSP)     'default':1     sidmgr
2001:db8:0:a2:40::     InUse  Y          End.DT4       'VRF1'          bgp-100
2001:db8:0:a2:41::     InUse  Y          End.X (PSP)   [Hu0/1/0/1, Link-Local]  isis-srv6

```

The following example shows how to display detail information regarding an allocated SRv6 local SID.

```

Router# show segment-routing srv6 locator myLoc1 sid 2001:db8:0:a2:40:: detail

SID          State  RW          Function      Context          Owner
-----
2001:db8:0:a2:40::     InUse  Y          End.DT4       'VRF1'          bgp-100
  SID context: { table-id=0xe0000011 ('VRF1':IPv4/Unicast) }
  Locator: myLoc1'

```

```
Allocation type: Dynamic
Created: Feb  1 14:04:02.901 (3d00h ago)
```

Similarly, you can display SID information across locators by using the **show segment-routing sid** command.

show Commands

You can use the following **show** commands to verify the SRv6 global and locator configuration:

Command	Description
show segment-routing srv6 manager	Displays the summary information from SRv6 manager, including platform capabilities.
show segment-routing srv6 locator <i>locator-name</i> [detail]	Displays the SRv6 locator information on the router.
show segment-routing srv6 locator <i>locator-name sid</i> [<i>sid-ipv6-address</i> [detail]]	Displays the information regarding SRv6 local SID(s) allocated from a given locator.
show segment-routing srv6 sid [<i>sid-ipv6-address</i> all stale] [detail]	Displays SID information across locators. By default, only “active” (i.e. non-stale) SIDs are displayed.
show route ipv6 local-srv6	Displays all SRv6 local-SID prefixes in IPv6 RIB.

Configuring SRv6 under IS-IS

Intermediate System-to-Intermediate System (IS-IS) protocol already supports segment routing with MPLS dataplane (SR-MPLS). This feature enables extensions in IS-IS to support Segment Routing with IPv6 data plane (SRv6). The extensions include advertising the SRv6 capabilities of nodes and node and adjacency segments as SRv6 SIDs.

SRv6 IS-IS performs the following functionalities:

1. Interacts with SID Manager to learn local locator prefixes and announces the locator prefixes in the IGP domain.
2. Learns remote locator prefixes from other IS-IS neighbor routers and installs the learned remote locator IPv6 prefix in RIB or FIB.
3. Allocate or learn prefix SID and adjacency SIDs, create local SID entries, and advertise them in the IGP domain.

Usage Guidelines and Restrictions

The following usage guidelines and restrictions apply for SRv6 IS-IS:

- An IS-IS address-family can support either SR-MPLS or SRv6, but both at the same time is not supported.

Configuring SRv6 under IS-IS

To configure SRv6 IS-IS, use the following command:

- **router isis** *instance* **address-family ipv6 unicast segment-routing srv6 locator** *locator* [**level** {**1** | **2**}]—Enable SRv6 under the IS-IS IPv6 address-family and assign SRv6 locator(s) to it. Use the **level** {**1** | **2**} keywords to advertise the locator only in the specified IS-IS level.

The following example shows how to configure SRv6 under IS-IS.

```
Router(config)# router isis core
Router(config-isis)# address-family ipv6 unicast
Router(config-isis-af)# segment-routing srv6
Router(config-isis-srv6)# locator myLoc1 level 1
Router(config-isis-srv6-loc)# exit
```

For more information about configuring IS-IS, refer to the "[Implementing IS-IS](#)" chapter in the *Routing Configuration Guide for Cisco ASR 9000*.

SRv6 Services: IPv4 L3VPN

The SRv6-based IPv4 L3VPN feature enables deployment of IPv4 L3VPN over a SRv6 data plane. Traditionally, it was done over an MPLS-based system. SRv6-based L3VPN uses SRv6 Segment IDs (SIDs) for service segments instead of labels. SRv6-based L3VPN functionality interconnects multiple sites to resemble a private network service over public infrastructure. To use this feature, you must configure SRv6-base.

For this feature, BGP allocates an SRv6 SID from the locator space, configured under SRv6-base and VPNv4 address family. For more information on this, refer [Segment Routing over IPv6 Overview, on page 5](#). The BGP SID can be allocated in the following ways:

- Per-VRF mode that provides End.DT4 support. End.DT4 represents the Endpoint with decapsulation and IPv4 table lookup.
- Per-CE mode that provides End.DX4 cross connect support. End.DX4 represents the Endpoint with decapsulation and IPv4 cross-connect.

BGP encodes the SRv6 SID in the prefix-SID attribute of the IPv4 L3VPN Network Layer Reachability Information (NLRI) and advertises it to IPv6 peering over an SRv6 network. The Ingress PE (provider edge) router encapsulates the VRF IPv4 traffic with the SRv6 VPN SID and sends it over the SRv6 network.

Usage Guidelines and Limitations

- SRv6 locator can be assigned globally, for all VRFs, or for an individual VRF.
- Equal-Cost Multi-path (ECMP) and Unequal Cost Multipath (UCMP) are supported.
- BGP, OSPF, Static are supported as PE-CE protocol.
- MPLS L3VPN and SRv6 L3VPN interworking gateway is not supported.

Configuring SRv6 based IPv4 L3VPN

To enable SRv6-based L3VPN, you need to configure SRv6 under BGP and configure the SID allocation mode. The following example shows how to configure SRv6-based L3VPN:

Configure an Individual VRF with Per-VRF Label Allocation Mode

```
RP/0/0/CPU0:Router(config-bgp-af)# vrf vrf1
RP/0/0/CPU0:Router(config-bgp-vrf)# rd 106:1
RP/0/0/CPU0:Router(config-bgp-vrf)# address-family ipv4 unicast
RP/0/0/CPU0:Router(config-bgp-vrf-af)# segment-routing srv6
RP/0/0/CPU0:Router(config-bgp-vrf-af-srv6)# alloc mode per-vrf
RP/0/0/CPU0:Router(config-bgp-vrf-af-srv6)# exit
RP/0/0/CPU0:Router(config-bgp-vrf-af)# exit
RP/0/0/CPU0:Router(config-bgp-vrf)# neighbor 10.1.2.2
RP/0/0/CPU0:Router(config-bgp-vrf-nbr)# remote-as 100
RP/0/0/CPU0:Router(config-bgp-vrf-nbr)# address-family ipv4 unicast
```

Configure an Individual VRF with Per-CE Label Allocation Mode

```
RP/0/0/CPU0:Router(config-bgp-af)# vrf vrf2
RP/0/0/CPU0:Router(config-bgp-vrf)# rd 106:2
RP/0/0/CPU0:Router(config-bgp-vrf)# address-family ipv4 unicast
RP/0/0/CPU0:Router(config-bgp-vrf-af)# segment-routing srv6
RP/0/0/CPU0:Router(config-bgp-vrf-af-srv6)# alloc mode per-ce
RP/0/0/CPU0:Router(config-bgp-vrf-af-srv6)# exit
RP/0/0/CPU0:Router(config-bgp-vrf-af)# exit
RP/0/0/CPU0:Router(config-bgp-vrf)# neighbor 10.1.2.2
RP/0/0/CPU0:Router(config-bgp-vrf-nbr)# remote-as 100
RP/0/0/CPU0:Router(config-bgp-vrf-nbr)# address-family ipv4 unicast
```

Verification

The following example shows how to verify the SRv6 based L3VPN configuration using the **show segment-routing srv6 sid** command.

In this example, End.X represents Endpoint function with Layer-3 cross-connect, End.DT4 represents Endpoint with decapsulation and IPv4 table lookup, and End.DX4 represents Endpoint with decapsulation and IPv4 cross-connect.

```
RP/0/0/CPU0:SRv6-Hub6# show segment-routing srv6 sid
*** Locator: 'my_locator' ***
SID          State  RW          Function      Context          Owner
-----
-----
-----
cafe:0:0:66:1::      InUse  Y          End (PSP)     'my_locator':1  sidmgr
cafe:0:0:66:40::    InUse  Y          End.X (PSP)   [Te0/0/0/2, Link-Local]  isis-srv6
cafe:0:0:66:41::    InUse  Y          End.X (PSP)   [BE6801, Link-Local]    isis-srv6
cafe:0:0:66:42::    InUse  Y          End.X (PSP)   [BE5601, Link-Local]    isis-srv6
cafe:0:0:66:43::    InUse  Y          End.X (PSP)   [BE5602, Link-Local]    isis-srv6
cafe:0:0:66:44::    InUse  Y          End.DT4       'VRF1'          bgp-100
cafe:0:0:66:45::    InUse  Y          End.DT4       'VRF2'          bgp-100
cafe:0:0:66:46::    InUse  Y          End.DX4       'VRF2':3        bgp-100
cafe:0:0:66:47::    InUse  Y          End.DX4       'VRF2':4        bgp-100
```

The following example shows how to verify the SRv6 based L3VPN configuration using the **show segment-routing srv6SID-prefixdetail** command.

```
RP/0/RP0/CPU0:SRv6-Hub6# show segment-routing srv6 sid cafe:0:0:66:44:: detail
Sun Dec 9 16:52:54.015 EST
*** Locator: 'my_locator' ***
SID                               Function      Context      Owner
  State  RW
-----  --
cafe:0:0:66:44::                  End.DT4      'VRF1'       bgp-100
  InUse  Y
  SID context: { table-id=0xe0000001 ('VRF1':IPv4/Unicast) }
  Locator: 'my_locator'
  Allocation type: Dynamic
  Created: Dec 8 16:34:32.506 (1d00h ago)

RP/0/RP0/CPU0:SRv6-Hub6# show segment-routing srv6 sid cafe:0:0:66:47:: detail
Sun Dec 9 16:54:26.073 EST
*** Locator: 'my_locator' ***
SID                               Function      Context      Owner
  State  RW
-----  --
cafe:0:0:66:47::                  End.DX4      'VRF2':4     bgp-100
  InUse  Y
  SID context: { table-id=0xe0000002 ('VRF2':IPv4/Unicast), nh-set-id=4 }
  Locator: 'my_locator'
  Allocation type: Dynamic
  Created: Dec 9 16:49:44.714 (00:04:41 ago)
```

The following example shows how to verify the SRv6 based L3VPN configuration using the **show bgp vpnv4 unicast rdroute-distinguisher/prefix** command on Egress PE.

```
RP/0/RP0/CPU0:SRv6-Hub6# show bgp vpnv4 unicast rd 106:1 10.15.0.0/30
Wed Nov 21 16:08:44.765 EST
BGP routing table entry for 10.15.0.0/30, Route Distinguisher: 106:1
Versions:
  Process          bRIB/RIB  SendTblVer
  Speaker          2282449   2282449
    SRv6-VPN SID: cafe:0:0:66:44::/128
Last Modified: Nov 21 15:50:34.235 for 00:18:10
Paths: (2 available, best #1)
  Advertised to peers (in unique update groups):
    2::2
  Path #1: Received by speaker 0
  Advertised to peers (in unique update groups):
    2::2
  200
    10.1.2.2 from 10.1.2.2 (10.7.0.1)
      Origin IGP, localpref 200, valid, internal, best, group-best, import-candidate
      Received Path ID 0, Local Path ID 1, version 2276228
      Extended community: RT:201:1
  Path #2: Received by speaker 0
  Not advertised to any peer
  200
    10.2.2.2 from 10.2.2.2 (10.20.1.2)
      Origin IGP, localpref 100, valid, internal
      Received Path ID 0, Local Path ID 0, version 0
      Extended community: RT:201:1
```

The following example shows how to verify the SRv6 based L3VPN configuration using the **show bgp vpnv4 unicast rdroute-distinguisher prefix** command on Ingress PE.

```

RP/0/RP0/CPU0:SRv6-LF1# show bgp vpnv4 unicast rd 106:1 10.15.0.0/30
Wed Nov 21 16:11:45.538 EST
BGP routing table entry for 10.15.0.0/30, Route Distinguisher: 106:1
Versions:
  Process          bRIB/RIB   SendTblVer
  Speaker          2286222   2286222
Last Modified: Nov 21 15:47:26.288 for 00:24:19
Paths: (1 available, best #1)
  Not advertised to any peer
  Path #1: Received by speaker 0
  Not advertised to any peer
  200, (received & used)
    6::6 (metric 24) from 2::2 (6.6.6.6)
      Received Label 3
      Origin IGP, localpref 200, valid, internal, best, group-best, import-candidate,
not-in-vrf
      Received Path ID 1, Local Path ID 1, version 2286222
      Extended community: RT:201:1
      Originator: 6.6.6.6, Cluster list: 2.2.2.2
      SRv6-VPN-SID: T1-cafe:0:0:66:44:: [total 1]

```

The following example shows how to verify the SRv6 based L3VPN configuration using the **show route vrfvrf-name/prefixdetail** command.

```

RP/0/RP0/CPU0:SRv6-LF1# show route vrf VRF1 10.15.0.0/30 detail
Wed Nov 21 16:35:17.775 EST
Routing entry for 10.15.0.0/30
  Known via "bgp 100", distance 200, metric 0
  Tag 200, type internal
  Installed Nov 21 16:35:14.107 for 00:00:03
  Routing Descriptor Blocks
    6::6, from 2::2
      Nexthop in Vrf: "default", Table: "default", IPv6 Unicast, Table Id: 0xe0800000
      Route metric is 0
      Label: None
      Tunnel ID: None
      Binding Label: None
      Extended communities count: 0
      Source RD attributes: 0x0000:106:1
      NHID:0x0(Ref:0)
      SRv6 Headend: H.Encaps.Red [base], SID-list { cafe:0:0:66:44:: }
      MPLS eid:0x13806000000001
  Route version is 0xd (13)
  No local label
  IP Precedence: Not Set
  QoS Group ID: Not Set
  Flow-tag: Not Set
  Fwd-class: Not Set
  Route Priority: RIB_PRIORITY_RECURSIVE (12) SVD Type RIB_SVD_TYPE_REMOTE
  Download Priority 3, Download Version 3038384
  No advertising protos.

```

The following example shows how to verify the SRv6 based L3VPN configuration for per-ce allocation mode using the **show bgp vrfvrf-namexthop-set** command.

```

RP/0/RP0/CPU0:SRv6-Hub6# show bgp vrf VRF2 nexthop-set
Wed Nov 21 15:52:17.464 EST
Resilient per-CE nexthop set, ID 3
Number of nexthops 1, Label 0, Flags 0x2200
SRv6-VPN SID: cafe:0:0:66:46:/128
Nexthops:
10.1.2.2

```

```

Reference count 1,
Resilient per-CE nexthop set, ID 4
Number of nexthops 2, Label 0, Flags 0x2100
SRv6-VPN SID: cafe:0:0:66:47::/128
Nexthops:
10.1.2.2
10.2.2.2
Reference count 2,

```

The following example shows how to verify the SRv6 based L3VPN configuration using the **show cef vrfvrf-name prefix detail locationline-card** command.

```

RP/0/RP0/CPU0:SRv6-LF1# show cef vrf VRF1 10.15.0.0/30 detail location 0/0/cpu0
Wed Nov 21 16:37:06.894 EST
151.1.0.0/30, version 3038384, SRv6 Transit, internal 0x5000001 0x0 (ptr 0x9ae6474c) [1],
0x0 (0x0), 0x0 (0x8c11b238)
Updated Nov 21 16:35:14.109
Prefix Len 30, traffic index 0, precedence n/a, priority 3
gateway array (0x8cd85190) reference count 1014, flags 0x2010, source rib (7), 0 backups
[1 type 3 flags 0x40441 (0x8a529798) ext 0x0 (0x0)]
LW-LDI[type=0, refc=0, ptr=0x0, sh-ldi=0x0]
gateway array update type-time 1 Nov 21 14:47:26.816
LDI Update time Nov 21 14:52:53.073
Level 1 - Load distribution: 0
[0] via cafe:0:0:66::/128, recursive
via cafe:0:0:66::/128, 7 dependencies, recursive [flags 0x6000]
path-idx 0 NHID 0x0 [0x8acb53cc 0x0]
next hop VRF - 'default', table - 0xe0800000
next hop cafe:0:0:66::/128 via cafe:0:0:66::/64
SRv6 H.Encaps.Red SID-list {cafe:0:0:66:44::}
Load distribution: 0 (refcount 1)
Hash OK Interface Address
0 Y Bundle-Ether1201 fe80::2

```

SRv6 Services: IPv4 L3VPN Active-Standby Redundancy using Port-Active Mode

The Segment Routing IPv6 (SRv6) Services: IPv4 L3VPN Active-Standby Redundancy using Port-Active Mode feature provides all-active per-port load balancing for multihoming. The forwarding of traffic is determined based on a specific interface rather than per-flow across multiple Provider Edge routers. This feature enables efficient load-balancing and provides faster convergence. In an active-standby scenario, the active PE router is detected using designated forwarder (DF) election by modulo calculation and the interface of the standby PE router brought down. For Modulo calculation, byte 10 of the Ethernet Segment Identifier (ESI) is used.

Usage Guidelines and Restrictions

- This feature can only be configured for bundle interfaces.
- When an EVPN Ethernet Segment (ES) is configured with port-active load-balancing mode, you cannot configure ACs of that bundle on bridge-domains with a configured EVPN instance (EVI). EVPN Layer 2 bridging service is not compatible with port-active load-balancing.

SRv6 Services for L3VPN Active-Standby Redundancy using Port-Active Mode: Operation

Under port-active operational mode, EVPN Ethernet Segment (ES) routes are exchanged across BGP for the routers servicing the multihomed ES. Each PE router then builds an ordered list of the IP addresses of all PEs connected to the ES, including itself, and assigns itself an ordinal for its position in the list. The ordinals are used with the modulo calculation to determine which PE will be the Designated Forwarder (DF) for a given ES. All non-DF PEs will take the respective bundles out of service.

In the case of link or port failure, the active DF PE withdraws its ES route. This re-triggers DF election for all PEs that service the ES and a new PE is elected as DF.

Configure SRv6 Services L3VPN Active-Standby Redundancy using Port-Active Mode

This section describes how you can configure SRv6 services L3VPN active-standby redundancy using port-active mode under an Ethernet Segment (ES).

Configuration Example

```

/* Configure Ethernet Link Bundles */
Router# configure
Router(config)# interface Bundle-Ether10
Router(config-if)# ipv4 address 10.0.0.2 255.255.255.0
Router(config-if)# ipv6 address 2001:DB8::1
Router(config-if)# lacp period short
Router(config-if)# mac-address 1.2.3
Router(config-if)# bundle wait-while 0
Router(config-if)# exit
Router(config)# interface GigabitEthernet 0/2/0/5
Router(config-if)# bundle id 14 mode active
Router(config-if)# commit

/* Configure load balancing. */
Router# configure
Router(config)# evpn
Router(config-evpn)# interface Bundle-Ether10
Router(config-evpn-ac)# ethernet-segment
Router(config-evpn-ac-es)# identifier type 0 11.11.11.11.11.11.11.11.14
Router(config-evpn-ac-es)# load-balancing-mode port-active
Router(config-evpn-ac-es)# commit
!
/* Configure address family session in BGP. */
Router# configure
Router(config)# router bgp 100
Router(config-bgp)# bgp router-id 192.168.0.2
Router(config-bgp)# address-family 12vpn evpn
Router(config-bgp)# neighbor 192.168.0.3
Router(config-bgp-nbr)# remote-as 200
Router(config-bgp-nbr)# update-source Loopback 0
Router(config-bgp-nbr)# address-family 12vpn evpn
Router(config-bgp-nbr)# commit

```

Running Configuration

```

interface Bundle-Ether14
  ipv4 address 14.0.0.2 255.255.255.0
  ipv6 address 14::2/64
  lacp period short
  mac-address 1.2.3
  bundle wait-while 0
!
interface GigabitEthernet0/2/0/5
  bundle id 14 mode active
!
evpn
  interface Bundle-Ether14
    ethernet-segment
      identifier type 0 11.11.11.11.11.11.11.11.14
      load-balancing-mode port-active
    !
  !
!
router bgp 100
  bgp router-id 192.168.0.2
  address-family l2vpn evpn
  !
  neighbor 192.168.0.3
    remote-as 100
    update-source Loopback0
    address-family l2vpn evpn
  !
!
!

```

Verification

Verify the SRv6 services L3VPN active-standby redundancy using port-active mode configuration.

```

/* Verify ethernet-segment details on active DF router */
Router# show evpn ethernet-segment interface Bundle-Ether14 detail
-----
Ethernet Segment Id      Interface      Nexthops
-----
0011.1111.1111.1111.1114 BE14          192.168.0.2
                                192.168.0.3

  ES to BGP Gates       : Ready
  ES to L2FIB Gates    : Ready
  Main port             :
    Interface name      : Bundle-Ether14
    Interface MAC       : 0001.0002.0003
    IfHandle            : 0x000041d0
    State               : Up
    Redundancy          : Not Defined
  ESI type              : 0
    Value               : 11.1111.1111.1111.1114
  ES Import RT         : 1111.1111.1111 (from ESI)
  Source MAC           : 0000.0000.0000 (N/A)
  Topology              :
    Operational        : MH
    Configured         : Port-Active
  Service Carving      : Auto-selection
    Multicast          : Disabled
  Peering Details      :
    192.168.0.2 [MOD:P:00]
    192.168.0.3 [MOD:P:00]

```

```

Service Carving Results:
  Forwarders      : 0
  Permanent      : 0
  Elected        : 0
  Not Elected    : 0
MAC Flushing mode : STP-TCN
Peering timer    : 3 sec [not running]
Recovery timer   : 30 sec [not running]
Carving timer    : 0 sec [not running]
Local SHG label  : None
Remote SHG labels : 0

```

```
/* Verify bundle Ethernet configuration on active DF router */
```

```
Router# show bundle bundle-ether 14
```

```

Bundle-Ether14
  Status: Up
  Local links <active/standby/configured>: 1 / 0 / 1
  Local bandwidth <effective/available>: 1000000 (1000000) kbps
  MAC address (source): 0001.0002.0003 (Configured)
  Inter-chassis link: No
  Minimum active links / bandwidth: 1 / 1 kbps
  Maximum active links: 64
  Wait while timer: Off
  Load balancing:
    Link order signaling: Not configured
    Hash type: Default
    Locality threshold: None
  LACP: Operational
    Flap suppression timer: Off
    Cisco extensions: Disabled
    Non-revertive: Disabled
  mLACP: Not configured
  IPv4 BFD: Not configured
  IPv6 BFD: Not configured

  Port          Device          State          Port ID          B/W, kbps
  -----
  Gi0/2/0/5     Local          Active         0x8000, 0x0003  1000000
  Link is Active

```

```
/* Verify ethernet-segment details on standby DF router */
```

```
Router# show evpn ethernet-segment interface bundle-ether 10 detail
```

```

Router# show evpn ethernet-segment interface Bundle-Ether24 detail
Ethernet Segment Id      Interface          Nexthops
-----
0011.1111.1111.1111.1114 BE24              192.168.0.2
                                192.168.0.3

  ES to BGP Gates      : Ready
  ES to L2FIB Gates    : Ready
  Main port            :
    Interface name     : Bundle-Ether24
    Interface MAC      : 0001.0002.0003
    IfHandle           : 0x000041b0
    State              : Standby
    Redundancy         : Not Defined
  ESI type             : 0
    Value              : 11.1111.1111.1111.1114
  ES Import RT        : 1111.1111.1111 (from ESI)
  Source MAC          : 0000.0000.0000 (N/A)

```

```

Topology      :
  Operational : MH
  Configured  : Port-Active
Service Carving : Auto-selection
  Multicast   : Disabled
Peering Details :
  192.168.0.2 [MOD:P:00]
  192.168.0.3 [MOD:P:00]

Service Carving Results:
  Forwarders : 0
  Permanent  : 0
  Elected    : 0
  Not Elected : 0
MAC Flushing mode : STP-TCN
Peering timer   : 3 sec [not running]
Recovery timer  : 30 sec [not running]
Carving timer   : 0 sec [not running]
Local SHG label : None
Remote SHG labels : 0

```

```

/* Verify bundle configuration on standby DF router */
Router# show bundle bundle-ether 24

```

```

Bundle-Ether24
Status: IACP OOS (out of service)
Local links <active/standby/configured>: 0 / 1 / 1
Local bandwidth <effective/available>: 0 (0) kbps
MAC address (source): 0001.0002.0003 (Configured)
Inter-chassis link: No
Minimum active links / bandwidth: 1 / 1 kbps
Maximum active links: 64
Wait while timer: Off
Load balancing:
  Link order signaling: Not configured
  Hash type: Default
  Locality threshold: None
LACP: Operational
  Flap suppression timer: Off
  Cisco extensions: Disabled
  Non-revertive: Disabled
mLACP: Not configured
IPv4 BFD: Not configured
IPv6 BFD: Not configured

```

Port	Device	State	Port ID	B/W, kbps
-----	-----	-----	-----	-----
Gi0/0/0/4	Local	Standby	0x8000, 0x0002	1000000

Link is in standby due to bundle out of service state



CHAPTER 3

Configure Segment Routing Global Block and Segment Routing Local Block

Local label allocation is managed by the label switching database (LSD). The Segment Routing Global Block (SRGB) and Segment Routing Local Block (SRLB) are label values preserved for segment routing in the LSD.

- [About the Segment Routing Global Block, on page 23](#)
- [About the Segment Routing Local Block, on page 25](#)
- [Understanding Segment Routing Label Allocation, on page 26](#)
- [Setup a Non-Default Segment Routing Global Block Range, on page 29](#)
- [Setup a Non-Default Segment Routing Local Block Range, on page 30](#)

About the Segment Routing Global Block

The Segment Routing Global Block (SRGB) is a range of labels reserved for Segment Routing global segments. A prefix-SID is advertised as a domain-wide unique index. The prefix-SID index points to a unique label within the SRGB range. The index is zero-based, meaning that the first index is 0. The MPLS label assigned to a prefix is derived from the Prefix-SID index plus the SRGB base. For example, considering an SRGB range of 16,000 to 23,999, a prefix 10.1.1.65/32 with prefix-SID index of **65** is assigned the label value of **16065**.

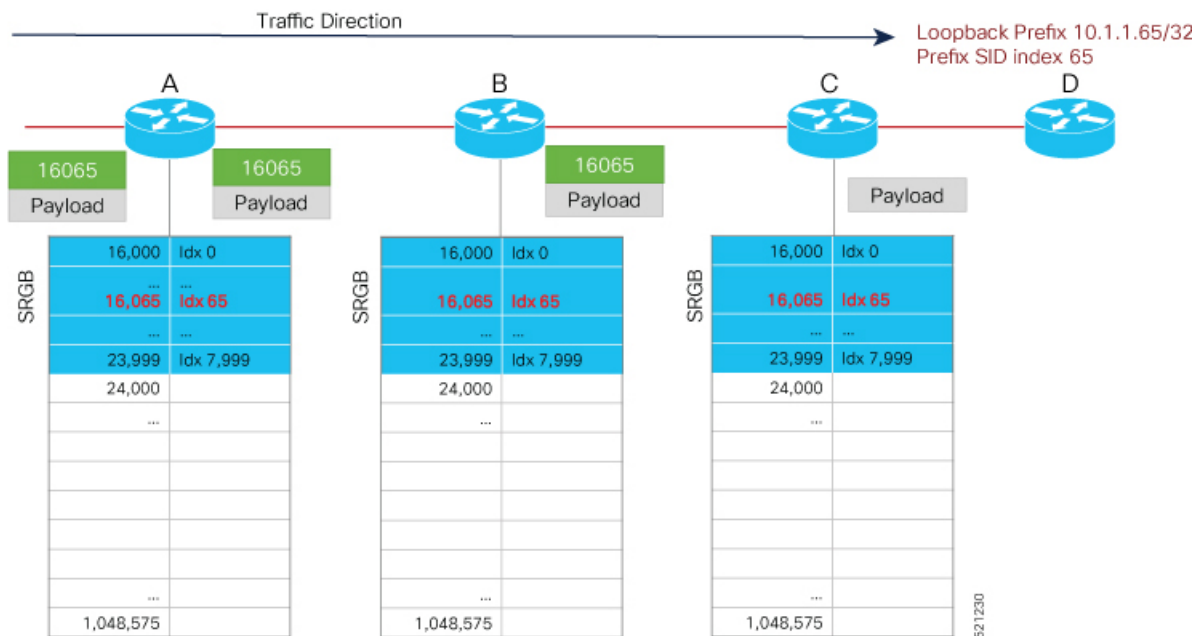

To keep the configuration simple and straightforward, we strongly recommended that you use a homogenous SRGB (meaning, the same SRGB range across all nodes). Using a heterogenous SRGB (meaning, a different SRGB range of the same size across nodes) is also supported but is not recommended.

Behaviors and Limitations

- The default SRGB in IOS XR has a size of 8000 starting from label value 16000. The default range is 16000 to 23,999. With this size, and assuming one loopback prefix per router, an operator can assign prefix SIDs to a network with 8000 routers.
- There are instances when you might need to define a different SRGB range. For example:
 - Non-IOS XR nodes with a SRGB range that is different than the default IOS XR SRGB range.
 - The default SRGB range is not large enough to accommodate all required prefix SIDs.
- A non-default SRGB can be configured following these guidelines:
 - The SRGB starting value can be configured anywhere in the dynamic label range space (16,000 to 1,048,575).
 - In Cisco IOS XR release earlier than 6.6.3, the SRGB can have a maximum configurable size of 262,143.
 - In Cisco IOS XR release 6.6.3 and later, the SRGB can be configured to any size value that fits within the dynamic label range space.
- Allocating an SRGB label range does not mean that all the labels in this range are programmed in the forwarding table. The label range is just reserved for SR and not available for other purposes. Furthermore, a platform may limit the number of local labels that can be programmed.
- We recommend that the non-default SRGB be configured under the **segment-routing** global configuration mode. By default, all IGP instances and BGP use this SRGB.

- You can also configure a non-default SRGB under the IGP, but it is not recommended.

SRGB Label Conflicts

When you define a non-default SRGB range, there might be a label conflict (for example, if labels are already allocated, statically or dynamically, in the new SRGB range). The following system log message indicates a label conflict:

```
%ROUTING-ISIS-4-SRGB_ALLOC_FAIL : SRGB allocation failed: 'SRGB reservation not
successful for [16000,80000], SRGB (16000 80000, SRGB_ALLOC_CONFIG_PENDING, 0x2)
(So far 16 attempts). Make sure label range is free'
```

To remove this conflict, you must reload the router to release the currently allocated labels and to allocate the new SRGB.

After the system reloads, LSD does not accept any dynamic label allocation before IS-IS/OSPF/BGP have registered with LSD. Upon IS-IS/OSPF/BGP registration, LSD allocates the requested SRGB (either the default range or the customized range).

After IS-IS/OSPF/BGP have registered and their SRGB is allocated, LSD starts serving dynamic label requests from other clients.



Note To avoid a potential router reload due to label conflicts, and assuming that the default SRGB size is large enough, we recommend that you use the default IOS XR SRGB range.



Note Allocating a non-default SRGB in the upper part of the MPLS label space increases the chance that the labels are available and a reload can be avoided.



Caution Modifying a SRGB configuration is disruptive for traffic and may require a reboot if the new SRGB is not available entirely.

About the Segment Routing Local Block

A local segment is automatically assigned an MPLS label from the dynamic label range. In most cases, such as TI-LFA backup paths and SR-TE explicit paths defined with IP addresses, this dynamic label allocation is sufficient. However, in some scenarios, it could be beneficial to allocate manually local segment label values to maintain label persistency. For example, an SR-TE policy with a manual binding SID that is performing traffic steering based on incoming label traffic with the binding SID.

The Segment Routing Local Block (SRLB) is a range of label values preserved for the manual allocation of local segments, such as adjacency segment identifiers (adj-SIDs), Layer 2 adj-SIDs, binding SIDs (BSIDs). These labels are locally significant and are only valid on the nodes that allocate the labels.

Behaviors and Limitations

- The default SRLB has a size of 1000 starting from label value 15000; therefore, the default SRLB range goes from 15000 to 15,999.
- A non-default SRLB can be configured following these guidelines:
 - The SRLB starting value can be configured anywhere in the dynamic label range space (16,000 to 1,048,575).
 - In Cisco IOS XR release earlier than 6.6.3, the SRLB can have a maximum configurable size of 262,143.
 - In Cisco IOS XR release 6.6.3 and later, the SRLB can be configured to any size value that fits within the dynamic label range space.

SRLB Label Conflicts

When you define a non-default SRLB range, there might be a label conflict (for example, if labels are already allocated, statically or dynamically, in the new SRLB range). In this case, the new SRLB range will be accepted, but not applied (pending state). The previous SRLB range (active) will continue to be in use.

To remove this conflict, you must reload the router to release the currently allocated labels and to allocate the new SRLB.



Caution You can use the **clear segment-routing local-block discrepancy all** command to clear label conflicts. However, using this command is disruptive for traffic since it forces all other MPLS applications with conflicting labels to allocate new labels.



Note To avoid a potential router reload due to label conflicts, and assuming that the default SRGB size is large enough, we recommend that you use the default IOS XR SRLB range.



Note Allocating a non-default SRLB in the upper part of the MPLS label space increases the chance that the labels are available and a reload can be avoided.

Understanding Segment Routing Label Allocation

In IOS XR, local label allocation is managed by the Label Switching Database (LSD). MPLS applications must register as a client with the LSD to allocate labels. Most MPLS applications (for example: LDP, RSVP, L2VPN, BGP [LU, VPN], IS-IS and OSPF [Adj-SID], SR-TE [Binding-SID]) use labels allocated dynamically by LSD.

With Segment Routing-capable IOS XR software releases, the LSD *preserves* the default SRLB label range (15,000 to 15,999) and default SRGB label range (16,000 to 23,999), even if Segment Routing is not enabled.

This preservation of the default SRLB/SRGB label range makes future Segment Routing activation possible without a reboot. No labels are allocated from this preserved range. When you enable Segment Routing with the default SRLB/SRGB in the future, these label ranges will be available and ready for use.

The LSD allocates dynamic labels starting from 24,000.



Note If an MPLS label range is configured and it overlaps with the default SRLB/SRGB label ranges (for example, **mpls label range 15000 1048575**), then the default SRLB/SRGB preservation is disabled.

Example 1: LSD Label Allocation When SR is not Configured

- Special use: 0-15
- MPLS static: 16 to 14,999
- SRLB (preserved): 15,000 to 15,999
- SRGB (preserved): 16,000 to 23,999
- Dynamic: 24,000 to max

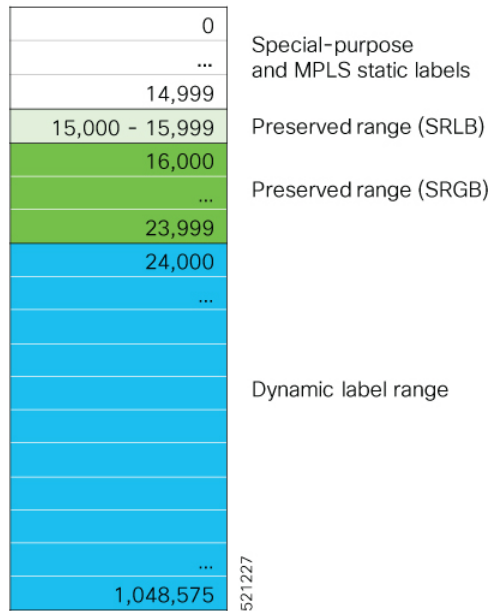

Example 2: LSD Label Allocation When SR is Configured with Default SRGB and Default SRLB

- Special use: 0-15
- MPLS static: 16 to 14,999
- SRLB (reserved): 15,000 to 15,999
- SRGB (reserved): 16,000 to 23,999
- Dynamic: 24,000 to max

0	Special-purpose and MPLS static labels
...	
14,999	
15,000 - 15,999	Reserved range (SRLB)
16,000	Reserved range (SRGB)
...	
23,999	
24,000	Dynamic label range
...	
...	
...	
...	
...	
...	
...	
...	
1,048,575	

521228

Example 3: LSD Label Allocation When SR is Configured with Non-default SRGB and Non-default SRLB

- Special use: 0-15
- MPLS static: 16 to 14,999
- SRLB (preserved): 15,000 to 15,999
- SRGB (preserved): 16,000 to 23,999
- Dynamic: 24000 to 28,999
- SRLB (reserved): 29,000 to 29,999
- SRGB (reserved): 30,000 to 39,999
- Dynamic: 40,000 to max

0	
...	Special-purpose and MPLS static labels
14,999	
15,000 - 15,999	Preserved range (SRLB)
16,000	
...	Preserved range (SRGB)
23,999	
24,000	
...	Dynamic label range
28,999	
29,000 - 29,999	Reserved range (SRLB)
30,000	
...	Reserved range (SRGB)
39,999	
40,000	
...	Dynamic label range
...	
1,048,575	521,229

Setup a Non-Default Segment Routing Global Block Range

This task explains how to configure a non-default SRGB range.

SUMMARY STEPS

1. **configure**
2. **segment-routing global-block** *starting_value ending_value*
3. Use the **commit** or **end** command.

DETAILED STEPS

	Command or Action	Purpose
Step 1	configure Example: RP/0/RSP0/CPU0:router# <code>configure</code>	Enters global configuration mode.
Step 2	segment-routing global-block <i>starting_value ending_value</i> Example: RP/0/RSP0/CPU0:router(config)# <code>segment-routing global-block 16000 80000</code>	Enter the lowest value that you want the SRGB range to include as the starting value. Enter the highest value that you want the SRGB range to include as the ending value.
Step 3	Use the commit or end command.	commit —Saves the configuration changes and remains within the configuration session. end —Prompts user to take one of these actions:

	Command or Action	Purpose
		<ul style="list-style-type: none"> • Yes — Saves configuration changes and exits the configuration session. • No — Exits the configuration session without committing the configuration changes. • Cancel — Remains in the configuration session, without committing the configuration changes.

Use the **show mpls label table [label label-value]** command to verify the SRGB configuration:

```
Router# show mpls label table label 16000 detail
Table Label   Owner                               State Rewrite
-----
0      16000   ISIS(A):1                               InUse  No
      (Lbl-blk SRGB, vers:0, (start_label=16000, size=64001))
```

What to do next

Configure prefix SIDs and enable segment routing.

Setup a Non-Default Segment Routing Local Block Range

This task explains how to configure a non-default SRLB range.

SUMMARY STEPS

1. **configure**
2. **segment-routing local-block** *starting_value ending_value*
3. Use the **commit** or **end** command.

DETAILED STEPS

	Command or Action	Purpose
Step 1	configure Example: RP/0/RSP0/CPU0:router# configure	Enters global configuration mode.
Step 2	segment-routing local-block <i>starting_value ending_value</i> Example: RP/0/RSP0/CPU0:router(config)# segment-routing local-block 30000 30999	Enter the lowest value that you want the SRLB range to include as the starting value. Enter the highest value that you want the SRLB range to include as the ending value.

	Command or Action	Purpose
Step 3	Use the commit or end command.	<p>commit —Saves the configuration changes and remains within the configuration session.</p> <p>end —Prompts user to take one of these actions:</p> <ul style="list-style-type: none"> • Yes — Saves configuration changes and exits the configuration session. • No —Exits the configuration session without committing the configuration changes. • Cancel —Remains in the configuration session, without committing the configuration changes.

Use the **show mpls label table [label label-value] [detail]** command to verify the SRLB configuration:

```
Router# show mpls label table label 30000 detail

Table Label   Owner                               State Rewrite
-----
0      30000   LSD(A)                               InUse  No
      (Lbl-blk SRLB, vers:0, (start_label=30000, size=1000, app_notify=0)
```

```
Router# show segment-routing local-block inconsistencies
```

```
No inconsistencies
```

The following example shows an SRLB label conflict in the range of 30000 and 30999. Note that the default SRLB is active and the configured SRLB is pending:

```
Router(config)# segment-routing local-block 30000 30999

%ROUTING-MPLS_LSD-3-ERR_SRLB_RANGE : SRLB allocation failed: 'SRLB reservation not successful
for [30000,30999]. Use with caution 'clear segment-routing local-block discrepancy all'
command
to force srlb allocation'
```



Caution You can use the **clear segment-routing local-block discrepancy all** command to clear label conflicts. However, using this command is disruptive for traffic since it forces all other MPLS applications with conflicting labels to allocate new labels.

```
Router# show mpls label table label 30000 detail

Table Label   Owner                               State Rewrite
-----
0      30000   LSD(A)                               InUse  No
      (Lbl-blk SRLB, vers:0, (start_label=30000, size=1000, app_notify=0)
```

```
Router# show segment-routing local-block inconsistencies
SRLB inconsistencies range: Start/End: 30000/30999
```

```
Router# show mpls lsd private | i SRLB

SRLB Lbl Mgr:
  Current Active SRLB block      = [15000, 15999]
  Configured Pending SRLB block = [30000, 30999]
```

Reload the router to release the currently allocated labels and to allocate the new SRLB:

```
Router# reload

Proceed with reload? [confirm]yes
```

After the system is brought back up, verify that there are no label conflicts with the SRLB configuration:

```
Router# show mpls lsd private | i SRLB

SRLB Lbl Mgr:
  Current Active SRLB block      = [30000, 30999]
  Configured Pending SRLB block = [0, 0]

Router# show segment-routing local-block inconsistencies

No inconsistencies
```

What to do next

Configure adjacency SIDs and enable segment routing.



CHAPTER 4

Configure Segment Routing for IS-IS Protocol

Integrated Intermediate System-to-Intermediate System (IS-IS), Internet Protocol Version 4 (IPv4), is a standards-based Interior Gateway Protocol (IGP). The Cisco IOS XR software implements the IP routing capabilities described in International Organization for Standardization (ISO)/International Engineering Consortium (IEC) 10589 and RFC 1995, and adds the standard extensions for single topology and multitopology IS-IS for IP Version 6 (IPv6).

This module provides the configuration information used to enable segment routing for IS-IS.



Note For additional information on implementing IS-IS on your Cisco ASR 9000 Series Router, see the *Implementing IS-IS* module in the *Cisco ASR 9000 Series Aggregation Services Router Routing Configuration Guide*.

- [Enabling Segment Routing for IS-IS Protocol](#), on page 33
- [Configuring a Prefix-SID on the IS-IS Enabled Loopback Interface](#), on page 35
- [Configuring an Adjacency SID](#), on page 38
- [Configuring Bandwidth-Based Local UCMP](#), on page 45
- [IS-IS Prefix Attributes for Extended IPv4 and IPv6 Reachability](#), on page 46
- [IS-IS Multi-Domain Prefix SID and Domain Stitching: Example](#), on page 49

Enabling Segment Routing for IS-IS Protocol

Segment routing on the IS-IS control plane supports the following:

- IPv4 and IPv6 control plane
- Level 1, level 2, and multi-level routing
- Prefix SIDs for host prefixes on loopback interfaces
- Multiple IS-IS instances on the same loopback interface for domain border nodes
- Adjacency SIDs for adjacencies
- MPLS penultimate hop popping (PHP) and explicit-null signaling

This task explains how to enable segment routing for IS-IS.

Before you begin

Your network must support the MPLS Cisco IOS XR software feature before you enable segment routing for IS-IS on your router.



Note You must enter the commands in the following task list on every IS-IS router in the traffic-engineered portion of your network.

SUMMARY STEPS

1. **configure**
2. **router isis** *instance-id*
3. **address-family** { **ipv4** | **ipv6** } [**unicast**]
4. **metric-style wide** [**level** { **1** | **2** }]
5. **router-id loopback** *loopback interface used for prefix-sid*
6. **segment-routing mpls**
7. **exit**
8. Use the **commit** or **end** command.

DETAILED STEPS

	Command or Action	Purpose
Step 1	configure Example: RP/0/RSP0/CPU0:router# configure	Enters global configuration mode.
Step 2	router isis <i>instance-id</i> Example: RP/0/RSP0/CPU0:router(config)# router isis isp	Enables IS-IS routing for the specified routing instance, and places the router in router configuration mode. Note You can change the level of routing to be performed by a particular routing instance by using the is-type router configuration command.
Step 3	address-family { ipv4 ipv6 } [unicast] Example: RP/0/RSP0/CPU0:router(config-isis)# address-family ipv4 unicast	Specifies the IPv4 or IPv6 address family, and enters router address family configuration mode.
Step 4	metric-style wide [level { 1 2 }] Example: RP/0/RSP0/CPU0:router(config-isis-af)# metric-style wide level 1	Configures a router to generate and accept only wide link metrics in the Level 1 area.
Step 5	router-id loopback <i>loopback interface used for prefix-sid</i> Example:	Configures router ID for each address-family (IPv4/IPv6).

	Command or Action	Purpose
	<pre>RP/0/RSP0/CPU0:router(config-isis-af)#router-id loopback0</pre>	IS-IS advertises the router ID in TLVs 134 (for IPv4 address family) and 140 (for IPv6 address family). Required when traffic engineering is used.
Step 6	<p>segment-routing mpls</p> <p>Example:</p> <pre>RP/0/RSP0/CPU0:router(config-isis-af)# segment-routing mpls</pre>	<p>Segment routing is enabled by the following actions:</p> <ul style="list-style-type: none"> • MPLS forwarding is enabled on all interfaces where IS-IS is active. • All known prefix-SIDs in the forwarding plain are programmed, with the prefix-SIDs advertised by remote routers or learned through local or remote mapping server. • The prefix-SIDs locally configured are advertised.
Step 7	<p>exit</p> <p>Example:</p> <pre>RP/0/RSP0/CPU0:router(config-isis-af)# exit RP/0/RSP0/CPU0:router(config-isis)# exit</pre>	
Step 8	Use the commit or end command.	<p>commit —Saves the configuration changes and remains within the configuration session.</p> <p>end —Prompts user to take one of these actions:</p> <ul style="list-style-type: none"> • Yes — Saves configuration changes and exits the configuration session. • No —Exits the configuration session without committing the configuration changes. • Cancel —Remains in the configuration session, without committing the configuration changes.

What to do next

Configure the prefix SID.

Configuring a Prefix-SID on the IS-IS Enabled Loopback Interface

A prefix segment identifier (SID) is associated with an IP prefix. The prefix SID is manually configured from the segment routing global block (SRGB) range of labels. A prefix SID is configured under the loopback interface with the loopback address of the node as the prefix. The prefix segment steers the traffic along the shortest path to its destination.

A prefix SID can be a node SID or an Anycast SID. A node SID is a type of prefix SID that identifies a specific node. An Anycast SID is a type of prefix SID that identifies a set of nodes, and is configured with n-flag clear.

The set of nodes (Anycast group) is configured to advertise a shared prefix address and prefix SID. Anycast routing enables the steering of traffic toward multiple advertising nodes. Packets addressed to an Anycast address are forwarded to the topologically nearest nodes.

Strict-SPF SIDs are used to forward traffic strictly along the SPF path. Strict-SPF SIDs are not forwarded to SR-TE policies. IS-IS advertises the SR Algorithm sub Type Length Value (TLV) (in the SR Router Capability SubTLV) to include both algorithm 0 (SPF) and algorithm 1 (Strict-SPF). When the IS-IS area or level is Strict-SPF TE-capable, Strict-SPF SIDs are used to build the SR-TE Strict-SPF policies. Strict-SPF SIDs are also used to program the backup paths for prefixes, node SIDs, and adjacency SIDs.



Note The same SRGB is used for both regular SIDs and strict-SPF SIDs.

The prefix SID is globally unique within the segment routing domain.

This task explains how to configure prefix segment identifier (SID) index or absolute value on the IS-IS enabled Loopback interface.

Before you begin

Ensure that segment routing is enabled on the corresponding address family.

SUMMARY STEPS

1. **configure**
2. **router isis** *instance-id*
3. **interface Loopback** *instance*
4. **address-family** { **ipv4** | **ipv6** } [**unicast**]
5. **prefix-sid** [**strict-spf** | **algorithm** *algorithm-number*] {**index** *SID-index* | **absolute** *SID-value*} [**n-flag-clear**] [**explicit-null**]
6. Use the **commit** or **end** command.

DETAILED STEPS

	Command or Action	Purpose
Step 1	configure Example: RP/0/RSP0/CPU0:router# <code>configure</code>	Enters global configuration mode.
Step 2	router isis <i>instance-id</i> Example: RP/0/RSP0/CPU0:router(config)# <code>router isis 1</code>	Enables IS-IS routing for the specified routing instance, and places the router in router configuration mode. <ul style="list-style-type: none"> • You can change the level of routing to be performed by a particular routing instance by using the is-type router configuration command.
Step 3	interface Loopback <i>instance</i> Example:	Specifies the loopback interface and instance.

	Command or Action	Purpose
	<pre>RP/0/RSP0/CPU0:router(config-isis)# interface Loopback0</pre>	
Step 4	<p>address-family { ipv4 ipv6 } [unicast]</p> <p>Example:</p> <p>The following is an example for ipv4 address family:</p> <pre>RP/0/RSP0/CPU0:router(config-isis-if)# address-family ipv4 unicast</pre>	<p>Specifies the IPv4 or IPv6 address family, and enters router address family configuration mode.</p>
Step 5	<p>prefix-sid [strict-spf algorithm <i>algorithm-number</i>] {index <i>SID-index</i> absolute <i>SID-value</i>} [n-flag-clear] [explicit-null]</p> <p>Example:</p> <pre>RP/0/RSP0/CPU0:router(config-isis-if-af)# prefix-sid index 1001</pre> <pre>RP/0/RSP0/CPU0:router(config-isis-if-af)# prefix-sid strict-spf index 101</pre> <pre>RP/0/RSP0/CPU0:router(config-isis-if-af)# prefix-sid absolute 17001</pre>	<p>Configures the prefix-SID index or absolute value for the interface.</p> <p>Specify strict-spf to configure the prefix-SID to use the SPF path instead of the SR-TE policy.</p> <p>Specify algorithm <i>algorithm-number</i> to configure SR Flexible Algorithm.</p> <p>Specify index <i>SID-index</i> for each node to create a prefix SID based on the lower boundary of the SRGB + the index.</p> <p>Specify absolute <i>SID-value</i> for each node to create a specific prefix SID within the SRGB.</p> <p>By default, the n-flag is set on the prefix-SID, indicating that it is a node SID. For specific prefix-SID (for example, Anycast prefix-SID), enter the n-flag-clear keyword. IS-IS does not set the N flag in the prefix-SID sub Type Length Value (TLV).</p> <p>To disable penultimate-hop-popping (PHP) and add explicit-Null label, enter explicit-null keyword. IS-IS sets the E flag in the prefix-SID sub TLV.</p> <p>Note IS-IS does not advertise separate explicit-NULL or flags for regular SIDs and strict-SPF SIDs. The settings in the regular SID are used if the settings are different.</p>
Step 6	Use the commit or end command.	<p>commit —Saves the configuration changes and remains within the configuration session.</p> <p>end —Prompts user to take one of these actions:</p> <ul style="list-style-type: none"> • Yes — Saves configuration changes and exits the configuration session. • No —Exits the configuration session without committing the configuration changes. • Cancel —Remains in the configuration session, without committing the configuration changes.

Verify the prefix-SID configuration:

```
RP/0/RSP0/CPU0:router# show isis database verbose

IS-IS 1 (Level-2) Link State Database
LSPID                LSP Seq Num  LSP Checksum  LSP Holdtime  ATT/P/OL
router.00-00         * 0x0000039b  0xfc27        1079          0/0/0
  Area Address: 49.0001
  NLPID:           0xcc
  NLPID:           0x8e
  MT:              Standard (IPv4 Unicast)
  MT:              IPv6 Unicast
  Hostname:        router
  IP Address:      10.0.0.1
  IPv6 Address:    2001:0db8:1234::0a00:0001
  Router Cap:      10.0.0.1, D:0, S:0
    Segment Routing: I:1 V:1, SRGB Base: 16000 Range: 8000
    SR Algorithm:
      Algorithm: 0
      Algorithm: 1
<...>
Metric: 0           IP-Extended 10.0.0.1/32
  Prefix-SID Index: 1001, Algorithm:0, R:0 N:1 P:0 E:0 V:0 L:0
  Prefix-SID Index: 101, Algorithm:1, R:0 N:1 P:0 E:0 V:0 L:0
<...>
```

Configuring an Adjacency SID

An adjacency SID (Adj-SID) is associated with an adjacency to a neighboring node. The adjacency SID steers the traffic to a specific adjacency. Adjacency SIDs have local significance and are only valid on the node that allocates them.

An adjacency SID can be allocated dynamically from the dynamic label range or configured manually from the segment routing local block (SRLB) range of labels.

Adjacency SIDs that are dynamically allocated do not require any special configuration, however there are some limitations:

- A dynamically allocated Adj-SID value is not known until it has been allocated, and a controller will not know the Adj-SID value until the information is flooded by the IGP.
- Dynamically allocated Adj-SIDs are not persistent and can be reallocated after a reload or a process restart.
- Each link is allocated a unique Adj-SID, so the same Adj-SID cannot be shared by multiple links.

Manually allocated Adj-SIDs are persistent over reloads and restarts. They can be provisioned for multiple adjacencies to the same neighbor or to different neighbors. You can specify that the Adj-SID is protected. If the Adj-SID is protected on the primary interface and a backup path is available, a backup path is installed. By default, manual Adj-SIDs are not protected.

Adjacency SIDs are advertised using the existing IS-IS Adj-SID sub-TLV. The S and P flags are defined for manually allocated Adj-SIDs.

```
0 1 2 3 4 5 6 7
```



```

+-----+
|F|B|V|L|S|P| |
+-----+
    
```

Table 1: Adjacency Segment Identifier (Adj-SID) Flags Sub-TLV Fields

Field	Description
S (Set)	This flag is set if the same Adj-SID value has been provisioned on multiple interfaces.
P (Persistent)	This flag is set if the Adj-SID is persistent (manually allocated).

Manually allocated Adj-SIDs are supported on point-to-point (P2P) interfaces.

This task explains how to configure an Adj-SID on an interface.

Before you begin

Ensure that segment routing is enabled on the corresponding address family.

Use the **show mpls label table detail** command to verify the SRLB range.

SUMMARY STEPS

1. **configure**
2. **router isis** *instance-id*
3. **interface** *type interface-path-id*
4. **point-to-point**
5. **address-family** { **ipv4** | **ipv6** } [**unicast**]
6. **adjacency-sid** {**index** *adj-SID-index* | **absolute** *adj-SID-value* } [**protected**]
7. Use the **commit** or **end** command.

DETAILED STEPS

	Command or Action	Purpose
Step 1	configure Example: RP/0/RSP0/CPU0:router# configure	Enters global configuration mode.
Step 2	router isis <i>instance-id</i> Example: RP/0/RSP0/CPU0:router(config)# router isis 1	Enables IS-IS routing for the specified routing instance, and places the router in router configuration mode. • You can change the level of routing to be performed by a particular routing instance by using the is-type router configuration command.
Step 3	interface <i>type interface-path-id</i> Example:	Specifies the interface and enters interface configuration mode.

	Command or Action	Purpose
	RP/0/RSP0/CPU0:router(config-isis)# interface GigabitEthernet0/0/0/7	
Step 4	<p>point-to-point</p> <p>Example:</p> <pre>RP/0/RSP0/CPU0:router(config-isis-if)# point-to-point</pre>	Specifies the interface is a point-to-point interface.
Step 5	<p>address-family { ipv4 ipv6 } [unicast]</p> <p>Example:</p> <p>The following is an example for ipv4 address family:</p> <pre>RP/0/RSP0/CPU0:router(config-isis-if)# address-family ipv4 unicast</pre>	Specifies the IPv4 or IPv6 address family, and enters router address family configuration mode.
Step 6	<p>adjacency-sid {index <i>adj-SID-index</i> absolute <i>adj-SID-value</i> } [protected]</p> <p>Example:</p> <pre>RP/0/RSP0/CPU0:router(config-isis-if-af)# adjacency-sid index 10</pre> <pre>RP/0/RSP0/CPU0:router(config-isis-if-af)# adjacency-sid absolute 15010</pre>	<p>Configures the Adj-SID index or absolute value for the interface.</p> <p>Specify index <i>adj-SID-index</i> for each link to create an Adj-SID based on the lower boundary of the SRLB + the index.</p> <p>Specify absolute <i>adj-SID-value</i> for each link to create a specific Adj-SID within the SRLB.</p> <p>Specify if the Adj-SID is protected. For each primary path, if the Adj-SID is protected on the primary interface and a backup path is available, a backup path is installed. By default, manual Adj-SIDs are not protected.</p>
Step 7	Use the commit or end command.	<p>commit —Saves the configuration changes and remains within the configuration session.</p> <p>end —Prompts user to take one of these actions:</p> <ul style="list-style-type: none"> • Yes — Saves configuration changes and exits the configuration session. • No —Exits the configuration session without committing the configuration changes. • Cancel —Remains in the configuration session, without committing the configuration changes.

Verify the Adj-SID configuration:

```
RP/0/RSP0/CPU0:router# show isis segment-routing label adjacency persistent
Mon Jun 12 02:44:07.085 PDT
```

```
IS-IS 1 Manual Adjacency SID Table
```

```

15010 AF IPv4
    GigabitEthernet0/0/0/3: IPv4, Protected 1/65/N, Active
    GigabitEthernet0/0/0/7: IPv4, Protected 2/66/N, Active

15100 AF IPv6
    GigabitEthernet0/0/0/3: IPv6, Not protected 255/255/N, Active

```

Verify the labels are added to the MPLS Forwarding Information Base (LFIB):

```

RP/0/RSP0/CPU0:router# show mpls forwarding labels 15010
Mon Jun 12 02:50:12.172 PDT
Local  Outgoing  Prefix          Outgoing  Next Hop  Bytes
Label  Label      or ID          Interface  Hop       Switched
-----
15010  Pop         SRLB (idx 10)  Gi0/0/0/3  10.0.3.3  0
        Pop         SRLB (idx 10)  Gi0/0/0/7  10.1.0.5  0
        16004      SRLB (idx 10)  Gi0/0/0/7  10.1.0.5  0          (!)
        16004      SRLB (idx 10)  Gi0/0/0/3  10.0.3.3  0          (!)

```

Protected Adjacency SID Backup Timer

IS-IS advertises a protected adjacency SID for an adjacency when a backup path is available. Primary and backup paths are programmed into the label switching database (LSD) as rewrites.

When an adjacency goes down, IS-IS stops advertising the protected adjacency SID immediately, and the backup path is promoted and installed as LSD rewrite. After a specified amount of time, the LSD rewrite is deleted. If the installed path fails again, the protection ends there and traffic through the original protected adjacency SID is permanently lost.

The Protected Adjacency SID Backup Timer provides a configurable maintenance time period. During this time period, IS-IS updates the LSD rewrite with primary and backup (if available) paths to the neighbor upon topology changes.

Configuration

Use the **segment-routing protected-adjacency-sid-delay** command in IS-IS address family configuration mode. The range is from 30 to 3600 seconds; the default is 900 seconds (15 min).

```

Router(config)# router isis 1
Router(config-isis)# address-family ipv4 unicast
Router(config-isis-af)# segment-routing protected-adjacency-sid-delay 360

```

Running Configuration

```

router isis 1
  address-family ipv4 unicast
    segment-routing protected-adjacency-sid-delay 360
  !
interface GigabitEthernet0/0/0/7
  point-to-point
  address-family ipv4 unicast
    fast-reroute per-prefix
    fast-reroute per-prefix ti-lfa
  !

```

!

!

Manually Configure a Layer 2 Adjacency SID

Typically, an adjacency SID (Adj-SID) is associated with a Layer 3 adjacency to a neighboring node, to steer the traffic to a specific adjacency. If you have Layer 3 bundle interfaces, where multiple physical interfaces form a bundle interface, the individual Layer 2 bundle members are not visible to IGP; only the bundle interface is visible.

You can configure a Layer 2 Adj-SID for the individual Layer 2 bundle interfaces. This configuration allows you to track the availability of individual bundle member links and to verify the segment routing forwarding over the individual bundle member links, for Operational Administration and Maintenance (OAM) purposes.

A Layer 2 Adj-SID can be allocated dynamically or configured manually.

- IGP dynamically allocates Layer 2 Adj-SIDs from the dynamic label range for each Layer 2 bundle member. A dynamic Layer 2 Adj-SID is not persistent and can be reallocated as the Layer 3 bundle link goes up and down.
- Manually configured Layer 2 Adj-SIDs are persistent if the Layer 3 bundle link goes up and down. Layer 2 Adj-SIDs are allocated from the Segment Routing Local Block (SRLB) range of labels. However, if the configured value of Layer 2 Adj-SID does not fall within the available SRLB, a Layer 2 Adj-SID will not be programmed into forwarding information base (FIB).

Restrictions

- Adj-SID forwarding requires a next-hop, which can be either an IPv4 address or an IPv6 address, but not both. Therefore, manually configured Layer 2 Adj-SIDs are configured per address-family.
- Manually configured Layer 2 Adj-SID can be associated with only one Layer 2 bundle member link.
- A SID value used for Layer 2 Adj-SID cannot be shared with Layer 3 Adj-SID.
- SR-TE using Layer 2 Adj-SID is not supported.

This task explains how to configure a Layer 2 Adj-SID on an interface.

Before you begin

Ensure that segment routing is enabled on the corresponding address family.

Use the **show mpls label table detail** command to verify the SRLB range.

SUMMARY STEPS

1. **configure**
2. **segment-routing**
3. **adjacency-sid**
4. **interface** *type interface-path-id*
5. **address-family** { **ipv4** | **ipv6** } [**unicast**]
6. **l2-adjacency sid** { **index** *adj-SID-index* | **absolute** *adj-SID-value* } [**next-hop** { *ipv4_address* | *ipv6_address* }]
7. Use the **commit** or **end** command.
8. **end**

9. `router isis instance-id`
10. `address-family { ipv4 | ipv6 } [unicast]`
11. `segment-routing bundle-member-adj-sid`

DETAILED STEPS

	Command or Action	Purpose
Step 1	<p>configure</p> <p>Example:</p> <pre>RP/0/RSP0/CPU0:router# configure</pre>	Enters global configuration mode.
Step 2	<p>segment-routing</p> <p>Example:</p> <pre>Router(config)# segment-routing</pre>	Enters segment routing configuration mode.
Step 3	<p>adjacency-sid</p> <p>Example:</p> <pre>Router(config-sr)# adjacency-sid</pre>	Enters adjacency SID configuration mode.
Step 4	<p>interface type interface-path-id</p> <p>Example:</p> <pre>Router(config-sr-adj)# interface GigabitEthernet0/0/0/3</pre>	Specifies the interface and enters interface configuration mode.
Step 5	<p>address-family { ipv4 ipv6 } [unicast]</p> <p>Example:</p> <pre>Router(config-sr-adj-intf)# address-family ipv4 unicast</pre>	Specifies the IPv4 or IPv6 address family, and enters router address family configuration mode.
Step 6	<p>l2-adjacency sid {index adj-SID-index absolute adj-SID-value } [next-hop {ipv4_address ipv6_address }]</p> <p>Example:</p> <pre>Router(config-sr-adj-intf-af)# l2-adjacency sid absolute 15015 next-hop 10.1.1.4</pre>	<p>Configures the Adj-SID index or absolute value for the interface.</p> <p>Specify index <i>adj-SID-index</i> for each link to create an Adj-SID based on the lower boundary of the SRLB + the index.</p> <p>Specify absolute <i>adj-SID-value</i> for each link to create a specific Adj-SID within the SRLB.</p> <p>For point-to-point interfaces, you are not required to specify a next-hop. However, if you do specify the next-hop, the Layer 2 Adj-SID will be used only if the specified next-hop matches the neighbor address.</p> <p>For LAN interfaces, you must configure the next-hop IPv4 or IPv6 address. If you do not configure the next-hop, the Layer 2 Adj-SID will not be used for LAN interface.</p>

	Command or Action	Purpose
Step 7	Use the commit or end command.	<p>commit —Saves the configuration changes and remains within the configuration session.</p> <p>end —Prompts user to take one of these actions:</p> <ul style="list-style-type: none"> • Yes — Saves configuration changes and exits the configuration session. • No —Exits the configuration session without committing the configuration changes. • Cancel —Remains in the configuration session, without committing the configuration changes.
Step 8	end	
Step 9	<p>router isis <i>instance-id</i></p> <p>Example:</p> <pre>Router(config)# router isis isp</pre>	Enables IS-IS routing for the specified routing instance, and places the router in router configuration mode.
Step 10	<p>address-family { ipv4 ipv6 } [unicast]</p> <p>Example:</p> <pre>Router(config-isis)# address-family ipv4 unicast</pre>	Specifies the IPv4 or IPv6 address family, and enters router address family configuration mode.
Step 11	<p>segment-routing bundle-member-adj-sid</p> <p>Example:</p> <pre>Router(config-isis-af)# segment-routing bundle-member-adj-sid</pre>	<p>Programs the dynamic Layer 2 Adj-SIDs, and advertises both manual and dynamic Layer 2 Adj-SIDs.</p> <p>Note This command is not required to program manual L2 Adj-SID, but is required to program the dynamic Layer 2 Adj-SIDs and to advertise both manual and dynamic Layer 2 Adj-SIDs.</p>

Verify the configuration:

```
Router# show mpls forwarding detail | i "Pop|Outgoing Interface|Physical Interface"
Tue Jun 20 06:53:51.876 PDT
. . .
15001 Pop          SRLB (idx 1)      BE1          10.1.1.4      0
   Outgoing Interface: Bundle-Ether1 (ifhandle 0x000000b0)
   Physical Interface: GigabitEthernet0/0/0/3 (ifhandle 0x000000b0)
```

```
Router# show running-config segment-routing
Tue Jun 20 07:14:25.815 PDT
segment-routing
 adjacency-sid
  interface GigabitEthernet0/0/0/3
   address-family ipv4 unicast
    l2-adjacency-sid absolute 15015 next-hop 10.1.1.4
```

```

!
!
!
!

```

Configuring Bandwidth-Based Local UCMP

Bandwidth-based local Unequal Cost Multipath (UCMP) allows you to enable UCMP functionality locally between Equal Cost Multipath (ECMP) paths based on the bandwidth of the local links.

Bandwidth-based local UCMP is performed for prefixes, segment routing Adjacency SIDs, and Segment Routing label cross-connects installed by IS-IS, and is supported on any physical or virtual interface that has a valid bandwidth.

For example, if the capacity of a bundle interface changes due to the link or line card up/down event, traffic continues to use the affected bundle interface regardless of the available provisioned bundle members. If some bundle members were not available due to the failure, this behavior could cause the traffic to overload the bundle interface. To address the bundle capacity changes, bandwidth-based local UCMP uses the bandwidth of the local links to load balance traffic when bundle capacity changes.

Before you begin

SUMMARY STEPS

1. **configure**
2. **router isis** *instance-id*
3. **address-family** { **ipv4** | **ipv6** } [**unicast**]
4. **apply-weight ecmp-only bandwidth**
5. Use the **commit** or **end** command.

DETAILED STEPS

	Command or Action	Purpose
Step 1	configure Example: RP/0/RSP0/CPU0:router# configure	Enters global configuration mode.
Step 2	router isis <i>instance-id</i> Example: RP/0/RSP0/CPU0:router(config)# router isis 1	Enables IS-IS routing for the specified routing instance, and places the router in router configuration mode. You can change the level of routing to be performed by a particular routing instance by using the is-type router configuration command.
Step 3	address-family { ipv4 ipv6 } [unicast] Example: The following is an example for ipv4 address family:	Specifies the IPv4 or IPv6 address family, and enters IS-IS address family configuration mode.

	Command or Action	Purpose
	RP/0/RSP0/CPU0:router(config-isis)# address-family ipv4 unicast	
Step 4	apply-weight ecmp-only bandwidth Example: RP/0/RSP0/CPU0:router(config-isis-af)# apply-weight ecmp-only bandwidth	Enables UCMP functionality locally between ECMP paths based on the bandwidth of the local links.
Step 5	Use the commit or end command.	commit —Saves the configuration changes and remains within the configuration session. end —Prompts user to take one of these actions: <ul style="list-style-type: none"> • Yes — Saves configuration changes and exits the configuration session. • No —Exits the configuration session without committing the configuration changes. • Cancel —Remains in the configuration session, without committing the configuration changes.

IS-IS Prefix Attributes for Extended IPv4 and IPv6 Reachability

The following sub-TLVs support the advertisement of IPv4 and IPv6 prefix attribute flags and the source router ID of the router that originated a prefix advertisement, as described in RFC 7794.

- Prefix Attribute Flags
- IPv4 and IPv6 Source Router ID

Prefix Attribute Flags

The Prefix Attribute Flag sub-TLV supports the advertisement of attribute flags associated with prefix advertisements. Knowing if an advertised prefix is directly connected to the advertising router helps to determine how labels that are associated with an incoming packet should be processed.

This section describes the behavior of each flag when a prefix advertisement is learned from one level to another.



Note Prefix attributes are only added when wide metric is used.

Prefix Attribute Flags Sub-TLV Format

0 1 2 3 4 5 6 7 ...

```
+-----+-----+-----+...
|X|R|N|           ...
+-----+-----+-----+...
```

Prefix Attribute Flags Sub-TLV Fields

Field	Description
X (External Prefix Flag)	This flag is set if the prefix has been redistributed from another protocol. The value of the flag is preserved when the prefix is propagated to another level.
R (Re-advertisement Flag)	This flag is set to 1 by the Level 1-2 router when the prefix is propagated between IS-IS levels (from Level 1 to Level 2, or from Level 2 to Level 1). This flag is set to 0 when the prefix is connected locally to an IS-IS-enabled interface (regardless of the level configured on the interface).
N (Node Flag)	For prefixes that are propagated from another level: <ol style="list-style-type: none"> Copy the N-flag from the prefix attribute sub-TLV, if present in the source level. Copy the N-flag from the prefix-SID sub-TLV, if present in the source level. Otherwise, set to 0. For connected prefixes: <ol style="list-style-type: none"> Set to 0 if prefix-attributes n-flag-clear is configured (see Configuring Prefix Attribute N-flag-clear). Set to 0 if n-flag-clear { n-flag-clearSID-index n-flag-clearSID-value } n-flag-clear is configured (see Configuring a Prefix-SID on the IS-IS Enabled Loopback Interface). Otherwise, set to 1 when the prefix is a host prefix (/32 for IPv4, /128 for IPv6) that is associated with a loopback address. <p>Note If the flag is set and the prefix length is not a host prefix, then the flag must be ignored.</p>

IPv4 and IPv6 Source Router ID

The Source Router ID sub-TLV identifies the source of the prefix advertisement. The IPv4 and IPv6 source router ID is displayed in the output of the **show isis database verbose** command.

The Source Router ID sub-TLV is added when the following conditions are met:

- The prefix is locally connected.
- The N-flag is set to 1 (when it's a host prefix and the **n-flag-clear** configuration is not used).
- The router ID is configured in the corresponding address family.

The source router ID is propagated between levels.

Table 2: Source Router Sub-TLV Format

IPv4 Source Router ID	Type: 11 Length: 4 Value: IPv4 Router ID of the source of the prefix advertisement
IPv6 Source Router ID	Type: 12 Length: 16 Value: IPv6 Router ID of the source of the prefix advertisement

Configuring Prefix Attribute N-flag-clear

The N-flag is set to 1 when the prefix is a host prefix (/32 for IPV4, /128 for IPV6) that is associated with a loopback address. The advertising router can be configured to not set this flag. This task explains how to clear the N-flag.

SUMMARY STEPS

1. **configure**
2. **router isis** *instance-id*
3. **interface Loopback** *instance*
4. **prefix-attributes n-flag-clear** [Level-1 | Level-2]
5. Use the **commit** or **end** command.

DETAILED STEPS

	Command or Action	Purpose
Step 1	configure Example: RP/0/RSP0/CPU0:router# configure	Enters global configuration mode.
Step 2	router isis <i>instance-id</i> Example: RP/0/RSP0/CPU0:router(config)# router isis 1	
Step 3	interface Loopback <i>instance</i> Example: RP/0/RSP0/CPU0:router(config)# interface Loopback0	Specifies the loopback interface.
Step 4	prefix-attributes n-flag-clear [Level-1 Level-2] Example:	Clears the prefix attribute N-flag explicitly.

	Command or Action	Purpose
	RP/0/RSP0/CPU0:router(config-if)# isis prefix-attributes n-flag-clear	
Step 5	Use the commit or end command.	<p>commit —Saves the configuration changes and remains within the configuration session.</p> <p>end —Prompts user to take one of these actions:</p> <ul style="list-style-type: none"> • Yes — Saves configuration changes and exits the configuration session. • No —Exits the configuration session without committing the configuration changes. • Cancel —Remains in the configuration session, without committing the configuration changes.

Verify the prefix attribute configuration:

```
RP/0/RSP0/CPU0:router# show isis database verbose

IS-IS 1 (Level-2) Link State Database
LSPID                LSP Seq Num  LSP Checksum  LSP Holdtime  ATT/P/OL
router.00-00         * 0x0000039b  0xfc27        1079           0/0/0
  Area Address: 49.0001
  NLPID:            0xcc
  NLPID:            0x8e
  MT:               Standard (IPv4 Unicast)
  MT:               IPv6 Unicast                       0/0/0
  Hostname:         router
  IP Address:       10.0.0.1
  IPv6 Address:     2001:0db8:1234::0a00:0001
  Router Cap:      10.0.0.1, D:0, S:0
  Segment Routing: I:1 V:1, SRGB Base: 16000 Range: 8000
  SR Algorithm:
    Algorithm: 0
    Algorithm: 1
<...>
  Metric: 0         IP-Extended 10.0.0.1/32
    Prefix-SID Index: 1001, Algorithm:0, R:1 N:0 P:1 E:0 V:0 L:0
    Prefix Attribute Flags: X:0 R:1 N:0
  Metric: 10        IP-Extended 10.0.0.2/32
    Prefix-SID Index: 1002, Algorithm:0, R:0 N:1 P:0 E:0 V:0 L:0
    Prefix Attribute Flags: X:0 R:0 N:1
  Source Router ID: 10.0.0.2
<...>
```

IS-IS Multi-Domain Prefix SID and Domain Stitching: Example

IS-IS Multi-Domain Prefix SID and Domain Stitching allows you to configure multiple IS-IS instances on the same loopback interface for domain border nodes. You specify a loopback interface and prefix SID under multiple IS-IS instances to make the prefix and prefix SID reachable in different domains.

This example uses the following topology. Node 5 and 9 are border nodes between two IS-IS domains (Domain1 and Domain2). Node 10 is configured as the Segment Routing Path Computation Element (SR-PCE).

Figure 2: Multi-Domain Topology

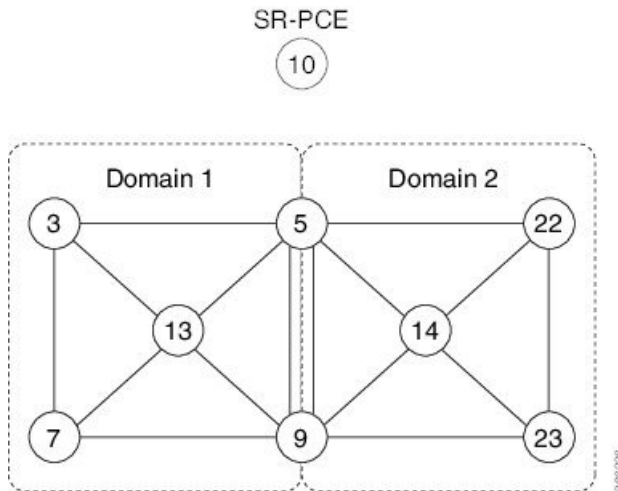

Configure IS-IS Multi-Domain Prefix SID

Specify a loopback interface and prefix SID under multiple IS-IS instances on each border node:

```

Example: Border Node 5
router isis Domain1
 interface Loopback0
  address-family ipv4 unicast
  prefix-sid absolute 16005

router isis Domain2
 interface Loopback0
  address-family ipv4 unicast
  prefix-sid absolute 16005

```

```

Example: Border Node 9
router isis Domain1
 interface Loopback0
  address-family ipv4 unicast
  prefix-sid absolute 16009

router isis Domain2
 interface Loopback0
  address-family ipv4 unicast
  prefix-sid absolute 16009

```

Border nodes 5 and 9 each run two IS-IS instances (Domain1 and Domain2) and advertise their Loopback0 prefix and prefix SID in both domains.

Nodes in both domains can reach the border nodes by using the same prefix and prefix SID. For example, Node 3 and Node 22 can reach Node 5 using prefix SID 16005.

Configure Common Router ID

On each border node, configure a common TE router ID under each IS-IS instance:

Example: Border Node 5

```
router isis Domain1
 address-family ipv4 unicast
  router-id loopback0

router isis Domain2
 address-family ipv4 unicast
  router-id loopback0
```

Example: Border Node 9

```
router isis Domain1
 address-family ipv4 unicast
  router-id loopback0

router isis Domain2
 address-family ipv4 unicast
  router-id loopback0
```

Distribute IS-IS Link-State Data

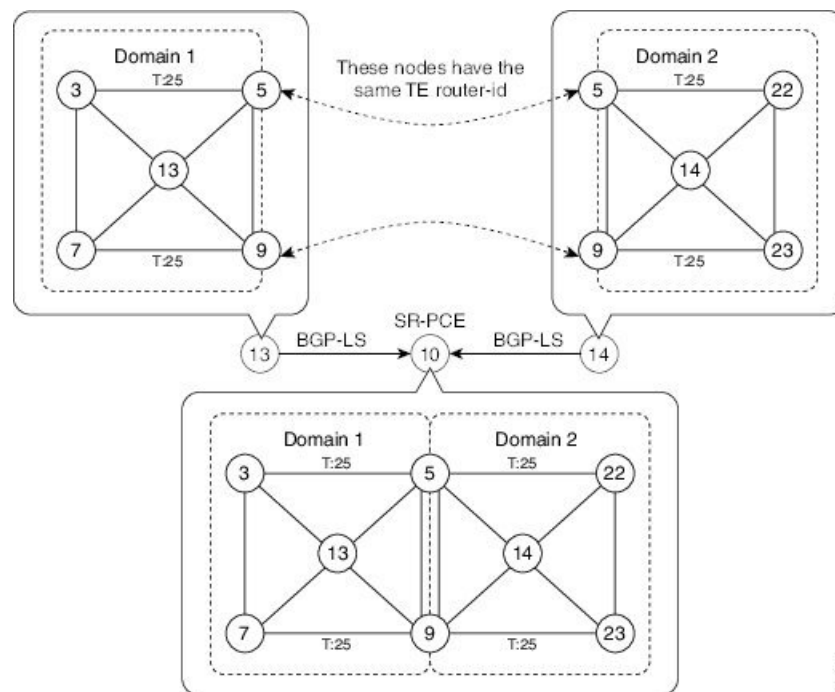

Configure BGP Link-state (BGP-LS) on Node 13 and Node 14 to report their local domain to Node 10:

Example: Node 13

```
router isis Domain1
 distribute link-state instance-id instance-id
```

Example: Node 14

```
router isis Domain2
  distribute link-state instance-id instance-id
```

Link-state ID starts from 32. One ID is required per IGP domain. Different domain IDs are essential to identify that the SR-TE TED belongs to a particular IGP domain.

Nodes 13 and 14 each reports its local domain in BGP-LS to Node 10.

Node 10 identifies the border nodes (Nodes 5 and 9) by their common advertised TE router ID, then combines (stitches) the domains on these border nodes for end-to-end path computations.



CHAPTER 5

Configure Segment Routing for OSPF Protocol

Open Shortest Path First (OSPF) is an Interior Gateway Protocol (IGP) developed by the OSPF working group of the Internet Engineering Task Force (IETF). Designed expressly for IP networks, OSPF supports IP subnetting and tagging of externally derived routing information. OSPF also allows packet authentication and uses IP multicast when sending and receiving packets.

This module provides the configuration information to enable segment routing for OSPF.



Note For additional information on implementing OSPF on your Cisco ASR 9000 Series Router, see the *Implementing OSPF* module in the *Cisco ASR 9000 Series Aggregation Services Router Routing Configuration Guide*.

- [Enabling Segment Routing for OSPF Protocol, on page 53](#)
- [Configuring a Prefix-SID on the OSPF-Enabled Loopback Interface, on page 55](#)
- [Configuring an Adjacency SID, on page 57](#)

Enabling Segment Routing for OSPF Protocol

Segment routing on the OSPF control plane supports the following:

- OSPFv2 control plane
- Multi-area
- IPv4 prefix SIDs for host prefixes on loopback interfaces
- Adjacency SIDs for adjacencies
- MPLS penultimate hop popping (PHP) and explicit-null signaling

This section describes how to enable segment routing MPLS and MPLS forwarding in OSPF. Segment routing can be configured at the instance, area, or interface level.

Before you begin

Your network must support the MPLS Cisco IOS XR software feature before you enable segment routing for OSPF on your router.



Note You must enter the commands in the following task list on every OSPF router in the traffic-engineered portion of your network.

SUMMARY STEPS

1. **configure**
2. **router ospf** *process-name*
3. **segment-routing mpls**
4. **area** *area*
5. **segment-routing mpls**
6. **exit**
7. Use the **commit** or **end** command.

DETAILED STEPS

	Command or Action	Purpose
Step 1	configure Example: RP/0/RSP0/CPU0:router# configure	Enters global configuration mode.
Step 2	router ospf <i>process-name</i> Example: RP/0/RSP0/CPU0:router(config)# router ospf 1	Enables OSPF routing for the specified routing process and places the router in router configuration mode.
Step 3	segment-routing mpls Example: RP/0/RSP0/CPU0:router(config-ospf)# segment-routing mpls	Enables segment routing using the MPLS data plane on the routing process and all areas and interfaces in the routing process. Enables segment routing forwarding on all interfaces in the routing process and installs the SIDs received by OSPF in the forwarding table.
Step 4	area <i>area</i> Example: RP/0/RSP0/CPU0:router(config-ospf)# area 0	Enters area configuration mode.
Step 5	segment-routing mpls Example: RP/0/RSP0/CPU0:router(config-ospf-ar)# segment-routing mpls	(Optional) Enables segment routing using the MPLS data plane on the area and all interfaces in the area. Enables segment routing forwarding on all interfaces in the area and installs the SIDs received by OSPF in the forwarding table.
Step 6	exit Example:	

	Command or Action	Purpose
	RP/0/RSP0/CPU0:router(config-ospf-ar)# exit RP/0/RSP0/CPU0:router(config-ospf)# exit	
Step 7	Use the commit or end command.	<p>commit —Saves the configuration changes and remains within the configuration session.</p> <p>end —Prompts user to take one of these actions:</p> <ul style="list-style-type: none"> • Yes — Saves configuration changes and exits the configuration session. • No —Exits the configuration session without committing the configuration changes. • Cancel —Remains in the configuration session, without committing the configuration changes.

What to do next

Configure the prefix SID.

Configuring a Prefix-SID on the OSPF-Enabled Loopback Interface

A prefix segment identifier (SID) is associated with an IP prefix. The prefix SID is manually configured from the segment routing global block (SRGB) range of labels. A prefix SID is configured under the loopback interface with the loopback address of the node as the prefix. The prefix segment steers the traffic along the shortest path to its destination.

A prefix SID can be a node SID or an Anycast SID. A node SID is a type of prefix SID that identifies a specific node. An Anycast SID is a type of prefix SID that identifies a set of nodes, and is configured with n-flag clear. The set of nodes (Anycast group) is configured to advertise a shared prefix address and prefix SID. Anycast routing enables the steering of traffic toward multiple advertising nodes. Packets addressed to an Anycast address are forwarded to the topologically nearest nodes.

The prefix SID is globally unique within the segment routing domain.

This task describes how to configure prefix segment identifier (SID) index or absolute value on the OSPF-enabled Loopback interface.

Before you begin

Ensure that segment routing is enabled on an instance, area, or interface.

SUMMARY STEPS

1. **configure**
2. **router ospf** *process-name*
3. **area** *value*

4. **interface Loopback** *interface-instance*
5. **prefix-sid** [**strict-spf**] {**index** *SID-index* | **absolute** *SID-value* } [**n-flag-clear**] [**explicit-null**]
6. Use the **commit** or **end** command.

DETAILED STEPS

	Command or Action	Purpose
Step 1	configure Example: RP/0/RSP0/CPU0:router# configure	Enters global configuration mode.
Step 2	router ospf <i>process-name</i> Example: RP/0/RSP0/CPU0:router(config)# router ospf 1	Enables OSPF routing for the specified routing process, and places the router in router configuration mode.
Step 3	area <i>value</i> Example: RP/0/RSP0/CPU0:router(config-ospf)# area 0	Enters area configuration mode.
Step 4	interface Loopback <i>interface-instance</i> Example: RP/0/RSP0/CPU0:router(config-ospf-ar)# interface Loopback0 passive	Specifies the loopback interface and instance.
Step 5	prefix-sid [strict-spf] { index <i>SID-index</i> absolute <i>SID-value</i> } [n-flag-clear] [explicit-null] Example: RP/0/RSP0/CPU0:router(config-ospf-ar)# prefix-sid index 1001 RP/0/RSP0/CPU0:router(config-ospf-ar)# prefix-sid absolute 17001	Configures the prefix-SID index or absolute value for the interface. Specify strict-spf to configure the prefix-SID to use the SPF path instead of the SR-TE policy. Specify index <i>SID-index</i> for each node to create a prefix SID based on the lower boundary of the SRGB + the index. Specify absolute <i>SID-value</i> for each node to create a specific prefix SID within the SRGB. By default, the n-flag is set on the prefix-SID, indicating that it is a node SID. For specific prefix-SID (for example, Anycast prefix-SID), enter the n-flag-clear keyword. OSPF does not set the N flag in the prefix-SID sub Type Length Value (TLV). To disable penultimate-hop-popping (PHP) and add an explicit-Null label, enter the explicit-null keyword. OSPF sets the E flag in the prefix-SID sub TLV.
Step 6	Use the commit or end command.	commit —Saves the configuration changes and remains within the configuration session.

	Command or Action	Purpose
		<p>end —Prompts user to take one of these actions:</p> <ul style="list-style-type: none"> • Yes — Saves configuration changes and exits the configuration session. • No —Exits the configuration session without committing the configuration changes. • Cancel —Remains in the configuration session, without committing the configuration changes.

Verify the prefix-SID configuration:

```
RP/0/RSP0/CPU0:router# show ospf database opaque-area 7.0.0.1 self-originate
OSPF Router with ID (10.0.0.1) (Process ID 1)
      Type-10 Opaque Link Area Link States (Area 0)
<...>
  Extended Prefix TLV: Length: 20
    Route-type: 1
    AF          : 0
    Flags       : 0x40
    Prefix      : 10.0.0.1/32

  SID sub-TLV: Length: 8
    Flags       : 0x0
    MTID        : 0
    Algo        : 0
    SID Index : 1001
```

Configuring an Adjacency SID

An adjacency SID (Adj-SID) is associated with an adjacency to a neighboring node. The adjacency SID steers the traffic to a specific adjacency. Adjacency SIDs have local significance and are only valid on the node that allocates them.

An adjacency SID can be allocated dynamically from the dynamic label range or configured manually from the segment routing local block (SRLB) range of labels.

Adjacency SIDs that are dynamically allocated do not require any special configuration, however there are some limitations:

- A dynamically allocated Adj-SID value is not known until it has been allocated, and a controller will not know the Adj-SID value until the information is flooded by the IGP.
- Dynamically allocated Adj-SIDs are not persistent and can be reallocated after a reload or a process restart.
- Each link is allocated a unique Adj-SID, so the same Adj-SID cannot be shared by multiple links.

Manually allocated Adj-SIDs are persistent over reloads and restarts. They can be provisioned for multiple adjacencies to the same neighbor or to different neighbors. You can specify that the Adj-SID is protected. If

the Adj-SID is protected on the primary interface and a backup path is available, a backup path is installed. By default, manual Adj-SIDs are not protected.

Adjacency SIDs are advertised using the existing OSPF Adj-SID sub-TLV. The P-flag is defined for manually allocated Adj-SIDs.

```

 0 1 2 3 4 5 6 7
+-----+-----+
|B|V|L|G|P|      |
+-----+-----+

```

Table 3: Adjacency Segment Identifier (Adj-SID) Flags Sub-TLV Fields

Field	Description
P (Persistent)	This flag is set if the Adj-SID is persistent (manually allocated).

This task explains how to configure an Adj-SID on an interface.

Before you begin

Ensure that segment routing is enabled on the corresponding address family.

Use the **show mpls label table detail** command to verify the SRLB range.

SUMMARY STEPS

1. **configure**
2. **router ospf** *process-name*
3. **area** *area*
4. **interface** *type interface-path-id*
5. **adjacency-sid** {*index adj-SID-index* | **absolute** *adj-SID-value*} [**protected**]
6. Use the **commit** or **end** command.

DETAILED STEPS

	Command or Action	Purpose
Step 1	configure Example: RP/0/RSP0/CPU0:router# configure	Enters global configuration mode.
Step 2	router ospf <i>process-name</i> Example: RP/0/RSP0/CPU0:router(config)# router ospf 1	Enables OSPF routing for the specified routing instance, and places the router in router configuration mode.
Step 3	area <i>area</i> Example: RP/0/RSP0/CPU0:router(config-ospf)# area 0	Enters area configuration mode.

	Command or Action	Purpose
Step 4	<p>interface <i>type interface-path-id</i></p> <p>Example:</p> <pre>RP/0/RSP0/CPU0:router(config-ospf-ar) # interface HundredGigE0/0/0/1</pre>	Specifies the interface and enters interface configuration mode.
Step 5	<p>adjacency-sid {index <i>adj-SID-index</i> absolute <i>adj-SID-value</i>} [protected]</p> <p>Example:</p> <pre>RP/0/RSP0/CPU0:router(config-config-ospf-ar-if) # adjacency-sid index 10</pre> <pre>RP/0/RSP0/CPU0:router(config-config-ospf-ar-if) # adjacency-sid absolute 15010</pre>	<p>Configures the Adj-SID index or absolute value for the interface.</p> <p>Specify index <i>adj-SID-index</i> for each link to create an Adj-SID based on the lower boundary of the SRLB + the index.</p> <p>Specify absolute <i>adj-SID-value</i> for each link to create a specific Adj-SID within the SRLB.</p> <p>Specify if the Adj-SID is protected. For each primary path, if the Adj-SID is protected on the primary interface and a backup path is available, a backup path is installed. By default, manual Adj-SIDs are not protected.</p>
Step 6	Use the commit or end command.	<p>commit —Saves the configuration changes and remains within the configuration session.</p> <p>end —Prompts user to take one of these actions:</p> <ul style="list-style-type: none"> • Yes — Saves configuration changes and exits the configuration session. • No —Exits the configuration session without committing the configuration changes. • Cancel —Remains in the configuration session, without committing the configuration changes.

What to do next

Configure the SR-TE policy.



CHAPTER 6

Configure Segment Routing for BGP

Border Gateway Protocol (BGP) is an Exterior Gateway Protocol (EGP) that allows you to create loop-free inter-domain routing between autonomous systems. An autonomous system is a set of routers under a single technical administration. Routers in an autonomous system can use multiple Interior Gateway Protocols (IGPs) to exchange routing information inside the autonomous system and an EGP to route packets outside the autonomous system.

This module provides the configuration information used to enable Segment Routing for BGP.



Note For additional information on implementing BGP on your Cisco ASR 9000 Series Router, see the *Implementing BGP* module in the *Cisco ASR 9000 Series Aggregation Services Router Routing Configuration Guide*.

- [Segment Routing for BGP, on page 61](#)
- [Configure BGP Prefix Segment Identifiers, on page 62](#)
- [Segment Routing Egress Peer Engineering, on page 63](#)
- [Configure BGP Link-State, on page 65](#)
- [Use Case: Configuring SR-EPE and BGP-LS, on page 69](#)
- [Configure BGP Proxy Prefix SID, on page 71](#)

Segment Routing for BGP

In a traditional BGP-based data center (DC) fabric, packets are forwarded hop-by-hop to each node in the autonomous system. Traffic is directed only along the external BGP (eBGP) multipath ECMP. No traffic engineering is possible.

In an MPLS-based DC fabric, the eBGP sessions between the nodes exchange BGP labeled unicast (BGP-LU) network layer reachability information (NLRI). An MPLS-based DC fabric allows any leaf (top-of-rack or border router) in the fabric to communicate with any other leaf using a single label, which results in higher packet forwarding performance and lower encapsulation overhead than traditional BGP-based DC fabric. However, since each label value might be different for each hop, an MPLS-based DC fabric is more difficult to troubleshoot and more complex to configure.

BGP has been extended to carry segment routing prefix-SID index. BGP-LU helps each node learn BGP prefix SIDs of other leaf nodes and can use ECMP between source and destination. Segment routing for BGP

simplifies the configuration, operation, and troubleshooting of the fabric. With segment routing for BGP, you can enable traffic steering capabilities in the data center using a BGP prefix SID.

Configure BGP Prefix Segment Identifiers

Segments associated with a BGP prefix are known as BGP prefix SIDs. The BGP prefix SID is global within a segment routing or BGP domain. It identifies an instruction to forward the packet over the ECMP-aware best-path computed by BGP to the related prefix. The BGP prefix SID is manually configured from the segment routing global block (SRGB) range of labels.

Each BGP speaker must be configured with an SRGB using the **segment-routing global-block** command. See the [About the Segment Routing Global Block](#) section for information about the SRGB.



Note Because the values assigned from the range have domain-wide significance, we recommend that all routers within the domain be configured with the same range of values.

To assign a BGP prefix SID, first create a routing policy using the **set label-index** *index* attribute, then associate the index to the node.



Note A routing policy with the **set label-index** attribute can be attached to a network configuration or redistribute configuration. Other routing policy language (RPL) configurations are possible. For more information on routing policies, refer to the "Implementing Routing Policy" chapter in the *Cisco ASR 9000 Series Aggregation Services Router Routing Configuration Guide*.

Example

The following example shows how to configure the SRGB, create a BGP route policy using a \$SID parameter and **set label-index** attribute, and then associate the prefix-SID index to the node.

```
RP/0/RSP0/CPU0:router(config)# segment-routing global-block 16000 23999

RP/0/RSP0/CPU0:router(config)# route-policy SID($SID)
RP/0/RSP0/CPU0:router(config-rpl)# set label-index $SID
RP/0/RSP0/CPU0:router(config-rpl)# end policy

RP/0/RSP0/CPU0:router(config)# router bgp 1
RP/0/RSP0/CPU0:router(config-bgp)# bgp router-id 10.1.1.1
RP/0/RSP0/CPU0:router(config-bgp)# address-family ipv4 unicast
RP/0/RSP0/CPU0:router(config-bgp-af)# network 10.1.1.3/32 route-policy SID(3)
RP/0/RSP0/CPU0:router(config-bgp-af)# allocate-label all
RP/0/RSP0/CPU0:router(config-bgp-af)# commit
RP/0/RSP0/CPU0:router(config-bgp-af)# end

RP/0/RSP0/CPU0:router# show bgp 10.1.1.3/32
BGP routing table entry for 10.1.1.3/32
Versions:
  Process          bRIB/RIB   SendTblVer
  Speaker          74         74
  Local Label: 16003
```



```

Last Modified: Sep 29 19:52:18.155 for 00:07:22
Paths: (1 available, best #1)
  Advertised to update-groups (with more than one peer):
    0.2
  Path #1: Received by speaker 0
  Advertised to update-groups (with more than one peer):
    0.2
  3
  99.3.21.3 from 99.3.21.3 (10.1.1.3)
  Received Label 3
  Origin IGP, metric 0, localpref 100, valid, external, best, group-best
  Received Path ID 0, Local Path ID 1, version 74
  Origin-AS validity: not-found
  Label Index: 3

```

Segment Routing Egress Peer Engineering

Segment routing egress peer engineering (EPE) uses a controller to instruct an ingress provider edge, or a content source (node) within the segment routing domain, to use a specific egress provider edge (node) and a specific external interface to reach a destination. BGP peer SIDs are used to express source-routed inter-domain paths.

Below are the BGP-EPE peering SID types:

- PeerNode SID—To an eBGP peer. Pops the label and forwards the traffic on any interface to the peer.
- PeerAdjacency SID—To an eBGP peer via interface. Pops the label and forwards the traffic on the related interface.

The controller learns the BGP peer SIDs and the external topology of the egress border router through BGP-LS EPE routes. The controller can program an ingress node to steer traffic to a destination through the egress node and peer node using BGP labeled unicast (BGP-LU).

EPE functionality is only required at the EPE egress border router and the EPE controller.

Configure Segment Routing Egress Peer Engineering

This task explains how to configure segment routing EPE on the EPE egress node.

SUMMARY STEPS

1. **router** **bgp** *as-number*
2. **neighbor** *ip-address*
3. **remote-as** *as-number*
4. **egress-engineering**
5. **exit**
6. Use the **commit** or **end** command.

DETAILED STEPS

	Command or Action	Purpose
Step 1	<p>router <i>bgp as-number</i></p> <p>Example:</p> <pre>RP/0/RSP0/CPU0:router(config)# router bgp 1</pre>	Specifies the BGP AS number and enters the BGP configuration mode, allowing you to configure the BGP routing process.
Step 2	<p>neighbor <i>ip-address</i></p> <p>Example:</p> <pre>RP/0/RSP0/CPU0:router(config-bgp)# neighbor 192.168.1.3</pre>	Places the router in neighbor configuration mode for BGP routing and configures the neighbor IP address as a BGP peer.
Step 3	<p>remote-as <i>as-number</i></p> <p>Example:</p> <pre>RP/0/RSP0/CPU0:router(config-bgp-nbr)# remote-as 3</pre>	Creates a neighbor and assigns a remote autonomous system number to it.
Step 4	<p>egress-engineering</p> <p>Example:</p> <pre>RP/0/RSP0/CPU0:router(config-bgp-nbr)# egress-engineering</pre>	Configures the egress node with EPE for the eBGP peer.
Step 5	<p>exit</p> <p>Example:</p> <pre>RP/0/RSP0/CPU0:router(config-bgp-nbr)# exit RP/0/RSP0/CPU0:router(config-bgp)# exit RP/0/RSP0/CPU0:router(config)#</pre>	
Step 6	Use the commit or end command.	<p>commit —Saves the configuration changes and remains within the configuration session.</p> <p>end —Prompts user to take one of these actions:</p> <ul style="list-style-type: none"> • Yes — Saves configuration changes and exits the configuration session. • No —Exits the configuration session without committing the configuration changes. • Cancel —Remains in the configuration session, without committing the configuration changes.

Example

Running Config:

```
router bgp 1
 neighbor 192.168.1.3
   remote-as 3
   egress-engineering
 !
 !
 !
```

Configure BGP Link-State

BGP Link-State (LS) is an Address Family Identifier (AFI) and Sub-address Family Identifier (SAFI) originally defined to carry interior gateway protocol (IGP) link-state information through BGP. The BGP Network Layer Reachability Information (NLRI) encoding format for BGP-LS and a new BGP Path Attribute called the BGP-LS attribute are defined in [RFC7752](#). The identifying key of each Link-State object, namely a node, link, or prefix, is encoded in the NLRI and the properties of the object are encoded in the BGP-LS attribute.

The BGP-LS Extensions for Segment Routing are documented in [RFC9085](#).

BGP-LS applications like an SR Path Computation Engine (SR-PCE) can learn the SR capabilities of the nodes in the topology and the mapping of SR segments to those nodes. This can enable the SR-PCE to perform path computations based on SR-TE and to steer traffic on paths different from the underlying IGP-based distributed best-path computation.

The following figure shows a typical deployment scenario. In each IGP area, one or more nodes (BGP speakers) are configured with BGP-LS. These BGP speakers form an iBGP mesh by connecting to one or more route-reflectors. This way, all BGP speakers (specifically the route-reflectors) obtain Link-State information from all IGP areas (and from other ASes from eBGP peers).

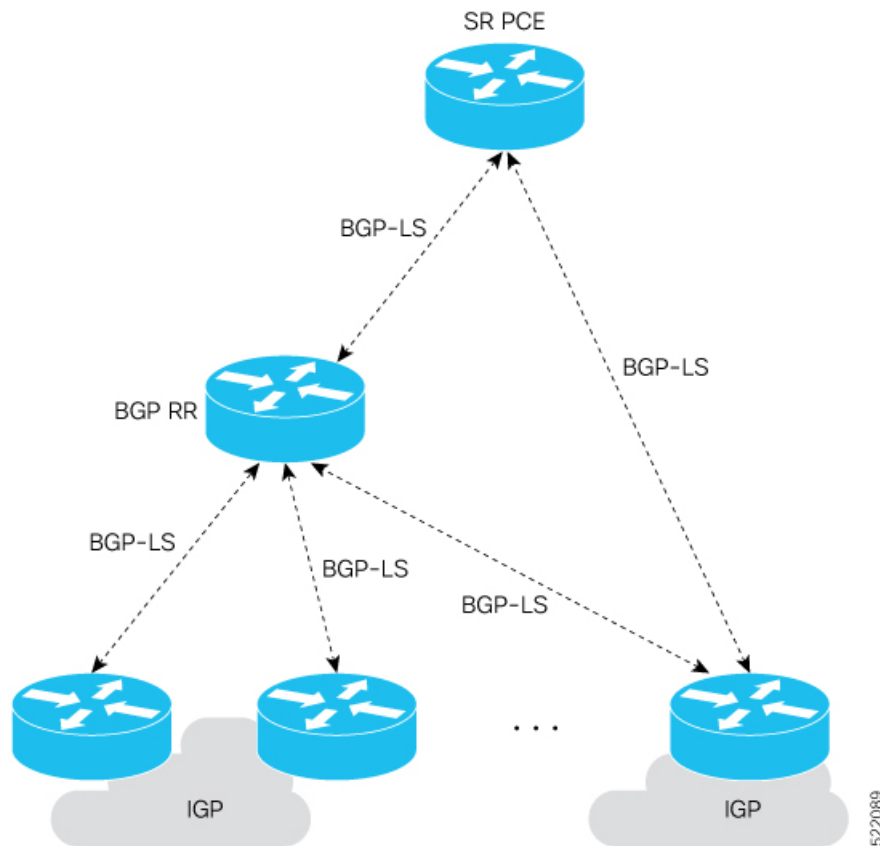

Usage Guidelines and Limitations

- BGP-LS supports IS-IS and OSPFv2.
- The identifier field of BGP-LS (referred to as the Instance-ID) identifies the IGP routing domain where the NLRI belongs. The NRIs representing link-state objects (nodes, links, or prefixes) from the same IGP routing instance must use the same Instance-ID value.
- When there is only a single protocol instance in the network where BGP-LS is operational, we recommend configuring the Instance-ID value to **0**.
- Assign consistent BGP-LS Instance-ID values on all BGP-LS Producers within a given IGP domain.
- NRIs with different Instance-ID values are considered to be from different IGP routing instances.
- Unique Instance-ID values must be assigned to routing protocol instances operating in different IGP domains. This allows the BGP-LS Consumer (for example, SR-PCE) to build an accurate segregated multi-domain topology based on the Instance-ID values, even when the topology is advertised via BGP-LS by multiple BGP-LS Producers in the network.
- If the BGP-LS Instance-ID configuration guidelines are not followed, a BGP-LS Consumer may see duplicate link-state objects for the same node, link, or prefix when there are multiple BGP-LS Producers deployed. This may also result in the BGP-LS Consumers getting an inaccurate network-wide topology.

- The following table defines the supported extensions to the BGP-LS address family for carrying IGP topology information (including SR information) via BGP. For more information on the BGP-LS TLVs, refer to [Border Gateway Protocol - Link State \(BGP-LS\) Parameters](#).

Table 4: IOS XR Supported BGP-LS Node Descriptor, Link Descriptor, Prefix Descriptor, and Attribute TLVs

TLV Code Point	Description	Produced by IS-IS	Produced by OSPFv2	Produced by BGP
256	Local Node Descriptors	X	X	—
257	Remote Node Descriptors	X	X	—
258	Link Local/Remote Identifiers	X	X	—
259	IPv4 interface address	X	X	—
260	IPv4 neighbor address	X		
261	IPv6 interface address	X	—	—
262	IPv6 neighbor address	X	—	—
263	Multi-Topology ID	X	—	—
264	OSPF Route Type	—	X	—
265	IP Reachability Information	X	X	—
266	Node MSD TLV	X	X	—
267	Link MSD TLV	X	X	—
512	Autonomous System	—	—	X
513	BGP-LS Identifier	—	—	X
514	OSPF Area-ID	—	X	—
515	IGP Router-ID	X	X	—
516	BGP Router-ID TLV	—	—	X
517	BGP Confederation Member TLV	—	—	X
1024	Node Flag Bits	X	X	—
1026	Node Name	X	X	—
1027	IS-IS Area Identifier	X	—	—
1028	IPv4 Router-ID of Local Node	X	X	—
1029	IPv6 Router-ID of Local Node	X	—	—
1030	IPv4 Router-ID of Remote Node	X	X	—
1031	IPv6 Router-ID of Remote Node	X	—	—
1034	SR Capabilities TLV	X	X	—
1035	SR Algorithm TLV	X	X	—
1036	SR Local Block TLV	X	X	—

TLV Code Point	Description	Produced by IS-IS	Produced by OSPFv2	Produced by BGP
1039	Flex Algo Definition (FAD) TLV	X	X	—
1044	Flex Algorithm Prefix Metric (FAPM) TLV	X	X	—
1088	Administrative group (color)	X	X	—
1089	Maximum link bandwidth	X	X	—
1090	Max. reservable link bandwidth	X	X	—
1091	Unreserved bandwidth	X	X	—
1092	TE Default Metric	X	X	—
1093	Link Protection Type	X	X	—
1094	MPLS Protocol Mask	X	X	—
1095	IGP Metric	X	X	—
1096	Shared Risk Link Group	X	X	—
1099	Adjacency SID TLV	X	X	—
1100	LAN Adjacency SID TLV	X	X	—
1101	PeerNode SID TLV	—	—	X
1102	PeerAdj SID TLV	—	—	X
1103	PeerSet SID TLV	—	—	X
1114	Unidirectional Link Delay TLV	X	X	—
1115	Min/Max Unidirectional Link Delay TLV	X	X	—
1116	Unidirectional Delay Variation TLV	X	X	—
1117	Unidirectional Link Loss	X	X	—
1118	Unidirectional Residual Bandwidth	X	X	—
1119	Unidirectional Available Bandwidth	X	X	—
1120	Unidirectional Utilized Bandwidth	X	X	—
1122	Application-Specific Link Attribute TLV	X	X	—
1152	IGP Flags	X	X	—
1153	IGP Route Tag	X	X	—
1154	IGP Extended Route Tag	X	—	—
1155	Prefix Metric	X	X	—
1156	OSPF Forwarding Address	—	X	—
1158	Prefix-SID	X	X	—
1159	Range	X	X	—

TLV Code Point	Description	Produced by IS-IS	Produced by OSPFv2	Produced by BGP
1161	SID/Label TLV	X	X	—
1170	Prefix Attribute Flags	X	X	—
1171	Source Router Identifier	X	—	—
1172	L2 Bundle Member Attributes TLV	X	—	—
1173	Extended Administrative Group	X	X	—

Exchange Link State Information with BGP Neighbor

The following example shows how to exchange link-state information with a BGP neighbor:

```
Router# configure
Router(config)# router bgp 1
Router(config-bgp)# neighbor 10.0.0.2
Router(config-bgp-nbr)# remote-as 1
Router(config-bgp-nbr)# address-family link-state link-state
Router(config-bgp-nbr-af)# exit
```

IGP Link-State Database Distribution

A given BGP node may have connections to multiple, independent routing domains. IGP link-state database distribution into BGP-LS is supported for both OSPF and IS-IS protocols in order to distribute this information on to controllers or applications that desire to build paths spanning or including these multiple domains.

To distribute IS-IS link-state data using BGP-LS, use the **distribute link-state** command in router configuration mode.

```
Router# configure
Router(config)# router isis isp
Router(config-isis)# distribute link-state instance-id 32
```

To distribute OSPFv2 link-state data using BGP-LS, use the **distribute link-state** command in router configuration mode.

```
Router# configure
Router(config)# router ospf 100
Router(config-ospf)# distribute link-state instance-id 32
```

Use Case: Configuring SR-EPE and BGP-LS

In the following figure, segment routing is enabled on autonomous system AS1 with ingress node A and egress nodes B and C. In this example, we configure EPE on egress node C.

Figure 3: Topology

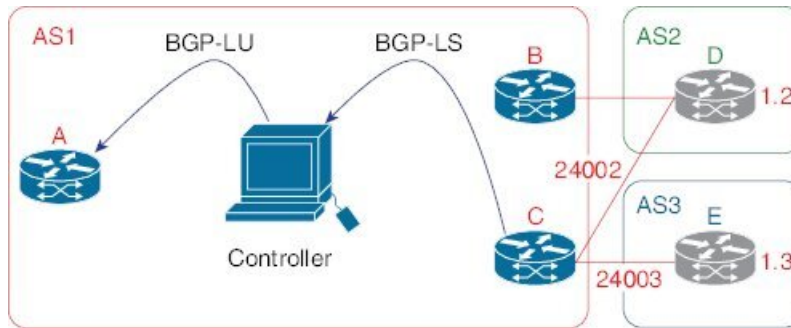

Step 1 Configure node C with EPE for eBGP peers D and E.

Example:

```
RP/0/RSP0/CPU0:router_C(config)# router bgp 1
RP/0/RSP0/CPU0:router_C(config-bgp)# neighbor 192.168.1.3
RP/0/RSP0/CPU0:router_C(config-bgp-nbr)# remote-as 3
RP/0/RSP0/CPU0:router_C(config-bgp-nbr)# description to E
RP/0/RSP0/CPU0:router_C(config-bgp-nbr)# egress-engineering
RP/0/RSP0/CPU0:router_C(config-bgp-nbr)# address-family ipv4 unicast
RP/0/RSP0/CPU0:router_C(config-bgp-nbr-af)# route-policy bgp_in in
RP/0/RSP0/CPU0:router_C(config-bgp-nbr-af)# route-policy bgp_out out
RP/0/RSP0/CPU0:router_C(config-bgp-nbr-af)# exit
RP/0/RSP0/CPU0:router_C(config-bgp-nbr)# exit
RP/0/RSP0/CPU0:router_C(config-bgp)# neighbor 192.168.1.2
RP/0/RSP0/CPU0:router_C(config-bgp-nbr)# remote-as 2
RP/0/RSP0/CPU0:router_C(config-bgp-nbr)# description to D
RP/0/RSP0/CPU0:router_C(config-bgp-nbr)# egress-engineering
RP/0/RSP0/CPU0:router_C(config-bgp-nbr)# address-family ipv4 unicast
RP/0/RSP0/CPU0:router_C(config-bgp-nbr-af)# route-policy bgp_in in
RP/0/RSP0/CPU0:router_C(config-bgp-nbr-af)# route-policy bgp_out out
RP/0/RSP0/CPU0:router_C(config-bgp-nbr-af)# exit
RP/0/RSP0/CPU0:router_C(config-bgp-nbr)# exit
```

Step 2 Configure node C to advertise peer node SIDs to the controller using BGP-LS.

Example:

```
RP/0/RSP0/CPU0:router_C(config-bgp)# neighbor 172.29.50.71
RP/0/RSP0/CPU0:router_C(config-bgp-nbr)# remote-as 1
RP/0/RSP0/CPU0:router_C(config-bgp-nbr)# description to EPE_controller
RP/0/RSP0/CPU0:router_C(config-bgp-nbr)# address-family link-state link-state
RP/0/RSP0/CPU0:router_C(config-bgp-nbr)# exit
RP/0/RSP0/CPU0:router_C(config-bgp)# exit
```

Step 3 Commit the configuration.

Example:

```
RP/0/RSP0/CPU0:router_C(config)# commit
```

Step 4 Verify the configuration.

Example:

```
RP/0/RSP0/CPU0:router_C# show bgp egress-engineering

Egress Engineering Peer Set: 192.168.1.2/32 (10b87210)
  Nexthop: 192.168.1.2
  Version: 2, rn_version: 2
  Flags: 0x00000002
  Local ASN: 1
  Remote ASN: 2
  Local RID: 10.1.1.3
  Remote RID: 10.1.1.4
  First Hop: 192.168.1.2
  NHID: 3
  Label: 24002, Refcount: 3
  rpc_set: 10b9d408

Egress Engineering Peer Set: 192.168.1.3/32 (10be61d4)
  Nexthop: 192.168.1.3
  Version: 3, rn_version: 3
  Flags: 0x00000002
  Local ASN: 1
  Remote ASN: 3
  Local RID: 10.1.1.3
  Remote RID: 10.1.1.5
  First Hop: 192.168.1.3
  NHID: 4
  Label: 24003, Refcount: 3
  rpc_set: 10be6250
```

The output shows that node C has allocated peer SIDs for each eBGP peer.

Example:

```
RP/0/RSP0/CPU0:router_C# show mpls forwarding labels 24002 24003
Local   Outgoing   Prefix      Outgoing   Next Hop    Bytes
Label   Label      or ID       Interface  -----
-----
24002   Pop        No ID      Te0/3/0/0  192.168.1.2  0
24003   Pop        No ID      Te0/1/0/0  192.168.1.3  0
```

The output shows that node C installed peer node SIDs in the Forwarding Information Base (FIB).

Configure BGP Proxy Prefix SID

To support segment routing, Border Gateway Protocol (BGP) requires the ability to advertise a segment identifier (SID) for a BGP prefix. A BGP-Proxy-SID is the segment identifier of the BGP prefix segment in a segment routing network. BGP proxy SID attribute is a BGP extension to signal BGP proxy-SIDs. However, there may be routers which do not support BGP extension for segment routing. Hence, those routers also do not support BGP proxy SID attribute and an alternate approach is required.

BGP proxy prefix SID feature allows you to attach BGP proxy SID attributes for remote prefixes learnt from BGP labeled unicast (LU) neighbours which are not SR-capable and propagate them as SR prefixes. This allows an LSP towards non SR endpoints to use segment routing global block in a SR domain. Since BGP proxy prefix SID uses global label values it minimizes the use of limited resources such as ECMP-FEC and provides more scalability for the networks.

BGP proxy prefix SID feature is implemented using the segment routing mapping server (SRMS). SRMS allows the user to configure SID mapping entries to specify the prefix-SIDs for the prefixes. The mapping server advertises the local SID-mapping policy to the mapping clients. BGP acts as a client of the SRMS and uses the mapping policy to calculate the prefix-SIDs.

Configuration Example:

This example shows how to configure the BGP proxy prefix SID feature for the segment routing mapping server.

```
RP/0/RSP0/CPU0:router(config)# segment-routing
RP/0/RSP0/CPU0:router(config-sr)# mapping-server
RP/0/RSP0/CPU0:router(config-sr-ms)# prefix-sid-map
RP/0/RSP0/CPU0:router(config-sr-ms-map)# address-family ipv4
RP/0/RSP0/CPU0:router(config-sr-ms-map-af)# 10.1.1.1/32 10 range 200
RP/0/RSP0/CPU0:router(config-sr-ms-map-af)# 192.168.64.1/32 400 range 300
```

This example shows how to configure the BGP proxy prefix SID feature for the segment-routing mapping client.

```
RP/0/RSP0/CPU0:router(config)# router bgp 1
RP/0/RSP0/CPU0:router(config-bgp)# address-family ipv4 unicast
RP/0/RSP0/CPU0:router(config-bgp-af)# segment-routing prefix-sid-map
```

Verification

These examples show how to verify the BGP proxy prefix SID feature.

```
RP/0/RSP0/CPU0:router# show segment-routing mapping-server prefix-sid-map ipv4 detail
Prefix
10.1.1.1/32
  SID Index:      10
  Range:          200
  Last Prefix:    10.1.1.200/32
  Last SID Index: 209
  Flags:
Number of mapping entries: 1

RP/0/RSP0/CPU0:router# show bgp ipv4 labeled-unicast 192.168.64.1/32

BGP routing table entry for 192.168.64.1/32
Versions:
  Process          bRIB/RIB  SendTblVer
  Speaker          117      117
  Local Label: 16400
Last Modified: Oct 25 01:02:28.562 for 00:11:45Paths: (2 available, best #1)
Advertised to peers (in unique update groups):
  201.1.1.1
Path #1: Received by speaker 0 Advertised to peers (in unique update groups):
  201.1.1.1
  Local
  20.0.101.1 from 20.0.101.1 (20.0.101.1)      Received Label 61
  Origin IGP, localpref 100, valid, internal, best, group-best, multipath, labeled-unicast

  Received Path ID 0, Local Path ID 0, version 117
Prefix SID Attribute Size: 7
Label Index: 1

RP/0/RSP0/CPU0:router# show route ipv4 unicast 192.68.64.1/32 detail
```

```

Routing entry for 192.168.64.1/32
  Known via "bgp 65000", distance 200, metric 0, [ei]-bgp, labeled SR, type internal
  Installed Oct 25 01:02:28.583 for 00:20:09
  Routing Descriptor Blocks
    20.0.101.1, from 20.0.101.1, BGP multi path
      Route metric is 0
      Label: 0x3d (61)
      Tunnel ID: None
      Binding Label: None
      Extended communities count: 0
      NHID:0x0(Ref:0)
      Route version is 0x6 (6)
  Local Label: 0x3e81 (16400)
  IP Precedence: Not Set
  QoS Group ID: Not Set
  Flow-tag: Not Set
  Fwd-class: Not Set
  Route Priority: RIB_PRIORITY_RECURSIVE (12) SVD Type RIB_SVD_TYPE_LOCAL
  Download Priority 4, Download Version 242
  No advertising protos.

```

```

RP/0/RSP0/CPU0:router# show cef ipv4 192.168.64.1/32 detail
192.168.64.1/32, version 476, labeled SR, drop adjacency, internal 0x5000001 0x80 (ptr
0x71c42b40) [1], 0x0 (0x71c11590), 0x808 (0x722b91e0)
  Updated Oct 31 23:23:48.733
  Prefix Len 32, traffic index 0, precedence n/a, priority 4
  Extensions: context-label:16400
    gateway array (0x71ae7e78) reference count 3, flags 0x7a, source rib (7), 0 backups
      [2 type 5 flags 0x88401 (0x722eb450) ext 0x0 (0x0)]
    LW-LDI[type=5, refc=3, ptr=0x71c11590, sh-ldi=0x722eb450]
    gateway array update type-time 3 Oct 31 23:49:11.720
  LDI Update time Oct 31 23:23:48.733
  LW-LDI-TS Oct 31 23:23:48.733
    via 20.0.101.1/32, 0 dependencies, recursive, bgp-ext [flags 0x6020]
      path-idx 0 NHID 0x0 [0x7129a294 0x0]
      recursion-via-/32
      unresolved
      local label 16400
      labels imposed {ExpNullv6}

```

```

RP/0/RSP0/CPU0:router# show bgp labels
BGP router identifier 2.1.1.1, local AS number 65000
BGP generic scan interval 60 secs
Non-stop routing is enabled
BGP table state: Active
Table ID: 0xe0000000 RD version: 245
BGP main routing table version 245
BGP NSR Initial initsync version 16 (Reached)
BGP NSR/ISSU Sync-Group versions 245/0
BGP scan interval 60 secs

```

```

Status codes: s suppressed, d damped, h history, * valid, > best
               i - internal, r RIB-failure, S stale, N Nexthop-discard
Origin codes: i - IGP, e - EGP, ? - incomplete

```

Network	Next Hop	Rcvd Label	Local Label
*>i10.1.1.1/32	10.1.1.1	3	16010
*> 2.1.1.1/32	0.0.0.0	nolabel	3
*> 192.68.64.1/32	20.0.101.1	2	16400
*> 192.68.64.2/32	20.0.101.1	2	16401



CHAPTER 7

Configure SR-TE Policies

This module provides information about segment routing for traffic engineering (SR-TE) policies, how to configure SR-TE policies, and how to steer traffic into an SR-TE policy.

- [SR-TE Policy Overview, on page 75](#)
- [Usage Guidelines and Limitations, on page 76](#)
- [Instantiation of an SR Policy, on page 76](#)
- [SR-TE Policy Path Types, on page 109](#)
- [Protocols, on page 123](#)
- [Traffic Steering, on page 130](#)
- [Miscellaneous, on page 144](#)

SR-TE Policy Overview

Segment routing for traffic engineering (SR-TE) uses a “policy” to steer traffic through the network. An SR-TE policy path is expressed as a list of segments that specifies the path, called a segment ID (SID) list. Each segment is an end-to-end path from the source to the destination, and instructs the routers in the network to follow the specified path instead of following the shortest path calculated by the IGP. If a packet is steered into an SR-TE policy, the SID list is pushed on the packet by the head-end. The rest of the network executes the instructions embedded in the SID list.

An SR-TE policy is identified as an ordered list (head-end, color, end-point):

- Head-end – Where the SR-TE policy is instantiated
- Color – A numerical value that distinguishes between two or more policies to the same node pairs (Head-end – End point)
- End-point – The destination of the SR-TE policy

Every SR-TE policy has a color value. Every policy between the same node pairs requires a unique color value.

An SR-TE policy uses one or more candidate paths. A candidate path is a single segment list (SID-list) or a set of weighted SID-lists (for weighted equal cost multi-path [WECCMP]). A candidate path is either dynamic or explicit. See *SR-TE Policy Path Types* section for more information.

Usage Guidelines and Limitations

Observe the following guidelines and limitations for the platform.

- Before configuring SR-TE policies, use the **distribute link-state** command under IS-IS or OSPF to distribute the link-state database to external services.
- GRE tunnel as primary interface for an SR policy is not supported.
- GRE tunnel as backup interface for an SR policy with TI-LFA protection is not supported.
- Head-end computed inter-domain SR policy with Flex Algo constraint and IGP redistribution is not supported.

Instantiation of an SR Policy

An SR policy is instantiated, or implemented, at the head-end router.

The following sections provide details on the SR policy instantiation methods:

- [On-Demand SR Policy – SR On-Demand Next-Hop](#) , on page 76
- [Manually Provisioned SR Policy](#), on page 109
- [PCE-Initiated SR Policy](#), on page 109

On-Demand SR Policy – SR On-Demand Next-Hop

Segment Routing On-Demand Next Hop (SR-ODN) allows a service head-end router to automatically instantiate an SR policy to a BGP next-hop when required (on-demand). Its key benefits include:

- **SLA-aware BGP service** – Provides per-destination steering behaviors where a prefix, a set of prefixes, or all prefixes from a service can be associated with a desired underlay SLA. The functionality applies equally to single-domain and multi-domain networks.
- **Simplicity** – No prior SR Policy configuration needs to be configured and maintained. Instead, operator simply configures a small set of common intent-based optimization templates throughout the network.
- **Scalability** – Device resources at the head-end router are used only when required, based on service or SLA connectivity needs.

The following example shows how SR-ODN works:

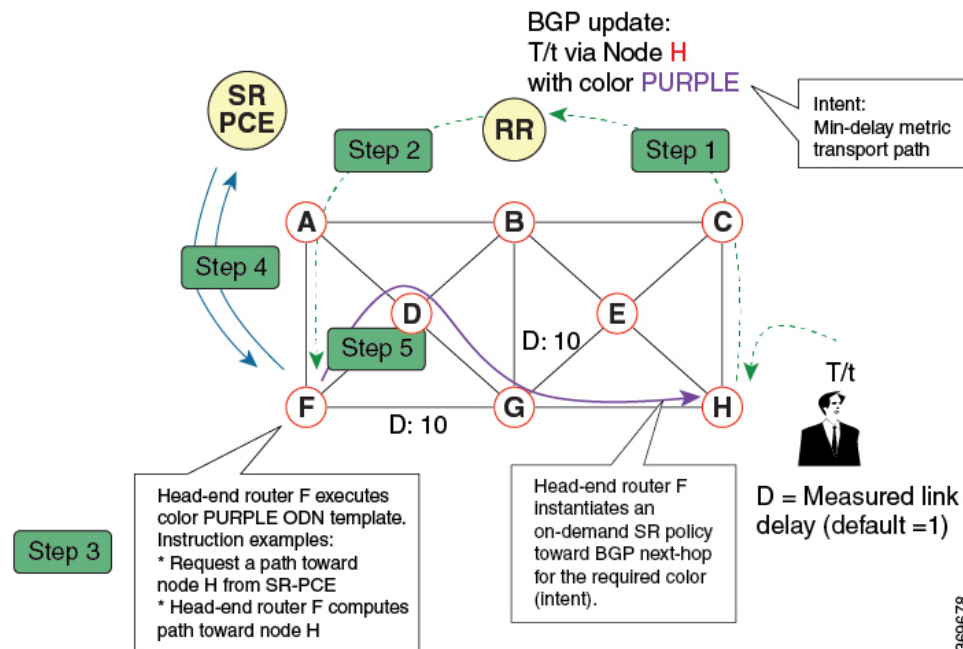

1. An egress PE (node H) advertises a BGP route for prefix T/t. This advertisement includes an SLA intent encoded with a BGP color extended community. In this example, the operator assigns color purple (example value = 100) to prefixes that should traverse the network over the delay-optimized path.
2. The route reflector receives the advertised route and advertises it to other PE nodes.
3. Ingress PEs in the network (such as node F) are pre-configured with an ODN template for color purple that provides the node with the steps to follow in case a route with the intended color appears, for example:
 - Contact SR-PCE and request computation for a path toward node H that does not share any nodes with another LSP in the same disjointness group.
 - At the head-end router, compute a path towards node H that minimizes cumulative delay.
4. In this example, the head-end router contacts the SR-PCE and requests computation for a path toward node H that minimizes cumulative delay.
5. After SR-PCE provides the compute path, an intent-driven SR policy is instantiated at the head-end router. Other prefixes with the same intent (color) and destined to the same egress PE can share the same on-demand SR policy. When the last prefix associated with a given [intent, egress PE] pair is withdrawn, the on-demand SR policy is deleted, and resources are freed from the head-end router.

An on-demand SR policy is created dynamically for BGP global or VPN (service) routes. The following services are supported with SR-ODN:

- IPv4 BGP global routes
- IPv6 BGP global routes (6PE)
- VPNv4
- VPNv6 (6vPE)
- EVPN-VPWS (single-homing)

SR-ODN/Automated Steering Support at ASBR for L3VPN Inter-AS Option B and L3VPN Inline Route Reflector

This feature augments support for SR-ODN and automated steering (AS) for the following scenarios:

- At ASBR nodes for L3VPN Inter-AS Option B
- At ABR nodes acting as L3VPN Inline Route Reflectors

With this feature, an ABR/ASBR node can trigger an on-demand SR policy used to steer traffic to remote colored destinations.



Note This feature is not supported when the Inter-AS Option B Per Next-Hop Label Allocation feature is enabled using the **label mode per-nexthop-received-label** command under the VPNv4 unicast address-family.

The below topology shows a network with different regions under a single BGP AS and with L3VPN services end-to-end. Nodes B and C are ABRs configured with BGP next-hop-self (NHS) for L3VPN. These ABRs program label cross connects for L3VPN destinations.

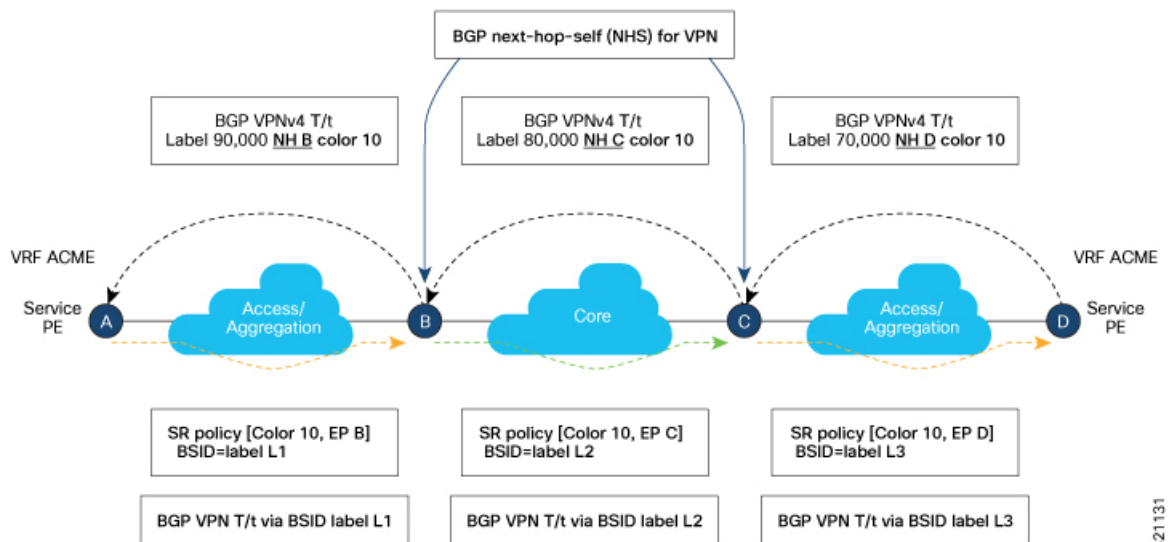

BGP advertises prefixes with SLA intent by attaching a color extended community. The objective is to steer traffic towards colored VPN prefixes with SR policies in *each* region. As shown in the figure, this feature allows ABR node B to steer traffic for remote BGP prefixes with color 10 over an SR policy with {color 10, end-point C}.

Similar behaviors apply at ASBR nodes for L3VPN Inter-AS Option B scenarios.

Configuring SR-ODN/AS at L3VPN ABR/ASBR

See the [SR-ODN Configuration Steps, on page 81](#) section for information about configuring the On-Demand Color Template.

Example – SR-ODN/AS at ASBR for L3VPN Inter-AS Option B

The following example depicts an L3VPN Inter-AS Option B scenario with node B acting as ASBR. Node B steers traffic for remote BGP prefix T/t with color 10 over an on-demand SR policy with a path to node C minimizing the TE metric.

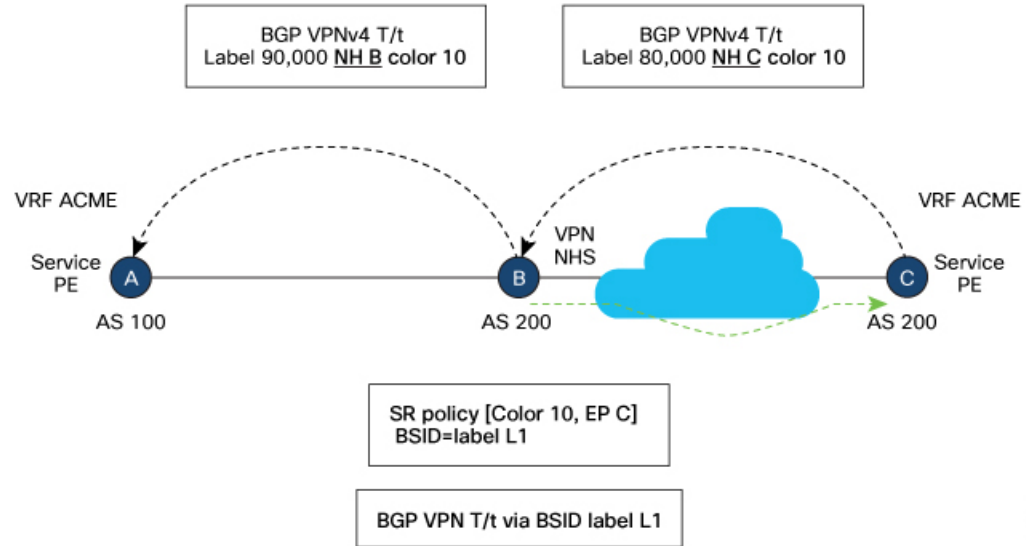

521132

Configuration on ASBR Node B

```
segment-routing
 traffic-eng
  on-demand color 10
  dynamic
  metric
  type te
  !
  !
  !
  !
router bgp 200
 address-family vpnv4 unicast
  retain route-target all
  !
 neighbor <neighbor_A>
  remote-as 100
  address-family vpnv4 unicast
  send-extended-community-ebgp
  route-policy pass-all in
  route-policy pass-all out
  !
 neighbor <neighbor_C>
  remote-as 200
  address-family vpnv4 unicast
  update-source Loopback0
  next-hop-self
```

Example - SR-ODN/AS at L3VPN ABR (BGP inline Route Reflector)

The following example depicts a scenario with node B acting as L3VPN BGP inline Route Reflector. Node B steers traffic for remote BGP prefix T/t with color 10 over an on-demand SR policy with a path to node C minimizing the delay metric.

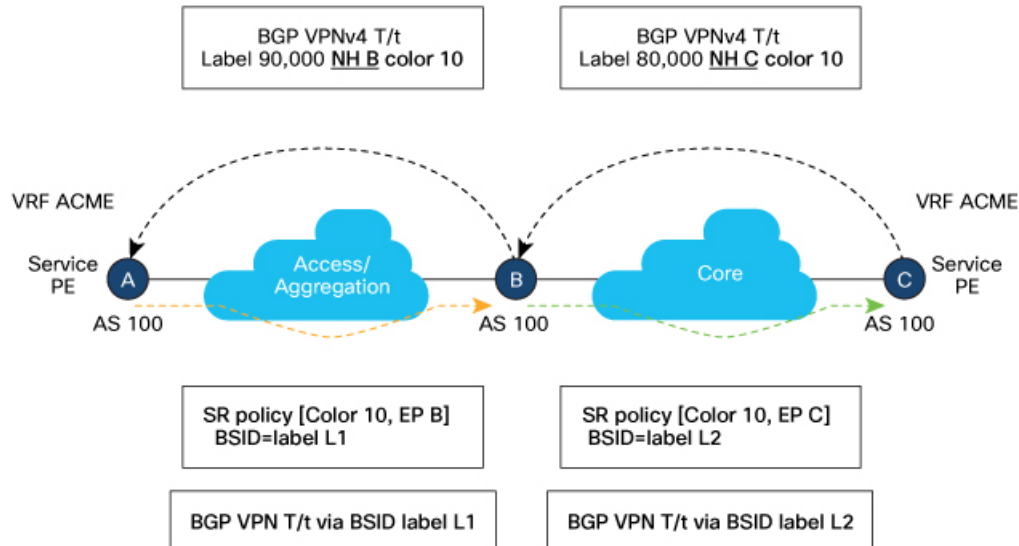

521133

Configuration on ASBR Node B

```

segment-routing
traffic-eng
  on-demand color 10
  dynamic
  metric
  type latency
  !
  !
  !
  !
router bgp 100
  ibgp policy out enforce-modifications
  address-family vpnv4 unicast
  !
  neighbor <neighbor_C>
  remote-as 100
  address-family vpnv4 unicast
  update-source Loopback0
  route-reflector-client
  next-hop-self
  !
  neighbor <neighbor_A>
  remote-as 100
  address-family vpnv4 unicast
  update-source Loopback0
  route-reflector-client
  next-hop-self

```

SR-ODN Configuration Steps

To configure SR-ODN, complete the following configurations:

1. Define the SR-ODN template on the SR-TE head-end router.
(Optional) If using Segment Routing Path Computation Element (SR-PCE) for path computation:
 - a. Configure SR-PCE. For detailed SR-PCE configuration information, see [Configure SR-PCE, on page 170](#).
 - b. Configure the head-end router as Path Computation Element Protocol (PCEP) Path Computation Client (PCC). For detailed PCEP PCC configuration information, see [Configure the Head-End Router as PCEP PCC](#).
2. Define BGP color extended communities. Refer to the "Implementing BGP" chapter in the [Routing Configuration Guide for Cisco ASR 9000 Series Routers](#).
3. Define routing policies (using routing policy language [RPL]) to set BGP color extended communities. Refer to the "Implementing Routing Policy" chapter in the [Routing Configuration Guide for Cisco ASR 9000 Series Routers](#).

The following RPL attach-points for setting/matching BGP color extended communities are supported:



Note The following table shows the supported RPL match operations; however, routing policies are required primarily to set BGP color extended community. Matching based on BGP color extended communities is performed automatically by ODN's on-demand color template.

Attach Point	Set	Match
VRF export	X	X
VRF import	–	X
Neighbor-in	X	X
Neighbor-out	X	X
Inter-AFI export	–	X
Inter-AFI import	–	X
Default-originate	X	–

4. Apply routing policies to a service. Refer to the "Implementing Routing Policy" chapter in the [Routing Configuration Guide for Cisco ASR 9000 Series Routers](#).

Configure On-Demand Color Template

- Use the **on-demand color** *color* command to create an ODN template for the specified color value. The head-end router automatically follows the actions defined in the template upon arrival of BGP global or VPN routes with a BGP color extended community that matches the color value specified in the template.

The *color* range is from 1 to 4294967295.

```
Router(config)# segment-routing traffic-eng
Router(config-sr-te)# on-demand color 10
```



Note Matching based on BGP color extended communities is performed automatically via ODN's on-demand color template. RPL routing policies are not required.

- Use the **on-demand color color dynamic** command to associate the template with on-demand SR policies with a locally computed dynamic path (by SR-TE head-end router utilizing its TE topology database) or centrally (by SR-PCE). The head-end router will first attempt to install the locally computed path; otherwise, it will use the path computed by the SR-PCE.

```
Router(config)# segment-routing traffic-eng
Router(config-sr-te)# on-demand color 10 dynamic
```

- Use the **on-demand color color dynamic pcep** command to indicate that only the path computed by SR-PCE should be associated with the on-demand SR policy. With this configuration, local path computation is not attempted; instead the head-end router will only instantiate the path computed by the SR-PCE.

```
Router(config-sr-te)# on-demand color 10 dynamic pcep
```

Configure Dynamic Path Optimization Objectives

- Use the **metric type {igp | te | latency}** command to configure the metric for use in path computation.

```
Router(config-sr-te-color-dyn)# metric type te
```

- Use the **metric margin {absolute value| relative percent}** command to configure the On-Demand dynamic path metric margin. The range for *value* and *percent* is from 0 to 2147483647.

```
Router(config-sr-te-color-dyn)# metric margin absolute 5
```

Configure Dynamic Path Constraints

- Use the **disjoint-path group-id group-id type {link | node | srlg | srlg-node} [sub-id sub-id]** command to configure the disjoint-path constraints. The *group-id* and *sub-id* range is from 1 to 65535.

```
Router(config-sr-te-color-dyn)# disjoint-path group-id 775 type link
```

- Use the **affinity {include-any | include-all | exclude-any} {name WORD}** command to configure the affinity constraints.

```
Router(config-sr-te-color-dyn)# affinity exclude-any name CROSS
```

- Use the **maximum-sid-depth value** command to customize the maximum SID depth (MSD) constraints advertised by the router.

The default MSD *value* is equal to the maximum MSD supported by the platform (10).

```
Router(config-sr-te-color)# maximum-sid-depth 5
```

See [Customize MSD Value at PCC, on page 125](#) for information about SR-TE label imposition capabilities.

- Use the **sid-algorithm** *algorithm-number* command to configure the SR Flexible Algorithm constraints. The *algorithm-number* range is from 128 to 255.

```
Router(config-sr-te-color-dyn)# sid-algorithm 128
```

Configuring SR-ODN: Examples

Configuring SR-ODN: Layer-3 Services Examples

The following examples show end-to-end configurations used in implementing SR-ODN on the head-end router.

Configuring ODN Color Templates: Example

Configure ODN color templates on routers acting as SR-TE head-end nodes. The following example shows various ODN color templates:

- color 10: minimization objective = te-metric
- color 20: minimization objective = igp-metric
- color 21: minimization objective = igp-metric; constraints = affinity
- color 22: minimization objective = te-metric; path computation at SR-PCE; constraints = affinity
- color 30: minimization objective = delay-metric
- color 128: constraints = flex-algo

```
segment-routing
traffic-eng
on-demand color 10
dynamic
metric
type te
!
!
on-demand color 20
dynamic
metric
type igp
!
!
on-demand color 21
dynamic
metric
type igp
!
affinity exclude-any
name CROSS
!
!
```

```

on-demand color 22
dynamic
pcep
!
metric
type te
!
affinity exclude-any
name CROSS
!
!
!
on-demand color 30
dynamic
metric
type latency
!
!
!
on-demand color 128
dynamic
sid-algorithm 128
!
!
end

```

Configuring BGP Color Extended Community Set: Example

The following example shows how to configure BGP color extended communities that are later applied to BGP service routes via route-policies.



Note In most common scenarios, egress PE routers that advertise BGP service routes apply (set) BGP color extended communities. However, color can also be set at the ingress PE router.

```

extcommunity-set opaque color10-te
10
end-set
!
extcommunity-set opaque color20-igp
20
end-set
!
extcommunity-set opaque color21-igp-excl-cross
21
end-set
!
extcommunity-set opaque color30-delay
30
end-set
!
extcommunity-set opaque color128-fa128
128
end-set
!

```

Configuring RPL to Set BGP Color (Layer-3 Services): Examples

The following example shows various representative RPL definitions that set BGP color community.

The first 4 RPL examples include the set color action only. The last RPL example performs the set color action for selected destinations based on a prefix-set.

```
route-policy SET_COLOR_LOW_LATENCY_TE
  set extcommunity color color10-te
  pass
end-policy
!
route-policy SET_COLOR_HI_BW
  set extcommunity color color20-igp
  pass
end-policy
!
route-policy SET_COLOR_LOW_LATENCY
  set extcommunity color color30-delay
  pass
end-policy
!
route-policy SET_COLOR_FA_128
  set extcommunity color color128-fa128
  pass
end-policy
!

prefix-set sample-set
  88.1.0.0/24
end-set
!
route-policy SET_COLOR_GLOBAL
  if destination in sample-set then
    set extcommunity color color10-te
  else
    pass
  endif
end-policy
```

Applying RPL to BGP Services (Layer-3 Services): Example

The following example shows various RPLs that set BGP color community being applied to BGP Layer-3 VPN services (VPNv4/VPNv6) and BGP global.

- The L3VPN examples show the RPL applied at the VRF export attach-point.
- The BGP global example shows the RPL applied at the BGP neighbor-out attach-point.

```
vrf vrf_cust1
  address-family ipv4 unicast
    export route-policy SET_COLOR_LOW_LATENCY_TE
  !
  address-family ipv6 unicast
    export route-policy SET_COLOR_LOW_LATENCY_TE
  !
!
vrf vrf_cust2
  address-family ipv4 unicast
    export route-policy SET_COLOR_HI_BW
  !
  address-family ipv6 unicast
    export route-policy SET_COLOR_HI_BW
  !
!
vrf vrf_cust3
  address-family ipv4 unicast
```

```

    export route-policy SET_COLOR_LOW_LATENCY
    !
    address-family ipv6 unicast
    export route-policy SET_COLOR_LOW_LATENCY
    !
    !

vrf vrf_cust4
  address-family ipv4 unicast
  export route-policy SET_COLOR_FA_128
  !
  address-family ipv6 unicast
  export route-policy SET_COLOR_FA_128
  !
  !
router bgp 100
  neighbor-group BR-TO-RR
  address-family ipv4 unicast
  route-policy SET_COLOR_GLOBAL out
  !
  !
  !
end

```

Verifying BGP VRF Information

Use the **show bgp vrf** command to display BGP prefix information for VRF instances. The following output shows the BGP VRF table including a prefix (88.1.1.0/24) with color 10 advertised by router 10.1.1.8.

```

RP/0/RP0/CPU0:R4# show bgp vrf vrf_cust1

BGP VRF vrf_cust1, state: Active
BGP Route Distinguisher: 10.1.1.4:101
VRF ID: 0x60000007
BGP router identifier 10.1.1.4, local AS number 100
Non-stop routing is enabled
BGP table state: Active
Table ID: 0xe0000007 RD version: 282
BGP main routing table version 287
BGP NSR Initial initsync version 31 (Reached)
BGP NSR/ISSU Sync-Group versions 0/0

Status codes: s suppressed, d damped, h history, * valid, > best
                i - internal, r RIB-failure, S stale, N Nexthop-discard
Origin codes: i - IGP, e - EGP, ? - incomplete
   Network        Next Hop           Metric LocPrf Weight Path
Route Distinguisher: 10.1.1.4:101 (default for vrf vrf_cust1)
*> 44.1.1.0/24    40.4.101.11                0 400 {1} i
*>i55.1.1.0/24    10.1.1.5                    100 0 500 {1} i
*>i88.1.1.0/24    10.1.1.8 C:10                100 0 800 {1} i
*>i99.1.1.0/24    10.1.1.9                    100 0 800 {1} i

Processed 4 prefixes, 4 paths

```

The following output displays the details for prefix 88.1.1.0/24. Note the presence of BGP extended color community 10, and that the prefix is associated with an SR policy with color 10 and BSID value of 24036.

```

RP/0/RP0/CPU0:R4# show bgp vrf vrf_cust1 88.1.1.0/24

BGP routing table entry for 88.1.1.0/24, Route Distinguisher: 10.1.1.4:101
Versions:
  Process          bRIB/RIB  SendTblVer
  Speaker          282      282

```



```

Last Modified: May 20 09:23:34.112 for 00:06:03
Paths: (1 available, best #1)
  Advertised to CE peers (in unique update groups):
    40.4.101.11
  Path #1: Received by speaker 0
  Advertised to CE peers (in unique update groups):
    40.4.101.11
  800 {1}
    10.1.1.8 C:10 (bsid:24036) (metric 20) from 10.1.1.55 (10.1.1.8)
      Received Label 24012
      Origin IGP, localpref 100, valid, internal, best, group-best, import-candidate,
imported
      Received Path ID 0, Local Path ID 1, version 273
      Extended community: Color:10 RT:100:1
      Originator: 10.1.1.8, Cluster list: 10.1.1.55
      SR policy color 10, up, registered, bsid 24036, if-handle 0x08000024

      Source AFI: VPNv4 Unicast, Source VRF: default, Source Route Distinguisher: 10.1.1.8:101

```

Verifying Forwarding (CEF) Table

Use the **show cef vrf** command to display the contents of the CEF table for the VRF instance. Note that prefix 88.1.1.0/24 points to the BSID label corresponding to an SR policy. Other non-colored prefixes, such as 55.1.1.0/24, point to BGP next-hop.

```
RP/0/RP0/CPU0:R4# show cef vrf vrf_cust1
```

Prefix	Next Hop	Interface
0.0.0.0/0	drop	default handler
0.0.0.0/32	broadcast	
40.4.101.0/24	attached	TenGigE0/0/0/0.101
40.4.101.0/32	broadcast	TenGigE0/0/0/0.101
40.4.101.4/32	receive	TenGigE0/0/0/0.101
40.4.101.11/32	40.4.101.11/32	TenGigE0/0/0/0.101
40.4.101.255/32	broadcast	TenGigE0/0/0/0.101
44.1.1.0/24	40.4.101.11/32	<recursive>
55.1.1.0/24	10.1.1.5/32	<recursive>
88.1.1.0/24	24036 (via-label)	<recursive>
99.1.1.0/24	10.1.1.9/32	<recursive>
224.0.0.0/4	0.0.0.0/32	
224.0.0.0/24	receive	
255.255.255.255/32	broadcast	

The following output displays CEF details for prefix 88.1.1.0/24. Note that the prefix is associated with an SR policy with BSID value of 24036.

```
RP/0/RP0/CPU0:R4# show cef vrf vrf_cust1 88.1.1.0/24
```

```

88.1.1.0/24, version 51, internal 0x5000001 0x0 (ptr 0x98c60ddc) [1], 0x0 (0x0), 0x208
(0x98425268)
Updated May 20 09:23:34.216
Prefix Len 24, traffic index 0, precedence n/a, priority 3
  via local-label 24036, 5 dependencies, recursive [flags 0x6000]
  path-idx 0 NHID 0x0 [0x97091ec0 0x0]
  recursion-via-label
  next hop VRF - 'default', table - 0xe0000000
next hop via 24036/0/21
  next hop srte_c_10_ep labels imposed {ImplNull 24012}

```

Verifying SR Policy

Use the **show segment-routing traffic-eng policy** command to display SR policy information.

The following outputs show the details of an on-demand SR policy that was triggered by prefixes with color 10 advertised by node 10.1.1.8.

```
RP/0/RP0/CPU0:R4# show segment-routing traffic-eng policy color 10 tabular
```

Color	Endpoint	Admin State	Oper State	Binding SID
10	10.1.1.8	up	up	24036

The following outputs show the details of the on-demand SR policy for BSID 24036.



Note There are 2 candidate paths associated with this SR policy: the path that is computed by the head-end router (with preference 200), and the path that is computed by the SR-PCE (with preference 100). The candidate path with the highest preference is the active candidate path (highlighted below) and is installed in forwarding.

```
RP/0/RP0/CPU0:R4# show segment-routing traffic-eng policy binding-sid 24036
```

```
SR-TE policy database
```

```
-----
Color: 10, End-point: 10.1.1.8
Name: srte_c_10_ep_10.1.1.8
Status:
  Admin: up Operational: up for 4d14h (since Jul  3 20:28:57.840)
Candidate-paths:
  Preference: 200 (BGP ODN) (active)
    Requested BSID: dynamic
    PCC info:
      Symbolic name: bgp_c_10_ep_10.1.1.8_discr_200
      PLSP-ID: 12
    Dynamic (valid)
      Metric Type: TE, Path Accumulated Metric: 30
      16009 [Prefix-SID, 10.1.1.9]
      16008 [Prefix-SID, 10.1.1.8]
  Preference: 100 (BGP ODN)
    Requested BSID: dynamic
    PCC info:
      Symbolic name: bgp_c_10_ep_10.1.1.8_discr_100
      PLSP-ID: 11
    Dynamic (pce 10.1.1.57) (valid)
      Metric Type: TE, Path Accumulated Metric: 30
      16009 [Prefix-SID, 10.1.1.9]
      16008 [Prefix-SID, 10.1.1.8]
Attributes:
  Binding SID: 24036
  Forward Class: 0
  Steering BGP disabled: no
  IPv6 caps enable: yes
```

Verifying SR Policy Forwarding

Use the **show segment-routing traffic-eng forwarding policy** command to display the SR policy forwarding information.

The following outputs show the forwarding details for an on-demand SR policy that was triggered by prefixes with color 10 advertised by node 10.1.1.8.

```
RP/0/RP0/CPU0:R4# show segment-routing traffic-eng forwarding policy binding-sid 24036
tabular
```

Color	Endpoint	Segment List	Outgoing Label	Outgoing Interface	Next Hop	Bytes Switched	Pure Backup
10	10.1.1.8	dynamic	16009	Gi0/0/0/4	10.4.5.5	0	
			16001	Gi0/0/0/5	11.4.8.8	0	Yes

```
RP/0/RP0/CPU0:R4# show segment-routing traffic-eng forwarding policy binding-sid 24036
detail
```

```
Mon Jul 8 11:56:46.887 PST
```

```
SR-TE Policy Forwarding database
-----
```

```
Color: 10, End-point: 10.1.1.8
```

```
  Name: srte_c_10_ep_10.1.1.8
```

```
  Binding SID: 24036
```

```
  Segment Lists:
```

```
    SL[0]:
```

```
      Name: dynamic
```

```
      Paths:
```

```
        Path[0]:
```

```
          Outgoing Label: 16009
```

```
          Outgoing Interface: GigabitEthernet0/0/0/4
```

```
          Next Hop: 10.4.5.5
```

```
          Switched Packets/Bytes: 0/0
```

```
          FRR Pure Backup: No
```

```
          Label Stack (Top -> Bottom): { 16009, 16008 }
```

```
          Path-id: 1 (Protected), Backup-path-id: 2, Weight: 64
```

```
        Path[1]:
```

```
          Outgoing Label: 16001
```

```
          Outgoing Interface: GigabitEthernet0/0/0/5
```

```
          Next Hop: 11.4.8.8
```

```
          Switched Packets/Bytes: 0/0
```

```
          FRR Pure Backup: Yes
```

```
          Label Stack (Top -> Bottom): { 16001, 16009, 16008 }
```

```
          Path-id: 2 (Pure-Backup), Weight: 64
```

```
Policy Packets/Bytes Switched: 0/0
```

```
Local label: 80013
```

Configuring SR-ODN for EVPN-VPWS: Use Case

Configuration: SR-PCE

For cases when PCC nodes support, or signal, PCEP association-group object to indicate the pair of LSPs in a disjoint set, there is no extra configuration required at the SR-PCE to trigger disjoint-path computation.



Note SR-PCE also supports disjoint-path computation for cases when PCC nodes do not support PCEP association-group object. See [Configure the Disjoint Policy \(Optional\)](#), on page 172 for more information.

Configuration: Site 1 Node A

This section depicts relevant configuration of Node A at Site 1. It includes service configuration, BGP color extended community, and RPL. It also includes the corresponding ODN template required to achieve the disjointness SLA.

Nodes in Site 1 are configured to set color 10000 on originating EVPN routes, while matching color 11000 on incoming EVPN routes from routers located at Site 2.

Since both nodes in Site 1 request path computation from SR-PCE using the same disjoint-path group-id (775), the PCE will attempt to compute disjointness for the pair of LSPs originating from Site 1 toward Site 2.

```

/* EVPN-VPWS configuration */

interface GigabitEthernet0/0/0/3.2500 l2transport
 encapsulation dot1q 2500
 rewrite ingress tag pop 1 symmetric
!
l2vpn
 xconnect group evpn_vpws_group
  p2p evpn_vpws_100
   interface GigabitEthernet0/0/0/3.2500
    neighbor evpn evi 100 target 21 source 11
   !
  !
!
!

/* BGP color community and RPL configuration */

extcommunity-set opaque color-10000
 10000
end-set
!
route-policy SET_COLOR_EVPN_VPWS
 if evpn-route-type is 1 and rd in (ios-regex '.*...*...*(100)') then
  set extcommunity color color-10000
 endif
 pass
end-policy
!
router bgp 65000
 neighbor 10.1.1.253
 address-family l2vpn evpn
  route-policy SET_COLOR_EVPN_VPWS out
!
!

/* ODN template configuration */

segment-routing
 traffic-eng
  on-demand color 11000
  dynamic

```

```

    pcep
    !
    metric
    type igp
    !
    disjoint-path group-id 775 type link
    !
    !
    !
    !

```

Configuration: Site 1 Node B

This section depicts relevant configuration of Node B at Site 1.

```

/* EVPN-VPWS configuration */

interface TenGigE0/3/0/0/8.2500 l2transport
 encapsulation dot1q 2500
 rewrite ingress tag pop 1 symmetric
 !
l2vpn
 xconnect group evpn_vpws_group
  p2p evpn_vpws_101
  interface TenGigE0/3/0/0/8.2500
   neighbor evpn evi 101 target 22 source 12
  !
 !
 !
 !

/* BGP color community and RPL configuration */

extcommunity-set opaque color-10000
 10000
end-set
!
route-policy SET_COLOR_EVPN_VPWS
 if evpn-route-type is 1 and rd in (ios-regex '.*..*..*..*:(101)') then
  set extcommunity color color-10000
 endif
 pass
end-policy
!
router bgp 65000
 neighbor 10.1.1.253
  address-family l2vpn evpn
   route-policy SET_COLOR_EVPN_VPWS out
  !
 !
 !

/* ODN template configuration */

segment-routing
 traffic-eng
  on-demand color 11000
  dynamic
  pcep
  !
  metric
  type igp
  !
  disjoint-path group-id 775 type link

```

```

!
!
!
!

```

Configuration: Site 2 Node C

This section depicts relevant configuration of Node C at Site 2. It includes service configuration, BGP color extended community, and RPL. It also includes the corresponding ODN template required to achieve the disjointness SLA.

Nodes in Site 2 are configured to set color 11000 on originating EVPN routes, while matching color 10000 on incoming EVPN routes from routers located at Site 1.

Since both nodes on Site 2 request path computation from SR-PCE using the same disjoint-path group-id (776), the PCE will attempt to compute disjointness for the pair of LSPs originating from Site 2 toward Site 1.

```

/* EVPN-VPWS configuration */

interface GigabitEthernet0/0/0/3.2500 l2transport
 encapsulation dot1q 2500
 rewrite ingress tag pop 1 symmetric
!
l2vpn
xconnect group evpn_vpws_group
 p2p evpn_vpws_100
   interface GigabitEthernet0/0/0/3.2500
     neighbor evpn evi 100 target 11 source 21
   !
!
!
!

/* BGP color community and RPL configuration */

extcommunity-set opaque color-11000
 11000
end-set
!
route-policy SET_COLOR_EVPN_VPWS
 if evpn-route-type is 1 and rd in (ios-regex '.*...*.*(100)') then
   set extcommunity color color-11000
 endif
 pass
end-policy
!
router bgp 65000
 neighbor 10.1.1.253
 address-family l2vpn evpn
 route-policy SET_COLOR_EVPN_VPWS out
!
!
!

/* ODN template configuration */

segment-routing
 traffic-eng
  on-demand color 10000
  dynamic
   pcep
  !

```

```

    metric
      type igp
    !
    disjoint-path group-id 776 type link
  !
!
!
!
!
!

```

Configuration: Site 2 Node D

This section depicts relevant configuration of Node D at Site 2.

```

/* EVPN-VPWS configuration */

interface GigabitEthernet0/0/0/1.2500 l2transport
  encapsulation dot1q 2500
  rewrite ingress tag pop 1 symmetric
!
l2vpn
  xconnect group evpn_vpws_group
  p2p evpn_vpws_101
    interface GigabitEthernet0/0/0/1.2500
      neighbor evpn evi 101 target 12 source 22
    !
  !
!
!

/* BGP color community and RPL configuration */

extcommunity-set opaque color-11000
  11000
end-set
!
route-policy SET_COLOR_EVPN_VPWS
  if evpn-route-type is 1 and rd in (ios-regex '.*.*.*.*:(101)') then
    set extcommunity color color-11000
  endif
  pass
end-policy
!
router bgp 65000
  neighbor 10.1.1.253
    address-family l2vpn evpn
      route-policy SET_COLOR_EVPN_VPWS out
    !
  !
!

/* ODN template configuration */

segment-routing
  traffic-eng
    on-demand color 10000
  dynamic
    pcep
    !
    metric
      type igp
    !
    disjoint-path group-id 776 type link
  !
!
!

```

```
!
!
```

Verification: SR-PCE

Use the **show pce ipv4 peer** command to display the SR-PCE's PCEP peers and session status. SR-PCE performs path computation for the 4 nodes depicted in the use-case.

```
RP/0/0/CPU0:SR-PCE# show pce ipv4 peer
Mon Jul 15 19:41:43.622 UTC

PCE's peer database:
-----
Peer address: 10.1.1.2
  State: Up
  Capabilities: Stateful, Segment-Routing, Update, Instantiation

Peer address: 10.1.1.4
  State: Up
  Capabilities: Stateful, Segment-Routing, Update, Instantiation

Peer address: 10.1.1.5
  State: Up
  Capabilities: Stateful, Segment-Routing, Update, Instantiation

Peer address: 10.1.1.6
  State: Up
  Capabilities: Stateful, Segment-Routing, Update, Instantiation
```

Use the **show pce association group-id** command to display information for the pair of LSPs assigned to a given association group-id value.

Based on the goals of this use case, SR-PCE computes link-disjoint paths for the SR policies associated with a pair of ELINE services between site 1 and site 2. In particular, disjoint LSPs from site 1 to site 2 are identified by association group-id 775. The output includes high-level information for LSPs associated to this group-id:

- At Node A (10.1.1.5): LSP symbolic name = `bgp_c_11000_ep_10.1.1.2_discr_100`
- At Node B (10.1.1.6): LSP symbolic name = `bgp_c_11000_ep_10.1.1.4_discr_100`

In this case, the SR-PCE was able to achieve the desired disjointness level; therefore the Status is shown as "Satisfied".

```
RP/0/0/CPU0:SR-PCE# show pce association group-id 775
Thu Jul 11 03:52:20.770 UTC

PCE's association database:
-----
Association: Type Link-Disjoint, Group 775, Not Strict
Associated LSPs:
LSP[0]:
  PCC 10.1.1.6, tunnel name bgp_c_11000_ep_10.1.1.4_discr_100, PLSP ID 18, tunnel ID 17,
LSP ID 3, Configured on PCC
LSP[1]:
  PCC 10.1.1.5, tunnel name bgp_c_11000_ep_10.1.1.2_discr_100, PLSP ID 18, tunnel ID 18,
LSP ID 3, Configured on PCC
Status: Satisfied
```

Use the **show pce lsp** command to display detailed information of an LSP present in the PCE's LSP database. This output shows details for the LSP at Node A (10.1.1.5) that is used to carry traffic of EVPN VPWS EVI 100 towards node C (10.1.1.2).

```
RP/0/0/CPU0:SR-PCE# show pce lsp pcc ipv4 10.1.1.5 name bgp_c_11000_ep_10.1.1.2_discr_100
Thu Jul 11 03:58:45.903 UTC
```

```
PCE's tunnel database:
```

```
-----
PCC 10.1.1.5:
```

```
Tunnel Name: bgp_c_11000_ep_10.1.1.2_discr_100
Color: 11000
Interface Name: srte_c_11000_ep_10.1.1.2
LSPs:
LSP[0]:
  source 10.1.1.5, destination 10.1.1.2, tunnel ID 18, LSP ID 3
  State: Admin up, Operation up
  Setup type: Segment Routing
  Binding SID: 80037
  Maximum SID Depth: 10
  Absolute Metric Margin: 0
  Relative Metric Margin: 0%
  Preference: 100
  Bandwidth: signaled 0 kbps, applied 0 kbps
  PCEP information:
    PLSP-ID 0x12, flags: D:1 S:0 R:0 A:1 O:1 C:0
  LSP Role: Exclude LSP
  State-sync PCE: None
  PCC: 10.1.1.5
  LSP is subdelegated to: None
  Reported path:
    Metric type: IGP, Accumulated Metric 40
    SID[0]: Adj, Label 80003, Address: local 11.5.8.5 remote 11.5.8.8
    SID[1]: Node, Label 16007, Address 10.1.1.7
    SID[2]: Node, Label 16002, Address 10.1.1.2
  Computed path: (Local PCE)
    Computed Time: Thu Jul 11 03:49:48 UTC 2019 (00:08:58 ago)
    Metric type: IGP, Accumulated Metric 40
    SID[0]: Adj, Label 80003, Address: local 11.5.8.5 remote 11.5.8.8
    SID[1]: Node, Label 16007, Address 10.1.1.7
    SID[2]: Node, Label 16002, Address 10.1.1.2
  Recorded path:
    None
Disjoint Group Information:
  Type Link-Disjoint, Group 775
```

This output shows details for the LSP at Node B (10.1.1.6) that is used to carry traffic of EVPN VPWS EVI 101 towards node D (10.1.1.4).

```
RP/0/0/CPU0:SR-PCE# show pce lsp pcc ipv4 10.1.1.6 name bgp_c_11000_ep_10.1.1.4_discr_100
Thu Jul 11 03:58:56.812 UTC
```

```
PCE's tunnel database:
```

```
-----
PCC 10.1.1.6:
```

```
Tunnel Name: bgp_c_11000_ep_10.1.1.4_discr_100
Color: 11000
Interface Name: srte_c_11000_ep_10.1.1.4
LSPs:
LSP[0]:
  source 10.1.1.6, destination 10.1.1.4, tunnel ID 17, LSP ID 3
  State: Admin up, Operation up
  Setup type: Segment Routing
  Binding SID: 80061
  Maximum SID Depth: 10
  Absolute Metric Margin: 0
```

```

Relative Metric Margin: 0%
Preference: 100
Bandwidth: signaled 0 kbps, applied 0 kbps
PCEP information:
  PLSP-ID 0x12, flags: D:1 S:0 R:0 A:1 O:1 C:0
LSP Role: Disjoint LSP
State-sync PCE: None
PCC: 10.1.1.6
LSP is subdelegated to: None
Reported path:
  Metric type: IGP, Accumulated Metric 40
  SID[0]: Node, Label 16001, Address 10.1.1.1
  SID[1]: Node, Label 16004, Address 10.1.1.4
Computed path: (Local PCE)
  Computed Time: Thu Jul 11 03:49:48 UTC 2019 (00:09:08 ago)
  Metric type: IGP, Accumulated Metric 40
  SID[0]: Node, Label 16001, Address 10.1.1.1
  SID[1]: Node, Label 16004, Address 10.1.1.4
Recorded path:
  None
Disjoint Group Information:
  Type Link-Disjoint, Group 775

```

Based on the goals of this use case, SR-PCE computes link-disjoint paths for the SR policies associated with a pair of ELINE services between site 1 and site 2. In particular, disjoint LSPs from site 2 to site 1 are identified by association group-id 776. The output includes high-level information for LSPs associated to this group-id:

- At Node C (10.1.1.2): LSP symbolic name = `bgp_c_10000_ep_10.1.1.5_discr_100`
- At Node D (10.1.1.4): LSP symbolic name = `bgp_c_10000_ep_10.1.1.6_discr_100`

In this case, the SR-PCE was able to achieve the desired disjointness level; therefore, the Status is shown as "Satisfied".

```

RP/0/0/CPU0:SR-PCE# show pce association group-id 776
Thu Jul 11 03:52:24.370 UTC

PCE's association database:
-----
Association: Type Link-Disjoint, Group 776, Not Strict
Associated LSPs:
LSP[0]:
  PCC 10.1.1.4, tunnel name bgp_c_10000_ep_10.1.1.6_discr_100, PLSP ID 16, tunnel ID 14,
LSP ID 1, Configured on PCC
LSP[1]:
  PCC 10.1.1.2, tunnel name bgp_c_10000_ep_10.1.1.5_discr_100, PLSP ID 6, tunnel ID 21,
LSP ID 3, Configured on PCC
Status: Satisfied

```

Use the `show pce lsp` command to display detailed information of an LSP present in the PCE's LSP database. This output shows details for the LSP at Node C (10.1.1.2) that is used to carry traffic of EVPN VPWS EVI 100 towards node A (10.1.1.5).

```

RP/0/0/CPU0:SR-PCE# show pce lsp pcc ipv4 10.1.1.2 name bgp_c_10000_ep_10.1.1.5_discr_100
Thu Jul 11 03:55:21.706 UTC

PCE's tunnel database:
-----
PCC 10.1.1.2:

Tunnel Name: bgp_c_10000_ep_10.1.1.5_discr_100
Color: 10000
Interface Name: srte_c_10000_ep_10.1.1.5

```

```

LSPs:
LSP[0]:
  source 10.1.1.2, destination 10.1.1.5, tunnel ID 21, LSP ID 3
  State: Admin up, Operation up
  Setup type: Segment Routing
  Binding SID: 80052
  Maximum SID Depth: 10
  Absolute Metric Margin: 0
  Relative Metric Margin: 0%
  Preference: 100
  Bandwidth: signaled 0 kbps, applied 0 kbps
  PCEP information:
    PLSP-ID 0x6, flags: D:1 S:0 R:0 A:1 O:1 C:0
  LSP Role: Exclude LSP
  State-sync PCE: None
  PCC: 10.1.1.2
  LSP is subdelegated to: None
  Reported path:
    Metric type: IGP, Accumulated Metric 40
    SID[0]: Node, Label 16007, Address 10.1.1.7
    SID[1]: Node, Label 16008, Address 10.1.1.8
    SID[2]: Adj, Label 80005, Address: local 11.5.8.8 remote 11.5.8.5
  Computed path: (Local PCE)
    Computed Time: Thu Jul 11 03:50:03 UTC 2019 (00:05:18 ago)
    Metric type: IGP, Accumulated Metric 40
    SID[0]: Node, Label 16007, Address 10.1.1.7
    SID[1]: Node, Label 16008, Address 10.1.1.8
    SID[2]: Adj, Label 80005, Address: local 11.5.8.8 remote 11.5.8.5
  Recorded path:
    None
Disjoint Group Information:
  Type Link-Disjoint, Group 776

```

This output shows details for the LSP at Node D (10.1.1.4) used to carry traffic of EVPN VPWS EVI 101 towards node B (10.1.1.6).

```

RP/0/0/CPU0:SR-PCE# show pce lsp pcc ipv4 10.1.1.4 name bgp_c_10000_ep_10.1.1.6_discr_100
Thu Jul 11 03:55:23.296 UTC

```

PCE's tunnel database:

```

-----
PCC 10.1.1.4:

```

```

Tunnel Name: bgp_c_10000_ep_10.1.1.6_discr_100
Color: 10000

```

```

Interface Name: srte_c_10000_ep_10.1.1.6

```

```

LSPs:
LSP[0]:
  source 10.1.1.4, destination 10.1.1.6, tunnel ID 14, LSP ID 1
  State: Admin up, Operation up
  Setup type: Segment Routing
  Binding SID: 80047
  Maximum SID Depth: 10
  Absolute Metric Margin: 0
  Relative Metric Margin: 0%
  Preference: 100
  Bandwidth: signaled 0 kbps, applied 0 kbps
  PCEP information:
    PLSP-ID 0x10, flags: D:1 S:0 R:0 A:1 O:1 C:0
  LSP Role: Disjoint LSP
  State-sync PCE: None
  PCC: 10.1.1.4
  LSP is subdelegated to: None
  Reported path:

```

```

Metric type: IGP, Accumulated Metric 40
  SID[0]: Node, Label 16001, Address 10.1.1.1
  SID[1]: Node, Label 16006, Address 10.1.1.6
Computed path: (Local PCE)
  Computed Time: Thu Jul 11 03:50:03 UTC 2019 (00:05:20 ago)
Metric type: IGP, Accumulated Metric 40
  SID[0]: Node, Label 16001, Address 10.1.1.1
  SID[1]: Node, Label 16006, Address 10.1.1.6
Recorded path:
  None
Disjoint Group Information:
  Type Link-Disjoint, Group 776

```

Verification: Site 1 Node A

This section depicts verification steps at Node A.

Use the **show bgp l2vpn evpn** command to display BGP prefix information for EVPN-VPWS EVI 100 (rd 10.1.1.5:100). The output includes an EVPN route-type 1 route with color 11000 originated at Node C (10.1.1.2).

```

RP/0/RSP0/CPU0:Node-A# show bgp l2vpn evpn rd 10.1.1.5:100
Wed Jul 10 18:57:57.704 PST
BGP router identifier 10.1.1.5, local AS number 65000
BGP generic scan interval 60 secs
Non-stop routing is enabled
BGP table state: Active
Table ID: 0x0   RD version: 0
BGP main routing table version 360
BGP NSR Initial initsync version 1 (Reached)
BGP NSR/ISSU Sync-Group versions 0/0
BGP scan interval 60 secs

Status codes: s suppressed, d damped, h history, * valid, > best
               i - internal, r RIB-failure, S stale, N Nexthop-discard
Origin codes: i - IGP, e - EGP, ? - incomplete
   Network          Next Hop              Metric LocPrf Weight Path
Route Distinguisher: 10.1.1.5:100 (default for vrf VPWS:100)
*> [1][0000.0000.0000.0000.0000][11]/120
           0.0.0.0                                0 i
*>i[1][0000.0000.0000.0000.0000][21]/120
           10.1.1.2 C:11000                        100   0 i

```

The following output displays the details for the incoming EVPN RT1. Note the presence of BGP extended color community 11000, and that the prefix is associated with an SR policy with color 11000 and BSID value of 80044.

```

RP/0/RSP0/CPU0:Node-A# show bgp l2vpn evpn rd 10.1.1.5:100
[1][0000.0000.0000.0000.0000][21]/120
Wed Jul 10 18:57:58.107 PST
BGP routing table entry for [1][0000.0000.0000.0000.0000][21]/120, Route Distinguisher:
10.1.1.5:100
Versions:
  Process          bRIB/RIB   SendTblVer
  Speaker          360        360
Last Modified: Jul 10 18:36:18.369 for 00:21:40
Paths: (1 available, best #1)
  Not advertised to any peer
  Path #1: Received by speaker 0
  Not advertised to any peer
  Local
    10.1.1.2 C:11000 (bsid:80044) (metric 40) from 10.1.1.253 (10.1.1.2)

```

```

Received Label 80056
Origin IGP, localpref 100, valid, internal, best, group-best, import-candidate,
imported, rib-install
Received Path ID 0, Local Path ID 1, version 358
Extended community: Color:11000 RT:65000:100
Originator: 10.1.1.2, Cluster list: 10.1.1.253
SR policy color 11000, up, registered, bsid 80044, if-handle 0x00001b20

Source AFI: L2VPN EVPN, Source VRF: default, Source Route Distinguisher: 10.1.1.2:100

```

Use the **show l2vpn xconnect** command to display the state associated with EVPN-VPWS EVI 100 service.

```

RP/0/RSP0/CPU0:Node-A# show l2vpn xconnect group evpn_vpws_group
Wed Jul 10 18:58:02.333 PST
Legend: ST = State, UP = Up, DN = Down, AD = Admin Down, UR = Unresolved,
        SB = Standby, SR = Standby Ready, (PP) = Partially Programmed

```

XConnect			Segment 1		Segment 2	
Group	Name	ST	Description	ST	Description	ST

evpn_vpws_group	evpn_vpws_100					
		UP	Gi0/0/0/3.2500	UP	EVPN 100,21,10.1.1.2	UP

The following output shows the details for the service. Note that the service is associated with the on-demand SR policy with color 11000 and end-point 10.1.1.2 (node C).

```

RP/0/RSP0/CPU0:Node-A# show l2vpn xconnect group evpn_vpws_group xc-name evpn_vpws_100
detail
Wed Jul 10 18:58:02.755 PST

```

```

Group evpn_vpws_group, XC evpn_vpws_100, state is up; Interworking none
AC: GigabitEthernet0/0/0/3.2500, state is up
Type VLAN; Num Ranges: 1
Rewrite Tags: []
VLAN ranges: [2500, 2500]
MTU 1500; XC ID 0x120000c; interworking none
Statistics:
  packets: received 0, sent 0
  bytes: received 0, sent 0
  drops: illegal VLAN 0, illegal length 0
EVPN: neighbor 10.1.1.2, PW ID: evi 100, ac-id 21, state is up ( established )
XC ID 0xa0000007
Encapsulation MPLS
Source address 10.1.1.5
Encap type Ethernet, control word enabled
Sequencing not set
Preferred path Active : SR TE srte_c_11000_ep_10.1.1.2, On-Demand, fallback enabled
Tunnel : Up
Load Balance Hashing: src-dst-mac

```

EVPN	Local	Remote
Label	80040	80056
MTU	1500	1500
Control word	enabled	enabled
AC ID	11	21
EVPN type	Ethernet	Ethernet

```

-----
Create time: 10/07/2019 18:31:30 (1d17h ago)

```

```

Last time status changed: 10/07/2019 19:42:00 (1d16h ago)
Last time PW went down: 10/07/2019 19:40:55 (1d16h ago)
Statistics:
  packets: received 0, sent 0
  bytes: received 0, sent 0

```

Use the **show segment-routing traffic-eng policy** command with **tabular** option to display SR policy summary information.

The following output shows the on-demand SR policy with BSID 80044 that was triggered by EVPN RT1 prefix with color 11000 advertised by node C (10.1.1.2).

```

RP/0/RSP0/CPU0:Node-A# show segment-routing traffic-eng policy color 11000 tabular
Wed Jul 10 18:58:00.732 PST

```

Color	Endpoint	Admin State	Oper State	Binding SID
11000	10.1.1.2	up	up	80044

The following output shows the details for the on-demand SR policy. Note that the SR policy's active candidate path (preference 100) is computed by SR-PCE (10.1.1.207).

Based on the goals of this use case, SR-PCE computes link-disjoint paths for the SR policies associated with a pair of ELINE services between site 1 and site 2. Specifically, from site 1 to site 2, LSP at Node A (srte_c_11000_ep_10.1.1.2) is link-disjoint from LSP at Node B (srte_c_11000_ep_10.1.1.4).

```

RP/0/RSP0/CPU0:Node-A# show segment-routing traffic-eng policy color 11000
Wed Jul 10 19:15:47.217 PST

```

```

SR-TE policy database
-----

```

```

Color: 11000, End-point: 10.1.1.2
Name: srte_c_11000_ep_10.1.1.2
Status:
  Admin: up Operational: up for 00:39:31 (since Jul 10 18:36:00.471)
Candidate-paths:
  Preference: 200 (BGP ODN) (shutdown)
    Requested BSID: dynamic
    PCC info:
      Symbolic name: bgp_c_11000_ep_10.1.1.2_discr_200
      PLSP-ID: 19
    Dynamic (invalid)
  Preference: 100 (BGP ODN) (active)
    Requested BSID: dynamic
    PCC info:
      Symbolic name: bgp_c_11000_ep_10.1.1.2_discr_100
      PLSP-ID: 18
  Dynamic (pce 10.1.1.207) (valid)
    Metric Type: IGP, Path Accumulated Metric: 40
      80003 [Adjacency-SID, 11.5.8.5 - 11.5.8.8]
      16007 [Prefix-SID, 10.1.1.7]
      16002 [Prefix-SID, 10.1.1.2]
Attributes:
  Binding SID: 80044
  Forward Class: 0
  Steering BGP disabled: no
  IPv6 caps enable: yes

```

Verification: Site 1 Node B

This section depicts verification steps at Node B.

Use the **show bgp l2vpn evpn** command to display BGP prefix information for EVPN-VPWS EVI 101 (rd 10.1.1.6:101). The output includes an EVPN route-type 1 route with color 11000 originated at Node D (10.1.1.4).

```
RP/0/RSP0/CPU0:Node-B# show bgp l2vpn evpn rd 10.1.1.6:101
Wed Jul 10 19:08:54.964 PST
BGP router identifier 10.1.1.6, local AS number 65000
BGP generic scan interval 60 secs
Non-stop routing is enabled
BGP table state: Active
Table ID: 0x0 RD version: 0
BGP main routing table version 322
BGP NSR Initial initsync version 7 (Reached)
BGP NSR/ISSU Sync-Group versions 0/0
BGP scan interval 60 secs

Status codes: s suppressed, d damped, h history, * valid, > best
                i - internal, r RIB-failure, S stale, N Nexthop-discard
Origin codes: i - IGP, e - EGP, ? - incomplete
   Network        Next Hop           Metric LocPrf Weight Path
Route Distinguisher: 10.1.1.6:101 (default for vrf VPWS:101)
*> [1][0000.0000.0000.0000.0000][12]/120
                0.0.0.0                                0 i
*>i [1][0000.0000.0000.0000.0000][22]/120
                10.1.1.4 C:11000                       100    0 i

Processed 2 prefixes, 2 paths
```

The following output displays the details for the incoming EVPN RT1. Note the presence of BGP extended color community 11000, and that the prefix is associated with an SR policy with color 11000 and BSID value of 80061.

```
RP/0/RSP0/CPU0:Node-B# show bgp l2vpn evpn rd 10.1.1.6:101
[1][0000.0000.0000.0000.0000][22]/120
Wed Jul 10 19:08:55.039 PST
BGP routing table entry for [1][0000.0000.0000.0000.0000][22]/120, Route Distinguisher:
10.1.1.6:101
Versions:
   Process          bRIB/RIB   SendTblVer
   Speaker          322        322
Last Modified: Jul 10 18:42:10.408 for 00:26:44
Paths: (1 available, best #1)
   Not advertised to any peer
   Path #1: Received by speaker 0
   Not advertised to any peer
Local
  10.1.1.4 C:11000 (bsid:80061) (metric 40) from 10.1.1.253 (10.1.1.4)
    Received Label 80045
    Origin IGP, localpref 100, valid, internal, best, group-best, import-candidate,
imported, rib-install
    Received Path ID 0, Local Path ID 1, version 319
    Extended community: Color:11000 RT:65000:101
    Originator: 10.1.1.4, Cluster list: 10.1.1.253
    SR policy color 11000, up, registered, bsid 80061, if-handle 0x00000560

Source AFI: L2VPN EVPN, Source VRF: default, Source Route Distinguisher: 10.1.1.4:101
```

Use the **show l2vpn xconnect** command to display the state associated with EVPN-VPWS EVI 101 service.

```
RP/0/RSP0/CPU0:Node-B# show l2vpn xconnect group evpn_vpws_group
Wed Jul 10 19:08:56.388 PST
Legend: ST = State, UP = Up, DN = Down, AD = Admin Down, UR = Unresolved,
       SB = Standby, SR = Standby Ready, (PP) = Partially Programmed
```

XConnect		Segment 1		Segment 2	
Group	Name	ST	Description	ST	Description

evpn_vpws_group					
	evpn_vpws_101				
		UP	Te0/3/0/0/8.2500	UP	EVPN 101,22,10.1.1.4
					UP

The following output shows the details for the service. Note that the service is associated with the on-demand SR policy with color 11000 and endpoint 10.1.1.4 (node D).

```
RP/0/RSP0/CPU0:Node-B# show l2vpn xconnect group evpn_vpws_group xc-name evpn_vpws_101
Wed Jul 10 19:08:56.511 PST
```

```
Group evpn_vpws_group, XC evpn_vpws_101, state is up; Interworking none
AC: TenGigE0/3/0/0/8.2500, state is up
Type VLAN; Num Ranges: 1
Rewrite Tags: []
VLAN ranges: [2500, 2500]
MTU 1500; XC ID 0x2a0000e; interworking none
Statistics:
  packets: received 0, sent 0
  bytes: received 0, sent 0
  drops: illegal VLAN 0, illegal length 0
EVPN: neighbor 10.1.1.4, PW ID: evi 101, ac-id 22, state is up ( established )
XC ID 0xa0000009
Encapsulation MPLS
Source address 10.1.1.6
Encap type Ethernet, control word enabled
Sequencing not set
Preferred path Active : SR TE srte_c_11000_ep_10.1.1.4, On-Demand, fallback enabled
Tunnel : Up
Load Balance Hashing: src-dst-mac
```

EVPN	Local	Remote

Label	80060	80045
MTU	1500	1500
Control word	enabled	enabled
AC ID	12	22
EVPN type	Ethernet	Ethernet

```
Create time: 10/07/2019 18:32:49 (00:36:06 ago)
Last time status changed: 10/07/2019 18:42:07 (00:26:49 ago)
Statistics:
  packets: received 0, sent 0
  bytes: received 0, sent 0
```

Use the **show segment-routing traffic-eng policy** command with **tabular** option to display SR policy summary information.

The following output shows the on-demand SR policy with BSID 80061 that was triggered by EVPN RT1 prefix with color 11000 advertised by node D (10.1.1.4).

```
RP/0/RSP0/CPU0:Node-B# show segment-routing traffic-eng policy color 11000 tabular
Wed Jul 10 19:08:56.146 PST
```

Color	Endpoint	Admin State	Oper State	Binding SID
11000	10.1.1.4	up	up	80061

The following output shows the details for the on-demand SR policy. Note that the SR policy's active candidate path (preference 100) is computed by SR-PCE (10.1.1.207).

Based on the goals of this use case, SR-PCE computes link-disjoint paths for the SR policies associated with a pair of ELINE services between site 1 and site 2. Specifically, from site 1 to site 2, LSP at Node B (srte_c_11000_ep_10.1.1.4) is link-disjoint from LSP at Node A (srte_c_11000_ep_10.1.1.2).

```
RP/0/RSP0/CPU0:Node-B# show segment-routing traffic-eng policy color 11000
Wed Jul 10 19:08:56.207 PST
```

```
SR-TE policy database
-----
```

```
Color: 11000, End-point: 10.1.1.4
Name: srte_c_11000_ep_10.1.1.4
Status:
  Admin: up Operational: up for 00:26:47 (since Jul 10 18:40:05.868)
Candidate-paths:
  Preference: 200 (BGP ODN) (shutdown)
    Requested BSID: dynamic
    PCC info:
      Symbolic name: bgp_c_11000_ep_10.1.1.4_discr_200
      PLSP-ID: 19
      Dynamic (invalid)
  Preference: 100 (BGP ODN) (active)
    Requested BSID: dynamic
    PCC info:
      Symbolic name: bgp_c_11000_ep_10.1.1.4_discr_100
      PLSP-ID: 18
      Dynamic (pce 10.1.1.207) (valid)
      Metric Type: IGP, Path Accumulated Metric: 40
      16001 [Prefix-SID, 10.1.1.1]
      16004 [Prefix-SID, 10.1.1.4]
Attributes:
  Binding SID: 80061
  Forward Class: 0
  Steering BGP disabled: no
  IPv6 caps enable: yes
```

Verification: Site 2 Node C

This section depicts verification steps at Node C.

Use the **show bgp l2vpn evpn** command to display BGP prefix information for EVPN-VPWS EVI 100 (rd 10.1.1.2:100). The output includes an EVPN route-type 1 route with color 10000 originated at Node A (10.1.1.5).

```
RP/0/RSP0/CPU0:Node-C# show bgp l2vpn evpn rd 10.1.1.2:100
BGP router identifier 10.1.1.2, local AS number 65000
BGP generic scan interval 60 secs
Non-stop routing is enabled
BGP table state: Active
Table ID: 0x0 RD version: 0
BGP main routing table version 21
```

```

BGP NSR Initial initsync version 1 (Reached)
BGP NSR/ISSU Sync-Group versions 0/0
BGP scan interval 60 secs

Status codes: s suppressed, d damped, h history, * valid, > best
               i - internal, r RIB-failure, S stale, N Nexthop-discard
Origin codes: i - IGP, e - EGP, ? - incomplete
   Network      Next Hop          Metric LocPrf Weight Path
Route Distinguisher: 10.1.1.2:100 (default for vrf VPWS:100)
*>i[1][0000.0000.0000.0000.0000][11]/120
      10.1.1.5 C:10000                100      0 i
*> [1][0000.0000.0000.0000.0000][21]/120
      0.0.0.0                          0 i

```

The following output displays the details for the incoming EVPN RT1. Note the presence of BGP extended color community 10000, and that the prefix is associated with an SR policy with color 10000 and BSID value of 80058.

```

RP/0/RSP0/CPU0:Node-C# show bgp l2vpn evpn rd 10.1.1.2:100
[1][0000.0000.0000.0000.0000][11]/120
BGP routing table entry for [1][0000.0000.0000.0000.0000][11]/120, Route Distinguisher:
10.1.1.2:100
Versions:
  Process          bRIB/RIB  SendTblVer
  Speaker          20        20
Last Modified: Jul 10 18:36:20.503 for 00:45:21
Paths: (1 available, best #1)
  Not advertised to any peer
  Path #1: Received by speaker 0
  Not advertised to any peer
  Local
    10.1.1.5 C:10000 (bsid:80058) (metric 40) from 10.1.1.253 (10.1.1.5)
      Received Label 80040
      Origin IGP, localpref 100, valid, internal, best, group-best, import-candidate,
imported, rib-install
      Received Path ID 0, Local Path ID 1, version 18
      Extended community: Color:10000 RT:65000:100
      Originator: 10.1.1.5, Cluster list: 10.1.1.253
      SR policy color 10000, up, registered, bsid 80058, if-handle 0x000006a0

  Source AFI: L2VPN EVPN, Source VRF: default, Source Route Distinguisher: 10.1.1.5:100

```

Use the **show l2vpn xconnect** command to display the state associated with EVPN-VPWS EVI 100 service.

```

RP/0/RSP0/CPU0:Node-C# show l2vpn xconnect group evpn_vpws_group
Legend: ST = State, UP = Up, DN = Down, AD = Admin Down, UR = Unresolved,
       SB = Standby, SR = Standby Ready, (PP) = Partially Programmed

```

XConnect		Segment 1		Segment 2	
Group	Name	ST	Description	ST	Description

evpn_vpws_group					
	evpn_vpws_100	UP	Gi0/0/0/3.2500	UP	EVPN 100,11,10.1.1.5

The following output shows the details for the service. Note that the service is associated with the on-demand SR policy with color 10000 and end-point 10.1.1.5 (node A).

```

RP/0/RSP0/CPU0:Node-C# show l2vpn xconnect group evpn_vpws_group xc-name evpn_vpws_100

```

```

Group evpn_vpws_group, XC evpn_vpws_100, state is up; Interworking none
AC: GigabitEthernet0/0/0/3.2500, state is up
Type VLAN; Num Ranges: 1
Rewrite Tags: []
VLAN ranges: [2500, 2500]
MTU 1500; XC ID 0x1200008; interworking none
Statistics:
  packets: received 0, sent 0
  bytes: received 0, sent 0
  drops: illegal VLAN 0, illegal length 0
EVPN: neighbor 10.1.1.5, PW ID: evi 100, ac-id 11, state is up ( established )
XC ID 0xa0000003
Encapsulation MPLS
Source address 10.1.1.2
Encap type Ethernet, control word enabled
Sequencing not set
Preferred path Active : SR TE srte_c_10000_ep_10.1.1.5, On-Demand, fallback enabled
Tunnel : Up
Load Balance Hashing: src-dst-mac

      EVPN          Local          Remote
-----
Label          80056          80040
MTU             1500          1500
Control word   enabled       enabled
AC ID           21            11
EVPN type      Ethernet     Ethernet

-----
Create time: 10/07/2019 18:36:16 (1d19h ago)
Last time status changed: 10/07/2019 19:41:59 (1d18h ago)
Last time PW went down: 10/07/2019 19:40:54 (1d18h ago)
Statistics:
  packets: received 0, sent 0
  bytes: received 0, sent 0

```

Use the **show segment-routing traffic-eng policy** command with **tabular** option to display SR policy summary information.

The following output shows the on-demand SR policy with BSID 80058 that was triggered by EVPN RT1 prefix with color 10000 advertised by node A (10.1.1.5).

```
RP/0/RSP0/CPU0:Node-C# show segment-routing traffic-eng policy color 10000 tabular
```

Color	Endpoint	Admin State	Oper State	Binding SID
10000	10.1.1.5	up	up	80058

The following output shows the details for the on-demand SR policy. Note that the SR policy's active candidate path (preference 100) is computed by SR-PCE (10.1.1.207).

Based on the goals of this use case, SR-PCE computes link-disjoint paths for the SR policies associated with a pair of ELINE services between site 1 and site 2. Specifically, from site 2 to site 1, LSP at Node C (srte_c_10000_ep_10.1.1.5) is link-disjoint from LSP at Node D (srte_c_10000_ep_10.1.1.6).

```
RP/0/RSP0/CPU0:Node-C# show segment-routing traffic-eng policy color 10000
```

```
SR-TE policy database
-----
```

```
Color: 10000, End-point: 10.1.1.5
```

```

Name: srte_c_10000_ep_10.1.1.5
Status:
  Admin: up Operational: up for 00:12:35 (since Jul 10 19:49:21.890)
Candidate-paths:
  Preference: 200 (BGP ODN) (shutdown)
    Requested BSID: dynamic
    PCC info:
      Symbolic name: bgp_c_10000_ep_10.1.1.5_discr_200
      PLSP-ID: 7
    Dynamic (invalid)
  Preference: 100 (BGP ODN) (active)
    Requested BSID: dynamic
    PCC info:
      Symbolic name: bgp_c_10000_ep_10.1.1.5_discr_100
      PLSP-ID: 6
  Dynamic (pce 10.1.1.207) (valid)
    Metric Type: IGP, Path Accumulated Metric: 40
    16007 [Prefix-SID, 10.1.1.7]
    16008 [Prefix-SID, 10.1.1.8]
    80005 [Adjacency-SID, 11.5.8.8 - 11.5.8.5]
Attributes:
  Binding SID: 80058
  Forward Class: 0
  Steering BGP disabled: no
  IPv6 caps enable: yes

```

Verification: Site 2 Node D

This section depicts verification steps at Node D.

Use the **show bgp l2vpn evpn** command to display BGP prefix information for EVPN-VPWS EVI 101 (rd 10.1.1.4:101). The output includes an EVPN route-type 1 route with color 10000 originated at Node B (10.1.1.6).

```

RP/0/RSP0/CPU0:Node-D# show bgp l2vpn evpn rd 10.1.1.4:101
BGP router identifier 10.1.1.4, local AS number 65000
BGP generic scan interval 60 secs
Non-stop routing is enabled
BGP table state: Active
Table ID: 0x0 RD version: 0
BGP main routing table version 570
BGP NSR Initial initsync version 1 (Reached)
BGP NSR/ISSU Sync-Group versions 0/0
BGP scan interval 60 secs

Status codes: s suppressed, d damped, h history, * valid, > best
               i - internal, r RIB-failure, S stale, N Nexthop-discard
Origin codes: i - IGP, e - EGP, ? - incomplete
   Network          Next Hop          Metric LocPrf Weight Path
Route Distinguisher: 10.1.1.4:101 (default for vrf VPWS:101)
*>i[1][0000.0000.0000.0000][12]/120
                10.1.1.6 C:10000                100      0 i
*> [1][0000.0000.0000.0000][22]/120
                0.0.0.0                                0 i

Processed 2 prefixes, 2 paths

```

The following output displays the details for the incoming EVPN RT1. Note the presence of BGP extended color community 10000, and that the prefix is associated with an SR policy with color 10000 and BSID value of 80047.

```

RP/0/RSP0/CPU0:Node-D# show bgp l2vpn evpn rd 10.1.1.4:101
[1] [0000.0000.0000.0000.0000] [12]/120
BGP routing table entry for [1] [0000.0000.0000.0000.0000] [12]/120, Route Distinguisher:
10.1.1.4:101
Versions:
  Process          bRIB/RIB  SendTblVer
  Speaker          569      569
Last Modified: Jul 10 18:42:12.455 for 00:45:38
Paths: (1 available, best #1)
  Not advertised to any peer
  Path #1: Received by speaker 0
  Not advertised to any peer
Local
  10.1.1.6 C:10000 (bsid:80047) (metric 40) from 10.1.1.253 (10.1.1.6)
    Received Label 80060
    Origin IGP, localpref 100, valid, internal, best, group-best, import-candidate,
imported, rib-install
    Received Path ID 0, Local Path ID 1, version 568
    Extended community: Color:10000 RT:65000:101
    Originator: 10.1.1.6, Cluster list: 10.1.1.253
    SR policy color 10000, up, registered, bsid 80047, if-handle 0x00001720

    Source AFI: L2VPN EVPN, Source VRF: default, Source Route Distinguisher: 10.1.1.6:101

```

Use the **show l2vpn xconnect** command to display the state associated with EVPN-VPWS EVI 101 service.

```

RP/0/RSP0/CPU0:Node-D# show l2vpn xconnect group evpn_vpws_group
Legend: ST = State, UP = Up, DN = Down, AD = Admin Down, UR = Unresolved,
      SB = Standby, SR = Standby Ready, (PP) = Partially Programmed

XConnect
Group      Name      ST      Segment 1      Segment 2
Description      ST      Description      ST
-----
evpn_vpws_group
          evpn_vpws_101
          UP      Gi0/0/0/1.2500      UP      EVPN 101,12,10.1.1.6      UP
-----

```

The following output shows the details for the service. Note that the service is associated with the on-demand SR policy with color 10000 and end-point 10.1.1.6 (node B).

```

RP/0/RSP0/CPU0:Node-D# show l2vpn xconnect group evpn_vpws_group xc-name evpn_vpws_101

Group evpn_vpws_group, XC evpn_vpws_101, state is up; Interworking none
AC: GigabitEthernet0/0/0/1.2500, state is up
Type VLAN; Num Ranges: 1
Rewrite Tags: []
VLAN ranges: [2500, 2500]
MTU 1500; XC ID 0x120000c; interworking none
Statistics:
  packets: received 0, sent 0
  bytes: received 0, sent 0
  drops: illegal VLAN 0, illegal length 0
EVPN: neighbor 10.1.1.6, PW ID: evi 101, ac-id 12, state is up ( established )
XC ID 0xa000000d
Encapsulation MPLS
Source address 10.1.1.4
Encap type Ethernet, control word enabled
Sequencing not set
Preferred path Active : SR TE srte_c_10000_ep_10.1.1.6, On-Demand, fallback enabled
Tunnel : Up
Load Balance Hashing: src-dst-mac

```

```

EVPN          Local                               Remote
-----
Label         80045                               80060
MTU           1500                               1500
Control word  enabled                               enabled
AC ID         22                                12
EVPN type    Ethernet                             Ethernet
-----
Create time: 10/07/2019 18:42:07 (00:45:49 ago)
Last time status changed: 10/07/2019 18:42:09 (00:45:47 ago)
Statistics:
  packets: received 0, sent 0
  bytes: received 0, sent 0

```

Use the **show segment-routing traffic-eng policy** command with **tabular** option to display SR policy summary information.

The following output shows the on-demand SR policy with BSID 80047 that was triggered by EVPN RT1 prefix with color 10000 advertised by node B (10.1.1.6).

```
RP/0/RSP0/CPU0:Node-D# show segment-routing traffic-eng policy color 10000 tabular
```

```

Color          Endpoint  Admin  Oper          Binding
              State    State
-----
10000          10.1.1.6  up     up           80047

```

The following output shows the details for the on-demand SR policy. Note that the SR policy's active candidate path (preference 100) is computed by SR-PCE (10.1.1.207).

Based on the goals of this use case, SR-PCE computes link-disjoint paths for the SR policies associated with a pair of ELINE services between site 1 and site 2. Specifically, from site 2 to site 1, LSP at Node D (srte_c_10000_ep_10.1.1.6) is link-disjoint from LSP at Node C (srte_c_10000_ep_10.1.1.5).

```
RP/0/RSP0/CPU0:Node-D# show segment-routing traffic-eng policy color 10000
```

```
SR-TE policy database
-----
```

```

Color: 10000, End-point: 10.1.1.6
Name: srte_c_10000_ep_10.1.1.6
Status:
  Admin: up Operational: up for 01:23:04 (since Jul 10 18:42:07.350)
Candidate-paths:
  Preference: 200 (BGP ODN) (shutdown)
  Requested BSID: dynamic
  PCC info:
    Symbolic name: bgp_c_10000_ep_10.1.1.6_discr_200
    PLSP-ID: 17
  Dynamic (invalid)
Preference: 100 (BGP ODN) (active)
Requested BSID: dynamic
  PCC info:
    Symbolic name: bgp_c_10000_ep_10.1.1.6_discr_100
    PLSP-ID: 16
Dynamic (pce 10.1.1.207) (valid)
Metric Type: IGP, Path Accumulated Metric: 40
  16001 [Prefix-SID, 10.1.1.1]
  16006 [Prefix-SID, 10.1.1.6]
Attributes:

```

```
Binding SID: 80047
Forward Class: 0
Steering BGP disabled: no
IPv6 caps enable: yes
```

Manually Provisioned SR Policy

Manually provisioned SR policies are configured on the head-end router. These policies can use dynamic paths or explicit paths. See the [SR-TE Policy Path Types, on page 109](#) section for information on manually provisioning an SR policy using dynamic or explicit paths.

PCE-Initiated SR Policy

An SR-TE policy can be configured on the path computation element (PCE) to reduce link congestion or to minimize the number of network touch points.

The PCE collects network information, such as traffic demand and link utilization. When the PCE determines that a link is congested, it identifies one or more flows that are causing the congestion. The PCE finds a suitable path and deploys an SR-TE policy to divert those flows, without moving the congestion to another part of the network. When there is no more link congestion, the policy is removed.

To minimize the number of network touch points, an application, such as a Network Services Orchestrator (NSO), can request the PCE to create an SR-TE policy. PCE deploys the SR-TE policy using PCC-PCE communication protocol (PCEP).

For more information, see the [PCE-Initiated SR Policies, on page 174](#) section.

SR-TE Policy Path Types

A **dynamic** path is based on an optimization objective and a set of constraints. The head-end computes a solution, resulting in a SID-list or a set of SID-lists. When the topology changes, a new path is computed. If the head-end does not have enough information about the topology, the head-end might delegate the computation to a Segment Routing Path Computation Element (SR-PCE). For information on configuring SR-PCE, see *Configure Segment Routing Path Computation Element* chapter.

An **explicit** path is a specified SID-list or set of SID-lists.

An SR-TE policy initiates a single (selected) path in RIB/FIB. This is the preferred valid candidate path.

A candidate path has the following characteristics:

- It has a preference – If two policies have same {color, endpoint} but different preferences, the policy with the highest preference is selected.
- It is associated with a single binding SID (BSID) – A BSID conflict occurs when there are different SR policies with the same BSID. In this case, the policy that is installed first gets the BSID and is selected.
- It is valid if it is usable.

A path is selected when the path is valid and its preference is the best among all candidate paths for that policy.



Note The protocol of the source is not relevant in the path selection logic.

Dynamic Paths

Optimization Objectives

Optimization objectives allow the head-end router to compute a SID-list that expresses the shortest dynamic path according to the selected metric type:

- IGP metric — Refer to the "Implementing IS-IS" and "Implementing OSPF" chapters in the *Routing Configuration Guide for Cisco ASR 9000 Series Routers*.
- TE metric — See the [Configure Interface TE Metrics, on page 110](#) section for information about configuring TE metrics.

This example shows a dynamic path from head-end router 1 to end-point router 3 that minimizes IGP or TE metric:

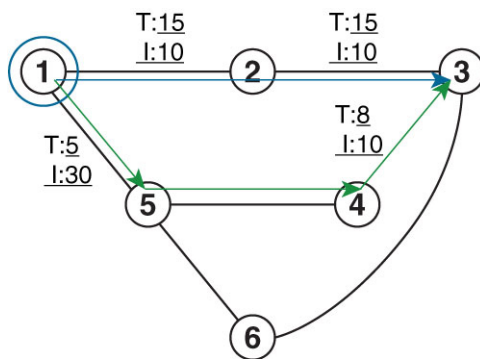

Default IGP link metric: I:10
Default TE link metric T:10

520016

- The blue path uses the minimum IGP metric: Min-Metric (1 → 3, IGP) = SID-list <16003>; cumulative IGP metric: 20
- The green path uses the minimum TE metric: Min-Metric (1 → 3, TE) = SID-list <16005, 16004, 16003>; cumulative TE metric: 23

Configure Interface TE Metrics

Use the **metric value** command in SR-TE interface submode to configure the TE metric for interfaces. The **value** range is from 0 to 2147483647.

```
Router# configure
Router(config)# segment-routing
Router(config-sr)# traffic-eng
Router(config-sr-te)# interface type interface-path-id
Router(config-sr-te-if)# metric value
```

Configuring TE Metric: Example

The following configuration example shows how to set the TE metric for various interfaces:

```
segment-routing
traffic-eng
 interface TenGigE0/0/0/0
  metric 100
 !
 interface TenGigE0/0/0/1
  metric 1000
 !
 interface TenGigE0/0/2/0
  metric 50
 !
 !
end
```

Constraints

Constraints allow the head-end router to compute a dynamic path according to the selected metric type:

- **Affinity** — You can apply a color or name to links or interfaces by assigning affinity bit-maps to them. You can then specify an affinity (or relationship) between an SR policy path and link colors. SR-TE computes a path that includes or excludes links that have specific colors, or combinations of colors. See the [Named Interface Link Admin Groups and SR-TE Affinity Maps, on page 111](#) section for information on named interface link admin groups and SR-TE Affinity Maps.
- **Disjoint** — SR-TE computes a path that is disjoint from another path in the same disjoint-group. Disjoint paths do not share network resources. Path disjointness may be required for paths between the same pair of nodes, between different pairs of nodes, or a combination (only same head-end or only same end-point).
- **Flexible Algorithm** — Flexible Algorithm allows for user-defined algorithms where the IGP computes paths based on a user-defined combination of metric type and constraint.

Named Interface Link Admin Groups and SR-TE Affinity Maps

Named Interface Link Admin Groups and SR-TE Affinity Maps provide a simplified and more flexible means of configuring link attributes and path affinities to compute paths for SR-TE policies.

In the traditional TE scheme, links are configured with attribute-flags that are flooded with TE link-state parameters using Interior Gateway Protocols (IGPs), such as Open Shortest Path First (OSPF).

Named Interface Link Admin Groups and SR-TE Affinity Maps let you assign, or map, up to 32 color names for affinity and attribute-flag attributes instead of 32-bit hexadecimal numbers. After mappings are defined, the attributes can be referred to by the corresponding color name in the CLI. Furthermore, you can define constraints using *include-any*, *include-all*, and *exclude-any* arguments, where each statement can contain up to 10 colors.



Note You can configure affinity constraints using attribute flags or the Flexible Name Based Policy Constraints scheme; however, when configurations for both schemes exist, only the configuration pertaining to the new scheme is applied.

Configure Named Interface Link Admin Groups and SR-TE Affinity Maps

Use the **affinity name** *NAME* command in SR-TE interface submode to assign affinity to interfaces. Configure this on routers with interfaces that have an associated admin group attribute.

```
Router# configure
Router(config)# segment-routing
Router(config-sr)# traffic-eng
Router(config-sr-te)# interface TenGigE0/0/1/2
Router(config-sr-if)# affinity
Router(config-sr-if-affinity)# name RED
```

Use the **affinity-map name** *NAME bit-position* *bit-position* command in SR-TE sub-mode to define affinity maps. The *bit-position* range is from 0 to 255.

Configure affinity maps on the following routers:

- Routers with interfaces that have an associated admin group attribute.
- Routers that act as SR-TE head-ends for SR policies that include affinity constraints.

```
Router# configure
Router(config)# segment-routing
Router(config-sr)# traffic-eng
Router(config-sr-te)# affinity-map
Router(config-sr-te-affinity-map)# name RED bit-position 23
```

Configuring Link Admin Group: Example

The following example shows how to assign affinity to interfaces and to define affinity maps. This configuration is applicable to any router (SR-TE head-end or transit node) with colored interfaces.

```
segment-routing
traffic-eng
interface TenGigE0/0/1/1
  affinity
  name CROSS
  name RED
!
!
interface TenGigE0/0/1/2
  affinity
  name RED
!
!
interface TenGigE0/0/2/0
  affinity
  name BLUE
!
!
affinity-map
name RED bit-position 23
name BLUE bit-position 24
name CROSS bit-position 25
!
end
```

Configure SR Policy with Dynamic Path

To configure a SR-TE policy with a dynamic path, optimization objectives, and affinity constraints, complete the following configurations:

1. Define the optimization objectives. See the [Optimization Objectives, on page 110](#) section.
2. Define the constraints. See the [Constraints, on page 111](#) section.
3. Create the policy.

Behaviors and Limitations

Examples

The following example shows a configuration of an SR policy at an SR-TE head-end router. The policy has a dynamic path with optimization objectives and affinity constraints computed by the head-end router.

```
segment-routing
traffic-eng
policy foo
color 100 end-point ipv4 10.1.1.2
candidate-paths
preference 100
dynamic
metric
type te
!
!
constraints
affinity
exclude-any
name RED
!
!
!
!
!
```

The following example shows a configuration of an SR policy at an SR-TE head-end router. The policy has a dynamic path with optimization objectives and affinity constraints computed by the SR-PCE.

```
segment-routing
traffic-eng
policy baa
color 101 end-point ipv4 10.1.1.2
candidate-paths
preference 100
dynamic
pcep
!
metric
type te
!
!
constraints
affinity
exclude-any
name BLUE
!
```

```

!
!
!
!
!

```

Explicit Paths

Configure SR-TE Policy with Explicit Path

To configure an SR-TE policy with an explicit path, complete the following configurations:

1. Create the segment lists.
2. Create the SR-TE policy.

Behaviors and Limitations

A segment list can use IP addresses or MPLS labels, or a combination of both.

- The IP address can be link or a Loopback address.
- Once you enter an MPLS label, you cannot enter an IP address.

When configuring an explicit path using IP addresses of links along the path, the SR-TE process selects either the protected or the unprotected Adj-SID of the link, depending on the order in which the Adj-SIDs were received.

Configure Local SR-TE Policy Using Explicit Paths

Create a segment list with IP addresses:

```

Router# configure
Router(config)# segment-routing
Router(config-sr)# traffic-eng
Router(config-sr-te)# segment-list name SIDLIST1
Router(config-sr-te-sl)# index 10 address ipv4 10.1.1.2
Router(config-sr-te-sl)# index 20 address ipv4 10.1.1.3
Router(config-sr-te-sl)# index 30 address ipv4 10.1.1.4
Router(config-sr-te-sl)# exit

```

Create a segment list with MPLS labels:

```

Router(config-sr-te)# segment-list name SIDLIST2
Router(config-sr-te-sl)# index 10 mpls label 16002
Router(config-sr-te-sl)# index 20 mpls label 16003
Router(config-sr-te-sl)# index 30 mpls label 16004
Router(config-sr-te-sl)# exit

```

Create a segment list with invalid MPLS label:

```

Router(config-sr-te)# segment-list name SIDLIST4
Router(config-sr-te-sl)# index 10 mpls label 16009
Router(config-sr-te-sl)# index 20 mpls label 16003
Router(config-sr-te-sl)# index 30 mpls label 16004
Router(config-sr-te-sl)# exit

```

Create a segment list with IP addresses and MPLS labels:

```

Router(config-sr-te)# segment-list name SIDLIST3
Router(config-sr-te-sl)# index 10 address ipv4 10.1.1.2
Router(config-sr-te-sl)# index 20 mpls label 16003
Router(config-sr-te-sl)# index 30 mpls label 16004
Router(config-sr-te-sl)# exit

```

Create the SR-TE policy:

```

Router(config-sr-te)# policy POLICY2
Router(config-sr-te-policy)# color 20 end-point ipv4 10.1.1.4
Router(config-sr-te-policy)# candidate-paths
Router(config-sr-te-policy-path)# preference 100
Router(config-sr-te-policy-path-pref)# explicit segment-list SIDLIST2
Router(config-sr-te-pp-info)# exit
Router(config-sr-te-policy-path-pref)# exit
Router(config-sr-te-policy-path)# preference 200
Router(config-sr-te-policy-path-pref)# explicit segment-list SIDLIST1
Router(config-sr-te-pp-info)# exit
Router(config-sr-te-policy-path-pref)# explicit segment-list SIDLIST4
Router(config-sr-te-pp-info)# exit
Router(config-sr-te-policy-path-pref)# exit

```

Running Configuration

```

Router# show running-configuration
segment-routing
traffic-eng
segment-list SIDLIST1
index 10 address ipv4 10.1.1.2
index 20 address ipv4 10.1.1.3
index 30 address ipv4 10.1.1.4
!
segment-list SIDLIST2
index 10 mpls label 16002
index 20 mpls label 16003
index 30 mpls label 16004
!
segment-list SIDLIST3
index 10 address ipv4 10.1.1.2
index 20 mpls label 16003
index 30 mpls label 16004
!
segment-list SIDLIST4
index 10 mpls label 16009
index 20 mpls label 16003
index 30 mpls label 16004
!
policy POLICY1
color 10 end-point ipv4 10.1.1.4
candidate-paths
preference 100
explicit segment-list SIDLIST1
!
!
!
policy POLICY2
color 20 end-point ipv4 10.1.1.4
candidate-paths
preference 100
explicit segment-list SIDLIST1
!
!

```

```

    preference 200
    explicit segment-list SIDLIST2
    !
    explicit segment-list SIDLIST4
    !
    !
    !
    !
policy POLICY3
color 30 end-point ipv4 10.1.1.4
candidate-paths
  preference 100
  explicit segment-list SIDLIST3
  !
  !
  !
!
!

```

Verification

Verify the SR-TE policy configuration using:

```
Router# show segment-routing traffic-eng policy name srte_c_20_ep_10.1.1.4
```

```
SR-TE policy database
-----
```

```

Color: 20, End-point: 10.1.1.4
Name: srte_c_20_ep_10.1.1.4
Status:
  Admin: up Operational: up for 00:00:15 (since Jul 14 00:53:10.615)
Candidate-paths:
  Preference: 200 (configuration) (active)
  Name: POLICY2
  Requested BSID: dynamic
  Protection Type: protected-preferred
  Maximum SID Depth: 8
  Explicit: segment-list SIDLIST2 (active)
  Weight: 1, Metric Type: TE
    16002
    16003
    16004
Attributes:
  Binding SID: 51301
  Forward Class: Not Configured
  Steering labeled-services disabled: no
  Steering BGP disabled: no
  IPv6 caps enable: yes
  Invalidation drop enabled: no

```

The following example displays the private output of an SRv6 policy with an explicit path:

```
Router# show segment-routing traffic-eng policy name srte_c_10_ep_fcbb:bb00:2::1 private
```

```
SR-TE policy database
-----
```

```

Color: 10, End-point: fcbb:bb00:2::1 ID: 3
Name: srte_c_10_ep_fcbb:bb00:2::1

```

```

Status:
  Admin: up Operational: up for 1w3d (since Jan 14 12:59:41.802)
Candidate-paths:
  Preference: 10 (configuration) (active)
  Originator: ASN 0 node-address <None> discriminator: 10
  Name: srv6_policy
  Requested BSID: dynamic
  Protection Type: protected-preferred
  Maximum SID Depth: 19
  ID: 1
  Source: fcbb:bb00:1::1
  Stale: no
  Checkpoint flags: 0x00000000
  Explicit: segment-list BLUE-SL-1 (valid)
  Weight: 1, Metric Type: TE
  IGP area: 0
  SID[0]: Unknown: fcbb:bb00:10:e0ab::/64 /* Behavior will be optional */
  Format: F3216
  LBL:32 LNL:16 FL:0 AL:0.
  SID[1]:Unknown: fcbb:bb00:e0bc::/48
  Format: F3216
  LBL:32 LNL:16 FL:0 AL:0. /* NAI not present for explicit path */
  SID[2]: Unknown: fcbb:bb00:e0cd::/48
  Format: F3216
  LBL:32 LNL:16 FL:0 AL:0.
  SID[3]: Unknown: fcbb:bb00:e0d2::/48
  Format: F3216
  LBL:32 LNL:16 FL:0 AL:0.
SRv6 Information:
  Locator: loc1
  Binding SID requested: Dynamic
  Binding SID behavior: End.B6.Insert.Red
LSPs:
LSP[0]:
  LSP-ID: 8 policy ID: 3 (active)
  State: Programmed
  Binding SID: fccc:cccl:a1:e006::
  Install timer:
  Running: no
  Cleanup timer:
  Running: no
  Delete timer:
  Running: no
  Revert timer:
  Running: no
  SM chain:
  Init -> BSID RW
  BSID rewrite pending -> Success
  Forwarding flags: 0x00000008
  Candidate path ID: 1
  Flags:
  SLs:
  SL[0]:
  Name: usid_list_1
  Type: Explicit
  NH SRV6 SID: fcbb:bb00:10:e0ab::
  Flags:
  Paths:
  Path[0]:
  Interface version: 1
  Flags:
  Outgoing interface: Gi0/0/0/0
  SID stack: fcbb:bb00:10:e0ab::/64, fcbb:bb00:e0bc::/48,

```

```

                                fcbb:bb00:e0cd::/48, fcbb:bb00:e0d2::/48
Path[1]:
  Interface version: 1
  Flags:
  Outgoing interface: Gi0/0/0/1
  SID stack: fcbb:bb00:bb22:e000::/64, fcbb:bb00:10:e0ab::/64,
                                fcbb:bb00:e0bc::/48, fcbb:bb00:e0cd::/48,
                                fcbb:bb00:e0d2::/48
Attributes:
  Binding SID: fccc:cccl:a1:e006::
  Forward Class: Not Configured
  Steering labeled-services disabled: no
  Steering BGP disabled: no
  IPv6 caps enable: yes
  Invalidation drop enabled: no
  Max Install Standby Candidate Paths: 0

```

The following example displays the private output of an SRv6 policy forwarding show command:

```

Router# show segment-routing traffic-eng forwarding policy name srte_c_10_ep_fcbb:bb00:2::1
private

SR-TE Policy Forwarding database
-----
Color: 10, End-point: fcbb:bb00:2::1
Name: srte_c_10_ep_fcbb:bb00:2::1
Binding SID: fccc:cccl:a1:e006::
Active LSP:
  Candidate path:
    Preference: 10 (configuration)
    Originator: ASN 0 node-address <None> discriminator: 10
    Name: srv6_policy
  Segment lists:
    SL[0]:
      Name: usid_list_1
      Switched Packets/Bytes: ??
      Paths:
        Path[0]:
          Outgoing Interfaces: GigabitEthernet0/0/0/0
          Next Hop: fe80::41:dbff:fe02:6513
          FRR Pure Backup: No
          ECMP/LFA Backup: No
          SID stack (Top -> Bottom): { fcbb:bb00:10:e0ab::/64, fcbb:bb00:e0bc::/48,
                                     fcbb:bb00:e0d2::/48,
                                     fcbb:bb00:e0cd::/48,
                                     fcbb:bb00:e0d2::/48}
        Path-id: 1 (Protected), Backup-path-id: 65, Weight: 0
        Flags: 0x0 (extended 0x0, RIB 0x42)
        Path[1]:
          Outgoing Interfaces: GigabitEthernet0/0/0/1
          Next Hop: fe80::cd:23ff:fe31:1766
          FRR Pure Backup: Yes
          ECMP/LFA Backup: Yes
          SID stack (Top -> Bottom): { fcbb:bb00:bb22:e000::/64, fcbb:bb00:10:e0ab::/64,
                                     fcbb:bb00:e0bc::/48,
                                     fcbb:bb00:e0cd::/48,
                                     fcbb:bb00:e0d2::/48}
        Path-id: 65 (Pure-Backup), Weight: 0
        Flags: 0x0 (extended 0x0, RIB 0x10182)

Policy Packets/Bytes Switched: ??
Interface: None (0x0)

```

Configuring Explicit Path with Affinity Constraint Validation

To fully configure SR-TE flexible name-based policy constraints, you must complete these high-level tasks in order:

1. Assign Color Names to Numeric Values
2. Associate Affinity-Names with SR-TE Links
3. Associate Affinity Constraints for SR-TE Policies

```
/* Enter the global configuration mode and assign color names to numeric values
Router# configure
Router(config)# segment-routing
Router(config-sr)# traffic-eng
Router(config-sr-te)# affinity-map
Router(config-sr-te-affinity-map)# blue bit-position 0
Router(config-sr-te-affinity-map)# green bit-position 1
Router(config-sr-te-affinity-map)# red bit-position 2
Router(config-sr-te-affinity-map)# exit
```

```
/* Associate affinity-names with SR-TE links
Router(config-sr-te)# interface Gi0/0/0/0
Router(config-sr-te-if)# affinity
Router(config-sr-te-if-affinity)# blue
Router(config-sr-te-if-affinity)# exit
Router(config-sr-te-if)# exit
Router(config-sr-te)# interface Gi0/0/0/1
Router(config-sr-te-if)# affinity
Router(config-sr-te-if-affinity)# blue
Router(config-sr-te-if-affinity)# green
Router(config-sr-te-if-affinity)# exit
Router(config-sr-te-if)# exit
Router(config-sr-te)#
```

```
/* Associate affinity constraints for SR-TE policies
Router(config-sr-te)# segment-list name SIDLIST1
Router(config-sr-te-sl)# index 10 address ipv4 10.1.1.2
Router(config-sr-te-sl)# index 20 address ipv4 2.2.2.23
Router(config-sr-te-sl)# index 30 address ipv4 10.1.1.4
Router(config-sr-te-sl)# exit
Router(config-sr-te)# segment-list name SIDLIST2
Router(config-sr-te-sl)# index 10 address ipv4 10.1.1.2
Router(config-sr-te-sl)# index 30 address ipv4 10.1.1.4
Router(config-sr-te-sl)# exit
Router(config-sr-te)# segment-list name SIDLIST3
Router(config-sr-te-sl)# index 10 address ipv4 10.1.1.5
Router(config-sr-te-sl)# index 30 address ipv4 10.1.1.4
Router(config-sr-te-sl)# exit
```

```
Router(config-sr-te)# policy POLICY1
Router(config-sr-te-policy)# color 20 end-point ipv4 10.1.1.4
Router(config-sr-te-policy)# binding-sid mpls 1000
Router(config-sr-te-policy)# candidate-paths
Router(config-sr-te-policy-path)# preference 200
Router(config-sr-te-policy-path-pref)# constraints affinity exclude-any red
Router(config-sr-te-policy-path-pref)# explicit segment-list SIDLIST1
```

```

Router(config-sr-te-pp-info)# exit
Router(config-sr-te-policy-path-pref)# explicit segment-list SIDLIST2
Router(config-sr-te-pp-info)# exit
Router(config-sr-te-policy-path-pref)# exit
Router(config-sr-te-policy-path)# preference 100
Router(config-sr-te-policy-path-pref)# explicit segment-list SIDLIST3

```

Running Configuration

```

Router# show running-configuration
segment-routing
traffic-eng

interface GigabitEthernet0/0/0/0
  affinity
    blue
  !
!
interface GigabitEthernet0/0/0/1
  affinity
    blue
    green
  !
!

segment-list name SIDLIST1
  index 10 address ipv4 10.1.1.2
  index 20 address ipv4 2.2.2.23
  index 30 address ipv4 10.1.1.4
!
segment-list name SIDLIST2
  index 10 address ipv4 10.1.1.2
  index 30 address ipv4 10.1.1.4
!
segment-list name SIDLIST3
  index 10 address ipv4 10.1.1.5
  index 30 address ipv4 10.1.1.4
!
policy POLICY1
  binding-sid mpls 1000
  color 20 end-point ipv4 10.1.1.4
  candidate-paths
    preference 100
      explicit segment-list SIDLIST3
    !
  !
  preference 200
    explicit segment-list SIDLIST1
    !
    explicit segment-list SIDLIST2
    !
  constraints
    affinity
      exclude-any
        red
    !
  !
  !
!
!
affinity-map

```

```

blue bit-position 0
green bit-position 1
red bit-position 2
!
!
!
```

Explicit Path with Affinity Constraint Validation for Anycast SIDs



Note For information about configuring Anycast SIDs, see [Configuring a Prefix-SID on the IS-IS Enabled Loopback Interface, on page 35](#) or [Configuring a Prefix-SID on the OSPF-Enabled Loopback Interface, on page 55](#).

Routers that are configured with the same Anycast SID, on the same Loopback address and with the same SRGB, advertise the same prefix SID (Anycast).

The shortest path with the lowest IGP metric is then verified against the affinity constraints. If multiple nodes have the same shortest-path metric, all their paths are validated against the affinity constraints. A path that is not the shortest path is not validated against the affinity constraints.

Affinity Support for Anycast SIDs: Examples

In the following examples, nodes 3 and 5 advertise the same Anycast prefix (10.1.1.8) and assign the same prefix SID (16100).

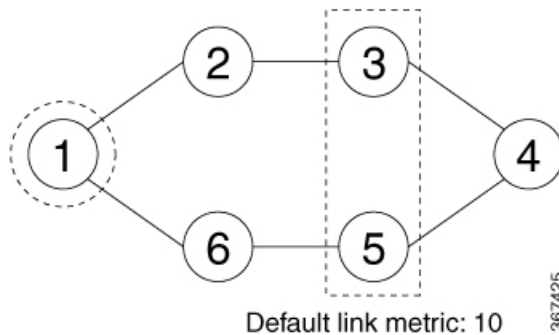

Node 1 uses the following SR-TE policy:

```

segment-routing
traffic-eng
policy POLICY1
color 20 end-point ipv4 10.1.1.4
binding-sid mpls 1000
candidate-paths
preference 100
explicit segment-list SIDLIST1
constraints
affinity
exclude-any
red
segment-list name SIDLIST1
index 10 address ipv4 100.100.100.100
```

```
index 20 address ipv4 4.4.4.4
```

Affinity Constraint Validation With ECMP Anycast SID: Example

In this example, the shortest path to both node 3 and node 5 has an equal accumulative IGP metric of 20. Both paths are validated against affinity constraints.

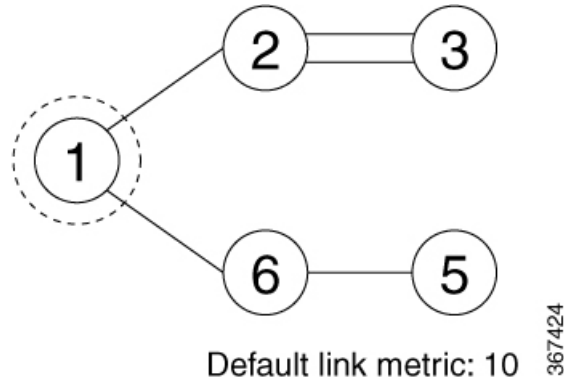

```
Name: POLICY1 (Color: 2, End-point: 198.51.100.6)
Status:
  Admin: up Operational: up for 00:03:52 (since Jan 24 01:52:14.215)
Candidate-paths:
  Preference 100:
  Constraints:
  Affinity:
    exclude-any: red
  Explicit: segment-list SIDLIST1 (active)
  Weight: 0, Metric Type: IGP
    16100 [Prefix-SID, 10.1.1.8]
    16004 [Prefix-SID, 4.4.4.4]
```

Affinity Constraint Validation With Non-ECMP Anycast SID: Example

In this example, the shortest path to node 5 has an accumulative IGP metric of 20, and the shortest path to node 3 has an accumulative IGP metric of 30. Only the shortest path to node 5 is validated against affinity constraints.

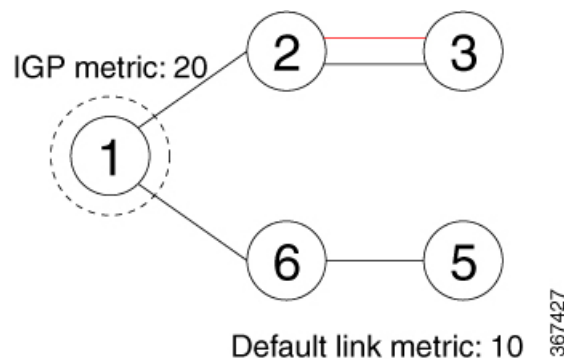



Note Even though parallel link (23) is marked with red, it is still considered valid since anycast traffic flows only on the path to node 5.

Invalid Path Based on Affinity Constraint: Example

In this example, parallel link (23) is marked as red, so the path to anycast node 3 is invalidated.

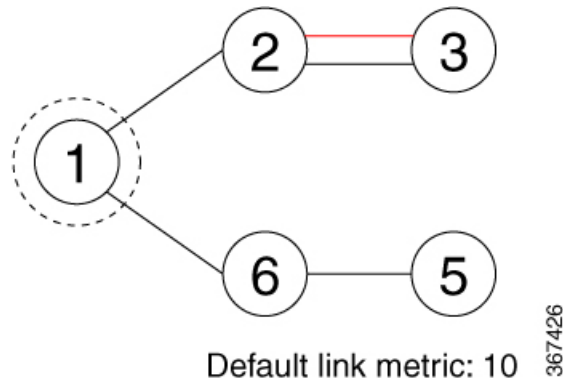

SR-TE policy database

```
-----
Name: POLICY1 (Color: 2, End-point: 198.51.100.6)
Status:
  Admin: up Operational: up for 00:03:52 (since Jan 24 01:52:14.215)
Candidate-paths:
  Preference 100:
    Constraints:
      Affinity:
        exclude-any: red
      Explicit: segment-list SIDLIST1 (inactive)
      Inactive Reason: Link [2.2.21.23,2.2.21.32] failed to satisfy affinity exclude-any
constraint=0x00000008, link attributes=0x0000000A
```

Protocols

Path Computation Element Protocol

The path computation element protocol (PCEP) describes a set of procedures by which a path computation client (PCC) can report and delegate control of head-end label switched paths (LSPs) sourced from the PCC to a PCE peer. The PCE can request the PCC to update and modify parameters of LSPs it controls. The stateful model also enables a PCC to allow the PCE to initiate computations allowing the PCE to perform network-wide orchestration.

Configure the Head-End Router as PCEP PCC

Configure the head-end router as PCEP Path Computation Client (PCC) to establish a connection to the PCE. The PCC and PCE addresses must be routable so that TCP connection (to exchange PCEP messages) can be established between PCC and PCE.

Configure the PCC to Establish a Connection to the PCE

Use the **segment-routing traffic-eng pcc** command to configure the PCC source address, the SR-PCE address, and SR-PCE options.

A PCE can be given an optional precedence. If a PCC is connected to multiple PCEs, the PCC selects a PCE with the lowest precedence value. If there is a tie, a PCE with the highest IP address is chosen for computing path. The precedence *value* range is from 0 to 255.

```
Router(config)# segment-routing
Router(config-sr)# traffic-eng
Router(config-sr-te)# pcc
Router(config-sr-te-pcc)# source-address ipv4 local-source-address
Router(config-sr-te-pcc)# pce address ipv4 PCE-address[precedence value]
Router(config-sr-te-pcc)# pce address ipv4 PCE-address[keychain WORD]
```

Configure PCEP-Related Timers

Use the **timers keepalive** command to specify how often keepalive messages are sent from PCC to its peers. The range is from 0 to 255 seconds; the default value is 30.

```
Router(config-sr-te-pcc)# timers keepalive seconds
```

Use the **timers deadtimer** command to specify how long the remote peers wait before bringing down the PCEP session if no PCEP messages are received from this PCC. The range is from 1 to 255 seconds; the default value is 120.

```
Router(config-sr-te-pcc)# timers deadtimer seconds
```

Use the **timers delegation-timeout** command to specify how long a delegated SR policy can remain up without an active connection to a PCE. The range is from 0 to 3600 seconds; the default value is 60.

```
Router(config-sr-te-pcc)# timers delegation-timeout seconds
```

PCE-Initiated SR Policy Timers

Use the **timers initiated orphans** command to specify the amount of time that a PCE-initiated SR policy will remain delegated to a PCE peer that is no longer reachable by the PCC. The range is from 10 to 180 seconds; the default value is 180.

```
Router(config-sr-te-pcc)# timers initiated orphans seconds
```

Use the **timers initiated state** command to specify the amount of time that a PCE-initiated SR policy will remain programmed while not being delegated to any PCE. The range is from 15 to 14440 seconds (24 hours); the default value is 600.

```
Router(config-sr-te-pcc)# timers initiated state seconds
```

To better understand how the PCE-initiated SR policy timers operate, consider the following example:

- PCE A instantiates SR policy P at head-end N.
- Head-end N delegates SR policy P to PCE A and programs it in forwarding.
- If head-end N detects that PCE A is no longer reachable, then head-end N starts the PCE-initiated **orphan** and **state** timers for SR policy P.
- If PCE A reconnects before the **orphan** timer expires, then SR policy P is automatically delegated back to its original PCE (PCE A).
- After the **orphan** timer expires, SR policy P will be eligible for delegation to any other surviving PCE(s).
- If SR policy P is not delegated to another PCE before the **state** timer expires, then head-end N will remove SR policy P from its forwarding.

Enable SR-TE SYSLOG Alarms

Use the **logging policy status** command to enable SR-TE related SYSLOG alarms.

```
Router(config-sr-te) # logging policy status
```

Enable PCEP Reports to SR-PCE

Use the **report-all** command to enable the PCC to report all SR policies in its database to the PCE.

```
Router(config-sr-te-pcc) # report-all
```

Customize MSD Value at PCC

Use the **maximum-sid-depth value** command to customize the Maximum SID Depth (MSD) signaled by PCC during PCEP session establishment.

The default MSD *value* is equal to the maximum MSD supported by the platform (10).

```
Router(config-sr-te) # maximum-sid-depth value
```

For cases with path computation at PCE, a PCC can signal its MSD to the PCE in the following ways:

- During PCEP session establishment – The signaled MSD is treated as a node-wide property.
 - MSD is configured under **segment-routing traffic-eng maximum-sid-depth value** command
- During PCEP LSP path request – The signaled MSD is treated as an LSP property.
 - On-demand (ODN) SR Policy: MSD is configured using the **segment-routing traffic-eng on-demand color color maximum-sid-depth value** command
 - Local SR Policy: MSD is configured using the **segment-routing traffic-eng policy WORD candidate-paths preference preference dynamic metric sid-limit value** command.



Note If the configured MSD values are different, the per-LSP MSD takes precedence over the per-node MSD.

After path computation, the resulting label stack size is verified against the MSD requirement.

- If the label stack size is larger than the MSD and path computation is performed by PCE, then the PCE returns a "no path" response to the PCC.
- If the label stack size is larger than the MSD and path computation is performed by PCC, then the PCC will not install the path.



Note A sub-optimal path (if one exists) that satisfies the MSD constraint could be computed in the following cases:

- For a dynamic path with TE metric, when the PCE is configured with the **pce segment-routing te-latency** command or the PCC is configured with the **segment-routing traffic-eng te-latency** command.
- For a dynamic path with LATENCY metric
- For a dynamic path with affinity constraints

For example, if the PCC MSD is 4 and the optimal path (with an accumulated metric of 100) requires 5 labels, but a sub-optimal path exists (with accumulated metric of 110) requiring 4 labels, then the sub-optimal path is installed.

Customize the SR-TE Path Calculation

Use the **te-latency** command to enable ECMP-aware path computation for TE metric.

```
Router(config-sr-te) # te-latency
```



Note ECMP-aware path computation is enabled by default for IGP and LATENCY metrics.

Configure PCEP Redundancy Type

Use the **redundancy pcc-centric** command to enable PCC-centric high-availability model. The PCC-centric model changes the default PCC delegation behavior to the following:

- After LSP creation, LSP is automatically delegated to the PCE that computed it.
- If this PCE is disconnected, then the LSP is redelegated to another PCE.
- If the original PCE is reconnected, then the delegation fallback timer is started. When the timer expires, the LSP is redelegated back to the original PCE, even if it has worse preference than the current PCE.

```
Router(config-sr-te-pcc) # redundancy pcc-centric
```

Configuring Head-End Router as PCEP PCC and Customizing SR-TE Related Options: Example

The following example shows how to configure an SR-TE head-end router with the following functionality:

- Enable the SR-TE head-end router as a PCEP client (PCC) with 3 PCEP servers (PCE) with different precedence values. The PCE with IP address 10.1.1.57 is selected as BEST.

- Enable SR-TE related syslogs.
- Set the Maximum SID Depth (MSD) signaled during PCEP session establishment to 5.
- Enable PCEP reporting for all policies in the node.

```
segment-routing
traffic-eng
pcc
  source-address ipv4 10.1.1.2
  pce address ipv4 10.1.1.57
  precedence 150
  password clear <password>
  !
  pce address ipv4 10.1.1.58
  precedence 200
  password clear <password>
  !
  pce address ipv4 10.1.1.59
  precedence 250
  password clear <password>
  !
  !
logging
  policy status
  !
maximum-sid-depth 5
pcc
  report-all
  !
  !
end
```

Verification

```
RP/0/RSP0/CPU0:Router# show segment-routing traffic-eng pcc ipv4 peer
```

```
PCC's peer database:
```

```
-----
```

```
Peer address: 10.1.1.57, Precedence: 150, (best PCE)
```

```
State up
```

```
Capabilities: Stateful, Update, Segment-Routing, Instantiation
```

```
Peer address: 10.1.1.58, Precedence: 200
```

```
State up
```

```
Capabilities: Stateful, Update, Segment-Routing, Instantiation
```

```
Peer address: 10.1.1.59, Precedence: 250
```

```
State up
```

```
Capabilities: Stateful, Update, Segment-Routing, Instantiation
```

BGP SR-TE

BGP may be used to distribute SR Policy candidate paths to an SR-TE head-end. Dedicated BGP SAFI and NLRI have been defined to advertise a candidate path of an SR Policy. The advertisement of Segment Routing policies in BGP is documented in the IETF draft <https://datatracker.ietf.org/doc/draft-ietf-idr-segment-routing-te-policy/>

SR policies with IPv4 and IPv6 end-points can be advertised over BGPv4 or BGPv6 sessions between the SR-TE controller and the SR-TE headend.

The Cisco IOS-XR implementation supports the following combinations:

- IPv4 SR policy advertised over BGPv4 session
- IPv6 SR policy advertised over BGPv4 session
- IPv6 SR policy advertised over BGPv6 session

Configure BGP SR Policy Address Family at SR-TE Head-End

Perform this task to configure BGP SR policy address family at SR-TE head-end:

SUMMARY STEPS

1. **configure**
2. **router bgp** *as-number*
3. **bgp router-id** *ip-address*
4. **address-family** {**ipv4** | **ipv6**} **sr-policy**
5. **exit**
6. **neighbor** *ip-address*
7. **remote-as** *as-number*
8. **address-family** {**ipv4** | **ipv6**} **sr-policy**
9. **route-policy** *route-policy-name* {**in** | **out**}

DETAILED STEPS

	Command or Action	Purpose
Step 1	configure	
Step 2	router bgp <i>as-number</i> Example: RP/0/RSP0/CPU0:router(config)# router bgp 65000	Specifies the BGP AS number and enters the BGP configuration mode, allowing you to configure the BGP routing process.
Step 3	bgp router-id <i>ip-address</i> Example: RP/0/RSP0/CPU0:router(config-bgp)# bgp router-id 10.1.1.1	Configures the local router with a specified router ID.
Step 4	address-family { ipv4 ipv6 } sr-policy Example: RP/0/RSP0/CPU0:router(config-bgp)# address-family ipv4 sr-policy	Specifies either the IPv4 or IPv6 address family and enters address family configuration submode.

	Command or Action	Purpose
Step 5	exit	
Step 6	neighbor <i>ip-address</i> Example: RP/0/RSP0/CPU0:router(config-bgp)# neighbor 10.10.0.1	Places the router in neighbor configuration mode for BGP routing and configures the neighbor IP address as a BGP peer.
Step 7	remote-as <i>as-number</i> Example: RP/0/RSP0/CPU0:router(config-bgp-nbr)# remote-as 1	Creates a neighbor and assigns a remote autonomous system number to it.
Step 8	address-family { <i>ipv4</i> <i>ipv6</i> } sr-policy Example: RP/0/RSP0/CPU0:router(config-bgp-nbr)# address-family ipv4 sr-policy	Specifies either the IPv4 or IPv6 address family and enters address family configuration submenu.
Step 9	route-policy <i>route-policy-name</i> { in out } Example: RP/0/RSP0/CPU0:router(config-bgp-nbr-af)# route-policy pass out	Applies the specified policy to IPv4 or IPv6 unicast routes.

Example: BGP SR-TE with BGPv4 Neighbor to BGP SR-TE Controller

The following configuration shows the an SR-TE head-end with a BGPv4 session towards a BGP SR-TE controller. This BGP session is used to signal both IPv4 and IPv6 SR policies.

```
router bgp 65000
  bgp router-id 10.1.1.1
  !
  address-family ipv4 sr-policy
  !
  address-family ipv6 sr-policy
  !
  neighbor 10.1.3.1
    remote-as 10
    description *** eBGP session to BGP SRTE controller ***
    address-family ipv4 sr-policy
      route-policy pass in
      route-policy pass out
    !
    address-family ipv6 sr-policy
      route-policy pass in
      route-policy pass out
    !
  !
  !
```

Example: BGP SR-TE with BGPv6 Neighbor to BGP SR-TE Controller

The following configuration shows an SR-TE head-end with a BGPv6 session towards a BGP SR-TE controller. This BGP session is used to signal IPv6 SR policies.

```
router bgp 65000
bgp router-id 10.1.1.1
 address-family ipv6 sr-policy
  !
 neighbor 3001::10:1:3:1
  remote-as 10
  description *** eBGP session to BGP SRTE controller ***
  address-family ipv6 sr-policy
   route-policy pass in
   route-policy pass out
  !
 !
 !
```

Traffic Steering

Automated Steering

Automated steering (AS) allows service traffic to be automatically steered onto the required transport SLA path programmed by an SR policy.

With AS, BGP automatically steers traffic onto an SR Policy based on the next-hop and color of a BGP service route. The color of a BGP service route is specified by a color extended community attribute. This color is used as a transport SLA indicator, such as min-delay or min-cost.

When the next-hop and color of a BGP service route matches the end-point and color of an SR Policy, BGP automatically installs the route resolving onto the BSID of the matching SR Policy. Recall that an SR Policy on a head-end is uniquely identified by an end-point and color.

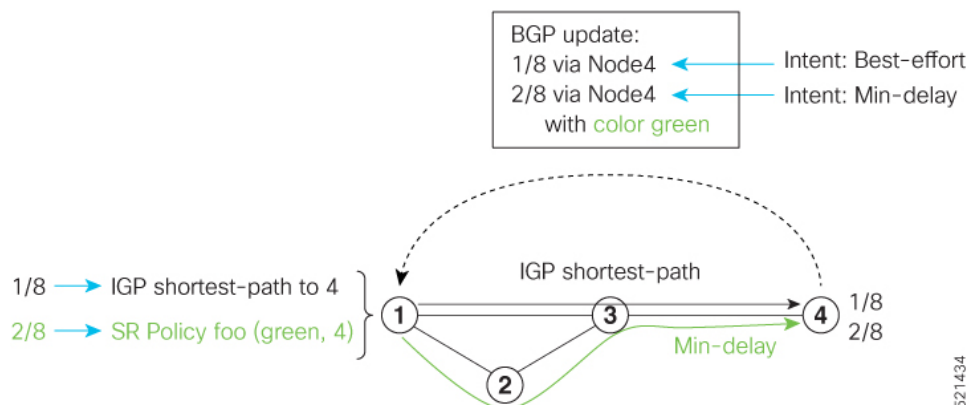

When a BGP route has multiple extended-color communities, each with a valid SR Policy, the BGP process installs the route on the SR Policy giving preference to the color with the highest numerical value.

The granularity of AS behaviors can be applied at multiple levels, for example:

- At a service level—When traffic destined to all prefixes in a given service is associated to the same transport path type. All prefixes share the same color.

- At a destination/prefix level—When traffic destined to a prefix in a given service is associated to a specific transport path type. Each prefix could be assigned a different color.
- At a flow level—When flows destined to the same prefix are associated with different transport path types

AS behaviors apply regardless of the instantiation method of the SR policy, including:

- On-demand SR policy
- Manually provisioned SR policy
- PCE-initiated SR policy

See the [Verifying BGP VRF Information, on page 86](#) and [Verifying Forwarding \(CEF\) Table, on page 87](#) sections for sample output that shows AS implementation.

Color-Only Automated Steering

Color-only steering is a traffic steering mechanism where a policy is created with given color, regardless of the endpoint.

You can create an SR-TE policy for a specific color that uses a NULL end-point (0.0.0.0 for IPv4 NULL, and ::0 for IPv6 NULL end-point). This means that you can have a single policy that can steer traffic that is based on that color and a NULL endpoint for routes with a particular color extended community, but different destinations (next-hop).



Note Every SR-TE policy with a NULL end-point must have an explicit path-option. The policy cannot have a dynamic path-option (where the path is computed by the head-end or PCE) since there is no destination for the policy.

You can also specify a color-only (CO) flag in the color extended community for overlay routes. The CO flag allows the selection of an SR-policy with a matching color, regardless of endpoint Sub-address Family Identifier (SAFI) (IPv4 or IPv6). See [Setting CO Flag, on page 132](#).

Configure Color-Only Steering

```
Router# configure
Router(config)# segment-routing
Router(config-sr)# traffic-eng
Router(config-sr-te)# policy P1
Router(config-sr-te-policy)# color 1 end-point ipv4 0.0.0.0
```

```
Router# configure
Router(config)# segment-routing
Router(config-sr)# traffic-eng
Router(config-sr-te)# policy P2
Router(config-sr-te-policy)# color 2 end-point ipv6 ::0
```

```
Router# show running-configuration
segment-routing
traffic-eng
```

```

policy P1
  color 1 end-point ipv4 0.0.0.0
!
policy P2
  color 2 end-point ipv6 ::
!
!
!
end

```

Setting CO Flag

The BGP-based steering mechanism matches BGP color and next-hop with that of an SR-TE policy. If the policy does not exist, BGP requests SR-PCE to create an SR-TE policy with the associated color, end-point, and explicit paths. For color-only steering (NULL end-point), you can configure a color-only (CO) flag as part of the color extended community in BGP.



Note See [Color-Only Automated Steering, on page 131](#) for information about color-only steering (NULL end-point).

The behavior of the steering mechanism is based on the following values of the CO flags:

co-flag 00	<ol style="list-style-type: none"> 1. The BGP next-hop and color <N, C> is matched with an SR-TE policy of same <N, C>. 2. If a policy does not exist, then IGP path for the next-hop N is chosen.
co-flag 01	<ol style="list-style-type: none"> 1. The BGP next-hop and color <N, C> is matched with an SR-TE policy of same <N, C>. 2. If a policy does not exist, then an SR-TE policy with NULL end-point with the same address-family as N and color C is chosen. 3. If a policy with NULL end-point with same address-family as N does not exist, then an SR-TE policy with any NULL end-point and color C is chosen. 4. If no match is found, then IGP path for the next-hop N is chosen.

Configuration Example

```

Router(config)# extcommunity-set opaque overlay-color
Router(config-ext)# 1 co-flag 01
Router(config-ext)# end-set
Router(config)#
Router(config)# route-policy color
Router(config-rpl)# if destination in (5.5.5.1/32) then
Router(config-rpl-if)# set extcommunity color overlay-color
Router(config-rpl-if)# endif
Router(config-rpl)# pass
Router(config-rpl)# end-policy
Router(config)#

```

Address-Family Agnostic Automated Steering

Address-family agnostic steering uses an SR-TE policy to steer both labeled and unlabeled IPv4 and IPv6 traffic. This feature requires support of IPv6 encapsulation (IPv6 caps) over IPv4 endpoint policy.

IPv6 caps for IPv4 NULL end-point is enabled automatically when the policy is created in Segment Routing Path Computation Element (SR-PCE). The binding SID (BSID) state notification for each policy contains an "ipv6_caps" flag that notifies SR-PCE clients (PCC) of the status of IPv6 caps (enabled or disabled).

An SR-TE policy with a given color and IPv4 NULL end-point could have more than one candidate path. If any of the candidate paths has IPv6 caps enabled, then all of the remaining candidate paths need IPv6 caps enabled. If IPv6 caps is not enabled on all candidate paths of same color and end-point, traffic drops can occur.

You can disable IPv6 caps for a particular color and IPv4 NULL end-point using the **ipv6 disable** command on the local policy. This command disables IPv6 caps on all candidate paths that share the same color and IPv4 NULL end-point.

Disable IPv6 Encapsulation

```
Router# configure
Router(config)# segment-routing
Router(config-sr)# traffic-eng
Router(config-sr-te)# policy P1
Router(config-sr-te-policy)# color 1 end-point ipv4 0.0.0.0
Router(config-sr-te-policy)# ipv6 disable
```

Using Binding Segments

The binding segment is a local segment identifying an SR-TE policy. Each SR-TE policy is associated with a binding segment ID (BSID). The BSID is a local label that is automatically allocated for each SR-TE policy when the SR-TE policy is instantiated.



Note In Cisco IOS XR 6.3.2 and later releases, you can specify an explicit BSID for an SR-TE policy. See the following **Explicit Binding SID** section.

BSID can be used to steer traffic into the SR-TE policy and across domain borders, creating seamless end-to-end inter-domain SR-TE policies. Each domain controls its local SR-TE policies; local SR-TE policies can be validated and rerouted if needed, independent from the remote domain's head-end. Using binding segments isolates the head-end from topology changes in the remote domain.

Packets received with a BSID as top label are steered into the SR-TE policy associated with the BSID. When the BSID label is popped, the SR-TE policy's SID list is pushed.

BSID can be used in the following cases:

- Multi-Domain (inter-domain, inter-autonomous system)—BSIDs can be used to steer traffic across domain borders, creating seamless end-to-end inter-domain SR-TE policies.
- Large-Scale within a single domain—The head-end can use hierarchical SR-TE policies by nesting the end-to-end (edge-to-edge) SR-TE policy within another layer of SR-TE policies (aggregation-to-aggregation). The SR-TE policies are nested within another layer of policies using the BSIDs, resulting in seamless end-to-end SR-TE policies.

- Label stack compression—If the label-stack size required for an SR-TE policy exceeds the platform capability, the SR-TE policy can be seamlessly stitched to, or nested within, other SR-TE policies using a binding segment.
- BGP SR-TE Dynamic—The head-end steers the packet into a BGP-based FIB entry whose next hop is a binding-SID.

Explicit Binding SID

Use the **binding-sid mpls label** command in SR-TE policy configuration mode to specify the explicit BSID. Explicit BSIDs are allocated from the segment routing local block (SRLB) or the dynamic range of labels. A best-effort is made to request and obtain the BSID for the SR-TE policy. If requested BSID is not available (if it does not fall within the available SRLB or is already used by another application or SR-TE policy), the policy stays down.

Use the **binding-sid explicit {fallback-dynamic | enforce-srlb}** command to specify how the BSID allocation behaves if the BSID value is not available.

- Fallback to dynamic allocation – If the BSID is not available, the BSID is allocated dynamically and the policy comes up:

```
Router# configure
Router(config)# segment-routing
Router(config-sr)# traffic-eng
Router(config-sr-te)# binding-sid explicit fallback-dynamic
```

- Strict SRLB enforcement – If the BSID is not within the SRLB, the policy stays down:

```
Router# configure
Router(config)# segment-routing
Router(config-sr)# traffic-eng
Router(config-sr-te)# binding-sid explicit enforce-srlb
```

This example shows how to configure an SR policy to use an explicit BSID of 1000. If the BSID is not available, the BSID is allocated dynamically and the policy comes up.

```
segment-routing
traffic-eng
binding-sid explicit fallback-dynamic
policy goo
binding-sid mpls 1000
!
!
!
```

Stitching SR-TE Polices Using Binding SID: Example

In this example, three SR-TE policies are stitched together to form a seamless end-to-end path from node 1 to node 10. The path is a chain of SR-TE policies stitched together using the binding-SIDs of intermediate policies, providing a seamless end-to-end path.

Figure 4: Stitching SR-TE Policies Using Binding SID

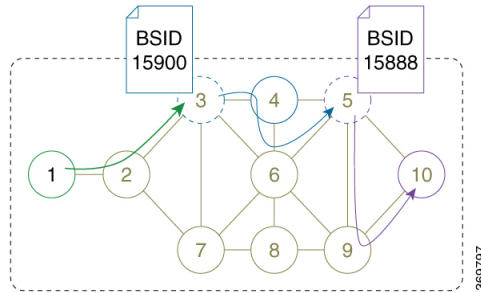

Table 5: Router IP Address

Router	Prefix Address	Prefix SID/Adj-SID
3	Loopback0 - 10.1.1.3	Prefix SID - 16003
4	Loopback0 - 10.1.1.4 Link node 4 to node 6 - 10.4.6.4	Prefix SID - 16004 Adjacency SID - dynamic
5	Loopback0 - 10.1.1.5	Prefix SID - 16005
6	Loopback0 - 10.1.1.6 Link node 4 to node 6 - 10.4.6.6	Prefix SID - 16006 Adjacency SID - dynamic
9	Loopback0 - 10.1.1.9	Prefix SID - 16009
10	Loopback0 - 10.1.1.10	Prefix SID - 16010

Step 1

On node 5, do the following:

- a) Define an SR-TE policy with an explicit path configured using the loopback interface IP addresses of node 9 and node 10.
- b) Define an explicit binding-SID (**mpls label 15888**) allocated from SRLB for the SR-TE policy.

Example:

Node 5

```
segment-routing
traffic-eng
segment-list PATH-9_10
index 10 address ipv4 10.1.1.9
index 20 address ipv4 10.1.1.10
!
policy foo
binding-sid mpls 15888
color 777 end-point ipv4 10.1.1.10
candidate-paths
preference 100
explicit segment-list PATH5-9_10
!
!
!
```

```

!
!
RP/0/RSP0/CPU0:Node-5# show segment-routing traffic-eng policy color 777

SR-TE policy database
-----

Color: 777, End-point: 10.1.1.10
Name: srte_c_777_ep_10.1.1.10
Status:
  Admin: up Operational: up for 00:00:52 (since Aug 19 07:40:12.662)
Candidate-paths:
  Preference: 100 (configuration) (active)
    Name: foo
    Requested BSID: 15888
    PCC info:
      Symbolic name: cfg_foo_discr_100
      PLSP-ID: 70
    Explicit: segment-list PATH-9_10 (valid)
      Weight: 1, Metric Type: TE
        16009 [Prefix-SID, 10.1.1.9]
        16010 [Prefix-SID, 10.1.1.10]
Attributes:
  Binding SID: 15888 (SRLB)
  Forward Class: 0
  Steering BGP disabled: no
  IPv6 caps enable: yes

```

Step 2 On node 3, do the following:

a) Define an SR-TE policy with an explicit path configured using the following:

- Loopback interface IP address of node 4
- Interface IP address of link between node 4 and node 6
- Loopback interface IP address of node 5
- Binding-SID of the SR-TE policy defined in Step 1 (**mpls label 15888**)

Note This last segment allows the stitching of these policies.

b) Define an explicit binding-SID (**mpls label 15900**) allocated from SRLB for the SR-TE policy.**Example:****Node 3**

```

segment-routing
traffic-eng
segment-list PATH-4_4-6_5_BSID
index 10 address ipv4 10.1.1.4
index 20 address ipv4 10.4.6.6
index 30 address ipv4 10.1.1.5
index 40 mpls label 15888
!
policy baa
binding-sid mpls 15900
color 777 end-point ipv4 10.1.1.5
candidate-paths
preference 100
explicit segment-list PATH-4_4-6_5_BSID
!

```

```

!
!
!
!
RP/0/RSP0/CPU0:Node-3# show segment-routing traffic-eng policy color 777

SR-TE policy database
-----

Color: 777, End-point: 10.1.1.5
Name: srte_c_777_ep_10.1.1.5
Status:
  Admin: up Operational: up for 00:00:32 (since Aug 19 07:40:32.662)
Candidate-paths:
  Preference: 100 (configuration) (active)
  Name: baa
  Requested BSID: 15900
  PCC info:
    Symbolic name: cfg_baa_discr_100
    PLSP-ID: 70
  Explicit: segment-list PATH-4_4-6_5_BSID (valid)
  Weight: 1, Metric Type: TE
    16004 [Prefix-SID, 10.1.1.4]
    80005 [Adjacency-SID, 10.4.6.4 - 10.4.6.6]
    16005 [Prefix-SID, 10.1.1.5]
    15888
Attributes:
  Binding SID: 15900 (SRLB)
  Forward Class: 0
  Steering BGP disabled: no
  IPv6 caps enable: yes

```

Step 3 On node 1, define an SR-TE policy with an explicit path configured using the loopback interface IP address of node 3 and the binding-SID of the SR-TE policy defined in step 2 (**mpls label 15900**). This last segment allows the stitching of these policies.

Example:

Node 1

```

segment-routing
traffic-eng
segment-list PATH-3_BSID
index 10 address ipv4 10.1.1.3
index 20 mpls label 15900
!
policy bar
color 777 end-point ipv4 10.1.1.3
candidate-paths
preference 100
explicit segment-list PATH-3_BSID
!
!
!
!
RP/0/RSP0/CPU0:Node-1# show segment-routing traffic-eng policy color 777

SR-TE policy database

```

```

-----
Color: 777, End-point: 10.1.1.3
Name: srte_c_777_ep_10.1.1.3
Status:
  Admin: up Operational: up for 00:00:12 (since Aug 19 07:40:52.662)
Candidate-paths:
  Preference: 100 (configuration) (active)
  Name: bar
  Requested BSID: dynamic
  PCC info:
    Symbolic name: cfg_bar_discr_100
    PLSP-ID: 70
  Explicit: segment-list PATH-3_BSID (valid)
  Weight: 1, Metric Type: TE
    16003 [Prefix-SID, 10.1.1.3]
    15900
Attributes:
  Binding SID: 80021
  Forward Class: 0
  Steering BGP disabled: no
  IPv6 caps enable: yes

```

L2VPN Preferred Path

EVPN VPWS Preferred Path over SR-TE Policy feature allows you to set the preferred path between the two end-points for EVPN VPWS pseudowire (PW) using SR-TE policy.

L2VPN VPLS or VPWS Preferred Path over SR-TE Policy feature allows you to set the preferred path between the two end-points for L2VPN Virtual Private LAN Service (VPLS) or Virtual Private Wire Service (VPWS) using SR-TE policy.

Refer to the [EVPN VPWS Preferred Path over SR-TE Policy](#) and [L2VPN VPLS or VPWS Preferred Path over SR-TE Policy](#) sections in the "L2VPN Services over Segment Routing for Traffic Engineering Policy" chapter of the *L2VPN and Ethernet Services Configuration Guide*.

Static Route over Segment Routing Policy

This feature allows you to specify a Segment Routing (SR) policy as an interface type when configuring static routes for MPLS data planes.

For information on configuring static routes, see the "Implementing Static Routes" chapter in the *Routing Configuration Guide for Cisco ASR 9000 Series Routers*.

Configuration Example

The following example depicts a configuration of a static route for an IPv4 destination over an SR policy according to following parameters:

- Target SR policy:
 - Color = 200
 - End-point = 10.1.1.4
 - Auto-generated SR policy name = srte_c_200_ep_10.1.1.4



Note Use the auto-generated SR-TE policy name to attach the SR policy to the static route. Auto-generated SR policy names use the following naming convention: **srte_c_color_val_ep_endpoint-address**.

Use the `show segment-routing traffic-eng policy color <color_val> endpoint ipv4 <ip_addr>` command to display the auto-generated policy name.

- Admin distance = 40
- Load metric = 150
- Install the route in RIB regardless of reachability

```
Router(config)# router static
Router(config-static)# address-family ipv4 unicast
Router(config-static-afi)# 10.1.1.4/32 sr-policy srte_c_200_ep_10.1.1.4 40 permanent metric
150
```

Running Configuration

```
router static
 address-family ipv4 unicast
  10.1.1.4/32 sr-policy srte_c_200_ep_10.1.1.4 40 permanent metric 150
!
```

Verification

```
RP/0/RP0/CPU0:RTR-1# show run segment-routing traffic-eng policy sample-policy-foo
Tue Feb 16 17:40:16.759 PST
segment-routing
 traffic-eng
  policy sample-policy-foo
   color 200 end-point ipv4 10.1.1.4
   candidate-paths
    preference 100
    dynamic
     metric
      type te
    !
  !
!
!
!
!
!

RP/0/RP0/CPU0:RTR-1# show segment-routing traffic-eng policy color 200 endpoint ipv4 10.1.1.4
Tue Feb 16 17:17:45.724 PST

SR-TE policy database
-----

Color: 200, End-point: 10.1.1.4
Name: srte_c_200_ep_10.1.1.4
```

```

Status:
  Admin: up Operational: up for 5d04h (since Feb 11 12:22:59.054)
Candidate-paths:
  Preference: 100 (configuration) (active)
  Name: sample-policy-foo
  Requested BSID: dynamic
  Protection Type: protected-preferred
  Maximum SID Depth: 10
  Dynamic (valid)
  Metric Type: TE, Path Accumulated Metric: 14
    16005 [Prefix-SID, 10.1.1.5]
    16004 [Prefix-SID, 10.1.1.4]
Attributes:
  Binding SID: 24014
  Forward Class: Not Configured
  Steering labeled-services disabled: no
  Steering BGP disabled: no
  IPv6 caps enable: yes
  Invalidation drop enabled: no

RP/0/RP0/CPU0:RTR-1# show static sr-policy srte_c_200_ep_10.1.1.4
Tue Feb 16 17:50:19.932 PST

Interface          VRF          State      Paths
srte_c_200_ep_10.1.1.4  default      Up         10.1.1.4/32
Reference Count(in path with both intf<-->NH):0
Last IM notification was Up at Feb 16 17:09:08.325

Global ifh          : 0x0000007c
IM state             : up
RSI registration    : Yes
Table IDs           : 0xe0000000

Address Info:
10.1.1.1/32
Route tag: 0x00000000 Flags: 0x00000000 Prefix SID: False [Active]

IP-STATIC-IDB-CLASS
Total entries : 1
Interface      : sr-srte_c_200_ep_10.1.1.4
| Event Name   | Time Stamp           | S, M
| idb-create   | Feb 16 17:09:08.352 | 0, 0

RP/0/RP0/CPU0:RTR-1# show route 10.1.1.4/32
Tue Feb 16 17:09:21.164 PST

Routing entry for 10.1.1.4/32
  Known via "static", distance 40, metric 0 (connected)
  Installed Feb 16 17:09:08.325 for 00:00:13
  Routing Descriptor Blocks
    directly connected, via srte_c_200_ep_10.1.1.4, permanent
    Route metric is 0, Wt is 150
  No advertising protos.

RP/0/RP0/CPU0:RTR-1# show route 10.1.1.4/32 detail
Tue Feb 16 17:09:36.718 PST

Routing entry for 10.1.1.4/32
  Known via "static", distance 40, metric 0 (connected)
  Installed Feb 16 17:09:08.325 for 00:00:28
  Routing Descriptor Blocks
    directly connected, via srte_c_200_ep_10.1.1.4, permanent
    Route metric is 0, Wt is 150

```

```

Label: None
Tunnel ID: None
Binding Label: None
Extended communities count: 0
NHID:0x0(Ref:0)
Route version is 0x4a (74)
Local Label: 0x3e84 (16004)
IP Precedence: Not Set
QoS Group ID: Not Set
Flow-tag: Not Set
Fwd-class: Not Set
Route Priority: RIB_PRIORITY_RECURSIVE (9) SVD Type RIB_SVD_TYPE_LOCAL
Download Priority 3, Download Version 258
No advertising protos.

```

```

RP/0/RP0/CPU0:RTR-1# show cef 10.1.1.4/32 detail
Tue Feb 16 17:10:06.956 PST
10.1.1.4/32, version 258, attached, internal 0x1000441 0x30 (ptr 0xd3f0d30) [1], 0x0
(0xe46f960), 0xa20 (0xe9694e0)
Updated Feb 16 17:09:08.328
Prefix Len 32, traffic index 0, precedence n/a, priority 3
gateway array (0xe2d9a08) reference count 2, flags 0x8068, source rib (7), 0 backups
[3 type 4 flags 0x108401 (0xe9aeb98) ext 0x0 (0x0)]
LW-LDI[type=1, refc=1, ptr=0xe46f960, sh-ldi=0xe9aeb98]
gateway array update type-time 1 Feb 16 17:07:59.946
LDI Update time Feb 16 17:07:59.946
LW-LDI-TS Feb 16 17:07:59.946
via srte_c_200_ep_10.1.1.4, 5 dependencies, weight 0, class 0 [flags 0xc]
path-idx 0 NHID 0x0 [0xf3b1a30 0x0]
local adjacency
local label 16004 labels imposed {None}

Load distribution: 0 (refcount 3)

Hash OK Interface Address
0 Y srte_c_200_ep_10.1.1.4 point2point

```

```

RP/0/RP0/CPU0:RTR-1# show mpls forwarding labels 16004 detail
Tue Feb 16 17:27:59.831 PST
Local Outgoing Prefix Outgoing Next Hop Bytes
Label Label or ID Interface Interface Switched
-----
16004 Unlabelled SR Pfx (idx 4) srte_c_200_e point2point 990
Updated: Feb 16 17:07:59.945
Path Flags: 0xc [ ]
Version: 258, Priority: 3
Label Stack (Top -> Bottom): { Unlabelled Unlabelled }
NHID: 0x0, Encap-ID: N/A, Path idx: 0, Backup path idx: 0, Weight: 0
MAC/Encaps: 0/0, MTU: 0
Outgoing Interface: srte_c_200_ep_10.1.1.4 (ifhandle 0x0000007c)
Packets Switched: 20

```

Autoroute Include

You can configure SR-TE policies with Autoroute Include to steer specific IGP (IS-IS, OSPF) prefixes, or all prefixes, over non-shortest paths and to divert the traffic for those prefixes on to the SR-TE policy.

The **autoroute include all** option applies Autoroute Announce functionality for all destinations or prefixes.

The **autoroute include ipv4 address** option applies Autoroute Destination functionality for the specified destinations or prefixes. This option is supported for IS-IS only; it is not supported for OSPF.

The Autoroute SR-TE policy adds the prefixes into the IGP, which determines if the prefixes on the endpoint or downstream of the endpoint are eligible to use the SR-TE policy. If a prefix is eligible, then the IGP checks if the prefix is listed in the Autoroute Include configuration. If the prefix is included, then the IGP downloads the prefix route with the SR-TE policy as the outgoing path.

Usage Guidelines and Limitations

- Autoroute Include supports three metric types:
 - Default (no metric): The path over the SR-TE policy inherits the shortest path metric.
 - Absolute (constant) metric: The shortest path metric to the policy endpoint is replaced with the configured absolute metric. The metric to any prefix that is Autoroute Included is modified to the absolute metric. Use the **autoroute metric constant** *constant-metric* command, where *constant-metric* is from 1 to 2147483647.
 - Relative metric: The shortest path metric to the policy endpoint is modified with the relative value configured (plus or minus). Use the **autoroute metric relative** *relative-metric* command, where *relative-metric* is from -10 to +10.



Note To prevent load-balancing over IGP paths, you can specify a metric that is lower than the value that IGP takes into account for autorouted destinations (for example, **autoroute metric relative -1**).

Configuration Examples

The following example shows how to configure autoroute include for all prefixes:

```
Router# configure
Router(config)# segment-routing
Router(config-sr)# traffic-eng
Router(config-sr-te)#policy P1
Router(config-sr-te-policy)# color 20 end-point ipv4 10.1.1.2
Router(config-sr-te-policy)# autoroute include all
Router(config-sr-te-policy)# candidate-paths
Router(config-sr-te-policy-path)# preference 100
Router(config-sr-te-pp-index)# explicit segment-list Plist-1
```

The following example shows how to configure autoroute include for the specified IPv4 prefixes:



Note This option is supported for IS-IS only; it is not supported for OSPF.

```
Router# configure
Router(config)# segment-routing
Router(config-sr)# traffic-eng
Router(config-sr-te)#policy P1
Router(config-sr-te-policy)# color 20 end-point ipv4 10.1.1.2
Router(config-sr-te-policy)# autoroute include ipv4 10.1.1.21/32
Router(config-sr-te-policy)# autoroute include ipv4 10.1.1.23/32
```



```
Router(config-sr-te-policy)# autoroute metric constant 1
Router(config-sr-te-policy)# candidate-paths
Router(config-sr-te-policy-path)# preference 100
Router(config-sr-te-pp-index)# explicit segment-list Plist-1
```

Policy-Based Tunnel Selection for SR-TE Policy

Policy-Based Tunnel Selection (PBTS) is a mechanism that lets you direct traffic into specific SR-TE policies based on different classification criteria. PBTS benefits Internet service providers (ISPs) that carry voice and data traffic through their networks, who want to route this traffic to provide optimized voice service.

PBTS works by selecting SR-TE policies based on the classification criteria of the incoming packets, which are based on the IP precedence, experimental (EXP), differentiated services code point (DSCP), or type of service (ToS) field in the packet. Default-class configured for paths is always zero (0). If there is no TE for a given forward-class, then the default-class (0) will be tried. If there is no default-class, then the packet is dropped. PBTS supports up to seven (exp 1 - 7) EXP values associated with a single SR-TE policy.

For more information about PBTS, refer to the "Policy-Based Tunnel Selection" section in the *MPLS Configuration Guide for Cisco ASR 9000 Series Routers*.

Configure Policy-Based Tunnel Selection for SR-TE Policies

The following section lists the steps to configure PBTS for an SR-TE policy.



Note Steps 1 through 4 are detailed in the "Implementing MPLS Traffic Engineering" chapter of the *MPLS Configuration Guide for Cisco ASR 9000 Series Routers*.

1. Define a class-map based on a classification criteria.
2. Define a policy-map by creating rules for the classified traffic.
3. Associate a forward-class to each type of ingress traffic.
4. Enable PBTS on the ingress interface, by applying this service-policy.
5. Create one or more egress SR-TE policies (to carry packets based on priority) to the destination and associate the egress SR-TE policy to a forward-class.

Configuration Example

```
Router(config)# segment-routing traffic-eng
Router(config-sr-te)# policy POLICY-PBTS
Router(config-sr-te-policy)# color 1001 end-point ipv4 10.1.1.20
Router(config-sr-te-policy)# autoroute
Router(config-sr-te-policy-autoroute)# include all
Router(config-sr-te-policy-autoroute)# forward-class 1
Router(config-sr-te-policy-autoroute)# exit
Router(config-sr-te-policy)# candidate-paths
Router(config-sr-te-policy-path)# preference 1
Router(config-sr-te-policy-path-pref)# explicit segment-list SIDLIST1
Router(config-sr-te-policy-path-pref)# exit
Router(config-sr-te-pp-info)# exit
Router(config-sr-te-policy-path-pref)# exit
Router(config-sr-te-policy-path)# preference 2
```

```

Router(config-sr-te-policy-path-pref)# dynamic
Router(config-sr-te-pp-info)# metric
Router(config-sr-te-path-metric)# type te
Router(config-sr-te-path-metric)# commit

```

Running Configuration

```

segment-routing
traffic-eng
policy POLICY-PBTS
color 1001 end-point ipv4 10.1.1.20
autoroute
include all
forward-class 1
!
candidate-paths
preference 1
explicit segment-list SIDLIST1
!
!
preference 2
dynamic
metric
type te

```

Miscellaneous

LDP over Segment Routing Policy

The LDP over Segment Routing Policy feature enables an LDP-targeted adjacency over a Segment Routing (SR) policy between two routers. This feature extends the existing MPLS LDP address family neighbor configuration to specify an SR policy as the targeted end-point.

LDP over SR policy is supported for locally configured SR policies with IPv4 end-points.

For more information about MPLS LDP, see the "Implementing MPLS Label Distribution Protocol" chapter in the *MPLS Configuration Guide*.

For more information about Autoroute, see the *Autoroute Announce for SR-TE* section.



Note Before you configure an LDP targeted adjacency over SR policy name, you need to create the SR policy under Segment Routing configuration. The SR policy interface names are created internally based on the color and endpoint of the policy. LDP is non-operational if SR policy name is unknown.

The following functionality applies:

1. Configure the SR policy – LDP receives the associated end-point address from the interface manager (IM) and stores it in the LDP interface database (IDB) for the configured SR policy.
2. Configure the SR policy name under LDP – LDP retrieves the stored end-point address from the IDB and uses it. Use the auto-generated SR policy name assigned by the router when creating an LDP targeted

adjacency over an SR policy. Auto-generated SR policy names use the following naming convention: `srte_c_color_val_ep_endpoint-address`. For example, `srte_c_1000_ep_10.1.1.2`

Configuration Example

```
/* Enter the SR-TE configuration mode and create the SR policy. This example corresponds
to a local SR policy with an explicit path. */
Router(config)# segment-routing
Router(config-sr)# traffic-eng
Router(config-sr-te)# segment-list sample-sid-list
Router(config-sr-te-sl)# index 10 address ipv4 10.1.1.7
Router(config-sr-te-sl)# index 20 address ipv4 10.1.1.2
Router(config-sr-te-sl)# exit
Router(config-sr-te)# policy sample_policy
Router(config-sr-te-policy)# color 1000 end-point ipv4 10.1.1.2
Router(config-sr-te-policy)# candidate-paths
Router(config-sr-te-policy-path)# preference 100
Router(config-sr-te-policy-path-pref)# explicit segment-list sample-sid-list
Router(config-sr-te-pp-info)# end

/* Configure LDP over an SR policy */
Router(config)# mpls ldp
Router(config-ldp)# address-family ipv4
Router(config-ldp-af)# neighbor sr-policy srte_c_1000_ep_10.1.1.2 targeted
Router(config-ldp-af)#
```



Note Do one of the following to configure LDP discovery for targeted hellos:

- Active targeted hellos (SR policy head end):

```
mpls ldp
  interface GigabitEthernet0/0/0/0
  !
  !
```

- Passive targeted hellos (SR policy end-point):

```
mpls ldp
  address-family ipv4
    discovery targeted-hello accept
  !
  !
```

Running Configuration

```
segment-routing
  traffic-eng
    segment-list sample-sid-list
      index 10 address ipv4 10.1.1.7
      index 20 address ipv4 10.1.1.2
    !
  policy sample_policy
    color 1000 end-point ipv4 10.1.1.2
    candidate-paths
      preference 100
      explicit segment-list sample-sid-list
    !
```

```

!
!
!
!
!
mpls ldp
address-family ipv4
neighbor sr-policy srte_c_1000_ep_10.1.1.2 targeted
  discovery targeted-hello accept
!
!

```

Verification

```

Router# show mpls ldp interface brief

```

Interface	VRF Name	Config	Enabled	IGP-Auto-Cfg	TE-Mesh-Grp	cfg
Te0/3/0/0/3	default	Y	Y	0	N/A	
Te0/3/0/0/6	default	Y	Y	0	N/A	
Te0/3/0/0/7	default	Y	Y	0	N/A	
Te0/3/0/0/8	default	N	N	0	N/A	
Te0/3/0/0/9	default	N	N	0	N/A	
srte_c_1000_	default	Y	Y	0	N/A	

```

Router# show mpls ldp interface
Interface TenGigE0/3/0/0/3 (0xa000340)
  VRF: 'default' (0x60000000)
  Enabled via config: LDP interface
Interface TenGigE0/3/0/0/6 (0xa000400)
  VRF: 'default' (0x60000000)
  Enabled via config: LDP interface
Interface TenGigE0/3/0/0/7 (0xa000440)
  VRF: 'default' (0x60000000)
  Enabled via config: LDP interface
Interface TenGigE0/3/0/0/8 (0xa000480)
  VRF: 'default' (0x60000000)
  Disabled:
Interface TenGigE0/3/0/0/9 (0xa0004c0)
  VRF: 'default' (0x60000000)
  Disabled:
Interface srte_c_1000_ep_10.1.1.2 (0x520)
  VRF: 'default' (0x60000000)
  Enabled via config: LDP interface

```

```

Router# show segment-routing traffic-eng policy color 1000

```

```

SR-TE policy database
-----

```

```

Color: 1000, End-point: 10.1.1.2
Name: srte_c_1000_ep_10.1.1.2
Status:
  Admin: up Operational: up for 00:02:00 (since Jul  2 22:39:06.663)
Candidate-paths:
  Preference: 100 (configuration) (active)
  Name: sample_policy
  Requested BSID: dynamic
  PCC info:
    Symbolic name: cfg_sample_policy_discr_100
    PLSP-ID: 17
  Explicit: segment-list sample-sid-list (valid)

```

```

Weight: 1, Metric Type: TE
  16007 [Prefix-SID, 10.1.1.7]
  16002 [Prefix-SID, 10.1.1.2]

```

```

Attributes:
  Binding SID: 80011
  Forward Class: 0
  Steering BGP disabled: no
  IPv6 caps enable: yes

```

```
Router# show mpls ldp neighbor 10.1.1.2 detail
```

```

Peer LDP Identifier: 10.1.1.2:0
TCP connection: 10.1.1.2:646 - 10.1.1.6:57473
Graceful Restart: No
Session Holdtime: 180 sec
State: Oper; Msgs sent/rcvd: 421/423; Downstream-Unsolicited
Up time: 05:22:02
LDP Discovery Sources:
  IPv4: (1)
    Targeted Hello (10.1.1.6 -> 10.1.1.2, active/passive)
  IPv6: (0)
Addresses bound to this peer:
  IPv4: (9)
    10.1.1.2      2.2.2.99      10.1.2.2      10.2.3.2
    10.2.4.2      10.2.22.2     10.2.222.2   10.30.110.132
    11.2.9.2
  IPv6: (0)
Peer holdtime: 180 sec; KA interval: 60 sec; Peer state: Estab
NSR: Disabled
Clients: LDP over SR Policy
Capabilities:
  Sent:
    0x508 (MP: Point-to-Multipoint (P2MP))
    0x509 (MP: Multipoint-to-Multipoint (MP2MP))
    0x50a (MP: Make-Before-Break (MBB))
    0x50b (Typed Wildcard FEC)
  Received:
    0x508 (MP: Point-to-Multipoint (P2MP))
    0x509 (MP: Multipoint-to-Multipoint (MP2MP))
    0x50a (MP: Make-Before-Break (MBB))
    0x50b (Typed Wildcard FEC)

```

SR-TE Reoptimization Timers

SR-TE path re-optimization occurs when the head-end determines that there is a more optimal path available than the one currently used. For example, in case of a failure along the SR-TE LSP path, the head-end could detect and revert to a more optimal path by triggering re-optimization.

Re-optimization can occur due to the following events:

- The explicit path hops used by the primary SR-TE LSP explicit path are modified
- The head-end determines the currently used path-option are invalid due to either a topology path disconnect, or a missing SID in the SID database that is specified in the explicit-path
- A more favorable path-option (lower index) becomes available

For event-based re-optimization, you can specify various delay timers for path re-optimization. For example, you can specify how long to wait before switching to a reoptimized path

Additionally, you can configure a timer to specify how often to perform reoptimization of policies. You can also trigger an immediate reoptimization for a specific policy or for all policies.

SR-TE Reoptimization

To trigger an immediate SR-TE reoptimization, use the **segment-routing traffic-eng reoptimization** command in Exec mode:

```
Router# segment-routing traffic-eng reoptimization {all | name policy}
```

Use the **all** option to trigger an immediate reoptimization for all policies. Use the **name policy** option to trigger an immediate reoptimization for a specific policy.

Configuring SR-TE Reoptimization Timers

Use these commands in SR-TE configuration mode to configure SR-TE reoptimization timers:

- **timers candidate-path cleanup-delay seconds**—Specifies the delay before cleaning up candidate paths, in seconds. The range is from 0 (immediate clean-up) to 86400; the default value is 120
- **timers cleanup-delay seconds**—Specifies the delay before cleaning up previous path, in seconds. The range is from 0 (immediate clean-up) to 300; the default value is 10.
- **timers init-verify-restart seconds**—Specifies the delay for topology convergence after the topology starts populating due to a restart, in seconds. The range is from 10 to 10000; the default is 40.
- **timers init-verify-startup seconds**—Specifies the delay for topology convergence after topology starts populating for due to startup, in seconds. The range is from 10 to 10000; the default is 300
- **timers init-verify-switchover seconds**—Specifies the delay for topology convergence after topology starts populating due to a switchover, in seconds. The range is from 10 to 10000; the default is 60.
- **timers install-delay seconds**—Specifies the delay before switching to a reoptimized path, in seconds. The range is from 0 (immediate installation of new path) to 300; the default is 10.
- **timers periodic-reoptimization seconds**—Specifies how often to perform periodic reoptimization of policies, in seconds. The range is from 0 to 86400; the default is 600.

Example Configuration

```
Router(config)# segment-routing traffic-eng
Router(config-sr-te)# timers
Router(config-sr-te-timers)# candidate-path cleanup-delay 600
Router(config-sr-te-timers)# cleanup-delay 60
Router(config-sr-te-timers)# init-verify-restart 120
Router(config-sr-te-timers)# init-verify-startup 600
Router(config-sr-te-timers)# init-verify-switchover 30
Router(config-sr-te-timers)# install-delay 60
Router(config-sr-te-timers)# periodic-reoptimization 3000
```

Running Config

```
segment-routing
 traffic-eng
  timers
   install-delay 60
   periodic-reoptimization 3000
   cleanup-delay 60
```

```
candidate-path cleanup-delay 600
init-verify-restart 120
init-verify-startup 600
init-verify-switchover 30
!
!
!
```



CHAPTER 8

Segment Routing Tree Segment Identifier

Tree Segment Identifier (Tree-SID) is a tree-building solution that uses a Segment Routing Path Computation Element (SR-PCE) using path computation element protocol (PCEP) to calculate the point-to-multipoint (P2MP) tree using SR policies. Tree-SID uses a single MPLS label for building a multicast replication tree in an SR network. Tree-SID does not require multicast control protocols such as RSVP, mLDP, and PIM.

A P2MP SR policy provides an SR-based TE solution for transporting multicast traffic. It works on existing data-plane (MPLS and IP) and supports TE capabilities and single/multi routing domains. At each node of the tree, the forwarding state is represented by the same segment (using a global Tree-SID specified from the SRLB range of labels). P2MP SR policy prevents transient loop and packet loss when updating the path of a P2MP SR policy.

A P2MP SR policy request contains the following:

- Policy name
- SID for the P2MP Tree (Tree-SID)
- Address of the root node
- Addresses of the leaf nodes
- Optimization objectives (TE, IGP metric)
- Constraints (affinity)

Tree SID Workflow Overview

This sections shows a basic workflow using a Tree SID policy:

1. User creates a Tree-SID policy.

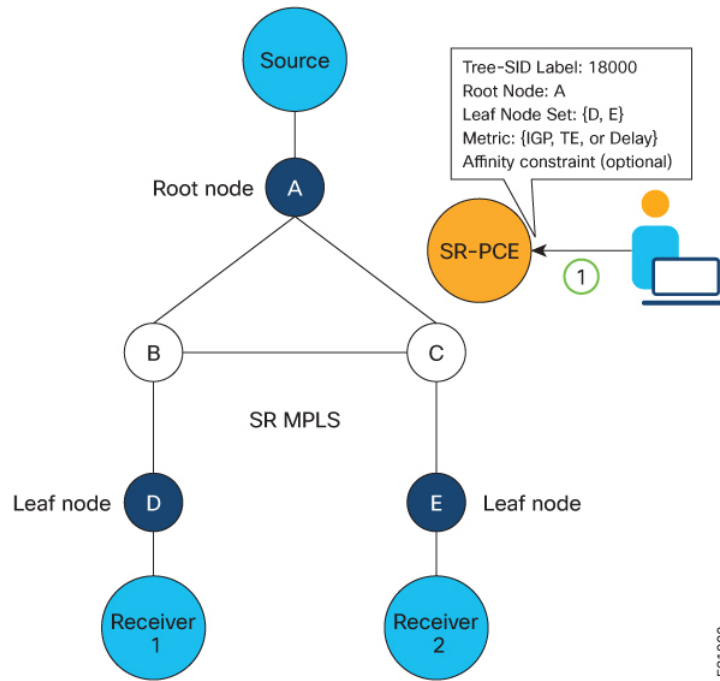

2. SR-PCE computes the P2MP Tree.

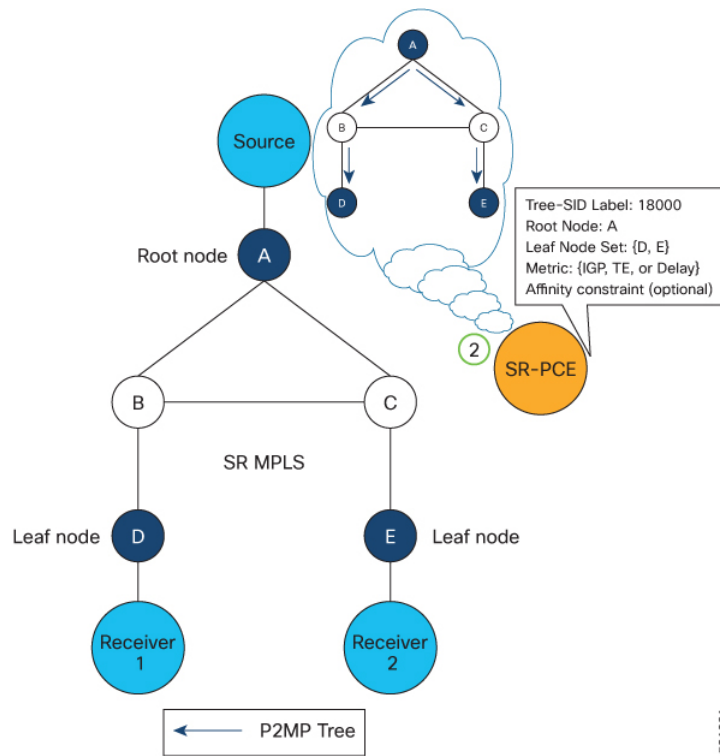

- SR-PCE instantiates the Tree-SID state at each node in the tree.

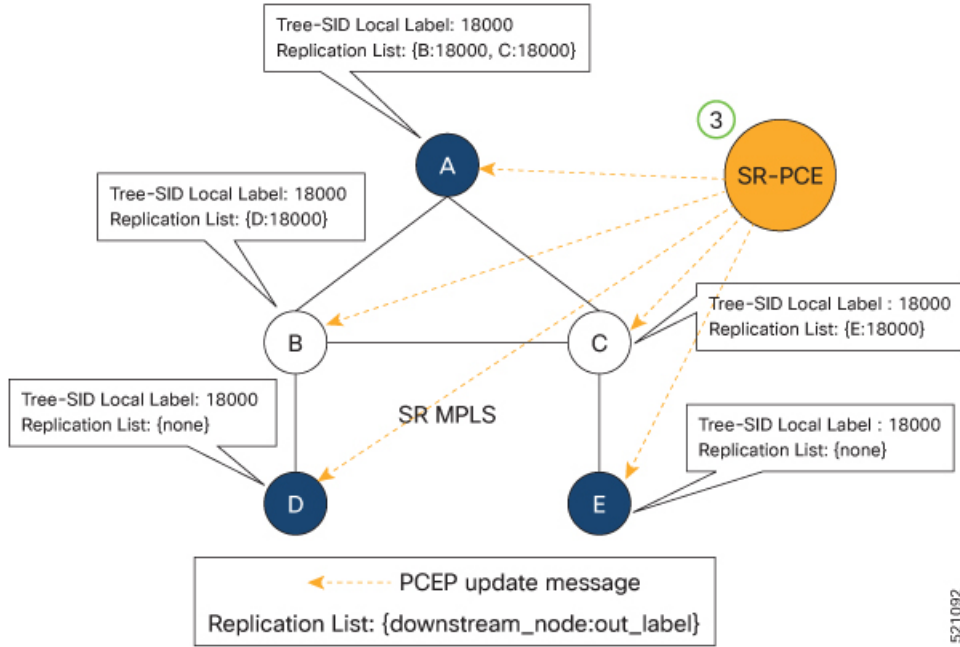

521092

- The Root node encapsulates the multicast traffic, replicates it, and forwards it to the Transit nodes.
- The Transit nodes replicate the multicast traffic and forward it to the Leaf nodes.
- The Leaf nodes decapsulate the multicast traffic and forward it to the multicast receivers.

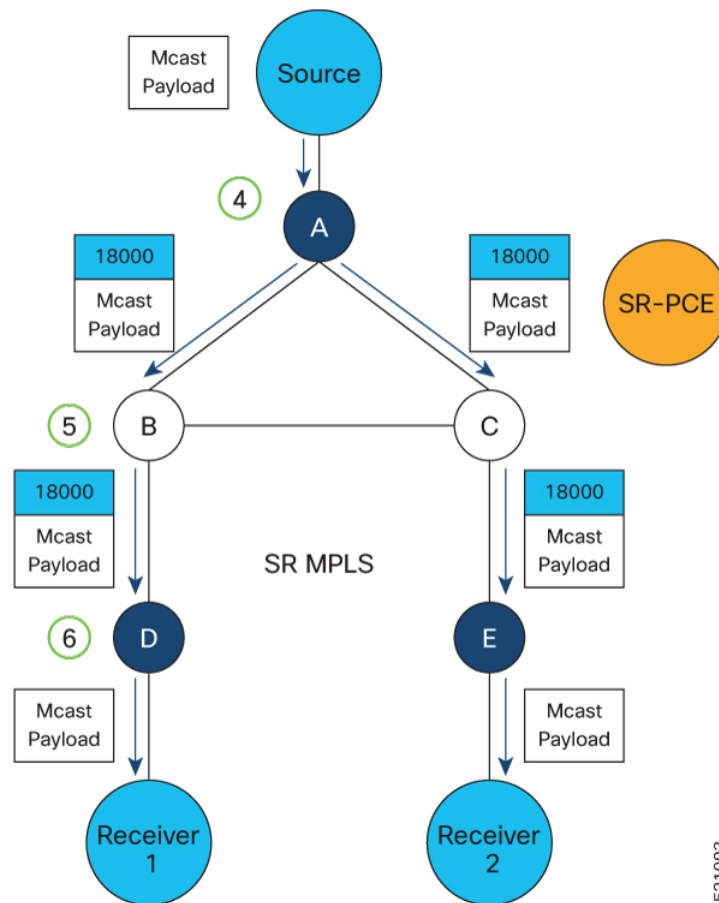

521093

- [Behaviors and Limitations](#), on page 154
- [Configure Segment Routing Tree-SID](#), on page 154
- [Running Config](#), on page 156

Behaviors and Limitations

PCE redundancy is not supported for Tree-SID. Tree-SID can only be controlled by a single PCE. Configure only one PCE on each PCC in the Tree-SID path.

Configure Segment Routing Tree-SID

To configure Segment Routing Tree-SID for Point-to-Multipoint (P2MP) SR policies, complete the following configurations:

1. Configure Path Computation Element Protocol (PCEP) Path Computation Client (PCC) on all nodes involved in the Tree-SID path (root, mid-point, leaf)
2. Configure Affinity Maps on the SR-PCE
3. Configure P2MP SR Policy on SR-PCE

4. Configure Multicast on the Root and Leaf Nodes

Configure PCEP PCC on All Nodes in Tree-SID Path

Configure all nodes involved in the Tree-SID path (root, mid-point, leaf) as PCEP PCC. For detailed PCEP PCC configuration information, see [Configure the Head-End Router as PCEP PCC, on page 124](#).

Configure Affinity Maps on the SR-PCE

Use the **affinity bit-map** *COLOR bit-position* command in PCE SR-TE sub-mode to define affinity maps. The bit-position range is from 0 to 255.

```
Router# configure
Router(config)# pce
Router(config-pce)# segment-routing traffic-eng
Router(config-pce-sr-te)# affinity bit-map RED 23
Router(config-pce-sr-te)# affinity bit-map BLUE 24
Router(config-pce-sr-te)# affinity bit-map CROSS 25
Router(config-pce-sr-te)#
```

Configure P2MP SR Policy on SR-PCE

Configure the end-point name and addresses, Tree-SID label, and constraints for the P2MP policy.

Use the **endpoint-set** *NAME* command in SR-PCE P2MP sub-mode to enter the name of the end-point set and to define the set of end-point addresses.

```
Router(config-pce-sr-te)# p2mp
Router(config-pce-sr-te-p2mp)# endpoint-set BAR
Router(config-pce-p2mp-ep-set)# ipv4 10.1.1.2
Router(config-pce-p2mp-ep-set)# ipv4 10.1.1.3
Router(config-pce-p2mp-ep-set)# ipv4 10.1.1.4
Router(config-pce-p2mp-ep-set)# exit
Router(config-pce-sr-te-p2mp)#
```

Use the **policy** *policy* command to configure the P2MP policy name and enter P2MP Policy sub-mode. Configure the source address, endpoint-set color, Tree-SID label, affinity constraints, and metric type.

```
Router(config-pce-sr-te-p2mp)# policy FOO
Router(config-pce-p2mp-policy)# source ipv4 10.1.1.6
Router(config-pce-p2mp-policy)# color 10 endpoint-set BAR
Router(config-pce-p2mp-policy)# tresid mpls 15200
Router(config-pce-p2mp-policy)# candidate-paths
Router(config-pce-p2mp-policy-path)# constraints
Router(config-pce-p2mp-policy-path-const)# affinity
Router(config-pce-p2mp-policy-path-const-affinity)# exclude BLUE
Router(config-pce-p2mp-policy-path-const-affinity)# exit
Router(config-pce-p2mp-policy-path-const)# exit
Router(config-pce-p2mp-policy-path-const-preference)# preference 100
Router(config-pce-p2mp-policy-path-const-preference)# dynamic
Router(config-pce-p2mp-policy-path-const-preference-info)# metric type te
Router(config-pce-p2mp-policy-path-const-preference-info)# root
Router(config-pce-p2mp-policy-path-const-preference-info)# root
Router(config)#
```

Configure Multicast on the Root and Leaf Nodes

On the root node of the SR P2MP segment, use the **router pim** command to enter Protocol Independent Multicast (PIM) configuration mode to statically steer multicast flows into an SR P2MP policy.



Note Enter this configuration only on an SR P2MP segment. Multicast traffic cannot be steered into a P2P policy.

```
Router(config)# router pim
Router(config-pim)# vrf name
Router(config-pim-name)# address-family ipv4
Router(config-pim-name-ipv4)# sr-p2mp-policy FOO
Router(config-pim-name-ipv4-srp2mp)# static-group 235.1.1.5 10.1.1.6
Router(config-pim-name-ipv4-srp2mp)# root
Router(config)#
```

On the root and leaf nodes of the SR P2MP tree, use the **mdt static segment-routing** command to configure the multicast distribution tree (MDT) core as Tree-SID from the multicast VRF configuration submode.

```
Router(config)# multicast-routing
Router(config-mcast)# vrf TEST
Router(config-mcast-TEST)# address-family ipv4
Router(config-mcast-TEST-ipv4)# mdt static segment-routing
```

On the leaf nodes of an SR P2MP segment, use the **static sr-policy p2mp-policy** command to configure the static SR P2MP Policy from the multicast VRF configuration submode to statically decapsulate multicast flows.

```
Router(config)# multicast-routing
Router(config-mcast)# vrf TEST
Router(config-mcast-TEST)# address-family ipv4
Router(config-mcast-TEST-ipv4)# static sr-policy FOO
```

Running Config

The following example shows how to configure the end point addresses and P2MP SR policy with affinity constraints on SR-PCE.

```
pce
segment-routing
traffic-eng
affinity bit-map
RED 23
BLUE 24
CROSS 25
!
p2mp
endpoint-set BAR
ipv4 10.1.1.2
ipv4 10.1.1.3
ipv4 10.1.1.4
!
policy FOO
source ipv4 10.1.1.6
color 10 endpoint-set BAR
treesid mpls 15200
candidate-paths
preference 100
dynamic
metric
```

```

        type te
        !
        !
        !
        constraints
        affinity
        exclude
        BLUE
        !
        !
        !
        !
        !
        !
        !
        !
        !

```

The following example shows how to statically decapsulate multicast flows on the leaf nodes.

```

multicast-routing
vrf TEST
  address-family ipv4
    static sr-policy FOO
  !
  !
  !

```

The following example shows to configure the multicast distribution tree (MDT) core as Tree-SID on the root and leaf nodes.

```

multicast-routing
vrf TEST
  address-family ipv4
    mdt static segment-routing
  !
  !
  !

```

The following example shows how to steer traffic to the SR P2MP policy on the root node.

```

router pim
vrf TEST
  address-family ipv4
    sr-p2mp-policy FOO
    static-group 232.1.1.5 10.1.1.6
  !
  !
  !
  !

```



CHAPTER 9

Enabling Segment Routing Flexible Algorithm

Segment Routing Flexible Algorithm allows operators to customize IGP shortest path computation according to their own needs. An operator can assign custom SR prefix-SIDs to realize forwarding beyond link-cost-based SPF. As a result, Flexible Algorithm provides a traffic engineered path automatically computed by the IGP to any destination reachable by the IGP.

The SR architecture associates prefix-SIDs to an algorithm which defines how the path is computed. Flexible Algorithm allows for user-defined algorithms where the IGP computes paths based on a user-defined combination of metric type and constraint.

This document describes the IS-IS extension to support Segment Routing Flexible Algorithm on an MPLS data-plane.

- [Prerequisites for Flexible Algorithm, on page 159](#)
- [Building Blocks of Segment Routing Flexible Algorithm, on page 159](#)
- [Configuring Flexible Algorithm, on page 161](#)
- [Example: Configuring IS-IS Flexible Algorithm, on page 163](#)
- [Example: Traffic Steering to Flexible Algorithm Paths, on page 163](#)

Prerequisites for Flexible Algorithm

Segment routing must be enabled on the router before the Flexible Algorithm functionality is activated.

Building Blocks of Segment Routing Flexible Algorithm

This section describes the building blocks that are required to support the SR Flexible Algorithm functionality in IS-IS .

Flexible Algorithm Definition

Many possible constraints may be used to compute a path over a network. Some networks are deployed with multiple planes. A simple form of constraint may be to use a particular plane. A more sophisticated form of constraint can include some extended metric, like delay, as described in [RFC7810]. Even more advanced case could be to restrict the path and avoid links with certain affinities. Combinations of these are also possible. To provide a maximum flexibility, the mapping between the algorithm value and its meaning can be defined by the user. When all the routers in the domain have the common understanding what the particular algorithm

value represents, the computation for such algorithm is consistent and the traffic is not subject to looping. Here, since the meaning of the algorithm is not defined by any standard, but is defined by the user, it is called a Flexible Algorithm.

Flexible Algorithm Membership

An algorithm defines how the best path is computed by IGP. Routers advertise the support for the algorithm as a node capability. Prefix-SIDs are also advertised with an algorithm value and are tightly coupled with the algorithm itself.

An algorithm is a one octet value. Values from 128 to 255 are reserved for user defined values and are used for Flexible Algorithm representation.

Flexible Algorithm Definition Advertisement

To guarantee the loop free forwarding for paths computed for a particular Flexible Algorithm, all routers in the network must share the same definition of the Flexible Algorithm. This is achieved by dedicated router(s) advertising the definition of each Flexible Algorithm. Such advertisement is associated with the priority to make sure that all routers will agree on a single and consistent definition for each Flexible Algorithm.

Definition of Flexible Algorithm includes:

- Metric type
- Affinity constraints

To enable the router to advertise the definition for the particular Flexible Algorithm, **advertise-definition** command is used. At least one router in the area, preferably two for redundancy, must advertise the Flexible Algorithm definition. Without the valid definition being advertised, the Flexible Algorithm will not be functional.

Flexible Algorithm Prefix-SID Advertisement

To be able to forward traffic on a Flexible Algorithm specific path, all routers participating in the Flexible Algorithm will install a MPLS labeled path for the Flexible Algorithm specific SID that is advertised for the prefix. Only prefixes for which the Flexible Algorithm specific Prefix-SID is advertised is subject to Flexible Algorithm specific forwarding.

Calculation of Flexible Algorithm Path

A router may compute path for multiple Flexible Algorithms. A router must be configured to support particular Flexible Algorithm before it can compute any path for such Flexible Algorithm. A router must have a valid definition of the Flexible Algorithm before Flexible Algorithm is used.

When computing the shortest path tree for particular Flexible Algorithm:

- All nodes that don't advertise support for Flexible Algorithm are pruned from the topology.
- If the Flexible Algorithm definition includes affinities that are excluded, then all links for which any of such affinities are advertised will be pruned from the topology.

- Router uses the metric that is part of the Flexible Algorithm definition. If the metric isn't advertised for the particular link, the link is pruned from the topology.

Configuring Microloop Avoidance for Flexible Algorithm

By default, Microloop Avoidance per Flexible Algorithm instance follows Microloop Avoidance configuration for algo-0. For information about configuring Microloop Avoidance, see [Configure Segment Routing Microloop Avoidance, on page 203](#).

You can disable Microloop Avoidance for Flexible Algorithm using the following commands:

```
router isis instance flex-algo algo microloop avoidance disable
router ospf process flex-algo algo microloop avoidance disable
```

Configuring LFA / TI-LFA for Flexible Algorithm

By default, LFA/TI-LFA per Flexible Algorithm instance follows LFA/TI-LFA configuration for algo-0. For information about configuring TI-LFA, see [Configure Topology-Independent Loop-Free Alternate \(TI-LFA\), on page 191](#).

You can disable TI-LFA for Flexible Algorithm using the following commands:

```
router isis instance flex-algo algo fast-reroute disable
router ospf process flex-algo algo fast-reroute disable
```

Installation of Forwarding Entries for Flexible Algorithm Paths

Flexible Algorithm path to any prefix must be installed in the forwarding using the Prefix-SID that was advertised for such Flexible Algorithm. If the Prefix-SID for Flexible Algorithm is not known, such Flexible Algorithm path is not installed in forwarding for such prefix..

Only MPLS to MPLS entries are installed for a Flexible Algorithm path. No IP to IP or IP to MPLS entries are installed. These follow the native IPG paths computed based on the default algorithm and regular IGP metrics.

Configuring Flexible Algorithm

The following ISIS configuration sub-mode is used to configure Flexible Algorithm:

```
router isis instance flex-algo algo
router ospf process flex-algo algo
algo—value from 128 to 255
```

Configuring Flexible Algorithm Definitions

The following commands are used to configure Flexible Algorithm definition under the flex-algo sub-mode:

- `metric-type delay`



Note By default the regular IGP metric is used. If delay metric is enabled, the advertised delay on the link is used as a metric for Flexible Algorithm computation.

- **affinity exclude-any** *name1, name2, ...*
name—name of the affinity map
- **priority** *priority value*
priority value—priority used during the Flexible Algorithm definition election.

The following command is used to enable advertisement of the Flexible Algorithm definition in IS-IS:

```
router isis instance flex-algo algo advertise-definition
```

Configuring Affinity

The following command is used for defining the affinity-map. Affinity-map associates the name with the particular bit positions in the Extended Admin Group bitmask.

```
router isis instance flex-algo algo affinity-map name bit-position bit number
```

```
router ospf process flex-algo algo affinity-map name bit-position bit number
```

The following command is used to associate the affinity with an interface:

```
router isis instance interface type interface-path-id affinity flex-algo anomaly name 1, name 2, ...
```

```
router ospf process area area interface type interface-path-id affinity flex-algo anomaly name 1, name 2, ...
```

name—name of the affinity-map

You can configure both normal and anomaly values. For the following example, the **blue** affinity is advertised; however, if a metric is received with the anomaly flag set, it will change to **red**:

```
router isis 1
interface GigabitEthernet0/0/0/2
affinity flex-algo blue
affinity flex-algo anomaly red
```

Configuring Prefix-SID Advertisement

The following command is used to advertise prefix-SID for default and strict-SPF algorithm:

```
router isis instance interface type interface-path-id address-family {ipv4 | ipv6} [unicast]
prefix-sid [strict-spf | algorithm algorithm-number] [index | absolute] sid value
```

```
router ospf process area area interface Loopback interface-instance prefix-sid [strict-spf
| algorithm algorithm-number] [index | absolute] sid value
```

- *algorithm-number*—Flexible Algorithm number

- *sid value*—SID value

Example: Configuring IS-IS Flexible Algorithm

```

router isis 1
  affinity-map red bit-position 65
  affinity-map blue bit-position 8
  affinity-map green bit-position 201

  flex-algo 128
    advertise-definition
    affinity exclude-any red
    affinity include-any blue
  !
  flex-algo 129
    affinity exclude-any green
  !
!
address-family ipv4 unicast
  segment-routing mpls
!
interface Loopback0
  address-family ipv4 unicast
    prefix-sid algorithm 128 index 100
    prefix-sid algorithm 129 index 101
  !
!
interface GigabitEthernet0/0/0/0
  affinity flex-algo red
!
interface GigabitEthernet0/0/0/1
  affinity flex-algo blue red
!
interface GigabitEthernet0/0/0/2
  affinity flex-algo blue
!

```

Example: Traffic Steering to Flexible Algorithm Paths

BGP Routes on PE – Color Based Steering

SR-TE On Demand Next-Hop (ODN) feature can be used to steer the BGP traffic towards the Flexible Algorithm paths.

The following example configuration shows how to setup BGP steering local policy, assuming two routers: R1 (2.2.2.2) and R2 (4.4.4.4), in the topology.

Configuration on router R1:

```

vrf Test
  address-family ipv4 unicast
    import route-target
      1:150
    !
    export route-policy SET_COLOR_RED_HI_BW
    export route-target

```

```

    1:150
    !
    !
    !
    interface Loopback0
    ipv4 address 2.2.2.2 255.255.255.255
    !
    interface Loopback150
    vrf Test
    ipv4 address 2.2.2.222 255.255.255.255
    !
    interface TenGigE0/1/0/3/0
    description exr1 to cxr1
    ipv4 address 10.0.20.2 255.255.255.0
    !
    extcommunity-set opaque color129-red-igp
    129
    end-set
    !
    route-policy PASS
    pass
    end-policy
    !
    route-policy SET_COLOR_RED_HI_BW
    set extcommunity color color129-red-igp
    pass
    end-policy
    !
    router isis 1
    is-type level-2-only
    net 49.0001.0000.0000.0002.00
    log adjacency changes
    affinity-map RED bit-position 28
    flex-algo 128
    priority 228
    !
    address-family ipv4 unicast
    metric-style wide
    advertise link attributes
    router-id 2.2.2.2
    segment-routing mpls
    !
    interface Loopback0
    address-family ipv4 unicast
    prefix-sid index 2
    prefix-sid algorithm 128 index 282
    !
    !
    interface TenGigE0/1/0/3/0
    point-to-point
    address-family ipv4 unicast
    !
    !
    !
    router bgp 65000
    bgp router-id 2.2.2.2
    address-family ipv4 unicast
    !
    address-family vpnv4 unicast
    retain route-target all
    !
    neighbor-group RR-services-group
    remote-as 65000
    update-source Loopback0

```

```

        address-family ipv4 unicast
        !
        address-family vpnv4 unicast
        !
    !
neighbor 4.4.4.4
    use neighbor-group RR-services-group
    !
vrf Test
    rd auto
    address-family ipv4 unicast
    redistribute connected
    !
segment-routing
traffic-eng
    logging
    policy status
    !
segment-list sl-cxr1
    index 10 mpls label 16294
    !
policy pol-foo
    color 129 end-point ipv4 4.4.4.4
    candidate-paths
    preference 100
    explicit segment-list sl-cxr1
    !
    !
    !
!
!
!

```

Configuration on router R2:

```

vrf Test
address-family ipv4 unicast
    import route-target
    1:150
    !
    export route-policy SET_COLOR_RED_HI_BW
    export route-target
    1:150
    !
!
!
interface TenGigE0/1/0/1
description cxr1 to exr1
ipv4 address 10.0.20.1 255.255.255.0
!
extcommunity-set opaque color129-red-igp
    129
end-set
!
route-policy PASS
    pass
end-policy
!
route-policy SET_COLOR_RED_HI_BW
    set extcommunity color color129-red-igp
    pass
end-policy
!
router isis 1

```

```

is-type level-2-only
net 49.0001.0000.0000.0004.00
log adjacency changes
affinity-map RED bit-position 28
affinity-map BLUE bit-position 29
affinity-map GREEN bit-position 30
flex-algo 128
    priority 228
!
flex-algo 129
    priority 229
!
flex-algo 130
    priority 230
!
address-family ipv4 unicast
    metric-style wide
    advertise link attributes
    router-id 4.4.4.4
    segment-routing mpls
!
interface Loopback0
    address-family ipv4 unicast
        prefix-sid index 4
        prefix-sid algorithm 128 index 284
        prefix-sid algorithm 129 index 294
        prefix-sid algorithm 130 index 304
    !
!
interface GigabitEthernet0/0/0/0
    point-to-point
    address-family ipv4 unicast
    !
!
interface TenGigE0/1/0/1
    point-to-point
    address-family ipv4 unicast
    !
!
router bgp 65000
    bgp router-id 4.4.4.4
    address-family ipv4 unicast
    !
    address-family vpnv4 unicast
    !
    neighbor-group RR-services-group
        remote-as 65000
        update-source Loopback0
        address-family ipv4 unicast
        !
        address-family vpnv4 unicast
        !
    !
    neighbor 10.1.1.1
        use neighbor-group RR-services-group
    !
    neighbor 2.2.2.2
        use neighbor-group RR-services-group
    !
vrf Test
    rd auto
    address-family ipv4 unicast
        redistribute connected
    !

```



```
neighbor 25.1.1.2
  remote-as 4
  address-family ipv4 unicast
    route-policy PASS in
    route-policy PASS out
  !
!
!
segment-routing
!
end
```



CHAPTER 10

Configure Segment Routing Path Computation Element

The Segment Routing Path Computation Element (SR-PCE) provides stateful PCE functionality by extending the existing IOS-XR PCEP functionality with additional capabilities. SR-PCE is supported on the MPLS data plane and IPv4 control plane.



Note The Cisco IOS XRv 9000 is the recommended platform to act as the SR-PCE. Refer to the [Cisco IOS XRv 9000 Router Installation and Configuration Guide](#) for more information.

- [About SR-PCE, on page 169](#)
- [Configure SR-PCE, on page 170](#)
- [PCE-Initiated SR Policies, on page 174](#)
- [ACL Support for PCEP Connection, on page 175](#)

About SR-PCE

The path computation element protocol (PCEP) describes a set of procedures by which a path computation client (PCC) can report and delegate control of head-end label switched paths (LSPs) sourced from the PCC to a PCE peer. The PCE can request the PCC to update and modify parameters of LSPs it controls. The stateful model also enables a PCC to allow the PCE to initiate computations allowing the PCE to perform network-wide orchestration.



Note For more information on PCE, PCC, and PCEP, refer to the [Path Computation Element](#) section in the *MPLS Configuration Guide for Cisco ASR 9000 Series Routers*.

SR-PCE learns topology information by way of IGP (OSPF or IS-IS) or through BGP Link-State (BGP-LS).

SR-PCE is capable of computing paths using the following methods:

- TE metric—SR-PCE uses the TE metric in its path calculations to optimize cumulative TE metric.
- IGP metric—SR-PCE uses the IGP metric in its path calculations to optimize reachability.

- LSP Disjointness—SR-PCE uses the path computation algorithms to compute a pair of disjoint LSPs. The disjoint paths can originate from the same head-end or different head-ends. Disjoint level refers to the type of resources that should not be shared by the two computed paths. SR-PCE supports the following disjoint path computations:
 - Link – Specifies that links are not shared on the computed paths.
 - Node – Specifies that nodes are not shared on the computed paths.
 - SRLG – Specifies that links with the same SRLG value are not shared on the computed paths.
 - SRLG-node – Specifies that SRLG and nodes are not shared on the computed paths.

When the first request is received with a given disjoint-group ID, the first LSP is computed, encoding the shortest path from the first source to the first destination. When the second LSP request is received with the same disjoint-group ID, information received in both requests is used to compute two disjoint paths: one path from the first source to the first destination, and another path from the second source to the second destination. Both paths are computed at the same time.

Configure SR-PCE

This task explains how to configure SR-PCE.

Before you begin

The Cisco IOS XRv 9000 is the recommended platform to act as the SR-PCE.

SUMMARY STEPS

1. **configure**
2. **pce**
3. **address ipv4** *address*
4. **state-sync ipv4** *address*
5. **tcp-buffer size** *size*
6. **password** {**clear** | **encrypted**} *password*
7. **segment-routing** {**strict-sid-only** | **te-latency**}
8. **timers**
9. **keepalive** *time*
10. **minimum-peer-keepalive** *time*
11. **reoptimization** *time*
12. **exit**

DETAILED STEPS

	Command or Action	Purpose
Step 1	configure Example: RP/0/RSP0/CPU0:router# <code>configure</code>	Enters global configuration mode.

	Command or Action	Purpose
Step 2	<p>pce</p> <p>Example:</p> <pre>RP/0/RSP0/CPU0:router(config)# pce</pre>	Enables PCE and enters PCE configuration mode.
Step 3	<p>address ipv4 address</p> <p>Example:</p> <pre>RP/0/RSP0/CPU0:router(config-pce)# address ipv4 192.168.0.1</pre>	Configures a PCE IPv4 address.
Step 4	<p>state-sync ipv4 address</p> <p>Example:</p> <pre>RP/0/RSP0/CPU0:router(config-pce)# state-sync ipv4 192.168.0.3</pre>	Configures the remote peer for state synchronization.
Step 5	<p>tcp-buffer size size</p> <p>Example:</p> <pre>RP/0/RSP0/CPU0:router(config-pce)# tcp-buffer size 1024000</pre>	Configures the transmit and receive TCP buffer size for each PCEP session, in bytes. The default buffer size is 256000. The valid range is from 204800 to 1024000.
Step 6	<p>password {clear encrypted} password</p> <p>Example:</p> <pre>RP/0/RSP0/CPU0:router(config-pce)# password encrypted pwd1</pre>	Enables TCP MD5 authentication for all PCEP peers. Any TCP segment coming from the PCC that does not contain a MAC matching the configured password will be rejected. Specify if the password is encrypted or clear text.
Step 7	<p>segment-routing {strict-sid-only te-latency}</p> <p>Example:</p> <pre>RP/0/RSP0/CPU0:router(config-pce)# segment-routing strict-sid-only</pre>	<p>Configures the segment routing algorithm to use strict SID or TE latency.</p> <p>Note This setting is global and applies to all LSPs that request a path from this controller.</p>
Step 8	<p>timers</p> <p>Example:</p> <pre>RP/0/RSP0/CPU0:router(config-pce)# timers</pre>	Enters timer configuration mode.
Step 9	<p>keepalive time</p> <p>Example:</p>	Configures the timer value for locally generated keep-alive messages. The default time is 30 seconds.

	Command or Action	Purpose
	RP/0/RSP0/CPU0:router(config-pce-timers)# keepalive 60	
Step 10	minimum-peer-keepalive <i>time</i> Example: RP/0/RSP0/CPU0:router(config-pce-timers)# minimum-peer-keepalive 30	Configures the minimum acceptable keep-alive timer that the remote peer may propose in the PCEP OPEN message during session establishment. The default time is 20 seconds.
Step 11	reoptimization <i>time</i> Example: RP/0/RSP0/CPU0:router(config-pce-timers)# reoptimization 600	Configures the re-optimization timer. The default timer is 1800 seconds.
Step 12	exit Example: RP/0/RSP0/CPU0:router(config-pce-timers)# exit	Exits timer configuration mode and returns to PCE configuration mode.

Configure the Disjoint Policy (Optional)

This task explains how to configure the SR-PCE to compute disjointness for a pair of LSPs signaled by PCCs that do not include the PCEP association group-ID object in their PCEP request. This can be beneficial for deployments where PCCs do not support this PCEP object or when the network operator prefers to manage the LSP disjoint configuration centrally.

SUMMARY STEPS

1. **disjoint-path**
2. **group-id** *value* **type** {link | node | srlg | srlg-node} [**sub-id** *value*]
3. **strict**
4. **lsp** {1 | 2} **pcc ipv4** *address* **lsp-name** *lsp_name* [**shortest-path**]

DETAILED STEPS

	Command or Action	Purpose
Step 1	disjoint-path Example: RP/0/RSP0/CPU0:router(config-pce)# disjoint-path	Enters disjoint configuration mode.

	Command or Action	Purpose
Step 2	<p>group-id <i>value</i> type {link node srlg srlg-node} [sub-id <i>value</i>]</p> <p>Example:</p> <pre>RP/0/RSP0/CPU0:router(config-pce-disjoint)# group-id 1 type node sub-id 1</pre>	<p>Configures the disjoint group ID and defines the preferred level of disjointness (the type of resources that should not be shared by the two paths):</p> <ul style="list-style-type: none"> • link—Specifies that links are not shared on the computed paths. • node—Specifies that nodes are not shared on the computed paths. • srlg—Specifies that links with the same SRLG value are not shared on the computed paths. • srlg-node—Specifies that SRLG and nodes are not shared on the computed paths. <p>If a pair of paths that meet the requested disjointness level cannot be found, then the paths will automatically fallback to a lower level:</p> <ul style="list-style-type: none"> • If the requested disjointness level is SRLG or node, then link-disjoint paths will be computed. • If the requested disjointness level was link, or if the first fallback from SRLG or node disjointness failed, then the lists of segments encoding two shortest paths, without any disjointness constraint, will be computed.
Step 3	<p>strict</p> <p>Example:</p> <pre>RP/0/RSP0/CPU0:router(config-pce-disjoint)# strict</pre>	<p>(Optional) Prevents the automatic fallback behavior of the preferred level of disjointness. If a pair of paths that meet the requested disjointness level cannot be found, the disjoint calculation terminates and no new path is provided. The existing path is not modified.</p>
Step 4	<p>lsp {1 2} pcc ipv4 <i>address</i> lsp-name <i>lsp_name</i> [shortest-path]</p> <p>Example:</p> <pre>RP/0/RSP0/CPU0:router(config-pce-disjoint)# lsp 1 pcc ipv4 192.168.0.1 lsp-name rtrA_t1 shortest-path RP/0/RSP0/CPU0:router(config-pce-disjoint)# lsp 2 pcc ipv4 192.168.0.5 lsp-name rtrE_t2</pre>	<p>Adds LSPs to the disjoint group.</p> <p>The shortest-path keyword forces one of the disjoint paths to follow the shortest path from the source to the destination. This option can only be applied to the the first LSP specified.</p>

PCE-Initiated SR Policies

Use cases based on centralized optimization, such as congestion mitigation solutions, rely on the ability of the PCE to signal and instantiate SR-TE policies in the network. We refer to this as PCE-initiated SR-TE policies.

PCE-initiated SR-TE policies can be triggered via Crossworks Network Controller (recommended approach) or via CLI at the PCE.

For more information on configuring SR-TE policies, see the [SR-TE Policy Overview, on page 75](#).

The PCE deploys the SR-TE policy using PCC-PCE communication protocol (PCEP).

1. PCE sends a PCInitiate message to the PCC.
2. If the PCInitiate message is valid, the PCC sends a PCRpt message; otherwise, it sends PCErr message.
3. If the PCInitiate message is accepted, the PCE updates the SR-TE policy by sending PCUpd message.

You can achieve high-availability by configuring multiple PCEs with SR-TE policies. If the head-end (PCC) loses connectivity with one PCE, another PCE can assume control of the SR-TE policy.

Configuration Example: PCE-Initiated SR Policy with Explicit SID List

To configure a PCE-initiated SR-TE policy, you must complete the following configurations:

1. Enter PCE configuration mode.
2. Create the segment list.



Note When configuring an explicit path using IP addresses of intermediate links, the SR-TE process selects either the protected or the unprotected Adj-SID of the link, depending on the order in which the Adj-SIDs were received.

3. Create the policy.

```

/* Enter PCE configuration mode and create the SR-TE segment lists */
Router# configure
Router(config)# pce

/* Create the SR-TE segment lists */
Router(config-pce)# segment-routing
Router(config-pce-sr)# traffic-eng
Router(config-pce-sr-te)# segment-list name addr2a
Router(config-pce-sr-te-sl)# index 10 address ipv4 10.1.1.2
Router(config-pce-sr-te-sl)# index 20 address ipv4 10.2.3.2
Router(config-pce-sr-te-sl)# index 30 address ipv4 10.1.1.4
Router(config-pce-sr-te-sl)# exit

/* Create the SR-TE policy */
Router(config-pce-sr-te)# peer ipv4 10.1.1.1
Router(config-pce-sr-te)# policy P1
Router(config-pce-sr-te-policy)# color 2 end-point ipv4 2.2.2.2
Router(config-pce-sr-te-policy)# candidate-paths

```



```

Router(config-pce-sr-te-policy-path)# preference 50
Router(config-pce-sr-te-policy-path-preference)# explicit segment-list addr2a
Router(config-pce-sr-te-pp-info)# commit
Router(config-pce-sr-te-pp-info)# end
Router(config)#

```

Running Config

```

pce
 segment-routing
  traffic-eng
    segment-list name addr2a
      index 10 address ipv4 10.1.1.2
      index 20 address ipv4 10.2.3.2
      index 30 address ipv4 10.1.1.4
    !
  peer ipv4 10.1.1.1
    policy P1
      color 2 end-point ipv4 2.2.2.2
      candidate-paths
        preference 50
        explicit segment-list addr2a
      !
    !

```

ACL Support for PCEP Connection

PCE protocol (PCEP) (RFC5440) is a client-server model running over TCP/IP, where the server (PCE) opens a port and the clients (PCC) initiate connections. After the peers establish a TCP connection, they create a PCE session on top of it.

The ACL Support for PCEP Connection feature provides a way to protect a PCE server using an Access Control List (ACL) to restrict IPv4 PCC peers at the time the TCP connection is created based on the source address of a client. When a client initiates the TCP connection, the ACL is referenced, and the client source address is compared. The ACL can either permit or deny the address and the TCP connection will proceed or not.

Refer to the Implementing Access Lists and Prefix Lists chapter in the *IP Addresses and Services Configuration Guide for Cisco ASR 9000 Series Routers* for detailed ACL configuration information.

To apply an ACL to the PCE, use the **pce peer-filter ipv4 access-list** *acl_name* command.

The following example shows how to configure an ACL and apply it to the PCE:

```

pce
 address ipv4 10.1.1.5
 peer-filter ipv4 access-list sample-peer-filter
 !
ipv4 access-list sample-peer-filter
 10 permit ipv4 host 10.1.1.6 any
 20 permit ipv4 host 10.1.1.7 any
 30 deny ipv4 any any
 !

```



CHAPTER 11

Configure Performance Measurement

Network performance metrics is a critical measure for traffic engineering (TE) in service provider networks. Network performance metrics include the following:

- Packet loss
- Delay
- Delay variation
- Bandwidth utilization

These network performance metrics provide network operators information about the performance characteristics of their networks for performance evaluation and help to ensure compliance with service level agreements. The service-level agreements (SLAs) of service providers depend on the ability to measure and monitor these network performance metrics. Network operators can use performance measurement (PM) feature to monitor the network metrics for links and end-to-end TE label switched paths (LSPs).

The following table explains the functionalities supported by performance measurement feature for measuring delay for links.

Table 6: Performance Measurement Functionalities

Functionality	Details
Profiles	You can configure different profiles for different types of delay measurements. Use the "interfaces" delay profile type for link-delay measurement. Delay profile allows you to schedule probe and configure metric advertisement parameters for delay measurement.
Protocols	MPLS (using RFC6374 with MPLS encap) or Two-Way Active Measurement Protocol (TWAMP) Light (using RFC 5357 with IP/UDP encap).
Probe and burst scheduling	Schedule probes and configure metric advertisement parameters for delay measurement.
Metric advertisements	Advertise measured metrics periodically using configured thresholds. Also supports accelerated advertisements using configured thresholds.
Measurement history and counters	Maintain packet delay and loss measurement history, session counters, and packet advertisement counters.

- [Measurement Modes, on page 178](#)
- [Link Delay Measurement, on page 179](#)

Measurement Modes

The following table compares the different hardware and timing requirements for the measurement modes supported in SR PM.

Table 7: Measurement Mode Requirements

Measurement Mode	Sender: PTP-Capable HW and HW Timestamping	Reflector: PTP-Capable HW and HW Timestamping	PTP Clock Synchronization between Sender and Reflector
One-way	Required	Required	Required
Two-way	Required	Required	Not Required

One-Way

One-way measurement mode provides the most precise form of one-way delay measurement. PTP-capable hardware and hardware timestamping are required on both Sender and Reflector, with PTP Clock Synchronization between Sender and Reflector.

Delay measurement in one-way mode is calculated as $(T2 - T1)$.

Figure 5: One-Way

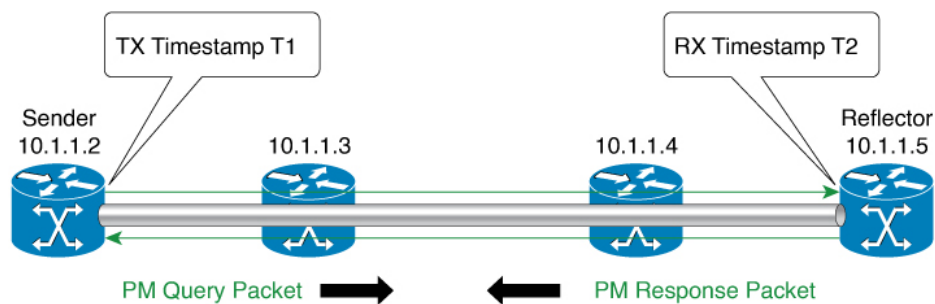

- One Way Delay = $(T2 - T1)$
- Hardware clock synchronized using PTP (IEEE 1588) between sender and reflector nodes (all nodes for higher accuracy)

521501

The PM query and response for one-way delay measurement can be described in the following steps:

1. The local-end router sends PM query packets periodically to the remote side once the egress line card on the router applies timestamps on packets.
2. The ingress line card on the remote-end router applies time-stamps on packets as soon as they are received.
3. The remote-end router sends the PM packets containing time-stamps back to the local-end router.
4. One-way delay is measured using the time-stamp values in the PM packet.

Two-Way

Two-way measurement mode provides two-way measurements. PTP-capable hardware and hardware timestamping are required on both Sender and Reflector, but PTP clock synchronization between Sender and Reflector is not required.

Delay measurements in two-way mode are calculated as follows:

- Two-Way Delay = $(T4 - T1) - (T3 - T2)$
- One-Way Delay = Two-Way Delay/2

Figure 6: Two-Way

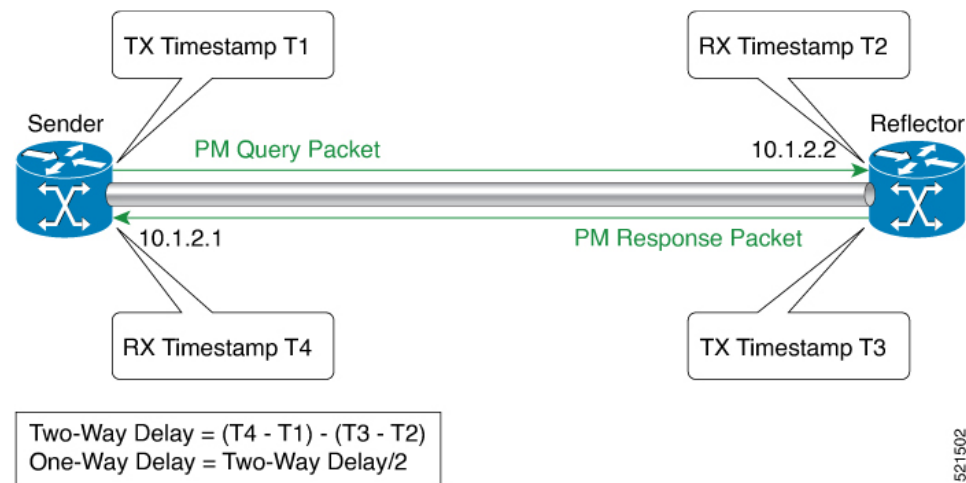

The PM query and response for two-way delay measurement can be described in the following steps:

1. The local-end router sends PM query packets periodically to the remote side once the egress line card on the router applies timestamps on packets.
2. Ingress line card on the remote-end router applies time-stamps on packets as soon as they are received.
3. The remote-end router sends the PM packets containing time-stamps back to the local-end router. The remote-end router time-stamps the packet just before sending it for two-way measurement.
4. The local-end router time-stamps the packet as soon as the packet is received for two-way measurement.
5. One-way delay and optionally two-way delay is measured using the time-stamp values in the PM packet.

Link Delay Measurement

The PM for link delay uses the MPLS packet format defined in RFC 6374 for probes. The MPLS packet format requires the remote side line card to be MPLS capable. For link delay measurement, MPLS multicast MAC address is used to send delay measurement probe packets to next-hops. So, the user does not need to configure next-hop addresses for the links. The remote side line card needs to support the MPLS multicast MAC address.

Usage Guidelines and Restrictions for PM for Link Delay

The following restrictions and guidelines apply for the PM for link delay feature for different links.

- For protocol pm-mpls, remote-end line card needs to be MPLS-capable.
- For broadcast links, only point-to-point (P2P) links are supported. P2P configuration on IGP is required for flooding the value.
- For link bundles, the hashing function may select a member link for forwarding but the reply may come from the remote line card on a different member link of the bundle.
- For one-way delay measurement, clocks should be synchronized on two end-point nodes of the link using PTP.

Configuration Example: PM for Link Delay

This example shows how to configure performance-measurement functionalities for link delay as a global default profile. The default values for the different parameters in the PM for link delay is given as follows:

- **probe measurement mode:** The default measurement mode for probe is two-way delay measurement. If you are configuring one-way delay measurement, hardware clocks must be synchronized between the local-end and remote-end routers using precision time protocol (PTP). See [Measurement Modes, on page 178](#) for more information.
- **protocol:**
 - **pm-mpls:** Interface delay measurement using RFC6374 with MPLS encap. This is the default protocol.
 - **pm-udp:** Interface delay measurement using RFC 6374-UDP with UDP encap.
- **burst interval:** Interval for sending probe packet. The default value is 3000 milliseconds and the range is from 30 to 15000 milliseconds.
- **computation interval:** Interval for metric computation. Default is 30 seconds; range is 1 to 3600 seconds.
- **periodic advertisement:** Periodic advertisement is enabled by default.
- **periodic-advertisement interval:** The default value is 120 seconds and the interval range is from 30 to 3600 seconds.
- **periodic-advertisement threshold:** Checks the minimum-delay metric change for threshold crossing for periodic advertisement. The default value is 10 percent and the range is from 0 to 100 percent.
- **periodic-advertisement minimum change:** The default value is 1000 microseconds (usec) and the range is from 0 to 100000 microseconds.
- **accelerated advertisement:** Accelerated advertisement is disabled by default.
- **accelerated-advertisement threshold:** Checks the minimum-delay metric change for threshold crossing for accelerated advertisement. The default value is 20 percent and the range is from 0 to 100 percent.
- **accelerated-advertisement minimum change:** The default value is 500 microseconds and the range is from 0 to 100000 microseconds.

```
RP/0/0/CPU0:router(config)# performance-measurement delay-profile interfaces
RP/0/0/CPU0:router(config-pm-dm-intf)# probe
```

```

RP/0/0/CPU0:router (config-pm-dm-intf-probe) # measurement-mode one-way
RP/0/0/CPU0:router (config-pm-dm-intf-probe) # burst-interval 60
RP/0/0/CPU0:router (config-pm-dm-intf-probe) # computation-interval 60
RP/0/0/CPU0:router (config-pm-dm-intf-probe) # exit

RP/0/0/CPU0:router (config-pm-dm-intf) # advertisement periodic
RP/0/0/CPU0:router (config-pm-dm-intf-adv-per) # interval 120
RP/0/0/CPU0:router (config-pm-dm-intf-adv-per) # threshold 20
RP/0/0/CPU0:router (config-pm-dm-intf-adv-per) # minimum-change 1000
RP/0/0/CPU0:router (config-pm-dm-intf-adv-per) # exit

RP/0/0/CPU0:router (config-pm-dm-intf) # advertisement accelerated
RP/0/0/CPU0:router (config-pm-dm-intf-adv-acc) # threshold 30
RP/0/0/CPU0:router (config-pm-dm-intf-adv-acc) # minimum-change 1000
RP/0/0/CPU0:router (config-pm-dm-intf-adv-per) # exit

```

Configure the UDP Destination Port

When you specify PM-UDP protocol, you need to configure the UDP destination port. The UDP port is configured for each PM measurement probe type (delay, loss, protocol, authentication mode, etc.) on querier and responder nodes. The UDP port for each PM measurement probe type must match on querier and responder nodes.



Note The same UDP destination port is used for delay measurement for links and SR Policy.

This example shows how to configure the UDP destination port for delay.

```

Router (config) # performance-measurement
Router (config-perf-meas) # protocol pm-udp
Router (config-pm-protocol) # measurement delay unauthenticated
Router (config-pm-proto-mode) # querier-dst-port 12000

```

Enable PM for Link Delay Over an Interface

This example shows how to enable PM for link delay over an interface.

```

RP/0/0/CPU0:router (config) # performance-measurement
RP/0/0/CPU0:router (config-perf-meas) # interface TenGigE0/0/0/0
RP/0/0/CPU0:router (config-pm-intf) # delay-measurement
RP/0/0/CPU0:router (config-pm-intf-dm) # exit

```

The source and destination IP addresses used in the OAM packet are determined by the IP address present on the interface where the delay-measurement operation is enabled.

the following rules apply to determine the source and destination IP addresses used in the OAM packet:

- If an IPv4 address is configured under the interface, then:
 - OAM packet source IP address = Interface's IPv4 address
 - OAM packet destination IP address = 127.0.0.0
- Else, if an IPv6 global address is configured under the interface, then:
 - OAM packet source IP address = Interface's IPv6 global address

- OAM packet destination IP address = 0::ff:127.0.0.0

This example shows how to enable PM for link delay over an interface with IPv4 address configured:

```
interface TenGigE0/0/0/0
  ipv4 address 10.10.10.1 255.255.255.0

performance-measurement
  interface TenGigE0/0/0/0
    delay-measurement
```

This example shows how to enable PM for link delay over an interface IPv6 address configured:

```
interface TenGigE0/0/0/0
  ipv6 address 10:10:10::1/64

performance-measurement
  interface TenGigE0/0/0/0
    delay-measurement
```

Verification

```
RP/0/0/CPU0:router# show performance-measurement profile interface
Thu Dec 12 14:13:16.029 PST
```

```
-----
0/0/CPU0
-----
```

```
Interface Delay-Measurement:
  Profile configuration:
    Measurement Type           : Two-Way
    Probe computation interval  : 30 (effective: 30) seconds
    Type of services           : Traffic Class: 6, DSCP: 48
    Burst interval              : 3000 (effective: 3000) mSec
    Burst count                 : 10 packets
    Encap mode                  : UDP
    Payload Type                : TWAMP-light
    Destination sweeping mode   : Disabled
    Periodic advertisement      : Enabled
      Interval                  : 120 (effective: 120) sec
      Threshold                  : 10%
      Minimum-Change            : 500 uSec
    Advertisement accelerated   : Disabled
    Threshold crossing check    : Minimum-delay
```

```
RP/0/0/CPU0:router# show performance-measurement summary detail location 0/2/CPU0
```

```
Thu Dec 12 14:09:59.162 PST
```

```
-----
0/2/CPU0
-----
```

```
Total interfaces           : 1
Total SR Policies           : 0
Total RSVP-TE tunnels       : 0
Total Maximum PPS           : 2000 pkts/sec
Total Interfaces PPS        : 0 pkts/sec
Maximum Allowed Multi-hop PPS : 2000 pkts/sec
Multi Hop Requested PPS     : 0 pkts/sec (0% of max allowed)
```



```
Dampened Multi Hop Requested PPS           : 0% of max allowed
Inuse Burst Interval Adjustment Factor      : 100% of configuration
```

Interface Delay-Measurement:

```
Total active sessions           : 1
Counters:
  Packets:
    Total sent                   : 26
    Total received               : 26
  Errors:
    TX:
      Reason interface down      : 0
      Reason no MPLS caps        : 0
      Reason no IP address       : 0
      Reason other               : 0
    RX:
      Reason negative delay      : 0
      Reason delay threshold exceeded : 0
      Reason missing TX timestamp : 0
      Reason missing RX timestamp : 0
      Reason probe full          : 0
      Reason probe not started   : 0
      Reason control code error  : 0
      Reason control code notif  : 0
  Probes:
    Total started                : 3
    Total completed              : 2
    Total incomplete             : 0
    Total advertisements         : 0
```

SR Policy Delay-Measurement:

```
Total active sessions           : 0
Counters:
  Packets:
    Total sent                   : 0
    Total received               : 0
  Errors:
    TX:
      Reason interface down      : 0
      Reason no MPLS caps        : 0
      Reason no IP address       : 0
      Reason other               : 0
    RX:
      Reason negative delay      : 0
      Reason delay threshold exceeded : 0
      Reason missing TX timestamp : 0
      Reason missing RX timestamp : 0
      Reason probe full          : 0
      Reason probe not started   : 0
      Reason control code error  : 0
      Reason control code notif  : 0
  Probes:
    Total started                : 0
    Total completed              : 0
    Total incomplete             : 0
    Total advertisements         : 0
```

RSVP-TE Delay-Measurement:

```
Total active sessions           : 0
Counters:
  Packets:
    Total sent                   : 0
    Total received               : 0
```

```

Errors:
  TX:
    Reason interface down      : 0
    Reason no MPLS caps       : 0
    Reason no IP address      : 0
    Reason other               : 0
  RX:
    Reason negative delay     : 0
    Reason delay threshold exceeded : 0
    Reason missing TX timestamp : 0
    Reason missing RX timestamp : 0
    Reason probe full        : 0
    Reason probe not started  : 0
    Reason control code error : 0
    Reason control code notif : 0
  Probes:
    Total started             : 0
    Total completed          : 0
    Total incomplete         : 0
    Total advertisements     : 0

Global Delay Counters:
  Total packets sent        : 26
  Total query packets received : 26
  Total invalid session id  : 0
  Total missing session    : 0

RP/0/0/CPU0:router# show performance-measurement interfaces detail
Thu Dec 12 14:16:09.692 PST

-----
0/0/CPU0
-----

-----
0/2/CPU0
-----

Interface Name: GigabitEthernet0/2/0/0 (ifh: 0x1004060)
  Delay-Measurement          : Enabled
  Loss-Measurement          : Disabled
  Configured IPv4 Address    : 10.10.10.2
  Configured IPv6 Address    : 10:10:10::2
  Link Local IPv6 Address    : fe80::3a:6fff:fec9:cd6b
  Configured Next-hop Address : Unknown
  Local MAC Address         : 023a.6fc9.cd6b
  Next-hop MAC Address       : 0291.e460.6707
  Primary VLAN Tag          : None
  Secondary VLAN Tag        : None
  State                     : Up

Delay Measurement session:
  Session ID                 : 1

Last advertisement:
  Advertised at: Dec 12 2019 14:10:43.138 (326.782 seconds ago)
  Advertised reason: First advertisement
  Advertised delays (uSec): avg: 839, min: 587, max: 8209, variance: 297

Next advertisement:
  Threshold check scheduled in 1 more probe (roughly every 120 seconds)
  Aggregated delays (uSec): avg: 751, min: 589, max: 905, variance: 112
  Rolling average (uSec): 756

Current Probe:

```

```

Started at Dec 12 2019 14:15:43.154 (26.766 seconds ago)
Packets Sent: 9, received: 9
Measured delays (uSec): avg: 795, min: 631, max: 1199, variance: 164
Next probe scheduled at Dec 12 2019 14:16:13.132 (in 3.212 seconds)
Next burst packet will be sent in 0.212 seconds
Burst packet sent every 3.0 seconds
Probe samples:
  Packet Rx Timestamp      Measured Delay (nsec)
Dec 12 2019 14:15:43.156    689223
Dec 12 2019 14:15:46.156    876561
Dec 12 2019 14:15:49.156    913548
Dec 12 2019 14:15:52.157    1199620
Dec 12 2019 14:15:55.156    794008
Dec 12 2019 14:15:58.156    631437
Dec 12 2019 14:16:01.157    656440
Dec 12 2019 14:16:04.157    658267
Dec 12 2019 14:16:07.157    736880

```

You can also use the following commands for verifying the PM for link delay on the local-end router.

Command	Description
show performance-measurement history probe interfaces [<i>interface</i>]	Displays the PM link-delay probe history for interfaces.
show performance-measurement history aggregated interfaces [<i>interface</i>]	Displays the PM link-delay aggregated history for interfaces.
show performance-measurement history advertisement interfaces [<i>interface</i>]	Displays the PM link-delay advertisement history for interfaces.
show performance-measurement counters [<i>interface interface</i>] [<i>location location-name</i>]	Displays the PM link-delay session counters.

You can also use the following commands for verifying the PM for link-delay configuration on the remote-end router.

Command	Description
show performance-measurement responder summary [<i>location location-name</i>]	Displays the PM for link-delay summary on the remote-end router (responder).
show performance-measurement responder interfaces [<i>interface</i>]	Displays PM for link-delay for interfaces on the remote-end router.
show performance-measurement responder counters [<i>interface interface</i>] [<i>location location-name</i>]	Displays the PM link-delay session counters on the remote-end router.

Configure a Static Delay Value on an Interface

You can configure an interface to advertise a static delay value, instead of the measured delay value. When you configure a static delay value, the advertisement is triggered immediately. The average, minimum, and maximum advertised values will use the static delay value, with a variance of 0.

Scheduled probes will continue, and measured delay metrics will be aggregated and stored in history buffer. However, advertisement threshold checks are suppressed so that there are no advertisements of the actual

measured delay values. If the configured static delay value is removed, the next scheduled advertisement threshold check will update the advertised measured delay values.

The static delay value can be configured from 1 to 16777215 microseconds (16.7 seconds).

This example shows how to configure a static delay of 1000 microseconds:

```
RP/0/0/CPU0:router(config)# performance-measurement
RP/0/0/CPU0:router(config-perf-meas)# interface TenGigE0/0/0/0
RP/0/0/CPU0:router(config-pm-intf)# delay-measurement
RP/0/0/CPU0:router(config-pm-intf-dm)# advertise-delay 1000
```

Running Configuration

```
performance-measurement
 interface GigabitEthernet0/0/0/0
   delay-measurement
     advertise-delay 1000
   !
 !
!
```

Verification

```
RP/0/RSP0/CPU0:ios# show performance-measurement interfaces detail
```

```
-----
0/0/CPU0
-----
```

```
Interface Name: GigabitEthernet0/0/0/0 (ifh: 0x0)
  Delay-Measurement           : Enabled
```

```
. . .
```

```
Last advertisement:
  Advertised at: Nov 29 2021 21:53:00.656 (7.940 seconds ago)
  Advertised reason: Advertise delay config
  Advertised delays (uSec): avg: 1000, min: 1000, max: 1000, variance: 0
```

```
. . .
```

SR Performance Measurement Named Profiles

You can create a named performance measurement profile for delay or liveness.

Delay Profile

This example shows how to create a named SR performance measurement delay profile.

```
Router(config)# performance-measurement delay-profile sr-policy name profile2
Router(config-pm-dm-srpolicy)# probe
Router(config-pm-dm-srpolicy-probe)# burst-interval 60
Router(config-pm-dm-srpolicy-probe)# computation-interval 60
Router(config-pm-dm-srpolicy-probe)# protocol twamp-light
Router(config-pm-dm-srpolicy-probe)# tos dscp 63

Router(config-pm-dm-srpolicy)# advertisement
Router(config-pm-dm-srpolicy-adv)# periodic
Router(config-pm-dm-srpolicy-adv-per)# interval 60
Router(config-pm-dm-srpolicy-adv-per)# minimum-change 1000
```

```
Router(config-pm-dm-srpolicy-adv-per)# threshold 20
Router(config-pm-dm-srpolicy-adv-per)# commit
```

Apply the delay profile for an SR Policy.

```
Router(config)# segment-routing traffic-eng
Router(config-sr-te)# policy TEST
Router(config-sr-te-policy)# color 4 end-point ipv4 10.10.10.10
Router(config-sr-te-policy)# performance-measurement
Router(config-sr-te-policy-perf-meas)# delay-measurement delay-profile name profile2
```

```
Router(config-sr-te-policy)#candidate-paths
Router(config-sr-te-policy-path)#preference 100
Router(config-sr-te-policy-path-pref)#explicit segment-list LIST1
Router(config-sr-te-pp-info)#weight 2
```

```
Router(config-sr-te-policy-path-pref)#explicit segment-list LIST2
Router(config-sr-te-pp-info)#weight 3
```

Running Configuration

```
Router# show run segment-routing traffic-eng policy TEST
```

```
segment-routing
 traffic-eng
  policy TEST
    color 4 end-point ipv4 10.10.10.10
    candidate-paths
      preference 100
      explicit segment-list LIST1
        weight 2
      !
      explicit segment-list LIST2
        weight 3
      !
    !
  !
  performance-measurement
    delay-measurement
      delay-profile name profile2
```

Verification

```
Router# show performance-measurement profile named-profile delay sr-policy name profile2
```

```
-----
0/RSP0/CPU0
-----
SR Policy Delay Measurement Profile Name: profile2
Profile configuration:
  Measurement mode           : One-way
  Protocol type              : TWAMP-light
  Encap mode                 : UDP
  Type of service:
    PM-MPLS traffic class    : 6
    TWAMP-light DSCP         : 63
  Probe computation interval : 60 (effective: 60) seconds
  Burst interval             : 60 (effective: 60) mSec
  Packets per computation interval : 1000
  Periodic advertisement    : Enabled
    Interval                 : 60 (effective: 60) sec
    Threshold                 : 20%
    Minimum-change           : 1000 uSec
  Advertisement accelerated  : Disabled
  Advertisement logging:
    Delay exceeded           : Disabled (default)
```

```

Threshold crossing check           : Maximum-delay
Router alert                       : Disabled (default)
Destination sweeping mode         : Disabled
Liveness detection parameters:
Multiplier                         : 3
Logging state change              : Disabled

```

On-Demand SR Policy

```

Router(config-sr-te)# on-demand color 20
Router(config-sr-te-color)# performance-measurement delay-measurement
Router(config-sr-te-color-delay-meas)# delay-profile name profile2
Router(config-sr-te-color-delay-meas)# commit

```

Running Configuration

```

Router# show run segment-routing traffic-eng on-demand color 20

segment-routing
 traffic-eng
  on-demand color 20
  performance-measurement
  delay-measurement
  delay-profile name profile2

```

Liveness Profile

This example shows how to create a *named* SR performance measurement liveness profile.

```

Router(config)# performance-measurement liveness-profile sr-policy name profile3
Router(config-pm-ld-srpolicy)# probe
Router(config-pm-ld-srpolicy-probe)# burst-interval 60
Router(config-pm-ld-srpolicy-probe)# measurement-mode loopback
Router(config-pm-ld-srpolicy-probe)# tos dscp 10
Router(config-pm-ld-srpolicy-probe)# liveness-detection
Router(config-pm-ld-srpolicy-probe)# multiplier 5
Router(config-pm-ld-srpolicy-probe)# commit

```

Apply the liveness profile for the SR policy

This example shows how to enable PM for SR policy liveness for a specific policy.

For the same policy, you cannot enable delay-measurement (delay-profile) and liveness-detection (liveness-profile) at the same time. For example, if delay measurement is enabled, use the **no delay-measurement** command to disable it, and then enable the following command for enabling liveness detection.

```

Router(config)# segment-routing traffic-eng
Router(config-sr-te)# policy TRST2
Router(config-sr-te-policy)# color 40 end-point ipv4 20.20.20.20
Router(config-sr-te-policy)#candidate-paths
Router(config-sr-te-policy-path)#preference 50
Router(config-sr-te-policy-path-pref)#explicit segment-list LIST3
Router(config-sr-te-pp-info)#weight 2

Router(config-sr-te-policy-path-pref)#explicit segment-list LIST4
Router(config-sr-te-pp-info)#weight 3

Router(config-sr-te-policy)# performance-measurement
Router(config-sr-te-policy-perf-meas)# liveness-detection liveness-profile name profile3

```

Running Configuration

```

Router# show run segment-routing traffic-eng policy TRST2

```

```

segment-routing
traffic-eng
policy TRST2
color 40 end-point ipv4 20.20.20.20
candidate-paths
preference 50
explicit segment-list LIST3
weight 2
!
explicit segment-list LIST4
weight 3
!
!
!
performance-measurement
liveness-detection
liveness-profile name profile3
!

```

Verification

```
Router# show performance-measurement profile named-profile delay sr-policy name profile3
```

```

-----
0/RSP0/CPU0
-----

```

```
SR Policy Liveness Detection Profile Name: profile1
```

```

Profile configuration:
Measurement mode           : Loopback
Protocol type              : TWAMP-light
Type of service:
  TWAMP-light DSCP         : 10
Burst interval             : 60 (effective: 60) mSec
Destination sweeping mode  : Disabled
Liveness detection parameters:
  Multiplier               : 3
  Logging state change     : Disabled

```

```
SR Policy Liveness Detection Profile Name: profile3
```

```

Profile configuration:
Measurement mode           : Loopback
Protocol type              : TWAMP-light
Type of service:
  TWAMP-light DSCP         : 10
Burst interval             : 60 (effective: 60) mSec
Destination sweeping mode  : Disabled
Liveness detection parameters:
  Multiplier               : 3
  Logging state change     : Disabled

```

On-Demand SR Policy

For the same policy, you cannot enable delay-measurement (delay-profile) and liveness-detection (liveness-profile) at the same time. For example, to disable delay measurement, use the **no delay-measurement** command, and then enable the following command for enabling liveness detection.

```

Router(config-sr-te)#on-demand color 30
Router(config-sr-te-color)#performance-measurement
Router(config-sr-te-color-pm)# liveness-detection liveness-profile name profile1
Router(config-sr-te-color-delay-meas)# commit

```

Running Configuration

```
Router# show run segment-routing traffic-eng on-demand color 30

segment-routing
 traffic-eng
  on-demand color 30
  performance-measurement
    liveness-detection
      liveness-profile name profile3
  !
```

Verification

```
Router# show performance-measurement profile named-profile liveness sr-policy name profile3

-----
0/RSP0/CPU0
-----
SR Policy Liveness Detection Profile Name: profile3
Profile configuration:
  Measurement mode                : Loopback
  Protocol type                    : TWAMP-light
  Type of service:
    TWAMP-light DSCP              : 10
  Burst interval                   : 60 (effective: 60) mSec
  Destination sweeping mode       : Disabled
  Liveness detection parameters:
    Multiplier                     : 3
    Logging state change           : Disabled
```



CHAPTER 12

Configure Topology-Independent Loop-Free Alternate (TI-LFA)

Topology-Independent Loop-Free Alternate (TI-LFA) uses segment routing to provide link, node, and Shared Risk Link Groups (SRLG) protection in topologies where other fast reroute techniques cannot provide protection.

- Classic Loop-Free Alternate (LFA) is topology dependent, and therefore cannot protect all destinations in all networks. A limitation of LFA is that, even if one or more LFAs exist, the optimal LFA may not always be provided.
- Remote LFA (RLFA) extends the coverage to 90-95% of the destinations, but it also does not always provide the most desired repair path. RLFA also adds more operational complexity by requiring a targeted LDP session to the RLFAs to protect LDP traffic.

TI-LFA provides a solution to these limitations while maintaining the simplicity of the IPFRR solution.

The goal of TI-LFA is to reduce the packet loss that results while routers converge after a topology change due to a link or node failure. Rapid failure repair (< 50 msec) is achieved through the use of pre-calculated backup paths that are loop-free and safe to use until the distributed network convergence process is completed.

The optimal repair path is the path that the traffic will eventually follow after the IGP has converged. This is called the post-convergence path. This path is preferred for the following reasons:

- Optimal for capacity planning — During the capacity-planning phase of the network, the capacity of a link is provisioned while taking into consideration that such link will be used when other links fail.
- Simple to operate — There is no need to perform a case-by-case adjustments to select the best LFA among multiple candidate LFAs.
- Fewer traffic transitions — Since the repair path is equal to the post-convergence path, the traffic switches paths only once.

The following topology illustrates the optimal and automatic selection of the TI-LFA repair path.

Figure 7: TI-LFA Repair Path

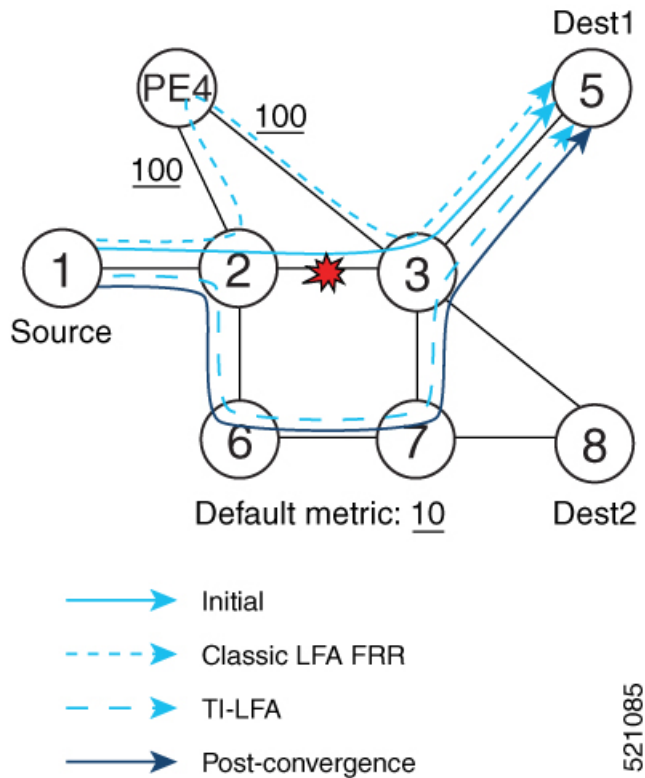

Node 2 protects traffic to destination Node 5.

With classic LFA, traffic would be steered to Node 4 after a failure of the protected link. This path is not optimal, since traffic is routed over edge node Node 4 that is connected to lower capacity links.

TI-LFA calculates a post-convergence path and derives the segment list required to steer packets along the post-convergence path without looping back.

In this example, if the protected link fails, the shortest path from Node 2 to Node 5 would be:

Node 2 → Node 6 → Node 7 → Node 3 → Node 5

Node 7 is the PQ-node for destination Node 5. TI-LFA encodes a single segment (prefix SID of Node 7) in the header of the packets on the repair path.

TI-LFA Protection Types

TI-LFA supports the following protection:

- Link protection — The link is excluded during the post-convergence backup path calculation.
- Node protection — The neighbor node is excluded during the post convergence backup path calculation.
- Shared Risk Link Groups (SRLG) protection — SRLG refer to situations in which links in a network share a common fiber (or a common physical attribute). These links have a shared risk: when one link fails, other links in the group might also fail. TI-LFA SRLG protection attempts to find the post-convergence backup path that excludes the SRLG of the protected link. All local links that share any SRLG with the protecting link are excluded.

When you enable link protection, you can also enable node protection, SRLG protection, or both, and specify a tiebreaker priority in case there are multiple LFAs.

The following example illustrates the link, node, and SRLG protection types. In this topology, Node2 applies different protection models to protect traffic to Node7.

Figure 8: TI-LFA Protection Types

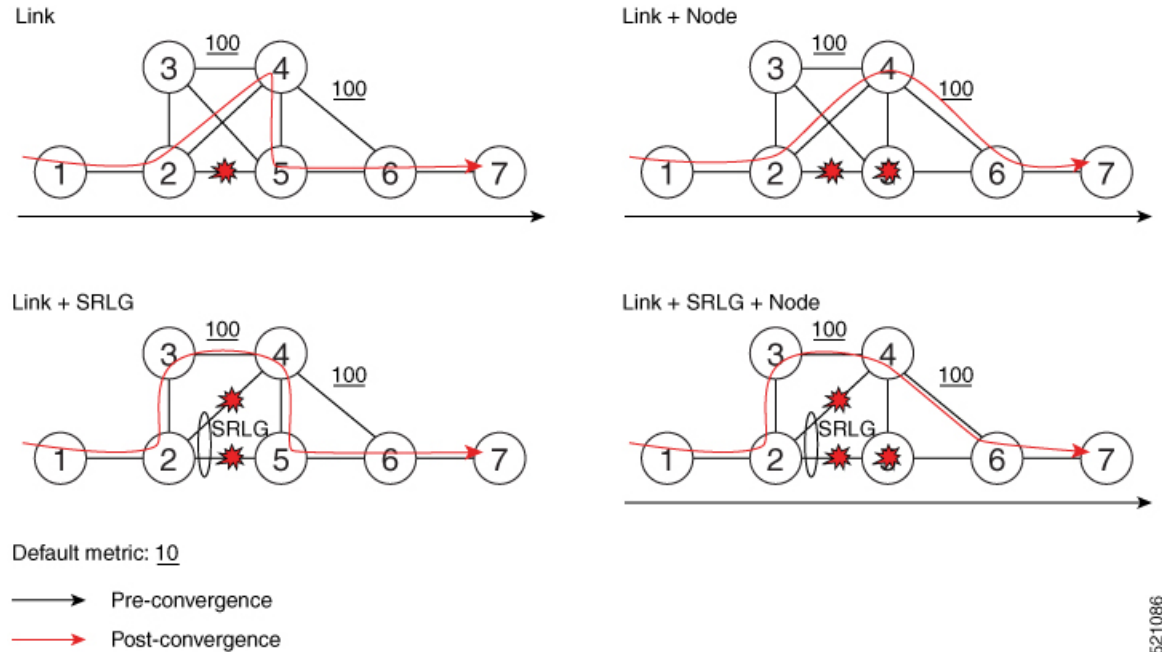

- [Usage Guidelines and Limitations, on page 193](#)
- [Configuring TI-LFA for IS-IS, on page 194](#)
- [Configuring TI-LFA for OSPF, on page 196](#)
- [TI-LFA Node and SRLG Protection: Examples, on page 198](#)
- [Configuring Global Weighted SRLG Protection, on page 199](#)

Usage Guidelines and Limitations

The TI-LFA guidelines and limitations are listed below:

TI-LFA Functionality	IS-IS ¹	OSPFv2
Protected Traffic Types		
Protection for SR labeled traffic	Supported	Supported
Protection of IPv4 unlabeled traffic	Supported (IS-ISv4)	Supported
Protection of IPv6 unlabeled traffic	Unsupported	N/A
Protection Types		
Link Protection	Supported	Supported

TI-LFA Functionality	IS-IS ¹	OSPFv2
Node Protection	Supported	Supported
Local SRLG Protection	Supported	Supported
Weighted Remote SRLG Protection	Supported	Unsupported
Line Card Disjoint Protection	Supported	Unsupported
<i>Interface Types</i>		
Ethernet Interfaces	Supported	Supported
TI-LFA with L3VPN	Supported	Supported
Ethernet Bundle Interfaces	Supported	Supported
TI-LFA over GRE Tunnel as Protecting Interface	Unsupported	Unsupported
Bridge Virtual Interfaces (BVI)	Unsupported	Unsupported
Network Virtualization (nV) Satellite Access Interfaces	Unsupported	Unsupported
<i>Additional Functionality</i>		
BFD-triggered	Supported	Supported
BFDv6-triggered	Supported	N/A
Prefer backup path with lowest total metric	Supported	Supported
Prefer backup path from ECMP set	Supported	Supported
Prefer backup path from non-ECMP set	Supported	Supported
Load share prefixes across multiple backups paths	Supported	Supported
Limit backup computation up to the prefix priority	Supported	Supported

¹ Unless specified, IS-IS support is IS-ISv4 and IS-ISv6

Configuring TI-LFA for IS-IS

This task describes how to enable per-prefix Topology Independent Loop-Free Alternate (TI-LFA) computation to converge traffic flows around link, node, and SRLG failures.

Before you begin

Ensure that the following topology requirements are met:

- Router interfaces are configured as per the topology.
- Routers are configured with IS-IS.
- Segment routing for IS-IS is configured. See [Enabling Segment Routing for IS-IS Protocol, on page 33](#).

SUMMARY STEPS

1. **configure**
2. **router isis** *instance-id*
3. **interface** *type interface-path-id*
4. **address-family ipv4** [**unicast**]
5. **fast-reroute per-prefix**
6. **fast-reroute per-prefix ti-lfa**
7. **fast-reroute per-prefix tiebreaker** {**node-protecting** | **srlg-disjoint**} **index** *priority*

DETAILED STEPS

	Command or Action	Purpose
Step 1	configure Example: <pre>RP/0/RSP0/CPU0:router# configure</pre>	Enters global configuration mode.
Step 2	router isis <i>instance-id</i> Example: <pre>RP/0/RSP0/CPU0:router(config)# router isis 1</pre>	Enables IS-IS routing for the specified routing instance, and places the router in router configuration mode. Note You can change the level of routing to be performed by a particular routing instance by using the is-type router configuration command.
Step 3	interface <i>type interface-path-id</i> Example: <pre>RP/0/RSP0/CPU0:router(config-isis)# interface GigabitEthernet0/0/2/1</pre> <pre>RP/0/RSP0/CPU0:router(config-isis)# interface Bundle-Ether1</pre>	Enters interface configuration mode. Note You can configure TI-LFA under Ethernet-based interfaces and logical Bundle-Ethernet interfaces.
Step 4	address-family ipv4 [unicast] Example: <pre>RP/0/RSP0/CPU0:router(config-isis-if)# address-family ipv4 unicast</pre>	Specifies the IPv4 address family, and enters router address family configuration mode.
Step 5	fast-reroute per-prefix Example: <pre>RP/0/RSP0/CPU0:router(config-isis-if-af)# fast-reroute per-prefix</pre>	Enables per-prefix fast reroute.
Step 6	fast-reroute per-prefix ti-lfa Example:	Enables per-prefix TI-LFA fast reroute link protection.

	Command or Action	Purpose
	RP/0/RSP0/CPU0:router(config-isis-if-af) # fast-reroute per-prefix ti-lfa	
Step 7	fast-reroute per-prefix tiebreaker { node-protecting srlg-disjoint } index <i>priority</i> Example: RP/0/RSP0/CPU0:router(config-isis-if-af) # fast-reroute per-prefix tie-breaker srlg-disjoint index 100	<p>Enables TI-LFA node or SRLG protection and specifies the tiebreaker priority. Valid <i>priority</i> values are from 1 to 255. The lower the <i>priority</i> value, the higher the priority of the rule. Link protection always has a lower priority than node or SRLG protection.</p> <p>Note The same attribute cannot be configured more than once on an interface.</p> <p>Note For IS-IS, TI-LFA node protection and SRLG protection can be configured on the interface or the instance.</p>

TI-LFA has been successfully configured for segment routing.

Configuring TI-LFA for OSPF

This task describes how to enable per-prefix Topology Independent Loop-Free Alternate (TI-LFA) computation to converge traffic flows around link, node, and SRLG failures.



Note TI-LFA can be configured on the instance, area, or interface. When configured on the instance or area, all interfaces in the instance or area inherit the configuration.

Before you begin

Ensure that the following topology requirements are met:

- Router interfaces are configured as per the topology.
- Routers are configured with OSPF.
- Segment routing for OSPF is configured. See [Enabling Segment Routing for OSPF Protocol, on page 53](#).

SUMMARY STEPS

1. **configure**
2. **router ospf *process-name***
3. **area *area-id***
4. **interface *type interface-path-id***
5. **fast-reroute per-prefix**
6. **fast-reroute per-prefix ti-lfa**
7. **fast-reroute per-prefix tiebreaker { node-protecting | srlg-disjoint } index *priority***

DETAILED STEPS

	Command or Action	Purpose
Step 1	configure Example: RP/0/RSP0/CPU0:router# configure	Enters global configuration mode.
Step 2	router ospf process-name Example: RP/0/RSP0/CPU0:router(config)# router ospf 1	Enables OSPF routing for the specified routing process, and places the router in router configuration mode.
Step 3	area area-id Example: RP/0/RSP0/CPU0:router(config-ospf)# area 1	Enters area configuration mode.
Step 4	interface type interface-path-id Example: RP/0/RSP0/CPU0:router(config-ospf-ar)# interface GigabitEthernet0/0/2/1 RP/0/RSP0/CPU0:router(config-ospf-ar)# interface Bundle-Ether1	Enters interface configuration mode. Note You can configure TI-LFA under Ethernet-based interfaces and logical Bundle-Ethernet interfaces.
Step 5	fast-reroute per-prefix Example: RP/0/RSP0/CPU0:router(config-ospf-ar-if)# fast-reroute per-prefix	Enables per-prefix fast reroute.
Step 6	fast-reroute per-prefix ti-lfa Example: RP/0/RSP0/CPU0:router(config-ospf-ar-if)# fast-reroute per-prefix ti-lfa	Enables per-prefix TI-LFA fast reroute link protection.
Step 7	fast-reroute per-prefix tiebreaker {node-protecting srlg-disjoint} index priority Example: RP/0/RSP0/CPU0:router(config-ospf-ar-if)# fast-reroute per-prefix tie-breaker srlg-disjoint index 100	Enables TI-LFA node or SRLG protection and specifies the tiebreaker priority. Valid <i>priority</i> values are from 1 to 255. The higher the <i>priority</i> value, the higher the priority of the rule. Link protection always has a lower priority than node or SRLG protection. Note The same attribute cannot be configured more than once on an interface.

TI-LFA has been successfully configured for segment routing.

TI-LFA Node and SRLG Protection: Examples

The following examples show the configuration of the tiebreaker priority for TI-LFA node and SRLG protection, and the behavior of post-convergence backup-path. These examples use OSPF, but the same configuration and behavior applies to IS-IS.

Example: Enable link-protecting and node-protecting TI-LFA

```
router ospf 1
  area 1
    interface GigabitEthernet0/0/2/1
      fast-reroute per-prefix
      fast-reroute per-prefix ti-lfa
      fast-reroute per-prefix tiebreaker node-protecting index 100
```

Both link-protecting and node-protecting TI-LFA backup paths will be computed. If the priority associated with the node-protecting tiebreaker is higher than any other tiebreakers, then node-protecting post-convergence backup paths will be selected, if it is available.

Example: Enable link-protecting and SRLG-protecting TI-LFA

```
router ospf 1
  area 1
    interface GigabitEthernet0/0/2/1
      fast-reroute per-prefix
      fast-reroute per-prefix ti-lfa
      fast-reroute per-prefix tiebreaker srlg-disjoint index 100
```

Both link-protecting and SRLG-protecting TI-LFA backup paths will be computed. If the priority associated with the SRLG-protecting tiebreaker is higher than any other tiebreakers, then SRLG-protecting post-convergence backup paths will be selected, if it is available.

Example: Enable link-protecting, node-protecting and SRLG-protecting TI-LFA

```
router ospf 1
  area 1
    interface GigabitEthernet0/0/2/1
      fast-reroute per-prefix
      fast-reroute per-prefix ti-lfa
      fast-reroute per-prefix tiebreaker node-protecting index 200
      fast-reroute per-prefix tiebreaker srlg-disjoint index 100
```

Link-protecting, node-protecting, and SRLG-protecting TI-LFA backup paths will be computed. If the priority associated with the node-protecting tiebreaker is highest from all tiebreakers, then node-protecting post-convergence backup paths will be selected, if it is available. If the node-protecting backup path is not available, SRLG-protecting post-convergence backup path will be used, if it is available.

Configuring Global Weighted SRLG Protection

A shared risk link group (SRLG) is a set of links sharing a common resource and thus shares the same risk of failure. The existing loop-free alternate (LFA) implementations in interior gateway protocols (IGPs) support SRLG protection. However, the existing implementation considers only the directly connected links while computing the backup path. Hence, SRLG protection may fail if a link that is not directly connected but shares the same SRLG is included while computing the backup path. Global weighted SRLG protection feature provides better path selection for the SRLG by associating a weight with the SRLG value and using the weights of the SRLG values while computing the backup path.

To support global weighted SRLG protection, you need information about SRLGs on all links in the area topology. For IS-IS, you can flood SRLGs for remote links or manually configuring SRLGs on remote links.

The administrative weight (cost) of the SRLG can be configured using the **admin-weight** command. This command can be applied for all SRLG (global), or for a specific (named) SRLG. The default (global) admin-weight value is 1 for IS-IS.

Configuration Examples: Global Weighted SRLG Protection for IS-IS

There are three types of configurations that are supported for the global weighted SRLG protection feature for IS-IS:

- Local SRLG with global weighted SRLG protection
- Remote SRLG flooding
- Remote SRLG static provisioning

This example shows how to configure the local SRLG with global weighted SRLG protection feature.

```
RP/0/RP0/CPU0:router(config)# srlg
RP/0/RP0/CPU0:router(config-srlg)# interface TenGigE0/0/0/0
RP/0/RP0/CPU0:router(config-srlg-if)# name group1
RP/0/RP0/CPU0:router(config-srlg-if)# exit
RP/0/RP0/CPU0:router(config-srlg)# interface TenGigE0/0/0/1
RP/0/RP0/CPU0:router(config-srlg-if)# name group1
RP/0/RP0/CPU0:router(config-srlg)# exit
RP/0/RP0/CPU0:router(config-srlg)# name group1 value 100
RP/0/RP0/CPU0:router(config-srlg)# exit
RP/0/RP0/CPU0:router(config)# router isis 1
RP/0/RP0/CPU0:router(config-isis)# address-family ipv4 unicast
RP/0/RP0/CPU0:router(config-isis-af)# fast-reroute per-prefix srlg-protection weighted-global
RP/0/RP0/CPU0:router(config-isis-af)# fast-reroute per-prefix tiebreaker srlg-disjoint index
1
RP/0/RP0/CPU0:router(config-isis-af)# exit
RP/0/RP0/CPU0:router(config-isis)# interface TenGigE0/0/0/0
RP/0/RP0/CPU0:router(config-isis-if)# point-to-point
RP/0/RP0/CPU0:router(config-isis-if)# address-family ipv4 unicast
RP/0/RP0/CPU0:router(config-isis-if-af)# fast-reroute per-prefix
RP/0/RP0/CPU0:router(config-isis-if-af)# fast-reroute per-prefix ti-lfa
RP/0/RP0/CPU0:router(config-isis-if-af)# exit
RP/0/RP0/CPU0:router(config-isis-if)# exit
RP/0/RP0/CPU0:router(config-isis)# srlg
RP/0/RP0/CPU0:router(config-isis-srlg)# name group1
RP/0/RP0/CPU0:router(config-isis-srlg-name)# admin-weight 5000
```

This example shows how to configure the global weighted SRLG protection feature with remote SRLG flooding. The configuration includes local and remote router configuration. On the local router, the global weighted SRLG protection is enabled by using the **fast-reroute per-prefix srlg-protection weighted-global** command. In the remote router configuration, you can control the SRLG value flooding by using the **advertise application lfa link-attributes srlg** command. You should also globally configure SRLG on the remote router.

The local router configuration for global weighted SRLG protection with remote SRLG flooding is as follows:

```
RP/0/RP0/CPU0:router(config)# router isis 1
RP/0/RP0/CPU0:router(config-isis)# address-family ipv4 unicast
RP/0/RP0/CPU0:router(config-isis-af)# fast-reroute per-prefix srlg-protection weighted-global
RP/0/RP0/CPU0:router(config-isis-af)# fast-reroute per-prefix tiebreaker srlg-disjoint index
1
RP/0/RP0/CPU0:router(config-isis-af)# exit
RP/0/RP0/CPU0:router(config-isis)# interface TenGigE0/0/0/0
RP/0/RP0/CPU0:router(config-isis-if)# point-to-point
RP/0/RP0/CPU0:router(config-isis-if)# address-family ipv4 unicast
RP/0/RP0/CPU0:router(config-isis-if-af)# fast-reroute per-prefix
RP/0/RP0/CPU0:router(config-isis-if-af)# fast-reroute per-prefix ti-lfa
RP/0/RP0/CPU0:router(config-isis-if-af)# exit
RP/0/RP0/CPU0:router(config-isis-if)# exit
RP/0/RP0/CPU0:router(config-isis)# srlg
RP/0/RP0/CPU0:router(config-isis-srlg)# name group1
RP/0/RP0/CPU0:router(config-isis-srlg-name)# admin-weight 5000
```

The remote router configuration for global weighted SRLG protection with remote SRLG flooding is as follows:

```
RP/0/RP0/CPU0:router(config)# srlg
RP/0/RP0/CPU0:router(config-srlg)# interface TenGigE0/0/0/0
RP/0/RP0/CPU0:router(config-srlg-if)# name group1
RP/0/RP0/CPU0:router(config-srlg-if)# exit
RP/0/RP0/CPU0:router(config-srlg)# interface TenGigE0/0/0/1
RP/0/RP0/CPU0:router(config-srlg-if)# name group1
RP/0/RP0/CPU0:router(config-srlg-if)# exit
RP/0/RP0/CPU0:router(config-srlg)# name group1 value 100
RP/0/RP0/CPU0:router(config-srlg)# exit
RP/0/RP0/CPU0:router(config)# router isis 1
RP/0/RP0/CPU0:router(config-isis)# address-family ipv4 unicast
RP/0/RP0/CPU0:router(config-isis-af)# advertise application lfa link-attributes srlg
```

This example shows configuring the global weighted SRLG protection feature with static provisioning of SRLG values for remote links. You should perform these configurations on the local router.

```
RP/0/RP0/CPU0:router(config)# srlg
RP/0/RP0/CPU0:router(config-srlg)# interface TenGigE0/0/0/0
RP/0/RP0/CPU0:router(config-srlg-if)# name group1
RP/0/RP0/CPU0:router(config-srlg-if)# exit
RP/0/RP0/CPU0:router(config-srlg)# interface TenGigE0/0/0/1
RP/0/RP0/CPU0:router(config-srlg-if)# name group1
RP/0/RP0/CPU0:router(config-srlg-if)# exit
RP/0/RP0/CPU0:router(config-srlg)# name group1 value 100
RP/0/RP0/CPU0:router(config-srlg)# exit
RP/0/RP0/CPU0:router(config)# router isis 1
RP/0/RP0/CPU0:router(config-isis)# address-family ipv4 unicast
RP/0/RP0/CPU0:router(config-isis-af)# fast-reroute per-prefix srlg-protection weighted-global
RP/0/RP0/CPU0:router(config-isis-af)# fast-reroute per-prefix tiebreaker srlg-disjoint index
1
```

```
RP/0/RP0/CPU0:router(config-isis-af)# exit
RP/0/RP0/CPU0:router(config-isis)# interface TenGigE0/0/0/0
RP/0/RP0/CPU0:router(config-isis-if)# point-to-point
RP/0/RP0/CPU0:router(config-isis-if)# address-family ipv4 unicast
RP/0/RP0/CPU0:router(config-isis-if-af)# fast-reroute per-prefix
RP/0/RP0/CPU0:router(config-isis-if-af)# fast-reroute per-prefix ti-lfa
RP/0/RP0/CPU0:router(config-isis-if-af)# exit
RP/0/RP0/CPU0:router(config-isis-if)# exit
RP/0/RP0/CPU0:router(config-isis)# srlg
RP/0/RP0/CPU0:router(config-isis-srlg)# name group1
RP/0/RP0/CPU0:router(config-isis-srlg-name)# admin-weight 5000
RP/0/RP0/CPU0:router(config-isis-srlg-name)# static ipv4 address 10.0.4.1 next-hop ipv4
address 10.0.4.2
RP/0/RP0/CPU0:router(config-isis-srlg-name)# static ipv4 address 10.0.4.2 next-hop ipv4
address 10.0.4.1
```



CHAPTER 13

Configure Segment Routing Microloop Avoidance

The Segment Routing Microloop Avoidance feature enables link-state routing protocols, such as IS-IS, to prevent or avoid microloops during network convergence after a topology change.

- [About Segment Routing Microloop Avoidance, on page 203](#)
- [Configure Segment Routing Microloop Avoidance for IS-IS, on page 205](#)
- [Configure Segment Routing Microloop Avoidance for OSPF, on page 206](#)

About Segment Routing Microloop Avoidance

Microloops (uLoops) are brief packet loops that occur in the network following a topology change (link down, link up, or metric change events). Microloops are caused by the non-simultaneous convergence of different nodes in the network. If a node converges and sends traffic to a neighbor node that has not converged yet, traffic may be looped between these two nodes, resulting in packet loss, jitter, and out-of-order packets.

A router with the Segment Routing Microloop Avoidance feature detects if microloops are possible following a topology change associated with a remote link event. If a node computes that a microloop could occur on the new topology, the node installs a temporary (based on a RIB update delay timer) microloop-avoidant SR-TE policy path to the destination using a list of segments. After the RIB update delay timer expires, the SR-TE policy is replaced with regular forwarding paths.

Consider the following example topology.

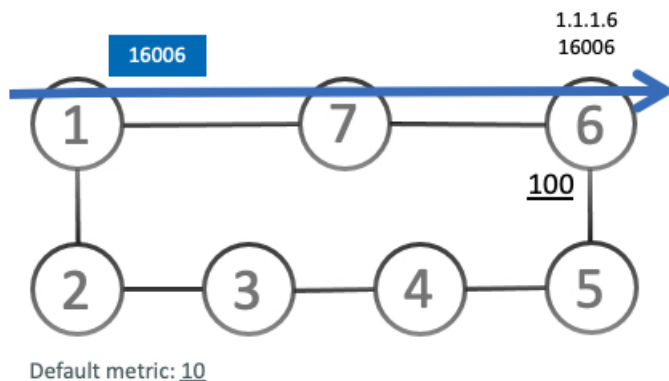

Node1 sends traffic to node 6 (16006) via Node7. Node 7 is configured with TI-LFA to protect traffic to Node6.

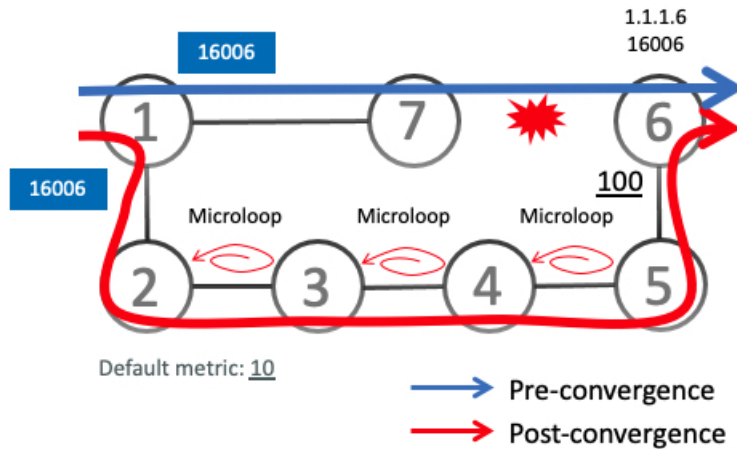

If the link between Node7 and Node6 goes down, TI-LFA on Node7 calculates a new path to Node6 (16006). All nodes are notified of the topology change due to the link failure.

However, if a node in this path does not converge fast enough, it would not be aware of the topology change. For example, if Node2 converged before Node3, Node3 would send traffic back to Node2 as the shortest IGP path to Node6. The traffic between Node2 and Node3 creates a microloop.

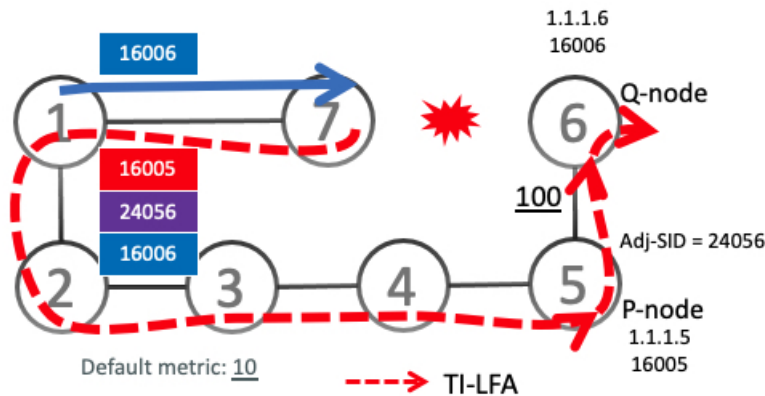

With microloop avoidance configured on Node1, a post-convergence path is computed and possible microloops on the post-convergence path for any destination are detected.

If microloops are possible on the post-convergence path to Node6, a microloop-avoidant SR-TE policy path is constructed to steer the traffic to Node6 over the post-convergence path (for example, <16005, 24056, 16006>).

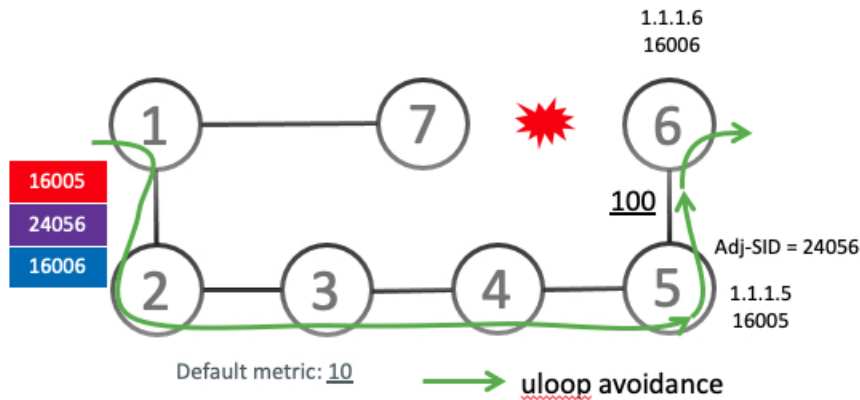

Node1 updates the forwarding table and installs the SID-list imposition entries for those destinations with possible microloops, such as Node6. All nodes converge and update their forwarding tables, using SID lists where needed.

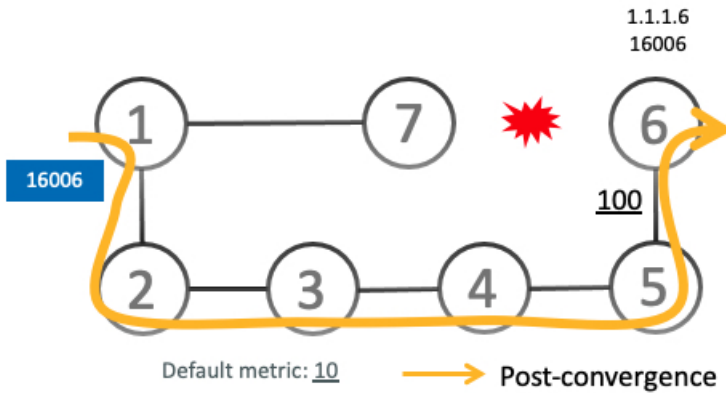

After the RIB update delay timer expires, the microloop-avoidant SR-TE policy is replaced with regular forwarding paths; traffic now natively follows the post-convergence path.

Configure Segment Routing Microloop Avoidance for IS-IS

This task describes how to enable Segment Routing Microloop Avoidance and set the Routing Information Base (RIB) update delay value for IS-IS.

Before you begin

Ensure that the following topology requirements are met:

- Routers are configured with IS-IS.
- Segment routing for IS-IS is configured. See [Enabling Segment Routing for IS-IS Protocol, on page 33](#).

SUMMARY STEPS

1. **configure**
2. **router isis** *instance-id*

3. `address-family ipv4 [unicast]`
4. `microloop avoidance segment-routing`
5. `microloop avoidance rib-update-delay delay-time`

DETAILED STEPS

	Command or Action	Purpose
Step 1	configure Example: RP/0/RSP0/CPU0:router# <code>configure</code>	Enters global configuration mode.
Step 2	router isis <i>instance-id</i> Example: RP/0/RSP0/CPU0:router(config)# <code>router isis 1</code>	Enables IS-IS routing for the specified routing instance, and places the router in router configuration mode. You can change the level of routing to be performed by a particular routing instance by using the is-type router configuration command.
Step 3	address-family ipv4 [unicast] Example: RP/0/RSP0/CPU0:router(config-isis)# <code>address-family ipv4 unicast</code>	Specifies the IPv4 address family and enters router address family configuration mode.
Step 4	microloop avoidance segment-routing Example: RP/0/RSP0/CPU0:router(config-isis-af)# <code>microloop avoidance segment-routing</code>	Enables Segment Routing Microloop Avoidance.
Step 5	microloop avoidance rib-update-delay <i>delay-time</i> Example: RP/0/RSP0/CPU0:router(config-isis-af)# <code>microloop avoidance rib-update-delay 3000</code>	Specifies the amount of time the node uses the microloop avoidance policy before updating its forwarding table. The <i>delay-time</i> is in milliseconds. The range is from 1-60000. The default value is 5000.

Configure Segment Routing Microloop Avoidance for OSPF

This task describes how to enable Segment Routing Microloop Avoidance and set the Routing Information Base (RIB) update delay value for OSPF.

Before you begin

Ensure that the following topology requirements are met:

- Routers are configured with OSPF.
- Segment routing for OSPF is configured. See [Enabling Segment Routing for OSPF Protocol, on page 53](#).

SUMMARY STEPS

1. **configure**
2. **router ospf** *process-name*
3. **microloop avoidance segment-routing**
4. **microloop avoidance rib-update-delay** *delay-time*

DETAILED STEPS

	Command or Action	Purpose
Step 1	configure Example: RP/0/RSP0/CPU0:router# configure	Enters global configuration mode.
Step 2	router ospf <i>process-name</i> Example: RP/0/RSP0/CPU0:router(config)# router ospf 1	Enables OSPF routing for the specified routing process, and places the router in router configuration mode.
Step 3	microloop avoidance segment-routing Example: RP/0/RSP0/CPU0:router(config-ospf)# microloop avoidance segment-routing	Enables Segment Routing Microloop Avoidance.
Step 4	microloop avoidance rib-update-delay <i>delay-time</i> Example: RP/0/RSP0/CPU0:router(config-ospf)# microloop avoidance rib-update-delay 3000	Specifies the amount of time the node uses the microloop avoidance policy before updating its forwarding table. The <i>delay-time</i> is in milliseconds. The range is from 1-60000. The default value is 5000.



CHAPTER 14

Configure Segment Routing Mapping Server

The mapping server is a key component of the interworking between LDP and segment routing. It enables SR-capable nodes to interwork with LDP nodes. The mapping server advertises Prefix-to-SID mappings in IGP on behalf of other non-SR-capable nodes.

- [Segment Routing Mapping Server, on page 209](#)
- [Segment Routing and LDP Interoperability, on page 210](#)
- [Configuring Mapping Server, on page 213](#)
- [Enable Mapping Advertisement, on page 215](#)
- [Enable Mapping Client, on page 217](#)

Segment Routing Mapping Server

The mapping server functionality in Cisco IOS XR segment routing centrally assigns prefix-SIDs for some or all of the known prefixes. A router must be able to act as a mapping server, a mapping client, or both.

- A router that acts as a mapping server allows the user to configure SID mapping entries to specify the prefix-SIDs for some or all prefixes. This creates the local SID-mapping policy. The local SID-mapping policy contains non-overlapping SID-mapping entries. The mapping server advertises the local SID-mapping policy to the mapping clients.
- A router that acts as a mapping client receives and parses remotely received SIDs from the mapping server to create remote SID-mapping entries.
- A router that acts as a mapping server and mapping client uses the remotely learnt and locally configured mapping entries to construct the non-overlapping consistent active mapping policy. IGP instance uses the active mapping policy to calculate the prefix-SIDs of some or all prefixes.

The mapping server automatically manages the insertions and deletions of mapping entries to always yield an active mapping policy that contains non-overlapping consistent SID-mapping entries.

- Locally configured mapping entries must not overlap each other.
- The mapping server takes the locally configured mapping policy, as well as remotely learned mapping entries from a particular IGP instance, as input, and selects a single mapping entry among overlapping mapping entries according to the preference rules for that IGP instance. The result is an active mapping policy that consists of non-overlapping consistent mapping entries.
- At steady state, all routers, at least in the same area or level, must have identical active mapping policies.

Usage Guidelines and Restrictions

- The position of the mapping server in the network is not important. However, since the mapping advertisements are distributed in IGP using the regular IGP advertisement mechanism, the mapping server needs an IGP adjacency to the network.
- The role of the mapping server is crucial. For redundancy purposes, you should configure multiple mapping servers in the networks.
- The mapping server functionality does not support a scenario where SID-mapping entries learned through one IS-IS instance are used by another IS-IS instance to determine the prefix-SID of a prefix. For example, mapping entries learnt from remote routers by 'router isis 1' cannot be used to calculate prefix-SIDs for prefixes learnt, advertised, or downloaded to FIB by 'router isis 2'. A mapping server is required for each IS-IS instance.
- Segment Routing Mapping Server does not support Virtual Routing and Forwarding (VRF) currently.

Segment Routing and LDP Interoperability

IGP provides mechanisms through which segment routing (SR) interoperates with label distribution protocol (LDP). The control plane of segment routing co-exists with LDP.

The Segment Routing Mapping Server (SRMS) functionality in SR is used to advertise SIDs for destinations, in the LDP part of the network, that do not support SR. SRMS maintains and advertises segment identifier (SID) mapping entries for such destinations. IGP propagates the SRMS mapping entries and interacts with SRMS to determine the SID value when programming the forwarding plane. IGP installs prefixes and corresponding labels, into routing information base (RIB), that are used to program the forwarding information base (FIB).

Example: Segment Routing LDP Interoperability

Consider a network with a mix of segment routing (SR) and label distribution protocol (LDP). A continuous multiprotocol label switching (MPLS) LSP (Labeled Switched Path) can be established by facilitating interoperability. One or more nodes in the SR domain act as segment routing mapping server (SRMS). SRMS advertises SID mappings on behalf of non-SR capable nodes. Each SR-capable node learns about SID assigned to non-SR capable nodes without explicitly configuring individual nodes.

Consider a network as shown in the following figure. This network is a mix of both LDP and SR-capable nodes.

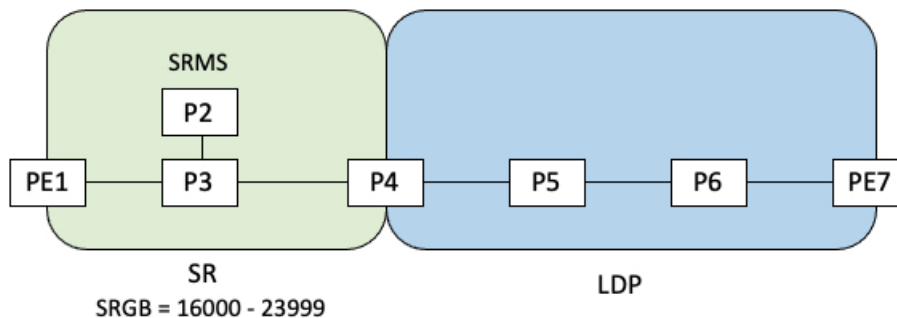

In this mixed network:

- Nodes PE1, P2, P3, and P4 are SR-capable
- Nodes P4, P5, P6, and PE7 are LDP-capable
- Nodes PE1, P2, P3, and P4 are configured with segment routing global block (SRGB) range of 16000 to 23999
- Nodes PE1, P2, P3, and P4 are configured with node segments of 16001, 16002, 16003, and 16004 respectively

A service flow must be established from PE1 to PE3 over a continuous MPLS tunnel. This requires SR and LDP to interoperate.

LDP-to-SR Traffic Direction

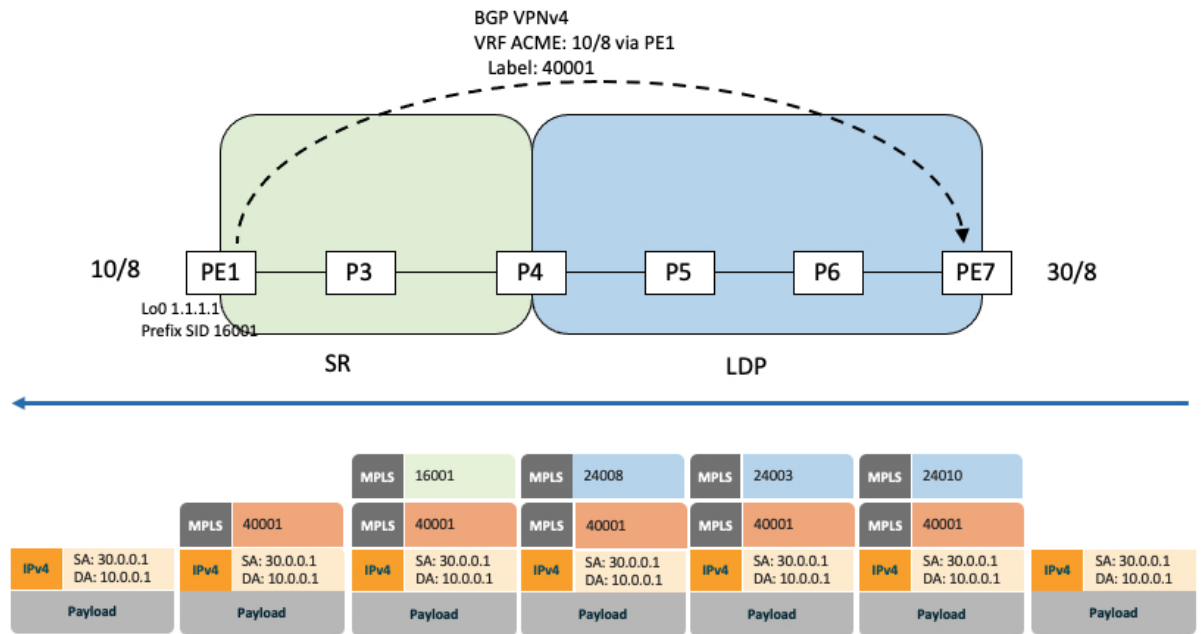

The traffic flow in the LDP-to-SR direction involves the following:

1. PE7 learns a service route with service label 40001 and BGP nhop PE1.
2. PE7 has an LDP label binding (24010) from the nhop P6 for the FEC PE1. PE7 forwards the packet to P6.
3. P6 has an LDP label binding (24003) from its nhop P5 for the FEC PE1. P6 forwards the packet to P5.
4. P5 has an LDP label binding (24008) from its nhop P4 for the FEC PE1. P5 forwards the packet to P4.
5. P4 does not have an LDP binding from its nhop P3 for the FEC PE1. But P4 has an SR node segment to the IGP route PE1. P4 forwards the packet to P3 and swaps its local LDP label (24008) for FEC PE1 by the equivalent node segment 16001. This process is called label merging.
6. P3 pops 16001, assuming PE1 has advertised its node segment 16001 with the penultimate-pop flag set and forwards to PE1.

7. PE1 receives the packet and processes the service label.

The end-to-end MPLS LSP is established from an LDP LSP from PE7 to P4 and the related node segment from P4 to PE1.

SR-to-LDP Traffic Direction

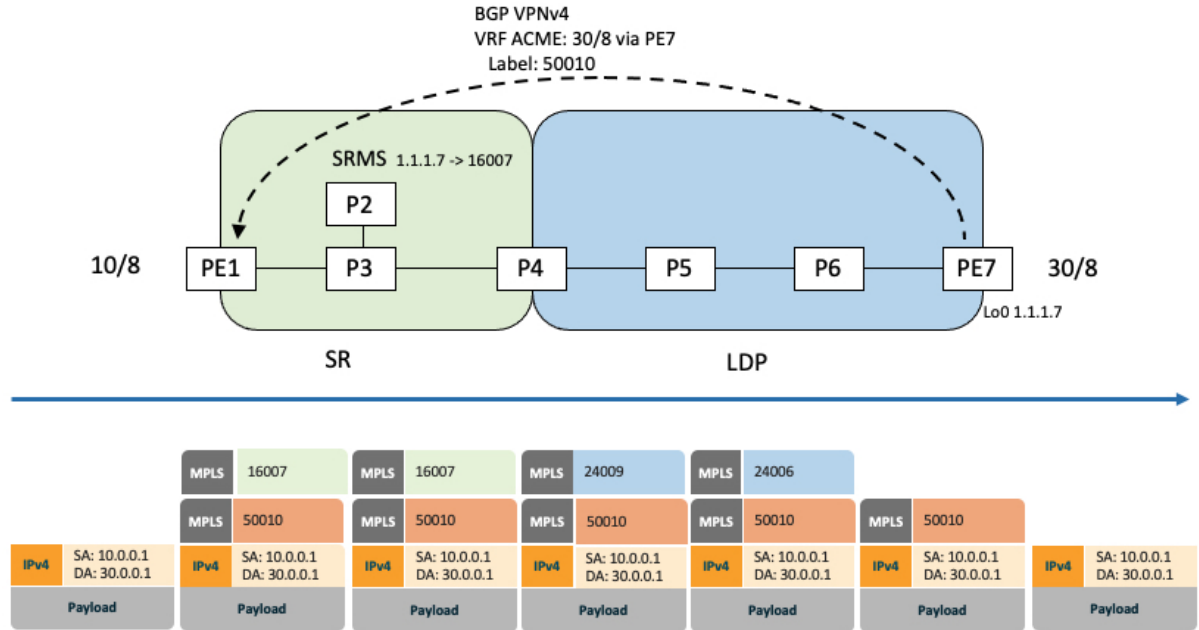

Suppose that the operator configures P2 as a Segment Routing Mapping Server (SRMS) and advertises the mappings (1.1.1.7, 16007 for PE7). Because PE7 is non-SR capable, the operator configures that mapping policy at the SRMS; the SRMS advertises the mapping on behalf of the non-SR capable nodes. Multiple SRMS servers can be provisioned in a network for redundancy. The mapping server advertisements are only understood by the SR-capable nodes. The SR-capable routers install the related node segments in the MPLS data plane in exactly the same manner as if node segments were advertised by the nodes themselves.

The traffic flow in the SR to LDP direction involves the following:

1. PE1 learns a service route with service label 50010 and BGP nhop PE7.
2. PE1 has an SR label binding (16007) learned from the SRMS (P2) for PE7.
3. PE1 installs the node segment 16007 following the IGP shortest-path with nhop P3.
4. P3 swaps 16007 for 16007 and forwards to P4.
5. The nhop for P4 for the IGP route PE7 is non-SR capable, since P5 does not advertise the SR capability. However, P4 has an LDP label binding from that nhop for the same FEC (for example, LDP label 24009). P4 would then swap 16007 for 24009 and forward to P5. We refer to this process as label merging.
6. P5 swaps this label with the LDP label received from P6 (for example, LDP label 24006) and forwards to P6.
7. P6 pops the LDP label and forwards to PE7.
8. PE7 receives the packet and processes the service label.

The end-to-end MPLS LSP is established from an SR node segment from PE1 to P4 and an LDP LSP from P4 to PE7.

Observe that the capabilities provided by the SRMS are only required in the SR-to-LDP direction.

Configuring Mapping Server

Perform these tasks to configure the mapping server and to add prefix-SID mapping entries in the active local mapping policy.

SUMMARY STEPS

1. **configure**
2. **segment-routing**
3. **mapping-server**
4. **prefix-sid-map**
5. **address-family ipv4 | ipv6**
6. *ip-address/prefix-length first-SID-value range range*
7. Use the **commit** or **end** command.

DETAILED STEPS

	Command or Action	Purpose
Step 1	configure Example: RP/0/RSP0/CPU0:router# configure	Enters global configuration mode.
Step 2	segment-routing Example: RP/0/RSP0/CPU0:router(config)# segment-routing	Enables segment routing.
Step 3	mapping-server Example: RP/0/RSP0/CPU0:router(config-sr)# mapping-server	Enables mapping server configuration mode.
Step 4	prefix-sid-map Example: RP/0/RSP0/CPU0:router(config-sr-ms)# prefix-sid-map	Enables prefix-SID mapping configuration mode. Note Two-way prefix SID can be enabled directly under IS-IS or through a mapping server.
Step 5	address-family ipv4 ipv6 Example: This example shows the address-family for ipv4:	Configures address-family for IS-IS.

	Command or Action	Purpose
	<pre>RP/0/RSP0/CPU0:router(config-sr-ms-map)# address-family ipv4</pre> <p>This example shows the address-family for ipv6:</p> <pre>RP/0/RSP0/CPU0:router(config-sr-ms-map)# address-family ipv6</pre>	
Step 6	<p><i>ip-address/prefix-length first-SID-value range range</i></p> <p>Example:</p> <pre>RP/0/RSP0/CPU0:router(config-sr-ms-map-af)# 10.1.1.1/32 10 range 200 RP/0/RSP0/CPU0:router(config-sr-ms-map-af)# 20.1.0.0/16 400 range 300</pre>	<p>Adds SID-mapping entries in the active local mapping policy. In the configured example:</p> <ul style="list-style-type: none"> • Prefix 10.1.1.1/32 is assigned prefix-SID 10, prefix 10.1.1.2/32 is assigned prefix-SID 11,..., prefix 10.1.1.199/32 is assigned prefix-SID 200 • Prefix 20.1.0.0/16 is assigned prefix-SID 400, prefix 20.2.0.0/16 is assigned prefix-SID 401,..., and so on.
Step 7	Use the commit or end command.	<p>commit —Saves the configuration changes and remains within the configuration session.</p> <p>end —Prompts user to take one of these actions:</p> <ul style="list-style-type: none"> • Yes — Saves configuration changes and exits the configuration session. • No —Exits the configuration session without committing the configuration changes. • Cancel —Remains in the configuration session, without committing the configuration changes.

Verify information about the locally configured prefix-to-SID mappings.



Note Specify the address family for IS-IS.

```
RP/0/RSP0/CPU0:router# show segment-routing mapping-server prefix-sid-map ipv4
Prefix          SID Index  Range  Flags
20.1.1.0/24     400        300
10.1.1.1/32     10         200
```

Number of mapping entries: 2

```
RP/0/RSP0/CPU0:router# show segment-routing mapping-server prefix-sid-map ipv4 detail
Prefix
20.1.1.0/24
  SID Index:      400
  Range:          300
  Last Prefix:    20.2.44.0/24
  Last SID Index: 699
  Flags:
10.1.1.1/32
```



```

SID Index:      10
Range:         200
Last Prefix:   10.1.1.200/32
Last SID Index: 209
Flags:

```

Number of mapping entries: 2

What to do next

Enable the advertisement of the local SID-mapping policy in the IGP.

Enable Mapping Advertisement

In addition to configuring the static mapping policy, you must enable the advertisement of the mappings in the IGP.

Perform these steps to enable the IGP to advertise the locally configured prefix-SID mapping.

Configure Mapping Advertisement for IS-IS

SUMMARY STEPS

1. `router isis instance-id`
2. `address-family { ipv4 | ipv6 } [unicast]`
3. `segment-routing prefix-sid-map advertise-local`
4. Use the `commit` or `end` command.

DETAILED STEPS

	Command or Action	Purpose
Step 1	<p><code>router isis <i>instance-id</i></code></p> <p>Example:</p> <pre>RP/0/RSP0/CPU0:router(config)# router isis 1</pre>	<p>Enables IS-IS routing for the specified routing instance, and places the router in router configuration mode.</p> <ul style="list-style-type: none"> You can change the level of routing to be performed by a particular routing instance by using the is-type router configuration command.
Step 2	<p><code>address-family { ipv4 ipv6 } [unicast]</code></p> <p>Example:</p> <p>The following is an example for ipv4 address family:</p> <pre>RP/0/RSP0/CPU0:router(config-isis)# address-family ipv4 unicast</pre>	<p>Specifies the IPv4 or IPv6 address family, and enters router address family configuration mode.</p>
Step 3	<p><code>segment-routing prefix-sid-map advertise-local</code></p> <p>Example:</p>	<p>Configures IS-IS to advertise locally configured prefix-SID mappings.</p>

	Command or Action	Purpose
	RP/0/RSP0/CPU0:router(config-isis-af)# segment-routing prefix-sid-map advertise-local	
Step 4	Use the commit or end command.	<p>commit —Saves the configuration changes and remains within the configuration session.</p> <p>end —Prompts user to take one of these actions:</p> <ul style="list-style-type: none"> • Yes — Saves configuration changes and exits the configuration session. • No —Exits the configuration session without committing the configuration changes. • Cancel —Remains in the configuration session, without committing the configuration changes.

Verify IS-IS prefix-SID mapping advertisement and TLV.

```
RP/0/RSP0/CPU0:router# show isis database verbose
<...removed...>
SID Binding: 10.1.1.1/32 F:0 M:0 S:0 D:0 A:0 Weight:0 Range:200
SID: Start:10, Algorithm:0, R:0 N:0 P:0 E:0 V:0 L:0
SID Binding: 20.1.1.0/24 F:0 M:0 S:0 D:0 A:0 Weight:0 Range:300
SID: Start:400, Algorithm:0, R:0 N:0 P:0 E:0 V:0 L:0
```

Configure Mapping Advertisement for OSPF

SUMMARY STEPS

1. **router ospf** *process-name*
2. **segment-routing prefix-sid-map advertise-local**
3. Use the **commit** or **end** command.

DETAILED STEPS

	Command or Action	Purpose
Step 1	<p>router ospf <i>process-name</i></p> <p>Example:</p> <pre>RP/0/RSP0/CPU0:router(config)# router ospf 1</pre>	Enables OSPF routing for the specified routing instance, and places the router in router configuration mode.
Step 2	<p>segment-routing prefix-sid-map advertise-local</p> <p>Example:</p>	Configures OSPF to advertise locally configured prefix-SID mappings.

	Command or Action	Purpose
	RP/0/RSP0/CPU0:router(config-ospf)# segment-routing prefix-sid-map advertise-local	
Step 3	Use the commit or end command.	<p>commit —Saves the configuration changes and remains within the configuration session.</p> <p>end —Prompts user to take one of these actions:</p> <ul style="list-style-type: none"> • Yes — Saves configuration changes and exits the configuration session. • No —Exits the configuration session without committing the configuration changes. • Cancel —Remains in the configuration session, without committing the configuration changes.

Verify OSP prefix-SID mapping advertisement and TLV.

```
RP/0/RSP0/CPU0:router# show ospf database opaque-area
<...removed...>

Extended Prefix Range TLV: Length: 24
  AF      : 0
  Prefix  : 10.1.1.1/32
  Range Size: 200
  Flags   : 0x0

SID sub-TLV: Length: 8
  Flags   : 0x60
  MTID    : 0
  Algo    : 0
  SID Index : 10
```

Enable Mapping Client

By default, mapping client functionality is enabled.

You can disable the mapping client functionality by using the **segment-routing prefix-sid-map receive disable** command.

You can re-enable the mapping client functionality by using the **segment-routing prefix-sid-map receive** command.

The following example shows how to enable the mapping client for IS-IS:

```
RP/0/RSP0/CPU0:router(config)# router isis 1
RP/0/RSP0/CPU0:router(config-isis)# address-family ipv4 unicast
RP/0/RSP0/CPU0:router(config-isis-af)# segment-routing prefix-sid-map receive
```

The following example shows how to enable the mapping client for OSPF:

```
RP/0/RSP0/CPU0:router(config)# router ospf 1  
RP/0/RSP0/CPU0:router(config-ospf)# segment-routing prefix-sid-map receive
```



CHAPTER 15

Using Segment Routing Traffic Matrix

This module provides information about the Segment Routing Traffic Matrix (SR-TM) and the Traffic Collector process, and describes how to configure the TM border and the Traffic Collector and to display traffic information.

- [Segment Routing Traffic Matrix, on page 219](#)
- [Traffic Collector Process, on page 219](#)
- [Configuring Traffic Collector, on page 220](#)
- [Displaying Traffic Information, on page 222](#)

Segment Routing Traffic Matrix

A network's traffic matrix is a description, measure, or estimation of the aggregated traffic flows that enter, traverse, and leave a network.

The Segment Routing Traffic Matrix (SR-TM) is designed to help users understand traffic patterns on a router. The Traffic Matrix border divides the network into two parts: internal (interfaces that are inside the border) and external (interfaces that are outside the border). By default, all interfaces are internal. You can configure an interface as external.

Traffic Collector Process

The Traffic Collector collects packet and byte statistics from router components such as prefix counters, tunnel counters, and the TM counter. The TM counter increments when traffic that comes from an external interface to the network is destined for a segment routing prefix-SID. The Traffic Collector keeps histories of the statistics and makes them persistent across process restarts, failovers, and ISSU. Histories are retained for a configurable length of time.

Pcounters

A Pcounter is a packet and byte pair of counters. There is one Pcounter per tunnel. There are two Pcounters per prefix-SID:

- Base Pcounter – any packet that is switched on the prefix-SID forwarding information base (FIB) entry
- TM Pcounter – any packet from an external interface and switched on the prefix-SID FIB entry

The Traffic Collector periodically collects the Base Pcounters and TM Pcounters of all prefix-SIDs, and the Pcounters of all tunnel interfaces.

For each Pcounter, the Traffic Collector calculates the number of packets and bytes that have been forwarded during the last interval. The Traffic Collector keeps a history of the per-interval statistics for each of the Pcounters. Each entry in the history contains:

- The start and end time of the interval
- The number of packets forwarded during the interval
- The number of bytes forwarded during the interval

Feature Support and Limitations

- Pcounters for IPv4 SR Prefix SIDs are supported.
- Pcounters for IPv6 SR Prefix SIDs are not supported.
- TM Pcounters increment for incoming SR-labeled, LDP-labeled, and IP traffic destined for an SR Prefix SID.
- External interface support can be enabled on all Ethernet interfaces except Management, Bundle, and sub interfaces. Tunnels may not be set as external interfaces.
- Default VRF is supported. Non-default VRF is not supported.

Configuring Traffic Collector

Perform these tasks to configure the traffic collector.

SUMMARY STEPS

1. **configure**
2. **traffic-collector**
3. **statistics collection-interval** *value*
4. **statistics history-size** *value*
5. **statistics history-timeout** *value*
6. **interface** *type l3-interface-address*
7. Use the **commit** or **end** command.

DETAILED STEPS

	Command or Action	Purpose
Step 1	configure Example: RP/0/RSP0/CPU0:router# <code>configure</code>	Enters global configuration mode.

	Command or Action	Purpose
Step 2	traffic-collector Example: <pre>RP/0/RP0/CPU0:router(config)# traffic-collector</pre>	Enables traffic collector and places the router in traffic collector configuration mode.
Step 3	statistics collection-interval value Example: <pre>RP/0/RP0/CPU0:router(config-tc)# statistics collection-interval 5</pre>	(Optional) Sets the frequency that the traffic collector collects and posts data, in minutes. Valid values are 1, 2, 3, 4, 5, 6, 10, 12, 15, 20, 30, and 60. The default interval is 1.
Step 4	statistics history-size value Example: <pre>RP/0/RP0/CPU0:router(config-tc)# statistics history-size 10</pre>	(Optional) Specifies the number of entries kept in the history database. Valid values are from 1 to 10. The default is 5. Note The number of entries affects how the average packet and average byte rates are calculated. The rates are calculated over the range of the histories and are not averages based in real time.
Step 5	statistics history-timeout value Example: <pre>RP/0/RP0/CPU0:router(config-tc)# statistics history-timeout 24</pre>	(Optional) When a prefix SID or a tunnel-te interface is deleted, the history-timeout sets the length of time, in hours, that the prefix SID and tunnel statistics are retained in the history before they are removed. The minimum is one hour; the maximum is 720 hours. The default is 48. Note Enter 0 to disable the history timeout. (No history is retained.)
Step 6	interface type l3-interface-address Example: <pre>RP/0/RP0/CPU0:router(config-tc)# interface TenGigE 0/1/0/3</pre>	Identifies interfaces that handle external traffic. Only L3 interfaces are supported for external traffic.
Step 7	Use the commit or end command.	commit —Saves the configuration changes and remains within the configuration session. end —Prompts user to take one of these actions: <ul style="list-style-type: none"> • Yes — Saves configuration changes and exits the configuration session. • No —Exits the configuration session without committing the configuration changes. • Cancel —Remains in the configuration session, without committing the configuration changes.

This completes the configuration for the traffic collector.

Displaying Traffic Information

The following show commands display information about the interfaces and tunnels:



Note For detailed information about the command syntax for the following **show** commands, see the *Segment Routing Command Reference Guide*.

- Display the configured external interfaces:

```
RP/0/RSP0/CPU0:router# show traffic-collector external-interface
Interface          Status
-----
Te0/1/0/3          Enabled
Te0/1/0/4          Enabled
```

- Display the counter history database for a prefix-SID:

```
RP/0/RSP0/CPU0:router# show traffic-collector ipv4 counters prefix 10.1.1.10/32 detail
Prefix: 10.1.1.10/32 Label: 16010 State: Active
Base:
  Average over the last 5 collection intervals:
    Packet rate: 9496937 pps, Byte rate: 9363979882 Bps

  History of counters:
    23:01 - 23:02: Packets 9379529, Bytes: 9248215594
    23:00 - 23:01: Packets 9687124, Bytes: 9551504264
    22:59 - 23:00: Packets 9539200, Bytes: 9405651200
    22:58 - 22:59: Packets 9845278, Bytes: 9707444108
    22:57 - 22:58: Packets 9033554, Bytes: 8907084244

TM Counters:
  Average over the last 5 collection intervals:
    Packet rate: 9528754 pps, Byte rate: 9357236821 Bps

  History of counters:
    23:01 - 23:02: Packets 9400815, Bytes: 9231600330
    23:00 - 23:01: Packets 9699455, Bytes: 9524864810
    22:59 - 23:00: Packets 9579889, Bytes: 9407450998
    22:58 - 22:59: Packets 9911734, Bytes: 9733322788
    22:57 - 22:58: Packets 9051879, Bytes: 8888945178
```

This output shows the average Pcounter (packets, bytes), the Pcounter history, and the collection interval of the Base and TM for the specified prefix-SID.

- Display the counter history database for a policy:

```
RP/0/RSP0/CPU0:router# show traffic-collector counters tunnels srte_c_12_ep_6.6.6.2
detail
Tunnel: srte_c_12_ep_6.6.6.2 State: Active
  Average over the last 5 collection intervals:
    Packet rate: 9694434 pps, Byte rate: 9597489858 Bps
```

History of counters:

```
23:14 - 23:15: Packets 9870522 , Bytes: 9771816780
23:13 - 23:14: Packets 9553048 , Bytes: 9457517520
23:12 - 23:13: Packets 9647265 , Bytes: 9550792350
23:11 - 23:12: Packets 9756654 , Bytes: 9659087460
23:10 - 23:11: Packets 9694434 , Bytes: 9548235180
```

This output shows the average Pcounter (packets, bytes), the Pcounter history, and the collection interval for the policy.



CHAPTER 16

Using Segment Routing OAM

Segment Routing Operations, Administration, and Maintenance (OAM) helps service providers to monitor label-switched paths (LSPs) and quickly isolate forwarding problems to assist with fault detection and troubleshooting in the network. The Segment Routing OAM feature provides support for BGP prefix SIDs, IGP prefix SIDs, and Nil-FEC (forwarding equivalence classes) LSP Ping and Traceroute functionality.

- [MPLS Ping and Traceroute for BGP and IGP Prefix-SID, on page 225](#)
- [Examples: MPLS Ping, Traceroute, and Tree Trace for Prefix-SID, on page 226](#)
- [MPLS LSP Ping and Traceroute Nil FEC Target, on page 228](#)
- [Examples: LSP Ping and Traceroute for Nil_FEC Target, on page 228](#)
- [Segment Routing Ping and Traceroute, on page 230](#)
- [Segment Routing Policy Nil-FEC Ping and Traceroute, on page 234](#)
- [Segment Routing over IPv6 OAM, on page 236](#)

MPLS Ping and Traceroute for BGP and IGP Prefix-SID

MPLS Ping and Traceroute operations for Prefix SID are supported for various BGP and IGP scenarios, for example:

- Within an IS-IS level or OSPF area
- Across IS-IS levels or OSPF areas
- Route redistribution from IS-IS to OSPF and from OSPF to IS-IS
- Anycast Prefix SID
- Combinations of BGP and LDP signaled LSPs

The MPLS LSP Ping feature is used to check the connectivity between ingress Label Switch Routers (LSRs) and egress LSRs along an LSP. MPLS LSP ping uses MPLS echo request and reply messages, similar to Internet Control Message Protocol (ICMP) echo request and reply messages, to validate an LSP. The destination IP address of the MPLS echo request packet is different from the address used to select the label stack. The destination IP address is defined as a 127.x.y.z/8 address and it prevents the IP packet from being IP switched to its destination, if the LSP is broken.

The MPLS LSP Traceroute feature is used to isolate the failure point of an LSP. It is used for hop-by-hop fault localization and path tracing. The MPLS LSP Traceroute feature relies on the expiration of the Time to Live (TTL) value of the packet that carries the echo request. When the MPLS echo request message hits a

transit node, it checks the TTL value and if it is expired, the packet is passed to the control plane, else the message is forwarded. If the echo message is passed to the control plane, a reply message is generated based on the contents of the request message.

The MPLS LSP Tree Trace (traceroute multipath) operation is also supported for BGP and IGP Prefix SID. MPLS LSP Tree Trace provides the means to discover all possible equal-cost multipath (ECMP) routing paths of an LSP to reach a destination Prefix SID. It uses multipath data encoded in echo request packets to query for the load-balancing information that may allow the originator to exercise each ECMP. When the packet TTL expires at the responding node, the node returns the list of downstream paths, as well as the multipath information that can lead the operator to exercise each path in the MPLS echo reply. This operation is performed repeatedly for each hop of each path with increasing TTL values until all ECMP are discovered and validated.

MPLS echo request packets carry Target FEC Stack sub-TLVs. The Target FEC sub-TLVs are used by the responder for FEC validation. The BGP and IGP IPv4 prefix sub-TLV has been added to the Target FEC Stack sub-TLV. The IGP IPv4 prefix sub-TLV contains the prefix SID, the prefix length, and the protocol (IS-IS or OSPF). The BGP IPv4 prefix sub-TLV contains the prefix SID and the prefix length.

Examples: MPLS Ping, Traceroute, and Tree Trace for Prefix-SID

These examples use the following topology:

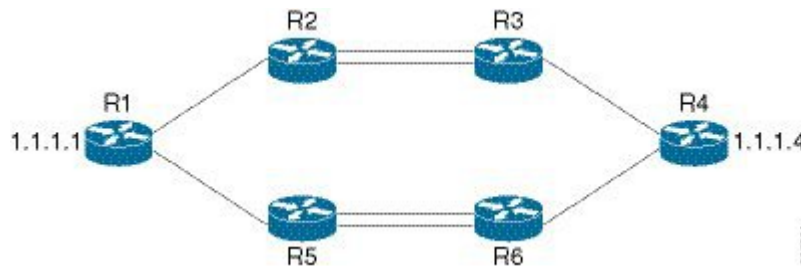

MPLS Ping for Prefix-SID

```
RP/0/RSP0/CPU0:router-arizona# ping mpls ipv4 10.1.1.4/32
Thu Dec 17 01:01:42.301 PST
```

```
Sending 5, 100-byte MPLS Echos to 10.1.1.4,
  timeout is 2 seconds, send interval is 0 msec:
```

```
Codes: '!' - success, 'Q' - request not sent, '.' - timeout,
'L' - labeled output interface, 'B' - unlabeled output interface,
'D' - DS Map mismatch, 'F' - no FEC mapping, 'f' - FEC mismatch,
'M' - malformed request, 'm' - unsupported tlvs, 'N' - no rx label,
'P' - no rx intf label prot, 'p' - premature termination of LSP,
'R' - transit router, 'I' - unknown upstream index,
'X' - unknown return code, 'x' - return code 0
```

Type escape sequence to abort.

```
!!!!
Success rate is 100 percent (5/5), round-trip min/avg/max = 2/2/3 ms
```

MPLS Traceroute for Prefix-SID

```
RP/0/RSP0/CPU0:router-arizona# traceroute mpls ipv4 10.1.1.4/32
Thu Dec 17 14:45:05.563 PST
```

```
Codes: '!' - success, 'Q' - request not sent, '.' - timeout,
'L' - labeled output interface, 'B' - unlabeled output interface,
'D' - DS Map mismatch, 'F' - no FEC mapping, 'f' - FEC mismatch,
'M' - malformed request, 'm' - unsupported tlvs, 'N' - no rx label,
'P' - no rx intf label prot, 'p' - premature termination of LSP,
'R' - transit router, 'I' - unknown upstream index,
'X' - unknown return code, 'x' - return code 0
```

Type escape sequence to abort.

```
 0 12.12.12.1 MRU 4470 [Labels: 16004 Exp: 0]
L 1 12.12.12.2 MRU 4470 [Labels: 16004 Exp: 0] 3 ms
L 2 23.23.23.3 MRU 4470 [Labels: implicit-null Exp: 0] 3 ms
! 3 34.34.34.4 11 ms
```

MPLS Tree Trace for Prefix-SID

```
RP/0/RSP0/CPU0:router-arizona# traceroute mpls multipath ipv4 10.1.1.4/32
Thu Dec 17 14:55:46.549 PST
```

Starting LSP Path Discovery for 10.1.1.4/32

```
Codes: '!' - success, 'Q' - request not sent, '.' - timeout,
'L' - labeled output interface, 'B' - unlabeled output interface,
'D' - DS Map mismatch, 'F' - no FEC mapping, 'f' - FEC mismatch,
'M' - malformed request, 'm' - unsupported tlvs, 'N' - no rx label,
'P' - no rx intf label prot, 'p' - premature termination of LSP,
'R' - transit router, 'I' - unknown upstream index,
'X' - unknown return code, 'x' - return code 0
```

Type escape sequence to abort.

```
LL!
Path 0 found,
  output interface TenGigE0/0/0/0 nexthop 12.12.12.2 source 12.12.12.1 destination 127.0.0.0
  L!
Path 1 found,
  output interface TenGigE0/0/0/0 nexthop 12.12.12.2 source 12.12.12.1 destination 127.0.0.2
  LL!
Path 2 found,
  output interface TenGigE0/0/0/1 nexthop 15.15.15.5 source 15.15.15.1 destination 127.0.0.1
  L!
Path 3 found,
  output interface TenGigE0/0/0/1 nexthop 15.15.15.5 source 15.15.15.1 destination 127.0.0.0

Paths (found/broken/unexplored) (4/0/0)
Echo Request (sent/fail) (10/0)
Echo Reply (received/timeout) (10/0)
Total Time Elapsed 53 ms
```

MPLS LSP Ping and Traceroute Nil FEC Target

The Nil-FEC LSP ping and traceroute operations are extensions of regular MPLS ping and traceroute.

Nil-FEC LSP Ping/Traceroute functionality supports segment routing and MPLS Static. It also acts as an additional diagnostic tool for all other LSP types. This feature allows operators to provide the ability to freely test any label stack by allowing them to specify the following:

- label stack
- outgoing interface
- nexthop address

In the case of segment routing, each segment nodal label and adjacency label along the routing path is put into the label stack of an echo request message from the initiator Label Switch Router (LSR); MPLS data plane forwards this packet to the label stack target, and the label stack target sends the echo message back.

The following table shows the syntax for the ping and traceroute commands.

Table 8: LSP Ping and Traceroute Nil FEC Commands

Command Syntax
<code>ping mpls nil-fec labels {label[,label]} [output {interface tx-interface} [nexthop nexthop-ip-addr]]</code>
<code>traceroute mpls nil-fec labels {label[,label]} [output {interface tx-interface} [nexthop nexthop-ip-addr]]</code>

Examples: LSP Ping and Traceroute for Nil_FEC Target

These examples use the following topology:

```
Node loopback IP address: 172.18.1.3   172.18.1.4   172.18.1.5   172.18.1.7
Node label:                    16004         16005         16007
Nodes:                          Arizona ---- Utah ----- Wyoming ---- Texas

Interface:                      GigabitEthernet0/2/0/1   GigabitEthernet0/2/0/1
Interface IP address:           10.1.1.3                 10.1.1.4
```

```
RP/0/RSP0/CPU0:router-utah# show mpls forwarding
```

```
Tue Jul  5 13:44:31.999 EDT
Local  Outgoing  Prefix      Outgoing    Next Hop    Bytes
Label  Label      or ID       Interface   Next Hop    Switched
-----
16004  Pop        No ID       Gi0/2/0/1   10.1.1.4    1392
        Pop        No ID       Gi0/2/0/2   10.1.2.2    0
16005  16005     No ID       Gi0/2/0/0   10.1.1.4    0
        16005     No ID       Gi0/2/0/1   10.1.2.2    0
16007  16007     No ID       Gi0/2/0/0   10.1.1.4    4752
        16007     No ID       Gi0/2/0/1   10.1.2.2    0
24000  Pop        SR Adj (idx 0)  Gi0/2/0/0   10.1.1.4    0
24001  Pop        SR Adj (idx 2)  Gi0/2/0/0   10.1.1.4    0
```

24002	Pop	SR Adj (idx 0)	Gi0/2/0/1	10.1.2.2	0
24003	Pop	SR Adj (idx 2)	Gi0/2/0/1	10.1.2.2	0
24004	Pop	No ID	tt10	point2point	0
24005	Pop	No ID	tt11	point2point	0
24006	Pop	No ID	tt12	point2point	0
24007	Pop	No ID	tt13	point2point	0
24008	Pop	No ID	tt30	point2point	0

Ping Nil FEC Target

```
RP/0/RSP0/CPU0:router-arizona# ping mpls nil-fec labels 16005,16007 output interface
GigabitEthernet 0/2/0/1 nexthop 10.1.1.4 repeat 1
```

```
Sending 1, 72-byte MPLS Echos with Nil FEC labels 16005,16007,
  timeout is 2 seconds, send interval is 0 msec:
```

```
Codes: '!' - success, 'Q' - request not sent, '.' - timeout,
  'L' - labeled output interface, 'B' - unlabeled output interface,
  'D' - DS Map mismatch, 'F' - no FEC mapping, 'f' - FEC mismatch,
  'M' - malformed request, 'm' - unsupported tlvs, 'N' - no label entry,
  'P' - no rx intf label prot, 'p' - premature termination of LSP,
  'R' - transit router, 'I' - unknown upstream index,
  'd' - see DDMAP for return code,
  'X' - unknown return code, 'x' - return code 0
```

```
Type escape sequence to abort.
```

```
!
```

```
Success rate is 100 percent (1/1), round-trip min/avg/max = 1/1/1 ms
  Total Time Elapsed 0 ms
```

Traceroute Nil FEC Target

```
RP/0/RSP0/CPU0:router-arizona# traceroute mpls nil-fec labels 16005,16007 output interface
GigabitEthernet 0/2/0/1 nexthop 10.1.1.4
```

```
Tracing MPLS Label Switched Path with Nil FEC labels 16005,16007, timeout is 2 seconds
```

```
Codes: '!' - success, 'Q' - request not sent, '.' - timeout,
  'L' - labeled output interface, 'B' - unlabeled output interface,
  'D' - DS Map mismatch, 'F' - no FEC mapping, 'f' - FEC mismatch,
  'M' - malformed request, 'm' - unsupported tlvs, 'N' - no label entry,
  'P' - no rx intf label prot, 'p' - premature termination of LSP,
  'R' - transit router, 'I' - unknown upstream index,
  'd' - see DDMAP for return code,
  'X' - unknown return code, 'x' - return code 0
```

```
Type escape sequence to abort.
```

```
 0 10.1.1.3 MRU 1500 [Labels: 16005/16007/explicit-null Exp: 0/0/0]
L 1 10.1.1.4 MRU 1500 [Labels: implicit-null/16007/explicit-null Exp: 0/0/0] 1 ms
L 2 10.1.1.5 MRU 1500 [Labels: implicit-null/explicit-null Exp: 0/0] 1 ms
! 3 10.1.1.7 1 ms
```

Segment Routing Ping and Traceroute

Segment Routing Ping

The MPLS LSP ping feature is used to check the connectivity between ingress and egress of LSP. MPLS LSP ping uses MPLS echo request and reply messages, similar to Internet Control Message Protocol (ICMP) echo request and reply messages, to validate an LSP. Segment routing ping is an extension of the MPLS LSP ping to perform the connectivity verification on the segment routing control plane.



Note Segment routing ping can only be used when the originating device is running segment routing.

You can initiate the segment routing ping operation only when Segment Routing control plane is available at the originator, even if it is not preferred. This allows you to validate the SR path before directing traffic over the path. Segment Routing ping can use either generic FEC type or SR control-plane FEC type (SR-OSPF, SR-ISIS). In mixed networks, where some devices are running MPLS control plane (for example, LDP) or do not understand SR FEC, generic FEC type allows the device to successfully process and respond to the echo request. By default, generic FEC type is used in the target FEC stack of segment routing ping echo request. Generic FEC is not coupled to a particular control plane; it allows path verification when the advertising protocol is unknown or might change during the path of the echo request. If you need to specify the target FEC, you can select the FEC type as OSPF, IS-IS, or BGP. This ensures that only devices that are running segment routing control plane, and can therefore understand the segment routing IGP FEC, respond to the echo request.

Configuration Examples

These examples show how to use segment routing ping to test the connectivity of a segment routing control plane. In the first example, FEC type is not specified. You can also specify the FEC type as shown in the other examples.

```
RP/0/RSP0/CPU0:router# ping sr-mpls 10.1.1.2/32

Sending 5, 100-byte MPLS Echos to 10.1.1.2/32,
    timeout is 2 seconds, send interval is 0 msec:

Codes: '!' - success, 'Q' - request not sent, '.' - timeout,
       'L' - labeled output interface, 'B' - unlabeled output interface,
       'D' - DS Map mismatch, 'F' - no FEC mapping, 'f' - FEC mismatch,
       'M' - malformed request, 'm' - unsupported tlvs, 'N' - no rx label,
       'P' - no rx intf label prot, 'p' - premature termination of LSP,
       'R' - transit router, 'I' - unknown upstream index,
       'X' - unknown return code, 'x' - return code 0

Type escape sequence to abort.

!!!!
Success rate is 100 percent (5/5), round-trip min/avg/max = 1/2/5 ms
RP/0/RSP0/CPU0:router# ping sr-mpls 10.1.1.2/32 fec-type generic

Sending 5, 100-byte MPLS Echos to 10.1.1.2/32,
    timeout is 2 seconds, send interval is 0 msec:

Codes: '!' - success, 'Q' - request not sent, '.' - timeout,
```



```
'L' - labeled output interface, 'B' - unlabeled output interface,
'D' - DS Map mismatch, 'F' - no FEC mapping, 'f' - FEC mismatch,
'M' - malformed request, 'm' - unsupported tlvs, 'N' - no rx label,
'P' - no rx intf label prot, 'p' - premature termination of LSP,
'R' - transit router, 'I' - unknown upstream index,
'X' - unknown return code, 'x' - return code 0
```

Type escape sequence to abort.

```
!!!!
```

```
Success rate is 100 percent (5/5), round-trip min/avg/max = 1/1/2 ms
```

```
RP/0/RSP0/CPU0:router# ping sr-mpls 10.1.1.2/32 fec-type igp ospf
```

```
Sending 5, 100-byte MPLS Echos to 10.1.1.2/32,
timeout is 2 seconds, send interval is 0 msec:
```

```
Codes: '!' - success, 'Q' - request not sent, '.' - timeout,
'L' - labeled output interface, 'B' - unlabeled output interface,
'D' - DS Map mismatch, 'F' - no FEC mapping, 'f' - FEC mismatch,
'M' - malformed request, 'm' - unsupported tlvs, 'N' - no rx label,
'P' - no rx intf label prot, 'p' - premature termination of LSP,
'R' - transit router, 'I' - unknown upstream index,
'X' - unknown return code, 'x' - return code 0
```

Type escape sequence to abort.

```
!!!!
```

```
Success rate is 100 percent (5/5), round-trip min/avg/max = 1/1/2 ms
```

```
RP/0/RSP0/CPU0:router# ping sr-mpls 10.1.1.2/32 fec-type igp isis
```

```
Sending 5, 100-byte MPLS Echos to 10.1.1.2/32,
timeout is 2 seconds, send interval is 0 msec:
```

```
Codes: '!' - success, 'Q' - request not sent, '.' - timeout,
'L' - labeled output interface, 'B' - unlabeled output interface,
'D' - DS Map mismatch, 'F' - no FEC mapping, 'f' - FEC mismatch,
'M' - malformed request, 'm' - unsupported tlvs, 'N' - no rx label,
'P' - no rx intf label prot, 'p' - premature termination of LSP,
'R' - transit router, 'I' - unknown upstream index,
'X' - unknown return code, 'x' - return code 0
```

Type escape sequence to abort.

```
!!!!
```

```
Success rate is 100 percent (5/5), round-trip min/avg/max = 1/1/2 ms
```

```
RP/0/RSP0/CPU0:router# ping sr-mpls 10.1.1.2/32 fec-type bgp
```

```
Sending 5, 100-byte MPLS Echos to 10.1.1.2/32,
timeout is 2 seconds, send interval is 0 msec:
```

```
Codes: '!' - success, 'Q' - request not sent, '.' - timeout,
'L' - labeled output interface, 'B' - unlabeled output interface,
'D' - DS Map mismatch, 'F' - no FEC mapping, 'f' - FEC mismatch,
'M' - malformed request, 'm' - unsupported tlvs, 'N' - no rx label,
'P' - no rx intf label prot, 'p' - premature termination of LSP,
'R' - transit router, 'I' - unknown upstream index,
'X' - unknown return code, 'x' - return code 0
```

Type escape sequence to abort.

```
!!!!
Success rate is 100 percent (5/5), round-trip min/avg/max = 1/1/2 ms
```

Segment Routing Traceroute

The MPLS LSP traceroute is used to isolate the failure point of an LSP. It is used for hop-by-hop fault localization and path tracing. The MPLS LSP traceroute feature relies on the expiration of the Time to Live (TTL) value of the packet that carries the echo request. When the MPLS echo request message hits a transit node, it checks the TTL value and if it is expired, the packet is passed to the control plane, else the message is forwarded. If the echo message is passed to the control plane, a reply message is generated based on the contents of the request message. Segment routing traceroute feature extends the MPLS LSP traceroute functionality to segment routing networks.

Similar to segment routing ping, you can initiate the segment routing traceroute operation only when Segment Routing control plane is available at the originator, even if it is not preferred. Segment Routing traceroute can use either generic FEC type or SR control-plane FEC type (SR-OSPF, SR-ISIS). By default, generic FEC type is used in the target FEC stack of segment routing traceroute echo request. If you need to specify the target FEC, you can select the FEC type as OSPF, IS-IS, or BGP. This ensures that only devices that are running segment routing control plane, and can therefore understand the segment routing IGP FEC, respond to the echo request.

The existence of load balancing at routers in an MPLS network provides alternate paths for carrying MPLS traffic to a target router. The multipath segment routing traceroute feature provides a means to discover all possible paths of an LSP between the ingress and egress routers.

Configuration Examples

These examples show how to use segment routing traceroute to trace the LSP for a specified IPv4 prefix SID address. In the first example, FEC type is not specified. You can also specify the FEC type as shown in the other examples.

```
RP/0/RSP0/CPU0:router# traceroute sr-mpls 10.1.1.2/32

Tracing MPLS Label Switched Path to 10.1.1.2/32, timeout is 2 seconds

Codes: '!' - success, 'Q' - request not sent, '.' - timeout,
       'L' - labeled output interface, 'B' - unlabeled output interface,
       'D' - DS Map mismatch, 'F' - no FEC mapping, 'f' - FEC mismatch,
       'M' - malformed request, 'm' - unsupported tlvs, 'N' - no rx label,
       'P' - no rx intf label prot, 'p' - premature termination of LSP,
       'R' - transit router, 'I' - unknown upstream index,
       'X' - unknown return code, 'x' - return code 0

Type escape sequence to abort.

 0 10.12.12.1 MRU 1500 [Labels: implicit-null Exp: 0]
! 1 10.12.12.2 3 ms

RP/0/RSP0/CPU0:router# traceroute sr-mpls 10.1.1.2/32 fec-type generic

Tracing MPLS Label Switched Path to 10.1.1.2/32, timeout is 2 seconds

Codes: '!' - success, 'Q' - request not sent, '.' - timeout,
       'L' - labeled output interface, 'B' - unlabeled output interface,
       'D' - DS Map mismatch, 'F' - no FEC mapping, 'f' - FEC mismatch,
       'M' - malformed request, 'm' - unsupported tlvs, 'N' - no rx label,
```

```
'P' - no rx intf label prot, 'p' - premature termination of LSP,
'R' - transit router, 'I' - unknown upstream index,
'X' - unknown return code, 'x' - return code 0
```

Type escape sequence to abort.

```
0 10.12.12.1 MRU 1500 [Labels: implicit-null Exp: 0]
! 1 10.12.12.2 2 ms
```

```
RP/0/RSP0/CPU0:router# traceroute sr-mpls 10.1.1.2/32 fec-type igp ospf
```

Tracing MPLS Label Switched Path to 10.1.1.2/32, timeout is 2 seconds

```
Codes: '!' - success, 'Q' - request not sent, '.' - timeout,
'L' - labeled output interface, 'B' - unlabeled output interface,
'D' - DS Map mismatch, 'F' - no FEC mapping, 'f' - FEC mismatch,
'M' - malformed request, 'm' - unsupported tlvs, 'N' - no rx label,
'P' - no rx intf label prot, 'p' - premature termination of LSP,
'R' - transit router, 'I' - unknown upstream index,
'X' - unknown return code, 'x' - return code 0
```

Type escape sequence to abort.

```
0 10.12.12.1 MRU 1500 [Labels: implicit-null Exp: 0]
! 1 10.12.12.2 2 ms
```

```
RP/0/RSP0/CPU0:router# traceroute sr-mpls 10.1.1.2/32 fec-type igp isis
```

Tracing MPLS Label Switched Path to 10.1.1.2/32, timeout is 2 seconds

```
Codes: '!' - success, 'Q' - request not sent, '.' - timeout,
'L' - labeled output interface, 'B' - unlabeled output interface,
'D' - DS Map mismatch, 'F' - no FEC mapping, 'f' - FEC mismatch,
'M' - malformed request, 'm' - unsupported tlvs, 'N' - no rx label,
'P' - no rx intf label prot, 'p' - premature termination of LSP,
'R' - transit router, 'I' - unknown upstream index,
'X' - unknown return code, 'x' - return code 0
```

Type escape sequence to abort.

```
0 10.12.12.1 MRU 1500 [Labels: implicit-null Exp: 0]
! 1 10.12.12.2 2 ms
```

```
RP/0/RSP0/CPU0:router#traceroute sr-mpls 10.1.1.2/32 fec-type bgp
```

Tracing MPLS Label Switched Path to 10.1.1.2/32, timeout is 2 seconds

```
Codes: '!' - success, 'Q' - request not sent, '.' - timeout,
'L' - labeled output interface, 'B' - unlabeled output interface,
'D' - DS Map mismatch, 'F' - no FEC mapping, 'f' - FEC mismatch,
'M' - malformed request, 'm' - unsupported tlvs, 'N' - no rx label,
'P' - no rx intf label prot, 'p' - premature termination of LSP,
'R' - transit router, 'I' - unknown upstream index,
'X' - unknown return code, 'x' - return code 0
```

Type escape sequence to abort.

```
0 10.12.12.1 MRU 1500 [Labels: implicit-null/implicit-null Exp: 0/0]
! 1 10.12.12.2 2 ms
```

This example shows how to use multipath traceroute to discover all the possible paths for a IPv4 prefix SID.

```
RP/0/RSP0/CPU0:router# traceroute sr-mpls multipath 10.1.1.2/32
```

```
Starting LSP Path Discovery for 10.1.1.2/32
```

```
Codes: '!' - success, 'Q' - request not sent, '.' - timeout,
'L' - labeled output interface, 'B' - unlabeled output interface,
'D' - DS Map mismatch, 'F' - no FEC mapping, 'f' - FEC mismatch,
'M' - malformed request, 'm' - unsupported tlvs, 'N' - no rx label,
'P' - no rx intf label prot, 'p' - premature termination of LSP,
'R' - transit router, 'I' - unknown upstream index,
'X' - unknown return code, 'x' - return code 0
```

```
Type escape sequence to abort.
```

```
!
Path 0 found,
  output interface GigabitEthernet0/0/0/2 nexthop 10.13.13.2
source 10.13.13.1 destination 127.0.0.0
!
Path 1 found,
  output interface Bundle-Ether1 nexthop 10.12.12.2
source 10.12.12.1 destination 127.0.0.0

Paths (found/broken/unexplored) (2/0/0)
Echo Request (sent/fail) (2/0)
Echo Reply (received/timeout) (2/0)
Total Time Elapsed 14 ms
```

Segment Routing Policy Nil-FEC Ping and Traceroute

Segment routing OAM supports Nil-FEC LSP ping and traceroute operations to verify the connectivity for segment routing MPLS data plane. For the existing Nil-FEC ping and traceroute commands, you need to specify the entire outgoing label stack, outgoing interface, as well as the next hop. SR policy Nil-FEC ping and SR policy Nil-FEC traceroute enhancements extend the data plane validation functionality of installed SR policies through Nil-FEC ping and traceroute commands while simplifying the operational process. Instead of specifying the entire outgoing label-stack, interface, and next-hop, you can use the policy name or the policy binding-SID label value to initiate Nil-FEC ping and traceroute operations for the SR policies. Specification of outgoing interface and next-hop is also not required for policy Nil-FEC OAM operations.

Restrictions and Usage Guidelines

The following restrictions and guidelines apply for this feature:

- You cannot select a specific candidate path for SR policy Nil-FEC ping and traceroute.
- You cannot use SR policy Nil-FEC ping or traceroute for non-selected candidate paths.

Examples: SR Policy Nil-FEC Ping

These examples show how to use SR policy Nil-FEC ping for a SR policy. The first example refers the SR policy-name while the second example refers the BSID.

```
RP/0/0/CPU0:router# ping sr-mpls nil-fec policy name POLICY1
Thu Feb 22 06:56:50.006 PST
Sending 5, 100-byte MPLS Echos with Nil FEC for SR-TE Policy POLICY1,
timeout is 2 seconds, send interval is 0 msec:
```

```

Codes: '!' - success, 'Q' - request not sent, '.' - timeout,
       'L' - labeled output interface, 'B' - unlabeled output interface,
       'D' - DS Map mismatch, 'F' - no FEC mapping, 'f' - FEC mismatch,
       'M' - malformed request, 'm' - unsupported tlvs, 'N' - no rx label,
       'P' - no rx intf label prot, 'p' - premature termination of LSP,
       'R' - transit router, 'I' - unknown upstream index,
       'X' - unknown return code, 'x' - return code 0
Type escape sequence to abort.
!!!!
Success rate is 100 percent (5/5), round-trip min/avg/max = 1/5/22 ms

RP/0/0/CPU0:router# ping sr-mpls nil-fec policy binding-sid 100001
Thu Dec 17 12:41:02.381 EST
Sending 5, 100-byte MPLS Echos with Nil FEC with labels [16002,16003],
      timeout is 2 seconds, send interval is 0 msec:
Codes: '!' - success, 'Q' - request not sent, '.' - timeout,
       'L' - labeled output interface, 'B' - unlabeled output interface,
       'D' - DS Map mismatch, 'F' - no FEC mapping, 'f' - FEC mismatch,
       'M' - malformed request, 'm' - unsupported tlvs, 'N' - no rx label,
       'P' - no rx intf label prot, 'p' - premature termination of LSP,
       'R' - transit router, 'I' - unknown upstream index,
       'X' - unknown return code, 'x' - return code 0

Type escape sequence to abort.
!!!!
Success rate is 100 percent (5/5), round-trip min/avg/max = 2/3/3 ms

```

Examples: SR Policy Nil-FEC Traceroute

These examples show how to use SR policy Nil-FEC traceroute for a SR policy. The first example refers the SR policy-name while the second example refers the binding SID (BSID).

```

RP/0/0/CPU0:router# traceroute sr-mpls nil-fec policy name POLICY1
Thu Feb 22 06:57:03.637 PST
Tracing MPLS Label Switched Path with Nil FEC for SR-TE Policy POLICY1, timeout is 2 seconds
Codes: '!' - success, 'Q' - request not sent, '.' - timeout,
       'L' - labeled output interface, 'B' - unlabeled output interface,
       'D' - DS Map mismatch, 'F' - no FEC mapping, 'f' - FEC mismatch,
       'M' - malformed request, 'm' - unsupported tlvs, 'N' - no rx label,
       'P' - no rx intf label prot, 'p' - premature termination of LSP,
       'R' - transit router, 'I' - unknown upstream index,
       'X' - unknown return code, 'x' - return code 0
Type escape sequence to abort.
 0 11.11.11.1 MRU 1500 [Labels: 16003/explicit-null Exp: 0/0]
L 1 11.11.11.2 MRU 1500 [Labels: implicit-null/explicit-null Exp: 0/0] 4 ms
! 2 14.14.14.3 2 ms

```

```

RP/0/0/CPU0:router# traceroute sr-mpls nil-fec binding-sid 100001
Tracing MPLS Label Switched Path with Nil FEC with labels [16002/16004], timeout is 2 seconds

Codes: '!' - success, 'Q' - request not sent, '.' - timeout,
       'L' - labeled output interface, 'B' - unlabeled output interface,
       'D' - DS Map mismatch, 'F' - no FEC mapping, 'f' - FEC mismatch,
       'M' - malformed request, 'm' - unsupported tlvs, 'N' - no rx label,
       'P' - no rx intf label prot, 'p' - premature termination of LSP,
       'R' - transit router, 'I' - unknown upstream index,
       'X' - unknown return code, 'x' - return code 0
Type escape sequence to abort.
 0 99.1.2.1 MRU 4470 [Labels: 16002/16004/explicit-null Exp: 0/0/0]
L 1 99.1.2.2 MRU 4470 [Labels: 16004/explicit-null Exp: 0/0] 3 ms

```

```
L 2 99.2.6.6 MRU 4470 [Labels: implicit-null Exp: 0] 3 ms
! 3 99.4.6.4 11 ms
```

Segment Routing over IPv6 OAM

Segment Routing over IPv6 data plane (SRv6) implementation adds a new type of routing extension header. Hence, the existing ICMPv6 mechanisms including ping and traceroute can be used in the SRv6 network. There is no change in the way ping and traceroute operations work for IPv6- or SRv6-capable nodes in an SRv6 network.

Restrictions and Usage Guidelines

The following restriction applies for SRv6 OAM:

- Ping to an SRv6 SID is not supported.

Examples: SRv6 OAM

The following example shows using ping in an SRv6 network.

```
RP/0/RP0/CPU0:Router# ping ipv6 2001::33:33:33:33
Mon Sep 17 20:04:10.068 UTC
Type escape sequence to abort.
Sending 5, 100-byte ICMP Echos to 2001::33:33:33:33, timeout is 2 seconds:
!!!!
Success rate is 100 percent (5/5), round-trip min/avg/max = 1/3/4 ms
```

The following example shows using traceroute in an SRv6 network.

```
RP/0/RP0/CPU0:Router# traceroute ipv6 2001::33:33:33:33 probe 1 timeout 0 srv6
Fri Sep 14 15:59:25.170 UTC
Type escape sequence to abort.
Tracing the route to 2001::33:33:33:33
 1 2001::22:22:22:22[IP tunnel: DA=cafe:0:0:a4:1::: SRH =(2001::33:33:33:33 ,SL=1)] 2
msec
 2 2001::2:2:2:2[IP tunnel: DA=cafe:0:0:a4:1::: SRH =(2001::33:33:33:33 ,SL=1)] 2 msec
 3 2001::44:44:44:44 2 msec
 4 2001::33:33:33:33 3 msec
```

The following example shows using traceroute in an SRv6 network without an SRH.

```
RP/0/RSP1/CPU0:Router# traceroute ipv6 2001::44:44:44:44 srv6
Wed Jan 16 14:35:27.511 UTC
Type escape sequence to abort.
Tracing the route to 2001::44:44:44:44
 1 2001::2:2:2:2 3 msec 2 msec 2 msec
 2 2001::44:44:44:44 3 msec 3 msec 3 msec
```

The following example shows using ping for a specified IP address in the VRF.

```
RP/0/RP0/CPU0:Router# ping 10.15.15.1 vrf red
Mon Sep 17 20:07:10.085 UTC
Type escape sequence to abort.
Sending 5, 100-byte ICMP Echos to 10.15.15.1, timeout is 2 seconds:
!!!!
Success rate is 100 percent (5/5), round-trip min/avg/max = 1/2/4 ms
```

The following example shows using traceroute for a specified IP address in the VRF.

```
RP/0/RP0/CPU0:Router# traceroute 10.15.15.1 vrf red
Mon Sep 17 20:07:18.478 UTC

Type escape sequence to abort.
Tracing the route to 10.15.15.1
 1 10.15.15.1 3 msec 2 msec 2 msec
```

The following example shows using traceroute for CE1 (4.4.4.5) to CE2 (5.5.5.5) in the VRF:

```
RP/0/RP0/CPU0:Router# traceroute 5.5.5.5 vrf a
Wed Jan 16 15:08:46.264 UTC

Type escape sequence to abort.
Tracing the route to 5.5.5.5
 1 14.14.14.1 5 msec 1 msec 1 msec
 2 15.15.15.1 3 msec 2 msec 2 msec
 3 15.15.15.2 2 msec * 3 msec
```

