



## **System Management Configuration Guide for Cisco ASR 9000 Series Routers, IOS XR Release 7.9.x**

**First Published:** 2023-03-31

### **Americas Headquarters**

Cisco Systems, Inc.  
170 West Tasman Drive  
San Jose, CA 95134-1706  
USA  
<http://www.cisco.com>  
Tel: 408 526-4000  
800 553-NETS (6387)  
Fax: 408 527-0883

THE SPECIFICATIONS AND INFORMATION REGARDING THE PRODUCTS IN THIS MANUAL ARE SUBJECT TO CHANGE WITHOUT NOTICE. ALL STATEMENTS, INFORMATION, AND RECOMMENDATIONS IN THIS MANUAL ARE BELIEVED TO BE ACCURATE BUT ARE PRESENTED WITHOUT WARRANTY OF ANY KIND, EXPRESS OR IMPLIED. USERS MUST TAKE FULL RESPONSIBILITY FOR THEIR APPLICATION OF ANY PRODUCTS.

THE SOFTWARE LICENSE AND LIMITED WARRANTY FOR THE ACCOMPANYING PRODUCT ARE SET FORTH IN THE INFORMATION PACKET THAT SHIPPED WITH THE PRODUCT AND ARE INCORPORATED HEREIN BY THIS REFERENCE. IF YOU ARE UNABLE TO LOCATE THE SOFTWARE LICENSE OR LIMITED WARRANTY, CONTACT YOUR CISCO REPRESENTATIVE FOR A COPY.

The Cisco implementation of TCP header compression is an adaptation of a program developed by the University of California, Berkeley (UCB) as part of UCB's public domain version of the UNIX operating system. All rights reserved. Copyright © 1981, Regents of the University of California.

NOTWITHSTANDING ANY OTHER WARRANTY HEREIN, ALL DOCUMENT FILES AND SOFTWARE OF THESE SUPPLIERS ARE PROVIDED "AS IS" WITH ALL FAULTS. CISCO AND THE ABOVE-NAMED SUPPLIERS DISCLAIM ALL WARRANTIES, EXPRESSED OR IMPLIED, INCLUDING, WITHOUT LIMITATION, THOSE OF MERCHANTABILITY, FITNESS FOR A PARTICULAR PURPOSE AND NON-INFRINGEMENT OR ARISING FROM A COURSE OF DEALING, USAGE, OR TRADE PRACTICE.

IN NO EVENT SHALL CISCO OR ITS SUPPLIERS BE LIABLE FOR ANY INDIRECT, SPECIAL, CONSEQUENTIAL, OR INCIDENTAL DAMAGES, INCLUDING, WITHOUT LIMITATION, LOST PROFITS OR LOSS OR DAMAGE TO DATA ARISING OUT OF THE USE OR INABILITY TO USE THIS MANUAL, EVEN IF CISCO OR ITS SUPPLIERS HAVE BEEN ADVISED OF THE POSSIBILITY OF SUCH DAMAGES.

Any Internet Protocol (IP) addresses and phone numbers used in this document are not intended to be actual addresses and phone numbers. Any examples, command display output, network topology diagrams, and other figures included in the document are shown for illustrative purposes only. Any use of actual IP addresses or phone numbers in illustrative content is unintentional and coincidental.

All printed copies and duplicate soft copies of this document are considered uncontrolled. See the current online version for the latest version.

Cisco has more than 200 offices worldwide. Addresses and phone numbers are listed on the Cisco website at [www.cisco.com/go/offices](http://www.cisco.com/go/offices).

Cisco and the Cisco logo are trademarks or registered trademarks of Cisco and/or its affiliates in the U.S. and other countries. To view a list of Cisco trademarks, go to this URL: <https://www.cisco.com/c/en/us/about/legal/trademarks.html>. Third-party trademarks mentioned are the property of their respective owners. The use of the word partner does not imply a partnership relationship between Cisco and any other company. (1721R)

© 2023 Cisco Systems, Inc. All rights reserved.



## Preface

From Release 6.1.2 onwards, Cisco introduces support for the 64-bit Linux-based IOS XR operating system. Extensive feature parity is maintained between the 32-bit and 64-bit environments. Unless explicitly marked otherwise, the contents of this document are applicable for both the environments. For more details on Cisco IOS XR 64 bit, refer to the [Release Notes](#) for Cisco ASR 9000 Series Routers, Release 6.1.2 document.

This guide describes the System Management configuration details for Cisco IOS XR software. This chapter contains details on the changes made to this document.

- [Changes to This Document, on page iii](#)
- [Communications, Services, and Additional Information, on page iii](#)

## Changes to This Document

This table lists the changes made to this document since it was first released.

**Table 1: Changes to This Document**

Date	Summary
None	None

## Communications, Services, and Additional Information

- To receive timely, relevant information from Cisco, sign up at [Cisco Profile Manager](#).
- To get the business impact you're looking for with the technologies that matter, visit [Cisco Services](#).
- To submit a service request, visit [Cisco Support](#).
- To discover and browse secure, validated enterprise-class apps, products, solutions and services, visit [Cisco DevNet](#).
- To obtain general networking, training, and certification titles, visit [Cisco Press](#).
- To find warranty information for a specific product or product family, access [Cisco Warranty Finder](#).

### **Cisco Bug Search Tool**

[Cisco Bug Search Tool](#) (BST) is a web-based tool that acts as a gateway to the Cisco bug tracking system that maintains a comprehensive list of defects and vulnerabilities in Cisco products and software. BST provides you with detailed defect information about your products and software.



# CHAPTER 1

## New and Changed System Management Features

This chapter lists all the features that have been added or modified in this guide. The table also contains references to these feature documentation sections.

- [System Management Features Added or Modified in IOS XR Release 7.9.x, on page 1](#)

### System Management Features Added or Modified in IOS XR Release 7.9.x

Feature	Description	Changed in Release	Where Documented
FQDN for NTP Server on Non-default VRF	This feature was introduced	Release 7.9.1	<a href="#">FQDN for NTP Server, on page 244</a>
1GbE Port Mode on SFP+ and SFP28 Ports	This feature was introduced	Release 7.9.1	<a href="#">Configuring Port Modes</a>





## CHAPTER 2

# YANG Data Models for System Management Features

---

This chapter provides information about the YANG data models for System Management features.

- [Using YANG Data Models, on page 3](#)

## Using YANG Data Models

Cisco IOS XR supports a programmatic way of configuring and collecting operational data of a network device using YANG data models. Although configurations using CLIs are easier and human-readable, automating the configuration using model-driven programmability results in scalability.

The data models are available in the release image, and are also published in the [Github](#) repository. Navigate to the release folder of interest to view the list of supported data models and their definitions. Each data model defines a complete and cohesive model, or augments an existing data model with additional XPath. To view a comprehensive list of the data models supported in a release, navigate to the **Available-Content.md** file in the repository.

You can also view the data model definitions using the [YANG Data Models Navigator](#) tool. This GUI-based and easy-to-use tool helps you explore the nuances of the data model and view the dependencies between various containers in the model. You can view the list of models supported across Cisco IOS XR releases and platforms, locate a specific model, view the containers and their respective lists, leaves, and leaf lists presented visually in a tree structure. This visual tree form helps you get insights into nodes that can help you automate your network.

To get started with using the data models, see the *Programmability Configuration Guide*.







## CHAPTER 3

# Configuring Simple Network Management Protocol

*Simple Network Management Protocol* (SNMP) is an application-layer protocol that provides a message format for communication between SNMP managers and agents. SNMP provides a standardized framework and a common language used for the monitoring and management of devices in a network.

This module describes the new and revised tasks you need to implement SNMP on your Cisco IOS XR network.

For detailed conceptual information about SNMP on the Cisco IOS XR software and complete descriptions of the SNMP commands listed in this module, see [Related Documents, on page 33](#). For information on specific MIBs, refer to *Cisco ASR 9000 Series Aggregation Services Routers MIB Specifications Guide*. To locate documentation for other commands that might appear in the course of performing a configuration task, search online in *Cisco ASR 9000 Series Aggregation Services Router Commands Master List*.

**Table 2: Feature History for Implementing SNMP on Cisco IOS XR Software**

Release	Modification
Release 3.7.2	This feature was introduced.
Release 3.9.0	Support was added for 3DES and AES encryption. The ability to preserve ENTITY-MIB and CISCO-CLASS-BASED-QOS-MIB data was added.
Release 4.2.0	Support was added for SNMP over IPv6.

This module contains the following topics:

- [Prerequisites for Implementing SNMP, on page 6](#)
- [Restrictions for SNMP Use on Cisco IOS XR Software, on page 6](#)
- [Information About Implementing SNMP, on page 6](#)
- [Session MIB support on subscriber sessions , on page 13](#)
- [How to Implement SNMP on Cisco IOS XR Software, on page 15](#)
- [Configuration Examples for Implementing SNMP, on page 25](#)
- [SNMP Context Mapping Configuration, on page 31](#)
- [Additional References, on page 33](#)

## Prerequisites for Implementing SNMP

You must be in a user group associated with a task group that includes the proper task IDs. The command reference guides include the task IDs required for each command. If you suspect user group assignment is preventing you from using a command, contact your AAA administrator for assistance.

## Restrictions for SNMP Use on Cisco IOS XR Software

SNMP outputs are only 32-bits wide and therefore cannot display any information greater than  $2^{32}$ .  $2^{32}$  is equal to 4.29 Gigabits. Note that a 10 Gigabit interface is greater than this and so if you are trying to display speed information regarding the interface, you might see concatenated results.

The recommended maximum number of object identifiers (OIDs) that can be accommodated in a single SNMP request is 75. A request with more than 75 OIDs can result in SNMP requests being dropped with SNMP polling timeout.

## Information About Implementing SNMP

To implement SNMP, you need to understand the concepts described in this section.

### SNMP Functional Overview

The SNMP framework consists of three parts:

- SNMP manager
- SNMP agent
- Management Information Base (MIB)

### SNMP Manager

The SNMP manager is the system used to control and monitor the activities of network hosts using SNMP. The most common managing system is called a *network management system* (NMS). The term NMS can be applied to either a dedicated device used for network management, or the applications used on such a device. A variety of network management applications are available for use with SNMP. These features range from simple command-line applications to feature-rich graphical user interfaces (such as the CiscoWorks 2000 line of products).

### SNMP Agent

The SNMP agent is the software component within the managed device that maintains the data for the device and reports these data, as needed, to managing systems. The agent and MIB reside on the router. To enable the SNMP agent, you must define the relationship between the manager and the agent.

### MIB

The *Management Information Base* (MIB) is a virtual information storage area for network management information, which consists of collections of managed objects. Within the MIB there are collections of related

objects, defined in MIB modules. MIB modules are written in the SNMP MIB module language, as defined in STD 58, RFC 2578, RFC 2579, and RFC 2580. Note that individual MIB modules are also referred to as MIBs; for example, the Interfaces Group MIB (IF-MIB) is a MIB module within the MIB on your system.

The SNMP agent contains MIB variables whose values the SNMP manager can request or change through Get or Set operations. A manager can get a value from an agent or store a value into that agent. The agent gathers data from the MIB, the repository for information about device parameters and network data. The agent can also respond to manager requests to get or set data.

This figure illustrates the communications relationship between the SNMP manager and agent. A manager can send the agent requests to get and set MIB values. The agent can respond to these requests. Independent of this interaction, the agent can send unsolicited notifications (traps) to the manager to notify the manager of network conditions.

**Figure 1: Communication Between an SNMP Agent and Manager**

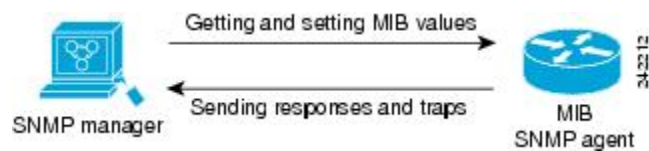

### IP-MIB Support

RFC4293 IP-MIB was specifically designed to provide IPv4 and IPv6 statistics individually. The **ipIfStatsTable** defined in RFC 4293, lists the interface specific statistics. IPv6 statistics support in **ipIfStatsTable** was added earlier but, IOS-XR implementation of IP-MIB did not support IPv4 statistics as per RFC4293 in earlier releases.

From Release 6.3.2 onwards, IOS-XR implementation of IP-MIB supports IPv4 statistics as per RFC4293. This will enable you to collect the IPV4 and IPv6 statistics separately for each interface. The **ipIfStatsTable** is indexed by two **sub-ids address type (IPv4 or IPv6)** and the **interface ifindex[1]**. The implementation of IP-MIB support for IPv4 and IPv6 is separated from Release 6.3.2 for better readability and maintainability.

The list of OIDs added to the **ipIfStatsTable** for IPv4 statistics are:

- ipIfStatsInReceives
- ipIfStatsHCInReceives
- ipIfStatsInOctets
- ipIfStatsHCInOctets
- ipIfStatsOutTransmits
- ipIfStatsHCOutTransmits
- ipIfStatsOutOctets
- ipIfStatsHCOutOctets
- ipIfStatsDiscontinuityTime

For more information on the list of new OIDs added for IPv4 statistics, see [SNMP OID Navigator](#).

### Related Topics

[Additional References](#), on page 33

## SNMP Notifications

A key feature of SNMP is the ability to generate notifications from an SNMP agent. These notifications do not require that requests be sent from the SNMP manager. On Cisco IOS XR software, unsolicited (asynchronous) notifications can be generated only as *traps*. Traps are messages alerting the SNMP manager to a condition on the network. Notifications can indicate improper user authentication, restarts, the closing of a connection, loss of connection to a neighbor router, or other significant events.



**Note** Inform requests (inform operations) are supported in Cisco IOS XR software from release 4.1 onwards. For more information see, [http://www.cisco.com/c/en/us/td/docs/routers/asr9000/software/asr9k\\_r5-3/sysman/command/reference/b-sysman-cr53xasr/b-sysman-cr53xasr\\_chapter\\_010010.html#wp2863682680](http://www.cisco.com/c/en/us/td/docs/routers/asr9000/software/asr9k_r5-3/sysman/command/reference/b-sysman-cr53xasr/b-sysman-cr53xasr_chapter_010010.html#wp2863682680)

Traps are less reliable than informs because the receiver does not send any acknowledgment when it receives a trap. The sender cannot determine if the trap was received. An SNMP manager that receives an inform request acknowledges the message with an SNMP response protocol data unit (PDU). If the manager does not receive an inform request, it does not send a response. If the sender never receives a response, the inform request can be sent again. Thus, informs are more likely to reach their intended destination.

However, traps are often preferred because informs consume more resources in the router and in the network. Unlike a trap, which is discarded as soon as it is sent, an inform request must be held in memory until a response is received or the request times out. Also, traps are sent only once, and an inform may be retried several times. The retries increase traffic and contribute to a higher overhead on the network. Thus, traps and inform requests provide a trade-off between reliability and resources.

**Figure 2: Trap Received by the SNMP Manager**

In this illustration, the agent router sends a trap to the SNMP manager. Although the manager receives the trap, it does not send any acknowledgment to the agent. The agent has no way of knowing that the trap reached

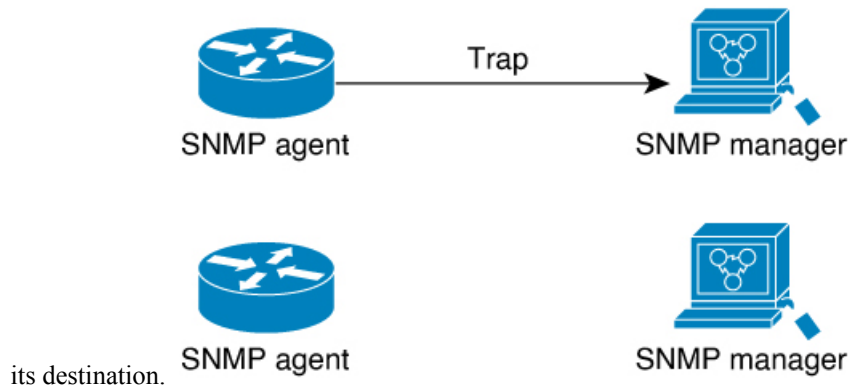

520503

**Figure 3: Trap Not Received by the SNMP Manager**

In this illustration, the agent sends a trap to the manager, but the trap does not reach the manager. Because the agent has no way of knowing that the trap did not reach its destination, the trap is not sent again. The

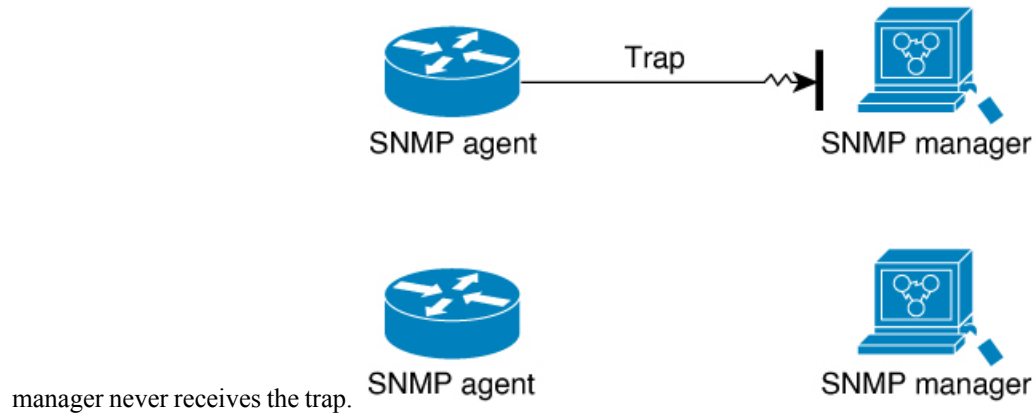

520504

## SNMP Versions

Cisco IOS XR software supports the following versions of SNMP:

- Simple Network Management Protocol Version 1 (SNMPv1)
- Simple Network Management Protocol Version 2c (SNMPv2c)
- Simple Network Management Protocol Version 3 (SNMPv3)

Both SNMPv1 and SNMPv2c use a community-based form of security. The community of managers able to access the agent MIB is defined by an IP address access control list and password.

SNMPv2c support includes a bulk retrieval mechanism and more detailed error message reporting to management stations. The bulk retrieval mechanism supports the retrieval of tables and large quantities of information, minimizing the number of round-trips required. The SNMPv2c improved error handling support includes expanded error codes that distinguish different kinds of error conditions; these conditions are reported through a single error code in SNMPv1. Error return codes now report the error type. Three kinds of exceptions are also reported: no such object exceptions, no such instance exceptions, and end of MIB view exceptions.

SNMPv3 is a security model. A *security model* is an authentication strategy that is set up for a user and the group in which the user resides. A *security level* is the permitted level of security within a security model. A combination of a security model and a security level will determine which security mechanism is employed when an SNMP packet is handled. See [Table 4: SNMP Security Models and Levels, on page 10](#) for a list of security levels available in SNMPv3. The SNMPv3 feature supports RFCs 3411 to 3418.

You must configure the SNMP agent to use the version of SNMP supported by the management station. An agent can communicate with multiple managers; for this reason, you can configure the Cisco IOS-XR software to support communications with one management station using the SNMPv1 protocol, one using the SNMPv2c protocol, and another using SMNPv3.

## Comparison of SNMPv1, v2c, and v3

SNMP v1, v2c, and v3 all support the following operations:

- get-request—Retrieves a value from a specific variable.

- **get-next-request**—Retrieves the value following the named variable; this operation is often used to retrieve variables from within a table. With this operation, an SNMP manager does not need to know the exact variable name. The SNMP manager searches sequentially to find the needed variable from within the MIB.
- **get-response**—Operation that replies to a get-request, get-next-request, and set-request sent by an NMS.
- **set-request**—Operation that stores a value in a specific variable.
- **trap**—Unsolicited message sent by an SNMP agent to an SNMP manager when some event has occurred.

The below table identifies other key SNMP features supported by the SNMP v1, v2c, and v3.

**Table 3: SNMPv1, v2c, and v3 Feature Support**

Feature	SNMP v1	SNMP v2c	SNMP v3
Get-Bulk Operation	No	Yes	Yes
Inform Operation	No	Yes (No on the Cisco IOS XR software)	Yes (No on the Cisco IOS XR software)
64 Bit Counter	No	Yes	Yes
Textual Conventions	No	Yes	Yes
Authentication	No	No	Yes
Privacy (Encryption)	No	No	Yes
Authorization and Access Controls (Views)	No	No	Yes

## Security Models and Levels for SNMPv1, v2, v3

The security level determines if an SNMP message needs to be protected from disclosure and if the message needs to be authenticated. The various security levels that exist within a security model are as follows:

- **noAuthNoPriv**—Security level that does not provide authentication or encryption.
- **authNoPriv**—Security level that provides authentication but does not provide encryption.
- **authPriv**—Security level that provides both authentication and encryption.

Three security models are available: SNMPv1, SNMPv2c, and SNMPv3. The security model combined with the security level determine the security mechanism applied when the SNMP message is processed.

The below table identifies what the combinations of security models and levels mean.

**Table 4: SNMP Security Models and Levels**

Model	Level	Authentication	Encryption	What Happens
v1	noAuthNoPriv	Community string	No	Uses a community string match for authentication.

Model	Level	Authentication	Encryption	What Happens
v2c	noAuthNoPriv	Community string	No	Uses a community string match for authentication.
v3	noAuthNoPriv	Username	No	Uses a username match for authentication.
v3	authNoPriv	HMAC-MD5 or HMAC-SHA	No	Provides authentication based on the HMAC <sup>1</sup> -MD5 <sup>2</sup> algorithm or the HMAC-SHA <sup>3</sup> .
v3	authPriv	HMAC-MD5 or HMAC-SHA	DES	Provides authentication based on the HMAC-MD5 or HMAC-SHA algorithms. Provides DES <sup>4</sup> 56-bit encryption in addition to authentication based on the CBC <sup>5</sup> DES (DES-56) standard.
v3	authPriv	HMAC-MD5 or HMAC-SHA	3DES	Provides authentication based on the HMAC-MD5 or HMAC-SHA algorithms. Provides 168-bit 3DES <sup>6</sup> level of encryption.
v3	authPriv	HMAC-MD5 or HMAC-SHA	AES	Provides authentication based on the HMAC-MD5 or HMAC-SHA algorithms. Provides 128-bit AES <sup>7</sup> level of encryption.

<sup>1</sup> Hash-Based Message Authentication Code

<sup>2</sup> Message Digest 5

<sup>3</sup> Secure Hash Algorithm

<sup>4</sup> Data Encryption Standard

<sup>5</sup> Cipher Block Chaining

<sup>6</sup> Triple Data Encryption Standard

<sup>7</sup> Advanced Encryption Standard

Use of 3DES and AES encryption standards requires that the security package (k9sec) be installed. For information on installing software packages, see *Upgrading and Managing Cisco IOS XR Software*.

## SNMPv3 Benefits

SNMPv3 provides secure access to devices by providing authentication, encryption and access control. These added security benefits secure SNMP against the following security threats:

- Masquerade—The threat that an SNMP user may assume the identity of another SNMP user to perform management operations for which that SNMP user does not have authorization.
- Message stream modification—The threat that messages may be maliciously reordered, delayed, or replayed (to an extent that is greater than can occur through the natural operation of a subnetwork service) to cause SNMP to perform unauthorized management operations.
- Disclosure—The threat that exchanges between SNMP engines could be eavesdropped. Protecting against this threat may be required as a matter of local policy.

In addition, SNMPv3 provides access control over protocol operations on SNMP managed objects.

## SNMPv3 Costs

SNMPv3 authentication and encryption contribute to a slight increase in the response time when SNMP operations on MIB objects are performed. This cost is far outweighed by the security advantages provided by SNMPv3.

This table shows the order of response time (from least to greatest) for the various security model and security level combinations.

*Table 5: Order of Response Times from Least to Greatest*

Security Model	Security Level
SNMPv2c	noAuthNoPriv
SNMPv3	noAuthNoPriv
SNMPv3	authNoPriv
SNMPv3	authPriv

## User-Based Security Model

SNMPv3 User-Based Security Model (USM) refers to SNMP message-level security and offers the following services:

- Message integrity—Ensures that messages have not been altered or destroyed in an unauthorized manner and that data sequences have not been altered to an extent greater than can occur nonmaliciously.
- Message origin authentication—Ensures that the claimed identity of the user on whose behalf received data was originated is confirmed.
- Message confidentiality—Ensures that information is not made available or disclosed to unauthorized individuals, entities, or processes.

SNMPv3 authorizes management operations only by configured users and encrypts SNMP messages.

USM uses two authentication protocols:

- HMAC-MD5-96 authentication protocol
- HMAC-SHA-96 authentication protocol

USM uses Cipher Block Chaining (CBC)-DES (DES-56) as the privacy protocol for message encryption.

## View-Based Access Control Model

The View-Based Access Control Model (VACM) enables SNMP users to control access to SNMP managed objects by supplying read, write, or notify access to SNMP objects. It prevents access to objects restricted by views. These access policies can be set when user groups are configured with the **snmp-server group** command.

## MIB Views

For security reasons, it is often valuable to be able to restrict the access rights of some groups to only a subset of the management information within the management domain. To provide this capability, access to a



management object is controlled through MIB views, which contain the set of managed object types (and, optionally, the specific instances of object types) that can be viewed.

## Access Policy

Access policy determines the access rights of a group. The three types of access rights are as follows:

- read-view access—The set of object instances authorized for the group when objects are read.
- write-view access—The set of object instances authorized for the group when objects are written.
- notify-view access—The set of object instances authorized for the group when objects are sent in a notification.

## IP Precedence and DSCP Support for SNMP

SNMP IP Precedence and differentiated services code point (DSCP) support delivers QoS specifically for SNMP traffic. You can change the priority setting so that SNMP traffic generated in a router is assigned a specific QoS class. The IP Precedence or IP DSCP code point value is used to determine how packets are handled in weighted random early detection (WRED).

After the IP Precedence or DSCP is set for the SNMP traffic generated in a router, different QoS classes cannot be assigned to different types of SNMP traffic in that router.

The IP Precedence value is the first three bits in the type of service (ToS) byte of an IP header. The IP DSCP code point value is the first six bits of the differentiate services (DiffServ Field) byte. You can configure up to eight different IP Precedence markings or 64 different IP DSCP markings.

## Session MIB support on subscriber sessions

SNMP monitoring requires information about subscribers of all types. The CISCO-SUBSCRIBER-SESSION-MIB is defined to model per-subscriber data as well as aggregate subscriber (PPPoE) data. It is required to support notifications (traps) for aggregate session counts crossing configured thresholds. Generic MIB Data Collector Manager (DCM) support for CISCO-SUBSCRIBER-SESSION-MIB, helps faster data collection and also better handling of parallel data.

## SNMP Notifications

A key feature of SNMP is the ability to generate notifications from an SNMP agent. These notifications do not require that requests be sent from the SNMP manager. On Cisco IOS XR software, unsolicited (asynchronous) notifications can be generated only as *traps*. Traps are messages alerting the SNMP manager to a condition on the network. Notifications can indicate improper user authentication, restarts, the closing of a connection, loss of connection to a neighbor router, or other significant events.



---

**Note** Inform requests (inform operations) are supported in Cisco IOS XR software from release 4.1 onwards. For more information see, [http://www.cisco.com/c/en/us/td/docs/routers/asr9000/software/asr9k\\_r5-3/sysman/command/reference/b-sysman-cr53xasr/b-sysman-cr53xasr\\_chapter\\_010010.html#wp2863682680](http://www.cisco.com/c/en/us/td/docs/routers/asr9000/software/asr9k_r5-3/sysman/command/reference/b-sysman-cr53xasr/b-sysman-cr53xasr_chapter_010010.html#wp2863682680)

---

Traps are less reliable than informs because the receiver does not send any acknowledgment when it receives a trap. The sender cannot determine if the trap was received. An SNMP manager that receives an inform request acknowledges the message with an SNMP response protocol data unit (PDU). If the manager does

not receive an inform request, it does not send a response. If the sender never receives a response, the inform request can be sent again. Thus, informs are more likely to reach their intended destination.

However, traps are often preferred because informs consume more resources in the router and in the network. Unlike a trap, which is discarded as soon as it is sent, an inform request must be held in memory until a response is received or the request times out. Also, traps are sent only once, and an inform may be retried several times. The retries increase traffic and contribute to a higher overhead on the network. Thus, traps and inform requests provide a trade-off between reliability and resources.

**Figure 4: Trap Received by the SNMP Manager**

In this illustration, the agent router sends a trap to the SNMP manager. Although the manager receives the trap, it does not send any acknowledgment to the agent. The agent has no way of knowing that the trap reached

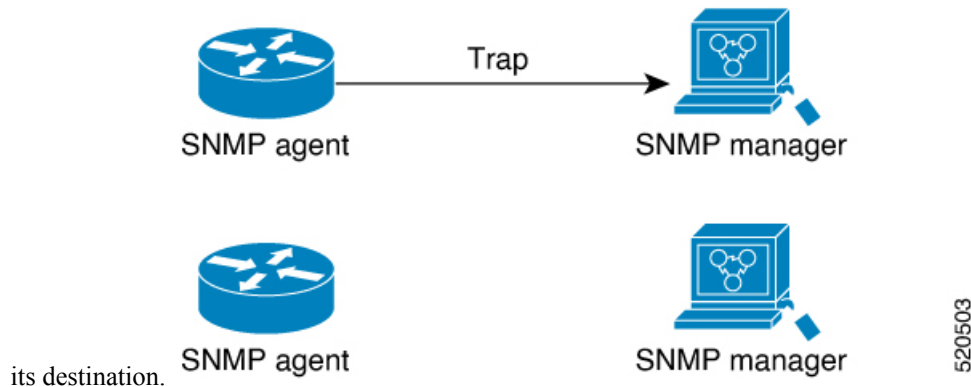

**Figure 5: Trap Not Received by the SNMP Manager**

In this illustration, the agent sends a trap to the manager, but the trap does not reach the manager. Because the agent has no way of knowing that the trap did not reach its destination, the trap is not sent again. The

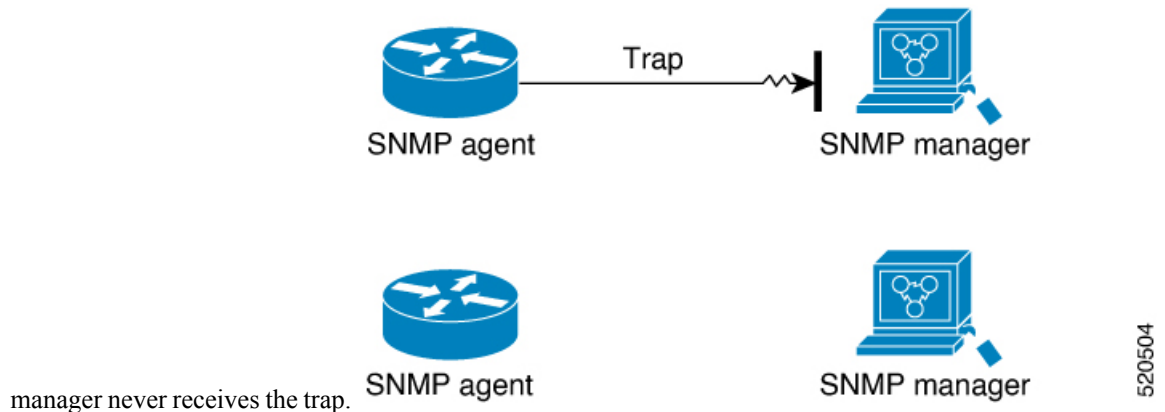

## Session Types

The supported session types are:

- PPPoE
- IP SUB PKT
- IP SUB DHCP

# How to Implement SNMP on Cisco IOS XR Software

This section describes how to implement SNMP.

The **snmp-server** commands enable SNMP on Management Ethernet interfaces by default. For information on how to enable SNMP server support on other inband interfaces, see the *Implementing Management Plane Protection on Cisco IOS XR Software* module in *System Security Configuration Guide for Cisco ASR 9000 Series Routers*.

## Configuring SNMPv3

This task explains how to configure SNMPv3 for network management and monitoring.



**Note** No specific command enables SNMPv3; the first **snmp-server** global configuration command (config), that you issue enables SNMPv3. Therefore, the sequence in which you issue the **snmp-server** commands for this task does not matter.

### SUMMARY STEPS

1. **configure**
2. **snmp-server view** *view-name oid-tree* {**included** | **excluded**}
3. **snmp-server group** *name* {**v1** | **v2c** | **v3** {**auth** | **noauth** | **priv**}} [**read view**] [**write view**] [**notify view**] [*access-list-name*]
4. **snmp-server user** *username groupname* {**v1** | **v2c** | **v3** [**auth** {**md5** | **sha**} {**clear** | **encrypted**} **auth-password** [**priv des56** {**clear** | **encrypted**} *priv-password*]]] [*access-list-name*]
5. Use the **commit** or **end** command.

### DETAILED STEPS

	Command or Action	Purpose
Step 1	<b>configure</b>  <b>Example:</b>  RP/0/RSP0/CPU0:router# <b>configure</b>	Enters global configuration mode.
Step 2	<b>snmp-server view</b> <i>view-name oid-tree</i> { <b>included</b>   <b>excluded</b> }	Creates or modifies a view record.
	<b>Example:</b>  RP/0/RSP0/CPU0:router(config)# <b>snmp-server view</b> <i>view_name</i> 1.3.6.1.2.1.1.5 <b>included</b>	
Step 3	<b>snmp-server group</b> <i>name</i> { <b>v1</b>   <b>v2c</b>   <b>v3</b> { <b>auth</b>   <b>noauth</b>   <b>priv</b> }} [ <b>read view</b> ] [ <b>write view</b> ] [ <b>notify view</b> ] [ <i>access-list-name</i> ]	Configures a new SNMP group or a table that maps SNMP users to SNMP views.

	Command or Action	Purpose
	<p><b>Example:</b></p> <pre>RP/0/RSP0/CPU0:router(config)# snmp-server group group_name v3 noauth read view_name1 write view_name2</pre>	
<b>Step 4</b>	<p><b>snmp-server user</b> <i>username groupname</i> {<b>v1</b>   <b>v2c</b>   <b>v3</b> [<b>auth</b> {<b>md5</b>   <b>sha</b>} {<b>clear</b>   <b>encrypted</b>} <b>auth-password</b> [<b>priv des56</b> {<b>clear</b>   <b>encrypted</b>} <b>priv-password</b>]]} [<i>access-list-name</i>]</p> <p><b>Example:</b></p> <pre>RP/0/RSP0/CPU0:router(config)# snmp-server user noauthuser group_name v3</pre>	<p>Configures a new user to an SNMP group.</p> <p><b>Note</b> Only one remote host can be assigned to the same username for SNMP version 3. If you configure the same username with different remote hosts, only the last username and remote host combination will be accepted and will be seen in the <b>show running</b> configuration. In the case of multiple SNMP managers, multiple unique usernames are required.</p>
<b>Step 5</b>	Use the <b>commit</b> or <b>end</b> command.	<p><b>commit</b> —Saves the configuration changes and remains within the configuration session.</p> <p><b>end</b> —Prompts user to take one of these actions:</p> <ul style="list-style-type: none"> <li>• <b>Yes</b> — Saves configuration changes and exits the configuration session.</li> <li>• <b>No</b> —Exits the configuration session without committing the configuration changes.</li> <li>• <b>Cancel</b> —Remains in the configuration session, without committing the configuration changes.</li> </ul>

## Configuring SNMP Trap Notifications

This task explains how to configure the router to send SNMP trap notifications.



**Note** You can omit [Step 3, on page 15](#) if you have already completed the steps documented under the [Configuring SNMPv3, on page 15](#) task.

### SUMMARY STEPS

1. **configure**
2. **snmp-server group** *name* {**v1** | **v2c** | **v3** [**auth** | **noauth** | **priv**]} [**read** *view*] [**write** *view*] [**notify** *view*] [*access-list-name*]
3. **snmp-server user** *username groupname* {**v1** | **v2c** | **v3** [**auth** {**md5** | **sha**} {**clear** | **encrypted**} **auth-password** [**priv des56** {**clear** | **encrypted**} **priv-password**]]} [*access-list-name*]
4. **snmp-server host** *address* [**traps**] [**version** {**1** | **2c** | **3** [**auth** | **noauth** | **priv**]}] *community-string* [**udp-port** *port*] [*notification-type*]
5. **snmp-server traps** [*notification-type*]

6. Use the **commit** or **end** command.
7. (Optional) **show snmp host**

## DETAILED STEPS

	Command or Action	Purpose
Step 1	<b>configure</b> <b>Example:</b> <pre>RP/0/RSP0/CPU0:router# configure</pre>	Enters global configuration mode.
Step 2	<b>snmp-server group</b> <i>name</i> { <b>v1</b>   <b>v2c</b>   <b>v3</b> { <b>auth</b>   <b>noauth</b>   <b>priv</b> }} [ <b>read view</b> ] [ <b>write view</b> ] [ <b>notify view</b> ] [ <i>access-list-name</i> ] <b>Example:</b> <pre>RP/0/RSP0/CPU0:router(config)# snmp-server group group_name v3 noauth read view_name1 write view_name2</pre>	Configures a new SNMP group or a table that maps SNMP users to SNMP views.
Step 3	<b>snmp-server user</b> <i>username</i> <i>groupname</i> { <b>v1</b>   <b>v2c</b>   <b>v3</b> [ <b>auth</b> { <b>md5</b>   <b>sha</b> } { <b>clear</b>   <b>encrypted</b> } <i>auth-password</i> [ <b>priv</b> <b>des56</b> { <b>clear</b>   <b>encrypted</b> } <i>priv-password</i> ]}] [ <i>access-list-name</i> ] <b>Example:</b> <pre>RP/0/RSP0/CPU0:router(config)# snmp-server user noauthuser group_name v3</pre>	Configures a new user to an SNMP group. <b>Note</b> Only one remote host can be assigned to the same username for SNMP version 3. If you configure the same username with different remote hosts, only the last username and remote host combination will be accepted and will be seen in the <b>show running</b> configuration. In the case of multiple SNMP managers, multiple unique usernames are required.
Step 4	<b>snmp-server host</b> <i>address</i> [ <b>traps</b> ] [ <b>version</b> { <b>1</b>   <b>2c</b>   <b>3</b> [ <b>auth</b>   <b>noauth</b>   <b>priv</b> ]}] [ <i>community-string</i> ] [ <b>udp-port</b> <i>port</i> ] [ <i>notification-type</i> ] <b>Example:</b> <pre>RP/0/RP0/CPU0:router(config)# snmp-server host 12.26.25.61 traps version 3 noauth userV3noauth</pre>	Specifies SNMP trap notifications, the version of SNMP to use, the security level of the notifications, and the recipient (host) of the notifications.
Step 5	<b>snmp-server traps</b> [ <i>notification-type</i> ] <b>Example:</b> <pre>RP/0/RP0/CPU0:router(config)# snmp-server traps bgp</pre>	Enables the sending of trap notifications and specifies the type of trap notifications to be sent. <ul style="list-style-type: none"> <li>• If a trap is not specified with the <i>notification-type</i> argument, all supported trap notifications are enabled on the router. To display which trap notifications are available on your router, enter the <b>snmp-server traps ?</b> command.</li> </ul>
Step 6	Use the <b>commit</b> or <b>end</b> command.	<b>commit</b> —Saves the configuration changes and remains within the configuration session. <b>end</b> —Prompts user to take one of these actions:

	Command or Action	Purpose
		<ul style="list-style-type: none"> <li>• <b>Yes</b> — Saves configuration changes and exits the configuration session.</li> <li>• <b>No</b> — Exits the configuration session without committing the configuration changes.</li> <li>• <b>Cancel</b> — Remains in the configuration session, without committing the configuration changes.</li> </ul>
<b>Step 7</b>	(Optional) <b>show snmp host</b> <b>Example:</b> <pre>RP/0/RSP0/CPU0:router# show snmp host</pre>	Displays information about the configured SNMP notification recipient (host), port number, and security model.

## Setting the Contact, Location, and Serial Number of the SNMP Agent

This task explains how to set the system contact string, system location string, and system serial number of the SNMP agent.



**Note** The sequence in which you issue the **snmp-server** commands for this task does not matter.

### SUMMARY STEPS

1. **configure**
2. (Optional) **snmp-server contact** *system-contact-string*
3. (Optional) **snmp-server location** *system-location*
4. (Optional) **snmp-server chassis-id** *serial-number*
5. Use the **commit** or **end** command.

### DETAILED STEPS

	Command or Action	Purpose
<b>Step 1</b>	<b>configure</b> <b>Example:</b> <pre>RP/0/RSP0/CPU0:router# configure</pre>	Enters global configuration mode.
<b>Step 2</b>	(Optional) <b>snmp-server contact</b> <i>system-contact-string</i> <b>Example:</b> <pre>RP/0/RSP0/CPU0:router(config)# snmp-server contact Dial System Operator at beeper # 27345</pre>	Sets the system contact string.

	Command or Action	Purpose
Step 3	(Optional) <b>snmp-server location</b> <i>system-location</i> <b>Example:</b>  RP/0/RSP0/CPU0:router(config)# snmp-server location Building 3/Room 214	Sets the system location string.
Step 4	(Optional) <b>snmp-server chassis-id</b> <i>serial-number</i> <b>Example:</b>  RP/0/RSP0/CPU0:router(config)# snmp-server chassis-id 1234456	Sets the system serial number.
Step 5	Use the <b>commit</b> or <b>end</b> command.	<b>commit</b> —Saves the configuration changes and remains within the configuration session. <b>end</b> —Prompts user to take one of these actions: <ul style="list-style-type: none"> <li>• <b>Yes</b> — Saves configuration changes and exits the configuration session.</li> <li>• <b>No</b> —Exits the configuration session without committing the configuration changes.</li> <li>• <b>Cancel</b> —Remains in the configuration session, without committing the configuration changes.</li> </ul>

## Defining the Maximum SNMP Agent Packet Size

This task shows how to configure the largest SNMP packet size permitted when the SNMP server is receiving a request or generating a reply.



**Note** The sequence in which you issue the **snmp-server** commands for this task does not matter.

### SUMMARY STEPS

1. **configure**
2. (Optional) **snmp-server packetsize** *byte-count*
3. Use the **commit** or **end** command.

### DETAILED STEPS

	Command or Action	Purpose
Step 1	<b>configure</b> <b>Example:</b>	Enters global configuration mode.

	Command or Action	Purpose
	RP/0/RSP0/CPU0:router# configure	
<b>Step 2</b>	(Optional) <b>snmp-server packetsize</b> <i>byte-count</i>  <b>Example:</b>  RP/0/RSP0/CPU0:router(config)# snmp-server packetsize 1024	Sets the maximum packet size.
<b>Step 3</b>	Use the <b>commit</b> or <b>end</b> command.	<b>commit</b> —Saves the configuration changes and remains within the configuration session.  <b>end</b> —Prompts user to take one of these actions: <ul style="list-style-type: none"> <li>• <b>Yes</b> — Saves configuration changes and exits the configuration session.</li> <li>• <b>No</b> —Exits the configuration session without committing the configuration changes.</li> <li>• <b>Cancel</b> —Remains in the configuration session, without committing the configuration changes.</li> </ul>

## Changing Notification Operation Values

After SNMP notifications have been enabled, you can specify a value other than the default for the source interface, message queue length, or retransmission interval.

This task explains how to specify a source interface for trap notifications, the message queue length for each host, and the retransmission interval.



**Note** The sequence in which you issue the **snmp-server** commands for this task does not matter.

### SUMMARY STEPS

1. **configure**
2. (Optional) **snmp-server trap-source** *type interface-path-id*
3. (Optional) **snmp-server queue-length** *length*
4. (Optional) **snmp-server trap-timeout** *seconds*
5. Use the **commit** or **end** command.

### DETAILED STEPS

	Command or Action	Purpose
<b>Step 1</b>	<b>configure</b>  <b>Example:</b>	Enters global configuration mode.



	Command or Action	Purpose
	RP/0/RSP0/CPU0:router# configure	
<b>Step 2</b>	(Optional) <b>snmp-server trap-source</b> <i>type interface-path-id</i> <b>Example:</b> RP/0/RSP0/CPU0:router(config)# snmp-server trap-source POS 0/0/1/0	Specifies a source interface for trap notifications.
<b>Step 3</b>	(Optional) <b>snmp-server queue-length</b> <i>length</i> <b>Example:</b> RP/0/RSP0/CPU0:router(config)# snmp-server queue-length 20	Establishes the message queue length for each notification.
<b>Step 4</b>	(Optional) <b>snmp-server trap-timeout</b> <i>seconds</i> <b>Example:</b> RP/0/RSP0/CPU0:router(config)# snmp-server trap-timeout 20	Defines how often to resend notifications on the retransmission queue.
<b>Step 5</b>	Use the <b>commit</b> or <b>end</b> command.	<b>commit</b> —Saves the configuration changes and remains within the configuration session. <b>end</b> —Prompts user to take one of these actions: <ul style="list-style-type: none"> <li>• <b>Yes</b> — Saves configuration changes and exits the configuration session.</li> <li>• <b>No</b> —Exits the configuration session without committing the configuration changes.</li> <li>• <b>Cancel</b> —Remains in the configuration session, without committing the configuration changes.</li> </ul>

## Setting IP Precedence and DSCP Values

This task describes how to configure IP Precedence or IP DSCP for SNMP traffic.

### Before you begin

SNMP must be configured.

### SUMMARY STEPS

1. **configure**
2. Use one of the following commands:
  - **snmp-server ipv4 precedence** *value*
  - **snmp-server ipv4 dscp** *value*

- Use the **commit** or **end** command.

## DETAILED STEPS

	Command or Action	Purpose
<b>Step 1</b>	<b>configure</b> <b>Example:</b> RP/0/RSP0/CPU0:router# configure	Enters global configuration mode.
<b>Step 2</b>	Use one of the following commands: <ul style="list-style-type: none"> <li><b>snmp-server ipv4 precedence</b> <i>value</i></li> <li><b>snmp-server ipv4 dscp</b> <i>value</i></li> </ul> <b>Example:</b> RP/0/RSP0/CPU0:router(config)# snmp-server dscp 24	Configures an IP precedence or IP DSCP value for SNMP traffic.
<b>Step 3</b>	Use the <b>commit</b> or <b>end</b> command.	<b>commit</b> —Saves the configuration changes and remains within the configuration session. <b>end</b> —Prompts user to take one of these actions: <ul style="list-style-type: none"> <li><b>Yes</b> — Saves configuration changes and exits the configuration session.</li> <li><b>No</b> —Exits the configuration session without committing the configuration changes.</li> <li><b>Cancel</b> —Remains in the configuration session, without committing the configuration changes.</li> </ul>

## Configuring MIB Data to be Persistent

Many SNMP MIB definitions define arbitrary 32-bit indices for their object tables. MIB implementations often do a mapping from the MIB indices to some internal data structure that is keyed by some other set of data. In these MIB tables the data contained in the table are often other identifiers of the element being modelled. For example, in the ENTITY-MIB, entries in the entPhysicalTable are indexed by the 31-bit value, entPhysicalIndex, but the entities could also be identified by the entPhysicalName or a combination of the other objects in the table.

Because of the size of some MIB tables, significant processing is required to discover all the mappings from the 32-bit MIB indices to the other data which the network management station identifies the entry. For this reason, it may be necessary for some MIB indices to be persistent across process restarts, switchovers, or device reloads. The ENTITY-MIB entPhysicalTable and CISCO-CLASS-BASED-QOS-MIB are two such MIBs that often require index values to be persistent.

Also, because of query response times and CPU utilization during CISCO-CLASS-BASED-QOS-MIB statistics queries, it is desirable to cache service policy statistics.

## SUMMARY STEPS

1. (Optional) **snmp-server entityindex persist**
2. (Optional) **snmp-server mibs cbqosmib persist**
3. (Optional) **snmp-server cbqosmib cache refresh time *time***
4. (Optional) **snmp-server cbqosmib cache service-policy count *count***
5. **snmp-server ifindex persist**

## DETAILED STEPS

	Command or Action	Purpose
Step 1	(Optional) <b>snmp-server entityindex persist</b> <b>Example:</b>  RP/0/RSP0/CPU0:router(config)# <b>snmp-server entityindex persist</b>	Enables the persistent storage of ENTITY-MIB data.
Step 2	(Optional) <b>snmp-server mibs cbqosmib persist</b> <b>Example:</b>  RP/0/RSP0/CPU0:router(config)# <b>snmp-server mibs cbqosmib persist</b>	Enables persistent storage of the CISCO-CLASS-BASED-QOS-MIB data.
Step 3	(Optional) <b>snmp-server cbqosmib cache refresh time <i>time</i></b> <b>Example:</b>  RP/0/RSP0/CPU0:router(config)# <b>snmp-server mibs cbqosmib cache refresh time 45</b>	Enables QoS MIB caching with a specified cache refresh time.
Step 4	(Optional) <b>snmp-server cbqosmib cache service-policy count <i>count</i></b> <b>Example:</b>  RP/0/RSP0/CPU0:router(config)# <b>snmp-server mibs cbqosmib cache service-policy count 50</b>	Enables QoS MIB caching with a limited number of service policies to cache.
Step 5	<b>snmp-server ifindex persist</b> <b>Example:</b>  RP/0/RSP0/CPU0:router(config)# <b>snmp-server ifindex persist</b>	Enables ifIndex persistence globally on all Simple Network Management Protocol (SNMP) interfaces.

## Configuring LinkUp and LinkDown Traps for a Subset of Interfaces

By specifying a regular expression to represent the interfaces for which you are interested in setting traps, you can enable or disable linkUp and linkDown traps for a large number of interfaces simultaneously.

**Before you begin**

SNMP must be configured.

**SUMMARY STEPS**

1. **configure**
2. **snmp-server interface subset** *subset-number* **regular-expression** *expression*
3. **notification linkupdown disable**
4. Use the **commit** or **end** command.
5. (Optional) **show snmp interface notification subset** *subset-number*
6. (Optional) **show snmp interface notification regular-expression** *expression*
7. (Optional) **show snmp interface notification** *type interface-path-id*

**DETAILED STEPS**

	Command or Action	Purpose
<b>Step 1</b>	<b>configure</b> <b>Example:</b> <pre>RP/0/RSP0/CPU0:router# configure</pre>	Enters global configuration mode.
<b>Step 2</b>	<b>snmp-server interface subset</b> <i>subset-number</i> <b>regular-expression</b> <i>expression</i> <b>Example:</b> <pre>RP/0/RSP0/CPU0:router(config)# snmp-server interface subset 10 regular-expression "^Gig[a-zA-Z]+[0-9/]+\."</pre>	<p>Enters snmp-server interface mode for the interfaces identified by the regular expression.</p> <p>The <i>subset-number</i> argument identifies the set of interfaces, and also assigns a priority to the subset in the event that an interface is included in more than one subset. Lower numbers have higher priority and their configuration takes precedent over interface subsets with higher numbers.</p> <p>The <i>expression</i> argument must be entered surrounded by double quotes.</p> <p>Refer to the <i>Understanding Regular Expressions, Special Characters, and Patterns</i> module in <i>Cisco ASR 9000 Series Aggregation Services Router Getting Started Guide</i> for more information regarding regular expressions.</p>
<b>Step 3</b>	<b>notification linkupdown disable</b> <b>Example:</b> <pre>RP/0/RSP0/CPU0:router(config-snmp-if-subset)# notification linkupdown disable</pre>	Disables linkUp and linkDown traps for all interfaces being configured. To enable previously disabled interfaces, use the <b>no</b> form of this command.
<b>Step 4</b>	Use the <b>commit</b> or <b>end</b> command.	<p><b>commit</b> —Saves the configuration changes, and remains within the configuration session.</p> <p><b>end</b> —Prompts user to take one of these actions:</p> <ul style="list-style-type: none"> <li>• <b>Yes</b> — Saves configuration changes and exits the configuration session.</li> </ul>

	Command or Action	Purpose
		<ul style="list-style-type: none"> <li>• <b>No</b> —Exits the configuration session without committing the configuration changes.</li> <li>• <b>Cancel</b> —Remains in the configuration mode, without committing the configuration changes.</li> </ul>
<b>Step 5</b>	(Optional) <b>show snmp interface notification subset</b> <i>subset-number</i>  <b>Example:</b>  <pre>RP/0/RSP0/CPU0:router# show snmp interface notification subset 10</pre>	Displays the linkUp and linkDown notification status for all interfaces identified by the subset priority.
<b>Step 6</b>	(Optional) <b>show snmp interface notification regular-expression</b> <i>expression</i>  <b>Example:</b>  <pre>RP/0/RSP0/CPU0:router# show snmp interface notification regular-expression "^Gig[a-zA-Z]+[0-9/]+\."</pre>	Displays the linkUp and linkDown notification status for all interfaces identified by the regular expression.
<b>Step 7</b>	(Optional) <b>show snmp interface notification type</b> <i>interface-path-id</i>  <b>Example:</b>  <pre>RP/0/RSP0/CPU0:router# show snmp interface notification tengige 0/4/0/3.10</pre>	Displays the linkUp and linkDown notification status for the specified interface.

## Configuration Examples for Implementing SNMP

### Configuring SNMPv3: Examples

#### Setting an Engine ID

This example shows how to set the identification of the local SNMP engine:

```
snmp-server engineID local 00:00:00:09:00:00:00:a1:61:6c:20:61
```



**Note** After the engine ID has been configured, the SNMP agent restarts.

### Verifying the Identification of the Local SNMP Engines

This example shows how to verify the identification of the local SNMP engine:

```
config
  show snmp engineid

SNMP engineID 00000009000000a1ffffffff
```

### Creating a View

There are two ways to create a view:

- You can include the object identifier (OID) of an ASN.1 subtree of a MIB family from a view by using the **included** keyword of the **snmp-server view** command.
- You can exclude the OID subtree of the ASN.1 subtree of a MIB family from a view by using the **excluded** keyword of the **snmp-server view** command.

This example shows how to create a view that includes the sysName (1.3.6.1.2.1.1.5) object:

```
config
  snmp-server view SNMP_VIEW1 1.3.6.1.2.1.1.5 included
```

This example shows how to create a view that includes all the OIDs of a system group:

```
config
  snmp-server view SNMP_VIEW1 1.3.6.1.2.1.1 included
```

This example shows how to create a view that includes all the OIDs under the system group except the sysName object (1.3.6.1.2.1.1.5), which has been excluded:

```
config
  snmp-server view SNMP_VIEW1 1.3.6.1.2.1.1 included
  snmp-server view SNMP_VIEW1 1.3.6.1.2.1.1.5 excluded
```

### Verifying Configured Views

This example shows how to display information about the configured views:

```
RP/0/RSP0/CPU0:router# show snmp view

v1default 1.3.6.1 - included nonVolatile active
SNMP_VIEW1 1.3.6.1.2.1.1 - included nonVolatile active
SNMP_VIEW1 1.3.6.1.2.1.1.5 - excluded nonVolatile active
```

## Creating Groups

If you do not explicitly specify a notify, read, or write view, the Cisco IOS XR software uses the v1 default (1.3.6.1). This example shows how to create a group that utilizes the default view:

```
RP/0/RSP0/CPU0:router(config)# snmp-server group group-name v3 auth
```

The following configuration example shows how to create a group that has read access to all the OIDs in the system except the sysUpTime object (1.3.6.1.2.1.1.3), which has been excluded from the view applied to the group, but write access only to the sysName object (1.3.6.1.2.1.1.5):

```
!
snmp-server view view_name1 1.3.6.1.2.1.1 included
snmp-server view view_name1 1.3.6.1.2.1.1.3 excluded
snmp-server view view_name2 1.3.6.1.2.1.1.5 included
snmp-server group group_name1 v3 auth read view_name1 write view_name2
!
```

## Verifying Groups

This example shows how to verify the attributes of configured groups:

```
RP/0/RSP0/CPU0:router# show snmp group

groupname: group_name1                security model:usm
readview : view_name1                 writeview: view_name2
notifyview: v1default
row status: nonVolatile
```

## Creating and Verifying Users

Given the following SNMPv3 view and SNMPv3 group configuration:

```
!
snmp-server view view_name 1.3.6.1.2.1.1 included
snmp-server group group_name v3 noauth read view_name write view-name
!
```

This example shows how to create a noAuthNoPriv user with read and write view access to a system group:

```
config
snmp-server user noauthuser group_name v3
```



---

**Note** The user must belong to a noauth group before a noAuthNoPriv user can be created.

---

Only one remote host can be assigned to the same username for SNMP version 3. If you configure the same username with different remote hosts, only the last username and remote host combination will be accepted and will be seen in the show running configuration. In the case of multiple SNMP managers, multiple unique usernames are required.

This example shows the same username case which only the last configuration will be accepted:

```
snmp-server user username nervectrgrp remote 10.69.236.146 udp-port 162 v3 auth sha
<password> priv aes 128 <password>
snmp-server user username nervectrgrp remote 10.214.127.2 udp-port 162 v3 auth sha <password>
  priv aes 128 <password>
snmp-server user username nervectrgrp remote 10.69.236.147 udp-port 162 v3 auth sha
<password> priv aes 128 <password>
RP/0/RSP0/CPU0:router# show run snmp-server user

snmp-server user username nervectrgrp remote 10.69.236.147 udp-port 162 v3 auth sha
encrypted <password> priv aes 128 encrypted <password>
```

This example shows all 3 hosts for username1, username2, and username3 will be accepted.

:

```
snmp-server user username1 nervectrgrp remote 10.69.236.146 udp-port 162 v3 auth sha
<password> priv aes 128 <password>
snmp-server user username2 nervectrgrp remote 10.214.127.2 udp-port 162 v3 auth sha
<password> priv aes 128 <password>
snmp-server user username3 nervectrgrp remote 10.69.236.147 udp-port 162 v3 auth sha
<password> priv aes 128 <password>
RP/0/RSP0/CPU0:router# show run snmp-server user

snmp-server user batmanusr1 nervectrgrp remote 10.69.236.146 udp-port 162 v3 auth sha
encrypted <password> priv aes 128 encrypted <password>
snmp-server user batmanusr2 nervectrgrp remote 10.214.127.2 udp-port 162 v3 auth sha
encrypted <password> priv aes 128 encrypted <password>
snmp-server user batmanusr3 nervectrgrp remote 10.69.236.147 udp-port 162 v3 auth sha
encrypted <password> priv aes 128 encrypted <password>
```

This example shows how to verify the attributes that apply to the SNMP user:

```
RP/0/RSP0/CPU0:router# show snmp user

User name: noauthuser
Engine ID: localSnmpID
storage-type: nonvolatile active
```

Given the following SNMPv3 view and SNMPv3 group configuration:

```
!
snmp-server view SNMP_VIEW1 1.3.6.1.2.1.1 included
snmp-server group SNMP_GROUP1 v3 auth notify SNMP_VIEW1 read SNMP_VIEW1 write SNMP_VIEW1
!
```

This example shows how to create a user with authentication (including encryption), read, and write view access to a system group:

```
config
snmp-server user userv3authpriv SNMP_GROUP1 v3 auth md5 password123 priv aes 128 password123
```



Given the following SNMPv3 view and SNMPv3 group configuration:

```
!
snmp-server view view_name 1.3.6.1.2.1.1 included
snmp group group_name v3 priv read view_name write view_name
!
```

This example shows how to create authNoPriv user with read and write view access to a system group:

```
RP/0/RSP0/CPU0:router(config)# snmp-server user authuser group_name v3 auth md5 clear
auth_passwd
```



---

**Note** Because the group is configured at a security level of Auth, the user must be configured as “auth” at a minimum to access this group (“priv” users could also access this group). The authNoPriv user configured in this group, authuser, must supply an authentication password to access the view. In the example, auth\_passwd is set as the authentication password string. Note that **clear** keyword is specified before the auth\_passwd password string. The **clear** keyword indicates that the password string being supplied is unencrypted.

---

This example shows how to verify the attributes that apply to SNMP user:

```
RP/0/RSP0/CPU0:router# show snmp user

User name: authuser
Engine ID: localSnmplD
storage-type: nonvolatile active
```

Given the following SNMPv3 view and SNMPv3 group configuration:

```
!
snmp view view_name 1.3.6.1.2.1.1 included
snmp group group_name v3 priv read view_name write view_name
!
```

This example shows how to create an authPriv user with read and write view access to a system group:

```
config
snmp-server user privuser group_name v3 auth md5 clear auth_passwd priv des56 clear
priv_passwd
```



---

**Note** Because the group has a security level of Priv, the user must be configured as a “priv” user to access this group. In this example, the user, privuser, must supply both an authentication password and privacy password to access the OIDs in the view.

---

This example shows how to verify the attributes that apply to the SNMP user:

```
RP/0/RSP0/CPU0:router# show snmp user

User name: privuser
Engine ID: localSnmpID
storage-type: nonvolatile active
```

## Configuring Trap Notifications: Example

The following example configures an SNMP agent to send out different types of traps. The configuration includes a v2c user, a noAuthNoPriv user, anauthNoPriv user, and an AuthPriv user.



---

**Note** The default User Datagram Protocol (UDP) port is 161. If you do not specify a UDP port with the **udp-port** keyword and *port* argument, then the configured SNMP trap notifications are sent to port 161.

---

```
!
snmp-server host 10.50.32.170 version 2c public udp-port 2345
snmp-server host 10.50.32.170 version 3 auth userV3auth udp-port 2345
snmp-server host 10.50.32.170 version 3 priv userV3priv udp-port 2345
snmp-server host 10.50.32.170 version 3 noauth userV3noauth udp-port 2345
snmp-server user userv2c groupv2c v2c
snmp-server user userV3auth groupV3auth v3 auth md5 encrypted 140F0A13
snmp-server user userV3priv groupV3priv v3 auth md5 encrypted 021E1C43 priv des56 encrypted
1110001C
snmp-server user userV3noauth groupV3noauth v3 LROwner
snmp-server view view_name 1.3 included
snmp-server community public RW
snmp-server group groupv2c v2c read view_name
snmp-server group groupV3auth v3 auth read view_name
snmp-server group groupV3priv v3 priv read view_name
snmp-server group groupV3noauth v3 noauth read view_name
!
```

This example shows how to verify the configuration SNMP trap notification recipients host, the recipients of SNMP trap notifications. The output displays the following information:

- IP address of the configured notification host
- UDP port where SNMP notification messages are sent
- Type of trap configured
- Security level of the configured user
- Security model configured

```
config
show snmp host

Notification host: 10.50.32.170 udp-port: 2345 type: trap
user: userV3auth security model: v3 auth

Notification host: 10.50.32.170 udp-port: 2345 type: trap
```

```
user: userV3noauth security model: v3 noauth

Notification host: 10.50.32.170 udp-port: 2345 type: trap
user: userV3priv security model: v3 priv

Notification host: 10.50.32.170 udp-port: 2345 type: trap
user: userv2c security model: v2c
```

## Setting an IP Precedence Value for SNMP Traffic: Example

The following example shows how to set the SNMP IP Precedence value to 7:

```
configure
  snmp-server ipv4 precedence 7
  exit

Uncommitted changes found, commit them before exiting(yes/no/cancel)? [cancel]: y
```

## Setting an IP DSCP Value for SNMP Traffic: Example

The following example shows how to set the IP DSCP value of SNMP traffic to 45:

```
configure
  snmp-server ipv4 dscp 45
  exit

Uncommitted changes found, commit them before exiting(yes/no/cancel)? [cancel]: y
```

# SNMP Context Mapping Configuration

### Configuration of VRF Aware SNMP Context for Polling BGP Data

VRF awareness is usually done using existing, non-VRF aware MIB definitions. This means that MIB definition doesn't mention anything about VRFs. However they could be used within VRF context.

The VRF-awareness is done using SNMP contexts, where a SNMP context maps to a specific VRF.

#### Before you begin

- Ensure that MIB implementation is VRF-aware.
- Ensure that the implementation of all get requests support VRF context.

The following example configures VRF aware SNMP context to allow polling BGP data using BGP4-MIB.

```
snmp-server vrf <vrf_1> context <context_1>
snmp-server community <vrf_1> RW
snmp-server context <context_1>
```

```
snmp-server community-map <vrf_1> context <context_1>
snmp-server host <IP> traps version 2c <vrf_1>
```

### Verification

The following configuration extracts BGP data from a peer VRF using context.

```
snmp-server vrf V1
 context V1_bgp
!
snmp-server community V1 RW
snmp-server context V1_bgp
snmp-server community-map V1 context V1_bgp
router bgp 65000
 nsr
 address-family ipv4 unicast
!
 address-family vpnv4 unicast
!
 neighbor 192.0.2.254
 remote-as 65001
 address-family ipv4 unicast
 route-policy ALL in
 route-policy ALL out
!
!
vrf V1
 rd 111:111
 address-family ipv4 unicast
!
 neighbor 192.0.2.255
 remote-as 65003
 address-family ipv4 unicast
!
!
!
end
```

### Configuration of OSPF processes Using SNMP Context

The following example configures data polling from two OSPF processes.

```
snmp-server community com1 RW
snmp-server community com2 RW
snmp-server context ctx1
snmp-server context ctx2
snmp-server community-map com1 context ctx1
snmp-server community-map com2 context ctx2
router ospf one
 snmp context ctx1
 area 0
 interface GigabitEthernet0/2/0/0
!
!
!
router ospf two
 snmp context ctx2
 area 0
 interface GigabitEthernet0/2/0/1
!
!
!
```

### Configuration of OSPF Neighbour in VRF

The following example configures OSPF neighbours in VRF using SNMP context.

```
snmp-server vrf VRF_A
  context ctx1
!
snmp-server community com1 RW
snmp-server context ctx1
snmp-server community-map com1 context ctx1
router ospf core
  vrf VRF_A
    snmp context ctx1
!
!
end
```

## Additional References

The following sections provide references related to Implementing SNMP on Cisco IOS XR software.

### Related Documents

Related Topic	Document Title
Cisco IOS XR SNMP commands	<i>SNMP Server Commands on the Cisco ASR 9000 Series Router</i> module of <i>System Management Command Reference for Cisco ASR 9000 Series Routers</i>
MIB information	<i>Cisco ASR 9000 Series Aggregation Services Routers MIB Specifications Guide</i>
Cisco IOS XR commands	<i>Cisco ASR 9000 Series Aggregation Services Router Commands Master List</i>
Getting started with Cisco IOS XR software	<i>Cisco ASR 9000 Series Aggregation Services Router Getting Started Guide</i>
Information about user groups and task IDs	<i>Configuring AAA Services on the Cisco ASR 9000 Series Router</i> module of <i>System Security Configuration Guide for Cisco ASR 9000 Series Routers</i>
Cisco IOS XR Quality of Service	<i>Modular QoS Configuration Guide for Cisco ASR 9000 Series Routers</i>

### Standards

Standards	Title
No new or modified standards are supported by this feature, and support for existing standards has not been modified by this feature.	—

**MIBs**

<b>MIBs</b>	<b>MIBs Link</b>
—	To locate and download MIBs using Cisco IOS XR software, use the Cisco MIB Locator found at the following URL and choose a platform under the Cisco Access Products menu: <a href="http://cisco.com/public/sw-center/netmgmt/cmtk/mibs.shtml">http://cisco.com/public/sw-center/netmgmt/cmtk/mibs.shtml</a>

**RFCs**

<b>RFCs</b>	<b>Title</b>
RFC 3411	<i>An Architecture for Describing Simple Network Management Protocol (SNMP) Management Frameworks</i>
RFC 3412	<i>Message Processing and Dispatching for the Simple Network Management Protocol (SNMP)</i>
RFC 3413	<i>Simple Network Management Protocol (SNMP) Applications</i>
RFC 3414	<i>User-based Security Model (USM) for version 3 of the Simple Network Management Protocol (SNMPv3)</i>
RFC 3415	<i>View-based Access Control Model (VACM) for the Simple Network Management Protocol (SNMP)</i>
RFC 3416	<i>Version 2 of the Protocol Operations for the Simple Network Management Protocol (SNMP)</i>
RFC 3417	<i>Transport Mappings for the Simple Network Management Protocol (SNMP)</i>
RFC 3418	<i>Management Information Base (MIB) for the Simple Network Management Protocol (SNMP)</i>

**Technical Assistance**

<b>Description</b>	<b>Link</b>
The Cisco Technical Support website contains thousands of pages of searchable technical content, including links to products, technologies, solutions, technical tips, and tools. Registered Cisco.com users can log in from this page to access even more content.	<a href="http://www.cisco.com/cisco/web/support/index.html">http://www.cisco.com/cisco/web/support/index.html</a>



## CHAPTER 4

# Configuring Object Tracking

This module describes the configuration of object tracking on your Cisco IOS XR network. For complete descriptions of the commands listed in this module, see [Related Documents, on page 50](#). To locate documentation for other commands that might appear in the course of performing a configuration task, search online in *Cisco ASR 9000 Series Aggregation Services Router Commands Master List*.

**Table 6: Feature History Table**

Feature Name	Release Information	Description
Enhanced Object Tracking	Release 6.4.2	The Enhanced Object Tracking feature is introduced. The ability to error-disable interfaces is added based on the state of objects that are tracked.
Enhanced Object Tracking	Release 4.2.1	The ability to create a tracked list based on a threshold percentage or weight was added.
Enhanced Object Tracking	Release 4.0.0	This feature was introduced.

This module contains the following topics:

- [Prerequisites for Implementing Object Tracking, on page 35](#)
- [Information About Object Tracking, on page 36](#)
- [Restrictions for Enhanced Object Tracking, on page 37](#)
- [How to Implement Object Tracking, on page 37](#)
- [Configure Enhanced Object Tracking, on page 47](#)
- [Configuration Examples for Configuring Object Tracking, on page 49](#)
- [Additional References, on page 50](#)

## Prerequisites for Implementing Object Tracking

You must be in a user group associated with a task group that includes the proper task IDs. The command reference guides include the task IDs required for each command. If you suspect user group assignment is preventing you from using a command, contact your AAA administrator for assistance.

# Information About Object Tracking

*Object tracking* is a mechanism for tracking an object to take any client action on another object as configured by the client. The object on which the client action is performed may not have any relationship to the tracked objects. The client actions are performed based on changes to the properties of the object being tracked.

You can identify each tracked object by a unique name that is specified by the track command in the configuration mode.

The tracking process periodically polls the tracked object and reports any changes to its state. The state of the tracked objects can be up or down. The polling occurs either immediately or after a delay of a configured period.

You can also track multiple objects by a list. You can use a flexible method for combining objects with Boolean logic. This functionality includes:

- **Boolean AND function**—When a tracked list has been assigned a Boolean AND function, each object that is defined within a subset must be in an "up" state. This condition enables the tracked object to be in the "up" state.
- **Boolean OR function**—When the tracked list has been assigned a Boolean OR function, at least one object that is defined within a subset must also be in an "up" state. This condition enables the tracked object to be in the "up" state.

*Enhanced Object Tracking* allows you to extend the track function to implement actions. These actions are triggered when the state of the object that is being tracked changes to "up" or "down". Based on the track state, you can error-disable one or more specified interfaces. Unless you configure the **auto-recover** keyword, the interfaces remain disabled even after the track state changes to the original state. You can configure **auto-recover** for each **action** configuration on a track.

In Figure 1, tracks named track1 and track2 are configured on router R1 to track the line protocol state of interfaces, GigabitEthernet0/0/0/1 and GigabitEthernet0/1/0/1 respectively. A track that is named track3 is configured to track track1 and track2 tracks with the Boolean logic AND. Therefore, track3 goes down if one or both the tracks, track1 and track2, go down. Track3 is also configured with the **action** command to put the interfaces GigabitEthernet0/0/0/0 and GigabitEthernet0/1/0/0 in a disabled state when track3 goes down.

Once the interfaces are error-disabled, they remain in the error-disabled state even if the track state changes to the "up" state. This is the default behaviour. To change this default behaviour, you can optionally configure the **auto-recover** keyword in the **action** command. If you configure the optional **auto-recover** keyword, the error-disabled state on the interfaces is cleared when the track state changes to the "up" state.



Figure 6: Enhanced Object Tracking

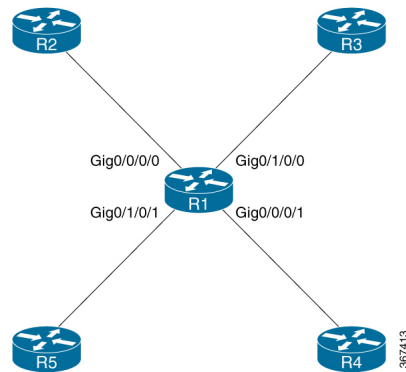

## Restrictions for Enhanced Object Tracking

- You can perform Enhanced Object Tracking only on physical interfaces and not on virtual interfaces.
- The only action you can perform is error-disabling interfaces based on the state of a track (up/down).
- The maximum number of action interfaces that can be added under a single track is 1024.

## How to Implement Object Tracking

This section describes the various object tracking procedures.

### Tracking the Line Protocol State of an Interface

Perform this task in global configuration mode to track the line protocol state of an interface.

A tracked object is considered up when a line protocol of the interface is up.

After configuring the tracked object, you may associate the interface whose state should be tracked and specify the number of seconds to wait before the tracking object polls the interface for its state.

#### SUMMARY STEPS

1. **configure**
2. **track** *track-name*
3. **type line-protocol state**
4. **interface** *type interface-path-id*
5. **exit**
6. (Optional) **delay** {**up** *seconds* | **down** *seconds*}
7. Use one of the following commands:
  - **end**
  - **commit**

## DETAILED STEPS

	Command or Action	Purpose
<b>Step 1</b>	<b>configure</b> <b>Example:</b>  RP/0/RSP0/CPU0:router# configure	Enters global configuration mode.
<b>Step 2</b>	<b>track track-name</b> <b>Example:</b>  RP/0/RSP0/CPU0:router(config)# track track1	Enters track configuration mode.  <ul style="list-style-type: none"> <li>• <i>track-name</i>—Specifies a name for the object to be tracked.</li> </ul> <p><b>Note</b> Special characters are not allowed in a <i>track-name</i>.</p>
<b>Step 3</b>	<b>type line-protocol state</b> <b>Example:</b>  RP/0/RSP0/CPU0:router(config-track)# type line-protocol state	Creates a track based on the line protocol of an interface.
<b>Step 4</b>	<b>interface type interface-path-id</b> <b>Example:</b>  RP/0/RSP0/CPU0:router(config-track-line-prot)# interface atm 0/2/0/0.1	Specifies the interface to track the protocol state.  <ul style="list-style-type: none"> <li>• <i>type</i>—Specifies the interface type. For more information, use the question mark (?) online help function.</li> <li>• <i>interface-path-id</i>—Identifies a physical interface or a virtual interface.</li> </ul> <p><b>Note</b> Use the <b>show interfaces</b> command to see a list of all possible interfaces currently configured on the router.</p> <p><b>Note</b> The loopback and null interfaces are always in the up state and, therefore, cannot be tracked.</p>
<b>Step 5</b>	<b>exit</b> <b>Example:</b>  RP/0/RSP0/CPU0:router(config-track-line-prot)# exit	Exits the track line protocol configuration mode.
<b>Step 6</b>	(Optional) <b>delay {up seconds   down seconds}</b> <b>Example:</b>  RP/0/RSP0/CPU0:router(config-track)# delay up 10	Schedules the delay that can occur between tracking whether the object is up or down.
<b>Step 7</b>	Use one of the following commands:  <ul style="list-style-type: none"> <li>• <b>end</b></li> <li>• <b>commit</b></li> </ul>	Saves configuration changes.  <ul style="list-style-type: none"> <li>• When you issue the <b>end</b> command, the system prompts you to commit changes:</li> </ul>

	Command or Action	Purpose
	<p><b>Example:</b></p> <pre>RP/0/RSP0/CPU0:router(config-track)# end</pre> <p>or</p> <pre>RP/0/RSP0/CPU0:router(config-track)# commit</pre>	<p>Uncommitted changes found, commit them before exiting (yes/no/cancel)? [cancel]:</p> <ul style="list-style-type: none"> <li>• Entering <b>yes</b> saves configuration changes to the running configuration file, exits the configuration session, and returns the router to EXEC mode.</li> <li>• Entering <b>no</b> exits the configuration session and returns the router to EXEC mode without committing the configuration changes.</li> <li>• Entering <b>cancel</b> leaves the router in the current configuration session without exiting or committing the configuration changes.</li> </ul> <ul style="list-style-type: none"> <li>• Use the <b>commit</b> command to save the configuration changes to the running configuration file and remain within the configuration session.</li> </ul>

## Tracking IP Route Reachability

When a host or a network goes down on a remote site, routing protocols notify the router and the routing table is updated accordingly. The routing process is configured to notify the tracking process when the route state changes due to a routing update.

A tracked object is considered up when a routing table entry exists for the route and the route is accessible.

### SUMMARY STEPS

1. **configure**
2. **track** *track-name*
3. **type route reachability**
4. Use one of the following commands:
  - **vrf** *vrf-table-name*
  - **route ipv4** *IP-prefix/mask*
5. **exit**
6. (Optional) **delay** {**up** *seconds* | **down** *seconds*}
7. Use the **commit** or **end** command.

### DETAILED STEPS

	Command or Action	Purpose
Step 1	<p><b>configure</b></p> <p><b>Example:</b></p> <pre>RP/0/RSP0/CPU0:router# configure</pre>	Enters global configuration mode.

	Command or Action	Purpose
<b>Step 2</b>	<p><b>track</b> <i>track-name</i></p> <p><b>Example:</b></p> <pre>RP/0/RSP0/CPU0:router(config)# track track1</pre>	<p>Enters track configuration mode.</p> <ul style="list-style-type: none"> <li>• <i>track-name</i>—Specifies a name for the object to be tracked.</li> </ul> <p><b>Note</b> Special characters are not allowed in a <i>track-name</i>.</p>
<b>Step 3</b>	<p><b>type route reachability</b></p> <p><b>Example:</b></p> <pre>RP/0/RSP0/CPU0:router(config-track)# type route reachability vrf internet</pre>	<p>Configures the routing process to notify the tracking process when the state of the route changes due to a routing update.</p>
<b>Step 4</b>	<p>Use one of the following commands:</p> <ul style="list-style-type: none"> <li>• <b>vrf</b> <i>vrf-table-name</i></li> <li>• <b>route ipv4</b> <i>IP-prefix/mask</i></li> </ul> <p><b>Example:</b></p> <pre>RP/0/RSP0/CPU0:router(config-track-route)# vrf vrf-table-4</pre> <p>or</p> <pre>RP/0/RSP0/CPU0:router(config-track-route)# route ipv4 10.56.8.10/16</pre>	<p>Configures the type of IP route to be tracked, which can consist of either of the following, depending on your router type:</p> <ul style="list-style-type: none"> <li>• <i>vrf-table-name</i>—A VRF table name.</li> <li>• <i>IP-prefix/mask</i>—An IP prefix consisting of the network and subnet mask (for example, 10.56.8.10/16).</li> </ul>
<b>Step 5</b>	<p><b>exit</b></p> <p><b>Example:</b></p> <pre>RP/0/RSP0/CPU0:router(config-track-line-prot)# exit</pre>	<p>Exits the track line protocol configuration mode.</p>
<b>Step 6</b>	<p>(Optional) <b>delay</b> {<b>up</b> <i>seconds</i>   <b>down</b> <i>seconds</i>}</p> <p><b>Example:</b></p> <pre>RP/0/RSP0/CPU0:router(config-track)# delay up 10</pre>	<p>Schedules the delay that can occur between tracking whether the object is up or down.</p>
<b>Step 7</b>	<p>Use the <b>commit</b> or <b>end</b> command.</p>	<p><b>commit</b> —Saves the configuration changes, and remains within the configuration session.</p> <p><b>end</b> —Prompts user to take one of these actions:</p> <ul style="list-style-type: none"> <li>• <b>Yes</b> — Saves configuration changes and exits the configuration session.</li> <li>• <b>No</b> —Exits the configuration session without committing the configuration changes.</li> <li>• <b>Cancel</b> —Remains in the configuration mode, without committing the configuration changes.</li> </ul>

## Building a Track Based on a List of Objects

Perform this task in the global configuration mode to create a tracked list of objects (which, in this case, are lists of interfaces or prefixes) using a Boolean expression to determine the state of the list.

A tracked list contains one or more objects. The Boolean expression enables two types of calculations by using either AND or OR operators. For example, when tracking two interfaces, using the AND operator, up means that *both* interfaces are up, and down means that *either* interface is down.



**Note** An object must exist before it can be added to a tracked list.

The NOT operator is specified for one or more objects and negates the state of the object.

After configuring the tracked object, you must associate the interface whose state should be tracked and you may optionally specify the number of seconds to wait before the tracking object polls the interface for its state.

### SUMMARY STEPS

1. **configure**
2. **track** *track-name*
3. **type list boolean { and | or }**
4. **object** *object-name* [ **not** ]
5. **exit**
6. (Optional) **delay** { **up** *seconds* | **down** *seconds* }
7. Use one of the following commands:
  - **end**
  - **commit**

### DETAILED STEPS

	Command or Action	Purpose
Step 1	<b>configure</b> <b>Example:</b> RP/0/RSP0/CPU0:router# <code>configure</code>	Enters global configuration mode.
Step 2	<b>track</b> <i>track-name</i> <b>Example:</b> RP/0/RSP0/CPU0:router(config)# <code>track track1</code>	Enters track configuration mode. <ul style="list-style-type: none"> <li>• <i>track-name</i>—Specifies a name for the object to be tracked.</li> </ul> <p><b>Note</b> Special characters are not allowed in a <i>track-name</i>.</p>
Step 3	<b>type list boolean { and   or }</b> <b>Example:</b>	Configures a Boolean list object and enters track list configuration mode.

	Command or Action	Purpose
	<pre>RP/0/RSP0/CPU0:router(config-track-list)# type list boolean and</pre>	<ul style="list-style-type: none"> <li>• <b>boolean</b>—Specifies that the state of the tracked list is based on a Boolean calculation.</li> <li>• <b>and</b>—Specifies that the list is up if all objects are up, or down if one or more objects are down. For example when tracking two interfaces, up means that both interfaces are up, and down means that either interface is down.</li> <li>• <b>or</b>—Specifies that the list is up if at least one object is up. For example, when tracking two interfaces, up means that either interface is up, and down means that both interfaces are down.</li> </ul>
<b>Step 4</b>	<p><b>object</b> <i>object-name</i> [ <b>not</b> ]</p> <p><b>Example:</b></p> <pre>RP/0/RSP0/CPU0:router(config-track-list)# object 3 not</pre>	<p>Specifies the object to be tracked by the list</p> <ul style="list-style-type: none"> <li>• <i>object-name</i>—Name of the object to track.</li> <li>• <b>not</b>—Negates the state of the object.</li> </ul>
<b>Step 5</b>	<p><b>exit</b></p> <p><b>Example:</b></p> <pre>RP/0/RSP0/CPU0:router(config-track-line-prot)# exit</pre>	<p>Exits the track line protocol configuration mode.</p>
<b>Step 6</b>	<p>(Optional) <b>delay</b> { <b>up</b> <i>seconds</i>   <b>down</b> <i>seconds</i> }</p> <p><b>Example:</b></p> <pre>RP/0/RSP0/CPU0:router(config-track)# delay up 10</pre>	<p>Schedules the delay that can occur between tracking whether the object is up or down.</p>
<b>Step 7</b>	<p>Use one of the following commands:</p> <ul style="list-style-type: none"> <li>• <b>end</b></li> <li>• <b>commit</b></li> </ul> <p><b>Example:</b></p> <pre>RP/0/RSP0/CPU0:router(config-track)# end</pre> <p>OR</p> <pre>RP/0/RSP0/CPU0:router(config-track)# commit</pre>	<p>Saves configuration changes.</p> <ul style="list-style-type: none"> <li>• When you issue the <b>end</b> command, the system prompts you to commit changes: <pre>Uncommitted changes found, commit them before exiting(yes/no/cancel)? [cancel]:</pre> <ul style="list-style-type: none"> <li>• Entering <b>yes</b> saves configuration changes to the running configuration file, exits the configuration session, and returns the router to EXEC mode.</li> <li>• Entering <b>no</b> exits the configuration session and returns the router to EXEC mode without committing the configuration changes.</li> <li>• Entering <b>cancel</b> leaves the router in the current configuration session without exiting or committing the configuration changes.</li> </ul> </li> <li>• Use the <b>commit</b> command to save the configuration changes to the running configuration file and remain within the configuration session.</li> </ul>

## Building a Track Based on a List of Objects - Threshold Percentage

Perform this task in the global configuration mode to create a tracked list of objects (which, in this case, are lists of interfaces or prefixes) using a threshold percentage to determine the state of the list.

### SUMMARY STEPS

1. **configure**
2. **track** *track-name*
3. **type list threshold percentage**
4. **object** *object-name*
5. **threshold percentage up percentage down percentage**
6. Use one of the following commands:
  - **end**
  - **commit**

### DETAILED STEPS

	Command or Action	Purpose
Step 1	<b>configure</b> <b>Example:</b> <pre>RP/0/RSP0/CPU0:router# configure</pre>	Enters global configuration mode.
Step 2	<b>track</b> <i>track-name</i> <b>Example:</b> <pre>RP/0/RSP0/CPU0:router(config)# track track1</pre>	Enters track configuration mode. <ul style="list-style-type: none"> <li>• <i>track-name</i>—Specifies a name for the object to be tracked.</li> </ul> <p><b>Note</b> Special characters are not allowed in a <i>track-name</i>.</p>
Step 3	<b>type list threshold percentage</b> <b>Example:</b> <pre>RP/0/RSP0/CPU0:router(config-track-list)# type list threshold percentage</pre>	Configures a track of type threshold percentage list.
Step 4	<b>object</b> <i>object-name</i> <b>Example:</b> <pre>RP/0/RSP0/CPU0:router(config-track-list-threshold)# object 1 RP/0/RSP0/CPU0:router(config-track-list-threshold)# object 2 RP/0/RSP0/CPU0:router(config-track-list-threshold)# object 3 RP/0/RSP0/CPU0:router(config-track-list-threshold)# object 4</pre>	Configures object 1, object 2, object 3 and object 4 as members of track type track1.

	Command or Action	Purpose
<b>Step 5</b>	<p><b>threshold</b> <b>percentage up</b> <i>percentage</i> <b>down</b> <i>percentage</i></p> <p><b>Example:</b></p> <pre>RP/0/RSP0/CPU0:router(config-track-list-threshold)#   threshold percentage up 50 down 33</pre>	<p>Configures the percentage of objects that need to be UP or DOWN for the list to be considered UP or Down respectively.</p> <p>For example, if object 1, object 2, and object 3 are in the UP state and object 4 is in the DOWN state, the list is considered to be in the UP state.</p>
<b>Step 6</b>	<p>Use one of the following commands:</p> <ul style="list-style-type: none"> <li>• <b>end</b></li> <li>• <b>commit</b></li> </ul> <p><b>Example:</b></p> <pre>RP/0/RSP0/CPU0:router(config-track)# end</pre> <p>or</p> <pre>RP/0/RSP0/CPU0:router(config-track)# commit</pre>	<p>Saves configuration changes.</p> <ul style="list-style-type: none"> <li>• When you issue the <b>end</b> command, the system prompts you to commit changes: <pre>Uncommitted changes found, commit them before exiting(yes/no/cancel)? [cancel]:</pre> <ul style="list-style-type: none"> <li>• Entering <b>yes</b> saves configuration changes to the running configuration file, exits the configuration session, and returns the router to EXEC mode.</li> <li>• Entering <b>no</b> exits the configuration session and returns the router to EXEC mode without committing the configuration changes.</li> <li>• Entering <b>cancel</b> leaves the router in the current configuration session without exiting or committing the configuration changes.</li> </ul> </li> <li>• Use the <b>commit</b> command to save the configuration changes to the running configuration file and remain within the configuration session.</li> </ul>

## Building a Track Based on a List of Objects - Threshold Weight

Perform this task in the global configuration mode to create a tracked list of objects (which, in this case, are lists of interfaces or prefixes) using a threshold weight to determine the state of the list.

### SUMMARY STEPS

1. **configure**
2. **track** *track-name*
3. **type list threshold weight**
4. **object** *object-name* **weight** *weight*
5. **threshold** **weight up** *weight* **down** *weight*
6. Use one of the following commands:
  - **end**
  - **commit**



DETAILED STEPS

	Command or Action	Purpose
Step 1	<p><b>configure</b></p> <p><b>Example:</b></p> <pre>RP/0/RSP0/CPU0:router# configure</pre>	Enters global configuration mode.
Step 2	<p><b>track track-name</b></p> <p><b>Example:</b></p> <pre>RP/0/RSP0/CPU0:router(config)# track track1</pre>	<p>Enters track configuration mode.</p> <ul style="list-style-type: none"> <li>• <i>track-name</i>—Specifies a name for the object to be tracked.</li> </ul> <p><b>Note</b> Special characters are not allowed in a <i>track-name</i>.</p>
Step 3	<p><b>type list threshold weight</b></p> <p><b>Example:</b></p> <pre>RP/0/RSP0/CPU0:router(config-track-list)# type list threshold weight</pre>	Configures a track of type, threshold weighted list.
Step 4	<p><b>object object-name weight weight</b></p> <p><b>Example:</b></p> <pre>RP/0/RSP0/CPU0:router(config-track-list-threshold)# object 1 weight 10 RP/0/RSP0/CPU0:router(config-track-list-threshold)# object 2 weight 5 RP/0/RSP0/CPU0:router(config-track-list-threshold)# object 3 weight 3</pre>	Configures object 1, object 2 and object 3 as members of track t1 and with weights 10, 5 and 3 respectively.
Step 5	<p><b>threshold weight up weight down weight</b></p> <p><b>Example:</b></p> <pre>RP/0/RSP0/CPU0:router(config-track-list-threshold)# threshold weight up 10 down 5</pre>	Configures the range of weights for the objects that need to be UP or DOWN for the list to be considered UP or DOWN respectively. In this example, the list is considered to be in the DOWN state because objects 1 and 2 are in the UP state and the cumulative weight is 15 (not in the 10-5 range).
Step 6	<p>Use one of the following commands:</p> <ul style="list-style-type: none"> <li>• <b>end</b></li> <li>• <b>commit</b></li> </ul> <p><b>Example:</b></p> <pre>RP/0/RSP0/CPU0:router(config-track)# end</pre> <p>or</p> <pre>RP/0/RSP0/CPU0:router(config-track)# commit</pre>	<p>Saves configuration changes.</p> <ul style="list-style-type: none"> <li>• When you issue the <b>end</b> command, the system prompts you to commit changes:</li> </ul> <pre>Uncommitted changes found, commit them before exiting(yes/no/cancel)? [cancel]:</pre> <ul style="list-style-type: none"> <li>• Entering <b>yes</b> saves configuration changes to the running configuration file, exits the configuration session, and returns the router to EXEC mode.</li> </ul>

	Command or Action	Purpose
		<ul style="list-style-type: none"> <li>• Entering <b>no</b> exits the configuration session and returns the router to EXEC mode without committing the configuration changes.</li> <li>• Entering <b>cancel</b> leaves the router in the current configuration session without exiting or committing the configuration changes.</li> <li>• Use the <b>commit</b> command to save the configuration changes to the running configuration file and remain within the configuration session.</li> </ul>

## Tracking IPSLA Reachability

Use this task to enable the tracking of the return code of IP service level agreement (SLA) operations.

### SUMMARY STEPS

1. **configure**
2. **track** *track-name*
3. **type rtr** *ipsla-no* **reachability**
4. Use the **commit** or **end** command.

### DETAILED STEPS

	Command or Action	Purpose
<b>Step 1</b>	<b>configure</b> <b>Example:</b> RP/0/RSP0/CPU0:router# <b>configure</b>	Enters global configuration mode.
<b>Step 2</b>	<b>track</b> <i>track-name</i> <b>Example:</b> RP/0/RSP0/CPU0:router(config)# <b>track t1</b>	Enters track configuration mode. <b>Note</b> Special characters are not allowed in a <i>track-name</i> .
<b>Step 3</b>	<b>type rtr</b> <i>ipsla-no</i> <b>reachability</b> <b>Example:</b> RP/0/RSP0/CPU0:router(config-track)# <b>type rtr 100 reachability</b>	Specifies the IP SLA operation ID to be tracked for reachability. Values for the <i>ipsla-no</i> can range from 1 to 2048.
<b>Step 4</b>	Use the <b>commit</b> or <b>end</b> command.	<b>commit</b> —Saves the configuration changes and remains within the configuration session. <b>end</b> —Prompts user to take one of these actions: <ul style="list-style-type: none"> <li>• <b>Yes</b> — Saves configuration changes and exits the configuration session.</li> </ul>

	Command or Action	Purpose
		<ul style="list-style-type: none"> <li>• <b>No</b> —Exits the configuration session without committing the configuration changes.</li> <li>• <b>Cancel</b> —Remains in the configuration session, without committing the configuration changes.</li> </ul>

### Configuring IPSLA Tracking: Example

This example shows the configuration of IPSLA tracking:

```
RP/0/RSP0/CPU0:router(config)# track track1
RP/0/RSP0/CPU0:router(config-track)# type rtr 1 reachability
RP/0/RSP0/CPU0:router(config-track)# delay up 5
RP/0/RSP0/CPU0:router(config-track)# delay down 10
```

## Configure Enhanced Object Tracking

You can configure tracks with the **action** command to enable Enhanced Object Tracking. As a prerequisite, configure the track type that is to be tracked.

The following example shows how to configure the **action** command on a track based on the change in state of the track:

```
/* Configure track1 to track line-protocol state of the interface FourHundredGigE0/0/0/1
*/
Router#configure
Router(config)#track track1
Router(config-track)#type line-protocol state
Router(config-track-line-prot)#interface FourHundredGigE0/0/0/1
Router(config-track-line-prot)#exit
Router(config-track)#exit

/* Configure track2 to track line-protocol state of the interface FourHundredGigE0/1/0/1
*/
Router(config)#track track2
Router(config-track)#type line-protocol state
Router(config-track-line-prot)#interface FourHundredGigE0/1/0/1
Router(config-track-line-prot)#exit
Router(config-track)#exit

/* Configure track3 with boolean AND of track1 state and track2 state. Specify actions to
take when track3 state changes. */
Router(config)#track track3
Router(config-track)#type list boolean and
Router(config-track-list-boolean)#object track1
Router(config-track-list-boolean)#object track2
Router(config-track-list-boolean)#exit
Router(config-track)#action
Router(config-track-action)#track-down error-disable interface FourHundredGigE0/0/0/0
auto-recover
```

```
Router(config-track-action)#track-down error-disable interface FourHundredGigE0/1/0/0
```

The following running configuration example shows you how to configure the **action** command for the scenario described in Figure 1.

```
track track1
  type line-protocol state
  interface FourHundredGigE0/0/0/1
  !
!
track track2
  type line-protocol state
  interface FourHundredGigE0/1/0/1
  !
!
track track3
  type list boolean and
  object track1
  object track2
  !
action
  track-down error-disable interface FourHundredGigE0/0/0/0 auto-recover
  track-down error-disable interface FourHundredGigE0/1/0/0
```

## Verification

To view the state of the track, use the **show track** command.

Initially, let us assume the line-protocol state of FourHundredGigE0/0/0/1 (track1 interface) and FourHundredGigE0/1/0/1 (track2 interface) are up and HundredGigE0/0/0/35 (track4 interface) is down.

```
Router#show track
Track track3
  List boolean and is UP
  7 changes, last change 16:04:28 IST Mon Jul 02 2018
  object track2 UP
  object track1 UP
Track track1
  Interface FourHundredGigE0/0/0/1 line-protocol
  Line protocol is UP
  7 changes, last change 16:04:28 IST Mon Jul 02 2018
Track track2
  Interface FourHundredGigE0/1/0/1 line-protocol
  Line protocol is UP
  7 changes, last change 16:02:41 IST Mon Jul 02 2018
```

To verify if the interface configured for tracking is error-disabled, use the **show error-disable** command. As none of the track states match the track-action state, there are no error-disabled interfaces.

```
Router#show error-disable
Interface          Error-Disable reason          Retry (s)  Time disabled
-----
There are no interfaces error-disabled matching the given criteria
```

To view the status of all the interfaces of the tracked object, use the **show interface brief** command.

```
Router#show interface brief
Intf Name          Intf State  LineP State  Encap Type  MTU (byte)  BW (Kbps)
-----
FourHundredGigE0/0/0/0    up        up          ARPA        1514        100000000
FourHundredGigE0/0/0/1    up        up          ARPA        1514        100000000
FourHundredGigE0/1/0/0    up        up          ARPA        1514        100000000
FourHundredGigE0/1/0/1    up        up          ARPA        1514        100000000
```

When a track state changes, the corresponding track action happens and the status of the interfaces configured in the action changes. The state of track3 becomes "down" when either track1 state or track2 state becomes "down". The following **show error-disable** command displays the corresponding output.

```
Router#show error-disable
Interface          Error-Disable reason          Retry (s)  Time disabled
-----
FH0/0/0/0          ot-track-state-change         ---        08:42:08
FH0/1/0/0          ot-track-state-change         ---        08:42:01
```

When the state of track3 is "down", the **show interface brief** command displays the following output.

```
Router#show interface brief
Intf Name          Intf State          LineP State          Encap Type          MTU (byte)
BW (Kbps)
FourHundredGigE0/0/0/0  admin-down          admin-down          ARPA                1514
100000000
FourHundredGigE0/0/0/1  admin-down          admin-down          ARPA                1514
100000000
FourHundredGigE0/1/0/0  admin-down          admin-down          ARPA                1514
100000000
FourHundredGigE0/1/0/1  up                  up                  ARPA                1514
100000000
```

When track3 state comes back up, the error-disable status on the interface FourHundredGigE0/0/0/0 clears. This is because of the **auto-recover** configuration for FourHundredGigE0/0/0/0. However, interface FourHundredGigE0/1/0/0 remains in the error-disable status because **auto-recover** isn't configured on this interface.

The change reflects in the output of the **show interface brief** command.

```
RP/0/0/CPU0:ios#show interface brief
Intf Name          Intf State          LineP State          Encap Type          MTU (byte)  BW (Kbps)
FourHundredGigE0/0/0/0  up                  up                  ARPA                1514        100000000
FourHundredGigE0/0/0/1  up                  up                  ARPA                1514        100000000
FourHundredGigE0/1/0/0  err-disable         admin-down          ARPA                1514        100000000
FourHundredGigE0/1/0/1  up                  up                  ARPA                1514        100000000
```

## Configuration Examples for Configuring Object Tracking

### Configuring IPSLA Tracking: Example

This example shows the configuration of IPSLA tracking, including the ACL and IPSLA configuration:

ACL configuration:

```
RP/0/RSP0/CPU0:router(config)# ipv4 access-list abf-track
RP/0/RSP0/CPU0:router(config-ipv4-acl)# 10 permit any any nexthop track track1 1.2.3.4
```

Object tracking configuration:

```
RP/0/RSP0/CPU0:router(config)# track track1
RP/0/RSP0/CPU0:router(config-track)# type rtr 1 reachability
RP/0/RSP0/CPU0:router(config-track)# delay up 5
```

```
RP/0/RSP0/CPU0:router(config-track)# delay down 10
```

IPSLA configuration:

```
RP/0/RSP0/CPU0:router(config)# ipsla
RP/0/RSP0/CPU0:router(config-ipsla)# operation 1
RP/0/RSP0/CPU0:router(config-ipsla-op)# type icmp echo
RP/0/RSP0/CPU0:router(config-ipsla-icmp-echo)# source address 2.3.4.5
RP/0/RSP0/CPU0:router(config-ipsla-icmp-echo)# destination address 1.2.3.4
RP/0/RSP0/CPU0:router(config-ipsla-icmp-echo)# frequency 60
RP/0/RSP0/CPU0:router(config-ipsla-icmp-echo)# exit
RP/0/RSP0/CPU0:router(config-ipsla-op)# exit
RP/0/RSP0/CPU0:router(config-ipsla)# schedule operation 1
RP/0/RSP0/CPU0:router(config-ipsla-sched)# start-time now
RP/0/RSP0/CPU0:router(config-ipsla-sched)# life forever
```

## Additional References

The following sections provide references related to implementing object tracking for IPSec network security.

### Related Documents

Related Topic	Document Title
IP SLA configuration information	<i>Implementing IP Service Level Agreements on the Cisco ASR 9000 Series Router module in System Monitoring Configuration Guide for Cisco ASR 9000 Series Routers</i>
IP SLA commands	<i>IP Service Level Agreement Commands on the Cisco ASR 9000 Series Router module in System Monitoring Command Reference for Cisco ASR 9000 Series Routers</i>
Object tracking commands	<i>Object Tracking Commands on the Cisco ASR 9000 Series Router module in System Management Command Reference for Cisco ASR 9000 Series Routers</i>

### Standards

Standards	Title
No new or modified standards are supported by this feature, and support for existing standards has not been modified by this feature.	—

### MIBs

MIBs	MIBs Link
—	To locate and download MIBs using Cisco IOS XR software, use the Cisco MIB Locator found at the following URL and choose a platform under the Cisco Access Products menu: <a href="http://cisco.com/public/sw-center/netmgmt/cmtk/mibs.shtml">http://cisco.com/public/sw-center/netmgmt/cmtk/mibs.shtml</a>

**RFCs**

<b>RFCs</b>	<b>Title</b>
RFC 2401	<i>Security Architecture for the Internet Protocol</i>

**Technical Assistance**

<b>Description</b>	<b>Link</b>
The Cisco Technical Support website contains thousands of pages of searchable technical content, including links to products, technologies, solutions, technical tips, and tools. Registered Cisco.com users can log in from this page to access even more content.	<a href="http://www.cisco.com/cisco/web/support/index.html">http://www.cisco.com/cisco/web/support/index.html</a>







## CHAPTER 5

# Configuring Periodic MIB Data Collection and Transfer

This document describes how to periodically transfer selected MIB data from your router to a specified Network Management System (NMS). The periodic MIB data collection and transfer feature is also known as bulk statistics.

*Table 7: Feature History for Periodic MIB Data Collection and Transfer*

Release	Modification
Release 4.2.0	The periodic MIB data collection and transfer feature was introduced and supported the IF-MIB only.
Release 4.2.1	Additional MIBs were supported.

This module contains the following topics:

- [Prerequisites for Periodic MIB Data Collection and Transfer, on page 53](#)
- [Information About Periodic MIB Data Collection and Transfer, on page 53](#)
- [How to Configure Periodic MIB Data Collection and Transfer, on page 55](#)
- [Periodic MIB Data Collection and Transfer: Example, on page 62](#)

## Prerequisites for Periodic MIB Data Collection and Transfer

To use periodic MIB data collection and transfer, you should be familiar with the Simple Network Management Protocol (SNMP) model of management information. You should also know what MIB information you want to monitor on your network devices, and the OIDs or object names for the MIB objects to be monitored.

## Information About Periodic MIB Data Collection and Transfer

### SNMP Objects and Instances

A type (or class) of SNMP management information is called an object. A specific instance from a type of management information is called an object instance (or SNMP variable). To configure a bulk statistics

collection, you must specify the object types to be monitored using a bulk statistics object list and the specific instances of those objects to be collected using a bulk statistics schema.

MIBs, MIB tables, MIB objects, and object indices can all be specified using a series of numbers called an object identifier (OID). OIDs are used in configuring a bulk statistics collection in both the bulk statistics object lists (for general objects) and in the bulk statistics schemas (for specific object instances).

## Bulk Statistics Object Lists

To group the MIB objects to be polled, you need to create one or more object lists. A bulk statistics object list is a user-specified set of MIB objects that share the same MIB index. Object lists are identified using a name that you specify. Named bulk statistics object lists allow the same configuration to be reused in different bulk statistics schemas.

All the objects in an object list must share the same MIB index. However, the objects do not need to be in the same MIB and do not need to belong to the same MIB table. For example, it is possible to group `ifInOctets` and a `CISCO-IF-EXTENSION-MIB` object in the same schema, because the containing tables for both objects are indexed by the `ifIndex`.

## Bulk Statistics Schemas

Data selection for the Periodic MIB Data Collection and Transfer Mechanism requires the definition of a schema with the following information:

- Name of an object list.
- Instance (specific instance or series of instances defined using a wild card) that needs to be retrieved for objects in the specified object list.
- How often the specified instances need to be sampled (polling interval). The default polling interval is 5 minutes.

A bulk statistics schema is also identified using a name that you specify. This name is used when configuring the transfer options.

## Bulk Statistics Transfer Options

After configuring the data to be collected, a single virtual file (VFile or *bulk statistics file*) with all collected data is created. This file can be transferred to a network management station using FTP or TFTP. You can specify how often this file should be transferred. The default transfer interval is once every 30 minutes. You can also configure a secondary destination for the file to be used if, for whatever reason, the file cannot be transferred to the primary network management station.

The value of the transfer interval is also the collection period (collection interval) for the local bulk statistics file. After the collection period ends, the bulk statistics file is frozen, and a new local bulk statistics file is created for storing data. The frozen bulk statistics file is then transferred to the specified destination.

By default, the local bulk statistics file is deleted after successful transfer to an network management station.

## Benefits of Periodic MIB Data Collection and Transfer

Periodic MIB data collection and transfer (bulk statistics feature) allows many of the same functions as the bulk file MIB (CISCO-BULK-FILE-MIB.my), but offers some key advantages. The main advantage is that this feature can be configured through the CLI and does not require an external monitoring application.

Periodic MIB data collection and transfer is mainly targeted for medium to high-end platforms that have sufficient local storage (volatile or permanent) to store bulk statistics files. Locally storing bulk statistics files helps minimize loss of data during temporary network outages.

This feature also has more powerful data selection features than the bulk file MIB; it allows grouping of MIB objects from different tables into data groups (object lists). It also incorporates a more flexible instance selection mechanism, where the application is not restricted to fetching an entire MIB table.

## How to Configure Periodic MIB Data Collection and Transfer

### Configuring a Bulk Statistics Object List

The first step in configuring the Periodic MIB Data Collection and Transfer Mechanism is to configure one or more object lists.

#### SUMMARY STEPS

1. **configure**
2. **snmp-server mib bulkstat object-list** *list-name*
3. **add** {oid | *object-name*}
4. Use the **commit** or **end** command.

#### DETAILED STEPS

	Command or Action	Purpose
Step 1	<b>configure</b> <b>Example:</b> RP/0/RSP0/CPU0:router# <code>configure</code>	Enters global configuration mode.
Step 2	<b>snmp-server mib bulkstat object-list</b> <i>list-name</i> <b>Example:</b> <code>snmp-server mib bulkstat object-list ifMib</code>	Defines an SNMP bulk statistics object list and enters bulk statistics object list configuration mode.
Step 3	<b>add</b> {oid   <i>object-name</i> } <b>Example:</b> RP/0/RSP0/CPU0:router(config-bulk-objects)# <code>add</code>	Adds a MIB object to the bulk statistics object list. Repeat as desired until all objects to be monitored in this list are added.

	Command or Action	Purpose
	<pre>1.3.6.1.2.1.2.2.1.11 RP/0/RSP0/CPU0:router(config-bulk-objects)# add ifAdminStatus RP/0/RSP0/CPU0:router(config-bulk-objects)# add ifDescr</pre>	<p><b>Note</b> All the objects in a bulk statistics object list have to be indexed by the same MIB index. However, the objects in the object list do not need to belong to the same MIB or MIB table.</p> <p>When specifying an object name instead of an OID (using the add command), only object names with mappings shown in the <b>show snmp mib object</b> command output can be used.</p>
<b>Step 4</b>	Use the <b>commit</b> or <b>end</b> command.	<p><b>commit</b> —Saves the configuration changes and remains within the configuration session.</p> <p><b>end</b> —Prompts user to take one of these actions:</p> <ul style="list-style-type: none"> <li>• <b>Yes</b> — Saves configuration changes and exits the configuration session.</li> <li>• <b>No</b> —Exits the configuration session without committing the configuration changes.</li> <li>• <b>Cancel</b> —Remains in the configuration session, without committing the configuration changes.</li> </ul>

**What to do next**

Configure a bulk statistics schema.

## Configuring a Bulk Statistics Schema

The second step in configuring periodic MIB data collection and transfer is to configure one or more schemas.

**Before you begin**

The bulk statistics object list to be used in the schema must be defined.

**SUMMARY STEPS**

1. **configure**
2. **snmp-server mib bulkstat schema** *schema-name*
3. **object-list** *list-name*
4. Do one of the following:
  - **instance exact** {**interface** *interface-id* [**sub-if**] | **oid** *oid*}
  - **instance wild** {**interface** *interface-id* [**sub-if**] | **oid** *oid*}
  - **instance range start** *oid* **end** *oid*
  - **instance repetition** *oid* **max** *repeat-number*
5. **poll-interval** *minutes*
6. Use the **commit** or **end** command.

## DETAILED STEPS

	Command or Action	Purpose
<b>Step 1</b>	<b>configure</b> <b>Example:</b> RP/0/RSP0/CPU0:router# configure	Enters global configuration mode.
<b>Step 2</b>	<b>snmp-server mib bulkstat schema <i>schema-name</i></b> <b>Example:</b> RP/0/RSP0/CPU0:router(config)# snmp-server mib bulkstat schema intE0 RP/0/RSP0/CPU0:router(config-bulk-sc)#	Names the bulk statistics schema and enters bulk statistics schema mode.
<b>Step 3</b>	<b>object-list <i>list-name</i></b> <b>Example:</b> RP/0/RSP0/CPU0:router(config-bulk-sc)# object-list ifMib	Specifies the bulk statistics object list to be included in this schema. Specify only one object list per schema. If multiple object-list commands are executed, the earlier ones are overwritten by newer commands.
<b>Step 4</b>	Do one of the following: <ul style="list-style-type: none"> <li>• <b>instance exact</b> {<b>interface</b> <i>interface-id</i> [<b>sub-if</b>]   <b>oid</b> <i>oid</i>}</li> <li>• <b>instance wild</b> {<b>interface</b> <i>interface-id</i> [<b>sub-if</b>]   <b>oid</b> <i>oid</i>}</li> <li>• <b>instance range</b> <b>start</b> <i>oid</i> <b>end</b> <i>oid</i></li> <li>• <b>instance repetition</b> <i>oid</i> <b>max</b> <i>repeat-number</i></li> </ul> <b>Example:</b> RP/0/RSP0/CPU0:router(config-bulk-sc)# instance wild oid 1 or RP/0/RSP0/CPU0:router(config-bulk-sc)# instance exact interface FastEthernet 0/1.25 or RP/0/RSP0/CPU0:router(config-bulk-sc)# instance range start 1 end 2 or RP/0/RSP0/CPU0:router(config-bulk-sc)# instance repetition 1 max 4	Specifies the instance information for objects in this schema: <ul style="list-style-type: none"> <li>• The <b>instance exact</b> command indicates that the specified instance, when appended to the object list, represents the complete OID.</li> <li>• The <b>instance wild</b> command indicates that all subindices of the specified OID belong to this schema. The wild keyword allows you to specify a partial, “wild carded” instance.</li> <li>• The <b>instance range</b> command indicates a range of instances on which to collect data.</li> <li>• The <b>instance repetition</b> command indicates data collection to repeat for a certain number of instances of a MIB object.</li> </ul> <b>Note</b> Only one <b>instance</b> command can be configured per schema. If multiple <b>instance</b> commands are executed, the earlier ones are overwritten by new commands.
<b>Step 5</b>	<b>poll-interval <i>minutes</i></b> <b>Example:</b> RP/0/RSP0/CPU0:router(config-bulk-sc)# poll-interval 10	Sets how often data should be collected from the object instances specified in this schema, in minutes. The default is once every 5 minutes. The valid range is from 1 to 20000.

	Command or Action	Purpose
<b>Step 6</b>	Use the <b>commit</b> or <b>end</b> command.	<p><b>commit</b> —Saves the configuration changes and remains within the configuration session.</p> <p><b>end</b> —Prompts user to take one of these actions:</p> <ul style="list-style-type: none"> <li>• <b>Yes</b> — Saves configuration changes and exits the configuration session.</li> <li>• <b>No</b> —Exits the configuration session without committing the configuration changes.</li> <li>• <b>Cancel</b> —Remains in the configuration session, without committing the configuration changes.</li> </ul>

**What to do next**

Configure the bulk statistics transfer options.

## Configuring Bulk Statistics Transfer Options

The final step in configuring periodic MIB data collection and transfer is to configure the transfer options. The collected MIB data are kept in a local file-like entity called a VFile (virtual file, referred to as a bulk statistics file in this document). This file can be transferred to a remote network management station at intervals you specify.

**Before you begin**

The bulk statistics object lists and bulk statistics schemas must be defined before configuring the bulk statistics transfer options.

**SUMMARY STEPS**

1. **configure**
2. **snmp-server mib bulkstat transfer-id** *transfer-id*
3. **buffer-size** *bytes*
4. **format** {**bulkBinary** | **bulkASCII** | **schemaASCII**}
5. **schema** *schema-name*
6. **transfer-interval** *minutes*
7. **url primary** *url*
8. **url secondary** *url*
9. **retry** *number*
10. **retain** *minutes*
11. **enable**
12. Use the **commit** or **end** command.

## DETAILED STEPS

	Command or Action	Purpose
Step 1	<b>configure</b> <b>Example:</b> RP/0/RSP0/CPU0:router# configure	Enters global configuration mode.
Step 2	<b>snmp-server mib bulkstat transfer-id <i>transfer-id</i></b> <b>Example:</b> RP/0/RSP0/CPU0:router(config)# snmp-server mib bulkstat transfer bulkstat1	Identifies the transfer configuration with a name ( <i>transfer-id</i> argument) and enters bulk statistics transfer configuration mode.
Step 3	<b>buffer-size <i>bytes</i></b> <b>Example:</b> RP/0/RSP0/CPU0:router(config-bulk-tr)# buffersize 3072	(Optional) Specifies the maximum size for the bulk statistics data file, in bytes. The valid range is from 1024 to 2147483647 bytes. The default buffer size is 2048 bytes. <b>Note</b> If the maximum buffer size for a bulk statistics file is reached before the transfer interval time expires, all additional data received is deleted. To correct this behavior, you can decrease the polling frequency, or increase the size of the bulk statistics buffer.
Step 4	<b>format {bulkBinary   bulkASCII   schemaASCII}</b> <b>Example:</b> RP/0/RSP0/CPU0:router(config-bulk-tr)# format schemaASCII	(Optional) Specifies the format of the bulk statistics data file (VFile). The default is schemaASCII. <b>Note</b> Transfers can only be performed using schemaASCII (cdcSchemaASCII) format. SchemaASCII is a human-readable format that contains parser-friendly hints for parsing data values.
Step 5	<b>schema <i>schema-name</i></b> <b>Example:</b> RP/0/RSP0/CPU0:router(config-bulk-tr)# schema ATM2/0-IFMIB RP/0/RSP0/CPU0:router(config-bulk-tr)# schema ATM2/0-CAR RP/0/RSP0/CPU0:router(config-bulk-tr)# schema Ethernet2/1-IFMIB	Specifies the bulk statistics schema to be transferred. Repeat this command as desired. Multiple schemas can be associated with a single transfer configuration; all collected data are placed in a single bulk data file (VFile).
Step 6	<b>transfer-interval <i>minutes</i></b> <b>Example:</b> RP/0/RSP0/CPU0:router RP/0/RSP0/CPU0:router(config-bulk-tr)# transfer-interval 20	(Optional) Specifies how often the bulk statistics file are transferred, in minutes. The default value is once every 30 minutes. The transfer interval is the same as the collection interval.

	Command or Action	Purpose
<b>Step 7</b>	<p><b>url primary url</b></p> <p><b>Example:</b></p> <pre>RP/0/RSP0/CPU0:router(config-bulk-tr)# url primary ftp://user:password@host/folder/bulkstat1</pre>	Specifies the network management system (host) that the bulk statistics data file is transferred to, and the protocol to use for transfer. The destination is specified as a Uniform Resource Locator (URL). FTP or TFTP can be used for the bulk statistics file transfer.
<b>Step 8</b>	<p><b>url secondary url</b></p> <p><b>Example:</b></p> <pre>RP/0/RSP0/CPU0:router(config-bulk-tr)# url secondary tftp://10.1.0.1/tftpboot/user/bulkstat1</pre>	(Optional) Specifies a backup transfer destination and protocol for use in the event that transfer to the primary location fails. FTP or TFTP can be used for the bulk statistics file transfer.
<b>Step 9</b>	<p><b>retry number</b></p> <p><b>Example:</b></p> <pre>RP/0/RSP0/CPU0:router(config-bulk-tr)# retry 1</pre>	<p>(Optional) Specifies the number of transmission retries. The default value is 0 (in other words, no retries). If an attempt to send the bulk statistics file fails, the system can be configured to attempt to send the file again using this command.</p> <p>One retry includes an attempt first to the primary destination then, if the transmission fails, to the secondary location. For example, if the retry value is 1, an attempt is made first to the primary URL, then to the secondary URL, then to the primary URL again, then to the secondary URL again. The valid range is from 0 to 100.</p> <p>If all retries fail, the next normal transfer occurs after the configured transfer-interval time.</p>
<b>Step 10</b>	<p><b>retain minutes</b></p> <p><b>Example:</b></p> <pre>RP/0/RSP0/CPU0:router(config-bulk-tr)# retain 60</pre>	<p>(Optional) Specifies how long the bulk statistics file should be kept in system memory, in minutes, after the completion of the collection interval and a transmission attempt is made. The default value is 0. Zero (0) indicates that the file is deleted immediately after the transfer is attempted. The valid range is from 0 to 20000.</p> <p><b>Note</b> If the retry command is used, you should configure a retain interval larger than 0. The interval between retries is the retain interval divided by the retry number. For example, if <b>retain 10</b> and <b>retry 2</b> are configured, two retries are attempted once every 5 minutes. Therefore, if retain 0 is configured, no retries are attempted.</p>
<b>Step 11</b>	<p><b>enable</b></p> <p><b>Example:</b></p> <pre>RP/0/RSP0/CPU0:router(config-bulk-tr)# enable</pre>	<p>Begins the bulk statistics data collection and transfer process for this configuration.</p> <ul style="list-style-type: none"> <li>• For successful execution of this action, at least one schema with non-zero number of objects must be configured.</li> <li>• Periodic collection and file transfer begins only if this command is configured. Conversely, the <b>no enable</b></li> </ul>



	Command or Action	Purpose
		<p>command stops the collection process. A subsequent <b>enable</b> starts the operations again.</p> <ul style="list-style-type: none"> <li>Each time the collection process is started using the <b>enable</b> command, data is collected into a new bulk statistics file. When the <b>no enable</b> command is used, the transfer process for any collected data immediately begins (in other words, the existing bulk statistics file is transferred to the specified management station).</li> </ul>
<b>Step 12</b>	Use the <b>commit</b> or <b>end</b> command.	<p><b>commit</b> —Saves the configuration changes and remains within the configuration session.</p> <p><b>end</b> —Prompts user to take one of these actions:</p> <ul style="list-style-type: none"> <li><b>Yes</b> — Saves configuration changes and exits the configuration session.</li> <li><b>No</b> —Exits the configuration session without committing the configuration changes.</li> <li><b>Cancel</b> —Remains in the configuration session, without committing the configuration changes.</li> </ul>

**What to do next**



**Note** If the maximum buffer size for a bulk statistics file is reached before the transfer interval time expires, the transfer operation is still initiated, but any bulk statistics data received after the file was full, and before it was transferred, are deleted. To correct this behavior, you can decrease the polling frequency, or increase the size of the bulk statistics buffer.

If **retain 0** is configured, no retries are attempted. This is because the interval between retries is the retain value divided by the retry value. For example, if **retain 10** and **retry 2** are configured, retries are attempted once every 5 minutes. Therefore, if you configure the retry command, you should also configure an appropriate value for the retain command.

## Monitoring Periodic MIB Data Collection and Transfer

**SUMMARY STEPS**

1. `show snmp mib bulkstat transfer transfer-name`

**DETAILED STEPS**

	Command or Action	Purpose
<b>Step 1</b>	<code>show snmp mib bulkstat transfer transfer-name</code>	(Optional) The show command for this feature lists all bulk statistics virtual files (VFiles) on the system that have

	Command or Action	Purpose
		<p>finished collecting data. (Data files that are not complete are not displayed.)</p> <p>The output lists all of the completed local bulk statistics files, the remaining time left before the bulk statistics file is deleted (remaining retention period), and the state of the bulk statistics file.</p> <p>The “STATE” of the bulk statistics file is one of the following:</p> <ul style="list-style-type: none"> <li>• Queued--Indicates that the data collection for this bulk statistics file is completed (in other words, the transfer interval has been met) and that the bulk statistics file is waiting for transfer to the configured destination(s).</li> <li>• Retry--Indicates that one or more transfer attempts have failed and that the file transfer will be attempted again. The number of retry attempts remaining are displayed in parenthesis.</li> <li>• Retained--Indicates that the bulk statistics file has either been successfully transmitted or that the configured number of retries have been completed.</li> </ul> <p>To display only the status of a named transfer (as opposed to all configured transfers), specify the name of the transfer in the transfer-name argument.</p>

### show snmp mib bulkstat transfer Sample Output

```
RP/0/RSP0/CPU0:router# show snmp mib bulkstat transfer

Transfer Name : ifmib
Retained files

File Name           : Time Left (in seconds)   :STATE
-----
ifmib_Router_020421_100554683 : 173 : Retry (2 Retry attempt(s) Left)
```

## Periodic MIB Data Collection and Transfer: Example

This example shows how to configure periodic MIB data collection and transfer:

```
snmp-server mib bulkstat object-list cempo
add cempMemPoolName
add cempMemPoolType
!
snmp-server mib bulkstat schema cempWild
object-list cempo
```

```

instance wild oid 8695772
poll-interval 1
!
snmp-server mib bulkstat schema cempRepeat
object-list cempo
instance repetition 8695772.1 max 4294967295
poll-interval 1
!
snmp-server mib bulkstat transfer-id cempt1
enable
url primary tftp://223.255.254.254/auto/tftp-sjc-users3/dseeniva/dumpdcm
schema cempWild
schema cempRepeat
transfer-interval 2
!

```

This example shows sample bulk statistics file content:

```

Schema-def cempt1.cempWild "%u, %s, %s, %d" Epochtime instanceoid
1.3.6.1.4.1.9.9.221.1.1.1.1.3 1.3.6.1.4.1.9.9.221.1.1.1.1.2
cempt1.cempWild: 1339491515, 8695772.1, processor, 2
cempt1.cempWild: 1339491515, 8695772.2, reserved, 11
cempt1.cempWild: 1339491515, 8695772.3, image, 12
cempt1.cempWild: 1339491575, 8695772.1, processor, 2
cempt1.cempWild: 1339491575, 8695772.2, reserved, 11
cempt1.cempWild: 1339491575, 8695772.3, image, 12
Schema-def cempt1.cempRepeat "%u, %s, %s, %d" Epochtime instanceoid
1.3.6.1.4.1.9.9.221.1.1.1.1.3 1.3.6.1.4.1.9.9.221.1.1.1.1.2
cempt1.cempRepeat: 1339491515, 8695772.1, processor, 2
cempt1.cempRepeat: 1339491515, 8695772.2, reserved, 11
cempt1.cempRepeat: 1339491515, 8695772.3, image, 12
cempt1.cempRepeat: 1339491515, 26932192.1, processor, 2
cempt1.cempRepeat: 1339491515, 26932192.2, reserved, 11
cempt1.cempRepeat: 1339491515, 26932192.3, image, 12
cempt1.cempRepeat: 1339491515, 35271015.1, processor, 2
cempt1.cempRepeat: 1339491515, 35271015.2, reserved, 11
cempt1.cempRepeat: 1339491515, 35271015.3, image, 12
cempt1.cempRepeat: 1339491515, 36631989.1, processor, 2
cempt1.cempRepeat: 1339491515, 36631989.2, reserved, 11
cempt1.cempRepeat: 1339491515, 36631989.3, image, 12
cempt1.cempRepeat: 1339491515, 52690955.1, processor, 2
cempt1.cempRepeat: 1339491515, 52690955.2, reserved, 11
cempt1.cempRepeat: 1339491515, 52690955.3, image, 12

```





## CHAPTER 6

# Managing Router Hardware

This chapter describes the command-line interface (CLI) techniques and commands used to manage and configure the hardware components of a router running the Cisco IOS XR software.

For complete descriptions of the commands listed in this module, see [Additional References, on page 124](#). To locate documentation for other commands that might appear in the course of performing a configuration task, search online in *Cisco ASR 9000 Series Aggregation Services Router Commands Master List*.

**Table 8: Feature History for Managing Router Hardware with Cisco IOS XR Software**

Release	Modification
Release 3.7.2	This feature was introduced.
Release 3.9.0	No modification.
Release 6.5.2	The Cisco CPAK 100GBASE-ER4 Lite (CPAK-100G-ER4L) module is supported on Cisco IOS XR 64-bit operating system with the following line cards: <ul style="list-style-type: none"><li>• A9K-8X100G-LB-SE</li><li>• A9K-8X100G-LB-TR</li><li>• A9K-8X100G-SE</li><li>• A9K-8X100G-TR</li><li>• A9K-8X100G-CM</li><li>• A99-8X100G-SE</li><li>• A99-8X100G-TR</li><li>• A99-8X100G-CM</li><li>• A9K-4X100G-TR</li><li>• A9K-4X100G-SE</li></ul>

This module contains the following topics:

- [Prerequisites for Managing Router Hardware, on page 66](#)

- [Displaying Hardware Status](#), on page 66
- [RSP Redundancy and Switchover](#), on page 83
- [Console Management Port](#), on page 90
- [CPAK](#), on page 94
- [Configuring Breakout on a 400GE Port](#), on page 96
- [Reloading, Shutting Down, or Power Cycling a Node](#), on page 100
- [Flash Disk Recovery](#), on page 103
- [Using Controller Commands to Manage Hardware Components](#), on page 103
- [Formatting Hard Drives, Flash Drives, and Other Storage Devices](#), on page 104
- [Removing and Replacing Cards](#), on page 104
- [Proactive Line Card Shut Down](#), on page 107
- [Advanced Power Management](#), on page 110
- [Overview of Erase and Wipeout Disk Memory](#), on page 111
- [Upgrading the CPU Controller Bits](#), on page 114
- [Configuring Port Modes](#), on page 114
- [Configure Single Feed Power Mode](#), on page 123
- [Additional References](#), on page 124

## Prerequisites for Managing Router Hardware

You must be in a user group associated with a task group that includes the proper task IDs. The command reference guides include the task IDs required for each command. If you suspect user group assignment is preventing you from using a command, contact your AAA administrator for assistance.

## Displaying Hardware Status

This section describes how to display different types of hardware status information.

## Displaying SDR Hardware Version Information

To display hardware version information for the components assigned to a secure domain router (SDR), connect to the designated shelf controller (DSC) and enter the **show diag** command in EXEC mode. The displayed information includes the card serial number and the ROMMON software version.

The syntax for the **show diag** command in EXEC mode is:

```
show diag [node-id | details | summary]
```

In the following example, the **show diag** command displays information for all nodes in the SDR:

```
RP/0/RSP0/CPU0:router# show diag

Mon Jun 29 00:36:41.576 PST

NODE module 0/RSP0/CPU0 :

  MAIN:  board type 0x100302
  S/N:    FOC1230803H
```

```
Top Assy. Number: 68-3160-04
PID: A2K-RSP-4G-HDD=
UDI_VID: VP4
HwRev: V4.8
New Deviation Number: 0
CLEI: IPUCARJBAA
Board State : IOS XR RUN
PLD: Motherboard: N/A, Processor: 0x8004 (rev: 2.2), Power: N/A
MONLIB: QNXFFS Monlib Version 3.2
ROMMON: Version 1.0(20081208:173612) [ASR9K ROMMON]
Board FPGA/CPLD/ASIC Hardware Revision:
  Compact Flash : V1.0
  XbarSwitch0 : V1.3
  XbarSwitch1 : V1.3
  XbarArbiter : V1.0
  XbarInterface : V0.0
  IntCtrl : V1.14
  ClkCtrl : V1.13
  PuntFPGA : V1.5
  HD : V3.0
  USB0 : V77.20
  USB1 : V77.20
  CPUCtrl : V1.17
  UTI : V1.6
  LIU : V1.0
  MLANSwitch : V0.0
  EOBCSwitch : V2.0
  CBC (active partition) : v1.2
  CBC (inactive partition) : v1.1
```

NODE module 0/1/CPU0 :

```
MAIN: board type 0x20207
S/N: FOC123081J6
Top Assy. Number: 68-3182-03
PID: A9K-40GE-B
UDI_VID: V1D
HwRev: V0.0
New Deviation Number: 0
CLEI:
Board State : IOS XR RUN
PLD: Motherboard: N/A, Processor: 0x8004 (rev: 2.2), Power: N/A
ROMMON: Version 1.0(20081208:174521) [ASR9K ROMMON]
Board FPGA/CPLD/ASIC Hardware Revision:
  NP0 : V3.194
  NP1 : V3.194
  NP2 : V3.194
  NP3 : V3.194
  XbarInterface : V18.4
  Bridge0 : V0.38
  Bridge1 : V0.38
  CPUCtrl : V0.15
  USB : V77.20
  PortCtrl : V0.8
  PHYCtrl : V0.6
  40 Port Gigabit Ethernet Daughter board : V0.0
  CBC (active partition) : v2.2
  CBC (inactive partition) : v2.1
```

NODE module 0/4/CPU0 :

```
MAIN: board type 0x2020a
S/N: FOC123081JA
Top Assy. Number: 68-3183-02
```

```

PID: A9K-8T/4-B
UDI_VID: V1D
HwRev: V0.0
New Deviation Number: 0
CLEI: IPU3AE0CAA
Board State : IOS XR RUN
PLD: Motherboard: N/A, Processor: 0x8004 (rev: 2.2), Power: N/A
ROMMON: Version 1.0(20081208:174521) [ASR9K ROMMON]
Board FPGA/CPLD/ASIC Hardware Revision:
  NP0 : V3.194
  NP1 : V3.194
  NP2 : V3.194
  NP3 : V3.194
  XbarInterface : V18.4
  Bridge0 : V0.38
  Bridge1 : V0.38
  CPUctrl : V0.15
  USB : V77.20
  PortCtrl : V0.10
  PHYctrl : V0.7
  PHY0 : V0.16
  PHY1 : V0.16
  PHY2 : V0.16
  PHY3 : V0.16
  PHY4 : V0.16
  PHY5 : V0.16
  PHY6 : V0.16
  PHY7 : V0.16
  8 Port Ten Gigabit Ethernet Daughter board : V0.0
  CBC (active partition) : v2.2
  CBC (inactive partition) : v2.1

```

NODE module 0/6/CPU0 :

```

MAIN: board type 0x20208
S/N: FHH12250033
Top Assy. Number: 68-3184-02
PID: A9K-4T-B
UDI_VID: V1D
HwRev: V0.0
New Deviation Number: 0
CLEI:
Board State : IOS XR RUN
PLD: Motherboard: N/A, Processor: 0x8004 (rev: 2.2), Power: N/A
ROMMON: Version 1.0(20081208:174521) [ASR9K ROMMON]
Board FPGA/CPLD/ASIC Hardware Revision:
  NP0 : V3.194
  NP1 : V3.194
  NP2 : V3.194
  NP3 : V3.194
  XbarInterface : V18.4
  Bridge0 : V0.38
  Bridge1 : V0.38
  CPUctrl : V0.15
  USB : V77.20
  PHY0 : V0.16
  PHY1 : V0.16
  PHY2 : V0.16
  PHY3 : V0.16
  PortCtrl : V0.10
  PHYctrl : V0.7
  4 Port Ten Gigabit Ethernet Daughter board : V0.0
  CBC (active partition) : v2.2
  CBC (inactive partition) : v2.1

```



In the following example, the **show diag** command displays information for a single node:

```
RP/0/RSP0/CPU0:router# show diag 0/6/cpu0

Mon Jun 29 00:41:43.450 PST

NODE module 0/6/CPU0 :

  MAIN: board type 0x20208
  S/N: FHH12250033
  Top Assy. Number: 68-3184-02
  PID: A9K-4T-B
  UDI_VID: V1D
  HwRev: V0.0
  New Deviation Number: 0
  CLEI:
  Board State : IOS XR RUN
  PLD: Motherboard: N/A, Processor: 0x8004 (rev: 2.2), Power: N/A
  ROMMON: Version 1.0(20081208:174521) [ASR9K ROMMON]
  Board FPGA/CPLD/ASIC Hardware Revision:
    NP0 : V3.194
    NP1 : V3.194
    NP2 : V3.194
    NP3 : V3.194
  XbarInterface : V18.4
  Bridge0 : V0.38
  Bridge1 : V0.38
  CPUCtrl : V0.15
  USB : V77.20
  PHY0 : V0.16
  PHY1 : V0.16
  PHY2 : V0.16
  PHY3 : V0.16
  PortCtrl : V0.10
  PHYCtrl : V0.7
  4 Port Ten Gigabit Ethernet Daughter board : V0.0
  CBC (active partition) : v2.2
  CBC (inactive partition) : v2.1
```

## Displaying System Hardware Version Information

To display hardware version information for all or some of the components assigned in a system, connect to the designated shelf controller (DSC) and enter the **show diag** command in administration EXEC mode. When this command is entered in administration EXEC mode, you can display information on RSPs, line cards, and system components such as the chassis, fan trays, and power supplies.



---

**Note** If you enter the **show diag** command in EXEC mode, the software displays only the hardware assigned to the SDR to which you are connected.

---

The syntax for the **show diag** command in administration EXEC mode is:

```
show diag [node-id | chassis | details | fans | memory | power-supply | summary]
```



**Tip** For information on the software version, use the **show version** command.

In the following example, the **show diag** command displays information for all nodes in the system:

```
RP/0/RSP0/CPU0:router(admin)# show diag

Mon Jun 29 01:21:04.571 PST

NODE module 0/RSP0/CPU0 :

  MAIN: board type 0x100302
  S/N:   FOC1230803H
  Top Assy. Number: 68-3160-04
  PID:   A2K-RSP-4G-HDD=
  UDI_VID: VP4
  HwRev: V4.8
  New Deviation Number: 0
  CLEI:  IPUCARJBAA
  Board State : IOS XR RUN
  PLD:   Motherboard: N/A, Processor: 0x8004 (rev: 2.2), Power: N/A
  MONLIB: QNXFFS Monlib Version 3.2
  ROMMON: Version 1.0(20081208:173612) [ASR9K ROMMON]
  Board FPGA/CPLD/ASIC Hardware Revision:
    Compact Flash : V1.0
    XbarSwitch0   : V1.3
    XbarSwitch1   : V1.3
    XbarArbiter   : V1.0
    XbarInterface : V0.0
    IntCtrl       : V1.14
    ClkCtrl       : V1.13
    PuntFPGA      : V1.5
    HD             : V3.0
    USB0          : V77.20
    USB1          : V77.20
    CPUCtrl       : V1.17
    UTI           : V1.6
    LIU           : V1.0
    MLANSwitch    : V0.0
    EOBCSwitch    : V2.0
    CBC (active partition) : v1.2
    CBC (inactive partition) : v1.1

NODE fantray 0/FT0/SP :

  MAIN: board type 0x900211
  S/N:
  Top Assy. Number: 32-0000-00
  PID:
  UDI_VID:
  HwRev: V32.0
  New Deviation Number: 0
  CLEI:
  PLD:   Motherboard: N/A, Processor: N/A, Power: N/A
  ROMMON:
  Board FPGA/CPLD/ASIC Hardware Revision:
    CBC (active partition) : v4.0
    CBC (inactive partition) : v0.13

NODE fantray 0/FT1/SP :
```

```
MAIN: board type 0x900211
S/N:
Top Assy. Number: 32-0000-00
PID:
UDI_VID:
HwRev: V32.0
New Deviation Number: 0
CLEI:
PLD: Motherboard: N/A, Processor: N/A, Power: N/A
ROMMON:
Board FPGA/CPLD/ASIC Hardware Revision:
  CBC (active partition) : v4.0
  CBC (inactive partition) : v0.13
```

NODE module 0/1/CPU0 :

```
MAIN: board type 0x20207
S/N: FOC123081J6
Top Assy. Number: 68-3182-03
PID: A9K-40GE-B
UDI_VID: V1D
HwRev: V0.0
New Deviation Number: 0
CLEI:
Board State : IOS XR RUN
PLD: Motherboard: N/A, Processor: 0x8004 (rev: 2.2), Power: N/A
ROMMON: Version 1.0(20081208:174521) [ASR9K ROMMON]
Board FPGA/CPLD/ASIC Hardware Revision:
  NP0 : V3.194
  NP1 : V3.194
  NP2 : V3.194
  NP3 : V3.194
  XbarInterface : V18.4
  Bridge0 : V0.38
  Bridge1 : V0.38
  CPUctrl : V0.15
  USB : V77.20
  PortCtrl : V0.8
  PHYCtrl : V0.6
  40 Port Gigabit Ethernet Daughter board : V0.0
  CBC (active partition) : v2.2
  CBC (inactive partition) : v2.1
```

NODE module 0/4/CPU0 :

```
MAIN: board type 0x2020a
S/N: FOC123081JA
Top Assy. Number: 68-3183-02
PID: A9K-8T/4-B
UDI_VID: V1D
HwRev: V0.0
New Deviation Number: 0
CLEI: IPU3AE0CAA
Board State : IOS XR RUN
PLD: Motherboard: N/A, Processor: 0x8004 (rev: 2.2), Power: N/A
ROMMON: Version 1.0(20081208:174521) [ASR9K ROMMON]
Board FPGA/CPLD/ASIC Hardware Revision:
  NP0 : V3.194
  NP1 : V3.194
  NP2 : V3.194
  NP3 : V3.194
  XbarInterface : V18.4
  Bridge0 : V0.38
```

```

Bridge1 : V0.38
CPUCtrl : V0.15
USB : V77.20
PortCtrl : V0.10
PHYCtrl : V0.7
PHY0 : V0.16
PHY1 : V0.16
PHY2 : V0.16
PHY3 : V0.16
PHY4 : V0.16
PHY5 : V0.16
PHY6 : V0.16
PHY7 : V0.16
8 Port Ten Gigabit Ethernet Daughter board : V0.0
CBC (active partition) : v2.2
CBC (inactive partition) : v2.1

```

NODE module 0/6/CPU0 :

```

MAIN: board type 0x20208
S/N: FHH12250033
Top Assy. Number: 68-3184-02
PID: A9K-4T-B
UDI_VID: V1D
HwRev: V0.0
New Deviation Number: 0
CLEI:
Board State : IOS XR RUN
PLD: Motherboard: N/A, Processor: 0x8004 (rev: 2.2), Power: N/A
ROMMON: Version 1.0(20081208:174521) [ASR9K ROMMON]
Board FPGA/CPLD/ASIC Hardware Revision:
NP0 : V3.194
NP1 : V3.194
NP2 : V3.194
NP3 : V3.194
XbarInterface : V18.4
Bridge0 : V0.38
Bridge1 : V0.38
CPUCtrl : V0.15
USB : V77.20
PHY0 : V0.16
PHY1 : V0.16
PHY2 : V0.16
PHY3 : V0.16
PortCtrl : V0.10
PHYCtrl : V0.7
4 Port Ten Gigabit Ethernet Daughter board : V0.0
CBC (active partition) : v2.2
CBC (inactive partition) : v2.1

```

NODE power-module 0/PM0/SP :

```

MAIN: board type 0xf00188
S/N:
Top Assy. Number: 341-00032-01
PID: A9K-3KW-AC
UDI_VID: V00
HwRev: V0.0
New Deviation Number: 0
CLEI: ACACACACAC
PLD: Motherboard: N/A, Processor: N/A, Power: N/A
ROMMON:
Board FPGA/CPLD/ASIC Hardware Revision:

```

```

NODE power-module 0/PM1/SP :

MAIN: board type 0xf00188
S/N:
Top Assy. Number: 341-00032-01
PID: A9K-3KW-AC
UDI_VID: V00
HwRev: V0.0
New Deviation Number: 0
CLEI: ACACACACAC
PLD: Motherboard: N/A, Processor: N/A, Power: N/A
ROMMON:
Board FPGA/CPLD/ASIC Hardware Revision:

NODE power-module 0/PM2/SP :

MAIN: board type 0xf00188
S/N:
Top Assy. Number: 341-00032-01
PID: A9K-3KW-AC
UDI_VID: V00
HwRev: V0.0
New Deviation Number: 0
CLEI: ACACACACAC
PLD: Motherboard: N/A, Processor: N/A, Power: N/A
ROMMON:
Board FPGA/CPLD/ASIC Hardware Revision:

Rack 0 - ASR-9010 Chassis, Includes Accessories
RACK NUM: 0
S/N:
PID: ASR-9010 Backplane
VID: 0.1
Desc: ASR-9010 Chassis, Includes Accessories
CLEI: NOCLEI
Top Assy. Number: 68-1234-56

```

In the following example, the **show diag** command displays information for a single system component:

```

RP/0/RSP0/CPU0:router(admin)# show diag chassis

Mon Jun 29 01:25:05.711 PST

Rack 0 - ASR-9010 Chassis, Includes Accessories
RACK NUM: 0
S/N:
PID: ASR-9010 Backplane
VID: 0.1
Desc: ASR-9010 Chassis, Includes Accessories
CLEI: NOCLEI
Top Assy. Number: 68-1234-56

```

## Displaying Software and Hardware Information

The **show version** command displays a variety of system information, including the hardware and software versions, router uptime, boot settings (including the configuration register), and active software.

The following is sample output from the **show version** command:

For Cisco ASR 9000 64 bit environment:

```
RP/0/RSP0/CPU0:Router#show version
Cisco IOS XR Software, Version 7.5.2
Copyright (c) 2013-2022 by Cisco Systems, Inc.
```

```
Build Information:
  Built By       : ingunawa
  Built On       : Tue Apr 26 18:26:36 PDT 2022
  Built Host     : iox-ucs-055
  Workspace      : /auto/srcarchive14/prod/7.5.2/asr9k-x64/ws
  Version        : 7.5.2
  Location       : /opt/cisco/XR/packages/
  Label         : 7.5.2
```

```
cisco ASR9K () processor
System uptime is 4 weeks 2 hours 31 minutes
```

For Cisco ASR9000 32 bit environment:

```
RP/0/RSP0/CPU0:Router#show version
Sat Aug 1 22:52:39.089 DST
Cisco IOS XR Software, Version 3.9.0.16I[DT_IMAGE]
Copyright (c) 2009 by Cisco Systems, Inc.
ROM: System Bootstrap, Version 1.1(20090521:183759) [ASR9K ROMMON],
router uptime is 1 day, 2 hours, 34 minutes
System image file is "bootflash:disk0/asr9k-os-mpi-3.9.0.16I/mbiasr9k-rp.vm"
cisco ASR9K Series (MPC8641D) processor with 4194304K bytes of memory.
MPC8641D processor at 1333MHz, Revision 2.2
 2 Management Ethernet
12 TenGigE
40 GigabitEthernet
219k bytes of non-volatile configuration memory.
975M bytes of compact flash card.
33994M bytes of hard disk.
1605616k bytes of disk0: (Sector size 512 bytes).
1605616k bytes of disk1: (Sector size 512 bytes).
Configuration register on node 0/RSP0/CPU0 is 0x102
Boot device on node 0/RSP0/CPU0 is disk0:
Package active on node 0/RSP0/CPU0:
asr9k-scfclient, V 3.9.0.16I[DT_IMAGE], Cisco Systems, at disk0:asr9k-scfclient-3.9.0.16I
  Built on Thu Jul 30 12:09:40 DST 2009
  By sjc-lds-208 in /auto/ioxbuild7/production/3.9.0.16I.DT_IMAGE/asr9k/workspace for
c4.2.1-p0
asr9k-adv-video, V 3.9.0.16I[DT_IMAGE], Cisco Systems, at disk0:asr9k-adv-video-3.9.0.16I
  Built on Thu Jul 30 13:49:37 DST 2009
  By sjc-lds-208 in /auto/ioxbuild7/production/3.9.0.16I.DT_IMAGE/asr9k/workspace for
c4.2.1-p0
asr9k-fpd, V 3.9.0.16I[DT_IMAGE], Cisco Systems, at disk0:asr9k-fpd-3.9.0.16I
  Built on Thu Jul 30 12:26:21 DST 2009
  By sjc-lds-208 in /auto/ioxbuild7/production/3.9.0.16I.DT_IMAGE/asr9k/workspace for
c4.2.1-p0
asr9k-diags, V 3.9.0.16I[DT_IMAGE], Cisco Systems, at disk0:asr9k-diags-3.9.0.16I
  Built on Thu Jul 30 12:09:43 DST 2009
  By sjc-lds-208 in /auto/ioxbuild7/production/3.9.0.16I.DT_IMAGE/asr9k/workspace for
c4.2.1-p0
asr9k-k9sec, V 3.9.0.16I[DT_IMAGE], Cisco Systems, at disk0:asr9k-k9sec-3.9.0.16I
  Built on Thu Jul 30 12:25:25 DST 2009
  By sjc-lds-208 in /auto/ioxbuild7/production/3.9.0.16I.DT_IMAGE/asr9k/workspace for
c4.2.1-p0
asr9k-mgbl, V 3.9.0.16I[DT_IMAGE], Cisco Systems, at disk0:asr9k-mgbl-3.9.0.16I
  Built on Thu Jul 30 13:48:16 DST 2009
--More--
```

## Displaying SDR Node IDs and Status

In EXEC mode, the **show platform** command displays information for all nodes assigned to the owner SDR. For each node, this information includes the host card type, the operational state, and the configuration state. To display information on a single node, enter the command with a node ID.

The syntax for the **show platform** command is:

```
show platform [node-id]
```

The following example displays the status for all nodes in the SDR to which you are connected:

```
RP/0/RSP0/CPU0:router# show platform
Mon Aug  3 07:39:01.416 DST
Node                Type                               State           Config State
-----
0/RSP0/CPU0        A9K-RSP-4G(Active)                IOS XR RUN      PWR, NSHUT, MON
0/1/CPU0           A9K-40GE-B                         IOS XR RUN      PWR, NSHUT, MON
0/4/CPU0           A9K-8T/4-B                         IOS XR RUN      PWR, NSHUT, MON
0/6/CPU0           A9K-4T-B                           IOS XR RUN      PWR, NSHUT, MON
```

The *node-id* appears in the *rack/slot/module* notation, and the *node-id* components are as follows:

- *rack* —In a single-shelf system the rack number is always “0.”
- *slot* —Number of the physical slot in which the card is installed.
- *module* —Subslot number of a system hardware component.

Table 9: Node ID Components, on page 75 summarizes the *node-id* for each type of card.

**Table 9: Node ID Components**

Card Type (the card to which your are issuing commands)	Rack (always “0”)	Slot (the physical slot in which the card is installed)	Module (the entity on the card that is the target of the command)
Route switch processor	0	RSP0 and RSP1	CPU0
40-Port Gigabit Ethernet Line Card 8-Port 10-Gigabit Ethernet Line Card 4-Port 10-Gigabit Ethernet Line Card	0-255	4-7 (6-slot chassis) 0-7 (10-slot chassis)	0-X (SFP and XFP module number on the line card)
Power Modules	0	PM0-PM5 (10-slot chassis) PM0-PM2 (6-slot chassis)	—
Fan controller cards	0	FC0-FC1	—

## Displaying Router Node IDs and Status

In administration EXEC mode, the **show platform** command displays information for all router nodes. In administration EXEC mode, the command display also includes additional node IDs such as those for fabric cards, alarm modules, and fan controllers. For each node, this information includes the host card type, the operational state, and the configuration state. To display information on a single node, enter the command with a node ID.

The syntax for the **show platform** command is:

**show platform** [*node-id*]

The following example displays the status for all nodes in the system:

```
RP/0/RSP0/CPU0:router (admin) # show platform

Sat Mar 24 05:02:18.569 DST
Node                Type                               State           Config State
-----
0/RSP0/CPU0        A9K-RSP-4G (Active)              IOS XR RUN      PWR, NSHUT, MON
0/1/CPU0           A9K-40GE-B                       IOS XR RUN      PWR, NSHUT, MON
0/4/CPU0           A9K-8T/4-B                       IOS XR RUN      PWR, NSHUT, MON
0/6/CPU0           A9K-4T-B                         IOS XR RUN      PWR, NSHUT, MON
```

The *node-id* appears in the *rack/slot/module* notation, and the *node-id* components are as follows:

- *rack* —In a single-shelf system the rack number is always “0.”
- *slot* —Number of the physical slot in which the card is installed.
- *module* —Subslot number of a system hardware component.

[Table 9: Node ID Components, on page 75](#) summarizes the *node-id* argument for each type of card.

## Displaying Router Environment Information

The **show environment** command displays hardware information for the system, including fan speeds, LED indications, power supply voltage and current information, and temperatures.

The syntax for the **show environment** command is:

**show environment** [*options*]

You can use the **show environment** command options to limit the detail in the command display. To view the command options, enter the **show environment ?** command. The following example shows the full environment status report:

```
RP/0/RSP0/CPU0:router (admin) # show environment

Mon Jun 29 04:32:07.587 PST

Temperature Information
-----
R/S/I  Modules           Inlet           Hotspot
          Temperature       Temperature
```



		(deg C)	(deg C)
0/1/*	host	31.5	39.5
0/RSP0/*	host	26.6	36.6
0/4/*	host	29.8	38.8
0/6/*	host	32.7	42.0
0/FT0/*	host	27.2	28.2
0/FT1/*	host	27.4	30.2

Voltage Information

-----

R/S/I	Modules	Sensor	(mV)	Margin
0/1/*	host	IBV	10647	n/a
	host	5.0V	4929	n/a
	host	VP3P3_CAN	3288	n/a
	host	3.3V	3301	n/a
	host	2.5V	2516	n/a
	host	1.8VB	1810	n/a
	host	1.2VB	1193	n/a
	host	1.8VA	1800	n/a
	host	0.9VB	884	n/a
	host	1.2V_LDO_BRG0	1193	n/a
	host	1.2V_LDO_BRG1	1195	n/a
	host	1.8VC	1811	n/a
	host	1.5VB	1505	n/a
	host	1.5VA	1503	n/a
	host	1.1V(1.05V_CPU)	1052	n/a
	host	0.75VA	751	n/a
	host	0.75VB_0.75VC	754	n/a
	host	1.1VB	1102	n/a
	host	1.2V_TCAM0	1003	n/a
	host	1.2V_TCAM1	1000	n/a
	host	1.0V_Bridge_LDO	998	n/a
	host	1.0VB	1043	n/a
	host	0.75VD_and_0.75VE	752	n/a
	host	1.2V_TCAM2	1005	n/a
	host	1.2V_TCAM3	1002	n/a
	host	1.5VC	1504	n/a
	host	1.8VD	1803	n/a
	host	1.1VC	1099	n/a
	host	ZARLINK_3.3V	3272	n/a
	host	ZARLINK_1.8V	1808	n/a
	host	1.2V_DB	1195	n/a
	host	3.3V_DB	3316	n/a
	host	2.5V_DB	2534	n/a
	host	1.5V_DB	1509	n/a
0/RSP0/*	host	0.75VTT	749	n/a
	host	0.9VTT_A	910	n/a

## Displaying Router Environment Information

host	0.9VTT_B	904	n/a
host	IBV	10586	n/a
host	5.0V	5013	n/a
host	VP3P3_CAN	3277	n/a
host	3.3V	3299	n/a
host	2.5V	2518	n/a
host	1.8VB	1807	n/a
host	1.2VA	1205	n/a
host	1.2VB	1202	n/a
host	1.05V	1047	n/a
host	1.2VD	1205	n/a
host	1.8VA	1811	n/a
host	1.5V	1496	n/a
host	1.9V	1887	n/a
0/4/*			
host	IBV	10627	n/a
host	5.0V	4917	n/a
host	VP3P3_CAN	3279	n/a
host	3.3V	3296	n/a
host	2.5V	2522	n/a
host	1.8VB	1805	n/a
host	1.2VB	1188	n/a
host	1.8VA	1796	n/a
host	0.9VB	881	n/a
host	1.2V_LDO_BRG0	1192	n/a
host	1.2V_LDO_BRG1	1195	n/a
host	1.8VC	1806	n/a
host	1.5VB	1510	n/a
host	1.5VA	1503	n/a
host	1.1V(1.05V_CPU)	1048	n/a
host	0.75VA	753	n/a
host	0.75VB_0.75VC	757	n/a
host	1.1VB	1105	n/a
host	1.2V_TCAM0	1003	n/a
host	1.2V_TCAM1	1000	n/a
host	1.0V_Bridge_LDO	997	n/a
host	1.0VB	1037	n/a
host	0.75VD_and_0.75VE	755	n/a
host	1.2V_TCAM2	1004	n/a
host	1.2V_TCAM3	1005	n/a
host	1.5VC	1505	n/a
host	1.8VD	1808	n/a
host	1.1VC	1104	n/a
host	ZARLINK_3.3V	3285	n/a
host	ZARLINK_1.8V	1806	n/a
host	1.2V_DB	1205	n/a
host	3.3V_DB	3318	n/a
host	2.5V_DB	2493	n/a
host	1.5V_DB	1497	n/a
host	1.8V_DB	1825	n/a
host	5.0V_XFP_DB	5001	n/a
host	1.2VB_DB	1228	n/a
0/6/*			
host	IBV	10628	n/a
host	5.0V	4893	n/a
host	VP3P3_CAN	3281	n/a
host	3.3V	3297	n/a
host	2.5V	2524	n/a
host	1.8VB	1804	n/a
host	1.2VB	1204	n/a
host	1.8VA	1795	n/a
host	0.9VB	881	n/a

host	1.2V_LDO_BRG0	1194	n/a
host	1.2V_LDO_BRG1	1193	n/a
host	1.8VC	1815	n/a
host	1.5VB	1495	n/a
host	1.5VA	1503	n/a
host	1.1V(1.05V_CPU)	1052	n/a
host	0.75VA	752	n/a
host	0.75VB_0.75VC	749	n/a
host	1.1VB	1001	n/a
host	1.2V_TCAM0	999	n/a
host	1.2V_TCAM1	1002	n/a
host	1.0V_Bridge_LDO	995	n/a
host	1.0VB	1050	n/a
host	0.75VD_and_0.75VE	752	n/a
host	1.2V_TCAM2	1002	n/a
host	1.2V_TCAM3	995	n/a
host	1.5VC	1502	n/a
host	1.8VD	1802	n/a
host	1.1VC	1101	n/a
host	ZARLINK_3.3V	3273	n/a
host	ZARLINK_1.8V	1804	n/a
host	1.2V_DB	1200	n/a
host	3.3V_DB	3314	n/a
host	2.5V_DB	2496	n/a
host	1.5V_DB	1496	n/a
host	1.8V_DB	1824	n/a
host	5.0V_XFP_DB	5004	n/a
host	1.2VB_DB	1227	n/a

LED Information

R/S/I	Modules	LED	Status
0/RSP0/*	host	Critical-Alarm	Off
	host	Major-Alarm	Off
	host	Minor-Alarm	Off
	host	ACO	Off

Fan Information

Fan speed (rpm):										
	FAN0	FAN1	FAN2	FAN3	FAN4	FAN5	FAN6	FAN7	FAN8	FAN9
FAN10	FAN11									
0/FT0/*	3510	3510	3510	3540	3510	3570	3480	3570	3510	3510
	3510									
0/FT1/*	3540	3510	3450	3540	3480	3600	3480	3450	3540	3540
	3480	3540								

Power Supply Information

R/S/I	Modules	Sensor	Watts
0/PM0/*	host	PM	3000
0/PM1/*	host	PM	3000

```

0/PM2/*
      host      PM          3000

Power Shelves Type: AC

Total Power Capacity:          9000W
Protected Power Capacity:     4500W
Worst Case Power Used:        3145W
Slot                           Max Watts
----                           -
0/1/CPU0                        375
0/RSP0/CPU0                     250
0/RSP1/CPU0                     350
0/4/CPU0                        375
0/6/CPU0                        375
0/FT0/SP                        710 (default)
0/FT1/SP                        710 (default)

Worst Case Protected Power Available:  1355W

```

## Configuring the Chassis Altitude

To allow your router to adjust the fan speed to compensate for lower cooling capabilities at higher altitudes, you should configure the chassis altitude setting. Use the **environment altitude** command in administration configuration mode. The default setting is 1800 meters.

The syntax for the environment altitude command is:

```
environment altitude altitude rack rack-no
```

## Displaying RP Redundancy Status

The **show redundancy** command displays the redundancy status of the route switch processors (RSPs). This command also displays the boot and switch-over history for the RSPs.

The **show redundancy** operates in EXEC and administration EXEC mode.

In the following example, the **show redundancy** command displays the redundancy status for a redundant RSP pair:

```

RP/0/RSP0/CPU0:router (admin) # show redundancy

Mon Jun 29 04:49:26.098 PST
Redundancy information for node 0/RSP0/CPU0:
=====
Node 0/RSP0/CPU0 is in ACTIVE role
Node 0/RSP0/CPU0 has no valid partner

Reload and boot info
-----
A9K-RSP-4G reloaded Thu Jun 11 15:20:50 2009: 2 weeks, 3 days, 13 hours, 28 minutes ago
Active node booted Thu Jun 11 15:20:50 2009: 2 weeks, 3 days, 13 hours, 28 minutes ago

Active node reload "Cause: Turboboot completed successfully"

```

## Displaying Field-Programmable Device Compatibility

The **show hw-module fpd** command displays field-programmable device (FPD) compatibility for all modules or a specific module.

The syntax for the **show hw-module fpd** command is:

**show hw-module fpd location {all | node-id}**

The **show hw-module fpd** operates in EXEC and administration EXEC mode.

The following example shows how to display FPD compatibility for all modules in the router:

```
RP/0/RSP0/CPU0:router# ios#show hw-module fpd
Tue Jan 22 13:56:55.082 UTC
```

Location	Card type	HWver	FPD device	ATR Status	FPD Versions	
					Running	Programd
0/RP0	NCS-55A2-MOD-S	0.3	MB-MIFPGA	CURRENT	0.19	0.19
0/RP0	NCS-55A2-MOD-S	0.3	Bootloader	CURRENT	1.10	1.10
0/RP0	NCS-55A2-MOD-S	0.3	CPU-IOFPGA	CURRENT	1.18	1.18
0/RP0	NCS-55A2-MOD-S	0.3	MB-IOFPGA	CURRENT	0.18	0.18
0/PM0	NC55-1200W-ACFW	1.0	LIT-PrimCU-ACFW	NEED UPGD	2.08	2.08
0/PM1	NC55-1200W-ACFW	1.0	LIT-PrimCU-ACFW	NEED UPGD	2.08	2.08

```
RP/0/RP0/CPU0:ios#.
```



**Note** After Release 5.3.x, Upg/Dng? will display Yes only for upgrade.

The following example shows the FPD for which upgrage will be skipped.

```
RP/0/RP0/CPU0:router# show hw-module fpd location all
```

```
===== Existing Field Programmable Devices =====
```

Location	Card Type	HW			Inst	Current SW Version	Upg/ Dng?
		Version	Type	Subtype			
0/SM1/SP	140G-4-S1S2S3	0.1	1c	rommonA	0	2.08	Yes
			1c	rommon	0	2.08	Yes
			1c	fpqa1	0	6.04^	No
			1c	fpga2	0	4.01	No

```
NOTES:
1. ^ One or more FPD will be intentionally skipped from upgrade using CLI with option "all"
   or during "Auto fpd".
   It can be upgraded only using the "admin> upgrade hw-module fpd <fpd> location <loc>"
   CLI with exact location.
```

```
RP/0/RSP1/CPU0:router# show hw-module fpd location all
Mon Jun 29 05:38:50.332 PST
```

```

===== Existing Field Programmable Devices =====
Location      Card Type      HW      Type  Subtype  Inst  Current SW Upg/
Version      Version      Dng?
=====
0/RSP0/CPU0   A9K-RSP-4G     4.8     lc    fpga3    0     1.13     No
              A9K-RSP-4G     4.8     lc    fpga1    0     1.5      No
              A9K-RSP-4G     4.8     lc    fpga2    0     1.14     No
              A9K-RSP-4G     4.8     lc    cbc      0     1.2      No
              A9K-RSP-4G     4.8     lc    fpga4    0     1.6      No
              A9K-RSP-4G     4.8     lc    rommon   0     1.0      No
-----
0/RSP0/CPU0   ASR-9010-FAN  1.0     lc    cbc      1     4.0      No
-----
0/RSP0/CPU0   ASR-9010-FAN  1.0     lc    cbc      2     4.0      No
-----
0/1/CPU0      A9K-40GE-B    1.0     lc    fpga1    0     0.38     No
              A9K-40GE-B    1.0     lc    fpga2    0     0.8      No
              A9K-40GE-B    1.0     lc    cbc      0     2.2      No
              A9K-40GE-B    1.0     lc    cpld1    0     0.15     No
              A9K-40GE-B    1.0     lc    rommon   0     1.0      No
-----
0/1/CPU0      A9K-40GE-B    1.0     lc    fpga1    1     0.38     No
-----
0/4/CPU0      A9K-8T/4-B    1.0     lc    fpga1    0     0.38     No
              A9K-8T/4-B    1.0     lc    fpga2    0     0.10     No
              A9K-8T/4-B    1.0     lc    cbc      0     2.2      No
              A9K-8T/4-B    1.0     lc    cpld2    0     0.7      No
              A9K-8T/4-B    1.0     lc    cpld1    0     0.15     No
              A9K-8T/4-B    1.0     lc    cpld3    0     0.3      No
              A9K-8T/4-B    1.0     lc    rommon   0     1.0      No
              A9K-8T/4-B    1.0     lc    fpga3    0     14.42    No
-----
0/4/CPU0      A9K-8T/4-B    1.0     lc    fpga1    1     0.38     No
-----
0/6/CPU0      A9K-4T-B      1.0     lc    fpga1    0     0.38     No
              A9K-4T-B      1.0     lc    fpga2    0     0.10     No
              A9K-4T-B      1.0     lc    cbc      0     2.2      No
              A9K-4T-B      1.0     lc    cpld2    0     0.7      No
              A9K-4T-B      1.0     lc    cpld1    0     0.15     No
              A9K-4T-B      1.0     lc    cpld3    0     0.3      No
              A9K-4T-B      1.0     lc    rommon   0     1.0      No
              A9K-4T-B      1.0     lc    fpga3    0     14.42    No
-----
0/6/CPU0      A9K-4T-B      1.0     lc    fpga1    1     0.38     No
-----

```

The following example shows how to display FPD compatibility for a specific module in the router:

**Table 10: show hw-module fpd Field Descriptions**

Field	Description
Location	Location of the module in the <i>rack/slot/module</i> notation.
Card Type	Module part number.
HW Version	Hardware model version for the module.

Field	Description
Type	Hardware type. Can be one of the following types: <ul style="list-style-type: none"> <li>• spa—Shared port adapter</li> <li>• lc—Line card</li> </ul>
Subtype	FPD type. Can be one of the following types: <ul style="list-style-type: none"> <li>• fabldr—Fabric downloader</li> <li>• fpga1—Field-programmable gate array</li> <li>• fpga2—Field-programmable gate array 2</li> <li>• fpga3—Field-programmable gate array 3</li> <li>• fpga4—Field-programmable gate array 4</li> <li>• fpga5—Field-programmable gate array 5</li> <li>• rommonA—Read-only memory monitor A</li> <li>• rommon—Read-only memory monitor B</li> </ul>
Inst	FPD instance. The FPD instance uniquely identifies an FPD and is used by the FPD process to register an FPD.
Current SW Version	Currently running FPD image version.
Upg/Dng?	Specifies whether an FPD upgrade or downgrade is required. A downgrade is required in rare cases when the version of the FPD image has a higher major revision than the version of the FPD image in the current Cisco IOS XR software package.

## RSP Redundancy and Switchover

This section describes RSP redundancy and switchover commands and issues.

### Establishing RSP Redundancy

Your router has two slots for RSPs: RSP0 and RSP1 (see [Figure 7: Redundant Set of RSPs Installed in Slots RSP0 and RSP1 in an 8-Slot Chassis, on page 84](#)). RSP0 is the slot on the left, facing the front of the chassis, and RSP1 is the slot on right. These slots are configured for redundancy by default, and the redundancy cannot be eliminated. To establish RSP redundancy, install RSPs into both slots.

Figure 7: Redundant Set of RSPs Installed in Slots RSP0 and RSP1 in an 8-Slot Chassis

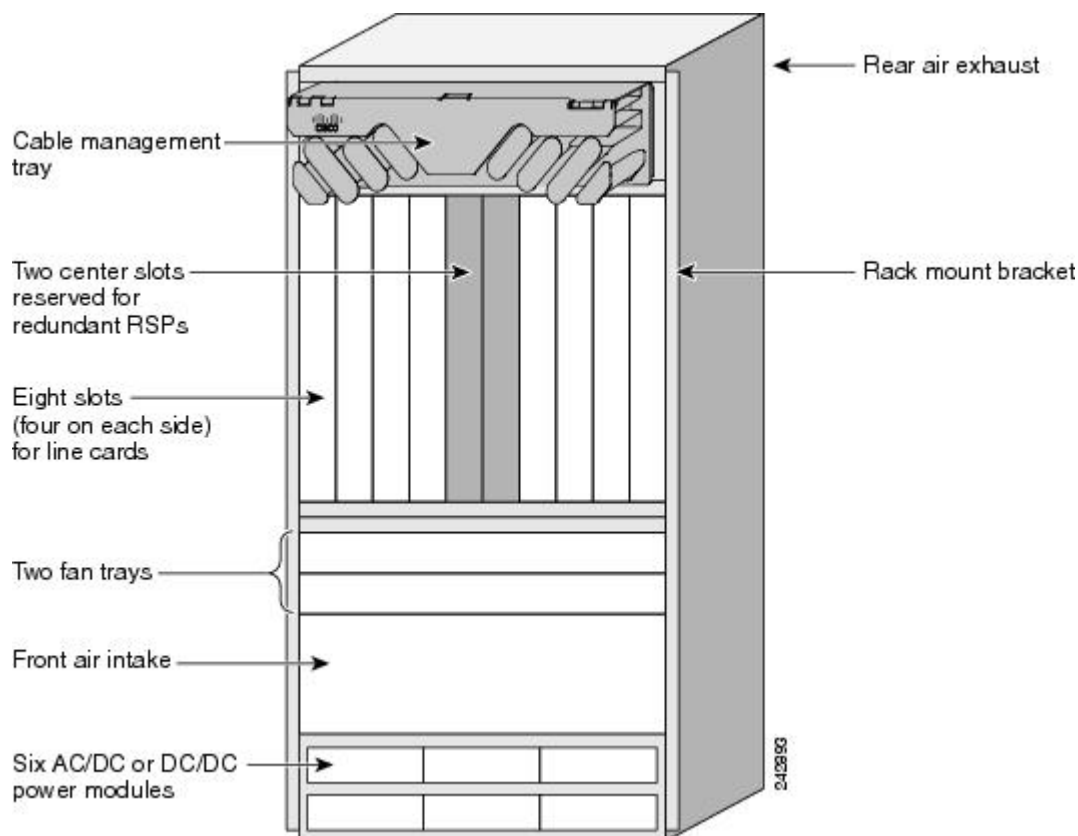

## Determining the Active RP in a Redundant Pair

During system startup, one RSP in each redundant pair becomes the active RSP. You can tell which RSP is the active RSP in the following ways:

- The active RSP can be identified by the green Primary LED on the faceplate of the card. The active RSP is indicated when the Primary LED is on. The alphanumeric LED display on the RSP displays ACTV RP.
- The slot of the active RSP is indicated in the CLI prompt. For example:

```
RP/0/RSP1/CPU0:router#
```

In this example, the prompt indicates that you are communicating with the active RSP in slot RSP1. See *Cisco ASR 9000 Series Aggregation Services Router Getting Started Guide* for a complete description of the CLI prompt.

- Enter the **show redundancy** command in EXEC mode to display a summary of the active and standby RSP status. For example:

```
RP/0/RSP0/CPU0:router(admin)# show redundancy

Mon Jun 29 04:49:26.098 PST
Redundancy information for node 0/RSP0/CPU0:
=====
```



```

Node 0/RSP0/CPU0 is in ACTIVE role
Node 0/RSP0/CPU0 has no valid partner

Reload and boot info
-----
A9K-RSP-4G reloaded Thu Jun 11 15:20:50 2009: 2 weeks, 3 days, 13 hours, 28 minutes ago
Active node booted Thu Jun 11 15:20:50 2009: 2 weeks, 3 days, 13 hours, 28 minutes ago

Active node reload "Cause: Turboboot completed successfully"

```

## Role of the Standby RSP

The second RSP to boot in a redundant pair automatically becomes the standby RSP. While the active RSP manages the system and communicates with the user interface, the standby RSP maintains a complete backup of the software and configurations for all cards in the system. If the active RSP fails or goes off line for any reason, the standby RSP immediately takes control of the system.

## Summary of Redundancy Commands

RSP redundancy is enabled by default in the Cisco IOS XR software, but you can use the commands described in [Table 11: RSP Redundancy Commands, on page 85](#) to display the redundancy status of the cards or force a manual switchover.

**Table 11: RSP Redundancy Commands**

Command	Description
<b>show redundancy</b>	Displays the redundancy status of the RSPs. This command also displays the boot and switch-over history for the RSPs.
<b>redundancy switchover</b>	Forces a manual switchover to the standby RSP. This command works only if the standby RSP is installed and in the “ready” state.
<b>show platform</b>	Displays the status for node, including the redundancy status of the RSP cards. In EXEC mode, this command displays status for the nodes assigned to the SDR. In administration EXEC mode, this command displays status for all nodes in the system.

## Automatic Switchover

Automatic switchover from the active RSP to the standby RSP occurs only if the active RSP encounters a serious system error, such as the loss of a mandatory process or a hardware failure. When an automatic switchover occurs, the RSPs respond as follows:

- If a standby RSP is installed and “ready” for switchover, the standby RSP becomes the active RSP. The original active RSP attempts to reboot.
- If the standby RSP is not in “ready” state, then both RSPs reboot. The first RSP to boot successfully assumes the role of active RSP.

## RSP Redundancy During RSP Reload

The **reload** command causes the active RSP to reload the Cisco IOS XR software. When an RSP reload occurs, the RSPs respond as follows:

- If a standby RSP is installed and “ready” for switchover, the standby RSP becomes the active RSP. The original active RSP reboots and becomes the standby RSP.
- If the standby RSP is not in the “ready” state, then both RSPs reboot. The first RSP to boot successfully assumes the role of active RSP.



**Caution** You should not use the **reload** command to force an RSP switchover because the result could be a significant loss of router operations. Instead, use the **redundancy switchover** command to fail over to the standby RSP, then use the **hw-module location node-id reload** command to reload the new standby RSP.

### Related Topics

[Reloading, Shutting Down, or Power Cycling a Node](#), on page 100

## Manual Switchover

You can force a manual switchover from the active RSP to the standby RSP using the **redundancy switchover** command.

If a standby RSP is installed and ready for switchover, the standby RSP becomes the active RSP. The original active RSP becomes the standby RSP. In the following example, partial output for a successful redundancy switchover operation is shown:

```
RP/0/RSP0/CPU0:router# show redundancy

This node (0/RSP0/CPU0) is in ACTIVE role
Partner node (0/RSP1/CPU0) is in STANDBY role
Standby node in 0/RSP1/CPU0 is ready

RP/0/RSP0/CPU0:router# redundancy switchover
Updating Commit Database. Please wait...[OK]
Proceed with switchover 0/RSP0/CPU0 -> 0/RSP1/CPU0? [confirm]
Initiating switch-over.
RP/0/RSP0/CPU0:router#

<Your 'TELNET' connection has terminated>
```

In the preceding example, the Telnet connection is lost when the previously active RP resets. To continue management of the router, you must connect to the newly activated RP as shown in the following example:

```
User Access Verification

Username: xxxxx
Password: xxxxx
Last switch-over Sat Apr 15 12:26:47 2009: 1 minute ago
```

```
RP/0/RSP1/CPU0:router#
```

If the standby RSP is not in “ready” state, the switchover operation is not allowed. In the following example, partial output for a failed redundancy switchover attempt is shown:

```
RP/0/RSP0/CPU0:router# show redundancy

Redundancy information for node 0/RP1/CPU0:
=====
Node 0/RSP0/CPU0 is in ACTIVE role
Partner node (0/RSP1/CPU0) is in UNKNOWN role

Reload and boot info
-----
RP reloaded Wed Mar 29 17:22:08 2009: 2 weeks, 2 days, 19 hours, 14 minutes ago
Active node booted Sat Apr 15 12:27:58 2009: 8 minutes ago
Last switch-over Sat Apr 15 12:35:42 2009: 1 minute ago
There have been 4 switch-overs since reload

RP/0/RSP0/CPU0:router# redundancy switchover

Switchover disallowed: Standby node is not ready.
```

## System Logs during RSP Switchover

**Table 12: Feature History Table**

Feature Name	Release Information	Feature Description
RSP Slot Location in Syslog	Release 7.8.1	When an RSP switchover occurs, the router logs the active RSP slot location in the syslog message. This helps you quickly identify the active RSP slot from your router's system log messages.  In earlier releases, the RSP switchover syslog message didn't include the active RSP slot location.

In the event of an RSP switchover, the router logs the following syslog messages:

```
RP/0/1/CPU0:Feb 19 09:08:00.655 UTC: rmf_svr[436]: %HA-REDCON-6-GO_ACTIVE : this card going active
RP/1/1/CPU0:Mar 8 11:43:29.041 UTC: rmf_svr[147]: %HA-REDCON-6-GO_STANDBY : this card going standby, location RP/1/1/CPU0
```

From Cisco IOS XR Release 7.8.1 onwards, the RSP switchover syslog message for the active RSP includes the RSP slot location as well:

```
RP/0/1/CPU0:Mar 8 11:42:50.876 UTC: rmf_svr[165]: %HA-REDCON-6-GO_ACTIVE : this card going active , location RP/0/1/CPU0:
```

## Communicating with a Standby RP

The active RSP automatically synchronizes all system software, settings, and configurations with the standby RSP.

If you connect to the standby RSP through the console port, you can view the status messages for the standby RSP. The standby RSP does not display a CLI prompt, so you cannot manage the standby card while it is in standby mode.

If you connect to the standby RSP through the management Ethernet port, the prompt that appears is for the active RSP, and you can manage the router the same as if you had connected through the management Ethernet port on the active RSP.

## PFM Alarm on OCXO Failure

*Table 13: Feature History Table*

Feature Name	Release Information	Feature Description
PFM Alarm on OCXO Failure	Release 6.7.35	<p>You now get notified via Platform Fault Manager (PFM) alarms when the internal oscillator Oven-Controlled Crystal Oscillator (OCXO) fails. OCXO failure causes timing loss in internal devices leading to possible interface flaps.</p> <p>This feature covers two scenarios:</p> <ul style="list-style-type: none"> <li>• In the case of a single RSP, you only receive a notification via the PFM alarm.</li> <li>• In the case of dual RSPs, RSP switchover takes place along with the notification.</li> </ul> <p>Use the <a href="#">show reboot</a> command to view the Onboard Failure Logging (OBFL) logs and track the PFM alarms.</p>

The function of the OCXO, which is an internal Oscillator, is to provide clock to the Phased-Locked Loop (PLL). OCXO is connected to PLL which is further connected to many hardware components. When OCXO fails to deliver the clock output, timing loss occurs. This may lead to further problems in the system such as interface flaps.

When the OCXO failure is detected, the PFM alarms are displayed on the router console. Contact the Cisco Support team when you see PFM alarms on router console as this is a hardware failure and you must get your hardware checked.



**Note** When OCXO fails, local oscillator clock output is unstable and the line card interfaces state might be unpredictable.

### PFM Alarms

The following are the examples of the PFM alarms that are generated on the router console:

- Dual RSP

```
Reboot Reason: Cause code 0x2c00001b Cause: Card reset requested by: Process ID: 102448
(dao_tmp), Target node: 0/RSP0/CPU0, CondID: 637, Fault Reason: RSP PLL error log:
Local oscillator clock output is unstable, Reloading the board. Process: pfm_node_rp
```

- Standalone RSP

```
RP/0/RSP1/CPU0:Mar 15 11:22:13.647 UTC: pfm_node_rp[365]:
%PLATFORM-CLKCTRL_T-3-RSP_OCXO_FAILURE_ALARM : Set|dao_tmp[102448]|0x1039000|RSP PLL
error log: Local oscillator clock output is unstable. Line card interfaces may be
unpredictable
```

## Restrictions for PFM Alarms on OCXO Failure

PFM alarm generation during OCXO failure is supported on the following Route Processor (RP)/Route Switch Processor (RSP) only:

- A9K-RSP880-LT-SE/TR
- A99-RP2-SE/TR
- A9K-RSP880-SE/TR

## Mitigation

The router tries to recover from OCXO failure by performing switchover of RSPs in the case of Dual RSPs.

Use the **show platform** command to detect whether your router has standalone RSP or dual RSPs.

Here, is an example of command output for dual RSP:

```
Router#show platform
Node                Type                                State                Config state
-----
0/RSP0/CPU0        A9K-RSP880-SE (Active)            IOS XR RUN           NSHUT
0/RSP1/CPU0        A9K-RSP880-SE (Standby)          IOS XR RUN           NSHUT
0/FT0              ASR-9904-FAN                      OPERATIONAL          NSHUT
0/0                A9K-48X10GE-1G-TR                SW_INACTIVE          NSHUT
0/1/CPU0           A9K-4X100GE-SE                   IOS XR RUN           NSHUT
0/PT0              A9K-AC-PEM-V2                    OPERATIONAL          NSHUT
Router#
```

Here, is an example of command output for standalone RSP:

```
Router#show platform
Node                Type                                State                Config state
-----
0/RSP0/CPU0        A9K-RSP880-SE (Active)            IOS XR RUN           NSHUT
0/FT0              ASR-9901-FAN                      OPERATIONAL          NSHUT
0/FT1              ASR-9901-FAN                      OPERATIONAL          NSHUT
```

```

0/FT2          ASR-9901-FAN          OPERATIONAL    NSHUT
0/0/CPU0       ASR9901-LC          IOS XR RUN     NSHUT
0/PT0         A9K-AC-PEM          OPERATIONAL    NSHUT
Router#

```

### Dual RSPs

When the router has High Availability (HA) RSPs or Dual RSPs, there are two RSPs: RSP0 and RSP1. One of them is active RSP and other is standby RSP. When OCXO fails, you can see a PFM alarm on the router console. The router performs RSP switchover to recover from the OCXO failure and to maintain the timing accuracy. During switchover, the active RSP becomes the standby RSP and the standby RSP takes the role of active RSP. RSP switchover takes maximum 10 seconds.

However, you must contact Cisco Support team.

To track the fatal PFM alarms generated, the router maintains OBFL logs. .

Use the **Router# show reboot history location 0/RSP0/CPU0** command to view the OBFL logs.

Here, is a sample output of reboot history.

```

No Time Cause code reason
01 Thu Nov 11 13:54:54 2021 0x2c00001b Cause: Card reset requested by: Process ID: 102448
   (dao_tmp), Target node: 0/RSP0/CPU0, CondID: 637, Fault Reason: RSP PLL error log: Local
oscillator clock output is unstable, Reloading the board.
Process: pfm_node_rp

02 Fri Nov 12 04:26:11 2021 0x0400004f Cause: MBI-HELLO reloading node on receiving reload
notification
Process: mbi-hello

```

### Standalone RSP

When only one RSP is in use, you can only see the PFM alarm on the router console. This alarm indicates that OCXO failure has occurred and you must contact Cisco Support team.

## Console Management Port

The Console Management Port (CMP) feature enables console access to the RSP and RP network devices through an ethernet port on the router using the Secure Shell (SSH).

To enable CMP feature the IPU and ROMMON must be upgraded to the latest version available in the Cisco IOS XR Software Release 5.3.2 through FPD upgrade for IOS XR 32-bit image, and Cisco IOS XR Software Release 6.4.1 for IOS XR 64-bit image. .

For information about FPD upgrade, see *Cisco ASR 9000 Series Aggregation Services Router System Management Configuration Guide*, chapter *Upgrading FPD*.



#### Note

- CMP feature helps troubleshoot the RP and RSP issues when IOS XR CLI is unavailable or when the CPU is inaccessible. On the contrary, using the CMP feature otherwise will result in unpredictable behavior of the router.
- CMP is supported only on RSP 880, RSP880-LT, RSP5, RP2, and RP3 hardware.

The CMP feature enables:

- Connection to route processor console port.
- Connection to route processor auxiliary port (32-bit image) or system admin plane (64-bit image).
- installation of new software image through SCP (32-bit image) or PXE (64-bit image) without a terminal server connected to the console port.
- CMP password recovery by using the **resetcmp** command on the CMP shell. This clears CMP data (user IDs, passwords, DNS name, hostname, SSH Key) to default settings.



---

**Note** The default login username is `cmp` and password is `cisco`.

---

You can download a new IOS XR 32-bit image using the **scpboot** command (image will be turbo booted), and a new IOS XR 64-bit image using the **pxeboot** command. You must provide the server IPv6 address and filename when using **scpboot** command. The image is copied from the server directly to the route processor CPU memory. If route processor CPU side is in ROMMON or already in IOS XR, it is reset and held in ROMMON until the image is copied. This image is automatically booted (turbo boot for 32-bit and pxeboot for 64-bit image) on the route processor CPU side. The image download options (`scpboot` and `pxeboot`) provided by the CMP can only download and boot a complete image. Subsequent image upgrades, pie downloads (32-bit image) and VM downloads (64-bit image) must be done through system admin (32-bit image), XR (64-bit image) and using the management ports.

CMP implements zero-configuration networking concepts such as mDNS and DNS-SD to ease the booting of a supervisor (RSP, RP) card. See the section [Zero Configuration Networking, on page 93](#) for information on zero-configuration networking.

For information on CMP shell, see the section [CMP Shell, on page 91](#).

## CMP Shell

CMP is accessed using IPv6 SSH. Use the default username/password to login to CMP shell. This table describes the commands available on the CMP shell:

**Table 14: CMP Shell Commands**

Command	Description
<b>adduser</b>	Adds a new CMP user ID/password.
<b>aux</b>	Connects to route processor CPU auxiliary port for 32-bit image. Connects to system admin plane for 64-bit image.
<b>con</b>	Connects to route processor CPU console port. Although multiple SSH sessions to the CMP shell are allowed, the <b>con</b> , <b>aux</b> , or <b>lc</b> command execution is allowed for only single user at a time.
<b>copykey</b>	SCP a key.

Command	Description
<b>deluser</b>	Deletes a user ID. It is recommended that you delete the default username <code>cmp</code> after a new user is created.
<b>desc_err</b>	Shows description of command error codes.
<b>debug</b>	Enables CMP console logging functionality.
<b>dns</b>	Changes DNS name. The initial service advertisement uses the domain name of chassis serial number + RSP/RP slot. This can be changed using the <b>dns</b> command.
<b>exit</b>	Logs out of CMP.
<b>fanspeed</b>	Shows information about fan trays in the chassis.
<b>help</b>	Displays available CMP commands.
<b>hostname</b>	Changes a host name.
<b>lc_con</b>	Connects to a line card console.
<b>lslotinfo</b>	Shows line card slot ID information.
<b>passwd</b>	Changes password (minimum 5 and maximum 8 characters).
<b>priv</b>	Enters privileged EXEC mode.
<b>pxeboot</b>	PXE boots a 64-bit Cisco IOS XR image to Route processor CPU memory.
<b>resetcmp</b>	Clears CMP data (user IDs, passwords, DNS name, hostname and SSH key) to default settings.
<b>run</b>	Runs diagnostic commands <code>ping/ping6/traceroute/traceroute6</code> to diagnose basic network connectivity problems.
<b>scpboot</b>	SCP boots 32-bit IOS XR image and TURBOBOOT to route processor CPU memory.
<b>show</b>	Shows all CMP data. Displays <code>ip/key/cmp</code> configuration.
<b>showinv</b>	Shows the physical inventory.
<b>showtemp</b>	Shows the temperature information.
<b>slotmap</b>	Displays physical slot and card mapping information.



Command	Description
<b>sshkeygen</b>	Generates a new SSH key.
<b>unlock</b>	Removes all system locks.  From CMP shell only one user is allowed to login to the console port, auxiliary port or LC console, and that user holds the lock and there is no access to other users.
<b>warmreset</b>	Warm resets local route processor.

Return Material Authorization (RMA) - In the event of a RMA of the supervisor (RSP/RP) card, since the CMP information is tied to the chassis serial number, all the modified information using the CMP shell is reverted back to factory default values. This means that the username/password database would be erased and the default username/password is in effect. The domain name used in service advertisement reverts to the chassis serial number plus slot ID.

## Limitations

These are the limitation of CMP:

- CMP supports only SSH service.
- Only one SSH session has console, auxiliary or system admin port.
- CMP does not support software image upgrade, pie or VM downloads.
- IPv6 link local address is preferred by Avahi application rather than the IPv6 global address.
- There is no authentication performed on users logging into the CMP shell.
- Warm reload causes loss of CMP SSH session only in A9K-RSP880-TR/SE or A99-RP2-TR/SE.

## Zero Configuration Networking

CMP configures the network devices using zero-configuration networking model and eliminates the need to have serial terminal servers. The zero-configuration networking enables:

- automatic IP address selection for network device—If a network device does not have an IP address assigned to it, then zero-configuration networking supports DHCP to obtain IPv6 Stateless Address Autoconfiguration (SLAAC), IPv4 and IPv6 addresses. The CMP port when connected to a IPv6 network obtains a link local address and also IPv6 global auto address based on IPv6 SLAAC.
- automatic domain name resolution and distribution of computer host names—The zero-configuration networking implements multicast DNS (mDNS). mDNS allows a network device to select a domain name in the local namespace and then broadcast that name using a special multicast IP address, allowing other devices on the network to connect to it by name instead of by numbered IP address. This eliminates the need to configure a DNS server.
- automatic location of network services through DNS service discovery—The zero-configuration networking enables a network device to use standard DNS queries to discover devices registered on the

network that are broadcasting the services that they provide. This eliminates the need to set up a directory server.

These are the zero-configuration networking applications that are supported:

- For Windows and MAC OS—Bonjour
- For Linux OS—Avahi

## CPAK

CPAKs are the Cisco's innovation for 100G pluggable optics, which is built with the industry leading smallest form factor, in full compliant with IEEE802.3ae specification for 100GE-SR10, -LR4, and can interoperate with all IEEE 802.3ba compliant CFP-SR10 or CFP-LR4 100G optics.

The key new functionality is that CPAK variants are being constructed that represent 10 x 10GE ports. A single physical port on the linecard needs to instantiate multiple breakout Ethernet interfaces, very much similar to serial interface channelization.

## Modes Supported on CPAKs

This table clearly lists the modes supported with the relevant PID:

CPAK (PID)	Modes Supported
CPAK-100G-SR10	100 GE, 10 GE, 40 GE
CPAK-100G-LR	100 GE
CPAK-10X10G-LR	10 GE.
CPAK-100G-ER4L	100 GE

The standard R/S/I/P format is 4-tuple. 5-tuple interfaces are represented as - R/S/I/P/SP. P is the CPAK port and SP indicates the breakout port. A CPAK which is configured as 5 tuple after executing the **breakout** command can be configured as 0x10G configuration. A CPAK, without the breakout mode can only be configured as 100G, represents a 4 tuple configuration. The default interface type is HundredGigE. If there is no configuration, then Hundred GigE interface would be created for the CPAK ports.

## Configuring Breakout

This task enables the user to configure the breakout option.

### SUMMARY STEPS

1. **configure**
2. **hw-module location preconfigure** *location port breakout interface*

## DETAILED STEPS

	Command or Action	Purpose
Step 1	<code>configure</code>	
Step 2	<p><b>hw-module location preconfigure</b> <i>location</i> <b>port breakout</b> <i>interface</i></p> <p><b>Example:</b></p> <pre>RP/0/RSP0/CPU0:router (config) # hw-module location 0/0/CPU0 port 0 breakout 10x TenGigE</pre>	<p>Configures the breakout option.</p> <p><b>Note</b> The optional keyword, <b>preconfigure</b> enables the user to preconfigure breakout on an empty slot.</p> <p>SR10 CPAK can operate in the following modes - 1x100GE or 10x10GE. 1x100GE is the default option. 10x10 CPAK can also support 10x10GE.</p>

## Power saving mode

8x100GE Line card consists of 4 Slices (0,1,2,3). Each slice has two physical ports. Slice-1, 2 and 3 can be configured into power save mode. Power save option is not applicable to Slice-0. Use the **hw-module power saving** command to configure the required slice to power saving mode.

Once a slice is configured in the power saving mode, the interfaces will be deleted and hence all traffic passing through the interfaces will be dropped.

*Table 15: Slice-Port mapping table*

Slice 1	Ports 2,3
Slice 2	Ports 4,5
Slice 3	Ports 6,7

## To configure the power save option

This task enables the user to configure the power save option.

## SUMMARY STEPS

1. **admin**
2. **configure**
3. **hw-module power saving location** *location slice number*

## DETAILED STEPS

	Command or Action	Purpose
Step 1	<p><b>admin</b></p> <p><b>Example:</b></p> <pre>RP/0/RSP0/CPU0:router# admin</pre>	Enters administration EXEC mode.
Step 2	<b>configure</b>	

	Command or Action	Purpose
<b>Step 3</b>	<b>hw-module power saving location</b> <i>location slice number</i> <b>Example:</b> RP/0/RSP0/CPU0:router (admin-config) # <b>hw-module power saving location 0/1/CPU0 slice 3</b>	Configures the power saving option for the specified slice. The available options are Slice1, 2, 3. <b>Note</b> Power save option is not applicable for Slice 0.

### What to do next

Use the **show plat slices** command to get the status of the slices.

## Configuring Breakout on a 400GE Port

Table 16: Feature History Table

Feature Name	Release Information	Description
Breakout in a 400GE Port	Release 7.4.1	You can configure breakout on a 400GE port for use the QSFP-28 transceiver module in a 1x100G mode. This feature is supported on Cisco ASR 9900 5th Generation 4Tb line cards (A99-10X400GE-X-SE/TR).
Configuring 4x100GE Breakout for ASR 9000 2T Combo Line Card (A9K-20HG-FLEX) and 800G Combo Line Card (A9K-8HG-FLEX)	Release 7.4.1	This release introduces support for 4x100 breakout on the ASR 9000 2T Combo Line Card (A9K-20HG-FLEX) and 800G Combo Line Card (A9K-8HG-FLEX). You can configure 4x100G breakout on a QSFP-DD port and use it as four individual 100G interfaces.

### 1x100GE Breakout

You can configure breakout on a 400GE port for use the QSFP-28 transceiver module in a 1x100G mode. This feature is supported on Cisco ASR 9900 5th Generation 4Tb line cards (A99-10X400GE-X-SE/TR). As part of this enhancement, 400GE ports support these QSFP28 optics:

- QSFP-100G-SR4-S
- QSFP-100G-PSM4-S
- QSFP-100G-CWDM4-S
- QSFP-100G-FR-S
- QSFP-100G-LR4-S
- QSFP-100G-ER4L-S
- QSFP-40/100-SRBD
- QSFP-100G-SM-SR

- QSFP-100G-LR-S

This task enables you to configure the breakout option:

```
RP/0/RSP0/CPU0:router# configure
RP/0/RSP0/CPU0:router(config)# hw-module location 0/2/CPU0 port 1 breakout 1xHundredGige
```

Here's the **show** command output indicating the breakout configuration:

```
RP/0/RSP0/CPU0:router# show ipv4 interface brief | include Hun
Tue May  4 07:59:56.996 UTC
FourHundredGigE0/1/0/2          unassigned          Down          Down          default
HundredGigE0/2/0/0              198.127.6.1         Up            Up            vpn6
HundredGigE0/2/0/1              198.127.12.1        Up            Up            vpn12
HundredGigE0/2/0/2              198.127.10.1        Up            Up            vpn10
HundredGigE0/2/0/3              198.127.11.1        Up            Up            vpn11
HundredGigE0/2/0/4              198.127.9.1         Up            Up            vpn9
HundredGigE0/2/0/5              198.127.5.1         Up            Up            vpn5
HundredGigE0/2/0/6              198.127.1.1         Up            Up            vpn1
HundredGigE0/2/0/7              198.127.7.1         Up            Up            vpn7
HundredGigE0/2/0/8              198.127.4.1         Up            Up            vpn4
```

Here's the **show** command output indicating the 100G optics plugged in the QSFP-DD port number 2:

```
RP/0/RSP0/CPU0:router#show inventory loc 0/2
Tue May  4 07:58:58.461 UTC
NAME: "0/2", DESCR: "ASR 9900 10-port 400GE SE linecard"
PID: A99-10X400GE-X-SE , VID: V00, SN: FOC2423NXUH

NAME: "HundredGigE0/2/0/0", DESCR: "100GE-SR4-S QSFP Module"
PID: QSFP-100G-SR4-S , VID: V03, SN: INL23332207

NAME: "HundredGigE0/2/0/1", DESCR: "100GE-LR4-S QSFP Module"
PID: QSFP-100G-LR4-S , VID: V01, SN: FNS213210US

NAME: "HundredGigE0/2/0/2", DESCR: "100GE-SM-SR QSFP Module"
PID: QSFP-100G-SM-SR , VID: V02, SN: FNS22151794

NAME: "HundredGigE0/2/0/3", DESCR: "100GE-FR-S QSFP Module"
PID: QSFP-100G-FR-S , VID: V01, SN: INL24080848

NAME: "HundredGigE0/2/0/4", DESCR: "100GE-CWDM4-S QSFP Module"
PID: QSFP-100G-CWDM4-S , VID: V01, SN: JFQ210530CN

NAME: "HundredGigE0/2/0/5", DESCR: "100GE-ER4L QSFP Module"
PID: QSFP-100G-ER4L-S , VID: V01, SN: FLJ2150J00V

NAME: "HundredGigE0/2/0/6", DESCR: "100GE-40/100-SRBD QSFP Module"
PID: QSFP-40/100-SRBD , VID: V01, SN: FOF2145N0LA

NAME: "HundredGigE0/2/0/7", DESCR: "100GE-PSM4 QSFP Module"
PID: QSFP-100G-PSM4-S , VID: V01, SN: CVR220500MB

NAME: "HundredGigE0/2/0/8", DESCR: "100GE-LR-S QSFP Module"
PID: QSFP-100G-LR-S , VID: V01, SN: FBN2415B004
```

### 4x100GE Breakout

The QSFP-DD modules support 400Gbps. You can configure 4x100G breakout on a QSFP-DD port and use it as four individual 100G interfaces.

This feature is supported on the following variant of Cisco ASR 9000 Series Line Cards:

- A99-10X400GE-X-SE
- A99-10X400GE-X-TR
- A9K-20HG-FLEX-SE
- A9K-20HG-FLEX-TR
- A9K-8HG-FLEX-SE
- A9K-8HG-FLEX-TR

This example shows how to enable 4x100GE breakout:

```
RP/0/RSP0/CPU0:router(config)# hw-module location 0/8/CPU0 port 0 breakout 4xHundredGigE
```

The following output shows the breakout configuration:

```
RP/0/RP0/CPU0:router# show ipv4 interfaces brief | i 0/8/0/0/
```

HundredGigE0/8/0/0/0	10.0.9.1	Up	Up	vpn9
HundredGigE0/8/0/0/1	10.0.8.1	Up	Up	vpn8
HundredGigE0/8/0/0/2	10.0.7.1	Up	Up	vpn7
HundredGigE0/8/0/0/3	10.0.2.1	Up	Up	vpn2

```
RP/0/RP0/CPU0:router# show interface hundredGigE 0/8/0/0/*
```

```
HundredGigE0/8/0/0/0 is up, line protocol is up
Interface state transitions: 1
Hardware is HundredGigE, address is 7c21.0e33.35f0 (bia 7c21.0e33.35f0)
Layer 1 Transport Mode is LAN
Description: noshut-interface
Internet address is 10.0.9.1/24
MTU 9216 bytes, BW 100000000 Kbit (Max: 100000000 Kbit)
  reliability 255/255, txload 0/255, rxload 0/255
Encapsulation ARPA,
Full-duplex, 100000Mb/s, 400GBASE-DR4, link type is force-up
output flow control is off, input flow control is off
Carrier delay (up) is 10 msec
loopback not set,
Last link flapped 08:07:28
ARP type ARPA, ARP timeout 04:00:00
Last input 00:00:00, output 00:00:00
Last clearing of "show interface" counters never
5 minute input rate 1000 bits/sec, 1 packets/sec
5 minute output rate 1000 bits/sec, 1 packets/sec
  18400 packets input, 4669038 bytes, 0 total input drops
  0 drops for unrecognized upper-level protocol
  Received 1 broadcast packets, 18397 multicast packets
    0 runts, 0 giants, 0 throttles, 0 parity
  0 input errors, 0 CRC, 0 frame, 0 overrun, 0 ignored, 0 abort
  19128 packets output, 4732388 bytes, 0 total output drops
  Output 1 broadcast packets, 19125 multicast packets
  0 output errors, 0 underruns, 0 applique, 0 resets
  0 output buffer failures, 0 output buffers swapped out
```

```
1 carrier transitions

HundredGigE0/8/0/0/1 is up, line protocol is up
Interface state transitions: 1
Hardware is HundredGigE, address is 7c21.0e33.35f1 (bia 7c21.0e33.35f1)
Layer 1 Transport Mode is LAN
Description: noshut-interface
Internet address is 10.0.8.1/24
MTU 9216 bytes, BW 100000000 Kbit (Max: 100000000 Kbit)
  reliability 255/255, txload 0/255, rxload 0/255
Encapsulation ARPA,
Full-duplex, 100000Mb/s, 400GBASE-DR4, link type is force-up
output flow control is off, input flow control is off
Carrier delay (up) is 10 msec
loopback not set,
Last link flapped 08:07:28
ARP type ARPA, ARP timeout 04:00:00
Last input 00:00:00, output 00:00:00
Last clearing of "show interface" counters never
5 minute input rate 1000 bits/sec, 1 packets/sec
5 minute output rate 1000 bits/sec, 1 packets/sec
  18408 packets input, 4677424 bytes, 5 total input drops
  0 drops for unrecognized upper-level protocol
  Received 1 broadcast packets, 18405 multicast packets
    0 runts, 0 giants, 0 throttles, 0 parity
  0 input errors, 0 CRC, 0 frame, 0 overrun, 0 ignored, 0 abort
  19118 packets output, 4725316 bytes, 0 total output drops
  Output 1 broadcast packets, 19115 multicast packets
  0 output errors, 0 underruns, 0 applique, 0 resets
  0 output buffer failures, 0 output buffers swapped out
  1 carrier transitions

HundredGigE0/8/0/0/2 is up, line protocol is up
Interface state transitions: 1
Hardware is HundredGigE, address is 7c21.0e33.35f2 (bia 7c21.0e33.35f2)
Layer 1 Transport Mode is LAN
Description: noshut-interface
Internet address is 10.0.7.1/24
MTU 9216 bytes, BW 100000000 Kbit (Max: 100000000 Kbit)
  reliability 255/255, txload 0/255, rxload 0/255
Encapsulation ARPA,
Full-duplex, 100000Mb/s, 400GBASE-DR4, link type is force-up
output flow control is off, input flow control is off
Carrier delay (up) is 10 msec
loopback not set,
Last link flapped 08:07:28
ARP type ARPA, ARP timeout 04:00:00
Last input 00:00:00, output 00:00:00
Last clearing of "show interface" counters never
5 minute input rate 1000 bits/sec, 1 packets/sec
5 minute output rate 1000 bits/sec, 1 packets/sec
  18446 packets input, 4676812 bytes, 0 total input drops
  0 drops for unrecognized upper-level protocol
  Received 1 broadcast packets, 18443 multicast packets
    0 runts, 0 giants, 0 throttles, 0 parity
  0 input errors, 0 CRC, 0 frame, 0 overrun, 0 ignored, 0 abort
  19184 packets output, 4729960 bytes, 0 total output drops
  Output 1 broadcast packets, 19181 multicast packets
  0 output errors, 0 underruns, 0 applique, 0 resets
  0 output buffer failures, 0 output buffers swapped out
  1 carrier transitions

HundredGigE0/8/0/0/3 is up, line protocol is up
Interface state transitions: 1
```

```

Hardware is HundredGigE, address is 7c21.0e33.35f3 (bia 7c21.0e33.35f3)
Layer 1 Transport Mode is LAN
Description: noshut-interface
Internet address is 10.0.2.1/24
MTU 9216 bytes, BW 100000000 Kbit (Max: 100000000 Kbit)
  reliability 255/255, txload 0/255, rxload 0/255
Encapsulation ARPA,
Full-duplex, 100000Mb/s, 400GBASE-DR4, link type is force-up
output flow control is off, input flow control is off
Carrier delay (up) is 10 msec
loopback not set,
Last link flapped 08:07:28
ARP type ARPA, ARP timeout 04:00:00
Last input 00:00:00, output 00:00:00
Last clearing of "show interface" counters never
5 minute input rate 1000 bits/sec, 1 packets/sec
5 minute output rate 1000 bits/sec, 1 packets/sec
  18444 packets input, 4677024 bytes, 0 total input drops
  0 drops for unrecognized upper-level protocol
  Received 1 broadcast packets, 18441 multicast packets
    0 runts, 0 giants, 0 throttles, 0 parity
  0 input errors, 0 CRC, 0 frame, 0 overrun, 0 ignored, 0 abort
  19170 packets output, 4734446 bytes, 0 total output drops
  Output 1 broadcast packets, 19167 multicast packets
  0 output errors, 0 underruns, 0 applique, 0 resets
  0 output buffer failures, 0 output buffers swapped out
  1 carrier transitions

```

## Reloading, Shutting Down, or Power Cycling a Node

Use the commands described in this section to reload the Cisco IOS XR software on the active RSP or on any specified node in the system. This section also describes the commands used to administratively shut down a node and power a node on or off.

**Table 17: Commands to Reload, Shut Down, or Power Cycle a Node**

Command	Description
<b>hw-module location <i>node-id</i> power disable</b>	<p>This command administratively turns the power off for a node. It is entered in administration configuration mode. The changes do not take effect until you enter the <b>commit</b> command.</p> <p>To power on a node, use the <b>no</b> form of this command.</p> <p><b>Note</b> This command cannot be used to disable power on the RSP from which the command is entered.</p>
<b>hw-module location <i>node-id</i> reload</b>	<p>This command works in EXEC mode and reloads the Cisco IOS XR software on a specific node or all nodes. To specify all nodes, enter the <b>all</b> keyword in place of the <i>node-id</i> argument. The node reloads with the current running configuration and active software set for that node.</p>



Command	Description
<b>hw-module shutdown location</b> <i>node-id</i>	This command must be entered in the configuration mode and administratively shuts down the specified node. Nodes that are shut down still have power but cannot load or operate Cisco IOS XR software.  To return a node to the up state, use the <b>no</b> form of this command.  <b>Note</b> This command cannot be used to shut down the RSP from which the command is entered.
<b>hw-module unshut location</b> <i>node-id</i>	This command must be entered in the configuration mode. This command is used to administratively bring up the specified node.



**Note** When you use the **hw-module shutdown location** *node-id* command to a line card, you must wait until the configuration is applied before removing the line card. Removal of the line card before the shutdown may result in a hardware issue.

## Reloading the Active RSP

The **reload** command causes the active RSP to reload the Cisco IOS XR software according to the configuration register setting. This setting determines how the active RSP acts when reloaded.

This section contains instructions to reload the Cisco IOS XR software and return to EXEC mode. For instructions to use the **reload** command for entering ROM Monitor bootstrap mode, see *ROM Monitor Configuration Guide for Cisco ASR 9000 Routers*.



**Caution** Because the **reload** command causes the active RSP to go off line and either reload the Cisco IOS XR software or enter ROM Monitor mode, the router experiences a loss of service unless a redundant standby RSP is installed and in “ready” state. To display the status of the standby RSP, use the **show redundancy** command in EXEC mode.

### SUMMARY STEPS

1. **show redundancy**
2. **admin**
3. **show variables boot**
4. (Optional) **config-register** *register-value*
5. **admin**
6. **reload**

### DETAILED STEPS

	Command or Action	Purpose
Step 1	<b>show redundancy</b>	Displays the RSP redundancy status.

	Command or Action	Purpose
	<p><b>Example:</b></p> <pre>RP/0/RSP0/CPU0:router# show redundancy</pre>	<ul style="list-style-type: none"> <li>If a standby RSP is in “ready” redundancy state, the <b>reload</b> command also causes the router to gracefully fail over to the standby RSP.</li> </ul>
<b>Step 2</b>	<p><b>admin</b></p> <p><b>Example:</b></p> <pre>RP/0/RSP0/CPU0:router# admin</pre>	Enters administration EXEC mode.
<b>Step 3</b>	<p><b>show variables boot</b></p> <p><b>Example:</b></p> <pre>RP/0/RSP0/CPU0:router(admin)# show variables boot</pre>	<p>Displays the configuration register setting.</p> <ul style="list-style-type: none"> <li>Enter this command in administration EXEC mode.</li> <li>For normal operations, the configuration register setting is 0x102 or 0x2102, which causes the active RSP to reload the Cisco IOS XR software.</li> <li>Verify that the configuration register setting is 0x102 or 0x2102. If it is not, complete <a href="#">Step 4, on page 102</a> to reset the configuration register to 0x102 or 0x2102.</li> </ul> <p><b>Note</b> For instructions on how to enter ROM Monitor bootstrap mode, see <i>ROM Monitor Configuration Guide for Cisco ASR 9000 Routers</i>.</p>
<b>Step 4</b>	<p>(Optional) <b>config-register</b> <i>register-value</i></p> <p><b>Example:</b></p> <pre>RP/0/RSP0/CPU0:router(admin)# config-register 0x102</pre>	Sets the configuration register to the respective value. This step is necessary only if the register is not set to the respective value (0x102 or 0x2102) in the running configuration. You can use either 0x102 or 0x2102. Both these values specify the same functionality, as bit 13 in 0x2102 is not significant for Cisco IOS XR software.
<b>Step 5</b>	<p><b>admin</b></p> <p><b>Example:</b></p> <pre>RP/0/RSP0/CPU0:router# admin</pre>	Enters administration EXEC mode.
<b>Step 6</b>	<p><b>reload</b></p> <p><b>Example:</b></p> <pre>RP/0/RSP0/CPU0:router# reload</pre>	<p>Reloads the active RSP according to the configuration register setting.</p> <ul style="list-style-type: none"> <li>If the setting is 0x102 or 0x2102, then the RSP reloads the Cisco IOS XR software.</li> <li>If the standby RSP is in “ready” redundancy state, the router switches over to the standby RSP.</li> <li>If a standby RSP is not installed or not in a “ready” state, the router experiences a loss of service while the active RSP is reloading the Cisco IOS XR software.</li> </ul>

## Flash Disk Recovery

When an RSP is power cycled or experiences an ungraceful reset, the boot disk (PCMCIA flash disk used to boot the card) may experience a file-system corruption. If this occurs, an error message is displayed and the RSP fails to boot. The corrupted flash disk is automatically reformatted and the Cisco IOS XR software is restored from the designated system controller (DSC) for the system.

For example, if a flash disk for an RSP is corrupted, the RP fails to boot and the following error message is displayed:

```
#####
Restricted Rights Legend
Use, duplication, or disclosure by the Government is
subject to restrictions as set forth in subparagraph
(c) of the Commercial Computer Software - Restricted
Rights clause at FAR sec. 52.227-19 and subparagraph
(c) (1) (ii) of the Rights in Technical Data and Computer
Software clause at DFARS sec. 252.227-7013.

cisco Systems, Inc.
170 West Tasman Drive
San Jose, California 95134-1706

Cisco IOS XR Software for the Cisco XR Cisco ASR 9000 Series Router-mbirp,
Copyright (c) 2009 by Cisco Systems, Inc.
Unable to mount /disk0:, filesystem is corrupted.
Check fsck log at /tmp/chkfs_fd0.log
init: special_commands:wait for disk0: failed
```

If this occurs, then the flash disk is automatically reformatted and the Cisco IOS XR software is restored to the flash disk.



---

**Note** If the flash disk is badly damaged and cannot be reformatted, the disk must be replaced.

If the corrupted flash disk is the DSC, then the router fails over to the standby DSC. If no standby DSC is installed, then the system fails to boot.

---

## Using Controller Commands to Manage Hardware Components

The **controller**, **controllers**, and **show controllers** commands are used to manage and display settings for various hardware components, including the switch fabric management, Ethernet control plane, and interface manager. These commands are primarily diagnostic and related to driver-level details. The information available with these commands varies widely and is hardware specific.

For information on the use of these commands, see *Interface and Hardware Component Command Reference for Cisco ASR 9000 Series Routers*.

# Formatting Hard Drives, Flash Drives, and Other Storage Devices

To format a storage device on the router, use the **format** command in EXEC mode.



**Caution** Formatting a storage device deletes all data on that device.

The following command syntax is used:

**format** *filesystem*: [*options*]

[Table 18: format command Syntax Description, on page 104](#) describes the **format** command syntax.

**Table 18: format command Syntax Description**

Variable	Description
<i>filesystem</i>	<p>Specifies the memory device to format. The supported file systems are:</p> <ul style="list-style-type: none"> <li>• <b>bootflash:</b></li> <li>• <b>compactflash:</b></li> <li>• <b>configflash:</b></li> <li>• <b>harddisk:</b></li> <li>• <b>harddiska:</b></li> <li>• <b>disk0:</b></li> <li>• <b>disk1:</b></li> </ul> <p>Enter <b>format ?</b> to see the devices supported on your router.</p>
<i>options</i>	<p>Enter <b>format filesystem: ?</b> to see the available options.</p> <p>For more information, see <i>System Management Command Reference for Cisco ASR 9000 Series Routers</i>.</p>

In the following example, the **format** command is used to format the hard disk:

```
RP/0/RSP0/CPU0:router# format harddisk:
```

## Removing and Replacing Cards

This section describes card replacement issues and procedures.

### Removing Line Cards

Line cards are designed for online insertion and removal (OIR). A line card is a single card that contains all service processing functions and physical line interfaces.

The OIR feature allows you to remove and replace cards without removing power to the card or chassis. Removing a card interrupts all traffic passing through the card, but it does not remove the card configuration.

When you remove a card, the configuration remains for all interfaces, but the interfaces do not appear in the output of the **show interfaces** command. You can view interface configurations by entering the **show running-config** command. The following example shows how the configuration appears when a card is removed:

```
RP/0/RSP0/CPU0:router# show running-config

Building configuration...
hostname router
router ospf 3269
  area 0
    interface POS0/3/0/0
      cost 20
    !
  interface preconfigure POS0/3/0/0
    ipv4 address 10.10.50.1 255.255.255.0
  !
  interface preconfigure POS0/3/0/1
    description POS0/3/0/1
    shutdown
  !
  interface preconfigure POS0/3/0/2
    description POS0/3/0/2
    shutdown
  !
  interface preconfigure POS0/3/0/3
    description POS0/3/0/3
    shutdown
  !
```

In this example, the line card in slot 3 is removed, and the interface configuration for all four interfaces changes to “interface preconfigure.” However, the “router ospf” reference to a slot 3 interface does not change. If you replace a line card with another line card that uses the same media type and port count, the configuration becomes active on the replacement card.

To remove the configuration for a slot after a card is removed, use the **no interface preconfigure** command to remove all interface configuration statements for that card in the running configuration. In addition, search the configuration for any references to the removed interfaces, such as the “router ospf” reference to slot 3 in the preceding example.

To remove the configuration for a slot when a card is installed, use the **no interface** command to remove all interface configuration statements for that card in the running configuration. In addition, search the configuration for any references to the removed interfaces.

Each line card supports a specific media type (Packet over SONET/SDH [POS] or Ethernet, for example) and port count. If you replace a line card with one that supports a different media type or port count, you should review the configuration and revise it to support the replacement line card.

## Replacing a Line Card with the Same Media Type and Port Count

When you replace a line card or PLIM with a card that is of the same media type and has the same port count as the replaced card, the guidelines in the [Removing Line Cards](#), on page 104 apply. Because the replacement card is of the same media type and port count, no special procedures are required for card removal and replacement.

## Replacing a Line Card with the Same Media Type and a Different Port Count

When you replace a line card with a card that is of the same media type with a different port count, the guidelines in [Removing Line Cards , on page 104](#) apply.

If the new card has a greater port count than the replaced card, the configuration applies to the corresponding lower port numbers, and the ports that did not exist on the replaced card have no configuration and come up in the shutdown state.

If the new card supports fewer ports, the existing configuration for the corresponding number of ports on the new card set is applied. The previous configuration for the removed ports remains in interface preconfigure state, as shown in the following example:

```
RP/0/RSP0/CPU0:router# show running-config

Building configuration...
hostname rtp-gsr1
interface POS0/3/0/0
  ipv4 address 10.10.50.1 255.255.255.0
  !
interface preconfigure POS0/3/0/1
  description POS0/3/0/1
  shutdown
  !
interface preconfigure POS0/3/0/2
  description POS0/3/0/2
  shutdown
  !
interface preconfigure POS0/3/0/3
  description POS0/3/0/3
  shutdown
  !
```

In the preceding example, a four-port card has been replaced with a single-port card. The configuration from port 1 on the four-port card is applied to the single port on the replacement card, and the remaining port configurations change to “interface preconfigure.” To remove the configuration for the missing interfaces, use the **no interface preconfigure** command. In addition, search for and remove any configuration references to the removed interfaces.

Whenever you replace a line card with the same media type and a different port count, review the running configuration in the router and revise the configuration as necessary.

## Replacing a Line Card or PLIM with a Different Media Type

When you replace a line card or PLIM with a card that is of a different media type (for example, if you replace a POS PLIM with an Ethernet PLIM), the guidelines in [Removing Line Cards , on page 104](#) apply. Review the running configuration in the router and revise the configuration as necessary for the new media type.

## Examples: Breakout and Power saving options

The following are the examples for the **power save** and **breakout** options:

### Power saving mode

Configuring the power saving option:

```
admin
```

```

config
  hw-module power saving location 0/0/CPU0 slice 3
!

show platform slices
Line Card      Slice  Config      Status
0/0/CPU0      0      Power on    Completed
              1      Power on    Completed
              2      Power on    Completed
              3      Power saving Completed

```

### Breakout option

Configuring the breakout option:

```

config
  hw-module location 0/0/CPU0 port 0 breakout 10xTenGigE
!

```

show command output indicating the breakout ports:

```

RP/0/RSP0/CPU0:TD02#show ipv4 interface brief | include Hun
Sun Sep  7 15:59:33.446 PST
HundredGigE0/0/0/0      34.34.34.2      Down      Down
HundredGigE0/0/0/1      100.0.1.1      Up      Up
HundredGigE0/0/0/2      unassigned      Up      Up
HundredGigE0/0/0/3      unassigned      Up      Up
HundredGigE0/0/0/4      unassigned      Shutdown  Down
HundredGigE0/0/0/5      unassigned      Shutdown  Down
HundredGigE0/0/0/6      unassigned      Shutdown  Down
HundredGigE0/0/0/7      unassigned      Shutdown  Down

```

```

RP/0/RSP0/CPU0:router(config)#hw-module location 0/0/CPU0 port 2 breakout 10xTenGigE
RP/0/RSP0/CPU0:router(config)#commit

```

```

RP/0/RSP0/CPU0:router#show ipv4 interface brief | include Ten
TenGigE0/0/0/2/0      unassigned      Shutdown  Down
TenGigE0/0/0/2/1      unassigned      Shutdown  Down
TenGigE0/0/0/2/2      unassigned      Shutdown  Down
TenGigE0/0/0/2/3      unassigned      Shutdown  Down
TenGigE0/0/0/2/4      unassigned      Shutdown  Down
TenGigE0/0/0/2/5      unassigned      Shutdown  Down
TenGigE0/0/0/2/6      unassigned      Shutdown  Down
TenGigE0/0/0/2/7      unassigned      Shutdown  Down
TenGigE0/0/0/2/8      unassigned      Shutdown  Down
TenGigE0/0/0/2/9      unassigned      Shutdown  Down

```

## Proactive Line Card Shut Down

The proactive line card shutdown feature enables powering down line cards automatically when the power that is drawn by the router exceeds configured threshold. The sequence of powering down LCs is based on the shutdown priorities that are assigned to them. The LC, however, does not boot automatically even after the router power draw is back to normal below the shutdown threshold. Therefore, you must manually bring up the LC by either reloading or OIR method.

Instead of provisioning more power to the router in worst case power draw scenarios, this feature helps in saving power by powering down the LC.

As part of this feature, you must configure two threshold values:

- **Syslog Threshold**—This value serves as a syslog warning threshold. If the router power draw exceeds the syslog threshold, then a warning error message is captured at the console. This warning message facilitates the user to take any preventive action.
- **Shutdown Threshold**—This value triggers the shutdown of line cards. If the router power draw exceeds the shutdown threshold, then the line cards are shutdown based on the priorities that are assigned to them. The system monitors the power draw for every 10 seconds.

### Shut Down Priorities for Powering Down the LC

You can configure a shutdown priority value of 0 to 19. A line card with lower value has the highest priority. By default, a priority of 20 is assigned to all the LC in the router.

When two or more LCs have equal priorities that are assigned, then the slot number takes precedence in the priority calculation. A lower slot number has the highest priority. For instance, when two LCs at slot 0 and slot 19 have the priority set as 10, then LC in slot 0 has higher priority than the LC in slot 19.

## Proactive Line Card Shut Down Implementation Consideration

Consider the following points while configuring proactive line card shut down feature:

- Shutdown threshold must be greater than the current system power draw.
- Shutdown threshold must be greater than the syslog threshold.
- Shutdown threshold must not be less than 3500 Watts.
- In Cisco IOS XR 32-bit OS, the priority of a LC is checked only when the LC is in **IOS XR RUN** state.
- In Cisco IOS XR 64-bit OS, the priority of a LC is checked only when the LC is in **Operational** state.

## Configure Proactive Line Card Shut Down

### Cisco IOS XR 32-bit

Configuring proactive line card shutdown includes:

- Assigning priorities to the line cards
- Configuring syslog threshold
- Configuring shutdown threshold

In this example, syslog threshold of 5000 W and shutdown threshold of 6000 W is configured along with the LC priorities:

```
config
power budget enforcement progressive
priority 1
  location 0/1/CPU0
  location 0/5/CPU0
!
priority 5
```



```

    location 0/4/CPU0
  !
  priority 11
    location 0/2/CPU0
  !
  priority 20
    location 0/3/CPU0
  !
  syslog-threshold 5000 W
  shutdown-threshold 6000 W

```

The following error message is seen when power draw exceeds the shutdown threshold:

```

RP/0/RP0/CPU0:Mar  8 11:42:00.146 : shelfmgr[406]: %PLATFORM-SHELFMGR-1-INRESET_ALARM :
Power off node 0/10/CPU0 due to multiple critical alarms, putting into IN_RESET state
RP/0/RP0/CPU0:Mar  8 11:42:10.948 : envmon[209]: %PLATFORM-ENVMON-2-PWR_EXCEEDED_SHUTDOWN
: Slot 0/3/CPU0 priority 20 is being shutdown,current power usage 6746 W exceeds the
configured threshold of 6000 W

```

### Cisco IOS XR 64-bit

Configuring proactive line card shutdown includes:

- Configuring syslog threshold
- Configuring shutdown threshold
- Assigning priorities to the line cards

In this example, syslog threshold of 3300 W and shutdown threshold of 3500 W is configured along with LC priorities:

```

sysadmin config
 power-mgmt progressive enable
  syslog-threshold 3300          /* syslog generated when power crosses this value */
  shutdown-threshold 3500      /* LCs shut down based on priority once power draw crosses
this limit */
  priority location 0/0 10     /* Priority assigned for each LC */
  !
  priority location 0/1 5
  !
  priority location 0/4 4
  !
  priority location 0/6 2
  !
  priority location 0/7 1
  !
!

```

The following error message is seen when power draw exceed the syslog threshold:

```

0/RSP0/ADMIN0:Feb 22 11:44:38.566 UTC: envmon[4202]: %PWR_MGMT-ENVMON-3-PWR_EXCEEDED_WARN
:
Chassis power usage 3448 W has exceeded the configured warning threshold of 3300 W

```

The following error message is seen when power draw exceeds the shutdown threshold:

```

0/RSP0/ADMIN0:Feb 22 11:44:38.567 UTC: envmon[4202]: %PKT_INFRA-FM-3-FAULT_MAJOR :
ALARM_MAJOR :Node shutdown by Progressive power-mgmt mode :DECLARE :0/0:
Node priority 10, Chassis power draw 3570 W exceeded shutdown threshold 3500 W

```

# Advanced Power Management

Advanced power management feature enables powering down the unused line card slices.

This feature helps to manage power consumption, as the slices that do not have any services enabled are power down. Later these slices can be powered when a new service is enabled on them.

This feature is supported on the Cisco ASR 9000 4th Generation Ethernet line cards.

## Configuring Advance Power Management

This procedure shows how to configure advance power management.

In this example these slices are powered down:

- slice 0, and 7 of the line card in the node 0 location
- slice 3, and 6 of the line card in the node 1 location

You should reload the line card for the configuration changes to take effect.

```
Router# configure
Router (config)# hw-module location 0/0/CPU0 slice 0 power-down
Router (config)# hw-module location 0/0/CPU0 slice 7 power-down
Router (config)# hw-module location 0/1/CPU0 slice 3 power-down
Router (config)# hw-module location 0/1/CPU0 slice 6 power-down
Router (config)# commit
Router (config)# end
Router # admin
Router (sysadmin-vm)# hw-module location 0/0 reload
Router (sysadmin-vm)# hw-module location 0/1 reload
```

### Running Configuration

```
config
hw-module location 0/0/CPU0 slice 0 power-down
hw-module location 0/0/CPU0 slice 7 power-down
hw-module location 0/1/CPU0 slice 3 power-down
hw-module location 0/1/CPU0 slice 6 power-down
```

### Verification

```
Router# show apm psm status
```

```
PSM Status
-----
PSM Client Status
    DIAG0:      Not registered
    DIAG1:      Registered
    0/1 PSA:    Registered

LC Status
-----
Line Card      Slice  Config  Status      DIAG0      DIAG1      PSA
```

0/0/CPU0	0	On	Completed	Not registered	Completed	Not present
	1	On	Completed	Not registered	Completed	Not present
	2	On	Completed	Not registered	Completed	Not present
	3	On	Completed	Not registered	Completed	Not present
	4	On	Completed	Not registered	Completed	Not present
	5	On	Completed	Not registered	Completed	Not present
	6	On	Completed	Not registered	Completed	Not present
	7	On	Completed	Not registered	Completed	Not present
0/1/CPU0	0	On	Completed	Not registered	Completed	Completed
	1	On	Completed	Not registered	Completed	Completed
	2	On	Completed	Not registered	Completed	Completed
	3	On	Completed	Not registered	Completed	Completed
	4	On	Completed	Not registered	Completed	Completed
	5	On	Completed	Not registered	Completed	Completed
	6	On	Completed	Not registered	Completed	Completed
	7	On	Completed	Not registered	Completed	Completed

New configuration after line card reboots

```
-----
Line Card      Slice  New Config
0/0/CPU0      0      Down
               7      Down
0/1/CPU0      3      Down
               6      Down
```

## Overview of Erase and Wipeout Disk Memory

Below two methods are used to delete the data from a RSP and line card. These methods are used based on your requirements:

- Erase Disk Memory
- Wipe Out Disk Memory

### Erase Disk Memory

The Erase Disk Memory operation clears the disk memory of RSPs and line cards. However, the deleted data is recoverable using recovery tools. The erase disk memory operation can be performed for quick sanitization of the card before reusing it in another device within the control space of your network or organization.

## How to Erase Disk Memory

Erasing disk memory operation uses zapdisk feature to erase the disk memory from the RSP and line card.

Erasing disk memory is done in three steps. First, you enable the zapdisk feature, later identify the card where zapdisk is supported. Next, activate the zapdisk operation on the card:

1. Enable zapdisk feature on the router.

Example:

```
sysadmin-vm# zapdisk set
```

2. Find out the card location where the zapdisk feature is supported using the **show zapdisk locations** command.

Example:

```
Router# show zapdisk locations

0/RSP1      Fully qualified location specification
0/7         Fully qualified location specification
0/4         Fully qualified location specification
all         all locations
```

3. Start the zapdisk operation on a specific node location or all node locations to erase disk memory.



---

**Note** You can run the zapdisk operation on all RSPs and line cards except the active RSP where zapdisk service is running in an active role.

---

After the zapdisk process is completed, the system clears all data and shuts down the card.

This example runs the zapdisk operation on the node location 0/4:

```
Router# zapdisk start location 0/4
Action on designated location is in progress, more detail logs will be located in sysadmin
at
/misc/disk1/tftpboot/zapdisk.log once action is completed
```



---

**Note** After deleting the data, remove the card from the slot, and do not reload the card or the router. If you reload the card or the router without removing the card, the data is reloaded into the card.

---

In the event when you must return or trash a card, the data in the disk memory should be permanently deleted. Therefore, the erase disk memory feature is not advice. You should use the enhanced version of the erase disk memory feature called Wipe Out Disk Memory.

## Wipe Out Disk Memory

The Wipe Out Disk Memory feature deletes data permanently from the disk memory of RSPs and line cards. The erased data is non-recoverable. We recommend this action when you perform a return material authorization (RMA) of a card to prevent pilferage of sensitive data.

## How to Wipe out Disk Memory

Wiping out disk memory actions are performed in the ROMMON mode. Generally to boot into ROMMON mode, the **config-register boot-mode rom-monitor** command is executed from the admin mode. However, the command is not available in Cisco IOS XR 64 bit OS. Therefore you must follow the below sequence to boot into ROMMON mode:

1. Reload the router
2. Break into the BIOS menu and select ROMMON
3. Wipe out disk memory in ROMMON

### Reload the router

Before reloading the router, ensure that the redundant RP is disabled in dual-RP routers and console is connected:

```
sysadmin-vm:0_RSP0# hw-module location all reload
```

### Break into the BIOS menu and select ROMMON

1. While the router boots, press CTRL+C to break into BIOS menu.
2. To enter into ROMMON mode, select the Boot to ROMMON option from the available boot options:

```
Please select the operating system and the boot device:
  1) Boot to ROMMON
  2) IOS-XR 64 bit Boot previously installed image
  3) IOS-XR 64 bit Mgmt Network boot using DHCP server
  4) IOS-XR 64 bit Mgmt Network boot using local settings (iPXE)
(Press 'p' for more option)
Selection [1/2/3/4]: 1
Selected Boot to ROMMON , Continue ? Y/N: y

rommon 1 >
```

### Wipe out disk memory in ROMMON

1. Go to Privilege Mode.

```
rommon > priv
```

2. Select the **hderase** option.

```
rommon > hderase
      SATA HD(0x4,0x0,0x0):
      Model      : <Model number>
      Serial No  : <serial number>

      Sanitize Crypto Scramble Erase Supported
      Sanitize State : Idle

      All the contents on this Drive will be Erased
      Do you wish to continue?(Y/N)
      Y
```

The data is permanently erased.

## Upgrading the CPU Controller Bits

Use this procedure to upgrade the CPU controller bits on all nodes that are installed in the router or on a specific node.

### SUMMARY STEPS

1. **admin**
2. **upgrade cpuctrlbits {all | location node-id}**

### DETAILED STEPS

	Command or Action	Purpose
<b>Step 1</b>	<b>admin</b> <b>Example:</b> RP/0/RSP0/CPU0:router# admin	Enters administration EXEC mode.
<b>Step 2</b>	<b>upgrade cpuctrlbits {all   location node-id}</b> <b>Example:</b> RP/0/RSP0/CPU0:router(admin)# upgrade cpuctrlbits all	Upgrades the CPU controller bits on all nodes in the router.  Use the <b>location node-id</b> keyword and argument to upgrade the CPU controller bits on a specific node.

## Examples

The following example shows how to upgrade the CPU controller bits on all nodes in a router:

```
RP/0/RSP0/CPU0:router# admin
RP/0/RSP0/CPU0:router(admin)# upgrade cpuctrlbits all
```

Please do not power cycle, reload the router or reset any nodes until all upgrades are completed.

Please check the syslog to make sure that all nodes are upgraded successfully.

If you need to perform multiple upgrades, please wait for current upgrade to be completed before proceeding to another upgrade. Failure to do so may render the cards under upgrade to be unusable.

## Configuring Port Modes

This section describes how to configure the various port modes on a router, port expansion card, or a line card.

Table 19: Feature History Table

Feature Name	Release Information	Description
1GbE Port Mode on SFP+ and SFP28 Ports	Release 7.9.1	<p>It is now possible to use the 10GbE SFP+ and SFP28 ports to transmit 1GbE traffic on the routers or line cards. The number of ports on which you can enable 1GbE port mode has been increased from the previous releases.</p> <p>The details of the number of ports on which you can configure 1GbE port mode on the Cisco ASR 9000 Series routers, port expansion card, and line cards is as follows:</p> <ul style="list-style-type: none"> <li>• Cisco ASR 9903 - 20 SFP+ ports</li> <li>• Cisco ASR 9902 - 24 SFP+ and 16 SFP28 ports</li> <li>• A9903-8HG-PEC - 40 SFP+ ports</li> <li>• A9K-4HG-FLEX-SE/TR - 24 SFP+ and 16 SFP28 ports</li> <li>• A99-4HG-FLEX-SE/TR - 24 SFP+ and 16 SFP28 ports</li> <li>• A9K-4HG-FLEX-FC - 24 SFP+ and 16 SFP28 ports</li> <li>• A99-4HG-FLEX-FC - 24 SFP+ and 16 SFP28 ports</li> </ul> <p>Use the <a href="#">hw-module location breakout</a> and <a href="#">hw-module location slice config mode</a> commands to enable 1GbE port mode configuration.</p>

## Configuring Port Mode in Cisco A9903-8HG-PEC

You can configure the SFP+ ports on the [Cisco A9903-8HG-PEC](#) (0.8T PEC card) in 10GbE, 25GbE, or 1GbE mode. By default, all ports are in 10GbE mode.

For more information on the ports, see the [Installing Modules and Cables in the Chassis](#) chapter in the *Cisco ASR 9000 Series Fixed-Port Routers Hardware Installation Guide*.

To configure a port, use the **hw-module location slice config mode** command.

The port mode configuration is per slice and not per port. Also, the 48 ports on Cisco A9903-8HG-PEC are available in slices 4 and 5. Each slice can be configured for 10GbE, 25GbE, or 1GbE port mode.

The number of ports available on the card depends on the port mode configured on each slice. This table shows the port mode, and available ports on Cisco A9903-8HG-PEC:

Table 20: Port Modes, and Available Ports on Cisco A9903-8HG-PEC

Port Mode	Number of Ports	Available Port Numbers
1GbE	48 24 on each slice	On slice 4: port numbers 0–23 On slice 5: port numbers 24–47
10GbE	48 24 on each slice	On slice 4: port numbers 0–23 On slice 5: port numbers 24–47
25GbE	32 16 on each slice	On slice 4: port numbers 0–15 On slice 5: port numbers 32–47

### Configuration

This sample configuration shows how to configure all ports on Cisco A9903-8HG-PEC in 25GbE mode:

```
RP/0/RP0/CPU0:ios#configure
RP/0/RP0/CPU0:ios(config)#hw-module location 0/0/CPU0 slice 4 config-mode
4x25GE,4x25GE,4x25GE,4x25GE
RP/0/RP0/CPU0:ios(config)#hw-module location 0/0/CPU0 slice 5 config-mode
4x25GE,4x25GE,4x25GE,4x25GE
RP/0/RP0/CPU0:ios(config)#commit
```

This sample configuration shows how to configure all ports on Cisco A9903-8HG-PEC in 1GbE mode:

```
RP/0/RP0/CPU0:ios#configure
RP/0/RP0/CPU0:ios(config)#hw-module location 0/0/CPU0 slice 4 config-mode
10x1GE,10x1GE,4x10GE,UNUSED
RP/0/RP0/CPU0:ios(config)#hw-module location 0/0/CPU0 slice 5 config-mode
10x1GE,10x1GE,4x10GE,UNUSED
RP/0/RP0/CPU0:ios(config)#commit
```

By default, all ports are in 10GbE mode. To revert to the default mode, use **no** form of the `hw-module location <node> slice <number> config-mode` command. This sample shows how to revert slice 4 ports to the default 10GbE mode:

```
RP/0/RP0/CPU0:ios#configure
RP/0/RP0/CPU0:ios(config)#no hw-module location 0/0/CPU0 slice 4 config-mode
4x25GE,4x25GE,4x25GE,4x25GE
RP/0/RP0/CPU0:ios(config)#commit
```

### Verification

Use the **show interface brief** command to verify the ports in slice 4 and 5 configured in 25GbE mode:

```
RP/0/RP0/CPU0:ios#show interfaces brief
Intf      Intf      LineP      Encap MTU      BW
Name      State     State      Type (byte) (Kbps)
-----
[SNIP]
TF0/0/1/0 admin-down admin-down ARPA 1514 25000000 /* slice 4 port numbers starts here */
TF0/0/1/1 admin-down admin-down ARPA 1514 25000000
TF0/0/1/2 admin-down admin-down ARPA 1514 25000000
TF0/0/1/3 admin-down admin-down ARPA 1514 25000000
```



```

TF0/0/1/4 admin-down admin-down ARPA 1514 25000000
TF0/0/1/5 admin-down admin-down ARPA 1514 25000000
TF0/0/1/6 admin-down admin-down ARPA 1514 25000000
TF0/0/1/7 admin-down admin-down ARPA 1514 25000000
TF0/0/1/8 admin-down admin-down ARPA 1514 25000000
TF0/0/1/9 admin-down admin-down ARPA 1514 25000000
TF0/0/1/10 admin-down admin-down ARPA 1514 25000000
TF0/0/1/11 admin-down admin-down ARPA 1514 25000000
TF0/0/1/12 admin-down admin-down ARPA 1514 25000000
TF0/0/1/13 admin-down admin-down ARPA 1514 25000000
TF0/0/1/14 admin-down admin-down ARPA 1514 25000000
TF0/0/1/15 admin-down admin-down ARPA 1514 25000000
TF0/0/1/32 admin-down admin-down ARPA 1514 25000000 /* slice 5 port numbers starts here */

TF0/0/1/33 admin-down admin-down ARPA 1514 25000000
TF0/0/1/34 admin-down admin-down ARPA 1514 25000000
TF0/0/1/35 admin-down admin-down ARPA 1514 25000000
TF0/0/1/36 admin-down admin-down ARPA 1514 25000000
TF0/0/1/37 admin-down admin-down ARPA 1514 25000000
TF0/0/1/38 admin-down admin-down ARPA 1514 25000000
TF0/0/1/39 admin-down admin-down ARPA 1514 25000000
TF0/0/1/40 admin-down admin-down ARPA 1514 25000000
TF0/0/1/41 admin-down admin-down ARPA 1514 25000000
TF0/0/1/42 admin-down admin-down ARPA 1514 25000000
TF0/0/1/43 admin-down admin-down ARPA 1514 25000000
TF0/0/1/44 admin-down admin-down ARPA 1514 25000000
TF0/0/1/45 admin-down admin-down ARPA 1514 25000000
TF0/0/1/46 admin-down admin-down ARPA 1514 25000000
TF0/0/1/47 admin-down admin-down ARPA 1514 25000000

```

This show command displays all 48 ports on Cisco A9903-8HG-PEC in 10GbE mode:

```

RP/0/RP0/CPU0:ios#show interfaces brief
Intf      Intf      LineP      Encap MTU      BW
Name      State     State      Type (byte) (Kbps)
-----
Te0/0/1/0 admin-down admin-down ARPA 1514 10000000 /* slice 4 port numbers starts here */
Te0/0/1/1 admin-down admin-down ARPA 1514 10000000
Te0/0/1/2 admin-down admin-down ARPA 1514 10000000
Te0/0/1/3 admin-down admin-down ARPA 1514 10000000
Te0/0/1/4 admin-down admin-down ARPA 1514 10000000
Te0/0/1/5 admin-down admin-down ARPA 1514 10000000
Te0/0/1/6 admin-down admin-down ARPA 1514 10000000
Te0/0/1/7 admin-down admin-down ARPA 1514 10000000
Te0/0/1/8 admin-down admin-down ARPA 1514 10000000
Te0/0/1/9 admin-down admin-down ARPA 1514 10000000
Te0/0/1/10 admin-down admin-down ARPA 1514 10000000
Te0/0/1/11 admin-down admin-down ARPA 1514 10000000
Te0/0/1/12 admin-down admin-down ARPA 1514 10000000
Te0/0/1/13 admin-down admin-down ARPA 1514 10000000
Te0/0/1/14 admin-down admin-down ARPA 1514 10000000
Te0/0/1/15 admin-down admin-down ARPA 1514 10000000
Te0/0/1/16 admin-down admin-down ARPA 1514 10000000
Te0/0/1/17 admin-down admin-down ARPA 1514 10000000
Te0/0/1/18 admin-down admin-down ARPA 1514 10000000
Te0/0/1/19 admin-down admin-down ARPA 1514 10000000
Te0/0/1/20 admin-down admin-down ARPA 1514 10000000
Te0/0/1/21 admin-down admin-down ARPA 1514 10000000
Te0/0/1/22 admin-down admin-down ARPA 1514 10000000
Te0/0/1/23 admin-down admin-down ARPA 1514 10000000
Te0/0/1/24 admin-down admin-down ARPA 1514 10000000 /* slice 5 port numbers starts here */
Te0/0/1/25 admin-down admin-down ARPA 1514 10000000
Te0/0/1/26 admin-down admin-down ARPA 1514 10000000
Te0/0/1/27 admin-down admin-down ARPA 1514 10000000

```

```

Te0/0/1/28 admin-down admin-down ARPA 1514 10000000
Te0/0/1/29 admin-down admin-down ARPA 1514 10000000
Te0/0/1/30 admin-down admin-down ARPA 1514 10000000
Te0/0/1/31 admin-down admin-down ARPA 1514 10000000
Te0/0/1/32 admin-down admin-down ARPA 1514 10000000
Te0/0/1/33 admin-down admin-down ARPA 1514 10000000
Te0/0/1/34 admin-down admin-down ARPA 1514 10000000
Te0/0/1/35 admin-down admin-down ARPA 1514 10000000
Te0/0/1/36 admin-down admin-down ARPA 1514 10000000
Te0/0/1/37 admin-down admin-down ARPA 1514 10000000
Te0/0/1/38 admin-down admin-down ARPA 1514 10000000
Te0/0/1/39 admin-down admin-down ARPA 1514 10000000
Te0/0/1/40 admin-down admin-down ARPA 1514 10000000
Te0/0/1/41 admin-down admin-down ARPA 1514 10000000
Te0/0/1/42 admin-down admin-down ARPA 1514 10000000
Te0/0/1/43 admin-down admin-down ARPA 1514 10000000
Te0/0/1/44 admin-down admin-down ARPA 1514 10000000
Te0/0/1/45 admin-down admin-down ARPA 1514 10000000
Te0/0/1/46 admin-down admin-down ARPA 1514 10000000
Te0/0/1/47 admin-down admin-down ARPA 1514 10000000

```

This show command displays ports in slice 4 configured in 25GbE mode and slice 5 in 10GbE mode:

```

RP/0/RP0/CPU0:ios#show interfaces brief
Intf      Intf      LineP      Encap MTU      BW
Name      State     State      Type (byte) (Kbps)
-----
TF0/0/1/0 admin-down admin-down ARPA 1514 25000000 /* slice 4 port numbers starts here */
TF0/0/1/1 admin-down admin-down ARPA 1514 25000000
TF0/0/1/2 admin-down admin-down ARPA 1514 25000000
TF0/0/1/3 admin-down admin-down ARPA 1514 25000000
TF0/0/1/4 admin-down admin-down ARPA 1514 25000000
TF0/0/1/5 admin-down admin-down ARPA 1514 25000000
TF0/0/1/6 admin-down admin-down ARPA 1514 25000000
TF0/0/1/7 admin-down admin-down ARPA 1514 25000000
TF0/0/1/8 admin-down admin-down ARPA 1514 25000000
TF0/0/1/9 admin-down admin-down ARPA 1514 25000000
TF0/0/1/10 admin-down admin-down ARPA 1514 25000000
TF0/0/1/11 admin-down admin-down ARPA 1514 25000000
TF0/0/1/12 admin-down admin-down ARPA 1514 25000000
TF0/0/1/13 admin-down admin-down ARPA 1514 25000000
TF0/0/1/14 admin-down admin-down ARPA 1514 25000000
TF0/0/1/15 admin-down admin-down ARPA 1514 25000000
Te0/0/1/24 admin-down admin-down ARPA 1514 10000000 /* slice 5 port numbers starts here */
Te0/0/1/25 admin-down admin-down ARPA 1514 10000000
Te0/0/1/26 admin-down admin-down ARPA 1514 10000000
Te0/0/1/27 admin-down admin-down ARPA 1514 10000000
Te0/0/1/28 admin-down admin-down ARPA 1514 10000000
Te0/0/1/29 admin-down admin-down ARPA 1514 10000000
Te0/0/1/30 admin-down admin-down ARPA 1514 10000000
Te0/0/1/31 admin-down admin-down ARPA 1514 10000000
Te0/0/1/32 admin-down admin-down ARPA 1514 10000000
Te0/0/1/33 admin-down admin-down ARPA 1514 10000000
Te0/0/1/34 admin-down admin-down ARPA 1514 10000000
Te0/0/1/35 admin-down admin-down ARPA 1514 10000000
Te0/0/1/36 admin-down admin-down ARPA 1514 10000000
Te0/0/1/37 admin-down admin-down ARPA 1514 10000000
Te0/0/1/38 admin-down admin-down ARPA 1514 10000000
Te0/0/1/39 admin-down admin-down ARPA 1514 10000000
Te0/0/1/40 admin-down admin-down ARPA 1514 10000000
Te0/0/1/41 admin-down admin-down ARPA 1514 10000000
Te0/0/1/42 admin-down admin-down ARPA 1514 10000000
Te0/0/1/43 admin-down admin-down ARPA 1514 10000000

```

```
Te0/0/1/44 admin-down admin-down ARPA 1514 10000000
Te0/0/1/45 admin-down admin-down ARPA 1514 10000000
Te0/0/1/46 admin-down admin-down ARPA 1514 10000000
Te0/0/1/47 admin-down admin-down ARPA 1514 10000000
```

This show command displays all 48 ports on Cisco A9903-8HG-PEC in 1GbE mode:

```
RP/0/RP0/CPU0:ios#show interfaces brief
```

```
-----
Fri Feb 24 10:33:06.517 UTC
```

Intf Name	Intf State	LineP State	Encap Type	MTU (byte)	BW (Kbps)
Nu0	up	up	Null	1500	0
Mg0/RP0/CPU0/0	up	up	ARPA	1514	10000000
Hu0/0/0/0	down	down	ARPA	1514	100000000
Hu0/0/0/1	down	down	ARPA	1514	100000000
Hu0/0/0/2	down	down	ARPA	1514	100000000
Hu0/0/0/3	down	down	ARPA	1514	100000000
Hu0/0/0/4	down	down	ARPA	1514	100000000
Hu0/0/0/5	up	up	ARPA	9216	100000000
Hu0/0/0/6	down	down	ARPA	1514	100000000
Hu0/0/0/7	down	down	ARPA	1514	100000000
Hu0/0/0/8	down	down	ARPA	1514	100000000
Hu0/0/0/9	down	down	ARPA	1514	100000000
Hu0/0/0/11	down	down	ARPA	1514	100000000
Hu0/0/0/12	down	down	ARPA	1514	100000000
Hu0/0/0/13	down	down	ARPA	1514	100000000
Hu0/0/0/15	up	up	ARPA	9216	100000000
Te0/0/0/16	down	down	ARPA	1514	100000000
Te0/0/0/17	down	down	ARPA	1514	100000000
Te0/0/0/18	down	down	ARPA	1514	100000000
Te0/0/0/19	down	down	ARPA	1514	100000000
Te0/0/0/20	down	down	ARPA	1514	100000000
Te0/0/0/21	down	down	ARPA	1514	100000000
Te0/0/0/22	down	down	ARPA	1514	100000000
Te0/0/0/23	down	down	ARPA	1514	100000000
Te0/0/0/24	down	down	ARPA	1514	100000000
Te0/0/0/25	down	down	ARPA	1514	100000000
Te0/0/0/26	down	down	ARPA	1514	100000000
Te0/0/0/27	down	down	ARPA	1514	100000000
Te0/0/0/28	down	down	ARPA	1514	100000000
Te0/0/0/29	down	down	ARPA	1514	100000000
Te0/0/0/30	down	down	ARPA	1514	100000000
Te0/0/0/31	down	down	ARPA	1514	100000000
Te0/0/0/32	down	down	ARPA	1514	100000000
Te0/0/0/33	down	down	ARPA	1514	100000000
Te0/0/0/34	down	down	ARPA	1514	100000000
Te0/0/0/35	down	down	ARPA	1514	100000000
<b>Gi0/0/1/0</b>	<b>down</b>	<b>down</b>	<b>ARPA</b>	<b>1514</b>	<b>1000000</b> /* slice 4 port numbers starts here */
Gi0/0/1/1	down	down	ARPA	1514	1000000
Gi0/0/1/2	down	down	ARPA	1514	1000000
Gi0/0/1/3	down	down	ARPA	1514	1000000
Gi0/0/1/4	down	down	ARPA	1514	1000000
Gi0/0/1/5	down	down	ARPA	1514	1000000
Gi0/0/1/6	down	down	ARPA	1514	1000000
Gi0/0/1/7	down	down	ARPA	1514	1000000
Gi0/0/1/8	down	down	ARPA	1514	1000000
Gi0/0/1/9	down	down	ARPA	1514	1000000
Gi0/0/1/10	down	down	ARPA	1514	1000000
Gi0/0/1/11	down	down	ARPA	1514	1000000
Gi0/0/1/12	down	down	ARPA	1514	1000000
Gi0/0/1/13	up	up	ARPA	9216	1000000
Gi0/0/1/14	down	down	ARPA	1514	1000000

```

Gi0/0/1/15 up up ARPA 9216 1000000
Gi0/0/1/16 down down ARPA 1514 1000000
Gi0/0/1/17 down down ARPA 1514 1000000
Gi0/0/1/18 down down ARPA 1514 1000000
Gi0/0/1/19 down down ARPA 1514 1000000
Gi0/0/1/24 down down ARPA 1514 1000000/* slice 5 port numbers starts here */
Gi0/0/1/25 down down ARPA 1514 1000000
Gi0/0/1/26 down down ARPA 1514 1000000
Gi0/0/1/27 down down ARPA 1514 1000000
Gi0/0/1/28 down down ARPA 1514 1000000
Gi0/0/1/29 down down ARPA 1514 1000000
Gi0/0/1/30 down down ARPA 1514 1000000
Gi0/0/1/31 down down ARPA 1514 1000000
Gi0/0/1/32 down down ARPA 1514 1000000
Gi0/0/1/33 down down ARPA 1514 1000000
Gi0/0/1/34 down down ARPA 1514 1000000
Gi0/0/1/35 down down ARPA 1514 1000000
Gi0/0/1/36 down down ARPA 1514 1000000
Gi0/0/1/37 down down ARPA 1514 1000000
Gi0/0/1/38 down down ARPA 1514 1000000
Gi0/0/1/39 down down ARPA 1514 1000000
Gi0/0/1/40 down down ARPA 1514 1000000
Gi0/0/1/41 down down ARPA 1514 1000000
Gi0/0/1/42 down down ARPA 1514 1000000
Gi0/0/1/43 down down ARPA 1514 1000000
Te0/0/1/20 down down ARPA 1514 10000000
Te0/0/1/21 down down ARPA 1514 10000000
Te0/0/1/22 down down ARPA 1514 10000000
Te0/0/1/23 down down ARPA 1514 10000000
Te0/0/1/44 down down ARPA 1514 10000000
Te0/0/1/45 down down ARPA 1514 10000000
Te0/0/1/46 down down ARPA 1514 10000000
Te0/0/1/47 down down ARPA 1514 10000000

```

## Configuring Port Mode in Cisco ASR 9902 Router

The router has 48 ports with maximum of 800G data bandwidth capacity. You can configure the 48 ports in various port modes (100GbE, 25GbE, 10GbE, 40GbE and 1GbE) using the **hw-module location <node> slice <number> config-mode** command.

The port mode configuration is per slice and not per port. Also, the 48 ports on the Cisco ASR 9902 router are available in slice 0 and 1. Each slice can be configured for a mix of 1GbE, 10GbE, 25GbE, 40GbE or 100GbE port modes. The default configuration is 1x100GE, 1x100GE, 10x10GE, and 10x10GE.

For more information on the ports, see the [Installing Modules and Cables in the Chassis](#) chapter in the *Cisco ASR 9000 Series Fixed-Port Routers Hardware Installation Guide*.

The number of ports available on the router depends on the port mode configured on each slice. This table shows the configuration options and supported port modes on Cisco ASR 9902 router:

**Table 21: Configuration Options, and Supported Port Modes on Cisco ASR 9902 Router**

Configuration Options	Supported Port Modes on Slice 0 and Slice 1
<b>Default</b>	1x100GE, 1x100GE, 10x10GE, and 10x10GE
<b>Option 1</b>	1x100GE/1X40G/4X10GE, 1x100GE/1X40GE/4X10GE, 10x10GE or 5x1GE_5x10GE or 10x1GE, and 10x10GE or 5x1GE_5x10GE or 10x1GE

Configuration Options	Supported Port Modes on Slice 0 and Slice 1
<b>Option 2</b>	1x100GE/1X40GE/4X10GE, 1x100GE/1X40G/4X10GE, 4x25GE, and 10x10GE or 5x1GE_5x10GE
<b>Option 3</b>	1x100GE/1X40GE/4X10GE, 4x25GE, 4x25GE, and 1x100GE/1x40GE/4x10GE
<b>Option 4</b>	1x100GE/1X40GE/4X10GE, 1x100GE/1X40GE/4X10GE, 1x100GE/1X40GE, and 1x100GE/1X40GE/4X10GE

This sample shows how to configure Configuration Option 1:

```
RP/0/RP0/CPU0:ios#configure
RP/0/RP0/CPU0:ios(config)#hw-module location 0/0/CPU0 slice 0 config-mode
1x100GE,1x100GE,5x1GE_5x10GE,5x1GE_5x10GE
RP/0/RP0/CPU0:ios(config)#commit
```

This sample shows how to configure Configuration Option 1 with 10x1GE optics speed:

```
RP/0/RP0/CPU0:ios#configure
RP/0/RP0/CPU0:ios(config)#hw-module location 0/0/CPU0 slice 0 config-mode
1x100GE,1x100GE,10x1GE,10x1GE
RP/0/RP0/CPU0:ios(config)#commit
```

To revert to the default mode, use **no** form of the **hw-module location <node> slice <number> config-mode** command.

```
RP/0/RP0/CPU0:ios#configure
RP/0/RP0/CPU0:ios(config)#no hw-module location 0/0/CPU0 slice 0 config-mode
1x100GE,1x100GE,5x1GE_5x10GE,5x1GE_5x10GE
RP/0/RP0/CPU0:ios(config)#commit
```

Use the **show interface brief** command to verify the ports configured using **config-mode** command.



**Note** The 40G port mode on the Cisco ASR 9902 router works only with Cisco IOS XR software version 7.8.x or higher. So, if you want to use the 40G port mode on the Cisco ASR 9902 router, you should update the Cisco IOS XR software version to 7.8.x or higher.

## Configuring Port Modes in Cisco ASR 9903 Router and Cisco ASR 9000 Series Line Cards

Table 22: Feature History Table

Feature Name	Release Information	Description
1GbE Port Mode	Release 7.7.1	<p>You can now use the 1GbE port mode option to configure 10GbE optics speed on the SFP+ ports. This allows you to enable SFP+ ports on the line cards or router to deliver 1GbE standard traffic by using the <b>hw-module location breakout</b> command.</p> <p>This option is enabled on the following Cisco ASR 9000 Series router and line cards:</p> <ul style="list-style-type: none"> <li>• ASR 9903</li> <li>• A9K-4HG-FLEX-SE/TR</li> <li>• A99-4HG-FLEX-SE/TR</li> <li>• A9K-4HG-FLEX-FC</li> <li>• A99-4HG-FLEX-FC</li> </ul>

The Cisco ASR 9903 router has 16 QSFP28 ports and 20 integrated SFP+ ports with a maximum of 1.6T data bandwidth capacity. You can configure the ports in various port modes (100GbE, 25GbE, 10GbE, and 1GbE) using the **hw-module location <node id> bay <bay number> port <port number> breakout <interface>** command.

For more information on the ports, see the [Installing Modules and Cables in the Chassis](#) chapter in the *Cisco ASR 9000 Series Fixed-Port Routers Hardware Installation Guide*.

This table shows the configuration options and supported port modes on Cisco ASR 9903 router and Cisco ASR 9000 Series line cards.

Table 23: Configuration Options and Supported Port Modes

Configuration Options	Supported Port Modes
<b>Default</b>	1x100GE, 1x100GE, 10x10GE, and 10x10GE
<b>Option 1</b>	1x100GE, 1x100GE, 10x10GE or 5x1GE_5x10GE or 10x1GE, and 10x10GE or 5x1GE_5x10GE or 10x1GE
<b>Option 2</b>	1x100GE, 1x100GE, 4x25GE, and 10x10GE or 5x1GE_5x10GE or 10x1GE
<b>Option 3</b>	1x100GE, 4x25GE, 4x25GE, and 1x100GE
<b>Option 4</b>	1x100GE, 1x100GE, 1x100GE, and 1x100GE

### Configuring Supported Port Modes on Routers

To configure 1GbE port mode on Cisco ASR 9903 router, use the QSFP28 ports 10 and 14. You can configure the ports for a mix of 1GbE, 10GbE, 25GbE, or 100GbE port modes.

This sample shows how to configure port mode of 1GbE on ports 10 with 5x1GE-5x10GE option for Cisco ASR 9903 router:

```
RP/0/RP0/CPU0:ios#configure
RP/0/RP0/CPU0:ios(config)#hw-module location 0/0/CPU0 bay 0 port 10 breakout
5x1GE-5x10GE
RP/0/RP0/CPU0:ios(config)#commit
```

This sample shows how to configure port mode of 1GbE on ports 10 with 10x1GE option for Cisco ASR 9903 router:

```
RP/0/RP0/CPU0:ios#configure
RP/0/RP0/CPU0:ios(config)#hw-module location 0/0/CPU0 bay 0 port 10 breakout 10x1GE
RP/0/RP0/CPU0:ios(config)#commit
```

### Configuring Supported Port Modes on Line Cards

To configure 1GbE port mode on the Cisco ASR 9000 Series line cards, use the **hw-module location <node> slice <number> config-mode** command. On these cards, the port mode configuration is done per slice and not per port.

For more information on the ports, see the [Overview](#) chapter in the *Cisco ASR 9000 Series Aggregation Services Router Ethernet Line Card Installation Guide*.

This sample shows how to configure Option 1 on slice 0 with 1x100GE, 1x100GE, 5x1GE\_5x10GE, and 5x1GE\_5x10GE port modes on the line cards:

```
RP/0/RP0/CPU0:ios#configure
RP/0/RP0/CPU0:ios(config)#hw-module location 0/0/CPU0 slice 0 config-mode
1x100GE,1x100GE,5x1GE_5x10GE,5x1GE_5x10GE
RP/0/RP0/CPU0:ios(config)#commit
```

This sample shows how to configure Option 1 on slice 0 with 1x100GE, 1x100GE, 10x10GE, and 10x1GE port modes on the line cards:

```
RP/0/RP0/CPU0:ios#configure
RP/0/RP0/CPU0:ios(config)#hw-module location 0/0/CPU0 slice 0 config-mode
1x100GE,1x100GE,10x1GE,10x1GE
RP/0/RP0/CPU0:ios(config)#commit
```

To revert to the default mode, use the **no** form of the **hw-module location <node> slice <number> config-mode** command.

```
RP/0/RP0/CPU0:ios#configure
RP/0/RP0/CPU0:ios(config)#no hw-module location 0/0/CPU0 slice 0 config-mode
1x100GE,1x100GE,5x1GE_5x10GE,5x1GE_5x10GE
RP/0/RP0/CPU0:ios(config)#commit
```

## Configure Single Feed Power Mode

Cisco ASR 9000 series router supports the operating of one or all power modules. For example, V1 DC, V2 DC, V3 AC and V3 DC.

Ideally, you're expected to connect all the power modules (or feed) to power supply. If you don't connect any one feed, the system raises an alarm or error message.

You can configure the single-feed power mode to suppress the error message or an alarm for any missing feeds.

### Configuration Example

The following example enables the single power feed mode for the 0/PS2/M0/SP power module:

```
Router#admin
Router(admin)#config
Router(admin-config)#power single-feed location 0/PS2/M0/SP
```

## Additional References

The following sections provide references related to hardware management on Cisco IOS XR software.

### Related Documents

Related Topic	Document Title
Cisco IOS XR hardware commands	Hardware Redundancy and Node Administration Commands on <i>the Cisco ASR 9000 Series Router</i> module of <i>System Management Command Reference for Cisco ASR 9000 Series Routers</i>
Cisco IOS XR hardware documentation	See Cisco Carrier Routing System Install and Upgrade Guides at: <a href="http://www.cisco.com/en/US/products/ps5763/prod_installation_guides_list.html">http://www.cisco.com/en/US/products/ps5763/prod_installation_guides_list.html</a>
Information about getting started with Cisco IOS XR software	<i>Cisco ASR 9000 Series Aggregation Services Router Getting Started Guide</i>
ROM Monitor	<i>ROM Monitor Configuration Guide for Cisco ASR 9000 Routers</i>
Cisco IOS XR command master list	<i>Cisco ASR 9000 Series Aggregation Services Router Commands Master List</i>
Information about user groups and task IDs	<i>Configuring AAA Services on the Cisco ASR 9000 Series Router</i> module of <i>System Security Configuration Guide for Cisco ASR 9000 Series Routers</i>

### Standards

Standards	Title
No new or modified standards are supported by this feature, and support for existing standards has not been modified by this feature.	—



**MIBs**

<b>MIBs</b>	<b>MIBs Link</b>
—	To locate and download MIBs using Cisco IOS XR software, use the Cisco MIB Locator found at the following URL and choose a platform under the Cisco Access Products menu: <a href="http://cisco.com/public/sw-center/netmgmt/cmtk/mibs.shtml">http://cisco.com/public/sw-center/netmgmt/cmtk/mibs.shtml</a>

**RFCs**

<b>RFCs</b>	<b>Title</b>
No new or modified RFCs are supported by this feature, and support for existing RFCs has not been modified by this feature.	—

**Technical Assistance**

<b>Description</b>	<b>Link</b>
The Cisco Technical Support website contains thousands of pages of searchable technical content, including links to products, technologies, solutions, technical tips, and tools. Registered Cisco.com users can log in from this page to access even more content.	<a href="http://www.cisco.com/cisco/web/support/index.html">http://www.cisco.com/cisco/web/support/index.html</a>





## CHAPTER 7

# Upgrading and Managing Cisco IOS XR Software

Cisco IOS XR software is divided into software packages so that you can select which features run on your router. This module describes the concepts and tasks necessary to add feature packages, upgrade the active set of packages, roll back to a previously active set of packages, and perform other related package management tasks.

For complete descriptions of the commands listed in this module, see [Related Documents, on page 184](#). To locate documentation for other commands that might appear in the course of performing a configuration task, search online in *Cisco ASR 9000 Series Aggregation Services Router Commands Master List*.

**Table 24: Feature History for Upgrading and Managing Cisco IOS XR Software**

Release	Modification
Release 3.7.2	The feature was introduced.
Release 3.9.0	No modification.
Release 4.0.0	A procedure to upgrade software from Cisco IOS XR Release 3.x was introduced. See <a href="#">Upgrading to Cisco IOS XR Software Release 4.0, on page 168</a> . Support for installation commands was removed from EXEC mode. The ability to install software on a specific SDR was removed.
Release 6.0.1	Support was added for digitally signed images. See <a href="#">Digitally Signed Images , on page 135</a>
Release 6.3.1	Support for parallel FPD upgrade for power modules was added.

This module contains the following topics:

- [Overview of Cisco IOS XR Software Packages, on page 128](#)
- [Information About Package Management, on page 132](#)
- [Package Management Procedures, on page 143](#)
- [Rolling Back to a Previous Software Set, on page 180](#)
- [Resetting Router to Factory Settings, on page 183](#)
- [Additional References, on page 184](#)

# Overview of Cisco IOS XR Software Packages

Cisco IOS XR software is divided into software packages so that you can select which features run on your router. Each package contains the components to perform a specific set of router functions, such as routing, security, or modular services card (MSC) support. Bundles are groups of packages that can be downloaded as a set. For example, Cisco IOS XR Unicast Routing Core Bundle (known as *mini*) provides the main packages for use on every router.

Adding a package to the router does not affect the operation of the router—it only copies the package files to a local storage device on the router, known as the *boot device* (such as the compact flash drive). To make the package functional on the router, you must activate it for one or more cards.

To upgrade a package, you activate a newer version of the package. When the automatic compatibility checks have been passed, the new version is activated, and the old version is deactivated.



---

**Note** Activating a software maintenance upgrade (SMU) does not cause any earlier SMUs or the package to which the SMU applies to be automatically deactivated.

---



---

**Note** If an interface on a router does not have a configuration and is brought up by performing no-shut operation, then upon router reload, the interface state changes to **admin-shutdown** automatically.

---

To downgrade a package, you activate an older version of the package. When the automatic compatibility checks have been passed, the older version is activated, and the newer version is deactivated.



---

**Caution** Do not perform any install operations when the router is reloading.

---



---

**Note** For more information on the features and components included in each package, refer to the release notes.

---

## Package Installation Envelopes

Package Installation Envelopes (PIEs) are nonbootable files that contain a single package or a set of packages (called a *composite package* or *bundle*). Because the files are nonbootable, they are used to add software package files to a running router.

PIE files have a `pie` extension. When a PIE file contains software for a specific bug fix, it is called a *software maintenance upgrade* (SMU).



**Note** Files with the `vm` extension are bootable installation files used only to replace all current Cisco IOS XR software. These files are installed from ROM Monitor mode, which causes significant router downtime. Cisco Systems recommends installing or upgrading software packages only using PIE files as described in this document. For more information on `vm` files, see *ROM Monitor Configuration Guide for Cisco ASR 9000 Routers*.

## Summary of Cisco IOS XR Software Packages

Every router includes a basic set of required packages contained in the Cisco IOS XR Unicast Routing Core Bundle. Additional optional packages can be added and activated on the router to provide specific features.

### Packages in the Cisco IOS XR Unicast Routing Core Bundle

The packages contained in the Cisco IOS XR Unicast Routing Core Bundle are as follows:

- Operating system (OS) and minimum boot image (MBI)—Kernel, file system, memory management, and other slow changing core components.
- Base—Interface manager, system database, checkpoint services, configuration management, other slow-changing components.
- Infra—Resource management: rack, fabric.
- Routing—RIB, BGP, ISIS, OSPF, EIGRP, RIP, RPL, and other routing protocols.
- Forwarding—FIB, ARP, QoS, ACL, and other components.
- LC— Line card drivers.

The filename for this bundle is: `asr9k-mini.pie-version`.

Refer to the release notes for additional information on the specific features provided by each package.

### Software Maintenance Upgrades

A software maintenance upgrade (SMU) is a PIE file that contains fixes for a specific defect. A composite SMU is a PIE file that contains SMUs for more than one package. SMUs are added and activated using the same procedures as other PIE files. SMUs are created to respond to immediate issues and do not include new features. Typically, SMUs do not have a large impact on router operations. SMU versions are synchronized to the package major, minor, and maintenance versions they upgrade.

The affect of an SMU depends on its type:

- Process Restart SMU—Causes a process or group of processes to restart on activation.
- Reload SMU—Causes a parallel reload (of RPs and line cards).

SMUs are not an alternative to maintenance releases. They provide quick resolution of immediate issues. All bugs fixed by SMUs are integrated into the maintenance releases. For information on available SMUs, contact Cisco Technical Support, as described in *Obtaining Technical Assistance* in the monthly [What's New in Cisco Product Documentation](#).



**Note** Activating a software maintenance upgrade (SMU) does not cause any earlier SMUs, or the package to which the SMU applies, to be automatically deactivated.

### Third-party SMUs

Consider these points while activating and deactivating third-party SMUs:

- To activate a third-party SMU you should have a corresponding base package.
- When you activate a third-party SMU, the corresponding third-party base package state is inactive, this is an expected behavior.
- To deactivate a third-party SMU, you should activate corresponding third-party base package.

### Related Topics

[Updating Software Images Without a Router Reload](#)

## PIE Filenames and Version Numbers

PIE filenames have two formats: one for composite-package PIEs (bundles) and one for single-package PIEs. A *composite-package file* is a PIE file that contains multiple packages.



**Note** Hyphens in the filename are part of the filename.

[Table 25: PIE Filenames, on page 130](#) shows the filenames for available PIE types.

**Table 25: PIE Filenames**

Software Delivery Type	Filename	Example
Composite (Bundle) PIE	<i>platform-composite_name.pie-major.minor.maintenance</i>	asr9k-mini.pie-3.7.2
Single package PIE	<i>platform-package_type-.p.pie-major.minor.maintenance</i>	asr9k-mps.pie-3.7.2
Composite SMU	<i>comp-platform-composite_name.ddts.pie</i>	comp-asr9k-001.CSCec98xxx.pie
Single package SMU	<i>platform-package_type-major.minor.maintenance.ddts.pie</i>	asr9k-base-3.7.2.CSCei45xxx.pie

**Note** A SMU composite name usually is “001”, which means the SMU is the first SMU for that DDTS. In rare cases in which the same DDTS requires multiple composite SMUs, a second composite version number is released as “002”. In the previous example, a second composite SMU “comp-002.CSCec98766” would be created for DDTS CSCec98766.

## Filename Component Description

The filename components for all packages are described in [Table 26: Composite- and Single-Package Filename Components, on page 131](#).

**Table 26: Composite- and Single-Package Filename Components**

Component	Description
<i>platform</i>	Identifies the platform for which the software package is designed. <ul style="list-style-type: none"> <li>• The platform designation is “asr9k.”</li> </ul>
<i>composite_name</i>	Identifies a specific composite package. <ul style="list-style-type: none"> <li>• The only composite PIE file at this time is named “mini” and includes all packages described in the Cisco IOS XR Unicast Routing Core Bundle.</li> </ul>
<i>package_type</i>	Identifies the type of package the file supports ( <i>package_type</i> applies only to single-package PIEs). Package types include: <ul style="list-style-type: none"> <li>• mcast—Multicast package</li> <li>• mgbl—Manageability package</li> <li>• mpls—MPLS package</li> <li>• k9sec—Security package</li> <li>• diags—Diagnostics package</li> <li>• fpd—Field-programmable device package</li> <li>• doc—Documentation package</li> </ul>
<i>major</i>	Identifies the major release of this package. <ul style="list-style-type: none"> <li>• A major release occurs when there is a major architectural change to the product (for example, a major new capability is introduced).</li> <li>• All packages operating on the router must be at the same major release level.</li> <li>• A major release is the least frequent release and may require a router reboot.</li> </ul>
<i>minor</i>	Identifies the minor release of this package. <ul style="list-style-type: none"> <li>• A minor release contains one or more of the following:               <ul style="list-style-type: none"> <li>• New features</li> <li>• Bug fixes</li> </ul> </li> <li>• The minor release version does not have to be identical for all software packages operating on the router, but the operating packages must be certified by Cisco as compatible with each other.</li> <li>• A minor release may require a router reboot.</li> </ul>

Component	Description
<i>maintenance</i>	Identifies the maintenance release of this package. <ul style="list-style-type: none"> <li>• A maintenance release contains a collection of bug fixes for a package.</li> <li>• The maintenance release version does not have to be identical for all software packages operating on the router, but the major and minor versions of the maintenance release must match those of the package being updated.</li> <li>• A maintenance release does not usually require a router reboot.</li> </ul>
<i>ddts</i>	SMUs only. Identifies a DDTS <sup>8</sup> number that describes the problem this SMU addresses. DDTS is the method used to track known bugs and the resolutions or workarounds for those issues.
<i>px</i>	Identifies images that are compatible with hardware that uses the x86 architecture. Starting with Cisco IOS XR Release 4.2, -px releases replace the -p releases.

<sup>8</sup> distributed defect tracking system

## Copying the PIE File to a Local Storage Device or Network Server

To add an optional package or upgrade or downgrade a package, you must copy the appropriate PIE file to a local storage device or to a network file server to which the router has access.

If you need to store PIE files on the router, we recommended storing PIE files on the hard disk. Flash disk0: serves as the boot device for packages that have been added or activated on the system. Flash disk1: is used as a backup for disk0:.



**Tip** Before copying PIE files to a local storage device, use the **dir** command to check to see if the required PIE files are already on the device.

# Information About Package Management

## Summary of Package Management

The general procedure for adding optional packages, upgrading a package or package set, or downgrading packages on the router is as follows:

1. Copy the package file or files to a local storage device or file server.
2. Add the package or packages on the router using the command **install add**.
3. Activate the package or packages on the router using the **install activate** command.
4. Commit the current set of packages using the **install commit** command.

Figure 8: Process to Add, Activate, and Commit Cisco IOS XR Software Packages, on page 133 illustrates key steps in the package management process.



Figure 8: Process to Add, Activate, and Commit Cisco IOS XR Software Packages

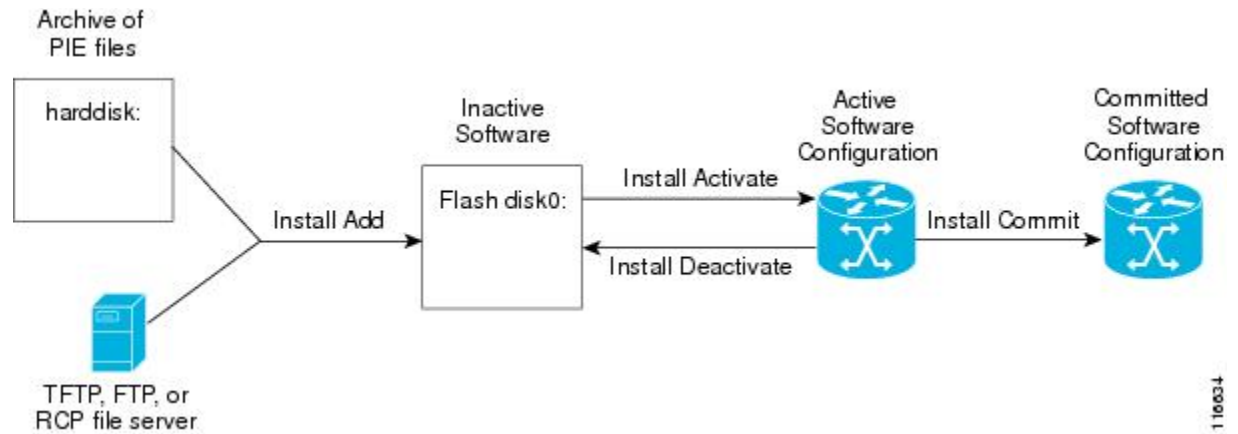

## Adding Packages

Use the **install add** command to unpack the package software files from a PIE file and copy them to the boot device (usually disk0:) of your router.

From administration EXEC mode, the package software files are added to the boot device of the DSC of the router, as well as all active and standby Route Processors (RPs) and fabric shelf controllers (SCs) installed on the router.



**Note** The disk that holds the unpacked software files is also known as the *boot device*. By default, flash disk0: is used as the boot device. To use an alternate storage device, such as flash disk1:, see the *Router Recovery with ROM Monitor* module of *ROM Monitor Configuration Guide for Cisco ASR 9000 Routers*. Remember that all RSPs in a system must use the same boot device. If the boot device on the primary RSP is flash disk0:, then the standby RSP must also have a flash disk0:.

## Verifying Package Details

Before you activate a package on the router, you can verify the type of upgrade that is required for the package and whether the package requires a router reload or not. Use the **show install package pie detail** command in admin mode.

```

RP/0/RSP0/CPU0:router(admin)# show install package disk0:asr9k-px-4.x.x.04I.CSCuc66088-0.0.4.i
detail

Mon Nov 19 09:44:24.036 UTC
disk0:asr9k-px-4.x.x.04I.CSCuc66088-0.0.4.i
  asr9k-px-4.x.x.04I.CSCuc66088 V0.0.4.i[SMU]  User specified bundle
    iosxr-infra-asr9k-px1-4.x.x.04I.CSCuc66088.pi.pie.
    [composite package]
    [root package, grouped contents]
  Vendor : Cisco Systems
  Desc   : User specified bundle iosxr-infra-asr9k-px1-4.x.x.04I.CSCuc66088.pi.pie.
  Build  : Built on Fri Nov  9 11:00:11 UTC 2012
  Source : By iox-bld27 in /scratch1/SMU_BLD_WS/ci-431_206626_CSCuc66088_121109102249 for
  pie
  Card(s): RP, CRS-RP-X86, CRS8-RP-x86, CRS16-RP-x86, ASR9001-RP, RP-STARSCREAM,
  
```

```

NP24-4x10GE,
    NP24-40x1GE, NP40-40x1GE, NP40-4x10GE, NP40-8x10GE, NP40-2_20_COMBO, NP80-8x10GE,
        NP80-16x10GE, NP200-24x10GE, NP200-36x10GE, NP200-2x100GE, NP200-1x100GE,
NP200-5x40GE,
    NP200-8x10GE, NP200-MOD-SMEM, NP200-MOD-LMEM, ASR9001-LC, A9K-SIP-700,
A9K-SIP-500, A9K-SIP-AVSM
  Restart information:
    Default:
      parallel impacted processes restart
    Size Compressed/Uncompressed: 1744KB/1830KB (95%)
    Components in package disk0:asr9k-px-4.x.x.04I.CSCuc66088-0.0.4.i, package
asr9k-px-4.x.x.04I.CSCuc66088:
  disk0:iosxr-infra-4.x.x.04I.CSCuc66088-0.0.4.i
    iosxr-infra-4.x.x.04I.CSCuc66088 V0.0.4.i[SMU]  IOS-XR Infra Package Definition
    Vendor : Cisco Systems
    Desc  : IOS-XR Infra Package Definition
    Build : Built on Fri Nov 9 11:00:10 UTC 2012
    Source : By iox-bld27 in /scratch1/SMU_BLD_WS/ci-431_206626_CSCuc66088_121109102249
  for pie
    Card(s): RP, CRS-RP-X86, CRS8-RP-x86, CRS16-RP-x86, ASR9001-RP, RP-STARSCREAM,
NP24-4x10GE,
    NP24-40x1GE, NP40-40x1GE, NP40-4x10GE, NP40-8x10GE, NP40-2_20_COMBO,
NP80-8x10GE,
    NP80-16x10GE, NP200-24x10GE, NP200-36x10GE, NP200-2x100GE, NP200-1x100GE,
        NP200-5x40GE, NP200-8x10GE, NP200-MOD-SMEM, NP200-MOD-LMEM, ASR9001-LC,
        A9K-SIP-700, A9K-SIP-500, A9K-SIP-AVSM

    Size Compressed/Uncompressed: 1744KB/1830KB (95%)
    Components in package disk0:iosxr-infra-4.x.x.04I.CSCuc66088-0.0.4.i,
    package iosxr-infra-4.x.x.04I.CSCuc66088:
    platforms-spa-chopper V[ci-4x-bugfix/8] This component contains Platform
Independent
  Chopper SPA Code.
  iosxr-infra-4.x.x.04I.CSCuc66088-package V[Default] Manifest information for
package
  iosxr-infra-4.x.x.04I.CSCuc66088
  iosxr-infra-4.x.x.04I.CSCuc66088-package-compatibility V[Default]
  Package Compatibility information for package iosxr-infra-4.x.x.04I.CSCuc66088

```

## Activating Packages

Software packages remain inactive until activated with the **install activate** command.

After a package has been added to the router, use the **install activate** command to activate the package or SMUs for all valid cards. Information within the package is used to verify compatibility with the target cards and with the other active software. Actual activation is performed only after the package compatibility and application programming interface (API) compatibility checks have been passed.

### Activating a Package on the Router

To activate a package on your router, use the **install activate** command in administration EXEC mode. The **install activate** command also activates the package on all administration plane nodes and resources, including service processors (SPs), fabric SCs, fan controllers, alarm modules, and power modules.

## Activating Multiple Packages or SMUs

To install multiple packages or software maintenance upgrades (SMUs) with a single command, use the **install activate** command and either specify up to 16 packages by repeating *device: package* arguments or

use wildcard syntax to specify multiple packages. Some SMUs may require a reload. If the operation requires a node reload, the user is prompted before the installation operation occurs.



---

**Note** After activating SMU CSCwc03813, ensure that you either reload the Line Card or remove and reapply the existing Access Control Lists, for the updates to take effect.

---

#### Related Topics

[SMU Installation Combinations](#)

## Activating All Packages Added in a Specific Operation

To install all packages that were added in a specific **install add** operation, use the **install activate** command with the **id add-id** keyword and argument, specifying the operation ID of the **install add** operation. You can specify up to 16 operations in a single command.

## Adding and Activating a Package with a Single Command

To add and activate a package with a single command, use the **install add** command with the **activate** keyword from administration EXEC mode.

## Digitally Signed Images

From Release 6.0.1 onwards, all Cisco IOS XR images are digitally signed to ensure the authenticity of the software. If the ROMMON/BIOS image on the line card is digitally signed, then ensure that the Cisco IOS XR image on the router is also digitally signed, as the ROMMON/BIOS checks the Cisco IOS XR image for a digital signature.



---

**Note** The Cisco IOS XR Release 5.3.x images are not digitally signed. If you are running Cisco IOS XR Release 5.3.x, then ensure that you install the Abraxas based SMU for successful operation of the router with the latest line cards.

---

The digitally signed images are supported on the following line cards:

- A99-RP2-TR
- A99-RP2-SE
- A9K-RSP880-TR
- A9K-RSP880-SE
- A9K-8X100GE-SE
- A9K-8X100GE-TR
- A9K-4X100GE-SE
- A9K-4X100GE-TR
- A99-8X100GE-SE
- A99-8X100GE-TR

- A9K-MOD400-SE
- A9K-MOD400-TR
- A9K-MOD200-SE
- A9K-MOD200-TR
- A9K-400G-DWDM-TR
- A99-12X100GE

For more information on installing line cards, see *Cisco ASR 9000 Series Aggregation Services Routers Ethernet Line Card Installation Guide*.

## Validation Messages

When image credentials, signature, and other attributes of the signature envelope are matched, the router reboots.

The following message is displayed on successful image validation.

```
File reception completed.**** check image validation ****.....BIOS CODE SIGN ENTRY ...Image
ASR9K-Tomahawk verified successfully~~~~~
```

If image validation is unsuccessful, the boot process is interrupted, and the router enters the ROMMON CLI mode.

The following message is displayed on unsuccessful image validation.

```
**** check image validation ****.....BIOS CODE SIGN ENTRY ... Image ASR9K-Tomahawk
Verification Failed Invalid signature offset ***** ASR9K
image validation failed, cannot boot image, contact tech support
*****
```

## Upgrading and Downgrading Packages

To upgrade a package, activate the latest version of the package; the previous version is automatically deactivated. To downgrade a package, activate the previous version of the package; the latest version is automatically deactivated.

Actual activation is performed only after compatibility checks have been passed.



### Note

- Activating a software maintenance upgrade (SMU) does not cause previous versions of the SMUs, or the package to which the SMU applies, to be automatically deactivated.
- If you upgrade an ASR 9000 router with low RSP card memory, then the RSP440-TR route-switch processor and Cisco ASR 9000 2nd Generation line card can become inaccessible due to insufficient memory. Power cycling the router may help bring the router back to the up state.

## Committing the Active Software Set

When a package is activated on the router, it becomes part of the current running configuration. To make the package activation persistent across reloads, enter the **install commit** command in administration EXEC mode. On startup, the designated shelf controller (DSC) of the secure domain router (SDR) loads the committed software set.



**Note** If the system is restarted before the active software set is saved with the **install commit** command, the previously committed software set is used.

## Rolling Back to a Previous Installation Operation

Although the term *commit* sounds final, the Cisco IOS XR software provides the flexibility to roll back the selected package set to previously saved package sets. Each time a package is activated or deactivated, a rollback point is created that defines the package set that is active after the package activation or deactivation. The software also creates a rollback point for the last committed package set. If you find that you prefer a previous package set over the currently active package set, you can use the **install rollback** command to make a previously active package set active again.

### Related Topics

[Rolling Back to a Previous Software Set](#), on page 180

## Multiple Disks Support during Installations

In installations on platforms where Cisco IOS XR Software is supported, only a single disk is used as an install device; that is, either disk0 or disk1. When multiple packages are installed on a single disk, it results in space constraints. To resolve this space limitation, the disk supported for the install operations has been extended to another disk called the disk1. When installing multiple packages, this feature enables you to choose between disk0 and disk1.

To add packages to a specific disk name, use the **install media** command in the admin configuration mode.

```
RP/0/RSP0/CPU0: router (admin) # install media disk1
```

## Restrictions

- Before enabling the addition of disk1 through the **install media** command, the disk mirroring feature should be explicitly disabled. For details regarding disk mirroring, see the Disk Mirroring chapter.
- All single version packages should be installed into one disk; that is, either disk0 or disk1.
- When downgrading to an image that does not support extended disk, the rollback points of the extended disk will not be available on the downgraded image. For example, assume a case where the version1 (V1) image does not support the extended disk functionality and version2 (V2) image supports the functionality. Upgrading from V1(disk0) to V2(disk1), in such a case, makes the rollback points of V1 available on V2. However, when downgrading from V2(disk1) to V1(disk0), the rollback points of V2 will not be available on V1. For more information about the rollback feature and rollback points, see the Upgrading and Managing Software chapter.

## Deactivation of fully superseded SMUs

Cisco IOS XR Software will accumulate a set of Software Maintenance Upgrades (SMUs) over time, where an older SMU gets superseded by the latest SMU. For example, if SMU A was initially delivered to you, and subsequently, as a result of a bug resolution, SMU B was delivered, then SMU A becomes the subset of SMU B and SMU A is superseded by SMU B. In this case, SMU A is redundant and can be deactivated to clean up the software package.



---

**Note** When an older SMU gets superseded their code is no longer used but it can be used for rollback purposes which consumes the disk space.

---

When you install a reload SMU which supersedes the existing SMU the router reboots and SMU is placed in the superseded list automatically. If the superseded reload SMU is deactivated and fully supersedes the existing SMU, then router will not reboot when you run the **install deactivate superseded** command and the **install remove inactive** command.



---

**Note** Removing the superseded SMUs will increase the disk space and it will not affect the functionality.

---

To deactivate all the fully superseded SMUs, use the **install deactivate superseded** command in the admin mode.

```
RP/0/RSP0/CPU0: router(admin) # install deactivate superseded
```

To display the details of the SMUs that are superseded, use the **show install superseded** command in the EXEC mode.

```
RP/0/RSP0/CPU0: router # show install superseded
Thu Feb 3 17:37:20.379 UTC
disk0:asr9k-px-4.3.0.CSCud93518-1.0.0 is fully superseded by
disk0:asr9k-px-4.3.0.CSCue23747-1.0.0
```

## Support for the Ignore Package Presence Check Option

During any software package upgrade in Cisco IOS XR Software, two versions of the packages get stored, both the previous version and the upgraded version. In Route Switch Processor 2 (RSP2), the disk space is insufficient to hold all packages of these two versions. To address this, a new optional keyword, **ignore-pkg-presence-check**, is added to the **install activate** command, which allows upgrading with lesser number of packages. For example, assume a case where version1 (V1) of the software consists of packages A, B, C, and D, and you want to upgrade to the version2 (V2) with only 3 packages (A, B, and C). The **ignore-pkg-presence-check** option allows only packages A, B, and C to be upgraded to V2 and deactivates package D of V1. Thus, an explicit deactivation of package D is not required and the user can add package D of V1 after upgrading to V2.

To upgrade software with lesser number of packages, use the **install activate [ignore-pkg-presence-check]** command in the admin mode.

```
RP/0/RSP0/CPU0: router(admin) # install activate [ignore-pkg-presence-check] V2 packages
```

### Restrictions

The restrictions for this option are:

- The **ignore-pkg-presence-check** keyword is supported only with the **install activate** command and is not supported with the **install add activate** command.
- When you upgrade using the **ignore-pkg-presence-check** option, the deactivation of packages always happens synchronously, using the **synchronous** keyword in the **install deactivate** command.

## Upgrading Packages

To upgrade a package that is currently active on your router, add and activate a newer version of the same package (see [Figure 9: Example of a Maintenance Release Package Upgrade, on page 139](#)). The older version of the software package is deactivated automatically. These actions are permitted only after the package compatibility checks and API version compatibility checks have been passed.

Deactivated packages are not removed from the router. To remove inactive package files, use the **install remove** command.



**Caution** Upgrading or downgrading a software package can cause a process to restart or a new process to start. Use the **test** option to preview the impact of the package activation.

**Figure 9: Example of a Maintenance Release Package Upgrade**

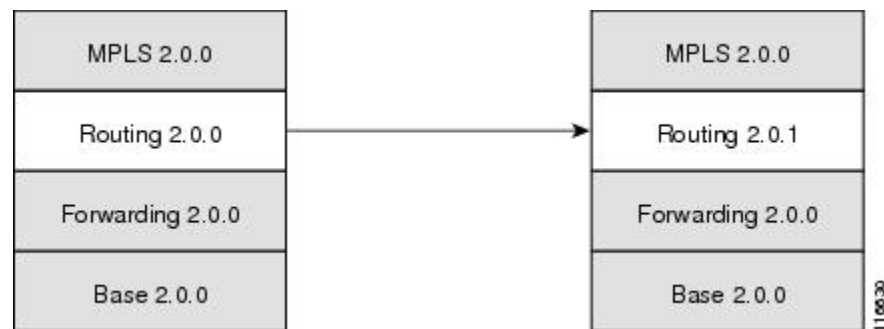

### Related Topics

[Deactivating and Removing Cisco IOS XR Software Packages, on page 175](#)

## Downgrading Packages

To downgrade a software package, activate an older version on one or more cards for which that package is already active. The newer version of the same software package is deactivated automatically. These actions are performed only after the package compatibility checks and API version compatibility checks have been passed.

Deactivated packages are not removed from the router. To remove inactive package files, use the **install remove** command. See the *Related Topics* section for links to more information.



**Note** If type 8,9, or 10 is the secret key configured, then before downgrading to 6.6.3 and earlier versions, perform either of the following methods:

- Type a combination of secret type and encrypted key instead of plain text for the password. Example:

```
username root
group root-lr
group cisco-support
secret 10
$6$Mwaqg/jdBPOn4g/. $PrJP2KjsCbL6bZqmY0ej5Ay67S/sSWJNlkiYhCTc/B/35E1kJBqffmBtn.ddQEHO02CU7V.ZEMmqIq7ue8cfz0
```

This is because 6.6.3 and earlier versions do not support type 8,9, or 10 key type.

- Ensure that there are secret type 5 users on the system.

#### Related Topics

[Deactivating and Removing Cisco IOS XR Software Packages](#), on page 175

## Impact of Package Version Changes

Each package version change has a different impact on the operation of the router, depending on the type of package and whether the upgrade is for a major, minor, or maintenance release. The following resources can provide more information on the impact of a package version change:

- See *Related Topics* for more information on the typical impact for major, minor, and maintenance releases.
- For specific information about the impact of an upgrade, consult the release notes for the package release, and test the impact of the package activation by adding the test option to the **install activate** command.
- The Cisco IOS XR Software Selector tool also contains information on package version compatibility.

#### Related Topics

[PIE Filenames and Version Numbers](#), on page 130

[Obtaining and Placing Cisco IOS XR Software](#), on page 145

## Impact of Package Activation and Deactivation

Activation or deactivation of a package can have an immediate impact on the system. The system can be affected in the following ways:

- When a new package is activated, any new CLI commands for the package are added to the router. The router need not be restarted or reloaded.
- When a package is deactivated, the commands associated with the features being deactivated are removed from the router. The commands are no longer available to the user.
- During a software package deactivation, upgrade, or downgrade, any incompatible configurations are removed from the running configuration of the router, and saved to a file. Messages for incompatible configurations are displayed. Incompatible configurations are those configurations that are not supported by the new version of the software package.



**Note** You must address any issues that result from the revised configuration and reapply the configuration, if necessary.



- New processes may be started.
- Running processes may be stopped or restarted.
- All processes in the cards may be restarted. Restarting processes in the cards is equivalent to a soft reset.
- The cards may reload.
- No impact: no processes in the card may be affected.



---

**Tip** When activating and deactivating packages, use the **test** option to test the effects of a command without impacting the running system. After the activation or deactivation process completes, enter the **show install log** command to display the process results.

---

## Delaying the Return of the CLI Prompt

By default, the CLI prompt is returned to the screen before the installation operation is complete, which allows you to enter other commands that are not installation commands. If additional installation requests are attempted before the first operation is complete, they are not run.

To delay the return of the CLI prompt until an installation operation is complete, enter the **install** command with the **synchronous** keyword. For example:

```
install add disk1:/pie-file synchronous
install activate disk0:package synchronous
```

To determine if an **install** command is currently running, enter the **show install request** command.

## Displaying Installation Log Information

The install log provides information on the history of the installation operations. Each time an installation operation is run, a number is assigned to that operation.

- Use the **show install log** command to display information about both successful and failed installation operations.
- The **show install log** command with no arguments displays a summary of all installation operations. Specify the *request-id* argument to display information specific to an operation. Use the **detail** or **verbose** keywords to display details for specific operation.
- Use the **detail** or **verbose** keywords to display detailed information, including file changes, nodes that could be reloaded, impact to processes, and impact to Dynamic Link Libraries (DLLs).



---

**Tip** By default, the install log stores up to 50 entries. Use the **clear install log-history** command to reset the number of entries to any value from 0 to 255.

---

## Examples

### Displaying install log Entries: Example

The following example displays information for the install requests. Use the **verbose** keyword to display detailed information, including files changes, impact to processes, and impact to DLLs.

```
RP/0/RSP0/CPU0:router(admin)# show install log verbose
```

```
Install operation 1 started by user 'labuser' at 17:48:51 UTC Sat Jun 03 2009.
install add /disk1:asr9k-diags-p.pie-PD34-06.06.07
/disk1:asr9k-k9sec-p.pie-PD34-06.06.07 /disk1:asr9k-mcast-p.pie-PD34-06.06.07
/disk1:asr9k-mgbl-p.pie-PD34-06.06.07 /disk1:asr9k-mpls-p.pie-PD34-06.06.07
Install operation 1 completed successfully at 17:51:32 UTC Sat Jun 03 2009.
```

```
Install logs:
```

```
Install operation 1 'install add /disk1:asr9k-diags-p.pie-PD34-06.06.07
/disk1:asr9k-k9sec-p.pie-PD34-06.06.07 /disk1:asr9k-mcast-p.pie-PD34-06.06.07
/disk1:asr9k-mgbl-p.pie-PD34-06.06.07 /disk1:asr9k-mpls-p.pie-PD34-06.06.07'
started by user 'labuser' at 17:48:51 UTC Sat Jun 03 2009.
```

```
Info: The following packages are now available to be activated:
```

```
Info:
Info:      disk0:asr9k-diags-3.7.2.1I
Info:      disk0:asr9k-k9sec-3.7.2.1I
Info:      disk0:asr9k-mcast-3.7.2.1I
Info:      disk0:asr9k-mgbl-3.7.2.1I
Info:      disk0:asr9k-mpls-3.7.2.1I
Info:
```

```
Install operation 1 completed successfully at 17:51:32 UTC Sat Jun 03 2009.
```

```
Install operation 2 started by user 'labuser' at 18:06:32 UTC Sat Jun 03 2009.
```

```
install activate disk0:asr9k-diags-3.7.2.1I disk0:asr9k-k9sec-3.7.2.1I
disk0:asr9k-mcast-3.7.2.1I disk0:asr9k-mgbl-3.7.2.1I disk0:asr9k-mpls-3.7.2.1I
```

```
Install operation 2 completed successfully at 18:07:48 UTC Sat Jun 03 2009.
```

```
Summary:
```

```
Install method: parallel
```

```
Summary of changes on nodes 0/1/SP, 0/6/SP, 0/SM0/SP, 0/SM1/SP,
0/SM2/SP,0/SM3/SP:
```

```
Activated:      asr9k-diags-3.7.2.1I
No processes affected
```

```
Summary of changes on nodes 0/1/CPU0, 0/6/CPU0:
```

```
Activated:      asr9k-diags-3.7.2.1I
                 asr9k-mcast-3.7.2.1I
                 asr9k-mpls-3.7.2.1I
```

```
1 asr9k-mpls processes affected (0 updated, 1 added, 0 removed, 0 impacted)
2 asr9k-mcast processes affected (0 updated, 2 added, 0 removed, 0 impacted)
```

```
Summary of changes on nodes 0/RP0/CPU0, 0/RP1/CPU0:
```

```
Activated:      asr9k-diags-3.7.2.1I
                 asr9k-k9sec-3.7.2.1I
                 asr9k-mcast-3.7.2.1I
                 asr9k-mgbl-3.7.2.1I
                 asr9k-mpls-3.7.2.1I
```

```
6 asr9k-mgbl processes affected (0 updated, 6 added, 0 removed, 0 impacted)
8 asr9k-mpls processes affected (0 updated, 8 added, 0 removed, 0 impacted)
7 asr9k-k9sec processes affected (0 updated, 7 added, 0 removed, 0 impacted)
14 asr9k-mcast processes affected (0 updated, 14 added, 0 removed, 0 impacted)
```

```
Install logs:
```

```
Install operation 2 'install activate disk0:asr9k-diags-3.7.2.1I
disk0:asr9k-k9sec-3.7.2.1I disk0:asr9k-mcast-3.7.2.1I disk0:asr9k-mgbl-3.7.2.1I
disk0:asr9k-mpls-3.7.2.1I' started by user 'labuser' at
18:06:32 UTC Sat Jun 03 2009.
```

```
Info: The changes made to software configurations will not be
Info: persistent across system reloads. Use the command 'admin install
Info: commit' to make changes persistent.
Info: Please verify that the system is consistent following the
Info: software change using the following commands:
Info:      show system verify
```

```
--More--
```

The following example displays information for a specific install request. Use the **detail** keyword to display additional information, including impact to processes and nodes impacted.

```
RP/0/RSP0/CPU0:router(admin)# show install log 2 detail

Install operation 2 started by user 'labuser' at 18:06:32 UTC Sat Jun 03 2009.
install activate disk0:asr9k-diags-3.7.2.1I disk0:asr9k-k9sec-3.7.2.1I
disk0:asr9k-mcast-3.7.2.1I disk0:asr9k-mgbl-3.7.2.1I disk0:asr9k-mpls-3.7.2.1I
Install operation 2 completed successfully at 18:07:48 UTC Sat Jun 03 2006.

Summary:
  Install method: parallel
  Summary of changes on nodes 0/1/SP, 0/6/SP, 0/SM0/SP, 0/SM1/SP,
  0/SM2/SP, 0/SM3/SP:
    Activated:   asr9k-diags-3.7.2.1I
    No processes affected

  Summary of changes on nodes 0/1/CPU0, 0/6/CPU0:
    Activated:   asr9k-diags-3.7.2.1I
                 asr9k-mcast-3.7.2.1I
                 asr9k-mpls-3.7.2.1I
    1 asr9k-mpls processes affected (0 updated, 1 added, 0 removed, 0 impacted)
    2 asr9k-mcast processes affected (0 updated, 2 added, 0 removed, 0 impacted)

  Summary of changes on nodes 0/RP0/CPU0, 0/RP1/CPU0:
    Activated:   asr9k-diags-3.7.2.1I
                 asr9k-k9sec-3.7.2.1I
                 asr9k-mcast-3.7.2.1I
                 asr9k-mgbl-3.7.2.1I
                 asr9k-mpls-3.7.2.1I
    6 asr9k-mgbl processes affected (0 updated, 6 added, 0 removed, 0 impacted)
    8 asr9k-mpls processes affected (0 updated, 8 added, 0 removed, 0 impacted)
    7 asr9k-k9sec processes affected (0 updated, 7 added, 0 removed, 0 impacted)
    14 asr9k-mcast processes affected (0 updated, 14 added, 0 removed, 0 impacted)

Install logs:
  Install operation 2 'install activate disk0:asr9k-diags-3.7.2.1I
  disk0:asr9k-k9sec-3.7.2.1I disk0:asr9k-mcast-3.7.2.1I disk0:asr9k-mgbl-3.7.2.1I
  disk0:asr9k-mpls-3.7.2.1I' started by user 'labuser' at 18:06:32 UTC
  Sat Jun 03 2006.
  Info:      The changes made to software configurations will not be
  Info:      persistent across system reloads. Use the command 'admin install
  Info:      commit' to make changes persistent.
  Info:      Please verify that the system is consistent following the
  Info:      software change using the following commands:
  Info:      show system verify
  Info:      install verify packages
  Install operation 2 completed successfully at 18:07:48 UTC Sat Jun 03 2006.
```

## Package Management Procedures



---

**Note** Review the concepts about package management before performing the tasks described in this module.

---

**Related Topics**

[Information About Package Management](#), on page 132

**Activation and Deactivation Prerequisites**

These prerequisites must be met for a package to be activated or deactivated:

- You must be in a user group associated with a task group that includes the proper task IDs. The command reference guides include the task IDs required for each command. If you suspect user group assignment is preventing you from using a command, contact your AAA administrator for assistance.
- Verify that all cards are installed and operating properly. For example, do not activate or deactivate packages while cards are booting, while cards are being upgraded or replaced, or when you anticipate an automatic switchover activity.
- If a ROM Monitor upgrade is required for the software package, the upgrade must be completed before the package is activated. For ROM Monitor upgrade information and procedures, see *ROM Monitor Configuration Guide for Cisco ASR 9000 Routers*.
- Check the sanity of the configuration file system and recover from any internal inconsistencies by using the **cfs check** command.

```
RP/0/RSP0/CPU0:router# cfs check
```

```
Tue Sep 20 07:22:03.374 DST
```

```
Creating any missing directories in Configuration File system...OK
Initializing Configuration Version Manager...OK
Syncing commit database with running configuration...OK
```

- Clear any inconsistency alarms and remove any failed configurations using the **clear configuration inconsistency** command.

An inconsistency alarm is set when there is a failure to restore the configuration; this can occur during router startup, or when a line card or route switch processor (RSP) card is inserted or removed. If an inconsistency alarm is set, a message similar to the one in this example is displayed:

```
RP/0/0/CPU0:May 26 11:58:40.662 : cfgmgr-rp[130]: %MGBL-CONFIGCLI-3
  BATCH_CONFIG_FAIL : 28 config(s) failed during startup. To view
  failed config(s) use the command - "show configuration failed startup"
```

When the inconsistency alarm is set, all configuration commit operations fail until the alarm is cleared.

- Although more than one version of a software package can be added to a storage device, only one version of a package can be active for any card.
- Some packages require the activation or deactivation of other packages.
- The package being activated must be compatible with the current active software set.

Activation is performed only after the package compatibility checks and API version compatibility checks have been passed. If a conflict is found, an on-screen error message is displayed.

While a software package is being activated, other requests are not allowed to run on any of the impacted nodes. Package activation is completed when a message similar to this one appears:

```
Install operation 2 completed successfully at 20:30:29 UTC Mon Nov 14 2005.
```

Each CLI install request is assigned a request ID, which can be used later to review the events.

## Obtaining and Placing Cisco IOS XR Software

This section contains information to locate the available software packages and to transfer them either to a local storage device or to a network server. When this is done, the package or packages can be added and activated on the router .

There are two primary ways to obtain packages in Cisco IOS XR software:

- Request the software from Cisco on a flash disk that you can insert into the removable flash disk slot (usually flash disk1:). Flash disk1: is optional. When it is installed, flash disk1: can be used to store PIE files, which can then be used to add new software to the boot device (usually flash disk0:).
- Download the Cisco IOS XR software packages to a local storage device of the DSC, such as flash disk1:, or to a remote server, such as a tftp or rcp server.

The boot device is the local disk on the DSC where Cisco IOS XR software is added and activated. PIE files should not be stored on this boot device. The default boot device is disk0:. All PIE files should be stored on flash disk1:.

### Transferring Installation Files from a Network File Server to a Local Storage Device

If the Cisco IOS XR software PIE files are located on a remote TFTP, FTP, SFTP, or rcp server, you can copy the files to a local storage device such as disk1:. When the PIE files are located on a local storage device, the software packages can be added and activated on the router from that storage device. [Table 27: Download Protocols Supported by Cisco IOS XR Software, on page 145](#) describes the supported server protocols, and the CLI syntax used copy files from each server type to the local storage device.



**Tip** Cisco IOS XR software PIE files can also be added to the router boot device directly from the remote server.



**Note** Consult your system administrator for the location and availability of your network server.

**Table 27: Download Protocols Supported by Cisco IOS XR Software**

Name	Description
Trivial File Transfer Protocol	TFTP allows files to be transferred from one computer to another over a network, usually without the use of client authentication (for example, username and password). It is a simplified version of FTP.  <b>Note</b> Some Cisco IOS XR software images may be larger than 32 MB, and the TFTP services provided by some vendors may not support a file this large. If you do not have access to a TFTP server that supports files larger than 32 MB, download the software image using FTP or rcp.
File Transfer Protocol	FTP is part of the TCP/IP protocol stack and requires a username and password.
Remote Copy Protocol	The rcp protocol uses TCP to ensure the reliable delivery of data, and rcp downloads require a usernames.

Name	Description
SSH File Transfer Protocol	SFTP is part of the SSHv2 feature in the Security package and provides for secure file transfers. For more information, see the <i>System Security Configuration Guide for Cisco ASR 9000 Series Routers</i> .

The router commands listed in [Table 28: Commands for Copying Package Files to the Router, on page 146](#) show how to copy package files to the router using three types of file transfer protocols.

**Table 28: Commands for Copying Package Files to the Router**

Server Type	Command and Examples
TFTP	The following command syntax is used: <b>copy tftp:// hostname_or_ipaddress / directory-path / pie-name disk1:</b> Example: <pre>RP/0/RSP0/CPU0:router# copy tftp://10.1.1.1/images/comp- asr9k-mini.pie disk1:</pre>
FTP	The following command syntax is used: <b>copy ftp:// username : password @ hostname_or_ipaddress / directory-path / pie-name disk1:</b> Example: <pre>RP/0/RSP0/CPU0:router# copy ftp://john:secret@10.1.1.1/images/ comp-asr9k-mini.pie disk1:</pre>
rcp	The following command syntax is used: <b>copy rcp:// username @ hostname_or_ipaddress / directory-path / pie-name disk1:</b> Example: <pre>RP/0/RSP0/CPU0:router# copy rcp://john@10.1.1.1/images/ comp-asr9k-mini.pie disk1:</pre>

[Table 29: Command Variables for Copying and Adding Packages from a Network Server, on page 146](#) describes the command variables for copying packages from a network server.

**Table 29: Command Variables for Copying and Adding Packages from a Network Server**

Variable	Description
<i>hostname_or_ipaddress</i>	Host name or IP address of the server that stores the source file.
<i>pie-name</i>	Name of the PIE file (package). See the <a href="#">Overview of Cisco IOS XR Software Packages, on page 128</a> for descriptions of the available packages.
<i>username</i>	Required for FTP and rcp only and must be a valid username on the FTP or rcp server.

Variable	Description
<i>password</i>	Required for FTP only. If a password is not provided, the networking device accepts anonymous FTP.
<i>directory-path</i>	The specified directory should be a directory under the home directory of the user. In the rcp and FTP examples in <a href="#">Table 28: Commands for Copying Package Files to the Router, on page 146</a> , the file being downloaded is in a subdirectory called “images” in the home directory of the user “john.”  <b>Note</b> For FTP and rcp services, <i>directory-path</i> is the directory relative to the <i>username</i> home directory. If you want to specify an absolute path for the directory, you must add a "/" following the server address.

When the installation files have been transferred to a network file server or the router, you are ready to activate or upgrade the software.



**Note** Files with the *vm* extension are bootable installation files used only to replace all current Cisco IOS XR software. These files are installed from ROM monitor mode and cause significant router downtime. We recommend installing or upgrading software packages using PIE files only, as described in this chapter. See *ROM Monitor Configuration Guide for Cisco ASR 9000 Routers* for information on installing from *vm* files.

#### Related Topics

[Adding and Activating Packages](#), on page 158

[Overview of Cisco IOS XR Software Packages](#), on page 128

## Preparing for Software Installation Operations

This section includes instructions to prepare for software installation operations.



**Note** Activation is performed only after the automatic package compatibility and API version compatibility checks have been passed. If a conflict is found, an on-screen error message is displayed.

#### Before you begin

Before adding or activating Cisco IOS XR software:

- Update the ROM Monitor software, if necessary.
- Determine if a software change is required.
- Verify that the new package is supported on your system. Some software packages require that other packages or package versions be activated, and some packages only support specific cards.
- Review the release notes for important information related to that release and to help determine the package compatibility with your router configuration.
- Verify that the system is stable and prepared for the software changes.

## SUMMARY STEPS

1. **admin**
2. **show diag**
3. Update the ROMMON software if necessary.
4. **show install active**
5. **show install pie-info** *device:package* [ **brief** | **detail** | **verbose** ]
6. **verify packages**
7. **exit**
8. (Optional) **show system verify start**
9. (Optional) **show system verify** [ **detail** | **report** ]
10. **show clock**

## DETAILED STEPS

	Command or Action	Purpose
<b>Step 1</b>	<b>admin</b> <b>Example:</b>  RP/0/RSP0/CPU0:router# admin	Enters administration EXEC mode.
<b>Step 2</b>	<b>show diag</b> <b>Example:</b>  RP/0/RSP0/CPU0:router(admin)# show diag	Displays the ROMMON software version for all cards in the system. Verify that the correct ROMMON software version is installed before upgrading a Cisco IOS XR software package.  <b>Note</b> See <i>Related Topics</i> for information regarding the required ROM Monitor (ROMMON) software version.
<b>Step 3</b>	Update the ROMMON software if necessary.	Updates the ROMMON software. For instructions, see <i>ROM Monitor Configuration Guide for Cisco ASR 9000 Routers</i> .
<b>Step 4</b>	<b>show install active</b> <b>Example:</b>  RP/0/RSP0/CPU0:router(admin)# show install active	Displays the active software on the router for the owner SDR. Use this command to determine what software should be added, upgraded or downgraded on the router, and to compare to the active software report after installation operations are complete.  <b>Note</b> You can also display the active packages for a specific node, and view results in detailed or summary mode. See the <i>Software Package Management Commands on the Cisco ASR 9000 Series Router</i> module of <i>System Management Command Reference for Cisco ASR 9000 Series Routers</i> for more information.
<b>Step 5</b>	<b>show install pie-info</b> <i>device:package</i> [ <b>brief</b>   <b>detail</b>   <b>verbose</b> ]	Displays information imbedded in the package. The following keywords provide three levels of information:



	Command or Action	Purpose
	<p><b>Example:</b></p> <pre>RP/0/RSP0/CPU0:router(admin)# show install pie-info disk1:/asr9k-mcast-p.pie-3.8.30</pre>	<ul style="list-style-type: none"> <li>• <b>brief</b> (default)—Displays the expiration date of the file, the size, and the installed package name. The expiration date is used for certifying the package.</li> <li>• <b>detail</b>—Displays the package components, the compatible cards, the expiration date, file size, and the installed package name.</li> <li>• <b>verbose</b>—Displays information from the <b>detail</b> display and sub-component information.</li> </ul> <p><b>Note</b> Always review the release notes for the software package for important information related to that release and to help determine the package compatibility with your router configuration.</p>
<b>Step 6</b>	<p><b>verify packages</b></p> <p><b>Example:</b></p> <pre>RP/0/RSP0/CPU0:router(admin)# install verify packages</pre>	<p>Verifies that there are no corrupted software files. The consistency of a previously installed software set is verified against the package file from which it originated. This command can be used as a debugging tool to verify the validity of the files that constitute the packages, to determine if there are any corrupted files. This command also checks for corruptions of installation state files and MBI image files. This command is particularly useful when issued after the activation of a package or upgrading the Cisco IOS XR software to a major release.</p> <p><b>Note</b> The <b>install verify packages</b> command can take up to two minutes per package to process.</p>
<b>Step 7</b>	<p><b>exit</b></p> <p><b>Example:</b></p> <pre>RP/0/RSP0/CPU0:router(admin)# exit</pre>	<p>Exits administration EXEC mode and returns to EXEC mode.</p>
<b>Step 8</b>	<p>(Optional) <b>show system verify start</b></p> <p><b>Example:</b></p> <pre>RP/0/RSP0/CPU0:router# show system verify start</pre>	<p>Starts the system status check.</p>
<b>Step 9</b>	<p>(Optional) <b>show system verify [ detail   report ]</b></p> <p><b>Example:</b></p> <pre>RP/0/RSP0/CPU0:router# show system verify</pre>	<p>Displays system status information. A variety of information is displayed including the memory and CPU usage, process status, protocol status, and other status information. Use this information to verify that the system is stable.</p> <ul style="list-style-type: none"> <li>• <b>detail</b>—Displays additional information at the card and processor level, including actual numbers.</li> <li>• <b>report</b>—Displays the same information as the default <b>show system verify</b> command</li> </ul>

	Command or Action	Purpose
		<b>Note</b> Although most of the output should display the status “OK,” some processes may show other output, such as “Warning.” This does not specifically indicate a problem. Contact your Cisco technical support representative for more information on the output of this command.
<b>Step 10</b>	<b>show clock</b> <b>Example:</b> RP/0/RSP0/CPU0:router# show clock	Verifies that the system clock is correct. Software operations use certificates based on router clock times.

**Related Topics**

[Activation and Deactivation Prerequisites](#), on page 144

**Examples****Verifying That the ROM Monitor Version Is Correct: Example**

In the following example, the ROM Monitor software version is displayed in the “ROMMON:” field for each card.



**Note** For instructions to upgrade the ROM Monitor software, see *ROM Monitor Configuration Guide for Cisco ASR 9000 Routers*.

```
RP/0/RSP0/CPU0:router# admin
RP/0/RSP0/CPU0:router(admin)# show diag

Mon Jun 22 12:55:10.554 PST

NODE module 0/RSP0/CPU0 :

  MAIN: board type 0x100302
  S/N: FOC1230803H
  Top Assy. Number: 68-3160-04
  PID: A2K-RSP-4G-HDD=
  UDI_VID: VP4
  HwRev: V4.8
  New Deviation Number: 0
  CLEI: IPUCARJBAA
  Board State : IOS XR RUN
  PLD: Motherboard: N/A, Processor: 0x8004 (rev: 2.2), Power: N/A
  MONLIB: QNXFFS Monlib Version 3.2
  ROMMON: Version 1.0(20081208:173612) [ASR9K ROMMON]
  Board FPGA/CPLD/ASIC Hardware Revision:
    Compact Flash : V1.0
    XbarSwitch0 : V1.3
    XbarSwitch1 : V1.3
    XbarArbiter : V1.0
    XbarInterface : V0.0
```

```
IntCtrl : V1.14
ClkCtrl : V1.13
PuntFPGA : V1.5
HD : V3.0
USB0 : V77.20
USB1 : V77.20
CPUCtrl : V1.17
UTI : V1.6
LIU : V1.0
MLANSwitch : V0.0
EOBCSwitch : V2.0
CBC (active partition) : v1.2
CBC (inactive partition) : v1.1

NODE fantray 0/FT0/SP :

MAIN: board type 0x900211
S/N:
Top Assy. Number: 32-0000-00
PID:
UDI_VID:
HwRev: V32.0
New Deviation Number: 0
CLEI:
PLD: Motherboard: N/A, Processor: N/A, Power: N/A
ROMMON:
Board FPGA/CPLD/ASIC Hardware Revision:
  CBC (active partition) : v4.0
  CBC (inactive partition) : v0.13

NODE fantray 0/FT1/SP :

MAIN: board type 0x900211
S/N:
Top Assy. Number: 32-0000-00
PID:
UDI_VID:
HwRev: V32.0
New Deviation Number: 0
CLEI:
PLD: Motherboard: N/A, Processor: N/A, Power: N/A
ROMMON:
Board FPGA/CPLD/ASIC Hardware Revision:
  CBC (active partition) : v4.0
  CBC (inactive partition) : v0.13

NODE module 0/1/CPU0 :

MAIN: board type 0x20207
S/N: FOC123081J6
Top Assy. Number: 68-3182-03
PID: A9K-40GE-B
UDI_VID: V1D
HwRev: V0.0
New Deviation Number: 0
CLEI:
Board State : IOS XR RUN
PLD: Motherboard: N/A, Processor: 0x8004 (rev: 2.2), Power: N/A
ROMMON: Version 1.0(20081208:174521) [ASR9K ROMMON]
Board FPGA/CPLD/ASIC Hardware Revision:
  NP0 : V3.194
  NP1 : V3.194
  NP2 : V3.194
  NP3 : V3.194
```

```

XbarInterface : V18.4
Bridge0      : V0.38
Bridge1      : V0.38
CPUCtrl      : V0.15
USB          : V77.20
PortCtrl     : V0.8
PHYCtrl      : V0.6
40 Port Gigabit Ethernet Daughter board : V0.0
CBC (active partition) : v2.2
CBC (inactive partition) : v2.1

```

NODE module 0/4/CPU0 :

```

MAIN: board type 0x2020a
S/N: FOC123081JA
Top Assy. Number: 68-3183-02
PID: A9K-8T/4-B
UDI_VID: V1D
HwRev: V0.0
New Deviation Number: 0
CLEI: IPU3AEOCAA
Board State : IOS XR RUN
PLD: Motherboard: N/A, Processor: 0x8004 (rev: 2.2), Power: N/A
ROMMON: Version 1.0(20081208:174521) [ASR9K ROMMON]
Board FPGA/CPLD/ASIC Hardware Revision:
NP0 : V3.194
NP1 : V3.194
NP2 : V3.194
NP3 : V3.194
XbarInterface : V18.4
Bridge0      : V0.38
Bridge1      : V0.38
CPUCtrl      : V0.15
USB          : V77.20
PortCtrl     : V0.10
PHYCtrl      : V0.7
PHY0         : V0.16
PHY1         : V0.16
PHY2         : V0.16
PHY3         : V0.16
PHY4         : V0.16
PHY5         : V0.16
PHY6         : V0.16
PHY7         : V0.16
8 Port Ten Gigabit Ethernet Daughter board : V0.0
CBC (active partition) : v2.2
CBC (inactive partition) : v2.1

```

NODE module 0/6/CPU0 :

```

MAIN: board type 0x20208
S/N: FHH12250033
Top Assy. Number: 68-3184-02
PID: A9K-4T-B
UDI_VID: V1D
HwRev: V0.0
New Deviation Number: 0
CLEI:
Board State : IOS XR RUN
PLD: Motherboard: N/A, Processor: 0x8004 (rev: 2.2), Power: N/A
ROMMON: Version 1.0(20081208:174521) [ASR9K ROMMON]
Board FPGA/CPLD/ASIC Hardware Revision:
NP0 : V3.194
NP1 : V3.194

```

```
NP2 : V3.194
NP3 : V3.194
XbarInterface : V18.4
Bridge0 : V0.38
Bridge1 : V0.38
CPUCtrl : V0.15
USB : V77.20
PHY0 : V0.16
PHY1 : V0.16
PHY2 : V0.16
PHY3 : V0.16
PortCtrl : V0.10
  PHYCtrl : V0.7
4 Port Ten Gigabit Ethernet Daughter board : V0.0
CBC (active partition) : v2.2
CBC (inactive partition) : v2.1
```

NODE power-module 0/PM0/SP :

```
MAIN: board type 0xf00188
S/N:
Top Assy. Number: 341-00032-01
PID: A9K-3KW-AC
UDI_VID: V00
HwRev: V0.0
New Deviation Number: 0
CLEI: ACACACACAC
PLD: Motherboard: N/A, Processor: N/A, Power: N/A
ROMMON:
Board FPGA/CPLD/ASIC Hardware Revision:
```

NODE power-module 0/PM1/SP :

```
MAIN: board type 0xf00188
S/N:
Top Assy. Number: 341-00032-01
PID: A9K-3KW-AC
UDI_VID: V00
HwRev: V0.0
New Deviation Number: 0
CLEI: ACACACACAC
PLD: Motherboard: N/A, Processor: N/A, Power: N/A
ROMMON:
Board FPGA/CPLD/ASIC Hardware Revision:
```

NODE power-module 0/PM2/SP :

```
MAIN: board type 0xf00188
S/N:
Top Assy. Number: 341-00032-01
PID: A9K-3KW-AC
UDI_VID: V00
HwRev: V0.0
New Deviation Number: 0
CLEI: ACACACACAC
PLD: Motherboard: N/A, Processor: N/A, Power: N/A
ROMMON:
Board FPGA/CPLD/ASIC Hardware Revision:
```

Rack 0 - ASR-9010 Chassis, Includes Accessories

```
RACK NUM: 0
S/N:
PID: ASR-9010 Backplane
VID: 0.1
```

```

Desc: ASR-9010 Chassis, Includes Accessories
CLEI: NOCLEI
Top Assy. Number: 68-1234-56

```

### Displaying the Active Software for the Entire System: Example

The following example displays the active packages for the entire system. Use this information to determine if a software change is required:

```

RP/0/RSP0/CPU0:router(admin)# show install active summary

Mon Jun 22 13:01:46.438 PST
Default Profile:
  SDRs:
    Owner
  Active Packages:
    disk0:comp-asr9k-mini-3.9.0.12I
    disk0:asr9k-fpd-3.9.0.12I
    disk0:asr9k-k9sec-3.9.0.12I
    disk0:asr9k-mcast-3.9.0.12I
    disk0:asr9k-mgbl-3.9.0.12I
    disk0:asr9k-mpis-3.9.0.12I

```

### Displaying Information About the Contents of a PIE File: Example

In the following example, information is displayed about the manageability PIE. This command displays the expiry date of the package, the cards supported by the package, and other details. Use this information to verify the compatibility of the package with your system and other software packages.



---

**Note** A software activation is performed only after the automatic package compatibility and API version compatibility checks have been passed. If a conflict is found, an on-screen error message is displayed.

---

```

RP/0/RSP0/CPU0:router(admin)# show install pie-info disk1:/
asr9k-mgbl-p.pie-3.8.0 detail

Contents of pie file '/disk1:/asr9k-mgbl-p.pie-3.8.0':
  Expiry date      : Jan 19, 2007 02:55:56 UTC
  Uncompressed size : 17892613

asr9k-mgbl-3.8.0
  asr9k-mgbl V3.8.0[00] Manageability Package
  Vendor : Cisco Systems
  Desc   : Manageability Package
  Build  : Built on Wed May 10 08:04:58 UTC 2006
  Source : By edde-bld1 in /vws/aga/production/3.8.0/asr9k/workspace for c28
  Card(s): RP, DRP, DRPSC
  Restart information:
    Default:
      parallel impacted processes restart

```

```

Components in package asr9k-mgbl-3.8.0, package asr9k-mgbl:
  manageability-cwi V[r33x/2] Craft Web Interface related binaries ae
  asr9k-feature-ipsla V[r33x/1] IPSLA time stamping feature
  doc-asr9k-mgbl V[r33x/2] Contains the man page documentation for asr9ks
--More--

```

### Verifying That There Are No Corrupted Software Files: Example

The following sample output verifies the consistency of the currently active software against the file from which it originated:

```

RP/0/RSP0/CPU0:router(admin)# install verify packages

Mon Jun 22 13:19:08.590 PST
Install operation 3 '(admin) install verify packages' started by user 'user'
via CLI at 13:19:08 DST Mon Jun 22 2009.
The install operation will continue asynchronously.
RP/0/RSP0/CPU0:router(admin)#Info:
This operation can take up to 2 minutes per package being verified.
Info:      Please be patient.

Info:      0/6/CPU0 [LC] [SDR: Owner]
Info:      meta-data: [SUCCESS] Verification Successful.
Info:      /install/asr9k-scfclient-3.9.0.12I: [SUCCESS] Verification
Info:      Successful.
Info:      /install/asr9k-os-mbi-3.9.0.12I: [SUCCESS] Verification
Info:      Successful.
Info:      /install/asr9k-mpls-3.9.0.12I: [SUCCESS] Verification Successful.
Info:      /install/asr9k-mcast-3.9.0.12I: [SUCCESS] Verification
Info:      Successful.
Info:      /install/asr9k-lc-3.9.0.12I: [SUCCESS] Verification Successful.
Info:      /install/asr9k-fwgd-3.9.0.12I: [SUCCESS] Verification Successful.
Info:      /install/asr9k-fpd-3.9.0.12I: [ERROR] Detected anomalies.
Info:      /install/asr9k-diags-3.9.0.12I: [SUCCESS] Verification
Info:      Successful.
Info:      /install/asr9k-base-3.9.0.12I: [SUCCESS] Verification Successful.
Info:      /install/asr9k-admin-3.9.0.12I: [SUCCESS] Verification
Info:      Successful.
Info:      0/1/CPU0 [LC] [SDR: Owner]
Info:      meta-data: [SUCCESS] Verification Successful.
Info:      /install/asr9k-scfclient-3.9.0.12I: [SUCCESS] Verification
Info:      Successful.
Info:      /install/asr9k-os-mbi-3.9.0.12I: [SUCCESS] Verification
Info:      Successful.
Info:      /install/asr9k-mpls-3.9.0.12I: [SUCCESS] Verification Successful.
Info:      /install/asr9k-mcast-3.9.0.12I: [SUCCESS] Verification
Info:      Successful.
Info:      /install/asr9k-lc-3.9.0.12I: [SUCCESS] Verification Successful.
Info:      /install/asr9k-fwgd-3.9.0.12I: [SUCCESS] Verification Successful.
Info:      /install/asr9k-fpd-3.9.0.12I: [ERROR] Detected anomalies.
Info:      /install/asr9k-diags-3.9.0.12I: [SUCCESS] Verification
Info:      Successful.
Info:      /install/asr9k-base-3.9.0.12I: [SUCCESS] Verification Successful.
Info:      /install/asr9k-admin-3.9.0.12I: [SUCCESS] Verification
Info:      Successful.
Info:      0/4/CPU0 [LC] [SDR: Owner]
Info:      meta-data: [SUCCESS] Verification Successful.
Info:      /install/asr9k-scfclient-3.9.0.12I: [SUCCESS] Verification
Info:      Successful.
Info:      /install/asr9k-os-mbi-3.9.0.12I: [SUCCESS] Verification

```

```

Info:      Successful.
Info:      /install/asr9k-mpls-3.9.0.12I: [SUCCESS] Verification Successful.
Info:      /install/asr9k-mcast-3.9.0.12I: [SUCCESS] Verification
Info:      Successful.
Info:      /install/asr9k-lc-3.9.0.12I: [SUCCESS] Verification Successful.
Info:      /install/asr9k-fwgdg-3.9.0.12I: [SUCCESS] Verification Successful.
Info:      /install/asr9k-fpd-3.9.0.12I: [ERROR] Detected anomalies.
Info:      /install/asr9k-diags-3.9.0.12I: [SUCCESS] Verification
Info:      Successful.
Info:      /install/asr9k-base-3.9.0.12I: [SUCCESS] Verification Successful.
Info:      /install/asr9k-admin-3.9.0.12I: [SUCCESS] Verification
Info:      Successful.
Info:      0/RSP0/CPU0 [RP] [SDR: Owner]
Info:      meta-data: [SUCCESS] Verification Successful.
Info:      /install/asr9k-fpd-3.9.0.12I: [ERROR] Detected anomalies.
Info:      /install/asr9k-mpls-3.9.0.12I: [SUCCESS] Verification Successful.
Info:      /install/asr9k-mgbl-3.9.0.12I: [SUCCESS] Verification Successful.
Info:      /install/asr9k-mcast-3.9.0.12I: [SUCCESS] Verification
Info:      Successful.
Info:      /install/asr9k-k9sec-3.9.0.12I: [SUCCESS] Verification
Info:      Successful.
Info:      /install/asr9k-os-mpi-3.9.0.12I: [SUCCESS] Verification
Info:      Successful.
Info:      /install/asr9k-base-3.9.0.12I: [SUCCESS] Verification Successful.
Info:      /install/asr9k-admin-3.9.0.12I: [SUCCESS] Verification
Info:      Successful.
Info:      /install/asr9k-fwgdg-3.9.0.12I: [SUCCESS] Verification Successful.
Info:      /install/asr9k-lc-3.9.0.12I: [SUCCESS] Verification Successful.
Info:      /install/asr9k-rout-3.9.0.12I: [SUCCESS] Verification Successful.
Info:      /install/asr9k-diags-3.9.0.12I: [SUCCESS] Verification
Info:      Successful.
Info:      /install/asr9k-scfclient-3.9.0.12I: [SUCCESS] Verification
Info:      Successful.
Info:      Verification Summary:
Info:      0/6/CPU0: ERROR. Anomalies found.
Info:      0/1/CPU0: ERROR. Anomalies found.
Info:      0/4/CPU0: ERROR. Anomalies found.
Info:      0/RSP0/CPU0: ERROR. Anomalies found.
Info:      Anomalies found on the primary RP.
Info:      No standby RP is present.
Info:      Please contact your technical services representative to repair
Info:      the system.
Install operation 3 completed successfully at 13:21:29 DST Mon Jun 22 2009.

```

### Verifying the Current System Status: Example

The following example shows how to prepare for system verification:

```

RP/0/RSP0/CPU0:router# show system verify start

Storing initial router status ...
done.

```

The following example shows output from running the **show system verify** command.





**Note** Although most of the output should display the status “OK,” some processes may show other output, such as “Warning.” This does not specifically indicate a problem. Contact your Cisco technical support representative for more information on the output of this command.

```
RP/0/RSP0/CPU0:router# show system verify

Getting current router status ...
System Verification Report
=====
- Verifying Memory Usage
- Verified Memory Usage : [OK]
- Verifying CPU Usage
- Verified CPU Usage : [OK]

- Verifying Blocked Processes
- Verified Blocked Processes : [OK]
- Verifying Aborted Processes
- Verified Aborted Processes : [OK]
- Verifying Crashed Processes
- Verified Crashed Processes : [OK]

- Verifying LC Status
- Verified LC Status : [OK]
- Verifying QNET Status
Unable to get current LC status info
- Verified QNET Status : [FAIL]

- Verifying GSP Fabric Status
- Verified GSP Fabric Status : [OK]
- Verifying GSP Ethernet Status
gsp WARNING messages for router
Current set of gsp ping nodes does not match initial set of nodes
- Verified GSP Ethernet Status : [WARNING]

- Verifying POS interface Status
- Verified POS interface Status : [OK]
- Verifying TenGigE interface Status
- Verified TenGigE interface Status : [OK]

- Verifying TCP statistics
- Verified TCP statistics : [OK]
- Verifying UDP statistics
tcp_udp_raw WARNING messages for router
UDP Packets sent has not increased during this period.
- Verified UDP statistics : [WARNING]
- Verifying RAW statistics
- Verified RAW statistics : [OK]

- Verifying RIB Status
- Verified RIB Status : [OK]
- Verifying CEF Status
- Verified CEF Status : [OK]
- Verifying CEF Consistency Status
- Verified CEF Consistency Status : [OK]
- Verifying BGP Status
- Verified BGP Status : [OK]
- Verifying ISIS Status
- Verified ISIS Status : [OK]
- Verifying OSPF Status
```

```

- Verified OSPF Status                               : [OK]
- Verifying Syslog Messages
- Verified Syslog Messages                           : [OK]

System may not be stable. Please look into WARNING messages.

```

### Verifying That the System Clock Is Correct: Example

The following example displays the current system clock setting:

```

RP/0/RSP0/CPU0:router# show clock

02:14:51.474 PST Wed Jan 28 2009

```

## Adding and Activating Packages

The procedure in this section describes how to upgrade or add Cisco IOS XR software PIE files that are stored on a local storage device, such as a flash disk, or on a remote TFTP, FTP, SFTP, or rcp server. The PIE software file can include any of the following:

- The Cisco IOS XR Unicast Routing Core Bundle (six packages in one composite PIE file)
- Any of the optional packages (one package per PIE file)
- Software maintenance upgrades (SMUs)

When you need to add and activate two or more of the preceding package types, you should add and activate them in the order listed above.



---

**Note** When adding and activating two or more packages, optional packages can be activated together. Also, if the operation is a reload, multiple packages can be activated together. For example, five reload SMUs can be activated together or the Cisco IOS XR Unicast Routing Core Bundle plus the SMUs and optional packages can be activated together.

---

For a description of the software management process, see the *Related Topics* section.

These instructions are also used to downgrade software packages.



---

**Note** By default, installation operations are performed asynchronously: the CLI prompt is returned before the operation is complete, allowing the operator to continue work while the installation is completed in the background. Use the **synchronous** keyword at the end of install commands to delay the return of the CLI prompt until an installation operation is complete. See the *Related Topics* section for more information.

---

### Before you begin

Before upgrading or adding packages, verify that these prerequisites have been met:

- Verify that the ROMMON version is correct. For instructions on upgrading ROM Monitor, see *ROM Monitor Configuration Guide for Cisco ASR 9000 Routers*.
- All packages to be upgraded or added are present on a local storage device (for example a flash disk), or a network file server.
- Prerequisites for the activation of packages are met as described in the Prerequisites section.
- Complete the procedures described in the [Preparing for Software Installation Operations, on page 147](#) section.



**Note** To use the automatic FPD upgrade feature, the **fpd auto-upgrade** command must be enabled in administration configuration mode.

## SUMMARY STEPS

1. Connect to the console port and log in.
2. (Optional) **dir flash-disk :**
3. **admin**
4. **install add [source source-path | tar] file [activate ]**
5. (Optional) **show install inactive summary**
6. **install activate {id add-id | device package} [test] [location node-id] [pause sw-change] [prompt-level {all | none}] [auto-abort-timer {time | off}]**
7. Repeat [Step 4, on page 160](#) through [Step 6, on page 161](#) until all packages are activated.
8. (Optional) **show install active summary**
9. (Optional) **install verify packages**
10. (Optional) **exit**
11. (Optional) **show system verify start**
12. **admin**
13. (Optional) **install commit**
14. Upgrade the field-programmable device (FPD) software, if necessary.

## DETAILED STEPS

	Command or Action	Purpose
<b>Step 1</b>	Connect to the console port and log in.	Establishes a CLI management session with the SDR. Connect to the console port for the active DSC.  For more information on console connections, see <i>Cisco ASR 9000 Series Aggregation Services Router Getting Started Guide</i> .
<b>Step 2</b>	(Optional) <b>dir flash-disk :</b>  <b>Example:</b>  RP/0/RSP0/CPU0:router# dir disk1:	Displays the package files that are available for package upgrades and additions.  <b>Note</b> Only PIE files can be added and activated using this procedure.
<b>Step 3</b>	Required: <b>admin</b>  <b>Example:</b>	Enters administration EXEC mode.

	Command or Action	Purpose
	<pre>RP/0/RSP0/CPU0:router# admin</pre>	<p><b>Note</b> Some <b>show install</b> commands can be entered in EXEC mode on an SDR.</p>
<p><b>Step 4</b></p>	<p><b>install add</b> [<i>source source-path</i>   <b>tar</b>] file [<b>activate</b> ]</p> <p><b>Example:</b></p> <pre>RP/0/RSP0/CPU0:router(admin)# install add disk1:/asr9k-mgbl-px.pie-6.0.1</pre> <p>or</p> <pre>RP/0/RSP0/CPU0:router(admin)# install add source tftp://10.1.1.1/images/ asr9k-k9sec-p.pie asr9k-mpis-p.pie asr9k-mcast-p.pie</pre> <p>or</p> <pre>RP/0/RSP0/CPU0:router(admin)# install add ftp://john:secret@10.1.1.1/images/asr9k-k9sec-p.pie</pre> <p>or</p> <pre>RP/0/RSP0/CPU0:router(admin)# install add tar rcp://john@10.1.1.1/images/asr9k-iosxr-3.6.0.tar</pre>	<p>Unpacks a PIE file from local storage device or network server and adds the package files to the boot device of the router. The boot device is located on the DSC.</p> <ul style="list-style-type: none"> <li>• If the <b>source</b> keyword is used, the <i>source-path</i> specifies the directory path that is used for multiple filenames in the same directory.</li> <li>• If the <b>tar</b> keyword is used, all PIE files contained in the tar file are unpacked.</li> </ul> <p>The <i>file</i> argument can take any of these formats:</p> <ul style="list-style-type: none"> <li>• <i>device filename</i></li> <li>• <b>tftp://</b><i>hostname_or_ipaddress</i> /<i>directory-path</i> /<i>filename</i></li> <li>• <b>ftp://</b><i>username:password@hostname_or_ipaddress</i> /<i>directory-path</i>/<i>filename</i></li> <li>• <b>rcp://</b><i>username@hostname_or_ipaddress</i> /<i>directory-path</i>/<i>filename</i></li> </ul> <p>These are descriptions for each of the terms used here:</p> <ul style="list-style-type: none"> <li>• <i>device</i>—Name of the local storage device where the PIE file is stored, such as <b>disk1:/</b>.</li> <li>• <i>filename</i>—Name of the PIE file you want to add. If the <b>tar</b> keyword is used, the <i>file</i> argument is the name of a tar file containing one or more PIE files, or directories containing PIE files.</li> <li>• <b>tftp://</b>—Unpacks the PIE file from a network server using Trivial File Transfer Protocol.</li> <li>• <b>ftp://</b>—Unpacks the PIE file from a network server using File Transfer Protocol.</li> <li>• <b>rcp://</b>—Unpacks the PIE file from a network server using Remote Copy Protocol</li> <li>• <i>hostname_or_ipaddress</i>—Host name or IP address of the network file server.</li> <li>• <i>directory-path</i>—Network file server path that leads to the PIE file to be added.</li> <li>• <i>username</i>—Username of user that has access privileges to the directory in which the PIE file is stored.</li> <li>• <i>password</i>—Password associated with the username of user that has access privileges to the directory in which the PIE file is stored.</li> </ul>

	Command or Action	Purpose
		<ul style="list-style-type: none"> <li>• <b>activate</b>—Automatically activates the software package after it is successfully added.</li> </ul> <p><b>Note</b> Multiple versions of a software package can be added to the storage device without impacting the running configuration, but only one version of a package can be activated for a card.</p> <p><b>Tip</b> The automatic FPD upgrade occurs only when the FPD pie is added and activated together with the install PIE.</p>
<b>Step 5</b>	(Optional) <b>show install inactive summary</b> <b>Example:</b> <pre>RP/0/RSP0/CPU0:router(admin)# show install inactive summary</pre>	Displays the inactive packages on the router. Verify that the package added in the previous step appears in the display.
<b>Step 6</b>	<b>install activate</b> { <i>id add-id</i>   <i>device package</i> } [ <b>test</b> ] [ <b>location</b> <i>node-id</i> ] [ <b>pause sw-change</b> ] [ <b>prompt-level</b> { <b>all</b>   <b>none</b> }] [ <b>auto-abort-timer</b> { <i>time</i>   <b>off</b> }] <b>Example:</b> <pre>RP/0/RSP0/CPU0:router(admin)# install activate disk0:asr9k-mini-px-4.3.99</pre>	Activates a package that was added to the router. (Skip this step if the package was activated earlier with the <b>install add</b> command.) <ul style="list-style-type: none"> <li>• <b>id add-id</b>—Specifies the package using the operation ID of the <b>install add</b> operation in which you added the package. The operation ID is provided in the output of the <b>install add</b> command. You can also use <b>show install log</b> to display installation operation IDs.</li> <li>• <b>device:package</b>—Specifies the package by name. Replace the <i>device:package</i> argument with the name of the boot device and inactive package, which can be displayed as described in the previous step.</li> </ul> <p><b>Note</b> Press ? after a partial package name to display all possible matches available for activation. If there is only one match, press [TAB] to fill in the rest of the package name.</p> <ul style="list-style-type: none"> <li>• <b>location node-id</b>—Activates a package for a specific card (node). To display a list of node IDs for the entire system, enter the <b>show platform</b> command in administration EXEC mode. A package cannot be activated on a single node unless some version of the package being activated is already active on all nodes.</li> </ul> <p><b>Note</b> By default, packages are activated for all cards supported by that package.</p> <ul style="list-style-type: none"> <li>• <b>pause sw-change</b>—Pauses the operation after preparatory checks and before the configuration is locked for the actual activation. This action enables you to hold the operation while you perform</li> </ul>

	Command or Action	Purpose
		<p>configuration changes, and proceed with the activation whenever you choose. This operation is useful, for example, if your workflow involves configuring a router out of the network during software installation and you want to minimize the time that the router is out of the network. Follow onscreen instructions to control the pausing and completion of the operation.</p> <ul style="list-style-type: none"> <li>• <b>prompt-level</b>—Use a prompt-level of <b>all</b> to view all stages of the installation process and to specify whether to continue, or not.</li> <li>• <b>auto-abort-timer</b>—Specifies an abort timer value, in minutes, which when expired loads the last committed loadpath. The default is 60. The timer is enabled by default. After the installation, if the activated software is working correctly, use the <b>install commit</b> command to cancel the timer and commit the new loadpath.</li> </ul> <p><b>Note</b> The package being activated must be compatible with the currently active software to operate. When an activation is attempted, the system runs an automatic compatibility check to ensure that the package is compatible with the other active software on the router. The activation is permitted only after all compatibility checks have been passed.</p> <p><b>Tip</b> When activating packages, use the <b>test</b> option to test the effects of a command without impacting the running system. After the activation process finishes, enter the <b>show install log</b> command to display the process results.</p> <p><b>Tip</b> The automatic FPD upgrade occurs only when the FPD pie is added and activated together with the install PIE.</p>
<b>Step 7</b>	Repeat <a href="#">Step 4, on page 160</a> through <a href="#">Step 6, on page 161</a> until all packages are activated.	Activates additional packages as required.
<b>Step 8</b>	(Optional) <b>show install active summary</b> <b>Example:</b> <pre>RP/0/RSP0/CPU0:router(admin)# show install active</pre>	Displays all active packages. Use this display to determine if the correct packages are active:
<b>Step 9</b>	(Optional) <b>install verify packages</b> <b>Example:</b>	Verifies the consistency of a installed software set with the package file from which it originated. This command can be used as a debugging tool to verify the validity of

	Command or Action	Purpose
	<pre>RP/0/RSP0/CPU0:router(admin)# install verify packages</pre>	<p>the files that constitute the packages, to determine whether there are any corrupted files. This command also checks for corruptions of installation state files and MBI image files. This command is particularly useful when issued after the activation of a package or upgrading the Cisco IOS XR software to a major release.</p> <p><b>Note</b> The <b>install verify packages</b> command can take up to two minutes for each package to process.</p>
<b>Step 10</b>	<p>(Optional) <b>exit</b></p> <p><b>Example:</b></p> <pre>RP/0/RSP0/CPU0:router(admin)# exit</pre>	Exits administration EXEC mode and returns to EXEC mode.
<b>Step 11</b>	<p>(Optional) <b>show system verify start</b></p> <p><b>Example:</b></p> <pre>RP/0/RSP0/CPU0:router# show system verify start</pre>	Starts the system status check.
<b>Step 12</b>	<p><b>admin</b></p> <p><b>Example:</b></p> <pre>RP/0/RSP0/CPU0:router# admin</pre>	Enters administration EXEC mode.
<b>Step 13</b>	<p>(Optional) <b>install commit</b></p> <p><b>Example:</b></p> <pre>RP/0/RSP0/CPU0:router# dir disk1:</pre> <pre>RP/0/RSP0/CPU0:router(admin)# install commit</pre>	<p>Commits the current set of packages on the router so that these packages are used if the router is restarted.</p> <p>For more information, see the <i>Related Topics</i> section.</p>
<b>Step 14</b>	Upgrade the field-programmable device (FPD) software, if necessary.	<p>Whenever a Cisco IOS XR software image that supports SPAs and SIPs is released, a companion SPA or SIP FPD image is bundled with the Cisco IOS XR software release. Generally, the FPD image is not automatically upgraded. You must manually upgrade the FPD image running on the SPA or SIP when you upgrade the Cisco IOS XR software image. FPD versions must be compatible with the Cisco IOS XR software that is running on the router.</p> <p><b>Note</b> If you have enabled the <b>fpd auto-upgrade</b> command and add and activate the FPD PIE together with the software installation PIE, the FPD image is automatically upgraded before the router is rebooted.</p>

	Command or Action	Purpose
		For information on FPDs, including instructions to upgrade FPD images, see the <i>Upgrading FPD Cisco IOS XR Software</i> section.

### Related Topics

[Obtaining and Placing Cisco IOS XR Software](#), on page 145

[Activation and Deactivation Prerequisites](#), on page 144

[Preparing for Software Installation Operations](#), on page 147

[Information About Package Management](#), on page 132

[Downgrading Packages](#), on page 139

[PIE Filenames and Version Numbers](#), on page 130

[Committing the Active Package Set](#), on page 166

[Prerequisites for ISSU](#)

[Restrictions for ISSU](#)

[ISSU Software Images](#)

## Examples

### Adding a Package: Example

The following example shows how to add the contents of a PIE file on disk1: to the boot device. Because the software package is added to the boot device by default, it is not necessary to specify the destination device in the CLI.



**Note** From Cisco IOS XR Software Release 6.0.1 and later, you must append a forward slash (/) to the source location (for example, **disk1:/**) of the PIE file in the **install add** command.

```
RP/0/RSP0/CPU0:router(admin)# install add disk1:/asr9k-mpls-px.pie-6.0.1 synchronous

Install operation 4 'install add /disk1:/asr9k-mpls.pie-mpls-px.pie-6.0.1 synchronous'
started by user
'cisco' at 18:10:18 UTC Sat Apr 08 2009.
Info:      The following package is now available to be activated:
Info:
Info:      disk0:asr9k-mpls-px.pie-6.0.1
Info:
Install operation 4 completed successfully at 18:14:11 UTC Sat Apr 08 2009.
```

The following example shows how to add the contents of a PIE file on a TFTP server to the boot device:

```
RP/0/RSP0/CPU0:router(admin)# install add tftp://209.165.201.1/
asr9k-mpls.pie synchronous

Install operation 4 '(admin) install add /tftp://209.165.201.1/asr9k-mpls.pie synchronous'
started by user 'cisco' at 18:16:18 UTC Thu Jan 03 2009.
```



```

Info:      The following package is now available to be activated:
Info:
Info:      disk0:asr9k-mpls-3.7.2
Info:
Install operation 4 completed successfully at 18:19:10 UTC Thu Jan 03 2009.

```

### Activating a Package: Example

The following example shows the activation of the MPLS package. The package is activated on the boot device disk0:

```

RP/0/RSP0/CPU0:router(admin)# install activate disk0:
asr9k-mpls-3.7.2 synchronous

Install operation 15 'install activate disk0:asr9k-mpls-3.7.2 synchronous'
started by user 'lab' at 19:15:33 UTC Sat Apr 08 2009.
Info:      The changes made to software configurations will not be persistent
Info:      across system reloads. Use the command 'admin install commit' to make
Info:      changes persistent.
Info:      Please verify that the system is consistent following the software
Info:      change using the following commands:
Info:      show system verify
Info:      install verify packages
Install operation 5 completed successfully at 19:16:18 UTC Sat Apr 08 2009.

```

### Activating a Package by Specifying an Operation ID: Example

The following example shows the activation of the MPLS package using the operation ID of the **install add** operation that added the package:

```

RP/0/RSP0/CPU0:router(admin)# install activate id 4

Install operation 5 '(admin) install activate id 4' started by user 'lab' via
CLI at 18:20:17 UTC Thu Jan 03 2009.
Info:      This operation will activate the following package:
Info:      disk0:asr9k-mpls-3.7.2
Info:      Install Method: Parallel Process Restart
The install operation will continue asynchronously.
Info:      The changes made to software configurations will not be persistent
Info:      across system reloads. Use the command '(admin) install commit' to
Info:      make changes persistent.
Info:      Please verify that the system is consistent following the software
Info:      change using the following commands:
Info:      show system verify
Info:      install verify packages
Install operation 5 completed successfully at 18:21:30 UTC Thu Jan 03 2009.

```

### Adding and Activating a Package from an FTP File Server with One Command: Example

To add and activate a package with a single command, enter the **install add** command with the **activate** keyword. In the following example, the Manageability PIE located on disk1: is verified,

unpacked, and added to the boot device disk0. Because this operation is performed in administration EXEC mode, the package is activated for all SDRs in the system.

```
RP/0/RSP0/CPU0:router(admin)# install add disk1:/
asr9k-mgbl-px.pie-6.0.1 activate

Install operation 4 'install add /disk1:/asr9k-mgbl-px.pie-6.0.1 activate' started
by user 'cisco' at 07:58:56 UTC Wed Mar 01 2009.
The install operation will continue asynchronously.
:router(admin)#Part 1 of 2 (add software): Started
Info:      The following package is now available to be activated:
Info:
Info:      disk0:asr9k-mgbl-px.pie-6.0.1
Info:
Part 1 of 2 (add software): Completed successfully
Part 2 of 2 (activate software): Started
Info:      The changes made to software configurations will not be
persistent across system reloads. Use the command 'admin install
Info:      commit' to make changes persistent.
Info:      Please verify that the system is consistent following
the software change using the following commands:
Info:      show system verify
Info:      install verify packages
Part 2 of 2 (activate software): Completed successfully
Part 1 of 2 (add software): Completed successfully
Part 2 of 2 (activate software): Completed successfully
Install operation 4 completed successfully at 08:00:24 UTC Wed Mar 01 2009.
```

### Displaying the Active Packages: Example

The following example displays a summary of the active packages on a router. Because this operation is performed in administration EXEC mode, the active packages for all SDRs are displayed.

```
RP/0/RSP0/CPU0:router(admin)# show install active summary
Mon Jun 22 23:41:19.509 PST
Default Profile:
  SDRs:
    Owner
  Active Packages:
    disk0:comp-asr9k-mini-3.9.0.12I
    disk0:asr9k-fpd-3.9.0.12I
    disk0:asr9k-k9sec-3.9.0.12I
    disk0:asr9k-mcast-3.9.0.12I
    disk0:asr9k-mgbl-3.9.0.12I
    disk0:asr9k-mpls-3.9.0.12I
```

## Committing the Active Package Set

When a package is activated, it becomes part of the current running configuration. To make the package activation persistent across system-wide reloads, enter the **install commit** command. On startup, DSC of the owner SDR loads this committed software set. If the system is reloaded before the current active software is committed with the **install commit** command, the previously committed software set is used.

If the system is reloaded before the current active software is committed with the **install commit** command, the previously committed software set is used.



**Tip** Before committing a package set, verify that the SDR is operating correctly and is forwarding packets as expected.

## SUMMARY STEPS

1. **admin**
2. **install commit**
3. **show install committed [detail | summary | verbose] [location node-id]**

## DETAILED STEPS

	Command or Action	Purpose
<b>Step 1</b>	<b>admin</b> <b>Example:</b> RP/0/RSP0/CPU0:router# admin	Enters administration EXEC mode.
<b>Step 2</b>	Required: <b>install commit</b> <b>Example:</b> RP/0/RSP0/CPU0:router(admin)# install commit	Commits the current set of packages on the router so that these packages are used if the router is restarted.
<b>Step 3</b>	<b>show install committed [detail   summary   verbose] [location node-id]</b> <b>Example:</b> RP/0/RSP0/CPU0:router(admin)# show install committed	Displays which packages are committed.

## Examples

### Committing the Active Package Set: Example

In the following example, the active software packages are committed on the router:

```
RP/0/RSP0/CPU0:router(admin)# install commit

Install operation 16 'install commit' started by user 'lab' at 19:18:58 UTC
Sat Apr 08 2009.
Install operation 16 completed successfully at 19:19:01 UTC Sat Apr 08 2009.
```

### Displaying the Committed Package Versions: Example

In the following example, the committed packages are shown for the owner SDR:

```

RP/0/RSP0/CPU0:router(admin)# show install committed

Tue Jun 23 05:11:29.968 PST
Secure Domain Router: Owner

Node 0/RSP0/CPU0 [RP] [SDR: Owner]
  Boot Device: disk0:
  Boot Image: /disk0/asr9k-os-mpi-3.9.0.12I/mbiasr9k-rp.vm
  Committed Packages:
    disk0:comp-asr9k-mini-3.9.0.12I
    disk0:asr9k-fpd-3.9.0.12I
    disk0:asr9k-k9sec-3.9.0.12I
    disk0:asr9k-mcast-3.9.0.12I
    disk0:asr9k-mgbl-3.9.0.12I
    disk0:asr9k-mps-3.9.0.12I

Node 0/1/CPU0 [LC] [SDR: Owner]
  Boot Device: mem:
  Boot Image: /disk0/asr9k-os-mpi-3.9.0.12I/lc/mbiasr9k-lc.vm
  Committed Packages:
    disk0:comp-asr9k-mini-3.9.0.12I
    disk0:asr9k-fpd-3.9.0.12I
    disk0:asr9k-mcast-3.9.0.12I
    disk0:asr9k-mps-3.9.0.12I

Node 0/4/CPU0 [LC] [SDR: Owner]
  Boot Device: mem:
  Boot Image: /disk0/asr9k-os-mpi-3.9.0.12I/lc/mbiasr9k-lc.vm
  Committed Packages:
    disk0:comp-asr9k-mini-3.9.0.12I
    disk0:asr9k-fpd-3.9.0.12I
    disk0:asr9k-mcast-3.9.0.12I
    disk0:asr9k-mps-3.9.0.12I

Node 0/6/CPU0 [LC] [SDR: Owner]
  Boot Device: mem:
  Boot Image: /disk0/asr9k-os-mpi-3.9.0.12I/lc/mbiasr9k-lc.vm
  Committed Packages:
    disk0:comp-asr9k-mini-3.9.0.12I
    disk0:asr9k-fpd-3.9.0.12I
    disk0:asr9k-mcast-3.9.0.12I
    disk0:asr9k-mps-3.9.0.12I

```

As with the **show install active** command, the **show install committed** command may display a composite package that represents all packages in the Cisco IOS XR Unicast Routing Core Bundle.

## Upgrading to Cisco IOS XR Software Release 4.0

In Cisco IOS XR Software Release 4.0, the software packages were reorganized into functionally well-defined and independently-releasable packages. For this reason, when you upgrade from a software release prior to Release 4.0, you must perform the following procedure in order to synchronize all of the software packages according to the reorganized structure. General information regarding the the addition and activation of software packages is not covered in this procedure.

The main difference between the standard upgrade procedure and the procedure required to upgrade from Release 3.x to 4.x is that the later requires the addition of one additional software package, known as the *upgrade package* (asr9k-upgrade-p.pie).

**Before you begin**

Before performing this procedure, see the adding and activating software package procedures described in this module.

**SUMMARY STEPS**

1. **admin**
2. **install add tftp:// hostname\_or\_ipaddress / directory-path / mandatory-bundle-pie**
3. **install add tftp:// hostname\_or\_ipaddress / directory-path / asr9k-upgrade-p.pie**
4. **install activate device:mandatory-bundle-pie device:upgrade-package**
5. **install deactivate device:upgrade-package**
6. (Optional) **install commit**
7. **install remove device:upgrade-package**

**DETAILED STEPS**

	<b>Command or Action</b>	<b>Purpose</b>
<b>Step 1</b>	Required: <b>admin</b> <b>Example:</b> <pre>RP/0/RSP0/CPU0:router# admin</pre>	Enters administration EXEC mode.
<b>Step 2</b>	<b>install add tftp:// hostname_or_ipaddress / directory-path / mandatory-bundle-pie</b> <b>Example:</b> <pre>RP/0/RSP0/CPU0:router(admin)# install add tftp://10.1.1.1/auto/tftpboot/usr/400/asr9k-mini-p.pie</pre>	Unpacks the mandatory bundle PIE file from a network server and adds the package file to the boot device of the router. <b>Note</b> Refer to the standard procedure to add and activate packages to see other options of PIE file locations and a description of the various arguments for the <b>install add</b> command.
<b>Step 3</b>	<b>install add tftp:// hostname_or_ipaddress / directory-path / asr9k-upgrade-p.pie</b> <b>Example:</b> <pre>RP/0/RSP0/CPU0:router(admin)# install add tftp://10.1.1.1/auto/tftpboot/usr/400/asr9k-upgrade-p.pie</pre>	Unpacks the upgrade PIE file from a network server and adds the package file to the boot device of the router.
<b>Step 4</b>	<b>install activate device:mandatory-bundle-pie device:upgrade-package</b> <b>Example:</b> <pre>RP/0/RSP0/CPU0:router(admin)# install activate disk0:asr9k-mini-p-4.0.0 disk0:asr9k-upgrade-p-4.0.0</pre>	Activates the package that was added to the router together with the upgrade package. <b>Note</b> The bundle of mandatory packages and the upgrade bundle are activated together to perform the successful upgrade from release 3.x to 4.x.

	Command or Action	Purpose
<b>Step 5</b>	<b>install deactivate</b> <i>device:upgrade-package</i> <b>Example:</b> RP/0/RSP0/CPU0:router(admin)# install deactivate disk0:asr9k-upgrade-p-4.0.0	Deactivates the upgrade package on the router. For specific information regarding the deactivation and removal of software packages, refer to the general procedure.
<b>Step 6</b>	(Optional) <b>install commit</b> <b>Example:</b> RP/0/RSP0/CPU0:router(admin)# install commit	Commits the current set of packages so that these packages are used if the router is restarted. Packages can be removed only if the deactivation operation is committed.
<b>Step 7</b>	Required: <b>install remove</b> <i>device:upgrade-package</i> <b>Example:</b> RP/0/RSP0/CPU0:router(admin)# install remove disk0:asr9k-upgrade-p-4.0.0	Removes the inactive upgrade package.

### Example

The following example illustrates the upgrade operation:

```
RP/0/RSP0/CPU0:router(admin)# install add /tftp://223.255.254.254/auto/tftpboot/users/user/
asr9k-mini-p.pie

Fri Jul 9 03:53:11.052 UTCRP/0/RP1/CPU0:Jul 9 03:53:12.053 :
instdir[235]: %INSTALL-INSTMGR-6-INSTALL_OPERATION_STARTED :
Install operation 4 '(admin) install add
/tftp://223.255.254.254/auto/tftpboot/users/user/asr9k-mini-p.pie'
started by user 'lab'
Install operation 4 '(admin) install add
/tftp://223.255.254.254/auto/tftpboot/users/user/asr9k-mini-p.pie'
started by user 'lab' via CLI at 03:53:12 UTC Fri Jul 09 2010.
The install operation will continue asynchronously.
RP/0/RSP0/CPU0:router(admin)#
Info: The following package is now available to be activated:
Info: disk0:asr9k-mini-p-4.0.0
Info: The package can be activated across the entire router.
Info: RP/0/RP1/CPU0:Jul 9 04:32:26.152 : instdir[235]:
%INSTALL-INSTMGR-6-INSTALL_OPERATION_COMPLETED_SUCCESSFULLY :
Info: Install operation 4 completed successfully
Info: Install operation 4 completed successfully at 04:32:26 UTC Fri Jul 09 2010.
RP/0/RSP0/CPU0:router(admin)# install add /tftp://223.255.254.254/auto/tftpboot/users/user/
asr9k-mpls-p.pie

Fri Jul 9 05:07:52.237 UTCRP/0/RP1/CPU0:Jul 9 05:07:53.710 : instdir[235]:
%INSTALL-INSTMGR-6-INSTALL_OPERATION_STARTED :
Info: Install operation 5 '(admin) install add
Info: /tftp://223.255.254.254/auto/tftpboot/users/user/asr9k-mpls-p.pie'
Info: started by user 'lab'
Info: Install operation 5 '(admin) install add
Info: /tftp://223.255.254.254/auto/tftpboot/users/user/asr9k-mpls-p.pie'
Info: started by user 'lab' via CLI at 05:07:53 UTC Fri Jul 09 2010.
Info: The install operation will continue asynchronously.
RP/0/RSP0/CPU0:router(admin)#
```

```

Info:    RP/0/RP1/CPU0:Jul  9 05:09:08.854 : instdir[235]:
%INSTALL-INSTMGR-6-INSTALL_OPERATION_COMPLETED_SUCCESSFULLY :
Install operation 5 completed successfully
Info:    The following package is now available to be activated:
Info:    disk0:asr9k-mpls-p-4.0.0
Info:    The package can be activated across the entire router.
Info:    Install operation 5 completed successfully at 05:09:08 UTC Fri Jul 09 2010.
RP/0/RSP0/CPU0:router# install add /tftp://223.255.254.254/auto/tftpboot/users/user/
asr9k-upgrade-p.pie

Fri Jul  9 05:10:31.133 UTCRP/0/RP1/CPU0:Jul  9 05:10:32.156 : instdir[235]:
%INSTALL-INSTMGR-6-INSTALL_OPERATION_STARTED :
Info:    Install operation 6 '(admin) install add
Info:    /tftp://223.255.254.254/auto/tftpboot/users/user/asr9k-upgrade-p.pie'
Info:    started by user 'lab'
Info:    Install operation 6 '(admin) install add
Info:    /tftp://223.255.254.254/auto/tftpboot/users/user/asr9k-upgrade-p.pie'
Info:    started by user 'lab' via CLI at 05:10:32 UTC Fri Jul 09 2010.
Info:    The install operation will continue asynchronously.
RP/0/RSP0/CPU0:router(admin)#RP/0/RP1/CPU0:
  Jul  9 05:11:55.634 : instdir[235]:
%INSTALL-INSTMGR-6-INSTALL_OPERATION_COMPLETED_SUCCESSFULLY :
Info:    Install operation 6 completed successfully
Info:    The following package is now available to be activated:
Info:    disk0:asr9k-upgrade-p-4.0.0
Info:    The package can be activated across the entire router.
Info:    Install operation 6 completed successfully at 05:11:55 UTC Fri Jul 09 2010.
RP/0/RSP0/CPU0:router(admin)# install activate disk0:asr9k-mini-p-4.0.0
disk0:asr9k-upgrade-p-4.0.0 disk0:asr9k-mpls-p-4.0.0

Fri Jul  9 05:23:23.150 UTC
Install operation 7 '(admin) install activate disk0:asr9k-mini-p-4.0.0
Info:    disk0:asr9k-upgrade-p-4.0.0 disk0:asr9k-mpls-p-4.0.0'
Info:    started by user 'lab'RP/0/RP1/CPU0:Jul  9 05:23:24.161 : instdir[235]:
%INSTALL-INSTMGR-6-INSTALL_OPERATION_STARTED :
Info:    Install operation 7 '(admin) install activate disk0:asr9k-mini-p-4.0.0
Info:    disk0:asr9k-upgrade-p-4.0.0 disk0:asr9k-mpls-p-4.0.0'
Info:    started by user 'lab' via CLI at 05:23:24 UTC Fri Jul 09 2010.\ 1% complete:
Info:    The operation can still be aborted (ctrl-c for options)
Info:    This operation will reload the following nodes in parallel:
Info:    0/RP1/CPU0 (HRP) (SDR: Owner)
Info:    0/SM0/SP (Fabric-SP) (Admin Resource)Proceed with this install operation (y/n)?
[y]
Info:    1% complete: The operation can still be aborted (ctrl-c for options)
Info:    Install Method: Parallel Reload/ 1% complete: The operation can still be aborted
(ctrl-c for options)
Info:    The install operation will continue asynchronously.
RP/0/RSP0/CPU0:router(admin)#SP/0/SM0/SP:
  Jul  9 05:36:41.152 : insthelper[62]: %INSTALL-INSTHELPER-6-RELOAD_NODE_INFO :
Info:    As part of install operation 7 this node (0/SM0/SP) will now reload.
Info:    The changes made to software configurations will not be persistent
Info:    across system reloads. Use the command '(admin) install commit' to
Info:    make changes persistent.
Info:    Please verify that the system is consistent following the software
RP/0/RP1/CPU0:Jul  9 05:36:43.962 : instdir[235]:
%INSTALL-INSTMGR-6-INSTALL_OPERATION_COMPLETED_SUCCESSFULLY :
Info:    Install operation 7 completed successfully
Info:    change using the following commands:
Info:    show system verify
Info:    install verify packages
Info:    Install operation 7 completed successfully at 05:36:43 UTC Fri Jul 09 2010.
rebooting .....Initializing DDR SDRAM...found 4096 MB
Initializing ECC on bank 0Initializing ECC on bank 1
Initializing ECC on bank 2

```

```

Initializing ECC on bank 3
Turning off data cache, using DDR for first time
Initializing NVRAM...Testing a portion of DDR SDRAM ...done
Reading ID EEPROMs .....
Initializing SQUID ...
Initializing PCI ...PCI0 device[1]: Vendor ID 0x10eePCI0 device[1]: Device ID 0x300ePCI1
device[1]:
Device ID 0x1100PCI1 device[1]: Vendor ID 0x1013PCI1 device[2]: Device ID 0x680PCI1 device[2]:
Vendor ID 0x1095PCI1 device[3]: Device ID 0x5618PCI1 device[3]: Vendor ID 0x14e4Configuring
MPPs ...
Configuring PCMCIA slots ...System Bootstrap, Version 1.53(20090311:225342) [CRS-1 ROMMON],

Copyright (c) 1994-2009 by Cisco Systems, Inc.
Acquiring backplane mastership ... successful
Preparing for fan initialization..... ready
Setting fan speed to 4000 RPMs successfulReading backplane EEPROM ...
Released backplane mastership ...Board type is 0x100002 (1048578)
Switch 0 initialized
Switch 0 Port fe1: link up (100Mb Full Duplex Copper)
Enabling watchdogG4(7457-NonSMP-MV64360 Rev 3) platform with 4096 MB of main memory....

CARD_RACK_NUMBER: 0    CARD_SLOT_NUMBER: 1    CPU_INSTANCE: 1
RACK_SERIAL_NUMBER: TBC08052402
MBI Validation starts ... using Control Plane Ethernet.
DEBUG : Driving up signal strength for Intel LXT971
Our MAC address is 0005.9a3e.89da
Interface link changed state to UP.
Interface link state up.
MBI validation sending request.
HIT CTRL-C to abort
MBI validation sending request.
HIT CTRL-C to abort
MBI validation sending request.
HIT CTRL-C to abort
MBI validation sending request.
HIT CTRL-C to abort
MBI validation sending request.
HIT CTRL-C to abort
No MBI confirmation received from dSCboot: booting from
bootflash:disk0/asr9k-os-mpi-4.0.0/mbiasr9k-rp.vm
.....
#####

Restricted Rights LegendUse, duplication, or disclosure by the Government is
subject to restrictions as set forth in subparagraph(c) of the Commercial Computer Software
- Restricted
Rights clause at FAR sec. 52.227-19 and subparagraph(c) (1) (ii) of the Rights in Technical
Data and Computer
Software clause at DFARS sec. 252.227-7013.
cisco Systems, Inc.
170 West Tasman Drive
San Jose, California 95134-1706
Cisco IOS XR Software for the Cisco XR Router, Version 4.0.0 Copyright (c) 2010 by Cisco
Systems, Inc.
Jul 09 05:39:21.334 : Install (Node Preparation): Booting with software activated by previous
install
operation,errno=2
RP/0/RP1/CPU0:Jul 9 05:44:45.941: syslogd_helper: [89]: dsc_event_handler: Got SysMgr dSC
event : 1
RP/0/RP1/CPU0:Jul 9 05:45:11.354 : shelfmgr[306]: %PLATFORM-SHELFMGR-3-POWERDOWN_RESET :
Node 0/2/SP is powered off due to admin power off request ios con0/RP1/CPU0 is now available
Press RETURN to get started.
RP/0/RP1/CPU0:Jul 9 05:45:27.453 : instdir[216]:

```



```
%INSTALL-INSTMGR-4-ACTIVE_SOFTWARE_COMMITTED_INFO :
The currently active software is not committed. If the system reboots then the committed
software will be used.
Use 'install commit' to commit the active software. SYSTEM CONFIGURATION IN PROCESS
The startup configuration for this device is presently loading.
This may take a few minutes. You will be notified upon completion.
Please do not attempt to reconfigure the device until this process is complete.
User Access VerificationUsername: labPassword:
RP/0/RSP0/CPU0:router# admin
Fri Jul 9 05:45:55.941 UTC
RP/0/RSP0/CPU0:router(admin)# show platform
```

Fri Jul 9 05:45:59.805 UTC	Node	Type	PLIM	State
-----				
0/2/SP	MSC(SP)	N/A	UNPOWERED	NPWR, NSHUT, MON
0/RP1/CPU0	RP(Active)	N/A	IOS XR RUN	PWR, NSHUT, MON
0/SM0/SP	FC-40G/S(SP)	N/A	MBI-RUNNING	PWR, NSHUT, MON
0/SM1/*	UNKNOWN	N/A	PRESENT	PWR, NSHUT, MON

```
RP/0/RP1/CPU0:ios(admin)#
RP/0/RP1/CPU0:Jul 9 05:46:08.411 : instdir_lr[217]:
%INSTALL-INSTMGR-4-ACTIVE_SOFTWARE_COMMITTED_INFO :
The currently active software is not committed. If the system reboots then the committed
software will be used.
Use 'install commit' to commit the active software.
RP/0/RP1/CPU0:Jul 9 05:50:40.918 : placed[283]: LR-PLANE-READY DECLARATIONSYSTEM
CONFIGURATION COMPLETED
RP/0/RP1/CPU0:Jul 9 05:50:57.293 : ifmgr[213]: %PKT_INFRA-LINK-3-UPDOWN :
Interface MgmtEth0/RP1/CPU0/0, changed state to Down
RP/0/RP1/CPU0:Jul 9 05:50:57.313 : ifmgr[213]: %PKT_INFRA-LINK-3-UPDOWN :
Interface MgmtEth0/RP1/CPU0/0, changed state to Up
RP/0/RSP0/CPU0:router(admin)# show platform
```

Fri Jul 9 05:59:36.266 UTC	Node	Type	PLIM	State	Config State
-----					
0/2/SP	MSC(SP)	N/A	UNPOWERED	NPWR, NSHUT, MON	
0/RP1/CPU0	RP(Active)	N/A	IOS XR RUN	PWR, NSHUT, MON	
0/SM0/SP	FC-40G/S(SP)	N/A	IOS XR RUN	PWR, NSHUT, MON	
0/SM1/*	UNKNOWN	N/A	PRESENT	PWR, NSHUT, MON	

```
RP/0/RSP0/CPU0:router(admin)# install commit
```

```
Fri Jul 9 05:59:41.851 UTC
Install operation 8 '(admin) install commit' started by user 'lab' via CLI at
05:59:43 UTC Fri Jul 09 2010./
20% complete: The operation can no longer be aborted (ctrl-c for options)-
20% complete: The operation can no longer be aborted (ctrl-c for options)\
100% complete:
The operation can no longer be aborted (ctrl-c for options)
RP/0/RP1/CPU0:Jul 9 05:59:46.402 : instdir[216]:
%INSTALL-INSTMGR-4-ACTIVE_SOFTWARE_COMMITTED_INFO :
The currently active software is now the same as the committed software.
Install operation 8 completed successfully at 05:59:46 UTC Fri Jul 09 2010.
RP/0/RSP0/CPU0:router(admin)# install deactivate disk0:
asr9k-upgrade-p-4.0.0
```

```
Fri Jul 9 05:59:58.082 UTC
Install operation 9 '(admin) install deactivate disk0:asr9k-upgrade-p-4.0.0' started
by user 'lab' via CLI at 05:59:59 UTC
Fri Jul 09 2010.
1% complete: The operation can still be aborted (ctrl-c for options)-
1% complete: The operation can still be aborted (ctrl-c for options)
```

```

Info:      Install Method: Parallel Process Restart\
1% complete: The operation can still be aborted (ctrl-c for options)
The install operation will continue asynchronously.
RP/0/RSP0/CPU0:router(admin)#
Info:      The changes made to software configurations will not be persistent
Info:      across system reloads. Use the command '(admin) install commit' to
Info:      make changes persistent.
Info:      Please verify that the system is consistent following the software
Info:      change using the following commands:
Info:      show system verify
Info:      install verify packages
RP/0/RP1/CPU0:Jul  9 06:01:45.662 : instdir[216]:
%INSTALL-INSTMGR-4-ACTIVE_SOFTWARE_COMMITTED_INFO :
The currently active software is not committed. If the system reboots then the committed
software will be used.
Use 'install commit' to commit the active software.
Install operation 9 completed successfully at 06:01:45 UTC Fri Jul 09 2010.
RP/0/RSP0/CPU0:router(admin)# install commit

Fri Jul  9 06:01:53.583 UTC
Install operation 10 '(admin) install commit' started by user 'lab' via CLI at06:01:54 UTC
  Fri Jul 09 2010./
20% complete: The operation can no longer be aborted (ctrl-c for options)-
20% complete: The operation can no longer be aborted (ctrl-c for options)\
100% complete: The operation can no longer be aborted (ctrl-c for options)
RP/0/RP1/CPU0:Jul  9 06:01:57.807 : instdir[216]:
%INSTALL-INSTMGR-4-ACTIVE_SOFTWARE_COMMITTED_INFO :
The currently active software is now the same as the committed software.
Install operation 10 completed successfully at 06:01:57 UTC Fri Jul 09 2010.
RP/0/RSP0/CPU0:router(admin)#
RP/0/RSP0/CPU0:router(admin)#
RP/0/RSP0/CPU0:router(admin)# install remove disk0:
asr9k-upgrade-p-4.0.0

Fri Jul  9 06:04:57.676 UTC
Install operation 11 '(admin) install remove disk0:asr9k-upgrade-p-4.0.0' started
  by user 'lab' via CLI at 06:04:58 UTC
  Fri Jul 09 2010./
1% complete: The operation can no longer be aborted (ctrl-c for options)
Info:      This operation will remove the following packages:
Info:      disk0:asr9k-fpd-4.0.0
Info:      disk0:asr9k-doc-4.0.0
Info:      disk0:asr9k-k9sec-4.0.0
Info:      disk0:asr9k-sbc-4.0.0
Info:      disk0:asr9k-diags-4.0.0
Info:      disk0:asr9k-mgbl-4.0.0
Info:      disk0:asr9k-mcast-4.0.0
Info:      disk0:asr9k-mpls-4.0.0
Info:      disk0:asr9k-rout-4.0.0
Info:      disk0:asr9k-fwdg-4.0.0
Info:      disk0:asr9k-lc-4.0.0
Info:      disk0:asr9k-admin-4.0.0
Info:      disk0:asr9k-upgrade-p-4.0.0-
1% complete: The operation can no longer be aborted (ctrl-c for options)
Info:      After this install remove the following install rollback point will
Info:      no longer be reachable, as the required packages will not be present:
Info:      7\
1% complete: The operation can no longer be aborted (ctrl-c for options)
Proceed with removing these packages? [confirm]
1% complete: The operation can no longer be aborted (ctrl-c for options)
The install operation will continue asynchronously.
RP/0/RSP0/CPU0:router(admin)#SP/0/SM0/SP:Jul
  9 06:05:03.902 : envmon[117]: %PLATFORM-ENVMON-4-ALARM : MINOR_HI alarm
cleared by host__temp__Inlet0

```

```

Install operation 11 completed successfully at 06:05:33 UTC
Fri Jul 09 2010.
RP/0/RSP0/CPU0:router(admin)#
RP/0/RSP0/CPU0:router(admin)# show install act
Fri Jul 9 06:08:11.372 UTC
Secure Domain Router: Owner Node 0/RP1/CPU0 [HRP] [SDR: Owner]
Boot Device: disk0:      Boot Image: /disk0/asr9k-os-mpi-4.0.0/mbiasr9k-rp.vm
Active Packages:      disk0:asr9k-mps-p-4.0.0      disk0:asr9k-mini-p-4.0.0
Admin Resources: Node 0/SM0/SP [Fabric-SP] [Admin Resource]
Boot Device: bootflash:  Boot Image: /disk0/asr9k-os-mpi-4.0.0/sp/mbiasr9k-sp.vm
Active Packages:      disk0:asr9k-mini-p-4.0.0
RP/0/RSP0/CPU0:router(admin)#

```

### Related Topics

[Activation and Deactivation Prerequisites](#), on page 144

[Adding and Activating Packages](#), on page 158

[Deactivating and Removing Cisco IOS XR Software Packages](#), on page 175

## Deactivating and Removing Cisco IOS XR Software Packages

When a package is deactivated, it is no longer active on the router, but the package files remain on the boot disk. The package files can be reactivated later, or they can be removed from the disk.

A package is deactivated using the following methods:

- When a newer version of a package is activated, the earlier version of the package is automatically deactivated. See *Related Topics* for more information.



---

**Note** Activating a software maintenance upgrade (SMU) does not cause any earlier SMUs or the package to which the SMU applies to be automatically deactivated.

---

- When an earlier version of a package is activated, the newer version is deactivated automatically. See *Related Topics* for more information.
- A specific package is deactivated using the **install deactivate** command. This command turns off the package features for a card or card type.

### Before you begin

The following are the restrictions when deactivating and removing Cisco IOS XR Software packages:

- A package cannot be deleted if it is part of the running or committed software of the SDR.
- A package cannot be deactivated if that package is required by another active package. When a deactivation is attempted, the system runs an automatic check to ensure that the package is not required by other active packages. The deactivation is permitted only after all compatibility checks have been passed.
- Router reloads: If the deactivation requires a router reload, a confirmation prompt appears. Use the **install deactivate** command with the **prompt-level none** keywords to automatically ignore any reload confirmation prompts and proceed with the package deactivation. The router reloads if required.
- Node reloads: If a software operation requires a node reload, the configuration register for that node should be set to autoboot. If the config-register for the node is not set to autoboot, then the system automatically changes the setting and the node reloads. A message describing the change is displayed.
- FPD versions must be compatible with the Cisco IOS XR software that is running on the router; if an incompatibility exists between an FPD version and the Cisco IOS XR software, the device with the

field-programmable gate array (FPGA) may not operate properly until the incompatibility is resolved. For information on FPDs, including instructions to upgrade FPD images, see the *Upgrading FPD Cisco IOS XR Software* module of *Interface and Hardware Component Configuration Guide for Cisco ASR 9000 Series Routers*.

## SUMMARY STEPS

1. Connect to the console port and log in.
2. **admin**
3. **install deactivate** { **id** *add-id* | *device : package* } [ **location** *node-id* ] [ **test** ] [ **pause sw-change** ]
4. (Optional) **show install inactive summary**
5. (Optional) **install verify packages**
6. **exit**
7. (Optional) **show system verify start**
8. (Optional) **show system verify** [ **detail** | **report** ]
9. **admin**
10. (Optional) **install commit**
11. (Optional) **install remove** { **id** *add-id* | *device : package* | **inactive** } [ **test** ]

## DETAILED STEPS

	Command or Action	Purpose
<b>Step 1</b>	Connect to the console port and log in.	Establishes a CLI management session with the SDR.  Connect to the console port for the active DSC.  For more information on console connections, see <i>Cisco ASR 9000 Series Aggregation Services Router Getting Started Guide</i> .
<b>Step 2</b>	Required: <b>admin</b>  <b>Example:</b>  RP/0/RSP0/CPU0:router# admin	Enters administration EXEC mode.
<b>Step 3</b>	<b>install deactivate</b> { <b>id</b> <i>add-id</i>   <i>device : package</i> } [ <b>location</b> <i>node-id</i> ] [ <b>test</b> ] [ <b>pause sw-change</b> ]  <b>Example:</b> RP/0/RSP0/CPU0:router(admin)# install deactivate disk0:asr9k-diags-3.7.2	Deactivates a package on all SDRs a router.  <ul style="list-style-type: none"> <li>• To deactivate all packages that were added in one or more specific install add operations, or specify packages by name, use the <b>id</b> <i>add-id</i> keyword and argument. The operation ID of an install add operation is indicated in the syslog displayed during the operation and in the output of the <b>show install log</b> command.</li> <li>• Use the <b>location</b> <i>node-id</i> keyword and argument to deactivate the package for a specific node, if supported.</li> </ul>

	Command or Action	Purpose
		<ul style="list-style-type: none"> <li>Use the <b>pause sw-change</b> keywords to pause the operation after preparatory checks and before the configuration is locked for the actual deactivation. This enables you to hold the operation while you perform configuration changes, and proceed with the deactivation whenever you choose. This is useful, for example, if your workflow involves configuring a router out of the network during software changes and you want to minimize the time that the router is out of the network. Follow the onscreen instructions to control the pausing and completion of the operation.</li> </ul> <p><b>Note</b> Press <b>?</b> after a partial package name to display all possible matches available for deactivation. If there is only one match, press [TAB] to fill in the rest of the package name.</p> <p>When a package is deactivated for an SDR from administration EXEC mode, a notification message appears on the console for that SDR, with information on the impact of the deactivation.</p>
<b>Step 4</b>	(Optional) <b>show install inactive summary</b> <b>Example:</b> <pre>RP/0/RSP0/CPU0:router(admin)# show install inactive summary</pre>	Displays the inactive packages on the router.
<b>Step 5</b>	(Optional) <b>install verify packages</b> <b>Example:</b> <pre>RP/0/RSP0/CPU0:router(admin)# install verify packages</pre>	Verifies the consistency of an installed software set with the package file from which it originated. This command can be used as a debugging tool to verify the validity of the files that constitute the packages, to determine if there are any corrupted files. This command also checks for corruptions of installation state files and MBI image files. This command is particularly useful when issued after the activation of a package or upgrading the Cisco IOS XR software to a major release.  <b>Note</b> The <b>install verify packages</b> command can take up to two minutes per package to process.
<b>Step 6</b>	Required: <b>exit</b> <b>Example:</b> <pre>RP/0/RSP0/CPU0:router(admin)# exit</pre>	Exits administration EXEC mode and returns to EXEC mode.
<b>Step 7</b>	(Optional) <b>show system verify start</b> <b>Example:</b>	Starts the system status check.

	Command or Action	Purpose
	RP/0/RSP0/CPU0:router# show system verify start	
<b>Step 8</b>	<p>(Optional) <b>show system verify</b> [ <b>detail</b>   <b>report</b> ]</p> <p><b>Example:</b></p> <pre>RP/0/RSP0/CPU0:router# show system verify</pre>	<p>Displays system status information. A variety of information is displayed including the memory and CPU usage, process status, protocol status, and other status information. Use this information to verify that the system is stable.</p> <ul style="list-style-type: none"> <li>• <b>detail</b>—Displays additional information at the card and processor level, including actual numbers.</li> <li>• <b>report</b>—Displays the same information as the default <b>show system verify</b> command</li> </ul> <p><b>Note</b> Although most of the output should display the status “OK,” some processes may show other output, such as “Warning.” This does not specifically indicate a problem. Contact your Cisco technical support representative for more information on the output of this command.</p>
<b>Step 9</b>	<p><b>admin</b></p> <p><b>Example:</b></p> <pre>RP/0/RSP0/CPU0:router# admin</pre>	Enters administration EXEC mode.
<b>Step 10</b>	<p>(Optional) <b>install commit</b></p> <p><b>Example:</b></p> <pre>RP/0/RSP0/CPU0:router(admin)# install commit</pre>	<p>Commits the current set of packages so that these packages are used if the router is restarted. Packages can be removed only if the deactivation operation is committed.</p> <p><b>Note</b> This command is entered in administration EXEC mode.</p>
<b>Step 11</b>	<p>(Optional) <b>install remove</b> { <b>id</b> <i>add-id</i>   <i>device</i> : <i>package</i>   <b>inactive</b> } [ <b>test</b> ]</p> <p><b>Example:</b></p> <pre>RP/0/RSP0/CPU0:router(admin)# install remove disk0:asr9k-diags-3.8.30</pre>	<p>Removes the inactive package.</p> <ul style="list-style-type: none"> <li>• Only inactive packages can be removed.</li> <li>• Packages can be removed only if they are deactivated from all cards in the router.</li> <li>• The package deactivation must be committed.</li> <li>• To remove a specific inactive package from a storage device, use the <b>install remove</b> command with the <i>device: package</i> arguments.</li> <li>• To remove all packages that were added in one or more specific <b>install add</b> operations, use the <b>id</b> <i>add-id</i> keyword and argument. The operation ID of an <b>install add</b> operation is indicated in the syslog displayed during the operation and in the output of the <b>show install log</b> command. If you specify packages according to operation ID, all the packages</li> </ul>

	Command or Action	Purpose
		<p>that were added by the specified operation must still be on the router.</p> <ul style="list-style-type: none"> <li>To remove all inactive packages from all nodes in the system, use the <b>install remove</b> command with the <b>inactive</b> keyword.</li> </ul>

### Related Topics

[Adding and Activating Packages](#), on page 158

[Committing the Active Package Set](#), on page 166

## Examples

In the following examples, a package is deactivated from the router. The changes are committed and the inactive package is removed from the router.

### Deactivating the Package: Example

```
RP/0/RSP0/CPU0:router(admin)# install deactivate disk0:asr9k
-diags-.7.2
```

```
Install operation 27 'install deactivate disk0:asr9k-diags-3.7.2' started by
user 'lab' at 23:29:37 UTC Sat Apr 15 2009.
The install operation will continue asynchronously.
Info:      The changes made to software configuration
Info:      across system reloads. Use the command 'admin install commit' to make
Info:      changes persistent.
Info:      Please verify that the system is consistent following the software
Info:      change using the following commands:
Info:      show system verify
Info:      install verify packages
Install operation 27 completed successfully at 23:30:22 UTC Sat Apr 15 2009.
```

### Committing the Active Software Set: Example

```
RP/0/RSP0/CPU0:router(admin)# install commit
```

```
Install operation 29 'install commit' started by user 'lab' at 23:39:21 UTC
Sat Apr 15 2009.
Install operation 29 completed successfully at 23:39:24 UTC Sat Apr 15 2009.
```

### Displaying the Inactive Packages: Example

```
RP/0/RSP0/CPU0:router(admin)# show install inactive summary
```

```
Default Profile:
SDRs:
Owner
Inactive Packages:
disk0:asr9k-diags-3.7.2
```

### Removing the Inactive Package from the Router: Example

The following example shows how to remove an inactive package. In this example, the operation is run in test mode. The operation is confirmed and the package is removed.

```
RP/0/RSP0/CPU0:router(admin)# install remove disk0:asr9k-diags-3.7.2 test

Install operation 30 'install remove disk0:hfr-diags-3.7.2 test' started by
user 'lab' at 23:40:22 UTC Sat Apr 15 2009.
Warning: No changes will occur due to 'test' option being specified. The
Warning: following is the predicted output for this install command.
Info: This operation will remove the following package:
Info: disk0:asr9k-diags-3.7.2
Info: After this install remove the following install rollback points will
Info: no longer be reachable, as the required packages will not be present:
Info: 4, 9, 10, 14, 15, 17, 18
Proceed with removing these packages? [confirm] y

The install operation will continue asynchronously.
Install operation 30 completed successfully at 23.
```

### Pausing Before Configuration Lock: Example

The following example shows how to deactivate a package, pausing the operation before locking the configuration for the actual software deactivation. While the operation is paused, you can enter a configuration mode and perform configurations. When you want to complete the operation, enter the **install operation id complete** command, or the **install operation id attach synchronous** command.

```
RP/0/RSP0/CPU0:router(admin)# install deactivate disk0:comp-asr9k
-3.7.2.07I.CSCsr09575-1.0.0 pause sw-change

Install operation 12 '(admin) install deactivate
disk0:comp-asr9k-3.7.2.07I.CSCsr09575-1.0.0 pause sw-change'
started by user 'admin' via CLI at 09:06:26 BST Mon Jul 07 2009.
Info: This operation will reload the following nodes in parallel:
Info: 0/0/CPU0 (RP) (SDR: Owner)
Info: 0/1/CPU0 (LC(E3-GE-4)) (SDR: Owner)
Info: 0/5/CPU0 (LC(E3-OC3-POS-4)) (SDR: Owner)
Proceed with this install operation (y/n)? [y]
The install operation will continue asynchronously.
Info: Install Method: Parallel Reload
Info: Install operation 12 is pausing before the config lock is applied for
Info: the software change as requested by the user.
Info: No further install operations will be allowed until the operation is resumed.
Info: Please continue the operation using one of the following steps:
Info: - run the command '(admin) install operation 12 complete'.
Info: - run the command '(admin) install operation 12 attach synchronous' and then
Info: answer the query.
```

## Rolling Back to a Previous Software Set

Cisco IOS XR software allows you to roll back one or more SDRs to a previous committed or uncommitted software set. Use the **show install rollback ?** command to view the available rollback points and use the **install rollback to** command to roll back the SDR to a previous software set. You can also use the **install rollback to committed** command to roll back to the most recent committed software set.





---

**Note** Rollback operations can be performed by running the command in administration EXEC or EXEC mode.

---



---

**Note** If type 8,9, or 10 is the secret key configured, then before downgrading to 6.6.3 and earlier versions, perform either of the following methods:

- Type a combination of secret type and encrypted key instead of plain text for the password. Example:

```
username root
group root-lr
group cisco-support
secret 10
$6$mwaqg/jdBFO4g/.$PrJP2KjsCbL6bZqmYOej5Ay67S/sSWJN1kiYhCTc/B/35E1kJBqffmBtn.ddQEHO02CU7V.ZEMmqIq7uE8cfz0
```

This is because 6.6.3 and earlier versions do not support type 8,9, or 10 key type.

- Ensure that there are secret type 5 users on the system.
- 

## Displaying Rollback Points

A rollback point is created every time a software package is activated, deactivated, or committed. Use the **show install rollback ?** command to display the eligible rollback points.

```
RP/0/RSP0/CPU0:router# admin
RP/0/RSP0/CPU0:router(admin)# show install rollback ?

 0 ID of the rollback point to show package information for
 2 ID of the rollback point to show package information for
```

In this example, the rollback points are 0 and 2. The rollback point with the highest number is the current software point. For example, if the last installation operation was operation 3 (activating the MPLS package) then the highest rollback point is 3, which is the same as the current software (MPLS package activated).

To easily identify specific rollback points, you can assign a label or description to a rollback point using the **install label** command.

You can enter the command in either administration EXEC mode or EXEC mode.

## Displaying the Active Packages Associated with a Rollback Point

To display the active packages associated with a rollback point, use the **show install rollback** command with the *point-id* argument. This command displays the packages that are active if you roll back one or more SDRs to that installation point. For example, the **show install rollback 2** command displays the packages that are active if you roll back to rollback point 2.

```
RP/0/RSP0/CPU0:router(admin)# show install rollback 0

Tue Jun 23 06:25:06.493 PST
ID: 0, Label:
```

```

Timestamp: 23:11:20 UTC Sat Oct 28 2000

Secure Domain Router: Owner

Node 0/RSP0/CPU0 [RP] [SDR: Owner]
  Boot Device: disk0:
  Boot Image: /disk0/asr9k-os-mpi-3.9.0.12I/mbiasr9k-rp.vm
  Rollback Packages:
    disk0:comp-asr9k-mini-3.9.0.12I

Node 0/1/CPU0 [LC] [SDR: Owner]
  Boot Device: mem:
  Boot Image: /disk0/asr9k-os-mpi-3.9.0.12I/lc/mbiasr9k-lc.vm
  Rollback Packages:
    disk0:comp-asr9k-mini-3.9.0.12I

Node 0/4/CPU0 [LC] [SDR: Owner]
  Boot Device: mem:
  Boot Image: /disk0/asr9k-os-mpi-3.9.0.12I/lc/mbiasr9k-lc.vm
  Rollback Packages:
    disk0:comp-asr9k-mini-3.9.0.12I

Node 0/6/CPU0 [LC] [SDR: Owner]
  Boot Device: mem:
  Boot Image: /disk0/asr9k-os-mpi-3.9.0.12I/lc/mbiasr9k-lc.vm
  Rollback Packages:
    disk0:comp-asr9k-mini-3.9.0.12I

```

You can enter the command in either administration EXEC mode or EXEC mode.



---

**Note** For more information on the command options, see the *Software Package Management Commands on Cisco IOS XR Software* module of *System Management Command Reference for Cisco ASR 9000 Series Routers*.

---

## Rolling Back to a Specific Rollback Point

You can roll back to a specific rollback point, including a noncommitted software set:

- If you roll back to the most recent noncommitted rollback point (with the highest number), you do not need to reload the router.
- You can repeat the rollback process one rollback point at a time without reloading if you always choose the most recent rollback point.
- If you choose a rollback point that is older than the most recent point, the impacted nodes reload, interrupting data traffic on those nodes. Before the reload occurs, you are prompted to confirm the install rollback operation.

In the following example, the system is rolled back to noncommitted rollback point 8:

```

RP/0/RSP0/CPU0:router(admin)# install rollback to 8

Install operation 10 'install rollback to 8' started by user 'cisco' at 07:49:26
UTC Mon Nov 14 2009.
The install operation will continue asynchronously.
Info:      The changes made to software configurations will not be persistent
Info:      across system reloads. Use the command 'admin install commit' to make
Info:      changes persistent.

```

```

Info:      Please verify that the system is consistent following the software
Info:      change using the following commands:
Info:      show system verify
Info:      install verify packages

```

The currently active software is the same as the committed software.

Install operation 10 completed successfully at 07:51:24 UTC Mon Nov 14 2009.

## Rolling Back to the Last Committed Package Set

Use the **install rollback to committed** command to roll back to the last committed package set.

In the following example, the owner SDR is rolled back to the last committed package set:

```

RP/0/RSP0/CPU0:router(admin)# install rollback to committed

Install operation 27 'install rollback to committed' started by user 'lab' at
16:41:38 UTC Sat Nov 19 2009.
Info:      The rollback to committed software will require a reload of impacted
Info:      nodes because it is over multiple activation & deactivation
Info:      operations.
Info:      This operation will reload the following node:
Info:      0/RP1/CPU0 (RP) (SDR: Owner)
Info:      This operation will reload all RPs in the Owner SDR, and thereby
Info:      indirectly cause every node in the router to reload.

Proceed with this install operation? [confirm]

Updating Commit Database. Please wait...[OK]
Info:      The changes made to software configurations will not be persistent
Info:      across system reloads. Use the command 'admin install commit' to make
Info:      changes persistent.
Info:      Please verify that the system is consistent following the software
Info:      change using the following commands:
Info:      show system verify
Info:      install verify packages
Install operation 27 completed successfully at 16:42:23 UTC Sat Nov 19 2009.

```

## Resetting Router to Factory Settings

The logical volumes and ROMMON variables of CPU boards on a router can be reset to factory settings using zapdisk feature. After enabling the zapdisk feature on the router, the CPU boards are reset to factory settings in the next reimage of the boards. During the reimage process, all logical volumes of the CPU boards including the files saved in harddisk: are cleaned up, and ROMMON variables of the CPU boards are reset to factory settings.

### Step 1 admin

#### Example:

```
Router# admin
```

Enters the System Admin EXEC mode.

**Step 2**    **zapdisk set****Example:**

```
sysadmin-vm:0_RP0# zapdisk set
Fri Jul 21 22:32:29.242 UTC
result Zapdisk set command success
```

Enables zapdisk feature.

**Note** To disable the zapdisk feature, run the **zapdisk unset** command:

```
sysadmin-vm:0_RP0# zapdisk unset
Fri Jul 21 22:32:29.242 UTC
result Zapdisk unset command success
```

**Step 3**    **run****Example:**

```
sysadmin-vm:0_RP0# run
[sysadmin-vm:0_RP0:~]$/opt/cisco/calvados/bin/nvram_dump -a
PS1=rommon ! >
ZAPDISK_CARD=1
```

Verifies status of zapdisk feature on the CPU board. ZAPDISK\_CARD=1 indicates that zapdisk feature is enabled; ZAPDISK\_CARD=0 indicates that zapdisk feature is disabled.

---

## Additional References

The following sections provide references related to software package management on Cisco IOS XR software.

**Related Documents**

Related Topic	Document Title
Cisco IOS XR install commands	<i>Software Package Management Commands on the Cisco ASR 9000 Series Router</i> module of <i>System Management Command Reference for Cisco ASR 9000 Series Routers</i>
Cisco IOS XR getting started material	<i>Cisco ASR 9000 Series Aggregation Services Router Getting Started Guide</i>
Cisco IOS XR master command index	<i>Cisco ASR 9000 Series Aggregation Services Router Commands Master List</i>
Information about user groups and task IDs	<i>Configuring AAA Services on the Cisco ASR 9000 Series Router</i> module of <i>System Security Configuration Guide for Cisco ASR 9000 Series Routers</i>
ROM Monitor	<i>ROM Monitor Configuration Guide for Cisco ASR 9000 Routers</i>

**Standards**

Standards	Title
No new or modified standards are supported by this feature, and support for existing standards has not been modified by this feature.	—

**MIBs**

MIBs	MIBs Link
—	To locate and download MIBs using Cisco IOS XR software, use the Cisco MIB Locator found at the following URL and choose a platform under the Cisco Access Products menu: <a href="http://cisco.com/public/sw-center/netmgmt/cmtk/mibs.shtml">http://cisco.com/public/sw-center/netmgmt/cmtk/mibs.shtml</a>

**RFCs**

RFCs	Title
No new or modified RFCs are supported by this feature, and support for existing RFCs has not been modified by this feature.	—

**Technical Assistance**

Description	Link
The Cisco Technical Support website contains thousands of pages of searchable technical content, including links to products, technologies, solutions, technical tips, and tools. Registered Cisco.com users can log in from this page to access even more content.	<a href="http://www.cisco.com/cisco/web/support/index.html">http://www.cisco.com/cisco/web/support/index.html</a>





## CHAPTER 8

# In Service Software Upgrade for Cisco IOS XR 64 Bit

---

This module contains the following topics:

- [Overview of ISSU on ASR 9000 with IOS XR 64 Bit](#) , on page 187
- [Restrictions and Usage Guidelines](#), on page 188
- [Pre-Installation Tasks](#), on page 189
- [ISSU on ASR 9000 with IOS XR 64 Bit: Single Phase Installation](#) , on page 192
- [ISSU on ASR 9000 with IOS XR 64 Bit: Multi Step Installation](#), on page 196
- [Installing Packages Using ISSU : Related Commands](#), on page 197

## Overview of ISSU on ASR 9000 with IOS XR 64 Bit

In-Service Software Upgrade (ISSU) provides the ability to upgrade the IOS XR 64 Bit version on ASR 9000 with minimal disruption on the control plane and forwarding plane. ISSU supports upgrading an image from a lower to a higher version. ISSU supports zero topology loss (ZTL) and causes only a minimal packet loss of less than six seconds.

You can perform ISSU installation in a single step or as multiple phases. You need to perform the pre-installation tasks before executing ISSU. During the pre-installation tasks and ISSU execution, V1 refers to the image currently running on the router and V2 will be the upgraded image.

ISSU execution contains the following phases:

- **Prepare phase:** The installable files are pre-checked and loaded on the router before activation. This phase is optional.
- **Activate phase:** The new image (V2) is downloaded to all nodes in the router replacing the old image (V1). This phase can be run in step-by-step phases like *Load*, *Run*, and *Cleanup* or by using a one-shot *Activate* phase.



---

**Note** The *Prepare* phase is optional and can be skipped because the *Load* phase prepares the package if *Prepare* phase was not performed before the *Load* phase.

---

- **Commit phase:** The ISSU installation is complete with V2 on all nodes.

ISSU supports upgrading the System Admin VM and XR VM individually. Using ISSU, the System Admin VM and XR VM can also be upgraded sequentially. The upgrade sequence is System Admin ISSU followed by XR ISSU. Committing the upgrade from XR VM commits both the System Admin and XR software. But, committing the upgrade from System Admin VM commits only the System Admin software.



---

**Note** When RSP1 is the active RP and System Admin VM ISSU is triggered on Cisco ASR 9000 with IOS XR 64 bit, there is an additional VM switch over compared to performing System Admin VM ISSU from RSP0. This is an expected behaviour.

---

## Restrictions and Usage Guidelines

ISSU on ASR 9000 with IOS XR 64 Bit is supported only on few third generation ASR 9000 Series Ethernet line cards, RSPs and RPs.

The third generation of line cards include:

- A9K-8X100G-LB-SE
- A9K-8X100G-LB-TR
- A9K-8X100GE-SE
- A9K-8X100GE-TR
- A9K-4X100GE-SE
- A9K-4X100GE-TR
- A9K-MOD400-SE
- A9K-MOD400-TR
- A9K-MOD200-SE
- A9K-MOD200-TR
- A9K-4X100GE
- A99-12X100GE
- A99-12X100GE-CM
- A9K-24X10GE-1G-SE
- A9K-24X10GE-1G-TR
- A9K-48X10GE-1G-SE
- A9K-48X10GE-1G-TR
- A99-48X10GE-1G-SE
- A99-48X10GE-1G-TR

The third generation of RSP and RP cards include:



- A9K-RSP880-SE
- A9K-RSP880-TR
- A9K-RSP880-LT-SE
- A9K-RSP880-LT-TR
- A99-RSP-SE
- A99-RSP-TR
- A99-RP2-SE
- A99-RP2-TR

ISSU is not supported on the ASR 9000 fourth generation QSFP28 based dense 100GE line cards. The line cards include:

- A9K-16X100GE-TR
- A99-32X100GE-TR
- A99-16X100GE-X-SE

ISSU is not supported on the single RP system of ASR 9901, ASR 9902, and ASR 9903.

ISSU is not supported on ASR 9000 fifth generation line cards.

## Pre-Installation Tasks

### Pre-Installation Tasks

Before performing ISSU on ASR 9000 with IOS XR 64 Bit, complete the following tasks.

1. Configure NTP in XR VM. Once you configure NTP on XR VM, System Admin VM automatically synchronizes with NTP running on RSP. If NTP server is not available, configure clock on both XR VM and System Admin VM in configuration mode and make sure that your clock is set to the correct location and timezone.

```
RP/0/RSP0/CPU0:Router# show ntp associations
  address          ref clock      st  when  poll reach  delay  offset  disp
*~172.27.131.19    171.68.38.65  2   13   64   77   2.05 -1.174 191.09
~172.27.130.34    171.68.38.65  2   35   64   0    0.00 0.000 15937
+~172.27.130.33    171.68.38.65  2    9   64   77   2.41 10.370 189.47
* sys_peer, # selected, + candidate, - outlayer, x falseticker, ~ configured
```

```
sysadmin-vm:0_RSP0:Router# show ntp associations
Wed Oct 31 15:18:59.728 UTC-07:00
  remote          refid          st t when  poll reach  delay  offset  jitter
=====
external:
*rsp0_xr          172.27.131.19  3 u 12 128 347  0.171  0.989  0.456
  rsp1_xr          .STEP.         16 u - 256  0    0.000  0.000  0.000
internal:
*192.0.16.4       172.27.131.19  3 u 12 128 347  0.171  0.989  0.456
  192.0.20.4       .STEP.         16 u - 256  0    0.000  0.000  0.000
```

2. Ensure that the dual RP and RSP systems are synchronized and they are in active and standby roles respectively using the **show redundancy summary** command. The line card status should be *Final Band* or *Running*.

```
RP/0/RSP0/CPU0:Router# show redundancy summary

Active Node      Standby Node
-----
0/RSP0/CPU0     0/RSP1/CPU0 (Node Ready, NSR:Ready)
```

```
RP/0/RSP0/CPU0:Router# show platform vm
Node name      Node type      Partner name    SW status      IP address
-----
0/3/CPU0      LC (ACTIVE)    NONE           FINAL Band     192.0.12.3
0/7/CPU0      LC (ACTIVE)    NONE           FINAL Band     192.0.36.3
0/RSP1/CPU0    RP (STANDBY)  0/RSP0/CPU0    FINAL Band     192.0.20.4
0/4/CPU0      LC (ACTIVE)    NONE           FINAL Band     192.0.24.3
0/RSP0/CPU0    RP (ACTIVE)    0/RSP1/CPU0    FINAL Band     192.0.16.4
```

3. Ensure that firmware on linecards, RSP, and RP is upgraded to the latest version. You can upgrade the router cards in a single step by using the **upgrade hw-module location all fpd all** command. Use the **show hw-module location location fpd** command to verify the firmware versions.

```
RP/0/RSP0/CPU0:Router# upgrade hw-module location all fpd all
```

This example shows verifying the firmware versions for a node.

```
RP/0/RSP0/CPU0:Router# show hw-module location 0/rsp1 fpd
```

Location	Card type	HWver	FPD device	ATR Status	FPD Versions	
					Running	Programd
0/RSP1	A9K-RSP880-SE	1.0	Alpha-FPGA	CURRENT	0.16	0.16
0/RSP1	A9K-RSP880-SE	1.0	CBC	CURRENT	34.39	34.39
0/RSP1	A9K-RSP880-SE	1.0	Cha-FPGA	CURRENT	0.08	0.08
0/RSP1	A9K-RSP880-SE	1.0	IPU-FPGA	CURRENT	0.66	0.66
0/RSP1	A9K-RSP880-SE	1.0	IPU-FSBL	CURRENT	1.108	1.108
0/RSP1	A9K-RSP880-SE	1.0	IPU-Linux	CURRENT	1.108	1.108
0/RSP1	A9K-RSP880-SE	1.0	Omega-FPGA	CURRENT	0.16	0.16
0/RSP1	A9K-RSP880-SE	1.0	Optimus-FPGA	CURRENT	0.12	0.12
0/RSP1	A9K-RSP880-SE	1.0	Primary-BIOS	CURRENT	10.60	10.60
0/RSP1	A9K-RSP880-SE	1.0	SSDa-SMART	N/A	7.05	7.05
0/RSP1	A9K-RSP880-SE	1.0	SSDb-SMART	N/A	7.05	7.05

4. Check the disk storage space on both System Admin VM and XR VM and ensure that sufficient disk space is available. Remove files like show-tech, cores, kernel dumps, manually created text, log, debug information and so on.

This example shows verifying the disk storage space for System Admin VM and XR VM on RSP0. You also need to verify the disk space on the standby RSP (RSP1). If required you can verify the disk storage on line cards using the **show media location** command.

```
RP/0/RSP0/CPU0:Router# show media
```

Media Information for local node.

```
-----
Partition      Size      Used      Percent    Avail
rootfs:        3.8G     1.3G     34%        2.4G
/run           14G      340K      1%         14G
harddisk:     5.5G     1.6G     31%        3.6G
/run/netns     14G      340K      1%         14G
log:           469M     33M      8%         401M
config:        469M     1.7M     1%         432M
```

```

disk0:                968M    5.3M    1%    897M
harddiska:            3.6G    11M    1%    3.5G
/misc/app_host        2.4G    61M    3%    2.2G
-----
rootfs: = root file system (read-only)
log:    = system log files (read-only)
config: = configuration storage (read-only)

RP/0/RSP0/CPU0:Router# admin show media
-----
Partition              Size      Used  Percent  Avail
-----
rootfs:                2.4G    838M    38%    1.4G
harddisk:              7.6G    1.2G    17%    6.0G
log:                   469M    22M     5%    412M
config:                469M    3.3M    1%    431M
disk0:                 968M    1.6M    1%    900M
a9ksys:               736M    4.3M    1%    695M
harddiskb:             3.0G    1.2G    41%    1.8G
install:               4.8G    932M    21%    3.6G
install:/tmp           7.6G    1.2G    17%    6.0G
install:/cache         7.6G    1.2G    17%    6.0G
rootfs:/install/tmp    7.6G    1.2G    17%    6.0G
-----
rootfs: = root file system (read-only)
log:    = system log files (read-only)
config: = configuration storage (read-only)
install: = install repository (read-only)
a9ksys: = ASR9K system storage (read-only)

```

5. Populate the repository with RPMs and SMUs. You can pick and install individual RPMs, SMUs, one by one, or make a tarball and install one tarball or break it down with multiple tarballs.



**Note** You cannot include a tarball within another tarball. However, multiple tarballs can be specified at once.

```

RP/0/RSP0/CPU0:Router# install add source tftp://172.27.131.19/xrimages/e652/
asr9k-mini-x64-6.5.2.13I.iso ASR9K-RPMS-65213I.tar

RP/0/RSP0/CPU0:Router# show install request
The install add operation 4 is 80% complete
RP/0/RSP0/CPU0:Router#

RP/0/RSP0/CPU0:Router#
RP/0/RSP0/CPU0:Oct 31 19:44:34.076 : sdr_instmgr[1156]:
%INSTALL-INSTMGR-2-OPERATION_SUCCESS : Install operation 4 finished successfully
Oct 31 19:44:35 Install operation 4 finished successfully

```

6. Check the repository to validate that packages, images, or SMUs are populated properly in the router's repository by using the **show install repository** command. There should be a one to one relationship between V1 and V2 images and SMUs. For example, if you install a SMU on V1, you also need the corresponding V2 version in the repository to execute ISSU.

```

RP/0/RSP0/CPU0:Router# show install repository | i mini
asr9k-mini-x64-6.2.3          <--V1 iso image currently running
asr9k-mini-x64-6.5.2.13I    <--V2 iso image to upgrade to

```

7. Extract the ISO image in System Admin VM or XR VM depending on the version of the image.
  - For IOS XR versions prior to 6.5.1: You should extract the ISO image in XR VM as well as in System Admin VM because the system can only use packages in RPM format.

- For IOS XR version 6.5.1 and onwards: System automatically extracts the system admin package from the ISO file once you mentioned the file name while executing ISSU. You only need to extract the XR package separately.

```
RP/0/RSP0/CPU0:Router# install extract asr9k-mini-x64-6.5.2.13I
Oct 31 20:50:30 Install operation 9 started by root:
  install extract asr9k-mini-x64-6.5.2.13I
Oct 31 20:50:30 Package list:
Oct 31 20:50:30      asr9k-mini-x64-6.5.2.13I
Oct 31 20:50:31 Install operation will continue in the background

RP/0/RSP0/CPU0:Router# show install repository | i xr-

  asr9k-xr-6.5.2.13I          <--V2 extracted image to upgrade to
  asr9k-xr-6.2.3

sysadmin-vm:0_RSP0:Router# install extract asr9k-mini-x64-6.5.2.13I
result Wed Oct 31 20:36:34 2018 Install operation 1 (install extract) started by user
'root' will continue asynchronously.
sysadmin-vm:0_RSP0:MYISSU#

sysadmin-vm:0_RSP0:Router# show install repository | i sys
asr9k-sysadmin-6.2.3
asr9k-sysadmin-6.5.2.13I          <--V2 extracted image to upgrade to
```

## ISSU on ASR 9000 with IOS XR 64 Bit: Single Phase Installation

This section shows how to perform ISSU on ASR 9000 with IOS XR 64 Bit in a single step. You can either upgrade the system or install a patch in a single step. The system upgrade is done using an ISO image file, while the patch installation is done using packages and SMUs.

You should perform the following steps before performing this task:

- Copy the package to be installed either on the router's hard disk or on a network server to which the router has access.
- Ensure that dual route processor (RP) system with standby is in "is ready" state.

Perform the following steps to upgrade the system or install a patch in a single step.



---

**Note** Depending on whether you are installing a System Admin package or a XR package, execute these commands in the System Admin EXEC mode or XR EXEC mode respectively

---

1. (Optional) Prepare the installable files by using the **install prepare issu** *package\_name* command. During the prepare phase, pre-activation checks are made, and the components of the installable files are loaded on to the router setup.

For System Admin VM:

```
sysadmin-vm:0_RSP0# install prepare issu asr9k-xr-<release-version>
```

For XR VM:

```
RP/0/RSP0/CPU0:router# install prepare issu asr9k-xr-<release-version>
```

2. Activate the ISSU installation in XR VM or System Admin VM in a single step by using the **install activate issu** command.

For System Admin VM:

```
sysadmin-vm:0_RSP0# install activate issu asr9k-xr-<release-version>
```

For XR VM:

```
RP/0/RSP0/CPU0:router# install activate issu asr9k-xr-<release-version>
```



---

**Note** ISSU operation takes about 30 minutes to complete. If the ISSU operation is not concluded in 40 minutes, the ISSU may timeout or abort.

---

3. Commit the newly active software by using the **install commit** command.

For System Admin VM:

```
sysadmin-vm:0_RSP1# install commit
```

For XR VM:

```
RP/0/RSP0/CPU0:router# install commit
```

### Examples: Install Packages Using ISSU Single Step Installation on ASR 9000 with IOS XR 64 Bit

This example shows performing System Admin VM upgrade using ISSU and how to verify the installation using show commands.

```
!# Verify packages in the repository

sysadmin-vm:0_RSP0:Router# show install repository all | i "host|sysadmin"
asr9k-sysadmin-6.2.3
  asr9k-sysadmin-6.5.2.13I
  host-6.2.3
  host-6.5.2.13I
sysadmin-vm:0_RSP0:Router#

!# Performing ISSU installation

sysadmin-vm:0_RSP0:Router# install activate issu asr9k-sysadmin-6.5.2.13I host-6.5.2.13I
This install operation will result in admin VMs reload
Do you want to proceed [yes/no]: yes
Proceeding with operation
result Wed Oct 31 21:12:21 2018 Install operation 2 (install prepare and activate issu)
started by user 'root' will continue asynchronously.
sysadmin-vm:0_RSP0:Router#

!# Monitoring the progress of the installation.
!# The installation may take up to 30 minutes.

sysadmin-vm:0_RSP0:Router# show install request

User root, Op Id 2

install prepare issu

host-6.5.2.13I
```

```

This operation is 40% complete

Waiting for agents to complete host prepare ..

sysadmin-vm:0_RSP0:#

!# Verifying the installation status again after few minutes

sysadmin-vm:0_RSP0:Router# show install request
User root, Op Id 2
install activate issu
ISSU stage Phasel
asr9k-sysadmin-6.5.2.13I
Node 0/RSP0 [RP] : 90% of current state is completed
Node 0/RSP1 [RP] : 90% of current state is completed
Node 0/1 [LC] : 90% of current state is completed
Node 0/3 [LC] : 90% of current state is completed
Node 0/4 [LC] : 90% of current state is completed
Node 0/7 [LC] : 90% of current state is completed

sysadmin-vm:0_RSP0:MYISSU#

!# Message after successful completion. Admin VM will reload after this message. . There
should be no packet drop.

0/RSP0/ADMIN0:Oct 31 21:27:53.260 : inst_mgr[5019]: %INFRA-INSTMGR-2-OPERATION_SUCCESS :
Install operation 2 completed successfully

!# Verifying the active package

sysadmin-vm:0_RSP1# show install active summary
Active Packages: 1
asr9k-sysadmin-6.5.2.13I version=6.5.2.13I [Boot image]

!# Verifies the image previously committed

sysadmin-vm:0_RSP1# show install commit summary
Committed Packages: 1
asr9k-sysadmin-6.2.3 version=6.2.3 [Boot image]

!# Commits the latest image

sysadmin-vm:0_RSP1# install commit
result Wed Oct 31 21:32:58 2018 Install operation 3 (install commit) started by user 'root'
will continue asynchronously.
sysadmin-vm:0_RSP1# 0/RSP1/ADMIN0:Oct 31 21:33:02.061 : inst_mgr[6913]:
%INFRA-INSTMGR-2-OPERATION_SUCCESS : Install operation 3 completed successfully
Wed Oct 31 21:33:02 2018 Install operation 3 completed successfully.
sysadmin-vm:0_RSP1#

```

This example shows performing XR VM upgrade using ISSU and verifying the installation using show commands.

```

!# Verify the active packages

RP/0/RSP0/CPU0:Router# show install active summary
Active Packages: 8
asr9k-xr-6.2.3 version=6.2.3 [Boot image]
asr9k-isis-x64-1.3.0.0-r623
asr9k-mpls-x64-2.0.0.0-r623
asr9k-mpls-te-rsvp-x64-1.3.0.0-r623
asr9k-ospf-x64-1.0.0.0-r623

```

```

asr9k-mgbl-x64-2.0.0.0-r623
asr9k-mcast-x64-2.2.0.0-r623
asr9k-k9sec-x64-3.2.0.0-r623

!# Performing ISSU Installation

RP/0/RSP0/CPU0:Router# install activate issu asr9k-xr-6.5.2.13I *r65213I
Oct 31 21:48:14 Install operation 10 started by root:
  install activate issu asr9k-xr-6.5.2.13I *r65213I
Oct 31 21:48:14 Package list:
Oct 31 21:48:14   asr9k-isis-x64-1.1.0.0-r65213I.x86_64
Oct 31 21:48:14   asr9k-ospf-x64-1.0.0.0-r65213I.x86_64
Oct 31 21:48:14   asr9k-mcast-x64-2.0.0.0-r65213I.x86_64
Oct 31 21:48:14   asr9k-mps-te-rsvp-x64-2.1.0.0-r65213I.x86_64
Oct 31 21:48:14   asr9k-mgbl-x64-2.0.0.0-r65213I.x86_64
Oct 31 21:48:14   asr9k-k9sec-x64-2.1.0.0-r65213I.x86_64
Oct 31 21:48:14   asr9k-mps-x64-2.0.0.0-r65213I.x86_64
Oct 31 21:48:14   asr9k-xr-6.5.2.13I
This install operation will start the issu, continue?
[yes/no]:[yes] yes
Oct 31 21:49:13 Install operation will continue in the background
RP/0/RSP0/CPU0:Router#

!# Monitoring the progress of the installation.
!# The installation may take up to 30 minutes.

RP/0/RSP1/CPU0:Router# show issu
INSTALL Operation ID   : Operation 11 Started at Wed Oct 31 22:23:30 2018
ISSU Progress          : 100.0%
Total ISSU Time        : 00:25:07
ISSU Type              : SMU

Phase                  Start-Time      End-Time        State
-----
Prepare                22:23:30       22:34:21       Completed
Load                   22:34:28       22:47:01       Completed
Run                    22:47:01       22:47:44       Completed
Cleanup                22:47:44       22:48:44       Completed
-----
Current Status         : ISSU Orchestration Successfully Completed

Setup Information      : Single Chassis
ISSU Ready/Not Ready  : 0 / 0

Node ISSU readiness per rack per slot
Key: Ready - 'Y', Not ready - 'N', Primary node - '*', Complete - '-'

Rack 0  RP0  RP1  LC1  LC3  LC4  LC7
        -   -   -   -   -   -   -

!# Verifying the VM status after the installation

RP/0/RSP1/CPU0:Router# admin show sdr

SDR: default-sdr
Location      IP Address      Status          Boot Count  Time Started
-----
0/1/VM2      192.0.4.4       RUNNING        1           10/31/2018 22:34:55
0/3/VM2      192.0.12.4      RUNNING        1           10/31/2018 22:34:54
0/RSP0/VM2   192.0.16.6      RUNNING        1           10/31/2018 22:49:58
0/RSP1/VM2   192.0.20.6      RUNNING        1           10/31/2018 22:35:39
0/4/VM2      192.0.24.4      RUNNING        1           10/31/2018 22:34:55
0/7/VM2      192.0.36.4      RUNNING        1           10/31/2018 22:34:55

```

```

!# Verify the active packages

RP/0/RSP1/CPU0:Router# show install active sum
Active Packages: 8
  asr9k-xr-6.5.2.13I version=6.5.2.13I [Boot image]
  asr9k-isis-x64-1.1.0.0-r65213I
  asr9k-ospf-x64-1.0.0.0-r65213I
  asr9k-mcast-x64-2.0.0.0-r65213I
  asr9k-mps-te-rsvp-x64-2.1.0.0-r65213I
  asr9k-mgbl-x64-2.0.0.0-r65213I
  asr9k-k9sec-x64-2.1.0.0-r65213I
  asr9k-mps-x64-2.0.0.0-r65213I

!# You can either perform install commit and stay with the latest image or reload the router
to continue using the old image.

!# Commits the latest image after the necessary checks
RP/0/RSP0/CPU0:Router# install commit

```

## ISSU on ASR 9000 with IOS XR 64 Bit: Multi Step Installation

This section shows how to perform ISSU on ASR 9000 with IOS XR 64 Bit in multiple steps.

You should perform the following steps before performing the steps in this task:

- Copy the package to be installed either on the router's hard disk or on a network server to which the router has access.
- Ensure that dual route processor (RP) system with standby is in "is ready" state.

Perform the following steps to upgrade the system or install a patch in multiple phases.



---

**Note** Depending on whether you are installing a System Admin package or a XR package, execute these commands in the System Admin EXEC mode or XR EXEC mode respectively.

---



---

**Note** You should update the System Admin VM first and then update the XR VM. IOS XR 64 bit ISSU will fail if the System Admin VM is not updated first.

---

1. (Optional) Prepare the installable files by using the **install prepare issu** *package\_name* command. During the prepare phase, pre-activation checks are performed and the components of the installable files are loaded on to the router setup.

For System Admin VM :

```
sysadmin-vm:0_RSP0# install prepare issu asr9k-xr-<release-version>
```

For XR VM:

```
RP/0/RSP0/CPU0:router# install prepare issu asr9k-xr-<release-version>
```

2. Start the load phase by issuing the **install activate issu load** command.

For System Admin VM :



```
sysadmin-vm:0_RSP0# install activate issu load asr9k-xr-<release-version>
```

For XR VM:

```
RP/0/RSP0/CPU0:router# install activate issu load asr9k-xr-<release-version>
```

This step downloads the new image (V2) to all nodes in the router. The new image is checked for compatibility to ensure that the router can be upgraded. At the start of the *Load* phase, the router configuration mode is locked, and you cannot perform any configuration on the router until ISSU completes the phase. At the end of this stage, all standby nodes run V2 and all active nodes (including all line cards) still run the original software images (V1).

- Starts the run phase by issuing the **install activate issu run** command.

For System Admin VM :

```
sysadmin-vm:0_RSP0# install activate issu run
```

For XR VM:

```
RP/0/RSP0/CPU0:router# install activate issu run
```

This phase starts version switch from V1 to V2. All the packages that have been prepared are activated to make the package configurations active on the router.

- Starts the cleanup phase by issuing the **install activate issu cleanup** command.

For System Admin VM :

```
sysadmin-vm:0_RSP0# install activate issu cleanup
```

For XR VM:

```
RP/0/RSP0/CPU0:router# install activate issu cleanup
```

This phase Initiates shutdown of VMs with previous versions after running the activation. The cleanup phase concludes the ISSU process and the new software runs on all nodes in the system.

- Commit the newly active software by using the **install commit** command.

For System Admin VM:

```
sysadmin-vm:0_RSP0# install commit
```

For XR VM:

```
RP/0/RSP0/CPU0:router# install commit
```

## Installing Packages Using ISSU : Related Commands

Related Commands	Purpose
<b>show install active</b>	Displays the active packages on the system.
<b>show install request</b>	Displays the progress of the ISSU installation.
<b>show issu</b>	Displays the state or status of the ISSU operation. Effective with Cisco IOS XR version 6.5.1, this command is also supported for System Admin VM ISSU.

Related Commands	Purpose
<b>install prepare clean</b>	Clears the existing prepared image. If there is a failure in the prepare phase, you can run this command to clear the prepared image.
<b>install activate ISSU abort</b>	Initiates ISSU abort in XR VM. ISSU aborts if the command is run before ISSU Run phase starts. All the changes due to the install activity are reset.



## CHAPTER 9

# Upgrading Field-Programmable Devices

In general terms, *field-programmable devices* (FPDs) are hardware devices implemented on router cards that support separate software upgrades. A *field-programmable gate array* (FPGA) is a type of programmable memory device that exists on most hardware components of the router. The term *FPD* has been introduced to collectively and generically describe any type of programmable hardware device on SIPs and shared port adapters (SPAs), including FPGAs. Cisco IOS XR software provides the Cisco FPD upgrade feature to manage the upgrade of FPD images on SIPs and SPAs.

This chapter describes the information that you must know to verify image versions and to perform an upgrade for SPA or SIP FPD images when incompatibilities arise.

For complete descriptions of the FPD commands listed in this module, refer to the upcoming sections. To locate documentation for other commands that might appear in the course of performing a configuration task, search online in *Cisco ASR 9000 Series Aggregation Services Router Commands Master List*.

**Table 30: Feature History for Upgrading FPD Software on Cisco IOS XR Software**

Release	Modification
Release 3.9.0	Support for FPD upgrades was introduced.
Release 5.3.2	Enhance FPD upgrade and downgrade behavior.
Release 6.3.1	Support for parallel FPD upgrade for power modules.

This module contains the following topics:

- [Upgrading Field-Programmable Device, on page 200](#)
- [Prerequisites for FPD Image Upgrades, on page 200](#)
- [Overview of FPD Image Upgrade Support, on page 200](#)
- [FPD upgrade service, on page 205](#)
- [YANG Data Model for Field Programmable Device, on page 208](#)
- [How to Upgrade FPD Images, on page 208](#)
- [Configuration Examples for FPD Image Upgrade, on page 211](#)
- [Troubleshooting Problems with FPD Image Upgrades, on page 218](#)

# Upgrading Field-Programmable Device

An FPD is a field programmable logic device which contains non-volatile, re-programmable memory to define its internal wiring and functionality. The contents of this non-volatile memory are called the FPD image or FPD firmware. Over the lifespan of an FPD, FPD firmware images may need upgrades for bug fixes or functionality improvements. These upgrades are performed in the field with minimum system impact.

## Prerequisites for FPD Image Upgrades

You must install the FPD pie before you install the SMUs or Service Packs. If you install the SMU or Service Packs before the FPD pie, the FPDs on the line card may not upgrade. In such cases, you must remove the SMUs and Service Packs and reload the router.

## Overview of FPD Image Upgrade Support

An FPD image is used to upgrade the software on an FPD.

Whenever an image is released that supports SIPs and SPAs, a companion SIP and SPA FPD image is bundled. Generally, the FPD image is not automatically upgraded. You must manually upgrade the FPD image running on the SPA or SIP when you upgrade the Cisco IOS XR software image.

FPD versions must be compatible with the Cisco IOS XR software that is running on the router; if an incompatibility exists between an FPD version and the Cisco IOS XR software, the device with the FPGA may not operate properly until the incompatibility is resolved. An FPGA incompatibility on a SPA does not necessarily affect the running of the SPA interfaces; an FPD incompatibility on a SIP disables all interfaces for all SPAs in the SIP until the incompatibility is addressed.

Use the **show hw-module fpd** command to determine if an FPD upgrade is required. A value of 'Yes' in the Upg/Dng? (upgrade/downgrade) column indicates that an upgrade or downgrade is required.

The NCS 5500 supports upgrades for FPGA devices on its SIPs and SPAs. FPGA and ROMMON software upgrades are part of an FPD image package that corresponds to a Cisco IOS XR software image. SIPs and SPAs support manual upgrades for FPGA devices using the Cisco FPD upgrade feature that is further described in this chapter.



### Note

- It is mandatory to upgrade all the required FPDs before doing a reload when you are upgrading FPDs on line cards. This is because, partial FPD component upgrades might result in booting errors (in some cases).
- You must not reload any line card or the router before all FPD image upgrades are completed successfully.

## Automatic FPD Upgrade

The following conditions must be met for an Automatic FPD Upgrade to work on a system upgrade:

- FPD package installation envelope (PIE) must be installed on the router.

- FPD PIE must be activated together with the new Cisco IOS XR image.
- The **fpd auto-upgrade** command must be configured in the XR Configuration mode.

The following conditions must be met for an Automatic FPD Upgrade to work on a FRU Insertion or reload:

- The **fpd auto-upgrade** command must be configured in the XR Configuration mode.



---

**Note** Although the FPD upgrade is performed during the install operation, there is no install commit performed. Therefore, once the FPD has been upgraded, if the image is rolled back to the original version, the FPD version is not downgraded to the previous version.

---



---

**Note** A message is displayed when router modules cannot get upgraded during automatic FPD upgrade indicating that the FPGA is intentionally skipped during upgrade. To upgrade such FPGAs, you can use the CLI command with a particular location explicitly specified. For example, **upgrade hw-module fpd all location 0/3/1**.

---

## Restrictions For Automatic FPD Upgrade

- Newly inserted or reloaded line cards do not reload automatically after a FPD image automatic upgrade, so you must reload the line card manually to use the new FPD image
- By default, the FPD image is not automatically upgraded. You must manually upgrade the FPD image running on the Field Replaceable Unit (FRU) when you upgrade the Cisco IOS XR software image. However, if you enable the **fpd auto-upgrade** command in XR Configuration mode, FPD images are automatically updated when:
  - Software upgrade is carried out.
  - Line cards are added to an existing router or reloaded.
- Automatic FPD Upgrade is not performed when:
  - A non-reload software maintenance upgrade (SMU) or PIE installation is performed, even where the FPD image version changes. Since a non-reload installation is, by definition, not supposed to reload the router, and an FPD upgrade requires a router reload, an Automatic FPD Upgrade is repressed.
- In all cases where the automatic FPD upgrade is not performed, you must perform a manual FPD upgrade using the **upgrade hw-module fpd** command.
- CFP2-DCO Optical modules do not support automatic-FPD upgrade.
- The TimingIC-A and TimingIC-B FPDs upgrades are excluded from the **fpd auto-upgrade** configuration and the user-executed **upgrade hw-module location all** command. The following ASR 9000 5th Generation ASR9000 Line Cards contain FPDs TimingIC-A and TimingIC-B:
  - A99-4HG-FLEX-SE
  - A99-4HG-FLEX-TR

- A9K-8HG-FLEX-SE
- A9K-8HG-FLEX-TR
- A9K-20HG-FLEX-SE
- A9K-20HG-FLEX-TR

To upgrade TimingIC-A and TimingIC-B FPDs, see [Upgrade TimingIC-A and TimingIC-B FPDs](#), on page 207.

## Parallel Power Module Upgrade

Power modules can now be upgraded in parallel on Cisco Routers. This feature lets you perform FPD upgrades on multiple power modules simultaneously. The newer power modules (V3) take more time to upgrade separately than their previous counterparts, which increases the total time taken to upgrade a full chassis to an unacceptable limit.

Parallel upgrade process reduces the overall time required to upgrade a full chassis with many power modules. Only power modules that support FPD upgrades can be upgraded in parallel. This includes V3 AC-DC and V2 AC-DC power modules.



---

**Note** Power module upgrades are time consuming and cannot be implicitly upgraded or as a part of automatic FPD upgrades. These modules must be upgraded independent of the other fpga upgrades.

---

To upgrade the power modules in parallel, use **upgrade hw-module location pm-all fpd all** or **upgrade hw-module fpd all location pm-all** command in Admin mode.

To force a power module upgrade, use **upgrade hw-module fpd all force location pm-all** command in Admin mode.

### Pre-requisites to perform Parallel Upgrade

- Ensure that all power connections to the power supply are energized. To verify the power supply details, use **show environment power-supply** command in Admin mode.
- Ensure power available to the power supply is equal to the rated power. For example, 6KW power module must have a 6KW power feed. If the power feed to the power supply is less, the excess power calculation will be incorrect and the chassis may run out of power during an upgrade and suffer a sudden shutdown.
- Ensure sufficient or excess power is available in the chassis before you start the upgrade process.
- Do not add or remove any component (Line cards, RPs, power connections) from the chassis during an upgrade. This may cause power failure in the system due to sudden change in power in the system.



- Note**
- The system upgrades the power modules in random order.
  - The number of modules that can be upgraded simultaneously depends on the excess power available to the chassis.
  - Ensure you initiate the parallel upgrade process only when all the pre-requisites are satisfied because the upgrade process cannot be aborted in between.

### Performing Parallel Power Module Upgrade

To initiate a parallel upgrade process and upgrade all the power modules in the chassis simultaneously, use **pm-all** keyword in the **upgrade hw-module fpd** command in Admin mode.

#### Example

The following section illustrates parallel power module upgrade implementation:

#### Verification

Use **show hw-module fpd** command to verify the upgrade:

## Manual Power Module Upgrade

Manual Power modules FPD upgrades are supported on Cisco ASR 9000 Series Routers and should be performed in Admin mode only. This feature lets you perform FPD upgrades on individual Power Entry Modules (PEMs) rather than initiating a [Parallel Power Module Upgrade](#).

Only power modules that support FPD upgrades can be upgraded manually. This includes V3 AC-DC and V2 AC-DC power modules



- Note** Power module upgrades are time consuming and can't be implicitly upgraded or as a part of automatic FPD upgrades. These modules must be upgraded independent of the other fpga upgrades.

To determine which PEMs requires upgrade, use **show hw-module location all fpd**.

PEMs requiring upgrade are in **UPGD SKIP** status.

```
Router#show hw-module location all fpd
```

```
Auto-upgrade:Enabled
```

```

                                                                 FPD Versions
                                                                 =====
Location   Card type                HWver FPD device           ATR Status   Running   Programd
-----
0/PT0     PWR-4.4KW-DC-V3         2.11  PM0-DT-Pri0MCU        UPGD SKIP   3.00     3.00
0/PT0     PWR-4.4KW-DC-V3         2.11  PM0-DT-Pri1MCU        UPGD SKIP   3.00     3.00
0/PT0     PWR-4.4KW-DC-V3         2.11  PM0-DT-Sec054vMCU     UPGD SKIP   3.00     3.00

```

```

0/PT0      PWR-4.4KW-DC-V3      2.11  PM0-DT-Sec154vMCU      UPGD SKIP  3.00      3.00
0/PT0      PWR-4.4KW-DC-V3      2.11  PM0-DT-Sec5vMCU       UPGD SKIP  3.00      3.00

```

To upgrade the power modules manually, use **[admin] upgrade hw-module location 0/PT<location> fpd <fpd\_device>**.

```

Router# admin
Router# upgrade hw-module location 0/PT0 fpd PM0-DT-Pri0MCU

```

## Automatic Line Card Reload on FPD Upgrade

This feature automatically reloads a newly inserted line card (LC) after a successful FPD upgrade. The current auto FPD upgrade process does not reload the line card automatically, the user had to manually reload the LC. To enable this feature on Cisco IOS XR 32 bit operating system, use the **fpd auto-reload** command and use **fpd auto-reload enable** command in Cisco IOS XR 64 bit OS.

### Implementation Considerations

The following limitation must be considered while configuring automatic line card reload on FPD upgrade:

- In Cisco IOS XR 32-bit OS, FPDs that are part of MPAs are not auto upgraded neither on inserting them to a line card nor when the entire line card gets inserted into a chassis.
- In Cisco IOS XR 64-bit OS, FPDs that are part of MPAs are auto upgraded. But the MPA will not be auto reloaded.
- If the FPD upgrade fails on a line card then the automatic line card reload feature (if enabled) stops the LC from reloading.

### Configuring Automatic Line Card Reload on FPD Upgrade

The auto-reload feature works only if auto-upgrade feature is also configured on the router. The following sample shows how to configure auto-reload feature for Cisco IOS XR 32-bit OS:

```

RP/0/RSP0/CPU0:ios(config)#admin
RP/0/RSP0/CPU0:ios(admin-config)#fpd auto-upgrade
RP/0/RSP0/CPU0:ios(admin-config)#fpd auto-reload
RP/0/RSP0/CPU0:ios(admin-config)#commit

```

The auto-reload feature is only supported on line cards.

The following sample shows how to configure auto-reload feature for Cisco IOS XR 64-bit OS:

```

RP/0/RSP1/CPU0:ios# config
RP/0/RSP1/CPU0:ios(config)#fpd auto-upgrade enable
RP/0/RSP1/CPU0:ios(config)#fpd auto-reload enable
RP/0/RSP1/CPU0:ios(config)#commit

```



---

**Note** During the FPD upgrade process, the linecard may display IOS XR RUN state before triggering auto-reload.

---



**Note To manually reload the line card on FPD upgrade**

During FPD upgrade process, ensure to use **hw-module location node-id reload** command in EXEC or administration EXEC mode at the end of the upgrade procedure. This cause the selected card(s) to perform a complete hardware reload, which is required for some FPDs.

## FPD upgrade service

The main tasks of the FPD upgrade service are:

- Check FPD image version to decide if a specific firmware image needs an upgrade or not.
- Manual FPD Image Upgrade using the **upgrade hw-module fpd** command.
- Invoke the appropriate device driver with a name of the new image to load.

An FPD image package is used to upgrade FPD images. The **install activate** command is used to place the FPD binary files into the expected location on the boot devices.

### Supported Upgrade Methods

Method	Remarks
Manual Upgrade	Upgrade using CLI, force upgrade supported.

## Determining Upgrade Requirement

Use the **show hw-module fpd** command to determine if an FPD upgrade is required. Check for NEED UPGD in the Status column.

### Example

```
Router: #show hw - module fpd
```

```
Wed Dec 14 07:08:08.424 UTC
```

```
Auto-upgrade:Disabled
```

Location	Card type	HWver	FPD device	ATR Status	FPD Versions	
					Running	Programd
0/0	NC55-18H18F	1.0	MIFPGA	<b>NEED UPGD</b>	7.01	7.01
0/0	NC55-18H18F	1.0	Bootloader	CURRENT	1.14	1.14
0/0	NC55-18H18F	1.0	IOFPGA	CURRENT	0.07	0.07
0/0	NC55-18H18F	1.0	SATA-M600-MCT	CURRENT	0.23	0.23

Use the **show fpd package** command to find out which FPGAs are supported with your current software release and minimum hardware requirements for each module.

## Automatic FPD upgrade

Use the **fpd auto-upgrade enable** command to enable the auto upgrade feature.



---

**Note** The auto FPD upgrade may result in certain intentional exceptions, which may need manual upgrades or reloading for a few FPDs. We recommend you use the **show hw-module fpd** command to check the hardware module status immediately after the FPD auto upgrade is complete and take necessary action in both admin and XR VM mode. That is, if any FPD displays a **NEED UPGD** status, then upgrade those FPDs individually by the manual upgrade and follow it with a reload in admin mode, and if any FPDs show a **RLOAD REQ** status, perform a hardware module reload from admin mode.

---

The FPD images are upgraded as part of the install activation of the new image. The FPDs are upgraded before the router is reloaded.

During an FPD auto-upgrade, the installed FPD rpm package includes an FPD image with a new version of software that is different than the version of the image running on the hardware. Once the FPDs have been upgraded, even if the base image is rolled back to the older version, the FPD will not be downgraded to its previous version.

When a reload package is installed with new FPD images, the FPD images are upgraded before the router gets reloaded. This feature is controlled through an **fpd auto-upgrade** configuration option. The auto-upgrade feature does not address the following:

- FPD Upgrade during initial boot
- FPD Upgrade during new card insertion

## Manual FPD upgrade

Manual FPD upgrade is performed using the **upgrade hw-module fpd** command. All cards or all FPGA in a card can be upgraded. If reload is required to activate FPD, the upgrade should be complete. Line-cards, fabric cards and RP cards cannot be reloaded during the process of the FPD upgrade.

FPD upgrade is transaction-based:

- Each **fpd upgrade** CLI execution is one transaction.
- Only one transaction is allowed at any given time.
- One transaction may include one or many FPD upgrades

The **force** option can be used to forcibly upgrade the FPD (regardless of whether it is required or not). It triggers all FPDs to be upgraded or downgraded. The **force** option can also be used to downgrade or upgrade the FPGAs even after the version check.

**Note**

- Sometimes, FPDs can have primary and backup images.
- Force FPD upgrade with **upgrade hw-module location all fpd all force** command affects forwarding over BVI interface. You must reload involved locations to recover.
- The use of the **force** option when performing an FPD upgrade is not recommended except under explicit direction from Cisco engineering or TAC for a one-time purpose only.
- FPD upgrade should be performed in Admin mode only.
- A new FPD upgrade should be issued only when previous FPD upgrades have been completed on the same FPD with the following syslog message:

```
RP/0/RP0/CPU0:May 10 10:11:44.414 UTC: fpd-serv[205]: %INFRA-FPD_Manager-1-UPGRADE_ALERT
: FPD Upgrade Completed (use "show hw-module fpd" to check upgrade status)
```

## Upgrade TimingIC-A and TimingIC-B FPDs

Perform the following steps to upgrade timing IC-A and Timing IC-B FPDs:

- Upgrade Timing IC-A FPD.

```
Router#upgrade hw-module location 0/[slot-number] fpd TimingIC-A
```

- Upgrade TimingIC-B FPD.

```
Router#upgrade hw-module location 0/[slot-number] fpd TimingIC-B
```

- Run the new XR using the **install commit** command, if you're performing this manual FPD upgrade.

```
Router(admin)#install commit
```

If you don't perform the install commit of the new XR, the LC reinstalls itself with this new XR again which could take 30 minutes.

- Reload the 5th Generation ASR9000 Line Card.

```
Router#admin
sysadmin-vm:0_RP0#hw-module location 0/[slot-number] reload
```

# YANG Data Model for Field Programmable Device

Table 31: Feature History Table

Feature Name	Release Information	Description
Unified Model for FPD: Cisco-IOS-XR-um-fpd-cfg	Release 7.7.1	We have introduced the Cisco-IOS-XR-um-fpd-cfg unified model to enable or disable the automatic reload and automatic upgrade of Field Programmable Devices.  You can access this unified model from the <a href="#">Github</a> repository.

YANG is a data modeling language that helps to create configurations, retrieve operational data and execute actions. The router acts on the data definition when these operations are requested using NETCONF RPCs. The data model handles the following types of requirements on the routers for FPD:

Operational Data	Native Data Model	CLI Commands
<b>Auto Upgrade:</b> Enabling or disabling of automatic upgrade of FPD.	Cisco-IOS-XR-fpd-infra-cfg.yang	<ul style="list-style-type: none"> <li>• <b>fpd auto-upgrade enable</b></li> <li>• <b>fpd auto-upgrade disable</b></li> </ul>
<b>Auto Reload:</b> Enabling or disabling of automatic reload of FPD.	Cisco-IOS-XR-fpd-infra-cfg.yang	<ul style="list-style-type: none"> <li>• <b>fpd auto-reload enable</b></li> <li>• <b>fpd auto-reload disable</b></li> </ul>

You can access the data models from the [Github](#) repository. To learn more about the data models and put them to use, see the *Programmability Configuration Guide for Cisco ASR 9000 Series Routers*.

## How to Upgrade FPD Images

You must determine if an FPD image upgrade is needed using the **show hw-module fpd** command and perform the upgrade, if needed, under the following circumstances:

- Migrate the software to a later Cisco IOS XR software release.
- Swap line cards from a system running a different Cisco IOS XR software release.
- Insert a new line card.

In the event of an FPD incompatibility with your card, you might receive the following error message:

```
LC/0/0/CPU0:Jul 5 03:00:18.929 UTC: optics_driver[220]: %L2-OPTICS-3-BAD_FPGA_IMAGE :
Detected bad MI FPGA image programmed in MI FPGA SPI flash in 0/0/CPU0 location: Failed to
validate meta data CRC
LC/0/0/CPU0:Jul 5 03:00:19.019 UTC: optics_driver[220]: %L2-OPTICS-3-BACKUP_FPGA_LOADED :
Detected Backup FPGA image running on 0/0/CPU0 - primary image corrupted (@0x8c = 0x44)
```

```
RP/0/RP0/CPU0:Jul 5 03:00:48.987 UTC: fpd-serv[301]: %PKT_INFRA-FM-3-FAULT_MAJOR : ALARM_MAJOR
:FPD-NEED-UPGRADE :DECLARE :0/0:
```

Upgrades to the Cisco IOS XR software might result in an FPD incompatibility. Ensure that you perform the FPD upgrade procedure and resolve all incompatibilities, for the cards to function properly.



**Note** The use of the **force** option when performing a FPD upgrade is not recommended except under explicit direction from Cisco engineering or TAC for a one-time purpose only.

### Before you begin

- The FPD upgrade procedure is performed while the card is online. At the end of the procedure the card must be reloaded before the FPD upgrade is complete. To reload the card, you can use the **hw-module location <location> reload** command in Admin mode, during the next maintenance window. The upgrade procedure is not complete until the card is reloaded.
- During the FPD upgrade, you *must not* do the following:
  - Reload, perform an online insertion and removal (OIR) of a line card (LC), or power down the chassis. Doing so may cause the node to enter an unusable state.
  - Press **Ctrl-C** if the console appears to hang without any output. Doing so may abort the upgrade.
- If you are not sure whether a card requires an FPD upgrade, you can install the card and use the **show hw-module fpd** command to determine if the FPD image on the card is compatible with the currently running Cisco IOS XR software release.

### Procedure

	Command or Action	Purpose
<b>Step 1</b>	<p><b>show hw-module fpd location</b> {all   node-id}</p> <p><b>Example:</b></p> <pre>RP/0/RSP0/CPU0:router# show hw-module fpd location all</pre> <p>or</p> <pre>RP/0/RSP0/CPU0:router# show hw-module fpd location 0/4/cpu0</pre>	Displays the current FPD image versions for the specified card or all cards installed in the router. Use this command to determine if you must upgrade the FPD image on your card.
<b>Step 2</b>	<p><b>admin</b></p> <p><b>Example:</b></p> <pre>RP/0/RSP0/CPU0:router# admin</pre>	Enters administration EXEC mode.
<b>Step 3</b>	<p>(Optional) <b>show fpd package</b></p> <p><b>Example:</b></p> <pre>RP/0/RSP0/CPU0:router(admin)# show fpd package</pre>	Displays which cards are supported with your current Cisco IOS XR software release, which FPD image you need for each card, and what the minimum hardware requirements are for the various modules. (A minimum hardware

	Command or Action	Purpose
		<p>requirement version of 0.0 indicates that all hardware can support this FPD image version.)</p> <p>If there are multiple FPD images for your card, use this command to determine which FPD image to use if you want to upgrade only a specific FPD type.</p>
<p><b>Step 4</b></p>	<p><b>upgrade hw-module fpd</b> {all   <i>fpga-type</i>} [<b>force</b>] <b>location</b> [all   <i>node-id</i>]</p> <p><b>Example:</b></p> <pre>RP/0/RSP0/CPU0:router(admin)# upgrade hw-module fpd all location 0/3/1 . . . Successfully upgraded 1 FPD for SPA-2XOC48POS/RPR on location 0/3/1  RP/0/RP0/CPU0:V3_DC_MT(admin)# upgrade hw-module fpd all location all RP/0/RP0/CPU0:May 14 22:06:38.715 : upgrade_fpd_cli[65878]: %PLATFORM-UPGRADE_FPD-6-STATUS_UPG_LOC_ALL_OPT : pm fpga11 instance 14 on location 0/RP0/CPU0 was intentionally skipped during upgrade using location all option</pre>	<p>Upgrades all the current FPD images that must be upgraded on the specified card with new images.</p> <p>Before continuing to the next step, wait for confirmation that the FPD upgrade has successfully completed. Status messages, similar to these, are displayed to the screen until the FPD upgrade is completed:</p> <pre>FPD upgrade started. FPD upgrade in progress.. FPD upgrade in progress.. FPD upgrade sent to location xxxx FPD upgrade sent to location yyyy FPD upgrade in progress.. FPD upgrade finished for location xxx FPD upgrade in progress.. FPD upgrade finished for location yyyy FPD upgrade completed.</pre> <p>The “FPD upgrade in progress.” message is printed every minute. These logs are information logs, and as such, are displayed if the <b>logging console informational</b> command is configured.</p> <p>If Ctrl-C is pressed while the FPD upgrade is in progress, the following warning message is displayed:</p> <pre>FPD upgrade in progress on some hardware, aborting now is not recommended as it might cause HW programming failure and result in RMA of the hardware. Do you want to continue? [Confirm(y/n)]</pre> <p>If you confirm that you want to abort the FPD upgrade procedure, this message is displayed:</p> <pre>FPD upgrade process has been aborted, please check the status of the hardware and reissue the upgrade command if required.</pre>

	Command or Action	Purpose
		<p><b>Note</b></p> <ul style="list-style-type: none"> <li>• If your card supports multiple FPD images, you can use the <b>show fpd package</b> admin command to determine what specific image to upgrade in the <b>upgrade hw-module fpd</b> command.</li> <li>• A message is displayed when router modules cannot get upgraded during upgrade with <b>location all</b> option indicating that the FPGA is intentionally skipped during upgrade. To upgrade such FPGAs, you can use the CLI command with a particular location explicitly specified. For example, <b>upgrade hw-module fpd all location 0/3/1</b>.</li> <li>• It is recommended to upgrade all FPGAs on a given node using the <b>upgrade hw-module fpd all location {all   node-id}</b> command. Do not upgrade the FPGA on a node using the <b>upgrade hw-module fpd &lt;individual-fpd&gt; location {all   node-id}</b> as it may cause errors in booting the card.</li> </ul>
Step 5	<b>exit</b> <b>Example:</b> <pre>sysadmin-vm:0_RP0# exit</pre>	
Step 6	<b>hw-module location { node-id   all } reload</b>	Use the <b>hw-module location reload</b> command to reload a line card.  <pre>sysadmin-vm:0_RP0# hw-module location 0/3 reload</pre>
Step 7	<b>exit</b>	
Step 8	<b>show hw-module fpd</b>	Verifies that the FPD image on the card has been successfully upgraded by displaying the status of all FPDs in the system.

## Configuration Examples for FPD Image Upgrade

The following examples indicates the use of commands associated with the FPD image upgrade procedure.

### show hw-module fpd Command Output: Example

Use the **show hw-module fpd** to display the current version of FPD images on the SPAs, SIPs and other cards installed on your router.

## show hw-module fpd Command Output: Example

This command can be used to identify information about FPDs on any card. If you enter the location of a line card that is not a SPA, the output displays information about any programmable devices on that line card.

The following example shows how to display FPD compatibility for all modules in the router:

```
RP/0/RSP0/CPU0:router# ios#show hw-module fpd
Tue Jan 22 13:56:55.082 UTC
```

Location	Card type	HWver	FPD device	ATR	Status	FPD Versions	
						Running	Programd
0/RP0	NCS-55A2-MOD-S	0.3	MB-MIFPGA	CURRENT	0.19	0.19	
0/RP0	NCS-55A2-MOD-S	0.3	Bootloader	CURRENT	1.10	1.10	
0/RP0	NCS-55A2-MOD-S	0.3	CPU-IOFPGA	CURRENT	1.18	1.18	
0/RP0	NCS-55A2-MOD-S	0.3	MB-IOFPGA	CURRENT	0.18	0.18	
0/PM0	NC55-1200W-ACFW	1.0	LIT-PrimCU-ACFW	NEED UPGD	2.08	2.08	
0/PM1	NC55-1200W-ACFW	1.0	LIT-PrimCU-ACFW	NEED UPGD	2.08	2.08	

```
RP/0/RP0/CPU0:ios#.
```



**Note** After Release 5.3.x, Upg/Dng? will display Yes only for upgrade.

The following example shows the FPD for which upgrade will be skipped.

```
RP/0/RP0/CPU0:router# show hw-module fpd location all
```

Existing Field Programmable Devices								
Location	Card Type	HW				Inst	Current SW Version	Upg/Dng?
		Version	Type	Subtype				
0/SM1/SP	140G-4-S1S2S3	0.1	1c	rommonA	0	2.08	Yes	
			1c	rommon	0	2.08	Yes	
			1c	fpqa1	0	6.04^	No	
			1c	fpga2	0	4.01	No	

NOTES:

- ^ One or more FPD will be intentionally skipped from upgrade using CLI with option "all" or during "Auto fpd".  
It can be upgraded only using the "admin> upgrade hw-module fpd <fpd> location <loc>" CLI with exact location.

```
RP/0/RSP1/CPU0:router# show hw-module fpd location all
```

```
Mon Jun 29 05:38:50.332 PST
```

Existing Field Programmable Devices								
Location	Card Type	HW				Inst	Current SW Version	Upg/Dng?
		Version	Type	Subtype				
0/RSP0/CPU0	A9K-RSP-4G	4.8	1c	fpga3	0	1.13	No	
			1c	fpga1	0	1.5	No	



```

lc fpga2 0 1.14 No
lc cbc 0 1.2 No
lc fpga4 0 1.6 No
lc rommon 0 1.0 No
-----
0/RSP0/CPU0 ASR-9010-FAN 1.0 lc cbc 1 4.0 No
-----
0/RSP0/CPU0 ASR-9010-FAN 1.0 lc cbc 2 4.0 No
-----
0/1/CPU0 A9K-40GE-B 1.0 lc fpga1 0 0.38 No
lc fpga2 0 0.8 No
lc cbc 0 2.2 No
lc cpld1 0 0.15 No
lc rommon 0 1.0 No
-----
0/1/CPU0 A9K-40GE-B 1.0 lc fpga1 1 0.38 No
-----
0/4/CPU0 A9K-8T/4-B 1.0 lc fpga1 0 0.38 No
lc fpga2 0 0.10 No
lc cbc 0 2.2 No
lc cpld2 0 0.7 No
lc cpld1 0 0.15 No
lc cpld3 0 0.3 No
lc rommon 0 1.0 No
lc fpga3 0 14.42 No
-----
0/4/CPU0 A9K-8T/4-B 1.0 lc fpga1 1 0.38 No
-----
0/6/CPU0 A9K-4T-B 1.0 lc fpga1 0 0.38 No
lc fpga2 0 0.10 No
lc cbc 0 2.2 No
lc cpld2 0 0.7 No
lc cpld1 0 0.15 No
lc cpld3 0 0.3 No
lc rommon 0 1.0 No
lc fpga3 0 14.42 No
-----
0/6/CPU0 A9K-4T-B 1.0 lc fpga1 1 0.38 No
-----

```

The following example shows how to display FPD compatibility for a specific module in the router:

**Table 32: show hw-module fpd Field Descriptions**

Field	Description
Location	Location of the module in the <i>rack/slot/module</i> notation.
Card Type	Module part number.
HW Version	Hardware model version for the module.
Type	Hardware type. Can be one of the following types: <ul style="list-style-type: none"> <li>• spa—Shared port adapter</li> <li>• lc—Line card</li> </ul>

Field	Description
Subtype	<p>FPD type. Can be one of the following types:</p> <ul style="list-style-type: none"> <li>• fabldr—Fabric downloader</li> <li>• fpga1—Field-programmable gate array</li> <li>• fpga2—Field-programmable gate array 2</li> <li>• fpga3—Field-programmable gate array 3</li> <li>• fpga4—Field-programmable gate array 4</li> <li>• fpga5—Field-programmable gate array 5</li> <li>• rommonA—Read-only memory monitor A</li> <li>• rommon—Read-only memory monitor B</li> </ul>
Inst	FPD instance. The FPD instance uniquely identifies an FPD and is used by the FPD process to register an FPD.
Current SW Version	Currently running FPD image version.
Upg/Dng?	Specifies whether an FPD upgrade or downgrade is required. A downgrade is required in rare cases when the version of the FPD image has a higher major revision than the version of the FPD image in the current Cisco IOS XR software package.

## show fpd package Command Output: Example

Use the **show fpd package** command in administration EXECAdmin EXEC mode mode to find out which line cards are supported with your current Cisco IOS XR software release, which FPD image package you need for each line card, and what the minimum hardware requirements are for each module. If multiple FPD images are available for your card, they are listed as Subtype fpga2, fpga3, and so on.



**Note** The FPD name used in the FPD Description column of the output of the `show fpd package` command includes the last ten characters of DCO-PID. Depending on the slot and port numbers, the FPD name is appended with DCO\_0, DCO\_1, or DCO\_2. For example, the FPD names for CFP2-WDM-D-1HL in port 0 and port 1 are -WDM-D-1HL\_DCO\_0 and WDM-D-1HL\_DCO\_1 respectively.



**Note** The FPD name used in the FPD Description column of the output of the `show fpd package` command displays QDD\_*instance*\_*port-number*. For example, depending on the instance and the port number, the FPD names for the QDD-400G-ZR-S and QDD-400G-ZRP-S modules will be QDD\_0\_3, QDD\_1\_0, and so on.



**Note** In case of Cisco ASR 9903 routers, the output of the `show fpd package` command displays QDD\_*bay*\_*port-number*. For example, depending on the bay and the port number, the FPD names for the QDD-400G-ZR-S and QDD-400G-ZRP-S modules will be QDD\_0\_3, QDD\_0\_4, and so on.

The following example shows sample output from the **show fpd package** command:

```
show fpd package
Tue Jan 22 13:56:00.212 UTC
```

```
=====
```

Field Programmable Device Package					
Card Type	FPD Description	Req Reload	SW Ver	Min Req SW Ver	Min Req Board Ver
NC55-1200W-ACFW	LIT-PrimMCU-ACFW (A)	NO	2.09	2.09	0.0
NC55-900W-ACFW-I	LIT-PrimMCU-ACFW-I (A)	NO	1.04	1.04	0.0
NC55-900W-DCFW-I	LIT-PrimMCU-DCFW-I (A)	NO	2.260	2.260	0.0
NC55-930W-DCFW-C	LIT-PrimMCU-DCFW-C (A)	NO	2.259	2.259	0.0
NC55-MPA-12T-S	MPAFPGA	YES	0.27	0.27	0.0
NC55-MPA-1TH2H-S	-WDM-D-1HL_DCO_2	NO	38.518	38.518	0.1
	MPAFPGA	YES	0.53	0.53	0.0
	WDM-DE-1HL_DCO_2	NO	38.518	38.518	0.1
	WDM-DS-1HL_DCO_2	NO	38.268	38.268	0.1
NC55-MPA-2TH-HX-S	-WDM-D-1HL_DCO_0	NO	38.518	38.518	0.1
	-WDM-D-1HL_DCO_1	NO	38.518	38.518	0.1
	MPAFPGA	YES	0.53	0.53	0.0
	WDM-DE-1HL_DCO_0	NO	38.518	38.518	0.1
	WDM-DE-1HL_DCO_1	NO	38.518	38.518	0.1
	WDM-DS-1HL_DCO_0	NO	38.268	38.268	0.1
	WDM-DS-1HL_DCO_1	NO	38.268	38.268	0.1
NC55-MPA-2TH-S	-WDM-D-1HL_DCO_0	NO	38.518	38.518	0.1
	-WDM-D-1HL_DCO_1	NO	38.518	38.518	0.1
	MPAFPGA	YES	0.53	0.53	0.0
	WDM-DE-1HL_DCO_0	NO	38.518	38.518	0.1
	WDM-DE-1HL_DCO_1	NO	38.518	38.518	0.1
	WDM-DS-1HL_DCO_0	NO	38.268	38.268	0.1
	WDM-DS-1HL_DCO_1	NO	38.268	38.268	0.1
NC55-MPA-4H-HD-S	MPAFPGA	YES	0.53	0.53	0.0
NC55-MPA-4H-HX-S	MPAFPGA	YES	0.53	0.53	0.0
NC55-MPA-4H-S	MPAFPGA	YES	0.53	0.53	0.0
NC55A2-MOD-SE-H-S	Bootloader (A)	YES	1.11	1.11	0.0
	CPU-IOFPGA (A)	YES	1.18	1.18	0.1
	MB-IOFPGA (A)	YES	0.18	0.18	0.1
	MB-MIFPGA	YES	0.19	0.19	0.0
	SATA (A)	NO	5.00	5.00	0.0
NCS-55A2-MOD-HD-S	Bootloader (A)	YES	1.11	1.11	0.0
	CPU-IOFPGA (A)	YES	1.18	1.18	0.1
	MB-IOFPGA (A)	YES	0.18	0.18	0.1
	MB-MIFPGA	YES	0.19	0.19	0.0
	SATA (A)	NO	5.00	5.00	0.0
NCS-55A2-MOD-HX-S	Bootloader (A)	YES	1.11	1.11	0.0
	CPU-IOFPGA (A)	YES	1.18	1.18	0.1
	MB-IOFPGA (A)	YES	0.18	0.18	0.1
	MB-MIFPGA	YES	0.19	0.19	0.0
	SATA (A)	NO	5.00	5.00	0.0

```
=====
```

```

-----
NCS-55A2-MOD-S      Bootloader (A)      YES      1.11      1.11      0.0
                    CPU-IOFPGA (A)      YES      1.18      1.18      0.1
                    MB-IOFPGA (A)      YES      0.18      0.18      0.1
                    MB-MIFPGA          YES      0.19      0.19      0.0
                    SATA (A)          NO       5.00      5.00      0.0
-----
NCS-55A2-MOD-SE-S  Bootloader (A)      YES      1.11      1.11      0.0
                    CPU-IOFPGA (A)      YES      1.18      1.18      0.1
                    MB-IOFPGA (A)      YES      0.18      0.18      0.1
                    MB-MIFPGA          YES      0.19      0.19      0.0
                    SATA (A)          NO       5.00      5.00      0.0
                    STATSFPGA         YES      0.01      0.01      0.0

```

This table describes the significant fields shown in the display:

**Table 33: show fpd package Field Descriptions**

Field	Description
Card Type	Module part number.
FPD Description	Description of all FPD images available for the line card.
Type	Hardware type. Possible types can be: <ul style="list-style-type: none"> <li>• spa—Shared port adapter</li> <li>• lc—Line card</li> </ul>
Subtype	FPD subtype. These values are used in the <b>upgrade hw-module fpd</b> command to indicate a specific FPD image type to upgrade.
SW Version	FPD software version recommended for the associated module running the current Cisco IOS XR software.
Min Req SW Vers	Minimum required FPD image software version to operate the card. Version 0.0 indicates that a minimum required image was not programmed into the card.
Min Req HW Vers	Minimum required hardware version for the associated FPD image. A minimum hardware requirement of version 0.0 indicates that all hardware can support this FPD image version.



**Note** In the **show fpd package** command output, the “subtype” column shows the FPDs that correspond with each line card image. To upgrade a specific FPD with the **upgrade hw-module fpd** command, replace the *fpga-type* argument with the appropriate FPD from the “subtype” column, as shown in the following example:

```
RP/0/RSP0/CPU0:router (admin) # upgrade hw-module fpd fpga2 location 0/3/1 reload
```

## upgrade hw-module fpd Command Output: Example

Use the **upgrade hw-module fpd** command to upgrade the FPD image on a line card. The upgrade can be executed for all FPDs or for specific FPDs that need an upgrade. To upgrade all FPDs, use **upgrade hw-module fpd all location all** command. To upgrade a specific FPD image type, use the FPD subtype value in the **upgrade hw-module fpd** command.

```
RP/0/RSP0/CPU0:router# admin
RP/0/RSP0/CPU0:router(admin)# upgrade hw-module fpd fpga location 0/1/cpu0

Mon Jan 12 05:44:37.611 PST

% RELOAD REMINDER: - The upgrade operation of the target module will not interrupt its
normal
operation. However, for the changes to take effect, the target module
will need to be manually reloaded after the upgrade operation. This can
be accomplished with the use of "hw-module <target> reload" command.
- If automatic reload operation is desired after the upgrade, please use
the "reload" option at the end of the upgrade command.
- The output of "show hw-module fpd location" command will not display
correct version information after the upgrade if the target module is
not reloaded.
Continue? [confirm] y

Starting the upgrade/download of following FPD:

=====
Location      Type Subtype Upg/Dng   Current   Upg/Dng
              =====
0/1/CPU0     lc  fpga   upg      0.40      0.40
-----

LC/0/1/CPU0:Jan 12 05:44:43.700 : lc_fpd_upgrade[192]: %PLATFORM-UPGRADE_FPD-6-START :
Starting to upgrade fpga subtype image from 0.4 to 0.4 for for this card on location
0/1/CPU0
LC/0/1/CPU0:Jan 12 05:44:42.990 : fabricq_mgr[152]: EES:Internal clock detect IDLE
period(-106461) more than threshold(1200000)
LC/0/1/CPU0:Jan 12 05:44:42.990 : ingressq[179]: EES:Internal clock detect IDLE
period(-106461) more than threshold(1200000)
LC/0/1/CPU0:Jan 12 05:45:09.240 : fabricq_mgr[152]: EES:Internal clock detect IDLE
period(-105945) more than threshold(1200000)
LC/0/1/CPU0:Jan 12 05:45:09.241 : ingressq[179]: EES:Internal clock detect IDLE
period(-105944) more than threshold(1200000)
SP/0/1/SP:Jan 12 05:45:16.020 : upgrade_daemon[280]: ...programming...
SP/0/1/SP:Jan 12 05:45:16.034 : upgrade_daemon[280]: ...it will take a while...
SP/0/1/SP:Jan 12 05:45:16.053 : upgrade_daemon[280]: ...it will take a while...
SP/0/1/SP:Jan 12 05:47:42.967 : upgrade_daemon[280]: ...programming...
SP/0/1/SP:Jan 12 05:47:42.981 : upgrade_daemon[280]: ...it will take a while...

% SLC/0/1/CPU0:Jan 12 05:48:08.737 : lc_fpd_upgrade[192]: %PLATFORM-UPGRADE_FPD-6-PASSED :

Successfully upgrade fpga subtype image for for this card on location 0/1/CPU0
```

## show platform Command Output: Example

Use the **show platform** command to verify that the line card is up and running.

# Troubleshooting Problems with FPD Image Upgrades

This section contains information to help troubleshoot problems that can occur during the upgrade process.

## Power Failure or Removal of a SPA During an FPD Image Upgrade

If the FPD upgrade operation is interrupted by a power failure or the removal of the SPA, it could corrupt the FPD image. This corruption of the FPD image file makes the SPA unusable by the router and the system displays the following messages when it tries to power up the SPA. When it cannot successfully power up the SPA, it places it in the failed state, as shown in the following example:

```
LC/0/3/CPU0:Feb  4 08:23:16.672 : spa_192_jacket[188]: %L2-SPA-5-OIR_INSERTED : SPA discovered
in bay 0
LC/0/3/CPU0:Feb  4 08:23:23.349 : spa_192_jacket[188]: %L2-SPA-5-OIR_ERROR : SPA (0): An
error occurred (0x1002), error recovery action: reset SPA
LC/0/3/CPU0:Feb  4 08:23:26.431 : spa_192_jacket[188]: %L2-SPA-5-OIR_INSERTED : SPA
discovered in bay 0
LC/0/3/CPU0:Feb  4 08:23:32.593 : spa_192_jacket[188]: %L2-SPA-5-OIR_ERROR : SPA (0): Too
many retries, error recovery stopped
LC/0/3/CPU0:Feb  4 08:23:32.593 : spa_192_jacket[188]: %L2-SPA-5-OIR_ERROR : SPA (0): An
error occurred (0x1002), error recovery action: hold SPA in reset
```

When a SPA is in the failed state, it may not register itself with the FPD upgrade mechanism. In this case, you do not see the SPA listed when you use the **show hw-module fpd** command. To verify the state of a SPA, use the **show hw-module subslot error** command and the **show hw-module subslot status** command.

## Performing a SPA FPD Recovery Upgrade

To recover a SPA from the failed state because of a corrupted FPD image, you must manually shut down the SPA. Use the **hw-module subslot subslot-id shutdown** command in Global Configuration mode to administratively shutdown the SPA. After the SPA is shut down, you can use the **upgrade hw-module fpd** command in administration EXEC mode:

```
RP/0/RSP0/CPU0:router# admin
RP/0/RSP0/CPU0:router(admin)# upgrade hw-module fpd fpga location 0/3/0
```

## Performing a SIP FPD Recovery Upgrade

If a SIP upgrade fails for whatever reason, do not reload the SIP. Try to perform the upgrade procedure again. You can perform the upgrade procedure multiple times, as long as you do not reload the SIP. The FPD upgrade procedure takes several minutes to complete; do not interrupt the procedure. If you reload the SIP when the FPD image is corrupted, the SIP malfunctions and you must contact Cisco technical support for assistance.

To recover a SIP from the failed state because of a corrupted FPD image, you must contact Cisco technical support.

To recover a SIP from the failed state because of a corrupted FPD image, you must turn off the automatic reset of the SIP card. Use the **hw-module reset auto disable** command in administration configuration mode, as shown in the following example:

```
RP/0/RSP0/CPU0:router(admin-config)# hw-module reset auto disable location 0/1/4
```







# CHAPTER 10

## Configuring Network Time Protocol

*Network Time Protocol* (NTP) is a protocol designed to time-synchronize devices within a network. Cisco IOS XR software implements NTPv4. NTPv4 retains backwards compatibility with the older versions of NTP, including NTPv3 and NTPv2 but excluding NTPv1, which has been discontinued due to security vulnerabilities.

This module describes the tasks you need to implement NTP on the Cisco IOS XR software.

For more information about NTP on the Cisco IOS XR software and complete descriptions of the NTP commands listed in this module, see [Related Documents, on page 247](#). To locate documentation for other commands that might appear in the course of running a configuration task, search online in *Cisco ASR 9000 Series Aggregation Services Router Commands Master List*.

**Table 34: Feature History for Implementing NTP on Cisco IOS XR Software**

Release	Modification
Release 3.7.2	This feature was introduced.
Release 3.9.0	Support was added for IPv6 addresses, VRFs, multicast-based associations, and burst and iburst modes for poll-based associations.
Release 4.3.0	Support was added for NTP-PTP interworking.
Release 4.3.1	Support was added for NTP server inside VRF interface

This module contains the following topics:

- [Prerequisites for Implementing NTP on Cisco IOS XR Software, on page 222](#)
- [Information About Implementing NTP, on page 222](#)
- [How to Implement NTP, on page 224](#)
- [Configuration Examples for Implementing NTP, on page 240](#)
- [FQDN for NTP Server, on page 244](#)
- [Configuring NTP server inside VRF interface, on page 246](#)
- [Additional References, on page 247](#)

# Prerequisites for Implementing NTP on Cisco IOS XR Software

You must be in a user group associated with a task group that includes the proper task IDs. The command reference guides include the task IDs required for each command. If you suspect user group assignment is preventing you from using a command, contact your AAA administrator for assistance.

## Information About Implementing NTP

NTP synchronizes timekeeping among a set of distributed time servers and clients. This synchronization allows events to be correlated when system logs are created and other time-specific events occur.

NTP uses the User Datagram Protocol (UDP) as its transport protocol. All NTP communication uses Coordinated Universal Time (UTC). An NTP network usually receives its time from an authoritative time source, such as a radio clock or an atomic clock attached to a time server. NTP distributes this time across the network. NTP is extremely efficient; no more than one packet per minute is necessary to synchronize two machines to within a millisecond of each other.

NTP uses the concept of a “stratum” to describe how many NTP “hops” away a machine is from an authoritative time source. A “stratum 1” time server typically has an authoritative time source (such as a radio or atomic clock, or a GPS time source) directly attached, a “stratum 2” time server receives its time via NTP from a “stratum 1” time server, and so on.

NTP avoids synchronizing to a machine whose time may not be accurate, in two ways. First, NTP never synchronizes to a machine that is not synchronized itself. Second, NTP compares the time reported by several machines and does not synchronize to a machine whose time is significantly different than the others, even if its stratum is lower. This strategy effectively builds a self-organizing tree of NTP servers.

The Cisco implementation of NTP does not support stratum 1 service; in other words, it is not possible to connect to a radio or atomic clock (for some specific platforms, however, you can connect a GPS time-source device). We recommend that time service for your network be derived from the public NTP servers available in the IP Internet.

If the network is isolated from the Internet, the Cisco implementation of NTP allows a machine to be configured so that it acts as though it is synchronized via NTP, when in fact it has determined the time using other means. Other machines can then synchronize to that machine via NTP.

Several manufacturers include NTP software for their host systems, and a publicly available version for systems running UNIX and its various derivatives is also available. This software also allows UNIX-derivative servers to acquire the time directly from an atomic clock, which would subsequently propagate time information along to Cisco routers.

The communications between machines running NTP (known as *associations*) are usually statically configured; each machine is given the IP address of all machines with which it should form associations. Accurate timekeeping is made possible by exchanging NTP messages between each pair of machines with an association.

The Cisco implementation of NTP supports two ways that a networking device can obtain NTP time information on a network:

- By polling host servers
- By listening to NTP broadcasts

In a LAN environment, NTP can be configured to use IP broadcast messages. As compared to polling, IP broadcast messages reduce configuration complexity, because each machine can simply be configured to send or receive broadcast or multicast messages. However, the accuracy of timekeeping is marginally reduced because the information flow is one-way only.

An NTP broadcast client listens for broadcast messages sent by an NTP broadcast server at a designated IPv4 address. The client synchronizes the local clock using the first received broadcast message.

The time kept on a machine is a critical resource, so we strongly recommend that you use the security features of NTP to avoid the accidental or malicious setting of incorrect time. Two mechanisms are available: an access list-based restriction scheme and an encrypted authentication mechanism.

When multiple sources of time (VINES, hardware clock, manual configuration) are available, NTP is always considered to be more authoritative. NTP time overrides the time set by any other method.



---

**Note** NTP associations will not be formed if the packets received are from a VRF which is different from the VRF that is configured for the NTP server or peer.

---

#### Preventing Issues due to GPS Week Number Rollover (WNRO)

- If there are no GPS sources in the NTP source chain or server chain, there is no impact of GPS Week Number Rollover (WNRO).
- GPS WNRO affects only the system clock and not user traffic.
- Contact your GPS manufacturer to fix the GPS source for this condition.

To mitigate impact of GPS sources that are subject to GPS WNRO perform the following optional workarounds:

- If the GPS source has been identified to be a cause of potential disruption on April 6, 2019 (or after), configure `ntp master` in the Cisco that is device connected to this source, and its clock on the Stratum 1 device to preventively isolate it. This configuration enables the device to present its own clock for synchronization to downstream NTP clients.



---

**Note** The usage of `ntp master` command as mentioned above is only a workaround to this condition. Use this command until the GPS source-related conditions are resolved, and to prevent the distribution of incorrect clock values throughout the network.

---

- Configure multiple NTP servers (ideally 4, but more than 3) at Stratum 2 level of the network, to enable NTP clients at Stratum 2 level to get clock from more than one Stratum 1 server. This way, WNRO affected Stratum 1 servers are staged to be marked as ‘false ticker’ or ‘outlier’ clock sources as compared to other non-WNRO affected Stratum 1 servers.

## NTP-PTP Interworking

NTP-PTP interworking provides the ability to use PTP, as well as other valid time of day (TOD) sources such as Data over Cable Service Interface Specification (DOCSIS) Timing Interface (DTI) and global positioning

system (GPS), as the time source for the operating system. Prior to the support of NTP-PTP interworking, only backplane time was supported for the operating system time.

NTP-PTP interworking also provides the means to communicate status changes between PTP and NTP processes. It also supports the unambiguous control of the operating system time and backplane time in the event of bootup, switchovers or card and process failures.

#### Related Topics

[Configuring NTP-PTP Interworking](#), on page 236

## How to Implement NTP

### Configuring Poll-Based Associations



---

**Note** No specific command enables NTP; the first NTP configuration command that you issue enables NTP.

---

You can configure the following types of poll-based associations between the router and other devices (which may also be routers):

- Client mode
- Symmetric active mode

The client and the symmetric active modes should be used when NTP is required to provide a high level of time accuracy and reliability.

When a networking device is operating in the client mode, it polls its assigned time serving hosts for the current time. The networking device then picks a host from all the polled time servers to synchronize with. Because the relationship that is established in this case is a client-host relationship, the host does not capture or use any time information sent by the local client device. This mode is most suited for file-server and workstation clients that are not required to provide any form of time synchronization to other local clients. Use the **server** command to individually specify the time-serving hosts that you want your networking device to consider synchronizing with and to set your networking device to operate in the client mode.

When a networking device is operating in the symmetric active mode, it polls its assigned time-serving hosts for the current time and it responds to polls by its hosts. Because this is a peer-to-peer relationship, the host also retains time-related information about the local networking device that it is communicating with. This mode should be used when there are several mutually redundant servers that are interconnected via diverse network paths. Most stratum 1 and stratum 2 servers on the Internet today adopt this form of network setup. Use the **peer** command to individually specify the time-serving hosts that you want your networking device to consider synchronizing with and to set your networking device to operate in the symmetric active mode.

When the router polls several other devices for the time, the router selects one device with which to synchronize.



**Note** To configure a peer-to-peer association between the router and another device, you must also configure the router as a peer on the other device.

You can configure multiple peers and servers, but you cannot configure a single IP address as both a peer and a server at the same time.

To change the configuration of a specific IP address from peer to server or from server to peer, use the **no** form of the **peer** or **server** command to remove the current configuration before you perform the new configuration. If you do not remove the old configuration before performing the new configuration, the new configuration does not overwrite the old configuration.

## SUMMARY STEPS

1. **configure**
2. **ntp**
3. **server** *ip-address* [**version number**] [**key key-id**] [**minpoll interval**] [**maxpoll interval**] [**source type interface-path-id**] [**prefer**] [**burst**] [**iburst**]
4. **peer** *ip-address* [**version number**] [**key key-id**] [**minpoll interval**] [**maxpoll interval**] [**source type interface-path-id**] [**prefer**]
5. Use one of the following commands:
  - **end**
  - **commit**

## DETAILED STEPS

	Command or Action	Purpose
<b>Step 1</b>	<b>configure</b> <b>Example:</b> <pre>RP/0/RSP0/CPU0:router# configure</pre>	Enters global configuration mode.
<b>Step 2</b>	<b>ntp</b> <b>Example:</b> <pre>RP/0/RSP0/CPU0:router(config)# ntp</pre>	Enters NTP configuration mode.
<b>Step 3</b>	<b>server</b> <i>ip-address</i> [ <b>version number</b> ] [ <b>key key-id</b> ] [ <b>minpoll interval</b> ] [ <b>maxpoll interval</b> ] [ <b>source type interface-path-id</b> ] [ <b>prefer</b> ] [ <b>burst</b> ] [ <b>iburst</b> ] <b>Example:</b> <pre>RP/0/RSP0/CPU0:router(config-ntp)# server 172.16.22.44 minpoll 8 maxpoll 12</pre>	Forms a server association with another system. This step can be repeated as necessary to form associations with multiple devices.

	Command or Action	Purpose
<b>Step 4</b>	<p><b>peer</b> <i>ip-address</i> [<b>version number</b>] [<b>key key-id</b>] [<b>minpoll interval</b>] [<b>maxpoll interval</b>] [<b>source type interface-path-id</b>] [<b>prefer</b>]</p> <p><b>Example:</b></p> <pre>RP/0/RSP0/CPU0:router(config-ntp)# peer 192.168.22.33 minpoll 8 maxpoll 12 source tengige 0/0/0/1</pre>	<p>Forms a peer association with another system. This step can be repeated as necessary to form associations with multiple systems.</p> <p><b>Note</b> To complete the configuration of a peer-to-peer association between the router and the remote device, the router must also be configured as a peer on the remote device.</p>
<b>Step 5</b>	<p>Use one of the following commands:</p> <ul style="list-style-type: none"> <li>• <b>end</b></li> <li>• <b>commit</b></li> </ul> <p><b>Example:</b></p> <pre>RP/0/RSP0/CPU0:router(config-ntp)# end</pre> <p>or</p> <pre>RP/0/RSP0/CPU0:router(config-ntp)# commit</pre>	<p>Saves configuration changes.</p> <ul style="list-style-type: none"> <li>• When you issue the <b>end</b> command, the system prompts you to commit changes:</li> </ul> <pre>Uncommitted changes found, commit them before   exiting(yes/no/cancel)? [cancel]:</pre> <ul style="list-style-type: none"> <li>• Entering <b>yes</b> saves configuration changes to the running configuration file, exits the configuration session, and returns the router to EXEC mode.</li> <li>• Entering <b>no</b> exits the configuration session and returns the router to EXEC mode without committing the configuration changes.</li> <li>• Entering <b>cancel</b> leaves the router in the current configuration session without exiting or committing the configuration changes.</li> </ul> <ul style="list-style-type: none"> <li>• Use the <b>commit</b> command to save the configuration changes to the running configuration file and remain within the configuration session.</li> </ul>

## Configuring Broadcast-Based NTP Associates

In a broadcast-based NTP association, an NTP server propagates NTP broadcast packets throughout a network. Broadcast clients listen for the NTP broadcast packets propagated by the NTP server and do not engage in any polling.

Broadcast-based NTP associations should be used when time accuracy and reliability requirements are modest and if your network is localized and has a large number of clients (more than 20). Broadcast-based NTP associations also are recommended for use on networks that have limited bandwidth, system memory, or CPU resources. Time accuracy is marginally reduced in broadcast-based NTP associations because information flows only one way.

Use the **broadcast client** command to set your networking device to listen for NTP broadcast packets propagated through a network. For broadcast client mode to work, the broadcast server and its clients must be located on the same subnet. The time server that is transmitting NTP broadcast packets must be enabled on the interface of the given device using the **broadcast** command.

Use the **broadcast** command to set your networking device to send NTP broadcast packets.



**Note** No specific command enables NTP; the first NTP configuration command that you issue enables NTP.



**Note** If you enable NTP broadcast on the physical interface, subinterface or bundle interface, then it breaks the inter-VRF Poll-Based association between client and server. As these interfaces also handle NTP unicast traffic, the interface designated as broadcast, rejects service unicast clients on it. So, NTP broadcast and NTP unicast are not allowed on the same interface.

## SUMMARY STEPS

1. **configure**
2. **ntp**
3. (Optional) **broadcastdelay** *microseconds*
4. **interface** *type interface-path-id*
5. **broadcast client**
6. **broadcast** [**destination** *ip-address*] [**key** *key-id*] [**version** *number*]
7. Use one of the following commands:
  - **end**
  - **commit**

## DETAILED STEPS

	Command or Action	Purpose
Step 1	<b>configure</b> <b>Example:</b> RP/0/RSP0/CPU0:router# <code>configure</code>	Enters global configuration mode.
Step 2	<b>ntp</b> <b>Example:</b> RP/0/RSP0/CPU0:router(config)# <code>ntp</code>	Enters NTP configuration mode.
Step 3	(Optional) <b>broadcastdelay</b> <i>microseconds</i> <b>Example:</b> RP/0/RSP0/CPU0:router(config-ntp)# <code>broadcastdelay</code> 5000	Adjusts the estimated round-trip delay for NTP broadcasts.
Step 4	<b>interface</b> <i>type interface-path-id</i> <b>Example:</b>	Enters NTP interface configuration mode.

	Command or Action	Purpose
	RP/0/RSP0/CPU0:router(config-ntp)# interface POS 0/1/0/0	
<b>Step 5</b>	<p><b>broadcast client</b></p> <p><b>Example:</b></p> <pre>RP/0/RSP0/CPU0:router(config-ntp-int)# broadcast client</pre>	<p>Configures the specified interface to receive NTP broadcast packets.</p> <p><b>Note</b> Go to next step to configure the interface to send NTP broadcast packets.</p>
<b>Step 6</b>	<p><b>broadcast [destination ip-address] [key key-id] [version number]</b></p> <p><b>Example:</b></p> <pre>RP/0/RSP0/CPU0:router(config-ntp-int)# broadcast destination 10.50.32.149</pre>	<p>Configures the specified interface to send NTP broadcast packets.</p> <p><b>Note</b> Go to previous step to configure the interface to receive NTP broadcast packets.</p>
<b>Step 7</b>	<p>Use one of the following commands:</p> <ul style="list-style-type: none"> <li>• <b>end</b></li> <li>• <b>commit</b></li> </ul> <p><b>Example:</b></p> <pre>RP/0/RSP0/CPU0:router(config-ntp-int)# end</pre> <p>or</p> <pre>RP/0/RSP0/CPU0:router(config-ntp-int)# commit</pre>	<p>Saves configuration changes.</p> <ul style="list-style-type: none"> <li>• When you issue the <b>end</b> command, the system prompts you to commit changes: <pre>Uncommitted changes found, commit them before exiting (yes/no/cancel)? [cancel]:</pre> <ul style="list-style-type: none"> <li>• Entering <b>yes</b> saves configuration changes to the running configuration file, exits the configuration session, and returns the router to EXEC mode.</li> <li>• Entering <b>no</b> exits the configuration session and returns the router to EXEC mode without committing the configuration changes.</li> <li>• Entering <b>cancel</b> leaves the router in the current configuration session without exiting or committing the configuration changes.</li> </ul> </li> <li>• Use the <b>commit</b> command to save the configuration changes to the running configuration file and remain within the configuration session.</li> </ul>

## Configuring NTP Access Groups



**Note** No specific command enables NTP; the first NTP configuration command that you issue enables NTP.

The access list-based restriction scheme allows you to grant or deny certain access privileges to an entire network, a subnet within a network, or a host within a subnet.



The access group options are scanned in the following order, from least restrictive to most restrictive:

1. **peer**—Allows time requests and NTP control queries and allows the system to synchronize itself to a system whose address passes the access list criteria.
2. **serve**—Allows time requests and NTP control queries, but does not allow the system to synchronize itself to a system whose address passes the access list criteria.
3. **serve-only**—Allows only time requests from a system whose address passes the access list criteria.
4. **query-only**—Allows only NTP control queries from a system whose address passes the access list criteria.

If the source IP address matches the access lists for more than one access type, the first type is granted. If no access groups are specified, all access types are granted to all systems. If any access groups are specified, only the specified access types are granted.

For details on NTP control queries, see RFC 1305 (NTP version 3).

## SUMMARY STEPS

1. **configure**
2. **ntp**
3. **access-group** {**peer** | **query-only** | **serve** | **serve-only**} *access-list-name*
4. Use one of the following commands:
  - **end**
  - **commit**

## DETAILED STEPS

	Command or Action	Purpose
<b>Step 1</b>	<b>configure</b> <b>Example:</b> RP/0/RSP0/CPU0:router# configure	Enters global configuration mode.
<b>Step 2</b>	<b>ntp</b> <b>Example:</b> RP/0/RSP0/CPU0:router(config)# ntp	Enters NTP configuration mode.
<b>Step 3</b>	<b>access-group</b> { <b>peer</b>   <b>query-only</b>   <b>serve</b>   <b>serve-only</b> } <i>access-list-name</i> <b>Example:</b> RP/0/RSP0/CPU0:router(config-ntp)# access-group peer access1	Creates an access group and applies a basic IPv4 or IPv6 access list to it.
<b>Step 4</b>	Use one of the following commands: <ul style="list-style-type: none"> <li>• <b>end</b></li> <li>• <b>commit</b></li> </ul> <b>Example:</b>	Saves configuration changes. <ul style="list-style-type: none"> <li>• When you issue the <b>end</b> command, the system prompts you to commit changes:</li> </ul> <pre>Uncommitted changes found, commit them before</pre>

	Command or Action	Purpose
	<pre>RP/0/RSP0/CPU0:router(config-ntp)# end</pre> <p>or</p> <pre>RP/0/RSP0/CPU0:router(config-ntp)# commit</pre>	<p>exiting(yes/no/cancel)? [cancel]:</p> <ul style="list-style-type: none"> <li>• Entering <b>yes</b> saves configuration changes to the running configuration file, exits the configuration session, and returns the router to EXEC mode.</li> <li>• Entering <b>no</b> exits the configuration session and returns the router to EXEC mode without committing the configuration changes.</li> <li>• Entering <b>cancel</b> leaves the router in the current configuration session without exiting or committing the configuration changes.</li> </ul> <ul style="list-style-type: none"> <li>• Use the <b>commit</b> command to save the configuration changes to the running configuration file and remain within the configuration session.</li> </ul>

## Configuring NTP Authentication

This task explains how to configure NTP authentication.



**Note** No specific command enables NTP; the first NTP configuration command that you issue enables NTP.

The encrypted NTP authentication scheme should be used when a reliable form of access control is required. Unlike the access-list-based restriction scheme that is based on IP addresses, the encrypted authentication scheme uses authentication keys and an authentication process to determine if NTP synchronization packets sent by designated peers or servers on a local network are deemed as trusted, before the time information that it carries along is accepted.

The authentication process begins from the moment an NTP packet is created. A message authentication code (MAC) is computed using the MD5 Message Digest Algorithm and the MAC is embedded into an NTP synchronization packet. The NTP synchronization packet together with the embedded MAC and key number are transmitted to the receiving client. If authentication is enabled and the key is trusted, the receiving client computes the MAC in the same way. If the computed MAC matches the embedded MAC, the system is allowed to sync to the server that uses this key in its packets.

After NTP authentication is properly configured, your networking device only synchronizes with and provides synchronization to trusted time sources.

### SUMMARY STEPS

1. **configure**
2. **ntp**
3. **authenticate**
4. **authentication-key** *key-number* **md5** [**clear** | **encrypted**] *key-name*
5. **trusted-key** *key-number*

## 6. Use one of the following commands:

- **end**
- **commit**

## DETAILED STEPS

	Command or Action	Purpose
<b>Step 1</b>	<b>configure</b> <b>Example:</b> <pre>RP/0/RSP0/CPU0:router# configure</pre>	Enters global configuration mode.
<b>Step 2</b>	<b>ntp</b> <b>Example:</b> <pre>RP/0/RSP0/CPU0:router(config)# ntp</pre>	Enters NTP configuration mode.
<b>Step 3</b>	<b>authenticate</b> <b>Example:</b> <pre>RP/0/RSP0/CPU0:router(config-ntp)# authenticate</pre>	Enables the NTP authentication feature.
<b>Step 4</b>	<b>authentication-key</b> <i>key-number</i> <b>md5</b> [ <b>clear</b>   <b>encrypted</b> ] <i>key-name</i> <b>Example:</b> <pre>RP/0/RSP0/CPU0:router(config-ntp)# authentication-key 42 md5 clear key1</pre>	Defines the authentication keys. <ul style="list-style-type: none"> <li>• Each key has a key number, a type, a value, and, optionally, a name. Starting from Cisco IOS-XR Release 7.5.1 the following authentication types are supported:               <ul style="list-style-type: none"> <li>• <b>cmac</b> CMAC authentication</li> <li>• <b>md5</b> MD5 authentication</li> <li>• <b>sha1</b> SHA1 authentication</li> <li>• <b>sha2</b> SHA2 authentication</li> </ul> </li> </ul>
<b>Step 5</b>	<b>trusted-key</b> <i>key-number</i> <b>Example:</b> <pre>RP/0/RSP0/CPU0:router(config-ntp)# trusted-key 42</pre>	Defines trusted authentication keys. <ul style="list-style-type: none"> <li>• If a key is trusted, this router only synchronizes to a system that uses this key in its NTP packets.</li> </ul>
<b>Step 6</b>	Use one of the following commands: <ul style="list-style-type: none"> <li>• <b>end</b></li> <li>• <b>commit</b></li> </ul> <b>Example:</b> <pre>RP/0/RSP0/CPU0:router(config-ntp)# end</pre>	Saves configuration changes. <ul style="list-style-type: none"> <li>• When you issue the <b>end</b> command, the system prompts you to commit changes:   <pre>Uncommitted changes found, commit them before</pre> </li> </ul>

	Command or Action	Purpose
	or  RP/0/RSP0/CPU0:router(config-ntp)# commit	exiting(yes/no/cancel)? [cancel]:  <ul style="list-style-type: none"> <li>• Entering <b>yes</b> saves configuration changes to the running configuration file, exits the configuration session, and returns the router to EXEC mode.</li> <li>• Entering <b>no</b> exits the configuration session and returns the router to EXEC mode without committing the configuration changes.</li> <li>• Entering <b>cancel</b> leaves the router in the current configuration session without exiting or committing the configuration changes.</li> </ul> <ul style="list-style-type: none"> <li>• Use the <b>commit</b> command to save the configuration changes to the running configuration file and remain within the configuration session.</li> </ul>

## Disabling NTP Services on a Specific Interface

NTP services are disabled on all interfaces by default.

NTP is enabled globally when any NTP commands are entered. You can selectively prevent NTP packets from being received through a specific interface by turning off NTP on a given interface.

### SUMMARY STEPS

1. **configure**
2. **ntp**
3. Use one of the following commands:
  - **no interface** *type interface-path-id*
  - **interface** *type interface-path-id* **disable**
4. Use one of the following commands:
  - **end**
  - **commit**

### DETAILED STEPS

	Command or Action	Purpose
<b>Step 1</b>	<b>configure</b>  <b>Example:</b>  RP/0/RSP0/CPU0:router# configure	Enters global configuration mode.

	Command or Action	Purpose
<b>Step 2</b>	<b>ntp</b> <b>Example:</b> <pre>RP/0/RSP0/CPU0:router(config)# ntp</pre>	Enters NTP configuration mode.
<b>Step 3</b>	Use one of the following commands: <ul style="list-style-type: none"> <li>• <b>no interface</b> <i>type interface-path-id</i></li> <li>• <b>interface</b> <i>type interface-path-id</i> <b>disable</b></li> </ul> <b>Example:</b> <pre>RP/0/RSP0/CPU0:router(config-ntp)# no interface pos 0/0/0/1</pre> or <pre>RP/0/RSP0/CPU0:router(config-ntp)# interface POS 0/0/0/1 disable</pre>	Disables NTP services on the specified interface.
<b>Step 4</b>	Use one of the following commands: <ul style="list-style-type: none"> <li>• <b>end</b></li> <li>• <b>commit</b></li> </ul> <b>Example:</b> <pre>RP/0/RSP0/CPU0:router(config-ntp)# end</pre> or <pre>RP/0/RSP0/CPU0:router(config-ntp)# commit</pre>	Saves configuration changes. <ul style="list-style-type: none"> <li>• When you issue the <b>end</b> command, the system prompts you to commit changes:   <pre>Uncommitted changes found, commit them before   exiting(yes/no/cancel)? [cancel]:</pre> <ul style="list-style-type: none"> <li>• Entering <b>yes</b> saves configuration changes to the running configuration file, exits the configuration session, and returns the router to EXEC mode.</li> <li>• Entering <b>no</b> exits the configuration session and returns the router to EXEC mode without committing the configuration changes.</li> <li>• Entering <b>cancel</b> leaves the router in the current configuration session without exiting or committing the configuration changes.</li> </ul> </li> <li>• Use the <b>commit</b> command to save the configuration changes to the running configuration file and remain within the configuration session.</li> </ul>

## Configuring the Source IP Address for NTP Packets

By default, the source IP address of an NTP packet sent by the router is the address of the interface through which the NTP packet is sent. Use this procedure to set a different source address.



**Note** No specific command enables NTP; the first NTP configuration command that you issue enables NTP.

## SUMMARY STEPS

1. **configure**
2. **ntp**
3. **source** *type interface-path-id*
4. Use one of the following commands:
  - **end**
  - **commit**

## DETAILED STEPS

	Command or Action	Purpose
<b>Step 1</b>	<b>configure</b> <b>Example:</b> RP/0/RSP0/CPU0:router# configure	Enters global configuration mode.
<b>Step 2</b>	<b>ntp</b> <b>Example:</b> RP/0/RSP0/CPU0:router(config)# ntp	Enters NTP configuration mode.
<b>Step 3</b>	<b>source</b> <i>type interface-path-id</i> <b>Example:</b> RP/0/RSP0/CPU0:router(config-ntp)# source POS 0/0/0/1	Configures an interface from which the IP source address is taken.  <b>Note</b> This interface is used for the source address for all packets sent to all destinations. If a source address is to be used for a specific association, use the <b>source</b> keyword in the <b>peer</b> or <b>server</b> command shown in <a href="#">Configuring Poll-Based Associations, on page 224</a> .
<b>Step 4</b>	Use one of the following commands: <ul style="list-style-type: none"> <li>• <b>end</b></li> <li>• <b>commit</b></li> </ul> <b>Example:</b> RP/0/RSP0/CPU0:router(config-ntp)# end or RP/0/RSP0/CPU0:router(config-ntp)# commit	Saves configuration changes. <ul style="list-style-type: none"> <li>• When you issue the <b>end</b> command, the system prompts you to commit changes:                 Uncommitted changes found, commit them before                exiting(yes/no/cancel)?                [cancel]:             </li> <li>• Entering <b>yes</b> saves configuration changes to the running configuration file, exits the configuration session, and returns the router to EXEC mode.</li> </ul>

	Command or Action	Purpose
		<ul style="list-style-type: none"> <li>• Entering <b>no</b> exits the configuration session and returns the router to EXEC mode without committing the configuration changes.</li> <li>• Entering <b>cancel</b> leaves the router in the current configuration session without exiting or committing the configuration changes.</li> <li>• Use the <b>commit</b> command to save the configuration changes to the running configuration file and remain within the configuration session.</li> </ul>

## Configuring the System as an Authoritative NTP Server

You can configure the router to act as an authoritative NTP server, even if the system is not synchronized to an outside time source.



**Note** No specific command enables NTP; the first NTP configuration command that you issue enables NTP.

### SUMMARY STEPS

1. **configure**
2. **ntp**
3. **master** *stratum*
4. Use one of the following commands:
  - **end**
  - **commit**

### DETAILED STEPS

	Command or Action	Purpose
<b>Step 1</b>	<b>configure</b> <b>Example:</b> RP/0/RSP0/CPU0:router# configure	Enters global configuration mode.
<b>Step 2</b>	<b>ntp</b> <b>Example:</b> RP/0/RSP0/CPU0:router(config)# ntp	Enters NTP configuration mode.
<b>Step 3</b>	<b>master</b> <i>stratum</i> <b>Example:</b>	Makes the router an authoritative NTP server.

	Command or Action	Purpose
	<pre>RP/0/RSP0/CPU0:router(config-ntp)# master 9</pre>	<p><b>Note</b> Use the <b>master</b> command with caution. It is very easy to override valid time sources using this command, especially if a low stratum number is configured. Configuring multiple machines in the same network with the <b>master</b> command can cause instability in time keeping if the machines do not agree on the time.</p>
<b>Step 4</b>	<p>Use one of the following commands:</p> <ul style="list-style-type: none"> <li>• <b>end</b></li> <li>• <b>commit</b></li> </ul> <p><b>Example:</b></p> <pre>RP/0/RSP0/CPU0:router(config-ntp)# end</pre> <p>or</p> <pre>RP/0/RSP0/CPU0:router(config-ntp)# commit</pre>	<p>Saves configuration changes.</p> <ul style="list-style-type: none"> <li>• When you issue the <b>end</b> command, the system prompts you to commit changes: <pre>Uncommitted changes found, commit them before   exiting(yes/no/cancel)? [cancel]:</pre> <ul style="list-style-type: none"> <li>• Entering <b>yes</b> saves configuration changes to the running configuration file, exits the configuration session, and returns the router to EXEC mode.</li> <li>• Entering <b>no</b> exits the configuration session and returns the router to EXEC mode without committing the configuration changes.</li> <li>• Entering <b>cancel</b> leaves the router in the current configuration session without exiting or committing the configuration changes.</li> </ul> </li> <li>• Use the <b>commit</b> command to save the configuration changes to the running configuration file and remain within the configuration session.</li> </ul>

## Configuring NTP-PTP Interworking

Use this task to configure NTP to use PTP as the time source.

### Before you begin

PTP must be supported and enabled on the router before NTP-PTP interworking can be configured. If PTP is not enabled, you receive an error message similar to the following when you try to commit the configuration:

```
RP/0/RSP0/CPU0:router(config)# ntp master primary-reference-clock
RP/0/RSP0/CPU0:router(config)# commit

% Failed to commit one or more configuration items. Please issue
'show configuration failed' from this session to view the errors

RP/0/RSP0/CPU0:router(config)# show configuration failed
[:::]
ntp
```



```

master primary-reference-clock
!!% 'ip-ntp' detected the 'fatal' condition 'PTP is not supported on this platform'
!
end

```

Refer to the [Configuring PTP, on page 410](#) module for more information.

## SUMMARY STEPS

1. **configure**
2. **ntp**
3. **master primary-reference-clock**
4. Use one of the following commands:
  - **end**
  - **commit**

## DETAILED STEPS

	Command or Action	Purpose
<b>Step 1</b>	<b>configure</b> <b>Example:</b> RP/0/RSP0/CPU0:router# configure	Enters global configuration mode.
<b>Step 2</b>	<b>ntp</b> <b>Example:</b> RP/0/RSP0/CPU0:router(config)# ntp	Enters NTP configuration mode.
<b>Step 3</b>	<b>master primary-reference-clock</b> <b>Example:</b> RP/0/RSP0/CPU0:router(config-ntp)# master primary-reference-clock	Specifies PTP to be the NTP time source.
<b>Step 4</b>	Use one of the following commands: <ul style="list-style-type: none"> <li>• <b>end</b></li> <li>• <b>commit</b></li> </ul> <b>Example:</b> RP/0/RSP0/CPU0:router(config-ntp)# end or RP/0/RSP0/CPU0:router(config-ntp)# commit	Saves configuration changes. <ul style="list-style-type: none"> <li>• When you issue the <b>end</b> command, the system prompts you to commit changes:               <pre> Uncommitted changes found, commit them before   exiting(yes/no/cancel)? [cancel]:               </pre> </li> <li>• Entering <b>yes</b> saves configuration changes to the running configuration file, exits the configuration session, and returns the router to EXEC mode.</li> </ul>

	Command or Action	Purpose
		<ul style="list-style-type: none"> <li>• Entering <b>no</b> exits the configuration session and returns the router to EXEC mode without committing the configuration changes.</li> <li>• Entering <b>cancel</b> leaves the router in the current configuration session without exiting or committing the configuration changes.</li> <li>• Use the <b>commit</b> command to save the configuration changes to the running configuration file and remain within the configuration session.</li> </ul>

## Updating the Hardware Clock

On devices that have hardware clocks (system calendars), you can configure the hardware clock to be periodically updated from the software clock. This is advisable for devices using NTP, because the time and date on the software clock (set using NTP) is more accurate than the hardware clock. The time setting on the hardware clock has the potential to drift slightly over time.



**Note** No specific command enables NTP; the first NTP configuration command that you issue enables NTP.

### SUMMARY STEPS

1. **configure**
2. **ntp**
3. **update-calendar**
4. Use one of the following commands:
  - **end**
  - **commit**

### DETAILED STEPS

	Command or Action	Purpose
<b>Step 1</b>	<b>configure</b> <b>Example:</b> RP/0/RSP0/CPU0:router# <code>configure</code>	Enters global configuration mode.
<b>Step 2</b>	<b>ntp</b> <b>Example:</b> RP/0/RSP0/CPU0:router(config)# <code>ntp</code>	Enters NTP configuration mode.

	Command or Action	Purpose
<b>Step 3</b>	<b>update-calendar</b> <b>Example:</b> <pre>RP/0/RSP0/CPU0:router(config-ntp)# update-calendar</pre>	Configures the router to update its system calendar from the software clock at periodic intervals.
<b>Step 4</b>	Use one of the following commands: <ul style="list-style-type: none"> <li>• <b>end</b></li> <li>• <b>commit</b></li> </ul> <b>Example:</b> <pre>RP/0/RSP0/CPU0:router(config-ntp)# end</pre> OR <pre>RP/0/RSP0/CPU0:router(config-ntp)# commit</pre>	Saves configuration changes. <ul style="list-style-type: none"> <li>• When you issue the <b>end</b> command, the system prompts you to commit changes:   <pre>Uncommitted changes found, commit them before   exiting(yes/no/cancel)? [cancel]:</pre> <ul style="list-style-type: none"> <li>• Entering <b>yes</b> saves configuration changes to the running configuration file, exits the configuration session, and returns the router to EXEC mode.</li> <li>• Entering <b>no</b> exits the configuration session and returns the router to EXEC mode without committing the configuration changes.</li> <li>• Entering <b>cancel</b> leaves the router in the current configuration session without exiting or committing the configuration changes.</li> </ul> </li> <li>• Use the <b>commit</b> command to save the configuration changes to the running configuration file and remain within the configuration session.</li> </ul>

## Verifying the Status of the External Reference Clock

This task explains how to verify the status of NTP components.



**Note** The commands can be entered in any order.

### SUMMARY STEPS

1. **show ntp associations** [detail] [location *node-id*]
2. **show ntp status** [location *node-id*]

## DETAILED STEPS

	Command or Action	Purpose
<b>Step 1</b>	<b>show ntp associations [detail] [location node-id]</b> <b>Example:</b> RP/0/RSP0/CPU0:router# show ntp associations	Displays the status of NTP associations.
<b>Step 2</b>	<b>show ntp status [location node-id]</b> <b>Example:</b> RP/0/RSP0/CPU0:router# show ntp status	Displays the status of NTP.

## Examples

The following is sample output from the **show ntp associations** command:

```
RP/0/RSP0/CPU0:router# show ntp associations
      address      ref clock      st  when  poll reach  delay  offset  disp
+~127.127.1.1     127.127.1.1    5   5    1024   37    0.0   0.00   438.3
*~172.19.69.1    172.24.114.33  3   13   1024    1    2.0   67.16   0.0
 * master (syncd), # master (unsyncd), + selected, - candidate, ~ configured
```

The following is sample output from the **show ntp status** command:

```
RP/0/RSP0/CPU0:router# show ntp status

Clock is synchronized, stratum 4, reference is 172.19.69.1
nominal freq is 1000.0000 Hz, actual freq is 999.9988 Hz, precision is 2**26
reference time is C54C131B.9EECF6CA (07:26:19.620 UTC Mon Nov 24 2008)
clock offset is 66.3685 msec, root delay is 7.80 msec
root dispersion is 950.04 msec, peer dispersion is 3.38 msec
```

## Configuration Examples for Implementing NTP

### Configuring Poll-Based Associations: Example

The following example shows an NTP configuration in which the router's system clock is configured to form a peer association with the time server host at IP address 192.168.22.33, and to allow the system clock to be synchronized by time server hosts at IP address 10.0.2.1 and 172.19.69.1:

```
ntp
 server 10.0.2.1 minpoll 5 maxpoll 7
 peer 192.168.22.33

 server 172.19.69.1
```

### Configuring Broadcast-Based Associations: Example

The following example shows an NTP client configuration in which interface 0/2/0/0 is configured to receive NTP broadcast packets, and the estimated round-trip delay between an NTP client and an NTP broadcast server is set to 2 microseconds:

```
ntp
 interface tengige 0/2/0/0
   broadcast client
 exit
 broadcastdelay 2
```

The following example shows an NTP server configuration where interface 0/2/0/2 is configured to be a broadcast server:

```
ntp
 interface tengige 0/2/0/2
   broadcast
```

### Configuring NTP Access Groups: Example

The following example shows a NTP access group configuration where the following access group restrictions are applied:

- Peer restrictions are applied to IP addresses that pass the criteria of the access list named peer-acl.
- Serve restrictions are applied to IP addresses that pass the criteria of access list named serve-acl.
- Serve-only restrictions are applied to IP addresses that pass the criteria of the access list named serve-only-acl.
- Query-only restrictions are applied to IP addresses that pass the criteria of the access list named query-only-acl.

```
ntp
 peer 10.1.1.1
 peer 10.1.1.1
 peer 10.2.2.2
 peer 10.3.3.3
 peer 10.4.4.4
 peer 10.5.5.5
 peer 10.6.6.6
 peer 10.7.7.7
 peer 10.8.8.8
 access-group peer peer-acl
 access-group serve serve-acl
 access-group serve-only serve-only-acl
 access-group query-only query-only-acl
 exit
ipv4 access-list peer-acl
 10 permit ip host 10.1.1.1 any
 20 permit ip host 10.8.8.8 any
 exit
ipv4 access-list serve-acl
 10 permit ip host 10.4.4.4 any
 20 permit ip host 10.5.5.5 any
 exit
```

```

ipv4 access-list query-only-acl
 10 permit ip host 10.2.2.2 any
 20 permit ip host 10.3.3.3 any
 exit
ipv4 access-list serve-only-acl
 10 permit ip host 10.6.6.6 any
 20 permit ip host 10.7.7.7 any
 exit

```

### Configuring NTP Authentication: Example

The following example shows an NTP authentication configuration. In this example, the following is configured:

- NTP authentication is enabled.
- Two authentication keys are configured (key 2 and key 3).
- The router is configured to allow its software clock to be synchronized with the clock of the peer (or vice versa) at IP address 10.3.32.154 using authentication key 2.
- The router is configured to allow its software clock to be synchronized with the clock by the device at IP address 10.32.154.145 using authentication key 3.
- The router is configured to synchronize only to systems providing authentication key 3 in their NTP packets.

```

ntp
 authenticate
 authentication-key 2 md5 encrypted 06120A2D40031D1008124
 authentication-key 3 md5 encrypted 1311121E0741110232621
 trusted-key 3
 server 10.3.32.154 key 3
 peer 10.32.154.145 key 2

```

### Disabling NTP on an Interface: Example

The following example shows an NTP configuration in which 0/2/0/0 interface is disabled:

```

ntp
 interface tengige 0/2/0/0
  disable
  exit
 authentication-key 2 md5 encrypted 06120A2D40031D1008124
 authentication-key 3 md5 encrypted 1311121E0741110232621
 authenticate
 trusted-key 3
 server 10.3.32.154 key 3
 peer 10.32.154.145 key 2

```

### Configuring the Source IP Address for NTP Packets: Example

The following example shows an NTP configuration in which Ethernet management interface 0/0/CPU0/0 is configured as the source address for NTP packets:

```
ntp
 authentication-key 2 md5 encrypted 06120A2D40031D1008124
 authentication-key 3 md5 encrypted 1311121E074110232621
 authenticate
 trusted-key 3
 server 10.3.32.154 key 3
 peer 10.32.154.145 key 2
 source MgmtEth0/0/CPU0/0
```

### Configuring the System as an Authoritative NTP Server: Example

The following example shows a NTP configuration in which the router is configured to use its own NTP master clock to synchronize with peers when an external NTP source becomes unavailable:

```
ntp
 master 6
```

### Updating the Hardware Clock: Example

The following example shows an NTP configuration in which the router is configured to update its hardware clock from the software clock at periodic intervals:

```
ntp
 server 10.3.32.154
 update-calendar
```

# FQDN for NTP Server

Table 35: Feature History Table

Feature Name	Release Information	Feature Description
FQDN for NTP Server on Non-default VRF	Release 7.9.1	<p>You can now specify a Fully Qualified Domain Name (FQDN) as the hostname for NTP server configuration over nondefault VRFs.</p> <p>FQDNs are easy to remember compared to numeric IP addresses. Service migration from one host to another can cause a change in IP address leading to outages.</p> <p>Prior releases allowed FQDN handling in only default VRFs.</p>

NTP on Cisco IOS XR Software supports configuration of servers and peers using their Fully Qualified Domain Names (FQDN). While configuring, the FQDN is resolved via DNS into its corresponding IPv4 or IPv6 address and is stored in the running-configuration of the system. NTP supports FQDN for both IPv4 and IPv6 protocols. You can configure FQDN on default vrf.

Starting Cisco IOS XR Software Release 7.9.1 you can configure FQDN in nondefault vrf also.

## Configure FQDN for NTP server

### Prerequisites for configuring FQDN in a nondefault VRF

- Configuration must exist for DNS resolution over that specific VRF.
- The server must be reachable.

### Configuration Example for FQDN on NTP Server on Default VRF

Use the **ntp server** command with the FQDN name to configure FQDN on default VRF. You dont need to specify VRF name. In the following example, time.cisco.com is the FQDN.

```
Router#configure
Router (config)#ntp server time.cisco.com
Router (config)#commit
```



**Note** When you are configuring FQDN over default VRF, you don't need to specify VRF name.



## Running Configuration

Use the **show running-config ntp** command to see the ntp running configuration.

```
Router#show running-config ntp
ntp
 server 10.48.59.212
!
```

## Verification

Use the **show ntp associations** command to verify that an NTP association has come up.

```
Router#show ntp associations

      address          ref clock      st  when  poll reach  delay  offset  disp
~10.48.59.212         173.38.201.67   2   42   128   3  196.06 -14.25 3949.4
* sys_peer, # selected, + candidate, - outlayer, x falseticker, ~ configured
```

## Configuration Example for FQDN on NTP Server on Nondefault VRF

FQDN must be reachable from the router to configure it as an NTP server or peer. You can use the **ping** command and verify that FQDN is reachable. In the following example, time.cisco.com is the FQDN and vrf\_1 is the VRF over which it is reachable.

```
Router#ping time.cisco.com vrf vrf_1
Type escape sequence to abort.
Sending 5, 100-byte ICMP Echos to 192.0.2.1 timeout is 2 seconds:
!!!!
Success rate is 100 percent (5/5), round-trip min/avg/max = 171/171/172 ms
```

When you have confirmed that FQDN is pingable, you can configure FQDN to be used as an NTP server/peer. The following example shows how to configure an NTP server using its FQDN over a nondefault vrf.

```
Router#configure
Router(config)#ntp server vrf vrf_1 time.cisco.com minpoll 4 maxpoll 4 iburst
Router(config)#commit
```



---

**Note** If the FQDN you're trying to configure isn't reachable, the CLI treats it as invalid input.

---

## Running Configuration

Use the **show running-config ntp** command to see the ntp running configuration.

```
Router#show running-config ntp
ntp
 server vrf vrf_1 192.0.2.1 minpoll 4 maxpoll 4 iburst
!
```

## Verification

Use the **show ntp associations** command to verify that an NTP association has come up.

```
Router#show ntp associations

      address          ref clock      st  when  poll reach  delay  offset  disp
~192.0.2.1 vrf vrf_1
      173.38.201.115   2   14   16   37  179.10 13.492 16.680
* sys_peer, # selected, + candidate, - outlayer, x falseticker, ~ configured
```

# Configuring NTP server inside VRF interface

This task explains how to configure NTP server inside VRF interface.



**Note** No specific command enables NTP; the first NTP configuration command that you issue enables NTP.

## SUMMARY STEPS

1. **configure**
2. **ntp**
3. **vrf vrf-name**
4. **source interface-type interface-instance**
5. Use one of the following commands:
  - **end**
  - **commit**

## DETAILED STEPS

	Command or Action	Purpose
<b>Step 1</b>	<b>configure</b> <b>Example:</b> RP/0/RSP0/CPU0:router# configure	Enters global configuration mode.
<b>Step 2</b>	<b>ntp</b> <b>Example:</b> RP/0/RSP0/CPU0:router(config)# ntp	Enters NTP configuration mode.
<b>Step 3</b>	<b>vrf vrf-name</b> <b>Example:</b> RP/0/RSP0/CPU0:router(config)# ntp vrf Customer_A	Specify name of a VRF (VPN- routing and forwarding) instance to configure.
<b>Step 4</b>	<b>source interface-type interface-instance</b> <b>Example:</b> RP/0/RSP0/CPU0:router(config)# ntp vrf Customer_A source bvi 70	Configures an interface from which the IP source address is taken. This allows IOS-XR to respond to NTP queries on VRF interfaces, in this case the source is BVI. <b>Note</b> This interface is used for the source address for all packets sent to all destinations. If a source address is to be used for a specific association, use the <b>source</b> keyword in the <b>peer</b> or <b>server</b> command shown in <a href="#">Configuring Poll-Based Associations, on page 224</a> .

	Command or Action	Purpose
<b>Step 5</b>	<p>Use one of the following commands:</p> <ul style="list-style-type: none"> <li>• <b>end</b></li> <li>• <b>commit</b></li> </ul> <p><b>Example:</b></p> <pre>RP/0/RSP0/CPU0:router(config-ntp)# end</pre> <p>or</p> <pre>RP/0/RSP0/CPU0:router(config-ntp)# commit</pre>	<p>Saves configuration changes.</p> <ul style="list-style-type: none"> <li>• When you issue the <b>end</b> command, the system prompts you to commit changes: <pre>Uncommitted changes found, commit them before   exiting (yes/no/cancel)? [cancel]:</pre> <ul style="list-style-type: none"> <li>• Entering <b>yes</b> saves configuration changes to the running configuration file, exits the configuration session, and returns the router to EXEC mode.</li> <li>• Entering <b>no</b> exits the configuration session and returns the router to EXEC mode without committing the configuration changes.</li> <li>• Entering <b>cancel</b> leaves the router in the current configuration session without exiting or committing the configuration changes.</li> </ul> </li> <li>• Use the <b>commit</b> command to save the configuration changes to the running configuration file and remain within the configuration session.</li> </ul>

## Additional References

The following sections provide references related to implementing NTP on Cisco IOS XR software.

### Related Documents

Related Topic	Document Title
Cisco IOS XR clock commands	<i>Clock Commands on the Cisco ASR 9000 Series Router module of System Management Command Reference for Cisco ASR 9000 Series Routers</i>
Cisco IOS XR NTP commands	<i>NTP Commands on module of System Management Command Reference for Cisco ASR 9000 Series Routers</i>
Information about getting started with Cisco IOS XR Software	<i>Cisco ASR 9000 Series Aggregation Services Router Getting Started Guide</i>
Cisco IOS XR master command index	<i>Cisco ASR 9000 Series Aggregation Services Router Commands Master List</i>
Information about user groups and task IDs	<i>Configuring AAA Services on the Cisco ASR 9000 Series Router module of System Security Configuration Guide for Cisco ASR 9000 Series Routers</i>

**Standards**

Standards	Title
No new or modified standards are supported by this feature, and support for existing standards has not been modified by this feature.	—

**MIBs**

MIBs	MIBs Link
—	To locate and download MIBs using Cisco IOS XR software, use the Cisco MIB Locator found at the following URL and choose a platform under the Cisco Access Products menu: <a href="http://cisco.com/public/sw-center/netmgmt/cmtk/mibs.shtml">http://cisco.com/public/sw-center/netmgmt/cmtk/mibs.shtml</a>

**RFCs**

RFCs	Title
RFC 1059	<i>Network Time Protocol, Version 1: Specification and Implementation</i>
RFC 1119	<i>Network Time Protocol, Version 2: Specification and Implementation</i>
RFC 1305	<i>Network Time Protocol, Version 3: Specification, Implementation, and Analysis</i>

**Technical Assistance**

Description	Link
The Cisco Technical Support website contains thousands of pages of searchable technical content, including links to products, technologies, solutions, technical tips, and tools. Registered Cisco.com users can log in from this page to access even more content.	<a href="http://www.cisco.com/cisco/web/support/index.html">http://www.cisco.com/cisco/web/support/index.html</a>



# CHAPTER 11

## Configuring Open Flow Agent

OpenFlow is a specification from the Open Networking Foundation (ONF) that defines a flowbased forwarding infrastructure (L2-L4 Ethernet switch model) and a standardized application programmatic interface (protocol definition) to learn capabilities, add and remove flow control entries and request statistics. OpenFlow allows a controller to direct the forwarding functions of a switch through a secure channel.

This module has details about the Open Flow Agent, relevant concepts and configurations.

**Table 36: Feature History for Implementing OFACisco IOS XR Software**

Release	Modification
Release 5.1.2	This feature was introduced.
Release 5.3.4	OnePK support was discontinued.

- [OpenFlow](#), on page 250
- [OpenFlow Agent Packet In and Out Feature](#), on page 252
- [OpenFlow Agent with NetFlow Collection and Analytics](#), on page 253
- [OFA on Cisco Routers and Switches](#), on page 254
- [Functional Components](#), on page 254
- [OFA on ASR 9000 series routers](#), on page 254
- [OpenFlow Matches](#), on page 254
- [OpenFlow Actions](#), on page 257
- [Cisco Extension Actions](#), on page 258
- [Set Field Actions](#), on page 259
- [Configuring OneP for Openflow](#), on page 261
- [Configuring a Layer 2\\_Layer 3 Logical Switch for the OpenFlow Agent](#), on page 262
- [Configuring a Layer 2\\_VRF Logical Switch for the OpenFlow Agent](#), on page 264
- [Configuring a Layer 3\\_VRF Logical Switch for the OpenFlow Agent](#), on page 266
- [Configuring a Layer 3\\_Dual-stack Logical Switch for the OpenFlow Agent](#), on page 267
- [Enabling TLS](#), on page 269
- [Configuring NetFlow for the OpenFlow Agent](#), on page 270
- [Configuration Examples: Openflow](#), on page 273
- [Usecase for Layer2](#), on page 275
- [Usecase for Layer3](#), on page 275

# OpenFlow

Openflow is an open standard to communicate between controllers, which are running applications and network elements (such as, routers and switches).

For details regarding OpenFlow, please refer the OpenFlow chapter in the *System Management Configuration Guide for Cisco ASR 9000 Series Routers*.

## An overview of OFA

OpenFlow is a specification from the Open Networking Foundation (ONF) that defines a flowbased forwarding infrastructure (L2-L4 Ethernet switch model) and a standardized application programmatic interface (protocol definition) to learn capabilities, add and remove flow control entries and request statistics. OpenFlow allows a controller to direct the forwarding functions of a switch through a secure channel. Local device configuration is out of scope of the OpenFlow protocol. OpenFlow essentially provides a forwarding instruction set, allowing applications to directly program any-to-any routing and switching, with header field rewrite. New matches and actions can be applied to packets in arbitrary unconstrained fashion, allowing routing and switching on the new criteria. Routers and switches embed the fast packet forwarding and the high level routing decisions together into their software on the same device. With only a few exceptions based on user configuration, all routing and switching decisions are made by the built-in protocols and control plane logic that reside on the switch.

## Prerequisites for OpenFlow Agent

The following prerequisites are required to use the OpenFlow agent on the platforms supporting IOS-XR:

- Special build of the Release 5.1.x software that has the OpenFlow functionality is required.
- The Enhanced Ethernet line card for the Cisco ASR 9000 Series Router is required for the OpenFlow agent feature.
- Any controller with version 1.1 or 1.3 is required (example, POX, ODL ).
- The asr9k-k9sec Package Installation Envelope (PIE) must be present. The asr9k-mpls PIE is required for support on MPLS core (such as, PWHE).

## Restrictions for OpenFlow Agent

- Same interface cannot be added to more than one logical open flow switch.
- No support for output as an action for layer3 openflow logical switch (such as pipeline131, 132).
- Only layer 3 interface support for netflow sampling statistics.

## Advantages

The advantages with Open Flow Agent are:

- increases network scalability
- reduces network complexity
- allows greater application control

- enables customer-feature-independence

## About OpenFlow

The OpenFlow protocol is based on the concept of an Ethernet switch, with an internal flow-table and standardized interface to allow traffic flows on a switch to be added or removed. The OpenFlow protocol defines the communications channel between the OpenFlow agent and the OpenFlow controller. In an OpenFlow network, the OpenFlow Agent exists on the switch and the OpenFlow controller exists on a server, which is external to the switch. Any network management is either part of the controller or accomplished through the controller.

In the Cisco OpenFlow scheme, the physical switch is divided into multiple logical switches by using the CLI to configure the connection to the controller for each logical switch and enable interfaces for each logical switch. The Openflow Agent software manages these logical switches.

The following figure shows the Cisco implementation of the OpenFlow network.

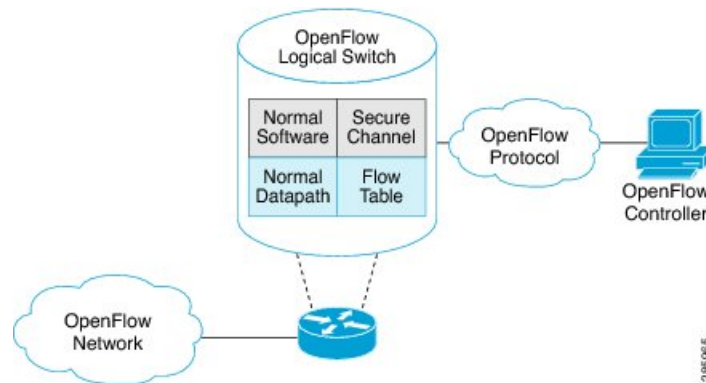

## Openflow Mode for ASR9000

Openflow for the Cisco ASR 9000 Series router functions in the Integrated Hybrid mode. In this mode, both Openflow and normal switching and routing (for layer 3) operations such as L2 ethernet switching, L3 routing, etc are supported. Packets processed as the Openflow forwarding path can be processed as a normal forwarding path.

## OpenFlow Table Types

An OpenFlow flow table consists of a set of flows. Each flow contains a set of matches and actions. A table has a set of capabilities in terms of supported matches and actions. Just like a policy-map, a table can be applied to a set of targets but only in the ingress direction. Hence, OpenFlow matches and actions are applied to the incoming traffic only.



**Note** A set of ordered tables is referred to as a pipeline. A pipeline may contain one or more ordered tables. An OpenFlow pipeline of an OpenFlow switch on ASR9K supports only one flow table.

Table 37: OpenFlow Table Types

Table Type	Pipeline	Supported Interfaces	Description
L2	129	Bridge-domain, Gigabit ethernet, Bundle, Bundle-subinterfaces, PWHE-subinterfaces	<ul style="list-style-type: none"> <li>• Supports L2 header matches.</li> <li>• Supports L2 actions.</li> <li>• Can be applied to the ingress L2 interfaces.</li> </ul>
L2_L3	130	Bridge-domain, Gigabit ethernet, Bundle, Bundle-subinterfaces, PWHE-subinterfaces	<ul style="list-style-type: none"> <li>• Supports L2 and L3 (IPv4/IPv6) header matches.</li> <li>• Supports L2 actions.</li> <li>• Can be applied to the ingress L2 interfaces.</li> </ul>
L3_V4	131	VRF and global interfaces, BVI (ipv4 only), Bridge-domain, Gigabit ethernet, Bundle, Bundle-subinterfaces	<ul style="list-style-type: none"> <li>• Supports L3 (IPv4) header matches.</li> <li>• Supports L3 (IPv4) actions.</li> <li>• Can be applied to the ingress L3 interfaces.</li> </ul>
L3_DS	132	VRF and global interfaces, BVI, Bridge-domain, Gigabit ethernet, Bundle, Bundle-subinterfaces	<ul style="list-style-type: none"> <li>• Supports L2 and L3 (IPv4/IPv6) header matches.</li> <li>• Supports L3 (IPv4/IPv6) actions.</li> <li>• Can be applied to the ingress L3 interfaces.</li> </ul>

- L2 Table--Supports L2 header matches and has L2 actions only. This table type can be applied to the ingress of an L2 interface.
- L2\_L3 Table--Supports L2 and L3 header matches and has L2 actions only. Match parameters can be IPv4 or IPv6 type. This table type can be applied to the ingress of an L2 interface.
- L3\_V4 Table--Supports L3 IPv4 header matches and has L3 actions only. This table type can be applied to the ingress of L3 interfaces.
- L3\_DS(Dual Stack) Table--Supports L2 and L3 IPv4 and IPv6 (Dual Stack) matches and has L3 actions only. This table type can be applied to the ingress of L3 interfaces.

## OpenFlow Agent Packet In and Out Feature

The Packet In and Out feature allows a flow to be programmed by the OpenFlow Agent logical switch so that packets are sent to the Controller. The special output port: **OFP\_CONTROLLER** is specified for the flow action.

The Packet In and Out feature enables support for the OpenFlow output-to-port action. The output action tells the OpenFlow Agent to send all packets matching the flow to a specific port.



# OpenFlow Agent with NetFlow Collection and Analytics

Applications can be provided with on-demand analytics by using the OpenFlow protocol with NetFlow. NetFlow provides statistics on packets flowing through the router, and is the standard for acquiring IP operational data from IP networks.

The following NetFlow maps must be configured:

- Flow Exporter Map—Specifies the destination IP address of the NetFlow collector where the NetFlow Version 9 packets are sent.
- Flow Monitor Map—Specifies the profile of the NetFlow producer, including the timeout values of active and inactive timers, size of the NetFlow cache and the exporter to be used.
- Sampler Map—Specifies how often Network Processor (NPU) needs to sample incoming and outgoing packets and create flow-packets to punt to the Line Card (LC) Central Processing Unit (CPU).

The following parameters must be specified on the OpenFlow Agent logical switch:

- Interface associated with the OpenFlow Agent logical switch that is enabled for NetFlow.
- Flow Monitor Map
- Sampler Map
- Controller IP address

**Figure 10: OpenFlow Agent and NetFlow collection and analytics workflow**

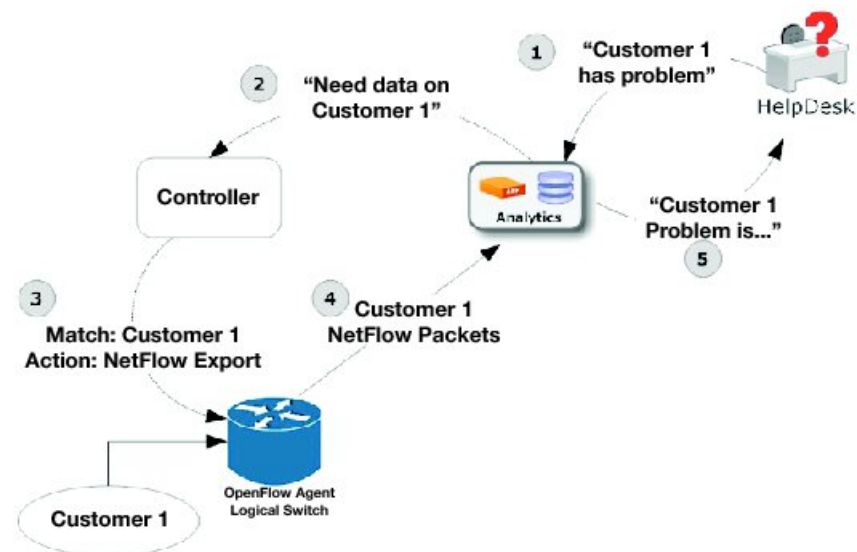

1. The help desk application tells the analytics application that Customer 1 has a problem.
2. The analytics application determines that it requires more information and requests more network data about Customer 1 from the Controller.
3. The Controller instructs the OpenFlow logical switch on the router to look for Customer 1 packets and generate and export NetFlow data based on Customer 1 packet flows.

4. The OpenFlow Agent logical switch exports NetFlow packets to the analytics application where they are processed.
5. The analytics application informs the help desk application of the problem.

## OFA on Cisco Routers and Switches

OpenFlow SDN Applications expect network elements to speak standard OpenFlow protocol and to implement standard OpenFlow switch model. The OpenFlow Agent as a local process provides:

- OF protocol stack
- OF switch model derived from disparate Cisco software and hardware
- Version, model and feature negotiation
- Local aggregation of state and statistics
- Native dedicated CLI and troubleshooting
- High Availability

## Functional Components

OpenFlow supports the configuration of multiple controllers for a logical switch. The Openflow agent can connect to a single controller or up to 8 controllers. It creates connections to all configured controllers to provide the controllers access to the OpenFlow logical switch flow tables and interfaces. It will receive flow entries from the controllers and report interface and flow status and statistics to the controllers.

The set nexthop action for layer 3 matches is implemented through a Cisco extension to the OpenFlow (1.0 and 1.3) protocol.

## OFA on ASR 9000 series routers

The OpenFlow Agent supports multiple logical switch instances on ASR9K platform, with each logical switch managing a set of physical/logical interfaces, an L2 bridge domain or a VRF. Each logical switch may have one openflow connection to a single controller, or multiple connects for reliability, each to a different controller . The openflow connection to the controller uses standard TLS or plain TCP.

When the logical switch initialises a connection to the configured controller, the signaling version for the agent-controller connection is negotiated based on the bitmap version supported on both- agent and controller sides. When a logical switch starts up for the first time or at the time a logical switch loses contact with all controllers, it operates in either fail-secure mode (with default-set rule) or fail-standalone mode depending on the CLI of fail-standalone (on or off). The default for configuration is in the fail-secure mode.

## OpenFlow Matches

Matches are supported on ingress port and various packet headers depending upon the packet type. Flows can have priorities. Hence, the highest priority flow entry that matches the packet gets selected.

Following table shows the list of matches supported on ASR9K for various table types:

OpenFlow Matches		OpenFlow Switch Types Supported on ASR9K			
		Applied to L2 Bridge domain		Applied to L3 or L3 VRF interface	
OXM Flow match field type for OpenFlow basic class	Description	L2 only	L2_L3	L3_V4	L3_DS
OFPXMT_OFB_IN_PORT	Switch input port	Yes	Yes	Yes	Yes
OFPXMT_OFB_IN_PHY_PORT	Switch physical port	No	No	No	No
OFPXMT_OFB_METADATA	Metadata passed between tables	No	No	No	No
OFPXMT_OFB_ETH_DST	Ethernet destination address	Yes	Yes	No	Yes
OFPXMT_OFB_ETH_SRC	Ethernet source address	Yes	Yes	No	Yes
OFPXMT_OFB_ETH_TYPE	Ethernet frame type	Yes	Yes	No	Yes
OFPXMT_OFB_VLAN_VID	VLAN ID	Yes	Yes	No	Yes
OFPXMT_OFB_VLAN_PCP	VLAN priority	Yes	Yes	No	Yes
OFPXMT_OFB_IP_DSCP	IP DSCP (6 bits in ToS field)	No	Yes	Yes	Yes
OFPXMT_OFB_IP_ECN	IP ECN (2 bits in ToS field)	No	No	No	No
OFPXMT_OFB_IP_PROTO	IP protocol	No	Yes	Yes	Yes
OFPXMT_OFB_IPV4_SRC	IPv4 source address	No	Yes	Yes	Yes
OFPXMT_OFB_IPV4_DST	IPv4 destination address	No	Yes	Yes	Yes
OFPXMT_OFB_TCP_SRC	TCP source port	No	Yes	Yes	Yes
OFPXMT_OFB_TCP_DST	TCP destination port	No	Yes	Yes	Yes

OpenFlow Matches		OpenFlow Switch Types Supported on ASR9K			
		Applied to L2 Bridge domain		Applied to L3 or L3 VRF interface	
OFPXMT_OFB_UDP_SRC	UDP source port	No	Yes	Yes	Yes
OFPXMT_OFB_UDP_DST	UDP destination port	No	Yes	Yes	Yes
OFPXMT_OFB_SCTP_SRC	SCTP source port	No	Yes	Yes	Yes
OFPXMT_OFB_SCTP_DST	SCTP destination port	No	No	No	No
OFPXMT_OFB_ICMPV4_TYPE	ICMP type	No	No	No	No
OFPXMT_OFB_ICMPV4_CODE	ICMP code	No	No	No	No
OFPXMT_OFB_ARP_OP	ARP opcode	No	No	No	No
OFPXMT_OFB_ARP_SPA	ARP source IPv4 address	No	No	No	No
OFPXMT_OFB_ARP_TPA	ARP target IPv4 address	No	No	No	No
OFPXMT_OFB_ARP_SHA	ARP source hardware address	No	No	No	No
OFPXMT_OFB_ARP_THA	ARP target hardware address	No	No	No	No
OFPXMT_OFB_IPV6_SRC	IPv6 source address	No	Yes	No	Yes
OFPXMT_OFB_IPV6_DST	IPv6 destination address	No	Yes	No	Yes
OFPXMT_OFB_IPV6_LABEL	IPv6 Flow Label	No	No	No	No
OFPXMT_OFB_ICMPV6_TYPE	ICMPv6 type	No	No	No	No
OFPXMT_OFB_ICMPV6_CODE	ICMPv6 code	No	No	No	No
OFPXMT_OFB_IPV6_ND_TARGET	Target address for ND	No	No	No	No
OFPXMT_OFB_IPV6_ND_SLL	Source link-layer for ND	No	No	No	No

OpenFlow Matches		OpenFlow Switch Types Supported on ASR9K			
		Applied to L2 Bridge domain		Applied to L3 or L3 VRF interface	
OFPXMT_OFB_IPV6_ND_TLL	Target link-layer for ND	No	No	No	No
OFPXMT_OFB_MPLS_LABEL	MPLS label	No	No	No	Yes
OFPXMT_OFB_MPLS_TC	MPLS TC	No	No	No	No
OFPXMT_OFB_MPLS_BOS	MPLS BoS bit	No	No	No	Yes
OFPXMT_OFB_PBB_ISID	PBB I-SID	No	No	No	No
OFPXMT_OFB_TUNNEL_ID	Logical Port Metadata	No	No	No	No
OFPXMT_OFB_IPV6_EXIHDR	IPv6 Extension Header pseudo-field	No	No	No	No

## OpenFlow Actions

Packet forwarding and packet modification types of actions are supported. The lists of actions are always immediately applied to the packet.



### Note

- Only “Apply-actions” instruction (OFPIT\_APPLY\_ACTIONS) of OpenFlow 1.3 is supported.
- Pipeline processing instructions that allow packets to be sent to subsequent tables for further processing are not supported in this release.
- Group tables and Meter tables are not supported.

Following table shows the list of action types supported on ASR9K for various table types.

OpenFlow Actions		OpenFlow Switch Types Supported on ASR9K			
		Applied to L2 Bridge domain		Applied to L3 or L3 VRF interface	
OXM Flow action field type for OpenFlow basic class	Description	L2 only	L2_L3	L3_V4	L3_DS
OFPAT_OUTPUT	Output to switch port.	Yes	Yes	No	No
OFPAT_COPY_TTL_OUT	Copy TTL "outwards"	No	No	No	No

OpenFlow Actions		OpenFlow Switch Types Supported on ASR9K			
		Applied to L2 Bridge domain		Applied to L3 or L3 VRF interface	
OFPAT_COPY_TTL_IN	Copy TTL "inwards"	No	No	No	No
OFPAT_SET_MPLS_TTL	MPLS TTL	No	No	No	No
OFPAT_DEC_MPLS_TTL	Decrement MPLS TTL	No	No	No	No
OFPAT_PUSH_VLAN	Push a new VLAN tag	Yes	Yes	No	No
OFPAT_POP_VLAN	Pop the outer VLAN tag	Yes	Yes	No	No
OFPAT_PUSH_MPLS	Push a new MPLS tag	No	No	No	No
OFPAT_POP_MPLS	Pop the outer MPLS tag	No	No	No	No
OFPAT_SET_QUEUE	Set queue id when outputting to a port	No	No	No	No
OFPAT_GROUP	Apply group	No	No	No	No
OFPAT_SET_NW_TTL	IP TTL	No	No	No	No
OFPAT_DEC_NW_TTL	Decrement IP TTL	No	No	No	No
OFPAT_SET_FIELD	Set a header field using OXM TLV format	Yes	Yes	Yes	Yes
OFPAT_PUSH_PBB	Push a new PBB service tag (I-TAG)	No	No	No	No
OFPAT_POP_PBB	Pop the outer PBB service tag	No	No	No	No

## Cisco Extension Actions

The set ipv4 or set ipv6 nexthop actions are used to redirect an ipv4 or ipv6 packet to the specified nexthop address, instead of using the destination address in the packet. This provides ABF (ACL Based Forwarding) kind of functionality using OpenFlow. However, VRF support and nexthop tracking as supported by CLI based ABF feature is not supported in this release.

The set fcid (Forward Class ID) action can be used to support PBTS (Policy Based Tunnel Selection) functionality using OpenFlow.

Following table shows the list of actions added by Cisco to support some extra features on ASR9K.

Cisco proprietary actions		OpenFlow Switch Types Supported on ASR9K			
		Applied to L2 Bridge domain		Applied to L3 or L3 VRF interface	
OXM Flow match field type for OpenFlow basic class	Description	L2 only	L2_L3	L3_V4	L3_DS
Set Ipv4 Nexthop	Set ipv4 nexthop address	No	No	Yes	Yes
Set Ipv6 Nexthop	Set ipv6 nexthop address	No	No	No	Yes
Set Forward Class ID	Set forward class ID	No	No	Yes	Yes
Set VRF	Set forward ipv4/ipv6 packet based on VRF	No	No	Yes	Yes

## Set Field Actions

This table lists the set field actions supported by the Cisco ASR 9000 series router:

OpenFlow Matches		OpenFlow Switch Types Supported on ASR9K			
		Applied to L2 Bridge domain		Applied to L3 or L3 VRF interface	
OXM Flow match field type for OpenFlow basic class	Description	L2 only	L2_L3	L3_V4	L3_DS
OFPXMT_OFB_ETH_DST	Ethernet destination address	Yes	Yes	No	No
OFPXMT_OFB_ETH_SRC	Ethernet source address	Yes	Yes	No	No
OFPXMT_OFB_ETH_TYPE	Ethernet frame type	No	No	No	No
OFPXMT_OFB_VLAN_VID	VLAN ID	Yes	Yes	No	No
OFPXMT_OFB_VLAN_PCP	VLAN priority	Yes	Yes	No	No

OpenFlow Matches		OpenFlow Switch Types Supported on ASR9K			
		Applied to L2 Bridge domain		Applied to L3 or L3 VRF interface	
OFPXMT_OFB_IP_DSCP	IP DSCP (6 bits in ToS field)	No	No	Yes	Yes
OFPXMT_OFB_IP_ECN	IP ECN (2 bits in ToS field)	No	No	No	No
OFPXMT_OFB_IP_PROTO	IP protocol	No	No	No	No
OFPXMT_OFB_IPV4_SRC	IPv4 source address	No	No	Yes	Yes
OFPXMT_OFB_IPV4_DST	IPv4 destination address	No	No	Yes	Yes
OFPXMT_OFB_TCP_SRC	TCP source port	No	No	Yes	Yes
OFPXMT_OFB_TCP_DST	TCP destination port	No	No	Yes	Yes
OFPXMT_OFB_UDP_SRC	UDP source port	No	No	Yes	Yes
OFPXMT_OFB_UDP_DST	UDP destination port	No	No	Yes	Yes
OFPXMT_OFB_SCTP_SRC	SCTP source port	No	No	No	No
OFPXMT_OFB_SCTP_DST	SCTP destination port	No	No	No	No
OFPXMT_OFB_ICMPV4_TYPE	ICMP type	No	No	No	No
OFPXMT_OFB_ICMPV4_CODE	ICMP code	No	No	No	No
OFPXMT_OFB_ARP_OP	ARP opcode	No	No	No	No
OFPXMT_OFB_ARP_SPA	ARP source IPv4 address	No	No	No	No
OFPXMT_OFB_ARP_TPA	ARP target IPv4 address	No	No	No	No
OFPXMT_OFB_ARP_SHA	ARP source hardware address	No	No	No	No



OpenFlow Matches		OpenFlow Switch Types Supported on ASR9K			
		Applied to L2 Bridge domain		Applied to L3 or L3 VRF interface	
OFPXMT_OFB_ARP_THA	ARP target hardware address	No	No	No	No
OFPXMT_OFB_IPV6_SRC	IPv6 source address	No	No	No	No
OFPXMT_OFB_IPV6_DST	IPv6 destination address	No	No	No	No
OFPXMT_OFB_IPV6_LABEL	IPv6 Flow Label	No	No	No	No
OFPXMT_OFB_ICMPV6_TYPE	ICMPv6 type	No	No	No	No
OFPXMT_OFB_ICMPV6_CODE	ICMPv6 code	No	No	No	No
OFPXMT_OFB_IPV6_ND_TARGET	Target address for ND	No	No	No	No
OFPXMT_OFB_IPV6_ND_SLL	Source link-layer for ND	No	No	No	No
OFPXMT_OFB_IPV6_ND_TLL	Target link-layer for ND	No	No	No	No
OFPXMT_OFB_MPLS_LABEL	MPLS label	No	No	No	No
OFPXMT_OFB_MPLS_TC	MPLS TC	No	No	No	No
OFPXMT_OFB_MPLS_BOS	MPLS BoS bit	No	No	No	No
OFPXMT_OFB_PBB_ISID	PBB I-SID	No	No	No	No
OFPXMT_OFB_TUNNEL_ID	Logical Port Metadata	No	No	No	No
OFPXMT_OFB_IPV6_EXTHDR	IPv6 Extension Header pseudo-field	No	No	No	No

## Configuring OneP for Openflow

### SUMMARY STEPS

1. **configure**
2. **onep**

3. **datapath transport vpathudp sender-id** *number*
4. Use the **commit** or **end** command.

#### DETAILED STEPS

	Command or Action	Purpose
<b>Step 1</b>	<b>configure</b> <b>Example:</b> RP/0/RSP0/CPU0:router# <code>configure</code>	Enters global configuration mode.
<b>Step 2</b>	<b>onep</b> <b>Example:</b> RP/0/RSP0/CPU0:router (config) # <code>onep</code>	Enters the OneP configuration mode.
<b>Step 3</b>	<b>datapath transport vpathudp sender-id</b> <i>number</i> <b>Example:</b> RP/0/RSP0/CPU0:router (config) # <code>datapath transport vpathudp sender-id 1</code>	Configures the virtual-path udp transport datapath for the specified sender-id.
<b>Step 4</b>	Use the <b>commit</b> or <b>end</b> command.	<b>commit</b> —Saves the configuration changes and remains within the configuration session. <b>end</b> —Prompts user to take one of these actions: <ul style="list-style-type: none"> <li>• <b>Yes</b> — Saves configuration changes and exits the configuration session.</li> <li>• <b>No</b> —Exits the configuration session without committing the configuration changes.</li> <li>• <b>Cancel</b> —Remains in the configuration session, without committing the configuration changes.</li> </ul>

## Configuring a Layer 2 Logical Switch for the OpenFlow Agent

#### SUMMARY STEPS

1. **configure**
2. **openflow**
3. **switch** *switch -id pipeline pipeline-number*
4. **tls trust-point local** *local-tp-name remote remote-tp-name*
5. **bridge-group** *SDN-id bridge-domain switch-id*
6. **controller ipv4** *ip-address security [tls | none]*
7. **commit**
8. Use the **commit** or **end** command.

## DETAILED STEPS

	Command or Action	Purpose
Step 1	<b>configure</b> <b>Example:</b> RP/0/RSP0/CPU0:router# <code>configure</code>	Enters global configuration mode.
Step 2	<b>openflow</b> <b>Example:</b> RP/0/RSP0/CPU0:router(config)# <code>openflow</code>	Enters the openflow configuration mode.
Step 3	<b>switch <i>switch-id</i> pipeline <i>pipeline-number</i></b> <b>Example:</b> RP/0/RSP0/CPU0:router(config-openflow)# <code>switch 1 pipeline 129</code>	Enters the logical switch configuration mode. For L2-only switch, the pipeline number is 129.
Step 4	<b>tls trust-point local <i>local-tp-name</i> remote <i>remote-tp-name</i></b> <b>Example:</b> RP/0/RSP0/CPU0:router(config-openflow-switch)# <code>tls trust-point local tp1 remote tp2</code>	Enters the TLS configuration mode. Configures the local and remote trustpoints.
Step 5	<b>bridge-group <i>SDN-id</i> bridge-domain <i>switch-id</i></b> <b>Example:</b> RP/0/RSP0/CPU0:router (config-openflow) # <code>bridge-group SDN-1 bridge-domain of2</code>	Configures the bridge-domain for the openflow switch. For layer2, the bridge-domain can be configured in the openflow switch and the interfaces of the bridge-domain will be learnt by the openflow switch.
Step 6	<b>controller ipv4 <i>ip-address</i> security [tls   none]</b> <b>Example:</b> RP/0/RSP0/CPU0:router(config-openflow-switch)# <code>controller ipv4 5.0.1.1 port 6633 security tls</code>	<p>Configures the Openflow controller for the logical switch.</p> <p>Configures the Openflow controller for the logical switch. Once the <b>controller</b> command is entered, a connection to the OpenFlow controller is started for the logical switch. The <b>tls</b> keyword enables the TLS connection, whereas the <b>none</b> keyword enables the TCP connection.</p> <p><b>Note</b> The OpenFlow Agent can connect to a single Controller or up to 8 Controllers. Repeat this step if you need to configure additional Controllers. An openflow switch can communicate to multiple controllers ( the support for high-availability is a controller functionality).</p>
Step 7	<b>commit</b> <b>Example:</b> RP/0/RSP0/CPU0:router(logical-switch)# <code>commit</code>	Adds the Layer 2 logical switch configuration for the OpenFlow agent to the running configuration.
Step 8	Use the <b>commit</b> or <b>end</b> command.	<b>commit</b> —Saves the configuration changes and remains within the configuration session. <b>end</b> —Prompts user to take one of these actions:

	Command or Action	Purpose
		<ul style="list-style-type: none"> <li>• <b>Yes</b> — Saves configuration changes and exits the configuration session.</li> <li>• <b>No</b> —Exits the configuration session without committing the configuration changes.</li> <li>• <b>Cancel</b> —Remains in the configuration session, without committing the configuration changes.</li> </ul>

### What to do next

Repeat these steps to configure another logical switch for the OpenFlow Agent.

# Configuring a Layer 2\_Layer 3 Logical Switch for the OpenFlow Agent

## SUMMARY STEPS

1. **configure**
2. **openflow**
3. **switch** *switch -id pipeline pipeline-number*
4. **tls trust-point local** *local-tp-name* **remote** *remote-tp-name*
5. **bridge-group** *SDN-id* **bridge-domain** *switch-id*
6. **controller ipv4** *ip-address* **security** [**tls** | **none**]
7. **commit**
8. Use the **commit** or **end** command.

## DETAILED STEPS

	Command or Action	Purpose
<b>Step 1</b>	<b>configure</b> <b>Example:</b> RP/0/RSP0/CPU0:router# <b>configure</b>	Enters global configuration mode.
<b>Step 2</b>	<b>openflow</b> <b>Example:</b> RP/0/RSP0/CPU0:router(config)# <b>openflow</b>	Enters the openflow configuration mode.
<b>Step 3</b>	<b>switch</b> <i>switch -id pipeline pipeline-number</i> <b>Example:</b> RP/0/RSP0/CPU0:router(config-openflow)# <b>switch 1</b> <b>pipeline 130</b>	Enters the logical switch configuration mode. For L2_L3 switch, the pipeline number is 130.

	Command or Action	Purpose
Step 4	<b>tls trust-point local</b> <i>local-tp-name</i> <b>remote</b> <i>remote-tp-name</i> <b>Example:</b> RP/0/RSP0/CPU0:router(config-openflow-switch)# <b>tls trust-point local tp1 remote tp2</b>	Enters the TLS configuration mode. Configures the local and remote trustpoints.
Step 5	<b>bridge-group</b> <i>SDN-id</i> <b>bridge-domain</b> <i>switch-id</i> <b>Example:</b> RP/0/RSP0/CPU0:router (config-openflow) # <b>bridge-group SDN-1 bridge-domain of2</b>	Configures a bridge-domain for the openflow switch.
Step 6	<b>controller ipv4</b> <i>ip-address</i> <b>security [tls   none]</b> <b>Example:</b> RP/0/RSP0/CPU0:router(config-openflow-switch)# <b>controller ipv4 5.0.1.1 port 6633 security tls</b>	<p>Configures the Openflow controller for the logical switch.</p> <p>Configures the Openflow controller for the logical switch. Once the <b>controller</b> command is entered, a connection to the OpenFlow controller is started for the logical switch. The <b>tls</b> keyword enables the TLS connection, whereas the <b>none</b> keyword enables the TCP connection.</p> <p><b>Note</b> The OpenFlow Agent can connect to a single Controller or up to 8 Controllers. Repeat this step if you need to configure additional Controllers. An openflow switch can communicate to multiple controllers ( the support for high-availability is a controller functionality).</p>
Step 7	<b>commit</b> <b>Example:</b> RP/0/RSP0/CPU0:router(logical-switch)# <b>commit</b>	Adds the Layer 2 logical switch configuration for the OpenFlow agent to the running configuration.
Step 8	Use the <b>commit</b> or <b>end</b> command.	<p><b>commit</b> —Saves the configuration changes and remains within the configuration session.</p> <p><b>end</b> —Prompts user to take one of these actions:</p> <ul style="list-style-type: none"> <li>• <b>Yes</b> — Saves configuration changes and exits the configuration session.</li> <li>• <b>No</b> —Exits the configuration session without committing the configuration changes.</li> <li>• <b>Cancel</b> —Remains in the configuration session, without committing the configuration changes.</li> </ul>

### What to do next

Repeat these steps to configure another logical switch for the OpenFlow Agent.

# Configuring a Layer 3\_VRF Logical Switch for the OpenFlow Agent

## SUMMARY STEPS

1. **configure**
2. **openflow**
3. **switch** *switch -id pipeline pipeline-number*
4. **vrf IPv4**
5. **tls trust-point local** *local-tp-name* **remote** *remote-tp-name*
6. **controller ipv4** *ip-address* **security** [**tls** | **none**]
7. **commit**
8. Use the **commit** or **end** command.

## DETAILED STEPS

	Command or Action	Purpose
<b>Step 1</b>	<b>configure</b> <b>Example:</b>  RP/0/RSP0/CPU0:router# <b>configure</b>	Enters global configuration mode.
<b>Step 2</b>	<b>openflow</b> <b>Example:</b>  RP/0/RSP0/CPU0:router(config)# <b>openflow</b>	Enters the openflow configuration mode.
<b>Step 3</b>	<b>switch</b> <i>switch -id pipeline pipeline-number</i> <b>Example:</b>  RP/0/RSP0/CPU0:router(config-openflow)# <b>switch 1 pipeline 131</b>	Enters the logical switch configuration mode. For L3_V4(VRF) switch, the pipeline number is 131.
<b>Step 4</b>	<b>vrf IPv4</b> <b>Example:</b>  RP/0/RSP0/CPU0:router(config)# <b>vrf IPv4</b>	VRF configuration. All the interfaces belonging to IPv4 VRF will be learnt by the openflow switch.
<b>Step 5</b>	<b>tls trust-point local</b> <i>local-tp-name</i> <b>remote</b> <i>remote-tp-name</i> <b>Example:</b>  RP/0/RSP0/CPU0:router(config-openflow-switch)# <b>tls trust-point local tp1 remote tp2</b>	Enters the TLS configuration mode. Configures the local and remote trustpoints.
<b>Step 6</b>	<b>controller ipv4</b> <i>ip-address</i> <b>security</b> [ <b>tls</b>   <b>none</b> ] <b>Example:</b>	Configures the Openflow controller for the logical switch.  Configures the Openflow controller for the logical switch. Once the <b>controller</b> command is entered, a connection to the OpenFlow controller is started for the logical switch.

	Command or Action	Purpose
	<code>RP/0/RSP0/CPU0:router(config-openflow-switch)# controller ipv4 5.0.1.1 port 6633 security tls</code>	<b>Note</b> The OpenFlow Agent can connect to a single Controller or up to 8 Controllers. Repeat this step if you need to configure additional Controllers.
<b>Step 7</b>	<b>commit</b> <b>Example:</b> <code>RP/0/RSP0/CPU0:router(logical-switch)# commit</code>	Adds the Layer 2 logical switch configuration for the OpenFlow agent to the running configuration.
<b>Step 8</b>	Use the <b>commit</b> or <b>end</b> command.	<b>commit</b> —Saves the configuration changes and remains within the configuration session. <b>end</b> —Prompts user to take one of these actions: <ul style="list-style-type: none"> <li>• <b>Yes</b> — Saves configuration changes and exits the configuration session.</li> <li>• <b>No</b> —Exits the configuration session without committing the configuration changes.</li> <li>• <b>Cancel</b> —Remains in the configuration session, without committing the configuration changes.</li> </ul>

**What to do next**

Repeat these steps to configure another logical switch for the OpenFlow Agent.

## Configuring a Layer 3\_Dual-stack Logical Switch for the OpenFlow Agent

**SUMMARY STEPS**

1. **configure**
2. **openflow**
3. **switch** *switch -id* **pipeline** *pipeline-number*
4. **interface** *type interface-path-id*
5. **tls** *trust-point local local-tp-name remote remote-tp-name*
6. **bridge-group** *SDN-id* **bridge-domain** *switch-id*
7. **controller ipv4** *ip-address* **security** [**tls** | **none**]
8. **commit**
9. Use the **commit** or **end** command.

## DETAILED STEPS

	Command or Action	Purpose
<b>Step 1</b>	<b>configure</b> <b>Example:</b> RP/0/RSP0/CPU0:router# <code>configure</code>	Enters global configuration mode.
<b>Step 2</b>	<b>openflow</b> <b>Example:</b> RP/0/RSP0/CPU0:router(config)# <code>openflow</code>	Enters the openflow configuration mode.
<b>Step 3</b>	<b>switch <i>switch -id pipeline pipeline-number</i></b> <b>Example:</b> RP/0/RSP0/CPU0:router(config-openflow)# <code>switch 1 pipeline 132</code>	Enters the logical switch configuration mode. For L3_DS switch, the pipeline number is 132.
<b>Step 4</b>	<b>interface <i>type interface-path-id</i></b> <b>Example:</b> RP/0/RSP0/CPU0:router(config-openflow)# <code>interface Bundle-Ether2.1</code>	Interface configuration. <b>Note</b> VRFs can be configured here. Both IPv4 and IPv6 VRFs are supported.
<b>Step 5</b>	<b>tls trust-point local <i>local-tp-name</i> remote <i>remote-tp-name</i></b> <b>Example:</b> RP/0/RSP0/CPU0:router(config-openflow-switch)# <code>tls trust-point local tp1 remote tp2</code>	Enters the TLS configuration mode. Configures the local and remote trustpoints.
<b>Step 6</b>	<b>bridge-group <i>SDN-id</i> bridge-domain <i>switch-id</i></b> <b>Example:</b> RP/0/RSP0/CPU0:router (config-openflow) # <code>bridge-group SDN-1 bridge-domain of2</code>	
<b>Step 7</b>	<b>controller ipv4 <i>ip-address</i> security [tls   none]</b> <b>Example:</b> RP/0/RSP0/CPU0:router(config-openflow-switch)# <code>controller ipv4 5.0.1.1 port 6633 security tls</code>	Configures the Openflow controller for the logical switch. Configures the Openflow controller for the logical switch. Once the <b>controller</b> command is entered, a connection to the OpenFlow controller is started for the logical switch. <b>Note</b> The OpenFlow Agent can connect to a single Controller or up to 8 Controllers. Repeat this step if you need to configure additional Controllers.
<b>Step 8</b>	<b>commit</b> <b>Example:</b> RP/0/RSP0/CPU0:router(logical-switch)# <code>commit</code>	Adds the Layer 2 logical switch configuration for the OpenFlow agent to the running configuration.
<b>Step 9</b>	Use the <b>commit</b> or <b>end</b> command.	<b>commit</b> —Saves the configuration changes and remains within the configuration session. <b>end</b> —Prompts user to take one of these actions:



	Command or Action	Purpose
		<ul style="list-style-type: none"> <li>• <b>Yes</b> — Saves configuration changes and exits the configuration session.</li> <li>• <b>No</b> — Exits the configuration session without committing the configuration changes.</li> <li>• <b>Cancel</b> — Remains in the configuration session, without committing the configuration changes.</li> </ul>

### What to do next

Repeat these steps to configure another logical switch for the OpenFlow Agent.

## Enabling TLS

### SUMMARY STEPS

1. **configure**
2. **openflow switch** *logical-switch-id*
3. **tls trust-point local** *local-tp-name* **remote** *remote-tp-name*
4. **commit**
5. **end**

### DETAILED STEPS

	Command or Action	Purpose
<b>Step 1</b>	<b>configure</b> <b>Example:</b> RP/0/RSP0/CPU0:router# <b>configure</b>	Enters global configuration mode.
<b>Step 2</b>	<b>openflow switch</b> <i>logical-switch-id</i> <b>Example:</b> RP/0/RSP0/CPU0:router (config)# <b>openflow switch 100</b>	Enters the OpenFlow logical switch configuration mode.
<b>Step 3</b>	<b>tls trust-point local</b> <i>local-tp-name</i> <b>remote</b> <i>remote-tp-name</i> <b>Example:</b> RP/0/RSP0/CPU0:router (config-openflow-switch)# <b>tls trust-point local tp1 remote tp2</b>	Enters the TLS configuration mode. Configures the local and remote trustpoints.
<b>Step 4</b>	<b>commit</b> <b>Example:</b> RP/0/RSP0/CPU0:router (config-openflow-switch)# <b>commit</b>	Adds the logical switch configuration for the OpenFlow agent to the running configuration.

	Command or Action	Purpose
<b>Step 5</b>	<b>end</b> <b>Example:</b> RP/0/RSP0/CPU0:router(config-openflow-switch)# end	Exits logical switch configuration mode and enters EXEC mode.

## Configuring NetFlow for the OpenFlow Agent

### SUMMARY STEPS

1. **configure**
2. **flow exporter-map** *fem-name*
3. **destination** *location*
4. **version v9**
5. **commit**
6. **exit**
7. **flow monitor-map** *map-name*
8. **record ipv4**
9. **exporter** *map-name*
10. **cache entries** *number*
11. **cache timeout** {*active timeout-value* | *inactive timeout-value* | **update** *timeout-value*}
12. **commit**
13. **exit**
14. **sampler-map** *map-name*
15. **random 1 out-of** *sampling-interval*
16. **commit**
17. **exit**
18. Use the **commit** or **end** command.

### DETAILED STEPS

	Command or Action	Purpose
<b>Step 1</b>	<b>configure</b> <b>Example:</b> RP/0/RSP0/CPU0:router# configure	Enters global configuration mode.
<b>Step 2</b>	<b>flow exporter-map</b> <i>fem-name</i> <b>Example:</b> RP/0/RSP0/CPU0:router(config)# flow exporter-map fem	Enters flow exporter map configuration mode. <b>Note</b> A single flow monitor map can support up to eight exporters.

	Command or Action	Purpose
Step 3	<b>destination</b> <i>location</i> <b>Example:</b> RP/0/RSP0/CPU0:router(config-fem)# destination 10.0.1.2	Configures the export destination for the flow exporter map. The destination <b>location</b> argument can be a hostname or an IP address.
Step 4	<b>version v9</b> <b>Example:</b> RP/0/RSP0/CPU0:router(config-fem)# version v9	Specifies export version parameters and enters the flow exporter map version configuration mode.
Step 5	<b>commit</b> <b>Example:</b> RP/0/RSP0/CPU0:router(config-fem-ver)# commit	Commits the configuration changes to running to the running configuration.
Step 6	<b>exit</b> <b>Example:</b> RP/0/RSP0/CPU0:router(config-fem-ver)# exit	Exits flow exporter map version configuration mode and enters global configuration mode.
Step 7	<b>flow monitor-map</b> <i>map-name</i> <b>Example:</b> RP/0/RSP0/CPU0:router(config)# flow monitor-map mmap	Creates a monitor map and configures a monitor map name and enters flow monitor map configuration mode
Step 8	<b>record ipv4</b> <b>Example:</b> RP/0/RSP0/CPU0:router(config-fmm)# record ipv4	Configures the flow record map name for IPv4. By default, the originating autonomous system (AS) numbers are collected and exported.
Step 9	<b>exporter</b> <i>map-name</i> <b>Example:</b> RP/0/RSP0/CPU0:router(config-fmm)# exporter fmap	Associates an exporter map with a monitor map.  <b>Note</b> A single flow monitor map can support up to eight exporters.
Step 10	<b>cache entries</b> <i>number</i> <b>Example:</b> RP/0/RSP0/CPU0:router(config-fmm)# cache entries 4096	(Optional) Configures the number of entries in the flow cache. Replace the number argument with the number of flow entries allowed in the flow cache, in the range from 4096 through 1000000.  The default number of cache entries is 65535.
Step 11	<b>cache timeout</b> { <b>active</b> <i>timeout-value</i>   <b>inactive</b> <i>timeout-value</i>   <b>update</b> <i>timeout-value</i> } <b>Example:</b> RP/0/RSP0/CPU0:router(config-fmm)# cache timeout active 10	(Optional) Configures the active, inactive, or update flow cache timeout value.  <ul style="list-style-type: none"> <li>• The default timeout value for the inactive flow cache is 15 seconds.</li> <li>• The default timeout value for the active flow cache is 1800 seconds.</li> <li>• The default timeout value for the update flow cache is 1800 seconds.</li> </ul>

	Command or Action	Purpose
		<b>Note</b> The <b>update</b> keyword and <i>timeout-value</i> argument are used for permanent caches only. It specifies the timeout value that is used to export entries from permanent caches. In this case, the entries are exported but remain the cache.
<b>Step 12</b>	<b>commit</b> <b>Example:</b> RP/0/RSP0/CPU0:router(config-fmm) # commit	Commits the configuration changes to running to the running configuration.
<b>Step 13</b>	<b>exit</b> <b>Example:</b> RP/0/RSP0/CPU0:router(config-fmm) # exit	Exits flow monitor map version configuration mode and enters global configuration mode.
<b>Step 14</b>	<b>sampler-map</b> <i>map-name</i> <b>Example:</b> RP/0/RSP0/CPU0:router(config) # sampler-map	Creates a sampler map and enters sampler map configuration mode. <b>Note</b> When configuring a sampler map, be aware that NetFlow supports policing at a rate of 35,000 packets per second per direction for each individual line card.
<b>Step 15</b>	<b>random 1 out-of</b> <i>sampling-interval</i> <b>Example:</b> RP/0/RSP0/CPU0:router(config-sm) # random 1 out-of 65535	Configures the sampling interval to use random mode for sampling packets. For the <i>sampling-interval</i> argument, specify a number from 1 to 65535.
<b>Step 16</b>	<b>commit</b> <b>Example:</b> RP/0/RSP0/CPU0:router(config-sm) # commit	Commits the configuration changes to running to the running configuration.
<b>Step 17</b>	<b>exit</b> <b>Example:</b> RP/0/RSP0/CPU0:router(config-sm) # exit	Exits sampler map version configuration mode and enters global configuration mode.
<b>Step 18</b>	Use the <b>commit</b> or <b>end</b> command.	<b>commit</b> —Saves the configuration changes and remains within the configuration session. <b>end</b> —Prompts user to take one of these actions: <ul style="list-style-type: none"> <li>• <b>Yes</b> — Saves configuration changes and exits the configuration session.</li> <li>• <b>No</b> —Exits the configuration session without committing the configuration changes.</li> <li>• <b>Cancel</b> —Remains in the configuration session, without committing the configuration changes.</li> </ul>

**What to do next**

Go to the “Associating the OpenFlow Agent Logical Switch with NetFlow” section to complete the second part of this configuration.

## Configuration Examples: Openflow

### Attaching a bridge domain to an Openflow Switch: Examples

- Attaching a L2-only Openflow switch

```
openflow
switch 1 pipeline 129
  tls trust-point local tp1 remote tp1
  bridge-group SDN-2 bridge-domain OF-2
  controller ipv4 5.0.1.200 port 6653 security tls
```

- Attaching a L2\_L3 Openflow switch

```
openflow
switch 1 pipeline 130
  tls trust-point local tp1 remote tp1
  bridge-group SDN-2 bridge-domain OF-2
  controller ipv4 5.0.1.200 port 6653 security tls
```

- L3\_V4 switch can be attached either to a VRF or directly to layer 3 interfaces under global VRF. In case of VRF, all the interfaces in that VRF become part of the OpenFlow switch.

```
openflow
switch 11 pipeline 131
  vrf IPv4
  controller ipv4 5.0.1.200 port 6653 security none
!
```

- L3\_DS switch can be attached either to a VRF or directly to layer 3 interfaces under global VRF.

```
openflow
switch 12 pipeline 132
  vrf IPv4
  controller ipv4 5.0.1.200 port 6653 security none
!
```

### OpenFlow Agent with NetFlow Collection and Analytics Configuration: Example

The following example describes the NetFlow exporter map configuration for the OpenFlow logical switch.

```
Device> enable
Device# configure terminal
Device(config)# flow exporter-map fem
Device(config-fem)# destination 10.0.1.2
Device(config-fem)# version v9
```

```
Device(config-fem-ver) # commit
Device(config-fem-ver) # exit
```

The following example describes the NetFlow monitor map configuration for the OpenFlow logical switch.

```
Device(config) # flow monitor-map mmap
Device(config-fmm) # record ipv4
Device(config-fmm) # exporter fmap
Device(config-fmm) # cache entries 4096
Device(config-fmm) # commit
Device(config-fmm) # exit
```

The following example describes the NetFlow sampler map configuration for the OpenFlow logical switch.

```
Device(config) # sampler-map
Device(config-sm) # random 1 out-of 65535
Device(config-sm) # commit
Device(config-sm) # exit
```

The following example describes how the OpenFlow Agent logical switch is configured so that the NetFlow collection and analytics are associated with it.

```
Device(config) # openflow switch 100 netflow
Device(logical-switch) # flow monitor mmap sampler smap
Device(logical-switch) # interface GigabitEthernet0/1/0/6
Router(logical-switch) # controller 10.0.1.2 port 6633
Device(logical-switch) # commit
Device(logical-switch) # end
```

The following example describes **show** command output for an OpenFlow Agent logical switch that is configured with NetFlow collection and analytics.

```
Device# show openflow switch 100
Fri Jan 25 14:29:21.078 UTC

Logical Switch Context
  Id: 100
  Switch type: Netflow
  Layer: NONE
  Signal version: Openflow 1.0
  Data plane: secure
  Fallback: normal
  Config state: no-shutdown
  Working state: enabled
  TLS version: NONE
  TLS private key: none:none
  TLS private key file: NONE
  TLS certificate file: NONE
  Controller: 10.0.1.2:6633, last alive ping: 2013-01-25 14:29:20
  Netflow Monitor: mmap
  Netflow Sampler: smap
  Loopback i/f: <none>
  Loopback addr: <none>
  Interfaces:
    GigabitEthernet0/1/0/6

Device# show openflow switch 100 flows
```

```

Fri Jan 25 14:29:24.787 UTC

Logical Openflow Switch [100]:
NXST_FLOW reply (xid=0x0):
cookie=0x0, duration=204.729s, table=0, n_packets=0, n_bytes=0, priority=500 actions=netflow

Switch flow count: 1

Device# show openflow switch 100 controllers
Fri Jan 25 14:29:28.660 UTC

Logical Openflow Switch [100]:
Controller [tcp:10.0.1.2:6633]
  role           : Other
  connected      : Yes
  state          : ACTIVE
  sec_since_connect : 487

```

## Usecase for Layer2

**The Scenario:** Enterprise Data Center needs to perform data backup to multiple other backup sites based on the Traffic flow. The Main DC is in Vlan 100 and Backup sites are at VLAN 1000,1001,1002. These Sites are interconnected through L2VPN.

**The Solution:** Openflow, we can match any Layer 2 header field (in this example we have taken priority bits) and steer the traffic to go on any L2 interconnect and also rewrite the VLANs appropriately.

## Usecase for Layer3

**The Scenario:** Three different flows from 3 different sites connected to PE1 are trying to send 350 mbps of traffic each to PE2. The bandwidth of the shortest link, Path-2 (between PE1 and PE2) is only 1 Gigabit. Hence Path-2 gets congested as soon as the third site begins to send traffic.

**The Solution:** Openflow controller can be used to install rules on PE1:

- Match on Flow 1 (destined to Video server) and redirect traffic to Path-2
- Match on Flow 2 (destined to Web server) and redirect traffic to Path-1
- Match on Flow 3 (destined to File transfer server) and redirect traffic to Path-3

**The Inference:** Effectively utilizing the network bandwidth by redirecting destination specific traffic using OpenFlow rules.







# CHAPTER 12

## Configuring Data Collection Manager

This module describes the configuring of the Data Collection Manager feature.

**Table 38: Feature History for Configuring Data Collection Manager**

Release	Modification
Release 5.2.2	This feature was introduced

- [Data Collection Manager, on page 277](#)

## Data Collection Manager

Cisco Data Collection Manager (DCM) is an efficient and reliable data collection agent that is embedded in managed devices, such as routers and switches. DCM works on a push model, which is based on a subscribe-and-notify data pattern, as opposed to the pull model, which is based on a request-and-response data pattern. The Data Collection Manager (DCM) supports advanced on-board data processing that includes baseline calculation, summary calculation, statistical distribution, and percentile computation.

## Data Collection Manager and Bulkstat

The Data Collection Manager (DCM) and the bulkstat module are the vital units of a framework which enables the bulk collection mechanism to include multiple data sources and multiple data export mechanisms.

The Bulkstat client application is implemented using the DCM core services to retrieve data and export it to the user. The Bulkstat client provides the only available user interface for DCM access. The client also provides CLI access through a new set of configuration commands and MIB access through the CISCO-DATA-COLLECTION-MIB.

DCM provides data subscription service for different data sources (such as, SNMP MIB objects and show command outputs). It also provides data retrieval management and data filtering services. With DCM, one source can be allocated for periodically collecting all management data.

Bulkstat, is an application which will use DCM to provide the following:

- Profiles and data-groups for different data-sources.
- Data processing – Summary, Distribution, Percentile and Auto-baseline.
- Data exports – File.

- Calendar scheduling.

## Benefits of DCM

DCM is very useful for Data Retrieval and Export and Performance Management solutions. This list includes all the benefits of DCM.

- **Data export and retrieval:** The Data Collection Manager (DCM) provides data retrieval management to ensure that the data collection does not impact device resources. The DCM can export data in a file format using multiple export protocols such as FTP, TFTP, Secure copy protocol (SCP), and Secure File Transfer Protocol (SFTP). The DCM provides a query mechanism with which data can be selectively exported based on the configured time interval and other selection criteria. The DCM application also provides data filtering services and exports the filtered data. You can also set primary and secondary destinations for exporting the collected data in a raw or processed format. Snapshots of the collected data can be stored for later retrieval.
- **Performance Management:** The Data Collection Manager (DCM) can be used to manage various aspects of performance management. It can collect data with a high granularity to help the Network Management Server (NMS) make dynamic traffic engineering decisions. DCM can also be used to collect resource variables that are important for effective capacity trend information, such as memory, queue depth, broadcast volume, buffer, Frame Relay congestion notification, and backplane utilization.
- **Troubleshooting:** The streaming function of the DCM can be used for real-time troubleshooting.
- **SLA:** A service level agreement (SLA) includes a what-if analysis for network changes and application changes, a trend for defined performance variables, exception management for defined capacity and performance variables, and QoS management. The DCM can be used to collect periodic data for reporting purposes.

## Bulkstat

Two challenges that network providers usually face are data gathering and data analysis. Network providers need to gather large volumes of data to analyze the performance of the network and to have operational control over their network. Large service providers are strengthening their data gathering and analysis infrastructure. Traditionally, Simple Network Management Protocol (SNMP) agents are used to expose management data on managed systems. But, SNMP is not well suited for gathering large volumes of data, especially over short time intervals. For example, service providers charge customers depending on the network usage. Also this data must be available on customer request. Accounting applications based on SNMP polling models consume significant network bandwidth because they poll large volumes of data frequently. The SNMP protocol data unit (PDU) is a complex data type specific to SNMP and is expensive to process because the SNMP objects and tables must be sorted in a lexicographic order. All the entries in SNMP MIB tables are lexicographically ordered by their object identifiers, because there is an implied ordering in the MIB based on the order of the object identifiers. In such cases, the need to continuously poll large or bulk SNMP statistics can be avoided by using applications known as collectors to retrieve data.

The Bulkstat application is one such collector that uses the services of the Data Collection Manager (DCM) to provide the following functions:

- Collecting SNMP MIB object values.
- Processing the collected data to create summary, percentiles, and auto-baselined values.
- Exporting collected data through simple file transfers.

- Scheduling calendar events for data collection and export.

The Bulkstat application provides command-line access through a set of new configuration commands and exclusive MIB access through CISCO-DATA-COLLECTION-MIB to collect SNMP data.

You can configure Bulkstat for the following functions:

- Specify the way Bulkstat retrieves bulk statistics.
- Specify the time interval in seconds at which Bulkstat transfers data to receivers.
- Specify the maximum size of the bulk statistics file.
- Specify the context, instance, and period at which the system retrieves bulk statistics.
- Configure file-related parameters.
- Configure the interface type on which you want to collect statistics.
- View the parameters that Bulkstat uses to collect statistics by using the show bulkstat commands.

## Bulkstat Configuration Elements

The following list shows the elements that you can configure using the Bulkstat interface:

- Data set
- Instance set
- Filter set
- Data group
- Process set
- Data profile
- Calendar Scheduling

### Data Set

This section describes the data set elements that you can configure to collect Simple Network Management Protocol (SNMP) data and CLI data. Only objects having the same index elements can be grouped in a single object list.

The SNMP data set contains the following fields:

Name	Description	Configuration Status
Objects	Specifies the object to be collected. Multiple objects can be configured to form a data set. The textual name of the object can be used for configuring an object. If the device does not recognize the textual name, the object identifier (OID) format can be used for configuring the name.	Mandatory

Name	Description	Configuration Status
Object Alias	Specifies the optional alias name that each object can have.	Optional

The CLI data set contains the following fields:

Name	Description	Configuration Status
CLI	Specifies the CLI command for which the show output needs to be collected. More than one CLI can be specified in the same data set.	Mandatory

## Filter Set

This section describes the filter configuration per object.

The filter set elements that you can configure to collect Simple Network Management Protocol (SNMP) data are described here. More than one filter of the same type can be added to the set.

Name	Description	Status
Object match	Specifies the value to be used to match against the value retrieved for the object during collection. The value provided needs to match the type of the object. If there is an error in the type matching, the configuration is not accepted.  More than one value can be specified for an object, and more than one object can have matching values.	Optional

## Instance Set

This section specifies the instance set elements that you can configure to collect Simple Network Management Protocol (SNMP) data. More than one instance of the same type can be added to the set. Combinations of types of instance set elements are not supported.

The SNMP Instance set contains the following fields:

Name	Description	Configuration Status
Exact	Specifies the instance for which the data should be collected. More than one instance can be specified, but only fully qualified instances should be specified.	Optional

Name	Description	Configuration Status
Wildcard	Specifies all instances for all objects under the object configured in the data set.	Optional
Range	Specifies the start and end instances. All instances within the range, including the start and end, are collected, but only fully qualified instances should be specified.	Optional
Repetition	Specifies the start of the repetition and the number of repetitions. All instances from the start until the number of repetitions within the subtree are collected.	Optional
Interface	Specifies the interface instead of the index. The ifIndex assigned to the interface will be used as an index. This can be used for MIB objects indexed by ifindex.	Optional

## Process Set

Data processing allows users to derive information from raw SNMP data, by calculating summaries and percentiles. Service providers rely on monitored SNMP data to alert network management systems (NMSs) of changing network conditions. By periodically monitoring the device data and comparing it against a set of thresholds, the network can automatically alert the operators, thereby allowing efficient operations.

- **Summary:** You can enable summary processing on the collected object value and calculate minimum, maximum, and average values. A summary is calculated for only those objects that are marked as process capable in the data group and uses the absolute or delta value as per the object configuration.
- **Distribution:** You can enable distribution processing on the collected object value by specifying the object type, minimum value, maximum value, and the number of buckets to distribute the value. Based on the configuration, counters are maintained per bucket and are incremented whenever the data falls into a bucket range.
- **Percentile:** You can enable percentile processing on the collected object value. A percentile is calculated on every process interval expiry. Distribution configuration is mandatory to enable percentile processing. Percentile computation is done assuming that the distribution is normal.
- **Auto-baseline:** You can enable baseline processing on the collected object value. The baseline internally uses all summary, distribution, and percentile calculations to provide baseline values. You can configure either baseline processing or other forms of processing, such as summary, distribution, and percentile calculations. The auto-baseline feature in DCM calculates the baseline values for variables of interest on the device and allows network management applications or network operators to retrieve the baseline values. The baseline values can be displayed in terms of percentiles or a median with standard deviation.

## Data Group

This section describes the data group, which contains the data-group name, data-group type, data set, instance set, filter set, polling interval, SNMP context, and other processing options.

The Data Group elements are:

Name	Description	Configuration Status
Data	Specifies any one of the data types as defined in the topic <b>Data Set</b> .	Mandatory
Instance	Specifies any one of the instance types as defined in the topic <b>Instance Set</b> .	Optional, if not specified. Default behavior of the instance set is wildcard. Only applicable for SNMP.
Filter	Specifies any one of the filter types as defined in the topic <b>Filter Set</b> .	Optional, if not specified. Only applicable for SNMP.
Polling Interval	Specifies the collection periodic interval in seconds. In case of recurring collection, the data is collected at the expiration of the collection interval until the collection is stopped.	Optional
Context	Specifies the management context from which to obtain data for this data group.	Optional
Process Summary	Enables summary processing of the data marked to be processed in the corresponding data-set configuration.	Optional
Process Distribution	Enables distribution processing of the data marked to be processed in the corresponding data-set configuration.	Optional
Process Percentile	Enables percentile processing of the data marked to be processed in the corresponding data-set configuration.	Optional

Name	Description	Configuration Status
Process Auto-baseline	<p>Enables auto-baselining processing of the data marked to be processed in the corresponding data-set configuration. If auto-baseline process is enabled, the other processes, such as summary, distribution, and percentile configurations, if done previously, are removed because auto-baseline process uses these functionalities internally.</p> <p><b>Note</b> Removing this configuration will not reinstate the other configurations that are removed.</p>	Optional
Discard raw	<p>Specifies whether to store raw data. If data is processed, the user can choose to store only process data by setting the option.</p>	Optional

## Data Profile

This section describes the data profile that is used to group multiple data groups. This is done to simplify the configuration and to aggregate data of similar nature. A data profile can have multiple data groups. A data group can have constraints in the data specified in the element. If two sets of data need to be written to the same file, the respective data groups should be linked as part of a single profile.

The Data Profile has these fields:

Name	Description	Status
Data groups	<p>Specifies the data group to be linked to this profile. Multiple data groups can be linked to a single profile.</p>	Mandatory before activating a profile
Transfer Interval	<p>Specifies the transfer periodic interval in seconds. In case of recurring transfer, the data is transferred when the transfer interval expires.</p>	Optional

Name	Description	Status
Process Interval	Specifies the process periodic interval in seconds. The data is processed during every collection interval as soon as it is collected. When the process interval expires, the processed data is written into a file and transferred.	Optional
Primary URL	Specifies the URL of the primary management station. The files containing the collected data are transferred to this URL when the transfer interval expires.	Mandatory
Secondary URL	Specifies the URL of the secondary management station to be used in case the transfer to the primary management station fails.	Optional
Schema	Specifies the file data format. The schema ASCII option is supported.	Optional
Retry	<p>Specifies the number of times that the transfer is retried in case of transfer failures to both primary and secondary management stations. This command has an effect only if the retain command is configured in the profile.</p> <p>The retry interval is computed by dividing the retention time by the number of retries. For example, if the file is retained for 60 minutes and the retry is 6 times, the transfer is attempted every 10 minutes, until the transfer succeeds or the file is removed.</p>	Optional
Buffer-size	Specifies the maximum size to which the file containing the collected data can grow. When it reaches the limit, the file is closed and the transfer is attempted based on the transfer configuration associated with the data group or profile.	Optional
Retention Memory	Specifies the time, in seconds, to retain the file in the memory.	Optional



Name	Description	Status
Retention USB	Specifies the time, in seconds, to retain the file in the USB. This option is available only if the device supports the USB drive.	Optional

## Calendar Scheduling

The Bulkstat application allows you to schedule each subscription for collection. A subscription can be scheduled for one-time collection or periodic collection. A periodic subscription can be repeated infinitely or for a specified number of repetitions. A timer is instantiated for every activated subscription.

The calendar scheduling elements are:

Name	Description	Configuration Status
One shot	Specifies that the data is collected for a specified collection interval.	Optional
Recurring	Specifies that the data is collected regularly at the specified time, day, month, and for a specified collection interval.	Optional

## File Data Export

The file data export feature on the Data Collection Manager (DCM) exports the collected data based on the transfer configurations. Data can be exported in various formats, and Bulkstat files are one such format to collect data. The format in which the data is inserted into the file conforms to the schema-Ascii format described in CISCO-DATA-COLLECTION-MIB and CISCO-BULK-FILE-MIB. The data sequence in which the data is stored is determined based on the sequence in which the data is received.

The Cisco File Transfer module is responsible for transferring the files as per the transfer configuration. A file can be retained in the device whether the transfer was a success or a failure.

## Configuring an SNMP Bulkstat Data Set

The first step in configuring the Simple Network Management Protocol (SNMP) periodic data collection and transfer mechanism is to configure one or more data sets. A data set is used to group objects of similar types, based on the data source. The data set is defined outside of the data group. This external definition gives the user the flexibility to use the same data set across multiple data groups and to collect the output for different instances and different contexts.

All objects in an SNMP data set must be indexed by the same MIB index. However, the objects in the data set must not belong to the same MIB or the MIB table.

Perform this task to configure the SNMP Bulkstat data set.

### SUMMARY STEPS

1. **configure**
2. **bulkstat data** *data-set -name* **type snmp**

### 3. `object oid [ alias alias-name ]`

#### DETAILED STEPS

	Command or Action	Purpose
<b>Step 1</b>	<b>configure</b> <b>Example:</b> RP/0/RSP0/CPU0:router# configure	Enters global configuration mode.
<b>Step 2</b>	<b>bulkstat data data-set -name type snmp</b> <b>Example:</b> RP/0/RSP0/CPU0:router (config) # <b>bulkstat data interface-stats type snmp</b>	Defines an SNMP Bulkstat data set and enters SNMP bulk statistics data set configuration mode. The creation of an SNMP Bulkstat data set creates a row in the cdcDGBaseObjectEntry table in the SNMP MIB.
<b>Step 3</b>	<b>object oid [ alias alias-name ]</b> <b>Example:</b> RP/0/RSP0/CPU0:router (config-bs-ds-snmp) # <b>object 1.3.6.1.2.1.2.2.1.10 alias ifInOctets</b>	Adds a MIB object to the SNMP Bulkstat data set. If the object is already present in the data set, this command replaces the old object configuration with the new configuration.  <b>Note</b> Repeat this command until all objects to be monitored are added to this list.

## Configuring an SNMP Bulkstat Filter Set

The Simple Network Management Protocol (SNMP) filter set specifies the filter configuration for every SNMP object.

Perform this task to configure the SNMP Bulkstat filter set.

#### SUMMARY STEPS

1. **configure**
2. **bulkstat filter filter-set -name**
3. **match object-name { eq line | start line | not { eq line | start line } }**

#### DETAILED STEPS

	Command or Action	Purpose
<b>Step 1</b>	<b>configure</b> <b>Example:</b> RP/0/RSP0/CPU0:router# configure	Enters global configuration mode.
<b>Step 2</b>	<b>bulkstat filter filter-set -name</b> <b>Example:</b> RP/0/RSP0/CPU0:router (config) # <b>bulkstat filter ifType</b>	Defines an SNMP Bulkstat filter set and enters SNMP bulk statistics filter set configuration mode.

	Command or Action	Purpose
Step 3	<b>match</b> <i>object-name</i> { <b>eq</b> <i>line</i>   <b>start</b> <i>line</i>   <b>not</b> { <b>eq</b> <i>line</i>   <b>start</b> <i>line</i> } }  <b>Example:</b> RP/0/RSP0/CPU0:router (config-bs-fs) # <b>match</b> <b>ifType</b> <b>eq</b> 6767	(Optional) Specifies a value to be used to match against the value retrieved for the object during collection.  <b>Note</b> More than one value can be specified for an object, and more than one object can have match values.

## Configuring an SNMP Bulkstat Instance Set

The Simple Network Management Protocol (SNMP) instance set specifies the instances for which the data should be collected. Each subscription can collect different entries for specified objects based on the instance configuration. While more than one instance of the same type can be added to the instance set, a combination of different types is not supported.

Perform this task to configure the SNMP Bulkstat instance set.

### SUMMARY STEPS

1. **configure**
2. **bulkstat instance** *instance-set -name* **type snmp**
3. **exact oid** *oid*
4. **exact interface** *interface-id*
5. **wildcard**
6. **wildcard oid** *oid*
7. **wildcard interface** *interface-id*
8. **repetition oid** *oid max value*
9. **range start** *oid end oid*

### DETAILED STEPS

	Command or Action	Purpose
Step 1	<b>configure</b>  <b>Example:</b> RP/0/RSP0/CPU0:router# <b>configure</b>	Enters global configuration mode.
Step 2	<b>bulkstat instance</b> <i>instance-set -name</i> <b>type snmp</b>  <b>Example:</b> RP/0/RSP0/CPU0:router (config) # <b>bulkstat instance</b> <b>exact type snmp</b>	Defines an SNMP Bulkstat instance set and enters SNMP Bulkstat instance set configuration mode. The creation of an SNMP Bulkstat instance set creates a row in the cdcDGInstanceEntry table in the SNMP MIB.  <b>Note</b> An instance created using this command can be linked to more than one data group.
Step 3	<b>exact oid</b> <i>oid</i>  <b>Example:</b>	(Optional) Indicates that the specified instance, when appended to the object list, is the complete OID.

	Command or Action	Purpose
	RP/0/RSP0/CPU0:router (config-bs-is-snmp) # <b>exact oid 1</b>	
<b>Step 4</b>	<b>exact interface</b> <i>interface-id</i> <b>Example:</b> RP/0/RSP0/CPU0:router (config-bs-is-snmp) # <b>exact interface Ethernet0/0 sub-if</b>	(Optional) Specifies an interface name and number, for example interface Ethernet 0, instead of specifying the ifIndex OID for the interface.
<b>Step 5</b>	<b>wildcard</b> <b>Example:</b> RP/0/RSP0/CPU0:router (config-bs-is-snmp) # <b>wildcard</b>	(Optional) Specifies whether an object used for evaluating an expression should be made a wildcard during an event configuration.
<b>Step 6</b>	<b>wildcard oid</b> <i>oid</i> <b>Example:</b> RP/0/RSP0/CPU0:router (config-bs-is-snmp) # <b>wildcard oid 1</b>	(Optional) Indicates that all subindices of the specified OID belong to this schema.
<b>Step 7</b>	<b>wildcard interface</b> <i>interface-id</i> <b>Example:</b> RP/0/RSP0/CPU0:router (config-bs-is-snmp) # <b>wildcard interface Ethernet0/0 sub-if</b>	(Optional) Specifies an interface name and number, for example interface Ethernet 0, instead of specifying the ifIndex OID for the interface.
<b>Step 8</b>	<b>repetition oid</b> <i>oid max value</i> <b>Example:</b> RP/0/RSP0/CPU0:router (config-bs-is-snmp) # <b>repetition oid 1.2.3.4 max 2000</b>	(Optional) Configures data collection to repeat get-next for the maximum number of instances starting from the specified oid instance.
<b>Step 9</b>	<b>range start</b> <i>oid end oid</i> <b>Example:</b> RP/0/RSP0/CPU0:router (config-bs-is-snmp) # <b>range start 1.2.3.4 end 1.2.3.6</b>	(Optional) Configures a range of instances for which the data is collected.

## Configuring a Bulkstat Data Group

The Bulkstat data group element is used to group the data set, filter set, and instance set and also to specify the processing options.

Perform this task to configure the Bulkstat data group.

### SUMMARY STEPS

1. **configure**
2. **bulkstat data-group** *data-group-name*
3. **collect type** { { **command** | **expression** } **date** *date-set-name* **filter** *filter-set-name* | **snmp** { **data** *data-set-name* **instance** *instance-set-name* **filter** *filter-set-name* } }
4. **context** *context-name*

5. **interval polling** *polling-interval*
6. **discard**
7. **process**

## DETAILED STEPS

	Command or Action	Purpose
<b>Step 1</b>	<b>configure</b> <b>Example:</b> RP/0/RSP0/CPU0:router# <b>configure</b>	Enters global configuration mode.
<b>Step 2</b>	<b>bulkstat data-gorup</b> <i>data-group-name</i> <b>Example:</b> RP/0/RSP0/CPU0:router (config) # <b>bulkstat data-group if-dg</b>	Defines a Bulkstat data group and enters Bulkstat data group configuration mode.  The creation of a Simple Network Management Protocol (SNMP) Bulkstat data group creates a row in the cdcDgEntry table in the SNMP MIB.
<b>Step 3</b>	<b>collect type</b> { { <b>command</b>   <b>expression</b> } <b>date</b> <i>date-set-name</i> <b>filter</b> <i>filter-set-name</i>   <b>snmp</b> { <b>data</b> <i>data-set-name</i> <b>instance</b> <i>instance-set-name</i> <b>filter</b> <i>filter-set-name</i> } } <b>Example:</b> RP/0/RSP0/CPU0:router (config-bs-dg) # <b>collect type snmp data interface-stats instance ins-exact filter ifType</b>	Specifies the collection type to collect data from different sources for this data group.
<b>Step 4</b>	<b>context</b> <i>context-name</i> <b>Example:</b> RP/0/RSP0/CPU0:router (config-bs-dg) # <b>context ctx-name</b>	Specifies the management context from which to obtain data for this data group.
<b>Step 5</b>	<b>interval polling</b> <i>polling-interval</i> <b>Example:</b> RP/0/RSP0/CPU0:router (config-bs-dg) # <b>interval polling 100</b>	Specifies the collection periodic interval in seconds. In case of recurring collection, the data is collected at the expiration of the collection interval until the collection is stopped.
<b>Step 6</b>	<b>discard</b> <b>Example:</b> RP/0/RSP0/CPU0:router (config-bs-dg) # <b>discard</b>	Specifies whether to discard the raw data.
<b>Step 7</b>	<b>process</b> <b>Example:</b> RP/0/RSP0/CPU0:router (config-bs-dg) # <b>process</b>	Configures process-related parameters for a data group.

## Configuring a Bulkstat Profile

Perform this task to configure the Bulkstat Profile.

The profile element is used to group multiple data groups. This grouping simplifies the configuration and aggregates data of a similar nature. If two sets of data need to be written to the same file, the respective data groups should be linked as part of a single profile.

### SUMMARY STEPS

1. **configure**
2. **bulkstat profile** *profile-name*
3. **data-group** *data-group name*
4. **interval transfer** { **process** | **raw** } *seconds*
5. **file-format schema** ASCII
6. **file retain** { **disk url** | **memory seconds** }
7. **file size** *bytes*
8. **file transfer** { **retry number** | **url** { **primary url** | **secondary url** } }
9. **enable**

### DETAILED STEPS

	Command or Action	Purpose
<b>Step 1</b>	<b>configure</b> <b>Example:</b>  RP/0/RSP0/CPU0:router# <b>configure</b>	Enters global configuration mode.
<b>Step 2</b>	<b>bulkstat profile</b> <i>profile-name</i> <b>Example:</b> RP/0/RSP0/CPU0:router (config) # <b>bulkstat profile</b> <b>if-stats</b>	Creates a profile with the given name and enters Bulkstat profile configuration mode. If the profile is already created, this command sets the context for the existing profile.
<b>Step 3</b>	<b>data-group</b> <i>data-group name</i> <b>Example:</b> RP/0/RSP0/CPU0:router (config-bs-profile) # <b>data-group if-dg</b>	Specifies the data group to be linked to this profile. Multiple data groups can be linked to a single profile.
<b>Step 4</b>	<b>interval transfer</b> { <b>process</b>   <b>raw</b> } <i>seconds</i> <b>Example:</b> RP/0/RSP0/CPU0:router (config-bs-profile) # <b>interval transfer process 2000</b>	Specifies the transfer periodic interval in seconds. In case of recurring transfer, the data is transferred at the expiration of the transfer interval until the transfer is stopped.
<b>Step 5</b>	<b>file-format schema</b> ASCII <b>Example:</b> RP/0/RSP0/CPU0:router (config-bs-profile) # <b>file-format schemaASCII</b>	Configures the file-related parameter for a profile. Specifies the file data format in ASCII.
<b>Step 6</b>	<b>file retain</b> { <b>disk url</b>   <b>memory seconds</b> }	Configures the file-related parameter for a profile.

	Command or Action	Purpose
	<b>Example:</b> <pre>RP/0/RSP0/CPU0:router (config-bs-profile) # file retain memory 1500</pre>	<ul style="list-style-type: none"> <li>• <b>disk</b> - retains the file in the specified location in the disk for a specified amount of time in seconds.</li> <li>• <b>memory</b> - retains the file in the memory for a specified amount of time in seconds.</li> </ul>
<b>Step 7</b>	<b>file size</b> <i>bytes</i> <b>Example:</b> <pre>RP/0/RSP0/CPU0:router (config-bs-profile) # file size 2048</pre>	Configures the file-related size parameter for a profile. <b>size</b> - Specifies the maximum buffer size in bytes. When the limit is reached, the file is closed and transfer is attempted based on the transfer configuration associated with the data group or the profile.
<b>Step 8</b>	<b>file transfer</b> { <i>retry number</i>   <b>url</b> { <b>primary url</b>   <b>secondary url</b> } } <b>Example:</b> <pre>RP/0/RSP0/CPU0:router (config-bs-profile) # file transfer url primary tftp://20.1.1.1/iox</pre>	Configures the file-related transfer parameter for a profile. <ul style="list-style-type: none"> <li>• <b>primary</b> - specifies the URL of the primary management station. The files containing the collected data are transferred to this URL when the transfer interval expires.</li> <li>• <b>secondary</b> - specifies the URL to be used in case the transfer to the primary management station fails.</li> </ul>
<b>Step 9</b>	<b>enable</b> <b>Example:</b> <pre>RP/0/RSP0/CPU0:router (config-bs-profile) # enable</pre>	Enables the profile for collection and transfer.

## Configuring Bulkstat Calendar Scheduling

### SUMMARY STEPS

1. **configure**
2. **bulkstat schedule** *schedule at time-detail* { **oneshot** | **recurring** }
3. **profile** *profile-name start* { **oneshot** | **recurring number** }
4. **profile** *profile-name stop*

### DETAILED STEPS

	Command or Action	Purpose
<b>Step 1</b>	<b>configure</b> <b>Example:</b> <pre>RP/0/RSP0/CPU0:router# configure</pre>	Enters global configuration mode.
<b>Step 2</b>	<b>bulkstat schedule</b> <i>schedule at time-detail</i> { <b>oneshot</b>   <b>recurring</b> }	Defines the Bulkstat calendar scheduler set and enters Bulkstat event scheduler configuration mode.

	Command or Action	Purpose
	<b>Example:</b> <pre>RP/0/RSP0/CPU0:router (config) # bulkstat schedule event1 at 11:30 jan 10 oneshot</pre>	For the time-detail option, enter the details of the time as prompted. First the time in the 24-hour clock format, followed by the month and then the date.
<b>Step 3</b>	<b>profile</b> <i>profile-name</i> <b>start</b> { <b>oneshot</b>   <b>recurring</b> <i>number</i> } <b>Example:</b> <pre>RP/0/RSP0/CPU0:router (config-bs-schedule) # profile cpu-process start recurring 5</pre>	Creates a profile and sets the condition to enable the profile for a one-time event or enables the profile for multiple events.
<b>Step 4</b>	<b>profile</b> <i>profile-name</i> <b>stop</b> <b>Example:</b> <pre>RP/0/RSP0/CPU0:router (config-bs-schedule) # profile cpu-process stop</pre>	Disables the profile.

## Configuration Examples and Usecase Scenarios

The usecase scenarios with examples are discussed here.

### Usecase-1: Collecting MIB Statistics

**Goal: To collect IF MIB Statistics**

Procedure	Example
Step1: Identifying the inputs and other parameters	MIB Objects of interest: <ul style="list-style-type: none"> <li>• 1.3.6.1.2.1.2.2.1.2 (ifDescr)</li> <li>• 1.3.6.1.2.1.2.2.1.10 (ifInOctets)</li> <li>• 1.3.6.1.2.1.2.2.1.16 (ifOutOctets)</li> </ul> Export Parameters: <ul style="list-style-type: none"> <li>• Interval: 60 seconds</li> <li>• Protocol: TFTP</li> <li>• Server: 10.105.33.135</li> <li>• Path: dcm_data</li> </ul>
Step2: Configuring the <b>Data set if-mib</b> For detailed procedure: <a href="#">Configuring an SNMP Bulkstat Data Set, on page 285</a>	<pre>bulkstat data if-mib type snmp object 1.3.6.1.2.1.2.2.1.2 object 1.3.6.1.2.1.2.2.1.10 object 1.3.6.1.2.1.2.2.1.16</pre>



Procedure	Example
Step3: Configuring the <b>Instance set if-mib</b> For detailed procedure: <a href="#">Configuring an SNMP Bulkstat Instance Set, on page 287</a>	<pre>bulkstat instance if-mib type snmp wildcard</pre>
Step4: Configuring <b>Data Group if-group</b> For detailed procedure: <a href="#">Configuring a Bulkstat Data Group, on page 288</a>	<pre>bulkstat data-group if-group interval polling 30 collect type snmp data if-mib instance if-mib</pre>
Step5: Configuring <b>Profile snmp_profile</b> For detailed procedure: <a href="#">Configuring a Bulkstat Profile, on page 290</a>	<pre>bulkstat profile snmp_profile file transfer url primary tftp://10.105.33.135/dcm_data/ interval transfer raw 60 data-group if-group enable</pre>



**Note** Step2 and Step3 can be interchanged.

## Usecase-2: Using Filters

**Goal:** To collect gigabit ethernet interface statistics (using filters)

Procedure	Example
Step1: Identifying the inputs and other parameters	MIB Objects of interest: <ul style="list-style-type: none"> <li>• 1.3.6.1.2.1.2.2.1.2 (ifDescr)</li> <li>• 1.3.6.1.2.1.2.2.1.10 (ifInOctets)</li> <li>• 1.3.6.1.2.1.2.2.1.16 (ifOutOctets)</li> </ul> Export Parameters: <ul style="list-style-type: none"> <li>• Interval: 60 seconds</li> <li>• Protocol: TFTP</li> <li>• Server: 10.105.33.135</li> <li>• Path: dcm_data</li> </ul>
Step2: Configuring the <b>Data set if-mib</b> For detailed procedure: <a href="#">Configuring an SNMP Bulkstat Data Set, on page 285</a>	<pre>bulkstat data if-mib type snmp object 1.3.6.1.2.1.2.2.1.2 object 1.3.6.1.2.1.2.2.1.10 object 1.3.6.1.2.1.2.2.1.16</pre>

Procedure	Example
<p>Step3: Configuring the <b>Instance set if-mib</b></p> <p>For detailed procedure:  <a href="#">Configuring an SNMP Bulkstat Instance Set, on page 287</a></p>	<pre>bulkstat instance if-mib type snmp wildcard</pre>
<p>Step4: Configuring the <b>Filter set if-mib</b></p> <p>For detailed procedure:  <a href="#">Configuring an SNMP Bulkstat Filter Set, on page 286</a></p>	<p>Setting the filter (in this case, it is - gigabit ethernet interface)</p> <pre>bulkstat filter if-mib match 1.3.6.1.2.1.2.2.1.2 start "GigabitEthernet"</pre>
<p>Step5: Configuring <b>Data Group if-group</b></p> <p>For detailed procedure:  <a href="#">Configuring a Bulkstat Data Group, on page 288</a></p>	<pre>bulkstat data-group if-group interval polling 30 collect type snmp data if-mib instance if-mib</pre>
<p>Step6: Configuring <b>Profile snmp_profile</b></p> <p>For detailed procedure:  <a href="#">Configuring a Bulkstat Profile, on page 290</a></p>	<pre>bulkstat profile snmp_profile file transfer url primary tftp://10.105.33.135/dcm_data/ interval transfer raw 60 data-group if-group enable</pre>



**Note** Step2, Step3 and Step4 can be interchanged.

## Usecase-3: Collecting CLI output in XML format

**Goal:** To collect show cli output in XML format

Procedure	Example
<p>Step1: Identifying the inputs and other parameters</p>	<p>CLI of interest: <b>add cmd show operational AAA xml</b></p> <p>Export Parameters:</p> <ul style="list-style-type: none"> <li>• Interval: 5 minutes</li> <li>• Protocol: TFTP</li> <li>• Server: 10.64.68.12</li> <li>• Path: dcm_data</li> </ul>

Procedure	Example
<p>Step2: Configuring the <b>Data set process</b></p> <p>For detailed procedure:  <a href="#">Configuring an SNMP Bulkstat Data Set, on page 285</a></p>	<pre>bulkstat data process type command add cmd show operational AAA xml</pre>
<p>Step3: Configuring <b>Data Group cli-group</b></p> <p>For detailed procedure:  <a href="#">Configuring a Bulkstat Data Group, on page 288</a></p>	<pre>bulkstat data-group cli-group interval polling 60 collect type command data sh snmp</pre>
<p>Step4: Configuring <b>Profile cli_profile</b></p> <p>For detailed procedure:  <a href="#">Configuring a Bulkstat Profile, on page 290</a></p>	<pre>bulkstat profile cli_profile file transfer url primary tftp://10.64.68.12/dcm_data/ interval transfer raw 300 data-group cli-group enable</pre>





# CHAPTER 13

## Smart Licensing

Cisco IOS XR software contains all the supported features for a given release. Before the introduction of smart licensing (or software entitlement) on Cisco IOS XR software, you could freely activate all available software packages on your network devices and could enable all the bundled features. Smart licensing has been introduced so you pay only for the features that you need today, but can upgrade when necessary while keeping your investment safe. Licensing enables you to purchase individual software features and upgrade hardware capacity in a safe and reliable way.

The licensing methods supported on Cisco IOS XR software are:

- Smart Licensing
- Default (traditional) Licensing

**Table 39: Feature Support for Smart Licensing**

Release	Modification
Release 3.9.0	The software entitlement feature was introduced.
Release 4.3.1	NV Satellite license was supported.
Release 5.2.0	Smart Licensing was introduced.
Release 5.3.1	Support for Smart Licensing was introduced on Cisco ASR 9000 High Density 100GE Ethernet line cards. General availability release for Smart Licensing on ASR 9000.
Release 6.0.1	Updated consumption model line card support
Release 7.4.1	YANG data models for Smart Licensing was introduced.

This model contains the following topics:

- [What is Smart Licensing?, on page 298](#)
- [Smart Versus Traditional Licensing, on page 298](#)
- [What is Flexible Consumption Model?, on page 304](#)
- [How Does Smart Licensing Work?, on page 316](#)
- [What is Cisco Smart Software Manager?, on page 318](#)

- [YANG Data Models for Smart Licensing](#), on page 320
- [Permanent License Reservation](#) , on page 322
- [Configuring Permanent License Reservation](#), on page 322
- [How to Cancel, Return and Disable PLR](#), on page 325
- [Specific License Reservation](#), on page 329
- [Configuring Specific License Reservation](#), on page 329
- [To cancel, verify, remove, and return SLR](#), on page 332
- [Configuration Examples for SLR](#), on page 333
- [Configuring Smart Licensing](#), on page 341
- [Registering and Activating Your Router](#), on page 349
- [Verifying the Smart Licensing Configuration](#) , on page 355

## What is Smart Licensing?

Smart Licensing is a cloud-based, flexible software licensing model that enables you to activate and manage Cisco software licenses across their organization. Smart Licensing solution allows you to easily track the status of your license and software usage trends. Cisco Smart Licensing establishes a pool of licenses or entitlements that can be used across the entire organization in a flexible and automated manner. Smart Licensing helps simplify four core functions:

- **Purchase**—Creates a Smart Account (and optionally, your Virtual Account). Licenses are added to your Smart Account and are immediately available for use.
- **Install**—Register your product with your Smart Account using an account-based Registration Token. Thereafter, the entire process is automatic. Product Activation Keys (PAKs) and license files are no longer needed.
- **Management**—Make changes to license consumption by updating your configuration; any license change is automatically reflected in your Smart Account. You can share licenses in your Virtual Account through the license pooling option. License pools (logical grouping of licenses) can reflect your organization structure. Smart Licensing solution also offers Cisco Smart Software Manager, a centralized portal that enables you to manage all your Cisco software licenses from one centralized website.
- **Visibility and Asset Management**—Cisco Smart Software Manager (CSSM) portal offers an integrated view of the licenses you own and have deployed. You can use this data to make better purchase decisions, based on your consumption.

## Smart Versus Traditional Licensing

Traditional (node locked) licencing	Smart (dynamic) licencing
You must procure the license and manually install it on the device.	Your device initiates a call home and requests the licenses it needs.  <i>Configuring Call Home on the Cisco ASR 9000 Series Router</i> describes the Smart Call Home feature.

Node-locked licences - license is associated with a specific device.	Pooled licences - licences are company account-specific, and can be used with any compatible device in your company. You can activate or deactivate different types of licenses on the device without actually installing a license file on the device.
No common install base location to view licenses purchased or software usage trends	Licenses are stored securely on Cisco servers accessible 24x7x365.
No easy means to transfer licenses from one device to another.	Licenses can be moved between product instances without a license transfer. This greatly simplifies the reassignment of a software license as part of the Return Material Authorization (RMA) process.
Limited visibility into all software licenses being used in the network. Licenses are tracked only on per node basis.	Complete view of all Smart Software Licenses used in the network using a consolidated usage report of software licenses and devices in one easy-to-use portal.

## Smart Licensing for Cisco IOS XR 64 bit

**Table 40: Feature History Table**

Feature Name	Release Information	Feature Description
Support for Smart Licensing on ASR 9902 Routers, 0.8T PEC, and ASR 9000 5th generation 400G Line Cards.	Release 7.4.1	Smart Licensing support is now extended to the following routers and line cards: <ul style="list-style-type: none"> <li>• ASR-9902</li> <li>• A9K-8HG-FLEX-SE/TR</li> <li>• A9K-4HG-FLEX-SE/-TR ine cards</li> <li>• A99-4HG-FLEX-SE/TR line cards</li> </ul>

Cisco IOS XR 64 bit does not support Traditional Licensing. Only Smart Licensing is supported in Cisco IOS XR 64 bit. Smart Licensing is enabled by default on Cisco IOS XR 64 bit. Here are few things to consider for Smart Licensing in Cisco IOS XR 64 bit:

- Smart Licensing cannot be disabled.
- All the Smart Licensing CLIs are executed from EXEC mode.
- EVAL Period is supported.

This table shows license consumption logic for non-Consumption Model (CM) line cards:

Table 41: Feature wise requirement for Non-CM Line Cards

License	Eligibility Criteria
AIP	If number of VRFs are greater than 8, AIP license is consumed.
IVRF	<p>If number of VRFs are less than or equal to 8, IVRF license is consumed.</p> <p>If customer has less than or equal to 8 VRFs, who purchased AIP license in their smart account, please contact your Cisco account representative if you see issues like insufficient IVRF licenses.</p> <p>The router consumes the IVRF license only when a physical interface on the line card has two or more VRFs.</p> <p><b>Note</b> The router does not consider VRFs in the logical interfaces for IVRF licensing. You must configure two or more separate VRFs to request an IVRF license.</p>

This table lists supported licenses for non-Consumption Model (CM) line cards:

Table 42: Non-CM Line Cards Software Licenses for Cisco IOS XR 64-bit

Non-CM Line Cards Software License PID	Description
A9K-800G-IVRF	ASR 9000 8-port 100 GE Infrastructure VRF Right to Use License
A9K-400G-IVRF	ASR 9000 4-port 100 GE Infrastructure VRF license Right to Use License
A99-1200G-IVRF	ASR 9900 Infrastructure VRF license Right to Use License
A9K-800G-AIP-SE	ASR 9000 8-port 100 GE Advance IP Service Edge Right to Use License
A9K-800G-AIP-TR	ASR 9000 8-port 100 GE Advance IP Transport Optimised Right to Use License
A9K-400G-AIP-SE	ASR 9000 4-port 100 GE Advance IP Service Edge Right to Use License
A9K-400G-AIP-TR	ASR 9000 4-port 100 GE Advance IP Transport Optimised Right to Use License
A99-1200G-AIP	ASR 9900 12port 100GE Advanced IP Right to Use License



<b>Non-CM Line Cards Software License PID</b>	<b>Description</b>
A9K-800G-OPT-LIC	ASR 9000 8-port 100 GE Advance Optical Right to Use License
A9K-400G-OPT-LIC	ASR 9000 4-port 100 GE Advance Optical Right to Use License
A99-1200G-ADVRTNG	ASR 9900 12port 100GE Advanced Routng Right to Use License
S-A9K-9901-AIP-LC	ASR 9000 Smart License L3 VPN for NON PAYG 9901 System
S-A9K-9901-VRF-LC	ASR 9000 Smart License I-VRF for NON PAYG 9901 System
S-A9K-9901-120AIP	ASR 9000 Smart License L3 VPN for 120G PAYG 9901 System
S-A9K-9901-256AIP	ASR 9000 Smart License L3 VPN for 256G PAYG 9901 System
S-A9K-BNG-ADV-8K	ASR 9000 Smart License for BNG license for Advance Features
S-A9K-BNG-LIC-8K	ASR 9000 BNG License Unit for 8000 subscribers
A9K-24P-80GRTU-SE	ASR 9000 80G Upgrade license for 24-port 10G/1G dual rate Service Edge
A9K-24P-80GRTU-TR	ASR 9000 80G Upgrade license for 24-port 10G/1G dual rate Transport Optimized
A9K-48P1GE-AIP-SE	ASR 9000 Advance IP Service Edge License for full scale VRFs for 48-port 1G mode
A9K-48P1GE-AIP-TR	ASR 9000 Advance IP Transport Optimized License for full scale VRFs for 48-port 1G mode
A9K-48P10G-SE-UPG	ASR 9000 48-port 1G to 10G Service Edge Upgrade License
A9K-48P10G-TR-UPG	ASR 9000 48-port 1G to 10G Transport Optimized Upgrade License
S-A9903-8HG-IVRF	ASR 9003 800G Infrastructure VRF license Right to Use License
S-A9903-8HG-AIP	ASR 9003 800G Advance IP Right to Use License
S-A9903-8HG-CGN	ASR 9003 800G CGN Right to Use License
S-A9K-MACSEC-10	ASR 9000 MACsec 10G License

Non-CM Line Cards Software License PID	Description
S-A9K-MACSEC-40	ASR 9000 MACsec 40G (4x10G) License
S-A9K-MACSEC-100	ASR 9000 MACsec 100G (10x10G) License
S-A9K-4HG-IVRF	ASR 9000 400G Infrastructure VRF license Right to Use License
S-A9K-4HG-AIP-TR	ASR 9000 400G Advance IP Transport Optimised Right to Use License
S-A9K-4HG-AIP-SE	ASR 9000 400G Advance IP Service Edge Right to Use License
S-A9K-4HG-CGN	ASR 9000 400G CGN Right to Use License
S-A9902-IVRF	ASR 9902 Infrastructure VRF license Right to Use License
S-A9902-AIP	ASR 9902 Advance IP Right to Use License
S-A9902-CGN	ASR 9902 CGN Right to Use License
S-A9902-OPTLIC	ASR 9902 Optical Right to Use License



**Note** Currently, A9K-48P1GE-AIP-TR license is not supported on Cisco IOS XR 32 bit software.

Consumption Model licenses are of two types: Foundation and Premium. This table lists supported licenses for CM line cards:

#### Foundation Licenses

Foundation	License PID	Eligibility Criteria	License PID
L2VPN	S-A9K-L2-10G/1G/100G	per 10G	Check the output of the following commands: <ul style="list-style-type: none"> <li>• <b>show l2vpn xconnect</b></li> <li>• <b>show l2vpn bridge-domain</b></li> </ul> Each main-interface in the output qualifies for a license.

L3VPN	S-A9K-L3-10G/1G/100G	per 10G	<p>Check the output of the following commands:</p> <ul style="list-style-type: none"> <li>• show ipv4 vrf all interface brief   ex default</li> <li>• show ipv6 vrf all interface brief   ex default</li> </ul> <p>First, remove all internal VRFs from the output (VRF names starting with "***").</p> <p>Each remaining main-interface in the output qualifies for a license.</p>
IP/MPLS	S-A9K-IP-10G/1G/100G	per 10G	<ol style="list-style-type: none"> <li>1. Check if main-interface qualifies for L2VPN Foundation License.</li> <li>2. Check if main-interface qualifies for L3VPN Foundation License.</li> <li>3. Check if main-interface is in "no shutdown" state.</li> <li>4. If any of 1, 2 and 3 is met, main-interface qualifies for a license.</li> </ol>

#### Configuration Threshold for Premium Licenses

Configuration	Threshold Value
L2 Subinterfaces	4,096
Bridge Domain	1,024
MAC scale	32,000
L3 Routes (IPv4/IPv6 global)	132,000
MPLS TE (Head+Tail)	1,024

VRF scale	8
L3 Subinterfaces	1,024

This is the list of show commands available for Smart Licensing in Cisco IOS XR 64 bit :

- show license all—shows all information regarding Smart license
- show license platform—shows platform-specific licensing information (cisco-support)
- show license status—shows smart licensing status information
- show license summary—shows smart licensing summary
- show license techsupport—shows smart licensing tech support information
- show license trace—shows tracing for smart licensing code (cisco-support)
- show license udi—shows smart licensing UDI information
- show license usage—shows smart licensing usage information
- show license platform detail—shows smart license detail information (cisco-support)
- show license platform summary—shows smart license summary (cisco-support)
- show license platform trace—shows platform specific licensing trace information (cisco-support)

## What is Flexible Consumption Model?

*Table 43: Feature History Table*

Feature Name	Release Information	Feature Description
Support for Flexible Consumption Model on <ul style="list-style-type: none"> <li>• A99-8X100GE-SE</li> <li>• A9K-48X10GE-1G-SE</li> <li>• A99-48X10GE-1G-SE</li> <li>• A9K-MOD400-SE</li> <li>• A9K-24X10GE-1G-SE</li> <li>• A9K-4X100GE</li> <li>• A9K-MOD200-SE</li> <li>• ASR-9901</li> </ul>	Release 7.3.1	Support for Flexible Consumption Model (FCM) is now extended to the hardware: <ul style="list-style-type: none"> <li>• A99-8X100GE-SE</li> <li>• A9K-48X10GE-1G-SE</li> <li>• A99-48X10GE-1G-SE</li> <li>• A9K-MOD400-SE</li> <li>• A9K-24X10GE-1G-SE</li> <li>• A9K-4X100GE</li> <li>• A9K-MOD200-SE</li> <li>• ASR-9901</li> </ul>

Feature Name	Release Information	Feature Description
Essential and Advantage smart licenses in a combined entitlement	Release 7.4.1	<p>With this release, the Advanced licenses are now referred to as the Advantage licenses, without essential entitlement.</p> <p>Also, a new license model – Advantage with Essentials, has been introduced that contains both Essential and Advantage licenses as a combined entitlement in a single PID. This simplifies the license procurement and management effort by eliminating the need to procure separate PIDs for Essential and Advantage licenses.</p>

The Flexible Consumption Model (FCM) provides the capability and flexibility to purchase software capacity as needed. FCM delivers the following:

- Pay-as-you-grow—Enables you to lower initial costs and add more capacity over time.
- Simplify operations—FCM delivers the carrier-class IOS-XR software feature set with two software suites, Essentials and Advantage, that simplify license management.
- Utilize capital efficiently—License pooling enables an efficient way to share licenses across the network.

The types of licenses in this model are:

- Essential Licenses are the base licenses that are required by every active port for its operation. An example of Essential License is ESS-ED-100G-RTU1.
- Advantage (earlier known as Advanced licenses) without essential licenses, are the licenses that are required on top of Essential Licenses for ports that use advanced features like L3VPN. An example of an advantage license is ADV-ED-100G-RTU1.
- Advantage with Essential combination licenses are the licenses that are packaged together as a combined entitlement. Example of an advantage license with essentials is ADN-ED-100G-SIA3.
- Tracking licenses are the licenses that are required for the hardware for its operation, for example A99-32X100GE-TRK.

To enable Flexible Consumption model licensing on routers running Cisco IOS XR :

```
Router(config)# license smart flexible-consumption enable
Router(config)# commit
```

Alternatively, you can use the YANG data model `Cisco-IOS-XR-smart-license-cfg` to enable FCM:

```
<rpc xmlns="urn:ietf:params:xml:ns:netconf:base:1.0" message-id="101">
  <get-config>
    <source>
      <running/>
    </source>
    <filter>
      <licensing xmlns="http://cisco.com/ns/yang/Cisco-IOS-XR-smart-license-cfg">
        <flex-consumption/>
      </licensing>
    </filter>
```

```
</get-config>
</rpc>
```

To verify the Flexible Consumption Model configuration:

```
Device# show running-config license smart flexible-consumption enable
```

The following table provides information about FCM licenses for ASR 9000 Series routers:

**Table 44: Flexible Consumption Model Licensing Usage Pattern**

License Name	Hardware Supported	Consumption Pattern
Essential Licenses: <ul style="list-style-type: none"> <li>• ESS-ED-100G-RTU1</li> </ul> Advantage Licenses: <ul style="list-style-type: none"> <li>• ADV-ED-100G-RTU1</li> </ul>	Line-cards: A9K-16X100GE-TR, A99-32X100GE-TR and A99-16X100GE-X-SE	The number of essential or advanced licenses consumed depends on the number of active ports and is reported on per chassis basis
Hardware Tracking Licenses: <ul style="list-style-type: none"> <li>• A99-32X100GE-TRK</li> <li>• A9K-16X100GE-TRK</li> <li>• A99-16X100G-X-TRK</li> <li>• A99-8X100GE-TRK</li> <li>• A9K-48X10GE-1G-TRK</li> <li>• A99-48X10GE-1G-TRK</li> <li>• A9K-MOD400-TRK</li> <li>• A9K-24X10GE-1G-TRK</li> <li>• A9K-400GE-LAN-TRK</li> <li>• A9K-MOD200-TRK</li> <li>• ASR-9901-TRK</li> <li>• ASR-9902-TRK</li> <li>• A9903-8HG-PEC-TRK</li> <li>• A9K-400GE-LAN-TRK</li> </ul>	These Tracking licenses are named on the basis of the hardware supported.	The number of licenses consumed depends on the hardware in use.

License Name	Hardware Supported	Consumption Pattern
RTU License <ul style="list-style-type: none"> <li>• Essential: ESS-ED-100G-RTU1</li> <li>• Advantage: ADV-ED-100G-RTU1</li> </ul> SIA License: <ul style="list-style-type: none"> <li>• Essential: ESS-ED-100G-SIA3</li> <li>• Advantage: ADV-ED-100G-SIA3</li> </ul> Upgrade License: <ul style="list-style-type: none"> <li>• Essential: A9K-ESS-ED-100G-EU</li> <li>• Advantage: A9K-ADV-ED-100G-EU</li> </ul>	Line cards: A9K-24X10GE-1G-SE, A9K-24X10GE-1G-TR, A9K-48X10GE-1G-SE and A9K-48X10GE-1G-TR	The number of essential or advanced licenses consumed depends on the number of active ports and is reported on per chassis basis  Either SIA or Upgrade license is consumed and that depends on the system configuration.

**Table 45: Advantage with Essential Licenses**

License Product ID	License Description
ADN-ED-100G-SIA3	Edge Advantage with Essentials SIA per 100G for 36-59 months
ADN-ED-100G-SIA5	Edge Advantage with Essentials SIA per 100G for 60-120 months
ADN-ED-400G-SIA3	Edge Advantage with Essentials SIA per 400G for 36-59 months
ADN-ED-400G-SIA5	Edge Advantage with Essentials SIA per 400G for 60-120 months
ESS-ADN-ED-100G	Edge Essentials to Advantage Upgrade RTU per 100G
ESS-ADN-ED-400G	Edge Essentials to Advantage Upgrade RTU per 400G
ADN-ED-100G-SIAST	Edge Advantage with Essentials SIA per 100G 1-35 months Term
ADN-ED-400G-SIAST	Edge Advantage with Essentials SIA per 400G 1-35 months Term
ESS-ADN-ED-100G-S5	Edge Essentials-Advantage Upgrade SIA per 100G 60-120 months

License Product ID	License Description
ESS-ADN-ED-100G-S3	Edge Essentials -Advantage Upgrade SIA per 100G 36-59 months
ESS-ADN-ED-100G-ST	Edge Essentials - Advantage Upgrade SIA per 100G 1-35 months Term
ESS-ADN-ED-400G-S5	Edge Essentials -Advantage Upgrade SIA per 400G 60-120 months
ESS-ADN-ED-400G-S3	Edge Essentials -Advantage Upgrade SIA per 400G 36-59 months
ESS-ADN-ED-400G-ST	Edge Essentials - Advantage Upgrade SIA per 400G 1-35 months Term
ADN-ED-100G-RTU1	Edge Advantage with Essentials Software RTU License per 100G
ADN-ED-400G-RTU1	Edge Advantage with Essentials Software RTU License per 400G
ESS-ED-400G-SIAST	Edge Essentials SIA per 400G 1-35 months Term
A9K-CONV-ADN	ASR 9000 Consumption Model conversion to Flexible Consumption Model: ADN-ED-100G-RTU1
A9K-CONV-ESS-400G	ASR 9000 Traditional license conversion to Flexible Consumption Model: ESS-ED-400G-RTU1
A9K-CONV-ADN-400G	ASR 9000 Traditional license conversion to Flexible Consumption Model: ADN-ED-400G-RTU1
A9KCM-CONV-ADN	ASR 9000 CM conversion to Flexible Consumption Model: ADN-ED-100G-RTU1
A9KCM-CONV-ESS400G	ASR 9000 CM conversion to Flexible Consumption Model: ESS-ED-400G-RTU1
A9KCM-CONV-ADN400G	ASR 9000 CM conversion to Flexible Consumption Model: ADN-ED-400G-RTU1

This table lists supported advanced licenses, license type, their eligibility criteria, and license PIDs.

#### List of Advanced licenses

Advances Licenses	License PID	Eligibility Criteria	License PID
nV Satellite	A9K-NVSAT1-LIC	per-number	Feature is enabled if command output of <b>show nv satellite status brief</b> generates non-zero output.



H-QoS	A9K-HQoS-RTU-10/ A9K-HQoS-RTU-1/ A9K-HQOS-100G-X	per-10G/1G/100G	<ol style="list-style-type: none"> <li>1. Run the <b>show qos summary queue loc 0/X/cpu0 out</b> command for each linecard slot.</li> <li>2. Count number of queues for each physical interface.</li> <li>3. Do not count lines which have N/A as QueueID.</li> <li>4. Interface qualifies for license if it uses more than 8 queues.</li> </ol>
LI	A9K-LI-LIC	per-chassis	Feature is enabled if output of <b>show install active summary</b> command matches <b>-li-px</b> .
Timing	A9K-MOBILE-LIC	per-chassis	Feature is enabled if output of <b>show ptp interfaces</b> or <b>show frequency synchronization interfaces brief</b> shows at least one interface.
Adv Optical	A9K-DWDM-RTU-10, A9K-DWDM-RTU-1	per-10G/1G	Run <b>show controllers hundredGigE 0/X/0/X internal</b> and <b>show controllers tenGigE 0/X/0/X internal</b> commands for each 10GE and 100GE interface in the chassis.  Interface qualifies for license if Transport mode is OTN.
MACSec	A9K-MAC-RTU-10	per-10G	Run the <b>show macsec mka interface</b> command. Each main-interface in the output qualifies for a license.
OAM	A9K-OAM-RTU-10, A9K-OAM-RTU-1, A9K-OAM-100G-X	per-10G/1G/100G	Run the <b>show ethernet cfm local maintenance-points mep</b> and <b>show ethernet cfm local maintenance-points mip</b> commands. Each main-interface in the output qualifies for a license. Interfaces appearing under several commands do only require one license. This captures MEPS/MIPS as well as Y.1731 PM.\

Virtual Interface	S-A9K-VIRT-RTU-10	per-10G	<p>Run the <b>show interfaces summary</b> command. If output shows IFT_BVI instances, run the command for BVIs. Or, if output shows IFT_PW_ETHER instances, run the command for PW-HE.</p> <p>BVI:</p> <ol style="list-style-type: none"> <li>1. Run the <b>show l2vpn bridge-domain detail</b> command. For each bridge-domain in the output, check if bridge-domain contains a BVI. If bridge-domain doesn't contain BVI, there is nothing to license. You should proceed to the next bridge-domain.</li> <li>2. If bridge-domain contains a BVI, each main-interface in that bridge-domain qualifies for a license.</li> <li>3. If output shows Bundle-Ether, use <b>show int bundle-ether X</b> to find members.</li> <li>4. Interfaces appearing under several bridge-domains do only require one license.</li> </ol> <p>PW-HE:</p> <ol style="list-style-type: none"> <li>1. Run the <b>show generic-interface-list</b> command.</li> <li>2. Each main-interface in the output qualifies for a license if it downloaded to FIB and number of items should be non-zero</li> <li>3. If output shows Bundle-Ether, use the <b>show int bundle-ether X</b> command to find members.</li> <li>4. Interfaces appearing several times do only require one license.</li> </ol>
-------------------	-------------------	---------	--

VxLAN	A9K-VXLN-RTU-10	per-10G/per 1G/per 100G	<ol style="list-style-type: none"> <li>1. Run the <b>show l2vpn bridge-domain</b> command.</li> <li>2. For each bridge-domain in the output, check if bridge-domain contains a list of VNIs.</li> <li>3. If bridge-domain doesn't contain a list of VNIs, there is nothing to license. You can proceed to the next-bridge domain.</li> <li>4. If bridge-domain contains a list of VNIs, each main-interface in that bridge-domain qualifies for a license.</li> <li>5. Interfaces appearing under several bridge-domains do only require one license.</li> </ol>
EVPN	A9K-EVPN-RTU-10	per-10G/per 1G/per 100G	<ol style="list-style-type: none"> <li>1. Run the <b>show l2vpn bridge-domain</b> command.</li> <li>2. For each bridge-domain in the output, check if bridge-domain is of type: .pbb-edge or pbb-core</li> <li>3. If bridge-domain is not of type: pbb-edge or pbb-core, there is nothing to license. You can proceed to the next bridge-domain.</li> <li>4. If bridge-domain is of type: pbb-edge or pbb-core then, each main-interface in that bridge-domain qualifies for a license.</li> <li>5. Interfaces appearing under several bridge-domains do only require one license.</li> </ol>

BNG	<del>SAKENG</del> SAKENGADMK	per-number	<p>Run the <b>show subscriber session all summary</b> command. Add up all subscribers reported as "activated".</p> <p><b>Note</b></p> <ul style="list-style-type: none"> <li>• This catches IPv4/IPv6 and dual-stack subscribers.</li> <li>• Each dual-stack subscriber is only counted once.</li> </ul>
-----	------------------------------	------------	--



**Note** 100G licenses are consumed only on the following hardware:

- A9K-16X100GE-TR
- A99-32X100GE-TR
- A99-16X100GE-X-SE
- A9K-20HG-FLEX-SE/TR
- A99-24HG-FLEX-SE/TR
- A99-32X100GE-X-SE/TR
- A9K-8HG-FLEX-SE/TR

This is the list of show commands available for Smart Licensing in Cisco IOS XR 64 bit :

- show license all—shows all information regarding Smart license
- show license platform—shows platform-specific licensing information (cisco-support)
- show license status—shows smart licensing status information
- show license summary—shows smart licensing summary
- show license techsupport—shows smart licensing tech support information
- show license trace—shows tracing for smart licensing code (cisco-support)
- show license udi—shows smart licensing UDI information
- show license usage—shows smart licensing usage information
- show license platform detail—shows smart license detail information (cisco-support)
- show license platform summary—shows smart license summary (cisco-support)
- show license platform trace—shows platform specific licensing trace information (cisco-support)



**Note** The consumption of a particular license can be derived from its license type. If the license type is based on increments of 10G, then a 100G interface consumes ten 10G tags. Likewise, a 40G interface consumes four 10G tags.

## Software Innovation Access

*Table 46: Feature History Table*

	Release Information	Feature Description
Software Innovation Access (SIA) Entitlement	Release 7.3.1	SIA license grants you access to the latest software upgrades which contain new features, bug fixes, and security enhancements for devices on your network. Also, it enables the consumption of Advantage and Essential Right-to-Use (RTU) licenses on your device, and allows portability of these RTU licenses from one device to another.

### Overview

Software Innovation Access (SIA) subscription, a type of FCM licensing, provides access to the latest software upgrades and features for your network. SIA licenses enable the consumption of Right-to-Use (RTU) licenses for your devices to access software innovation and avail support for your devices throughout the term of subscription.

The benefits of SIA subscription are:

- **Access to software innovation:** SIA subscription provides access to continuous software upgrades which contain latest features, security enhancements, and bug fixes for all your devices at a network level.
- **Pooling of licenses:** SIA subscription enables Right-to-Use (RTU) licenses to be shared across your FCM network from a common license pool through the virtual account.
- **Protects your investment:** SIA subscription enables the portability of perpetual RTU licenses purchased for your current device to a next-generation router when you expand or upgrade your network.

The initial term of a SIA subscription is for a term of three years. You can renew the subscription by contacting your Cisco account representative. An equal number of SIA licenses and corresponding RTU licenses are required to enjoy the benefits, and ensure that your network is in compliance. There are two types of SIA licenses available:

- To utilize Advantage RTU licenses, you need Advantage SIA licenses.
- Essential SIA licenses are required to utilise Essential RTU on your device.

If your device is in a state of SIA Out-of-Compliance (OOC) the benefits cease.

### SIA Out-of-compliance (OOC) state

When your device is in a SIA Out-of-compliance state, support for major software version upgrades in your network devices are restricted. However, you can continue to perform minor updates, SMU installations, and RPM installations, and continue to utilize the RTU licenses without support for porting.

A device can get into a SIA Out-of-compliance (OOC) state in the following instances:

- The SIA License *EVAL* period of 90 days has expired.
- The number of SIA licenses consumed has exceeded the number of SIA licenses purchased. This can also occur when the RTU licenses consumed is higher than the number of SIA licenses purchased.
- The term of the SIA license has expired and you haven't renewed the subscription.
- The license authorization status is:
  - Not Authorized: The license authorization code installed doesn't contain sufficient counts for the request. This can occur when you attempt to use more licenses than the licenses available in your Virtual Account.
  - Authorization expired: The device hasn't been able to connect to CSSM for an extended period, due to which the authorization status couldn't be verified.



---

**Note** The CSSM smart license hierarchy applies to the Right-to-Use (RTU) license only. Therefore, if there is an insufficient RTU 100G license, CSSM can convert the RTU 400G license into four RTU 100G licenses. This is not applicable for SIA license.

---

In order to bring your device to In-Compliance state, perform one of the following steps:

- Register your device with CSSM if the SIA license *EVAL* period has expired.
- If the SIA license has expired or the number of SIA licenses consumed is more than the number of SIA licenses purchased, contact your Cisco Account Representative to purchase or renew the required licenses.
- If the authorization code has insufficient counts for the request, generate the code with sufficient counts.
- If the authorization has expired, connect the device with CSSM.

When the device enters an OOC state, a grace period of 90 days (cumulative of all the previous occurrences) begins. During this period, SIA license benefits can still be availed. The system attempts to renew the authorization period by connecting with the CSSM during the grace period, or even after the grace period has expired. If an attempt isn't successful, it remains in an OOC state. If the attempt is successful, a new authorization period begins and the device is In-Compliance.

## Verification

To verify the device compliance status, use the **show license platform summary** command:

### Examples

#### Status: In-Compliance

```
Router# show license platform summary
Sun Feb 14 22:25:36.115 UTC
```

```

Collection: LAST: Sun Feb 14 2021 22:24:40 UTC
           NEXT: Sun Feb 14 2021 22:25:40 UTC
Reporting: LAST: Sun Feb 14 2021 22:24:40 UTC
           NEXT: Sun Feb 14 2021 22:25:40 UTC
SIA Status: In Compliance

```

Feature/Area	Entitlement	Count	
		Last	Next
FCM	Total A9K-48X10GE-1G LCs in the system	1	0
FCM	ASR9k Core & Agg Netw SW&Autom Adv 1.0 Perp RTU (pe	1	0
FCM	Advance Edge SIA per 100G Subscription	1	0
FCM	ASR9k Core & Agg Netw SW&Autom Ess 1.0 Perp RTU (pe	1	0
FCM	Essential Edge SIA per 100G Subscription	1	0

### Status: Out-of-Compliance (Grace Period Remaining)

```
Router# show license platform summary
```

```
Mon Feb 15 12:10:00.009 UTC
```

```
Collection: LAST: Mon Feb 15 2021 12:09:17 UTC
           NEXT: Mon Feb 15 2021 12:10:17 UTC
```

```
Reporting: LAST: Mon Feb 15 2021 12:09:17 UTC
           NEXT: Mon Feb 15 2021 12:10:17 UTC
```

```
*****IMPORTANT*****
```

```
SIA Status: Out of Compliance(Remaining Grace Period: 89 days, 23 hours)
```

```
SIA license(s) status is Not Authorized.
```

```
SW Upgrade will still be allowed as SIA Grace Period is remaining
```

```
*****
```

Feature/Area	Entitlement	Count	
		Last	Next
FCM	ASR9k Core & Agg Netw SW&Autom Adv 1.0 Perp RTU (pe	1	0
FCM	Advance Edge SIA per 100G Subscription	1	0
FCM	ASR9k Core & Agg Netw SW&Autom Ess 1.0 Perp RTU (pe	1	0
FCM	Essential Edge SIA per 100G Subscription		

### Status: Out-of-Compliance (Grace Period expired and upgrades are blocked)

```
Router# show license platform summary
```

```
Mon Feb 15 12:10:00.009 UTC
```

```
Collection: LAST: Mon Feb 15 2021 12:16:17 UTC
           NEXT: Mon Feb 15 2021 12:17:17 UTC
```

```
Reporting: LAST: Mon Feb 15 2021 12:16:17 UTC
           NEXT: Mon Feb 15 2021 12:17:17 UTC
```

```
*****IMPORTANT*****
```

```
SIA Status: Out of Compliance(Grace Period Expired)
```

```
SW Upgrades are blocked as SIA license(s) are in "Not Authorized" state
```

```
*****
```

Feature/Area	Entitlement	Count	
		Last	Next
FCM	ASR9k Core & Agg Netw SW&Autom Adv 1.0 Perp RTU (pe	1	0
FCM	Advance Edge SIA per 100G Subscription	1	0
FCM	ASR9k Core & Agg Netw SW&Autom Ess 1.0 Perp RTU (pe	1	0
FCM	Essential Edge SIA per 100G Subscription		

## How Does Smart Licensing Work?

Table 47: Feature History Table

Feature Name	Release Information	Feature Description
Smart Transport Support	Release 7.4.1	<p>You can now use Smart transport to communicate with CSSM. Smart transport is a transport method where a Smart Licensing (JSON) message is contained within an HTTPs message, and exchanged between a product instance and CSSM, to communicate. The following Smart transport configuration options are available:</p> <ul style="list-style-type: none"> <li>• Smart transport: In this method, a product instance uses a specific Smart transport licensing server URL. This must be configured exactly as shown in the workflow section.</li> <li>• Smart transport through an HTTPs proxy: In this method, a product instance uses a proxy server to communicate with the licensing server, and eventually, CSSM.</li> </ul>



Figure 11: Smart Licensing - Workflow

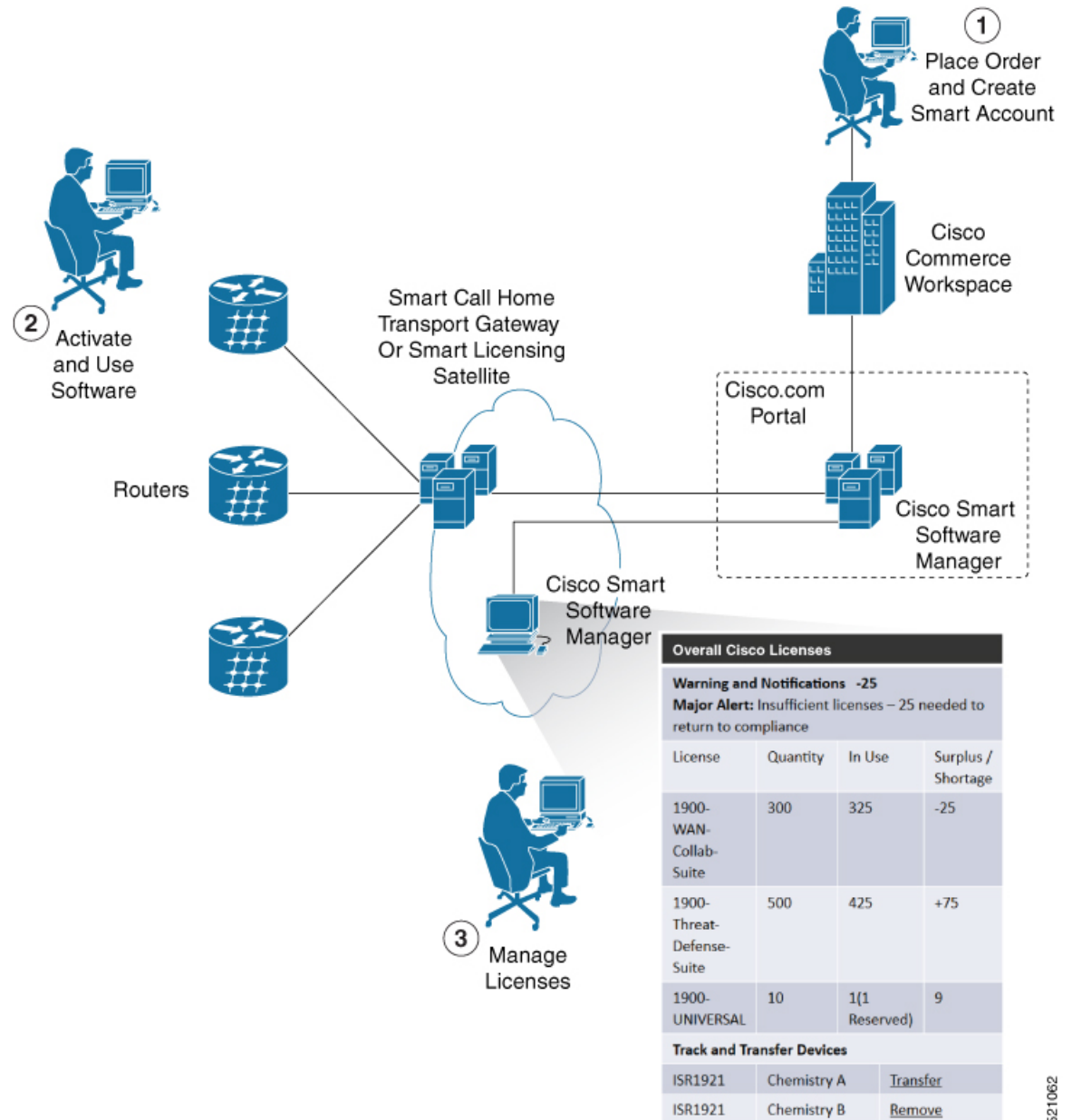

1. Place Order and Create Smart Account—You must have a Smart Account to set up Smart Licensing.
  - a. Go to <https://software.cisco.com/>.
  - b. Under the **Administration** section, click **Get a Smart Account or Request Access to an Existing Smart Account**.
  - c. Verify or enter your Cisco.com profile details to complete creating a Smart Account.
2. Activate and Use Software—Register your product. For more information, see the *Registering your Router* section. You can use either of the following options to communicate with the CSSM:

- Smart Transport—The Smart Transport method is a transport method where a Smart Licensing (JSON) message is contained within a HTTPs message, and exchanged between a product instance and CSSM to communicate. The following Smart transport configuration options are available.
    - Smart Transport: In this method, a product instance uses a specific Smart transport licensing server URL. This must be configured exactly as shown in the workflow section.
    - Smart transport through an HTTPs proxy: In this method, a product instance uses a proxy server to communicate with the licensing server, and eventually, CSSM.
  - Smart Call Home—The Smart Call Home feature is automatically configured. Smart Call Home is used by Smart Licensing as a medium for communication with the CSSM. You can use this feature to page a network support engineer, email a Network Operations Center, or use Cisco Smart Call Home services to generate a case with the Technical Assistance Center. The Call Home feature can deliver alert messages containing information about diagnostics and environmental faults and events. For more information on Smart Call Home feature, see the [Smart Call Home Deployment Guide](#).
  - Smart Licensing CSSM On-Prem—The Smart licensing on-premise option provides an on-premises collector that can be used to consolidate and manage Smart license usage, as well as facilitate communications back to the CSSM at Cisco.com.
3. Manage Licenses—You can manage and view reports about your overall license usage in the Smart Software Manager portal.

## What is Cisco Smart Software Manager?

Cisco Smart Software Manager enables you to manage all of your Cisco Smart software licenses from one centralized website. With Cisco Smart Software Manager, you organize and view your licenses in groups called virtual accounts (collections of licenses and product instances). The Cisco Smart Software Manager allows you to:

- Create, manage, or view virtual accounts
- Create and manage Product Instance Registration Tokens
- Transfer licenses between virtual accounts or view licenses
- Transfer, remove, or view product instances
- Run reports against your virtual accounts
- Modify your email notification settings
- View overall account information

To access the Cisco Smart Software Manager:

- Go to <https://software.cisco.com>.
- Under the **License** section, click **Smart Software Licensing**.

## Smart Licensing Deployment Options

The following illustration shows the various options available for deploying Smart Licensing:

Figure 12: Smart Licensing Deployment Options

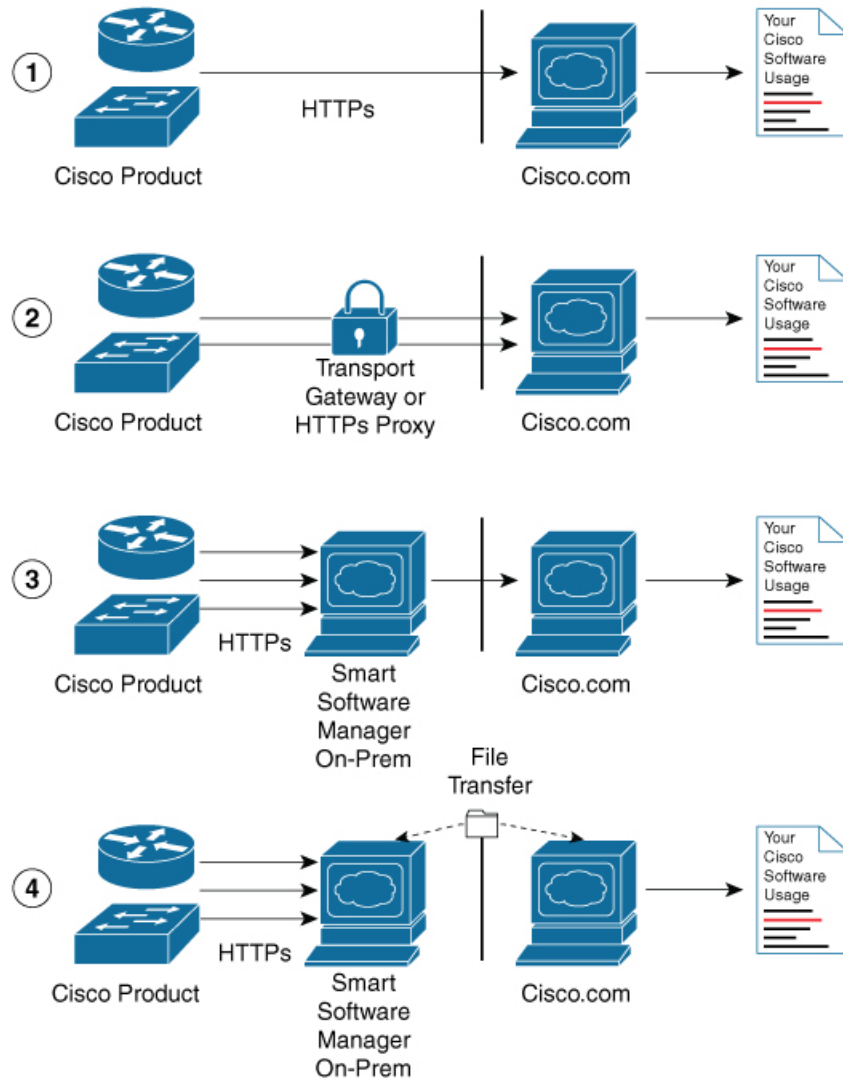

1. Direct cloud access—In this method, Cisco products send usage information directly over the internet to CSSM on <http://www.cisco.com>; no additional components are needed for deployment.
2. Direct cloud access through an HTTPs proxy—In direct cloud access through an HTTPs proxy deployment method, Cisco products send usage information over the internet through a proxy server—either a Smart Call Home Transport Gateway or off-the-shelf Proxy (such as Apache) to CSSM on <http://www.cisco.com>.
3. Mediated access through an on-premises collector-connected—In mediated access through an on-premises collector-connected deployment method, Cisco products send usage information to a locally connected collector, which acts as a local license authority. Periodically, the information is exchanged to keep the databases in synchronization.

4. Mediated access through an on-premises collector-disconnected—In the mediated access through an on-premises collector-disconnected deployment method, Cisco products send usage information to a local disconnected collector, which acts as a local license authority. Exchange of human-readable information is performed occasionally (once a month) to keep the databases in synchronization.

Options 1 and 2 provide easy deployment options, whereas options 3 and 4 provide secure environment deployment options.



**Note** Smart Software On-Premise provides support for options 3 and 4.

The communication between Cisco devices and CSSM is facilitated by the Smart Call Home software.

## YANG Data Models for Smart Licensing

*Table 48: Feature History Table*

Feature Name	Release Information	Description
YANG Data Models for Smart Licensing	Release 7.4.1	<p>With this feature, you can use data models for all the smart licensing operations such as registering your device with a token, renewing token ID, deregistering device to remove the software entitlements and so on using NETCONF remote procedure calls (RPCs).</p> <p>The following data models are introduced:</p> <p>Cisco-IOS-XR-smart-license-cfg.yang  cisco-smart-license.yang  Cisco-IOS-XR-smartlicense-platform-oper.yang  Cisco-IOS-XR-infra-smartlicense-oper.yang  Cisco-IOS-XR-smart-license-act.yang</p> <p>You can access these data models from the <a href="#">Github</a> repository.</p>

YANG is a data modeling language that helps to create configurations, retrieve operational data and execute actions. The router acts on the data definition when these operations are requested using NETCONF RPCs. The data model handles the following types of requirements on the routers for smart licensing functionality:

Data	Data Model	CLI Commands
<p><b>Configuration data:</b> a set of writable data that is required to configure smart licensing on the router.</p>	<p><b>Native data model:</b> Cisco-IOS-XR-smart-license-cfg.yang</p>	<ul style="list-style-type: none"> <li>• license smart reservation</li> <li>• [no] license smart reservation</li> <li>• license smart flexible-consumption enable</li> <li>• [no] license smart flexible-consumption enable</li> </ul>
<p><b>Operational state data:</b> a set of data that the system obtains at run time.</p>	<p><b>Common data model:</b> cisco-smart-license.yang</p> <p><b>Native data model:</b> Cisco-IOS-XR-smart-license-platform-oper.yang Cisco-IOS-XR-infra-smartlicense-oper.yang</p>	<ul style="list-style-type: none"> <li>• show license platform summary</li> <li>• show license platform detail</li> <li>• show license [all   summary   usage   udi]</li> </ul>
<p><b>Actions:</b> a set of NETCONF actions that support robust networkwide configuration transactions.</p>	<p><b>Native data model:</b> Cisco-IOS-XR-smart-license-act.yang</p>	<ul style="list-style-type: none"> <li>• license smart register id token</li> <li>• license smart deregister</li> <li>• license smart renew id</li> <li>• license smart renew auth</li> <li>• license smart reservation request local</li> <li>• license smart reservation cancel local</li> <li>• license smart reservation install file &lt;file path&gt;</li> <li>• license smart reservation return local</li> <li>• license smart reservation return authorization file &lt;file path&gt;</li> <li>• license smart transport smart</li> <li>• license smart url &lt;url&gt;</li> <li>• license smart software-upgrade enable</li> <li>• license smart proxy hostname &lt;hostname/ip&gt;</li> <li>• license smart proxy port &lt;port&gt;</li> </ul>

You can access the data models from the [Github](#) repository. To learn more about the data models and put them to use, see the *Programmability Configuration Guide for Cisco ASR 9000 Series Routers*.

# Permanent License Reservation

Permanent License Reservation (PLR) is a solution designed for classified environments that don't allow electronic communication in or out of the environment. In such environments, routers are unable to communicate to the Cisco Smart Software Manager (CSSM) directly or through CSSM OnPrem. These deployments can use PLR that allows using all entitlements on the router without communicating to Cisco.

To enable and use the PLR feature, generate a reservation request code from the router. Use this code in the CSSM portal to reserve an available PLR license and generate an authorization code. When you enter this authorization code in the router CLI, the license reservation becomes effective. Both the request and the authorization codes are short sequences of characters that you can write down on a paper. Later, you can enter the codes without the need for any electronic transfers.

## Limitation

To use the Permanent License Reservation feature, you must have an approval and authorization from Cisco. For assistance, go to [www.cisco.com/go/scm](http://www.cisco.com/go/scm) or contact your account representative.

# Configuring Permanent License Reservation

## Prerequisites

You must ensure these prerequisites are completed before configuring Permanent License Reservation:



---

**Note** Work with your account representative for assistance with the below prerequisites.

---

- Create a Smart Account
- Enable your Smart Account for PLR
- Get access to PLR PIDs in CCW
- Order PLR licenses in CCW and make sure they are reflected in your Smart Account on CSSM

## Workflow

Here is the list of configurations that should be executed in sequence to complete the PLR feature:

1. Enabling Permanent License Reservation
2. Generating a Request Code from the Router
3. Reserving a PLR License in Cisco SSM
4. Registering a Router with the Authorization Code

Here is the list of configurations that are used to cancel, return and disable PLR:

- Cancel a Reservation in Progress

- Return a Reserved License
- Return a Reservation from an Authorization Code
- Disabling Permanent License Reservation

## Steps to Enable PLR

### Enabling Permanent License Reservation

#### Before you begin

Enable Flexible Consumption Model (FCM) of licensing. To enable Flexible Consumption model licensing for your hardware, use **license smart flexible-consumption enable** command in the global configuration mode.

#### Configuration

In order to enable PLR feature, license reservation must be configured in the global configuration mode:

```
Router(config)# license smart reservation
```



---

**Note** These commands initiate communication with CSSM portal and hence will not work after enabling PLR:

- license smart register
  - license smart deregister
  - license smart renew
- 

### Generating a Request Code from the Router

After enabling the PLR feature, you must generate a request code.

This procedure shows how to generate a request code from the router:

```
RP/0/RSP0/CPU0:router# license smart reservation request local
Fri Mar  6 12:39:02.818 UTC
Enter this request code in the Cisco Smart Software Manager portal:
CD-ZNCS-5501-SE:FOC2118R24P-AVYd1FABK-AC /* This is a sample code */
```

The command will print a reservation code on the console that needs to be entered in CSSM.



- 
- Note**
- Evaluation timer will continue to count down until an authorization code is installed.
  - A syslog is logged for every 24 hours until the authorization code is installed.
-

## Reserving a PLR License in Cisco SSM

This procedure shows how to generate an authorization code from CSSM portal:

- 
- Step 1** Go to Cisco SSM from <https://software.cisco.com>  
Log in to the Cisco SSM portal using the username and password provided by Cisco.
- Step 2** Under **License** section, click **Smart Software Licensing**
- Step 3** Click the **Inventory** tab and from the **Virtual Account** drop-down list, choose your virtual account.  
You can search by typing your virtual account name, or you can scroll the list and select your account name.
- Step 4** Go to **Licenses** tab and click **License Reservation**.  
The Smart License Reservation window appears. This window has four steps that should be performed in sequence to complete the procedure.
- In **Enter Request Code** tab, type the code in the **Reservation Request Code** field and click **Next**.
  - In **Select Licenses** tab, select **Permanent License Reservation** option and click **Next**.  
The required platform-specific PLR licenses are selected automatically.
  - In **Review and confirm** tab, review the product instance details, and click **Generate Authorization Code**.
  - The Authorization Code is generated and displayed in the **Authorization Code** tab. Click **Copy to Clipboard** to copy the authorization code or write it down.  
The authorization code is a short sequence of characters that you can enter in the router CLI without the need for any electronic transfers.
- 

## Registering a Router with the Authorization Code

This procedure shows how to register a router with the authorization code that is generated from CSSM:

```
Router# license smart reservation install <authorization-code>
```

The PLR license reservation is enabled, and the SL status changes to Authorized state.

The router stops using the evaluation period.

### Verification

To verify the license status after the registration, use the **show license status** command:

```
RP/0/RSP0/CPU0:router# show license status
Thu Jul 16 11:27:16.052 UTC
Smart Licensing is ENABLED
Utility:
  Status: DISABLED
License Reservation is ENABLED
Data Privacy:
  Sending Hostname: yes
  Callhome hostname privacy: DISABLED
  Smart Licensing hostname privacy: DISABLED
  Version privacy: DISABLED
```



```

Transport:
  Type: Callhome
Registration:
  Status: REGISTERED - UNIVERSAL LICENSE RESERVATION
  Export-Controlled Functionality: ALLOWED
  Initial Registration: SUCCEEDED on Jul 16 2020 11:27:08 UTC
License Authorization:
  Status: AUTHORIZED - RESERVED on Jul 16 2020 11:27:08 UTC

Export Authorization Key:
  Features Authorized:
    <none>

Miscellaneous:
  Custom Id: <empty>

```

The show command confirms that the PLR license reservation is enabled, and the License Authorization status changed to Authorized Reserved state.

This completes the PLR feature configuration.

## How to Cancel, Return and Disable PLR

### Cancel a Reservation in Progress

A reservation is cancelled when you want to reserve the license for a different chassis.

#### Before you begin

- A reservation request has been made but an authorization code has not been installed on the router.

#### Configuration

This procedure shows how to cancel a reservation process before the authorization code is installed:

```
Router# license smart reservation cancel local
```

#### Verification

To verify the license status after cancelling a reservation, use the **show license reservation** command:

```

RP/0/RSP0/CPU0:router# show license reservation
Thu Jul 16 11:52:21.476 UTC
Smart Licensing is ENABLED
Utility:
  Status: DISABLED
License Reservation is ENABLED
Data Privacy:
  Sending Hostname: yes
    Callhome hostname privacy: DISABLED
    Smart Licensing hostname privacy: DISABLED
  Version privacy: DISABLED
Transport:
  Type: Callhome
Registration:
  Status: UNREGISTERED
  Export-Controlled Functionality: NOT ALLOWED

```

```
License Authorization:
  Status: No Licenses in Use
Export Authorization Key:
  Features Authorized:
    <none>
Miscellaneous:
  Custom Id: <empty>
```

## Return a Reserved License

You can return a reserved license when the chassis is decommissioned. One more use case is when you want to go back to Smart Licensing mode.

To return a reserved license, first generate a return code. Afterwards the return code will be used in CSSM portal to return the licenses to the virtual pool. The returned PLR licenses can be used later on the same or another router.

### 1. Generate a return code:

```
RP/0/RSP0/CPU0:router# license smart reservation return local
Thu Jul 16 11:39:06.113 UTC
Enter this return code in Cisco Smart Software Manager portal:
CsnKVs-nRNATW-opCeeR-yfefzh-uiDGfh-XvD /* This is a sample code */
```

The license reservation return code is printed on the console. Copy the code to clipboard or write it down.

The request code is a short sequence of characters that you can enter without the need for any electronic transfers.

### 2. Enter the code in the CSSM portal.

- a. Log into the Cisco SSM portal at <https://software.cisco.com> using the username and password provided by Cisco.
- b. Under **License** section, click Smart Software Licensing.
- c. Click **Inventory** tab and from the **Virtual Account** drop-down, choose your virtual account.  
You can search by typing your virtual account name, or you can scroll the list and select your account name.
- d. Go to **Product Instance**.  
This page displays the list of product instances by name and product type.
- e. Search for your router name and select **Remove** from the **Actions** drop-down list corresponding to the router name.
- f. In the **Remove Product Instance** window, paste the license reservation return code and click **Remove Product Instance** to perform the action.

### Verification

To verify the license status after returning a license, use the **show license status** command:

```
RP/0/RSP0/CPU0:router# show license status
Thu Jul 16 11:41:28.727 UTC
Smart Licensing is ENABLED
Utility:
  Status: DISABLED
```

```

License Reservation is ENABLED
Data Privacy:
  Sending Hostname: yes
    Callhome hostname privacy: DISABLED
    Smart Licensing hostname privacy: DISABLED
  Version privacy: DISABLED
Transport:
  Type: Callhome
Registration:
  Status: UNREGISTERED
  Export-Controlled Functionality: NOT ALLOWED
License Authorization:
  Status: No Licenses in Use
Export Authorization Key:
  Features Authorized:
    <none>

Miscellaneous:
  Custom Id: <empty>

```

After returning the license:

- The registration status changes to the UNREGISTERED state.
- Export controlled functionality gets disabled.
- Smart License status returns to the Unidentified state and starts to consume the Evaluation period.



---

**Note** To use the device in the normal Smart Licensing mode, disable PLR and register the device with Smart License server.

For information on how to disable PLR, see [Disabling Permanent License Reservation, on page 328](#)

---

## Return a Reservation from an Authorization Code

When you generate an authorization code, it causes CSSM to permanently reserve the license. Before installing the license you can return the license.

### Before you begin

- The router should not have a reservation authorization code installed.
- A reservation request should not be pending.

### Generating a Return Code

Using the authorization code generate a return code from the CLI using the **license smart reservation return authorization** command. Unlike the reservation return CLI the **license smart reservation return authorization** command takes the authorization code from the command line. The current reservation state is ignored.

This command is useful if the customer has created a request code and generated an authorization code from CSSM portal but then cancels the request on the device. The following command allows the customer to still generate a return code and enter it in the CSSM to return the license to the account.

```
Router# license smart reservation return authorization <authorization code>
```

The command prints the reservation return code that must be entered in the CSSM portal to return the license to the virtual pool.

**Note**

- If there is an existing return code saved by the smart agent it will be ignored and a new return code will be generated from the specified authorization code.
- The generated return code will not be saved.

## Disabling Permanent License Reservation

This procedure shows how to disable the PLR feature in Smart Licensing:

```
Router(config)# no license smart reservation
Router(config)# commit
```

**Note**

- If a reservation request has been made but an authorization code hasn't been installed, disabling PLR cancels the reservation request on the router.
- If there's an authorization code installed on the router, then PLR won't be removed. Instead, a message to use the **license smart reservation return** command to remove the authorization code is displayed. This means that the license reservation feature may be disabled but there's still an authorization code installed. This will be reflected in the show commands.
- If any entitlements are in use, then the evaluation period countdown begins. Register the device with the existing token before evaluation period expires.
- If an authorization code is installed and the Agent is in the authorized state, it will transition back to the unidentified state. The Authorization code won't be removed.

### What to do next

Reload and register the device with Smart License server using the existing token:

```
RP/0/RP0/CPU0:ios#license smart register idtoken <token_ID>
Thu Jul 23 13:07:38.761 UTC
```

License command "license smart register idtoken" completed successfully.

In the previous command, use the existing token in place of *token\_ID* attribute.

If you do not have a token, then generate a new token from the CSSM portal.

For information on how to generate a new token, see *Generate Product Registration Token from the Portal* topic in the latest release of System Management Configuration Guide for respective platform in Cisco.com

# Specific License Reservation

*Table 49: Feature History Table*

Feature Name	Release	Feature Description
Specific License Reservation	Release 7.3.1	Specific License Reservation (SLR) allows customers in highly secure networks to utilize smart licenses without communicating the license information to the Cisco Smart Software manager (CSSM).

SLR is reservation of specific licenses from the smart account as per the usage on the router. Whereas, PLR is for selected customers who don't want tracking of license usage. This license allows unlimited usage without taking into consideration of license usage on the router.

Specific License Reservation (SLR) allows customers in highly secure networks to utilize smart licenses without communicating the license information to the Cisco Smart Software manager (CSSM). Routers that are registered with smart licenses share router information at regular intervals with Cisco Smart Software Manager (CSSM). Routers that are deployed in a highly secure network must not share the router information externally. Cisco offers license reservation as an on-request configuration for these routers.

Specific License Reservation is a solution designed for classified environments that don't allow electronic communication in or out of the environment. In such environments, routers are unable to communicate with the Cisco Smart Software Manager (CSSM) directly or through CSSM OnPrem. These deployments can use SLR that allows using all entitlements on the router without communicating to Cisco.

To enable and use the SLR feature, generate a reservation request code from the router. Use this code in the CSSM portal to reserve an available SLR license and generate an authorization code. When you enter this authorization code in the router CLI, the license reservation becomes effective.

## Limitations

- License reservation provides limited or no functionality to certain smart licensing features such as transfer of licenses between products, license usage, asset management and so on.
- To use the Specific License Reservation feature, you must have an approval and authorization from Cisco. For assistance, go to [www.cisco.com/go/scm](http://www.cisco.com/go/scm) or contact your account representative.

# Configuring Specific License Reservation

Before configuring Specific License Reservation, connect with your account representative and complete the following tasks:

- Create a Smart Account.
- Enable your Smart Account for SLR.
- Get access to SLR PIDs in Cisco Commerce Workspace (CCW).

- Order SLR licenses in CCW and make sure they are available in your Smart Account on CSSM.

Enable Specific License Reservation feature of licensing using the **license smart reservation** command in the global configuration mode.

### Workflow

Here is the list of configurations that should be executed in sequence to complete the SLR feature:

1. Enabling Specific License Reservation
2. Generating a Request Code from the Router
3. Reserving a SLR License in Cisco SSM
4. Registering a Router with the Authorization Code

Here is the list of configurations that are used to cancel, verify, remove, and return SLR:

- Cancelling a SLR Request
- Verifying the License Status After Cancelling SLR
- Removing SLR from a Router
- Generating a Return Code from a Router
- Removing the Product Instance from CSSM

## Enabling Specific License Reservation

First, enable Flexible Consumption Model (FCM) of licensing. To enable FCM for your hardware, use the **license smart flexible-consumption enable** command in the global configuration mode.

Then, enable Specific License Reservation feature of licensing. In order to enable SLR feature, license reservation must be configured in the global configuration mode:

```
Router(config)# license smart reservation
```

## Generating a Request Code from the Router

After enabling the SLR feature, use the **license smart reservation request local** command to generate a request code. Enter this code in CSSM.

Example:

```
RP/0/RSP0/CPU0:router# license smart reservation request local
Fri Mar 6 12:39:02.818 UTC
Enter this request code in the Cisco Smart Software Manager portal:
CD-ZNCS-5501-SE:FOC2118R24P-AVYd1FABK-AC /* This is a sample code */
```

## Reserving a SLR License in Cisco SSM

This procedure shows how to generate an authorization code from CSSM portal:

## SUMMARY STEPS

1. Go to Cisco SSM from <https://software.cisco.com>
2. Under **License** section, click **Smart Software Licensing**
3. Click the **Inventory** tab and from the **Virtual Account** drop-down list, choose your virtual account.
4. Go to **Licenses** tab and click **License Reservation**.

## DETAILED STEPS

	Command or Action	Purpose
<b>Step 1</b>	Go to Cisco SSM from <a href="https://software.cisco.com">https://software.cisco.com</a>	Log in to the Cisco SSM portal using the username and password provided by Cisco.
<b>Step 2</b>	Under <b>License</b> section, click <b>Smart Software Licensing</b>	
<b>Step 3</b>	Click the <b>Inventory</b> tab and from the <b>Virtual Account</b> drop-down list, choose your virtual account.	You can search by typing your virtual account name, or you can scroll the list and select your account name.
<b>Step 4</b>	Go to <b>Licenses</b> tab and click <b>License Reservation</b> .	The Smart License Reservation window appears. This window has four steps that should be performed in sequence to complete the procedure.

## Registering a Router with the Authorization Code

This procedure shows how to register a router with the authorization code that is generated from CSSM:

```
Router# license smart reservation install [<> | file]
```



### Note

- '<>' is the code itself or an alternative is to import from a file.
- 'file' option is preferred in those cases where the authorization code is long.

Example:

```
RP/0/RSP0/CPU0:router# license smart reservation install file
/disk2:/AuthorizationCode_SN_FOX24XXXXX.txt /* This is a sample code */
```

The "/" before the directory (/disk2:/ or /harddisk:/) is needed because of the linux file path.

The SLR license reservation is enabled, and the SL status changes to Authorized state.

The router stops using the evaluation period.

### Verification

To verify the license status after the registration, use the **show license reservation** command:

```
RP/0/RSP0/CPU0:router# show license reservation
Fri Feb 5 16:35:37.340 UTC
License reservation: ENABLED
Overall status:
  Active: PID:NCS-55A2-MOD-S,SN:FOC2245R05H
```

```
Reservation status: RESERVATION IN PROGRESS on Feb 05 2021 16:33:08 UTC
Request code: CC-ZNCS-55A2-MOD-S:FOC2245R05H-AVYd1FABK-45
```

## To cancel, verify, remove, and return SLR

### Cancelling a SLR Request

The license reservation request code can be cancelled before or after an authorization code is generated. Note that the authorization file needs to be returned to Cisco SSM if the cancellation request is raised after an authorization code is generated from CSSM.

To cancel an SLR request before the authorization code is installed, perform this procedure:

```
RP/0/RSP0/CPU0:router# license smart reservation cancel local
Fri Feb 5 16:41:55.262 UTC
Reservation cancelled
```

### Verifying the License Status After Cancelling SLR

To verify the status of license after cancelling SLR, use the **show license reservation** command:

```
RP/0/RSP0/CPU0:router# show license reservation
Fri Feb 5 16:41:58.284 UTC
License reservation: ENABLED
Overall status:
Active: PID:NCS-55A2-MOD-S,SN:FOC2245R05H
Reservation status: NOT INSTALLED
Last return code: CQ8K5Y-gYxar7-baroN9-BH2d4X-EaG7bH-6L7QmQ-mEGwy3-fxSCxo-Dku
```

### Removing SLR from a Router

To remove SLR from a router, perform the following tasks:

1. Generate a return code from a router.
2. Enter the return code on CSSM.
3. Remove the product instance.

### Generating a Return Code from a Router

To generate a return code, use the **license smart reservation return** command:

To verify the license status after returning a license, use the **show license status** command:

```
Router# license smart reservation return [local]
```

The command prints the reservation return code that must be entered in the CSSM portal to return the license to the virtual pool.

### Removing the Product Instance from CSSM

This procedure shows how to remove the product instance from CSSM portal:



## SUMMARY STEPS

1. Go to Cisco SSM from <https://software.cisco.com>
2. Under **License** section, click **Smart Software Licensing**
3. Click the **Inventory** tab and from the **Virtual Account** drop-down list, choose your virtual account.
4. Click the **Product** instances tab.
5. Locate the required product instance from the product instances list. Optionally, you can enter a name or product type string in the search tab to locate the product instance.
6. Click the required product instance to expand the same.
7. From the **Actions** drop-down list, choose **Remove**.
8. In the **Reservation Return Code** field, enter the return code.
9. Click **Remove Product Instance**.

## DETAILED STEPS

	Command or Action	Purpose
<b>Step 1</b>	Go to Cisco SSM from <a href="https://software.cisco.com">https://software.cisco.com</a>	Log in to the Cisco SSM portal using the username and password provided by Cisco.
<b>Step 2</b>	Under <b>License</b> section, click <b>Smart Software Licensing</b>	
<b>Step 3</b>	Click the <b>Inventory</b> tab and from the <b>Virtual Account</b> drop-down list, choose your virtual account.	You can search by typing your virtual account name, or you can scroll the list and select your account name.
<b>Step 4</b>	Click the <b>Product</b> instances tab.	The list of product instances that are available is displayed.
<b>Step 5</b>	Locate the required product instance from the product instances list. Optionally, you can enter a name or product type string in the search tab to locate the product instance.	
<b>Step 6</b>	Click the required product instance to expand the same.	The <b>Overview</b> window is displayed.
<b>Step 7</b>	From the <b>Actions</b> drop-down list, choose <b>Remove</b> .	The <b>Remove Product Instance</b> window is displayed.
<b>Step 8</b>	In the <b>Reservation Return Code</b> field, enter the return code.	
<b>Step 9</b>	Click <b>Remove Product Instance</b> .	

The reservation information is removed, and the license is made available in the virtual account.

# Configuration Examples for SLR

The following sections provide various SLR examples.

## Enabling FCM

To enable FCM, use the **license smart flexible-consumption enable** command:

```
Router# configure
Router(config)# license smart flexible-consumption enable
Router(config)# exit
```

## Enabling SLR

Before enabling SLR, you must enable Flexible Consumption Model (FCM) of licensing. To enable FCM for your hardware, use the **license smart flexible-consumption enable** command in the global configuration mode.

To enable SLR, use the **license smart reservation** command in the global configuration mode:

```
Router# configure
Router(config)# license smart reservation
Router(config)# exit
```

## Viewing the License Information Before Registering

To display license entitlements, use the **show license all** command:

```
RP/0/RSP0/CPU0:router# show license all
Fri Feb 5 16:35:41.983 UTC

Smart Licensing Status
=====
Smart Licensing is ENABLED
License Reservation is ENABLED

Registration:
Status: RESERVATION IN PROGRESS
Export-Controlled Functionality: NOT ALLOWED
Reservation process started on: Feb 05 2021 16:33:08 UTC

License Authorization:
Status: EVAL MODE
Evaluation Period Remaining: 81 days, 21 hours, 24 minutes, 53 seconds

Export Authorization Key:
Features Authorized:
<none>

Utility:
Status: DISABLED

Data Privacy:
Sending Hostname: yes
Callhome hostname privacy: DISABLED
Smart Licensing hostname privacy: DISABLED
Version privacy: DISABLED

Transport:
Type: Transport Off

Miscellaneous:
Custom Id: <empty>

License Usage
=====
(ADV-100G-RTU-1):
Description:
Count: 1
```

```

Version: 1.0
Status: EVAL MODE
Export status: NOT RESTRICTED
Reservation:
Reservation status: NOT INSTALLED

```

```

(ADV-100G-SIA-3):
Description:
Count: 1
Version: 1.0
Status: EVAL MODE
Export status: NOT RESTRICTED
Reservation:
Reservation status: NOT INSTALLED

```

```

(ESS-100G-RTU-1):
Description:
Count: 1
Version: 1.0
Status: EVAL MODE
Export status: NOT RESTRICTED
Reservation:
Reservation status: NOT INSTALLED

```

```

(ESS-100G-SIA-3):
Description:
Count: 1
Version: 1.0
Status: EVAL MODE
Export status: NOT RESTRICTED
Reservation:
Reservation status: NOT INSTALLED

```

```

Product Information
=====
UDI: PID:NCS-55A2-MOD-S,SN:FOC2245R05H

```

```

Agent Version
=====
Smart Agent for Licensing: 5.1.8_rel/25

```

```

Reservation Info
=====
License reservation: ENABLED

```

```

Overall status:
Active: PID:NCS-55A2-MOD-S,SN:FOC2245R05H
  Reservation status: RESERVATION IN PROGRESS on Feb 05 2021 16:33:08 UTC
  Request code: CC-ZNCS-55A2-MOD-S:FOC2245R05H-AVYd1FABK-45

```

To display the license usage information, use the **show license usage** command:

```
RP/0/RSP0/CPU0:router# show license usage
```

```
Fri Feb 5 16:40:55.693 UTC
```

```

License Authorization:
Status: EVAL MODE
Evaluation Period Remaining: 81 days, 21 hours, 22 minutes, 46 seconds

```

```

(ADV-100G-RTU-1):
Description:
Count: 1
Version: 1.0
Status: EVAL MODE

```

```
Export status: NOT RESTRICTED
Reservation:
Reservation status: NOT INSTALLED
```

```
(ADV-100G-SIA-3):
Description:
Count: 1
Version: 1.0
Status: EVAL MODE
Export status: NOT RESTRICTED
Reservation:
Reservation status: NOT INSTALLED
```

```
(ESS-100G-RTU-1):
Description:
Count: 1
Version: 1.0
Status: EVAL MODE
Export status: NOT RESTRICTED
Reservation:
Reservation status: NOT INSTALLED
```

```
(ESS-100G-SIA-3):
Description:
Count: 1
Version: 1.0
Status: EVAL MODE
Export status: NOT RESTRICTED
Reservation:
Reservation status: NOT INSTALLED
```

To display all the license summaries, use the **show license summary** command:

```
RP/0/RSP0/CPU0:router# show license summary

Fri Feb 5 16:35:32.192 UTC

Smart Licensing is ENABLED
License Reservation is ENABLED

Registration:
  Status: RESERVATION IN PROGRESS
  Export-Controlled Functionality: NOT ALLOWED

License Authorization:
  Status: EVAL MODE
  Evaluation Period Remaining: 81 days, 21 hours, 25 minutes, 3 seconds

License Usage:
License           Entitlement Tag           Count Status
-----
                  (ADV-100G-RTU-1)         1 EVAL MODE
                  (ADV-100G-SIA-3)         1 EVAL MODE
                  (ESS-100G-RTU-1)         1 EVAL MODE
                  (ESS-100G-SIA-3)         1 EVAL MODE
```

To display the license status information, use the **show license status** command:

```
RP/0/RSP0/CPU0:router# show license status

Fri Feb 5 16:35:47.566 UTC

Smart Licensing is ENABLED
```

```
Utility:
  Status: DISABLED
License Reservation is ENABLED

Data Privacy:
  Sending Hostname: yes
  Callhome hostname privacy: DISABLED
  Smart Licensing hostname privacy: DISABLED
  Version privacy: DISABLED
Transport:
  Type: Transport Off

Registration:
  Status: RESERVATION IN PROGRESS
  Export-Controlled Functionality: NOT ALLOWED
  Reservation process started on: Feb 05 2021 16:33:08 UTC

License Authorization:
  Status: EVAL MODE
  Evaluation Period Remaining: 81 days, 21 hours, 24 minutes, 47 seconds

Export Authorization Key:
  Features Authorized:
  <none>

Miscellaneous:
  Custom Id: <empty>
```

## Viewing the License Status After Registering

To display license entitlements, use the `show license all` command:

```
RP/0/RSP0/CPU0:router# show license all

Fri Feb 5 16:37:57.228 UTC

Smart Licensing Status
=====
Smart Licensing is ENABLED
License Reservation is ENABLED

Registration:
  Status: REGISTERED - SPECIFIC LICENSE RESERVATION
  Export-Controlled Functionality: ALLOWED
  Initial Registration: SUCCEEDED on Feb 05 2021 16:37:38 UTC

License Authorization:
  Status: AUTHORIZED - RESERVED on Feb 05 2021 16:37:38 UTC

Export Authorization Key:
  Features Authorized:
  <none>

Utility:
  Status: DISABLED

Data Privacy:
  Sending Hostname: yes
  Callhome hostname privacy: DISABLED
  Smart Licensing hostname privacy: DISABLED
  Version privacy: DISABLED

Transport:
```

```

Type: Transport Off

Miscellaneous:
  Custom Id: <empty>

License Usage
=====
Core and Aggregation Advanced SW Right-to-Use v1.0 per 100G (ADV-100G-RTU-1):
  Description: Core and Aggregation Advanced SW Right-to-Use v1.0 per 100G
  Count: 1
  Version: 1.0
  Status: AUTHORIZED
  Export status: NOT RESTRICTED
  Reservation:
    Reservation status: SPECIFIC INSTALLED
    Total reserved count: 1

Core & Aggr Advanced SIA per 100G (ADV-100G-SIA-3):
  Description: Core & Aggr Advanced SIA per 100G
  Count: 1
  Version: 1.0
  Status: AUTHORIZED
  Export status: NOT RESTRICTED
  Reservation:
    Reservation status: SPECIFIC INSTALLED
    Total reserved count: 1

Core and Aggregation Essentials SW Right-to-Use v1.0 per 100G (ESS-100G-RTU-1):
  Description: Core and Aggregation Essentials SW Right-to-Use v1.0 per 100G
  Count: 1
  Version: 1.0
  Status: AUTHORIZED
  Export status: NOT RESTRICTED
  Reservation:
    Reservation status: SPECIFIC INSTALLED
    Total reserved count: 1

Core & Aggr Essentials SIA per 100G (ESS-100G-SIA-3):
  Description: Core & Aggr Essentials SIA per 100G
  Count: 1
  Version: 1.0
  Status: AUTHORIZED
  Export status: NOT RESTRICTED
  Reservation:
    Reservation status: SPECIFIC INSTALLED
    Total reserved count: 1

Product Information
=====
UDI: PID:NCS-55A2-MOD-S,SN:FOC2245R05H

Agent Version
=====
Smart Agent for Licensing: 5.1.8_rel/25

Reservation Info
=====
License reservation: ENABLED

Overall status:
  Active: PID:NCS-55A2-MOD-S,SN:FOC2245R05H
  Reservation status: SPECIFIC INSTALLED on Feb 05 2021 16:37:38 UTC
  Last Confirmation code: 21662953

```

```

Specified license reservations:
  Core & Aggr Advanced SIA per 100G (ADV-100G-SIA-3):
    Description: Core & Aggr Advanced SIA per 100G
    Total reserved count: 1
    Enforcement type: ENFORCED
    Term information:
      Active: PID:NCS-55A2-MOD-S,SN:FOC2245R05H
      Authorization type: SPECIFIC INSTALLED on Feb 05 2021 16:37:38 UTC
      License type: TERM
      Start Date: 2020-SEP-11 UTC
      End Date: 2021-SEP-11 UTC
      Term Count: 1
  Core & Aggr Essentials SIA per 100G (ESS-100G-SIA-3):
    Description: Core & Aggr Essentials SIA per 100G
    Total reserved count: 1
    Enforcement type: ENFORCED
    Term information:
      Active: PID:NCS-55A2-MOD-S,SN:FOC2245R05H
      Authorization type: SPECIFIC INSTALLED on Feb 05 2021 16:37:38 UTC
      License type: TERM
      Start Date: 2020-SEP-11 UTC
      End Date: 2021-SEP-11 UTC
      Term Count: 1
  Core and Aggregation Advanced SW Right-to-Use v1.0 per 100G (ADV-100G-RTU-1):
    Description: Core and Aggregation Advanced SW Right-to-Use v1.0 per 100G
    Total reserved count: 1
    Enforcement type: ENFORCED
    Term information:
      Active: PID:NCS-55A2-MOD-S,SN:FOC2245R05H
      Authorization type: SPECIFIC INSTALLED on Feb 05 2021 16:37:38 UTC
      License type: TERM
      Start Date: 2021-JAN-11 UTC
      End Date: 2022-JAN-11 UTC
      Term Count: 1
  Core and Aggregation Essentials SW Right-to-Use v1.0 per 100G (ESS-100G-RTU-1):
    Description: Core and Aggregation Essentials SW Right-to-Use v1.0 per 100G
    Total reserved count: 1
    Enforcement type: ENFORCED
    Term information:
      Active: PID:NCS-55A2-MOD-S,SN:FOC2245R05H
      Authorization type: SPECIFIC INSTALLED on Feb 05 2021 16:37:38 UTC
      License type: TERM
      Start Date: 2021-JAN-11 UTC
      End Date: 2022-JAN-11 UTC
      Term Count: 1

```

To display the license usage information, use the **show license usage** command:

```

RP/0/RSP0/CPU0:router# show license usage

Fri Feb 5 16:38:08.167 UTC

License Authorization:
  Status: AUTHORIZED - RESERVED on Feb 05 2021 16:37:38 UTC

Core and Aggregation Advanced SW Right-to-Use v1.0 per 100G (ADV-100G-RTU-1):
  Description: Core and Aggregation Advanced SW Right-to-Use v1.0 per 100G
  Count: 1
  Version: 1.0
  Status: AUTHORIZED
  Export status: NOT RESTRICTED
  Reservation:
    Reservation status: SPECIFIC INSTALLED
    Total reserved count: 1

```

```

Core & Aggr Advanced SIA per 100G (ADV-100G-SIA-3):
  Description: Core & Aggr Advanced SIA per 100G
  Count: 1
  Version: 1.0
  Status: AUTHORIZED
  Export status: NOT RESTRICTED
  Reservation:
    Reservation status: SPECIFIC INSTALLED
    Total reserved count: 1

Core and Aggregation Essentials SW Right-to-Use v1.0 per 100G (ESS-100G-RTU-1):
  Description: Core and Aggregation Essentials SW Right-to-Use v1.0 per 100G
  Count: 1
  Version: 1.0
  Status: AUTHORIZED
  Export status: NOT RESTRICTED
  Reservation:
    Reservation status: SPECIFIC INSTALLED
    Total reserved count: 1

Core & Aggr Essentials SIA per 100G (ESS-100G-SIA-3):
  Description: Core & Aggr Essentials SIA per 100G
  Count: 1
  Version: 1.0
  Status: AUTHORIZED
  Export status: NOT RESTRICTED
  Reservation:
    Reservation status: SPECIFIC INSTALLED
    Total reserved count: 1

```

To display all the license summaries, use the **show license summary** command:

```

RP/0/RSP0/CPU0:router# show license summary

Fri Feb 5 16:37:51.470 UTC

Smart Licensing is ENABLED
License Reservation is ENABLED

Registration:
  Status: REGISTERED - SPECIFIC LICENSE RESERVATION
  Export-Controlled Functionality: ALLOWED

License Authorization:
Status: AUTHORIZED - RESERVED

License Usage:
License                               Entitlement Tag                Count Status
-----
Core and Aggregation...                (ADV-100G-RTU-1)              1 AUTHORIZED
Core & Aggr Advanced...                (ADV-100G-SIA-3)              1 AUTHORIZED
Core and Aggregation...                (ESS-100G-RTU-1)              1 AUTHORIZED
Core & Aggr Essentia...                 (ESS-100G-SIA-3)              1 AUTHORIZED

```

To display the license status information, use the **show license status** command:

```

RP/0/RSP0/CPU0:router# show license status

Fri Feb 5 16:38:03.370 UTC

Smart Licensing is ENABLED

Utility:
  Status: DISABLED
License Reservation is ENABLED

```



```
Data Privacy:
  Sending Hostname: yes
    Callhome hostname privacy: DISABLED
    Smart Licensing hostname privacy: DISABLED
  Version privacy: DISABLED

Transport:
  Type: Transport Off

Registration:
  Status: REGISTERED - SPECIFIC LICENSE RESERVATION
  Export-Controlled Functionality: ALLOWED
  Initial Registration: SUCCEEDED on Feb 05 2021 16:37:38 UTC

License Authorization:
  Status: AUTHORIZED - RESERVED on Feb 05 2021 16:37:38 UTC

Export Authorization Key:
  Features Authorized:
    <none>

Miscellaneous:
  Custom Id: <empty>
```

# Configuring Smart Licensing

## Prerequisites for Configuring Smart Licensing

Ensure that you have completed the following activities on Cisco Smart Software Manager:

- Set up a Cisco Smart Account. For more information, see the *How Smart Licensing Works* section in this document.
- Set up Virtual Account or accounts. For more information, see the *Virtual Accounts* section in the [Smart Software Manager Help](#).
- Create user roles in the **Users** tab in the **Manage Smart Account** page. Provide the appropriate user access rights.
- Accept the Smart Software Licensing Agreement on Cisco Smart Software Manager to register your router.
- Have a layer 3 connection set up on your router.
- Configure a valid DNS and proper time on the router to connect CSSM or CSSM On-Prem.

## Setting up the Router for Smart Licensing

Table 50: Three-step Roadmap to Set up the Router for Smart Licensing

Activity	Communication Connection Options		
Step 1—Configure Communications	See the <i>Configuring a Direct Cloud Connection</i> section.	See the <i>Configuring a Connection through a HTTP Proxy</i> section.	See the <i>Connecting to CSSM On-Premise</i> section.
Step 2—Register and Activate	See the <i>Registering and Activating your Router</i> section.		
Step 3—Verify the Configuration	See the <i>Verifying your Smart Licensing Configuration</i> section.		

## Configuring a Communications Connection Between the Router and Cisco Smart Software Manager

### Configuring a Direct Cloud Connection

In this deployment option, the **configure call-home profile** is configured by default. Use the **show call-home profile all** command to check the profile status.

Call Home service provides email-based and web-based notification of critical system events to Cisco Smart Software Manager.

To configure and enable Call Home service:

#### SUMMARY STEPS

1. **configure**
2. **call-home**
3. **service active**
4. **contact-email-addr** *email-address*
5. **profile** **CiscoTAC-1**
6. **destination transport-method** **http**
7. **destination address** **http** *url*
8. **active**
9. **no destination transport-method** **email**
10. **commit**
11. **exit**
12. **exit**

## DETAILED STEPS

	Command or Action	Purpose
<b>Step 1</b>	<b>configure</b> <b>Example:</b> Router# configureterminal	Enters global configuration mode.
<b>Step 2</b>	<b>call-home</b> <b>Example:</b> Router(config)# call-home	Enters Call Home configuration mode.
<b>Step 3</b>	<b>service active</b> <b>Example:</b> Router(config-call-home)# service active	Activates Call Home service.
<b>Step 4</b>	<b>contact-email-addr</b> <i>email-address</i> <b>Example:</b> Router(config-call-home)# contact-email-addr username@example.com	Assigns the provided email address. You can enter up to 200 characters in email address format. <b>Note</b> Spaces are not allowed in the email address.
<b>Step 5</b>	<b>profile CiscoTAC-1</b> <b>Example:</b> Router(config-call-home)# profile CiscoTAC-1	Enables the CiscoTAC-1 profile to be used with the Call Home service. By default, the CiscoTAC-1 profile is disabled.
<b>Step 6</b>	<b>destination transport-method http</b> <b>Example:</b> Router(config-call-home-profile)# destination transport-method http	Enables the Call Home service through an HTTP connection.
<b>Step 7</b>	<b>destination address http</b> <i>url</i> <b>Example:</b> Router(config-call-home-profile)# destination address http https://tools.cisco.com/its/service/odce/services/DDCEService	Connects the router to the Cisco Smart Software Manager.
<b>Step 8</b>	<b>active</b> <b>Example:</b> Router(config-call-home-profile)# active	Enables the destination profile.
<b>Step 9</b>	<b>no destination transport-method email</b> <b>Example:</b> Router(config-call-home-profile)# no destination transport-method email	Disables the email option for the Call Home service.
<b>Step 10</b>	<b>commit</b> <b>Example:</b> Router(config-call-home-profile)# commit	Commits the configuration.

	Command or Action	Purpose
<b>Step 11</b>	<b>exit</b> <b>Example:</b> Router(config-call-home-profile)# exit	Exits the Call Home destination profile configuration mode and returns to the Call Home configuration mode.
<b>Step 12</b>	<b>exit</b> <b>Example:</b> Router(config-call-home)# exit Router(config)#	Exits the Call Home configuration mode and returns to the global configuration mode.

## Configuring a Connection Through an HTTP Proxy

The Call Home service can be configured through an HTTPs proxy server.

### SUMMARY STEPS

1. **configure**
2. **call-home**
3. **service active**
4. **contact-email-address** *email-address*
5. **http-proxy** *proxy-address* **port** *port-number*
6. **profile** **CiscoTAC-1**
7. **no destination transport-method email**
8. **exit**
9. **profile** *profile-name*
10. **reporting smart-licensing-data**
11. **destination transport-method http**
12. **destination address http** *url*
13. **active**
14. **exit**
15. **exit**
16. **commit**

### DETAILED STEPS

	Command or Action	Purpose
<b>Step 1</b>	<b>configure</b> <b>Example:</b> Router# configure	Enters global configuration mode.
<b>Step 2</b>	<b>call-home</b> <b>Example:</b> Router(config)# call-home	Enters Call Home configuration mode.

	Command or Action	Purpose
Step 3	<b>service active</b> <b>Example:</b> <pre>Router(config-call-home)# service active</pre>	Enables the Call Home feature.
Step 4	<b>contact-email-address <i>email-address</i></b> <b>Example:</b> <pre>Router(config-call-home)# contact-email-addr sch-smart-licensing@cisco.com</pre>	Configures the default email address.
Step 5	<b>http-proxy <i>proxy-address</i> port <i>port-number</i></b> <b>Example:</b> <pre>Router(config-call-home)# http-proxy 198.51.100.10 port 3128</pre>	Provides the proxy server information to the Call Home service.
Step 6	<b>profile CiscoTAC-1</b> <b>Example:</b> <pre>Router(config-call-home)# profile CiscoTAC-1</pre>	Enables the CiscoTAC-1 profile to be used with the Call Home service. By default, the CiscoTAC-1 profile is disabled.
Step 7	<b>no destination transport-method email</b> <b>Example:</b> <pre>Router(config-call-home-profile)# no destination transport-method email</pre>	Disables the email option for the Call Home service.
Step 8	<b>exit</b> <b>Example:</b> <pre>Router(config-call-home-profile)# exit Router(config-call-home)#</pre>	Exits the Call Home destination profile configuration mode and returns to the Call Home configuration mode.
Step 9	<b>profile <i>profile-name</i></b> <b>Example:</b> <pre>Router(config-call-home)# profile test1</pre>	Enters the Call Home destination profile configuration mode for the specified destination profile name. If the specified destination profile does not exist, it is created.
Step 10	<b>reporting smart-licensing-data</b> <b>Example:</b> <pre>Router(config-call-home-profile)# reporting smart-licensing-data</pre>	Enables data sharing with the Call Home service through the configured transport method, in this case, HTTP.
Step 11	<b>destination transport-method http</b> <b>Example:</b> <pre>Router(config-call-home-profile)# destination transport-method http</pre>	Enables the HTTP message transport method.
Step 12	<b>destination address http <i>url</i></b> <b>Example:</b> <pre>Router(config-call-home-profile)# destination address http https://tools.cisco.com/its/service/oddce/services/DDCEService</pre>	Connects the router to the Cisco Smart Software Manager.

	Command or Action	Purpose
<b>Step 13</b>	<b>active</b> <b>Example:</b> Router(config-call-home-profile)# active	Enables the destination profile.
<b>Step 14</b>	<b>exit</b> <b>Example:</b> Router(config-call-home-profile)# exit	Exits the Call Home destination profile configuration mode and returns to the Call Home configuration mode.
<b>Step 15</b>	<b>exit</b> <b>Example:</b> Router(config-call-home)# exit Router(config)#	Exits the Call Home configuration mode and returns to the global configuration mode.
<b>Step 16</b>	<b>commit</b> <b>Example:</b> Router(config)# commit	Commits the configuration.

## Configuring Smart Transport Through an HTTPs Proxy

To use a proxy server to communicate with CSSM when using the Smart transport mode, complete the following steps:



**Note** Authenticated HTTPs proxy configurations are not supported.

### SUMMARY STEPS

1. **configure terminal**
2. **license smart transport smart**
3. **license smart url***transport-url*
4. **license smart proxy** *hostname***port***port-number*
5. **commit**

### DETAILED STEPS

	Command or Action	Purpose
<b>Step 1</b>	<b>configure terminal</b> <b>Example:</b> Router# configure terminal	Enters global configuration mode.
<b>Step 2</b>	<b>license smart transport smart</b> <b>Example:</b> Router(config)# license smart transport smart	Enables Smart transport mode. Automatically configures the Smart URL. ( <a href="https://smartreceiver.cisco.com/licservice/license">https://smartreceiver.cisco.com/licservice/license</a> ).

	Command or Action	Purpose
Step 3	<b>license smart url</b> <i>transport-url</i> <b>Example:</b> <pre>Router(config)# license smart url https://your-transport-url.com</pre>	Configures the url of smart transport for transporting messages.  <i>transport-url</i> : The Smart Transport url
Step 4	<b>license smart proxy</b> <i>hostname</i> <b>port</b> <i>port-number</i> <b>Example:</b> <pre>Router(config)# license smart proxy 198.51.100.10 port 3128</pre>	Configures a proxy for the Smart transport mode. When a proxy is configured, licensing messages are sent to the proxy along with the final destination URL (CSSM). The proxy sends the message on to CSSM. Provide the address and port information: <ul style="list-style-type: none"> <li>• <b>hostname</b>: Enter the IP Address or hostname of the proxy server.</li> <li>• <b>port</b>: Specifies the proxy port. Enter the proxy port number.</li> </ul>
Step 5	<b>commit</b> <b>Example:</b> <pre>Router(config)# commit</pre>	Commits the configuration.

## Connecting to CSSM On-Premise

This section describes how to configure the Call Home service for on-premise smart software through connected or disconnected mode.

### SUMMARY STEPS

1. **configure**
2. **call-home**
3. **profile** *profile-name*
4. **reporting smart-licensing-data**
5. **destination transport-method** **http**
6. **destination address** **http** *url*
7. **no destination address** **http** *url*
8. **destination preferred-msg-format** {**long-text** | **short-text** | **xml**}
9. **active**
10. **exit**
11. **exit**
12. **http client source-interface** *ip-version interface-type interface-number*
13. **crypto ca trustpoint** *name*
14. **commit**
15. **end**

## DETAILED STEPS

	Command or Action	Purpose
<b>Step 1</b>	<b>configure</b> <b>Example:</b> Router# configure	Enters global configuration mode.
<b>Step 2</b>	<b>call-home</b> <b>Example:</b> Router(config)# call-home	Enters Call Home configuration mode.
<b>Step 3</b>	<b>profile <i>profile-name</i></b> <b>Example:</b> Router(config-call-home)# profile test1	Enters the Call Home destination profile configuration mode for the specified destination profile name. If the specified destination profile doesn't exist, it is created.
<b>Step 4</b>	<b>reporting smart-licensing-data</b> <b>Example:</b> Router(config-call-home-profile)# reporting smart-licensing-data	Enables data sharing with the Call Home service through the configured transport method, in this case, HTTP.
<b>Step 5</b>	<b>destination transport-method http</b> <b>Example:</b> Router(config-call-home-profile)# destination transport-method http	Enables the HTTP message transport method.
<b>Step 6</b>	<b>destination address http <i>url</i></b> <b>Example:</b> Router(config-call-home-profile)# destination address http http://209.165.201.15/Transportgateway/services/DeviceRequestHandler  Or Router(config-call-home-profile)# destination address http https://209.165.201.15/Transportgateway/services/DeviceRequestHandler	Configures the destination URL (CSSM) to which Call Home messages are sent. Ensure the IP address or the fully qualified domain name (FQDN) in the destination URL matches the IP address or the FQDN as configured for the <b>Host Name</b> on the CSSM On-Prem.
<b>Step 7</b>	<b>no destination address http <i>url</i></b> <b>Example:</b> Router(config-call-home-profile)# no destination address http https://tools.cisco.com/its/service/oddce/services/DDCEService	Removes the default destination address.
<b>Step 8</b>	<b>destination preferred-msg-format {<i>long-text</i>   <i>short-text</i>   xml}</b> <b>Example:</b> Router(config-call-home-profile)# destination preferred-msg-format xml	(Optional) Configures a preferred message format. The default message format is XML.



	Command or Action	Purpose
Step 9	<b>active</b> <b>Example:</b> <pre>Router(config-call-home-profile)# active</pre>	Enables the destination profile.
Step 10	<b>exit</b> <b>Example:</b> <pre>Router(config-call-home-profile)# exit</pre>	Exits the Call Home destination profile configuration mode and returns to the Call Home configuration mode.
Step 11	<b>exit</b> <b>Example:</b> <pre>Router(config-call-home)# exit Router(config)#</pre>	Exits the Call Home configuration mode and returns to the global configuration mode.
Step 12	<b>http client source-interface</b> <i>ip-version interface-type interface-number</i> <b>Example:</b> <pre>Router(config)# http client source-interface ipv4 Vlan100</pre>	Configures a source interface for the HTTP client. <b>Note</b> This command is mandatory for a VRF interface.
Step 13	<b>crypto ca trustpoint</b> <i>name</i> <b>Example:</b> <pre>Router(config)# crypto ca trustpoint SLA-TrustPoint Router(config-trustp)#</pre>	(Optional) Declares the trustpoint and its name.
Step 14	<b>commit</b> <b>Example:</b> <pre>Router(config-trustp)# commit</pre>	Commits the configuration.
Step 15	<b>end</b> <b>Example:</b> <pre>Router(config-trustp)# end Router(config)#</pre>	Returns to the global configuration mode.

## Installing CSSM On-Premise

For information on installation instructions, see the [Smart Software Manager On-Prem Installation Guide](#).

## Registering and Activating Your Router

Product registration securely associates a device with the Smart Account and the Virtual Account of your choice. It also establishes trust between the end product and the CSSM. Tokens are used to register a product with the appropriate Virtual Account on CSSM Cloud (on Cisco.com) or CSSM On-Premise.

A Registration Token:

- Can be either used once or reused multiple times. You can set a limit to the number of times a token can be reused when you create the token.
- Can be created and revoked at any time.
- Expires after a period of time (default is 30 days; minimum is one day; maximum is 365 days)

A Registration Token is not:

- Product specific: The same Registration Token can be used on different product types.
- A license, key, or PAK.
- Stored on the Cisco device and they are not persistent.
- Required after the product is registered. Token expiration has no effect on previously registered products; it simply means that that token can no longer be used to register a new product.

## Generating a New Token from CSSM

- Step 1** If you choose the direct cloud access deployment option, log in to CSSM from <https://software.cisco.com/>.  
If you chose the mediated access deployment option, log in to CSSM On-Prem from <https://<on-prem-ip-address>:8443>.
- Step 2** Select the **Inventory** tab.
- Step 3** From the Virtual Account drop-down list, choose the virtual account to which you want to register your product.
- Step 4** Select the **General** tab.
- Step 5** Click **New Token**.

The screenshot displays the Cisco Software Central interface for Smart Software Licensing. The breadcrumb trail is 'Cisco Software Central > Smart Software Licensing'. The page title is 'Smart Software Licensing'. The 'Virtual Account' is set to 'IOSXR'. The 'General' tab is selected, showing the 'Virtual Account' details (Description: Default Virtual Account: No) and the 'Product Instance Registration Tokens' section. A 'New Token...' button is highlighted with a red box. Below the button is a table with columns: Token, Expiration Date, Uses, Export-Controlled, Description, Created By, and Actions. The table content is 'No Records Found'. A footer bar contains links for Contacts, Feedback, Help, Site Map, Terms & Conditions, Privacy Statement, Cookie Policy, and Trademarks.

The **Create Registration Token** window is displayed.

### Step 6

In the **Description** field, enter the token description.

In the **Expire After** field, enter the number of days the token must be active. The default value is 30 days.

In the **Max. Number of Uses** field, enter the maximum number of uses allowed after which the token expires.

Select the **Allow export-controlled functionality on the products registered with this token** checkbox to ensure Cisco compliance with US and country-specific export policies and guidelines. For more information, see <https://www.cisco.com/c/en/us/about/legal/global-export-trade.html>.

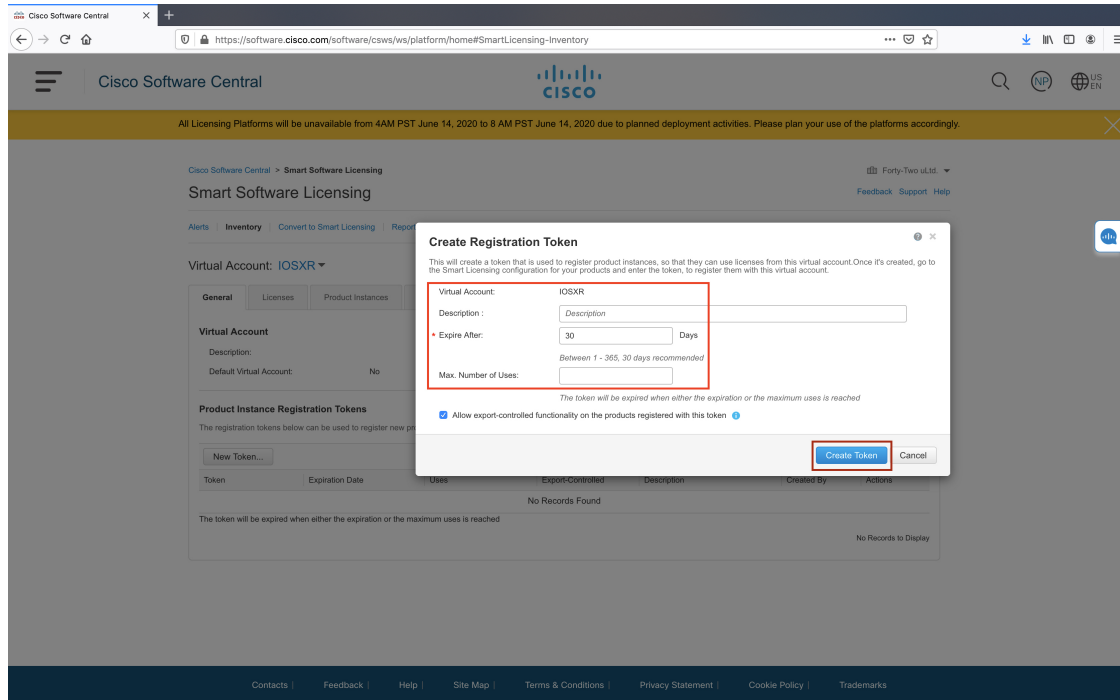

Click **Create Token**.

### Step 7

After the token is created, select and copy the token to a text file.

Cisco Software Central > Smart Software Licensing

Smart Software Licensing

Virtual Account: IOSXR

General | Licenses | Product Instances | Event Log

Virtual Account

Description:

Default Virtual Account: No

Product Instance Registration Tokens

The registration tokens below can be used to register new product instances to this virtual account.

New Token...

Token	Expiration Date	Uses	Export-Controlled	Description	Created By	Actions
YTdYtJhOTAYtYt3NS	2020-Jul-12 16:28:57 (in 30 ...)	0 of 10	Allowed		neparaka	Actions

The token will be expired when either the expiration or the maximum uses is reached

Showing 1 Record

521052

Cisco Software Central > Smart Software Licensing

Smart Software Licensing

Virtual Account: IOSXR

General | Licenses | Product Instances | Event Log

Virtual Account

Description:

Default Virtual Account: No

Product Instance Registration Tokens

The registration tokens below can be used to register new product instances to this virtual account.

New Token...

Token	Expiration Date	Uses	Export-Controlled	Description	Created By	Actions
YTdYtJhOTAYtYt3NS	2020-Jul-12 16:28:57 (in 30 ...)	0 of 10	Allowed		neparaka	Actions

The token will be expired when either the expiration or the maximum uses is reached

Showing 1 Record

521053

You need this token to register your router.

**What to do next**

See the *Registering Your Device With the Token* section.

## Registering Your Device With the Token

### SUMMARY STEPS

1. `license smart register idtoken token-ID`

### DETAILED STEPS

	Command or Action	Purpose
Step 1	<p><b>license smart register idtoken token-ID</b></p> <p><b>Example:</b></p> <pre>license smart register idtoken \$T14UytrNXBzbEs1ck8veUtWaG5abnZJOFdDa1FwbvRa%0Ab1RMbz0%3D%0A</pre>	<p>Registers Smart Licensing on the router using the registration token created in the CSSM. On successful registration, the product instance is created in the CSSM virtual account and its license usage is displayed on the CSSM.</p> <p><b>Register Device Using YANG Data Model</b></p> <p>As an alternative to the CLI command, the <code>Cisco-IOS-XR-smart-license-act</code> YANG data model can also be used to register your device with CSSM On-prem server:</p> <pre>&lt;rpc xmlns="urn:ietf:params:xml:ns:netconf:base:1.0" message-id="101"&gt;   &lt;register-id-token xmlns="http://cisco.com/ns/yang/Cisco-IOS-XR-smart-license-act"&gt;  &lt;id-token&gt;\$T14UytrNXBzbEs1ck8veUtWaG5abnZJOFdDa1FwbvRa%0Ab1RMbz0%3D%0A&lt;/id-token&gt;    &lt;/register-id-token&gt; &lt;/rpc&gt;</pre>

## Renewing Your Smart Licensing Registration

Your registration is automatically renewed every six months. To find the status of the license, use the **license smart renew auth** command.

As long as the license is in an 'Authorized' or 'Out-of-compliance' (OOC) state, the authorization period is renewed. Grace period starts when an authorization period expires. During the grace period or when the grace period is in the 'Expired' state, the system continues to try to renew the authorization period. If a retry is successful, a new authorization period starts.



**Note** If the smart license renewal fails, then the product instance goes to an unidentified state and starts consuming the evaluation period.

**Before you begin**

Ensure that the following conditions are met to renew your smart license:

- Smart licensing is enabled.
- The router is registered.

**SUMMARY STEPS**

1. `license smart renew {auth | id}`

**DETAILED STEPS**

	Command or Action	Purpose
<b>Step 1</b>	<b>license smart renew {auth   id}</b> <b>Example:</b> Router# license smart renew auth	Renews your token ID or authorization with Cisco smart licensing.

**Example****Renew Token ID Using YANG Data Model**

You can renew your token ID or smart licensing registration using `Cisco-IOS-XR-smart-license-act` YANG data model. The following example shows the NETCONF RPC request:

```
<rpc xmlns="urn:ietf:params:xml:ns:netconf:base:1.0" message-id="101">
  <renew-id xmlns="http://cisco.com/ns/yang/Cisco-IOS-XR-smart-license-act"/>
</rpc>
```

To renew the authorization, use the following NETCONF RPC request:

```
<rpc xmlns="urn:ietf:params:xml:ns:netconf:base:1.0" message-id="101">
  <renew-auth xmlns="http://cisco.com/ns/yang/Cisco-IOS-XR-smart-license-act"/>
</rpc>
```

**Deregistering Your Router from CSSM**

When a router is taken off the inventory, shipped elsewhere for redeployment, or returned to Cisco for replacement, you can deregister that router.

**Before you begin**

Ensure that a Layer 3 connection to CSSM is available to successfully deregister the device.

**SUMMARY STEPS**

1. `license smart deregister`

## DETAILED STEPS

	Command or Action	Purpose
Step 1	<b>license smart deregister</b> <b>Example:</b> Router# license smart deregister	Cancels the registration of the router and sends the router into evaluation mode. All smart licensing entitlements and certificates on the corresponding platform are removed. The product instance of the router stored on CSSM is also removed.

**Example****Deregister Device Using YANG Data Model**

You can deregister your device with CSSM On-prem server using `Cisco-IOS-XR-smart-license-act` YANG data model. The following example shows the NETCONF RPC request:

```
<rpc xmlns="urn:ietf:params:xml:ns:netconf:base:1.0" message-id="101">
  <de-register xmlns="http://cisco.com/ns/yang/Cisco-IOS-XR-smart-license-act"/>
</rpc>
```

## Verifying the Smart Licensing Configuration

Use the following **show** commands to verify the default Smart Licensing configuration. If any issue is detected, take corrective action before making further configurations.

## SUMMARY STEPS

1. **show license status**
2. **show license all**
3. **show license status**
4. **show license udi**
5. **show license summary**
6. **show license platform summary**
7. **show license platform detail**
8. **show call-home smart-licensing statistics**

## DETAILED STEPS

	Command or Action	Purpose
Step 1	<b>show license status</b> <b>Example:</b> Router# show license status	Displays the compliance status of Smart Licensing. Following are the possible status: <ul style="list-style-type: none"> <li>• <b>Waiting</b>—Indicates that the initial state after your device has made a license entitlement request. The device establishes communication with Cisco and successfully registers itself with the Cisco license manager.</li> </ul>

	Command or Action	Purpose
		<ul style="list-style-type: none"> <li>• <b>Authorized</b>—Indicates that your device is able to communicate with the Cisco license manager, and is authorized to initiate requests for license entitlements.</li> <li>• <b>Out-Of-Compliance</b>—Indicates that one or more of your licenses are out-of-compliance. Buy more licenses, or renew the existing licenses.</li> <li>• <b>Eval Period</b>—Indicates that Smart Licensing is consuming the evaluation period. Register the device with the Cisco Licensing manager, else your license expires. <ul style="list-style-type: none"> <li><b>Note</b> Repetitive 'Smart Licensing evaluation expired' warning messages are displayed on the console every hour, but there is no functionality impact on the device. To stop these repetitive messages, register the device again with new a registration token.</li> </ul> </li> <li>• <b>Disabled</b>—Indicates that Smart Licensing is disabled.</li> <li>• <b>Invalid</b>—Indicates that Cisco does not recognize the entitlement tag as the tag is not in the database.</li> </ul>
<b>Step 2</b>	<b>show license all</b> <b>Example:</b> Router# show license all	Displays all entitlements in use. The output also displays the associated licensing certificates, compliance status, Unique Device Identifier (UDI), and other details.
<b>Step 3</b>	<b>show license status</b> <b>Example:</b> Router# show license status	Displays the status of all entitlements in use.
<b>Step 4</b>	<b>show license udi</b> <b>Example:</b> Router# show license udi	Displays the Unique Device Identifier (UDI) information.
<b>Step 5</b>	<b>show license summary</b> <b>Example:</b> Router# show license summary	Displays a summary of all entitlements in use.
<b>Step 6</b>	<b>show license platform summary</b> <b>Example:</b> Router# show license platform summary	Displays the registration status and provides detailed information about the essential, advantage, and tracking license consumption in generic or vortex license model.
<b>Step 7</b>	<b>show license platform detail</b> <b>Example:</b> Router# show license platform detail	Displays detailed information about: <ul style="list-style-type: none"> <li>• Licenses that can be consumed on a platform in both, generic and vortex models</li> </ul>



	Command or Action	Purpose
		<ul style="list-style-type: none"> <li>• The active model, whether generic or vortex model</li> <li>• The current count and the next consumption count of a license</li> </ul>
<b>Step 8</b>	<b>show call-home smart-licensing statistics</b>  <b>Example:</b> Router# show call-home smart-licensing statistics	Displays statistics of the communication between the Smart Licensing manager and the Cisco back-end using Smart Call Home.  <b>Note</b> If the communication fails or drops, check your call home configuration for any errors.

## Smart Licensing Configuration Examples

### Example: Viewing the Call Home Profile

To display the **http Call Home profile** or the **On-Prem Call Home profile**, use the **show call-home profile all** command.

```
RP/0/RSP0/CPU0:router# show call-home profile all
Fri Sep 11 17:56:22.254 PDT
```

```
Profile Name: CiscoTAC-1
Profile status: ACTIVE
Profile mode: Full Reporting
Reporting Data: Smart Call Home, Smart Licensing
Preferred Message Format: xml
Message Size Limit: 3145728 Bytes
Transport Method: http
HTTP address(es): https://tools.cisco.com/its/service/oddce/services/DDCEService
Other address(es): default

Periodic configuration info message is scheduled every 11 day of the month at 11:25

Periodic inventory info message is scheduled every 11 day of the month at 11:10

Alert-group          Severity
-----
inventory            normal

Syslog-Pattern       Severity
-----
.*                   critical
```

```
RP/0/RSP0/CPU0:router#show call-home profile all
Fri Sep 11 17:33:00.962 PDT
Profile Name: CiscoTAC-1
Profile status: ACTIVE
Profile mode: Full Reporting
Reporting Data: Smart Call Home, Smart Licensing
Preferred Message Format: xml
Message Size Limit: 3145728 Bytes
Transport Method: http
HTTP address(es): http://10.30.110.38/Transportgateway/services/DeviceRequestHandler
Other address(es): default
```

Periodic configuration info message is scheduled every 11 day of the month at 11:25

Periodic inventory info message is scheduled every 11 day of the month at 11:10

Alert-group	Severity
-----	-----
inventory	normal
Syslog-Pattern	Severity
-----	-----
.*	critical

## Example: Viewing License Information Before Registration

To display the license entitlements, use the **show license all** command:

```
RP/0/RSP0/CPU0:router# show license all
Smart Licensing Status
=====

Smart Licensing is ENABLED

Registration:
  Status: UNREGISTERED
  Export-Controlled Functionality: NOT ALLOWED

License Authorization:
  Status: EVAL MODE
  Evaluation Period Remaining: 33 days, 22 hours, 52 minutes, 34 seconds

Export Authorization Key:
  Features Authorized:
    <none>

Utility:
  Status: DISABLED

Data Privacy:
  Sending Hostname: yes
  Callhome hostname privacy: DISABLED
  Smart Licensing hostname privacy: DISABLED
  Version privacy: DISABLED

Transport:
  Type: Callhome

License Usage
=====

(A9K-48P10G-TR-UPG):
  Description:
  Count: 1
  Version: 1.0
  Status: EVAL MODE
  Export status: NOT RESTRICTED

Product Information
=====
UDI: PID:ASR-9906, SN:FOX2247P3QM

HA UDI List:
  0/RSP0/CPU0: Active:PID:ASR-9906, SN:FOX2247P3QM
  0/RSP1/CPU0: Standby:PID:ASR-9906, SN:FOX2247P3QM
```

```
Agent Version
=====
Smart Agent for Licensing: 4.10.10_rel/45
```

```
Reservation Info
=====
License reservation: DISABLED
```

To display the license usage information, use the **show license usage** command:

```
RP/0/RSP0/CPU0:router# show license usage
License Authorization:
  Status: EVAL MODE
  Evaluation Period Remaining: 33 days, 22 hours, 51 minutes, 34 seconds
(A9K-48P10G-TR-UPG):
  Description:
  Count: 1
  Version: 1.0
  Status: EVAL MODE
  Export status: NOT RESTRICTED
```

To display all the license summaries, use the **show license summary** command:

```
RP/0/RSP0/CPU0:router# show license summary
Smart Licensing is ENABLED

Registration:
  Status: UNREGISTERED
  Export-Controlled Functionality: NOT ALLOWED

License Authorization:
  Status: EVAL MODE
  Evaluation Period Remaining: 33 days, 22 hours, 42 minutes, 48 seconds

License Usage:
  License                               Entitlement tag                Count Status
  -----
                               (A9K-48P10G-TR-UPG)           1 EVAL MODE
```

To display the license status information, use the **show license status** command:

```
RP/0/RSP0/CPU0:router# show license status

Smart Licensing is ENABLED

Utility:
  Status: DISABLED

Data Privacy:
  Sending Hostname: yes
  Callhome hostname privacy: DISABLED
  Smart Licensing hostname privacy: DISABLED
  Version privacy: DISABLED

Transport:
  Type: Callhome

Registration:
  Status: UNREGISTERED
  Export-Controlled Functionality: NOT ALLOWED

License Authorization:
  Status: EVAL MODE
```

```
Evaluation Period Remaining: 33 days, 22 hours, 41 minutes, 37 seconds
```

```
Export Authorization Key:
Features Authorized:
<none>
```

## Example: Registering the Router

To register a device, use the **license smart register idtoken** command:

```
Router# license smart register idtoken
Tl4UytrNXBzbEs1ck8veUtWaG5abnZJOFdDalFwbVRa%0Ab1RMbz0%3D%0A
```

## Example: Viewing License Information After Registration

To display the license entitlements, use the **show license all** command

```
RP/0/RSP0/CPU0:router# show license all

Smart Licensing Status
=====

Smart Licensing is ENABLED

Registration:
  Status: REGISTERED
  Smart Account: Forty-Two uLtd.
  Virtual Account: IOSXR
  Export-Controlled Functionality: ALLOWED
  Initial Registration: SUCCEEDED on Sep 11 2020 18:13:49 PDT
  Last Renewal Attempt: None
  Next Renewal Attempt: Mar 10 2021 17:13:48 PST
  Registration Expires: Sep 11 2021 18:08:46 PDT

License Authorization:
  Status: OUT OF COMPLIANCE on Sep 11 2020 18:14:01 PDT
  Last Communication Attempt: SUCCEEDED on Sep 11 2020 18:14:01 PDT
  Next Communication Attempt: Sep 12 2020 06:14:00 PDT
  Communication Deadline: Dec 10 2020 17:08:59 PST

Export Authorization Key:
  Features Authorized:
  <none>

Utility:
  Status: DISABLED

Data Privacy:
  Sending Hostname: yes
  Callhome hostname privacy: DISABLED
  Smart Licensing hostname privacy: DISABLED
  Version privacy: DISABLED

Transport:
  Type: Callhome

License Usage
=====

Essentials Software RTU License (per 100G) for Edge (ESS-SE-100G-RTU-1):
  Description: Essentials Software RTU License (per 100G) for Edge
  Count: 1
  Version: 1.0
```

```

Status: OUT OF COMPLIANCE
Export status: NOT RESTRICTED

Advanced Software RTU License (per 100G) for Edge (ADV-SE-100G-RTU-1):
Description: Advanced Software RTU License (per 100G) for Edge
Count: 1
Version: 1.0
Status: OUT OF COMPLIANCE
Export status: NOT RESTRICTED

ASR 9900 32X100GE FC Tracking PID (A99-32X100GE-TRK):
Description: ASR 9900 32X100GE FC Tracking PID
Count: 1
Version: 1.0
Status: OUT OF COMPLIANCE
Export status: NOT RESTRICTED

ASR 9000 3rd Generation 12x100GE Hardware Tracking PID (A99-12X100GE-TRK):
Description: ASR 9000 3rd Generation 12x100GE Hardware Tracking PID
Count: 1
Version: 1.0
Status: OUT OF COMPLIANCE
Export status: NOT RESTRICTED

ASR 9000 3rd Generation 7 Fabric 48x10GE-1GE Hardware Tracking PID (A99-48X10GE-1G-TRK):
Description: ASR 9000 3rd Generation 7 Fabric 48x10GE-1GE Hardware Tracking
                PID
Count: 1
Version: 1.0
Status: OUT OF COMPLIANCE
Export status: NOT RESTRICTED

Product Information
=====
UDI: PID:ASR-9906,SN:FOX2247P3QM

HA UDI List:
  0/RSP0/CPU0: Active:PID:ASR-9906,SN:FOX2247P3QM
  0/RSP1/CPU0: Standby:PID:ASR-9906,SN:FOX2247P3QM

Agent Version
=====
Smart Agent for Licensing: 4.10.10_rel/45

Reservation Info
=====
License reservation: DISABLED

To display the license usage information, use the show license usage command:

RP/0/RSP0/CPU0:router# show license usage
License Authorization:
  Status: OUT OF COMPLIANCE on Sep 11 2020 18:14:01 PDT

Essentials Software RTU License (per 100G) for Edge (ESS-SE-100G-RTU-1):
Description: Essentials Software RTU License (per 100G) for Edge
Count: 1
Version: 1.0
Status: OUT OF COMPLIANCE
Export status: NOT RESTRICTED

Advanced Software RTU License (per 100G) for Edge (ADV-SE-100G-RTU-1):
Description: Advanced Software RTU License (per 100G) for Edge
Count: 1
Version: 1.0

```

## Example: Viewing License Information After Registration

```

Status: OUT OF COMPLIANCE
Export status: NOT RESTRICTED

ASR 9900 32X100GE FC Tracking PID (A99-32X100GE-TRK):
Description: ASR 9900 32X100GE FC Tracking PID
Count: 1
Version: 1.0
Status: OUT OF COMPLIANCE
Export status: NOT RESTRICTED

ASR 9000 3rd Generation 12x100GE Hardware Tracking PID (A99-12X100GE-TRK):
Description: ASR 9000 3rd Generation 12x100GE Hardware Tracking PID
Count: 1
Version: 1.0
Status: OUT OF COMPLIANCE
Export status: NOT RESTRICTED

ASR 9000 3rd Generation 7 Fabric 48x10GE-1GE Hardware Tracking PID (A99-48X10GE-1G-TRK):
Description: ASR 9000 3rd Generation 7 Fabric 48x10GE-1GE Hardware Tracking
              PID
Count: 1
Version: 1.0
Status: OUT OF COMPLIANCE
Export status: NOT RESTRICTED

```

To display all the license summaries, use the **show license summary** command:

```

RP/0/RSP0/CPU0:router# show license summary
Smart Licensing is ENABLED

Registration:
Status: REGISTERED
Smart Account: Forty-Two uLtd.
Virtual Account: IOSXR
Export-Controlled Functionality: ALLOWED
Last Renewal Attempt: None
Next Renewal Attempt: Mar 10 2021 17:13:49 PST

License Authorization:
Status: OUT OF COMPLIANCE
Last Communication Attempt: SUCCEEDED
Next Communication Attempt: Sep 12 2020 06:14:01 PDT

```

```

License Usage:
License                               Entitlement tag                Count Status
-----
Essentials Software ... (ESS-SE-100G-RTU-1)         1 OUT OF COMPLIANCE
Advanced Software RT... (ADV-SE-100G-RTU-1)         1 OUT OF COMPLIANCE
ASR 9900 32X100GE FC... (A99-32X100GE-TRK)         1 OUT OF COMPLIANCE
ASR 9000 3rd Generat... (A99-12X100GE-TRK)         1 OUT OF COMPLIANCE
ASR 9000 3rd Generat... (A99-48X10GE-1G-TRK)         1 OUT OF

```

To display the license status information, use the **show license status** command:

```

RP/0/RSP0/CPU0:router# show license status

Smart Licensing is ENABLED

Utility:
Status: DISABLED

Data Privacy:
Sending Hostname: yes
Callhome hostname privacy: DISABLED
Smart Licensing hostname privacy: DISABLED

```

Version privacy: DISABLED

Transport:

Type: Callhome

Registration:

Status: REGISTERED

Smart Account: Forty-Two uLtd.

Virtual Account: IOSXR

Export-Controlled Functionality: ALLOWED

Initial Registration: SUCCEEDED on Sep 11 2020 18:13:49 PDT

Last Renewal Attempt: None

Next Renewal Attempt: Mar 10 2021 17:13:48 PST

Registration Expires: Sep 11 2021 18:08:46 PDT

License Authorization:

Status: OUT OF COMPLIANCE on Sep 11 2020 18:14:01 PDT

Last Communication Attempt: SUCCEEDED on Sep 11 2020 18:14:01 PDT

Next Communication Attempt: Sep 12 2020 06:14:00 PDT

Communication Deadline: Dec 10 2020 17:08:59 PST

Export Authorization Key:

Features Authorized:

<none>







## CHAPTER 14

# Configuring Frequency Synchronization

Frequency Synchronization is used to distribute precision frequency around a network. Frequency is synchronized accurately using Synchronized Ethernet (SyncE) in devices connected by Ethernet in a network.

This module describes the concepts around this and details the various configurations involved. For information on SyncE commands, see *System Management Command Reference for Cisco ASR 9000 Series Routers*.

This module contains the following topics:

- [Overview, on page 365](#)
- [Clocking Support for nV Cluster, on page 369](#)
- [Configuring Frequency Synchronization, on page 371](#)

## Overview

Frequency or timing synchronization is the ability to distribute precision frequency around a network. In this context, timing refers to precision frequency, not an accurate time of day. Precision frequency is required in next generation networks for applications such as circuit emulation.

To achieve compliance to ITU specifications for TDM, differential method circuit emulation must be used, which requires a known, common precision frequency reference at each end of the emulated circuit. The incumbent example of frequency synchronization is provided by SDH equipment. This is used in conjunction with an external timing technology to provide synchronization of precision timing across the network.

SDH equipments are widely replaced by Ethernet equipments and synchronized frequency is required over such Ethernet ports. Synchronous Ethernet (SyncE) is used to accurately synchronize frequency in devices connected by Ethernet in a network. SyncE provides level frequency distribution of known common precision frequency references to a physical layer Ethernet network.

To maintain SyncE links, a set of operational messages are required. These messages ensure that a node is always deriving timing information from the most reliable source and then transfers the timing source quality information to clock the SyncE link. In SDH networks, these are known as Synchronization Status Messages (SSMs). SyncE uses Ethernet Synchronization Message Channel (ESMC) to provide transport for SSMs.

### Source and Selection Points

Frequency Synchronization implementation involves Sources and Selection Points.

A Source inputs frequency signals into a system or transmits them out of a system. There are four types of sources:

- Line interfaces. This includes SyncE interfaces and SONET interfaces.
- Clock interfaces. These are external connectors for connecting other timing signals, such as BITS, UTI and GPS.
- PTP clock. If IEEE 1588 version 2 is configured on the router, a PTP clock may be available to frequency synchronization as a source of the time-of-day and frequency.
- Internal oscillator. This is a free-running internal oscillator chip.

Each source has a Quality Level (QL) associated with it which gives the accuracy of the clock. This QL information is transmitted across the network using ESMC or SSMS contained in the SDH frames. This provides information about the best available source the devices in the system can synchronize to. To define a predefined network synchronization flow and prevent timing loops, you can assign priority values to the sources on each router. The combination of QL information and user-assigned priority levels allow each router to choose a source to synchronize its SyncE or SDH interfaces, as described in the ITU standard G.781.

A Selection Point is any point where a choice is made between several frequency signals and possibly one or many of them are selected. Selection points form a graph representing the flow of timing signals between different cards in a router running Cisco IOS XR software. For example, there can be one or many selection points between different Synchronous Ethernet inputs available on a single line card. This information is forwarded to a selection point on the RSP, to choose between the selected source from each card.

The input signals to the selection points can be:

- Received directly from a source.
- Received as the output from another selection point on the same card.
- Received as the output from a selection point on a different card.

The output of a selection point can be used in a number of ways, like:

- To drive the signals sent out of a set of interfaces.
- As input into another selection point on a card.
- As input into a selection point on an another card.

Use **show frequency synchronization selection** command to see a detailed view of the different selection points within the system.



---

**Note**

- We recommend you to configure, and enable Frequency Synchronization selection input on two interfaces per line card.
  - For link aggregation, you must configure and enable Frequency Synchronization selection input on a single bundle member.
- 

## SyncE Hardware Support Matrix

This table provides details on the hardware that supports SyncE:



**Note** The table also contains support details of upcoming releases. You can read this table in context of the current release and see relevant *Release Notes* for more information on supported features and hardware.

**Table 51: Feature History Table**

Feature Name	Release Information	Feature Description
SyncE Support on 5th Generation 10-Port 400 Gigabit Ethernet Line Cards: <ul style="list-style-type: none"> <li>• A99-10X400GE-X-SE</li> <li>• A99-10X400GE-X-TR</li> </ul>	Release 7.3.2	Frequency Synchronization is used to distribute precision frequency around a network. Frequency is synchronized accurately using Synchronized Ethernet (SyncE) in devices connected by Ethernet in a network.  SyncE is now supported on the line cards: <ul style="list-style-type: none"> <li>• A99-10X400GE-X-SE</li> <li>• A99-10X400GE-X-TR</li> </ul>
Hardware Variant	Cisco IOS XR	Cisco IOS XR 64 bit
A9K-8X100GE-L-SE/TR (10GE and 100GE)	5.3.0	6.1.1
A9K-RSP880-SE/TR	5.3.0	6.1.1
A9K-8X100GE-L-SE/TR (40-GE)	6.0.1	6.1.1
A9K-4X100GE-SE/TR	5.3.2 (100G LAN only)	6.1.1
A9K-8X100GE-SE/TR	6.0.1	
A9K-MOD400-SE/TR	6.0.1	6.2.2
A9K-MOD200-SE/TR with MPA 20x10GE and Legacy MPAs		
A9K-MOD400-SE/TR	6.1.3	6.2.2
A9K-MOD200-SE/TR with MPAs 2x100 and 1x100		
A9K-400G-DWDM-TR	5.3.3 6.0.1	
A9K-24X10GE-1G-SE/TR	6.2.1	6.3.2
A9K-48X10GE-1G-SE/TR		

Hardware Variant	Cisco IOS XR	Cisco IOS XR 64 bit
A99-RSP-SE/TR (Cisco ASR 9910 Series Routers)	6.1.4	6.3.2
RSP880-LT-SE/TR	6.2.2	6.4.1
A9K-RSP440-TR/SE Enhanced Ethernet Linecards A99-RP-SE	4.3.4	
A99-RP2-TR/SE	5.3.0	6.3.2 6.4.1
Cisco ASR 9001 Series Routers	4.3.4	
Cisco ASR 9901 Series Routers	NA	6.4.1
A99-RSP-SE/TR (Cisco ASR 9906 Series Routers)	6.3.1	6.3.2
A9K-RSP5-SE/TR	NA	6.5.15
A99-RP3-SE/TR	NA	6.5.15
A9K-8X100GE-X-TR	NA	6.5.15
A9K-16X100GE-TR	NA	6.5.15
A9K-32X100GE-TR	NA	6.5.15
A99-32X100GE-X-TR	NA	7.1.15
A9K-8HG-FLEX-SE/TR	NA	7.1.15
A9K-20HG-FLEX-SE/TR	NA	7.1.15
ASR-9903	NA	7.1.3
A9903-20HG-PEC	NA	7.1.3
A99-10X400GE-X-SE/TR	NA	7.3.2
A99-12X100GE	NA	7.4.1
A9K-4X100GE	NA	7.4.1
ASR-9902	NA	7.4.1
A9K-4HG-FLEX-SE/TR	NA	7.4.1
A99-4HG-FLEX-SE/TR	NA	7.4.1

## SyncE Restrictions

This section lists a few restrictions in configuring frequency synchronization. They are:

- On SyncE line interfaces, you can configure multiple interfaces for SyncE input. However, only one interface from each PHY gets selected as best source and programmed as SyncE input (there is no restriction on SyncE output) on the A9K-24X10GE-1G-SE/TR and A9K-48X10GE-1G-SE/TR line cards.

## Clocking Support for nV Cluster

ASR9K cluster consists of two chassis connected together to provide redundancy and to meet higher bandwidth requirements. RSP440 provides two ICS (Inter-Chassis Synchronization) interfaces on the front plate. Clocking functionality support is added to the ICS interfaces. The ICS interfaces could be used for clocking, in the absence of other methods to synchronize frequency and Time-of-day information between the two cluster racks

## nV Cluster Limitations

The limitations for the frequency synchronization support for cluster are:

- This feature is supported only on RSP440.
- The two chassis of the cluster have to be co-located. The length of the cable used for the ICS link should be less than 10 meters. This is needed to ensure the phase delay added due the length of the cable is within limits.
- SSM and QL is not supported on ICS links. SSM messages are not exchanged over the ICS interface. Hence, QL value needs to be configured under ICS clock interface configuration.
- The selection of an input clock source is based on the configuration of priority, QL as well as the clock quality. For SyncE, the ICS interfaces are similar to the SyncE line interfaces as far as input clock selection is concerned.
- All Input clock sources to cluster setup has to be redundant.
- No support for 1588 BC on LAG interfaces with member links across racks.

## Inter-Chassis Synchronization (ICS)

### ICS-Frequency Synchronization

Frequency synchronization is provided using Inter-Chassis Synchronization links (ICS). These are dedicated interfaces on the RSP used to synchronize the time and frequency.

The ICS link between the Primary DSC and Backup DSC carries the clock. There is no transfer of QL information from Primary DSC to Backup DSC. The clock direction is always from Primary DSC to Backup DSC. The Primary DSC transmits the clock and Backup DSC receives the clock.

The ICS clock interface (sync 2 or sync 3) is a clock input on the Backup DSC. The clock selection algorithm for SyncE is independent on each RSP. So, output clock from the rack which has Primary DSC is the outcome

of the clock selection on the Primary DSC. The output clock from the rack which has Backup DSC is the outcome of the clock selection on the Backup DSC. If the ICS clock interface configuration is such that it is the selected clock on the Backup DSC, then the output clocks from the Primary rack and Backup rack are synchronised.

### ICS-Time-of-Day

The ICS links also carry Time of Day (ToD) information when the ICS clock interfaces are configured for the same. Only the Backup DSC can synchronise with ToD from the Primary DSC and not vice versa. The 1588 clock information transmitted on all 1588 interfaces in the cluster (including interfaces on Backup rack) is of the clock selected at the Primary DSC. Thus, it is important that ICS clock interface on Backup DSC is configured such that it is the clock which is selected for ToD on the Backup DSC.

### Recommended ICS Interface Connections

**No inter-chassis frequency or time synchronization support:**

*Figure 13: No inter-chassis frequency support*

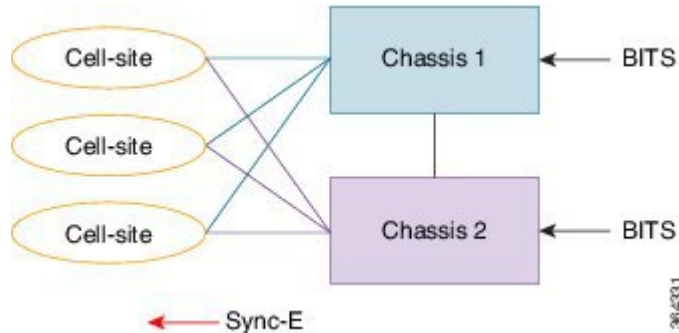

SyncE is used from the ASR9K cluster to provide precision frequency to mobile cell sites. A BITS clock is connected to each chassis of the cluster, meaning that the frequencies of both chassis are synchronized and the cell sites will all be synchronized, regardless of which chassis they synchronize to. In most deployments redundant BITS connections would be made to each chassis, to prevent against failure of any single BITS link.

**With inter-chassis synchronization support:**

*Figure 14: With inter-chassis synchronization support*

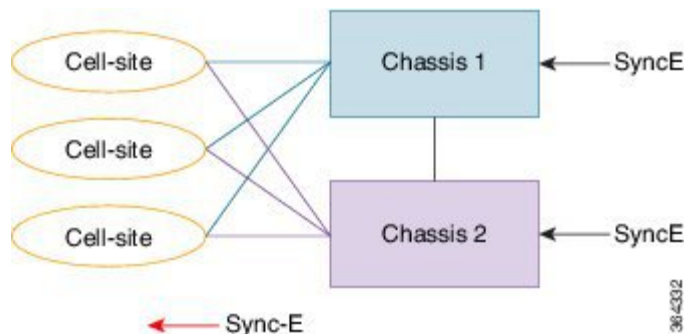

SyncE is used to synchronize the frequency of an ASR9k cluster to an upstream device. To provide redundancy in the case of one of the external SyncE inputs going down, the frequencies of the different cluster chassis

must somehow be synchronized; else cell sites which select links from different chassis to synchronize may be out of sync if one of the SyncE links goes down.

# Configuring Frequency Synchronization

## Enabling Frequency Synchronization on the Router

This task describes the router-level configuration required to enable frequency synchronization.



**Important** **Frequency synchronization** configuration is mandatory to enable any type of frequency or time source on the router. This includes SyncE, clock-interfaces, Precision Time Protocol (PTP) or internal oscillator.



**Note** If timing mode system is not configured, the major alarm `T4 PLL is in FREERUN mode` is raised. This alarm has no functional impact to the system behavior.

### SUMMARY STEPS

1. **configure**
2. **frequency synchronization**
3. **clock-interface timing-mode {independent | system}**
4. **quality itu-t option {1 | 2 generation {1 | 2}}**
5. **log selection {changes | errors}**
6. Use one of these commands:
  - **end**
  - **commit**

### DETAILED STEPS

	Command or Action	Purpose
Step 1	<b>configure</b> <b>Example:</b> <pre>RP/0/RSP0/CPU0:router# configure</pre>	Enters global configuration mode.
Step 2	<b>frequency synchronization</b> <b>Example:</b> <pre>RP/0/RSP0/CPU0:router(config)# frequency synchronization</pre>	Enables frequency synchronization on the router.
Step 3	<b>clock-interface timing-mode {independent   system}</b> <b>Example:</b>	Configures the type of timing sources that can be used to drive the output from a clock interface. If this command is

	Command or Action	Purpose
	<pre>RP/0/RSP0/CPU0:router(config-freqsync)# clock-interface timing-mode system</pre>	<p>not used, the default quality mode is used. In the default mode, the clock interface output is driven only by input from line interfaces and the internal oscillator; it is never driven by input from another clock interface. In addition, some heuristic tests are run to detect if the signal being sent out of one clock interface can be looped back by some external box and sent back in via the same, or another clock interface.</p> <ul style="list-style-type: none"> <li>• <b>independent</b>—Specifies that the output of clock interfaces is driven only by the line interfaces (SyncE and SONET/SDH), as in the default mode. Loopback detection is disabled.</li> <li>• <b>system</b>—Specifies that the output of a clock interface is driven by the system-selected timing source (the source used to drive all SyncE and SONET/SDH interfaces), including clock interfaces. Loopback detection is disabled.</li> </ul>
<b>Step 4</b>	<p><b>quality itu-t option {1   2 generation {1   2}}</b></p> <p><b>Example:</b></p> <pre>RP/0/RSP0/CPU0:router(config-freqsync)# quality itu-t option 2 generation 1</pre>	<p>(Optional) Specifies the quality level for the router. The default is <b>option 1</b>.</p> <ul style="list-style-type: none"> <li>• <b>option 1</b>—Includes PRC, SSU-A, SSU-B, SEC and DNU.</li> <li>• <b>option 2 generation 1</b>—Includes PRS, STU, ST2, ST3, SMC, ST4, RES and DUS.</li> <li>• <b>option 2 generation 2</b>—Includes PRS, STU, ST2, ST3, TNC, ST3E, SMC, ST4, PROV and DUS.</li> </ul> <p><b>Note</b> The quality option configured here must match the quality option specified in the <b>quality receive</b> and <b>quality transmit</b> commands in interface frequency synchronization configuration mode.</p>
<b>Step 5</b>	<p><b>log selection {changes   errors}</b></p> <p><b>Example:</b></p> <pre>RP/0/RSP0/CPU0:router(config-freqsync)# log selection changes</pre>	<p>Enables logging to frequency synchronization.</p> <ul style="list-style-type: none"> <li>• <b>changes</b>—Logs every time there is a change to the selected source, in addition to errors.</li> <li>• <b>errors</b>—Logs only when there are no available frequency sources, or when the only available frequency source is the internal oscillator.</li> </ul>
<b>Step 6</b>	<p>Use one of these commands:</p> <ul style="list-style-type: none"> <li>• <b>end</b></li> <li>• <b>commit</b></li> </ul>	<p>Saves configuration changes.</p> <ul style="list-style-type: none"> <li>• When you issue the <b>end</b> command, the system prompts you to commit changes:</li> </ul>



	Command or Action	Purpose
	<p><b>Example:</b></p> <pre>RP/0/RSP0/CPU0:router(config-freqsync)# end</pre> <p>or</p> <pre>RP/0/RSP0/CPU0:router(config-freqsync)# commit</pre>	<p>Uncommitted changes found, commit them before exiting(yes/no/cancel)? [cancel]:</p> <ul style="list-style-type: none"> <li>• Entering <b>yes</b> saves configuration changes to the running configuration file, exits the configuration session, and returns the router to EXEC mode.</li> <li>• Entering <b>no</b> exits the configuration session and returns the router to EXEC mode without committing the configuration changes.</li> <li>• Entering <b>cancel</b> leaves the router in the current configuration session without exiting or committing the configuration changes.</li> <li>• Use the <b>commit</b> command to save the configuration changes to the running configuration file, and remain within the configuration session.</li> </ul>

### What to do next

Configure frequency synchronization on any interfaces that should participate in frequency synchronization.

## Configuring Frequency Synchronization on an Interface

By default, there is no frequency synchronization on line interfaces. Use this task to configure an interface to participate in frequency synchronization.

### Before you begin

You must enable frequency synchronization globally on the router.

### SUMMARY STEPS

1. **configure**
2. **interface** *type interface-path-id*
3. **frequency synchronization**
4. **selection input**
5. **priority** *priority-value*
6. **wait-to-restore** *minutes*
7. **ssm disable**
8. **time-of-day-priority** *priority*
9. **quality transmit** {**exact** | **highest** | **lowest**} **itu-t option** *ql-option*
10. **quality receive** {**exact** | **highest** | **lowest**} **itu-t option** *ql-option*
11. Use one of these commands:
  - **end**
  - **commit**

## DETAILED STEPS

	Command or Action	Purpose
<b>Step 1</b>	<b>configure</b> <b>Example:</b> RP/0/RSP0/CPU0:router# configure	Enters global configuration mode.
<b>Step 2</b>	<b>interface</b> <i>type interface-path-id</i> <b>Example:</b> RP/0/RSP0/CPU0:router(config)# interface GigabitEthernet0/1/1/0	Enters interface configuration mode.
<b>Step 3</b>	<b>frequency synchronization</b> <b>Example:</b> RP/0/RSP0/CPU0:router(config-if)# frequency synchronization	Enables frequency synchronization on the interface and enters interface frequency synchronization mode to configure the various options. By default, this causes the system selected frequency signal to be used for clocking transmission, but does not enable the use of the interface as an input.
<b>Step 4</b>	<b>selection input</b> <b>Example:</b> RP/0/RSP0/CPU0:router(config-if-freqsync)# selection input	(Optional) Specifies the interface as a timing source to be passed to the selection algorithm.
<b>Step 5</b>	<b>priority</b> <i>priority-value</i> <b>Example:</b> RP/0/RSP0/CPU0:router(config-if-freqsync)# priority 100	<p>(Optional) Configures the priority of the frequency source on a controller or an interface. Values can range from 1 (highest priority) to 254 (lowest priority). The default value is 100.</p> <p>This command is used to set the priority for an interface or clock interface. The priority is used in the clock-selection algorithm to choose between two sources that have the same quality level (QL). Lower priority values are preferred.</p>
<b>Step 6</b>	<b>wait-to-restore</b> <i>minutes</i> <b>Example:</b> RP/0/RSP0/CPU0:router(config-if-freqsync)# wait-to-restore 300	(Optional) Configures the wait-to-restore time, in minutes, for frequency synchronization on an interface. This is the amount of time after the interface comes up before it is used for synchronization. Values can range from 0 to 12. The default value is 5.
<b>Step 7</b>	<b>ssm disable</b> <b>Example:</b> RP/0/RSP0/CPU0:router(config-if-freqsync)# ssm disable	<p>(Optional) Disables Synchronization Status Messages (SSMs) on the interface.</p> <ul style="list-style-type: none"> <li>• For SyncE interfaces, this disables sending ESMC packets, and ignores any received ESMC packets.</li> <li>• For SONET and clock interfaces, this causes DNUs to be sent, and ignores any received QL value.</li> </ul>

	Command or Action	Purpose
Step 8	<p><b>time-of-day-priority</b> <i>priority</i></p> <p><b>Example:</b></p> <pre>RP/0/RSP0/CPU0:router(config-if-freqsync)# time-of-day-priority 50</pre>	<p>(Optional) Specifies the priority of this time source as the time-of-day (ToD) source. The priority is used as the first criterion when selecting between sources for a time-of-day selection point. Values can range from 1 (highest priority) to 254 (lowest priority); the default value is 100.</p>
Step 9	<p><b>quality transmit</b> {<b>exact</b>   <b>highest</b>   <b>lowest</b>} <b>itu-t option</b> <i>ql-option</i></p> <p><b>Example:</b></p> <pre>RP/0/RSP0/CPU0:router(config-clk-freqsync)# quality transmit highest itu-t option 1 prc</pre>	<p>(Optional) Adjusts the QL that is transmitted in SSMs.</p> <ul style="list-style-type: none"> <li>• <b>exact</b> <i>ql</i>—Specifies the exact QL to send, unless DNU would otherwise be sent.</li> <li>• <b>highest</b> <i>ql</i>—Specifies an upper limit on the QL to be sent. If the selected source has a higher QL than the QL specified here, this QL is sent instead.</li> <li>• <b>lowest</b> <i>ql</i>—Specifies a lower limit on the QL to be sent. If the selected source has a lower QL than the QL specified here, DNU is sent instead.</li> </ul> <p>The quality option specified in this command must match the globally-configured quality option in the <b>quality itu-t option</b> command.</p> <p><b>Note</b> For clock interfaces that do not support SSM, only the lowest QL can be specified. In this case, rather than sending DNU, the output is squelched, and no signal is sent.</p>
Step 10	<p><b>quality receive</b> {<b>exact</b>   <b>highest</b>   <b>lowest</b>} <b>itu-t option</b> <i>ql-option</i></p> <p><b>Example:</b></p> <pre>RP/0/RSP0/CPU0:router(config-clk-freqsync)# quality receive highest itu-t option 1 prc</pre>	<p>(Optional) Adjusts the QL value that is received in SSMs, before it is used in the selection algorithm.</p> <ul style="list-style-type: none"> <li>• <b>exact</b> <i>ql</i>—Specifies the exact QL regardless of the value received, unless the received value is DNU.</li> <li>• <b>highest</b> <i>ql</i>—Specifies an upper limit on the received QL. If the received value is higher than this specified QL, this QL is used instead.</li> <li>• <b>lowest</b> <i>ql</i>—Specifies a lower limit on the received QL. If the received value is lower than this specified QL, DNU is used instead.</li> </ul> <p>The quality option specified in this command must match the globally-configured quality option in the <b>quality itu-t option</b> command.</p> <p><b>Note</b> For clock interfaces that do not support SSM, only the exact QL can be specified.</p>
Step 11	<p>Use one of these commands:</p> <ul style="list-style-type: none"> <li>• <b>end</b></li> <li>• <b>commit</b></li> </ul>	<p>Saves configuration changes.</p> <ul style="list-style-type: none"> <li>• When you issue the <b>end</b> command, the system prompts you to commit changes:</li> </ul>

	Command or Action	Purpose
	<p><b>Example:</b></p> <pre>RP/0/RSP0/CPU0:router(config-if-freqsync)# end</pre> <p>or</p> <pre>RP/0/RSP0/CPU0:router(config-if-freqsync)# commit</pre>	<p>Uncommitted changes found, commit them before exiting(yes/no/cancel)? [cancel]:</p> <ul style="list-style-type: none"> <li>• Entering <b>yes</b> saves configuration changes to the running configuration file, exits the configuration session, and returns the router to EXEC mode.</li> <li>• Entering <b>no</b> exits the configuration session and returns the router to EXEC mode without committing the configuration changes.</li> <li>• Entering <b>cancel</b> leaves the router in the current configuration session without exiting or committing the configuration changes.</li> <li>• Use the <b>commit</b> command to save the configuration changes to the running configuration file, and remain within the configuration session.</li> </ul>

## Configuring Frequency Synchronization on a Clock Interface

To enable a clock interface to be used as frequency input or output, you must configure the port parameters and frequency synchronization, as described in this task.



**Note** The configuration on clock interfaces must be the same for corresponding clock interfaces across all RSPs to avoid changes in frequency synchronization behavior in the event of an RSP switchover.

### SUMMARY STEPS

1. **configure**
2. **clock-interface sync** *port-no location node-id*
3. **port-parameters** {**bits-input** *mode* | **bits-output** *mode* | **dti**}
4. **ics**
5. **frequency synchronization**
6. **selection input**
7. **priority** *priority-value*
8. **wait-to-restore** *minutes*
9. **ssm disable**
10. **time-of-day-priority** *priority*
11. **quality transmit** {**exact** | **highest** | **lowest**} **itu-t option** *ql-option*
12. **quality receive** {**exact** | **highest** | **lowest**} **itu-t option** *ql-option*
13. Use one of these commands:
  - **end**

- **commit**

## DETAILED STEPS

	Command or Action	Purpose
<b>Step 1</b>	<b>configure</b> <b>Example:</b> RP/0/RSP0/CPU0:router# configure	Enters global configuration mode.
<b>Step 2</b>	<b>clock-interface sync port-no location node-id</b> <b>Example:</b> RP/0/RSP0/CPU0:router(config)# clock-interface sync 2 location 0/2/0	Enters clock interface configuration mode to configure the clock interface.
<b>Step 3</b>	<b>port-parameters {bits-input mode   bits-output mode   dti}</b> <b>Example:</b> RP/0/RSP0/CPU0:router(config-clock-if)# port-parameters dti	Specifies the type of external clock source for the clock interface. Options are BITS RX, BITS TX or DTI. The possible <i>mode</i> values for BITS interfaces are <b>2m</b> , <b>6m-output-only</b> , <b>e1</b> or <b>t1</b> .
<b>Step 4</b>	<b>ics</b> <b>Example:</b> RP/0/RSP0/CPU0:router(config)# ics	Enables chassis synchronization.
<b>Step 5</b>	<b>frequency synchronization</b> <b>Example:</b> RP/0/RSP0/CPU0:router(config-clock-if)# frequency synchronization RP/0/RSP0/CPU0:router(config-clk-freqsync)#	Enters clock interface frequency synchronization mode to configure frequency synchronization parameters.  <b>Note</b> The remaining steps in this task are the same as those used to configure the interface frequency synchronization.
<b>Step 6</b>	<b>selection input</b> <b>Example:</b> RP/0/RSP0/CPU0:router(config-if-freqsync)# selection input	(Optional) Specifies the interface as a timing source to be passed to the selection algorithm.
<b>Step 7</b>	<b>priority priority-value</b> <b>Example:</b> RP/0/RSP0/CPU0:router(config-if-freqsync)# priority 100	(Optional) Configures the priority of the frequency source on a controller or an interface. Values can range from 1 (highest priority) to 254 (lowest priority). The default value is 100.  This command is used to set the priority for an interface or clock interface. The priority is used in the clock-selection algorithm to choose between two sources that have the same quality level (QL). Lower priority values are preferred.

	Command or Action	Purpose
<b>Step 8</b>	<p><b>wait-to-restore</b> <i>minutes</i></p> <p><b>Example:</b></p> <pre>RP/0/RSP0/CPU0:router(config-if-freqsync)# wait-to-restore 300</pre>	<p>(Optional) Configures the wait-to-restore time, in minutes, for frequency synchronization on an interface. This is the amount of time after the interface comes up before it is used for synchronization. Values can range from 0 to 12. The default value is 5.</p>
<b>Step 9</b>	<p><b>ssm disable</b></p> <p><b>Example:</b></p> <pre>RP/0/RSP0/CPU0:router(config-if-freqsync)# ssm disable</pre>	<p>(Optional) Disables Synchronization Status Messages (SSMs) on the interface.</p> <ul style="list-style-type: none"> <li>• For SyncE interfaces, this disables sending ESMC packets, and ignores any received ESMC packets.</li> <li>• For SONET and clock interfaces, this causes DNUs to be sent, and ignores any received QL value.</li> </ul>
<b>Step 10</b>	<p><b>time-of-day-priority</b> <i>priority</i></p> <p><b>Example:</b></p> <pre>RP/0/RSP0/CPU0:router(config-if-freqsync)# time-of-day-priority 50</pre>	<p>(Optional) Specifies the priority of this time source as the time-of-day (ToD) source. The priority is used as the first criterion when selecting between sources for a time-of-day selection point. Values can range from 1 (highest priority) to 254 (lowest priority); the default value is 100.</p>
<b>Step 11</b>	<p><b>quality transmit</b> {<b>exact</b>   <b>highest</b>   <b>lowest</b>} <b>itu-t option</b> <i>ql-option</i></p> <p><b>Example:</b></p> <pre>RP/0/RSP0/CPU0:router(config-clk-freqsync)# quality transmit highest itu-t option 1 prc</pre>	<p>(Optional) Adjusts the QL that is transmitted in SSMs.</p> <ul style="list-style-type: none"> <li>• <b>exact ql</b>—Specifies the exact QL to send, unless DNU would otherwise be sent.</li> <li>• <b>highest ql</b>—Specifies an upper limit on the QL to be sent. If the selected source has a higher QL than the QL specified here, this QL is sent instead.</li> <li>• <b>lowest ql</b>—Specifies a lower limit on the QL to be sent. If the selected source has a lower QL than the QL specified here, DNU is sent instead.</li> </ul> <p>The quality option specified in this command must match the globally-configured quality option in the <b>quality itu-t option</b> command.</p> <p><b>Note</b> For clock interfaces that do not support SSM, only the lowest QL can be specified. In this case, rather than sending DNU, the output is squelched, and no signal is sent.</p>
<b>Step 12</b>	<p><b>quality receive</b> {<b>exact</b>   <b>highest</b>   <b>lowest</b>} <b>itu-t option</b> <i>ql-option</i></p> <p><b>Example:</b></p> <pre>RP/0/RSP0/CPU0:router(config-clk-freqsync)# quality receive highest itu-t option 1 prc</pre>	<p>(Optional) Adjusts the QL value that is received in SSMs, before it is used in the selection algorithm.</p> <ul style="list-style-type: none"> <li>• <b>exact ql</b>—Specifies the exact QL regardless of the value received, unless the received value is DNU.</li> <li>• <b>highest ql</b>—Specifies an upper limit on the received QL. If the received value is higher than this specified QL, this QL is used instead.</li> </ul>

	Command or Action	Purpose
		<ul style="list-style-type: none"> <li>• <b>lowest ql</b>—Specifies a lower limit on the received QL. If the received value is lower than this specified QL, DNU is used instead.</li> </ul> <p>The quality option specified in this command must match the globally-configured quality option in the <b>quality itu-t option</b> command.</p> <p><b>Note</b> For clock interfaces that do not support SSM, only the exact QL can be specified.</p>
<b>Step 13</b>	<p>Use one of these commands:</p> <ul style="list-style-type: none"> <li>• <b>end</b></li> <li>• <b>commit</b></li> </ul> <p><b>Example:</b></p> <pre>RP/0/RSP0/CPU0:router(config-if-freqsync)# end</pre> <p>or</p> <pre>RP/0/RSP0/CPU0:router(config-if-freqsync)# commit</pre>	<p>Saves configuration changes.</p> <ul style="list-style-type: none"> <li>• When you issue the <b>end</b> command, the system prompts you to commit changes:</li> </ul> <pre>Uncommitted changes found, commit them before exiting(yes/no/cancel)? [cancel]:</pre> <ul style="list-style-type: none"> <li>• Entering <b>yes</b> saves configuration changes to the running configuration file, exits the configuration session, and returns the router to EXEC mode.</li> <li>• Entering <b>no</b> exits the configuration session and returns the router to EXEC mode without committing the configuration changes.</li> <li>• Entering <b>cancel</b> leaves the router in the current configuration session without exiting or committing the configuration changes.</li> </ul> <ul style="list-style-type: none"> <li>• Use the <b>commit</b> command to save the configuration changes to the running configuration file, and remain within the configuration session.</li> </ul>

## Configuring Clock Interface with DTI input

This procedure describes the steps involved to configure a Clock interface with DTI input.

1. To configure a clock interface, use **clock-interface sync value location node** command in the configuration mode.

```
RP/0/RSP0/CPU0:router(config)# clock-interface sync 1 location 0/RSP0/CPU0
```

2. To configure port parameters for the given clock interface, use **port-parameters dti** command in the clock-interface configuration mode.

```
RP/0/RSP0/CPU0:router(config-clock-if)# port-parameters dti
```

- To enable frequency synchronization, use **frequency synchronization** command in the clock-interface configuration mode.

```
RP/0/RSP0/CPU0:router(config-clock-if)# frequency synchronization
```

- To configure selection input for the given clock interface, use **selection input** command in the frequency-synchronization clock-configuration mode.

```
RP/0/RSP0/CPU0:router(config-clk-freqsync)# selection input
```

- To configure priority for the clock interface, use **priority number** command in the frequency-synchronization clock-configuration mode.

```
RP/0/RSP0/CPU0:router(config-clk-freqsync)# priority 1
```

- To configure wait-to-restore time for the clock interface, use **wait-to-restore number** command in the frequency-synchronization clock-configuration mode.

```
RP/0/RSP0/CPU0:router(config-clk-freqsync)# wait-to-restore 0
```

- To disable SSM packets for the clock interface, use **ssm disable** command in the frequency-synchronization clock-configuration mode.

```
RP/0/RSP0/CPU0:router(config-clk-freqsync)# ssm disable
```

- To configure quality settings for the clock interface, use **quality receive exact itu-t option number generation number PRS** command in the frequency-synchronization clock-configuration mode.

```
RP/0/RSP0/CPU0:router(config-clk-freqsync)# quality receive exact itu-t option 2 generation 2 PRS
```

### Verification

To display the current running configuration of an interface, use **show run clock-interface** command.

```
RP/0/RSP0/CPU0:router# show run clock-interface sync 1 location 0/RSP0/CPU0

clock-interface sync 1 location 0/RSP0/CPU0
port-parameters
  dti
!
frequency synchronization
  selection input
  priority 1
  wait-to-restore 0
  ssm disable
  quality receive exact itu-t option 2 generation 2 PRC
!
!RP/0/RSP0/CPU0:router#
```

## Configuring GPS Settings for a sync2 interface

This procedure describes the steps involved to configure GPS settings for a sync2 interface.



1. To configure a clock interface, use **clock-interface sync** *port-number* **location** *interface-location* command in the configuration mode.

```
RP/0/RSP0/CPU0:router(config)# clock-interface sync 2 location 0/RSP0/CPU0
```

2. To configure port parameters for the given clock interface, use **port-parameters** command in the clock-interface configuration mode.

```
RP/0/RSP0/CPU0:router(config-clock-if)# port-parameters
```

3. To configure GPS input parameters, use **gps-input tod-format gprmc pps-input ttl** command.

```
RP/0/RSP0/CPU0:router(config-clk-parms)# gps-input tod-format gprmc pps-input ttl
```

4. To return to the clock-interface configuration mode, use **exit** command.

```
RP/0/RSP0/CPU0:router(config-clk-parms)# exit
```

5. To enable frequency synchronization, use **frequency synchronization** command in the clock-interface configuration mode.

```
RP/0/RSP0/CPU0:router(config-clock-if)# frequency synchronization
```

6. To configure selection input for the given clock interface, use **selection input** command in the frequency-synchronization clock-configuration mode.

```
RP/0/RSP0/CPU0:router(config-clk-freqsync)# selection input
```

7. To configure priority for the clock interface, use **priority** *number* command in the frequency-synchronization clock-configuration mode.

```
RP/0/RSP0/CPU0:router(config-clk-freqsync)# priority 10
```

8. To configure wait-to-restore time for the clock interface, use **wait-to-restore** *number* command in the frequency-synchronization clock-configuration mode.

```
RP/0/RSP0/CPU0:router(config-clk-freqsync)# wait-to-restore 0
```

9. To disable SSM packets for the clock interface, use **ssm disable** command in the frequency-synchronization clock-configuration mode.

```
RP/0/RSP0/CPU0:router(config-clk-freqsync)# ssm disable
```

10. To configure quality settings for the clock interface, use **quality receive exact itu-t option** *number* **generation** *number* **PRS** command in the frequency-synchronization clock-configuration mode.

```
RP/0/RSP0/CPU0:router(config-clk-freqsync)# quality receive exact itu-t option 2 generation 2 PRS
```

## Verification

To verify the configured GPS parameters, use **show run clock-interface** command.

```
RP/0/RSP0/CPU0:router# show run clock-interface sync 2 location 0/RSP0/CPU0

clock-interface sync 2 location 0/RSP0/CPU0
port-parameters
gps-input tod-format gprmc pps-input ttl
!
```

## GPS ToD Support for NMEA

National Marine Electronics Associations (NMEA) 0183 is a standard protocol used by GPS receivers to transmit data and is responsible for creating a standard uniform interface for digital data exchange between different marine electronic products. NMEA provides protocol strings to send out GPS updates. GPRMC is one such NMEA string that provides exact data and time (Greenwich time), latitude, longitude, heading, and speed. Router receives GPS ToD messages in serial ASCII stream through the RS422 interface in three formats - NTP Type 4, Cisco, and GPRMC. The timing data is extracted from this stream.



---

**Note** Cisco ASR 9000 Series Routers can support ToD in NMEA or GPRMC format. Currently, this is supported only on RS422.

---



---

**Note** You can refer to the below support information in context of the current release and see relevant *Release Notes* for more information on supported features and hardware.

---

Supported hardware are:

- A9K-RSP440-SE/TR
- A9K-RSP880-SE/TR
- A99-RP2-SE/TR
- A9K-RSP880-LT-SE/TR
- A99-RSP-SE/TR

## Configuring ICS

This task enables inter-chassis synchronization for interfaces.

### SUMMARY STEPS

1. **configure**
2. **clock-interface sync** *port-no* **location** *node-id*
3. **port-parameters ics**
4. **frequency synchronization**
5. **selection input**
6. **priority** *priority-value*
7. **wait-to-restore** *minutes*

8. **time-of-day-priority** *priority*
9. **quality receive** { **exact** | **highest** | **lowest** } **itu-t option** *option*

## DETAILED STEPS

	Command or Action	Purpose
<b>Step 1</b>	<b>configure</b> <b>Example:</b> RP/0/RSP0/CPU0:router# configure	Enters global configuration mode.
<b>Step 2</b>	<b>clock-interface sync</b> <i>port-no location node-id</i> <b>Example:</b> RP/0/RSP0/CPU0:router(config)# clock-interface sync 2 location 1/RSP0/CPU0	Enters clock interface configuration mode to configure the clock interface.
<b>Step 3</b>	<b>port-parameters ics</b> <b>Example:</b> RP/0/RSP0/CPU0:router(config-clock-if)# port-parameters ics	Enables inter-chassis synchronization.
<b>Step 4</b>	<b>frequency synchronization</b> <b>Example:</b> RP/0/RSP0/CPU0:router(config-clock-if)# frequency synchronization RP/0/RSP0/CPU0:router(config-clk-freqsync)#	Enters clock interface frequency synchronization mode to configure frequency synchronization parameters. <b>Note</b> The remaining steps in this task are the same as those used to configure the interface frequency synchronization.
<b>Step 5</b>	<b>selection input</b> <b>Example:</b> RP/0/RSP0/CPU0:router(config-if-freqsync)# selection input	(Optional) Specifies the interface as a timing source to be passed to the selection algorithm.
<b>Step 6</b>	<b>priority</b> <i>priority-value</i> <b>Example:</b> RP/0/RSP0/CPU0:router(config-if-freqsync)# priority 100	(Optional) Configures the priority of the frequency source on a controller or an interface. Values can range from 1 (highest priority) to 254 (lowest priority). The default value is 100.  This command is used to set the priority for an interface or clock interface. The priority is used in the clock-selection algorithm to choose between two sources that have the same quality level (QL). Lower priority values are preferred.
<b>Step 7</b>	<b>wait-to-restore</b> <i>minutes</i> <b>Example:</b> RP/0/RSP0/CPU0:router(config-if-freqsync)# wait-to-restore 300	(Optional) Configures the wait-to-restore time, in minutes, for frequency synchronization on an interface. This is the amount of time after the interface comes up before it is used for synchronization. Values can range from 0 to 12. The default value is 5.

	Command or Action	Purpose
<b>Step 8</b>	<b>time-of-day-priority</b> <i>priority</i> <b>Example:</b> RP/0/RSP0/CPU0:router (config-if-freqsync) # time-of-day-priority 50	(Optional) Specifies the priority of this time source as the time-of-day (ToD) source. The priority is used as the first criterion when selecting between sources for a time-of-day selection point. Values can range from 1 (highest priority) to 254 (lowest priority); the default value is 100.
<b>Step 9</b>	<b>quality receive { exact   highest   lowest} itu-t option</b> <i>option</i> <b>Example:</b> RP/0/RSP0/CPU0:router (config-clk-freqsync) # <b>quality receive exact itu-t option 1 PRC</b>	

## Verifying the Frequency Synchronization Configuration

After performing the frequency synchronization configuration tasks, use this task to check for configuration errors and verify the configuration.

### SUMMARY STEPS

1. **show frequency synchronization configuration-errors**
2. **show frequency synchronization interfaces brief**
3. **show frequency synchronization interfaces** *node-id*
4. **show processes fsyncmgr location** *node-id*

### DETAILED STEPS

#### Step 1 **show frequency synchronization configuration-errors**

##### Example:

```
RP/0/RSP0/CPU0:router# show frequency synchronization configuration-errors

Node 0/2/CPU0:
=====
interface GigabitEthernet0/2/0/0 frequency synchronization
 * Frequency synchronization is enabled on this interface, but isn't enabled globally.

interface GigabitEthernet0/2/0/0 frequency synchronization quality transmit exact itu-t option 2
generation 1 PRS
 * The QL that is configured is from a different QL option set than is configured globally.
```

Displays any errors that are caused by inconsistencies between shared-plane (global) and local-plane (interface) configurations. There are two possible errors that can be displayed:

- Frequency Synchronization is configured on an interface (line interface or clock-interface), but is not configured globally. Refer to [Enabling Frequency Synchronization on the Router, on page 371](#)
- The QL option configured on some interface does not match the global QL option. Under an interface (line interface or clock interface), the QL option is specified using the **quality transmit** and **quality receive** commands. The value

specified must match the value configured in the global **quality itu-t option** command, or match the default (option 1) if the global **quality itu-t option** command is not configured.

Once all the errors have been resolved, meaning there is no output from the command, continue to the next step.

## Step 2 show frequency synchronization interfaces brief

### Example:

```
RP/0/RSP0/CPU0:router# show frequency synchronization interfaces brief

Flags:  > - Up                D - Down                S - Assigned for selection
        d - SSM Disabled       x - Peer timed out      i - Init state

Fl  Interface                QLrcv  QLuse  Pri  QLsnt  Source
====  =====
>Sx GigabitEthernet0/2/0/0  Fail   Fail   100  DNU    None
Dd  GigabitEthernet0/2/0/1  n/a    Fail   100  n/a    None

RP/0/RSP0/CPU0:router# show frequency synchronization clock-interfaces brief

Flags:  > - Up                D - Down                S - Assigned for selection
        d - SSM Disabled       s - Output squelched   L - Looped back

Node 0/0/CPU0:
=====
Fl  Clock Interface          QLrcv  QLuse  Pri  QLsnd  Source
====  =====
>S   Sync0                   PRC    Fail   100  SSU-B  Internal0 [0/0/CPU0]
>    Sync1                   SSU-A  Fail   100  SSU-B  Internal0 [0/0/CPU0]
>S   Internal0               n/a    SSU-B  255  n/a    None

Node 0/1/CPU0:
=====
Fl  Clock Interface          QLrcv  QLuse  Pri  QLsnd  Source
====  =====
D    Sync0                   None   Fail   100  SSU-B  Internal0 [0/1/CPU0]
D    Sync1                   None   Fail   100  SSU-B  Internal0 [0/1/CPU0]
>S   Internal0               n/a    SSU-B  255  n/a    None
```

Verifies the configuration. Note the following points:

- All line interface that have frequency synchronization configured are displayed.
  - All clock interfaces and internal oscillators are displayed.
  - Sources that have been nominated as inputs (in other words, have **selection input** configured) have ‘S’ in the Flags column; sources that have not been nominated as inputs do not have ‘S’ displayed.
- Note** Internal oscillators are always eligible as inputs.
- ‘>’ or ‘D’ is displayed in the flags field as appropriate.

If any of these items are not true, continue to the next step.

## Step 3 show frequency synchronization interfaces *node-id*

### Example:

```
RP/0/RSP0/CPU0:router# show frequency synchronization interfaces GigabitEthernet0/2/0/2
```

```
Interface GigabitEthernet0/2/0/2 (shutdown)
  Assigned as input for selection
  SSM Enabled
  Input:
    Down
    Last received QL: Failed
    Effective QL:      Failed, Priority: 100
  Output:
    Selected source:   Sync0 [0/0/CPU0]
    Selected source QL: Opt-I/PRC
    Effective QL:      Opt-I/PRC
  Next selection points: LC_INGRESS
```

```
RP/0/RSP0/CPU0:router# show frequency synchronization clock-interfaces location 0/1/CPU0
```

```
Node 0/1/CPU0:
```

```
=====
```

```
Clock interface Sync0 (Down: mode not configured)
  SSM supported and enabled
  Input:
    Down
    Last received QL: Opt-I/PRC
    Effective QL:      Failed, Priority: 100
  Output:
    Selected source:   Internal0 [0/1/CPU0]
    Selected source QL: Opt-I/SSU-B
    Effective QL:      Opt-I/SSU-B
  Next selection points: RP_SYSTEM
```

```
Clock interface Sync1 (Down: mode not configured)
  SSM supported and enabled
  Input:
    Down
    Last received QL: Opt-I/PRC
    Effective QL:      Failed, Priority: 100
  Output:
    Selected source:   Internal0 [0/1/CPU0]
    Selected source QL: Opt-I/SSU-B
    Effective QL:      Opt-I/SSU-B
  Next selection points: RP_SYSTEM
```

```
Clock interface Internal0 (Up)
  Assigned as input for selection
  Input:
    Default QL:   Opt-I/SSU-B
    Effective QL: Opt-I/SSU-B, Priority: 255
  Next selection points: RP_SYSTEM RP_CLOCK_INTF
```

Investigates issues within individual interfaces. If the clock interface is down, a reason is displayed. This may be because there is missing or conflicting platform configuration on the clock interface.

#### Step 4 show processes fsyncmgr location *node-id*

##### Example:

```
RP/0/RSP0/CPU0:router# show processes fsyncmgr location 0/0/CPU0

      Job Id: 134
      PID: 30202
  Executable path: /pkg/bin/fsyncmgr
      Instance #: 1
```

```
Version ID: 00.00.0000
  Respawn: ON
  Respawn count: 1
Max. spawns per minute: 12
  Last started: Mon Mar  9 16:30:43 2009
  Process state: Run
  Package state: Normal
  Started on config: cfg/gl/freqsync/g/a/enable
    core: MAINMEM
  Max. core: 0
  Placement: None
  startup_path: /pkg/startup/fsyncmgr.startup
  Ready: 0.133s
  Process cpu time: 1730768.741 user, -133848.-361 kernel, 1596920.380 total
-----
```

Verifies that the fsyncmgr process is running on the appropriate nodes.

---







# CHAPTER 15

## Configuring Precision Time Protocol

*Precision Time Protocol (PTP)* is a protocol that defines a method to distribute time around a network. PTP support is based on the IEEE 1588-2008 standard.

This module describes the concepts around this protocol and details the various configurations involved. For information on PTP commands, see *System Management Command Reference for Cisco ASR 9000 Series Routers*.

This module contains the following topics:

- [Overview, on page 389](#)
- [ITU-T Telecom Profiles for PTP, on page 405](#)
- [Configuring PTP, on page 410](#)
- [Configuring PTP Delay Asymmetry, on page 425](#)
- [Double Failure Clock Class Over-ride, on page 428](#)
- [PTP Holdover Traceability suppression, on page 428](#)
- [Configuration Examples, on page 429](#)

### Overview

The Precision Time Protocol (PTP), as defined in the IEEE 1588 standard, synchronizes with nanosecond accuracy the real-time clocks of the devices in a network. The clocks are organized into a server-client hierarchy. PTP identifies the port that is connected to a device with the most precise clock. This clock is referred to as the server clock. All the other devices on the network synchronize their clocks with the server and are referred to as members. Constantly-exchanged timing messages ensure continued synchronization. PTP ensures that the best available clock is selected as the source of time (the grandmaster clock) for the network and that other clocks in the network are synchronized to the grandmaster.

**Table 52: PTP Clocks**

Network Element	Description
Grandmaster (GM)	A network device physically attached to the primary time source. All clocks are synchronized to the grandmaster clock.

Network Element	Description
Ordinary Clock (OC)	<p>An ordinary clock is a 1588 clock with a single PTP port that can operate in one of the following modes:</p> <ul style="list-style-type: none"> <li>• server mode—Distributes timing information over the network to one or more client clocks, thus allowing the client to synchronize its clock to the server.</li> <li>• client mode—Synchronizes its clock to a server clock. You can enable the client mode on up to two interfaces simultaneously in order to connect to two different server clocks.</li> </ul>
Boundary Clock (BC)	<p>The device participates in selecting the best server clock and can act as the server clock if no better clocks are detected.</p> <p>Boundary clock starts its own PTP session with a number of downstream clients. The boundary clock mitigates the number of network hops and results in packet delay variations in the packet network between the Grandmaster and client.</p>
Transparent Clock (TC)	<p>A transparent clock is a device or a switch that calculates the time it requires to forward traffic and updates the PTP time correction field to account for the delay, making the device transparent in terms of time calculations.</p>

PTP consists of two parts:

- The port State machine and Best Master Clock Algorithm: This provides a method to determine the ports in the network that will remain passive (neither server nor client), run as a server (providing time to other clocks in the network), or run as clients (receiving time from other clocks in the network).
- Delay-Request/Response mechanism and a Peer-delay mechanism: This provides a mechanisms for client ports to calculate the difference between the time of their own clocks and the time of their server clock.



---

**Note** Cisco ASR 9000 Series routers do not support Peer-delay mechanism.

---

The implementation of PTP on Cisco IOS XR software is designed to operate effectively in Telecommunication networks, which are different from the networks for which PTP was originally designed.

PTP is configurable on Gigabit Ethernet interfaces (1G, 10G, 40G, and 100G), Bundle Ethernet interfaces, and sub-interfaces. PTP is not configurable on LAG Ethernet sub-interfaces.

### Frequency and Time Selection

The selection of the source to synchronize the backplane clock frequency is made by frequency synchronization, and is outside of the scope of PTP. The Announce, Sync, and Delay-request frequencies must be the same on the server and client.

### Delay-Response Mechanism

The Delay Request-response mechanism (defined in section 11.3 of IEEE Std 1588-2008) lets a client port estimate the difference between its own clock-time and the clock-time of its server. The following options are supported:

- One-step mechanism - The timestamp for a Sync message is sent in the Sync message itself.
- Two-step mechanism - The timestamp for a Sync message is sent later in a Follow-up message.

When running a port in client state, a router can send Delay-request messages and handle incoming Sync, Follow-up, and Delay-response messages. The timeout periods for both Sync and Delay-response messages are individually configurable.

### Hybrid Mode

Your router allows the ability to select separate sources for frequency and time-of-day (ToD). Frequency selection can be between any source of frequency available to the router, such as: BITS, GPS, SyncE or IEEE 1588 PTP. The ToD selection is between the source selected for frequency and PTP, if available (ToD selection is from GPS, DTI or PTP). This is known as hybrid mode, where a physical frequency source (BITS or SyncE) is used to provide frequency synchronization, while PTP is used to provide ToD synchronization.

Frequency selection uses the algorithm described in ITU-T recommendation G.871, and is described in the *Configuring Frequency Synchronization* module in this document. The ToD selection is controlled using the time-of-day priority configuration. This configuration is found under the source interface frequency synchronization configuration mode and under the global PTP configuration mode. It controls the order for which sources are selected for ToD. Values in the range of 1 to 254 are allowed, with lower numbers indicating higher priority.

### Port States

State machine indicates the behavior of each port. The possible states are:

State	Description
INIT	Port is not ready to participate in PTP.
LISTENING	First state when a port becomes ready to participate in PTP: In this state, the port listens to PTP servers for a (configurable) period of time.
PRE-MASTER	Port is ready to enter the Server state.
MASTER	Port provides timestamps for any client or boundary clocks that are listening.
UNCALIBRATED	Port receives timestamps from a server clock but, the router's clock is not yet synchronized to the server.

State	Description
SLAVE	Port receives timestamps from a server clock and the router's clock is synchronized to the server.
PASSIVE	Port is aware of a better clock than the one it would advertise if it was in server state and is not a client clock to that server clock.

## Leap Seconds

In prior releases, IOS-XR only offered a static and time-consuming solution to manage leap seconds. For every upcoming leap second inclusion, the number of leap seconds had to be hard-coded into a Software Maintenance Update (SMU) and also installed on the router for the same. It is a prolonged and tedious process to provide and install a SMU each time a new leap second is announced.

From Release 6.4.1 onward, Cisco IOS-XR supports leap-second configuration instead of SMU installations or reloads.

Time is measured using a common timescale. Leap second factor is used to adjust the current time to compensate for any drift from the common timescale. Leap seconds are introduced to dynamically adjust the UTC offset in response to leap second events. The two most relevant timescales are:

- **TAI - International Atomic Time** : This is a notional passage of time determined by weighted average of readings across a large number of atomic clocks.
- **UTC - Universal Coordinated Time** : This differs from TAI by an integer number of seconds to remain in synchronization with mean solar time. UTC is related to a notion of time called **UT1**, which represents the mean solar time at 0° longitude. Leap seconds are periodically inserted to ensure UTC and UT1 are never more than 0.9 seconds apart.

PTP uses TAI timescale. UTC time is derived using UTC offset. UTC offset and the number of seconds in the last minute of the current UTC day are sent in the PTP header of Announce messages.

UTC is calculated as: **UTC = TAI - offset**.

IOS-XR PTP implementation uses the following sources (in order of decreasing precedence) to determine the current UTC offset value:

- The current grandmaster clock, if present.
- UTC offset configuration, if present.
- The previous grandmaster clock, if one exists.
- The hardware (e.g. a locally connected GPS receiver), if available.
- Zero, indicating that no UTC offset information is available.

If any upcoming leap second (being advertised at the time synchronization with a grandmaster) is lost, that too will be applied at the appropriate time while in holdover

**Note**

- Leap seconds are generally added by including an extra second (23:59:60), either on June 30th or on December 31st.
- UTC offset is + 37 seconds, as of 01 Jan 2017.

## Multiple PTP Profile Interoperability

Communication between two different profiles was not possible previously due to various factors like, incompatible domain numbers, BMCA, or clock-class leading to drop in packets. Also, you cannot compare devices running different profiles in such configurations. For example, the domain number for G.8275.1 profile (24) is incompatible with the domain number for G.8275.2 profile (44).

Multiple PTP Profile Interoperability feature lets you develop a configuration to communicate with a peer device running a different PTP profile than the profile that is configured on the source router. This means that multiple profiles can interoperate on a single device in this implementation.

Interoperation is achieved by converting packets on ingress/egress so that it is acceptable to the profile configured on the receiving device. This prevents packet loss and allows comparison of different profiles. You can configure the interoperation using the **interop** command. Configuration details are described in a later section in this chapter. For command details, refer to Precision Time Protocol (PTP) Commands chapter in the *System Management Command Reference for Cisco ASR 9000 Series Routers* guide.

**Note**

- Multiple ingress conversions are performed for interfaces configured with multiple servers.
- Only G.8275.1 and G.8275.2 profiles can be configured to interoperate.

## PTP Support Information

This table lists different types of support information related to PTP:

Transport Media	<ul style="list-style-type: none"> <li>• UDP over IPv4</li> <li>• Ethernet</li> <li>• IPv6</li> </ul>
-----------------	---

Messages	<ul style="list-style-type: none"> <li>• Signaling</li> <li>• Announce</li> <li>• Sync</li> <li>• Follow-up</li> <li>• Delay-request</li> <li>• Delay-response</li> <li>• Management</li> </ul>
Transport Modes	<ul style="list-style-type: none"> <li>• Unicast: This is the default mode. All packets are sent as unicast messages.</li> <li>• Mixed: Announce and Sync messages are sent as multicast messages. Signaling, Delay-request, and Delay-response messages are sent as unicast messages.</li> <li>• Multicast: All packets are sent as multicast messages.</li> </ul>

## PTP Hardware Support Matrix

*Table 53: Feature History Table*

Feature Name	Release Information	Feature Description
Precision Time Protocol on 12-port 100 Gigabit Ethernet line cards, ASR 9000 5th generation 400G line cards, ASR 9902 Series Routers, and 0.8T PEC	Release 7.4.1	Support for IEEE-1588 PTP is extended to the following routers and line cards: <ul style="list-style-type: none"> <li>• A99-12X100GE</li> <li>• A9K-4X100GE</li> <li>• ASR-9902</li> <li>• A9K-8HG-FLEX-SE/TR</li> <li>• A9K-4HG-FLEX-SE</li> <li>• A9K-4HG-FLEX-TR</li> <li>• A99-4HG-FLEX-SE</li> <li>• A99-4HG-FLEX-TR</li> </ul>

Feature Name	Release Information	Feature Description
PTP support on 5th Generation 10-Port 400 Gigabit Ethernet Line Cards: <ul style="list-style-type: none"> <li>A99-10X400GE-X-SE</li> <li>A99-10X400GE-X-TR</li> </ul>	Release 7.3.2	Support for IEEE-1588 PTP is extended to the following line cards: <ul style="list-style-type: none"> <li>A99-10X400GE-X-SE</li> <li>A99-10X400GE-X-TR</li> </ul>



**Note** The table also contains support details of upcoming releases. You can read this table in context of the current release and see relevant *Release Notes* for more information on supported features and hardware.

This table provides a detailed information on the supported hardware:

Hardware Variant	1588/PTP	Cisco IOS XR	Cisco IOS XR 64 bit	Comments
A9K-8X100GE-L-SE/TR (10GE and 100GE)	Default & G.8265.1	5.3.3	6.3.2 6.4.1	PTP over Ethernet does not work on 100G ports on Cisco IOS XR until 6.4.1. Support was introduced in 6.4.1.
	G.8275.1 & G.8275.2	6.2.1	6.3.2 6.4.1	
	G.8273.2	6.2.1	6.3.2	
	PTP Multiprofile	6.5.1	6.5.1	
A9K-RSP880-SE/TR	1588/PTP	5.3.3	6.3.2	-
	Default & G.8265.1		6.4.1	
	1588/PTP	6.2.1	6.3.2	
	G.8275.1 & G.8275.2		6.4.1	
	1588/PTP	6.2.1	6.3.2	
G.8273.2		6.4.1		
	PTP Multiprofile	6.5.1	6.5.1	

Hardware Variant	1588/PTP	Cisco IOS XR	Cisco IOS XR 64 bit	Comments
A9K-8X100GE-L-SE/TR (40-GE)	1588/PTP Default & G.8265.1	6.0.1	6.3.2 6.4.1	-
	1588/PTP G.8275.1 & G.8275.2	6.2.1	6.3.2 6.4.1	
	1588/PTP G.8273.2	NA	NA	
	PTP Multiprofile	6.5.1	6.5.1	
A9K-4X100GE-SE/TR A9K-8X100GE-SE/TR	1588/PTP Default & G.8265.1	6.2.1	6.4.1	PTP over Ethernet does not work on 100G ports on Cisco IOS XR until 6.4.1. Support was introduced in 6.4.1.  In 6.2.1, only G.8275.1 PTP profile is supported on the cards; No support for G.8273.2 PTP profile.
	1588/PTP G.8275.1 & G.8275.2	6.2.1	6.4.1	
	1588/PTP G.8273.2	6.4.1	6.4.1	
	PTP Multiprofile	6.5.1	6.5.1	
A9K-MOD400-SE/TR & A9K-MOD200-SE/TR with Legacy MPAs	1588/PTP Default & G.8265.1	6.1.3	6.4.1	-
	1588/PTP G.8275.1 & G.8275.2	6.2.2	6.4.1	-
	1588/PTP G.8273.2	-	-	-
	PTP Multiprofile	6.5.1	6.5.1	-



Hardware Variant	1588/PTP	Cisco IOS XR	Cisco IOS XR 64 bit	Comments
A9K-MOD400-SE/TR & A9K-MOD200-SE/TR with MPA 20x10GE , A9K-MPA-1X100GE and A9K-MPA-2X100GE	1588/PTP Default & G.8265.1	6.1.3	6.4.1	PTP over Ethernet does not work on 100G ports on Cisco IOS XR until 6.4.1. Support was introduced in 6.4.1.  In 6.2.2, only G.8275.1 PTP profile is supported on the cards. No support for G.8273.2 PTP profile until 6.5.1.
	1588/PTP G.8275.1 & G.8275.2	6.2.2	6.4.1	
	1588/PTP G.8273.2	6.5.1	6.5.1	
	PTP Multiprofile	6.5.1	6.5.1	
A9K-24X10GE-1GSE/TR A9K-48X10GE-1GSE/TR	1588/PTP Default & G.8265.1	6.2.2 6.3.1	6.3.2	-
	1588/PTP G.8275.1 & G.8275.2	6.2.2 6.3.1	6.3.2	
	1588/PTP G.8273.2	6.3.1	6.3.2	
	PTP Multiprofile	6.5.1	6.5.1	
A99-RSP-SE/TR (Cisco ASR 9910 Series Routers)	1588/PTP Default & G.8265.1	6.3.1	6.3.2	-
	1588/PTP G.8275.1 & G.8275.2	6.3.1	6.3.2	
	1588/PTP G.8273.2	6.4.1	6.3.2	
	PTP Multiprofile	6.5.1	6.5.1	

Hardware Variant	1588/PTP	Cisco IOS XR	Cisco IOS XR 64 bit	Comments
A9K-RSP880-LT-SE/TR	1588/PTP Default & G.8265.1	6.2.2	6.4.1	-
	1588/PTP G.8275.1 & G.8275.2	6.2.2	6.4.1	
	1588/PTP G.8273.2	6.4.1	6.4.1	
	PTP Multiprofile	6.5.1	6.5.1	
A9K-RSP440-TR/SE A99-RP-SE Enhanced Ethernet Linecards	1588/PTP Default & G.8265.1	4.3.4	NA	Enhanced Ethernet linecards do not support G.8273.2 with G.8275.1 PTP profile. .
	1588/PTP G.8275.1 & G.8275.2	NA	NA	
	1588/PTP G.8273.2	NA	NA	
A99-RP2-TR/SE	1588/PTP Default & G.8265.1	5.3.3	6.3.2 6.4.1	-
	1588/PTP G.8275.1 & G.8275.2	6.2.1	6.3.2 6.4.1	
	1588/PTP G.8273.2	NA	NA	
Cisco ASR 9001 Series Routers	1588/PTP Default & G.8265.1	4.3.4	NA	Enhanced Ethernet based hardware does not support G.8273.2 with G.8275.1 PTP profile.
	1588/PTP G.8275.1 & G.8275.2	NA	NA	
	1588/PTP G.8273.2	NA	NA	

Hardware Variant	1588/PTP	Cisco IOS XR	Cisco IOS XR 64 bit	Comments
Cisco ASR 9901 Series Routers	1588/PTP Default & G.8265.1	NA	6.4.1	-
	1588/PTP G.8275.1 & G.8275.2	NA	6.4.1	
	1588/PTP G.8273.2	NA	6.6.1	
	PTP Multiprofile	NA	6.5.1	
A99-RSP-SE/TR (Cisco ASR 9906 Series Routers)	1588/PTP Default & G.8265.1	6.3.1	6.3.2	-
	1588/PTP G.8275.1 & G.8275.2	6.3.1	6.3.2	
	1588/PTP G.8273.2	6.4.1	6.3.2	
	PTP Multiprofile	6.5.1	6.5.1	
A9K-RSP5-SE	1588/PTP Default & G.8265.1	NA	6.5.15	-
	1588/PTP G.8275.2	NA	6.5.15	
	1588/PTP G.8275.1 & G.8273.2	NA	6.6.1	
	PTP Multiprofile	NA	6.5.15	
A9K-RSP5-TR	1588/PTP Default & G.8265.1	NA	6.5.15	-
	1588/PTP G.8275.2	NA	6.5.15	
	1588/PTP G.8275.1 & G.8273.2	NA	6.6.1	
	PTP Multiprofile	NA	6.5.15	

Hardware Variant	1588/PTP	Cisco IOS XR	Cisco IOS XR 64 bit	Comments
A99-RP3-SE	1588/PTP Default & G.8265.1	NA	6.5.15	-
	1588/PTP G.8275.2	NA	6.5.15	
	1588/PTP G.8275.1 & G.8273.2	NA	6.6.1	
	PTP Multiprofile	NA	6.5.15	
A99-RP3-TR	1588/PTP Default & G.8265.1	NA	6.5.15	-
	1588/PTP G.8275.2	NA	6.5.15	
	1588/PTP G.8275.1 & G.8273.2	NA	6.6.1	
	PTP Multiprofile	NA	6.5.15	
A9K-8X100GE-X-TR	1588/PTP Default & G.8265.1	NA	6.5.15	-
	1588/PTP G.8275.2	NA	6.5.15	
	1588/PTP G.8275.1 & G.8273.2	NA	6.6.1	
	PTP Multiprofile	NA	6.5.15	
A9K-16X100GE-TR	1588/PTP Default & G.8265.1	NA	6.5.15	NA
	1588/PTP G.8275.2	NA	6.5.15	
	1588/PTP G.8275.1 & G.8273.2	NA	6.6.1	
	PTP Multiprofile	NA	6.5.15	
A99-16X100GE-X-SE A99-32X100GE-TR/CM	1588/PTP Default & G.8265.1	NA	6.6.1	NA
	1588/PTP G.8275.2	NA	6.6.1	
	1588/PTP G.8275.1 & G.8273.2	NA	6.6.1	
	PTP Multiprofile	NA	6.6.1	

Hardware Variant	1588/PTP	Cisco IOS XR	Cisco IOS XR 64 bit	Comments
A9K-32X100GE-TR	1588/PTP Default & G.8265.1	NA	6.5.15	-
	1588/PTP G.8275.2	NA	6.5.15	
	1588/PTP G.8275.1 & G.8273.2	NA	6.6.1	
	PTP Multiprofile	NA	6.5.15	
Cisco ASR 9903 Series Routers	1588/PTP Default & G.8265.1	NA	7.1.3	You must configure <i>'one-step'</i> clock operation on the <i>PTP master interface</i> .
	1588/PTP G.8275.2	NA	7.1.3	
	1588/PTP G.8275.1 & G.8273.2	NA	7.1.3	
	PTP Multiprofile	NA	NA	
A9903-20HG-PEC	1588/PTP Default & G.8265.1	NA	7.1.3	
	1588/PTP G.8275.2	NA	7.1.3	
	1588/PTP G.8275.1 & G.8273.2	NA	7.1.3	
	PTP Multiprofile	NA	NA	
A9932X100GE-X-SE/TR	1588/PTP Default & G.8265.1	NA	7.1.15	
	1588/PTP G.8275.2	NA	7.1.15	
	1588/PTP G.8275.1 & G.8273.2	NA	7.1.15	
	PTP Multiprofile	NA	NA	
A9K-8HG-FLEX-SE/TR	1588/PTP Default & G.8265.1	NA	7.1.15	You must configure <i>'one-step'</i> clock operation on the <i>PTP master interface</i> .
	1588/PTP G.8275.2	NA	7.1.15	
	1588/PTP G.8275.1 & G.8273.2	NA	7.1.15	
	PTP Multiprofile	NA	NA	

Hardware Variant	1588/PTP	Cisco IOS XR	Cisco IOS XR 64 bit	Comments
A9K-20HG-FLEX-SE/TR	1588/PTP Default & G.8265.1	NA	7.1.15	You must configure 'one-step' clock operation on the <i>PTP master interface</i> .
	1588/PTP G.8275.2	NA	7.1.15	
	1588/PTP G.8275.1 & G.8273.2	NA	7.1.15	
	PTP Multiprofile	NA	NA	
A99-10X400GE-X-SE/TR	1588/PTP Default & G.8265.1	NA	7.3.2	You must configure 'one-step' clock operation on the <i>PTP master interface</i> .  Class B Performance (Applicable to 1588/PTP G.8275.1 & G.8273.2)
	1588/PTP G.8275.2	NA	7.3.2	
	1588/PTP G.8275.1 & G.8273.2	NA	7.3.2	
	PTP Multiprofile	NA	NA	
A99-12x100GE A99-12X100GE-CM	1588/PTP Default & G.8265.1	NA	7.4.1	
	1588/PTP G.8275.2	NA	7.4.1	
	1588/PTP G.8275.1 & G.8273.2	NA	7.4.1	Class B Performance
	PTP Multiprofile	NA	7.4.1	
A99-8X100GE-SE/TRCM	1588/PTP Default & G.8265.1	6.2.2	6.2.2	
A9K-8X100GE-CM	1588/PTP G.8275.2	6.2.2	6.2.2	
A9K-8X100G-LB-SE/TR	1588/PTP G.8275.1 & G.8273.2	6.2.2	6.2.2	
A9K-400G-DWDM-TR	1588/PTP G.8275.1 & G.8273.2	6.2.2	6.2.2	
A99-48X10GE-1G-SE/TR	PTP Multiprofile	6.2.2	6.2.2	
A9K-4X100GE	1588/PTP Default & G.8265.1	NA	7.4.1	
	1588/PTP G.8275.2	NA	7.4.1	
	1588/PTP G.8275.1 & G.8273.2	NA	7.4.1	Class B Performance
	PTP Multiprofile	NA	NA	

Hardware Variant	1588/PTP	Cisco IOS XR	Cisco IOS XR 64 bit	Comments
A9K-400GE-SE/TR	1588/PTP Default & G.8265.1	NA	7.4.1	
	1588/PTP G.8275.2	NA	7.4.1	
	1588/PTP G.8275.1 & G.8273.2	NA	7.4.1	Class B Performance
	PTP Multiprofile	NA	NA	
A99-400GE-SE/TR	1588/PTP Default & G.8265.1	NA	7.4.1	
	1588/PTP G.8275.2	NA	7.4.1	
	1588/PTP G.8275.1 & G.8273.2	NA	7.4.1	Class B Performance
	PTP Multiprofile	NA	NA	
ASR 9902	1588/PTP Default & G.8265.1	NA	7.4.1	Port 12 to Port 35 provides Class B Performance and requires two-step clock operation on PTP master interface Port 0 to port 11 and port 36 to port 47 provide Class C performance and requires one-step clock operation on PTP master interface.
	1588/PTP G.8275.2	NA	7.4.1	
	1588/PTP G.8275.1 & G.8273.2	NA	7.4.1	
	PTP Multiprofile	NA	NA	
ASR-9903	1588/PTP Default & G.8265.1	NA	7.4.1	You must configure <i>'one-step'</i> clock operation on the <i>PTP master interface</i> .
	1588/PTP G.8275.2	NA	7.4.1	
	1588/PTP G.8275.1 & G.8273.2	NA	7.4.1	
	PTP Multiprofile	NA	NA	

Hardware Variant	1588/PTP	Cisco IOS XR	Cisco IOS XR 64 bit	Comments
A9K-4HG-FLEX-SE/TR	1588/PTP Default & G.8265.1	NA	7.4.1	You must configure 'one-step' clock operation on the <i>PTP master interface</i> .
	1588/PTP G.8275.2	NA	7.4.1	
	1588/PTP G.8275.1 & G.8273.2	NA	7.4.1	
	PTP Multiprofile	NA	7.4.1	
A99-4HG-FLEX-SE/TR	1588/PTP Default & G.8265.1	NA	7.4.1	You must configure 'one-step' clock operation on the <i>PTP master interface</i> .
	1588/PTP G.8275.2	NA	7.4.1	
	1588/PTP G.8275.1 & G.8273.2	NA	7.4.1	
	PTP Multiprofile	NA	7.4.1	



**Note** The following 2<sup>nd</sup> generation line cards support all IEEE-1588 PTP telecom profiles (Default, G.8265.1, G.8275.2, G.8275.1, G.8273.2, and PTP Multiprofile) in Cisco IOS XR 32 bit:

**Table 54: 2nd Generation Line Cards Supporting IEEE-1588 PTP**

Hardware Variant	Hardware Variant	Hardware Variant
A9K-2X100GE-SE/TR	A9K-40GE-SE/TR	A9K-40GE-SE/TR
A9K-1X100GE-SE/TR	A9K-MOD160-SE/TR	A9K-VSM-500
A9K-36X10GE-SE/TR	A9K-MOD80-SE/TR	A9K-SIP-700
A9K-4T16GE-SE/TR	A9K-4T16GE-SE/TR	

## Restrictions

- PTP Grandmaster (GM) is not supported with all the PTP profiles.
- RSP IEEE 1588 port on RSP/RP is not supported.
- Two-step clock operation is recommended over one-step clock operation for a PTP server.
- If PTP clock operation CLI is not configured, the default clock operation is two-step on all ASR9000 hardware variants.
- Due to the difference in PTP timestamp unit, which involves the PHY injecting the timestamp instead of the NPU, you must configure PTP clock operation **one-step** on the PTP master interface of the line



cards which are explicitly specified in the [PTP Hardware Support Matrix, on page 394](#). Rest of the line cards only support PTP clock operation **two-step** on the PTP master interface.

- PTP clock operation one-step or two-step restriction is only for PTP master interface. PTP slave interface can operate in either one-step or two-step.
- Cisco ASR 9000 Series Routers do not support Class B 1 Pulse Per Second (PPS) performance with Forward Error Correction (FEC) enabled optics.
- The upgrade of TimingIC-X firmware impacts timing functionality on the ASR 9902 and ASR 9903 Routers, and 5th Generation Line Cards. You must reload the linecard after upgrade of timing firmware for proper functioning of SyncE and PTP features. Interface flapping and traffic drops are expected during this process.
- G.8275.1 and G.8275.2 profiles are not supported on Cisco ASR 9001 chassis, Cisco ASR 9000 Ethernet line cards, Cisco ASR 9000 Enhanced Ethernet line cards, and A9K-400G-DWDM-SE/TR line cards.
- As recommended in Appendix VI of ITU-T G.8275.1 document, G.8275.1 profile is supported only on Bundle Link Aggregation (LAG) member links and not supported on a bundle interface.
- G.8273.2 Telecom Boundary Clock (T-BC) performance is not supported on 40G interfaces.
- The G.8273.2 Class B performance is observed when the same type of line card is used for both PTP server and PTP client ports. Class A performance is observed when different types of line cards are used for PTP server and PTP client on T-BC.
- G.8275.2 profile is supported on Cisco ASR 9000 Series Routers. However, the performance standards of this profile are not aligned with any of the ITU-T standards because performance specifications for G.8275.2 profile has not yet been made available by ITU-T.
- Transparent Clock (TC) is not supported.
- PTP Multiprofile is not supported for G.8273.2 Class B performance.
- Platform Fault Manager (PFM) alarms for the 10MHz port are not supported on A9K-RSP5-SE, A9K-RSP5-TR, A99-RP3-SE, and A99-RP3-TR.
- Select 5th generation line cards (A9K-20HG-FLEX-xx and A9K-8HG-FLEX-xx) will support PTP Telecom Profile G.8275.2 in combination with transit G.8265.1/G.8275.2 packets, in a future version of these cards.



---

**Note** Forwarding PTP packets as IP or MPLS isn't possible without the redirecting device not being PTP-aware. If each node across the PTP path isn't performing the T-BC function, timing accuracy can't be maintained.

---

## ITU-T Telecom Profiles for PTP

Cisco IOS XR software supports ITU-T Telecom Profiles for PTP as defined in the ITU-T recommendation. A profile consists of PTP configuration options applicable only to a specific application.

Separate profiles can be defined to incorporate PTP in different scenarios based on the IEEE 1588-2008 standard. A telecom profile differs in several ways from the default behavior defined in the IEEE 1588-2008 standard and the key differences are mentioned in the subsequent sections.

The following sections describe the ITU-T Telecom Profiles that are supported for PTP.

## G.8265.1 Profile

G.8265.1 profile fulfills specific frequency-distribution requirements in telecom networks. Features of G.8265.1 profile are:

- *Clock advertisement*: G.8265.1 profile specifies changes to values used in Announce messages for advertising PTP clocks. The clock class value is used to advertise the quality level of the clock, while the other values are not used.
- *Clock Selection*: G.8265.1 profile also defines an alternate Best Master Clock Algorithm (BMCA) to select port states and clocks is defined for the profile. This profile also requires to receive Sync messages (and optionally, Delay-Response messages) to qualify a clock for selection.
- *Port State Decision*: The ports are statically configured to be Master or Slave instead of using FSM to dynamically set port states.
- *Packet Rates*: The packet rates higher than rates specified in the IEEE 1588-2008 standard are used. They are:
  - Sync/Follow-Up Packets: Rates from 128 packets-per-second to 16 seconds-per-packet.
  - Delay-Request/Delay-Response Packets: Rates from 128 packets-per-second to 16 seconds-per-packet.
  - Announce Packets: Rates from 8 packets-per-second to 64 packets-per-second.
- *Transport Mechanism*: G.8265.1 profile only supports IPv4 PTP transport mechanism.
- *Mode*: G.8265.1 profile supports transport of data packets only in unicast mode.
- *Clock Type*: G.8265.1 profile only supports Ordinary Clock-type (a clock with only one PTP port).
- *Domain Numbers*: The domain numbers that can be used in a G.8265.1 profile network ranges from 4 to 23. The default domain number is 4.
- *Port Numbers*: All PTP port numbers can only be 1 because all clocks in a this profile network are Ordinary Clocks.

G.8265.1 profile defines an alternate algorithm to select between different master clocks based on the local priority given to each master clock and their quality levels (QL). This profile also defines Packet Timing Signal Fail (PTSF) conditions to identify the master clocks that do not qualify for selection. They are:

- *PTSF-lossSync condition*: Raised for master clocks that do not receive a reliable stream of Sync and Delay-Resp messages. Cisco IOS XR software requests Sync and Delay-Resp grants for each configured master clock to track the master clock with this condition.
- *PTSF-lossAnnounce condition*: Raised for master clocks that do not receive a reliable stream of Announce messages.
- *PTSF-unusable condition*: Raised for master clocks that receives a reliable stream of Announce, Sync, and Delay-Resp messages, but not usable by slave clocks. Cisco IOS XR software does not use this condition.

### Hardware variant-specific behavior

The profile G8265.1 displays the following behavior on these hardware variants A9K-RSP5-SE, A9K-RSP5-TR, A99-RP3-SE, and A99-RP3-TR:

- Configuring either a master or slave clock type is mandatory.
- G.8265.1 is only a frequency synchronization profile and the servo state is displayed as `FREQ_LOCKED` and the PTP slave interface remains as slave. Phase synchronization is not supported.
- G.8265.1 profile supports only PTP pure mode and not PTP hybrid mode.

## G.8275.1 Profile

G.8275.1 profile fulfills the time-of-day and phase synchronization requirements in telecom networks with all network devices participating in the PTP protocol. G.8275.1 profile with SyncE provides better frequency stability for the time-of-day and phase synchronization.

Features of G.8275.1 profile are:

- *Synchronization Model*: G.8275.1 profile adopts hop-by-hop synchronization model. Each network device in the path from master to slave synchronizes its local clock to upstream devices and provides synchronization to downstream devices.
- *Clock Selection*: G.8275.1 profile also defines an alternate BMCA that selects a clock for synchronization and port state for the local ports of all devices in the network is defined for the profile. The parameters defined as a part of the BMCA are:
  - Clock Class
  - Clock Accuracy
  - Offset Scaled Log Variance
  - Priority 2
  - Clock Identity
  - Steps Removed
  - Port Identity
  - notSlave flag
  - Local Priority
- *Port State Decision*: The port states are selected based on the alternate BMCA algorithm. A port is configured to a **master-only** port state to enforce the port to be a master for multicast transport mode.
- *Packet Rates*: The nominal packet rate for Announce packets is 8 packets-per-second and 16 packets-per-second for Sync/Follow-Up and Delay-Request/Delay-Response packets.
- *Transport Mechanism*: G.8275.1 profile only supports Ethernet PTP transport mechanism.
- *Mode*: G.8275.1 profile supports transport of data packets only in multicast mode. The forwarding is done based on forwardable or non-forwardable multicast MAC address.
- *Clock Type*: G.8275.1 profile supports the following clock types:

- *Telecom Grandmaster (T-GM)*: Provides timing for other network devices and does not synchronize its local clock to other network devices.
- *Telecom Time Slave Clock (T-TSC)*: A slave clock synchronizes its local clock to another PTP clock, but does not provide PTP synchronization to any other network devices.
- *Telecom Boundary Clock (T-BC)*: Synchronizes its local clock to a T-GM or an upstream T-BC clock and provides timing information to downstream T-BC or T-TSC clocks.
- *Domain Numbers*: The domain numbers that can be used in a G.8275.1 profile network ranges from 24 to 43. The default domain number is 24.

#### Hardware variant-specific behavior

The profile G8275.1 displays the following behavior on these hardware variants A9K-RSP5-SE, A9K-RSP5-TR, A99-RP3-SE, and A99-RP3-TR:

- SyncE input is mandatory as only PTP hybrid mode is supported.
- The frequency is derived from the SyncE interface and phase adjustments are based on PTP.
- If you configure SyncE before you configure PTP, the Servo state is set to `FREQ_LOCKED` by default.
- After the Servo is in `PHASE_LOCKED` state, if the SyncE input is lost or removed, the Servo transitions to `HOLDOVER` state.
- After the Servo is in `PHASE_LOCKED` state, if the PTP input is lost or removed, the Servo transitions to `FREQ_LOCKED` state.



---

**Note** For the hardware variants A9K-8X100GE-X-TR, A9K-16X100GE-TR and A9K-32X100GE-TR you are not required to shut the 100 GE link to configure this profile.

---

## G.8275.2 Profile

G.8275.2 profile fulfills the time-of-day and phase synchronization requirements in telecom networks with partial timing support from the network. Features of G.8275.2 profile are:

- *Clock Selection*: G.8275.2 profile also defines an alternate BMCA that selects a clock for synchronization and port state for the local ports of all devices in the network is defined for the profile. The parameters defined as a part of the BMCA are:
  - Clock Class
  - Clock Accuracy
  - Offset Scaled Log Variance
  - Priority 2
  - Clock Identity
  - Steps Removed
  - Port Identity

- notSlave flag
- Local Priority



---

**Note** See ITU-T G.8275.2 document to determine the valid values for Clock Class parameter.

---

- *Port State Decision*: The port states are selected based on the alternate BMCA algorithm. A port is configured to a **master-only** port state to enforce the port to be a master for unicast transport mode.
- *Packet Rates*:
  - Synchronization/Follow-Up—minimum is one packet-per-second and maximum of 128 packets-per-second.
  - Packet rate for Announce packets—minimum of one packet-per-second and maximum of eight packets-per-second.
  - Delay-Request/Delay-Response packets—minimum is one packet-per-second and maximum of 128 packets-per-second
- *Transport Mechanism*: G.8275.2 profile supports only IPv4 and IPv6 PTP transport mechanism.
- *Mode*: G.8275.2 profile supports transport of data packets only in unicast mode.
- *Clock Type*: G.8275.2 profile supports the following clock types:
  - *Telecom Grandmaster (T-GM)*: Provides timing for other network devices and does not synchronize its local clock to other network devices.
  - *Telecom Time Slave Clock (T-TSC)*: A slave clock synchronizes its local clock to another PTP clock, but does not provide PTP synchronization to any other network devices.
  - *Telecom Boundary Clock (T-BC)*: Synchronizes its local clock to a T-GM or an upstream T-BC clock and provides timing information to downstream T-BC or T-TSC clocks.
- *Domain Numbers*: The domain numbers that can be used in a G.8275.2 profile network ranges from 44 to 63. The default domain number is 44.

### Hardware variant-specific behavior

The profile G8275.2 displays the following behavior on these hardware variants A9K-RSP5-SE, A9K-RSP5-TR, A99-RP3-SE, and A99-RP3-TR:

- Hybrid PTP and pure PTP are supported on this profile.
- The physical-layer-frequency command must be used to configure Hybrid PTP.
- To switch from Hybrid PTP to Pure PTP, you must remove the physical-layer-frequency configuration and frequency synchronization configuration to remove SyncE inputs from line card interfaces and RSP clock-interfaces.

# Configuring PTP

## Prerequisite

You must be in a user group associated with a task group that includes the proper task IDs. The command reference guides include the task IDs required for each command. If you suspect user group assignment is preventing you from using a command, contact your AAA administrator for assistance.

## PTP Interface and Profile Configuration

When a global PTP profile is attached to an interface, its values are used as default settings for that interface. When additional settings are configured under an interface itself, these settings override the defaults in that profile. When no profile is attached to an interface, the configuration on the interface is used to determine the PTP settings for that interface.

When configuring PTP, use one of the following approaches:

- Create a profile (or multiple profiles) containing all the default settings to use on all PTP interfaces. Override any settings that differ for particular interfaces by using the interface configuration under the interfaces themselves.
- Configure all settings separately for each interface, without using any global profiles. Use this approach if the interfaces do not have consistent settings, or if you are configuring only a small number of PTP interfaces.

## Configuring Frequency Synchronization and Quality Settings for PTP

This procedure describes the steps involved to configure frequency and quality settings for PTP on a router.

1. To enable frequency synchronization on the router, use **frequency synchronization** command in the configuration mode.

```
RP/0/RSP0/CPU0:router(config)# frequency synchronization
```

2. To configure ITU-T quality parameters, use **quality itu-t option generation number** command in the frequency synchronization configuration mode.

- **option 1**: Includes PRC, SSU-A, SSU-B, SEC, and DNU. This is the default option.
- **option 2 generation 1**: Includes PRS, STU, ST2, ST3, SMC, and DUS.
- **option 2 generation 2**: Includes PRS, STU, ST2, ST3, TNC, ST3E, SMC, and DUS.



---

**Note** The **quality option** configured here must match the **quality option** specified in the **quality receive** and **quality transmit** commands.

---

```
RP/0/RSP0/CPU0:router(config-freqsync)# quality itu-t
option 2 generation 2
```

## Verification

To display the frequency synchronization selection, use **show frequency synchronization selection** command.

```
RP/0/RSP0/CPU0:router# show frequency synchronization selection
Node 0/RSP1/CPU0:
=====
Selection point: T0-SEL-B (3 inputs, 1 selected)
  Last programmed 06:49:27 ago, and selection made 06:49:15 ago
  Next selection points
    SPA scoped      : None
    Node scoped     : T4-SEL-C CHASSIS-TOD-SEL
    Chassis scoped  : LC_TX_SELECT
    Router scoped   : None
  Uses frequency selection
  Used for local line interface output
  S  Input                               Last Selection Point          QL Pri Status
  == =====
  1  Sync1 [0/RSP1/CPU0]                  n/a                            PRC  1  Locked
     HundredGigE0/5/0/2                  0/5/CPU0 ETH_RXMUX 1         PRC  1  Available
     Internal0 [0/RSP1/CPU0]              n/a                            SEC 255 Available

Selection point: T4-SEL-A (1 inputs, 1 selected)
  Last programmed 06:49:27 ago, and selection made 06:49:15 ago
  Next selection points
    SPA scoped      : None
    Node scoped     : T4-SEL-C
    Chassis scoped  : None
    Router scoped   : None
  Uses frequency selection
  S  Input                               Last Selection Point          QL Pri Status
  == =====
  1  HundredGigE0/5/0/2                  0/5/CPU0 ETH_RXMUX 1         PRC  1  Available

Selection point: T4-SEL-C (2 inputs, 1 selected)
  Last programmed 06:49:15 ago, and selection made 06:49:15 ago
  Next selection points
    SPA scoped      : None
    Node scoped     : None
    Chassis scoped  : None
    Router scoped   : None
  Uses frequency selection
  Used for local clock interface output
  S  Input                               Last Selection Point          QL Pri Status
  == =====
  1  Sync1 [0/RSP1/CPU0]                  0/RSP1/CPU0 T0-SEL-B 1         PRC  1  Locked
     HundredGigE0/5/0/2                  0/RSP1/CPU0 T4-SEL-A 1         PRC  1  Available

Selection point: CHASSIS-TOD-SEL (1 inputs, 1 selected)
  Last programmed 6d04h ago, and selection made 6d04h ago
  Next selection points
    SPA scoped      : None
    Node scoped     : None
    Chassis scoped  : None
    Router scoped   : None
  Uses time-of-day selection
  S  Input                               Last Selection Point          Pri Time Status
  == =====
  1  Sync1 [0/RSP1/CPU0]                  0/RSP1/CPU0 T0-SEL-B 1         100 Yes  Available

Node 0/3/CPU0:
=====
Selection point: ETH_RXMUX (0 inputs, 0 selected)
```

```

Last programmed 9w6d ago, and selection made 9w6d ago
Next selection points
  SPA scoped      : None
  Node scoped     : None
  Chassis scoped: T0-SEL-B T4-SEL-A
  Router scoped  : None
Uses frequency selection

Selection point: LC_TX_SELECT (1 inputs, 1 selected)
Last programmed 9w6d ago, and selection made 9w6d ago
Next selection points
  SPA scoped      : None
  Node scoped     : None
  Chassis scoped: None
  Router scoped  : None
Uses frequency selection
Used for local line interface output
S  Input                               Last Selection Point           QL  Pri  Status
==  =====                               =====                       ==  ==  =====
24 Sync1 [0/RSP1/CPU0]                 0/RSP1/CPU0 T0-SEL-B 1         PRC  1  Available

Node 0/5/CPU0:
=====
Selection point: ETH_RXMUX (1 inputs, 1 selected)
Last programmed 06:49:27 ago, and selection made 06:49:27 ago
Next selection points
  SPA scoped      : None
  Node scoped     : None
  Chassis scoped: T0-SEL-B T4-SEL-A
  Router scoped  : None
Uses frequency selection
S  Input                               Last Selection Point           QL  Pri  Status
==  =====                               =====                       ==  ==  =====
1  HundredGigE0/5/0/2                  n/a                             PRC  1  Available

Selection point: LC_TX_SELECT (1 inputs, 1 selected)
Last programmed 6d04h ago, and selection made 6d04h ago
Next selection points
  SPA scoped      : None
  Node scoped     : None
  Chassis scoped: None
  Router scoped  : None
Uses frequency selection
Used for local line interface output
S  Input                               Last Selection Point           QL  Pri  Status
==  =====                               =====                       ==  ==  =====
24 Sync1 [0/RSP1/CPU0]                 0/RSP1/CPU0 T0-SEL-B 1         PRC  1  Available

```

## Configuring Global Profile

This procedure describes the steps involved to create a global configuration profile for a PTP interface that can then be assigned to any interface as required.





**Note** Prior to Cisco IOS XR Software Release 6.3.3, the default PTP timers for G2875.1 were not set to standard values. This could lead to interoperability issues with other routers running the timers with updated values. Hence, to prevent such issues arising due to difference in packet rates, you must explicitly configure the **announce interval** value to 8, **sync frequency** value to 16 and **delay-request frequency** value to 16 while configuring global g.2875.1 profile.

1. To enter the PTP configuration mode, use **ptp** command in the configuration mode.

```
RP/0/RSP0/CPU0:router(config)# ptp
```

2. To configure a PTP profile, use **profile** command in the ptp configuration mode.

```
RP/0/RSP0/CPU0:router(config-ptp)# profile tp64
```

3. To configure frequency for a Sync message for the given PTP profile, use **sync frequency rate** command in the ptp-profile configuration mode.

```
RP/0/RSP0/CPU0:router(config-ptp-profile)# sync frequency 16
```

4. To configure delay-request frequency for the given PTP profile, use **delay-request frequency rate** command in the ptp-profile configuration mode.

```
RP/0/RSP0/CPU0:router(config-ptp-profile)# delay-request frequency 16
```

### Verification

To display the configured PTP profile details, use **show run ptp** command.

```
RP/0/RSP0/CPU0:router# show run ptp
```

```
Wed Feb 28 11:16:05.943 UTC
ptp
clock
  domain 24
  profile g.8275.1 clock-type T-BC
!
profile slave
  transport ethernet
  sync frequency 16
  announce interval 1
  delay-request frequency 16
!
profile master
  transport ethernet
  sync frequency 16
  announce interval 1
  delay-request frequency 16
!
profile slave1
  transport ethernet
  sync frequency 64
  announce interval 1
  delay-request frequency 64
```

!

## Configuring PTP Slave Interface

This procedure describes the steps involved to configure a PTP interface to be a Slave.

1. To configure an interface, use **interface** *type interface-path-id* command in the configuration mode.

```
RP/0/RSP0/CPU0:router(config)# interface TenGigE 0/1/0/5
```

2. To enter the PTP configuration mode for the given interface, use **ptp** command in the interface configuration mode.

```
RP/0/RSP0/CPU0:router(config-if)# ptp
```

3. To configure a PTP profile (or specify a previously defined profile), use **profile** *name* command in the ptp interface configuration mode.



---

**Note** Any additional commands entered in ptp-interface configuration mode overrides the global profile settings.

---

```
RP/0/RSP0/CPU0:router(config-if-ptp)# profile tp64
```

4. To configure the transport mode for all PTP messages in the given PTP profile, use **transport** *mode\_type* command in the ptp interface configuration mode.

```
RP/0/RSP0/CPU0:router(config-if-ptp)# transport ipv4
```

5. To configure timeout for PTP announce messages in the given PTP profile, use **announce** *interval interval-value* command in the ptp interface configuration mode.

```
RP/0/RSP0/CPU0:router(config-if-ptp)# announce interval 1
```

6. To configure the port state, use **port state** command in the ptp interface configuration mode.

```
RP/0/RSP0/CPU0:router(config-if-ptp)# port state slave-only
```

7. To configure IPv4 or IPv6 address for PTP master, use **master** *ipv4|ipv6 address* command in the ptp interface configuration mode.

```
RP/0/RSP0/CPU0:router(config-if-ptp)# master ipv4 192.168.2.1
```

```
RP/0/RSP0/CPU0:router(config-if-ptp)# master ipv6 2001:DB8::1
```

8. To return to the interface configuration mode, use **exit** command.

```
RP/0/RSP0/CPU0:router(config-if-ptp)# exit
```

9. To configure a gateway for the given interface, use **ipv4 address** *address mask* command in the interface configuration mode.

```
RP/0/RSP0/CPU0:router(config-if)# ipv4 address 1.7.1.2 255.255.255.0
```

### Verification

To verify the port state details, use **show run interface** *interface-name* command.

```
RP/0/RSP0/CPU0:router# show run interface TenGigE 0/1/0/5
```

```
Fri Aug 3 19:57:14.184 UTC
interface TenGigE 0/1/0/5
 ptp
  profile tp64
  transport ipv4
  port state slave-only
  master ipv4 192.168.2.1
  !
  announce interval 1
  !
  ipv4 address 1.7.1.1 255.255.255.0
  !
```

## Configuring PTP Master Interface

This procedure describes the steps involved to configure a PTP interface to be a Master.

1. To configure an interface, use **interface** *type interface-path-id* command in the configuration mode.

```
RP/0/RSP0/CPU0:router(config)# interface TenGigE 0/1/0/5
```

2. To enter the PTP configuration mode for the given interface, use **ptp** command in the interface configuration mode.

```
RP/0/RSP0/CPU0:router(config-if)# ptp
```

3. To configure a PTP profile (or specify a previously defined profile), use **profile** *name* command in the ptp interface configuration mode.



---

**Note** Any additional commands entered in PTP interface configuration mode override settings in this profile.

---

```
RP/0/RSP0/CPU0:router(config-if-ptp)# profile tp64
```

4. To configure the transport mode for all PTP messages in the given PTP profile, use **transport** *mode\_type* command in the ptp interface configuration mode.

```
RP/0/RSP0/CPU0:router(config-if-ptp)# transport ipv4
```

5. To configure timeout for PTP announce messages in the given PTP profile, use **announce interval** *interval-value* command in the ptp interface configuration mode.

```
RP/0/RSP0/CPU0:router(config-if-ptp)# announce interval 1
```

- To return to the interface configuration mode, use **exit** command.

```
RP/0/RSP0/CPU0:router(config-if-ptp)# exit
```

- To configure a gateway for the given interface, use **ipv4 address address mask** command in the interface configuration mode.

```
RP/0/RSP0/CPU0:router(config-if)# ipv4 address 1.7.1.2 255.255.255.0
```

### Verification

To verify the port state details, use **show run interface interface-name** command.

```
RP/0/RSP0/CPU0:router# show run interface TenGigE 0/1/0/5

Fri Aug  3 13:57:44.366 PST
interface TenGigE 0/1/0/5
 ptp
  profile tp64
  transport ipv4
  !
 announce interval 1
  !
 ipv4 address 1.7.1.2 255.255.255.0
  !
```

## Configuring PTP Hybrid Mode

This procedure describes the steps involved to configure router in a hybrid mode. You can do this by selecting PTP for Time-of-Day (ToD) and another source for frequency.

- To enable frequency synchronization on the router, use **frequency synchronization** command in the configuration mode.

```
RP/0/RSP0/CPU0:router(config)# frequency synchronization
```

- To configure a SyncE source, create an interface to be a SyncE input. This can be configured using **interface** command in the configuration mode.



---

**Note** The time-of-day-priority setting specifies that SyncE to be used as a ToD source if there is no source available with a lower priority.

---

```
RP/0/RSP0/CPU0:router(config)# interface GigabitEthernet 0/1/0/0
RP/0/RSP0/CPU0:router(config-if)# frequency synchronization
RP/0/RSP0/CPU0:router(config-if-freqsync)# selection input
RP/0/RSP0/CPU0:router(config-if-freqsync)# time-of-day-priority 100
RP/0/RSP0/CPU0:router(config-if-freqsync)# commit
```

- To configure PTP as the source for ToD, enable PTP on the router using **ptp** command in command in the configuration mode. ToD priority values can range from 1 (highest priority) to 254 (lowest priority).

```
RP/0/RSP0/CPU0:router(config)# ptp
RP/0/RSP0/CPU0:router(config-ptp)# time-of-day-priority 1
RP/0/RSP0/CPU0:router(config)# commit
```

4. To configure a PTP interface, use **interface** command in configuration mode. To enable this interface as a PTP Master, use **master** command in ptp-interface configuration mode.

```
RP/0/RSP0/CPU0:router(config)# interface gigabitEthernet 0/1/0/1
RP/0/RSP0/CPU0:router(config-if)# ipv4 address 10.0.0.1/24
RP/0/RSP0/CPU0:router(config-if)# ptp
RP/0/RSP0/CPU0:router(config-if-ptp)# master ipv4 10.0.0.2
RP/0/RSP0/CPU0:router(config-if-ptp)# commit
```

## Verification

To display the frequency synchronization selection, use **show frequency synchronization selection** command.

```
RP/0/RSP0/CPU0:router# show frequency synchronization selection
Node 0/RSP1/CPU0:
=====
Selection point: T0-SEL-B (3 inputs, 1 selected)
  Last programmed 06:49:27 ago, and selection made 06:49:15 ago
  Next selection points
    SPA scoped      : None
    Node scoped     : T4-SEL-C CHASSIS-TOD-SEL
    Chassis scoped: LC_TX_SELECT
    Router scoped  : None
  Uses frequency selection
  Used for local line interface output
  S  Input                               Last Selection Point          QL  Pri  Status
  == =====
  1  Sync1 [0/RSP1/CPU0]                  n/a                            PRC  1   Locked
     HundredGigE0/5/0/2                  0/5/CPU0 ETH_RXMUX 1         PRC  1   Available
     Internal0 [0/RSP1/CPU0]              n/a                            SEC  255 Available

Selection point: T4-SEL-A (1 inputs, 1 selected)
  Last programmed 06:49:27 ago, and selection made 06:49:15 ago
  Next selection points
    SPA scoped      : None
    Node scoped     : T4-SEL-C
    Chassis scoped: None
    Router scoped  : None
  Uses frequency selection
  S  Input                               Last Selection Point          QL  Pri  Status
  == =====
  1  HundredGigE0/5/0/2                  0/5/CPU0 ETH_RXMUX 1         PRC  1   Available

Selection point: T4-SEL-C (2 inputs, 1 selected)
  Last programmed 06:49:15 ago, and selection made 06:49:15 ago
  Next selection points
    SPA scoped      : None
    Node scoped     : None
    Chassis scoped: None
    Router scoped  : None
  Uses frequency selection
  Used for local clock interface output
  S  Input                               Last Selection Point          QL  Pri  Status
  == =====
```

```

1 Sync1 [0/RSP1/CPU0]          0/RSP1/CPU0 T0-SEL-B 1      PRC    1 Locked
  HundredGigE0/5/0/2          0/RSP1/CPU0 T4-SEL-A 1      PRC    1 Available

Selection point: CHASSIS-TOD-SEL (1 inputs, 1 selected)
Last programmed 6d04h ago, and selection made 6d04h ago
Next selection points
  SPA scoped      : None
  Node scoped     : None
  Chassis scoped: None
  Router scoped  : None
Uses time-of-day selection
S  Input                Last Selection Point      Pri  Time  Status
== =====
1  Sync1 [0/RSP1/CPU0]  0/RSP1/CPU0 T0-SEL-B 1    100  Yes   Available

Node 0/3/CPU0:
=====
Selection point: ETH_RXMUX (0 inputs, 0 selected)
Last programmed 9w6d ago, and selection made 9w6d ago
Next selection points
  SPA scoped      : None
  Node scoped     : None
  Chassis scoped: T0-SEL-B T4-SEL-A
  Router scoped  : None
Uses frequency selection

Selection point: LC_TX_SELECT (1 inputs, 1 selected)
Last programmed 9w6d ago, and selection made 9w6d ago
Next selection points
  SPA scoped      : None
  Node scoped     : None
  Chassis scoped: None
  Router scoped  : None
Uses frequency selection
Used for local line interface output
S  Input                Last Selection Point      QL  Pri  Status
== =====
24 Sync1 [0/RSP1/CPU0]  0/RSP1/CPU0 T0-SEL-B 1    PRC    1 Available

Node 0/5/CPU0:
=====
Selection point: ETH_RXMUX (1 inputs, 1 selected)
Last programmed 06:49:27 ago, and selection made 06:49:27 ago
Next selection points
  SPA scoped      : None
  Node scoped     : None
  Chassis scoped: T0-SEL-B T4-SEL-A
  Router scoped  : None
Uses frequency selection
S  Input                Last Selection Point      QL  Pri  Status
== =====
1  HundredGigE0/5/0/2  n/a                       PRC    1 Available

Selection point: LC_TX_SELECT (1 inputs, 1 selected)
Last programmed 6d04h ago, and selection made 6d04h ago
Next selection points
  SPA scoped      : None
  Node scoped     : None
  Chassis scoped: None
  Router scoped  : None
Uses frequency selection
Used for local line interface output
S  Input                Last Selection Point      QL  Pri  Status
== =====

```

```
24 Sync1 [0/RSP1/CPU0]          0/RSP1/CPU0 T0-SEL-B 1      PRC      1 Available
```

## Configuring Leap Seconds

This procedure describes the steps involved in leap second configuration. The configuration can be executed in two ways:

- By directly providing the **UTC offset value** in the command.
- By providing the path to a **file** in the command, where the UTC offset information is stored (or available).

1. To enter the PTP configuration mode, use **ptp** command in the configuration mode.

```
RP/0/RSP0/CPU0:router(config)# ptp
```

2. To configure the UTC offset information by providing the offset value directly, use **{ utc-offset {baseline | date } {offset-value} }** command in the ptp configuration mode.

- Using the **baseline** keyword, enter a positive number for the *offset-value* (it is assumed that a negative UTC offset will not be required).
- **OR** provide a date (in YYYY-MM-DD format) and the *offset-value*. UTC offset used by PTP will be updated on this date. If you do not specify a date, the configuration is applied for the current day, at midnight.



---

**Note** In both cases, providing the UTC *offset-value* directly in the command is mandatory.

---

```
RP/0/RSP0/CPU0:router(config-ptp)# utc-offset baseline 37
```

```
RP/0/RSP0/CPU0:router(config-ptp)# utc-offset 2018-07-01 38
```

3. To configure UTC offset information by providing the path to a file containing the UTC offset information, use **{ utc-offset leap-second-file {file-path} } [ poll-frequency days ]** command in the ptp configuration mode. Optionally, you can provide a polling frequency in days, at which to poll the file for changes. If a frequency for polling is not specified, the file will be polled on the day the file is set to expire.



---

**Note** The format of this file must be based on the canonical list present at <http://www.ietf.org/timezones/data/leap-seconds.list>.

---

```
RP/0/RSP0/CPU0:router(config-ptp)# utc-offset leap-second-file http://<remote-url>
```

```
RP/0/RSP0/CPU0:router(config-ptp)# utc-offset leap-second-file file://<local-path>
poll-frequency 7
```

### Verification

To display the current UTC offset value, use **show ptp utc-offset** command.

```
RP/0/RSP0/CPU0:router# show ptp utc-offset

Current offset: +36 seconds (not valid)
Pending leap seconds:
  From 2017-01-01 offset will be +37 seconds
  From 2018-07-01 offset will be +38 second
  From 2019-07-01 offset will be +39 seconds
Source: User-configured
```

To display the current UTC offset value and related details, use **show ptp utc-offset detail** command.

```
RP/0/RSP0/CPU0:router# show ptp utc-offset detail

Current offset: +36 seconds (valid)
Known leap seconds:
From 1996-01-01 offset was +30 seconds
From 1997-07-01 offset was +31 seconds
From 1999-01-01 offset was +32 seconds
From 2006-01-01 offset was +33 seconds
From 2009-01-01 offset was +34 seconds
From 2012-07-01 offset was +35 seconds
From 2015-07-01 offset was +36 seconds
From 2017-01-01 offset will be +37 seconds
Source: file:///test/xxxuser/leapsec/test/list-leap-seconds.list
Expiry date: 2017-12-28
```

## Configuring Multiple PTP Profile Interoperability

This procedure describes the steps involved in configuring interoperability for PTP profiles.

1. To configure an interface and then enter the PTP configuration mode, use **interface** and **ptp** commands respectively.

```
RP/0/RSP0/CPU0:router(config)# interface tenGigE 0/0/0/9

RP/0/RSP0/CPU0:router(config-if)# ptp
```

2. To configure PTP profile, use **profile** command in the interface-ptp configuration mode.

```
RP/0/RSP0/CPU0:router(config-if-ptp)# profile interop-slave
```

3. To configure interoperability, use **interop** command in the interface-ptp configuration mode.

```
RP/0/RSP0/CPU0:router(config-if-ptp)# interop
```

4. To configure the Telecom profile and domain number to interoperate with, use **profile {profile-type}** and **domain domain-number** commands in the interface-ptp-interop configuration mode.

```
RP/0/RSP0/CPU0:router(config-if-ptp-interop)# profile g.8275.2

RP/0/RSP0/CPU0:router(config-if-ptp-interop)# domain 44
```



- To enable conversion of packets on ingress, use **ingress-conversion** command in the interface-ptp-interop configuration mode. The **ingress-conversion** command, converts the packets received from the incoming Announce messages.

```
RP/0/RSP0/CPU0:router(config-if-ptp-interop)#
ingress-conversion
```

- To explicitly configure the other related parameters, use the respective commands in the interop-ingress submode.



**Note** Default values are used for parameters that are not explicitly configured during ingress-conversion. For example, default values will be used for parameters like **ClockAccuracy** or **OffsetScaledLogVariance** if they are not explicitly configured.

```
RP/0/RSP0/CPU0:router(config-if-ptp-interop-ingress)#
priority1 10
priority2 10
```

- To enable conversion of packets on egress, use **egress-conversion** command in the interface-ptp-interop configuration mode. The **egress-conversion** command converts the packets sent through the outgoing Announce messages. The configuration is the same as for ingress conversion.

```
RP/0/RSP0/CPU0:router(config-if-ptp-interop)#
egress-conversion
```

### Verification

To display the interop conversions, use **show ptp interop** command.

```
RP/0/RSP0/CPU0:router# show ptp interop tenGigE 0/0/0/9
Egress Conversions:
  Profile:                Default -> G.8275.2
  Domain:                 0 -> 10
  Priority1:              1 -> 128
  Priority2:              100 -> 100
  ClockClass:            52 -> 140
  ClockAccuracy:         0 -> 0x21
  OffsetScaledLogVariance: 0 -> 0x4e5d

Ingress Conversions:
  Profile:                G.8275.2 -> Default
  Domain:                 10 -> 0
  Master 51.51.51.51:
  Priority1:              1 -> 100
  Priority2:              2 -> 254
  ClockClass:            3 -> 13
  ClockAccuracy:         0x20 -> 0x20
  OffsetScaledLogVariance: 0x4e5d -> 0x4e5d
```

## Configuring PTP Telecom Profile Interface

This procedure describes the steps involved to create an interface for PTP ITU-T Telecom Profiles.



**Note** It is also possible to make these definitions within a global PTP profile and attach them to the interface using the profile command in PTP interface configuration mode.

1. To configure an interface, use **interface** *type interface-path-id* command in the configuration mode.

```
RP/0/RSP0/CPU0:router(config)# interface gigabitethernet 0/1/0/1
```

2. To enter the PTP configuration mode for the given interface, use **ptp** command in the interface configuration mode.

```
RP/0/RSP0/CPU0:router(config-if)# ptp
```

3. To configure a PTP profile (or specify a previously defined profile), use **profile** *name* command in the ptp-interface configuration mode.



**Note** Any additional commands entered in ptp-interface configuration mode overrides the global profile settings.

```
RP/0/RSP0/CPU0:router(config-if-ptp)# profile tele64
```

4. To configure frequency for Sync or Delay-request messages for the given ptp interface, use **sync frequency** *rate* command or **delay-request frequency** *rate* command appropriately in the ptp-interface configuration mode. The valid configurable values are **2, 4, 8, 16, 32, 64 or 128**.

```
RP/0/RSP0/CPU0:router(config-if-ptp)# sync frequency 128
```

```
RP/0/RSP0/CPU0:router(config-if-ptp)# delay-request frequency 128
```

5. To configure duration for different PTP messages, use one of the following commands in the ptp-interface configuration mode: **announce grant-duration** *duration*, **sync grant-duration** *duration*, or **delay-response grant-duration** *duration*. The duration value can be between **60 and 1000 seconds**.



**Note** This duration value represents the length of grant that is requested for a port in Slave state and represents the maximum grant-duration allowed when the port is in Master state.

```
RP/0/RSP0/CPU0:router(config-if-ptp)# announce grant-duration 120
```

```
RP/0/RSP0/CPU0:router(config-if-ptp)# sync grant-duration 120
```

```
RP/0/RSP0/CPU0:router(config-if-ptp)# delay-response grant-duration 120
```

6. To configure a timeout value, length of time by when a PTP message must be received (before PTSP-lossSync is raised), use one of the following commands in the ptp-interface configuration mode: **sync timeout** *timeout* or **delay-response timeout** *timeout*. The timeout value can be between **100 to 10000 micro seconds**.

```
RP/0/RSP0/CPU0:router(config-if-ntp)# sync timeout 120
```

```
RP/0/RSP0/CPU0:router(config-if-ntp)# delay-response timeout 120
```

- To configure a response for unicast-grant invalid-request, use **unicast-grant invalid-request {reduce | deny}** command. The response for requests with unacceptable parameters would either be denied or granted with reduced parameters.

```
RP/0/RSP0/CPU0:router(config-if-ntp)# unicast-grant
invalid-request reduce
```

- To configure IPv4 or IPv6 address for a PTP master, use **master {ipv4 | ipv6} ip-address** command in the ptp-interface configuration mode.

```
RP/0/RSP0/CPU0:router(config-if-ntp)# master ipv4 192.168.2.1
```

```
RP/0/RSP0/CPU0:router(config-if-ntp)# master ipv6 2001:DB8::1
```

- To override the clock-class received in Announce messages from the specified Master, use **clock-class class** command in the ptp-master-interface configuration mode. The class values can range from **0** to **255**.

```
RP/0/RSP0/CPU0:router(config-if-ntp-master)# clock-class 2
```

## Verification

To display the PTP interface details, use **show ptp interfaces brief** command.

```
RP/0/RSP0/CPU0:router# show ptp interfaces brief
Fri Feb 9 11:16:45.248 UTC
Intf          Port      Port      Encap      Line
Name          Number   State     State      State      Mechanism
-----
BE1           1         Slave    IPv4       up         2-step DRRM
Gi0/0/0/40   2         Master   IPv4       up         2-step DRRM
```

To verify the configured profile details, use **show run interface interface-name** command.

```
RP/0/RSP0/CPU0:router# show run interface Gi0/0/0/33

Wed Feb 28 11:49:16.940 UTC
interface GigabitEthernet0/0/0/33
 ptp
  profile slave
  multicast target-address ethernet 01-1B-19-00-00-00
  transport ethernet
  port state slave-only
  clock operation two-step
!
ipv4 address 21.1.1.2 255.255.255.0
frequency synchronization
  selection input
  priority 5
  wait-to-restore 0
!
```

## Configuring PTP Telecom Profile Clock

This procedure describes the steps involved to configure PTP clock and its settings to be consistent with ITU-T Telecom Profiles for Frequency.

1. To enter the PTP configuration mode, use **ptp** command in the configuration mode.

```
RP/0/RSP0/CPU0:router(config)# ptp
```

2. To enter the PTP-clock configuration mode, use **clock** command in the ptp-configuration mode.

```
RP/0/RSP0/CPU0:router(config-ptp)# clock
```

3. To configure the domain-number for a PTP profile, use **domain number** command in the ptp-configuration mode. The allowed domain number range for G.8265.1 profile is between **4 and 23** and the range for G.8275.1 profile is between **24 and 43**.

```
RP/0/RSP0/CPU0:router(config-ptp)# domain 24
```

4. To configure timescale, use **timescale source** command in the ptp-clock configuration mode.

```
RP/0/RSP0/CPU0:router(config-ptp-clock)# timescale PTP
```

5. To configure the time-source that will be advertised in Announce messages, use **time-source source** command in the ptp-clock configuration mode. The allowed options are: atomic-clock, GPS, hand-set, internal-oscillator, NTP, other, PTP, and terrestrial-radio.

```
RP/0/RSP0/CPU0:router(config-ptp-clock)# time-source GPS
```

6. To exit the ptp-clock configuration mode, use **exit** command.

```
RP/0/RSP0/CPU0:router(config-ptp-clock)# exit
```

7. To configure the desired telecom profile and the clock type for the profile, use **clock profile { g.8265.1 | g.8275.1 | g.8275.2 } clock-type {T-GM | T-BC | T-TSC}** command in the ptp configuration mode.



---

**Note** The **clock-selection telecom-profile** and **clock-advertisement telecom-profile** commands are deprecated from Release 6.1.2. They are replaced by the **clock profile** command.

---

```
RP/0/RSP0/CPU0:router(config-ptp)# clock profile g.8275.1 clock-type T-BC
```

### Verification

To display the configured PTP clock profile details, use **show run ptp** command.

```
RP/0/RSP0/CPU0:router# show run ptp !
ptp
clock
  domain 24
  profile g.8275.1 clock-type T-BC
!
```

```

profile slave
  sync frequency 16
  announce frequency 8
  delay-request frequency 16
!
profile master
  sync frequency 16
  announce frequency 8
  delay-request frequency 16
!
log
  servo events
  best-master-clock changes
!
!

```

To verify that PTP has been enabled on the router and the device is in LOCKED Phase, use **show ptp platform servo** command.

```
RP/0/RSP0/CPU0:router # show ptp platform servo
```

```

Fri Feb  9 11:16:54.568 UTC
Servo status: Running
Servo stat_index: 2
Device status: PHASE_LOCKED
Servo log level: 0
Phase Alignment Accuracy: 1 ns
Sync timestamp updated: 111157
Sync timestamp discarded: 0
Delay timestamp updated: 111157
Delay timestamp discarded: 0
Previous Received Timestamp T1: 1518155252.263409770  T2: 1518155252.263410517  T3:
1518155252.287008362  T4: 1518155252.287009110
Last Received Timestamp T1: 1518155252.325429435  T2: 1518155252.325430194  T3:
1518155252.348938058  T4: 1518155252.348938796
Offset from master:  0 secs, 11 nsecs
Mean path delay    :  0 secs, 748 nsecs
setTime():2  stepTime():1  adjustFreq():10413  adjustFreqTime():0
Last setTime: 1.0000000000  flag:1  Last stepTime:-736216, Last adjustFreq:465

```

## Configuring PTP Delay Asymmetry

**Table 55: Feature History Table**

Feature Name	Release Information	Description
PTP Delay Asymmetry	Release 7.3.1	Any delays on Precision Time Protocol (PTP) paths can impact PTP accuracy and in turn impact clock settings for all devices in a network. This feature allows you to configure the static asymmetry such that the delay is accounted for and the PTP synchronization remains accurate.  The <b>delay-symmetry</b> command is introduced for this feature.

Configure PTP delay asymmetry to offset the static delays on a PTP path that occur due to different route selection for forward and reverse PTP traffic. Delays can also be due to any node having different delay for ingress or egress path. These delays can impact PTP accuracy due to the asymmetry in PTP. With this feature, you can enable a higher degree of accuracy in the PTP server performance leading to better synchronization between real-time clocks of the devices in a network. Better synchronization between the clocks of different devices in a network leads to a network that performs efficiently.

Configuration of this delay asymmetry provides an option to configure static delays on a client clock for every server clock. You can configure this value in microseconds and nanoseconds. Configured PTP delay asymmetry is also synchronized with the Servo.



---

**Note** If you configure multiple PTP delay asymmetries for the same PTP profile, the latest PTP delay asymmetry that you configure is applied to the PTP profile.

---

A positive value indicates that the server-to-client propagation time is longer than the client-to-server propagation time, and conversely for negative values.

### Supported PTP Profiles

The following PTP profiles support the configuration of PTP delay asymmetry:

- PTP over IP (G8275.2 or default profile)
- PTP over L2 (G8275.1)

### Restrictions

- PTP delay asymmetry can be configured only on the PTP port of the grandmaster clock, which can either be a boundary clock or an ordinary clock.
- For G875.1 and G875.2 PTP profiles, PTP delay asymmetry is supported for both, client port and dynamic port that act as a client.
- PTP delay asymmetry is supported for fixed cable delay compensation and not for variable delay in the network.
- PTP delay asymmetry can be configured within the range of 3 microseconds and -3 microseconds or 3000 nanoseconds and -3000 nanoseconds.
- Fixed delay can be measured by using any test and measurement tool. Fixed delay can be compensated by using the positive or negative values. For example, if the fixed delay is +10 nanoseconds, configure -10 nanoseconds to compensate the fixed delay.

### Configuration

To configure PTP delay asymmetry:

1. Configure an interface with PTP.
2. Configure PTP delay asymmetry on the client side.

## Configuration Example

```
/* Configure an interface with PTP. */
Router# configure
Router(config)# interface HundredGigE 0/1/0/0
Router(config-if)# ptp

/* Configure PTP delay asymmetry on the client side. */
Router(config-if-ptp-master)# delay-asymmetry 3 microseconds
Router(config-if-ptp-master)# commit
```

## Running Configuration

```
interface preconfigure HundredGigE 0/1/0/0
  ptp
  delay-asymmetry 3 microseconds
```

## Verification

To verify if PTP delay asymmetry delay is applied, use the **show ptp foreign-masters** command:

```
Router# show ptp foreign-masters
Sun Nov 1 10:19:21.874 UTC
Interface HundredGigE0/1/0/0 (PTP port number 1)
IPv4, Address 209.165.200.225, Unicast
Configured priority: 1
Configured clock class: None
Configured delay asymmetry: 3 microseconds <----- configured variable delay asymmetry value
Announce granted: every 2 seconds, 300 seconds
Sync granted: 16 per-second, 300 seconds
Delay-resp granted: 16 per-second, 300 seconds
Qualified for 2 minutes, 45 seconds
Clock ID: 80e01dffffe8ab73f
Received clock properties:
Domain: 0, Priority1: 128, Priority2: 128, Class: 6
Accuracy: 0x22, Offset scaled log variance: 0xcd70
Steps-removed: 1, Time source: GPS, Timescale: PTP
Frequency-traceable, Time-traceable
Current UTC offset: 37 seconds (valid)
Parent properties:
Clock ID: 80e01dffffe8ab73f
Port number: 1
```

To validate the approximate compensated delay value, use the **show ptp platform servo** command:

```
Router# show ptp platform servo
Sat Nov 1 15:17:14.611 UTC
Servo status: Running
Servo stat_index: 2
Device status: PHASE_LOCKED
Servo Mode: Non Hybrid
Servo log level: 0
Phase Alignment Accuracy: -3 ns
Sync timestamp updated: 54754
Sync timestamp discarded: 0
Delay timestamp updated: 55196
Delay timestamp discarded: 0
Previous Received Timestamp T1: 1563984472.036333938 T2: 1563984472.036334935 T3:
1563984472.077066895 T4: 1563984472.077067478
Last Received Timestamp T1: 1563984472.100355188 T2: 1563984472.100356182 T3:
1563984472.139059682 T4: 1563984472.139060266
Offset from master: 0 secs, 6 microsecs <----- compensated value, showing 6
microseconds because actual fixed delay is 3 microseconds, we configured 3 microseconds and
router detected it as fixed delay and tries to compensate.
```

```

Mean path delay : 0 secs, 771 nsecs
setTime():1 stepTime():0 adjustFreq():4278
Last setTime: 1563981048.000000000 flag:0 Last stepTime:0 Last adjustFreq:51511

```

## Double Failure Clock Class Over-ride

*Table 56: Feature History Table*

Feature Name	Release Information	Feature Description
PTP Double Failure Clock Class	Release 7.7.1	<p>This feature enables you to configure a clock class that will over-ride the existing class during a state of double-failure where PTP and SyncE are lost.</p> <p>This feature introduces the <b>double-failure-clock-class</b> command.</p>

## PTP Holdover Traceability suppression

*Table 57: Feature History Table*

Feature Name	Release Information	Feature Description
PTP Holdover Traceability Suppression	Release 7.3.1	<p>When a device which is configured as a Boundary clock (T-BC) loses synchronization with a quality Primary clock, to ensure that the downstream nodes continue to receive the configured clock class for a specified duration, and it's traceable you can configure this feature.</p>

When the device loses synchronization with a quality Primary clock, to ensure the downstream nodes continue to receive the configured clock class, and it is traceable you can configure this feature.

This feature enables the device which is configured as a boundary clock (T-BC) with PTP Profiles G.8275.1 or G.8275.2 to send out the configured clock-class as holdover clock-class and the time traceability flag to be set as TRUE for the specified duration. This is to ensure the downstream nodes do not have an impact as this is a deviation from prescribed G.8275.1 ITU-T standards.



**Note**

- There will be PTP flaps during switchovers or ISSU as the PTP holdover timer is running on the active RSP.
- Once the configured holdover override duration has lapsed and the device is unable to receive quality Primary clock within this duration, the device will send the prescribed default clock class of 165 and the traceability flag will be set as FALSE to advertise loss of clock to downstream nodes.

**Configuring PTP Holdover traceability suppression**

This section describes how to configure the PTP holdover traceability suppression feature:

```
Router# config
Router(config)# ptp
Router(config-ptp)# holdover-spec-duration 1000
Router(config-ptp)# holdover-spec-clock-class 135
Router(config-ptp)# uncalibrated-traceable-override
Router(config-ptp)# holdover-spec-traceable-override
```

## Configuration Examples

### Slave Configuration Example

The following example shows a PTP slave configuration:

```
interface TenGigE 0/1/0/5
 ptp
  profile tp64
  transport ipv4
  port state slave-only
  master ipv4 1.7.1.2
  !
  announce interval 1
  !
  ipv4 address 1.7.1.1 255.255.255.0
 !
```

### Master Configuration Example

This example shows a PTP master configuration:

```
ptp
 profile tp64
 transport ipv4
 announce interval 1
 !
 ipv4 address 1.7.1.2 255.255.255.0
 !
```

## PTP Hybrid Mode Configuration Example

This example shows the configuration of PTP hybrid mode:

```
ptp
  time-of-day priority 10
  !
interface GigabitEthernet0/1/1/0
  ptp
    transport ipv4
    port state slave-only
    master ipv4 192.168.52.38
    !
    sync frequency 64
    announce interval 1
    delay-request frequency 64
    !
interface GigabitEthernet 0/1/0/1
  ipv4 address 192.168.52.41 255.255.255.0
  speed 100
  frequency synchronization
  selection input
  priority 10
  wait-to-restore 0
  ssm disable
  time-of-day-priority 100
  !
```

## ITU-T Telecom Profiles Configuration Examples

**Master global** configuration for the telecom profile:

```
-- For G.8265.1 profile --

ptp
  clock
  domain 4
  profile g.8265.1
  !
  profile master
  transport ipv4
  sync frequency 16
  announce interval 1
  delay-request frequency 16
interface gi 0/2/0/4
  ptp
  profile master
  transport ipv4
  clock operation two-step
  !
  ipv4 address 17.1.1.1/24

-- For G.8275.1 profile --

ptp
  clock
  domain 24
```

```

profile g.8275.1
!
profile master
transport ethernet
sync frequency 16
announce interval 1
delay-request frequency 16
interface gi 0/2/0/4
ptp
profile master
transport ethernet
multicast target-address ethernet 01-1B-19-00-00-00
clock operation two-step
!
ipv4 address 17.1.1.1/24

```

### Slave global configuration for the telecom profile:

-- For G.8265.1 profile --

```

ptp
clock
domain 4
profile g.8265.1
!
profile slave
transport ipv4
sync frequency 16
announce interval 1
delay-request frequency 16
interface gi 0/1/0/0
ptp
profile slave
transport ipv4
Master ipv4 18.1.1.1
port state slave-only
!
clock operation two-step
!
ipv4 address 18.1.1.2/24

```

-- For G.8275.1 profile --

```

ptp
clock
domain 24
profile g.8275.1 clock-type T-TSC
!
profile slave
transport ethernet
sync frequency 16
announce interval 1
delay-request frequency 16
interface gi 0/1/0/0
ptp
profile slave
transport ethernet
multicast target-address ethernet 01-1B-19-00-00-00
!
clock operation two-step
!

```

```
ipv4 address 18.1.1.2/24
```

```
-- For G.8275.2 profile --
```

```
ptp
clock
  domain 44
  profile g.8275.2 clock-type T-TSC
!
profile slave
  transport ipv6
  port state slave-only
  sync frequency 64
  announce frequency 8
  unicast-grant invalid-request deny
  delay-request frequency 64
!
log
  servo events
  best-master-clock changes
!
!
interface GigabitEthernet0/2/0/12
  ptp
  profile slave
  master ipv6 30::2
  !
  !
  ipv6 address 30::1/64
  !
```

**Global configuration** with clock type as T-Boundary Clock (T-BC) for the telecom profile:

```
-- For G.8275.1 profile --
```

```
ptp
clock
  domain 24
  profile g.8275.1 clock-type T-BC
!
  profile master
  transport ethernet
  sync frequency 16
  announce interval 1
  delay-request frequency 16
  exit
  profile slave
  transport ethernet
  sync frequency 16
  announce interval 1
  delay-request frequency 16
  exit
interface gi 0/2/0/4
  ptp
  profile slave
  transport ethernet
  multicast target-address ethernet 01-1B-19-00-00-00
  !
  clock operation two-step
```

```

!
ipv4 address 17.1.1.2/24
interface gi 0/2/0/0
 ptp
  profile master
  transport ethernet
  multicast target-address ethernet 01-1B-19-00-00-00
  clock operation two-step
!
ipv4 address 18.1.1.1/24

```



---

**Note** When G.8275.1 profile is configured on a 100G interface, keywords **commit replace** and **rollback config last 1** does not work and the router configuration rollback fails entirely. Use **rollback config last 1 best-effort** instead.

---

```

-- For G.8275.2 profile --
ptp
 clock
  domain 44
  profile g.8275.2 clock-type T-BC
!
profile slave
 transport ipv6
 port state slave-only
 sync frequency 64
 announce frequency 8
 unicast-grant invalid-request deny
 delay-request frequency 64
!
profile master
 transport ipv6
 sync frequency 64
 announce frequency 8
 unicast-grant invalid-request deny
 delay-request frequency 64
!
log
 servo events
 best-master-clock changes
!
!

interface GigabitEthernet0/2/0/11
 ptp
  profile master
!
 ipv6 address 30::1/64
!

interface GigabitEthernet0/2/0/12
 ptp
  profile slave
  master ipv6 40::2
!
!
 ipv6 address 40::1/64
!

```





## CHAPTER 16

# Network Synchronization Design Best Practices

---

This chapter provides guidelines and best practices to follow when designing timing requirements for your network.

- [Network Synchronization Design Best Practices, on page 435](#)

## Network Synchronization Design Best Practices

The synchronization of a network is essential for ensuring that all devices in a network run on the same clock time. It also ensures that the applications in the network function correctly. To design your network synchronization accurately, you must have a clear understanding of your network requirements, timing budget, application requirements, and the desired level of synchronization accuracy. This section describes some best practices to follow when designing your network synchronization.

## Network Synchronization Decision Tree

Use the network synchronization decision tree for determining the appropriate synchronization solution for your network deployment. Network synchronization helps in ensuring that the network operates with accurate and synchronized time.

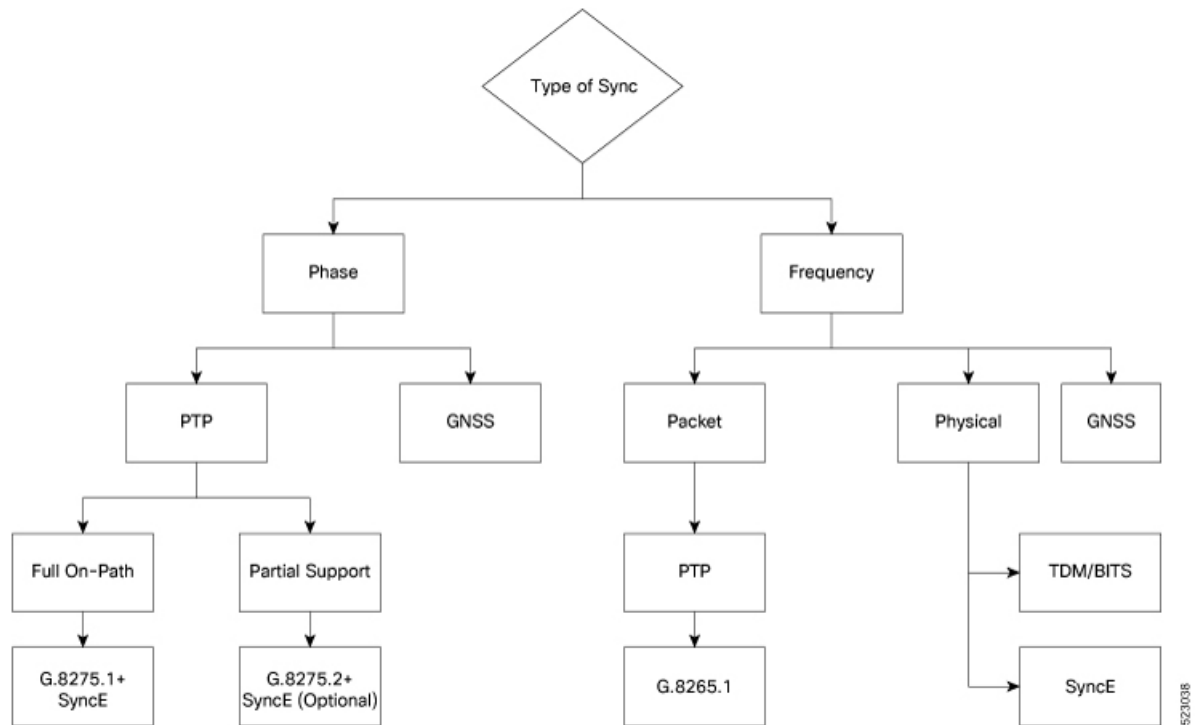

## General Guidelines for Successful Synchronization Deployments

Network synchronization is crucial for maintaining reliable and efficient network operations, ensuring data integrity, complying with regulations, and facilitating troubleshooting and management tasks. The following guidelines help in deploying successful network synchronization for your network:

- Ensure that you use a standards-based solution designed for your need. For example, use the correct profile.
- Configure the appropriate clock source for your network. It can be Global Navigation Satellite System (GNSS) based such as a Global Positioning System (GPS) clock, or a Precision Time Protocol (PTP) grandmaster clock.
  - Frequency synchronization requires Building Integrated Timing Supply (BITS) or synchronous Ethernet, and Phase synchronization requires PTP and/or GNSS.
- Use a combination of GNSS over the air and/or PTP or synchronous Ethernet over transport.

For more information on [Configuring Frequency Synchronization](#) and [Configuring Precision Time Protocol](#), refer to *System Management Configuration Guide for Cisco ASR 9000 Series Routers*.

- Set up the synchronization protocols that are required, which includes PTP, Network Time Protocol (NTP), or synchronous Ethernet.
  - NTP uses the system clock for logging events in the system, or to show clock output, whereas PTP and GNSS work on the IEEE 1588 hardware clock in the system.
  - The NTP clock of a node can't be used to synchronize the downstream network using PTP. However, a node can synchronize its NTP clock with the available PTP or GNSS clock.





---

**Note** Most NTP implementations are software-based. Software-based time synchronization is less accurate than hardware-based synchronization, but it's still useful for applications where low levels of accuracy, such as 10's or 100's of milliseconds, are acceptable.

---

- Use PTP for phase synchronization in the absence of a GNSS.
- Synchronous Ethernet (SyncE) is a recommendation from ITU Telecommunication Standardization Sector (ITU-T) on how to deliver a frequency in a network. If you require a frequency-only synchronization solution, use SyncE instead of PTP.
- Configure the appropriate synchronization profiles and preferences for your network. It might include the accuracy, priority, and other parameters that determine how your network handles synchronization events.
- Design your network for phase synchronization with optimal time error budgets.
  - Use boundary clocks to reduce time error and to reset Packet Delay Variation (PDV).
  - Ensure that PTP awareness is implemented consistently throughout, including the transport system, and that boundary clocks accurately transmit time to minimize accumulated time error.
- For phase synchronization, use a hybrid clock that incorporates both SyncE and PTP.

For more information on [Configuring PTP Hybrid Mode](#), refer to *System Management Configuration Guide for Cisco ASR 9000 Series Routers*.

- Reduce the number of hops:
  - Distribute sources of time to meet the budget. If you have too many hops, install a GNSS receiver further out into the network.
  - Don't centralize two Primary Reference Time Clocks (PRTC) and Telecom Grandmasters (T-GM) in two different locations and try to run a synchronization signal accurately across the whole network.
- Minimize Packet Delay Variation (PDV) and jitter. Ensure that microwaves, Gigabit-capable Passive Optical Networks (GPON), Digital Subscriber Line (DSL), and Dense Wavelength Division Multiplexing (DWDM) are PTP aware.
- Monitor your synchronization deployment to ensure that it's functioning correctly and meeting your desired level of accuracy.

For more information, refer to [Verifying the Frequency Synchronization Configuration](#) in the *System Management Configuration Guide for Cisco ASR 9000 Series Routers*.

- Be aware of any relevant industry standards and practices when deploying synchronization.

## Guidelines for Phase Synchronization Deployments

Follow these guidelines for phase synchronization deployments.

- Set up the necessary network infrastructure to support phase synchronization. It includes installing timing devices such as GPS receivers, synchronous Ethernet interfaces, and timing servers.

- Configure the phase synchronization protocols such as setting up PTP as appropriate.
- As best practice, use the G.8275.1 telecommunication profile standard with complete on-path support, including Layer-2 multicast in combination with SyncE.
- Minimize phase time error by performing the following tasks:
  - Remove asymmetric routing issues.
  - Reduce the number of hops, unless telecommunication grandmaster (T-GM) clocks are deployed in the preaggregation network.
  - Decrease PDV or packet jitter.
- If you use IP protocols for PTP, you can run into issues with rerouting, asymmetric routing, Equal Cost Multi-Path (ECMP), bundles, and so on.
- If you need tight timing budgets over many hops, ensure that your hardware supports the highest levels of clock accuracy.
- For GNSS deployments:
  - Meet all the requirements for cable and antenna installations.
  - Consult with a professional if you don't have experience with GNSS installation and calibration.
- Make sure that your deployment is working as intended. Monitor it regularly to identify any potential issues.
- Consult with Cisco technical support if you encounter any issues or have questions.



---

**Note** When PTP is used with MACsec, achieving high accuracy can be challenging. PTP requires exact timestamping to maintain tight network synchronization. MACsec affixes and detaches a header that is between 24–32 bytes in size. This process can lead to significant inconsistencies in the time delays between where the link is connected and the location where the egress timestamps are applied.

---

## PTP over IP Network Design

When using networks to carry frequency over Precision Time Protocol over Internet Protocol (PTPoIP), the goal is to minimize Packet Delay Variation (PDV) by reducing the number of hops. Use the following guidelines:

- The placement of the telecom grandmaster (T-GM) clock plays an important role in ensuring that the network operates within your timing budget. For example, place a pair of T-GM clocks in a centralized location only if the network has a small number of hops. In larger networks with multiple hops, it may be necessary to distribute T-GM clocks throughout the network to ensure proper timing management at each hop.
- Use a dedicated frequency synchronization protocol such as synchronous Ethernet or 1588v2, which is designed specifically to maintain precise frequency synchronization between devices.

- Use the G.8265.1 standard. Frequency synchronization using the G.8265.1 standard is a way to make sure multiple devices on a network are operating at the same frequency, allowing for more accurate and reliable communication.
- Configure Quality of Service (QoS) policies to prioritize network traffic and reduce delays. This can be done by using traffic shaping, traffic policing, and queue management.

## Selecting the Correct Profile For Network Synchronization

### G.8275.1 PTPoE

G.8275.1 is a technical specification standard for Precision Time Protocol over Ethernet (PTPoE). It defines how you can use the Precision Time Protocol (PTP) to synchronize clocks over Ethernet networks with layer 2 multicast. PTPoE is an extension of PTP that allows it to be used over Ethernet networks. It's used in applications where precise time synchronization is required.

For more information, refer to [G.8275.1 Profile](#) in the *System Management Configuration Guide for Cisco ASR 9000 Series Routers*.

### G.8275.2 PTPoIP

G.8275.2 is a technical specification standard for Precision Time Protocol over Internet Protocol (PTPoIP). It defines the use of the Precision Time Protocol (PTP) over packet-based networks such as Internet Protocol (IP) networks, to provide precise time synchronization of network devices.

For more information, refer to [G.8275.2](#) in the *System Management Configuration Guide for Cisco ASR 9000 Series Routers*.

### Feature Adaptability on Each Profile

The following table lists the adaptability of features on each profile:

Feature	G.8275.1 PTPoE	G.8275.2 PTPoIP
Network Model	Full on-path support	Partial on-path support
IP Routing	Not applicable	Can cause issues in rings and asymmetry from a number of causes
Transit Traffic	Not allowed	Can result in jitter and asymmetry
Performance	Optimal	Variable
Configuration Model	Physical port	L3 device
PTP over Bundles	No issues	Work in progress for Telecom Boundary Clocks (T-BC)
Asymmetry	Reduced due to T-BC on every node	Optimal when deployed as a Partial Support Telecom Boundary Clock (T-BC-P)

Feature	G.8275.1 PTPoE	G.8275.2 PTPoIP
PDV/Jitter	Reduced due to T-BC on every node	Optimal when deployed as a T-BC-P

## Reducing Asymmetry

Asymmetry occurs in a PTP unaware network for the following scenarios:

- When routing large networks, complex topologies, rings, and Equal-cost multi-path (ECMP)
- When using PTP unaware transit nodes, especially with varying traffic patterns
- In the transport layer such as Passive Optical Network (PON), cable, DWDM, and complex optics



---

**Note** Every 2 seconds of asymmetry results in 1 microsecond of time error.

---

To reduce asymmetry in a PTP unaware network:

- Use QoS: QoS can help reduce asymmetry in an unaware network.
- Implement Telecom Boundary Clocks (T-BC): T-BCs can handle asymmetry in the nodes when implemented correctly.

## Reducing Packet Delay Variation

To reduce the effects of Packet Delay Variation (PDV) on PTP clock recovery, you must have a steady layer of packets that arrive in minimum time.

- Implement Telecom Boundary Clocks (T-BC) in the PTP unaware node. T-BC introduces a time reference to the PTP unaware node, which then synchronizes its clock with the T-BC.
- Use a high-quality network connection between the T-BC and the PTP unaware node. A high-quality network connection, such as a dedicated fiber link, can help reduce PDV due to network impairments.

## Remediating Transport Asymmetry

Transport asymmetry occurs when data is transported at varying rates in different directions over a communication link, leading to an imbalance in transport. To correct this issue:

- Ensure that your transport layer is PTP aware.

In optical devices, use a wavelength division multiplexing (WDM) technology such as Optical Service Channel (OSC) for managing your fiber optic infrastructure effectively.

## Synchronizing Across Networks

To avoid synchronization issues when connecting to other mobile networks:

- Make sure to align all mobile networks to a common source of time. For example, align mobile networks to the Coordinated Universal Time (UTC) from a Global Navigation Satellite System (GNSS) such as Global Positioning System (GPS).
- Monitor your clocks at the interconnect points.

**Note**

---

In 5G networks, using standalone GNSS receivers at every radio site may not provide the sub-100 nanosecond accuracy required for the timing requirements of Fronthaul radio systems.

---

