



## **Cisco ASR 900 Router Series Configuration Guide, Cisco IOS XE 16**

**First Published:** 2017-04-05

**Last Modified:** 2020-04-10

### **Americas Headquarters**

Cisco Systems, Inc.  
170 West Tasman Drive  
San Jose, CA 95134-1706  
USA  
<http://www.cisco.com>  
Tel: 408 526-4000  
800 553-NETS (6387)  
Fax: 408 527-0883

THE SPECIFICATIONS AND INFORMATION REGARDING THE PRODUCTS IN THIS MANUAL ARE SUBJECT TO CHANGE WITHOUT NOTICE. ALL STATEMENTS, INFORMATION, AND RECOMMENDATIONS IN THIS MANUAL ARE BELIEVED TO BE ACCURATE BUT ARE PRESENTED WITHOUT WARRANTY OF ANY KIND, EXPRESS OR IMPLIED. USERS MUST TAKE FULL RESPONSIBILITY FOR THEIR APPLICATION OF ANY PRODUCTS.

THE SOFTWARE LICENSE AND LIMITED WARRANTY FOR THE ACCOMPANYING PRODUCT ARE SET FORTH IN THE INFORMATION PACKET THAT SHIPPED WITH THE PRODUCT AND ARE INCORPORATED HEREIN BY THIS REFERENCE. IF YOU ARE UNABLE TO LOCATE THE SOFTWARE LICENSE OR LIMITED WARRANTY, CONTACT YOUR CISCO REPRESENTATIVE FOR A COPY.

The Cisco implementation of TCP header compression is an adaptation of a program developed by the University of California, Berkeley (UCB) as part of UCB's public domain version of the UNIX operating system. All rights reserved. Copyright © 1981, Regents of the University of California.

NOTWITHSTANDING ANY OTHER WARRANTY HEREIN, ALL DOCUMENT FILES AND SOFTWARE OF THESE SUPPLIERS ARE PROVIDED "AS IS" WITH ALL FAULTS. CISCO AND THE ABOVE-NAMED SUPPLIERS DISCLAIM ALL WARRANTIES, EXPRESSED OR IMPLIED, INCLUDING, WITHOUT LIMITATION, THOSE OF MERCHANTABILITY, FITNESS FOR A PARTICULAR PURPOSE AND NON-INFRINGEMENT OR ARISING FROM A COURSE OF DEALING, USAGE, OR TRADE PRACTICE.

IN NO EVENT SHALL CISCO OR ITS SUPPLIERS BE LIABLE FOR ANY INDIRECT, SPECIAL, CONSEQUENTIAL, OR INCIDENTAL DAMAGES, INCLUDING, WITHOUT LIMITATION, LOST PROFITS OR LOSS OR DAMAGE TO DATA ARISING OUT OF THE USE OR INABILITY TO USE THIS MANUAL, EVEN IF CISCO OR ITS SUPPLIERS HAVE BEEN ADVISED OF THE POSSIBILITY OF SUCH DAMAGES.

Any Internet Protocol (IP) addresses and phone numbers used in this document are not intended to be actual addresses and phone numbers. Any examples, command display output, network topology diagrams, and other figures included in the document are shown for illustrative purposes only. Any use of actual IP addresses or phone numbers in illustrative content is unintentional and coincidental.

All printed copies and duplicate soft copies of this document are considered uncontrolled. See the current online version for the latest version.

Cisco has more than 200 offices worldwide. Addresses and phone numbers are listed on the Cisco website at [www.cisco.com/go/offices](http://www.cisco.com/go/offices).

Cisco and the Cisco logo are trademarks or registered trademarks of Cisco and/or its affiliates in the U.S. and other countries. To view a list of Cisco trademarks, go to this URL: [www.cisco.com go trademarks](http://www.cisco.com/go/trademarks). Third-party trademarks mentioned are the property of their respective owners. The use of the word partner does not imply a partnership relationship between Cisco and any other company. (1721R)

© 2017–2020 Cisco Systems, Inc. All rights reserved.



## CONTENTS

---

### CHAPTER 1

#### Feature History 1

---

### CHAPTER 2

#### Using Cisco IOS XE Software 3

- Understanding Command Modes 3
- Understanding Diagnostic Mode 5
- Accessing the CLI Using a Console 6
  - Accessing the CLI Using a Directly-Connected Console 6
    - Connecting to the Console Port 6
    - Using the Console Interface 6
  - Accessing the CLI from a Remote Console Using Telnet 7
    - Preparing to Connect to the Router Console Using Telnet 7
    - Using Telnet to Access a Console Interface 8
  - Accessing the CLI from a Remote Console Using a Modem 9
- Using the Auxiliary Port 9
- Using Keyboard Shortcuts 9
- Using the History Buffer to Recall Commands 10
- Getting Help 10
  - Finding Command Options Example 11
- Using the no and default Forms of Commands 14
- Saving Configuration Changes 14
- Managing Configuration Files 14
- Filtering Output from the show and more Commands 16
- Password Recovery 16
- Powering Off the Router 17
- Finding Support Information for Platforms and Cisco Software Images 17
  - Using Cisco Feature Navigator 18

Using Software Advisor	18
Using Software Release Notes	18

---

**CHAPTER 3**

<b>Console Port Telnet and SSH Handling</b>	<b>19</b>
Console Port Overview	19
Connecting Console Cables	19
Installing USB Device Drivers	19
Console Port Handling Overview	20
Telnet and SSH Overview	20
Persistent Telnet and Persistent SSH Overview	20
Configuring a Console Port Transport Map	21
Examples	22
Configuring Persistent Telnet	23
Examples	25
Configuring Persistent SSH	25
Examples	27
Viewing Console Port, SSH, and Telnet Handling Configurations	28
Important Notes and Restrictions	32

---

**CHAPTER 4**

<b>Configuring the Route Switch Processor</b>	<b>33</b>
Configuring Timing Ports	33
Configuring the Management Ethernet Port	33
Configuring Console Ports	33
Reloading the Route Switch Processor	33
Forcing a Route Switch Processor Switchover	34

---

**CHAPTER 5**

<b>Configuring Ethernet Interfaces</b>	<b>35</b>
Configuring Ethernet Interfaces	35
Limitations and Restrictions	35
Configuring an Interface	37
Specifying the Interface Address on an Interface Module	39
Configuring Hot Standby Router Protocol	39
Verifying HSRP	40
Modifying the Interface MTU Size	41

Interface MTU Configuration Guidelines	42
Configuring Interface MTU	42
Verifying the MTU Size	43
MPLS MTU	43
Restrictions	43
Configuring MPLS MTU Globally	44
Verifying MPLS MTU	45
Configuring the Encapsulation Type	45
Configuring Autonegotiation on an Interface	45
Enabling Autonegotiation	46
Disabling Autonegotiation	46
Configuring Carrier Ethernet Features	46
Saving the Configuration	46
Shutting Down and Restarting an Interface	47
Shutting Down and Restarting an Interface Module	47
Verifying the Interface Configuration	47
Verifying Per-Port Interface Status	48
Verifying Interface Module Status	48
Configuring LAN/WAN-PHY Controllers	50
Restrictions for LAN/WAN-PHY Mode	50
Configuring LAN-PHY Mode	50
Configuring WAN-PHY Mode	52
Configuring the Flag for Path Trace	53
Configuring WAN-PHY Error Thresholds	54
Configuration Examples	56
Example: Basic Interface Configuration	56
Example: MTU Configuration	57
Example: VLAN Encapsulation	57
<b>CHAPTER 6</b>	<b>Using the Management Ethernet Interface</b>
	59
Gigabit Ethernet Management Interface Overview	59
Gigabit Ethernet Port Numbering	59
IP Address Handling in ROMmon and the Management Ethernet Port	60
Gigabit Ethernet Management Interface VRF	60

Common Ethernet Management Tasks	61
Viewing the VRF Configuration	61
Viewing Detailed VRF Information for the Management Ethernet VRF	61
Setting a Default Route in the Management Ethernet Interface VRF	62
Setting the Management Ethernet IP Address	62
Telnetting over the Management Ethernet Interface	62
Pinging over the Management Ethernet Interface	62
Copy Using TFTP or FTP	62
NTP Server	63
SYSLOG Server	63
SNMP-related services	63
Domain Name Assignment	63
DNS service	64
RADIUS or TACACS+ Server	64
VTY lines with ACL	64

---

**CHAPTER 7**

<b>Configuring T1/E1 Interfaces</b>	<b>65</b>
Configuration Tasks	65
Limitations	65
Required Configuration Tasks	66
Setting the Card Type	66
Configuring the Controller	67
Verifying Controller Configuration	69
Optional Configurations	69
Configuring Framing	69
Setting an IP Address	70
Configuring Encapsulation	71
Configuring the CRC Size for T1 Interfaces	73
Configuring a Channel Group	74
Saving the Configuration	75
Troubleshooting E1 and T1 Controllers	76
Setting Loopbacks	76
Running Bit Error Rate Testing	77
Monitoring and Maintaining the T1/E1 Interface Module	79

AIS on Core Failure	79
Limitations of AIS	80
Core Failure Event Detection	80
Configuring AIS for Core Failure	80
Verifying AIS Configuration	81
Example: AIS Trigger	81
Verifying the Interface Configuration	81
Verifying Per-Port Interface Status	81
Configuration Examples	82
Example: Framing and Encapsulation Configuration	82
Example: CRC Configuration	82
Example: Facility Data Link Configuration	83
Example: Invert Data on the T1/E1 Interface	83
<hr/>	
<b>CHAPTER 8</b>	<b>Configuring Optical Interface Modules 85</b>
Limitations and Restrictions	85
Configuring the Controller	86
Configuring SDH	87
Configuring SDH Mode	87
SDH T1 Mode	87
SDH T1 Mode	90
Configuring SDH in POS Mode	94
Configuring SONET Mode	95
Configuring SONET Mode	95
Configuring SONET Mode	95
Configuring SONET POS Mode	96
Configuring a CEM group	98
Configuring CEM Group in SONET Mode	98
Configuring CEM Group in SDH Mode	100
Configuring DS3 Clear Channel on OC-3 and OC-12 Interface Module	102
Configuring DS3 Clear Channel in SONET Mode	102
Configuring DS3 Clear Channel in SDH Mode	104
Optional Configurations	106
Configuring the National Bit	106

Verifying the National Bit	106
Configuring the CRC Size for T1	107
Optional Packet over SONET Configurations	107
Encapsulation	107
MTU Value	108
CRC Value	108
Keepalive Value	108
Bandwidth	108
Scrambling	108
C2 Flag	108
J1 Flag	109
Managing Interface Naming	109
Identifying Slots and Subslot	109
Configuring Multilink Point-to-Point Protocol	109
MLPPP Configuration Guidelines	109
Creating a Multilink Bundle	110
Assigning an Interface to a Multilink Bundle	110
Configuring Fragmentation Size and Delay on an MLPPP Bundle	111
Changing the Default Endpoint Discriminator	112
Disabling Fragmentation on an MLPPP Bundle	113
Configuring BERT	113
Configuring Automatic Protection Switching	114
TU-AIS Alarms	114
Restrictions for TU-AIS Alarms	114
Configuring TU-AIS Alarms	114
Verification of TU-AIS Alarm Configuration	115
Core Failure Event Detection	115
Verifying Interface Configuration	115
Verifying Per-Port Interface Status	115
Troubleshooting	116
Framing and Encapsulation Configuration Example	117
National Bit Configuration Example	117
CRC Configuration Example	118
Facility Data Link Configuration Example	118



MLPPP Configuration Example	119
MFR Configuration Example	119
Configuration Examples	120
Example of Cyclic Redundancy Check Configuration	120
Example of Facility Data Link Configuration	121
Example of Invert Data on T1/E1 Interface	121
Additional Resources	121

---

**CHAPTER 9**
**Configuring Serial Interfaces 123**

Information About Serial Interface Module	123
Restrictions	124
How to Configure Serial Interface	126
Required Configuration Tasks	126
Configuring the Controller	126
Optional Configurations	127
Configuring Layer 1 on Sync and Async Interface Server	127
Configuring Layer 1 on Sync and Async Interface Client	129
Configuring a Channel Group	130
Configuring Encapsulation	131
Configuring Transparent Pseudowire (PW) Cross-Connect	132
Configuring Invert Clock Signal	133
Configuring NRZI Formats	134
Saving the Configuration	134
Verifying the Serial Interface Configuration	134
Configuration Examples	136
Example: Encapsulation Configuration	136

---

**CHAPTER 10**
**Enabling Support for Tunable DWDM-XFP-C 137**

Configuring the DWDM-XFP-C Module	140
Verifying the ITU Configuration	141

---

**CHAPTER 11**
**Dying Gasp Support for Loss of Power Supply via SNMP, Syslog and Ethernet OAM 143**

Prerequisites for Dying Gasp Support	143
Restrictions for Dying Gasp Support	143

Configuration Examples for Dying Gasp Support	144
Configuring SNMP Community Strings on a Router	144
Configuring SNMP-Server Host Details on the Router Console	144
Dying Gasp Trap Support for Different SNMP Server Host/Port Configurations	144
Environmental Settings on the Network Management Server	144
Message Displayed on the Peer Router on Receiving Dying Gasp Notification	146
Displaying SNMP Configuration for Receiving Dying Gasp Notification	146
Dying GASP via SNMP Trap Support on Cisco RSP3 Module	146
Restrictions for Dying GASP via SNMP Trap Support on Cisco RSP3 Module	146
Enabling Dying GASP Support on Cisco RSP3 Module	147
Verifying SNMP Host Configuration	147
Verifying SNMP Configurations	148

---

**CHAPTER 12**
**Configuring Pseudowire 149**

Pseudowire Overview	149
Circuit Emulation Overview	150
Structure-Agnostic TDM over Packet	150
Circuit Emulation Service over Packet-Switched Network	151
Asynchronous Transfer Mode over MPLS	153
Transportation of Service Using Ethernet over MPLS	154
Limitations	154
Configuring CEM	155
Configuration Guidelines and Restrictions	155
Configuring a CEM Group	155
Using CEM Classes	156
Configuring a Clear-Channel ATM Interface	159
Configuring CEM Parameters	159
Configuring Payload Size (Optional)	159
Setting the Dejitter Buffer Size	159
Setting an Idle Pattern (Optional)	159
Enabling Dummy Mode	159
Setting a Dummy Pattern	160
Shutting Down a CEM Channel	160
Configuring CAS	160

Information About CAS	160
Configuring CAS	161
Verifying CAS Configuration	162
Configuration Examples for CAS	163
Configuring ATM	163
Configuring a Clear-Channel ATM Interface	163
Configuring ATM IMA	164
BGP PIC with TDM Configuration	167
Configuring Structure-Agnostic TDM over Packet (SATO P)	167
Configuring Circuit Emulation Service over Packet-Switched Network (CESoPSN)	168
Configuring a Clear-Channel ATM Pseudowire	169
Configuring an ATM over MPLS Pseudowire	170
Configuring the Controller	171
Configuring an IMA Interface	172
Configuring the ATM over MPLS Pseudowire Interface	173
Configuring 1-to-1 VCC Cell Transport Pseudowire	174
Configuring N-to-1 VCC Cell Transport Pseudowire	175
Configuring 1-to-1 VPC Cell Transport	175
Configuring ATM AAL5 SDU VCC Transport	177
Configuring a Port Mode Pseudowire	178
Optional Configurations	179
Configuring an Ethernet over MPLS Pseudowire	180
Configuring Pseudowire Redundancy	182
Pseudowire Redundancy with Uni-directional Active-Active	184
Restrictions	185
Configuring Pseudowire Redundancy Active-Active— Protocol Based	185
Configuring the Working Controller for MR-APS with Pseudowire Redundancy Active-Active	186
Configuring the Protect Controller for MR-APS with Pseudowire Redundancy Active-Active	186
Verifying the Interface Configuration	186
Configuration Examples	187
Example: CEM Configuration	187
Example: BGP PIC with TDM Configuration	188
Example: BGP PIC with TDM-PW Configuration	189
Example: ATM IMA Configuration	190

Example: ATM over MPLS	190
Cell Packing Configuration Examples	190
Cell Relay Configuration Examples	193
Example: Ethernet over MPLS	197
Adaptive Clock Recovery (ACR)	198
Benefits of ACR for 8 T1/E1 Interface Module	199
Prerequisites for ACR Configuration in 8 T1/E1 Interface Module	199
Restrictions for ACR on 8 T1/E1 Interface Module	199
Configuring ACR for T1 Interfaces for SAToP	200
Verifying the ACR Configuration of T1 Interfaces for SAToP	200
Associated Commands	202

---

**CHAPTER 13**      **Digital Optical Monitoring for Transceivers**    203

---

**CHAPTER 14**      **Configuring the SDM Template**    205

Prerequisites for the SDM Template	205
Restrictions for the SDM Template	205
Information About the SDM Template	207
Selecting the SDM Template	218
Verifying the SDM Template	220
SDM Template Supported Features on RSP3 Module	222
VPLS Statistics	222
Split Horizon Enhancements on the RSP3 Module	223
Prerequisites for Split-Horizon Groups on the RSP3 Module	223
Restrictions for Split-Horizon Groups on the RSP3 Module	224
Split-Horizon Supported Scale	224
Configuring Split-Horizon Group on the RSP3 Module	225
8K EFP (4 Queue Model)	225
Information About 8000 (8K) EFP	225
Prerequisites for 8000 (8K) EFP	225
Restrictions for 8000 (8K) EFP	225
Configuring 8K Model	226
16K EFP Support on Port Channel	228
Restrictions for 16K EFP on Port Channel	229

Configuring 16K EFP on Port Channel	229
Verifying 16k EFP on Port Channel	229
Control Plane Policing	230
Restrictions for Control Plane Policing	230
Restrictions for CoPP on the RSP3	231
Supported Protocols	232
Input Rate-Limiting and Silent Mode Operation	234
How to Use Control Plane Policing	234
Configuration Examples for Control Plane Policing	235
Verification Examples for CoPP	235
QoS Support on Port Channel LACP Active Active	236
Benefits of QoS Support on Port Channel LACP Active Active	236
Restrictions for QoS Support on Port Channel Active Active	236
Configuring QoS Support on Port Channel Active Active	237
Verification of QoS Support on Port Channel LACP Active Active	238
Match Inner DSCP on RSP3 Module	239
Restrictions for Match Inner DSCP on RSP3 Module	239
Configuring Match Inner DSCP on RSP3 Module	240
Verifying Match Inner DSCP on RSP3 Module	240

---

**CHAPTER 15**
**BCP Support on MLPPP 241**

Prerequisites for BCP Support on MLPPP	241
Restrictions for BCP Support on MLPPP	241
Information About BCP Support on MLPPP	242
Supported Profiles and Protocols	243
Quality of Service	243
How to Configure BCP Support on MLPPP	243
Configuring Multiple EFPs Bridged Through the Same Link	243
Configuring an EFP	243
Adding an EFP to a Multilink	244
Configuring Multiple Encapsulated VLANs Bridged Through Different Multilinks	245
Adding an Encapsulated VLAN to Multilinks	245
Configuring QoS for BCP Support on MLPPP	246
Defining a QoS Policy	246

Applying a QoS Policy on an MLPPP Interface	248
Verifying BCP Support on MLPPP	249
Configuration Examples for BCP Support on MLPPP	250
Example: Configuring an EFP	250
Example: Multilink with a Single EFP	251
Example: Multilink with Multiple EFPs	251
Example: Multilink with QoS	252
Example: Multilink Between Cisco ASR 903 Series Routers and Cisco C7600 Series Routers	253
Example: Multilink with Maximum 10 Links	254

**CHAPTER 16****Tracing and Trace Management 259**

Tracing Overview	259
How Tracing Works	260
Tracing Levels	260
Viewing a Tracing Level	261
Setting a Tracing Level	263
Viewing the Content of the Trace Buffer	263

**CHAPTER 17****Configuring and Monitoring Alarm 265**

Monitoring Alarms	265
Network Administrator Checks Console or Syslog for Alarm Messages	266
Enabling the Logging Alarm Command	266
Examples of Alarm Messages	266
ALARMS for Router	266
Reviewing and Analyzing Alarm Messages	270
Configuring External Alarm Trigger	270
Approaches for Monitoring Hardware Alarms	271
Onsite Network Administrator Responds to Audible or Visual Alarms	271
How to Configure External Alarms	271
Example	272
Alarm Filtering Support	273
Information About Alarm Filtering Support	273
Overview of Alarm Filtering Support	273
Prerequisites for Alarm Filtering Support	274

Restrictions for Alarm Filtering Support	274
How to Configure Alarm Filtering for Syslog Messages and SNMP Notifications	274
Configuring Alarm Filtering for Syslog Messages	274
Configuring Alarm Filtering for SNMP Notifications	275
Configuration Examples for Alarm Filtering Support	275
Configuring Alarm Filtering for Syslog Messages: Example	275
Configuring Alarm Filtering for SNMP Notifications: Example	275
Facility Protocol Status Support	275
show facility protocol status	276
Restrictions	276
Routing Protocols Outputs	276
show facility-protocol status command	280
<hr/>	
<b>CHAPTER 18</b>	<b>OTN Wrapper Overview 281</b>
Advantages of OTN	283
ODU and OTU	283
OTU1e and OTU 2e Support on 8x10GE Interface Module	283
Deriving OTU1e and OTU2e Rates	284
OTU3 Support in 2x40GE Interface Module	285
Supported Transceivers	285
OTN Specific Functions	285
Standard MIBS	286
Restrictions for OTN	286
DWDM Provisioning	287
Prerequisites for DWDM Provisioning	287
Configuring DWDM Provisioning	287
Configuring Transport Mode in 8x10GE and 2x40GE Interface Modules	287
Verification of LAN Transport Mode Configuration	288
Verification of OTN Transport Mode Configuration in 8x10GE Interface Modules	288
Verification of OTN Transport Mode Configuration in 2x40GE Interface Modules	289
Changing from OTN to LAN Mode	289
Verification of Enabled Ports for Controller Configuration	290
OTN Alarms	290
Configuring OTN Alarm Reports	291

Configuring OTU Alarm Reports	291
Configuring ODU Alarm Report	293
OTN Threshold	293
Configuring OTU Threshold	293
Configuring ODU Threshold	294
Verification of OTU and ODU Threshold Configuration	294
Configuring OTU Alerts	295
Configuring ODU Alerts	295
Configuring ODU Alerts	295
Verifying Alerts Configuration	296
Loopback	297
Configuring Loopback	297
Forward Error Connection	297
Benefits of FEC	297
Configuring FEC	298
Trail Trace Identifier	299
Verifying Loopback Configuration	300
SNMP Support	301
Performance Monitoring	302
OTUk Section Monitoring	304
ODUk Path Monitoring	305
Configuring PM Parameters for FEC	305
Configuring PM Parameters for OTN	306
Verifying PM Parameters Configuration	306
Troubleshooting Scenarios	309
Associated Commands	309
<b>CHAPTER 19</b>	<b>Using Zero Touch Provisioning 313</b>
	Prerequisites for Using ZTP 313
	Restrictions for Using ZTP 314
	Information About Using ZTP 314
	Example ZTP Configuration 316
	Downloading the Initial Configuration 316
	DHCP Server 317



TFTP Server	317
ZTP LED Behavior	317
Verifying the ZTP Configuration	318

**CHAPTER 20****Configuring 1G Traffic on 8-port 10 Gigabit Ethernet Interface Module 319**

Restrictions for 1G Mode on 8X10 GE Interface Module	319
Configuring 1G Mode	320
Verifying 1G Mode Configuration	320
Configuring 10G Mode from 1G Mode	321
Verifying 10G Mode Configuration	321
Associated Commands	322
Overview of Over Subscription and Partial Port Modes on the 8-port 10 Gigabit Ethernet Interface Module	323
Over Subscription Mode	323
Partial Port Mode	324
Prerequisites for Over Subscription Mode on the 8-port 10 Gigabit Ethernet Interface Module	324
Restrictions for Over Subscription Mode 8-port 10 Gigabit Ethernet Interface Module	324
Supported Features and Constraints	324
Supported Subslots	325
FPGA Operating Mode	325
Maximum Slot Population of the 8-port 10 Gigabit Ethernet Interface Module	326
Configuring Over Subscription and Partial Mode	327

**CHAPTER 21****Configuring 8/16-port 1 Gigabit Ethernet (SFP / SFP) + 1-port 10 Gigabit Ethernet (SFP+) / 2-port 1 Gigabit Ethernet (CSFP) Interface Module 329**

Operating Modes	330
Full Subscription Mode	331
Over Subscription Mode	331
Egress Packet Classifiers	332
SADT Mode	332
Bandwidth Mode	332
Slot Support on Operating Modes	335
IOS Port Numbering	336
Supported Features on the Interface Module	337

Benefits	337
Restrictions	337
Configuring Interface Module	337
Example: Configuring Full Subscription Modes	338
Example: Configuring Over Subscription Modes	342
Example: Configuring Egress Classification	344
Verifying PFC	345
Verifying Configuration	345
Verifying High Priority and Low Priority Counters Configuration	346
Configuring Bandwidth Mode	346
Verifying Bandwidth Mode Configuration	346
Interface Module Rules	347
Associated Commands	357
Additional References	357



## CHAPTER

# 1

## Feature History

The following table lists the new and modified features supported in the Cisco ASR 900 Router Series Configuration Guide in Cisco IOS XE 16 releases.

Feature Name	Cisco IOS XE Release
RS232 Async with E2E Signaling Support	16.11.1a
Video Template - IPv4 QoS classifications	
SDM template enhancement for uRPF scale	16.9.4
Dying Gasp via SNMP Trap	16.9.1a
IPv6 QoS ACL L4 classification with expansion approach on IPv6 QoS SDM Template	
RS232 Sync	
Over Subscription Mode and Partial Port Mode Support on 8-port 10 Gigabit Ethernet Interface Module on the ASR 907 Chassis	
IPv6 QoS support for SDM Template	16.8.1
AIS Coreflap	16.7.1
Card Protection for 48-port T1/E1 CEM Interface Module and 48-port T3/E3 CEM Interface Module	16.6.3
Alarm support for 900W	16.6.1
DS1 and DS3 Card Protection	

Feature Name	Cisco IOS XE Release
BCP Support on MLPPP	16.5.1
Configuring 1G Mode on 8-port 10 Gigabit Ethernet Interface Module	
Configuring Unidirectional Path Switching Ring (UPSR)	
OTN Wrapper	
SSM Support on Cisco 48 X T3/E3 CEM Interface Module	



## CHAPTER 2

# Using Cisco IOS XE Software

---

- [Understanding Command Modes, on page 3](#)
- [Understanding Diagnostic Mode, on page 5](#)
- [Accessing the CLI Using a Console, on page 6](#)
- [Using the Auxiliary Port, on page 9](#)
- [Using Keyboard Shortcuts, on page 9](#)
- [Using the History Buffer to Recall Commands, on page 10](#)
- [Getting Help, on page 10](#)
- [Using the no and default Forms of Commands, on page 14](#)
- [Saving Configuration Changes, on page 14](#)
- [Managing Configuration Files, on page 14](#)
- [Filtering Output from the show and more Commands, on page 16](#)
- [Password Recovery, on page 16](#)
- [Powering Off the Router, on page 17](#)
- [Finding Support Information for Platforms and Cisco Software Images, on page 17](#)

## Understanding Command Modes

The command modes available in the traditional Cisco IOS CLI are exactly the same as the command modes available in Cisco IOS XE.

You use the CLI to access Cisco IOS XE software. Because the CLI is divided into many different modes, the commands available to you at any given time depend on the mode that you are currently in. Entering a question mark (?) at the CLI prompt allows you to obtain a list of commands available for each command mode.

When you log in to the CLI, you are in user EXEC mode. User EXEC mode contains only a limited subset of commands. To have access to all commands, you must enter privileged EXEC mode, normally by using a password. From privileged EXEC mode, you can issue any EXEC command—user or privileged mode—or you can enter global configuration mode. Most EXEC commands are one-time commands. For example, **show** commands show important status information, and **clear** commands clear counters or interfaces. The EXEC commands are not saved when the software reboots.

Configuration modes allow you to make changes to the running configuration. If you later save the running configuration to the startup configuration, these changed commands are stored when the software is rebooted. To enter specific configuration modes, you must start at global configuration mode. From global configuration

mode, you can enter interface configuration mode and a variety of other modes, such as protocol-specific modes.

ROM monitor mode is a separate mode used when the Cisco IOS XE software cannot load properly. If a valid software image is not found when the software boots or if the configuration file is corrupted at startup, the software might enter ROM monitor mode.

[Table 1: Accessing and Exiting Command Modes](#), on page 4 describes how to access and exit various common command modes of the Cisco IOS XE software. It also shows examples of the prompts displayed for each mode.

**Table 1: Accessing and Exiting Command Modes**

Command Mode	Access Method	Prompt	Exit Method
User EXEC	Log in.	Router>	Use the <b>logout</b> command.
Privileged EXEC	From user EXEC mode, use the <b>enable</b> EXEC command.	Router#	To return to user EXEC mode, use the <b>disable</b> command.
Global configuration	From privileged EXEC mode, use the <b>configure terminal</b> privileged EXEC command.	Router (config) #	To return to privileged EXEC mode from global configuration mode, use the <b>exit</b> or <b>end</b> command.
Interface configuration	From global configuration mode, specify an interface using an <b>interface</b> command.	Router (config-if) #	To return to global configuration mode, use the <b>exit</b> command. To return to privileged EXEC mode, use the <b>end</b> command.
Diagnostic	The router boots up or accesses diagnostic mode in the following scenarios: <ul style="list-style-type: none"> <li>In some cases, diagnostic mode will be reached when the IOS process or processes fail. In most scenarios, however, the router will reload.</li> <li>A user-configured access policy was configured using the <b>transport-map</b> command that directed the user into diagnostic mode. See the <a href="#">Using Cisco IOS XE Software, on page 3</a> chapter of this book for information on configuring access policies.</li> <li>The router was accessed using a Route Switch Processor auxiliary port.</li> <li>A break signal (<b>Ctrl-C</b>, <b>Ctrl-Shift-6</b>, or the <b>send break</b> command ) was entered and the router was configured to go into diagnostic mode when the break signal was received.</li> </ul>	Router (diag) #	If the IOS process failing is the reason for entering diagnostic mode, the IOS problem must be resolved and the router rebooted to get out of diagnostic mode.  If the router is in diagnostic mode because of a transport-map configuration, access the router through another port or using a method that is configured to connect to the Cisco IOS CLI.  If the router is accessed through the Route Switch Processor auxiliary port, access the router through another port. Accessing the router through the auxiliary port is not useful for customer purposes anyway.

Command Mode	Access Method	Prompt	Exit Method
ROM monitor	From privileged EXEC mode, use the <b>reload</b> EXEC command. Press the <b>Break</b> key during the first 60 seconds while the system is booting.	>	To exit ROM monitor mode, use the <b>continue</b> command.

### Universal IOS Image

Starting with XE318SP, there are two flavors of universal images supported on Cisco ASR900 series routers:

- Universal images with the "universalk9" designation in the image name: This universal image offers the strong payload cryptography Cisco IOS feature, the IPsec VPN feature.
- Universal images with the universalk9\_npe" designation in the image name: The strong enforcement of encryption capabilities provided by Cisco Software Activation satisfies requirements for the export of encryption capabilities. However, some countries have import requirements that require that the platform does not support any strong crypto functionality such as payload cryptography. To satisfy the import requirements of those countries, the `npe' universal image does not support any strong payload encryption.

Starting with Cisco IOS XE Release 3.18SP, IPsec tunnel is supported only on the Cisco ASR903 and ASR907 routers with payload encryption (PE) images. IPsec requires an IPsec license to function.



#### Note

- IPsec license must be acquired and installed in the router for IPsec functionality to work. When you enable or disable the IPsec license, reboot is mandatory for the system to function properly. IPsec is not supported on Cisco IOS XE Everest 16.5.1.
- NPE images shipped for Cisco ASR 900 routers do not support data plane encryptions. However, control plane encryption is supported with NPE images, with processing done in software, without the crypto engine.

## Understanding Diagnostic Mode

Diagnostic mode is supported.

The router boots up or accesses diagnostic mode in the following scenarios:

- The IOS process or processes fail, in some scenarios. In other scenarios, the RSP will simply reset when the IOS process or processes fail.
- A user-configured access policy was configured using the **transport-map** command that directs the user into diagnostic mode.
- A send break signal (**Ctrl-C** or **Ctrl-Shift-6**) was entered while accessing the router, and the router was configured to enter diagnostic mode when a break signal was sent.

In diagnostic mode, a subset of the commands that are also available in User EXEC mode are made available to users. Among other things, these commands can be used to:

- Inspect various states on the router, including the IOS state.
- Replace or roll back the configuration.

- Provide methods of restarting the IOS or other processes.
- Reboot hardware, such as the entire router, an RSP, an IM, or possibly other hardware components.
- Transfer files into or off of the router using remote access methods such as FTP, TFTP, SCP, and so on.

The diagnostic mode provides a more comprehensive user interface for troubleshooting than previous routers, which relied on limited access methods during failures, such as ROMmon, to diagnose and troubleshoot IOS problems.

The diagnostic mode commands are stored in the non-IOS packages on the chassis, which is why the commands are available even if the IOS process is not working properly. Importantly, all the commands available in diagnostic mode are also available in privileged EXEC mode on the router even during normal router operation. The commands are entered like any other commands in the privileged EXEC command prompts when used in privileged EXEC mode.

## Accessing the CLI Using a Console

The following sections describe how to access the command-line interface (CLI) using a directly-connected console or by using Telnet or a modem to obtain a remote console:

### Accessing the CLI Using a Directly-Connected Console

This section describes how to connect to the console port on the router and use the console interface to access the CLI. The console port is located on the front panel of each Route Switch Processor (RSP).

#### Connecting to the Console Port

Before you can use the console interface on the router using a terminal or PC, you must perform the following steps:

##### Procedure

---

- Step 1** Configure your terminal emulation software with the following settings:
- 9600 bits per second (bps)
  - 8 data bits
  - No parity
  - 1 stop bit
  - No flow control
- Step 2** Connect to the port using the RJ-45-to-RJ-45 cable and RJ-45-to-DB-25 DTE adapter or using the RJ-45-to-DB-9 DTE adapter (labeled “Terminal”).
- 

#### Using the Console Interface

Every RSP has a console interface. Notably, a standby RSP can be accessed using the console port in addition to the active RSP in a dual RSP configuration.

To access the CLI using the console interface, complete the following steps:



## Procedure

---

- Step 1** After you attach the terminal hardware to the console port on the router and you configure your terminal emulation software with the proper settings, the following prompt appears:
- Example:**
- ```
Press RETURN to get started.
```
- Step 2** Press **Return** to enter user EXEC mode. The following prompt appears:
- Example:**
- ```
Router>
```
- Step 3** From user EXEC mode, enter the **enable** command as shown in the following example:
- Example:**
- ```
Router> enable
```
- Step 4** At the password prompt, enter your system password. If an enable password has not been set on your system, this step may be skipped. The following example shows entry of the password called “enablepass”:
- Example:**
- ```
Password: enablepass
```
- Step 5** When your enable password is accepted, the privileged EXEC mode prompt appears:
- Example:**
- ```
Router#
```
- Step 6** You now have access to the CLI in privileged EXEC mode and you can enter the necessary commands to complete your desired tasks.
- Step 7** To exit the console session, enter the **exit** command as shown in the following example:
- Example:**
- ```
Router# exit
```
- 

## Accessing the CLI from a Remote Console Using Telnet

This section describes how to connect to the console interface on a router using Telnet to access the CLI.

### Preparing to Connect to the Router Console Using Telnet

Before you can access the router remotely using Telnet from a TCP/IP network, you need to configure the router to support virtual terminal lines (vty) using the **line vty** global configuration command. You also should configure the vty to require login and specify a password.



**Note** To prevent disabling login on the line, be careful that you specify a password with the **password** command when you configure the **login** line configuration command. If you are using authentication, authorization, and accounting (AAA), you should configure the **login authentication** line configuration command. To prevent disabling login on the line for AAA authentication when you configure a list with the **login authentication** command, you must also configure that list using the **aaa authentication login** global configuration command. For more information about AAA services, refer to the *Cisco IOS XE Security Configuration Guide*, Release 2 and *Cisco IOS Security Command Reference* publications.

In addition, before you can make a Telnet connection to the router, you must have a valid host name for the router or have an IP address configured on the router. For more information about requirements for connecting to the router using Telnet, information about customizing your Telnet services, and using Telnet key sequences, refer to the *Cisco IOS Configuration Fundamentals Configuration Guide*, Release 12.2SR.

## Using Telnet to Access a Console Interface

To access a console interface using Telnet, complete the following steps:

### Procedure

**Step 1** From your terminal or PC, enter one of the following commands:

- **connect** *host* [*port*] [*keyword*]
- **telnet** *host* [*port*] [*keyword*]

In this syntax, *host* is the router hostname or an IP address, *port* is a decimal port number (23 is the default), and *keyword* is a supported keyword. For more information, refer to the *Cisco IOS Configuration Fundamentals Command Reference*.

**Note** If you are using an access server, then you will need to specify a valid port number such as **telnet 172.20.52.40 2004**, in addition to the hostname or IP address.

The following example shows the **telnet** command to connect to the router named “router”:

#### Example:

```
unix_host% telnet router
Trying 172.20.52.40...
Connected to 172.20.52.40.
Escape character is '^]'.
unix_host% connect
```

**Step 2** At the password prompt, enter your login password. The following example shows entry of the password called “mypass”:

#### Example:

```
User Access Verification
Password: mypass
```

**Note** If no password has been configured, press **Return**.

**Step 3** From user EXEC mode, enter the **enable** command as shown in the following example:

**Example:**

```
Router> enable
```

- Step 4** At the password prompt, enter your system password. The following example shows entry of the password called “enablepass”:

**Example:**

```
Password: enablepass
```

- Step 5** When the enable password is accepted, the privileged EXEC mode prompt appears:

**Example:**

```
Router#
```

- Step 6** You now have access to the CLI in privileged EXEC mode and you can enter the necessary commands to complete your desired tasks.

- Step 7** To exit the Telnet session, use the **exit** or **logout** command as shown in the following example:

**Example:**

```
Router# logout
```

---

## Accessing the CLI from a Remote Console Using a Modem

To access the router remotely using a modem through an asynchronous connection, connect the modem to the console port.

The console port on a chassis is an EIA/TIA-232 asynchronous, serial connection with no flow control and an RJ-45 connector. The console port is located on the front panel of the RSP.

To connect a modem to the console port, place the console port mode switch in the in position. Connect to the port using the RJ-45-to-RJ-45 cable and the RJ-45-to-DB-25 DCE adapter (labeled “Modem”).

To connect to the router using the USB console port, connect to the port using a USB Type A-to-Type A cable.

## Using the Auxiliary Port

The auxiliary port on the Route Switch Processor does not serve any useful purpose for customers.

This port should only be accessed under the advisement of a customer support representative.

## Using Keyboard Shortcuts

Commands are not case sensitive. You can abbreviate commands and parameters if the abbreviations contain enough letters to be different from any other currently available commands or parameters.

Table 2: Keyboard Shortcuts , on page 10 lists the keyboard shortcuts for entering and editing commands.

Table 2: Keyboard Shortcuts

Keystrokes	Purpose
<b>Ctrl-B</b> or the <b>Left Arrow</b> key <sup>1</sup>	Move the cursor back one character
<b>Ctrl-F</b> or the <b>Right Arrow</b> key <sup>1</sup>	Move the cursor forward one character
<b>Ctrl-A</b>	Move the cursor to the beginning of the command line
<b>Ctrl-E</b>	Move the cursor to the end of the command line
<b>Esc B</b>	Move the cursor back one word
<b>Esc F</b>	Move the cursor forward one word

<sup>1</sup> The arrow keys function only on ANSI-compatible terminals such as VT100s.

## Using the History Buffer to Recall Commands

The history buffer stores the last 20 commands you entered. History substitution allows you to access these commands without retyping them, by using special abbreviated commands.

Table 3: History Substitution Commands, on page 10 lists the history substitution commands.

Table 3: History Substitution Commands

Command	Purpose
<b>Ctrl-P</b> or the <b>Up Arrow</b> key <sup>2</sup>	Recall commands in the history buffer, beginning with the most recent command. Repeat the key sequence to recall successively older commands.
<b>Ctrl-N</b> or the <b>Down Arrow</b> key <sup>1</sup>	Return to more recent commands in the history buffer after recalling commands with <b>Ctrl-P</b> or the <b>Up Arrow</b> key.
Router# <b>show history</b>	While in EXEC mode, list the last several commands you have just entered.

<sup>2</sup> The arrow keys function only on ANSI-compatible terminals such as VT100s.

## Getting Help

Entering a question mark (?) at the CLI prompt displays a list of commands available for each command mode. You can also get a list of keywords and arguments associated with any command by using the context-sensitive help feature.

To get help specific to a command mode, a command, a keyword, or an argument, use one of the following commands:

Table 4: Help Commands and Purpose

Command	Purpose
<code>help</code>	Provides a brief description of the help system in any command mode.
<code>abbreviated-command-entry ?</code>	Provides a list of commands that begin with a particular character string. (No space between command and question mark.)
<code>abbreviated-command-entry &lt;Tab&gt;</code>	Completes a partial command name.
<code>?</code>	Lists all commands available for a particular command mode.
<code>command ?</code>	Lists the keywords or arguments that you must enter next on the command line. (Space between command and question mark.)

## Finding Command Options Example

This section provides an example of how to display syntax for a command. The syntax can consist of optional or required keywords and arguments. To display keywords and arguments for a command, enter a question mark (?) at the configuration prompt or after entering part of a command followed by a space. The Cisco IOS XE software displays a list and brief description of available keywords and arguments. For example, if you were in global configuration mode and wanted to see all the keywords or arguments for the **rep** command, you would type **rep ?**.

The <cr> symbol in command help output stands for “carriage return.” On older keyboards, the carriage return key is the Return key. On most modern keyboards, the carriage return key is the Enter key. The <cr> symbol at the end of command help output indicates that you have the option to press **Enter** to complete the command and that the arguments and keywords in the list preceding the <cr> symbol are optional. The <cr> symbol by itself indicates that no more arguments or keywords are available and that you must press **Enter** to complete the command.

[Table 5: Finding Command Options](#), on page 11 shows examples of how you can use the question mark (?) to assist you in entering commands.

Table 5: Finding Command Options

Command	Comment
<pre>Router&gt; enable Password: &lt;password&gt; Router#</pre>	Enter the <b>enable</b> command and password to access privileged EXEC commands. You are in privileged EXEC mode when the prompt changes to a “#” from the “>”; for example, Router> to Router# .

## Finding Command Options Example

Command	Comment
<pre>Router# <b>configure terminal</b> Enter configuration commands, one per line. End with CNTL/Z. Router(config)#</pre>	<p>Enter the <b>configure terminal</b> privileged EXEC command to enter global configuration mode. You are in global configuration mode when the prompt changes to Router(config)# .</p>
<pre>Router(config)# <b>interface gigabitEthernet ?</b> &lt;0-0&gt; GigabitEthernet interface number &lt;0-1&gt; GigabitEthernet interface number Router(config)#<b>interface gigabitEthernet 0?</b> . / &lt;0-0&gt; Router(config)#<b>interface gigabitEthernet 0/?</b> &lt;0-5&gt; Port Adapter number Router(config)#<b>interface gigabitEthernet 0/0?</b> / Router(config)#<b>interface gigabitEthernet 0/0/?</b> &lt;0-15&gt; GigabitEthernet interface number Router(config)#<b>interface gigabitEthernet 0/0/0?</b> . &lt;0-23&gt; Router(config)#<b>interface gigabitEthernet 0/0/0</b></pre>	<p>Enter interface configuration mode by specifying the serial interface that you want to configure using the <b>interface serial</b> global configuration command.</p> <p>Enter ? to display what you must enter next on the command line. In this example, you must enter the serial interface slot number and port number, separated by a forward slash.</p> <p>When the &lt;cr&gt; symbol is displayed, you can press Enter to complete the command.</p> <p>You are in interface configuration mode when the prompt changes to Router(config-if)# .</p>
<pre>Router(config-if)# ? Interface configuration commands: . . . ip                Interface Internet Protocol config commands keepalive         Enable keepalive lan-name          LAN Name command llc2              LLC2 Interface Subcommands load-interval    Specify interval for load calculation for an interface locaddr-priority Assign a priority group logging           Configure logging for interface loopback         Configure internal loopback on an interface mac-address       Manually set interface MAC address mls               mls router sub/interface commands mpoa              MPOA interface configuration commands mtu               Set the interface Maximum Transmission Unit (MTU) netbios          Use a defined NETBIOS access list or enable name-caching     name-caching no               Negate a command or set its defaults nrzi-encoding    Enable use of NRZI encoding ntp              Configure NTP . . . Router(config-if)#</pre>	<p>Enter ? to display a list of all the interface configuration commands available for the serial interface. This example shows only some of the available interface configuration commands.</p>

Command	Comment
<pre>Router(config-if)# ip ? Interface IP configuration subcommands:   access-group          Specify access control for packets   accounting            Enable IP accounting on this interface   address              Set the IP address of an interface   authentication        authentication subcommands   bandwidth-percent    Set EIGRP bandwidth limit   broadcast-address    Set the broadcast address of an interface   cgmp                 Enable/disable CGMP   directed-broadcast   Enable forwarding of directed broadcasts   dvmrp                DVMRP interface commands   hello-interval       Configures IP-EIGRP hello interval   helper-address       Specify a destination address for UDP broadcasts   hold-time            Configures IP-EIGRP hold time   .   .   . Router(config-if)# ip</pre>	<p>Enter the command that you want to configure for the interface. This example uses the <b>ip</b> command.</p> <p>Enter <b>?</b> to display what you must enter next on the command line. This example shows only some of the available interface IP configuration commands.</p>
<pre>Router(config-if)# ip address ? A.B.C.D              IP address negotiated           IP Address negotiated over PPP Router(config-if)# ip address</pre>	<p>Enter the command that you want to configure for the interface. This example uses the <b>ip address</b> command.</p> <p>Enter <b>?</b> to display what you must enter next on the command line. In this example, you must enter an IP address or the <b>negotiated</b> keyword.</p> <p>A carriage return (&lt;cr&gt;) is not displayed; therefore, you must enter additional keywords or arguments to complete the command.</p>
<pre>Router(config-if)# ip address 172.16.0.1 ? A.B.C.D              IP subnet mask Router(config-if)# ip address 172.16.0.1</pre>	<p>Enter the keyword or argument that you want to use. This example uses the 172.16.0.1 IP address.</p> <p>Enter <b>?</b> to display what you must enter next on the command line. In this example, you must enter an IP subnet mask.</p> <p>A &lt;cr&gt; is not displayed; therefore, you must enter additional keywords or arguments to complete the command.</p>
<pre>Router(config-if)# ip address 172.16.0.1 255.255.255.0 ? secondary           Make this IP address a secondary address &lt;cr&gt; Router(config-if)# ip address 172.16.0.1 255.255.255.0</pre>	<p>Enter the IP subnet mask. This example uses the 255.255.255.0 IP subnet mask.</p> <p>Enter <b>?</b> to display what you must enter next on the command line. In this example, you can enter the <b>secondary</b> keyword, or you can press <b>Enter</b>.</p> <p>A &lt;cr&gt; is displayed; you can press <b>Enter</b> to complete the command, or you can enter another keyword.</p>

Command	Comment
Router(config-if)# <b>ip address</b> 172.16.0.1 255.255.255.0 Router(config-if)#	In this example, <b>Enter</b> is pressed to complete the command.

## Using the no and default Forms of Commands

Almost every configuration command has a **no** form. In general, use the **no** form to disable a function. Use the command without the **no** keyword to re-enable a disabled function or to enable a function that is disabled by default. For example, IP routing is enabled by default. To disable IP routing, use the **no ip routing** command; to re-enable IP routing, use the **ip routing** command. The Cisco IOS software command reference publications provide the complete syntax for the configuration commands and describe what the **no** form of a command does.

Many CLI commands also have a **default** form. By issuing the command **default command-name**, you can configure the command to its default setting. The Cisco IOS software command reference publications describe the function of the **default** form of the command when the **default** form performs a different function than the plain and **no** forms of the command. To see what default commands are available on your system, enter **default ?** in the appropriate command mode.

## Saving Configuration Changes

Use the **copy running-config startup-config** command to save your configuration changes to the startup configuration so that the changes will not be lost if the software reloads or a power outage occurs. For example:

```
Router# copy running-config startup-config
Building configuration...
```

It might take a minute or two to save the configuration. After the configuration has been saved, the following output appears:

```
[OK]
Router#
```

This task saves the configuration to NVRAM.

## Managing Configuration Files

On the chassis, the startup configuration file is stored in the nvram: file system and the running-configuration files are stored in the system: file system. This configuration file storage setup is not unique to the chassis and is used on several Cisco router platforms.

As a matter of routine maintenance on any Cisco router, users should backup the startup configuration file by copying the startup configuration file from NVRAM onto one of the router's other file systems and, additionally, onto a network server. Backing up the startup configuration file provides an easy method of recovering the startup configuration file in the event the startup configuration file in NVRAM becomes unusable for any reason.



The **copy** command can be used to backup startup configuration files. Below are some examples showing the startup configuration file in NVRAM being backed up:

### Example 1: Copying Startup Configuration File to Bootflash

```
Router# dir bootflash:
Directory of bootflash:/
  11  drwx      16384   Feb 2 2000 13:33:40 +05:30  lost+found
15105 drwx      4096    Feb 2 2000 13:35:07 +05:30  .ssh
45313 drwx      4096   Nov 17 2011 17:36:12 +05:30  core
75521 drwx      4096   Feb 2 2000 13:35:11 +05:30  .prst_sync
90625 drwx      4096   Feb 2 2000 13:35:22 +05:30  .rollback_timer
105729 drwx      8192  Nov 21 2011 22:57:55 +05:30  tracelogs
30209 drwx      4096   Feb 2 2000 13:36:17 +05:30  .installer
1339412480 bytes total (1199448064 bytes free)
Router# copy nvram:startup-config bootflash:
Destination filename [startup-config]?
3517 bytes copied in 0.647 secs (5436 bytes/sec)
Router# dir bootflash:
Directory of bootflash:/
  11  drwx      16384   Feb 2 2000 13:33:40 +05:30  lost+found
15105 drwx      4096    Feb 2 2000 13:35:07 +05:30  .ssh
45313 drwx      4096   Nov 17 2011 17:36:12 +05:30  core
75521 drwx      4096   Feb 2 2000 13:35:11 +05:30  .prst_sync
90625 drwx      4096   Feb 2 2000 13:35:22 +05:30  .rollback_timer
  12  -rw-       0      Feb 2 2000 13:36:03 +05:30  tracelogs.878
105729 drwx      8192  Nov 21 2011 23:02:13 +05:30  tracelogs
30209 drwx      4096   Feb 2 2000 13:36:17 +05:30  .installer
  13  -rw-      1888   Nov 21 2011 23:03:17 +05:30  startup-config
1339412480 bytes total (1199439872 bytes free)
```

### Example 2: Copying Startup Configuration File to USB Flash Disk

```
Router# dir usb0:
Directory of usb0:/
43261 -rwx    208904396  May 27 2008 14:10:20 -07:00  asr903rspl-adventerprisek9.02.01.00.122-33.XNA.bin
255497216 bytes total (40190464 bytes free)
Router# copy nvram:startup-config usb0:
Destination filename [startup-config]?
3172 bytes copied in 0.214 secs (14822 bytes/sec)
Router# dir usb0:
Directory of usb0:/
43261 -rwx    208904396  May 27 2008 14:10:20 -07:00
asr903rspl-adventerprisek9.02.01.00.122-33.XNA.bin 43262 -rwx
 3172 Jul 2 2008 15:40:45 -07:00 startup-config255497216 bytes total (40186880 bytes free)
```

### Example 3: Copying Startup Configuration File to a TFTP Server

```
Router# copy bootflash:startup-config tftp:
Address or name of remote host []? 172.17.16.81
Destination filename [pe24_config]? /auto/tftp-users/user/startup-config
!!
3517 bytes copied in 0.122 secs (28828 bytes/sec)
```

For more detailed information on managing configuration files, see the *Configuration Fundamentals Configuration Guide, Cisco IOS XE Release 3S*.

## Filtering Output from the show and more Commands

You can search and filter the output of **show** and **more** commands. This functionality is useful if you need to sort through large amounts of output or if you want to exclude output that you need not see.

To use this functionality, enter a **show** or **more** command followed by the “pipe” character (|); one of the keywords **begin**, **include**, or **exclude**; and a regular expression on which you want to search or filter (the expression is case sensitive):

**show command** | {**append** | **begin** | **exclude** | **include** | **redirect** | **section** | **tee** | **count**} *regular-expression*

The output matches certain lines of information in the configuration file. The following example illustrates how to use output modifiers with the **show interface** command when you want the output to include only lines in which the expression “protocol” appears:

```
Router# show interface | include protocol
GigabitEthernet0/0/0 is up, line protocol is up
Serial4/0/0 is up, line protocol is up
Serial4/1/0 is up, line protocol is up
Serial4/2/0 is administratively down, line protocol is down
Serial4/3/0 is administratively down, line protocol is down
```

## Password Recovery



### Note

The configuration register is usually set to 0x2102 or 0x102. If you can no longer access the router (because of a lost login or TACACS password), you can safely assume that your configuration register is set to 0x2102.

### Before you begin

Make sure that the hyperterminal has the following settings:

- 9600 baud rate
- No parity
- 8 data bits
- 1 stop bit
- No flow control

### Procedure

- Step 1** Use the power switch to turn off the router, and then turn it on again.
- Step 2** Press **Break** on the terminal keyboard within 60 seconds of power up to put the router into ROMMON. In some cases Ctrl+Break key combination can be used.
- Step 3** Type **confreg 0x2142** at the ROMMON.

```
1> confreg 0x2142
1>sync
```

(This step bypasses the startup configuration where the passwords are stored.)

**Step 4** Type **reset** at the ROMOMN.

```
2> reset
```

The router reboots, but ignores the saved configuration.

**Step 5** The router reloads and prompts for configuration. Type **no** after each setup question, or press Ctrl-C to skip the initial setup procedure.

**Step 6** Type **enable** at the Router> prompt.

You are now in enable mode and should see the Router# prompt.

**Step 7** Reset the config-register from 0x2142 to 0x2102. To do so, type the following:

```
config-register configuration_register_setting
```

Where, configuration\_register\_setting is 0x2102. For example,

```
hostname (config) #config-register 0x2102
```

---

## Powering Off the Router

Before you turn off a power supply, make certain the chassis is grounded and you perform a soft shutdown on the power supply. Not performing a soft shutdown will often not harm the router, but may cause problems in certain scenarios.

To perform a soft shutdown before powering off the router, enter the **reload** command to halt the system and then wait for ROM Monitor to execute before proceeding to the next step.

The following screenshot shows an example of this process:

```
Router# reload
Proceed with reload? [confirm]
*Jun 18 19:38:21.870: %SYS-5-RELOAD: Reload requested by console. Reload Reason: Reload
command.
```

Place the power supply switch in the Off position after seeing this message.

## Finding Support Information for Platforms and Cisco Software Images

Cisco software is packaged in feature sets consisting of software images that support specific platforms. The feature sets available for a specific platform depend on which Cisco software images are included in a release. To identify the set of software images available in a specific release or to find out if a feature is available in a given Cisco IOS XE software image, you can use Cisco Feature Navigator or the software release notes.

## Using Cisco Feature Navigator

Use Cisco Feature Navigator to find information about platform support and software image support. Cisco Feature Navigator enables you to determine which Cisco IOS XE software images support a specific software release, feature set, or platform. To access Cisco Feature Navigator, go to <http://www.cisco.com/go/cfn>. An account on Cisco.com is not required.

## Using Software Advisor

To see if a feature is supported by a Cisco IOS XE release, to locate the software document for that feature, or to check the minimum software requirements of Cisco IOS XE software with the hardware installed on your router, Cisco maintains the Software Advisor tool on Cisco.com at <http://www.cisco.com/cgi-bin/Support/CompNav/Index.pl>.

You must be a registered user on Cisco.com to access this tool.

## Using Software Release Notes

Cisco IOS XE software releases include release notes that provide the following information:

- Platform support information
- Memory recommendations
- New feature information
- Open and resolved severity 1 and 2 caveats for all platforms

Release notes are intended to be release-specific for the most current release, and the information provided in these documents may not be cumulative in providing information about features that first appeared in previous releases. Refer to Cisco Feature Navigator for cumulative feature information.



## CHAPTER 3

# Console Port Telnet and SSH Handling

---

This chapter covers the following topics:

- [Console Port Overview, on page 19](#)
- [Connecting Console Cables, on page 19](#)
- [Installing USB Device Drivers, on page 19](#)
- [Console Port Handling Overview, on page 20](#)
- [Telnet and SSH Overview, on page 20](#)
- [Persistent Telnet and Persistent SSH Overview, on page 20](#)
- [Configuring a Console Port Transport Map, on page 21](#)
- [Configuring Persistent Telnet, on page 23](#)
- [Configuring Persistent SSH, on page 25](#)
- [Viewing Console Port, SSH, and Telnet Handling Configurations, on page 28](#)
- [Important Notes and Restrictions, on page 32](#)

## Console Port Overview

The console port on the chassis is an EIA/TIA-232 asynchronous, serial connection with no flow control and an RJ-45 connector. The console port is used to access the chassis and is located on the front panel of the Route Switch Processor (RSP).

For information on accessing the chassis using the console port, see the [“Accessing the CLI Using a Console” section on page 1-4](#).

## Connecting Console Cables

For information about connecting console cables to the chassis, see the [ASR 900 Series Hardware Installation Guides](#).

## Installing USB Device Drivers

For instructions on how to install device drivers in order to use the USB console port, see the [ASR 900 Series Hardware Installation Guides](#).

## Console Port Handling Overview

Users using the console port to access the chassis are automatically directed to the IOS command-line interface, by default.

If a user is trying to access the router through the console port and sends a break signal (a break signal can be sent by entering **Ctrl-C** or **Ctrl-Shift-6**, or by entering the **send break** command at the Telnet prompt ) before connecting to the IOS command-line interface, the user is directed into diagnostic mode by default if the non-RPIOS sub-packages can be accessed.

These settings can be changed by configuring a transport map for the console port and applying that transport map to the console interface.

## Telnet and SSH Overview

Telnet and Secure Shell (SSH) can be configured and handled like Telnet and SSH on other Cisco platforms. For information on traditional Telnet, see the **line** command in the *Cisco IOS Terminal Services Command Reference guide* located at [http://www.cisco.com/en/US/docs/ios/12\\_2/termsrv/command/reference/trfloslo.html#wp1029818](http://www.cisco.com/en/US/docs/ios/12_2/termsrv/command/reference/trfloslo.html#wp1029818).

For information on configuring traditional SSH, see the [Secure Shell Configuration Guide, Cisco IOS XE Release 3S](#)

The chassis also supports persistent Telnet and persistent SSH. Persistent Telnet and persistent SSH allow network administrators to more clearly define the treatment of incoming traffic when users access the router through the Management Ethernet port using Telnet or SSH. Notably, persistent Telnet and persistent SSH provide more robust network access by allowing the router to be configured to be accessible through the Ethernet Management port using Telnet or SSH even when the IOS process has failed.

## Persistent Telnet and Persistent SSH Overview

In traditional Cisco routers, accessing the router using Telnet or SSH is not possible in the event of an IOS failure. When Cisco IOS fails on a traditional Cisco router, the only method of accessing the router is through the console port. Similarly, if all active IOS processes have failed on a chassis that is not using persistent Telnet or persistent SSH, the only method of accessing the router is through the console port.

With persistent Telnet and persistent SSH, however, users can configure a transport map that defines the treatment of incoming Telnet or SSH traffic on the Management Ethernet interface. Among the many configuration options, a transport map can be configured to direct all traffic to the IOS command-line interface, diagnostic mode, or to wait for an IOS vty line to become available and then direct users into diagnostic mode when the user sends a break signal while waiting for the IOS vty line to become available. If a user uses Telnet or SSH to access diagnostic mode, that Telnet or SSH connection will be usable even in scenarios when no IOS process is active. Therefore, persistent Telnet and persistent SSH introduce the ability to access the router via diagnostic mode when the IOS process is not active. For information on diagnostic mode, see the [“Understanding Diagnostic Mode” section on page 1-3](#) .

For more information on the various other options that are configurable using persistent Telnet or persistent SSH transport map see the [Configuring Persistent Telnet, on page 23](#) and the [Configuring Persistent SSH, on page 25](#) .

# Configuring a Console Port Transport Map

This task describes how to configure a transport map for a console port interface.

## Procedure

	Command or Action	Purpose
<b>Step 1</b>	<b>enable</b> <b>Example:</b> <pre>Router&gt; enable</pre>	Enables privileged EXEC mode. <ul style="list-style-type: none"> <li>• Enter your password if prompted.</li> </ul>
<b>Step 2</b>	<b>configure terminal</b> <b>Example:</b> <pre>Router# configure terminal</pre>	Enters global configuration mode.
<b>Step 3</b>	<b>transport-map type console</b> <b>transport-map-name</b> <b>Example:</b> <pre>Router(config)# transport-map type console consolehandler</pre>	Creates and names a transport map for handling console connections, and enter transport map configuration mode.
<b>Step 4</b>	<b>connection wait [allow interruptible   none]</b> <b>Example:</b> <pre>Router(config-tmap)# connection wait none</pre> <b>Example:</b>	Specifies how a console connection will be handled using this transport map: <ul style="list-style-type: none"> <li>• <b>allow interruptible</b>—The console connection waits for an IOS vty line to become available, and also allows user to enter diagnostic mode by interrupting a console connection waiting for the IOS vty line to become available. This is the default setting.</li> </ul> <p><b>Note</b> Users can interrupt a waiting connection by entering <b>Ctrl-C</b> or <b>Ctrl-Shift-6</b>.</p> <ul style="list-style-type: none"> <li>• <b>none</b>—The console connection immediately enters diagnostic mode.</li> </ul>
<b>Step 5</b>	<b>banner [diagnostic   wait] banner-message</b> <b>Example:</b> <pre>Router(config-tmap)# banner diagnostic X</pre> <b>Example:</b>	(Optional) Creates a banner message that will be seen by users entering diagnostic mode or waiting for the IOS vty line as a result of the console transport map configuration. <ul style="list-style-type: none"> <li>• <b>diagnostic</b>—Creates a banner message seen by users directed into diagnostic mode as a result of the console transport map configuration.</li> </ul>

	Command or Action	Purpose
	<p>Enter TEXT message. End with the character 'X'.</p> <p><b>Example:</b></p> <pre>--Welcome to Diagnostic Mode--</pre> <p><b>Example:</b></p> <pre>X</pre> <p><b>Example:</b></p> <pre>Router(config-tmap)#</pre> <p><b>Example:</b></p>	<ul style="list-style-type: none"> <li>• <b>wait</b>—Creates a banner message seen by users waiting for the IOS vty to become available.</li> <li>• <i>banner-message</i>—The banner message, which begins and ends with the same delimiting character.</li> </ul>
<b>Step 6</b>	<p><b>exit</b></p> <p><b>Example:</b></p> <pre>Router(config-tmap)# exit</pre>	Exits transport map configuration mode to re-enter global configuration mode.
<b>Step 7</b>	<p><b>transport type console</b> <i>console-line-number</i> <b>input</b> <i>transport-map-name</i></p> <p><b>Example:</b></p> <pre>Router(config)# transport type console 0 input consolehandler</pre>	<p>Applies the settings defined in the transport map to the console interface.</p> <p>The <i>transport-map-name</i> for this command must match the <i>transport-map-name</i> defined in the <b>transport-map type console</b> command.</p>

## Examples

In the following example, a transport map to set console port access policies is created and attached to console port 0:

```
Router(config)# transport-map type console consolehandler
Router(config-tmap)# connection wait allow interruptible
Router(config-tmap)# banner diagnostic X
Enter TEXT message. End with the character 'X'.
Welcome to diagnostic mode
X
Router(config-tmap)# banner wait X
Enter TEXT message. End with the character 'X'.
Waiting for IOS vty line
X
Router(config-tmap)# exit
Router(config)# transport type console 0 input consolehandler
```



# Configuring Persistent Telnet

## Before you begin

For a persistent Telnet connection to access an IOS vty line on the chassis, local login authentication must be configured for the vty line (the **login** command in line configuration mode). If local login authentication is not configured, users will not be able to access IOS using a Telnet connection into the Management Ethernet interface with an applied transport map. Diagnostic mode will still be accessible in this scenario.

## Procedure

	Command or Action	Purpose
<b>Step 1</b>	<b>enable</b> <b>Example:</b> <pre>Router&gt; enable</pre>	Enables privileged EXEC mode. <ul style="list-style-type: none"> <li>• Enter your password if prompted.</li> </ul>
<b>Step 2</b>	<b>configure terminal</b> <b>Example:</b> <pre>Router# configure terminal</pre>	Enters global configuration mode.
<b>Step 3</b>	<b>transport-map type persistent telnet</b> <i>transport-map-name</i> <b>Example:</b> <pre>Router(config)# transport-map type persistent telnet telnethandler</pre>	Creates and names a transport map for handling persistent Telnet connections, and enters transport map configuration mode.
<b>Step 4</b>	<b>connection wait [allow {interruptible}  none {disconnect}]</b> <b>Example:</b> <pre>Router(config-tmap)# connection wait none</pre> <b>Example:</b>	Specifies how a persistent Telnet connection will be handled using this transport map: <ul style="list-style-type: none"> <li>• <b>allow</b>—The Telnet connection waits for an IOS vty line to become available, and exits the router if interrupted.</li> <li>• <b>allow interruptible</b>—The Telnet connection waits for the IOS vty line to become available, and also allows user to enter diagnostic mode by interrupting a Telnet connection waiting for the IOS vty line to become available. This is the default setting.</li> </ul> <p><b>Note</b> Users can interrupt a waiting connection by entering <b>Ctrl-C</b> or <b>Ctrl-Shift-6</b>.</p> <ul style="list-style-type: none"> <li>• <b>none</b>—The Telnet connection immediately enters diagnostic mode.</li> </ul>

	Command or Action	Purpose
		<ul style="list-style-type: none"> <li>• <b>none disconnect</b>—The Telnet connection does not wait for the IOS vty line and does not enter diagnostic mode, so all Telnet connections are rejected if no vty line is immediately available in IOS.</li> </ul>
<b>Step 5</b>	<p><b>banner</b> [<b>diagnostic</b>   <b>wait</b>] <i>banner-message</i></p> <p><b>Example:</b></p> <pre>Router(config-tmap)# banner diagnostic X</pre> <p><b>Example:</b></p> <pre>Enter TEXT message. End with the character 'X'.</pre> <p><b>Example:</b></p> <pre>--Welcome to Diagnostic Mode--</pre> <p><b>Example:</b></p> <pre>X</pre> <p><b>Example:</b></p> <pre>Router(config-tmap)#</pre> <p><b>Example:</b></p>	<p>(Optional) Creates a banner message that will be seen by users entering diagnostic mode or waiting for the IOS vty line as a result of the persistent Telnet configuration.</p> <ul style="list-style-type: none"> <li>• <b>diagnostic</b>—creates a banner message seen by users directed into diagnostic mode as a result of the persistent Telnet configuration.</li> <li>• <b>wait</b>—creates a banner message seen by users waiting for the vty line to become available.</li> <li>• <i>banner-message</i>—the banner message, which begins and ends with the same delimiting character.</li> </ul>
<b>Step 6</b>	<p><b>transport interface type</b> <i>num</i></p> <p><b>Example:</b></p> <pre>Router(config-tmap)# transport interface gigabitethernet 0</pre>	<p>Applies the transport map settings to the Management Ethernet interface (interface gigabitethernet 0).</p> <p>Persistent Telnet can only be applied to the Management Ethernet interface on the chassis. This step must be taken before applying the transport map to the Management Ethernet interface.</p>
<b>Step 7</b>	<p><b>exit</b></p> <p><b>Example:</b></p> <pre>Router(config-tmap)# exit</pre>	<p>Exits transport map configuration mode to re-enter global configuration mode.</p>
<b>Step 8</b>	<p><b>transport type persistent telnet input</b> <i>transport-map-name</i></p> <p><b>Example:</b></p> <pre>Router(config)# transport type persistent telnet input telnethandler</pre>	<p>Applies the settings defined in the transport map to the Management Ethernet interface.</p> <p>The <i>transport-map-name</i> for this command must match the <i>transport-map-name</i> defined in the <b>transport-map type persistent telnet</b> comm and.</p>

## Examples

In the following example, a transport map that will make all Telnet connections wait for an IOS vty line to become available before connecting to the router, while also allowing the user to interrupt the process and enter diagnostic mode, is configured and applied to the Management Ethernet interface (interface gigabitethernet 0).

A diagnostic and a wait banner are also configured.

The transport map is then applied to the interface when the **transport type persistent telnet input** command is entered to enable persistent Telnet.

```
Router(config)# transport-map type persistent telnet telnethandler
Router(config-tmap)#
connection wait allow interruptible
Router(config-tmap)# banner diagnostic X
Enter TEXT message. End with the character 'X'.
--Welcome to Diagnostic Mode--
X
Router(config-tmap)# banner wait X
Enter TEXT message. End with the character 'X'.
--Waiting for IOS Process--
X
Router(config-tmap)# transport interface gigabitethernet 0
Router(config-tmap)# exit
Router(config)# transport type persistent telnet input telnethandler
```

## Configuring Persistent SSH

This task describes how to configure persistent SSH.

### Procedure

	Command or Action	Purpose
<b>Step 1</b>	<b>enable</b> <b>Example:</b>  Router> enable	Enables privileged EXEC mode.  • Enter your password if prompted.
<b>Step 2</b>	<b>configure terminal</b> <b>Example:</b>  Router# configure terminal	Enters global configuration mode.
<b>Step 3</b>	<b>transport-map type persistent ssh</b> <i>transport-map-name</i> <b>Example:</b>  Router(config)# transport-map type persistent ssh sshhandler	Creates and names a transport map for handling persistent SSH connections, and enters transport map configuration mode.

	Command or Action	Purpose
Step 4	<p><b>connection wait</b> [<b>allow</b> {<b>interruptible</b>}   <b>none</b> {<b>disconnect</b>}]</p> <p><b>Example:</b></p> <pre>Router(config-tmap)# connection wait allow interruptible</pre> <p><b>Example:</b></p>	<p>Specifies how a persistent SSH connection will be handled using this transport map:</p> <ul style="list-style-type: none"> <li>• <b>allow</b>—The SSH connection waits for the vty line to become available, and exits the router if interrupted.</li> <li>• <b>allow interruptible</b>—The SSH connection waits for the vty line to become available, and also allows users to enter diagnostic mode by interrupting a SSH connection waiting for the vty line to become available. This is the default setting.</li> </ul> <p><b>Note</b> Users can interrupt a waiting connection by entering <b>Ctrl-C</b> or <b>Ctrl-Shift-6</b>.</p> <ul style="list-style-type: none"> <li>• <b>none</b>—The SSH connection immediately enters diagnostic mode.</li> <li>• <b>none disconnect</b>—The SSH connection does not wait for the vty line from IOS and does not enter diagnostic mode, so all SSH connections are rejected if no vty line is immediately available.</li> </ul>
Step 5	<p><b>rsa keypair-name</b> <i>rsa-keypair-name</i></p> <p><b>Example:</b></p> <pre>Router(config-tmap)# rsa keypair-name sshkeys</pre>	<p>Names the RSA keypair to be used for persistent SSH connections.</p> <p>For persistent SSH connections, the RSA keypair name must be defined using this command in transport map configuration mode. The RSA keypair definitions defined elsewhere on the router, such as through the use of the <b>ip ssh rsa keypair-name</b> command, do not apply to persistent SSH connections.</p> <p>No <i>rsa-keypair-name</i> is defined by default.</p>
Step 6	<p><b>authentication-retries</b><i>number-of-retries</i></p> <p><b>Example:</b></p> <pre>Router(config-tmap)# authentication-retries 4</pre>	<p>(Optional) Specifies the number of authentication retries before dropping the connection.</p> <p>The default <i>number-of-retries</i> is 3.</p>
Step 7	<p><b>banner</b> [<b>diagnostic</b>   <b>wait</b>] <i>banner-message</i></p> <p><b>Example:</b></p> <pre>Router(config-tmap)# banner diagnostic X</pre> <p><b>Example:</b></p>	<p>(Optional) Creates a banner message that will be seen by users entering diagnostic mode or waiting for the vty line as a result of the persistent SSH configuration.</p> <ul style="list-style-type: none"> <li>• <b>diagnostic</b>—Creates a banner message seen by users directed into diagnostic</li> </ul>

	Command or Action	Purpose
	<p>Enter TEXT message. End with the character 'X'.</p> <p><b>Example:</b></p> <pre>--Welcome to Diagnostic Mode--</pre> <p><b>Example:</b></p> <pre>X</pre> <p><b>Example:</b></p> <pre>Router(config-tmap)#</pre>	<p>mode as a result of the persistent SSH configuration.</p> <ul style="list-style-type: none"> <li>• <b>wait</b>—Creates a banner message seen by users waiting for the vty line to become active.</li> <li>• <i>banner-message</i>—The banner message, which begins and ends with the same delimiting character.</li> </ul>
<b>Step 8</b>	<p><b>time-out</b><i>timeout-interval</i></p> <p><b>Example:</b></p> <pre>Router(config-tmap)# time-out 30</pre>	<p>(Optional) Specifies the SSH time-out interval in seconds.</p> <p>The default <i>timeout-interval</i> is 120 seconds.</p>
<b>Step 9</b>	<p><b>transport interface type</b> <i>num</i></p> <p><b>Example:</b></p> <pre>Router(config-tmap)# transport interface gigabitethernet 0</pre>	<p>Applies the transport map settings to the Management Ethernet interface (interface gigabitethernet 0).</p> <p>Persistent SSH can only be applied to the Management Ethernet interface on the chassis.</p>
<b>Step 10</b>	<p><b>exit</b></p> <p><b>Example:</b></p> <pre>Router(config-tmap)# exit</pre>	<p>Exits transport map configuration mode to re-enter global configuration mode.</p>
<b>Step 11</b>	<p><b>transport type persistent ssh input</b> <i>transport-map-name</i></p> <p><b>Example:</b></p> <pre>Router(config)# transport type persistent ssh input sshhandler</pre>	<p>Applies the settings defined in the transport map to the Management Ethernet interface.</p> <p>The <i>transport-map-name</i> for this command must match the <i>transport-map-name</i> defined in the <b>transport-map type persistent ssh</b> command.</p>

## Examples

In the following example, a transport map that will make all SSH connections wait for the vty line to become active before connecting to the router is configured and applied to the Management Ethernet interface (interface gigabitethernet 0). The RSA keypair is named sshkeys.

This example only uses the commands required to configure persistent SSH.

```
Router(config)# transport-map type persistent ssh sshhandler
Router(config-tmap)# connection wait allow
Router(config-tmap)# rsa keypair-name sshkeys
Router(config-tmap)# transport interface gigabitethernet 0
```

In the following example, a transport map is configured that will apply the following settings to any users attempting to access the Management Ethernet port via SSH:

- Users using SSH will wait for the vty line to become active, but will enter diagnostic mode if the attempt to access IOS through the vty line is interrupted.
- The RSA keypair name is “sshkeys”
- The connection allows one authentication retry.
- The banner “--Welcome to Diagnostic Mode--” will appear if diagnostic mode is entered as a result of SSH handling through this transport map.
- The banner “--Waiting for vty line--” will appear if the connection is waiting for the vty line to become active.

The transport map is then applied to the interface when the **transport type persistent ssh input** command is entered to enable persistent SSH.

```
Router(config)# transport-map type persistent ssh sshhandler
Router(config-tmap)# connection wait allow interruptible
Router(config-tmap)# rsa keypair-name sshkeys
Router(config-tmap)# authentication-retries 1

Router(config-tmap)# banner diagnostic X

Enter TEXT message. End with the character 'X'.

--Welcome to Diagnostic Mode--

X

Router(config-tmap)#banner wait X
Enter TEXT message. End with the character 'X'.
--Waiting for vty line--
X
Router(config-tmap)#
time-out 30
Router(config-tmap)# transport interface gigabitethernet 0
Router(config-tmap)# exit
Router(config)# transport type persistent ssh input sshhandler
```

## Viewing Console Port, SSH, and Telnet Handling Configurations

Use the **show transport-map all name transport-map-name | type console persistent ssh telnet]]] EXEC** or privileged EXEC command to view the transport map configurations.

In the following example, a console port, persistent SSH, and persistent Telnet transport are configured on the router and various forms of the **show transport-map** command are entered to illustrate the various ways the **show transport-map** command can be entered to gather transport map configuration information.

```
Router# show transport-map all
Transport Map:
  Name: consolehandler
  Type: Console Transport
Connection:
  Wait option: Wait Allow Interruptable
  Wait banner:
```

```
Waiting for the IOS CLI
  bshell banner:
Welcome to Diagnostic Mode
Transport Map:
  Name: sshhandler
  Type: Persistent SSH Transport
Interface:
  GigabitEthernet0
Connection:
  Wait option: Wait Allow Interruptable
  Wait banner:
Waiting for IOS prompt
  Bshell banner:

Welcome to Diagnostic Mode
SSH:
  Timeout: 120
  Authentication retries: 5
  RSA keypair: sshkeys
Transport Map:
  Name: telnethandler
  Type: Persistent Telnet Transport
Interface:
  GigabitEthernet0
Connection:
  Wait option: Wait Allow Interruptable
  Wait banner:
Waiting for IOS process
  Bshell banner:
Welcome to Diagnostic Mode
Transport Map:
  Name: telnethandling1
  Type: Persistent Telnet Transport
Connection:
  Wait option: Wait Allow
Router# show transport-map type console
Transport Map:
  Name: consolehandler
  Type: Console Transport
Connection:
  Wait option: Wait Allow Interruptable
  Wait banner:
Waiting for the IOS CLI
  Bshell banner:
Welcome to Diagnostic Mode
Router# show transport-map type persistent ssh
Transport Map:
  Name: sshhandler
  Type: Persistent SSH Transport
Interface:
  GigabitEthernet0
Connection:
  Wait option: Wait Allow Interruptable
  Wait banner:
Waiting for IOS prompt
  Bshell banner:
Welcome to Diagnostic Mode
SSH:
  Timeout: 120
  Authentication retries: 5
  RSA keypair: sshkeys
Router# show transport-map type persistent telnet

Transport Map:
```

```

    Name: telnethandler
    Type: Persistent Telnet Transport
Interface:
    GigabitEthernet0
Connection:
    Wait option: Wait Allow Interruptable
    Wait banner:
Waiting for IOS process
    Bshell banner:
Welcome to Diagnostic Mode
Transport Map:
    Name: telnethandling1
    Type: Persistent Telnet Transport
Connection:
    Wait option: Wait Allow
Router# show transport-map name telnethandler
Transport Map:
    Name: telnethandler
    Type: Persistent Telnet Transport
Interface:
    GigabitEthernet0
Connection:
    Wait option: Wait Allow Interruptable
    Wait banner:
Waiting for IOS process
    Bshell banner:
Welcome to Diagnostic Mode
Router# show transport-map name consolehandler
Transport Map:
    Name: consolehandler
    Type: Console Transport
Connection:
    Wait option: Wait Allow Interruptable
    Wait banner:
Waiting for the IOS CLI
    Bshell banner:
Welcome to Diagnostic Mode
Router# show transport-map name sshhandler
Transport Map:
    Name: sshhandler
    Type: Persistent SSH Transport
Interface:
    GigabitEthernet0
Connection:
    Wait option: Wait Allow Interruptable
    Wait banner:
Waiting for IOS prompt
    Bshell banner:
Welcome to Diagnostic Mode
SSH:
    Timeout: 120
    Authentication retries: 5
    RSA keypair: sshkeys
Router#

```

The **show platform software configuration access policy** command can be used to view the current configurations for the handling of incoming console port, SSH, and Telnet connections. The output of this command provides the current wait policy for each type of connection, as well as any information on the currently configured banners. Unlike **show transport-map**, this command is available in diagnostic mode so it can be entered in cases when you need transport map configuration information but cannot access the IOS CLI.



```

Router# show platform software configuration access policy
The current access-policies
Method      : telnet
Rule        : wait
Shell banner:
Wait banner :
Method      : ssh
Rule        : wait
Shell banner:
Wait banner :
Method      : console
Rule        : wait with interrupt
Shell banner:
Wait banner :

```

In the following example, the connection policy and banners are set for a persistent SSH transport map, and the transport map is enabled.

The **show platform software configuration access policy** output is given both before the new transport map is enabled and after the transport map is enabled so the changes to the SSH configuration are illustrated in the output.

```

Router# show platform software configuration access policy

The current access-policies
Method      : telnet
Rule        : wait with interrupt
Shell banner:
Welcome to Diagnostic Mode
Wait banner :
Waiting for IOS Process
Method      : ssh
Rule        : wait
Shell banner:
Wait banner :
Method      : console
Rule        : wait with interrupt
Shell banner:
Wait banner :
Router# configure terminal
Enter configuration commands, one per line.  End with CNTL/Z.
Router(config)# transport-map type persistent ssh sshhandler
Router(config-tmap)# connection wait allow interruptible
Router(config-tmap)# banner diagnostic X
Enter TEXT message.  End with the character 'X'.
Welcome to Diag Mode
X
Router(config-tmap)# banner wait X
Enter TEXT message.  End with the character 'X'.
Waiting for IOS
X
Router(config-tmap)# rsa keypair-name sshkeys
Router(config-tmap)# transport interface gigabitethernet 0
Router(config-tmap)# exit
Router(config)# transport type persistent ssh input sshhandler
Router(config)# exit
Router# show platform software configuration access policy
The current access-policies
Method      : telnet
Rule        : wait with interrupt
Shell banner:
Welcome to Diagnostic Mode

```

```
Wait banner :  
Waiting for IOS process  
Method      : ssh  
Rule       : wait with interrupt  
Shell banner:  
Welcome to Diag Mode  
Wait banner :  
Waiting for IOS  
Method      : console  
Rule       : wait with interrupt  
Shell banner:  
Wait banner :
```

## Important Notes and Restrictions

- The Telnet and SSH settings made in the transport map override any other Telnet or SSH settings when the transport map is applied to the Management Ethernet interface.
- Only local usernames and passwords can be used to authenticate users entering a Management Ethernet interface. AAA authentication is not available for users accessing the router through a Management Ethernet interface using persistent Telnet or persistent SSH.
- Applying a transport map to a Management Ethernet interface with active Telnet or SSH sessions can disconnect the active sessions. Removing a transport map from an interface, however, does not disconnect any active Telnet or SSH sessions.
- Configuring the diagnostic and wait banners is optional but recommended. The banners are especially useful as indicators to users of the status of their Telnet or SSH attempts.



## CHAPTER 4

# Configuring the Route Switch Processor

---

This chapter describes how to configure the Route Switch Processor (RSP) on the Cisco ASR 900 Series Router and contains the following sections:

- [Configuring Timing Ports, on page 33](#)
- [Configuring the Management Ethernet Port, on page 33](#)
- [Configuring Console Ports, on page 33](#)
- [Reloading the Route Switch Processor, on page 33](#)
- [Forcing a Route Switch Processor Switchover, on page 34](#)

## Configuring Timing Ports

For information about configuring timing ports on the RSP, see [Chapter 1, “Configuring Clocking and Timing.”](#)

## Configuring the Management Ethernet Port

For information about configuring the management Ethernet port on the RSP, see [Chapter 1, “Using the Management Ethernet Interface.”](#)

## Configuring Console Ports

For information about configuring console ports, see [Chapter 1, “Console Port, Telnet, and SSH Handling.”](#)

## Reloading the Route Switch Processor

Use the following command in privileged EXEC mode:

Table 6: Route Switch Processor Reload

Command	Purpose
<code>hw-module slot <i>number</i> {logging } reload [force]   start   stop [force]}</code>	Restarts, stops, or starts a slot on the router. You can also use this command to disable or enable onboard logging of the hardware.



**Note** The command is used to reload the standby RSP module. Use the **show platform** command to find active/standby slot number.



**Note** The above task does not apply to Cisco ASR 902 router.

## Forcing a Route Switch Processor Switchover

To force the standby RSP to assume the role of the active RSP, use the **redundancy force-switchover** command in privileged EXEC mode.

```
Router# redundancy force-switchover
```



**Note** The above task does not apply to Cisco ASR 902 router.



**Note** Router should be in hot standby state for executing this command. This can be verified by using the show redundancy command.



## CHAPTER 5

# Configuring Ethernet Interfaces

This chapter provides information about configuring the Gigabit Ethernet interface modules.

For more information about the commands used in this chapter, see the [Cisco IOS XE 3S Command References](#).

- [Configuring Ethernet Interfaces, on page 35](#)
- [Verifying the Interface Configuration, on page 47](#)
- [Verifying Interface Module Status, on page 48](#)
- [Configuring LAN/WAN-PHY Controllers, on page 50](#)
- [Configuration Examples, on page 56](#)

## Configuring Ethernet Interfaces

This section describes how to configure the Gigabit and Ten Gigabit Ethernet interface modules and includes information about verifying the configuration.

### Limitations and Restrictions

- Interface module A900-IMA8Z in slot 0 with A900-RSP3C-200-S supports a maximum of 6 ports at 10GE speed and needs explicit enablement using the **hw-module subslot 0/0 A900-IMA8Z mode 6-port** command.
- VRF-Aware Software Infrastructure (VASI) interface commands **interface vasileft** and **interface vasiright** are not supported starting Cisco IOS XE Release 3.15.
- Interface modules have slot restrictions, see [ASR 900 Series Hardware Installation Guides](#)
- MPLS MTU is *not* supported on releases prior to Cisco IOS XE Release 3.10.2 on the router. This is not applicable for Cisco IOS XE Everest 16.5.1.
- IP MTU and MPLS MTU are supported. But MPLS MTU support is restricted only to CPU originated traffic. For the forwarded traffic, it is the IP MTU that decides the behavior.
- On the RSP3 module, MTU value configured for a BDI interface should match with the MTU configuration for all the physical interfaces, which have a service instance associated with this BDI.
- To replace the configured interface module with a different interface module in a particular slot, run the **hw-module subslot slot-num default** command.

- Only A900-IMA8Z Interface Modules support LAN/WAN-PHY mode on the Cisco ASR 900 RSP3 Module.
- SNMP support is not available for WAN-PHY in Cisco IOS XE Release 3.18.1SP.
- IEEE 1588 and SyncE are not supported in the WAN-PHY mode on A900-IMA8Z Interface Modules.
- Giant counters are not supported.
- Mixed configurations of features are not supported on the same port. For example, one OC-3 port can have only CEM (CESoP or SAToP), ATM, IMA or DS3 configurations, but not a combination of these features on a single port.
- Ingress counters are not incremented for packets of the below packet format on the RSP3 module for the 10 Gigabit Ethernet interfaces, 100 Gigabit Ethernet interfaces, and 40 Gigabit Ethernet interfaces:  
MAC header---->Vlan header---->Length/Type  
When these packets are received on the RSP3 module, the packets are not dropped, but the counters are not incremented.
- If the IM is shutdown using **hw-module subslot shutdown** command, then the IM goes out-of-service. You should perform a Stateful Switchover (SSO) in the interim, as the IM needs to be re-inserted for successful reactivation.
- Following are some of the IMs that are not supported on certain slots when IPsec license is enabled:
  - The below IMs are not supported on the Slot 11 on the Cisco ASR 907 router:
    - SPA\_TYPE\_ETHER\_IM\_8x10GE
    - SPA\_TYPE\_ETHER\_IM\_2x40GE
  - The below IMs are not supported on the Slot 2 on the Cisco ASR 903 router for RSP3-200 and RSP3-400:
    - SPA\_TYPE\_ETHER\_IM\_8xGE\_SFP\_1x10GE
    - SPA\_TYPE\_ETHER\_IM\_8xGE\_CU\_1x10GE
    - SPA\_TYPE\_ETHER\_IM\_1x10GE
    - SPA\_TYPE\_ETHER\_IM\_8x10GE
    - SPA\_TYPE\_OCX\_IM\_OC3OC12
    - SPA\_TYPE\_ETHER\_IM\_8xGE\_SFP
    - SPA\_TYPE\_ETHER\_IM\_8xGE\_CU
- CTS signal goes down, when control signal frequency is configured more than 5000 ms and timeout setting is more than 20,000 ms (4x control\_frequency), which is greater than the OIR time (~20s) for a selected slave to complete an OIR cycle. This results in the master unaware that the slave is down and CTS of all slaves are down too. To avoid this situation, ensure that the timeout is shorter than the OIR time of the slave. Set the control frequency to less than or equal to 5000 ms and the timeout setting to less than or equal to 20,000 ms before you perform OIR.

## Configuring an Interface

This section lists the required configuration steps to configure Gigabit and Ten Gigabit Ethernet interface modules.

### Procedure

	Command or Action	Purpose
<b>Step 1</b>	<b>configure terminal</b> <b>Example:</b> <pre>Router# configure terminal</pre>	Enters global configuration mode.
<b>Step 2</b>	Do one of the following: <ul style="list-style-type: none"> <li>• <b>interface gigabitethernet</b> <i>slot/subslot/port</i></li> <li>• <b>interface tengigabitethernet</b> <i>slot/subslot/port</i></li> </ul> <b>Example:</b> <pre>Router (config)# interface gigabitethernet 0/0/1</pre> <b>Example:</b> <pre>Router (config)# interface tengigabitethernet 0/0/1</pre>	Specifies the Gigabit Ethernet or Ten Gigabit Ethernet interface to configure and enters interface configuration mode, where: <b>Note</b> The slot number is always 0.
<b>Step 3</b>	<b>ip address</b> <i>ip-address mask {secondary}   dhcp {client-id interface-name} {hostname host-name}</i> <b>Example:</b> <pre>Router (config-if)# ip address 192.168.1.1 255.255.255.255 dhcp hostname host1</pre>	Sets a primary or secondary IP address for an interface that is using IPv4, where: <ul style="list-style-type: none"> <li>• <i>ip-address</i>—The IP address for the interface.</li> <li>• <i>mask</i>—The mask for the associated IP subnet.</li> <li>• <b>secondary</b>—(Optional) Specifies that the configured address is a secondary IP address. If this keyword is omitted, the configured address is the primary IP address.</li> <li>• <b>dhcp</b>—Specifies that IP addresses will be assigned dynamically using DHCP.</li> <li>• <b>client-id</b> <i>interface-name</i>—Specifies the client identifier. The <i>interface-name</i> sets the client identifier to the hexadecimal MAC address of the named interface.</li> <li>• <b>hostname</b> <i>host-name</i>—Specifies the hostname for the DHCP purposes. The <i>host-name</i> is the name of the host to be placed in the DHCP option 12 field.</li> </ul>

	Command or Action	Purpose
<b>Step 4</b>	<p><b>no negotiation auto</b></p> <p><b>Example:</b></p> <pre>Router(config-if) # no negotiation auto</pre>	<p>(Optional) Disables automatic negotiation.</p> <p><b>Note</b> Use the <b>speed</b> command only when the mode is set to no negotiation auto.</p>
<b>Step 5</b>	<p><b>speed { 10   100   1000 }</b></p> <p><b>Example:</b></p> <pre>Router(config-if) # speed 1000</pre>	<p>(Optional) Specifies the speed for an interface to transmit at 10, 100, and 1000 Mbps (1 Gbps), where the default is 1000 Mbps.</p>
<b>Step 6</b>	<p><b>mtu bytes</b></p> <p><b>Example:</b></p> <pre>Router(config-if) # mtu 1500</pre>	<p>(As Required) Specifies the maximum packet size for an interface, where:</p> <ul style="list-style-type: none"> <li>• <i>bytes</i>—The maximum number of bytes for a packet.</li> </ul> <p>The default is 1500 bytes; the range is from 1500 to 9216.</p>
<b>Step 7</b>	<p><b>standby [group-number] ip [ip-address [secondary]]</b></p> <p><b>Example:</b></p> <pre>Router(config-if) # standby 250 ip 192.168.10.1</pre>	<p>Creates or enables the Hot Standby Router Protocol (HSRP) group using its number and virtual IP address, where:</p> <ul style="list-style-type: none"> <li>• (Optional) <i>group-number</i>—The group number on the interface for which HSRP is being enabled. The range is from 0 to 255; the default is 0. If there is only one HSRP group, you do not need to enter a group number.</li> <li>• (Optional on all but one interface if configuring HSRP) <i>ip-address</i>—The virtual IP address of the hot standby router interface. You must enter the virtual IP address for at least one of the interfaces; it can be learned on the other interfaces.</li> <li>• (Optional) <b>secondary</b>—Specifies that the IP address is a secondary hot standby router interface. If neither router is designated as a secondary or standby router and no priorities are set, the primary IP addresses are compared and the higher IP address is the active router, with the next highest as the standby router.</li> </ul> <p><b>Note</b> This command is required only for configurations that use HSRP.</p> <p><b>Note</b> This command enables HSRP but does not configure it further.</p>



	Command or Action	Purpose
<b>Step 8</b>	<b>no shutdown</b> <b>Example:</b> Router(config-if)# <b>no shutdown</b>	Enables the interface.

## Specifying the Interface Address on an Interface Module

To configure or monitor Ethernet interfaces, you need to specify the physical location of the interface module and interface in the CLI. The interface address format is slot/subslot/port, where:

- slot—The chassis slot number in the chassis where the interface module is installed.



**Note** The interface module slot number is always 0.

- subslot—The subslot where the interface module is installed. Interface module subslots are numbered from 0 to 5 for ASR 903 and from 0 to 15 for ASR 907, from bottom to top.
- port—The number of the individual interface port on an interface module.

The following example shows how to specify the first interface (0) on an interface module installed in the first interface module slot:

```
Router(config)# interface GigabitEthernet 0/0/0
no ip address
shutdown
negotiation auto
no cdp enable
```

## Configuring Hot Standby Router Protocol

Hot Standby Router Protocol (HSRP) provides high network availability because it routes IP traffic from hosts without relying on the availability of any single router. You can deploy HSRP in a group of routers to select an active router and a standby router. (An *active* router is the router of choice for routing packets; a *standby* router is a router that takes over the routing duties when an active router fails, or when preset conditions are met).

HSRP is enabled on an interface by entering the **standby** [*group-number*] **ip** [*ip-address* [**secondary**]] command. The **standby** command is also used to configure various HSRP elements. This document does not discuss more complex HSRP configurations. For additional information on configuring HSRP, see to the HSRP section of the Cisco IP Configuration Guide publication that corresponds to your Cisco IOS XE software release. In the following HSRP configuration, standby group 2 on Gigabit Ethernet port 0/1/0 is configured at a priority of 110 and is also configured to have a preemptive delay should a switchover to this port occur:

```
Router(config)#interface GigabitEthernet 0/1/0
Router(config-if)#standby 2 ip 192.168.1.200
Router(config-if)#standby 2 priority 110
Router(config-if)#standby 2 preempt
```

The maximum number of different HSRP groups that can be created on one physical interface is 4. If additional groups are required, create 4 groups on the physical interface, and the remaining groups on the BDI or on another physical interface.

The maximum number of HSRP or VRRP groups allowed are:

- RSP1A—128 HSRP or VRRP groups. 128 HSRP or VRRP groups restriction implies that the maximum number of different interfaces that can be configured with VRRP or HSRP is 128. You cannot configure HSRP or VRRP for more than 128 interfaces but you can configure up to 256 HSRP or VRRP groups in those 128 interfaces.
- RSP1B—256 HSRP or VRRP groups
- RSP2A-64 and RSP2-128—128 HSRP or VRRP groups, prior to Cisco IOS Release XE 3.15S
- RSP2A-64 and RSP2-128—256 HSRP or VRRP groups, starting Cisco IOS Release XE 3.15S
- RSP3-200 and RSP3-400—255 HSRP or VRRP groups, starting Cisco IOS Release XE 3.18.1SP



---

**Note** TCAM space utilization changes when HSRP groups are configured on the router. If HSRP groups are configured the TCAM space is utilized. Each HSRP group takes 1 TCAM entry. The “Out of TCAM” message may be displayed if total number of TCAM space used by HSRP groups and prefixes on the router exceeds scale limit.

---



---

**Note** HSRP state flaps with sub-second “Hello” or “Dead” timers.

---

### Restrictions

HSRPv2 is not supported.

## Verifying HSRP

To verify the HSRP information, use the show standby command in EXEC mode:

```
Router# show standby
Ethernet0 - Group 0
Local state is Active, priority 100, may preempt
Hellotime 3 holdtime 10
Next hello sent in 0:00:00
Hot standby IP address is 198.92.72.29 configured
Active router is local
Standby router is 198.92.72.21 expires in 0:00:07
Standby virtual mac address is 0000.0c07.ac00
Tracking interface states for 2 interfaces, 2 up:
UpSerial0
UpSerial1
```

## Modifying the Interface MTU Size



**Note** The maximum number of unique MTU values that can be configured on the physical interfaces on the chassis is 8. Use the **show platform hardware pp active interface mtu command** to check the number of values currently configured on the router. This is not applicable on Cisco ASR 900 RSP3 Module.

The Cisco IOS software supports three different types of configurable maximum transmission unit (MTU) options at different levels of the protocol stack:

- **Interface MTU**—The interface module checks the MTU value of incoming traffic. Different interface types support different interface MTU sizes and defaults. The interface MTU defines the maximum packet size allowable (in bytes) for an interface before drops occur. If the frame is smaller than the interface MTU size, but is not smaller than the minimum frame size for the interface type (such as 64 bytes for Ethernet), then the frame continues to process.
- **IP MTU**—Can be specified on an interface. If an IP packet exceeds the IP MTU size, then the packet is fragmented.

When the value of the IP MTU is 9216 bytes and the packet is sent with 9214 bytes, 18 bytes are added to the packet by FPGA. The total size of the packet then becomes 9232 bytes. The maximum supported MTU of the packet without fragmentation in ASIC is 9232, so there is no traffic loss with a packet size of 9214. When IP MTU is 9216, and the packet is sent with either 9215 or 9216 bytes, 18 bytes are added to the packet by FPGA. The total size of the packet then becomes 9233 or 9234 bytes respectively. As the packet size exceeds the maximum supported MTU size of the packet without fragmentation, the packet is dropped.

When the traffic with packet size greater than 9216 bytes is sent and the MTU is configured as 9216 bytes, the packet is fragmented. Hence, the packet loss is prevented.



**Note** The IP MTU configured on BDI should not be greater than the Layer2 MTU configured on the underlying Layer2 interface. For Cisco ASR 900 RSP3 Module the IP MTU configured on a BDI should be equal to the Layer2 MTU configured on the underlying Layer 2 interface.

- **MPLS MTU**—If the MPLS MTU is set to a value, for example, 1500 bytes, the value is programmed as 1504 bytes at the hardware level to allow the addition of one label. Consider the case of pseudowire. If the packet size of Layer 2 traffic sent with four bytes of Frame Check Sequence (FCS) to the pseudowire is 1500 bytes, then and four bytes of pseudowire control word and one pseudowire label (label size is four bytes) is added to the packet, the packet size is now 1508 bytes with FCS. However, note that while calculating the packet size, FCS is not considered. So the calculated packet size is 1504 bytes, which is equal to the MPLS MTU programmed in the hardware. This packet is forwarded as expected.

However, if another label is added to this packet, the packet size becomes 1508 bytes without FCS. This value is greater than programmed MTU value, so this packet is dropped. This restriction applies not only to pseudowire, but to the entire MPLS network.

To ensure that packets are not dropped, MPLS MTUs should be set considering the maximum size of the label stack that is added to the packet in the network.

Encapsulation methods and MPLS MTU labels add additional overhead to a packet. For example, Subnetwork Access Protocol (SNAP) encapsulation adds an 8-byte header, dot1q encapsulation adds a 2-byte header, and each MPLS label adds a 4-byte header ( $n$  labels  $\times$  4 bytes).

For the Gigabit Ethernet interface module on the chassis, the default MTU size is 1500 bytes. The maximum configurable MTU is 9216 bytes. The interface module automatically adds an additional 22 bytes to the configured MTU size to accommodate some of the additional overhead.

## Interface MTU Configuration Guidelines

When configuring the interface MTU size, consider the following guidelines:

- The default interface MTU size accommodates a 1500-byte packet, plus 22 additional bytes to cover the following additional overhead:
  - Layer 2 header—14 bytes
  - Dot1q header—4 bytes
  - CRC—4 bytes



**Note** If you are using MPLS, ensure that the **mpls mtu** command is configured for a value less than or equal to the interface MTU. This is not applicable for Cisco ASR 900 RSP3 Module.

- If you are using MPLS labels, then you should increase the default interface MTU size to accommodate the number of MPLS labels. Each MPLS label adds 4 bytes of overhead to a packet.
- Interface MTU is not supported on BDI Interface

## Configuring Interface MTU

To modify the MTU size on an interface, use the following command in interface configuration mode:

Command	Purpose
<b>mtu</b> <i>bytes</i>  Router(config-if) # <b>mtu</b> <i>bytes</i>	Configures the maximum packet size for an interface, where: <ul style="list-style-type: none"> <li>• <i>bytes</i>— Specifies the maximum number of bytes for a packet.</li> </ul> The default is 1500 bytes and the maximum configurable MTU is 9216 bytes.

To return to the default MTU size, use the **no** form of the command.



**Note** When IP FRR over BDI is configured, the maximum allowed packet size is 1504 bytes.

When the BGP-PIC core is enabled, a packet destined to a prefix that is learnt through eBGP, is dropped if the packet size is greater than 1504 bytes. To work around this limitation, do one of the following:

- Disable the BGP-PIC core,

- Use the static route, or
- Use routed-port instead of BDI.

## Verifying the MTU Size

To verify the MTU size for an interface, use the **show interfaces gigabitethernet** privileged EXEC command and observe the value shown in the “MTU” field.

The following example shows an MTU size of 1500 bytes for interface port 0 (the second port) on the Gigabit Ethernet interface module installed in slot 1:

```
Router# show interfaces gigabitethernet 0/1/0
GigabitEthernet0/1/0 is up, line protocol is up
  Hardware is A900-IMA8T , address is d0c2.8216.0590 (bia d0c2.8216.0590)
  MTU 1500 bytes
, BW 1000000 Kbit/sec, DLY 10 usec,
  reliability 255/255, txload 1/255, rxload 22/255
  Encapsulation ARPA, loopback not set
  Keepalive set (10 sec)
```

## MPLS MTU

MPLS MTU configuration is supported starting with Cisco IOS XE Release 3.10.2 and later. The **platform mpls mtu-enable** command is introduced to enable MPLS MTU on the router.

## Restrictions

- MPLS MTU is not supported if IP address is not configured on the interface.
- MPLS MTU is not supported with MPLS LDP Auto configuration.
- MPLS MTU is not supported with BGP send-label.
- IP MTU configuration on an interface does not program MPLS MTU in the hardware. MPLS MTU value is obtained from the Interface MTU or IP MTU.
- In releases prior to Cisco IOS XE Release 3.10.2, if IP MTU is changed, MPLS MTU also changes.
- If both Interface MTU and IP MTU are configured MPLS MTU is obtained from IP MTU. See [Table 7: MTU Normal Behavior \(Command Not Enabled\)](#), on page 43.

**Table 7: MTU Normal Behavior (Command Not Enabled)**

Interface-MTU	IP MTU	MPLS MTU	MPLS MTU Value Derived
Yes	No	No	Interface MTU
No	Yes	No	IP MTU
Yes	Yes	No	IP MTU

- If MPLS MTU is enabled using **platform mpls mtu-enable** command, then IP MTU does not affect the MPLS MTU configuration. See [Table 8: MTU Behavior with platform mpls mtu-enable Command Configured](#), on page 44.

Table 8: MTU Behavior with platform mpls mtu-enable Command Configured

Interface MTU	IP MTU	MPLS MTU	MPLS MTU Value Derived
Yes	No	No	Interface MTU
No	Yes	No	Default value
Yes	Yes	No	Interface MTU
No	No	No	Default value
Yes	No	Yes	MPLS MTU
No	Yes	Yes	MPLS MTU
Yes	Yes	Yes	MPLS MTU
No	No	Yes	MPLS MTU

## Configuring MPLS MTU Globally

We recommend not to toggle the command as inconsistent results may be displayed.



**Note** After configuring or unconfiguring the command, we recommend that all MTU values on all the interfaces are re-configured.

### Procedure

	Command or Action	Purpose
<b>Step 1</b>	<b>platform mpls mtu-enable</b> <b>Example:</b> Router (config)# platform mpls mtu-enable	Configures MPLS MTU globally on the router
<b>Step 2</b>	<b>interface gigabitethernet slot /subslot /port</b> <b>Example:</b> Router (config)# interface GigabitEthernet 0/0/1 <b>Example:</b>	Specifies the Gigabit Ethernet or Ten Gigabit Ethernet interface to configure and enters interface configuration mode, where: <b>Note</b> The slot number is always 0.
<b>Step 3</b>	<b>mpls mtu mtu-value</b> <b>Example:</b> Router(config-if)# mpls mtu 700	Configures the MTU value.

	Command or Action	Purpose
	<b>Example:</b>	

## Verifying MPLS MTU

Use the **show platform hardware pp active feature mpls mtu-table** command to display the MPLS MTU values configured on the router.

```
Router# show platform hardware pp active feature mpls mtu-table
MPLS MTU Table
Index      MTU      Ref-Count
-----
0          1504    1
1           704    0
2            0    0
3            0    0
4            0    0
5            0    0
6            0    0
7            0    0
```

## Configuring the Encapsulation Type

The only encapsulation supported by the interface modules is IEEE 802.1Q encapsulation for virtual LANs (VLANs).



**Note** VLANs are only supported on Ethernet Virtual Connection (EVC) service instances and Trunk Ethernet Flow Point (EFP) interfaces.

For more information about how to configure these features, see the [Configuring Ethernet Virtual Connections on the Cisco ASR 900 Series Router](#) document.

## Configuring Autonegotiation on an Interface

Gigabit Ethernet interfaces use a connection-setup algorithm called *autonegotiation*. Autonegotiation allows the local and remote devices to configure compatible settings for communication over the link. Using autonegotiation, each device advertises its transmission capabilities and then agrees upon the settings to be used for the link.

For the Gigabit Ethernet interfaces on the chassis, flow control is autonegotiated when autonegotiation is enabled. Autonegotiation is enabled by default.

The Copper SFP does not auto-negotiate full duplex with 8-port Gigabit Ethernet RJ45 (Copper) Interface Module (8X1GE) with speed 100 configured.

When enabling autonegotiation, consider these guidelines:

- If autonegotiation is disabled on one end of a link, it must be disabled on the other end of the link. If one end of a link has autonegotiation disabled while the other end of the link does not, the link will not come up properly on both ends.

- Flow control is enabled by default.
- Flow control will be on if autonegotiation is disabled on both ends of the link.

## Enabling Autonegotiation

To enable autonegotiation on a Gigabit Ethernet interface, use the following command in interface configuration mode:

Command	Purpose
<b>negotiation auto</b>  Router(config-if) # <b>negotiation auto</b>	Enables autonegotiation on a Gigabit Ethernet interface. Advertisement of flow control occurs.

## Disabling Autonegotiation

Autonegotiation is automatically enabled and can be disabled on Gigabit Ethernet interfaces. During autonegotiation, advertisement for flow control, speed, and duplex occurs, depending on the media (fiber or copper) in use.

Speed and duplex configurations can be advertised using autonegotiation. The values that are negotiated are:

- For Gigabit Ethernet interfaces using RJ-45 ports and for Copper (Cu) SFP ports—10, 100, and 1000 Mbps for speed and full-duplex mode. Link speed is not negotiated when using fiber interfaces.

To disable autonegotiation, use the following command in interface configuration mode:

Command	Purpose
<b>no negotiation auto</b>  Router(config-if) # <b>no negotiation auto</b>	Disables autonegotiation on Gigabit Ethernet interfaces. No advertisement of flow control occurs.

## Configuring Carrier Ethernet Features

For information about configuring an Ethernet interface as a layer 2 Ethernet virtual circuit (EVC) or Ethernet flow point (EFP), see the [Ethernet Virtual Connections Configuration](#).

## Saving the Configuration

To save your running configuration to NVRAM, use the following command in privileged EXEC configuration mode:

Command	Purpose
<b>copy running-config startup-config</b>  Router# <b>copy running-config startup-config</b>	Writes the new configuration to NVRAM.



For information about managing your system image and configuration files, refer to the [Cisco IOS Configuration Fundamentals Configuration Guide](#) and [Cisco IOS Configuration Fundamentals Command Reference](#) publications that correspond to your Cisco IOS software release.

## Shutting Down and Restarting an Interface

You can shut down and restart any of the interface ports on an interface module independently of each other. Shutting down an interface stops traffic and enters the interface into an “administratively down” state.

If you are preparing for an OIR of an interface module, it is not necessary to independently shut down each of the interfaces prior to deactivation of the module.

Command	Purpose
<p><b>shutdown</b></p> <pre>router#configure terminal Enter configuration commands, one per line. End with CNTL/Z. router(config) router(config)#interface GigabitEthernet 0/1/0 router(config-if)#shutdown</pre> <p><b>no shutdown</b></p> <pre>router#configure terminal Enter configuration commands, one per line. End with CNTL/Z. router(config) router(config)#interface GigabitEthernet 0/1/0 router(config-if)#no shutdown</pre>	<p>Restarts, stops, or starts an interface.</p>

## Shutting Down and Restarting an Interface Module

You can use the following commands in EXEC mode to automatically stop traffic on the affected interfaces and deactivate them along with the interface module in preparation for OIR:

Command	Purpose
<p><b>hw-module subslot slot/subslot {reload [force]   start   stop [force]}</b></p>	<p>Restarts, stops, or starts a subslot and its interfaces. You can also use this command to disable or enable onboard logging of the hardware.</p>

## Verifying the Interface Configuration

Besides using the **show running-configuration** command to display the configuration settings, you can use the **show interfaces gigabitethernet** command to get detailed information on a per-port basis for your Gigabit Ethernet interface module.

## Verifying Per-Port Interface Status

To find detailed interface information on a per-port basis for the Gigabit Ethernet interface module, use the **show interfaces gigabitethernet** command.

The following example provides sample output for interface port 0 on the interface module located in slot 1:

```
Router# show interfaces GigabitEthernet0/1/0
GigabitEthernet0/1/0 is up, line protocol is up
  Hardware is A900-IMA8T , address is d0c2.8216.0590 (bia d0c2.8216.0590)
  MTU 1500 bytes, BW 1000000 Kbit/sec, DLY 10 usec,
    reliability 255/255, txload 1/255, rxload 1/255
  Encapsulation ARPA, loopback not set
  Keepalive set (10 sec)
  Full Duplex, 1000Mbps, link type is auto, media type is RJ45
  output flow-control is off, input flow-control is off
  ARP type: ARPA, ARP Timeout 04:00:00
  Last input never, output 08:59:45, output hang never
  Last clearing of show interface counters 09:00:18
  Input queue: 0/375/0/0 (size/max/drops/flushes); Total output drops: 0
  Queueing strategy: fifo
  Output queue: 0/40 (size/max)
  5 minute input rate 0 bits/sec, 0 packets/sec
  5 minute output rate 0 bits/sec, 0 packets/sec
    11 packets input, 704 bytes, 0 no buffer
  Received 11 broadcasts (0 IP multicasts)
    0 runts, 0 giants, 0 throttles
    0 input errors, 0 CRC, 0 frame, 0 overrun, 0 ignored
    0 watchdog, 0 multicast, 0 pause input
    0 packets output, 0 bytes, 0 underruns
    0 output errors, 0 collisions, 0 interface resets
    0 unknown protocol drops
    0 babbles, 0 late collision, 0 deferred
    0 lost carrier, 0 no carrier, 0 pause output
    0 output buffer failures, 0 output buffers swapped out
```

## Verifying Interface Module Status

You can use various **show** commands to view information specific to SFP, XFP, CWDM, and DWDM optical transceiver modules.



---

**Note** The **show interface transceiver** command is *not* supported on the router.

---

To check or verify the status of an SFP Module or XFP Module, use the following **show** commands:

Use **show hw-module slot/subslot transceiver port status** or **show interfaces interface transceiver detail** to view the threshold values for temperature, voltage and so on.

For example, **show hw-module subslot 0/5 transceiver 1 status** or **show interfaces tenGigabitEthernet 0/5/1 transceiver detail**.

Command	Purpose
<b>show hw-module <i>slot/subslot</i> transceiver <i>port idprom</i></b>	Displays information for the transceiver identification programmable read only memory (idprom).  <b>Note</b> Transceiver types must match for a connection between two interfaces to become active.
<b>show hw-module <i>slot/subslot</i> transceiver <i>port idprom status</i></b>	Displays information for the transceiver initialization status.  <b>Note</b> The transmit and receive optical power displayed by this command is useful for troubleshooting Digital Optical Monitoring (DOM). For interfaces to become active, optical power must be within required thresholds.
<b>show hw-module <i>slot/subslot</i> transceiver <i>port idprom dump</i></b>	Displays a dump of all EEPROM content stored in the transceiver.

The following **show hw-module subslot** command sample output is for 1000BASE BX10-U:

```
Router#show hw-module subslot 0/2 transceiver 0 idprom brief

IDPROM for transceiver GigabitEthernet0/2/0:
  Description                               = SFP or SFP+ optics (type 3)
  Transceiver Type:                         = 1000BASE BX10-U (259)
  Product Identifier (PID)                  = GLC-BX-U
  Vendor Revision                           = 1.0
  Serial Number (SN)                        = NPH20441771
  Vendor Name                               = CISCO-NEO
  Vendor OUI (IEEE company ID)              = 00.15.06 (5382)
  CLEI code                                 = IPUIAG5RAC
  Cisco part number                         = 10-2094-03
  Device State                              = Enabled.
  Date code (yy/mm/dd)                     = 16/11/12
  Connector type                            = LC.
  Encoding                                  = 8B10B (1)
  Nominal bitrate                           = GE (1300 Mbits/s)
  Minimum bit rate as % of nominal bit rate = not specified
  Maximum bit rate as % of nominal bit rate = not specified
Router#
```

The following **show hw-module subslot** command sample output is for an SFP+ 10GBASE-SR:

```
Router#show hw-module subslot 0/2 transceiver 8 idprom brief

IDPROM for transceiver TenGigabitEthernet0/2/8:
  Description                               = SFP or SFP+ optics (type 3)
  Transceiver Type:                         = SFP+ 10GBASE-SR (273)
  Product Identifier (PID)                  = SFP-10G-SR
  Vendor Revision                           = 2
  Serial Number (SN)                        = JUR2052G19W
  Vendor Name                               = CISCO-LUMENTUM
  Vendor OUI (IEEE company ID)              = 00.01.9C (412)
  CLEI code                                 = COUIA8NCAA
  Cisco part number                         = 10-2415-03
  Device State                              = Enabled.
  Date code (yy/mm/dd)                     = 16/12/21
  Connector type                            = LC.
  Encoding                                  = 64B/66B (6)
```

```

Nominal bitrate                               = (10300 Mbits/s)
Minimum bit rate as % of nominal bit rate = not specified
Maximum bit rate as % of nominal bit rate = not specified
Router#

```



**Note** VID for optics displayed in **show inventory** command and vendor revision shown in **idprom detail** command output are stored in different places in Idprom.

## Configuring LAN/WAN-PHY Controllers

The LAN/WAN-PHY controllers are configured in the physical layer control element of the Cisco IOS XE software.

### Restrictions for LAN/WAN-PHY Mode

- Effective with Cisco IOS XE Release 3.18.1SP, A900-IMA8Z Interface Modules (IM) support LAN/WAN-PHY mode on the Cisco ASR 900 RSP3 Module.
- The following A900-IMA8Z IM alarms are not supported on the Cisco ASR 900 RSP3 Module:
  - NEWPTR
  - PSE
  - NSE
  - FELCDP
  - FEASIP

### Configuring LAN-PHY Mode

This section describes how to configure LAN-PHY mode on the Gigabit Ethernet interface modules.

#### Procedure

	Command or Action	Purpose
<b>Step 1</b>	<b>show controllers wanphy <i>slot/subslot/port</i></b>  <b>Example:</b>  <pre> Router# show controllers wanphy 0/1/0  TenGigabitEthernet0/1/0 Mode of Operation: WAN Mode SECTION LOF = 0             LOS   = 0                    BIP(B1) = 0  LINE AIS = 0             RDI   = 0 </pre>	Displays the configuration mode of the LAN/WAN-PHY controller. Default configuration mode is LAN.  If the configuration mode is WAN, complete the rest of the procedure to change the configuration mode to LAN. <ul style="list-style-type: none"> <li>• <i>slot /subslot /port</i>—The location of the interface.</li> </ul>

	Command or Action	Purpose
	<pre> FEBE = 0          BIP(B2) = 0 PATH AIS = 0           RDI = 0 FEBE = 0          BIP(B3) = 0 LOP = 0           NEWPTR = 0 PSE = 0           NSE = 0 WIS ALARMS SER = 0           FELCDP = 0 FEAISP = 0 WLOS = 0          PLCD = 0 LFEBIP = 0        PBEC = 0 Active Alarms[All defects]: SWLOF LAIS PAIS SER Active Alarms[Highest Alarms]: SWLOF Alarm reporting enabled for: SF SWLOF B1-TCA B2-TCA PLOP WLOS Rx(K1/K2): 00/00 Tx(K1/K2): 00/00 S1S0 = 00, C2 = 0x1A PATH TRACE BUFFER: UNSTABLE Remote J1 Byte : BER thresholds:  SD = 10e-6 SF = 10e-3 TCA thresholds:  B1 = 10e-6 B2 = 10e-6 B3 = 10e-6                     </pre>	
<b>Step 2</b>	<p><b>configure terminal</b></p> <p><b>Example:</b></p> <pre>Router# configure terminal</pre>	Enters global configuration mode.
<b>Step 3</b>	<p>Do one of the following:</p> <ul style="list-style-type: none"> <li><b>hw-module subslot slot/subslot enable LAN</b></li> <li><b>hw-module subslot slot/subslot interface port enable LAN</b></li> </ul> <p><b>Example:</b></p> <pre>Router(config)# hw-module subslot 0/1 enable LAN</pre> <p><b>Example:</b></p> <pre>Router(config)# hw-module subslot 0/1 interface 1 enable LAN</pre>	<p>Configures LAN-PHY mode for the Ethernet interface module.</p> <ul style="list-style-type: none"> <li><i>slot /subslot /port</i>—The location of the interface.</li> </ul> <p><b>hw-module subslot slot/subslot enable LAN</b> command is only applicable for A900-IMA1X on the ASR 903 RSP1 and RSP2 Modules.</p> <p>Use the <b>hw-module subslot slot/subslot interface port enable LAN</b> command to configure the LAN-PHY mode for the Ethernet interface module on the ASR 903 RSP3 Module.</p>
<b>Step 4</b>	<p><b>exit</b></p> <p><b>Example:</b></p> <pre>Router(config)# exit</pre>	Exits global configuration mode and enters privileged EXEC mode.
<b>Step 5</b>	<p><b>show controllers wanphy slot/subslot/port</b></p> <p><b>Example:</b></p> <pre>Router# show controllers wanphy 0/1/2</pre>	Displays configuration mode for the LAN/WAN-PHY controller. The example shows the mode of operation as LAN mode for the Cisco 8-Port 10 Gigabit Ethernet LAN/WAN-PHY Controller.

	Command or Action	Purpose
	TenGigabitEthernet0/1/2 Mode of Operation: LAN Mode	

## Configuring WAN-PHY Mode

This section describes how to configure WAN-PHY mode on the Gigabit Ethernet interface modules.

### Procedure

	Command or Action	Purpose
<b>Step 1</b>	<b>show controllers wanphy slot/subslot/port</b> <b>Example:</b> <pre>Router# show controllers wanphy 0/1/0 TenGigabitEthernet0/1/0 Mode of Operation: LAN Mode</pre>	Displays the configuration mode of the WAN-PHY controller. Default configuration mode is LAN. <ul style="list-style-type: none"> <li>• <i>slot /subslot /port</i>—The location of the interface.</li> </ul>
<b>Step 2</b>	<b>configure terminal</b> <b>Example:</b> <pre>Router# configure terminal</pre>	Enters global configuration mode.
<b>Step 3</b>	Do one of the following: <ul style="list-style-type: none"> <li>• <b>hw-module subslot slot/subslot enable WAN</b></li> <li>• <b>hw-module subslot slot/subslotinterface port enable WAN</b></li> </ul> <b>Example:</b> <pre>Router(config)# hw-module subslot 0/1 enable WAN</pre> <b>Example:</b> <pre>Router(config)# hw-module subslot 0/1 interface 1 enable WAN</pre>	Configures WAN-PHY mode for the Ethernet interface module. <ul style="list-style-type: none"> <li>• <i>slot /subslot /port</i> —The location of the interface.</li> </ul> <b>hw-module subslot slot/subslot enable WAN</b> command is only applicable for A900-IMA1X on the ASR 903 RSP1 and RSP2 Modules. Use the <b>hw-module subslot slot/subslot interface port enable WAN</b> command to configure the WAN-PHY mode for the Ethernet interface module on the ASR 903 RSP3 Module.
<b>Step 4</b>	<b>exit</b> <b>Example:</b> <pre>Router(config)# exit</pre>	Exits global configuration mode and enters privileged EXEC mode.
<b>Step 5</b>	<b>show controllers wanphy slot/subslot/port</b> <b>Example:</b> <pre>Router# show controllers wanphy 0/1/5 TenGigabitEthernet0/1/5</pre>	Displays configuration mode for the LAN/WAN-PHY controller. The example shows the mode of operation as WAN mode for the Cisco 8-Port 10 Gigabit Ethernet LAN/WAN-PHY Controller.

	Command or Action	Purpose
	<pre> Mode of Operation: WAN Mode SECTION   LOF = 0          LOS  = 0                    BIP(B1) = 0  LINE   AIS = 0          RDI  = 0   FEBE = 0        BIP(B2) = 0  PATH   AIS = 0          RDI  = 0   FEBE = 0        BIP(B3) = 0   LOP = 0          NEWPTR = 0   PSE = 0          NSE   = 0  WIS ALARMS   SER  = 0          FELCDP = 0   FEAI SP = 0   WLOS = 0          PLCD  = 0    LFEBIP = 0       PBEC  = 0  Active Alarms[All defects]: SWLOF LAIS PAIS SER Active Alarms[Highest Alarms]: SWLOF Alarm reporting enabled for: SF SWLOF B1-TCA B2-TCA PLOP WLOS   Rx(K1/K2): 00/00  Tx(K1/K2): 00/00   S1S0 = 00, C2 = 0x1A PATH TRACE BUFFER: UNSTABLE Remote J1 Byte : BER thresholds:  SD = 10e-6  SF = 10e-3 TCA thresholds:  B1 = 10e-6  B2 = 10e-6                   B3 = 10e-6                     </pre>	

## Configuring the Flag for Path Trace

The 1-Port 10GE LAN/WAN-PHY Shared Port Adapter can operate in either the WAN mode or the LAN mode. To check end-to-end connectivity, J1 flag byte values can be configured on the local SPA. The configured J1 byte values are displayed at the remote end in the **show controllers wanphy interface-path-id** command output.

### Procedure

	Command or Action	Purpose
<b>Step 1</b>	<b>configure terminal</b> <b>Example:</b> Router# configure terminal	Enters the global configuration mode.
<b>Step 2</b>	<b>controller wanphy interface-path-id</b> <b>Example:</b> Router(config)# controller wanphy 2/1/0	Enters the controller mode of the WAN-PHY SPA. In this example, it enters slot 1 of SIP 2.
<b>Step 3</b>	<b>wanphy flag j1 transmit string</b> <b>Example:</b>	Passes the string of J1 bytes specified to the remote end of WAN-PHY SPA. In this

	Command or Action	Purpose
	Router(config-controller)# wanphy flag j1 transmit passing_string_from_localend	example, the string value passing_string_from_localend is transmitted to the remotely connected WAN-PHY SPA.
<b>Step 4</b>	<b>exit</b> <b>Example:</b> Router(config-controller)# exit	Exits Controller-configuration (config) mode and enters global configuration mode.
<b>Step 5</b>	<b>exit</b> <b>Example:</b> Router(config)# exit	Exits global-configuration (config) mode and enters privilege-exec mode.
<b>Step 6</b>	<b>show controller wanphy &lt;interface-path-id&gt;</b> <b>Example:</b> Example: Router# show controller wanphy 2/2/0 TenGigabitEthernet0/2/0 Mode of Operation: WAN Mode SECTION LOF = 0 LOS = 0 BIP(B1) = 0 LINE AIS = 0 RDI = 0 FEBE = 0 BIP(B2) = 0 PATH AIS = 0 RDI = 0 FEBE = 0 BIP(B3) = 0 LOP = 0 NEWPTR = 0 PSE = 0 NSE = 0 WIS ALARMS SER = 0 FELCDP = 0 FEAISP = 0 WLOS = 0 PLCD = 0  LFEBIP = 0 PBEC = 0  Active Alarms[All defects]: None Active Alarms[Highest Alarms]: None Alarm reporting enabled for: SF SWLOF B1-TCA B2-TCA PLOP WLOS Rx(K1/K2): 00/00 Tx(K1/K2): 00/00 SIS0 = 00, C2 = 0x1A PATH TRACE BUFFER: STABLE Remote J1 Byte : passing_string_from_localend BER thresholds: SD = 10e-6 SF = 10e-3 TCA thresholds: B1 = 10e-6 B2 = 10e-6 B3 = 10e-6	This command must be executed on the remotely connected SPA. The command output displays the string of J1 byte values transmitted from the other end of the WAN-PHY SPA to check the path.  In this example, the last line Remote J1 Byte, of the <b>show controller wanphy 2/2/0</b> command output indicates that the string value passing_string_from_localend has been sent from the other end of the WAN-PHY SPA.

## Configuring WAN-PHY Error Thresholds

This section describes how to configure WAN-PHY Signal Failure (SF) and Signal Degrade (SD) Bit Error Rate (BER) reporting and thresholds.



An SF alarm is triggered if the line bit error (B2) rate exceeds a user-provisioned threshold range (over the range of 10e-3 to 10e-9).

An SD alarm is declared if the line bit error (B2) rate exceeds a user-provisioned threshold range (over the range of 10e-3 to 10e-9). If the B2 errors cross the SD threshold, a warning about link quality degradation is triggered. The WAN-PHY alarms are useful for some users who are upgrading their Layer 2 core network from a SONET ring to a 10-Gigabit Ethernet ring.

### Before you begin

The controller must be in the WAN-PHY mode before configuring the SF and SD BER reporting and thresholds.

### Procedure

	Command or Action	Purpose
<b>Step 1</b>	<b>configure terminal</b> <b>Example:</b>  Router# configure terminal	Enters global configuration mode.
<b>Step 2</b>	<b>controller wanphy slot/subslot/port</b> <b>Example:</b>  Router(config)# controller wanphy 0/3/0	Enters WAN physical controller configuration mode in which you can configure a 10-Gigabit Ethernet WAN-PHY controller.  <i>slot /subslot /port</i> —The location of the interface.
<b>Step 3</b>	<b>wanphy {delay   flag   report-alarm   threshold {b1-tca   b2-tca   sd-ber   sf-ber [bit error rate]}}</b> <b>Example:</b>  Router(config-controller)# wanphy threshold b1-tca 6	Configures WAN-PHY controller processing. <ul style="list-style-type: none"> <li>• delay—Delays WAN-PHY alarm triggers.</li> <li>• flag—Specifies byte values.</li> <li>• report-alarm—Configures WAN-PHY alarm reporting.</li> <li>• threshold—Sets BER threshold values. <ul style="list-style-type: none"> <li>• b1-tca—Sets B1 alarm BER threshold.</li> <li>• b2-tca—Sets B2 alarm BER threshold.</li> <li>• sd-ber—Sets Signal Degrade BER threshold.</li> <li>• sf-ber—Sets Signal Fail BER threshold.</li> </ul> </li> <li>• bit error rate— Specifies bit error rate.</li> </ul>
<b>Step 4</b>	<b>end</b> <b>Example:</b>  Router(config-controller)# end	Exits controller configuration mode and enters privileged EXEC mode.

# Configuration Examples

## Example: Basic Interface Configuration

The following example shows how to enter the global configuration mode to configure an interface, configure an IP address for the interface, and save the configuration:

```
! Enter global configuration mode.

!

Router# configure terminal

! Enter configuration commands, one per line. End with CNTL/Z.

!

! Specify the interface address.

!

Router(config)# interface gigabitethernet 0/0/1

!

! Configure an IP address.

!

Router(config-if)# ip address 192.168.50.1 255.255.255.0

!

! Start the interface.

!

Router(config-if)# no shut

!

! Save the configuration to NVRAM.

!

Router(config-if)# exit
```

```
Router# copy running-config startup-config
```

## Example: MTU Configuration



**Note** The maximum number of unique MTU values that can be configured on the physical interfaces on the chassis is eight. Use the **show platform hardware pp active interface mtu command** to check the number of values currently configured on the router.

The following example shows how to set the MTU interface to 9216 bytes.



**Note** The interface module automatically adds an additional 38 bytes to the configured MTU interface size.

```
! Enter global configuration mode.

!

Router# configure terminal

! Enter configuration commands, one per line. End with CNTL/Z.

!

! Specify the interface address

!

Router(config)# interface gigabitethernet 0/0/1

!

! Configure the interface MTU.

!

Router(config-if)# mtu 9216
```

## Example: VLAN Encapsulation

The following example shows how to configure interface module port 2 (the third port) and configure the first interface on the VLAN with the ID number 268 using IEEE 802.1Q encapsulation:

```
! Enter global configuration mode.
```

```
!  
Router# configure terminal  
! Enter configuration commands, one per line. End with CNTL/Z.  
!  
! Enter configuration commands, one per line. End with CNTL/Z.  
!  
Router(config)# service instance 10 ethernet  
!  
! Configure dot1q encapsulation and specify the VLAN ID.  
Router(config-subif)# encapsulation dot1q 268  
!
```



---

**Note** VLANs are supported only on EVC service instances and Trunk EFP interfaces.

---



## CHAPTER 6

# Using the Management Ethernet Interface

This chapter covers the following topics:

- [Gigabit Ethernet Management Interface Overview, on page 59](#)
- [Gigabit Ethernet Port Numbering, on page 59](#)
- [IP Address Handling in ROMmon and the Management Ethernet Port, on page 60](#)
- [Gigabit Ethernet Management Interface VRF, on page 60](#)
- [Common Ethernet Management Tasks, on page 61](#)

## Gigabit Ethernet Management Interface Overview

The chassis has one Gigabit Ethernet Management Ethernet interface on each Route Switch Processor.

The purpose of this interface is to allow users to perform management tasks on the router; it is basically an interface that should not and often cannot forward network traffic but can otherwise access the router, often via Telnet and SSH, and perform most management tasks on the router. The interface is most useful before a router has begun routing, or in troubleshooting scenarios when the interfaces are inactive.

The following aspects of the Management Ethernet interface should be noted:

- Each RSP has a Management Ethernet interface, but only the active RSP has an accessible Management Ethernet interface (the standby RSP can be accessed using the console port, however).
- IPv4, IPv6, and ARP are the only routed protocols supported for the interface.
- The interface provides a method of access to the router even if the interfaces or the IOS processes are down.
- The Management Ethernet interface is part of its own VRF. For more information, see the [Gigabit Ethernet Management Interface VRF, on page 60](#).

## Gigabit Ethernet Port Numbering

The Gigabit Ethernet Management port is always GigabitEthernet0.

In a dual RSP configuration, the Management Ethernet interface on the active RSP will always be Gigabit Ethernet 0, while the Management Ethernet interface on the standby RSP will not be accessible using the Cisco IOS CLI in the same telnet session. The standby RSP can be accessed via console port using telnet.

The port can be accessed in configuration mode like any other port on the chassis.

```
Router#config t
Enter configuration commands, one per line. End with CNTL/Z.
Router(config)#interface gigabitethernet0
Router(config-if)#
```

## IP Address Handling in ROMmon and the Management Ethernet Port

IP addresses can be configured using ROMmon (**IP\_ADDRESS=** and **IP\_SUBNET\_MASK=** commands) and the IOS command-line interface (the **ip address** command in interface configuration mode).

Assuming the IOS process has not begun running on the chassis, the IP address that was set in ROMmon acts as the IP address of the Management Ethernet interface. In cases where the IOS process is running and has taken control of the Management Ethernet interface, the IP address specified when configuring the Gigabit Ethernet 0 interface in the IOS CLI becomes the IP address of the Management Ethernet interface. The ROMmon-defined IP address is only used as the interface address when the IOS process is inactive.

For this reason, the IP addresses specified in ROMmon and in the IOS CLI can be identical and the Management Ethernet interface will function properly in single RSP configurations.

In dual RSP configurations, however, users should never configure the IP address in the ROMmon on either RP0 or RP1 to match each other or the IP address as defined by the IOS CLI. Configuring matching IP addresses introduces the possibility for an active and standby Management Ethernet interface having the same IP address with different MAC addresses, which will lead to unpredictable traffic treatment or possibility of an RSP boot failure.

## Gigabit Ethernet Management Interface VRF

The Gigabit Ethernet Management interface is automatically part of its own VRF. This VRF, which is named “Mgmt-intf,” is automatically configured on the chassis and is dedicated to the Management Ethernet interface; no other interfaces can join this VRF. Therefore, this VRF does not participate in the MPLS VPN VRF or any other network-wide VRF.

Placing the management ethernet interface in its own VRF has the following effects on the Management Ethernet interface:

- Many features must be configured or used inside the VRF, so the CLI may be different for certain Management Ethernet functions on the chassis than on Management Ethernet interfaces on other routers.
- Prevents transit traffic from traversing the router. Because all of the interfaces and the Management Ethernet interface are automatically in different VRFs, no transit traffic can enter the Management Ethernet interface and leave an interface, or vice versa.
- Improved security of the interface. Because the Mgmt-intf VRF has its own routing table as a result of being in its own VRF, routes can only be added to the routing table of the Management Ethernet interface if explicitly entered by a user.

The Management Ethernet interface VRF supports both IPv4 and IPv6 address families.

# Common Ethernet Management Tasks

Because users can perform most tasks on a router through the Management Ethernet interface, many tasks can be done by accessing the router through the Management Ethernet interface.

This section documents common configurations on the Management Ethernet interface and includes the following sections:

## Viewing the VRF Configuration

The VRF configuration for the Management Ethernet interface is viewable using the **show running-config vrf** command.

This example shows the default VRF configuration:

```
Router# show running-config vrf
Building configuration...
Current configuration : 351 bytes
vrf definition Mgmt-intf
!
 address-family ipv4
 exit-address-family
!
 address-family ipv6
 exit-address-family
!
(some output removed for brevity)
```

## Viewing Detailed VRF Information for the Management Ethernet VRF

To see detailed information about the Management Ethernet VRF, enter the **show vrf detail Mgmt-intf** command.

```
Router# show vrf detail Mgmt-intf
VRF Mgmt-intf (VRF Id = 4085); default RD <not set>; default VPNID <not set>
  Interfaces:
    Gi0
Address family ipv4 (Table ID = 4085 (0xFF5)):
  No Export VPN route-target communities
  No Import VPN route-target communities
  No import route-map
  No export route-map
  VRF label distribution protocol: not configured
  VRF label allocation mode: per-prefix
Address family ipv6 (Table ID = 503316481 (0x1E000001)):
  No Export VPN route-target communities
  No Import VPN route-target communities
  No import route-map
  No export route-map
  VRF label distribution protocol: not configured
  VRF label allocation mode: per-prefix
```

## Setting a Default Route in the Management Ethernet Interface VRF

To set a default route in the Management Ethernet Interface VRF, enter the following command

```
ip route vrf Mgmt-intf 0.0.0.0 0.0.0.0 next-hop-IP-address
```

## Setting the Management Ethernet IP Address

The IP address of the Management Ethernet port is set like the IP address on any other interface.

Below are two simple examples of configuring an IPv4 address and an IPv6 address on the Management Ethernet interface.

### IPv4 Example

```
Router(config)# interface GigabitEthernet 0
Router(config-if)# ip address A.B.C.D A.B.C.D
```

### IPv6 Example

```
Router(config)# interface GigabitEthernet 0
Router(config-if)# ipv6 address X:X:X:X::X
```

## Telnetting over the Management Ethernet Interface

Telnetting can be done through the VRF using the Management Ethernet interface.

In the following example, the router telnets to 172.17.1.1 through the Management Ethernet interface VRF:

```
Router# telnet 172.17.1.1 /vrf Mgmt-intf
```

## Pinging over the Management Ethernet Interface

Pinging other interfaces using the Management Ethernet interface is done through the VRF.

In the following example, the router pings the interface with the IP address of 172.17.1.1 through the Management Ethernet interface.

```
Router# ping vrf Mgmt-intf 172.17.1.1

Type escape sequence to abort.
Sending 5, 100-byte ICMP Echos to 172.17.1.1, timeout is 2 seconds:
.!!!!
Success rate is 80 percent (4/5), round-trip min/avg/max = 1/1/1 ms
```

## Copy Using TFTP or FTP

To copy a file using TFTP through the Management Ethernet interface, the **ip tftp source-interface GigabitEthernet 0** command must be entered before entering the **copy tftp** command because the **copy tftp** command has no option of specifying a VRF name.



Similarly, to copy a file using FTP through the Management Ethernet interface, the **ip ftp source-interface GigabitEthernet 0** command must be entered before entering the **copy ftp** command because the **copy ftp** command has no option of specifying a VRF name.

### TFTP Example

```
Router(config)# ip tftp source-interface gigabitEthernet 0
```

### FTP Example

```
Router(config)# ip ftp source-interface gigabitEthernet 0
```

## NTP Server

To allow the software clock to be synchronized by a Network Time Protocol (NTP) time server over the Management Ethernet interface, enter the **ntp server vrf Mgmt-intf** command and specify the IP address of the device providing the update.

The following CLI provides an example of this procedure.

```
Router(config)# ntp server vrf Mgmt-intf 172.17.1.1
```

## SYSLOG Server

To specify the Management Ethernet interface as the source IPv4 or IPv6 address for logging purposes, enter the **logging host ip-address vrf Mgmt-intf** command.

The following CLI provides an example of this procedure.

```
Router(config)# logging host <ip-address> vrf Mgmt-intf
```

## SNMP-related services

To specify the Management Ethernet interface as the source of all SNMP trap messages, enter the **snmp-server source-interface traps gigabitEthernet 0** command.

The following CLI provides an example of this procedure:

```
Router(config)# snmp-server source-interface traps gigabitEthernet 0
```

## Domain Name Assignment

The IP domain name assignment for the Management Ethernet interface is done through the VRF.

To define the default domain name as the Management Ethernet VRF interface, enter the **ip domain-name vrf Mgmt-intf domain** command.

```
Router(config)# ip domain-name vrf Mgmt-intf cisco.com
```

## DNS service

To specify the Management Ethernet interface VRF as a name server, enter the **ip name-server vrf Mgmt-intf IPv4-or-IPv6-address** command.

```
Router(config)# ip name-server vrf Mgmt-intf  
IPv4-or-IPv6-address
```

## RADIUS or TACACS+ Server

To group the Management VRF as part of a AAA server group, enter the **ip vrf forward Mgmt-intf** command when configuring the AAA server group.

The same concept is true for configuring a TACACS+ server group. To group the Management VRF as part of a TACACS+ server group, enter the **ip vrf forwarding Mgmt-intf** command when configuring the TACACS+ server group.

### Radius Server Group Configuration

```
Router(config)# aaa group server radius hello  
Router(config-sg-radius)# ip vrf forwarding Mgmt-intf
```

### Tacacs+ Server Group Example

```
outer(config)# aaa group server tacacs+ hello  
Router(config-sg-tacacs+)# ip vrf forwarding Mgmt-intf
```

## VTY lines with ACL

To ensure an access control list (ACL) is attached to vty lines that are and are not using VRF, use the **vrf-also** option when attaching the ACL to the vty lines.

```
Router(config)# line vty 0 4  
Router(config-line)# access-class 90 in vrf-also
```



## CHAPTER 7

# Configuring T1/E1 Interfaces

This chapter provides information about configuring the T1/E1 interface module on the chassis. It includes the following sections:

For information about managing your system images and configuration files, refer to the [Cisco IOS Configuration Fundamentals Configuration Guide](#) and [Cisco IOS Configuration Fundamentals Command Reference](#) publications.

For more information about the commands used in this chapter, refer to the [Cisco IOS Command Reference](#) publication for your Cisco IOS software release.

- [Configuration Tasks, on page 65](#)
- [Verifying the Interface Configuration, on page 81](#)
- [Configuration Examples, on page 82](#)

## Configuration Tasks

This section describes how to configure the T1/E1 interface module for the chassis and includes the following topics:

## Limitations

This section describes the software limitations that apply when configuring the T1/E1 interface module.

- The following interface modules are not supported on the RSP3 module:
  - 16-port T1/E1 interface module
  - 8-port T1/E1 interface module
  - 32-port T1/E1 interface module
- The **configure replace** command is not supported on the T1/E1 interface modules.
- The chassis does *not* support more than 16 IMA groups on each T1/E1 interface module.
- The chassis only supports the following BERT patterns: 2<sup>11</sup>, 2<sup>15</sup>, 2<sup>20</sup>-O153, and 2<sup>20</sup>-QRSS.
- L2TPv3 encapsulation is not supported.
- Replacing a configured interface module with a different interface module in the same slot is not supported.

- Mixed configurations of features are not supported on the same port.
- The Payload calculation per unit for T1/E1 interface module is:
  - Framed E1 / T1 with no. of time Slots less than 4 → Payload = 4 x no. of time slots.
  - Framed E1 / T1 with no. of Time Slots greater than or equal 4 → Payload = 2 x no. of time slots.
  - Unframed T1, C11 → Payload = 48 (2 x 24 (all slots)).
  - Unframed E1, C12 → Payload = 64 (2 x 32 (all slots))
- Channelization is not supported for serial interfaces. However, channelization is supported for CEM at the DS0 level.

## Required Configuration Tasks

This section lists the required configuration steps to configure the T1/E1 interface module. Some of the required configuration commands implement default values that might be appropriate for your network. If the default value is correct for your network, then you do not need to configure the command.

### Setting the Card Type

The interface module is not functional until the card type is set. Information about the interface module is not indicated in the output of any show commands until the card type has been set. There is no default card type.



**Note** Mixing of T1 and E1 interface types is not supported. All ports on the interface module must be of the same type.

To set the card type for the T1/E1 interface module, complete these steps:

#### Procedure

	Command or Action	Purpose
<b>Step 1</b>	<b>configure terminal</b> <b>Example:</b> Router# <b>configure terminal</b>	Enters global configuration mode.
<b>Step 2</b>	<b>card type {e1   t1} slot/subslot</b> <b>Example:</b> Router(config)# <b>card type e1 0/3</b>	Sets the serial mode for the interface module: <ul style="list-style-type: none"> <li>• t1—Specifies T1 connectivity of 1.536 Mbps. B8ZS is the default linecode for T1.</li> <li>• e1—Specifies a wide-area digital transmission scheme used predominantly in Europe that carries data at a rate of 1.984 Mbps in framed mode and 2.048 Mbps in unframed E1 mode.</li> <li>• <i>slot subslot</i>—Specifies the location of the interface module.</li> </ul>

	Command or Action	Purpose
<b>Step 3</b>	<b>exit</b> <b>Example:</b> Router(config)# exit	Exits configuration mode and returns to the EXEC command interpreter prompt.

### Enabling T1 Controller



**Note** T1/T3 or E1/E3 does not require any license.

To enable T1 controller:

```
enable
configure terminal
controller mediatype 0/4/0
mode t1
end
```

### Configuring the Controller

To create the interfaces for the T1/E1 interface module, complete these steps:

#### Procedure

	Command or Action	Purpose
<b>Step 1</b>	<b>configure terminal</b> <b>Example:</b> Router# <b>configure terminal</b>	Enters global configuration mode.
<b>Step 2</b>	<b>controller {t1   e1} slot/subslot/port</b> <b>Example:</b> Router(config)# controller t1 0/3/0	Selects the controller to configure and enters controller configuration mode. <ul style="list-style-type: none"> <li>• t1—Specifies the T1 controller.</li> <li>• e1—Specifies the E1 controller.</li> <li>• slot/subslot/port—Specifies the location of the interface.</li> </ul> <p><b>Note</b> The slot number is always 0.</p>
<b>Step 3</b>	<b>clock source {internal   line}</b> <b>Example:</b> Router(config-controller)# <b>clock source internal</b>	Sets the clock source. <p><b>Note</b> The clock source is set to internal if the opposite end of the connection is set to line and the clock source is set to line if the opposite end of the connection is set to internal.</p> <ul style="list-style-type: none"> <li>• internal—Specifies that the internal clock source is used.</li> </ul>

	Command or Action	Purpose
		<ul style="list-style-type: none"> <li>line—Specifies that the network clock source is used. This is the default for T1 and E1.</li> </ul>
<b>Step 4</b>	<p><b>linecode</b> {ami   b8zs   hdb3}</p> <p><b>Example:</b></p> <pre>Router(config-controller)# <b>linecode</b> <b>ami</b></pre>	<p>Selects the linecode type.</p> <ul style="list-style-type: none"> <li>ami—Specifies Alternate Mark Inversion (AMI) as the linecode type. Valid for T1 and E1 controllers.</li> <li>b8zs—Specifies binary 8-zero substitution (B8ZS) as the linecode type. Valid for T1 controller only. This is the default for T1 lines.</li> <li>hdb3—Specifies high-density binary 3 (HDB3) as the linecode type. Valid for E1 controller only. This is the default for E1 lines.</li> </ul>
<b>Step 5</b>	<p>For T1 Controllers:</p> <p><b>Example:</b></p> <pre><b>framing</b> {sf   esf}</pre> <p><b>Example:</b></p> <pre>Router(config-controller)# <b>framing</b> <b>sf</b></pre> <p><b>Example:</b></p> <p>For E1 Controllers:</p> <p><b>Example:</b></p> <pre><b>framing</b> {crc4   no-crc4}</pre> <p><b>Example:</b></p> <pre>Router(config-controller)# <b>framing</b> <b>crc4</b></pre>	<p>Selects the framing type.</p> <ul style="list-style-type: none"> <li>sf—Specifies Super Frame as the T1 frame type.</li> <li>esf—Specifies Extended Super Frame as the T1 frame type. This is the default for E1.</li> <li>crc4—Specifies CRC4 as the E1 frame type. This is the default for E1.</li> <li>no-crc4—Specifies no CRC4 as the E1 frame type.</li> </ul>
<b>Step 6</b>	<p><b>cablelength</b> {long   short}</p> <p><b>Example:</b></p> <pre>Router(config-controller)# <b>cablelength</b> <b>long</b></pre>	<p>To fine-tune the pulse of a signal at the receiver for an E1 cable, use the <b>cablelength</b> command in controller configuration mode.</p>
<b>Step 7</b>	<p><b>exit</b></p> <p><b>Example:</b></p> <pre>Router(config)# <b>exit</b></pre>	<p>Exits configuration mode and returns to the EXEC command interpreter prompt.</p>

## Verifying Controller Configuration

To verify the controller configuration, use the show controllers command :

```
Router# show controllers t1 0/3/0 brief
T1 0/3/0 is up.
  Applique type is A900-IMA16D
  Cablelength is long gain36 0db
  No alarms detected.
  alarm-trigger is not set
  Soaking time: 3, Clearance time: 10
  AIS State:Clear  LOS State:Clear  LOF State:Clear
  Framing is ESF, Line Code is B8ZS, Clock Source is Internal.
  Data in current interval (230 seconds elapsed):
    0 Line Code Violations, 0 Path Code Violations
    0 Slip Secs, 0 Fr Loss Secs, 0 Line Err Secs, 0 Degraded Mins
    0 Errored Secs, 0 Bursty Err Secs, 0 Severely Err Secs, 0 Unavail Secs
    0 Near-end path failures, 0 Far-end path failures, 0 SEF/AIS Secs
  Total Data (last 24 hours)
    136 Line Code Violations, 63 Path Code Violations,
    0 Slip Secs, 6 Fr Loss Secs, 4 Line Err Secs, 0 Degraded Mins,
    7 Errored Secs, 1 Bursty Err Secs, 6 Severely Err Secs, 458 Unavail Secs
    2 Near-end path failures, 0 Far-end path failures, 0 SEF/AIS Secs
```

## Optional Configurations

There are several standard, but optional, configurations that might be necessary to complete the configuration of your T1/E1 interface module.

## Configuring Framing

Framing is used to synchronize data transmission on the line. Framing allows the hardware to determine when each packet starts and ends. To configure framing, use the following commands.

### Procedure

	Command or Action	Purpose
<b>Step 1</b>	<b>configure terminal</b> <b>Example:</b>  Router# <b>configure terminal</b>	Enters global configuration mode.
<b>Step 2</b>	<b>controller {t1   e1} slot/subslot/port</b> <b>Example:</b>  Router(config)# <b>controller t1 0/3/0</b>	Selects the controller to configure. <ul style="list-style-type: none"> <li>• t1—Specifies the T1 controller.</li> <li>• e1—Specifies the E1 controller.</li> <li>• slot/subslot/port—Specifies the location of the controller.</li> </ul> <b>Note</b> The slot number is always 0.
<b>Step 3</b>	For T1 controllers <b>Example:</b> <b>framing {sf   esf}</b>	Sets the framing on the interface. <ul style="list-style-type: none"> <li>• sf—Specifies Super Frame as the T1 frame type.</li> </ul>

	Command or Action	Purpose
	<p><b>Example:</b></p> <pre>Router(config-controller)# framing sf</pre> <p><b>Example:</b></p> <p><b>Example:</b></p> <pre>For E1 controllers</pre> <p><b>Example:</b></p> <pre>framing {crc4   no-crc4}</pre> <p><b>Example:</b></p> <pre>Router(config-controller)# framing crc4</pre>	<ul style="list-style-type: none"> <li>• <b>esf</b>—Specifies Extended Super Frame as the T1 frame type. This is the default for T1.</li> <li>• <b>crc4</b>—Specifies CRC4 frame as the E1 frame type. This is the default for E1.</li> <li>• <b>no-crc4</b>—Specifies no CRC4 as the E1 frame type.</li> </ul>
<b>Step 4</b>	<p><b>exit</b></p> <p><b>Example:</b></p> <pre>Router(config)# exit</pre>	Exits configuration mode and returns to the EXEC command interpreter prompt.

## Verifying Framing Configuration

Use the `show controllers` command to verify the framing configuration:

```
Router# show controllers t1 0/3/0 brief
T1 0/3/0 is up.
  Applique type is A900-IMA16D
  Cablelength is long gain36 0db
  No alarms detected.
  alarm-trigger is not set
  Soaking time: 3, Clearance time: 10
  AIS State:Clear  LOS State:Clear  LOF State:Clear
Framing is ESF, Line Code is B8ZS
, Clock Source is Line.
Data in current interval (740 seconds elapsed):
  0 Line Code Violations, 0 Path Code Violations
  0 Slip Secs, 0 Fr Loss Secs, 0 Line Err Secs, 0 Degraded Mins
  0 Errored Secs, 0 Bursty Err Secs, 0 Severely Err Secs, 0 Unavail Secs
  0 Near-end path failures, 0 Far-end path failures, 0 SEF/AIS Secs
Total Data (last 24 hours)
  0 Line Code Violations, 0 Path Code Violations,
  0 Slip Secs, 0 Fr Loss Secs, 0 Line Err Secs, 0 Degraded Mins,
  0 Errored Secs, 0 Bursty Err Secs, 0 Severely Err Secs, 0 Unavail Secs
  0 Near-end path failures, 0 Far-end path failures, 0 SEF/AIS Secs
```

## Setting an IP Address

To set an IP address for the serial interface, complete these steps:

You can also set an IP address using an IMA or CEM configuration.



**Procedure**

	Command or Action	Purpose
<b>Step 1</b>	<b>interface serial</b> <i>0/subslot/port:channel-group</i> <b>Example:</b> <pre>Router(config)# interface serial 0/0/1:0</pre>	Selects the interface to configure from global configuration mode. <ul style="list-style-type: none"> <li>• <i>subslot</i>—Specifies the subslot in which the T1/E1 interface module is installed.</li> <li>• <i>port</i> —Specifies the location of the controller. The port range for T1 and E1 is 1 to 16.</li> <li>• <i>channel-group</i> —Specifies the channel group number configured on the controller. For example: interface serial 0/0/1:1.</li> </ul>
<b>Step 2</b>	<b>ip address</b> <i>address mask</i> <b>Example:</b> <pre>Router(config-if)# ip address 192.0.2.1 255.255.255.0</pre>	Sets the IP address and subnet mask. <ul style="list-style-type: none"> <li>• <i>address</i> —Specify the IP address.</li> <li>• <i>mask</i> —Specify the subnet mask.</li> </ul>
<b>Step 3</b>	<b>exit</b> <b>Example:</b> <pre>Router(config)# exit</pre>	Exits configuration mode and returns to the EXEC command interpreter prompt.

**What to do next**

**Note** IPv4 routing protocols, such as *eigrp*, *ospf*, *bgp*, and *rip*, are supported on serial interfaces.

**Configuring Encapsulation**

When traffic crosses a WAN link, the connection needs a Layer 2 protocol to encapsulate traffic.



**Note** L2TPv3 encapsulation is *not* supported.

To set the encapsulation method, use the following commands:

**Procedure**

	Command or Action	Purpose
<b>Step 1</b>	<b>configure terminal</b> <b>Example:</b> <pre>Router# configure terminal</pre>	Enters global configuration mode.

	Command or Action	Purpose
	<b>Example:</b>	
<b>Step 2</b>	<b>interface serial</b> <i>0/subslot/port:channel-group</i> <b>Example:</b> <pre>Router(config)# interface serial 0/0/1:0</pre> <b>Example:</b>	Selects the interface to configure from global configuration mode. <ul style="list-style-type: none"> <li>• <i>subslot</i>—Specifies the subslot in which the T1/E1 interface module is installed.</li> <li>• <i>port</i>—Specifies the location of the controller. The port range for T1 and E1 is 1 to 16.</li> <li>• <i>channel-group</i>—Specifies the channel group number configured on the controller. For example: interface serial 0/0/1:1.</li> </ul>
<b>Step 3</b>	<b>encapsulation {hdlc   ppp}</b> <b>Example:</b> <pre>Router(config-if)# encapsulation hdlc</pre>	Set the encapsulation method on the interface. <ul style="list-style-type: none"> <li>• <b>hdlc</b>—High-Level Data Link Control (HDLC) protocol for a serial interface. This encapsulation method provides the synchronous framing and error detection functions of HDLC without windowing or retransmission. This is the default for synchronous serial interfaces.</li> <li>• <b>ppp</b>—Described in RFC 1661, PPP encapsulates network layer protocol information over point-to-point links.</li> </ul>
<b>Step 4</b>	<b>exit</b> <b>Example:</b> <pre>Router(config)# exit</pre>	Exits configuration mode and returns to the EXEC command interpreter prompt.

## Verifying Encapsulation

Use the **show interfaces serial** command to verify encapsulation on the interface:

```
Router# show interfaces serial
0/0/1:0
Serial0/0/1:0 is up, line protocol is up
Hardware is Multichannel T1
MTU 1500 bytes, BW 1536 Kbit/sec, DLY 20000 usec,
    reliability 255/255, txload 1/255, rxload 1/255
Encapsulation HDLC
, crc 16, loopback not set
Keepalive set (10 sec)
Last input 00:00:01, output 00:00:02, output hang never
Last clearing of "show interface" counters never
Input queue: 0/75/0/0 (size/max/drops/flushes); Total output drops: 0
Queueing strategy: fifo
Output queue: 0/40 (size/max)
5 minute input rate 0 bits/sec, 0 packets/sec
5 minute output rate 0 bits/sec, 0 packets/sec
```

```

60 packets input, 8197 bytes, 0 no buffer
Received 39 broadcasts (0 IP multicasts)
0 runts, 0 giants, 0 throttles
0 input errors, 0 CRC, 0 frame, 0 overrun, 0 ignored, 0 abort
64 packets output, 8357 bytes, 0 underruns
0 output errors, 0 collisions, 0 interface resets
0 unknown protocol drops
0 output buffer failures, 0 output buffers swapped out
1 carrier transitions

```

## Configuring the CRC Size for T1 Interfaces

All T1/E1 serial interfaces use a 16-bit cyclic redundancy check (CRC) by default, but also support a 32-bit CRC. CRC is an error-checking technique that uses a calculated numeric value to detect errors in transmitted data. The designators 16 and 32 indicate the length (in bits) of the frame check sequence (FCS). A CRC of 32 bits provides more powerful error detection, but adds overhead. Both the sender and receiver must use the same setting.

CRC-16, the most widely used CRC throughout the United States and Europe, is used extensively with WANs. CRC-32 is specified by IEEE 802 and as an option by some point-to-point transmission standards.

To set the length of the cyclic redundancy check (CRC) on a T1 interface, use these commands:

### Procedure

	Command or Action	Purpose
<b>Step 1</b>	<b>configure terminal</b> <b>Example:</b> Router# <b>configure terminal</b> <b>Example:</b>	Enters global configuration mode.
<b>Step 2</b>	<b>interface serial 0/subslot/port:channel-group</b> <b>Example:</b> Router(config)# interface serial 0/0/1:0 <b>Example:</b>	Selects the interface to configure from global configuration mode. <ul style="list-style-type: none"> <li>• <i>number</i> —Specifies the location of the controller. The number range for T1 and E1 is 1 to 16.</li> <li>• <i>channel-group</i> —Specifies the channel group number configured on the controller. For example: interface serial 0/1:1.</li> </ul>
<b>Step 3</b>	<b>crc {16   32}</b> <b>Example:</b> Router(config-if)# <b>crc 16</b>	Selects the CRC size in bits. <ul style="list-style-type: none"> <li>• 16—16-bit CRC. This is the default.</li> <li>• 32—32-bit CRC.</li> </ul> <p><b>Note</b> Moving from CRC 16 to 32 bit (and vice-versa) is not supported.</p>
<b>Step 4</b>	<b>exit</b> <b>Example:</b>	Exits configuration mode and returns to the EXEC command interpreter prompt.

	Command or Action	Purpose
	Router(config)# exit	

## Verifying the CRC Size

Use the **show interfaces serial** command to verify the CRC size set on the interface:

```
Router# show interfaces serial 0/0/1:0
Serial0/0/1:0 is up, line protocol is up
  Hardware is Multichannel T1
  MTU 1500 bytes, BW 1536 Kbit/sec, DLY 20000 usec,
    reliability 255/255, txload 1/255, rxload 1/255
  Encapsulation HDLC, crc 16
, loopback not set
  Keepalive set (10 sec)
  Last input 00:00:01, output 00:00:02, output hang never
  Last clearing of "show interface" counters never
  Input queue: 0/75/0/0 (size/max/drops/flushes); Total output drops: 0
  Queueing strategy: fifo
  Output queue: 0/40 (size/max)
  5 minute input rate 0 bits/sec, 0 packets/sec
  5 minute output rate 0 bits/sec, 0 packets/sec
    60 packets input, 8197 bytes, 0 no buffer
  Received 39 broadcasts (0 IP multicasts)
    0 runts, 0 giants, 0 throttles
    0 input errors, 0 CRC, 0 frame, 0 overrun, 0 ignored, 0 abort
  64 packets output, 8357 bytes, 0 underruns
    0 output errors, 0 collisions, 0 interface resets
    0 unknown protocol drops
    0 output buffer failures, 0 output buffers swapped out
    1 carrier transitions
```

## Configuring a Channel Group

Follow these steps to configure a channel group:

### Procedure

	Command or Action	Purpose
<b>Step 1</b>	<b>configure terminal</b>  <b>Example:</b>  Router# <b>configure terminal</b>	Enters global configuration mode.
<b>Step 2</b>	<b>controller {t1   e1} slot/subslot/port</b>  <b>Example:</b>  Router(config)# controller t1 0/3/0	Select the controller to configure and enter global configuration mode.
<b>Step 3</b>	<b>channel-group [t1   e1] number {timeslots range   unframed} [speed {56   64}]</b>  <b>Example:</b>	Defines the time slots that belong to each T1 or E1 circuit. <ul style="list-style-type: none"> <li><i>number</i>— Channel-group number. When configuring a T1 data line, channel-group</li> </ul>

	Command or Action	Purpose
	<pre>Router(config-controller)# channel-group t1 1timeslots 1   unframed speed 56</pre>	<p>numbers can be values from 1 to 28. When configuring an E1 data line, channel-group numbers can be values from 0 to 30.</p> <ul style="list-style-type: none"> <li>• <b>timeslots range</b>— One or more time slots or ranges of time slots belonging to the channel group. The first time slot is numbered 1. For a T1 controller, the time slot range is from 1 to 24. For an E1 controller, the time slot range is from 1 to 31.</li> <li>• <b>unframed</b>—Unframed mode (G.703) uses all 32 time slots for data. None of the 32 time slots are used for framing signals.</li> <li>• <b>speed</b>—(Optional) Specifies the speed of the underlying DS0s in kilobits per second. Valid values are 56 and 64.</li> </ul> <p><b>Note</b> The default is 64. Speed is not mentioned in the configuration.</p> <p><b>Note</b> Each channel group is presented to the system as a serial interface that can be configured individually.</p> <p><b>Note</b> Once a channel group has been created with the channel-group command, the channel group cannot be changed without removing the channel group. To remove a channel group, use the <b>no</b> form of the <b>channel-group</b> command.</p> <p><b>Note</b> The unframed option is not currently supported.</p> <p><b>Note</b> DS0-level channelization is not currently supported.</p>
<b>Step 4</b>	<p><b>exit</b></p> <p><b>Example:</b></p> <pre>Router(config)# exit</pre>	Exits configuration mode and returns to the EXEC command interpreter prompt.

## Saving the Configuration

To save your running configuration to nonvolatile random-access memory (NVRAM), use the following command in privileged EXEC configuration mode:

Command	Purpose
<b>copy running-config startup-config</b>	Writes the new configuration to NVRAM.

For information about managing your system images and configuration files, refer to the [Cisco IOS Configuration Fundamentals Configuration Guide](#) and [Cisco IOS Configuration Fundamentals Command Reference](#) publications.

## Troubleshooting E1 and T1 Controllers

You can use the following methods to troubleshoot the E1 and T1 controllers using Cisco IOS software:

- [Setting Loopbacks, on page 76](#)
- [Running Bit Error Rate Testing, on page 77](#)

### Setting Loopbacks

The following sections describe how to set loopbacks:

#### Setting a Loopback on the E1 Controller

To set a loopback on the E1 controller, perform the first task followed by any of the following tasks beginning in global configuration mode:

Command	Purpose
<b>configure terminal</b>	Enters global configuration mode.
<b>controller e1</b> <i>slot/subslot/port</i>	Select the E1 controller and enter controller configuration mode. The slot number is always 0.
<b>loopback diag</b>	Set a diagnostic loopback on the E1 line.
<b>loopback network</b> { <b>line</b>   <b>payload</b> }	Set a network payload loopback on the E1 line.
<b>end</b>	Exit configuration mode when you have finished configuring the controller.

#### Setting a Loopback on the T1 Controller

You can use the following loopback commands on the T1 controller in global configuration mode:

Task	Command
<b>controller t1</b> <i>slot/subslot/port</i>	Selects the T1 controller and enter controller configuration mode The slot number is always 0.
<b>loopback diag</b>	Sets a diagnostic loopback on the T1 line.
<b>loopback local</b> { <b>line</b>   <b>payload</b> }	Sets a local loopback on the T1 line. You can select to loopback the line or the payload.
<b>loopback remote iboc</b>	Sets a remote loopback on the T1 line. This loopback setting will loopback the far end at line or payload, using IBOC (in band bit-orientated code) or the Extended Super Frame (ESF) loopback codes to communicate the request to the far end.
<b>end</b>	Exits configuration mode when you have finished configuring the controller.



**Note** To remove a loopback, use the **no loopback** command.

**Table 9: Loopback Descriptions**

Loopback	Description
<b>loopback diag</b>	Loops the outgoing transmit signal back to the receive signal. This is done using the diagnostic loopback feature in the interface module's PMC framer. The interface module transmits AIS in this mode. Set the <b>clock source</b> command to <b>internal</b> for this loopback mode.
<b>loopback local</b>	Loops the incoming receive signal back out to the transmitter. You can specify whether to use the <b>line</b> or <b>payload</b> .
<b>local line</b>	The incoming signal is looped back in the interface module using the framer's line loopback mode. The framer does not reclock or reframe the incoming data. All incoming data is received by the interface module driver.
<b>local payload</b>	Loops the incoming signal back in the interface module using the payload loopback mode of the framer. The framer reclocks and reframes the incoming data before sending it back out to the network. When in payload loopback mode, an all 1s data pattern is received by the local HDLC receiver and the clock source is automatically set to line (overriding the <b>clock source</b> command). When the payload loopback is ended, the clock source returns to the last setting selected by the <b>clock source</b> command.
<b>loopback remote iboc</b>	Attempts to set the far-end T1 interface into line loopback. This command sends an in-band bit-oriented code to the far-end to cause it to go into line loopback. This command is available when using ESF or SF framing mode.
<b>network line</b>	Loops the incoming signal back in the interface module using the line loopback mode of the framer. The framer does not reclock or reframe the incoming data. All incoming data is received by the interface module driver.
<b>network payload</b>	Loops the incoming signal back using the payload loopback mode of the framer. The framer reclocks and reframes the incoming data before sending it back out to the network. When in payload loopback mode, an all 1s data pattern is received by the local HDLC receiver, and the clock source is automatically set to line (overriding the <b>clock source</b> command). When the payload loopback is ended, the clock source returns to the last setting selected by the <b>clock source</b> command.

## Running Bit Error Rate Testing

Bit error rate testing (BERT) is supported on each of the E1 or T1 links. The BERT testing is done only over a framed E1 or T1 signal and can be run only on one port at a time.

The interface modules contain onboard BERT circuitry. With this, the interface module software can send and detect a programmable pattern that is compliant with CCITT/ITU O.151, O.152, and O.153 pseudo-random and repetitive test patterns. BERTs allows you to test cables and signal problems in the field.

When running a BER test, your system expects to receive the same pattern that it is transmitting. To help ensure this, two common options are available:

- Use a loopback somewhere in the link or network
- Configure remote testing equipment to transmit the same BERT test pattern at the same time

To run a BERT on an E1 or T1 controller, perform the following optional tasks beginning in global configuration mode:

Task	Command
<b>controller</b> {e1   t1} slot/subslot/port	Selects the E1 or T1 controller and enters controller configuration mode.  The slot number is always 0.
<b>bert pattern</b> 0s   1s   2^11   2^15   2^20-O153   2^20-QRSS   2^23   alt-0-1} interval minutes	Specifies the BERT pattern for the E1 or T1 line and the duration of the test in minutes. The valid range is 1 to 1440 minutes.  <b>Note</b> Only the 2^11, 2^15, 2^20-O153, and 2^20-QRSS patterns are supported.
<b>end</b>	Exit configuration mode when you have finished configuring the controller.
<b>show controllers</b> {e1   t1} slot/subslot/port	Displays the BERT results.

The following keywords list different BERT keywords and their descriptions.



**Caution**

Currently only the 2^11, 2^15, 2^20-O153, and 2^20-QRSS patterns are supported.

**Table 10: BERT Pattern Descriptions**

Keyword	Description
0s	Repeating pattern of zeros (...000...).
1s	Repeating pattern of ones (...111...).
2^11	Pseudo-random test pattern that is 2,048 bits in length.
2^15	Pseudo-random O.151 test pattern that is 32,768 bits in length.
2^20-O153	Pseudo-random O.153 test pattern that is 1,048,575 bits in length.
2^20-QRSS	Pseudo-random QRSS O.151 test pattern that is 1,048,575 bits in length.
2^23	Pseudo-random 0.151 test pattern that is 8,388,607 bits in length.



Keyword	Description
<b>alt-0-1</b>	Repeating alternating pattern of zeros and ones (...01010...).

Both the total number of error bits received and the total number of bits received are available for analysis. You can select the testing period from 1 minute to 24 hours, and you can also retrieve the error statistics anytime during the BER test.



**Note** To terminate a BERT test during the specified test period, use the **no bert** command.

You can view the results of a BERT test at the following times:

- After you terminate the test using the **no bert** command
- After the test runs completely
- Anytime during the test (in real time)

## Monitoring and Maintaining the T1/E1 Interface Module

After configuring the new interface, you can monitor the status and maintain the interface module by using **show** commands. To display the status of any interface, complete any of the following tasks in **EXEC** mode:

Task	Command
<b>show controllers</b> { <b>e1</b>   <b>t1</b> } [ <i>slot/port-adapter/port/e1-line</i> ] [ <b>brief</b> ]	Displays the status of the E1 or T1 controller.
<b>show interface serial</b> <i>slot/subslot/port</i>	Displays statistics about the serial information for a specific E1 or T1 channel group. Valid values are 0 to 30 for E1 and 0 to 23 for T1.
<b>clear counters serial</b> <i>slot/subslot/port</i>	Clears the interface counters



**Note** To change the T1/E1 card type configuration, use the **no card type** command and reload the router.

## AIS on Core Failure

AIS stands for Alarm Indication Signal. Prior to Cisco IOS XE Fuji Release 16.7.1, the PDH AIS alarms were generated only when the CE would go down and an event was set in the CEM control-word by the remote provider edge (PE). AIS alarms were not generated when the pseudowire went down. Now, AIS alarm are generated when the pseudowire goes down.

This feature is only supported on the Cisco ASR 900 RSP2 module, for 8-port T1/E1 and 16-port T1/E1 interface modules and only for unframed E1 mode (SAtOP) type.

## Limitations of AIS

- AIS is not supported on CESoP and CEM over UDP.
- AIS is not supported on T1 mode. It is only supported on E1 mode.
- AIS is not supported on the 4-port OC3/STM-1 (OC-3) interface module (IM) and 32-port T1/E1 IM.
- AIS is supported only for MPLS core.
- AIS is not supported in pseudowire HSPW mode, when **graceful-restart** command is enabled.
- Removing the MPLS IP address from the core interfaces results in a delay of 10-12 minutes to notify the peer end. This depends on the negotiated forwarding hold timer between the routers, which is the least value of the configured LDP GR forwarding hold timer of the two routers.
- Supported CEM class range of de-jitter buffer size is between 1 to 32 ms.
- If the **shutdown unpowered** command is used to shut down the IM, an OIR must be performed to trigger the AIS alarms..

## Core Failure Event Detection

AIS configuration is used to detect core defects. The core failure is detected in the following events:

- Shutdown of the PE controller or tug level.
- Removing the cross-connect feature.
- Removal of Gigabit Ethernet configuration, CEM configuration, controller configuration, or OSPF configuration.
- Shut on OSPF, CEM group, cross-connect, or Gigabit Ethernet interface.
- CE1 controller shut—AIS alarm is seen on the remote CE.
- PE1 controller shut—AIS alarm is seen on the remote CE.
- PE1 core shut—AIS alarm is seen on both the CEs.
- PE2 core shut—AIS alarm is seen on both the CEs.
- Pseudowire down—AIS alarm is seen on both the CEs.
- Core IGP down—AIS alarm is seen on both the CEs.
- Core LDP down—AIS alarm is seen on both the CEs.

## Configuring AIS for Core Failure

When you enable the AIS, Plesiochronous Digital Hierarchy (PDH) AIS alarm is supported for core failure events on the 8-port T1/E1 and 16-port T1/E1 interface modules. When a core failure is detected due to any event, core flap flag is updated and the core flap event sends an event, which asserts an AIS. When the AIS is not enabled, core failure events are ignored.

Use the following procedure to enable AIS:

```
Router> enable
Router#configure terminal
```



```

Queueing strategy: fifo
Output queue: 0/40 (size/max)
5 minute input rate 1744000 bits/sec, 644 packets/sec
5 minute output rate 1874000 bits/sec, 690 packets/sec
 180817311 packets input, 61438815508 bytes, 0 no buffer
  Received 0 broadcasts (0 IP multicasts)
  0 runts, 0 giants, 0 throttles
  2 input errors, 0 CRC, 0 frame, 0 overrun, 0 ignored, 2 abort
180845200 packets output, 61438125092 bytes, 0 underruns
  0 output errors, 0 collisions, 2 interface resets
  0 output buffer failures, 0 output buffers swapped out
  1 carrier transitions no alarm present
Timeslot(s) Used:1-31, subrate: 64Kb/s, transmit delay is 0 flags 2

```

## Configuration Examples

This section includes the following configuration examples:

### Example: Framing and Encapsulation Configuration

The following example sets the framing and encapsulation for the controller and interface:

```

! Specify the controller and enter controller configuration mode
!
Router(config)# controller t1 2/0/0
!
! Specify the framing method
!
Router(config-controller)# framing esf
!
! Exit controller configuration mode and return to global configuration mode
!
Router(config-controller)# exit
!
! Specify the interface and enter interface configuration mode
!
Router(config)# interface serial 2/0/0:0
!
! Specify the encapsulation protocol
!
Router(config-if)# encapsulation ppp
!
! Exit interface configuration mode
!
Router(config-if)# exit
!
! Exit global configuration mode
!
Router(config)# exit

```

### Example: CRC Configuration

The following example sets the CRC size for the interface:

```

! Specify the interface and enter interface configuration mode
!
Router(config)# interface serial 2/0/0:0

```

```
!  
! Specify the CRC size  
!  
Router(config-if)# crc 32  
!  
! Exit interface configuration mode and return to global configuration mode  
!  
Router(config-if)# exit  
!  
! Exit global configuration mode  
!  
Router(config)# exit
```

## Example: Facility Data Link Configuration

The following example configures Facility Data Link:

```
! Specify the controller and enter controller configuration mode  
!  
Router(config)# controller t1 2/0/0  
!  
! Specify the FDL specification  
!  
Router(config-controller)#  
fdl ansi  
!  
! Exit controller configuration mode and return to global configuration mode  
!  
Router(config-controller)# exit  
!  
! Exit global configuration mode  
!  
Router(config)# exit
```

## Example: Invert Data on the T1/E1 Interface

The following example inverts the data on the serial interface:

```
! Enter global configuration mode  
!  
Router# configure terminal  
!  
! Specify the serial interface and enter interface configuration mode  
!  
Router(config)# interface serial 2/1/3:0  
!  
! Configure invert data  
!  
Router(config-if)# invert data  
!  
! Exit interface configuration mode and return to global configuration mode  
!  
Router(config-if)# exit  
!  
! Exit global configuration mode  
!  
Router(config)# exit
```





## CHAPTER 8

# Configuring Optical Interface Modules

This chapter describes the most common configurations for optical interface modules on the Cisco ASR 900 Series Router.

- [Limitations and Restrictions, on page 85](#)
- [Configuring the Controller, on page 86](#)
- [Configuring SDH, on page 87](#)
- [Configuring SONET Mode, on page 95](#)
- [Configuring a CEM group, on page 98](#)
- [Configuring DS3 Clear Channel on OC-3 and OC-12 Interface Module, on page 102](#)
- [Optional Configurations, on page 106](#)
- [Managing Interface Naming, on page 109](#)
- [Configuring Multilink Point-to-Point Protocol, on page 109](#)
- [Configuring BERT, on page 113](#)
- [Configuring Automatic Protection Switching, on page 114](#)
- [TU-AIS Alarms, on page 114](#)
- [Verifying Interface Configuration, on page 115](#)
- [Troubleshooting, on page 116](#)
- [Configuration Examples, on page 120](#)
- [Additional Resources, on page 121](#)

## Limitations and Restrictions

- The 4-port OC3/STM-1 (OC-3) or 1-port OC12/STM-4 (OC-12) interface module is *not* supported on the ASR 900 RSP3 module.
- SDH framing mode is supported; SONET framing is supported beginning in Cisco IOS XE Release 3.8.
- On the OC-3 controller, framing mode is applicable on the interface module and per port. When framing mode is set to SONET, all the 4 ports on the interface module are enabled for SONET mode. Similarly, when framing mode is set to SDH mode, all 4 ports on the interface module are enabled for SDH mode.
- The OC-3 controller supports Asynchronous mode at the V5 byte level for Plesiochronous Digital Hierarchy (PDH). This value cannot be modified. If a mismatch occurs between the V5 byte, and the peer (remote router), loss of frames may be observed at the PDH level.
- HDLC, PPP, and MLPPP encapsulation are supported. In POS mode, HDLC and PPP are supported.

- ATM Layer 2 AAL0 and AAL5 encapsulation types are supported.
- E1 unframed encapsulation is not supported except using SAToP pseudowire interfaces.
- Unframed T1 is supported only for SATOP. E1 unframed is supported.
- MPLS-TP is not supported over Packet Over Sonet (POS) interfaces.
- Multicast is not supported on OC-12 interfaces.
- QoS is supported using MLPPP interfaces and egress POS interfaces.
- MPLS is supported only on PoS interfaces; MPLS on T1/E1 MLP is supported starting with Cisco IOS XE Release 3.9. MPLS over MLP is also supported.
- Channelization is not supported for serial interfaces. However, Channelization is supported for CEM at the DS0 level.
- DS3 Clear channel is supported only on CEM.
- BERT is not supported on DS0 and DS1 CEM. It is supported only on DS3 CEM mode.
- Configurations on the interface module must be completely removed before moving the interface module to a different slot on the router.
- Mixed configurations of features are not supported on the same port. For example, one OC-3 port can have only CEM (CESoP or SAToP) or ATM or IMA or DS3 configurations, but not a combination of these features on a single port.
- CEM is not supported across OC12/ STM-4 interface module. CEM is supported on all four ports of OC-3/STM-1 interface module.
- If two CEM circuits are configured under the same OC-3 interface module, the circuits should not be configured with the same circuit-id. If two CEM circuits are configured on different OC-3 interface modules, then both circuits can be configured with the same circuit-id.
- By default, AIS-SHUT is enabled on the OC-3 SONET/SDH controller and port level shut down of SONET/SDH controller results in AIS alarm on peer node. To enable the LOS alarm on controller shut down, you must configure “no ais-shut” at SONET/SDH controller level.
- Maximum channels per OC-3/ STM interface module for T1 interfaces is 336 for RSP1 and RSP2.
- Maximum channels per OC-3/STM interface module for E1 interfaces is 252 for RSP1 and RSP2.

## Configuring the Controller

Starting with Cisco IOS XE Release 3.10, OC-3 and OC-12 is licensed. For information on licensing these interfaces, see [Licensing the OC-3 and OC-12 Interface Modules](#).



---

**Note** When the mode is changed, the interface module reloads.

---



Command	Purpose
<p><b>platform enable controller controller-type slot/subslot/port</b></p> <pre>Router(config)# platform enable controller SONET 0/2/3</pre>	<p>Enables the ports on slot where the interface is present.</p> <p><b>Note</b> The slot number for the controller <b>sonet</b> is always zero on the router.</p> <ul style="list-style-type: none"> <li>• controller—Configures a specific controller</li> <li>• controller-type—Type of controller.</li> </ul>
<p><b>controller sonet slot/subslot/port</b></p> <pre>Router(config)# controller sonet 0/2/3</pre>	<p>Selects the controller to configure and enters controller configuration mode, where:</p> <ul style="list-style-type: none"> <li>• <i>slot/subslot/port</i> —Specifies the location of the interface.</li> </ul> <p><b>Note</b> The slot number is always zero on the Cisco ASR 900 Series Router.</p>

## Configuring SDH

The following sections describe how to configure SDH on the optical interface module:

### Configuring SDH Mode

#### SDH T1 Mode

To configure SDH T1 mode, complete the following steps:

##### Procedure

	Command or Action	Purpose
<b>Step 1</b>	<p><b>framing sdh</b></p> <p><b>Example:</b></p> <pre>Router(config-controller)# framing sdh</pre>	Specifies SDH as the frame type.
<b>Step 2</b>	<p><b>aug mapping {au-4}</b></p> <p><b>Example:</b></p> <pre>Router(config-controller)# aug mapping au-4</pre>	Configures AUG mapping for SDH framing.
<b>Step 3</b>	<p><b>clock source {internal   line}</b></p> <p><b>Example:</b></p> <pre>Router(config-controller)# clock source line</pre>	<p>Sets the clock source, where:</p> <ul style="list-style-type: none"> <li>• internal—Specifies that the internal clock source is used.</li> </ul>

	Command or Action	Purpose
		<ul style="list-style-type: none"> <li>line—Specifies that the network clock source is used. This is the default for T1 and E1.</li> </ul>
<b>Step 4</b>	<p><b>au-4</b> <i>au-4#</i> <b>tug-3</b> <i>tug-3#</i></p> <p><b>Example:</b></p> <pre>Router(config-controller)# <b>au-4</b> 1 <b>tug-3</b> 3</pre>	<p>Configures AU-4, and tributary unit groups, type 3 (TUG-3) for AU-4 and enters specific configuration mode.</p> <ul style="list-style-type: none"> <li><i>au-4#</i>—Range is from 1 to 4 for OC-12 mode and 1 for OC-3 mode</li> <li><i>tug-3#</i>—Range is from 1 to 3.</li> </ul>
<b>Step 5</b>	<p>In SDH framing in AU-4 mode:</p> <p><b>Example:</b></p> <pre>mode {c-11   c-12   t3   e3}</pre> <p><b>Example:</b></p> <pre>Router(config-ctrlr-tug3)# mode {c-11   c-12   t3   e3}</pre> <p><b>Example:</b></p> <p><b>Example:</b></p> <p>In SDH framing AU-3 mode:</p> <p><b>Example:</b></p> <pre>mode {c-11   c-12   t3   e3}</pre> <p><b>Example:</b></p> <pre>Router(config-ctrlr-au3)# mode {c-11   c-12   t3   e3}</pre>	<p>(Optional) Configures mode of operation for AU-3 or AU-4 mode, where:</p> <p>C-11 and C-12 are container level-n (SDH) channelized T3s. They are types of T3 channels that are subdivided into 28 T1 channels.</p> <ul style="list-style-type: none"> <li><b>c-11</b>—Specifies an AU-3/AU-4 TUG-3 divided into seven TUG-2s. Each TUG-2 is then divided into four TU11s, each carrying a C-11 T1.</li> <li><b>c-12</b>—Specifies an AU-3/AU-4 TUG-3 divided into seven TUG-2. Each TUG-2 is then divided into three TU12s, each carrying a C-12 E1.</li> <li><b>t3</b>—Specifies an AU-3/AU-4 TUG-3 carrying an unchannelized (clear channel) T3.</li> <li><b>e3</b>—Specifies an AU-3/AU-4 TUG-3 carrying an unchannelized (clear channel) E3.</li> </ul> <p><b>Note</b> Only c-11 and c-12 are currently supported.</p>
<b>Step 6</b>	<p><b>SAToP CEM Group</b></p> <p><b>Example:</b></p> <pre>tug-2 1 e1 1 cem-group 1 unframed</pre> <p><b>Example:</b></p> <pre>Router(config-ctrlr-tug3)# tug-2 1 e1 1 cem-group 1 unframed</pre> <p><b>Example:</b></p> <p><b>CESoPSN CEM Group</b></p> <p><b>Example:</b></p>	<p>Creates a CEM group, IMA group, or channel-group for the AU-3 or AU-4. Valid values are:</p> <ul style="list-style-type: none"> <li>e1—1-3</li> <li>tug-3—1-3</li> <li>tug-2—1-7</li> <li>unframed—Specifies that a single CEM channel is being created including all time slots and the framing structure of the line.</li> </ul>

	Command or Action	Purpose
	<p><b>tug-2 1 e1 1 cem-group 1 timeslots 1-31</b></p> <p><b>Example:</b></p> <pre>Router(config-ctrlr-tug3)# tug-2 1 e1 1 cem-group 1 timeslots 1-31</pre> <p><b>Example:</b></p> <p><b>Example:</b></p> <p><b>IMA Group</b></p> <p><b>Example:</b></p> <pre>tug-2 1 e1 1 ima-group 1</pre> <p><b>Example:</b></p> <pre>Router(config-ctrlr-tug3)# tug-2 1 e1 1 ima-group 1</pre> <p><b>Example:</b></p> <p><b>Example:</b></p> <p><b>Channel Group</b></p> <p><b>Example:</b></p> <pre>tug-2 1 e1 1 [[channel-group channel-group-number] [timeslots list-of-timeslots]]</pre> <p><b>Example:</b></p> <pre>Router(config-ctrlr-tug3)# tug-2 1 e1 1 channel-group 1 timeslots 1-31]</pre>	
<b>Step 7</b>	<p><b>exit</b></p> <p><b>Example:</b></p> <pre>Router(config-controller)# <b>exit</b></pre>	Exits controller configuration mode.
<b>Step 8</b>	<p><b>controller t1 interface-path-id</b></p> <p><b>Example:</b></p> <pre>Router(config-controller)# <b>controller t1 0/1/1/0/0/0</b></pre>	Enters controller configuration mode for an individual T1 or E1.

	Command or Action	Purpose
<b>Step 9</b>	Creates a CEM group, IMA group, or channel-group on the T1 or E1 controller.	<p><b>SAToP CEM Group</b></p> <pre>Router(config-ctrlr)# t1 cem-group 1 unframed</pre> <p><b>CESoPSN CEM Group</b></p> <pre>Router(config-ctrlr)# t1 cem-group 1 timeslots 1-24</pre> <p><b>Clear-Channel ATM</b></p> <pre>Router(config-ctrlr-tug3)# e1 1 atm</pre> <p><b>IMA Group</b></p> <pre>Router(config-ctrlr-tug3)# e1 1 ima-group 1</pre> <p><b>Channel Group</b></p> <pre>Router(config-ctrlr)# t1 2 channel-group 4 [[channel-group channel-group-number] [timeslots list-of-timeslots]]</pre>

**What to do next****Example**

The example configures SDH E1 mode:

```
Router# configure terminal
Router(config)# controller sonet 0/1/0
Router(config-controller)# framing sdh
Router(config-controller)# aug mapping au-4
Router(config-controller)# clock source internal
Router(config-controller)# au-4 1 tug-3 2
Router(config-ctrlr-tug3)# tug-2 1 e1 1 channel-group 1 timeslots 1-31
```

**SDH T1 Mode**

To configure SDH T1 mode, complete the following steps:

Procedure

	Command or Action	Purpose
<b>Step 1</b>	<b>framing sdh</b> <b>Example:</b> <pre>Router(config-controller)# framing sdh</pre>	Specifies SDH as the frame type.
<b>Step 2</b>	<b>aug mapping {au-3}</b> <b>Example:</b> <pre>Router(config-controller)# aug mapping au-3</pre>	Configures AUG mapping for SDH framing. Supports au-3 and au-4 aug mapping. The default setting is <b>au-3</b> .
<b>Step 3</b>	<b>clock source {internal   line}</b> <b>Example:</b> <pre>Router(config-controller)# clock source line</pre>	Sets the clock source, where: <ul style="list-style-type: none"> <li>• <b>internal</b>—Specifies that the internal clock source is used.</li> <li>• <b>line</b>—Specifies that the network clock source is used. This is the default for T1 and E1.</li> </ul>
<b>Step 4</b>	<b>au-3 au-3#</b> <b>Example:</b> <pre>Router(config-controller)# au-3 au-3#</pre>	Configures AU-3, and enters specific configuration mode. <ul style="list-style-type: none"> <li>• <b>au-3#</b>—Range is from 1 to 12 for OC-12 mode. For OC-3 mode, the value is 1–3.</li> </ul>
<b>Step 5</b>	In SDH framing in AU-4 mode: <b>Example:</b> <b>mode {c-11   c-12   t3   e3}</b> <b>Example:</b> <pre>Router(config-ctrlr-tug3)# mode {c-11   c-12   t3   e3}</pre> <b>Example:</b> <b>Example:</b> <b>Example:</b> In SDH framing AU-3 mode: <b>Example:</b> <b>mode {c-11   c-12   t3   e3}</b> <b>Example:</b>	(Optional) Configures mode of operation for AU-3 or AU-4 mode, where: C-11 and C-12 are container level-n (SDH) channelized T3s. They are types of T3 channels that are subdivided into 28 T1 channels. <ul style="list-style-type: none"> <li>• <b>c-11</b>—Specifies an AU-3/AU-4 TUG-3 divided into seven TUG-2s. Each TUG-2 is then divided into four TU11s, each carrying a C-11 T1.</li> <li>• <b>c-12</b>—Specifies an AU-3/AU-4 TUG-3 divided into seven TUG-2. Each TUG-2 is then divided into three TU12s, each carrying a C-12 E1.</li> <li>• <b>t3</b>—Specifies an AU-3/AU-4 TUG-3 carrying an unchannelized (clear channel) T3.</li> <li>• <b>e3</b>—Specifies an AU-3/AU-4 TUG-3 carrying an unchannelized (clear channel) E3.</li> </ul> <p><b>Note</b> Only c-11 and c-12 are currently supported.</p>

	Command or Action	Purpose
	Router(config-ctrlr-au3)# <b>mode</b> { <b>c-11</b>   <b>c-12</b>   <b>t3</b>   <b>e3</b> }	
<b>Step 6</b>	<p><b>SAToP CEM Group</b></p> <p><b>Example:</b></p> <pre>tug-2 1 t1 1 cem-group 1 unframed</pre> <p><b>Example:</b></p> <pre>Router(config-ctrlr-au3)# tug-2 1 t1 1 cem-group 1 unframed</pre> <p><b>Example:</b></p> <p><b>CESoPSN CEM Group</b></p> <p><b>Example:</b></p> <pre>tug-2 1 e1 1 cem-group 1 timeslots 1-31</pre> <p><b>Example:</b></p> <pre>Router(config-ctrlr-au3)# tug-2 1 t1 1 cem-group 1 timeslots 1-31</pre> <p><b>Example:</b></p> <p><b>IMA Group</b></p> <p><b>Example:</b></p> <pre>tug-2 1 t1 1 ima-group 1</pre> <p><b>Example:</b></p> <pre>Router(config-ctrlr-au3)# tug-2 1 t1 1 ima-group 1</pre> <p><b>Example:</b></p> <p><b>Channel Group</b></p> <p><b>Example:</b></p> <pre>tug-2 1 e1 1 [[channel-group channel-group-number] [timeslots list-of-timeslots]]</pre> <p><b>Example:</b></p>	<p>Creates a CEM group, IMA group, or channel-group for the AU-3 or AU-4. Valid values are:</p> <ul style="list-style-type: none"> <li>• <b>t1</b>—Range is from 1 to 12 for OC-12 mode. For OC-3 mode, the value is 1–3.</li> <li>• <b>tug-2</b>—1–7</li> <li>• <b>unframed</b>—Specifies that a single CEM channel is being created including all time slots and the framing structure of the line.</li> </ul>

	Command or Action	Purpose
	<pre>Router(config-ctrlr-tug3) # <b>tug-2 1 t1</b> <b>1 channel-group 0 timeslots 1-31</b></pre> <p><b>Example:</b></p>	
<b>Step 7</b>	<pre>exit</pre> <p><b>Example:</b></p> <pre>Router(config-controller) # <b>exit</b></pre>	Exits controller configuration mode.
<b>Step 8</b>	<p><b>controller t1 interface-path-id</b></p> <p><b>Example:</b></p> <pre>Router(config-controller) # <b>controller</b> <b>t1 0/1/1/0/0/0</b></pre>	Enters controller configuration mode for an individual T1 or E1.
<b>Step 9</b>	Creates a CEM group, IMA group, or channel-group on the T1 or E1 controller.	<p><b>SAToP CEM Group</b></p> <pre>Router(config-ctrlr) # <b>t1 cem-group 1</b> <b>unframed</b></pre> <p><b>CESoPSN CEM Group</b></p> <pre>Router(config-ctrlr) # <b>t1 cem-group 1</b> <b>timeslots 1-24</b></pre> <p><b>Clear-Channel ATM</b></p> <pre>Router(config-ctrlr-tug3) # <b>e1 1 atm</b></pre> <p><b>IMA Group</b></p> <pre>Router(config-ctrlr-tug3) # <b>e1 1</b> <b>ima-group 1</b></pre> <p><b>Channel Group</b></p> <pre>Router(config-ctrlr) # <b>t1 2</b> <b>channel-group 4</b> <b>[[channel-group</b> <b>channel-group-number] [timeslots</b> <b>list-of-timeslots]]</b></pre>

**What to do next**

The example configures SDH T1 mode:

```
Router# configure terminal
Router(config)# controller sonet 0/1/0
Router(config-controller)# framing sdh
Router(config-controller)# aug mapping au-3
Router(config-controller)# au-3 1
```

```
Router(config-ctrlr-au3)# tug-2 1 t1 1 channel-group 1 timeslots 1-31
```

For information about configuring optional features, see [Optional Configurations, on page 106](#).

## Configuring SDH in POS Mode

Follow these steps to configure SDH in POS mode on the optical interface module.

**Procedure**

	Command or Action	Purpose
<b>Step 1</b>	<b>controller sonet</b> <i>slot/subslot/port</i> <b>Example:</b> <b>Example:</b>  Router(config)# <b>controller sonet</b> <i>0/1/0</i>	Selects the controller to be configured.
<b>Step 2</b>	<b>framing {sonet   sdh}</b> <b>Example:</b>  Router(config)# <b>framing sdh</b>	Specifies SDH as the framing mode. <b>Note</b> The interface module reloads if the framing is changed.
<b>Step 3</b>	<b>aug mapping {au-3   au-4}</b> <b>Example:</b>  Router(config-controller)# <b>aug mapping</b> <b>au-4</b>	Specifies AUG mapping. <b>Note</b> POS mode is only supported with AU-4 mode.
<b>Step 4</b>	<b>au-4</b> <i>au-4-number</i> <b>pos</b> <b>Example:</b>  Router(config-controller)# <b>au-4 1 pos</b>	Selects the AU-4 to be configured in POS mode with SDH framing. The command creates a POS interface, such as POS0/0/1:1. In OC-3 mode, the value is 1; in OC-12 mode, valid values are 1-4.
<b>Step 5</b>	<b>end</b> <b>Example:</b>  Router(config-controller)# <b>end</b>	Exits configuration mode.



## Configuring SONET Mode

### Example

```
Router# configure terminal
Router(config)# controller sonet 0/1/0
Router(config-controller)# framing sdh
Router(config-controller)# aug mapping au-4
Router(config-controller)# au-4 1 pos
Router(config-controller)# end
```

For information about configuring optional features, see [Optional Packet over SONET Configurations](#), on page 107

## Configuring SONET Mode

The following sections describe how to configure SONET mode on the optical interface module:

### Configuring SONET Mode

To configure an interface module to use SONET mode:

#### Procedure

	Command or Action	Purpose
<b>Step 1</b>	<b>controller sonet</b> <i>slot/subslot/port</i>  <b>Example:</b>  Router(config)# <b>controller sonet</b> <i>0/1/0</i>	Selects the controller to be configured.
<b>Step 2</b>	<b>framing {sonet   sdh}</b>  <b>Example:</b>  Router(config-controller)# <b>framing</b> <b>sonet</b>	Specifies SONET as the framing mode.
<b>Step 3</b>	<b>clock source {line   internal}</b>  <b>Example:</b>  Router(config-if)# <b>clock source line</b>	Specifies the clock source for the POS link, where: <ul style="list-style-type: none"> <li>• <b>line</b>—The link uses the recovered clock from the line. This is the default setting.</li> <li>• <b>internal</b>—The link uses the internal clock source.</li> </ul>
<b>Step 4</b>	<b>sts-1 {1 - 12   1 - 3   4 - 6   7 - 9   10 - 12}</b>  <b>Example:</b>	Specifies the SONET Synchronous Transport Signal (STS) level and enters STS-1 configuration mode. The starting-number and

	Command or Action	Purpose
	<pre>Router(config-controller)# sts-1 1 - 3</pre>	<p>ending-number arguments indicate the starting and ending STS value of the interface.</p> <p>For OC-3 interfaces, this value is 1.</p> <p><b>Note</b> The <b>1-12</b> value is supported only in OC-12 mode.</p>
<b>Step 5</b>	<p><b>vtg vtg-number t1 t1-line-number channel-group channel-group-no timeslots list-of-timeslots</b></p> <p><b>Example:</b></p> <pre>Router(config-if)# vtg 1 t1 1 channel-group 0 timeslots 1-24</pre>	<p>Configures the T1 on the VTG, where</p> <ul style="list-style-type: none"> <li>• <i>vtg-number</i>—Specifies the VTG number. The framing is 1-7</li> <li>• <i>t1 t1-line-number</i>—1-4</li> <li>• <b>channel-group channel-group-no</b>—0-24</li> <li>• <b>timeslots list-of-timeslots</b>—1-24</li> </ul>
<b>Step 6</b>	<p><b>end</b></p> <p><b>Example:</b></p> <pre>Router(config-if)# end</pre>	<p>Exits configuration mode.</p>

### What to do next

The below example shows the configuration for the DS1 T1 serial interface:

```
Router# configure terminal
Router(config)# controller sonet 0/1/0
Router(config-controller)# framing sonet
Router(config-controller)# clock source line
Router(config-controller)# sts-1 1 - 3
Router(config-ctrlr-sts1)# vtg 1 t1 1 channel-group 0 timeslot 1-24
Router(config-controller)# end
```

For information on optional SONET configurations, see [Optional Configurations, on page 106](#). For information on optional ATM, IMA, POS and Serial interface configuration, see [Optional Configurations, on page 106](#).

## Configuring SONET POS Mode

To configure an interface module to use SONET in POS mode, perform the following procedure.

### Procedure

	Command or Action	Purpose
<b>Step 1</b>	<p><b>controller sonet slot/subslot/port</b></p> <p><b>Example:</b></p> <pre>Router(config)# controller sonet 0/1/0</pre>	<p>Selects the controller to be configured.</p>

	Command or Action	Purpose
<b>Step 2</b>	<b>framing {sonet   sdh}</b> <b>Example:</b> <pre>Router(config-controller)# framing sonet</pre>	Specifies SONET as the framing mode.
<b>Step 3</b>	<b>clock source {line   internal}</b> <b>Example:</b> <pre>Router(config-controller)# clock source line</pre>	Specifies the clock source for the POS link, where: <ul style="list-style-type: none"> <li>• <b>line</b>—The link uses the recovered clock from the line. This is the default setting.</li> <li>• <b>internal</b>—The link uses the internal clock source.</li> </ul>
<b>Step 4</b>	<b>sts-1 {1- 12   1 - 3   4 - 6   7 - 9   10 - 12} pos</b> <b>Example:</b> <pre>Router(config-controller)# sts-1 1 - 3 pos</pre>	Specifies POS mode; starting-number and ending-number arguments indicate the starting and ending STS value of the POS interface. For OC-3 interfaces, this value is 1. <b>Note</b> The <b>1-12</b> value is supported only in OC-12 mode.
<b>Step 5</b>	<b>exit</b> <b>Example:</b> <pre>Router(config-controller)# exit</pre>	Exits controller configuration mode.
<b>Step 6</b>	Do one of the following: <ul style="list-style-type: none"> <li>• <b>interface POS</b> <i>slot/subslot/port</i></li> <li>• <b>interface POS</b> <i>slot/subslot/port.POS-interface</i></li> <li>• <b>interface POS</b> <i>slot/subslot/port:POS-interface</i></li> </ul> <b>Example:</b> <pre>interface POS0/0/1</pre> <b>Example:</b> <pre>interface POS0/0/1.1</pre> <b>Example:</b> <pre>interface POS0/0/1:1</pre>	Use any of the following commands to access the POS interface.
<b>Step 7</b>	<b>encapsulation encapsulation-type {hdlc   ppp}</b> <b>Example:</b>	Configures encapsulation; you can configure the following options:

	Command or Action	Purpose
	Router(config-if) # <b>encapsulation hdlc</b>	<ul style="list-style-type: none"> <li>• <b>hdlc</b>—Serial HDLC. This is the default for synchronous serial interfaces</li> <li>• <b>ppp</b>—Point-to-Point Protocol (for serial interface).</li> </ul>
<b>Step 8</b>	<b>end</b>  <b>Example:</b>  Router(config-if) # end	Exits configuration mode.

### What to do next

#### Example

```
Router# configure terminal
Router(config)# controller sonet 0/1/0
Router(config-controller)# framing sonet
Router(config-controller)# clock source line
Router(config-controller)# sts-1 1 - 3 pos
Router(config-controller)# exit
Router(config)# interface POS0/0/1
Router(config-if)# encapsulation hdlc
Router(config-if)# end
```

For information on optional SONET configurations, see [Configuring SONET POS Mode, on page 96](#).

## Configuring a CEM group

### Configuring CEM Group in SONET Mode

To configure a T1 CEM group in SONET mode:

#### Procedure

	Command or Action	Purpose
<b>Step 1</b>	<b>enable</b>	Enables privileged EXEC mode. <ul style="list-style-type: none"> <li>• Enter your password if prompted</li> </ul>
<b>Step 2</b>	<b>configure terminal</b>	Enters global configuration mode.
<b>Step 3</b>	<b>controller sonet</b> <i>slot/bay/port</i>  <b>Example:</b>    <b>Example:</b>  Router(config)# controller sonet 0/4/1	Selects the controller to configure and enters controller configuration mode, where: <ul style="list-style-type: none"> <li>• <i>slot/bay/port</i>—Specifies the location of the interface.</li> </ul> <p><b>Note</b> The slot number is always 1 and the bay number is always 0.</p>

	Command or Action	Purpose
<b>Step 4</b>	<b>framing {sonet   sdh}</b> <b>Example:</b>   <b>Example:</b> <pre>Router(config)# framing sonet</pre>	Specifies SONET as the framing mode.
<b>Step 5</b>	<b>sts-1 {1 - 12   1 - 3   4 - 6   7 - 9   10 - 12}</b> <b>Example:</b> <pre>Router(config-controller)# sts-1 1 - 3</pre>	Specifies the SONET Synchronous Transport Signal (STS) level and enters STS-1 configuration mode. The starting-number and ending-number arguments indicate the starting and ending STS value of the interface. For OC-3 interfaces, this value is 1. <b>Note</b> The <b>1-12</b> value is supported only in OC-12 mode.
<b>Step 6</b>	<b>mode {t3   vt-15}</b> <b>Example:</b>   <b>Example:</b> <pre>Router(config-ctrlr-sts1-3)# mode t3</pre>	Specifies the mode of operation of an STS-1 path, where: <b>Note</b> Note VT-15 is the only supported mode. <ul style="list-style-type: none"> <li>• <b>t3</b>—DS3 clear channel mode. STS-1 carries an unchannelized (clear channel) T3.</li> <li>• <b>vt-15</b>—A STS-1 is divided into seven Virtual Tributary Groups (VTG). Each VTG is then divided into four VT1.5's, each carrying a T1.</li> </ul>
<b>Step 7</b>	<b>SATOP CEM</b> <b>Example:</b> <pre>cem-group channel-number unframed</pre> <b>Example:</b> <pre>Router(config-ctrlr-sts1-3)# cem-group 0 unframed</pre> <b>Example:</b>   <b>CeSOP CEM</b> <b>Example:</b> <pre>vtg vtg_number t1 t1_line_number cem-group channel-number timeslots list-of-timeslots</pre> <b>Example:</b>	Configures the T1 on the VTG, where: <ul style="list-style-type: none"> <li>• <i>vtg_number</i>—Specifies the VTG number. For SONET framing, values are 1 to 7.</li> <li>• <i>t1_line_number</i>—Specifies the T1 line number. Valid range is 1 to 4.</li> <li>• <i>channel-number</i>—Specifies the channel number. Valid range is 0 to 2015.</li> <li>• <i>list-of-timeslots</i>—Specifies the list of timeslots. Valid range is from 1 to 24.</li> </ul>

	Command or Action	Purpose
	Router(config-ctrlr-sts1-3)# vtg 1 t1 1 cem-group 1 timeslots 1-10	
<b>Step 8</b>	<b>end</b>	Exits controller configuration mode and returns to privileged EXEC mode.

**What to do next****Example**

The example shows a CEM interface configuration:

```
Router# configure terminal
Router(config)# controller sonet 0/1/0
Router(config-controller)# framing sonet
Router(config-controller)# sts-1 1
Router(config-ctrlr-sts1)# vtg 1 t1 1 cem-group 1 timeslots 1-10
Router(config-ctrlr-sts1)# exit
```

## Configuring CEM Group in SDH Mode

To configure CEM group in SDH mode:

**Procedure**

	Command or Action	Purpose
<b>Step 1</b>	<b>enable</b>	Enables privileged EXEC mode. <ul style="list-style-type: none"> <li>• Enter your password if prompted.</li> </ul>
<b>Step 2</b>	<b>configure terminal</b>	Enters global configuration mode.
<b>Step 3</b>	<b>controller sonet <i>slot/bay/port</i></b> <b>Example:</b>  Router(config)# controller sonet 0/1/0	Selects the controller to configure and enters controller configuration mode, where: <ul style="list-style-type: none"> <li>• <i>slot/bay/port</i>—Specifies the location of the interface.</li> </ul> <b>Note</b> The slot number is always 1 and the bay number is always 0.
<b>Step 4</b>	<b>framing {sonet   sdh}</b> <b>Example:</b>  Router(config-controller)# framing sdh	Specifies SDH as the framing mode.
<b>Step 5</b>	<b>au-4 <i>au-4#</i> tug-3 <i>tug-3#</i></b> <b>Example:</b>  Router(config-controller)# au-4 1 tug-3 1	Configures AU-4, and tributary unit groups, type 3 (TUG-3) for AU-4 and enters specific configuration mode.  In SDH framing mode, each TUG-3, and AU-4 can be configured with one of these commands.

	Command or Action	Purpose
		<p>Depending on currently configured AUG mapping setting, this command further specifies TUG-3, or AU-4 muxing. The CLI command parser enters into config-ctrlr-tug3 (SDH mode) or config-ctrlr-au3 (SDH mode), which makes only relevant commands visible.</p> <ul style="list-style-type: none"> <li>• <b>au-4#</b>—Range is from 1 to 4. For OC-3 mode, the value is 1.</li> </ul> <p><b>Note</b> DS3 configuration is supported only on AuU-4.</p> <ul style="list-style-type: none"> <li>• <b>tug-3#</b>—Range is from 1 to 3.</li> </ul> <p><b>Note</b> T1 can only be configured in au-3 mode, E1 can only be configured in the au-4 mode.</p>
<b>Step 6</b>	<p><b>mode {t3   e3}</b></p> <p><b>Example:</b></p> <pre>Router(config-ctrlr-tug3)# mode e3</pre>	<p>Specifies the mode of operation.</p> <ul style="list-style-type: none"> <li>• <b>t3</b>—Specifies an unchannelized (clear channel) T3.</li> <li>• <b>e3</b>—Specifies a AU-3 or C3 that carries a unchannelized (DS3 clear channel) E3.</li> </ul> <p><b>Note</b> Only e3 mode is supported for SDH framing.</p>
<b>Step 7</b>	<p><b>cem-group group-number {unframed}</b></p> <p><b>Example:</b></p> <pre>Router(config-ctrlr-tug3)# cem-group 4 unframed</pre>	<p>Creates a CEM group.</p> <ul style="list-style-type: none"> <li>• <b>unframed</b>—Specifies that a single CEM channel is being created including all time slots and the framing structure of the line.</li> </ul>
<b>Step 8</b>	<p><b>end</b></p> <p><b>Example:</b></p> <pre>Router(config-ctrlr-tug3)# end</pre>	<p>Exits controller configuration mode and returns to privileged EXEC mode.</p>

### What to do next

#### Example

```
Router# configure terminal
Router(config)# controller sonet 0/1/0
Router(config-controller)# framing sdh
Router(config-controller)# au-4 1 tug-3 1
Router(config-ctrlr-tug3)# mode e3
Router(config-ctrlr-tug3)# cem-group 4 unframed
Router(config-ctrlr-tug3)# end
```

# Configuring DS3 Clear Channel on OC-3 and OC-12 Interface Module



**Note** DS3 clear channel is supported only on CEM.

## Configuring DS3 Clear Channel in SONET Mode

To configure DS3 clear channel in SONET mode:

### Procedure

	Command or Action	Purpose
<b>Step 1</b>	<b>enable</b> <b>Example:</b>	Enables privileged EXEC mode. <ul style="list-style-type: none"> <li>• Enter your password if prompted</li> </ul>
<b>Step 2</b>	<b>configure terminal</b>	Enters global configuration mode.
<b>Step 3</b>	<b>controller sonet <i>slot/bay/port</i></b> <b>Example:</b>   <b>Example:</b>  Router(config)# controller sonet 0/4/1	Selects the controller to configure and enters controller configuration mode, where: <ul style="list-style-type: none"> <li>• <i>slot/bay/port</i>—Specifies the location of the interface.</li> </ul> <p><b>Note</b> The slot number is always 1 and the bay number is always 0.</p>
<b>Step 4</b>	<b>framing {sonet   sdh}</b> <b>Example:</b>   <b>Example:</b>  Router(config)# framing sonet	Specifies SONET as the framing mode.
<b>Step 5</b>	<b>clock source {line   internal}</b> <b>Example:</b>  Router(config-if)# <b>clock source internal</b>	Specifies the clock source for the POS link, where: <ul style="list-style-type: none"> <li>• <b>line</b>—The link uses the recovered clock from the line. This is the default setting.</li> <li>• <b>internal</b>—The link uses the internal clock source.</li> </ul>
<b>Step 6</b>	<b>sts-1 {1 - 12   1 - 3   4 - 6   7 - 9   10 - 12}</b> <b>Example:</b>	Specifies the SONET Synchronous Transport Signal (STS) level and enters STS-1 configuration mode. The starting-number and



	Command or Action	Purpose
	<p><b>Example:</b></p> <pre>Router(config-controller)# sts-1 1</pre>	<p>ending-number arguments indicate the starting and ending STS value of the interface.</p> <p>For OC-3 interfaces, this value is 1.</p> <p>The 1-12 value is supported only in OC-12 mode.</p>
<b>Step 7</b>	<p><b>mode {t3   vt-15}</b></p> <p><b>Example:</b></p> <pre>Router(config-ctrlr-sts1)# mode t3</pre>	<p>Specifies the mode of operation of an STS-1 path, where:</p> <ul style="list-style-type: none"> <li>• <b>t3</b>—DS3 clear channel mode. STS-1 carries an unchannelized (clear channel) T3.</li> <li>• <b>vt-15</b>—A STS-1 is divided into seven Virtual Tributary Groups (VTG). Each VTG is then divided into four VT1.5's, each carrying a T1.</li> </ul>
<b>Step 8</b>	<p><b>cem-group channel-number {unframed}</b></p> <p><b>Example:</b></p> <pre>Router(config-ctrlr-sts1)# cem-group 4 unframed</pre>	<p>Creates a CEM group.</p> <ul style="list-style-type: none"> <li>• <b>unframed</b>—Specifies that a single CEM channel is being created including all time slots and the framing structure of the line.</li> </ul>
<b>Step 9</b>	<p><b>end</b></p>	<p>Exits controller configuration mode and returns to privileged EXEC mode.</p>

### What to do next

#### Example

The below example shows the configuration for a DS3 interface:

```
Router# configure terminal
Router(config)# controller sonet 0/1/0
Router(config-controller)# framing sonet
Router(config-controller)# clock source line
Router(config-controller)# sts-1 1 - 3
Router(config-ctrlr-sts1)# mode t3
Router(config-ctrlr-sts1)# cem-group 0 unframed
Router(config-controller)# end
```

#### Configuration Example

```
controller SONET 1/0/0
framing sonet
clock source internal
!
sts-1 1
mode t3
cem-group 0 unframed
```

```

!
sts-1 2
mode t3
cem-group 1 unframed
!
sts-1 3
mode t3
cem-group 2 unframed
interface CEM1/0/0
no ip address
cem 0
xconnect 2.2.2.2 501 encapsulation mpls
!
cem 1
xconnect 2.2.2.2 502 encapsulation mpls
!
cem 2
xconnect 2.2.2.2 503 encapsulation mpls
!

```

## Configuring DS3 Clear Channel in SDH Mode

To configure DS3 clear channel in SDH mode:

### Procedure

	Command or Action	Purpose
<b>Step 1</b>	<b>enable</b>	Enables privileged EXEC mode. <ul style="list-style-type: none"> <li>• Enter your password if prompted.</li> </ul>
<b>Step 2</b>	<b>configure terminal</b>	Enters global configuration mode.
<b>Step 3</b>	<b>controller sonet <i>slot/bay/port</i></b> <b>Example:</b>  Router(config)# controller sdh 0/1/0	Selects the controller to configure and enters controller configuration mode, where: <ul style="list-style-type: none"> <li>• <i>slot/bay/port</i>—Specifies the location of the interface.</li> </ul> <p><b>Note</b> The slot number is always 1 and the bay number is always 0.</p>
<b>Step 4</b>	<b>framing {sonet   sdh}</b> <b>Example:</b>  Router(config-controller)# framing sdh	Specifies SDH as the framing mode.
<b>Step 5</b>	<b>clock source {line   internal}</b> <b>Example:</b>  Router(config-controller)# <b>clock source line</b>	Specifies the clock source for the POS link, where: <ul style="list-style-type: none"> <li>• <b>line</b>—The link uses the recovered clock from the line. This is the default setting.</li> <li>• <b>internal</b>—The link uses the internal clock source.</li> </ul>
<b>Step 6</b>	<b>aug mapping au-4</b>	Configures AUG mapping for SDH framing.

	Command or Action	Purpose
	<b>Example:</b> <pre>Router(config-controller)# aug mapping au-4</pre>	If the AUG mapping is configured to be AU-4, then the following muxing, alignment, and mapping will be used: TUG-3 <--> VC-4 <--> AU-4 <--> AUG.
<b>Step 7</b>	<b>au-4 au-4# tug-3 tug-3#</b> <b>Example:</b> <pre>Router(config-controller)# au-4 1 tug-3 1</pre>	Configures AU-4, and tributary unit groups, type 3 (TUG-3) for AU-4 and enters specific configuration mode. In SDH framing mode TUG-3, and AU-4 can be configured with one of these commands. Depending on currently configured AUG mapping setting, this command further specifies TUG-3, or AU-4 muxing. The CLI command parser enters into config-ctrlr-tug3 (SDH mode) or config-ctrlr-au3 (SDH mode), which makes only relevant commands visible. <ul style="list-style-type: none"> <li>• <b>au-4#</b>—Range is from 1 to 4. For OC-3 mode, the value is 1.</li> <li>• <b>tug-3#</b>—Range is from 1 to 3.</li> </ul> <b>Note</b> E1 can only be configured in the AU-4 mode.
<b>Step 8</b>	<b>mode e3</b> <b>Example:</b> <pre>Router(config-ctrlr-au4)# mode e3</pre>	Specifies the mode of operation. <ul style="list-style-type: none"> <li>• <b>e3</b>—Specifies a C3 that carries a unchannelized (DS3 clear channel) E3.</li> </ul>
<b>Step 9</b>	<b>cem-group channel-number {unframed}</b> <b>Example:</b> <pre>Router(config-ctrlr-au4)# cem-group 4 unframed</pre>	Creates a CEM group. <ul style="list-style-type: none"> <li>• <b>unframed</b>—Specifies that a single CEM channel is being created including all time slots and the framing structure of the line.</li> </ul>
<b>Step 10</b>	<b>end</b>	Exits controller configuration mode and returns to privileged EXEC mode.

### What to do next

#### Example

```
Router# configure terminal
Router(config)# controller sonet 0/1/0
Router(config-controller)# framing sdh
Router(config-controller)# clock source line
Router(config-controller)# aug mapping au-4
Router(config-controller)# au-4 1 tug-3 1
Router(config-ctrlr-au4)# mode e3
```

```
Router(config-ctrlr-au4)# cem-group 4 unframed
Router(config-ctrlr-au4)# end
```

## Optional Configurations

There are several standard, but optional, configurations that might be necessary to complete the configuration of your interface module.

### Configuring the National Bit

When G.751 framing is used, bit 11 of the G.751 frame is reserved for national use and is set to 1 by default.



**Note** Configure national bit 1 only when required for interoperability with your telephone company.

To set the national bit in the G.751 frame, use the following commands:

Command	Purpose
Router# <b>configure terminal</b>	Enters global configuration mode.
Router(config)# <b>controller {t1   e1} slot/subslot/port</b>	Selects the controller to configure. <ul style="list-style-type: none"> <li>• t1—Specifies the T1 controller.</li> <li>• e1—Specifies the E1 controller.</li> <li>• slot/subslot/port—Specifies the location of the controller.</li> </ul>
Router(config-controller)# <i>national reserve {0   1} {0   1} {0   1} {0   1} {0   1} {0   1}</i>	Sets the national bit (the first bit): <ul style="list-style-type: none"> <li>• 0—Sets the international bit in the G.704 frame to 0. This is the default.</li> <li>• 1—Sets the international bit in the G.704 frame to 1.</li> </ul> <p><b>Note</b> When CRC4 framing is configured, the first bit is the national bit. When no-CRC4 framing is configured, the first bit becomes the international bit and should be set to 1 if crossing international borders and 0 if not crossing international borders.</p> <p>Sets the five national bits:</p> <ul style="list-style-type: none"> <li>• 0—Set to 0 when not crossing international borders.</li> <li>• 1—Set to 1 when crossing international borders.</li> </ul>

### Verifying the National Bit

Use the show controllers command to verify the national bits:

```

router# show controllers E1
E1 6/0/0 is up.
Applique type is Channelized E1 - balanced
No alarms detected.
alarm-trigger is not set
Framing is CRC4, Line Code is HDB3, Clock Source is Line.
International Bit: 1, National Bits: 11111
Data in current interval (234 seconds elapsed):
0 Line Code Violations, 0 Path Code Violations
0 Slip Secs, 0 Fr Loss Secs, 0 Line Err Secs, 0 Degraded Mins
0 Errored Secs, 0 Bursty Err Secs, 0 Severely Err Secs, 0 Unavail Secs
Total Data (last 5 15 minute intervals):
0 Line Code Violations, 0 Path Code Violations,
0 Slip Secs, 0 Fr Loss Secs, 0 Line Err Secs, 0 Degraded Mins,
0 Errored Secs, 0 Bursty Err Secs, 0 Severely Err Secs, 0 Unavail Secs

```

## Configuring the CRC Size for T1

CRC is an error-checking technique that uses a calculated numeric value to detect errors in transmitted data. The 1-Port Channelized OC-3/STM-1 SPA and 1-Port Channelized OC-12/STM-4 SPA uses a 16-bit cyclic redundancy check (CRC) by default, but also supports a 32-bit CRC. The designators 16 and 32 indicate the length (in bits) of the frame check sequence (FCS). A CRC of 32 bits provides more powerful error detection, but adds overhead. Both the sender and receiver must use the same setting.

To set the length of the cyclic redundancy check (CRC) on a T1 interface, use these commands:

### Procedure

	Command or Action	Purpose
<b>Step 1</b>	<b>interface serial</b> <i>slot/subslot/port:channel-group</i> <b>Example:</b> Router(config)# <b>interface serial</b> 0/0/1.1/1/1/1:0	Selects the interface to configure and enters interface configuration mode. <ul style="list-style-type: none"> <li>• <i>slot/subslot/port:channel-group</i> —Specifies the location of the interface.</li> </ul>
<b>Step 2</b>	<b>crc {16   32}</b> <b>Example:</b> Router(config-if)# <b>crc 16</b>	Selects the CRC size in bits, where: <ul style="list-style-type: none"> <li>• 16—16-bit CRC. This is the default.</li> <li>• 32—32-bit CRC.</li> </ul>

## Optional Packet over SONET Configurations

The following sections describe how to configure optional settings on a packet over SONET (POS) interface.

### Encapsulation

<b>encapsulation</b> <i>encapsulation-type</i> Router(config-if)# <b>encapsulation hdlc</b>	Configures encapsulation; you can configure the following options: <ul style="list-style-type: none"> <li>• HDLC</li> <li>• PPP</li> </ul>
--	--

## MTU Value

<b>mtu bytes</b>  Router(config-if)# <b>mtu 4000</b>	Configures the maximum packet size for an interface in bytes. The default packet size is 4470 bytes.
--	--

## CRC Value

<b>crc size-in-bits</b>  Router(config-if)# <b>crc 32</b>	CRC size in bits. Valid values are 16 and 32. The default is 16.
---	--

## Keepalive Value

<b>keepalive</b> [ <i>period</i> [ <i>retries</i> ]]  Router(config-if)# <b>keepalive 9 4</b>	Specifies the frequency at which the Cisco IOS software sends messages to the other end of the line to ensure that a network interface is alive, where: <ul style="list-style-type: none"> <li>• <i>period</i>—Specifies the time interval in seconds for sending keepalive packets. The default is 10 seconds.</li> <li>• <i>retries</i>—Specifies the number of times that the device continues to send keepalive packets without response before bringing the interface down. The default is 3 retries.</li> </ul>
--	---

## Bandwidth

Use the following command to configure the bandwidth of a POS interface.

<b>bandwidth</b> { <i>kbps</i>   <b>inherit</b> [ <i>kbps</i> ]}	To set and communicate the current bandwidth value for an interface to higher-level protocols, use the <b>bandwidth</b> command in interface configuration mode. Valid values are from 1 to 10000000. You can apply the following keywords: <ul style="list-style-type: none"> <li>• <b>inherit</b> —Specifies how a subinterface inherits the bandwidth of its main interface.</li> <li>• <b>receive</b>—Specifies the receive-side bandwidth.</li> </ul>
--	--

## Scrambling

Use the following command to enable scrambling on a POS interface.

<b>pos scramble-atm</b>	Enables scrambling on the interface.
-----------------------------	--------------------------------------

## C2 Flag

Use the following command to configure the C2 flag on a POS interface.

<b>pos flag c2</b> <i>value</i>	Specifies the C2 byte field for the interface as defined in RFC 2615. Valid values are 0-255.
------------------------------------	---

## J1 Flag

Use the following command to configure the J1 flag on a POS interface.

<b>pos flag j1 message</b> <i>word</i>	Specifies the value of the J1 byte in the SONET Path OverHead (POH) column.
---	---

You can use the following commands to verify your configuration:

- **show interfaces pos**

## Managing Interface Naming

The following sections describe how to manage interface naming on the Cisco ASR 900 Series Router optical interface module.

### Identifying Slots and Subslot

To specify the physical address for controller or interface configuration, use the interface and controller sonet commands, where:

- **slot**—Specifies the chassis slot number where the interface module is installed; the slot number is always 0 for interface modules on the Cisco ASR 900 Series Router.
- **subslot**—Specifies the subslot where the interface module is installed.
- **port**—Specifies the SONET port number.

For example, if the optical interface module is installed in slot 0 of the chassis, the controller configuration address is specified as **controller sonet 0/0/0**.

For channelized configuration, the interface address format is: slot/subslot/port:channel-group, where:

- **channel-group**—Specifies the logical channel group assigned to the time slots within the T1 link.

## Configuring Multilink Point-to-Point Protocol

Multilink Point-to-Point Protocol (MLPPP) allows you to combine interfaces which correspond to an entire T1 or E1 multilink bundle. You can choose the number of bundles and the number of T1 or E1 lines in each bundle in any combination of E1 and T1 member link interfaces.

This section describes how to configure MLPPP on the optical interface module and includes the following topics:

### MLPPP Configuration Guidelines

When configuring MLPPP, consider the following guidelines:

- Only T1 and E1 links are supported in a bundle.
- Enable PPP encapsulation before configuring multilink-related commands.
- Interfaces can be grouped into the MLPPP bundle if they belong to same interface module.
- A group can have a maximum of 16 interfaces.
- Maximum MTU for MLPP is 9216. For serial links that are not part of MLPPP configuration, maximum MTU varies for OC-3 and T1/E1 interfaces. The MTU range is as follows:
  - OC-3: 64 to 7673
  - T1/E1: 64 to 9216

## Creating a Multilink Bundle

To create a multilink bundle, use the following commands:

### Procedure

	Command or Action	Purpose
<b>Step 1</b>	<b>configure terminal</b>  <b>Example:</b>  Router# <b>configure terminal</b>	Enters global configuration mode.
<b>Step 2</b>	<b>interface multilink</b> <i>group-number</i>  <b>Example:</b>  Router(config)# <b>interface multilink</b> 1	Creates a multilink interface and enters multilink interface mode, where: <ul style="list-style-type: none"> <li>• <i>group-number</i>—The group number for the multilink bundle.</li> </ul>
<b>Step 3</b>	<b>ip address</b> <i>address mask</i>  <b>Example:</b>  Router(config-if)# <b>ip address</b> 192.168.1.1 255.255.255.0	Sets the IP address for the multilink group, where: <ul style="list-style-type: none"> <li>• <i>address</i>—The IP address.</li> <li>• <i>mask</i>—The subnet mask.</li> </ul>

## Assigning an Interface to a Multilink Bundle

To assign an interface to a multilink bundle, use the following commands:

### Procedure

	Command or Action	Purpose
<b>Step 1</b>	<b>configure terminal</b>  <b>Example:</b>	Enters global configuration mode.



	Command or Action	Purpose
	Router# <b>configure terminal</b>	
<b>Step 2</b>	<b>interface serial</b> <i>slot/subslot/port</i> <b>Example:</b> Router(config)# <b>interface serial</b> 0/0/1.1/1/1/1:0	Selects the interface to configure and enters interface configuration mode, where: <ul style="list-style-type: none"> <li>• <i>slot/subslot/port</i>—Specifies the location of the controller.</li> </ul>
<b>Step 3</b>	<b>encapsulation ppp</b> <b>Example:</b> Router(config-if)# <b>encapsulation ppp</b>	Enables PPP encapsulation.
<b>Step 4</b>	<b>ppp multilink group</b> <i>group-number</i> <b>Example:</b> Router(config-if)# <b>ppp multilink group</b> 1	Assigns the interface to a multilink bundle, where: <ul style="list-style-type: none"> <li>• <i>group-number</i>—The multilink group number for the T1 or E1 bundle.</li> </ul>
<b>Step 5</b>	<b>end</b>	

#### What to do next



**Note** Repeat these commands for each interface you want to assign to the multilink bundle

```

Router# configure terminal
Router(config)# controller SONET 0/0/0
Router(config-controller)# framing sdh
Router(config-controller)# aug mapping au-4
Router(config-controller)# au-4 1 tug-3 1
Router(config-controller)# tug-2 1 e1 1 channel-group 0 timeslots 1-31
Router# configure terminal
Router(config)# interface multilink 1
Router(config-if)# ip address 192.168.1.1 255.255.255.0
Router(config-if)# ppp multilink endpoint string1
Router(config)# interface serial
0/0/1.1/1/1/1:0
Router(config-if)# encapsulation ppp
Router(config-if)# ppp multilink group 1

```

## Configuring Fragmentation Size and Delay on an MLPPP Bundle

To configure the fragmentation size on a multilink PPP bundle, use the following commands:

**Procedure**

	<b>Command or Action</b>	<b>Purpose</b>
<b>Step 1</b>	<b>configure terminal</b> <b>Example:</b>  Router# <b>configure terminal</b>	Enters global configuration mode.
<b>Step 2</b>	<b>interface multilink</b> <i>group-number</i> <b>Example:</b>  Router(config)# <b>interface multilink</b> 1	Creates a multilink interface and enters multilink interface mode, where: <ul style="list-style-type: none"> <li>• <i>group-number</i> —The group number for the multilink bundle. Range 1-2147483647</li> </ul>
<b>Step 3</b>	<b>ppp multilink fragment size</b> <i>fragment-size</i> <b>Example:</b>  Router(config-if)# <b>ppp multilink</b> <b>fragment size</b> 512	Sets the fragmentation size in bytes. Fragmentation is disabled by default. Valid values are 42 to 65535 bytes.
<b>Step 4</b>	<b>ppp multilink fragment-delay</b> <i>delay</i> <b>Example:</b>  Router(config-if)# <b>ppp multilink</b> <b>fragment-delay</b> 20	Sets the configured delay on the multilink bundle that satisfies the fragmentation size, where: <ul style="list-style-type: none"> <li>• <i>delay</i> —Delay in milliseconds.</li> </ul>

**What to do next**

The following example of the **show ppp multilink** command shows the MLPPP type and the fragmentation size:

```
Router#
show ppp multilink
Multilink1, bundle name is test2Bundle up for 00:00:13Bundle is Distributed0 lost fragments,
0 reordered, 0 unassigned0 discarded, 0 lost received, 206/255 load0x0 received sequence,
0x0 sent sequence Member links: 2 active, 0 inactive (max not set, min not set)Se4/2/0/1:0,
since 00:00:13, no frags rcvdSe4/2/0/2:0, since 00:00:10, no frags rcvdDistributed
fragmentation on. Fragment size 512. Multilink in Hardware.
```

## Changing the Default Endpoint Discriminator

To override or change the default endpoint discriminator, use the following command in interface configuration mode:

Command	Purpose
<pre>Router(config-if)# <b>ppp multilink endpoint</b> {<b>hostname</b>   <b>ip</b> <i>IP-address</i>   <b>mac</b> <i>LAN-interface</i>   <b>none</b>   <b>phone</b> <i>telephone-number</i>   <b>string</b> <i>char-string</i> }</pre>	Overrides or changes the default endpoint discriminator the system uses when negotiating the use of MLP with the peer.

## Disabling Fragmentation on an MLPPP Bundle

By default, PPP multilink fragmentation is enabled. To disable fragmentation on a multilink bundle, use the following commands:

### Procedure

	Command or Action	Purpose
<b>Step 1</b>	<b>configure terminal</b> <b>Example:</b> <pre>Router# <b>configure terminal</b></pre>	Enters global configuration mode.
<b>Step 2</b>	<b>interface multilink</b> <i>group-number</i> <b>Example:</b> <pre>Router(config)# <b>interface multilink</b> 1</pre>	<i>Specifies the multilink interface and enters multilink interface mode, where:</i> <ul style="list-style-type: none"> <li><i>group-number</i>—The group number for the multilink bundle. Range 1-2147483647</li> </ul>
<b>Step 3</b>	<b>ppp multilink fragment disable</b> <b>Example:</b> <pre>Router(config-if)# <b>ppp multilink</b> <b>fragment disable</b></pre>	Disables PPP multilink fragmentation.

## Configuring BERT

BERT (Bit-Error Rate Testing) is used for analyzing quality and for problem resolution of digital transmission equipment. BERT tests the quality of an interface by directly comparing a pseudorandom or repetitive test pattern with an identical locally generated test pattern.

The BERT operation is data-intensive. Regular data cannot flow on the path while the test is in progress. The path is reported to be in alarm state when BERT is in progress and restored to a normal state after BERT has been terminated.

The supported BERT patterns are 2<sup>15</sup>, 2<sup>23</sup>, all 0s and all 1s.

# Configuring Automatic Protection Switching

For information on how to configure Automatic Protection Switching (APS) on the optical interface module, see the Time Division Multiplexing Configuration Guide.

## TU-AIS Alarms

Tributary Unit-Alarm Indication Signal (TU-AIS) alarms are higher order alarms compared to the AIS alarms. Prior to Cisco IOS-XE Everest 16.6.1, the PDH AIS alarms were generated when the TDM circuits went down. But, the SDH devices are unable to detect the PDH AIS alarms. This feature enables the SDH device to detect the PDH AIS alarm. Effective Cisco IOS-XE Everest 16.6.1, TU-AIS alarms are generated and detected when the TDM circuits go down on the access layer of the network topology or a failure occurs in MPLS domain due to which SAToP connectivity goes down. TU-AIS alarms are supported on the OC3 IM in Cisco ASR 903 RSP1 and RSP2 modules according to TU-12 section as defined in ITU-G. 707 (8.3.2). TU-AIS means that all TU-12 (i.e. all 144B) carries all "1" according to ITU-T G.707 (6.2.4.1.3).

The following are some expected behaviour after configuring TU-AIS alarms:

- CE tug shut first displays AIS alarm and then TU-AIS alarms.
- After TU-AIS alarm gets cleared the RDI alarm is displayed for 11-12 seconds and gets cleared.
- If there is a change in dejitter on the CEM circuit and TU-AIS is not configured, it displays AIS alarms for 200-300 milliseconds. If TU-AIS is configured, it displays AIS alarms for 20-30 milliseconds.
- On cable pull in PE2 LOS is displayed and after connecting back it displays RDI and then clears.

## Restrictions for TU-AIS Alarms

- TU-AIS is not supported on the CEMoUDP.
- The interface modules reset after you enable or disable the TU-AIS alarms under OC3 Controller.
- TU-AIS configuration takes effect on all 4 ports of A900-IMA4OS IM.
- TU\_AIS alarm verification can be done by only using ANT-20 analyzer. ASR903 cannot display this alarm.

## Configuring TU-AIS Alarms

Use the following commands to configure TU-AIS alarms:

```
enable
configure terminal
controller sonet 0/1/2
tu-ais
end
```

## Verification of TU-AIS Alarm Configuration

Use the **show run | se** command to verify the configuration of TU-AIS alarm:

```
PE#show run | se SONET 0/1/2
platform enable controller SONET 0/1/2
controller SONET 0/1/2
  no ais-shut
  TU-AIS
  framing sdh
  clock source internal
  aug mapping au-4
  !
  au-4 1 tug-3 1
    mode c-12
    tug-2 1 e1 1 cem-group 555 unframed
    tug-2 1 e1 1 framing unframed
  !
  au-4 1 tug-3 2
    mode c-12
  !
  au-4 1 tug-3 3
    mode c-12
site1-PE#
```

## Core Failure Event Detection

Effective Cisco IOS XE Everest 16.6.1, TU-AIS configuration can be used to detect core defects. This feature is applicable only on Cisco ASR 900 RSP2 Module. The core failure is detected in the following events:

- Shut on PE controller/tug level
- Unconfiguration of Xconnect
- Removal of GigE configuration, CEM configuration, controller configuration, or OSPF configuration
- Shut on OSPF, CEM group, Xconnect, or GigE interface

## Verifying Interface Configuration

Besides using the **show running-configuration** command to display your Cisco ASR 900 Series Router configuration settings, you can use the **show interface serial** and the **show controllers sonet** commands to get detailed information on a per-port basis.

## Verifying Per-Port Interface Status

To find detailed interface information on a per-port basis on an optical interface module, use the **show interface serial** and **show controllers sonet** commands.

For examples of the show commands here, see the *Cisco IOS Interface and Hardware Component Command Reference* .

# Troubleshooting

You can use the following commands to verify your configuration:

- **show cem circuit**—shows information about the circuit state, administrative state, the CEM ID of the circuit, and the interface on which it is configured. If **xconnect** is configured under the circuit, the command output also includes information about the attached circuit.
- **show cem circuit 0-504**—Displays the detailed information about that particular circuit.
- **show cem circuit summary**—Displays the number of circuits which are up or down per interface basis.
- **show controller sonet x/y/z**—**Displays the alarm information.**
- **show hw-module subslot transceiver**—Displays information about the optical transceiver.
- **show mpls l2transport vc**—Displays the state of local and peer access circuits.
- **show running configuration**—Shows detail on each CEM group.
- **show xconnect all**—Displays the state of the pseudowire and local and peer access circuits.
- **show interfaces pos**—**Displays all the current interface processors and their interfaces.**

The **show controllers** command output reports the following alarms:

- SLOS
- SLOF
- B1-TCA
- B2-TCA

When SLOS is reported, all the other alarms are masked.

```
Router(config-controller)# show controller sonet 0/5/2
SONET 0/5/2 is down.
  Hardware is A900-IMA40S

Applique type is Channelized Sonet/SDH
Clock Source is Line, AUG mapping is AU4.
.
.
.
Multiplex Section:
  AIS = 6          RDI = 0          REI = 0          BIP(B2) = 0
Active Defects: None
Detected Alarms: SLOS SLOF LAIS B1-TCA B2-TCA .....<shows all alarms reported>
Asserted/Active Alarms: SLOS B1-TCA B2-TCA.....<shows hierarchy>
Alarm reporting enabled for: SLOS SLOF SF B1-TCA B2-TCA
BER thresholds:  SF = 10e-3  SD = 10e-6
TCA thresholds:  B1 = 10e-6  B2 = 10e-6
```

To provide information about system processes, the Cisco IOS software includes an extensive list of EXEC commands that begin with the word `show`, which, when executed, display detailed tables of system information. Following is a list of some of the common `show` commands for the APS feature.

To display the information described, use these commands in privileged EXEC mode.

Command or Action	Purpose
Router# <b>show aps</b>	Displays information about the automatic protection switching feature.
Router# <b>show controller sonet</b> <i>slot/</i> <i>port-adapter/ port</i>	Displays information about the hardware.
Router# <b>show interfaces</b>	Displays information about the interface.

For examples of the `show` commands here, see the *Cisco IOS Interface and Hardware Component Command Reference*.

## Framing and Encapsulation Configuration Example

The following example sets the framing and encapsulation for the controller and interface:

```

! Specify the controller and enter controller configuration mode
!
Router(config)# controller sonet 6/0/0
!
! Specify the framing method
!
Router(config-controller)# framing esf
!
! Exit controller configuration mode and return to global configuration mode
!
Router(config-controller)# exit
!
! Specify the interface and enter interface configuration mode
!
Router(config)# interface serial 6/0/0:0
!
! Specify the encapsulation protocol
!
Router(config-if)# encapsulation ppp
!
! Exit interface configuratin mode
!
Router(config-if)# exit
!
! Exit global configuration mode
!
Router(config)# exit
Router#

```

## National Bit Configuration Example

The following example sets the Natijonal Bits for the controller:

```

! Specify the controller and enter controller configuration mode
!
Router(config)# controller t1 6/0/0
!
! Set the national bits
!
Router(config-controller)#
national reserve 0 1 1 1 1
!
! Exit controller configuration mode and return to global configuration mode
!
Router(config-controller)# exit
!
! Exit global configuration mode
!
Router(config)# exit
Router#

```

## CRC Configuration Example

The following example sets the CRC size for the interface:

```

! Specify the interface and enter interface configuration mode
!
Router(config)# interface serial 6/0/0:0
!
! Specify the CRC size
!
Router(config-if)# crc 32
!
! Exit interface configuration mode and return to global configuration mode
!
Router(config-if)# exit
!
! Exit global configuration mode
!
Router(config)# exit
Router#

```

## Facility Data Link Configuration Example

The following example configures Facility Data Link:

```

! Specify the controller and enter controller configuration mode
!
Router(config)# controller sonet 6/0/0
!
! Specify the FDL specification
!
Router(config-controller)#
fdl ansi
!
! Exit controller configuration mode and return to global configuration mode
!
Router(config-controller)# exit
!
! Exit global configuration mode
!

```



```
Router(config)# exit
Router#
```

## MLPPP Configuration Example

The following example creates a PPP Multilink bundle:

```
! Enter global configuration mode
!
Router# configure terminal
!
! Create a multilink bundle and assign a group number to the bundle
!
Router(config)# interface multilink 1
!
! Specify an IP address for the multilink group
!
Router(config-if)# ip address 123.456.789.111 255.255.255.0
!
! Enable Multilink PPP
!
Router(config-if)# ppp multilink
!
! Leave interface multilink configuration mode
!
Router(config-if)# exit
!
! Specify the interface to assign to the multilink bundle
!
Router(config)# interface serial 3/1//0:1
!
! Enable PPP encapsulation on the interface
!
Router(config-if)# encapsulation PPP
!
! Assign the interface to a multilink bundle
!
Router(config-if)# multilink-group 1
!
! Enable Multilink PPP
!
Router(config-if)# ppp multilink
!
! Exit interface configuration mode
!
Router(config-if)# exit
!
! Exit global configuration mode
!
Router(config)# exit
Router#
```

## MFR Configuration Example

The following example configures Multilink Frame Relay (MFR):

```
! Create a MFR interface and enter interface configuration mode
!
Router(config)# interface mfr 49
```

```

!
! Assign the bundle identification (BID) name 'test' to a multilink bundle.
!
Router(config-if)# frame-relay multilink bid test
!
! Exit interface configuration mode and return to global configuration mode
!
Router(config-if)# exit
!
! Specify the serial interface to assign to a multilink bundle
!
Router(config)# interface serial 5/1/3:0
!
! Creates a multilink Frame Relay bundle link and associates the link with a multilink
bundle
!
Router(config-if)#
encapsulation frame-relay mfr 49
!
! Assigns a bundle link identification (LID) name with a multilink bundle link
!
Router(config-if)#
frame-relay multilink lid test
!
! Configures the interval at which the interface will send out hello messages
!
Router(config-if)# frame-relay multilink hello 15
!
! Configures the number of seconds the interface will wait for a hello message acknowledgement
before resending the hello message
!
Router(config-if)# frame-relay multilink ack 6
!
! Configures the maximum number of times the interface will resend a hello message while
waiting for an acknowledgement
!
Router(config-if)# frame-relay multilink retry 5
!
! Exit interface configuration mode and return to global configuration mode
!
Router(config-if)# exit
!
! Exit global configuration mode
!
Router(config)# exit

```

## Configuration Examples

This section includes the following configuration examples:

### Example of Cyclic Redundancy Check Configuration

The following example configures CRC on a T1 interface:

```

! Specify the interface to configure and enter interface configuration mode.
!
Router(config)# interface serial 2/0/0.1
!

```

```
! Specify the CRC type.  
!  
Router(config-if)# crc 32
```

## Example of Facility Data Link Configuration

The following example configures FDL on a T1 interface:

```
! Specify the interface to configure and enter interface configuration mode.  
!  
Router(config)# interface serial 1/0/0.2  
!  
! Specify the T1 number and select fdl.  
!  
Router(config-controller)#t1 2 fdl ansi
```

## Example of Invert Data on T1/E1 Interface

The following example inverts the data on the serial interface:

```
! Specify the interface to configure and enter interface configuration mode.  
!  
Router(config)# interface serial 3/0/0.1/2/1:0  
!  
! Configure invert data.  
!  
Router(config-if)# invert data
```

## Additional Resources

For more information about configuring ATM, see

- [Asynchronous Transfer Mode Configuration Guide, Cisco IOS XE Release 3S\(ASR 900 Series\)](#)

For additional information on configuring optical interfaces, see

- [Cisco IOS Asynchronous Transfer Mode Command Reference](#)
- [Interface and Hardware Component Configuration Guide, Cisco IOS XE Release 3S](#)
- [Wide-Area Networking Configuration Guide Library, Cisco IOS XE Release 3S](#)





## CHAPTER 9

# Configuring Serial Interfaces

---

This chapter configures the serial interface module (PN: A900-IMASER14A/S) Async/Sync R232 serial data using Transparent Pseudowire (PW) over MPLS network and raw socket. It includes the following sections:

For information about managing your system images and configuration files, refer to the [Cisco IOS Configuration Fundamentals Configuration Guide](#) and [Cisco IOS Configuration Fundamentals Command Reference](#) publications.

For more information about the commands used in this chapter, refer to the [Cisco IOS Command Reference](#) publication for your Cisco IOS software release.

- [Information About Serial Interface Module, on page 123](#)
- [Restrictions, on page 124](#)
- [How to Configure Serial Interface, on page 126](#)
- [Verifying the Serial Interface Configuration, on page 134](#)
- [Configuration Examples, on page 136](#)

## Information About Serial Interface Module

The serial interface module supports pseudowire transport over MPLS and raw socket for Async and Sync traffic. The Serial IM interfaces monitor and detect cable connections, cable types and also monitors modem control signals periodically.

Figure 1: Pseudowire Transport for Serial Interface

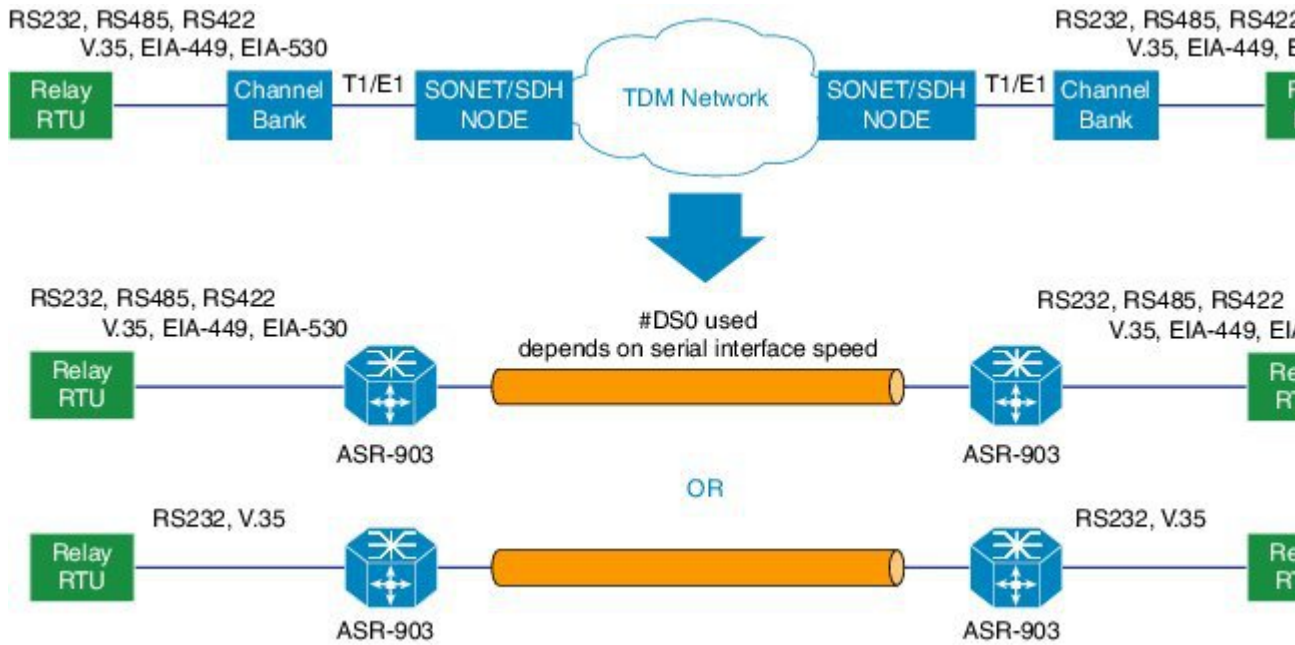

The A900-IMASER14A/S interface provides a direct connection between the Cisco ASR 903 router and external networks.



**Note** We recommend that you use a smart serial or 4-port octopus cable to connect the A900-IMASER14A/S with the external network.

Out of 14 ports, 6 ports support sync interfaces and 8 ports support async interfaces. RS232 Async data is carried over Raw Socket and Transparent byte mode and RS232 Sync data is carried over Raw Socket.

## Restrictions



**Note** Serial interfaces are *not* supported on the ASR 900 RSP3 Module.

This section describes the port restrictions for Serial interface module:

- Ports 0-7 are Async ports on the 68-pin connector
- Ports 8-13 are Sync or Async on the 12-in-1 connector



**Note** Sync is *not* supported in Cisco IOS XE Release 3.14S. Sync ports cannot be configured in Cisco IOS XE Release 3.14S.

- Maximum speed on all ports is 236Kbps.

This section describes the software limitations that apply when configuring the Serial interface module:

- The router can only be configured as data circuit-terminating equipment (DCE).
- Configuration of pseudowire between local and remote PE with different speed on Sync and Async ports is not supported.
- Sub-rate (below DS0 bandwidth) Async (R232) data over MPLS MPLS using T1/E1 CESoP is not supported.
- Pseudowire ping is *not* supported for the pseudowire configured on the serial interface module.
- Only two serial interface modules can come up on the router in release prior to Cisco IOS XE Release 3.14. Starting with Cisco IOS XE Release 3.14, all 6 bays on the router are available for insertion of interface modules simultaneously.
- Only Trans encapsulation is supported in Cisco IOS XE Release 3.14S.
- If you installed a new A900-IMASER14A/S or if you want to change the configuration of an existing interface, you must enter configuration mode to configure the new interfaces. If you replaced an A900-IMASER14A/S that was previously configured, the system recognizes the new interfaces and brings each of them up in their existing configuration.
- Pseudowire ping is *not* supported for cross-connect configured on A900-IMA14A/S interface module.
- A maximum speed of 64 kbps between PE and DTE is supported for RS232 Sync ports.
- PE can act only as DCE and provides the clock to DTE.
- Serial IM Sync signaling transport does not interoperate with the third party equipments. HLDC frames used for transport of these signals are Cisco-specific.
- CTS signal goes down, when control signal frequency is configured more than 5000 ms and timeout setting is more than 20,000 ms (4x control\_frequency), which is greater than the OIR time (~20s) for a selected subordinate to complete an OIR cycle. This results in the primary being unaware that the subordinate is down and CTS of all subordinates are down too. To avoid this situation, ensure that the timeout is shorter than the OIR time of the subordinate. Set the control frequency to less than or equal to 5000 ms and the timeout setting to less than or equal to 20,000 ms before you perform OIR.
- If the mode is changed from P2P to P2MP with one primary serving three subordinates (all three subordinates on the same card on another chassis, different from the primary) or an online insertion and removal (OIR) of the card is performed with P2MP configuration, CTS signal for all the subordinates will go down despite that all are still driving their RTS up. This will get corrected when the subordinates toggle their RTS.
- RS422 and RS485 can be configured only on ports 0-7 of the serial interface.

# How to Configure Serial Interface

## Required Configuration Tasks

### Configuring the Controller

To create the interfaces for the Serial interface module, complete these steps:

#### Procedure

	Command or Action	Purpose
<b>Step 1</b>	<b>configure terminal</b>  <b>Example:</b>  Router# <b>configure terminal</b>	Enters global configuration mode.
<b>Step 2</b>	<b>controller serial</b> <i>slot/subslot/port</i>  <b>Example:</b>  Router(config)# <b>controller serial</b> <i>0/4/1</i>	Selects the controller to configure and enters controller configuration mode.  <ul style="list-style-type: none"> <li><i>slot/subslot/port</i>—Specifies the location of the interface.</li> </ul> <b>Note</b> The slot number is always 0.
<b>Step 3</b>	<b>physical-layer async   sync</b>  <b>Example:</b>  Router(config-controller)# <b>physical-layer</b> <i>async</i>	Configures the serial interface in async or sync mode.  <ul style="list-style-type: none"> <li><b>async</b>—Specifies async interface.</li> <li><b>sync</b>—Specifies sync interface. This is the default mode.</li> </ul>
<b>Step 4</b>	<b>exit</b>  <b>Example:</b>  Router(config)# <b>exit</b>	Exits configuration mode and returns to the EXEC command interpreter prompt.

#### Example: Controller Configuration

```
Router# configure terminal
Router(config)# controller
0/4/1
Router(config-controller)# physical-layer async
Router(config)# exit
```



## Optional Configurations

### Configuring Layer 1 on Sync and Async Interface Server

The RS232 which is enabled by default on the async interface, supports RS232 DCE cable with the DB-25 connector. The Cisco smart serial cable with the DB-25 connector supports RS232, RS485, and RS422. The RJ45 cable type supports only RS485.

#### Procedure

---

**Step 1**     **configure terminal**

**Example:**

```
Router# configure terminal
```

Enters global configuration mode.

**Step 2**     **line slot/bay/port**

**Example:**

```
Router(config)#line 0/4/1
```

Select the controller to configure and enters serial interface configuration mode.

- *slot/subslot/port*—Specifies the location of the interface.

**Step 3**     **media-type {rs422 | rs485 }**

**Example:**

```
Router(config-line)# media-type rs422
```

Sets the media type to either RS422 or RS485.

**Step 4**     **databits {5 | 6 | 7 | 8}**

**Example:**

```
Router(config-line)# databits 8
```

Sets the databit configuration. The default is 8.

**Step 5**     **stopbits {1 | 1.5 | 2}**

**Example:**

```
Router(config-line)# stopbits 2
```

Sets the stopbit configuration. The default is 2.

**Step 6**     **speed speed-value**

**Example:**

```
Router(config-line)# speed 9600
```

Specifies the serial interface speed. The valid range is form 300 to 230400. The default is 9600.

**Step 7** **raw-socket tcp server** *port server ip address*

**Example:**

```
Router(config-line)# raw-socket tcp server 5000 1.1.1.1
```

Specifies raw-tcp server configuration.

**Step 8** **raw-socket packet length** *packet length*

**Example:**

```
Router(config-line)# raw-socket packet-length 32
```

Specifies raw-tcp packet length configuration options.

**Step 9** **parity** {**even** | **mark** | **none** | **odd** | **space**}

**Example:**

```
Router(config-line)# parity none
```

Sets the parity.

**Step 10** **sig-transport u-frame pattern** *pattern*

**Example:**

```
Router(config-line)#sig-transport u-frame pattern NR0
```

This step is specific to Sync mode only. Specifies the u-frame format used for internal signal transport.

**Step 11** **control-sig-transport** [**on** | **off**] **frequency** *frequency range*

**Example:**

```
Router(config-line)#control-sig-transport on frequency <50-65535>
```

Specifies if hardware control signals need to be sent to remote PE or not. Also specifies the frequency (period between successive control frames) in milliseconds. By default, control signal is OFF. Frequency needs to be configured only if the control signal is ON.

**Step 12** **connection-topology** [**point-to-point** | **point-to-multipoint**]

**Example:**

```
Router(config-line)#connection-topology point-to-multipoint
```

This step is specific to Sync mode only. Specifies the type of topology.

**Step 13** **dtr** [**used** | **not-used**]

**Example:**

```
Router(config-line)# dtr not-used
```

(Optional) DTR is programmable when DTR pin in FPGA is not connected. By default, DTR is set as used.

**Step 14** **connection-timeout** *timeout*

**Example:**

```
Router(config-line)# connection-timeout <800-65535>
```

(Optional) Specifies the connection timeout of the primary and subordinate session. It should be configured 4 times higher than the frequency.

**Step 15** **exit****Example:**

```
Router(config)# exit
```

Exits configuration mode and returns to the EXEC command interpreter prompt.

---

**Example: Async Layer 1 Parameters**

```
Router# configure terminal  
Router(config)# line 0/4/1  
Router(config-line)# databits 8  
Router(config-line)# stopbits 2  
Router(config-line)# speed 9600  
Router(config-line)# parity none  
Router(config-line)# exit
```

## Configuring Layer 1 on Sync and Async Interface Client

**Procedure**

---

**Step 1** **configure terminal****Example:**

```
Router# configure terminal
```

Enters global configuration mode.

**Step 2** **line slot/bay/port****Example:**

```
Router(config)# line 0/4/1
```

Select the controller to configure and enters serial interface configuration mode.

- *slot/subslot/port*—Specifies the location of the interface.

**Step 3** **databits {5 | 6 | 7 | 8}****Example:**

```
Router(config-line)# databits 8
```

**Example:**

Sets the databit configuration. The default is 8.

**Step 4** `stopbits {1 | 1.5 | 2}`**Example:**

```
Router(config-line)# stopbits 2
```

Sets the stopbit configuration. The default is 2.

**Step 5** `speed speed-value`**Example:**

```
Router(config-line)# speed 9600
```

Specifies the serial interface speed. The valid range is form 300 to 230400. The default is 9600.

**Step 6** `raw-socket tcp client server ip address server port client ip address client port`**Example:**

```
Router(config-line)# raw-socket tcp client 1.1.1.1 5000 10.10.10.10 9000
```

Specifies raw-tcp client configuration.

**Step 7** `raw-socket packet length packet length`**Example:**

```
Router(config-line)# raw-socket packet-length 32
```

Specifies raw-tcp packet length configuration options.

**Step 8** `parity {even | mark | none | odd | space}`**Example:**

```
Router(config-line)# parity none
```

Sets the parity.

**Step 9** `exit`**Example:**

```
Router(config)# exit
```

Exits configuration mode and returns to the EXEC command interpreter prompt.

## Configuring a Channel Group

### Procedure

	Command or Action	Purpose
<b>Step 1</b>	<b>configure terminal</b>  <b>Example:</b>  Router# <b>configure terminal</b>	Enters global configuration mode.

	Command or Action	Purpose
<b>Step 2</b>	<b>controller serial</b> <i>slot/bay/port</i> <b>Example:</b> Router(config)# <b>controller serial</b> <b>0/4/1</b>	Configures the controller.  <i>slot/subslot/port</i> —Specifies the location of the interface.
<b>Step 3</b>	<b>channel-group</b> <i>channel-group</i> <b>Example:</b> Router(config-controller)# <b>channel-group 0</b>	Configures the channel group with specified NxDS0 time slots.
<b>Step 4</b>	<b>exit</b> <b>Example:</b> Router(config-controller)# <b>exit</b>	Exits configuration mode and returns to the EXEC command interpreter prompt.

### Example: Channel Group

```
Router# configure terminal
Router(config)# controller serial 0/4/1
Router(config-controller)# channel-group 0
Router(config-controller)# exit
```

## Configuring Encapsulation

When traffic crosses a WAN link, the connection needs a Layer 2 protocol to encapsulate traffic.



**Note** L2TPv3 encapsulation is *not* supported on the Cisco ASR 900 Series router. Trans encapsulation is only supported in Cisco IOS XE Release 3.14S.

### Procedure

	Command or Action	Purpose
<b>Step 1</b>	<b>configure terminal</b> <b>Example:</b> Router# <b>configure terminal</b>	Enters global configuration mode.
<b>Step 2</b>	<b>interface serial</b> <i>slot/bay/port</i> <b>Example:</b> Router(config)# <b>interface serial</b> <b>0/4/1</b>	Selects the interface to configure from global configuration mode. <ul style="list-style-type: none"> <li>• <i>slot/subslot/port</i>—Specifies the location of the interface.</li> </ul>

## Example: Encapsulation

	Command or Action	Purpose
<b>Step 3</b>	<b>encapsulation {ppp raw-tcp   trans   sdmc}</b> <b>Example:</b> <pre>Router(config-if)# encapsulation raw-tcp</pre>	Set the encapsulation method on the interface. <ul style="list-style-type: none"> <li>• <b>ppp</b>—Described in RFC 1661, PPP encapsulates network layer protocol information over point-to-point links.</li> <li>• <b>trans</b>—Transparent encapsulation.</li> </ul> <p><b>Note</b> Trans encapsulation is supported on the access side for serial interfaces which has cross connect configured.</p> <ul style="list-style-type: none"> <li>• <b>sdmc</b>—Switched Multimegabit Data Services (SDMC) for serial interface.</li> </ul>
<b>Step 4</b>	<b>exit</b> <b>Example:</b> <pre>Router(config)# exit</pre>	Exits configuration mode and returns to the EXEC command interpreter prompt.

## Example: Encapsulation

```
Router# configure terminal
Router(config)# interface serial 0/
4/1
Router(config-if)# encapsulation trans
Router(config-if)# exit
```

## Configuring Transparent Pseudowire (PW) Cross-Connect

Transparent PW mode provides a facility to configure the speed between 300 bps to 230400 bps.

## Procedure

	Command or Action	Purpose
<b>Step 1</b>	<b>configure terminal</b> <b>Example:</b> <pre>Router# configure terminal</pre>	Enters global configuration mode.
<b>Step 2</b>	<b>interface serial <i>slot/bay/port</i></b> <b>Example:</b> <pre>Router(config)# interface serial 0/4/1</pre>	Selects the interface to configure from global configuration mode. <ul style="list-style-type: none"> <li>• <i>slot/subslot/port</i>—Specifies the location of the interface.</li> </ul>
<b>Step 3</b>	<b>xconnect <i>peer-router-id vcid</i> encapsulation mpls</b> <b>Example:</b>	Configures the VC to transport packets.

	Command or Action	Purpose
	Router(config-if)# <b>xconnect 1.1.1.1 1001 encapsulation mpls</b>	
<b>Step 4</b>	<b>exit</b> <b>Example:</b> Router(config)# <b>exit</b>	Exits configuration mode and returns to the EXEC command interpreter prompt.

### Example: Transparent Pseudowire on Cross Connect

```
Router# configure terminal
Router(config)# interface serial 0/
4/1
Router(config-if)# xconnect 1.1.1.1 1001 encapsulation mpls
Router(config)# exit
```

## Configuring Invert Clock Signal

### Procedure

	Command or Action	Purpose
<b>Step 1</b>	<b>configure terminal</b> <b>Example:</b> Router# <b>configure terminal</b>	Enters global configuration mode.
<b>Step 2</b>	<b>controller serial slot/bay/port</b> <b>Example:</b> Router(config)# <b>controller serial 0/4/1</b>	Configures the controller. <i>slot/subslot/port</i> —Specifies the location of the interface.
<b>Step 3</b>	<b>invert data</b> <b>Example:</b> Router(config-controller)# <b>invert data</b>	Configures the invert data clock signal.
<b>Step 4</b>	<b>exit</b> <b>Example:</b> Router(config)# <b>exit</b>	Exits configuration mode and returns to the EXEC command interpreter prompt.

### Example: Invert Data on the Serial Interface

The following example shows invert data configuration on the serial interface.

```
Router# configure terminal
Router(config)# controller serial 0/4/1
Router(config-controller)# invert data
Router(config-controller)# exit
```

## Configuring NRZI Formats

### Procedure

	Command or Action	Purpose
<b>Step 1</b>	<b>configure terminal</b> <b>Example:</b>  Router# <b>configure terminal</b>	Enters global configuration mode.
<b>Step 2</b>	<b>interface serial slot/bay/port</b> <b>Example:</b>  Router(config)# interface serial 0/4/1	Select the controller to configure and enters serial interface configuration mode. <ul style="list-style-type: none"> <li>• <i>slot/subslot/port</i>—Specifies the location of the interface.</li> </ul>
<b>Step 3</b>	<b>nrzi-encoding</b> <b>Example:</b>  Router(config-if)# nrzi-encoding	Enable NRZI encoding.  To disable NRZI encoding, use the no form of the command.

## Saving the Configuration

To save your running configuration to nonvolatile random-access memory (NVRAM), use the following command in privileged EXEC configuration mode:

Command	Purpose
<b>copy running-config startup-config</b>	Writes the new configuration to NVRAM.

For information about managing your system images and configuration files, refer to the [Cisco IOS Configuration Fundamentals Configuration Guide](#) and [Cisco IOS Configuration Fundamentals Command Reference](#) publications.

## Verifying the Serial Interface Configuration

Use the following commands to verify the configuration the serial interface

- **show controllers serial slot/bay/port**

Use the **show controllers serial slot/bay/port** command to **display** serial interface configuration on the router.

```
Router# show controllers serial 0/1/0
Serial0/1/0 - (A900-IMASER14A/S) is up
Encapsulation : RAW-TCP
Cable type: RS-232 DCE
```



```

mtu 1500, max_buffer_size 1524, max_pak_size 1524 enc 84
loopback: Off, crc: 16, invert_data: Off
nrzi: Off, idle char: Flag
dce_terminal_timing_enable: Off ignore_dtr: Off
serial_clockrate: 64000bps, serial_clock_index: 14 serial_restartdelay:30000,
serial_restartdelay_def:30000

```

```

DCD=up DSR=up DTR=up RTS=up CTS=up

```

- **show interfaces serial slot/bay/port**

Use the **show interfaces serial slot/bay/port** command to **display** serial interface packet status information, model control signal status information on the router.

```

Router# show interfaces serial 0/1/0
Serial0/1/0 is up, line protocol is up
  Hardware is A900-IMASER14A/S
  MTU 1500 bytes, BW 64 Kbit/sec, DLY 20000 usec,
    reliability 255/255, txload 47/255, rxload 103/255
  Encapsulation RAW-TCP, loopback not set
  Keepalive not supported
  Last input never, output 00:00:00, output hang never
  Last clearing of "show interface" counters 00:38:06
  Input queue: 0/375/0/0 (size/max/drops/flushes); Total output drops: 0
  Queueing strategy: fifo
  Output queue: 0/40 (size/max)
  5 minute input rate 26000 bits/sec, 69 packets/sec
  5 minute output rate 12000 bits/sec, 69 packets/sec
    157782 packets input, 7562229 bytes, 0 no buffer
    Received 0 broadcasts (0 IP multicasts)
    0 runts, 0 giants, 0 throttles
    0 input errors, 0 CRC, 0 frame, 0 overrun, 0 ignored, 0 abort
    156862 packets output, 3460471 bytes, 0 underruns
    0 output errors, 0 collisions, 0 interface resets
    0 unknown protocol drops
    0 output buffer failures, 0 output buffers swapped out
    0 carrier transitions
  DCD=up DSR=up DTR=up RTS=up CTS=up

```

- **show running-config interface serial slot/bay/port**

Use the **show running-config interface serial slot/bay/port** command to **display** serial interface IP address information, keep alive and cross-connect status information on the router.

```

Router# show running-config interface serial 0/1/0
Building configuration...
Current configuration : 107 bytes
!
interface Serial0/1/0
  no ip address
  encapsulation trans
  xconnect 1.1.1.1 1001 encapsulation mpls
End

```

- **show xconnect all**

Use the **show xconnect all** command to **display** all cross connect status on the router.

```

Router# show xconnect all
Legend:   XC ST=Xconnect State  S1=Segment1 State  S2=Segment2 State
          UP=Up                DN=Down            AD=Admin Down      IA=Inactive
          SB=Standby           HS=Hot Standby    RV=Recovering      NH=No Hardware

```

```

XC ST Segment 1                               S1 Segment 2                               S2
-----+-----+-----+-----+-----+-----+-----+-----+-----+-----+-----+-----+
UP pri ac Se0/1/0(HDLC)                        UP mpls 1.1.1.1:1001                        UP

```

Use the **show raw-socket tcp sessions** and **show raw-socket tcp statistic** commands to display the raw socket status.

```

Router#show raw-socket tcp sessions
----- TCP Sessions -----
Interface tty          vrf_name          socket mode      local_ip_addr  local_port
dest_ip_addr dest_port  up_time      idle_time/timeout
0/3/12 154          -----
listening  ----      -----
0/3/12 154          1 server      20.20.20.20    5000
10.10.10.10  9000      00:20:49     00:00:00/5 min

```

```

Router#show raw-socket tcp statistic
----- TCP-Serial Statistics -----
Interface tty          vrf_name          sessions      tcp_in_bytes
tcp_out_bytes tcp_to_tty_frames  tty_to_tcp_frames
0/3/12 154          1              1847204
4640310              87709          87671

```

## Configuration Examples

This section includes the following configuration examples:

### Example: Encapsulation Configuration

The following example sets encapsulation for the controller and interface:

#### PE1 CONFIG

```

controller SERIAL 0/1/0
 physical-layer async
 channel-group 0
interface Serial0/1/0
 no ip address
 encapsulation trans
 xconnect 2.2.2.2 1001 encapsulation mpls

```

#### PE2 CONFIG

```

controller SERIAL 0/2/0
 physical-layer async
 channel-group 0
interface Serial0/2/0
 no ip address
 encapsulation trans
 xconnect 1.1.1.1 1001 encapsulation mpls

```



# CHAPTER 10

## Enabling Support for Tunable DWDM-XFP-C

The dense wavelength-division multiplexing (DWDM) wavelengths of the DWDM-XFP-C module on the Cisco ASR 900 Series router is tunable. You can configure the DWDM ITU wavelengths using the **itu channel** command in the interface configuration mode. The **itu channel** command ensures that the traffic continues to flow.

[Table 11: DWDM-XFP-C Wavelength Mapping, on page 137](#) contains the wavelength mapping information for the DWDM-XFP-C module.

**Table 11: DWDM-XFP-C Wavelength Mapping**

Channel no	wavelength [nm]	Frequency [THz]
1	1561.79	191.95
2	1561.46	192
3	1560.98	192.05
4	1560.65	192.1
5	1560.17	192.15
6	1559.83	192.2
7	1559.35	192.25
8	1559.02	192.3
9	1558.54	192.35
10	1558.21	192.4
11	1557.73	192.45
12	1557.4	192.5
13	1556.92	192.55
14	1556.59	192.6

Channel no	wavelength [nm]	Frequency [THz]
15	1556.11	192.65
16	1555.79	192.7
17	1555.31	192.75
18	1554.98	192.8
19	1554.4	192.85
20	1554.17	192.9
21	1553.7	192.95
22	1553.37	193
23	1552.89	193.05
24	1552.57	193.1
25	1552.09	193.15
26	1551.76	193.2
27	1551.28	193.25
28	1550.96	193.3
29	1550.48	193.35
30	1550.16	193.4
31	1549.68	193.45
32	1549.35	193.5
33	1548.88	193.55
34	1548.55	193.6
35	1548.08	193.65
36	1548.75	193.7
37	1546.95	193.75
38	1546.95	193.8
39	1546.48	193.85
40	1546.16	193.9
41	1545.69	193.95

Channel no	wavelength [nm]	Frequency [THz]
42	1545.36	194
43	1544.89	194.05
44	1544.56	194.1
45	1544.09	194.15
46	1543.77	194.2
47	1543.3	194.25
48	1542.97	194.3
49	1542.5	194.35
50	1542.18	194.4
51	1541.71	194.45
52	1541.39	194.5
53	1540.92	194.55
54	1540.6	194.6
55	1540.13	194.65
56	1539.8	194.7
57	1539.34	194.75
58	1539.01	194.8
59	1538.55	194.85
60	1538.22	194.9
61	1537.76	194.95
62	1537.43	195
63	1536.97	195.05
64	1536.65	195.1
65	1536.18	195.15
66	1535.86	195.2
67	1535.396	195.25
68	1535.07	195.3

Channel no	wavelength [nm]	Frequency [THz]
69	1534.61	195.35
70	1534.29	195.4
71	1533.82	195.45
72	1533.5	195.5
73	1533.04	195.55
74	1532.72	195.6
75	1532.26	195.65
76	1531.94	195.7
77	1531.48	195.75
78	1531.14	195.8
79	1530.69	195.85
80	1530.37	195.9
81	1529.91	195.95
82	1529.59	196

- [Configuring the DWDM-XFP-C Module, on page 140](#)

## Configuring the DWDM-XFP-C Module

Perform the following procedure to configure the DWDM-XFP-C module.

### Procedure

	Command or Action	Purpose
<b>Step 1</b>	<b>enable</b> <b>Example:</b> Router# enable	Enables the privileged EXEC mode. If prompted, enter your password.
<b>Step 2</b>	<b>configure terminal</b> <b>Example:</b> Router# configure terminal	Enters the global configuration mode.

	Command or Action	Purpose
<b>Step 3</b>	interface tengigabitethernet <i>slot/port</i>  <b>Example:</b> <pre>Router(config)# interface tengigabitethernet 0/3</pre>	Specifies the 10-Gigabit Ethernet interface to be configured. <ul style="list-style-type: none"> <li>• <i>slot/port</i>—Specifies the location of the interface.</li> </ul>
<b>Step 4</b>	<b>itu channel number</b>  <b>Example:</b> <pre>Router(config-if)# itu channel 28</pre>	Sets the ITU channel. <ul style="list-style-type: none"> <li>• <i>number</i>—Specifies the ITU channel number. The acceptable values are from 1–82.</li> </ul>

## Verifying the ITU Configuration

The following example shows how to use the **show hw-module subslot** command to check an ITU configuration:

```
Router# show hw-module subslot 0/2 transceiver 0 idprom dump
Description = XFP optics (type 6)
Transceiver Type: = TUNABLE DWDM XFP (194)
Product Identifier (PID) = DWDM-XFP-C
Frequency Set for Tunable DWDM = 195.5 THz
Vendor Revision = 00
Serial Number (SN) = JFX1617800W
Vendor Name = CISCO-JDSU
Vendor OUI (IEEE company ID) = 00.01.9C (412)
CLEI code = IP9IAGGCAB
Cisco part number = 10-2544-02
Device State = Disabled.
XFP IDPROM Page 0x0:
000: 0C 00 49 00 F8 00 46 00 FB 00
010: 00 00 00 00 00 00 00 00 A6 04
020: 09 C4 8C A0 13 88 9B 83 13 93
030: 62 1F 1F 07 0F 8D 00 0A 09 CF
040: 00 10 00 18 FF E8 00 0C FF F4
050: 00 00 00 00 00 00 00 00 00 00
060: 00 BF 25 1C 00 C4 00 00 01 F4
070: 00 00 00 00 00 00 00 00 00 00
080: 00 00 00 00 9E 20 00 00 00 00
090: 00 00 00 00 00 00 1E 7C 00 00
100: 00 00 00 01 00 00 00 00 00 00
110: E2 98 00 14 00 00 00 00 00 00 <<See byte 113, the hexa decimal
equivalent for ITU channel 20>>
120: 00 00 00 00 00 00 00 00 01
XFP IDPROM Page 0x1:
128: 0C 98 07 00 00 00 00 00 00 00
138: 08 B4 63 71 50 00 00 00 00 9F
148: 43 49 53 43 4F 2D 4A 44 53
```







## CHAPTER 11

# Dying Gasp Support for Loss of Power Supply via SNMP, Syslog and Ethernet OAM

Dying Gasp—One of the following unrecoverable condition has occurred:

- Interface error-disable
- Reload
- Power failure or removal of power supply cable

This type of condition is vendor specific. An Ethernet Operations, Administration, and Maintenance (OAM) notification about the condition may be sent immediately.

- [Prerequisites for Dying Gasp Support, on page 143](#)
- [Restrictions for Dying Gasp Support, on page 143](#)
- [Configuration Examples for Dying Gasp Support, on page 144](#)
- [Dying Gasp Trap Support for Different SNMP Server Host/Port Configurations, on page 144](#)
- [Message Displayed on the Peer Router on Receiving Dying Gasp Notification, on page 146](#)
- [Displaying SNMP Configuration for Receiving Dying Gasp Notification, on page 146](#)
- [Dying GASP via SNMP Trap Support on Cisco RSP3 Module, on page 146](#)

## Prerequisites for Dying Gasp Support

Dying Gasp via ethernet OAM is not supported on Cisco RSP3 module.

You must enable Ethernet OAM on interface that requires Dying Gasp notification via Ethernet OAM. For more information, see *Enabling Ethernet OAM on an interface*.

You must enable SNMP global configurations to get notification via SNMP trap. For more information, see *Configuration Examples for Dying Gasp support via SNMP*.

## Restrictions for Dying Gasp Support

- The Dying Gasp feature is not supported if you remove the power supply unit (PSU) from the system.
- SNMP trap is sent only on power failure that results in the device to shut down.
- The Dying Gasp support feature cannot be configured using CLI. To configure hosts using SNMP, refer to the SNMP host configuration examples below.

- Dying Gasp via SNMP Trap is *not* supported on Management Port Gig0/Management-interface vrf on Cisco RSP3 module and Cisco ASR 920 routers.

## Configuration Examples for Dying Gasp Support

### Configuring SNMP Community Strings on a Router

Setting up the community access string to permit access to the SNMP:

```
Router> enable
Router# configure terminal
Router(config)# snmp-server community public RW
Router(config)# exit
```

For more information on command syntax and examples, refer to the Cisco IOS Network Management Command Reference.

### Configuring SNMP-Server Host Details on the Router Console

Specifying the recipient of a SNMP notification operation:

```
Router> enable
Router# configure terminal
Router(config)# snmp-server host X.X.X.XXX vrf mgmt-intf version 2c public udp-port 9800
Router(config)# exit
```

For more information on command syntax and examples, refer to the Cisco IOS Network Management Command Reference.

## Dying Gasp Trap Support for Different SNMP Server Host/Port Configurations



---

**Note** You can configure up to five different SNMP server host/port configurations.

---

### Environmental Settings on the Network Management Server

```
setenv SR_TRAP_TEST_PORT=UDP port
setenv SR_UTIL_COMMUNITY=public
setenv SR_UTIL_SNMP_VERSION=v2c
setenv SR_MGR_CONF_DIR=Path to the executable snmpinfo.DAT file
```

The following example shows SNMP trap configuration on three hosts:

Configuration example for the first host:

```

Router# configure terminal
Enter configuration commands, one per line. End with CNTL/Z.
Router(config)#
Router(config)# snmp-server host 7.0.0.149 vrf Mgmt-intf version 2c public udp-port 6264
Configuration example for the second host:
Router(config)#
Router(config)# snmp-server host 7.0.0.152 vrf Mgmt-intf version 2c public udp-port 9988
Configuration example for the third host:
Router(config)# snmp-server host 7.0.0.166 vrf Mgmt-intf version 2c public udp-port 9800
Router(config)#
Router(config)# ^Z
Router#

```

After performing a power cycle, the following output is displayed on the router console:



**Note** This is not supported on Cisco RSP1 and Cisco RSP2 modules.

```

Router#
System Bootstrap, Version 15.3(2r)S, RELEASE SOFTWARE (fc1)
Technical Support: http://www.cisco.com/techsupport
Copyright (c) 2012 by cisco Systems, Inc.
Compiled Wed 17-Oct-12 15:00
Current image running: Boot ROM1
Last reset cause: PowerOn
UEA platform with 2097152 Kbytes of main memory
rommon 1 >
=====
Dying Gasp Trap Received for the Power failure event:
-----

    Trap on Host1
    ++++++
    snmp-server host = 7.0.0.149 (nms1-lnx) and SR_TRAP_TEST_PORT=6264
    /auto/sw/packages/snmp/15.4.1.9/bin> /auto/sw/packages/snmp/15.4.1.9/bin/traprcv
    Waiting for traps.
    Received SNMPv2c Trap:
    Community: public
    From: 7.29.25.101
    snmpTrapOID.0 = ciscoMgmt.305.1.3.5.0.2
    ciscoMgmt.305.1.3.6 = Dying Gasp - Shutdown due to power loss
    -----

    Trap on Host2
    ++++++
    snmp-server host = 7.0.0.152 (nms2-lnx) and SR_TRAP_TEST_PORT=9988
    /auto/sw/packages/snmp/15.4.1.9/bin> /auto/sw/packages/snmp/15.4.1.9/bin/traprcv
    Waiting for traps.
    Received SNMPv2c Trap:
    Community: public
    From: 7.29.25.101
    snmpTrapOID.0 = ciscoMgmt.305.1.3.5.0.2
    ciscoMgmt.305.1.3.6 = Dying Gasp - Shutdown due to power loss
    -----

    Trap on Host3
    ++++++
    snmp-server host = 7.0.0.166 (erbusnmp-dc-lnx) and SR_TRAP_TEST_PORT=9800
    /auto/sw/packages/snmp/15.4.1.9/bin> /auto/sw/packages/snmp/15.4.1.9/bin/traprcv
    Waiting for traps.
    Received SNMPv2c Trap:
    Community: public
    From: 7.29.25.101

```

```
snmpTrapOID.0 = ciscoMgmt.305.1.3.5.0.2
ciscoMgmt.305.1.3.6 = Dying Gasp - Shutdown due to power loss
```

## Message Displayed on the Peer Router on Receiving Dying Gasp Notification

```
001689: *May 30 14:16:47.746 IST: %ETHERNET_OAM-6-RFI: The client on interface Gi4/2 has
received a remote failure indication from its remote peer(failure reason = remote client
power failure action = )
```

## Displaying SNMP Configuration for Receiving Dying Gasp Notification

Use the show running-config command to display the SNMP configuration for receiving dying gasp notification:

```
Router# show running-config | i snmp
snmp-server community public RW
snmp-server host 7.0.0.149 vrf Mgmt-intf version 2c public udp-port 6264
snmp-server host 7.0.0.152 vrf Mgmt-intf version 2c public udp-port 9988
snmp-server host 7.0.0.166 vrf Mgmt-intf version 2c public udp-port 9800
Router#
```

## Dying GASP via SNMP Trap Support on Cisco RSP3 Module

Dying GASP via SNMP trap feature is supported on Cisco RSP3 module. The supported modules are A900-RSP3C-200-S, A900-RSP3C-400-S, and RSP3-690t for ASR 907 routers.

For Cisco RSP3 module, CPU holdup time is 6.5 ms for Cisco ASR 900 Series routers. Hence, no packets can be processed in this time by CPU. To avoid this, this feature pre-constructs and installs the event packet in FPGA. When FPGA receives the power failure notification, it transfers the pre-constructed packet and thus the packet is forwarded to the required egress interface.

The feature helps to quickly notify a network administrator whenever a node undergoes power shutdown. The node undergoing power shutdown sends a SNMP DG trap message to the configured SNMP server.

The feature is supported on global MPLS and L3VPN. It uses UDP port 49151 as source port and 162 as destination port.

## Restrictions for Dying GASP via SNMP Trap Support on Cisco RSP3 Module

- The feature is enabled by default in Cisco RSP3C Port Expansion Mode when the channelized IMs (A900-IMA8(S/T) or A900-IMA8(S/T)1Z) are inserted in the device with the following conditions:
  - For ASR 903 routers, the above-mentioned IMs can be present in any slot.
  - For ASR 907 routers, the above-mentioned IMs need to be present on odd-numbered slots (1, 3, 5, 7, and so on)

If the above-mentioned IMs are not inserted in the above-mentioned slots, you can still connect by enabling the following command in the global configurations:

**platform dying-gasp-port-enable**



---

**Note** The above command only supported in Cisco RSP3C Port Expansion Mode.

---

But, some IMs in some slot can no longer be online. The enabled command checks if these slots are free of those IMs, if they are not, it rejects the implementation and error message is displayed. The same scenario is experienced when the command is enabled and incompatible IM is inserted. For information on incompatible IMs, refer the [IM Compatibility Tool](#).

- Only SNMP Dying Gasp traps are received in an event of power failure.

The SNMP Dying Gasp traps are *only* received for the first five configured SNMP hosts. Only five SNMP server hosts are notified about SNMP trap.

- Generation of SNMP trap for host via management VRF for a Dying GASP event is not supported in Cisco RSP3 Module.
- Reachability to the host must be present and Address Resolution Protocol (ARP) must be resolved before the event.
- Dying GASP support for loss of power supply via syslog and Ethernet OAM is not supported.

## Enabling Dying GASP Support on Cisco RSP3 Module

To enable Dying GASP feature for Cisco RSP3 module in Cisco RSP3C Port Expansion Mode:

```
enable
configure terminal
platform dying-gasp-port-enable
end
```

To enable the feature in Cisco RSP3C XFI-Pass Through Mode:

```
enable
configure terminal
license feature service-offload enable
Reload the device. If present, IM A-900-IMA8S goes out of service. If not, deactivate the IM.
license feature service-offload bandwidth 10gbps npu-[0 | 1]
Reload the device.
end
```

## Verifying SNMP Host Configuration

Use **show snmp host** command to verify all SNMP hosts configured.

```
#show snmp host
Notification host: 20.20.20.21  udp-port: 162  type: trap
user: public  security model: v2c

Notification host: 30.30.30.31  udp-port: 162  type: trap
user: public  security model: v2c
```

```
Notification host: 5000::2      udp-port: 162   VRFName: vrfl   type: trap
user: public      security model: v3 noauth

Notification host: 6000::2      udp-port: 162   VRFName: vrfl   type: trap
user: public      security model: v3 noauth

Notification host: 8000::2      udp-port: 162   type: trap
user: public      security model: v2c
```

## Verifying SNMP Configurations

Use **show running | i snmp** command to verify all SNMP hosts configured.

```
#show running | i snmp
snmp-server group public v3 noauth
snmp-server community public RO
snmp-server community private RW
snmp-server trap-source Loopback0
snmp-server host 20.20.20.21 version 2c public
snmp-server host 30.30.30.31 version 2c public
snmp-server host 5000::2 vrf vrfl version 3 noauth public
snmp-server host 6000::2 vrf vrfl version 3 noauth public
snmp-server host 8000::2 version 2c public
```



## CHAPTER 12

# Configuring Pseudowire

This chapter provides information about configuring pseudowire (PW) features on the router.

- [Pseudowire Overview](#), on page 149
- [Limitations](#), on page 154
- [Configuring CEM](#), on page 155
- [Configuring CAS](#), on page 160
- [Configuring ATM](#), on page 163
- [Configuring Structure-Agnostic TDM over Packet \(SAToP\)](#), on page 167
- [Configuring Circuit Emulation Service over Packet-Switched Network \(CESoPSN\)](#), on page 168
- [Configuring a Clear-Channel ATM Pseudowire](#), on page 169
- [Configuring an ATM over MPLS Pseudowire](#), on page 170
- [Configuring an Ethernet over MPLS Pseudowire](#), on page 180
- [Configuring Pseudowire Redundancy](#), on page 182
- [Pseudowire Redundancy with Uni-directional Active-Active](#), on page 184
- [Restrictions](#), on page 185
- [Configuring Pseudowire Redundancy Active-Active— Protocol Based](#), on page 185
- [Configuring the Working Controller for MR-APS with Pseudowire Redundancy Active-Active](#), on page 186
- [Configuring the Protect Controller for MR-APS with Pseudowire Redundancy Active-Active](#), on page 186
- [Verifying the Interface Configuration](#), on page 186
- [Configuration Examples](#), on page 187

## Pseudowire Overview

The following sections provide an overview of pseudowire support on the router.

Effective Cisco IOS XE Release 3.18S:

- BGP PIC with TDM Pseudowire is supported on the ASR 900 router with RSP2 module.
- BGP PIC for Pseudowires, with MPLS Traffic Engineering is supported on the ASR 900 router with RSP1 and RSP2 modules.

Starting Cisco IOS XE Release 3.18.1SP, Pseudowire Uni-directional Active-Active is supported on the RSP1 and RSP3 modules.

## Circuit Emulation Overview

Circuit Emulation (CEM) is a technology that provides a protocol-independent transport over IP networks. It enables proprietary or legacy applications to be carried transparently to the destination, similar to a leased line.

The Cisco ASR 903 Series Router supports two pseudowire types that utilize CEM transport: Structure-Agnostic TDM over Packet (SAToP) and Circuit Emulation Service over Packet-Switched Network (CESoPSN). The following sections provide an overview of these pseudowire types.

Starting with Cisco IOS XE Release 3.15, the 32xT1E1 and 8x T1/E1 interface modules support CEM CESoP and SATOP configurations with fractional timeslots.

With the 32xT1/E1 and 8xT1/E1 interface modules, the channelized CEM circuits configured under a single port (fractional timeslot) cannot be deleted or modified, unless the circuits created after the first CEM circuits are deleted or modified.

The following CEM circuits are supported on the 32xT1/E1 interface module:

### T1 mode

- 192 CESOP circuits with fractional timeslot
- 32 CESOP circuit full timeslot
- 32 SATOP circuits.

### E1 mode

- 256 CESOP circuit with fractional timeslot.
- 32 CESOP circuit full timeslot
- 32 SATOP circuit

## Structure-Agnostic TDM over Packet

SAToP encapsulates time division multiplexing (TDM) bit-streams (T1, E1, T3, E3) as PWs over public switched networks. It disregards any structure that may be imposed on streams, in particular the structure imposed by the standard TDM framing.

The protocol used for emulation of these services does not depend on the method in which attachment circuits are delivered to the provider edge (PE) devices. For example, a T1 attachment circuit is treated the same way for all delivery methods, including copper, multiplex in a T3 circuit, a virtual tributary of a SONET/SDH circuit, or unstructured Circuit Emulation Service (CES).

In SAToP mode the interface is considered as a continuous framed bit stream. The packetization of the stream is done according to IETF RFC 4553. All signaling is carried out transparently as a part of a bit stream. [Figure 2: Unstructured SAToP Mode Frame Format, on page 151](#) shows the frame format in Unstructured SAToP mode.

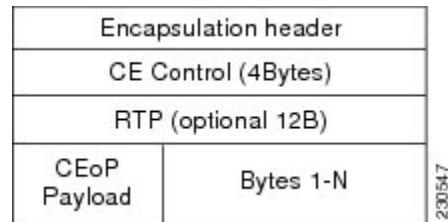

**Figure 2: Unstructured SAToP Mode Frame Format**

[#unique\\_254 unique\\_254\\_Connect\\_42\\_tab\\_1729930](#) shows the payload and jitter limits for the T1 lines in the SAToP frame format.

**Table 12: SAToP T1 Frame: Payload and Jitter Limits**

Maximum Payload	Maximum Jitter	Minimum Jitter	Minimum Payload	Maximum Jitter	Minimum Jitter
960	320	10	192	64	2

[#unique\\_254 unique\\_254\\_Connect\\_42\\_tab\\_1729963](#) shows the payload and jitter limits for the E1 lines in the SAToP frame format.

**Table 13: SAToP E1 Frame: Payload and Jitter Limits**

Maximum Payload	Maximum Jitter	Minimum Jitter	Minimum Payload	Maximum Jitter	Minimum Jitter
1280	320	10	256	64	2

For instructions on how to configure SAToP, see [Configuring Structure-Agnostic TDM over Packet \(SAToP\)](#), on page 167.

## Circuit Emulation Service over Packet-Switched Network

CESoPSN encapsulates structured TDM signals as PWs over public switched networks (PSNs). It complements similar work for structure-agnostic emulation of TDM bit streams, such as SAToP. Emulation of circuits saves PSN bandwidth and supports DS0-level grooming and distributed cross-connect applications. It also enhances resilience of CE devices due to the effects of loss of packets in the PSN.

CESoPSN identifies framing and sends only the payload, which can either be channelized T1s within DS3 or DS0s within T1. DS0s can be bundled to the same packet. The CESoPSN mode is based on IETF RFC 5086.

Each supported interface can be configured individually to any supported mode. The supported services comply with IETF and ITU drafts and standards.

[Figure 3: Structured CESoPSN Mode Frame Format, on page 152](#) shows the frame format in CESoPSN mode.

Figure 3: Structured CESoPSN Mode Frame Format

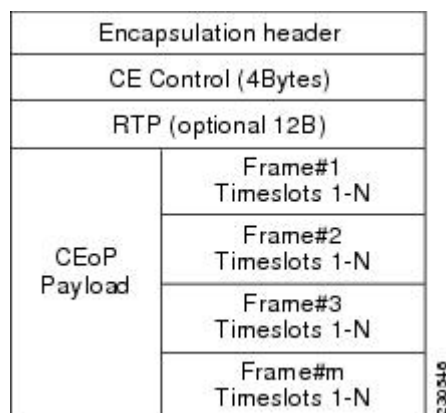

Table 14: CESoPSN DS0 Lines: Payload and Jitter Limits, on page 152 shows the payload and jitter for the DS0 lines in the CESoPSN mode.

Table 14: CESoPSN DS0 Lines: Payload and Jitter Limits

DS0	Maximum Payload	Maximum Jitter	Minimum Jitter	Minimum Payload	Maximum Jitter	Minimum Jitter
1	40	320	10	32	256	8
2	80	320	10	32	128	4
3	120	320	10	33	128	4
4	160	320	10	32	64	2
5	200	320	10	40	64	2
6	240	320	10	48	64	2
7	280	320	10	56	64	2
8	320	320	10	64	64	2
9	360	320	10	72	64	2
10	400	320	10	80	64	2
11	440	320	10	88	64	2
12	480	320	10	96	64	2
13	520	320	10	104	64	2
14	560	320	10	112	64	2
15	600	320	10	120	64	2
16	640	320	10	128	64	2

DS0	Maximum Payload	Maximum Jitter	Minimum Jitter	Minimum Payload	Maximum Jitter	Minimum Jitter
17	680	320	10	136	64	2
18	720	320	10	144	64	2
19	760	320	10	152	64	2
20	800	320	10	160	64	2
21	840	320	10	168	64	2
22	880	320	10	176	64	2
23	920	320	10	184	64	2
24	960	320	10	192	64	2
25	1000	320	10	200	64	2
26	1040	320	10	208	64	2
27	1080	320	10	216	64	2
28	1120	320	10	224	64	2
29	1160	320	10	232	64	2
30	1200	320	10	240	64	2
31	1240	320	10	248	64	2
32	1280	320	10	256	64	2

For instructions on how to configure SAToP, see [Configuring Structure-Agnostic TDM over Packet \(SAToP\)](#), on page 167.

## Asynchronous Transfer Mode over MPLS

An ATM over MPLS (AToM) PW is used to carry Asynchronous Transfer Mode (ATM) cells over an MPLS network. It is an evolutionary technology that allows you to migrate packet networks from legacy networks, while providing transport for legacy applications. AToM is particularly useful for transporting 3G voice traffic over MPLS networks.

You can configure AToM in the following modes:

- N-to-1 Cell—Maps one or more ATM virtual channel connections (VCCs) or virtual permanent connection (VPCs) to a single pseudowire.
- 1-to-1 Cell—Maps a single ATM VCC or VPC to a single pseudowire.
- Port—Maps a single physical port to a single pseudowire connection.

The Cisco ASR 903 Series Router also supports cell packing and PVC mapping for AToM pseudowires.



**Note** This release does not support AToM N-to-1 Cell Mode or 1-to-1 Cell Mode.

For more information about how to configure AToM, see [Configuring an ATM over MPLS Pseudowire](#), on page 170.

## Transportation of Service Using Ethernet over MPLS

Ethernet over MPLS (EoMPLS) PWs provide a tunneling mechanism for Ethernet traffic through an MPLS-enabled Layer 3 core network. EoMPLS PWs encapsulate Ethernet protocol data units (PDUs) inside MPLS packets and use label switching to forward them across an MPLS network. EoMPLS PWs are an evolutionary technology that allows you to migrate packet networks from legacy networks while providing transport for legacy applications. EoMPLS PWs also simplify provisioning, since the provider edge equipment only requires Layer 2 connectivity to the connected customer edge (CE) equipment. The Cisco ASR 903 Series Router implementation of EoMPLS PWs is compliant with the RFC 4447 and 4448 standards.

The Cisco ASR 903 Series Router supports VLAN rewriting on EoMPLS PWs. If the two networks use different VLAN IDs, the router rewrites PW packets using the appropriate VLAN number for the local network.

For instructions on how to create an EoMPLS PW, see [Configuring an Ethernet over MPLS Pseudowire](#), on page 180.

## Limitations

If you are running Cisco IOS XE Release 3.17S, the following limitation applies:

- BGP PIC with TDM Pseudowire is supported only on the ASR 900 router with RSP1 module.

If you are running Cisco IOS XE Release 3.17S and later releases, the following limitations apply:

- Channel associated signaling (CAS) is not supported on the T1/E1 and OC-3 interface modules on the router.
- BGP PIC is not supported for MPLS/LDP over MLPPP and POS in the core.
- BGP PIC is not supported for Multi-segment Pseudowire or Pseudowire switching.
- BGP PIC is not supported for VPLS and H-VPLS.
- BGP PIC is not supported for IPv6.
- If BGP PIC is enabled, Multi-hop BFD should not be configured using the **bfd neighbor fall-over** **bfd** command.
- If BGP PIC is enabled, **neighbor ip-address weight weight** command should not be configured.
- If BGP PIC is enabled, **bgp nexthop trigger delay 6** under the **address-family ipv4** command and **bgp nexthop trigger delay 7** under the **address-family vpnv4** command should be configured. For information on the configuration examples for BGP PIC–TDM, see [Example: BGP PIC with TDM-PW Configuration](#), on page 189.
- If BGP PIC is enabled and the targeted LDP for VPWS cross-connect services are established over BGP, perform the following tasks:

- configure Pseudowire-class (pw-class) with encapsulation "mpls"
- configure **no status control-plane route-watch** under the pw-class
- associate the pw-class with the VPWS cross-connect configurations

If you are running Cisco IOS-XE 3.18S, the following restrictions apply for BGP PIC with MPLS TE for TDM Pseudowire:

- MPLS TE over MLPPP and POS in the core is not supported.
- Co-existence of BGP PIC with MPLS Traffic Engineering Fast Reroute (MPLS TE FRR) is not supported.

The following restrictions are applicable only if the BFD echo mode is enabled on the Ethernet interface carrying CEM or TDM traffic:

- When the TDM interface module is present in anyone of the slot—0, 1, or 2, then the corresponding Ethernet interface module carrying the CEM traffic should also be present in one of these slots.
- When the TDM interface module is present in anyone of the slot—3, 4, or 5, then the corresponding Ethernet interface module carrying the CEM traffic should also be present in one of these slots.

## Configuring CEM

This section provides information about how to configure CEM. CEM provides a bridge between a time-division multiplexing (TDM) network and a packet network, such as Multiprotocol Label Switching (MPLS). The router encapsulates the TDM data in the MPLS packets and sends the data over a CEM pseudowire to the remote provider edge (PE) router. Thus, function as a physical communication link across the packet network.

The following sections describe how to configure CEM:



**Note** Steps for configuring CEM features are also included in the [Configuring Structure-Agnostic TDM over Packet \(SAToP\)](#), on page 167 and [Configuring Circuit Emulation Service over Packet-Switched Network \(CESoPSN\)](#), on page 168 sections.

## Configuration Guidelines and Restrictions

Not all combinations of payload size and dejitter buffer size are supported. If you apply an incompatible payload size or dejitter buffer size configuration, the router rejects it and reverts to the previous configuration.

## Configuring a CEM Group

The following section describes how to configure a CEM group on the Cisco ASR 903 Series Router.

### Procedure

**Step 1** enable

**Example:**

```
Router> enable
```

Enables privileged EXEC mode.

- Enter your password if prompted.

**Step 2**     **configure terminal****Example:**

```
Router# configure terminal
```

Enters global configuration mode.

**Step 3**     **controller {t1 | e1} slot/subslot/port****Example:**

```
Router(config)# controller t1 1/0
```

Enters controller configuration mode.

- Use the slot and port arguments to specify the slot number and port number to be configured.

**Note**     The slot number is always 0.

**Step 4**     **cem-group group-number {unframed | timeslots timeslot}****Example:**

```
Router(config-controller)# cem-group 6 timeslots 1-4,9,10
```

Creates a circuit emulation channel from one or more time slots of a T1 or E1 line.

- The **group-number** keyword identifies the channel number to be used for this channel. For T1 ports, the range is 0 to 23. For E1 ports, the range is 0 to 30.
- Use the **unframed** keyword to specify that a single CEM channel is being created including all time slots and the framing structure of the line.
- Use the **timeslots** keyword and the *timeslot* argument to specify the time slots to be included in the CEM channel. The list of time slots may include commas and hyphens with no spaces between the numbers.

**Step 5**     **end****Example:**

```
Router(config-controller)# end
```

Exits controller configuration mode and returns to privileged EXEC mode.

---

## Using CEM Classes

A CEM class allows you to create a single configuration template for multiple CEM pseudowires. Follow these steps to configure a CEM class:



---

**Note** The CEM parameters at the local and remote ends of a CEM circuit must match; otherwise, the pseudowire between the local and remote PE routers will not come up.

---



---

**Note** You cannot apply a CEM class to other pseudowire types such as ATM over MPLS.

---

### Procedure

---

#### Step 1

**enable**

**Example:**

```
Router> enable
```

Enables privileged EXEC mode.

- Enter your password if prompted.

#### Step 2

**configure terminal**

**Example:**

```
Router# configure terminal
```

Enters global configuration mode.

#### Step 3

**class cem** *cem-class*

**Example:**

```
Router(config)# class cem mycemclass
```

Creates a new CEM class

#### Step 4

**payload-size** *size* / **de jitter-buffer** *buffer-size* / **idle-pattern** *pattern*

**Example:**

```
Router(config-cem-class)# payload-size 512
```

**Example:**

```
Router(config-cem-class)# de jitter-buffer 10
```

**Example:**

```
Router(config-cem-class)# idle-pattern 0x55
```

Enter the configuration commands common to the CEM class. This example specifies a sample rate, payload size, de jitter buffer, and idle pattern.

#### Step 5

**exit**

**Example:**

```
Router(config-cem-class)# exit
```

Returns to the config prompt.

**Step 6** **interface cem *slot/subslot*****Example:****Example:**

```
Router(config)# interface cem 0/0
```

**Example:**

```
Router(config-if)# no ip address
```

**Example:**

```
Router(config-if)# cem 0
```

**Example:**

```
Router(config-if-cem)# cem class mycemclass
```

**Example:**

```
Router(config-if-cem)# xconnect 10.10.10.10 200 encapsulation mpls
```

**Example:**

Configure the CEM interface that you want to use for the new CEM class.

**Note** The use of the **xconnect** command can vary depending on the type of pseudowire you are configuring.

**Step 7** **exit****Example:**

```
Router(config-if-cem)# exit
```

**Example:**

Exits the CEM interface.

**Step 8** **exit****Example:**

```
Router(config-if)# exit
```

**Example:**



Exits configuration mode.

---

## Configuring a Clear-Channel ATM Interface

### Configuring CEM Parameters

The following sections describe the parameters you can configure for CEM circuits.



**Note** The CEM parameters at the local and remote ends of a CEM circuit must match; otherwise, the pseudowire between the local and remote PE routers will not come up.

---

### Configuring Payload Size (Optional)

To specify the number of bytes encapsulated into a single IP packet, use the payload-size command. The size argument specifies the number of bytes in the payload of each packet. The range is from 32 to 1312 bytes.

Default payload sizes for an unstructured CEM channel are as follows:

- E1 = 256 bytes
- T1 = 192 bytes
- DS0 = 32 bytes

Default payload sizes for a structured CEM channel depend on the number of time slots that constitute the channel. Payload size (L in bytes), number of time slots (N), and packetization delay (D in milliseconds) have the following relationship:  $L = 8 * N * D$ . The default payload size is selected in such a way that the packetization delay is always 1 millisecond. For example, a structured CEM channel of 16xDS0 has a default payload size of 128 bytes.

The payload size must be an integer multiple of the number of time slots for structured CEM channels.

### Setting the Dejitter Buffer Size

To specify the size of the dejitter buffer used to compensate for the network filter, use the dejitter-buffer-size command. The configured dejitter buffer size is converted from milliseconds to packets and rounded up to the next integral number of packets. Use the size argument to specify the size of the buffer, in milliseconds. The range is from 1 to 32 ms; the default is 5 ms.

### Setting an Idle Pattern (Optional)

To specify an idle pattern, use the [no] idle-pattern pattern1 command. The payload of each lost CESoPSN data packet must be replaced with the equivalent amount of the replacement data. The range for pattern is from 0x0 to 0xFF; the default idle pattern is 0xFF.

### Enabling Dummy Mode

Dummy mode enables a bit pattern for filling in for lost or corrupted frames. To enable dummy mode, use the **dummy-mode** [last-frame / user-defined] command. The default is last-frame. The following is an example:

```
Router(config-cem)# dummy-mode last-frame
```

## Setting a Dummy Pattern

If dummy mode is set to user-defined, you can use the **dummy-pattern** *pattern* command to configure the dummy pattern. The range for *pattern* is from 0x0 to 0xFF. The default dummy pattern is 0xFF. The following is an example:

```
Router(config-cem)# dummy-pattern 0x55
```



---

**Note** The dummy-pattern command is *not* supported on the following interface modules:

- 48-Port T3/E3 CEM interface module
  - 48-Port T1/E1 CEM interface module
  - 1-port OC-192 Interface module or 8-port Low Rate interface module
- 

## Shutting Down a CEM Channel

To shut down a CEM channel, use the **shutdown** command in CEM configuration mode. The **shutdown** command is supported only under CEM mode and not under the CEM class.

# Configuring CAS

This section provides information about how to configure Channel Associated Signaling (CAS).

## Information About CAS

The CAS is a method of signaling, where the signaling information is carried over a signaling resource that is specific to a particular channel. For each channel there is a dedicated and associated signaling channel.

The Cisco ASR Router with RSP2 module supports CAS with 8-port T1/E1 interface modules and is interoperable with 6-port Ear and Mouth (E&M) interface modules.



---

**Note** The Cisco ASR Router supports CAS only in the E1 mode for the 8-port T1/E1 interface cards. Use the **card type e1 slot/subslot** command to configure controller in the E1 mode.

---

In the E1 framing and signaling, each E1 frame supports 32 timeslots or channels. From the available timeslots, the timeslot 17 is used for signaling information and the remaining timeslots are used for voice and data. Hence, this kind of signaling is often referred as CAS.

In the E1 frame, the timeslots are numbered from 1 to 32, where the timeslot 1 is used for frame synchronization and is unavailable for traffic. When the first E1 frame passes through the controller, the first four bits of signaling channel (timeslot 17) are associated with the timeslot 2 and the second four bits are associated with

the timeslot 18. In the second E1 frame, the first four bits carry signaling information for the timeslot 3 and the second four bits for the timeslot 19.

## Configuring CAS

To configure CAS on the controller interface, perform the following steps:

### Procedure

	Command or Action	Purpose
<b>Step 1</b>	<b>configure terminal</b> <b>Example:</b>  Router# configure terminal	Enters the global configuration mode.
<b>Step 2</b>	<b>controller e1 slot/subslot/port</b> <b>Example:</b>  Router(config)# controller E1 0/4/2	Enters controller configuration mode to configure the E1 interface.  <b>Note</b> The CAS is supported only in the E1 mode. Use the <b>card type e1 slot/subslot</b> command to configure controller in the E1 mode.
<b>Step 3</b>	<b>cas</b> <b>Example:</b>  Router(config-controller)# cas	Configures CAS on the interface.
<b>Step 4</b>	<b>clock source internal</b> <b>Example:</b>  Router(config-controller)# clock source internal	Sets the clocking for individual E1 links.
<b>Step 5</b>	<b>cem-group group-number timeslots time-slot-range</b> <b>Example:</b>  Router(config-controller)# cem-group 0 timeslots 1-31	Creates a Circuit Emulation Services over Packet Switched Network circuit emulation (CESoPSN) CEM group. <ul style="list-style-type: none"> <li>• <b>cem-group</b>—Creates a circuit emulation (CEM) channel from one or more time slots of a E1 line.</li> <li>• <b>group-number</b>—CEM identifier to be used for this group of time slots. For E1 ports, the range is from 0 to 30.</li> <li>• <b>timeslots</b>—Specifies that a list of time slots is to be used as specified by the time-slot-range argument.</li> </ul>

	Command or Action	Purpose
		<ul style="list-style-type: none"> <li>time-slot-range—Specifies the time slots to be included in the CEM channel. The list of time slots may include commas and hyphens with no spaces between the numbers.</li> </ul>
<b>Step 6</b>	<b>end</b>  <b>Example:</b>  Router(config-controller)# end	Exits the controller session and returns to the configuration mode.

### What to do next

You can configure CEM interface and parameters such as xconnect.

## Verifying CAS Configuration

Use the **show cem circuit** *cem-group-id* command to display CEM statistics for the configured CEM circuits. If xconnect is configured under the circuit, the command output also includes information about the attached circuit.

Following is a sample output of the **show cem circuit** command to display the detailed information about CEM circuits configured on the router:

```
Router# show cem circuit 0
CEM0/3/0, ID: 0, Line: UP, Admin: UP, Ckt: ACTIVE
Controller state: up, T1/E1 state: up
Idle Pattern: 0xFF, Idle CAS: 0x8
Dejitter: 8 (In use: 0)
Payload Size: 32
Framing: Framed (DS0 channels: 1)
CEM Defects Set
None

Signalling: No CAS
RTP: No RTP

Ingress Pkts:    5001                Dropped:          0
Egress Pkts:    5001                Dropped:          0

CEM Counter Details
Input Errors:    0                    Output Errors:     0
Pkts Missing:    0                    Pkts Reordered:   0
Misorder Drops: 0                    JitterBuf Underrun: 0
Error Sec:       0                    Severly Errored Sec: 0
Unavailable Sec: 0                    Failure Counts:    0
Pkts Malformed: 0                    JitterBuf Overrun: 0
```



**Note** The **show cem circuit** command displays No CAS for the **Signaling** field. The No CAS is displayed since CAS is not enabled at the CEM interface level. The CAS is enabled for the entire port and you cannot enable or disable CAS at the CEM level. To view the CAS configuration, use the **show running-config** command.

## Configuration Examples for CAS

The following example shows how to configure CAS on a CEM interface on the router:

```
Router# configure terminal
Router(config)# controller E1 0/4/2
Router(config-controller)# cas
Router(config-controller)# clock source internal
Router(config-controller)# cem-group 0 timeslots 1
Router(config-controller)# exit
```

## Configuring ATM

The following sections describe how to configure ATM features on the T1/E1 interface module:

### Configuring a Clear-Channel ATM Interface

To configure the T1 interface module for clear-channel ATM, follow these steps:

#### Procedure

	Command or Action	Purpose
<b>Step 1</b>	<b>enable</b> <b>Example:</b>  Router> enable	Enables privileged EXEC mode.  • Enter your password if prompted.
<b>Step 2</b>	<b>configure terminal</b> <b>Example:</b>  Router# configure terminal	Enters global configuration mode.
<b>Step 3</b>	<b>controller {t1} slot/subslot/port</b> <b>Example:</b>  Router(config)# controller t1 0/3/0	Selects the T1 controller for the port you are configuring (where <i>slot/subslot</i> identifies the location and <i>/port</i> identifies the port).

	Command or Action	Purpose
<b>Step 4</b>	<b>atm</b> <b>Example:</b> <pre>Router(config-controller)# atm</pre>	Configures the port (interface) for clear-channel ATM. The router creates an ATM interface whose format is <code>atm/slot/subslot/port</code> . <b>Note</b> The slot number is always 0.
<b>Step 5</b>	<b>end</b> <b>Example:</b> <pre>Router(config-controller)# end</pre>	Exits configuration mode.

**What to do next**

To access the new ATM interface, use the **interface atm**`slot/subslot/port` command.

This configuration creates an ATM interface that you can use for a clear-channel pseudowire and other features. For more information about configuring pseudowires, see [Configuring Pseudowire, on page 149](#)

## Configuring ATM IMA

Inverse multiplexing provides the capability to transmit and receive a single high-speed data stream over multiple slower-speed physical links. In Inverse Multiplexing over ATM (IMA), the originating stream of ATM cells is divided so that complete ATM cells are transmitted in round-robin order across the set of ATM links. Follow these steps to configure ATM IMA on the Cisco ASR 903 Series Router.



**Note** ATM IMA is used as an element in configuring ATM over MPLS pseudowires. For more information about configuring pseudowires, see [Configuring Pseudowire, on page 149](#)



**Note** The maximum ATM over MPLS pseudowires supported per T1/E1 interface module is 500.

To configure the ATM interface on the router, you must install the ATM feature license using the **license install atm** command. To activate or enable the configuration on the IMA interface after the ATM license is installed, use the **license feature atm** command.

For more information about installing licenses, see the [Software Activation Configuration Guide, Cisco IOS XE Release 3S](#).



**Note** You can create a maximum of 16 IMA groups on each T1/E1 interface module.

## Procedure

	Command or Action	Purpose
<b>Step 1</b>	<b>enable</b> <b>Example:</b> Router> enable	Enables privileged EXEC mode. <ul style="list-style-type: none"> <li>• Enter your password if prompted.</li> </ul>
<b>Step 2</b>	<b>configure terminal</b> <b>Example:</b> Router# configure terminal	Enters global configuration mode.
<b>Step 3</b>	<b>card type {t1   e1} slot [bay]</b> <b>Example:</b> Router(config)# <b>card type e1 0 0</b>	Specifies the slot and port number of the E1 or T1 interface.
<b>Step 4</b>	<b>controller {t1   e1} slot/subslot/port</b> <b>Example:</b> Router(config)# <b>controller e1 0/0/4</b> <b>Example:</b>	Specifies the controller interface on which you want to enable IMA.
<b>Step 5</b>	<b>clock source internal</b> <b>Example:</b> Router(config-controller)# <b>clock source internal</b> <b>Example:</b>	Sets the clock source to internal.
<b>Step 6</b>	<b>ima group group-number</b> <b>Example:</b> Router(config-controller)# ima-group 0 scrambling-payload <b>Example:</b>	Assigns the interface to an IMA group, and set the scrambling-payload parameter to randomize the ATM cell payload frames. This command assigns the interface to IMA group 0. <b>Note</b> This command automatically creates an ATM0/IMAx interface. To add another member link, repeat <a href="#">Step 3</a> to <a href="#">Step 6</a> .
<b>Step 7</b>	<b>exit</b> <b>Example:</b> Router(config-controller)# <b>exit</b>	Exits the controller interface.

	Command or Action	Purpose
	<b>Example:</b>	
<b>Step 8</b>	<b>interface</b> <i>ATMslot/subslot/IMA group-number</i> <b>Example:</b> <pre>Router(config-if)# interface atm0/1/ima0</pre>	Specify the slot location and port of IMA interface group. <ul style="list-style-type: none"> <li>• <i>slot</i>—The location of the ATM IMA interface module.</li> <li>• <i>group-number</i>—The IMA group.</li> </ul> The example specifies the slot number as 0 and the group number as 0. <p><b>Note</b> To explicitly configure the IMA group ID for the IMA interface, use the optional <b>ima group-id</b> command. You cannot configure the same IMA group ID on two different IMA interfaces; therefore, if you configure an IMA group ID with the system-selected default ID already configured on an IMA interface, the system toggles the IMA interface to make the user-configured IMA group ID the effective IMA group ID. The system toggles the original IMA interface to select a different IMA group ID.</p>
<b>Step 9</b>	<b>no ip address</b> <b>Example:</b> <pre>Router(config-if)# no ip address</pre>	Disables the IP address configuration for the physical layer interface.
<b>Step 10</b>	<b>atm bandwidth dynamic</b> <b>Example:</b> <pre>Router(config-if)# atm bandwidth dynamic</pre>	Specifies the ATM bandwidth as dynamic.
<b>Step 11</b>	<b>no atm ilmi-keepalive</b> <b>Example:</b> <pre>Router(config-if)# no atm ilmi-keepalive</pre>	Disables the Interim Local Management Interface (ILMI) keepalive parameters. <p>ILMI is not supported on the router starting with Cisco IOS XE Release 3.15S.</p>
<b>Step 12</b>	<b>exit</b> <b>Example:</b> <pre>Router(config)# exit</pre>	Exits configuration mode.



**What to do next**

The above configuration has one IMA shorthaul with two member links (atm0/0 and atm0/1).

**BGP PIC with TDM Configuration**

To configure the TDM pseudowires on the router, see [Configuring CEM, on page 155](#).

To configure BGP PIC on the router, see [IP Routing: BGP Configuration Guide, Cisco IOS XE Release 3S \(Cisco ASR 900 Series\)](#).

See the configuration example, [Example: BGP PIC with TDM Configuration, on page 188](#).

**Configuring Structure-Agnostic TDM over Packet (SAToP)**

Follow these steps to configure SAToP on the Cisco ASR 903 Series Router:

**Procedure**

	Command or Action	Purpose
<b>Step 1</b>	<b>enable</b> <b>Example:</b> <pre>Router&gt; enable</pre>	Enables privileged EXEC mode. <ul style="list-style-type: none"> <li>• Enter your password if prompted.</li> </ul>
<b>Step 2</b>	<b>configure terminal</b> <b>Example:</b> <pre>Router# configure terminal</pre>	Enters global configuration mode.
<b>Step 3</b>	<b>controller [t1 e1] slot/subslot</b> <b>Example:</b> <pre>Router(config-controller)# controller t1 0/4</pre>	Configures the T1 or E1 interface.
<b>Step 4</b>	<b>cem-group group-number {unframed   timeslots timeslot}</b> <b>Example:</b> <pre>Router(config-if)# cem-group 4 unframed</pre>	Assigns channels on the T1 or E1 circuit to the CEM channel. This example uses the <b>unframed</b> parameter to assign all the T1 timeslots to the CEM channel.
<b>Step 5</b>	<b>interface cem slot/subslot</b> <b>Example:</b> <pre>Router(config)# interface CEM 0/4</pre> <b>Example:</b> <pre>Router(config-if)# no ip address</pre>	Defines a CEM group.

	Command or Action	Purpose
	<b>Example:</b> <pre>Router(config-if)# cem 4</pre>	
<b>Step 6</b>	<b>xconnect ip_address encapsulation mpls</b> <b>Example:</b> <pre>Router(config-if)# xconnect 10.10.2.204 encapsulation mpls</pre>	Binds an attachment circuit to the CEM interface to create a pseudowire. This example creates a pseudowire by binding the CEM circuit 304 to the remote peer 10.10.2.204.
<b>Step 7</b>	<b>exit</b> <b>Example:</b> <pre>Router(config)# exit</pre>	Exits configuration mode.

#### What to do next



**Note** When creating IP routes for a pseudowire configuration, we recommend that you build a route from the cross-connect address (LDP router-id or loopback address) to the next hop IP address, such as **ip route 10.10.10.2 255.255.255.254 10.2.3.4**.

## Configuring Circuit Emulation Service over Packet-Switched Network (CESoPSN)

#### Procedure

	Command or Action	Purpose
<b>Step 1</b>	<b>enable</b> <b>Example:</b> <pre>Router&gt; enable</pre>	Enables privileged EXEC mode. <ul style="list-style-type: none"> <li>• Enter your password if prompted.</li> </ul>
<b>Step 2</b>	<b>configure terminal</b> <b>Example:</b> <pre>Router# configure terminal</pre>	Enters global configuration mode.
<b>Step 3</b>	<b>controller [e1   t1] slot/subslot</b> <b>Example:</b> <pre>Router(config)# controller e1 0/0</pre>	Enters configuration mode for the E1 or T1 controller.

	Command or Action	Purpose
	<b>Example:</b>	
<b>Step 4</b>	<b>cem-group</b> <i>group-number</i> <b>timeslots</b> <i>timeslots</i> <b>Example:</b> <pre>Router(config-controller)# cem-group 5 timeslots 1-24</pre>	Assigns channels on the T1 or E1 circuit to the circuit emulation (CEM) channel. This example uses the <b>timeslots</b> parameter to assign specific timeslots to the CEM channel.
<b>Step 5</b>	<b>exit</b> <b>Example:</b> <pre>Router(config-controller)# exit</pre>	Exits controller configuration.
<b>Step 6</b>	<b>interface cem</b> <i>slot/subslot</i> <b>Example:</b> <pre>Router(config)# interface CEM0/5</pre> <b>Example:</b> <pre>Router(config-if-cem)# cem 5</pre> <b>Example:</b>	Defines a CEM channel.
<b>Step 7</b>	<b>xconnect</b> <i>ip_address</i> <b>encapsulation</b> <b>mpls</b> <b>Example:</b> <pre>Router(config-if)# xconnect 10.10.2.204 encapsulation mpls</pre>	Binds an attachment circuit to the CEM interface to create a pseudowire. This example creates a pseudowire by binding the CEM circuit 304 to the remote peer 10.10.2.204.
<b>Step 8</b>	<b>exit</b> <b>Example:</b> <pre>Router(config-if-cem)# exit</pre>	Exits the CEM interface.
<b>Step 9</b>	<b>exit</b> <b>Example:</b> <pre>Router(config)# exit</pre>	Exits configuration mode.

## Configuring a Clear-Channel ATM Pseudowire

To configure the T1 interface module for clear-channel ATM, follow these steps:

## Procedure

	Command or Action	Purpose
<b>Step 1</b>	<b>controller</b> <i>{t1} slot/subslot/port</i> <b>Example:</b> <pre>Router(config)# controller t1 0/4</pre>	Selects the T1 controller for the port you are configuring.  <b>Note</b> The slot number is always 0.
<b>Step 2</b>	<b>atm</b> <b>Example:</b> <pre>Router(config-controller)# atm</pre>	Configures the port (interface) for clear-channel ATM. The router creates an ATM interface whose format is <i>atm/slot /subslot /port</i> .  <b>Note</b> The slot number is always 0.
<b>Step 3</b>	<b>exit</b> <b>Example:</b> <pre>Router(config-controller)# exit</pre>	Returns you to global configuration mode.
<b>Step 4</b>	<b>interface atm</b> <i>slot/subslot/port</i> <b>Example:</b> <pre>Router(config)# interface atm 0/3/0</pre>	Selects the ATM interface in Step 2.
<b>Step 5</b>	<b>pvc</b> <i>vpi/vci</i> <b>Example:</b> <pre>Router(config-if)# pvc 0/40</pre>	Configures a PVC for the interface and assigns the PVC a VPI and VCI. Do not specify 0 for both the VPI and VCI.
<b>Step 6</b>	<b>xconnect</b> <i>peer-router-id vcid {encapsulation mpls   pseudowire-class name}</i> <b>Example:</b> <pre>Router(config-if)# xconnect 10.10.2.204 200 encapsulation mpls</pre>	Configures a pseudowire to carry data from the clear-channel ATM interface over the MPLS network.
<b>Step 7</b>	<b>end</b> <b>Example:</b> <pre>Router(config-if)# end</pre>	Exits configuration mode.

## Configuring an ATM over MPLS Pseudowire

ATM over MPLS pseudowires allow you to encapsulate and transport ATM traffic across an MPLS network. This service allows you to deliver ATM services over an existing MPLS network.

The following sections describe how to configure transportation of service using ATM over MPLS:

- [Configuring the Controller, on page 171](#)

- [Configuring an IMA Interface, on page 172](#)
- [Configuring the ATM over MPLS Pseudowire Interface, on page 173](#)

## Configuring the Controller

### Procedure

	Command or Action	Purpose
<b>Step 1</b>	<b>enable</b> <b>Example:</b> <pre>Router&gt; enable</pre>	Enables privileged EXEC mode. <ul style="list-style-type: none"> <li>• Enter your password if prompted.</li> </ul>
<b>Step 2</b>	<b>configure terminal</b> <b>Example:</b> <pre>Router# configure terminal</pre>	Enters global configuration mode.
<b>Step 3</b>	<b>card type {e1} slot/subslot</b> <b>Example:</b> <pre>Router(config)# card type e1 0 0</pre>	Configures IMA on an E1 or T1 interface.
<b>Step 4</b>	<b>controller {e1} slot/subslot</b> <b>Example:</b> <pre>Router(config)# controller e1 0/4</pre>	Specifies the controller interface on which you want to enable IMA.
<b>Step 5</b>	<b>clock source {internal   line}</b> <b>Example:</b> <pre>Router(config-controller)# clock source internal</pre>	Sets the clock source to internal.
<b>Step 6</b>	<b>ima-group group-number scrambling-payload</b> <b>Example:</b> <pre>Router(config-controller)# ima-group 0 scrambling-payload</pre>	If you want to configure an ATM IMA backhaul, use the <b>ima-group</b> command to assign the interface to an IMA group. For a T1 connection, use the <b>no-scrambling-payload</b> to disable ATM-IMA cell payload scrambling; for an E1 connection, use the <b>scrambling-payload</b> parameter to enable ATM-IMA cell payload scrambling.  The example assigns the interface to IMA group 0 and enables payload scrambling.
<b>Step 7</b>	<b>exit</b> <b>Example:</b>	Exits configuration mode.

	Command or Action	Purpose
	<code>Router(config)# exit</code>	

## Configuring an IMA Interface

If you want to use ATM IMA backhaul, follow these steps to configure the IMA interface.



**Note** You can create a maximum of 16 IMA groups on each T1/E1 interface module.

### Procedure

	Command or Action	Purpose
<b>Step 1</b>	<p><b>enable</b></p> <p><b>Example:</b></p> <pre>Router&gt; enable</pre>	<p>Enables privileged EXEC mode.</p> <ul style="list-style-type: none"> <li>• Enter your password if prompted.</li> </ul>
<b>Step 2</b>	<p><b>configure terminal</b></p> <p><b>Example:</b></p> <pre>Router# configure terminal</pre>	<p>Enters global configuration mode.</p>
<b>Step 3</b>	<p><b>interface ATM <i>slot</i> / IMA <i>group-number</i></b></p> <p><b>Example:</b></p> <pre>Router(config-controller)# interface atm0/ima0</pre> <p><b>Example:</b></p> <pre>Router(config-if)#</pre>	<p>Specifies the slot location and port of IMA interface group. The syntax is as follows:</p> <ul style="list-style-type: none"> <li>• <i>slot</i>—The slot location of the interface module.</li> <li>• <i>group-number</i>—The group number of the IMA group.</li> </ul> <p>The example specifies the slot number as 0 and the group number as 0.</p>

	Command or Action	Purpose
		<p><b>Note</b> To explicitly configure the IMA group ID for the IMA interface, you may use the optional <b>ima group-id</b> command. You cannot configure the same IMA group ID on two different IMA interfaces; therefore, if you configure an IMA group ID with the system-selected default ID already configured on an IMA interface, the system toggles the IMA interface to make the user-configured IMA group ID the effective IMA group ID. At the same, the system toggles the original IMA interface to select a different IMA group ID.</p>
<b>Step 4</b>	<p><b>no ip address</b></p> <p><b>Example:</b></p> <pre>Router(config-if)# no ip address</pre>	Disables the IP address configuration for the physical layer interface.
<b>Step 5</b>	<p><b>atm bandwidth dynamic</b></p> <p><b>Example:</b></p> <pre>Router(config-if)# atm bandwidth dynamic</pre>	Specifies the ATM bandwidth as dynamic.
<b>Step 6</b>	<p><b>no atm ilmi-keepalive</b></p> <p><b>Example:</b></p> <pre>Router(config-if)# no atm ilmi-keepalive</pre>	Disables the ILMI keepalive parameters.
<b>Step 7</b>	<p><b>exit</b></p> <p><b>Example:</b></p> <pre>Router(config)# exit</pre>	Exits configuration mode.

#### What to do next

For more information about configuring IMA groups, see the [Configuring ATM IMA, on page 164](#).

## Configuring the ATM over MPLS Pseudowire Interface

You can configure ATM over MPLS in several modes according to the needs of your network. Use the appropriate section according to the needs of your network. You can configure the following ATM over MPLS pseudowire types:

- [Configuring 1-to-1 VCC Cell Transport Pseudowire, on page 174](#)—Maps a single VCC to a single pseudowire

- [Configuring N-to-1 VCC Cell Transport Pseudowire](#), on page 175—Maps multiple VCCs to a single pseudowire
- [Configuring 1-to-1 VPC Cell Transport](#), on page 175—Maps a single VPC to a single pseudowire
- [Configuring ATM AAL5 SDU VCC Transport](#), on page 177—Maps a single ATM PVC to another ATM PVC
- [Configuring a Port Mode Pseudowire](#), on page 178—Maps one physical port to a single pseudowire connection
- [Optional Configurations](#), on page 179



**Note** When creating IP routes for a pseudowire configuration, build a route from the xconnect address (LDP router-id or loopback address) to the next hop IP address, such as **ip route 10.10.10.2 255.255.255.255 10.2.3.4**.

## Configuring 1-to-1 VCC Cell Transport Pseudowire

A 1-to-1 VCC cell transport pseudowire maps one ATM virtual channel connection (VCC) to a single pseudowire. Complete these steps to configure a 1-to-1 pseudowire.



**Note** Multiple 1-to-1 VCC pseudowire mapping on an interface is supported.

### Mapping a Single PVC to a Pseudowire

To map a single PVC to an ATM over MPLS pseudowire, use the **xconnect** command at the PVC level. This configuration type uses AAL0 and AAL5 encapsulations. Complete these steps to map a single PVC to an ATM over MPLS pseudowire.

#### Procedure

	Command or Action	Purpose
<b>Step 1</b>	<b>enable</b> <b>Example:</b> Router> enable	Enables privileged EXEC mode. <ul style="list-style-type: none"> <li>• Enter your password if prompted.</li> </ul>
<b>Step 2</b>	<b>configure terminal</b> <b>Example:</b> Router# configure terminal	Enters global configuration mode.
<b>Step 3</b>	<b>interface ATM slot / IMA group-number</b> <b>Example:</b> Router(config-controller)# interface atm0/ima0	Configures the ATM IMA interface.



	Command or Action	Purpose
<b>Step 4</b>	<b>pvc slot/subslot l2transport</b> <b>Example:</b>  Router(config-if-atm) # <b>pvc 0/40</b> <b>l2transport</b>	Defines a PVC. Use the <b>l2transport</b> keyword to configure the PVC as a layer 2 virtual circuit.
<b>Step 5</b>	<b>encapsulation aal0</b> <b>Example:</b>  Router(config-if-atm-l2trans-pvc) # encapsulation aal0	Defines the encapsulation type for the PVC. The default encapsulation type for the PVC is AAL5.
<b>Step 6</b>	<b>xconnect router_ip_address vcid encapsulation mpls</b> <b>Example:</b>  Router(config-if-atm-l2trans-pvc) # xconnect 1.1.1.1 40 encapsulation mpls	Binds an attachment circuit to the ATM IMA interface to create a pseudowire. This example creates a pseudowire by binding PVC 40 to the remote peer 1.1.1.1.
<b>Step 7</b>	<b>end</b> <b>Example:</b>  Router(config-if-atm-l2trans-pvp-xconn) # end	Exits configuration mode.

## Configuring N-to-1 VCC Cell Transport Pseudowire

An N-to-1 VCC cell transport pseudowire maps one or more ATM virtual channel connections (VCCs) to a single pseudowire. Complete these steps to configure an N-to-1 pseudowire.

## Configuring 1-to-1 VPC Cell Transport

A 1-to-1 VPC cell transport pseudowire maps one or more virtual path connections (VPCs) to a single pseudowire. While the configuration is similar to 1-to-1 VPC cell mode, this transport method uses the 1-to-1 VPC pseudowire protocol and format defined in RFCs 4717 and 4446. Complete these steps to configure a 1-to-1 VPC pseudowire.



**Note** Multiple 1-to-1 VCC pseudowire mapping on an interface is supported.

### Procedure

	Command or Action	Purpose
<b>Step 1</b>	<b>enable</b> <b>Example:</b>	Enables privileged EXEC mode. <ul style="list-style-type: none"> <li>• Enter your password if prompted.</li> </ul>

	Command or Action	Purpose
	Router> enable	
<b>Step 2</b>	<b>configure terminal</b> <b>Example:</b> Router# configure terminal	Enters global configuration mode.
<b>Step 3</b>	<b>interface ATM slot / IMA group-number</b> <b>Example:</b> Router(config-controller)# interface atm0/ima0 <b>Example:</b> Router(config-if)# <b>Example:</b>	Configures the ATM IMA interface.
<b>Step 4</b>	<b>atm pvp vpi l2transport</b> <b>Example:</b> Router(config-if-atm)# <b>atm pvp 10 l2transport</b> <b>Example:</b> Router(config-if-atm-l2trans-pvp)#	Maps a PVP to a pseudowire.
<b>Step 5</b>	<b>xconnect peer-router-id vcid {encapsulation mpls}</b> <b>Example:</b> Router(config-if-atm-l2trans-pvp)# <b>xconnect 10.10.10.2 305 encapsulation mpls</b> <b>Example:</b> Router(config-if-atm-l2trans-pvp-xconn)#	Binds an attachment circuit to the ATM IMA interface to create a pseudowire. This example creates a pseudowire by binding the ATM circuit 305 to the remote peer 30.30.30.2.
<b>Step 6</b>	<b>end</b> <b>Example:</b> Router(config-if-atm-l2trans-pvp-xconn)# <b>end</b> <b>Example:</b>	Exits the configuration mode.

## Configuring ATM AAL5 SDU VCC Transport

An ATM AAL5 SDU VCC transport pseudowire maps a single ATM PVC to another ATM PVC. Follow these steps to configure an ATM AAL5 SDU VCC transport pseudowire.

### Procedure

	Command or Action	Purpose
<b>Step 1</b>	<b>enable</b> <b>Example:</b> <pre>Router&gt; enable</pre>	Enables privileged EXEC mode. <ul style="list-style-type: none"> <li>• Enter your password if prompted.</li> </ul>
<b>Step 2</b>	<b>configure terminal</b> <b>Example:</b> <pre>Router# configure terminal</pre>	Enters global configuration mode.
<b>Step 3</b>	<b>interface ATM <i>slot / IMA group-number</i></b> <b>Example:</b> <pre>Router(config-controller)# interface atm0/ima0</pre> <b>Example:</b> <pre>Router(config-if)#</pre> <b>Example:</b>	Configures the ATM IMA interface.
<b>Step 4</b>	<b>atm pvp <i>vpi</i> l2transport</b> <b>Example:</b> <pre>Router(config-if)# pvc 0/12 l2transport</pre> <b>Example:</b> <pre>Router(config-if-atm-l2trans-pvc)#</pre>	Configures a PVC and specifies a VCI or VPI.
<b>Step 5</b>	<b>encapsulation aal5</b> <b>Example:</b> <pre>Router(config-if-atm-l2trans-pvc)# encapsulation aal5</pre>	Sets the PVC encapsulation type to AAL5. <b>Note</b> You must use the AAL5 encapsulation for this transport type.
<b>Step 6</b>	<b>xconnect <i>peer-router-id vcid</i> encapsulation mpls</b>	Binds an attachment circuit to the ATM IMA interface to create a pseudowire. This example

	Command or Action	Purpose
	<b>Example:</b> <pre>Router(config-if-atm-l2trans-pvc) # xconnect 10.10.10.2 125 encapsulation mpls</pre>	creates a pseudowire by binding the ATM circuit 125 to the remote peer 25.25.25.25.
<b>Step 7</b>	<b>exit</b> <b>Example:</b> <pre>Router(config)# exit</pre>	Exits configuration mode.

## Configuring a Port Mode Pseudowire

A port mode pseudowire allows you to map an entire ATM interface to a single pseudowire connection.

### Procedure

	Command or Action	Purpose
<b>Step 1</b>	<b>enable</b> <b>Example:</b> <pre>Router&gt; enable</pre>	Enables privileged EXEC mode. <ul style="list-style-type: none"> <li>• Enter your password if prompted.</li> </ul>
<b>Step 2</b>	<b>configure terminal</b> <b>Example:</b> <pre>Router# configure terminal</pre>	Enters global configuration mode.
<b>Step 3</b>	<b>interface ATM <i>slot</i> / IMA <i>group-number</i></b> <b>Example:</b> <pre>Router(config-controller)# interface atm0/ima0</pre> <b>Example:</b> <pre>Router(config-if)#</pre> <b>Example:</b>	Configures the ATM interface.
<b>Step 4</b>	<b>xconnect <i>peer-router-id</i> <i>vcid</i> encapsulation mpls</b> <b>Example:</b> <pre>Router(config-if-atm-l2trans-pvc) #</pre>	Binds an attachment circuit to the ATM IMA interface to create a pseudowire. This example creates a pseudowire by binding the ATM circuit 125 to the remote peer 10.10.10.2.

	Command or Action	Purpose
	<code>xconnect 10.10.10.2 125 encapsulation mpls</code>	
<b>Step 5</b>	<b>exit</b> <b>Example:</b>  <code>Router(config)# exit</code>	Exits configuration mode.

## Optional Configurations

You can apply the following optional configurations to a pseudowire link.

### Configuring Cell Packing

Cell packing allows you to improve the efficiency of ATM-to-MPLS conversion by packing multiple ATM cells into a single MPLS packet. Follow these steps to configure cell packing.

#### Procedure

	Command or Action	Purpose
<b>Step 1</b>	<b>enable</b> <b>Example:</b>  <code>Router&gt; enable</code>	Enables privileged EXEC mode. <ul style="list-style-type: none"> <li>• Enter your password if prompted.</li> </ul>
<b>Step 2</b>	<b>configure terminal</b> <b>Example:</b>  <code>Router# configure terminal</code>	Enters global configuration mode.
<b>Step 3</b>	<b>interface ATM slot / IMA group-number</b> <b>Example:</b>  <code>Router(config-controller)# interface atm0/ima0</code> <b>Example:</b>  <code>Router(config-if)#</code>	Configures the ATM interface.
<b>Step 4</b>	<b>atm mcpt-timers timer1 timer2 timer3</b> <b>Example:</b>  <code>Router(config-if)# atm mcpt-timers 1000 2000 3000</code>	Defines the three Maximum Cell Packing Timeout (MCPT) timers under an ATM interface. The three independent MCPT timers specify a wait time before forwarding a packet.
<b>Step 5</b>	<b>atm pvp vpi l2transport</b> <b>Example:</b>	Configures a PVC and specifies a VCI or VPI.

	Command or Action	Purpose
	<pre>Router(config-if)# pvc 0/12 12transport</pre> <p><b>Example:</b></p> <pre>Router(config-if-atm-12trans-pvc)#</pre>	
<b>Step 6</b>	<p><b>encapsulation aal5</b></p> <p><b>Example:</b></p> <pre>Router(config-if-atm-12trans-pvc)# encapsulation aal5</pre>	<p>Sets the PVC encapsulation type to AAL5.</p> <p><b>Note</b> You must use the AAL5 encapsulation for this transport type.</p>
<b>Step 7</b>	<p><b>cell-packing</b> <i>maxcells</i> <b>mcpt-timer</b> <i>timer-number</i></p> <p><b>Example:</b></p> <pre>Router(config-if-atm-12trans-pvc)# cell-packing 20 mcpt-timer 3</pre>	<p>Specifies the maximum number of cells in PW cell pack and the cell packing timer. This example specifies 20 cells per pack and the third MCPT timer.</p>
<b>Step 8</b>	<p><b>end</b></p> <p><b>Example:</b></p> <pre>Router(config-if-atm-12trans-pvc)# end</pre>	<p>Exits the configuration mode.</p>

## Configuring an Ethernet over MPLS Pseudowire

Ethernet over MPLS PWs allow you to transport Ethernet traffic over an existing MPLS network. The router supports EoMPLS pseudowires on EVC interfaces.

For more information about Ethernet over MPLS Pseudowires, see [Transportation of Service Using Ethernet over MPLS, on page 154](#).

### Procedure

	Command or Action	Purpose
<b>Step 1</b>	<p><b>enable</b></p> <p><b>Example:</b></p> <pre>Router&gt; enable</pre>	<p>Enables privileged EXEC mode.</p> <ul style="list-style-type: none"> <li>• Enter your password if prompted.</li> </ul>
<b>Step 2</b>	<p><b>configure terminal</b></p> <p><b>Example:</b></p> <pre>Router# configure terminal</pre>	<p>Enters global configuration mode.</p>

	Command or Action	Purpose
<b>Step 3</b>	<b>interface</b> <i>interface-id</i> <b>Example:</b> <pre>Router(config)# interface gigabitethernet 0/0/4</pre>	Specifies the port on which to create the pseudowire and enters interface configuration mode. Valid interfaces are physical Ethernet ports.
<b>Step 4</b>	<b>service instance</b> <i>number</i> <b>ethernet</b> [ <i>name</i> ] <b>Example:</b> <pre>Router(config-if)# service instance 2 ethernet</pre>	Configure an EFP (service instance) and enter service instance configuration mode. <ul style="list-style-type: none"> <li>• The <i>number</i> is the EFP identifier, an integer from 1 to 4000.</li> <li>• (Optional) <b>ethernet</b> <i>name</i> is the name of a previously configured EVC. You do not need to use an EVC name in a service instance.</li> </ul> <p><b>Note</b> You can use service instance settings such as encapsulation, dot1q, and rewrite to configure tagging properties for a specific traffic flow within a given pseudowire session. For more information, see <a href="http://www.cisco.com/c/en/us/td/docs/ios-xml/ios/cether/configuration/xe-3s/asr903/ce-xe-3s-asr903-book/ce-etc.html">http://www.cisco.com/c/en/us/td/docs/ios-xml/ios/cether/configuration/xe-3s/asr903/ce-xe-3s-asr903-book/ce-etc.html</a></p>
<b>Step 5</b>	<b>encapsulation</b> { <b>default</b>   <b>dot1q</b>   <b>priority-tagged</b>   <b>untagged</b> } <b>Example:</b> <pre>Router(config-if-srv)# encapsulation dot1q 2</pre>	Configure encapsulation type for the service instance. <ul style="list-style-type: none"> <li>• <b>default</b>—Configure to match all unmatched packets.</li> <li>• <b>dot1q</b>—Configure 802.1Q encapsulation.</li> <li>• <b>priority-tagged</b>—Specify priority-tagged frames, VLAN-ID 0 and CoS value of 0 to 7.</li> <li>• <b>untagged</b>—Map to untagged VLANs. Only one EFP per port can have untagged encapsulation.</li> </ul>
<b>Step 6</b>	<b>xconnect</b> <i>peer-ip-address</i> <i>vc-id</i> { <b>encapsulation</b> { <b>l2tpv3</b> [ <b>manual</b> ]   <b>mpls</b> [ <b>manual</b> ]}   <b>pw-class</b> <i>pw-class-name</i> } [ <b>pw-class</b> <i>pw-class-name</i> ] [ <b>sequencing</b> { <b>transmit</b>   <b>receive</b>   <b>both</b> }] <b>Example:</b>	Binds the Ethernet port interface to an attachment circuit to create a pseudowire. This example uses virtual circuit (VC) 101 to uniquely identify the PW. Ensure that the remote VLAN is configured with the same VC.

	Command or Action	Purpose
	<pre>Router (config-if-srv)# xconnect 10.1.1.2 101 encapsulation mpls</pre>	<b>Note</b> When creating IP routes for a pseudowire configuration, we recommend that you build a route from the xconnect address (LDP router-id or loopback address) to the next hop IP address, such as <b>ip route 10.10.10.2 255.255.255.255 10.2.3.4</b> .
<b>Step 7</b>	<b>exit</b>  <b>Example:</b>  <pre>Router(config)# exit</pre>	Exits configuration mode.

## Configuring Pseudowire Redundancy

A backup peer provides a redundant pseudowire (PW) connection in the case that the primary PW loses connection; if the primary PW goes down, the Cisco ASR 903 Series Router diverts traffic to the backup PW. This feature provides the ability to recover from a failure of either the remote PE router or the link between the PE router and CE router.

Figure 4: Pseudowire Redundancy, on page 182 shows an example of pseudowire redundancy.

Figure 4: Pseudowire Redundancy

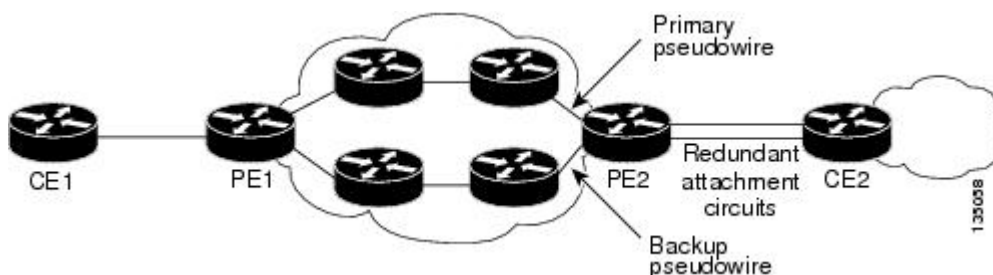

**Note** You must configure the backup pseudowire to connect to a router that is different from the primary pseudowire.

Follow these steps to configure a backup peer:

### Procedure

	Command or Action	Purpose
<b>Step 1</b>	<b>enable</b>  <b>Example:</b>  <pre>Router&gt; enable</pre>	Enables privileged EXEC mode. <ul style="list-style-type: none"> <li>• Enter your password if prompted.</li> </ul>



	Command or Action	Purpose
<b>Step 2</b>	<b>configure terminal</b> <b>Example:</b>  Router# configure terminal	Enters global configuration mode.
<b>Step 3</b>	<b>pseudowire-class [pw-class-name]</b> <b>Example:</b>  Router(config)# pseudowire-class mpls	Specify the name of a Layer 2 pseudowire class and enter pseudowire class configuration mode.
<b>Step 4</b>	<b>encapsulation mpls</b> <b>Example:</b>  Router(config-pw-class)# encapsulation mpls	Specifies MPLS encapsulation.
<b>Step 5</b>	<b>interface serial slot/subslot/port</b> <b>Example:</b>  Router(config)# interface serial10/0	Enters configuration mode for the serial interface.  <b>Note</b> The slot number is always 0.
<b>Step 6</b>	<b>backup delay enable-delay {disable-delay   never}</b> <b>Example:</b>  Router(config)# backup delay 0 10	Configures the backup delay parameters. Where: <ul style="list-style-type: none"> <li>• <i>enable-delay</i>—Time before the backup PW takes over for the primary PW.</li> <li>• <i>disable-delay</i>—Time before the restored primary PW takes over for the backup PW.</li> <li>• <b>never</b>—Disables switching from the backup PW to the primary PW.</li> </ul>
<b>Step 7</b>	<b>xconnect router-id encapsulation mpls</b> <b>Example:</b>  Router(config-if)# <b>xconnect 10.10.10.2 101 encapsulation mpls</b>	Binds the Ethernet port interface to an attachment circuit to create a pseudowire.
<b>Step 8</b>	<b>backup peer peer-router-ip-address vcid [pw-class pw-class name]</b> <b>Example:</b>  Router(config)# backup peer 10.10.10.1 104 pw-class pw1	Defines the address and VC of the backup peer.
<b>Step 9</b>	<b>exit</b> <b>Example:</b>  Router(config)# <b>exit</b>	Exits configuration mode.

## Pseudowire Redundancy with Uni-directional Active-Active

Pseudowire redundancy with uni-directional active-active feature configuration allows, pseudowires (PW) on both the working and protect circuits to remain in UP state to allow traffic to flow from the upstream. The **aps l2vpn-state detach** command and **redundancy all-active replicate** command is introduced to configure uni-directional active-active pseudowire redundancy.

In pseudowire redundancy Active-Standby mode, the designation of the active and standby pseudowires is decided either by the endpoint PE routers or by the remote PE routers when configured with MR-APS. The active and standby routers communicate via Protect Group Protocol (PGP) and synchronize their states. The PEs are connected to a Base Station Controller (BSC). APS state of the router is communicated to the Layer2 VPN, and is thereby coupled with the pseudowire status.

**Figure 5: Pseudowire Redundancy with MR-APS**

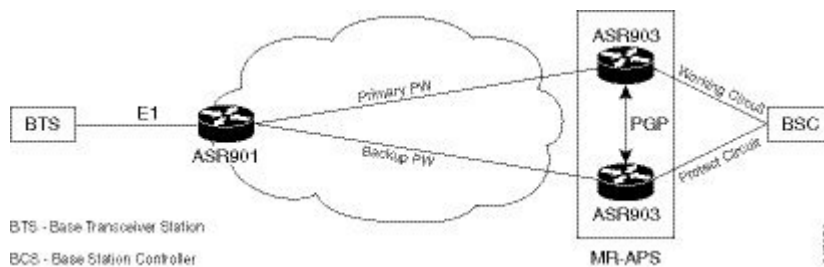

BSC monitors the status of the incoming signal from the working and protect routers. In the event of a switchover at the BSC, the BSC fails to inform the PE routers, hence causing traffic drops.

With pseudowire redundancy Active-Active configuration, the traffic from the upstream is replicated and transmitted over both the primary and backup pseudowires. PE routers forwards the received traffic to the working and protect circuits. The BSC receives the same traffic on both the circuits and selects the better Rx link, ensuring the traffic is not dropped.

**Figure 6: Pseudowire Redundancy with Uni-directional Active-Active**

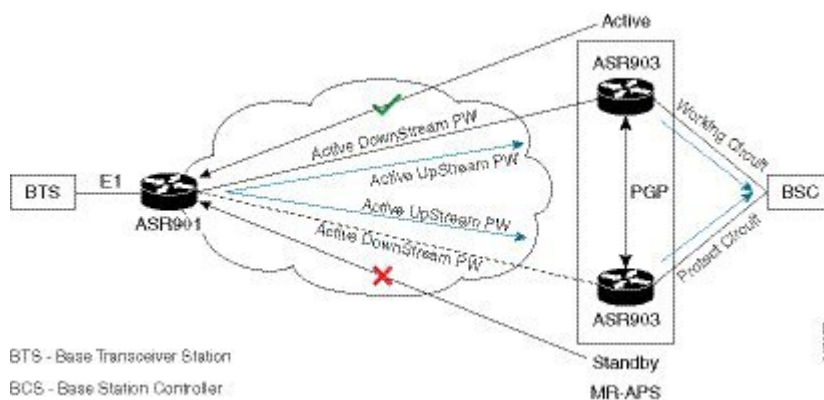



---

**Note** If the ASR 900 router is configured with the **aps l2vpn-state detach** command but, the ASR 901 router is not enabled with **redundancy all-active replicate** command, the protect PW is active after APS switchover. On the ASR 901 router, the PW state is UP and the data path status displays standby towards protect node. On an APS switchover on the ASR 900 router, the status is not communicated to ASR 901 router, and the VC data path state towards the protect node remains in the standby state.

---

## Restrictions

The following restrictions apply on the router:

- If the **aps l2vpn-state detach** command is enabled on the ASR 900 router, but the **redundancy all-active replicate** command *not* enabled on the ASR 901 router, the pseudowire status on the router displays UP, and the data path status for the protect node state displays Standby.
- After APS switchover on the ASR 900 router, the status is *not* communicated to ASR 901 router, and the virtual circuit data path state towards the protect node remains in the Standby state.
- The **aps l2vpn-state detach** command takes effect after a controller **shutdown** command, followed by a **no shutdown** command is performed. Alternately, the command can be configured when the controller is in shut state.
- The **status peer topology dual-homed** command in pseudowire-class configuration mode should *not* be configured on the ASR 900 router, irrespective of unidirectional or bidirectional mode. The command *must* be configured on the ASR 901 router.
- Traffic outages from the BSC to the BTS on PGP and ICRM failures at the working Active node, is same as the configured hold time.



---

**Note** APS switchover may be observed on the protect node, when PGP failure occurs on the working Active node.

---

- Convergence may be observed on performing a power cycle on the Active (whether on the protect or working) node. The observed convergence is same as the configured hold time.

## Configuring Pseudowire Redundancy Active-Active—Protocol Based

```
encapsulation mpls
status peer topology dual-homed
```

```
controller E1 0/1
framing unframed
cem-group 8 unframed
```

## Configuring the Working Controller for MR-APS with Pseudowire Redundancy Active-Active

The following configuration shows pseudowire redundancy active-active for MR-APS working controller:

```
controller sonet 0/1/0
aps group 2
aps adm
aps working 1
aps timers 1 3
aps l2vpn-state detach
aps hspw-icrm-grp 1
```

## Configuring the Protect Controller for MR-APS with Pseudowire Redundancy Active-Active

Following example shows pseudowire redundancy active-active on MR-APS protect controller:

```
controller sonet 0/1/0
aps group 2
aps adm
aps unidirectional
aps protect 10 10.10.10.1
aps timers 1 3
aps l2vpn-state detach
aps hspw-icrm-grp 1
```

## Verifying the Interface Configuration

You can use the following commands to verify your pseudowire configuration:

- **show cem circuit**—Displays information about the circuit state, administrative state, the CEM ID of the circuit, and the interface on which it is configured. If **xconnect** is configured under the circuit, the command output also includes information about the attached circuit.

```
Router# show cem circuit
?

<0-504>    CEM ID
detail    Detailed information of cem ckt(s)
interface CEM Interface
summary   Display summary of CEM ckts
|         Output modifiers
Router# show cem circuit
```

CEM Int.	ID	Line	Admin	Circuit	AC
CEM0/1/0	1	UP	UP	ACTIVE	--/--
CEM0/1/0	2	UP	UP	ACTIVE	--/--
CEM0/1/0	3	UP	UP	ACTIVE	--/--

```
CEM0/1/0      4    UP      UP      ACTIVE  --/--
CEM0/1/0      5    UP      UP      ACTIVE  --/--
```

- **show cem circuit**—Displays the detailed information about that particular circuit.

```
Router# show cem circuit 1
```

```
CEM0/1/0, ID: 1, Line State: UP, Admin State: UP, Ckt State: ACTIVE
Idle Pattern: 0xFF, Idle cas: 0x8, Dummy Pattern: 0xFF
Dejitter: 5, Payload Size: 40
Framing: Framed, (DS0 channels: 1-5)
Channel speed: 56
CEM Defects Set
Excessive Pkt Loss RatePacket Loss
Signalling: No CAS
Ingress Pkts:    25929          Dropped:          0
Egress Pkts:     0             Dropped:          0
CEM Counter Details
Input Errors:    0             Output Errors:    0
Pkts Missing:   25927         Pkts Reordered:  0
Misorder Drops: 0             JitterBuf Underrun: 1
Error Sec:      26            Severly Errored Sec: 26
Unavailable Sec: 5             Failure Counts:   1
Pkts Malformed: 0
```

- **show cem circuit summary**—Displays the number of circuits which are up or down per interface basis.

```
Router# show cem circuit summary
```

```
CEM Int.      Total Active Inactive
-----
CEM0/1/0      5         5         0
```

- **show running configuration**—The **show running configuration** command shows detail on each CEM group.

## Configuration Examples

The following sections contain sample pseudowire configurations.

### Example: CEM Configuration

The following example shows how to add a T1 interface to a CEM group as a part of a SAToP pseudowire configuration. For more information about how to configure pseudowires, see [Configuring Pseudowire, on page 149](#)



**Note** This section displays a partial configuration intended to demonstrate a specific feature.

```
controller T1 0/0/0
 framing unframed
 clock source internal
 linecode b8zs
 cablelength short 110
 cem-group 0 unframed
```

```

interface CEM0/0/0
  no ip address
  cem 0
  xconnect 18.1.1.1 1000 encapsulation mpls

```

## Example: BGP PIC with TDM Configuration

### CEM Configuration

```

pseudowire-class pseudowire1
  encapsulation mpls
  control-word
  no status control-plane route-watch
  !
  controller SONET 0/2/3
  description connected to CE2 SONET 4/0/0
  framing sdh
  clock source line
  aug mapping au-4
  !
  au-4 1 tug-3 1
    mode c-12
    tug-2 1 e1 1 cem-group 1101 unframed
    tug-2 1 e1 1 framing unframed
    tug-2 1 e1 2 cem-group 1201 timeslots 1-10
    !
  au-4 1 tug-3 2
    mode c-12
    tug-2 5 e1 1 cem-group 1119 unframed
    tug-2 5 e1 1 framing unframed
    tug-2 5 e1 2 cem-group 1244 timeslots 11-20
    !
  au-4 1 tug-3 3
    mode c-12
    tug-2 5 e1 3 cem-group 1130 unframed
    tug-2 5 e1 3 framing unframed
    tug-2 7 e1 3 cem-group 1290 timeslots 21-30
    !
  interface CEM0/2/3
  no ip address
  cem 1101
    xconnect 17.1.1.1 1101 encapsulation mpls pw-class pseudowire1
    !
  cem 1201
    xconnect 17.1.1.1 1201 encapsulation mpls pw-class pseudowire1
    !
  cem 1119
    xconnect 17.1.1.1 1119 encapsulation mpls pw-class pseudowire1
    !
  cem 1244
    xconnect 17.1.1.1 1244 encapsulation mpls pw-class pseudowire1
    !
  cem 1130
    xconnect 17.1.1.1 1130 encapsulation mpls pw-class pseudowire1
    !
  cem 1290
    xconnect 17.1.1.1 1290 encapsulation mpls pw-class pseudowire1

```

## BGP PIC Configuration

```

cef table output-chain build favor convergence-speed
!
router bgp 1
  bgp log-neighbor-changes
  bgp graceful-restart
  neighbor 18.2.2.2 remote-as 1
  neighbor 18.2.2.2 update-source Loopback0
  neighbor 18.3.3.3 remote-as 1
  neighbor 18.3.3.3 update-source Loopback0
!
address-family ipv4
  bgp additional-paths receive
  bgp additional-paths install
  bgp nexthop trigger delay 0
  network 17.5.5.5 mask 255.255.255.255
  neighbor 18.2.2.2 activate
  neighbor 18.2.2.2 send-community both
  neighbor 18.2.2.2 send-label
  neighbor 18.3.3.3 activate
  neighbor 18.3.3.3 send-community both
  neighbor 18.3.3.3 send-label
exit-address-family

```

## Example: BGP PIC with TDM-PW Configuration

This section lists the configuration examples for BGP PIC with TDM and TDM-Pseudowire.

The below configuration example is for BGP PIC with TDM:

```

router bgp 1
  neighbor 18.2.2.2 remote-as 1
  neighbor 18.2.2.2 update-source Loopback0
  neighbor 18.3.3.3 remote-as 1
  neighbor 18.3.3.3 update-source Loopback0
!
address-family ipv4
  bgp additional-paths receive
  bgp additional-paths install
  bgp nexthop trigger delay 6
  neighbor 18.2.2.2 activate
  neighbor 18.2.2.2 send-community both
  neighbor 18.2.2.2 send-label
  neighbor 18.3.3.3 activate
  neighbor 18.3.3.3 send-community both
  neighbor 18.3.3.3 send-label
  neighbor 26.1.1.2 activate
exit-address-family
!
address-family vpnv4
  bgp nexthop trigger delay 7
  neighbor 18.2.2.2 activate
  neighbor 18.2.2.2 send-community extended
  neighbor 18.3.3.3 activate
  neighbor 18.3.3.3 send-community extended
exit-address-family

```

The below configuration example is for BGP PIC with TDM PW:

```
pseudowire-class pseudowire1
```

```

encapsulation mpls
control-word
no status control-plane route-watch
status peer topology dual-homed
!
Interface CEM0/0/0
cem 1
  xconnect 17.1.1.1 4101 encapsulation mpls pw-class pseudowire1

```

## Example: ATM IMA Configuration

The following example shows how to add a T1/E1 interface to an ATM IMA group as a part of an ATM over MPLS pseudowire configuration. For more information about how to configure pseudowires, see [Configuring Pseudowire, on page 149](#)



---

**Note** This section displays a partial configuration intended to demonstrate a specific feature.

---

```

controller t1 4/0/0
  ima-group 0
  clock source line
interface atm4/0/ima0
  pvc 1/33 l2transport
  encapsulation aal0
  xconnect 1.1.1.1 33 encapsulation mpls

```

## Example: ATM over MPLS

The following sections contain sample ATM over MPLS configurations:

### Cell Packing Configuration Examples

The following sections contain sample ATM over MPLS configuration using Cell Relay:

#### VC Mode

##### CE 1 Configuration

```

interface Gig4/3/0
no negotiation auto
load-interval 30
interface Gig4/3/0
ip address 20.1.1.1 255.255.255.0
interface ATM4/2/4
no shut
exit
!
interface ATM4/2/4.10 point
ip address 50.1.1.1 255.255.255.0
pvc 20/101
encapsulation aal5snap
!
ip route 30.1.1.2 255.255.255.255 50.1.1.2

```



## CE 2 Configuration

```
interface Gig8/8
no negotiation auto
load-interval 30
interface Gig8/8
ip address 30.1.1.1 255.255.255.0
interface ATM6/2/1
no shut
!
interface ATM6/2/1.10 point
ip address 50.1.1.2 255.255.255.0
pvc 20/101
encapsulation aal5snap
!
ip route 20.1.1.2 255.255.255.255 50.1.1.1
```

## PE 1 Configuration

```
interface Loopback0
ip address 192.168.37.3 255.255.255.255
!
interface ATM0/0/0
no shut
!
interface ATM0/0/0
atm mcpt-timers 150 1000 4095
interface ATM0/0/0.10 point
pvc 20/101 l2transport
encapsulation aal0
cell-packing 20 mcpt-timer 1
xconnect 192.168.37.2 100 encapsulation mpls
!
interface Gig0/3/0
no shut
ip address 40.1.1.1 255.255.0.0
mpls ip
!
mpls ip
mpls label protocol ldp
mpls ldp router-id Loopback0 force
mpls ldp graceful-restart
router ospf 1
network 40.1.0.0 0.0.255.255 area 1
network 192.168.37.0 0.0.0.255 area 1
nsf
```

## PE 2 Configuration

```
interface Loopback0
ip address 192.168.37.2 255.255.255.255
!
interface ATM9/3/1
no shut
!
interface ATM9/3/1
atm mcpt-timers 150 1000 4095
interface ATM9/3/1.10 point
pvc 20/101 l2transport
encapsulation aal0
cell-packing 20 mcpt-timer 1
```

```
xconnect 192.168.37.3 100 encapsulation mpls
!
interface Gig6/2
no shut
ip address 40.1.1.2 255.255.0.0
mpls ip
!
mpls ip
mpls label protocol ldp
mpls ldp router-id Loopback0 force
mpls ldp graceful-restart
router ospf 1
network 40.1.0.0 0.0.255.255 area 1
network 192.168.37.0 0.0.0.255 area 1
nsf
```

## VP Mode

### CE 1 Configuration

```
interface Gig4/3/0
no negotiation auto
load-interval 30
interface Gig4/3/0
ip address 20.1.1.1 255.255.255.0
interface ATM4/2/4
!
interface ATM4/2/4.10 point
ip address 50.1.1.1 255.255.255.0
pvc 20/101
encapsulation aal5snap
!
ip route 30.1.1.2 255.255.255.255 50.1.1.2
```

### CE 2 Configuration

```
!
interface Gig8/8
no negotiation auto
load-interval 30
interface Gig8/8
ip address 30.1.1.1 255.255.255.0
interface ATM6/2/1
no shut
!
interface ATM6/2/1.10 point
ip address 50.1.1.2 255.255.255.0
pvc 20/101
encapsulation aal5snap
!
ip route 20.1.1.2 255.255.255.255 50.1.1.1
```

### PE 1 Configuration

```
interface Loopback0
ip address 192.168.37.3 255.255.255.255
!
interface ATM0/0/0
no shut
```

```

!
interface ATM0/0/0
atm mcpt-timers 150 1000 4095
interface ATM0/0/0.50 multipoint
atm pvp 20 l2transport
cell-packing 10 mcpt-timer 1
xconnect 192.168.37.2 100 encapsulation mpls
!
interface Gig0/3/0
no shut
ip address 40.1.1.1 255.255.0.0
mpls ip
!
mpls ip
mpls label protocol ldp
mpls ldp router-id Loopback0 force
mpls ldp graceful-restart
router ospf 1
network 40.1.0.0 0.0.255.255 area 1
network 192.168.37.0 0.0.0.255 area 1
nsf

```

### PE 2 Configuration

```

!
interface Loopback0
ip address 192.168.37.2 255.255.255.255
!
interface ATM9/3/1
no shut
!
interface ATM9/3/1
atm mcpt-timers 150 1000 4095
interface ATM9/3/1.50 multipoint
atm pvp 20 l2transport
cell-packing 10 mcpt-timer 1
xconnect 192.168.37.3 100 encapsulation mpls
!
interface Gig6/2
no shut
ip address 40.1.1.2 255.255.0.0
mpls ip
!
mpls ip
mpls label protocol ldp
mpls ldp router-id Loopback0 force
mpls ldp graceful-restart
router ospf 1
network 40.1.0.0 0.0.255.255 area 1
network 192.168.37.0 0.0.0.255 area 1
nsf

```

## Cell Relay Configuration Examples

The following sections contain sample ATM over MPLS configuration using Cell Relay:

## VC Mode

**CE 1 Configuration**

```

!
interface gigabitethernet4/3/0
no negotiation auto
load-interval 30
interface gigabitethernet4/3/0
ip address 20.1.1.1 255.255.255.0
!
interface ATM4/2/4
!
interface ATM4/2/4.10 point
ip address 50.1.1.1 255.255.255.0
pvc 20/101
encapsulation aal5snap
!
ip route 30.1.1.2 255.255.255.255 50.1.1.2
!

```

**CE 2 Configuration**

```

interface gigabitethernet8/8
no negotiation auto
load-interval 30
interface gigabitethernet8/8
ip address 30.1.1.1 255.255.255.0
interface ATM6/2/1
!
interface ATM6/2/1.10 point
ip address 50.1.1.2 255.255.255.0
pvc 20/101
encapsulation aal5snap
!
ip route 20.1.1.2 255.255.255.255 50.1.1.1

```

**PE 1 Configuration**

```

!
interface Loopback0
ip address 192.168.37.3 255.255.255.255
!
interface ATM0/0/0
!
interface ATM0/0/0.10 point
pvc 20/101 l2transport
encapsulation aal0
xconnect 192.168.37.2 100 encapsulation mpls
!
interface gigabitethernet0/3/0
ip address 40.1.1.1 255.255.0.0
mpls ip
!
mpls ip
mpls label protocol ldp
mpls ldp router-id Loopback0 force
mpls ldp graceful-restart
router ospf 1
network 40.1.0.0 0.0.255.255 area 1

```

```
network 192.168.37.0 0.0.0.255 area 1
nsf
```

## PE 2 Configuration

```
!
interface Loopback0
ip address 192.168.37.2 255.255.255.255
!
interface ATM9/3/1
!
interface ATM9/3/1.10 point
pvc 20/101 l2transport
encapsulation aal0
xconnect 192.168.37.3 100 encapsulation mpls
!
interface gigabitethernet6/2
ip address 40.1.1.2 255.255.0.0
mpls ip
!
mpls ip
mpls label protocol ldp
mpls ldp router-id Loopback0 force
mpls ldp graceful-restart
router ospf 1
network 40.1.0.0 0.0.255.255 area 1
network 192.168.37.0 0.0.0.255 area 1
nsf
```

## VP Mode

### CE 1 Configuration

```
!
interface gigabitethernet4/3/0
no negotiation auto
load-interval 30
interface gigabitethernet4/3/0
ip address 20.1.1.1 255.255.255.0
!
interface ATM4/2/4
!
interface ATM4/2/4.10 point
ip address 50.1.1.1 255.255.255.0
pvc 20/101
encapsulation aal5snap
!
ip route 30.1.1.2 255.255.255.255 50.1.1.2
```

### CE 2 Configuration

```
!
interface gigabitethernet8/8
no negotiation auto
load-interval 30
interface gigabitethernet8/8
ip address 30.1.1.1 255.255.255.0
interface ATM6/2/1
!
```

```
interface ATM6/2/1.10 point
ip address 50.1.1.2 255.255.255.0
pvc 20/101
encapsulation aal5snap
!
ip route 20.1.1.2 255.255.255.255 50.1.1.1
```

### PE 1 Configuration

```
interface Loopback0
ip address 192.168.37.3 255.255.255.255
!
!
interface ATM0/0/0
interface ATM0/0/0.50 multipoint
atm pvp 20 l2transport
xconnect 192.168.37.2 100 encapsulation mpls
!
interface gigabitethernet0/3/0
ip address 40.1.1.1 255.255.0.0
mpls ip
!
mpls ip
mpls label protocol ldp
mpls ldp router-id Loopback0 force
mpls ldp graceful-restart
router ospf 1
network 40.1.0.0 0.0.255.255 area 1
network 192.168.37.0 0.0.0.255 area 1
nsf
```

### PE 2 Configuration

```
interface Loopback0
ip address 192.168.37.2 255.255.255.255
!
!
interface ATM9/3/1
interface ATM9/3/1.50 multipoint
atm pvp 20 l2transport
xconnect 192.168.37.3 100 encapsulation mpls
!
interface gigabitethernet6/2
ip address 40.1.1.2 255.255.0.0
mpls ip
!
mpls ip
mpls label protocol ldp
mpls ldp router-id Loopback0 force
mpls ldp graceful-restart
router ospf 1
network 40.1.0.0 0.0.255.255 area 1
network 192.168.37.0 0.0.0.255 area 1
nsf
```

## Example: Ethernet over MPLS

### PE 1 Configuration

```

!
mpls label range 16 12000 static 12001 16000
mpls label protocol ldp
mpls ldp neighbor 10.1.1.1 targeted ldp
mpls ldp graceful-restart
multilink bundle-name authenticated
!
!
!
!
redundancy
 mode sso
!
!
!
ip tftp source-interface GigabitEthernet0
!
!
interface Loopback0
 ip address 10.5.5.5 255.255.255.255
!
interface GigabitEthernet0/0/4
 no ip address
 negotiation auto
!
 service instance 2 ethernet
  encapsulation dot1q 2
  xconnect 10.1.1.1 1001 encapsulation mpls
!
 service instance 3 ethernet
  encapsulation dot1q 3
  xconnect 10.1.1.1 1002 encapsulation mpls
!
!
interface GigabitEthernet0/0/5
 ip address 172.7.7.77 255.0.0.0
 negotiation auto
 mpls ip
 mpls label protocol ldp
!
router ospf 1
 router-id 5.5.5.5
 network 5.5.5.5 0.0.0.0 area 0
 network 172.0.0.0 0.255.255.255 area 0
 network 10.33.33.33 0.0.0.0 area 0
 network 192.0.0.0 0.255.255.255 area 0
!

```

### PE 2 Configuration

```

!
mpls label range 16 12000 static 12001 16000
mpls label protocol ldp
mpls ldp neighbor 10.5.5.5 targeted ldp
mpls ldp graceful-restart
multilink bundle-name authenticated

```

```

!
!
redundancy
 mode sso
!
!
!
ip tftp source-interface GigabitEthernet0
!
!
interface Loopback0
 ip address 10.1.1.1 255.255.255.255
!
interface GigabitEthernet0/0/4
 no ip address
 negotiation auto
!
 service instance 2 ethernet
  encapsulation dot1q 2
  xconnect 10.5.5.5 1001 encapsulation mpls
!
 service instance 3 ethernet
  encapsulation dot1q 3
  xconnect 10.5.5.5 1002 encapsulation mpls
!
!
interface GigabitEthernet0/0/5
 ip address 172.7.7.7 255.0.0.0
 negotiation auto
 mpls ip
 mpls label protocol ldp
!
router ospf 1
 router-id 10.1.1.1
 network 10.1.1.1 0.0.0.0 area 0
 network 172.0.0.0 0.255.255.255 area 0
 network 10.33.33.33 0.0.0.0 area 0
 network 192.0.0.0 0.255.255.255 area 0
!

```

## Adaptive Clock Recovery (ACR)

Adaptive Clock Recovery (ACR) is an averaging process that negates the effect of random packet delay variation and captures the average rate of transmission of the original bit stream. ACR recovers the original clock for a synchronous data stream from the actual payload of the data stream. In other words, a synchronous clock is derived from an asynchronous packet stream. ACR is a technique where the clock from the TDM domain is mapped through the packet domain, but is most commonly used for Circuit Emulation (CEM). ACR is supported on unframed and framed modes of SAToP.





---

**Note** Framing type should be maintained same in all routers end to end.

---

Effective Cisco IOS XE Everest 16.5.1, ACR is supported on the 8-port T1/E1 interface module.

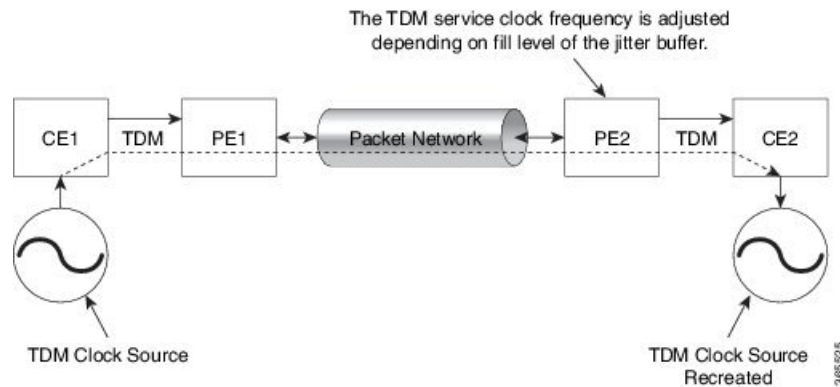



## Benefits of ACR for 8 T1/E1 Interface Module

- Customer-edge devices (CEs) can have different clocks from that of the Provide-edge devices (PEs). Every T1/E1 interface module supports eight pseudowires (or the derived clocks).

## Prerequisites for ACR Configuration in 8 T1/E1 Interface Module

- Ensure that CEM is configured before configuring the adaptive clock recovery.
- The following must be configured before configuring the ACR:
  - The remote Customer Equipment and the remote Provider Edge device. These can be configured by using the clock source internal and the clock source line commands under the T1/E1 controller.
  - The controller on the local Customer Equipment connected to the ACR router by using the **clock source line** command.
  - PRC or PRS reference clock from a GPS reference to the remote Customer Equipment or remote CEM Provider Edge device.

## Restrictions for ACR on 8 T1/E1 Interface Module

- ACR is supported only on the 8-port T1/E1 interface module (A900-IMA8D). It is not supported on the 16-port T1/E1 interface module (A900-IMA16D), the 32-port T1/E1 interface module (A900-IMA32D), or the 4-port OC3 interface module (A900-IMA4OS).
- ACR is supported only for unframed and framed CEM (SAToP) and for fully-framed CEM (CESoPSN). Fully-framed refers to all the timeslots of T1 (1-24) or E1 (1-31) interfaces.
- ACR is supported only for CEM circuits with MPLS PW encapsulation. ACR is not supported for CEM circuits with UDP or IP PW encapsulation.
- The clock recovered by an ACR clock for a CEM circuit is local to that CEM circuit. The recovered clock cannot be introduced to another circuit and also cannot be introduced to the system clock as a frequency input source.
- The clock ID should be unique for the entire device.
- When a CEM group is configured, dynamic change in clock source is not allowed.

- Physical or soft IM OIR causes the APS switchover time to be higher (500 to 600 ms). Shut or no shut of the port and removal of the active working or protect also cause the APS switchover time to be high. To overcome these issues, force the APS switchover.

## Configuring ACR for T1 Interfaces for SAToP

To configure the clock on T1/E1 interfaces for SAToP in controller mode:

```
enable
configure terminal
controller t1 0/4/3
clock source recovered 15
cem-group 20 unframed
exit
```

To configure the clock recovery on T1/E1 interfaces in global configuration mode:

```
recovered-clock 0 4
clock recovered 15 adaptive cem 3 20
exit
```



---

**Note** The clock source recovered configuration on the controller must be completed before configuring the clock recovery in global configuration mode.

---



---

**Note** On the controller, the clock source should be configured before CEM group is configured.

---



---

**Note** Follow a similar procedure to configure to configure CEM ACR for E1 Interfaces for SAToP. Also, follow a similar procedure to configure CEM ACR for T1 and E1 Interfaces for CESoPSN. Use **cem-group circuit-id timeslots <1-24> | <1-31>** command instead of **cem-group circuit-id unframed** command for the configuration depending on T1 or E1 controller.

---

To remove the clock configuration in ACR, you must remove the recovery clock configuration in global configuration mode, then remove the CEM circuit, and finally remove the clock source recovered configuration under the controller.



---

**Note** For the 8-port T1/E1 interface module (A900-IMA8D), the configuration or unconfiguration of the clock source recovered is not supported when the cem-group is already configured on the controller. To modify the clock source, you should remove the CEM group configuration from the controller.

---

## Verifying the ACR Configuration of T1 Interfaces for SAToP

### Important Notes

- When multiple ACR clocks are provisioned and if the core network or PSN traffic load primarily has fixed packet rate and fixed size packets, the states of one or more ACR clocks might flap between Acquiring and Acquired states and might not be stable in Acquired state.

This happens because of the "beating" phenomenon and is documented in *ITU-T G.8261 - Timing and synchronization aspects in packet networks*.

This is an expected behavior.

- After an ACR clock is provisioned and starts recovering the clock, a waiting period of 15-20 minutes is mandatory before measuring MTIE for the recovered clock.

This behavior is documented in *ITU-T G.8261 Timing and synchronization aspects in packet networks Appendix 2*.

- When the input stream of CEM packets from the core network or PSN traffic is lost or has many errors, the ACR clock enters the HOLDOVER state. In this state, the ACR clock fails to provide an output clock on the E1/T1 controller. Hence, during the HOLDOVER state, MTIE measurement fails.

This is an expected behavior.

- When the clock output from the clock master or GPS reference flaps or fails, the difference in the characteristics between the holdover clock at the source device and the original GPS clock may result in the ACR algorithm failing to recover clock for a transient period. The MTIE measurement for the ACR clock fails during this time. After this transient period, a fresh MTIE measurement is performed. Similarly, when the GPS clock recovers, for the same difference in characteristics, ACR fails to recover clock and MTIE fails for a transient period.

This is an expected behavior.

- When large-sized packets are received along with the CEM packets by the devices in the core network or PSN traffic, CEM packets may incur delay with variance in delay. As ACR is susceptible to delay and variance in delay, MTIE measurement may fail. This behavior is documented in *ITU-T G.8261 section 10*.

This is an expected behavior.

- For a provisioned ACR clock that is in Acquired state, if the ACR clock configuration under the recovered-clock global configuration mode is removed and then reconfigured, the status of the ACR clock may initially be ACQUIRED and not FREERUN and then move to Acquiring. This happens because the ACR clock is not fully unprovisioned until the CEM circuit and the controller clock source recovered configuration are removed. Hence, the clock starts from the old state and then re-attempts to recover the clock.

This is an expected behavior.

Use the **show recovered-clock** command to verify the ACR of T1 interfaces for SAToP:

```
Router#show recovered-clock
Recovered clock status for subslot 0/1
-----
Clock Type Mode Port CEM Status Frequency Offset (ppb)
1 T1/E1 ADAPTIVE 3 1 ACQUIRED 100
```

Use the **show running-config** command to verify the recovery of adaptive clock of T1 interfaces:

```
Router#show running-config
controller T1 0/1/2
clock source recovered 1
cem-group 1 unframed
```

```

interface CEM0/1/3
cem 1
no ip address
xconnect 2.2.2.2 10
encapsulation mpls

```

## Associated Commands

Commands	Links
cem-group	<a href="http://www.cisco.com/c/en/us/td/docs/ios-xml/ios/interface/command/ir-cr-book/ir-c1.html#wp2440628600">http://www.cisco.com/c/en/us/td/docs/ios-xml/ios/interface/command/ir-cr-book/ir-c1.html#wp2440628600</a>
clock source	<a href="http://www.cisco.com/c/en/us/td/docs/ios-xml/ios/interface/command/ir-cr-book/ir-c2.html#wp3848511150">http://www.cisco.com/c/en/us/td/docs/ios-xml/ios/interface/command/ir-cr-book/ir-c2.html#wp3848511150</a>
clock recovered adaptive cem	<a href="http://www.cisco.com/c/en/us/td/docs/ios-xml/ios/interface/command/ir-cr-book/ir-c2.html#wp8894393830">http://www.cisco.com/c/en/us/td/docs/ios-xml/ios/interface/command/ir-cr-book/ir-c2.html#wp8894393830</a>
controller t1	<a href="http://www.cisco.com/c/en/us/td/docs/ios-xml/ios/interface/command/ir-cr-book/ir-c2.html#wp1472647421">http://www.cisco.com/c/en/us/td/docs/ios-xml/ios/interface/command/ir-cr-book/ir-c2.html#wp1472647421</a>
recovered-clock	<a href="http://www.cisco.com/c/en/us/td/docs/ios-xml/ios/interface/command/ir-cr-book/ir-c2.html">http://www.cisco.com/c/en/us/td/docs/ios-xml/ios/interface/command/ir-cr-book/ir-c2.html</a>



## CHAPTER 13

# Digital Optical Monitoring for Transceivers

---

Starting with release Cisco IOS XE Release 3.13, Digital Optical Monitoring (DOM) is supported for the SFP, SFP+, and XFP transceiver modules.

DOM is supported for ASR 900 RSP3 Module.

For information on DOM supported transceivers, see <https://supportforums.cisco.com/document/75181/digital-optical-monitoring-dom>.

For a list of modules, see [Cisco ASR 903 Series Aggregation Services Router Hardware Installation Guide](#).

Real time DOM data is collected from SFPs, SFP+, and XFPs periodically and compared with warning and alarm threshold table values.

The DOM data collected are transceiver transmit bias current, transceiver transmit power, transceiver receive power, and transceiver power supply voltage.

The syslog messages are displayed when alarm threshold values are crossed.



---

**Note** The transceiver parameters are not monitored when the port is in ADMIN-DOWN.

---





## CHAPTER 14

# Configuring the SDM Template

This section details the approximate number of resources supported in each templates for a router running the license.

- [Prerequisites for the SDM Template, on page 205](#)
- [Restrictions for the SDM Template, on page 205](#)
- [Information About the SDM Template, on page 207](#)
- [Selecting the SDM Template, on page 218](#)
- [Verifying the SDM Template, on page 220](#)
- [SDM Template Supported Features on RSP3 Module, on page 222](#)

## Prerequisites for the SDM Template

Before using an SDM template, you must set the license boot level.

For IPv6 QoS template, the license to use should be *metroipaccess*. You can view the license level using the **show version | in License Level** command



---

**Note** If you use *advancedmetroipaccess*, then your options may vary.

---

## Restrictions for the SDM Template

- Do not configure CoPP and BDI-MTU SDM templates together, as it is not supported.
- If you do not enable the EFP feature template, then there is no traffic flow between EFP and VFI (when EFP is with Split Horizon group and VFI is default). But when you enable the EFP feature template, then there is traffic flow between EFP and VFI because of design limitations.
- You cannot edit individual values in a template category as all templates are predefined.
- You cannot use a new SDM template without reloading the router.
- SDM templates are supported only by the Metro Aggregation Services license. Use the help option of the **sdm prefer** command to display the supported SDM templates.

- A mismatch in an SDM template between an active RSP and standby RSP results in a reload of the standby RSP. During reload, SDM template of the standby RSP synchronizes with the SDM template of the active RSP.
- To revert to the current SDM template after using the **sdm prefer** command (which initiates reload of a new SDM template), you must wait for the reload to complete.
- Using the **configure replace** command which results in changes in the current SDM template is not supported.
- The supported group numbers are for scaling in uni-dimension. When scaling in multidimension, the numbers can vary as certain features may share resources.
- When scaling, features using Multiprotocol Label Switching (MPLS) are limited by the number of MPLS labels.
- Internal TCAM usage that is reserved for IPv6 is 133-135 entries. TCAM space that is allotted for SDM template is 135 entries on the router.
- EAID Exhaust occurs when two paths are MPLS and two are IP. It does not occur if all the four paths are IP.
- The following restrictions apply to the maximum IPv6 QoS ACL SDM template:
  - The number of QoS ACL class maps and policy maps that are supported depends on the maximum TCAM entries available.
  - The software solution with expansion is applicable only for maximum QoS SDM template and more than eight Layer 4-port matches are supported for the maximum QoS SDM template. For other templates, due to hardware restriction, a maximum of eight Layer 4-port operators is supported per interface.
  - Ethernet CFM, Ethernet OAM, and Y.1731 protocols are not supported. Features dependent on these protocols are impacted.
  - Layer 2 monitoring features are not supported.
  - The S-TAG based fields are not supported for classification, if IPv6 address match exists in the policy-map.
  - Only eight Layer 4 operations are supported in templates other than maximum IPv6 QoS ACL template.





Note

Release	Time	Activity
16.6.1	49-50 mins	Reload to SSO bulk Sync state
16.7.1	50 mins	Reload to SSO bulk Sync state
16.8.1	-	-
16.9.1	75 mins	Reload to SSO bulk Sync state

## Information About the SDM Template

The SDM templates are used to optimize system resources in the router to support specific features, depending on how the router is used in the network. The SDM templates allocate Ternary Content Addressable Memory (TCAM) resources to support different features. You can select the default template to balance system resources or select specific templates to support the required features.

The following table shows the approximate number of each resource supported in each of the templates for a router running the Metro Aggregation Services license on RSP3.

**Table 15: Approximate Number of Feature Resources Allowed by Each SDM Template (RSP3)**

Functionality	Default Template (RPF )	IPv4 Template (No RPF)	IPv6 Template
MAC table	200K	200K	200K
IPv4/VPNv4 Routes	Without MPLS 32k urpf ipv4 routes + 160k ipv4 routes With MPLS 32k urpf ipv4 routes + 160k (ipv4 routes + mpls labels ) MPLS Labels = 32000	Without MPLS 192k ipv4 routes With MPLS 192k (ipv4 routes + mpls labels) MPLS Labels = 32000	Without MPLS 76k ipv4 routes With MPLS 76k (ipv4 routes + mpls labels ) MPLS Labels = 32000
IPv6/VPNv6 Routes	8192	8192	36864
uRPF IPv4 routes	32768	32768	32768
IPv4 mcast routes (mroutes)	4000	4000	4000
IPv6 mcast routes (mroutes)	1000	1000	1000

Functionality	Default Template (RPF)	IPv4 Template (No RPF)	IPv6 Template
Bridge Domains	4094	4094	4094
EoMPLS Tunnels	4000	4000	4000
MPLS VPN	1000	1000	1000
VRF Lite	1000	1000	1000
VPLS Instances <sup>3</sup>	3500	3500	3500
IPv4 ACL entries	1000 (984 user configurable)	1000 (984 user configurable)	1000 (984 user configurable)
IPv6 ACL entries	128 (124 user configurable)	128 (124 user configurable)	128 (124 user configurable)
v4 QoS Classifications	16000	16000	16000
v6 QoS Classifications	NS	NS	NS
Egress policers per ASIC	NS	NS	NS
OAM sessions	1000	1000	1000
IPSLA sessions	1000	1000	1000
EFP	16000	16000	16000
Maximum VLANs per port	4,000 per ASIC	4,000 per ASIC	4,000 per ASIC
Maximum VPLS neighbors	64	64	64
Maximum attachment circuit per BD	64	64	64
STP Instances	16	16	16
Maximum Etherchannel groups	48	48	48
Maximum Interfaces per Etherchannel groups	8	8	8
Maximum VRRP per system	255	255	255
Maximum HSRP per system	255	255	255
Maximum Ingress MPLS labels	32000	32000	32000

Functionality	Default Template (RPF)	IPv4 Template (No RPF)	IPv6 Template
Maximum FRR/TE Headend	500	500	500
Maximum FRR/TE Midpoints	5000	5000	5000
Maximum E-LMI sessions	128	128	128
Maximum BFD sessions	1023	1023	1023
Maximum SPAN/RSPAN sessions	10	10	10
Maximum Queue counters per ASIC/system	40000/48000	40000/48000	40000/48000
Maximum Policer counters per ASIC/system	12000/24000	12000/24000	12000/24000
Max BDI for L3	1000	1000	1000
Multicast OIF per group for VF Lite or mVPN	255	255	255
Multicast OIF per group for native multicast	255	255	255
Queues per ASIC/system	40000/48000	40000/48000	40000/48000
Max Queues per EFP	8	8	8
Ingress Classifications	16000	16000	16000
Egress Classifications	48000	48000	48000
Max Ingress Policers per ASIC/system	12000/24000	12000/24000	12000/24000
Max Egress Policers per ASIC/system	NS	NS	NS
Maximum EFPs per BD	256	256	256
Maximum number of BDI for PW	128	128	128
Maximum Layer 3 interfaces	1000	1000	1000
Max REP segments	NS	NS	NS
Maximum class-maps	1000	1000	1000

Functionality	Default Template (RPF )	IPv4 Template (No RPF)	IPv6 Template
Maximum policy maps	1000	1000	1000
Max number of OSPF Neighbors	400	400	400
Max number of ISIS neighbors	400	400	400
Max number of ISIS instances	30	30	30
Max number of BGP neighbors	250	250	250
Max number IEEE 802.1ag/Y.1731(CFM) instances at 1sec for xconnect	1000	1000	1000
Max number IEEE 802.1ag/Y.1731(CFM) instances at 3.3 ms for BD & xconnect	1000	1000	1000
Max number IEEE 802.1ag/Y.1731(CFM) instances at 100 ms for BD & xconnect	1000	1000	1000
Max number IEEE 802.1ag/Y.1731(CFM) instances at 1Sec for BD	1000	1000	1000
Max number of Y.1731 instances	1000	1000	1000
Maximum Class-maps in policy-map	512	512	512
Max number of match statements per class-map	16	16	16
Max number of BFD sessions at 3.3ms	1023	1023	1023
Max number of BFD sessions at 100ms	1023	1023	1023
Max number of BFD sessions at 1S	1023	1023	1023

Functionality	Default Template (RPF)	IPv4 Template (No RPF)	IPv6 Template
Max number of IGP Prefixes protected via LFA-FRR	1500	1500	1500
Max number of L3VPN Prefixes protected via LFA-FRR	4000	4000	4000
Max number of L2VPN sessions protected via LFA-FRR	2000	2000	2000

<sup>3</sup> From release 16.7.x the VPLS backup PW feature is supported, so if VPLS instance is configured then the maximum VPLS session is limited to 1000 instead of 3500.

The following table shows the approximate number of each resource supported in each of the templates for a router running the Metro Aggregation Services license on RSP2.

**Table 16: Approximate Number of Feature Resources Allowed by Each SDM Template (RSP2)**

Resource	Default Template	Video Template	IP Template	Maximum IPv6 QoS Template
Ingress Qos TCAM	4000	4000	4000	4000
Egress Qos TCAM	5000	5000	5000	5000
IPv6 ACL TCAM	1000	1000	1000	1000
ACL TCAM	4000	2000	4000	2000
MAC table	16000	16000	16000	16000
Virtual local area network (VLAN) mapping	4000	4000	65536	4000
IPv4 routes <sup>4</sup>	20000	12000	24000	20000
IPv6 routes	3962	3962	1914	3962
VPNv4 routes <sup>5</sup>	20000	12000	24000	20000
VPNv6 routes	3962	3962	1914	3962
IPv4 multicast routes (mroutes)	1000	2000	1000	1000
Layer 2 multicast groups <sup>6</sup>	NA	NA	NA	NA
Bridge Domains (BD)	4000	4000	4000	4000

Resource	Default Template	Video Template	IP Template	Maximum IPv6 QoS Template
MAC-in-MAC	0	0	0	0
Ethernet over MPLS (EoMPLS) tunnels	2000	2000	2000	2000
MPLS Virtual Private Network (VPN)	128	128	128	128
Virtual Routing and Forwarding (VRF) lite	128	128	128	128
Virtual Private LAN Services (VPLS) instances	2000	2000	2000	2000
Access Control List (ACL) entries <sup>7</sup>	2000	4000	2000	2000
Queues per Application-Specific Integrated Circuit (ASIC) <sup>8</sup>	4095	4095	4095	4095
IPv4 Quality of Service (QoS) classifications	4096	2048	4096	4096
Policers	4096	4096	4096	4096
Ethernet Operations, Administration, and Maintenance (OAM) sessions	1000	1000	1000	0
IP Service Level Agreements (IPSLA) sessions	1000	1000	1000	1000
Ethernet Flow Point (EFP)	8000	8000	8000	8000
Maximum VLANs per port	4094	4094	4094	4094
Maximum I-TAG per system	500	500	500	500
Maximum VPLS neighbors	64	64	64	64

Resource	Default Template	Video Template	IP Template	Maximum IPv6 QoS Template
Maximum attachment circuit per BD	128	128	128	128
STP Instances	16	16	16	16
Maximum Etherchannel groups	64	64	64	64
Maximum Interfaces per Etherchannel groups	8	8	8	8
Maximum Hot Standby Router Protocol (HSRP)	128 (For Cisco IOS-XE Release 3.14 and earlier) 256 (For Cisco IOS-XE Release 3.15 and later)	128 (For Cisco IOS-XE Release 3.14 and earlier) 256 (For Cisco IOS-XE Release 3.15 and later)	128 (For Cisco IOS-XE Release 3.14 and earlier) 256 (For Cisco IOS-XE Release 3.15 and later)	128 (For Cisco IOS-XE Release 3.14 and earlier) 256 (For Cisco IOS-XE Release 3.15 and later)
Maximum Virtual Router Redundancy Protocol (VRRP)	128 (For Cisco IOS-XE Release 3.14 and earlier) 255 (For Cisco IOS-XE Release 3.15 and later)	128 (For Cisco IOS-XE Release 3.14 and earlier) 255 (For Cisco IOS-XE Release 3.15 and later)	128 (For Cisco IOS-XE Release 3.14 and earlier) 255 (For Cisco IOS-XE Release 3.15 and later)	128 (For Cisco IOS-XE Release 3.14 and earlier) 255 (For Cisco IOS-XE Release 3.15 and later)
Maximum Ingress MPLS labels	32000	32000	32000	32000
Maximum Egress MPLS labels	28500	28500	28500	28500
Maximum Fast Reroute (FRR)/Traffic Engineering (TE) headend	500	500	500	500
Maximum FRR/TE midpoints	5000	5000	5000	5000
Maximum Enhanced Local Management Interface (E-LMI) sessions	1000	1000	1000	1000

Resource	Default Template	Video Template	IP Template	Maximum IPv6 QoS Template
Maximum Bidirectional Forwarding Detection (BFD) sessions	1023	1023	1023	1023
Maximum Switched Port Analyzer (SPAN)/Remote SPAN (RSPAN) sessions	32	32	32	32
Maximum Queue counters (packet & byte)	65536	65536	65536	65536
Maximum Policer counters (packet & byte)	49152	49152	49152	49152
Maximum number of BDI for Layer 3	1000	1000	1000	1000
IPv6 ACL	1000	1000	1000	2000
IPv6 QoS classification	4096	4096	4096	4096
Maximum Number of Layer 4 Source/Destination matches per interface <a href="#">9</a>	8	8	8	NA

<sup>4</sup> Using IPv4 and VPNv4 routes concurrently reduces the maximum scaled value as both the routes use the same TCAM space.

<sup>5</sup> Due to label space limitation of 16000 VPNv4 routes, to achieve 24000 VPNv4 routes in IP template use per VRF mode.

<sup>6</sup> Using Layer 2 and Layer 3 multicast groups concurrently reduces the scale number to 1947.

<sup>7</sup> ACLs contend for TCAM resources with Multicast Virtual Private Network (MVPN).

<sup>8</sup> User available queues are 1920.

<sup>9</sup> TCAM consumption for IPv6 QoS ACL Layer 4 port match operations increase with Maximum IPv6 QoS SDM template.

The following table shows the approximate number of each resource supported in each of the templates for a router running the Metro Aggregation Services license on RSP1A.



Table 17: Approximate Number of Feature Resources Allowed by Each SDM Template (RSP1A)

Resource	IP template	Video template
MAC table	16000	16000
Virtual local area network (VLAN) mapping	4000	4000
IPv4 routes <sup>10</sup>	24000	12000
IPv6 routes <sup>11</sup>	4000	4000
VPNv4 routes <sup>12</sup>	24000	12000
VPNv6 routes	4000	4000
IPv4 multicast routes (mroutes)	1000	2000
Layer 2 multicast groups <sup>13</sup>	1000	2000
Bridge Domains (BD)	4094	4094
MAC-in-MAC	0	0
Ethernet over MPLS (EoMPLS) tunnels	512	512
MPLS Virtual Private Network (VPN)	128	128
Virtual Routing and Forwarding (VRF) lite	128	128
Virtual Private LAN Services (VPLS) instances	26	26
Access Control List (ACL) entries <sup>14</sup>	2000	4000
Queues per Application-Specific Integrated Circuit (ASIC) <sup>15</sup>	2048	2048
IPv4 Quality of Service (QoS) classifications	4096	2048
Policers	1024	1024
Ethernet Operations, Administration, and Maintenance (OAM) sessions	1000	1000
IP Service Level Agreements (IPSLA) sessions	1000	1000
Ethernet Flow Point (EFP)	4000	4000
Maximum VLANs per port	4094	4094
Maximum I-TAG per system	500	500
Maximum VPLS neighbors	62	62

Resource	IP template	Video template
Maximum attachment circuit per BD	62	62
STP Instances	16	16
Maximum Etherchannel groups	26	26
Maximum Interfaces per Etherchannel groups	8	8
Maximum Hot Standby Router Protocol (HSRP)/Virtual Router Redundancy Protocol (VRRP)	128	128
Maximum Ingress MPLS labels	16000	16000
Maximum Egress MPLS labels	28500	28500
Maximum Fast Reroute (FRR)/Traffic Engineering (TE) headend	512	512
Maximum FRR/TE midpoints	5000	5000
Maximum Enhanced Local Management Interface (E-LMI) sessions	1000	1000
Maximum Bidirectional Forwarding Detection (BFD) sessions	511	511
Maximum Switched Port Analyzer (SPAN)/Remote SPAN (RSPAN) sessions	32	32
Maximum Queue counters (packet & byte)	65536	65536
Maximum Policer counters (packet & byte)	49152	49152
Maximum number of BDI for Layer 3	256	256
IPv6 ACL	1000	1000
IPv6 QoS classification	4096	2048

<sup>10</sup> Using IPv4 and VPNv4 routes concurrently reduces the maximum scaled value as both the routes use the same TCAM space.

<sup>11</sup> User available routes are 3967.

<sup>12</sup> Due to label space limitation of 16000 VPNv4 routes, to achieve 24000 VPNv4 routes in IP template use per VRF mode.

<sup>13</sup> Using Layer 2 and Layer 3 multicast groups concurrently reduces the scale number to 1947.

<sup>14</sup> ACLs contend for TCAM resources with Multicast Virtual Private Network (MVPN).

<sup>15</sup> User available queues are 1920.

The following table shows the approximate number of each resource supported in each of the templates for a router running the Metro Aggregation Services license on RSP1B.

**Table 18: Approximate Number of Feature Resources Allowed by Each SDM Template (RSP1B)**

Resource	VPNv4/v6 template	Video template
MAC table	256000	256000
IVLAN mapping	4000	4000
EVLAN mapping	4000	4000
Maximum VLANs per port	4094	4094
Maximum security addresses per EFP	1000	1000
Maximum security addresses per BD	10000	10000
Maximum security addresses	256000	256000
Maximum security configuration addresses	256000	256000
EFPs per BD	62	62
IPv4 routes	80000	80000
IPv6 routes	40000	8000
Maximum BD interfaces	1000	1000
Maximum ITAG per system	500	500
IPv4 routing groups <sup>16</sup>	2000	8000
IPv6 routing groups <sup>17</sup>	2000	8000
IPv4 multicast groups <sup>18</sup>	2000	10000
IPv6 multicast groups <sup>19</sup>	2000	10000
BDs	4000	4000
MAC-in-MAC	0	0
EoMPLS tunnels	8000	8000
MPLS VPN	1000	1000
Virtual Routing and Forwarding Scale (VRFS)	1000	1000
VPLS instances	2000	2000
Maximum VPLS neighbors	62	62
ACL entries	4000	4000
IPv6 ACL entries	1000	1000
Queues per ASIC	16384	16384

Resource	VPNv4/v6 template	Video template
Classifications	12288	12288
Ingress policers per ASIC	8192	8192
Egress policers per ASIC	4096	4096
Maximum class maps	4096	4096
Maximum policy maps	1024	1024
Maximum queue counters	65536	65536
Maximum policer counters	48152	48152
OAM sessions	4000	4000
ELMI sessions	1000	1000
SLA sessions	1000	1000
EFPs	8000	8000
MPLS ingress labels	64000	64000
MPLS egress labels	80000	80000
FRR TE headend	1000	1000
FRR TE midpoints	7000	7000
STP instances	128	128
BFD sessions	511	511
HSRP VRRP sessions	256	256
Maximum EC groups	16	16
Maximum interfaces per EC groups	8	8
Maximum SPAN RSPAN sessions	32	32
IPv4 tunnel entries	1000	1000
Maximum VPNv4 and VPNv6 pre-fixes <sup>20</sup>	64000	64000

<sup>16</sup> Overall multicast groups in video template can be scaled to 8000 individually or in combination with other multicast features. For example: IPv4 routing groups can be scaled to 8000 or IPv4 routing groups and IPv6 routing groups together can be scaled to 8000.

<sup>17</sup> See footnote 7.

<sup>18</sup> See footnote 7.

<sup>19</sup> See footnote 7.

<sup>20</sup> VPNv4 and VPNv6 together can be scaled up to 64000 in per-prefix mode.

## Selecting the SDM Template

To select an SDM template, complete the following steps:

## Procedure

	Command or Action	Purpose
<b>Step 1</b>	<b>enable</b> <b>Example:</b> Router> <b>enable</b>	Enables privileged EXEC mode. <ul style="list-style-type: none"> <li>• Enter your password if prompted.</li> </ul>
<b>Step 2</b>	<b>configure terminal</b> <b>Example:</b> Router# <b>configure terminal</b>	Enters global configuration mode.
<b>Step 3</b>	<b>sdm prefer {default   video   ip   mvpn_rsp1a   VPNv4/v6   max-ipv6-acl   enable_8k_efp   enable_copp   ipv4   ipv6   efp_feat_ext   enable_8k_efp   enable_copp   enable_l3vpn_cm   enable_l3vpn_cm   enable_match_inner_dscp   enable_portchannel_qos_multiple_active   vpls_stats_enable}</b> <b>Example:</b> Router(config)# <b>sdm prefer default</b>	Specifies the SDM template to be used on the router. <ul style="list-style-type: none"> <li>• default—Balances all functions.</li> <li>• video—Increases multicast routes and ACLs.</li> <li>• ip—Increases IPv4/VPNv4 routes. This option is available only on RSP1A.</li> <li>• mvpn_rsp1a—Supports MVPN. This option is available only on RSP1A.</li> <li>• VPNv4/v6—Increases IPv4/VPNv4 routes. This option is available only on RSP1B.</li> <li>• max-ipv6-acl—Supports IPv6 QoS ACL routes. The NEQ Layer 4 operation is supported in maximum IPv6 QoS ACL template.  The maximum IPv6 QoS ACL template works in metro IP services license for RSP2.</li> <li>• ipv4—Enables the IPv4 template. This is supported on the RSP3 module.</li> <li>• ipv6—Enables the IPv6 feature template. This is supported on the RSP3 module.</li> <li>• efp_feat_ext—Enables the EFP feature template. This is supported on the RSP3 module.</li> <li>• enable_8k_efp—Enables the 8K EFP feature template. This is supported on the RSP3 module.</li> <li>• enable_copp—Enables the COPP feature template. This is supported on the RSP3 module.</li> </ul>

	Command or Action	Purpose
		<ul style="list-style-type: none"> <li>• <code>enable_l3vpn_cm</code>—Enables the L3VPN conditional marking feature template. This is supported on the RSP3 module.</li> <li>• <code>enable_match_inner_dscp</code>—Enables the match inner dscp feature template. This is supported on the RSP3 module.</li> <li>• <code>enable_portchannel_qos_multiple_active</code>—Enables the port channel QoS multiple active feature template. This is supported on the RSP3 module.</li> <li>• <code>vpls_stats_enable</code>—Enables the VPLS statistics feature template. This is supported on the RSP3 module.</li> </ul> <p><b>Note</b> When changing the SDM template, the router waits for two minutes before reloading. Do not perform any operation till the router reloads.</p> <p><b>Note</b> For the new SDM template to take effect, you must save and reload the new configuration, otherwise the current SDM template is retained.</p>

## Verifying the SDM Template

You can use the following **show** commands to verify configuration of your SDM template:

- **show sdm prefer**—Displays the resource numbers supported by the specified SDM template.
- **show sdm prefer current**—Displays information about the active SDM template.

Following is a sample output using the **show sdm prefer current** command to display the current template configured on the router:

```

Router# show sdm prefer current
The current template is "video" template.

Router# show sdm prefer current
The current template is "max-ipv6-qos" template.

Router# show sdm prefer current
The current template is "max-qos-video" template.

Router# show platform hardware pp active sdm current
Tcam blocks
CYLON_TCAM_VLAN_MAPPING_INGRESS      =      4
CYLON_TCAM_VLAN_MAPPING_EGRESS       =      4
CYLON_TCAM_IPV4_UCAST                 =     12
CYLON_TCAM_IPV4_MCAST                 =      8
CYLON_TCAM_IPV4_TUNNEL                =      4
CYLON_TCAM_IPV6_UCAST                 =      8
CYLON_TCAM_IPV6_MCAST                 =      4

```

```

CYLON_TCAM_ACL = 8
CYLON_TCAM_QOS = 4
CYLON_TCAM_MAC_IN_MAC = 0
CYLON_TCAM_EOAM = 4
CYLON_TCAM_IPV6_ACL = 4
CYLON_TCAM_EGRESS_IPV6_ACL = 4
CYLON_TCAM_EGRESS_ACL = 0

Feature Scale value:
CYLON_NUM_MAC_TABLE_ENTRIES = 16000
CYLON_NUM_IVLAN_MAPPING_ENTRIES = 4001
CYLON_NUM_EVLAN_MAPPING_ENTRIES = 4000
CYLON_NUM_MAX_VLANS_PER_PORT = 4094
CYLON_NUM_MAX_SEC_ADDR_PER_EFP = 1000
CYLON_NUM_MAX_SEC_ADDR_PER_BD = 10000
CYLON_NUM_MAX_SEC_ADDR = 16000
CYLON_NUM_MAX_SEC_CONFIG_ADDR = 16000
CYLON_NUM_MAX_EFPS_PER_BD = 128
CYLON_NUM_IPV4_ROUTES = 12000
CYLON_NUM_IPV6_ROUTES = 4000
CYLON_NUM_MAX_L3_INTERFACES = 1000
CYLON_NUM_MAX_ITAG_PER_SYSTEM = 500
CYLON_NUM_ROUTING_GROUPS = 2000
CYLON_NUM_MULTICAST_GROUPS = 2000
CYLON_NUM_IPV6_ROUTING_GROUPS = 0
CYLON_NUM_IPV6_MULTICAST_GROUPS = 1000
CYLON_NUM_BRIDGE_DOMAINS = 4096
CYLON_NUM_MAC_IN_MAC = 0
CYLON_NUM_PSEUDO_WIRES = 2000
CYLON_NUM_ROUTED_PSEUDO_WIRES = 128
CYLON_NUM_MPLS_VPN = 128
CYLON_NUM_VRFS = 128
CYLON_NUM_ACL_ENTRIES = 4000
CYLON_NUM_IPV6_ACL_ENTRIES = 1000
CYLON_NUM_EGRESS_ACL_ENTRIES = 1000
CYLON_NUM_QUEUES_PER_ASIC = 4095
CYLON_NUM_CLASSIFICATIONS = 2048
CYLON_NUM_SH_ING_EGR_POLICERS_PER_ASIC = 4096
CYLON_NUM_MAX_CLASS_MAPS = 4096
CYLON_NUM_MAX_POLICY_MAPS = 1024
CYLON_NUM_MAX_QUEUE_COUNTERS = 65536
CYLON_NUM_MAX_POLICER_COUNTERS = 49152
CYLON_NUM_OAM_SESSIONS = 1000
CYLON_NUM_ELMF_SESSIONS = 1000
CYLON_NUM_SLA_SESSIONS = 1000
CYLON_NUM_EFPS = 4000
CYLON_NUM_MPLS_SERVICES = 512
CYLON_NUM_MPLS_INGRESS_LABELS = 38912
CYLON_NUM_MPLS_EGRESS_LABELS = 28500
CYLON_NUM_FRR_TE_HEADEND = 512
CYLON_NUM_FRR_TE_MIDPOINTS = 5000
CYLON_NUM_STP_INSTANCES = 16
CYLON_NUM_HSRP_VRRP_SESSIONS = 256
CYLON_NUM_MAX_EC_GROUPS = 64
CYLON_NUM_MAX_INTF_PER_EC_GROUP = 8
CYLON_NUM_MAX_SPAN_RSPAN_SESSIONS = 32
CYLON_NUM_IPV4_TUNNEL_ENTRIES = 2000

```

## SDM Template Supported Features on RSP3 Module

This section details the supported SDM template features on the RSP3 module. The `sdm prefer` command provides the following templates

**Table 19: SDM Templates and Supported Features**

SDM Template	Supported Feature
<code>sdm prefer vpls_stats_enable</code>	VPLS Statistics
<code>sdm prefer efp_feat_ext</code>	Split-Horizon Groups
<code>sdm prefer enable_8k_efp</code>	8K EFP (4 Queue Model)
<code>sdm prefer enable_match_inner_dscp</code>	Match Inner DSCP
<code>sdm prefer enable_copp</code>	Control Plane Policing
<code>sdm prefer enable_portchannel_qos_multiple_active</code>	QoS Support on Port Channel LACP Active Active 16K EFP Support on Port Channel
<code>sdm prefer ipv4_ipv6</code>	Enhance uRPF scale to 32K

### VPLS Statistics

VPLS statistic feature supports packet and byte count in ingress and egress directions. The following are the required criteria to enable this feature:

- Metro Aggregation services license
- Special SDM template

Use the following commands to enable or disable VPLS statistics feature:

```
sdm prefer vpls_stats_enable
sdm prefer vpls_stats_disable
```

After template configuration, the node is auto reloaded.

#### Restrictions

- EFP statistics is not supported when VPLS statistics is enabled.
- Transit packet drops data is not supported.
- There is a sync time of 10 seconds between the software and the hardware for fetching the statistics.
- If access rewrite is configured (pop 1), VC statistics show 4 bytes less than the actual size (in both imposition and disposition node) because pop 1 removes the VLAN header.
- VC statistics do not account LDP and VC label. It displays what is received from access in both imposition and disposition node.

#### Example



The following example shows a sample VPLS Statics counter output:

```
router#show mpls l2transport vc 2200 detail

Local interface: Gi0/14/2 up, line protocol up, Ethernet:100 up
  Destination address: 10.163.123.218, VC ID: 2200, VC status: up
  Output interface: Te0/7/2, imposed label stack {24022 24025}
  Preferred path: not configured
  Default path: active
  Next hop: 10.163.122.74
Create time: 20:31:49, last status change time: 16:27:32
  Last label FSM state change time: 16:27:44
Signaling protocol: LDP, peer 10.163.123.218:0 up
  Targeted Hello: 10.163.123.215(LDP Id) -> 10.163.123.218, LDP is UP
  Graceful restart: configured and enabled
  Non stop routing: configured and enabled
Status TLV support (local/remote)   : enabled/supported
  LDP route watch                    : enabled
  Label/status state machine         : established, LruRru
  Last local dataplane status rcvd: No fault
  Last BFD dataplane status rcvd: Not sent
  Last BFD peer monitor status rcvd: No fault
  Last local AC circuit status rcvd: No fault
  Last local AC circuit status sent: No fault
  Last local PW i/f circ status rcvd: No fault
  Last local LDP TLV status sent: No fault
  Last remote LDP TLV status rcvd: No fault
  Last remote LDP ADJ status rcvd: No fault
MPLS VC labels: local 110, remote 24025
Group ID: local 40, remote 67109248
MTU: local 9000, remote 9000
  Remote interface description: TenGigE0_0_2_3.2200
Sequencing: receive disabled, send disabled
Control Word: Off (configured: autosense)
SSO Descriptor: 10.163.123.218/2200, local label: 110
Dataplane:
  SSM segment/switch IDs: 16911/90633 (used), PWID: 71
VC statistics:
  transit packet totals: receive 100, send 200
  transit byte totals:   receive 12800, send 25600
  transit packet drops: receive 0, seq error 0, send 0
```

## Split Horizon Enhancements on the RSP3 Module

Starting with Cisco IOS XE Release 16.6.1, the **efp\_feat\_ext** template is introduced. This template when enabled allows configuration of two split-horizon groups on the EVC bridge-domain.

- Two Split-horizon groups—Group 0 and Group 1 are configured through using the **bridge-domain *bd number* split-horizon group 0-1** command.

### Prerequisites for Split-Horizon Groups on the RSP3 Module

- The **efp\_feat\_ext** template must be configured to enable the feature.
- Metro services license must be enabled; **LICENSE\_ACTIVE\_LEVEL=metroaggrservices,all:ASR-903**;

## Restrictions for Split-Horizon Groups on the RSP3 Module

- The overall scale of EFPs is 8K, only if the split-horizon groups are configured. For information, see supported scale.



---

**Note** If split-horizon based-EFPs are not configured, the total EFPs supported are 4K.

---

- EFPs configured on the same bridge domain and same split-horizon group, cannot forward to or receive traffic from each other.
- We do not recommend configuration of Y.1564 and split-horizon group on the same EFP.
- We do not recommend configuring MAC security with split-horizon group.
- Split-horizon group is not supported for CFM on this template. Configuring split-horizon groups on CFM based MEPs may result in MEPs being unlearned, and unexpected behavior may be observed.
- If ethernet loopback is configured, and if a dynamic change in split-horizon group occurs on the EFP-BD, the ELB session must be restarted.
- A change in the split-horizon group configuration on a regular EFP results in hardware programming update and may impact L2 traffic. This results in a MAC-flush and re-learn of traffic with new MAC address.

Following are known behavior of split-horizon groups:

- Changing the split-horizon group on any EFP, results in traffic flooding back to same EFP for few milliseconds.
- A small traffic leak may be observed on defaulting an interface with higher number of EFP with split-horizon configured.
- BFD flaps and underlying IGP flaps may be observed upon changing split-horizon groups, if BFD is hardware based.

## Split-Horizon Supported Scale

8K EFPs are supported across RSP3-400 and 4K EFPs on RSP3-200.



---

**Note** If Split-horizon configuration does not exist, number of EFPs supported are reduced to 4K EFPs.

---

**Table 20: Split-Horizon Supported Template**

Split-Horizon Group	RSP3-400	RSP3-200
Default (No config)	4K EFP	2K EFP
Group 0	2K EFP	1K EFP
Group 1	2K EFP	1K EFP



**Note** Port-channel scale is half the regular scale of the EFP.

## Configuring Split-Horizon Group on the RSP3 Module

```
interface GigabitEthernet0/2/2
service instance 1 ethernet
  encapsulation dot1q 100
  bridge-domain 100 split-horizon group 0  When you configure split-horizon group 0, (0
is optional)

interface GigabitEthernet0/2/2
service instance 2 ethernet
  encapsulation dot1q 102
  bridge-domain 102 split-horizon group 1  When you configure split-horizon group 1
```

## 8K EFP (4 Queue Model)

In Cisco IOS XE Release 3.18SP, the 8K EFP (4 Queue Model) support allows up to 8000 EFPs at the system level. EFP scale implementation follows the static model, that is, eight queues are created per EFP by default.

### Information About 8000 (8K) EFP

- In default model, 5000 EFPs can be configured on Cisco ASR 903 RSP3 module.
- The Switch Database Management (SDM) template feature can be used to configure 8000 EFPs across ASIC( 4000 EFPs per ASIC interfaces).
- In 8K EFP model, each EFP consumes four Egress queues. If 8K EFP SDM template is not enabled, each EFP consumes eight Egress queues.
- Ingress policy map can specify more than eight traffic classes based on PHB matches, which remains the same. However, Egress policy map can have three user defined class and class-default class.
- Each Egress class-maps can be mapped to a single or multiple traffic classes and each class-map mapped to a single queue.
- Maximum of two queues are set to Priority according to policy configuration.
- All the existing QOS restrictions that apply in default model are also applicable to 8K EFP model.

### Prerequisites for 8000 (8K) EFP

- Activate the Metro Aggregation Services license on the device.
- To configure 8000 EFPs, enable the SDM template using CLI **sdm prefer enable\_8k\_efp**.
- Reset the SDM template using the CLI **sdm prefer disable\_8k\_efp**.

### Restrictions for 8000 (8K) EFP

- Traffic class to Queue mapping is done per interface and not per EVC.
- Four traffic classes including class-default can be supported in Egress policy.

- Same three traffic classes or subset of three traffic classes match is supported on EVCs of an interface.
- Traffic classes to queue mapping profiles are limited to four in global, hence excluding class-default, only three mode unique combinations can be supported across interfaces.
- TRTCM always operates with conform-action transmit, exceed-action transmit and violate-action drop.
- By default, 1R2C Policer will behave as 1R3C Policer in 4 Queue model.
- All the QOS restrictions that is applicable in default mode is also applicable in 8k EFP mode

## Configuring 8K Model

### Configuring 8K EFP Template

Below is the sample configuration to enable 8K EFP or 4 Queue mode template. On enabling **sdm prefer enable\_8k\_efp**, the router reloads and boots up with 8K EFP template.

```
RSP3-903(config)#sdm prefer enable_8k_efp
```

```
Template configuration has been modified. Save config and Reload? [yes/no]: yes
Building configuration...
```

```
Jul 22 05:58:30.774 IST: Changes to the EFP template preferences have been stored[OK]
Proceeding with system reload...
Reload scheduled for 06:00:38 IST Fri Jul 22 2016 (in 2 minutes) by console
Reload reason: EFP template change
```

### Verifying 8K EFP Template

You can verify the current template as below.

```
Device#sh sdm prefer current
```

```
The current sdm template is "default" template and efp template is "enable_8k_efp" template
```

### Configuring QOS in 8K EFP Model

Below is sample configuration to configure egress policy map when 4Q mode is enabled.

```
Device#enable
Device#configure terminal
Device(config)#interface GigabitEthernet0/3/0
Device(config-if)#service instance 10 e
Device(config-if-srv)#service-policy output egress
```

```
Current configuration : 193 bytes
!
policy-map egress
class qos2
  shape average 2000000
class qos3
  shape average 3000000
class qos4
  shape average 4000000
class class-default
  shape average 5000000
!
end
```

```
Device#sh run class-map qos2
Building configuration...

Current configuration : 54 bytes
!
class-map match-all qos2
match qos-group 2
!
end

Device#sh run class-map qos3
Building configuration...

Current configuration : 54 bytes
!
class-map match-all qos3
match qos-group 3
!
end

Device#sh run class-map qos4
Building configuration...

Current configuration : 54 bytes
!
class-map match-all qos4
match qos-group 4
!
end
```

## Verifying QOS in 8K EFP Model

You need to verify the interface and policy-map details to check 8K model queue is working.

```
Device# show run interface g0/3/0
Building configuration...

Current configuration : 217 bytes
!
interface GigabitEthernet0/3/0
no ip address
negotiation auto
service instance 10 ethernet
  encapsulation dot1q 10
  rewrite ingress tag pop 1 symmetric
  service-policy output egress
  bridge-domain 10
!
end

Router#show running-config policy-map egress
Building configuration...

Current configuration : 193 bytes
!
policy-map egress
class qos2
shape average 2000000
class qos3
shape average 3000000
class qos4
shape average 4000000
```

```

class class-default
shape average 5000000
!
end

Device#sh policy-map int g0/3/0 serv inst 10
Port-channel10: EFP 10

Service-policy output: egress

Class-map: qos2 (match-all)
122566 packets, 125262452 bytes
30 second offered rate 0000 bps, drop rate 0000 bps
Match: qos-group 2
Queueing
queue limit 4096000 us/ 1024000 bytes
(queue depth/total drops/no-buffer drops) 1032720/119746/0
(pkts output/bytes output) 2820/2882040
shape (average) cir 2000000, bc 8000, be 8000
target shape rate 2000000

Class-map: qos3 (match-all)
122566 packets, 125262452 bytes
30 second offered rate 0000 bps, drop rate 0000 bps
Match: qos-group 3
Queueing
queue limit 2730666 us/ 1024000 bytes
(queue depth/total drops/no-buffer drops) 1032720/118806/0
(pkts output/bytes output) 3760/3842720
shape (average) cir 3000000, bc 12000, be 12000
target shape rate 3000000

Class-map: qos4 (match-all)
245131 packets, 250523882 bytes
30 second offered rate 0000 bps, drop rate 0000 bps
Match: qos-group 4
Queueing
queue limit 2048000 us/ 1024000 bytes
(queue depth/total drops/no-buffer drops) 1032720/239961/0
(pkts output/bytes output) 5170/5283740
shape (average) cir 4000000, bc 16000, be 16000
target shape rate 4000000

Class-map: class-default (match-any)
245131 packets, 250523882 bytes
30 second offered rate 0000 bps, drop rate 0000 bps
Match: any
Queueing
queue limit 1638400 us/ 1024000 bytes
(queue depth/total drops/no-buffer drops) 1032720/239961/0
(pkts output/bytes output) 5170/5283740
shape (average) cir 5000000, bc 20000, be 20000
target shape rate 5000000
Device#

```

## 16K EFP Support on Port Channel

Starting with Cisco IOS XE 16.8.1 release, 16K EFPs on port channel are supported on the RSP3 module.

The following are the key features supported:

- In order to enable 16K EFP over a port channel, you need to enable the following template:

**enable\_portchannel\_qos\_multiple\_active**

- 16000 EFPs are supported on the RSP3 module (8K EFPs are supported per ASIC). Each port can have a maximum of 8K EFPs configured.
- 8K bridge domains are supported.
- On the RSP3 module, 1024 BDI interfaces that include physical interface, port channel interface, and BDI are available, and these interfaces can be configured upto 4096 BDI interfaces.



**Note** If a port channel is configured on an application-specific integrated circuit (ASIC), for example ASIC 0 , then ensure that physical members to be added to port channel also should be in the same ASIC.

## Restrictions for 16K EFP on Port Channel

- G.8032, SADT, CFM, and TEFM are not supported on the port channel.
- 16k EFP scale is not supported if SDM template is enabled for split horizon scale.
- Minimal traffic outage (for example, in milliseconds) is observed, when a policy map is applied or removed.
- In a complete scale environment, the EFP statistics update requires more than 1 minute to complete.

## Configuring 16K EFP on Port Channel

To configure 16K EFP on port channel, use the following commands:

```
router>enable
router#configure terminal
router(config)#sdm prefer enable_portchannel_qos_multiple_active
router(config)#platform port-channel 10 members-asic-id 1
router(config)#platform qos-port-channel_multiple_active port-channel 10
router(config)#interface port-channel 10
router(config-if)#end
```

After the SDM template update, the device reloads automatically and you need to enter *yes* to save the configuration.

## Verifying 16k EFP on Port Channel

The following are examples to verify for 16K EFP configuration on port channel.

### show etherchannel summary

```
Router# show etherchannel summary
Flags: D - down          P/bndl - bundled in port-channel
       I - stand-alone  s/susp - suspended
       H - Hot-standby (LACP only)
       R - Layer3       S - Layer2
       U - in use       f - failed to allocate aggregator
       M - not in use, minimum links not met
       u - unsuitable for bundling
       w - waiting to be aggregated
       d - default port
```

```

Number of channel-groups in use: 1
Number of aggregators:          1
Group  Port-channel  Protocol  Ports
-----+-----+-----+-----
10      Po10 (RU)          LACP    Te0/5/0 (bndl) Te0/5/1 (bndl)

RU - L3 port-channel UP State
SU - L2 port-channel UP state
P/bndl - Bundled
S/susp  - Suspended

```

### show ethernet service instance id interface stats

```

Router# show ethernet service instance id 12000 interface port-channel 10 stats
Port maximum number of service instances: 16000
Service Instance 12000, Interface port-channel 10
  Pkts In   Bytes In   Pkts Out   Bytes Out
    252     359352     252       359352

```

### show ethernet service instance summary

```

Router# show ethernet service instance summary
System summary
  Total      Up  AdminDo   Down  ErrorDi  Unknown  Deleted  BdAdmDo
bdomain    16000  16000     0      0      0        0        0
xconnect     0        0     0      0      0        0        0
local sw     0        0     0      0      0        0        0
other        0        0     0      0      0        0        0
all         16000  16000     0      0      0        0        0
Associated interface: port-channel 10
  Total      Up  AdminDo   Down  ErrorDi  Unknown  Deleted  BdAdmDo
bdomain     8000   8000     0      0      0        0        0
xconnect     0        0     0      0      0        0        0
local sw     0        0     0      0      0        0        0
other        0        0     0      0      0        0        0
all          8000   8000     0      0      0        0        0
Associated interface: port-channel 11
  Total      Up  AdminDo   Down  ErrorDi  Unknown  Deleted  BdAdmDo
bdomain     8000   8000     0      0      0        0        0
xconnect     0        0     0      0      0        0        0
local sw     0        0     0      0      0        0        0
other        0        0     0      0      0        0        0
all          8000   8000     0      0      0        0        0

```

## Control Plane Policing

The Control Plane Policing feature allows you to configure a quality of service (QoS) filter that manages the traffic flow of control plane packets to protect the control plane of routers and switches against reconnaissance and denial-of-service (DoS) attacks. In this way, the control plane (CP) can help maintain packet forwarding and protocol states despite an attack or heavy traffic load on the router or switch.

### Restrictions for Control Plane Policing

#### Input Rate-Limiting Support

Input rate-limiting is performed in silent (packet discard) mode. Silent mode enables a router to silently discard packets using policy maps applied to input control plane traffic with the **service-policy input** command. For more information, see the “Input Rate-Limiting and Silent Mode Operation” section.



### MQC Restrictions

The Control Plane Policing feature requires the Modular QoS CLI (MQC) to configure packet classification and traffic policing. All restrictions that apply when you use the MQC to configure traffic policing also apply when you configure control plane policing.

### Match Criteria Support

Only the extended IP access control lists (ACLs) classification (match) criteria is supported.

## Restrictions for CoPP on the RSP3

- `sdm prefer enable_copp` template must be enabled on the the RSP3 module to activate COPP.
- Ingress and Egress marking are not supported.
- Egress COPP is not supported. COPP with marking is not supported.
- CPU bound traffic (punted traffic) flows is supported via the same queue with or without CoPP.
- Only match on access group is supported on a CoPP policy.
- Hierarchical policy is not supported with CoPP.
- Class-default is not supported on CoPP policy.
- User defined ACLs are not subjected to CoPP classified traffic.
- A CoPP policy map applied on a physical interface is functional.
- When COPP template is enabled, classification on outer Vlan, inner Vlan, Inner Vlan Cos, destination MAC address, source IP address, and destination IP address are not supported.  
The template-based model is used to enable COPP features and disable some of the above mentioned QOS classifications.
- When `sdm prefer enable_copp` template is enabled, `sdm prefer enable_match_inner_dscp` template is not supported.
- Only IP ACLs based class-maps are supported. MAC ACLs are not supported.
- Multicast protocols like PIM, IGMP are not supported.
- Only CPU destined Unicast Layer3 protocols packets are matched as part of COPP classification.

### Restrictions on Firmware

- Port ranges are not supported.
- Only exact matches are supported, greater than, less than and not equal are not supported.
- Internet Control Message Protocol (ICMP) inner type's classification not supported.
- Match any is only supported at class-map level.
- Policing action is supported on a CoPP policy map.

## Supported Protocols

The following table lists the protocols supported on Control Plane Policing feature.

Supported Protocols	Criteria	Match	Queue#
TFTP - Trivial FTP	Port Match	IP access list ext copp-system-acl-tftp permit udp any any eq 69	NQ_CPU_HOST_Q
TELNET	Port Match	IP access list ext copp-system-acl-telnet permit tcp any any eq telnet	NQ_CPU_CONTROL_Q
NTP - Network Time Protocol	Port Match	IP access list ext copp-system-acl-ntp permit udp any any eq ntp	NQ_CPU_HOST_Q
FTP - File Transfer Protocol	Port Match	IP access list ext copp-system-acl-ftp permit tcp host any any eq ftp	NQ_CPU_HOST_Q
SNMP - Simple Network Management Protocol	Port Match	IP access list ext copp-system-acl-snmp permit udp any any eq snmp	NQ_CPU_HOST_Q
TACACS - Terminal Access Controller Access-Control System	Port Match	IP access list ext copp-system-acl-tacacs permit tcp any any tacacs	NQ_CPU_HOST_Q
FTP-DATA	Port Match	IP access list ext copp-system-acl-ftpdata permit tcp any any eq 20	NQ_CPU_HOST_Q
HTTP - Hypertext Transfer Protocol	Port Match	IP access list ext copp-system-acl-http permit tcp any any eq www	NQ_CPU_HOST_Q
WCCP - Web Cache Communication Protocol	Port Match	IP access list ext copp-system-acl-wccp permit udp any eq 2048 any eq 2048	NQ_CPU_HOST_Q

Supported Protocols	Criteria	Match	Queue#
SSH - Secure Shell	Port Match	IP access list ext copp-system-acl-ssh permit tcp any any eq 22	NQ_CPU_HOST_Q
ICMP - Internet Control Message Protocol	Protocol Match	IP access list copp-system-acl-icmp permit icmp any any	NQ_CPU_HOST_Q
DHCP - Dynamic Host Configuration Protocol	Port Match	IP access list copp-system-acl-dhcp permit udp any any eq bootps	NQ_CPU_HOST_Q
MPLS- OAM	Port Match	IP access list copp-system-acl-mplsoam permit udp any eq 3503 any	NQ_CPU_HOST_Q
LDP - Label Distribution Protocol	Port Match	IP access list copp-system-acl-ldp permit udp any eq 646 any eq 646 permit tcp any any eq 646	NQ_CPU_CFM_Q
RADIUS - Remote Authentication Dial In User Service	Port Match	IP access list copp-system-radius permit udp any any eq 1812 permit udp any any eq 1813 permit udp any any eq 1645 permit udp any any eq 1646 permit udp any eq 1812 any permit udp any eq 1813 any permit udp any eq 1645 any	NQ_CPU_HOST_Q

## Input Rate-Limiting and Silent Mode Operation

A router is automatically enabled to silently discard packets when you configure input policing on control plane traffic using the **service-policy input** *policy-map-name* command.

Rate-limiting (policing) of input traffic from the control plane is performed in silent mode. In silent mode, a router that is running Cisco IOS XE software operates without receiving any system messages. If a packet that is entering the control plane is discarded for input policing, you do not receive an error message.

## How to Use Control Plane Policing

### Defining Control Plane Services

Perform this task to define control plane services, such as packet rate control and silent packet discard for the RP.

#### Before you begin

Before you enter control-plane configuration mode to attach an existing QoS policy to the control plane, you must first create the policy using MQC to define a class map and policy map for control plane traffic.

- Platform-specific restrictions, if any, are checked when the service policy is applied to the control plane interface.
- Input policing does not provide any performance benefits. It simply controls the information that is entering the device.

#### Procedure

##### Step 1 enable

###### Example:

```
Device> enable
```

Enables privileged EXEC mode.

- Enter your password if prompted.

##### Step 2 configure terminal

###### Example:

```
Device# configure terminal
```

Enters global configuration mode.

##### Step 3 control-plane

###### Example:

```
Device(config)# control-plane
```

Enters control-plane configuration mode (which is a prerequisite for defining control plane services).

##### Step 4 service-policy [input |output] policy-map-name

###### Example:

```
Device(config-cp)# service-policy input control-plane-policy
```

Attaches a QoS service policy to the control plane.

- **input**—Applies the specified service policy to packets received on the control plane.
- *policy-map-name*—Name of a service policy map (created using the **policy-map** command) to be attached.

#### Step 5 end

#### Example:

```
Device(config-cp)# end
```

(Optional) Returns to privileged EXEC mode.

## Configuration Examples for Control Plane Policing

### Example: Configuring Control Plane Policing on Input Telnet Traffic

```
! Rate-limit all other Telnet traffic.
Device(config)# access-list 140 permit tcp any any eq telnet

! Define class-map "telnet-class."
Device(config)# class-map telnet-class
Device(config-cmap)# match access-group 140
Device(config-cmap)# exit
Device(config)# policy-map control-plane-in
Device(config-pmap)# class telnet-class
Device(config-pmap-c)# police 80000 conform transmit exceed drop
Device(config-pmap-c)# exit
Device(config-pmap)# exit

! Define aggregate control plane service for the active route processor.
Device(config)# control-plane
Device(config-cp)# service-policy input control-plane-in
Device(config-cp)# end
```

## Verification Examples for CoPP

The following example shows how to verify control plane policing on a policy map.

```
Router# show policy-map control-plane
Control Plane
Service-policy input: control-plane-in
Class-map: telnet-class (match-all)
  10521 packets, 673344 bytes
  5 minute offered rate 18000 bps, drop rate 15000 bps
Match: access-group 102
  police: cir 64000 bps, bc 8000 bytes
  conformed 1430 packets, 91520 bytes; actions:
  transmit
  exceeded 9091 packets, 581824 bytes; actions:
  drop
  conformed 2000 bps, exceeded 15000 bps
Class-map: class-default (match-any)
  0 packets, 0 bytes
```

```
5 minute offered rate 0000 bps, drop rate 0000 bps
Match: any
```

The following command is used to verify the TCAM usage on the router.

```
Router# show platform hardware pp active feature qos resource-summary 0
RSP3 QoS Resource Summary
```

```
Type Total Used Free
-----
QoS TCAM 2048 2 2046
VOQs 49152 808 48344
QoS Policers 32768 2 32766
QoS Policer Profiles 1023 1 1022
Ingress CoS Marking Profiles 16 1 15
Egress CoS Marking Profiles 16 1 15
Ingress Exp & QoS-Group Marking Profiles 64 3 61
Ingress QoS LPM Entries 32768 0 32768
```

## QoS Support on Port Channel LACP Active Active

Link Aggregation Control Protocol (LACP) supports the automatic creation of ether channels by exchanging LACP packets between LAN ports. Cisco IOS XE Everest 16.6.1 release introduces the support of QoS on port channel LACP active active mode. A maximum of eight member links form a port channel and thus the traffic is transported through the port channel. This feature is supported on Cisco RSP3 Module.

### Benefits of QoS Support on Port Channel LACP Active Active

- This feature facilitates increased bandwidth.
- The feature supports load balancing.
- This features allows support on QoS on Port Channel with one or more active member links.

### Restrictions for QoS Support on Port Channel Active Active

- Policy-map on member links is not supported.
- 100G ports and 40G ports cannot be a part of the port channel.
- Total number of port channel bandwidth supported on a given ASIC should not exceed 80G.
- This feature is not supported on multicast traffic.
- Only 3k service instance (EFP) scale is supported on port channel active active.
- Ensure that 2-3 seconds of delay is maintained before and after unconfiguring and re-configuring the port channel with the **platform qos-port-channel\_multiple\_active** command.



---

**Note** This delay increases when you have scaled EVC configurations on the port channel.

---

## Configuring QoS Support on Port Channel Active Active

### Enabling Port Channel Active/Active

Use the following commands to enable port channel active active:

```
enable
configure terminal
sdm prefer enable_portchannel_qos_multiple_active
end
```



**Note** The device restarts after enabling the `sdm prefer enable_portchannel_qos_multiple_active` command. After a successful reboot, verify the configuration using the command `show sdm prefer current`

### Disabling Port Channel Active/Active

Use the following commands to disable port channel active active:

```
enable
configure terminal
sdm prefer disable_portchannel_qos_multiple_active
end
```

### Configuring Active Active Port Channel per bundle

Use the following commands to configure active active port channel per bundle:

```
enable
configure terminal
platform qos-port-channel_multiple_active 10
end
```

### Creating Port Channel Interface

Use the following commands to configure the port channel interface:

```
enable
configure terminal
interface port-channel 10
no shutdown
end
```

### Attaching member link to port channel

Use the following commands to attach a member link to the port channel:

```
enable
configure terminal
interface Te0/4/0
channel-group 10 mode active
end
```

### Configuring QoS Class Map and Policy Map

Use the following commands to configure QoS class map and policy map:

```
enable
configure terminal
class-map match-any qos1
match qos-group 1
class-map match-any qos2
match qos-group 2
policy-map policymapqos
```

```

class qos1
shape average 10000 k
class qos2
shape average 20000 k
end

```

### Attaching Configured Policy Map (policymapqos) on Port Channel Interface on Egress Direction

Use the following commands to attach the configured policy map (policymapqos) on the port channel interface on egress direction:

```

enable
configure terminal
interface port-channel 10
service-policy output policymapqos
end

```

## Verification of QoS Support on Port Channel LACP Active Active

Use the commands below to verify the port channel summary details:

```

Device#show etherchannel summary
Flags: D - down          P/bndl - bundled in port-channel
       I - stand-alone  s/susp - suspended
       H - Hot-standby (LACP only)
       R - Layer3       S - Layer2
       U - in use       f - failed to allocate aggregator

       M - not in use, minimum links not met
       u - unsuitable for bundling
       w - waiting to be aggregated
       d - default port

```

```

Number of channel-groups in use: 1
Number of aggregators:          1

```

Group	Port-channel	Protocol	Ports
10	Po10 (RU)	LACP	Te0/4/0 (bndl)

Use the commands below to verify the attached policy map on the port channel interface:

```

Device#show policy-map interface brief
Service-policy input: ingress
TenGigabitEthernet0/4/0
Service-policy output: policymapqos
Port-channel10

```

```

Device#show policy-map interface po10
Port-channel10

```

```

Service-policy output: policymapqos

Class-map: qos1 (match-any)
 1027951 packets, 1564541422 bytes
 30 second offered rate 50063000 bps, drop rate 40020000 bps
Match: qos-group 1
Queueing
queue limit 819200 us/ 1024000 bytes
(queue depth/total drops/no-buffer drops) 0/821727/0
(pkts output/bytes output) 206224/313872928
shape (average) cir 10000000, bc 40000, be 40000
target shape rate 10000000

```



```

Class-map: qos2 (match-any)
  852818 packets, 1297988996 bytes
  30 second offered rate 41534000 bps, drop rate 21447000 bps
Match: qos-group 2
Queueing
queue limit 409600 us/ 1024000 bytes
(queue depth/total drops/no-buffer drops) 0/440370/0
(pkts output/bytes output) 412448/627745856
shape (average) cir 20000000, bc 80000, be 80000
target shape rate 20000000

Class-map: class-default (match-any)
  1565 packets, 118342 bytes
  30 second offered rate 3000 bps, drop rate 0000 bps
Match: any

queue limit 102 us/ 1024000 bytes
(queue depth/total drops/no-buffer drops) 0/0/0
(pkts output/bytes output) 1565/118342

```

Use the commands below to verify the configuration after enabling port channel active/active mode:

```

#show sdm prefer current
The current sdm template is "default"
The current portchannel template is "enable_portchannel_qos_multiple_active"

```

## Match Inner DSCP on RSP3 Module

Starting with Cisco IOS XE Release 16.6.1, the `match_inner_dscp` template is introduced. This template allows DSCP policy map configuration on the RSP3 module for MPLS and tunnel terminated traffic.

### Restrictions for Match Inner DSCP on RSP3 Module

- The IPv4 DSCP policy map configuration is not preserved in case of protection scenarios, where either primary or backup path is plane IP path and backup or primary is MPLS label path.
- Match on Inner DSCP for IPv6 is not supported.
- Only 1024 entries IPv4 TCAM entries are available. Hence, optimized usage of classes is recommended for configuration when policy map is applied on port channel or port or EFP.
- To support match on Inner DSCP for IPv4 when packets have MPLS forwarding type, three TCAM entries are added whenever there is a class map with match DSCP is configured.

One match is for normal DSCP scenario, one entry for Inner DSCP when outer header is MPLS header and other entry is when there is tunnel termination.

In Split Horizon template, each match DSCP class consumes 3 TCAM entries. For non-Split Horizon template, TCAM entries are one. For Class default, number of entries consumed is one. For TEFP, six entries are required for each match DSCP Class Map and two for class default.



---

**Note** Some of the IPv4 qualifiers are not supported when Split Horizon template is configured as there are limitation of Copy Engines in IPv4 Resource database. Whenever Split Horizon template is enabled, four new qualifiers are added in IPV4 QoS Field Group.

---

**RSP3-400 High Availability**

Z

**Table 21:**

Release Notes	Activity	Time
16.6.x	49-50 min	SSO bulk sync state

**Configuring Match Inner DSCP on RSP3 Module**

```

Class-map match-any dscp
Match dscp af13
exit
policy-map matchdscp
Class dscp
Police cir 1000000end

```

**Verifying Match Inner DSCP on RSP3 Module**

```

Router# show platform hardware pp active feature qos resource-summary 0
PE1#res
RSP3 QoS Resource Summary

```

Type	Total	Used	Free
-----			-----
QoS TCAM	1024	0	1024
VOQs	49152	408	48744
QoS Policers	32768	0	32768
QoS Policer Profiles	1023	0	1023
Ingress CoS Marking Profiles	16	1	15
Egress CoS Marking Profiles	16	1	15
Ingress Exp & QoS-Group Marking Profiles	64	3	61
Ingress QoS LPM Entries	32768	0	32768



## CHAPTER 15

# BCP Support on MLPPP

This feature module describes how to configure Bridge Control Protocol (BCP) Support over Multilink PPP (MLPPP).



**Note** This feature is only applicable for Cisco ASR 900 RSP2 Module.

- [Prerequisites for BCP Support on MLPPP, on page 241](#)
- [Restrictions for BCP Support on MLPPP, on page 241](#)
- [Information About BCP Support on MLPPP, on page 242](#)
- [How to Configure BCP Support on MLPPP, on page 243](#)
- [Configuration Examples for BCP Support on MLPPP, on page 250](#)

## Prerequisites for BCP Support on MLPPP

- Cisco IOS XE Everest 16.5.1 or a later release that supports the BCP Support on MLPPP feature must be installed previously on the Cisco ASR 900.

## Restrictions for BCP Support on MLPPP

- IPv6 is not supported.
- Routing is not supported, hence, BDI is also not supported on BCP over MLPPP.
- Spanning Tree Protocol (STP) and Resilient Ethernet Protocol (REP) are not supported.
- Jumbo frames are not supported.
- Supports 16 T1/E1 and OC3 IM only. A maximum number of 16 (0-15) links per MLPPP bundle are supported, where traffic rate is not beyond MLPPP bandwidth. For E1 link, 16 E1 serial interfaces can be in one MLPPP bundle. For T1, 16 T1 links can be in one MLPPP bundle.
- The following encapsulations are not supported: **QinQ**, **dot1ad**, and **dot1ad-dot1q**.
- You cannot configure **default** or **untagged** encapsulations on two different multilinks. When **default** is configured on a multilink, you can configure another EFP as **untagged** on the same multilink. For **untagged**, the same multilink cannot have another EFP configured as **untagged**.
- Two different multilinks cannot bridge the same encapsulated VLAN.

- The same bridge domain cannot be configured twice on the same interface.
- Connectivity Fault Management (CFM), Y.1731, and Layer 2 protocol forward tagged are not supported.
- Set qos-group is not supported in the output policy of physical Gigabit interface and EVC of the multilink interface. Set qos-group on ASR 903 will not mark the packet. The scope of the set qos-group is limited to the router.
- QoS policy is not supported on multilink at the interface level. However, it is supported on different EVCs of the multilink interfaces.
- Qos-group classification will work only on the egress interface or EFP interface.
- The MLPPP interface bundle supports only a maximum of 64 EVCs.
- A maximum of 64 VLANs are supported across all the MLPPPs.
- Layer 3 traffic with default encapsulation is not supported.
- Multicast and IGMP is not supported.
- For ingress classification to work, it should be classified based on “match cos inner <math>\diamond</math>” or “match vlan inner <math>\diamond</math>”.
- Layer 2 QoS behavior is supported only on tagged/priority tagged packets. It is not supported for untagged packets.
- Only 1r2C policer is supported at the egress.
- With BCP on MLPPP, the COS bits in the payload are not preserved end to end.

## Information About BCP Support on MLPPP

The BCP, as described in RFC 3518, is responsible for configuring, enabling and disabling the bridge protocol modules on both ends of the point-to-point link. The BCP feature enables forwarding of Ethernet frames over serial networks, and provides a high-speed extension of enterprise LAN backbone traffic through a metropolitan area.

When BCP is supported on MLPPP, it enables transport of Ethernet Layer 2 frames through MLPPP. In the following diagram, Bridge-A is connected to Bridge-B using MLPPP. The MLPPP bundle acts as a trunk link connecting Bridge-A and Bridge-B, transporting multiple VLANs. Using this feature, the hosts in VLAN 100, who are connected to Bridge-A, can talk to the hosts in VLAN 200, who are connected to Bridge-B.

**Figure 7: BCP over MLPPP**

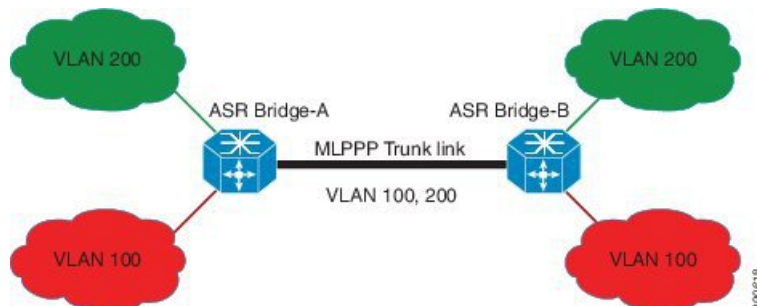

## Supported Profiles and Protocols

- Ethernet II frames
- 802.1Q tagged frames
- IPv4 packets
- Frame sizes from 64 to 1522 octets

## Quality of Service

The Ethernet Layer 2 traffic is classified on the egress at the EVC of the Multilink interface based on IP DSCP or VLAN CoS bits. Based on this classification, egress policing (bandwidth percent or priority percent) is achieved. You can also re-mark the QoS field. The following table lists the options available for re-marking.

*Table 22: Re-Marking Options*

IP DSCP	VLAN CoS or PCP Bits
Set IP DSCP (re-mark IP DSCP)	Set IP DSCP
Set VLAN CoS or Priority Code Point (PCP) Bits	Set VLAN CoS Bits (re-mark VLAN CoS or PCP Bits)
Bandwidth Percent or Priority Percent	Bandwidth Percent or Priority Percent

## How to Configure BCP Support on MLPPP

### Configuring Multiple EFPs Bridged Through the Same Link

To bridge multiple EFPs through the same multilink, you should create two EFPs and add them to the multilink.

To configure an EFP and a multilink, complete the following tasks:

#### Configuring an EFP

To configure an EFP, complete the following steps:

##### Procedure

	Command or Action	Purpose
<b>Step 1</b>	<b>enable</b>  <b>Example:</b> Router> enable	Enables privileged EXEC mode. Enter your password if prompted.
<b>Step 2</b>	<b>configure terminal</b>  <b>Example:</b> Router# configure terminal	Enters global configuration mode.

	Command or Action	Purpose
<b>Step 3</b>	<b>interface</b> <i>type number</i> <b>Example:</b> Router(config)# interface GigabitEthernet 0/0	Specifies an interface type and number, and places the device in interface configuration mode.
<b>Step 4</b>	<b>service instance</b> <i>number ethernet</i> <b>Example:</b> Router(config-if)# service instance 10 ethernet	Configures an EFP (service instance) and enters service instance configuration mode. <ul style="list-style-type: none"> <li>• <i>number</i>—EFP identifier; an integer from 1 to 4000.</li> </ul>
<b>Step 5</b>	<b>encapsulation dot1q</b> <i>vlan-id</i> <b>Example:</b> Router(config-if-srv)# encapsulation dot1q 50	Configures encapsulation type for the service instance. <ul style="list-style-type: none"> <li>• <i>vlan-id</i>—Virtual LAN identifier. The valid range is from 1 to 4094.</li> </ul>
<b>Step 6</b>	<b>rewrite ingress tag pop 1 symmetric</b> <b>Example:</b> Router(config-if-srv)# rewrite ingress tag pop 1 symmetric	Specifies that encapsulation modification occurs on packets at ingress.
<b>Step 7</b>	<b>bridge-domain</b> <i>bridge-id</i> <b>Example:</b> Router(config-if-srv)# bridge-domain 100	Configures the bridge domain ID. <ul style="list-style-type: none"> <li>• <i>bridge-id</i>—Bridge domain number. The valid range is from 1 to 4094.</li> </ul>

## Adding an EFP to a Multilink

To add an EFP to a multilink, complete the following steps:

### Procedure

	Command or Action	Purpose
<b>Step 1</b>	<b>enable</b> <b>Example:</b> Router> enable	Enables privileged EXEC mode. <ul style="list-style-type: none"> <li>• Enter your password if prompted.</li> </ul>
<b>Step 2</b>	<b>configure terminal</b> <b>Example:</b> Router# configure terminal	Enters global configuration mode.
<b>Step 3</b>	<b>interface</b> <i>type number</i> <b>Example:</b> Router(config)# interface Multilink 5	Specifies an interface type and number, and places the device in interface configuration mode.
<b>Step 4</b>	<b>service instance</b> <i>number ethernet</i> <b>Example:</b>	Configures an EFP (service instance) and enters service instance configuration mode.

	Command or Action	Purpose
	<code>Router(config-if)# service instance 10 ethernet</code>	<ul style="list-style-type: none"> <li><i>number</i>—EFP identifier; an integer from 1 to 4000.</li> </ul>
<b>Step 5</b>	<b>encapsulation dot1q <i>vlan-id</i></b> <b>Example:</b> <code>Router(config-if-srv)# encapsulation dot1q 60</code>	Configures encapsulation type for the service instance. <ul style="list-style-type: none"> <li><i>vlan-id</i>—Virtual LAN identifier. The valid range is from 1 to 4094.</li> </ul>
<b>Step 6</b>	<b>rewrite ingress tag pop 1 symmetric</b> <b>Example:</b> <code>Router(config-if-srv)# rewrite ingress tag pop 1 symmetric</code>	Specifies that encapsulation modification occurs on packets at ingress.
<b>Step 7</b>	<b>bridge-domain <i>bridge-id</i></b> <b>Example:</b> <code>Router(config-if-srv)# bridge-domain 100</code>	Configures the bridge domain ID. <ul style="list-style-type: none"> <li><i>bridge-id</i>—Bridge domain number. The valid range is from 1 to 4094.</li> </ul>
<b>Step 8</b>	<b>exit</b> <b>Example:</b> <code>Router(config-if-srv)# exit</code>	Exits service instance configuration mode and enters the interface configuration mode. <b>Note</b> Repeat Step 4 to Step 7 to add another EFP to the Multilink.

## Configuring Multiple Encapsulated VLANs Bridged Through Different Multilinks

You should create two encapsulated VLANs and add them to two multilinks for this configuration to work.

To configure multiple encapsulated VLANs bridged through different multilinks, complete the following tasks:

### Adding an Encapsulated VLAN to Multilinks

To add an encapsulated VLAN to separate multilinks, complete the following steps:

#### Procedure

	Command or Action	Purpose
<b>Step 1</b>	<b>enable</b> <b>Example:</b> <code>Router&gt; enable</code>	Enables privileged EXEC mode. <ul style="list-style-type: none"> <li>Enter your password if prompted.</li> </ul>
<b>Step 2</b>	<b>configure terminal</b> <b>Example:</b> <code>Router# configure terminal</code>	Enters global configuration mode.

	Command or Action	Purpose
<b>Step 3</b>	<b>interface</b> <i>type number</i> <b>Example:</b> Router(config)# interface Multilink 5	Specifies an interface type and number, and places the device in interface configuration mode.
<b>Step 4</b>	<b>service instance</b> <i>number ethernet</i> <b>Example:</b> Router(config-if)# service instance 10 ethernet	Configures an EFP (service instance) and enters service instance configuration mode.  • <i>number</i> —EFP identifier; an integer from 1 to 4000.
<b>Step 5</b>	<b>encapsulation dot1q</b> <i>vlan-id</i> <b>Example:</b> Router(config-if-srv)# encapsulation dot1q 60	Configures encapsulation type for the service instance.  • <i>vlan-id</i> —Virtual LAN identifier. The valid range is from 1 to 4094.
<b>Step 6</b>	<b>rewrite ingress tag pop 1 symmetric</b> <b>Example:</b> Router(config-if-srv)# rewrite ingress tag pop 1 symmetric	Specifies that encapsulation modification occurs on packets at ingress.
<b>Step 7</b>	<b>bridge-domain</b> <i>bridge-id</i> <b>Example:</b> Router(config-if-srv)# bridge-domain 100	Configures the bridge domain ID.  • <i>bridge-id</i> —Bridge domain number. The valid range is from 1 to 4094.
<b>Step 8</b>	<b>exit</b> <b>Example:</b> Router(config-if-srv)# exit	Exits service instance configuration mode and enters the interface configuration mode.  <b>Note</b> Repeat steps 3 to 7 to create another multilink and add the VLAN information.

## Configuring QoS for BCP Support on MLPPP

The egress policy at the EVC of the multilink interface matches the IP DSCP value and VLAN CoS bits. Based on this classification it re-marks these values and performs egress policing (Priority percent or Bandwidth percent), shaping, priority shaper, BRR/BRP.

To configure QoS for BCP Support on MLPPP, complete the following tasks:



**Note** Define a QoS policy, and apply it to the MLPPP interface, and configure a matching policy on the EFP interface.

### Defining a QoS Policy

To define a QoS policy, complete the following steps:



## Procedure

	Command or Action	Purpose
<b>Step 1</b>	<b>enable</b> <b>Example:</b> Router> enable	Enables privileged EXEC mode. <ul style="list-style-type: none"> <li>• Enter your password if prompted.</li> </ul>
<b>Step 2</b>	<b>configure terminal</b> <b>Example:</b> Router# configure terminal	Enters global configuration mode.
<b>Step 3</b>	<b>class-map match-any class-map-name</b> <b>Example:</b> Router(config)# class-map match-any dscpaf11	Creates a class map to be used for matching packets to a specified class and enters QoS class-map configuration mode. <ul style="list-style-type: none"> <li>• <i>class-map-name</i>—Name of the class for the class map. The class name is used for both the class map and to configure a policy for the class in the policy map.</li> </ul>
<b>Step 4</b>	<b>match ip dscp dscp-list</b> <b>Example:</b> Router(config-cmap)# match ip dscp af11	Matches IP DSCP packeting using Assured Forwarding (AF) by entering the binary representation of the DSCP value.
<b>Step 5</b>	<b>class-map match-any class-map-name</b> <b>Example:</b> Router(config-cmap)# class-map match-any qos-group3	Creates a class map to be used for matching packets to a specified class.
<b>Step 6</b>	<b>match qos-group qos-group-value</b> <b>Example:</b> Router(config-cmap)# match qos-group 3	Identifies a specific quality of service (QoS) group value as a match criterion. <ul style="list-style-type: none"> <li>• <i>qos-group-value</i>—The exact value used to identify a QoS group value. The valid range is from 0 to 7.</li> </ul>
<b>Step 7</b>	<b>policy-map policy-map-name</b> <b>Example:</b> Router(config-cmap)# policy-map bcplmppqos	Creates a policy map that can be attached to one or more interfaces. <ul style="list-style-type: none"> <li>• <i>policy-map-name</i>—Name of the policy map.</li> </ul>
<b>Step 8</b>	<b>class class-name</b> <b>Example:</b> Router(config-pmap)# class dscpaf11	Specifies the name of the class whose policy you want to create or change. Alternatively, is used to specify the default class (commonly known as the class-default class) before you configure its policy. <ul style="list-style-type: none"> <li>• <i>class-name</i>—Name of the class to be configured or whose policy is to be modified. The class name is used for both</li> </ul>

	Command or Action	Purpose
		the class map and to configure a policy for the class in the policy map. .
<b>Step 9</b>	<b>priority percent</b> <i>percentage</i> <b>Example:</b> Router(config-pmap-c)# priority percent 20	Provides priority to a class of traffic belonging to a policy map. <ul style="list-style-type: none"><li>• <i>percentage</i>—Total available bandwidth to be set aside for the priority class. The valid range is from 1 to 100.</li></ul>
<b>Step 10</b>	<b>set ip dscp</b> <i>ip-dscp-value</i> <b>Example:</b> Router(config-pmap-c)# set ip dscp ef	Marks a packet by setting the IP DSCP value in the type of service (ToS) byte. <ul style="list-style-type: none"><li>• <i>ip-dscp-value</i>—IP DSCP value; The valid values are from 0 to 63.</li></ul>
<b>Step 11</b>	<b>class</b> <i>class-name</i> <b>Example:</b> Router(config-pmap-c)# class qos-group3	Specifies the name of the class whose policy you want to create or change. Alternatively, is used to specify the default class (commonly known as the class-default class) before you configure its policy.
<b>Step 12</b>	<b>bandwidth percent</b> <i>percentage</i> <b>Example:</b> Router(config-pmap-c)# bandwidth percent 20	Specifies the bandwidth allocated for a class belonging to a policy map. <ul style="list-style-type: none"><li>• <i>percentage</i>—Specifies the percentage of guaranteed bandwidth based on an absolute percent of available bandwidth to be set aside for the priority class or on a relative percent of available bandwidth. The valid range is from 1 to 100.</li></ul>
<b>Step 13</b>	<b>set qos-group</b> <i>group-id</i> <b>Example:</b> Router(config-pmap-c)# set qos-group 4	Sets a QoS group identifier (ID) that can be used later to classify packets. <ul style="list-style-type: none"><li>• <i>group-id</i>—group-id—Group ID number. The valid range is from 0 to 99.</li></ul>

## Applying a QoS Policy on an MLPPP Interface

To apply a QoS policy on an MLPPP interface, complete the following steps:

### Procedure

	Command or Action	Purpose
<b>Step 1</b>	<b>enable</b> <b>Example:</b> Router> enable	Enables privileged EXEC mode. <ul style="list-style-type: none"><li>• Enter your password if prompted.</li></ul>
<b>Step 2</b>	<b>configure terminal</b> <b>Example:</b>	Enters global configuration mode.

	Command or Action	Purpose
	Router# configure terminal	
<b>Step 3</b>	<b>interface</b> <i>type number</i> <b>Example:</b> Router(config)# interface Multilink 5	Specifies an interface type and number, and places the device in interface configuration mode.
<b>Step 4</b>	<b>service instance</b> <i>number ethernet</i> <b>Example:</b> Router(config-if)# service instance 20 ethernet	Configures an EFP (service instance) and enters service instance configuration mode.  • <i>number</i> —EFP identifier; an integer from 1 to 4000.
<b>Step 5</b>	<b>service-policy output</b> <i>policy-map-name</i> <b>Example:</b> Router(config-if)# service-policy output bcplpppqos	Attaches a policy map to an input interface, a virtual circuit (VC), an output interface, or a VC that will be used as the service policy for the interface or VC.  • <i>policy-map-name</i> —The name of a service policy map (created using the <b>policy-map</b> command) to be attached.
<b>Step 6</b>	<b>encapsulation dot1q</b> <i>vlan-id</i> <b>Example:</b> Router(config-if-srv)# encapsulation dot1q 50	Configures encapsulation type for the service instance.  • <i>vlan-id</i> —Virtual LAN identifier. The valid range is from 1 to 4094.
<b>Step 7</b>	<b>rewrite ingress tag pop 1 symmetric</b> <b>Example:</b> Router(config-if-srv)# rewrite ingress tag pop 1 symmetric	Specifies that encapsulation modification occurs on packets at ingress.
<b>Step 8</b>	<b>bridge-domain</b> <i>bridge-id</i> <b>Example:</b> Router(config-if-srv)# bridge-domain 100	Configures the bridge domain ID.  • <i>bridge-id</i> —Bridge domain number. The valid range is from 1 to 4094.

## Verifying BCP Support on MLPPP

To display the Multilink PPP bundle information on various interfaces on a router, use the **show** command, as described in the following example:

```
Router# show ppp multilink interface multilink 1

Multilink1
  Bundle name: ASR1
  Remote Endpoint Discriminator: [1] ASR1
  Local Endpoint Discriminator: [1] ASR2
  Bundle up for 17:06:50, total bandwidth 20480, load 6/255
  2 receive classes, 2 transmit classes
  Receive buffer limit 123040 bytes per class, frag timeout 1000 ms
  Bundle is Distributed
  Receive Class 0:
    0/0 fragments/bytes in reassembly list
```

```

    0 lost fragments, 0 reordered
    0/0 discarded fragments/bytes, 0 lost received
    0xB9026C received sequence
Receive Class 1:
    0/0 fragments/bytes in reassembly list
    0 lost fragments, 0 reordered
    0/0 discarded fragments/bytes, 0 lost received
    0x5D2E8F received sequence
Transmit Class 0:
    0x5CBA5 sent sequence
Transmit Class 1:
    0x146FA1 sent sequence
Distributed MLP. Multilink in Hardware.
Distributed Fragmentation is on. Fragment size: 256.
Bundle status is: active
Member links: 10 active, 0 inactive (max 255, min not set)
    Se0/6:0, since 01:36:49, 7680 weight, 256 frag size
    Se0/2:0, since 01:26:26, 7680 weight, 256 frag size
    Se0/5:0, since 01:25:18, 7680 weight, 256 frag size
    Se0/9:0, since 01:25:17, 7680 weight, 256 frag size
    Se0/1:0, since 01:24:25, 7680 weight, 256 frag size
    Se0/4:0, since 01:24:20, 7680 weight, 256 frag size
    Se0/0:0, since 01:24:18, 7680 weight, 256 frag size
    Se0/7:0, since 01:24:17, 7680 weight, 256 frag size
    Se0/8:0, since 01:23:09, 7680 weight, 256 frag size
    Se0/3:0, since 01:23:08, 7680 weight, 256 frag size

```

## Configuration Examples for BCP Support on MLPPP

### Example: Configuring an EFP

The following are the examples of two ways in which you can configure an EFP.

#### Method 1

```

enable
configure terminal
interface GigabitEthernet 0/0
service instance 10 ethernet
encapsulation dot1q 50
rewrite ingress tag pop 1 symmetric
bridge-domain 100

```

#### Method 2

```

enable
configure terminal
interface GigabitEthernet 0/0
service instance 10 ethernet
encapsulation dot1q 50
rewrite ingress tag pop 1 symmetric
exit
configure terminal
bridge-domain 100
member Multilink1 service-instance 100

```

## Example: Multilink with a Single EFP

The following is a sample configuration of a multilink with a single EFP.

**Figure 8: Multilink with a Single EFP**

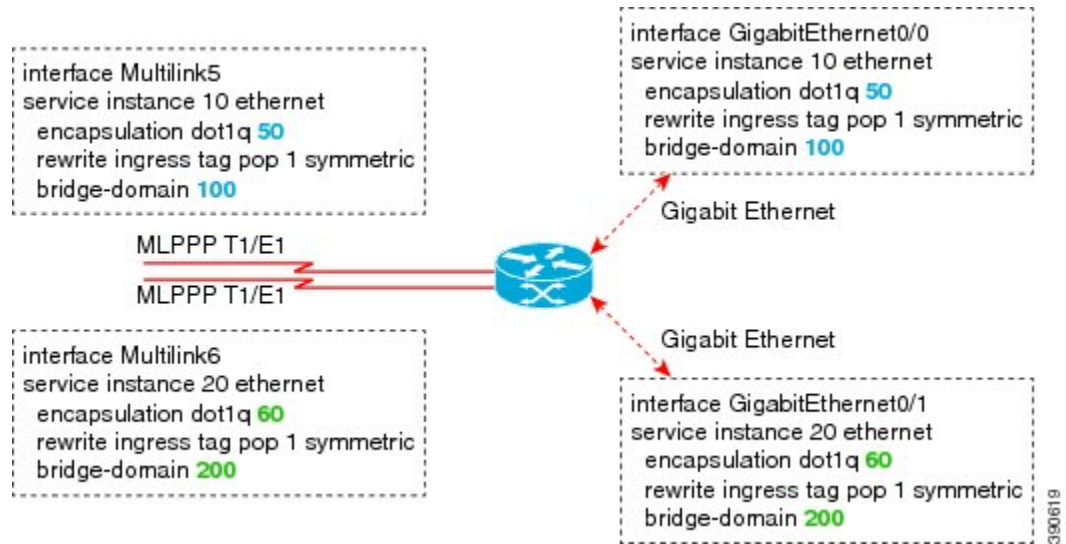

## Example: Multilink with Multiple EFPs

The following is a sample configuration of a multilink with multiple EFPs.

Figure 9: Multilink with Multiple EFPs

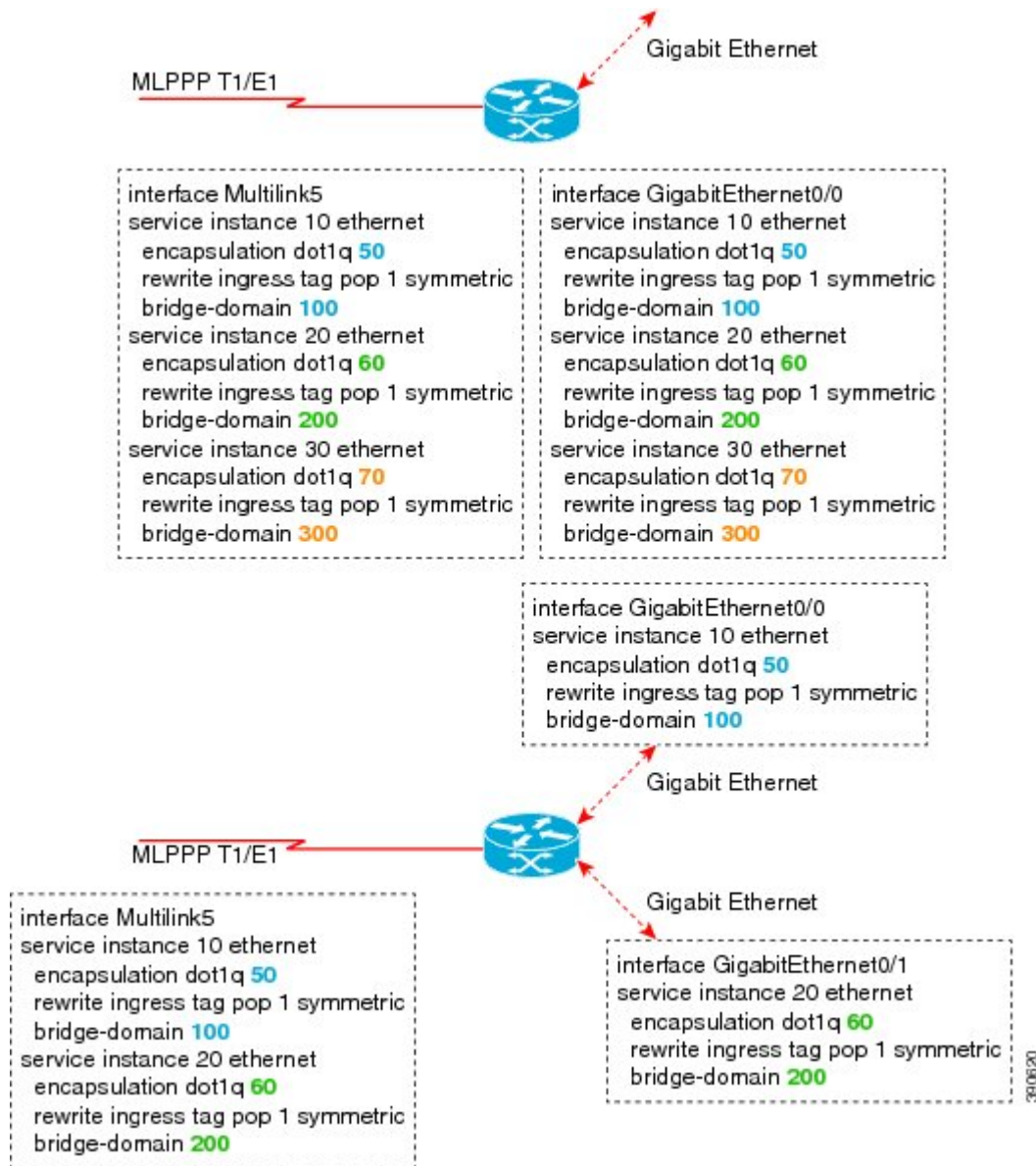

## Example: Multilink with QoS

The following is a sample configuration of Multilink with QoS:

Figure 10: Multilink with QoS

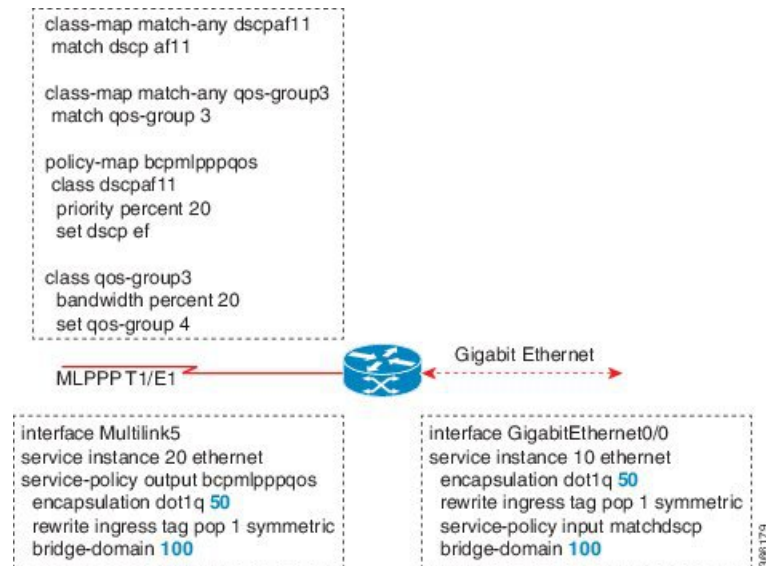

## Example: Multilink Between Cisco ASR 903 Series Routers and Cisco C7600 Series Routers

The following is a sample configuration of multilink between a Cisco ASR 903 Series Routers and Cisco C7600 Series Routers:

Figure 11: Multilink Between Cisco ASR 903 Series Routers and Cisco C7600 Series Routers

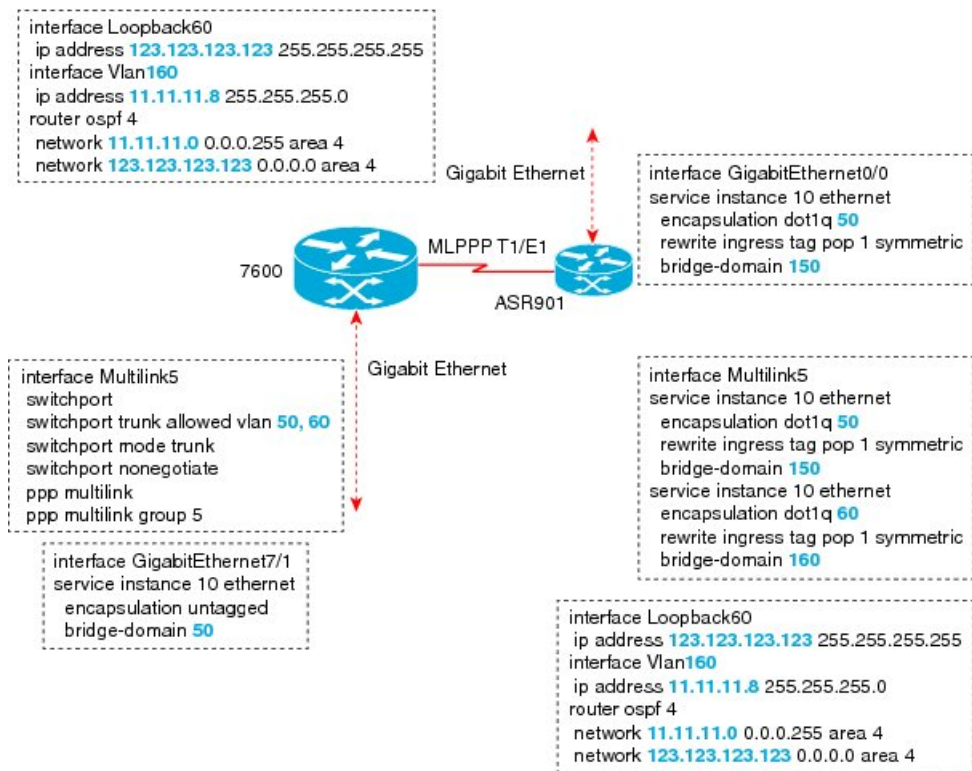

## Example: Multilink with Maximum 10 Links

The following is a sample configuration of multilink with maximum 10 links.

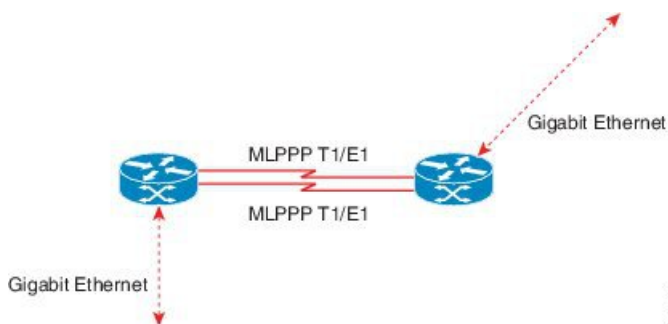

The following sample configurations show how to configure multilink with maximum 10 links.

### Policy Map 1

```

class-map match-any qos-group1
match qos-group 1
class-map match-any qos-group2
match qos-group 2
class-map match-any qos-group3
  
```



```
match qos-group 3
class-map match-any qos-group4
match qos-group 4
class-map match-any qos-group5
match qos-group 5
class-map match-any qos-group6
match qos-group 6
class-map match-any qos-group7
match qos-group 7
```

```
policy-map bcplpppqos
class qos-group1
priority percent 20
set qos-group 2
class qos-group2
bandwidth percent 20
set qos-group 3
class qos-group3
bandwidth percent 10
set qos-group 4
class qos-group4
bandwidth percent 5
set qos-group 5
class qos-group5
bandwidth percent 30
set qos-group 6
class qos-group7
bandwidth percent 15
set qos-group 1
```

## Policy Map 2

```
class-map match-any dscpaf11
match ip dscp af11
class-map match-any dscpaf12
match ip dscp af12
class-map match-any dscpaf21
match ip dscp af21
class-map match-any dscpaf31
match ip dscp af31
class-map match-any dscpcs1
match ip dscp cs1
class-map match-any dscpef
match ip dscp ef
class-map match-any dscpdefault
match ip dscp default
```

```
policy-map bcplpppdscp
class dscpaf11
priority percent 20
set ip dscp af12
class dscpaf12
bandwidth percent 20
set ip dscp af13
class dscpaf21
bandwidth percent 10
set ip dscp af22
class dscpaf31
bandwidth percent 5
set ip dscp af32
class dscpcs1
bandwidth percent 30
```

```

set ip dscp cs2
class dscpef
bandwidth percent 10
set ip dscp cs7
class dscpdefault
bandwidth percent 5
set ip dscp cs5

```

### MLPPP-GIG - 1

```

interface Multilink1
service instance 1 ethernet
service-policy output bcplmpppqos
encapsulation untagged
bridge-domain 3000

interface Multilink2
service instance 1 ethernet
service-policy output bcplmpppqos
encapsulation dot1q 50
bridge-domain 2000
service instance 2 ethernet
encapsulation dot1q 60
bridge-domain 2001

interface gigabitethernet 0/5
service instance 1 ethernet
encapsulation dot1q 50
bridge-domain 2000
service instance 2 ethernet
encapsulation dot1q 60
bridge-domain 2001
service instance 3 ethernet
encapsulation untagged
bridge-domain 3000

```

### ADD-MLPPP-GIG - 1

```

interface Multilink1
service instance 2 ethernet
service-policy output bcplmpppqos
encapsulation dot1q 70
bridge-domain 3001

interface gigabitethernet 0/5
service instance 4 ethernet
encapsulation dot1q 70
bridge-domain 3001

```

### MLPPP-GIG-2

```

interface Multilink1
service instance 1 ethernet
service-policy output bcplmpppdscp
encapsulation untagged
bridge-domain 3000

```

```

interface Multilink2
service instance 2 ethernet
service-policy output bcplpppsdscp
  encapsulation dot1q any
  bridge-domain 3001

interface gigabitethernet 0/5
service instance 1 ethernet
  encapsulation untagged
  bridge-domain 3000
service instance 2 ethernet
  encapsulation dot1q any
  bridge-domain 3001

```

### MLPPP-GIG-3

```

interface Multilink1
service instance 1 ethernet
service-policy output bcplpppsdscp
  encapsulation default
  bridge-domain 3000

interface gigabitethernet 0/5
service instance 1 ethernet
  encapsulation default
  bridge-domain 3000

```

### Sample Configuration of MLPPP Bundled 10 Member Links

```

interface Multilink1
no ip address
load-interval 30
ppp pfc local request
ppp pfc remote apply
ppp acfc local request
ppp acfc remote apply
ppp multilink
ppp multilink interleave
ppp multilink group 1
ppp multilink fragment size 256
ppp multilink multiclass
service instance 102 ethernet
service-policy output bcplpppqos
  encapsulation dot1q 102
  rewrite ingress tag pop 1 symmetric
bridge-domain 102
!

interface Serial0/0:0
no ip address
encapsulation ppp
ppp multilink
ppp multilink group 1
interface Serial0/1:0
no ip address
encapsulation ppp
ppp multilink

```

```
    ppp multilink group 1
interface Serial0/2:0
  no ip address
  encapsulation ppp
  ppp multilink
  ppp multilink group 1
interface Serial0/3:0
  no ip address
  encapsulation ppp
  ppp multilink
  ppp multilink group 1
interface Serial0/4:0
  no ip address
  encapsulation ppp
  ppp multilink
  ppp multilink group 1
interface Serial0/5:0
  no ip address
  encapsulation ppp
  ppp multilink
  ppp multilink group 1
interface Serial0/6:0
  no ip address
  encapsulation ppp
  ppp multilink
  ppp multilink group 1
interface Serial0/7:0
  no ip address
  encapsulation ppp
  ppp multilink
  ppp multilink group 1
interface Serial0/8:0
  no ip address
  encapsulation ppp
  ppp multilink
  ppp multilink group 1
interface Serial0/9:0
  no ip address
  encapsulation ppp
  ppp multilink
  ppp multilink group 1
```



## CHAPTER 16

# Tracing and Trace Management

---

This chapter contains the following sections:

- [Tracing Overview, on page 259](#)
- [How Tracing Works, on page 260](#)
- [Tracing Levels, on page 260](#)
- [Viewing a Tracing Level, on page 261](#)
- [Setting a Tracing Level, on page 263](#)
- [Viewing the Content of the Trace Buffer, on page 263](#)

## Tracing Overview

Tracing is a function that logs internal events. Trace files are automatically created and saved to the `tracelogs` directory on the harddisk: file system on the chassis, which stores tracing files in `bootflash:`. Trace files are used to store tracing data.



---

**Note** Starting release Cisco IOS XE Release 3.14 and later, logs are stored in compressed format.

The logs in the `bootflash` are stored in compressed format with `.gz` file extension. Use the archiving tools such as `gunzip`, `gzip`, `7-zip` to extract the files.

- If the system reloads unexpectedly, some of the files may not be in compressed format.
- Extraction of log files may lead to time hogs or CPU logs. We recommend to perform this by copying the files to the PC.
- Extraction of files *cannot* be performed at the IOS prompt.
- Log files not handled by the `bootflash` trace are *not* stored in the compressed format (for example, `system_shell_R*.log`).

---

The contents of trace files are useful for the following purposes:

- **Troubleshooting**—If a chassis is having an issue, the trace file output may provide information that is useful for locating and solving the problem. Trace files can almost always be accessed through diagnostic mode even if other system issues are occurring.

- Debugging—The trace file outputs can help users get a more detailed view of system actions and operations.

## How Tracing Works

The tracing function logs the contents of internal events on the chassis. Trace files with all trace output for a module are periodically created and updated and are stored in the `tracelog` directory. Trace files can be erased from this directory to recover space on the file system without impacting system performance.

The most recent trace information for a specific module can be viewed using the **show platform software trace message** privileged EXEC and diagnostic mode command. This command can be entered to gather trace log information even during an IOS failure because it is available in diagnostic mode.

Trace files can be copied to other destinations using most file transfer functions (such as FTP, TFTP, and so on) and opened using a plaintext editor.

Tracing cannot be disabled on the chassis. Trace levels, however, which set the message types that generate trace output, are user-configurable and can be set using the **set platform software trace** command. If a user wants to modify the trace level to increase or decrease the amount of trace message output, the user should set a new tracing level using the **set platform software trace** command. Trace levels can be set by process using the **all-modules** keyword within the **set platform software trace** command, or by module within a process. See the **set platform software trace** command reference for more information on this command, and the [Tracing Levels, on page 260](#) of this document for additional information on tracing levels.

## Tracing Levels

Tracing levels determine how much information about a module should be stored in the trace buffer or file.

[Table 23: Tracing Levels and Descriptions, on page 260](#) shows all of the trace levels that are available and provides descriptions of what types of messages are displayed with each tracing level.

**Table 23: Tracing Levels and Descriptions**

Trace Level	Level Number	Description
Emergency	0	The message is regarding an issue that makes the system unusable.
Alert	1	The message is regarding an action that must be taken immediately.
Critical	2	The message is regarding a critical condition. This is the default setting.
Error	3	The message is regarding a system error.
Warning	4	The message is regarding a system warning
Notice	5	The message is regarding a significant issue, but the router is still working normally.
Informational	6	The message is useful for informational purposes only.
Debug	7	The message provides debug-level output.

Trace Level	Level Number	Description
Verbose	8	All possible tracing messages are sent.
Noise	-	All possible trace messages for the module are logged.  The noise level is always equal to the highest possible tracing level. Even if a future enhancement to tracing introduces a higher tracing level, the noise level will become equal to the level of that new enhancement.

Trace level settings are leveled, meaning that every setting will contain all messages from the lower setting plus the messages from its own setting. For instance, setting the trace level to 3(error) ensures that the trace file will contain all output for the 0 (emergencies), 1 (alerts), 2 (critical), and 3 (error) settings. Setting the trace level to 4 (warning) will ensure that all trace output for the specific module will be included in that trace file.

The default tracing level for every module on the chassis is notice.

All trace levels are not user-configurable. Specifically, the alert, critical, and notice tracing levels cannot be set by users. If you wish to trace these messages, set the trace level to a higher level that will collect these messages.

When setting trace levels, it is also important to remember that the setting is not done in a configuration mode, so trace level settings are returned to their defaults after every router reload.



---

**Caution** Setting tracing of a module to the debug level or higher can have a negative performance impact. Setting tracing to this level or higher should be done with discretion.

---



---

**Caution** Setting a large number of modules to high tracing levels can severely degrade performance. If a high level of tracing is needed in a specific context, it is almost always preferable to set a single module on a higher tracing level rather than setting multiple modules to high tracing levels.

---

## Viewing a Tracing Level

By default, all modules on the chassis are set to notice. This setting will be maintained unless changed by a user.

To see the tracing level for any module on the chassis, enter the **show platform software trace level** command in privileged EXEC or diagnostic mode.

In the following example, the **show platform software trace level** command is used to view the tracing levels of the Forwarding Manager processes on the active RSP:

```
Router# show platform software trace level forwarding-manager rp active
Module Name                               Trace Level
-----
acl                                         Notice
binos                                       Notice
binos/brand                               Notice
bipc                                       Notice
```

bsignal	Notice
btrace	Notice
cce	Notice
cdllib	Notice
cef	Notice
chasfs	Notice
chasutil	Notice
erspan	Notice
ess	Notice
ether-channel	Notice
evlib	Notice
evutil	Notice
file_alloc	Notice
fman_rp	Notice
fpm	Notice
fw	Notice
icmp	Notice
interfaces	Notice
iosd	Notice
ipc	Notice
ipclog	Notice
iphc	Notice
ipsec	Notice
mgmte-acl	Notice
mlp	Notice
mqipc	Notice
nat	Notice
nbar	Notice
netflow	Notice
om	Notice
peer	Notice
qos	Notice
route-map	Notice
sbc	Notice
services	Notice
sw_wdog	Notice
tcl_acl_config_type	Notice
tcl_acl_db_type	Notice
tcl_cdlcore_message	Notice
tcl_cef_config_common_type	Notice
tcl_cef_config_type	Notice
tcl_dpibd_config_type	Notice
tcl_fman_rp_comm_type	Notice
tcl_fman_rp_message	Notice
tcl_fw_config_type	Notice
tcl_hapi_tcl_type	Notice
tcl_icmp_type	Notice
tcl_ip_options_type	Notice
tcl_ipc_ack_type	Notice
tcl_ipsec_db_type	Notice
tcl_mcp_comm_type	Notice
tcl_mlp_config_type	Notice
tcl_mlp_db_type	Notice
tcl_om_type	Notice
tcl_ui_message	Notice
tcl_ui_type	Notice
tcl_urpf_config_type	Notice
tdllib	Notice
trans_avl	Notice
uihandler	Notice
uipeer	Notice
uistatus	Notice
urpf	Notice



```
vista
wccp
```

```
Notice
Notice
```

## Setting a Tracing Level

To set a tracing level for any module on the chassis, or for all modules within a process, enter the **set platform software trace** privileged EXEC and diagnostic mode command.

In the following example, the trace level for the ACL module in the Forwarding Manager of the ESP processor in slot 0 is set to info.

```
set platform software trace forwarding-manager F0 acl info
```

See the **set platform software trace** command reference for additional information about the options for this command.

## Viewing the Content of the Trace Buffer

To view the trace messages in the trace buffer or file, enter the **show platform software trace message** privileged EXEC and diagnostic mode command.

In the following example, the trace messages for the Host Manager process in Route Switch Processor slot 0 are viewed using the **show platform software trace message** command:

```
Router# show platform software trace message host-manager R0
08/23 12:09:14.408 [uipeer]: (info): Looking for a ui_req msg
08/23 12:09:14.408 [uipeer]: (info): Start of request handling for con 0x100a61c8
08/23 12:09:14.399 [uipeer]: (info): Accepted connection for 14 as 0x100a61c8
08/23 12:09:14.399 [uipeer]: (info): Received new connection 0x100a61c8 on descriptor 14
08/23 12:09:14.398 [uipeer]: (info): Accepting command connection on listen fd 7
08/23 11:53:57.440 [uipeer]: (info): Going to send a status update to the shell manager in
slot 0
08/23 11:53:47.417 [uipeer]: (info): Going to send a status update to the shell manager in
slot 0
```





## CHAPTER 17

# Configuring and Monitoring Alarm

This chapter describes monitoring alarms, alarms filtering support and configuring external alarms for fan tray alarm port.

This chapter includes the following sections:

- [Monitoring Alarms, on page 265](#)
- [Configuring External Alarm Trigger, on page 270](#)
- [Alarm Filtering Support, on page 273](#)
- [Facility Protocol Status Support, on page 275](#)

## Monitoring Alarms

Once hardware is installed and operational, use alarms to monitor hardware status on a daily basis.

The routers are designed to send alarm notifications when problems are detected. Network administrators do not need to use show commands to poll devices on a routine basis and can monitor the network remotely. However, network administrators can perform onsite monitoring if they so choose.

Use **snmp-server enable traps alarms <severity>** command to enable the entity related Traps.

The default severity level is informational, which shows all alarms. Severity levels are defined as the following:

- 1—Critical. The condition affects service.
- 2—Major. Immediate action is needed.
- 3—Minor. Minor warning conditions.
- 4—Informational. No action is required. This is the default.

The entity notifications **ceAlarmAsserted** and **ceAlarmCleared** are used to report the condition for e.g. when a physical entity asserted or cleared an alarm.



**Note** Effective from Cisco IOS XE Everest 16.6.1, on RSP3 module, alarm notification is enabled on 900 watts DC power supply. There are 2 input feeds for 900 watts DC power supply, if one of the input voltage is lesser than the operating voltage, critical alarm is generated for that particular feed and clears (stops) once the voltage is restored but the power supply state remains in OK state as the other power supply is operationally up.

## Network Administrator Checks Console or Syslog for Alarm Messages

The network administrator can monitor alarm messages by reviewing alarm messages sent to the system console or to a syslog.

### Enabling the Logging Alarm Command

The logging alarm command must be enabled for the system to send alarm messages to a logging device, such as the console or a syslog. This command is not enabled by default.

You can specify the severity level of alarm to log. All alarms at and above the specified threshold generate alarm messages. For example, the following command sends only critical alarm messages to logging devices:

```
Router(config)# logging alarm critical
```

If alarm severity is not specified, alarm messages for all severity levels are sent to logging devices.

### Examples of Alarm Messages

The following alarm messages are examples of alarm messages that are sent to the console when a SPA is removed without first doing a graceful deactivation of the SPA. The alarm is cleared when the SPA is re-inserted.

SPA REMOVED

```
*May 18 14:50:48.540: %TRANSCEIVER-6-REMOVED: SIP0: iomd: Transceiver module removed from TenGigabitEthernet0/0/1
```

```
*May 18 14:50:49.471: %IOSXE_OIR-6-REMSPA: SPA removed from subslot 0/0, interfaces disabled
```

```
*May 18 14:50:49.490: %SPA_OIR-6-OFFLINECARD: SPA (A900-IMA2Z) offline in subslot 0/0
```

SPA RE-INSERTED

```
*May 18 14:52:11.803: %IOSXE_OIR-6-INSSPA: SPA inserted in subslot 0/0
```

```
*May 18 14:52:52.807: %SPA_OIR-6-ONLINECARD: SPA (A900-IMA2Z) online in subslot 0/0
```

```
*May 18 14:52:53.543: %TRANSCEIVER-6-INSERTED: SIP0: iomd: transceiver module inserted in TenGigabitEthernet0/0/0
```

```
*May 18 14:52:53.551: %TRANSCEIVER-6-INSERTED: SIP0: iomd: transceiver module inserted in TenGigabitEthernet0/0/1
```

```
*May 18 14:52:54.780: %LINK-3-UPDOWN: Interface TenGigabitEthernet0/0/0, changed state to down
```

```
*May 18 14:52:54.799: %LINK-3-UPDOWN: Interface TenGigabitEthernet0/0/1, changed state to down
```

```
*May 18 14:53:06.578: %LINEPROTO-5-UPDOWN: Line protocol on Interface TenGigabitEthernet0/0/1, changed state to up
```

```
*May 18 14:53:08.482: %LINK-3-UPDOWN: Interface TenGigabitEthernet0/0/1, changed state to up
```

### ALARMS for Router

To view the alarms on router, use the show facility-alarm status command. The example shows a critical alarm for Power supply along with the description:

```
SPA Removed
```

```

Router# show facility-alarm status
System Totals Critical: 22 Major: 0 Minor: 0
Source          Time          Severity      Description [Index]
-----
subslot 0/0    May 18 2016 14:50:49  CRITICAL      Active Card Removed OIR
Alarm [0]
GigabitEthernet0/1/0    May 11 2016 18:53:36  CRITICAL      Physical Port Link Down [1]
GigabitEthernet0/1/1    May 11 2016 18:53:36  CRITICAL      Physical Port Link Down [1]
GigabitEthernet0/1/2    May 11 2016 18:53:36  CRITICAL      Physical Port Link Down [1]
GigabitEthernet0/1/5    May 11 2016 18:53:36  CRITICAL      Physical Port Link Down [1]
GigabitEthernet0/1/6    May 11 2016 18:53:36  CRITICAL      Physical Port Link Down [1]
GigabitEthernet0/1/7    May 11 2016 18:53:36  CRITICAL      Physical Port Link Down [1]
xcvr container 0/2/0    May 11 2016 18:54:25  CRITICAL      Transceiver Missing - Link
  Down [1]
xcvr container 0/2/2    May 11 2016 18:54:25  CRITICAL      Transceiver Missing - Link
  Down [1]
GigabitEthernet0/2/3    May 11 2016 18:54:25  CRITICAL      Physical Port Link Down [1]
xcvr container 0/2/4    May 11 2016 18:54:25  CRITICAL      Transceiver Missing - Link
  Down [1]
xcvr container 0/2/5    May 11 2016 18:54:25  CRITICAL      Transceiver Missing - Link
  Down [1]
GigabitEthernet0/2/6    May 11 2016 18:54:25  CRITICAL      Physical Port Link Down [1]
SONET 0/3/0            May 11 2016 18:54:25  INFO          Physical Port Administrative
  State Down [36]
xcvr container 0/3/1    May 11 2016 18:53:44  INFO          Transceiver Missing [0]
xcvr container 0/3/2    May 11 2016 18:53:44  INFO          Transceiver Missing [0]
xcvr container 0/3/3    May 11 2016 18:53:44  INFO          Transceiver Missing [0]
xcvr container 0/4/0    May 11 2016 18:54:25  CRITICAL      Transceiver Missing - Link
  Down [1]
xcvr container 0/4/1    May 11 2016 18:54:25  CRITICAL      Transceiver Missing - Link
  Down [1]
xcvr container 0/4/2    May 11 2016 18:54:25  CRITICAL      Transceiver Missing - Link
  Down [1]
GigabitEthernet0/4/3    May 11 2016 18:54:25  CRITICAL      Physical Port Link Down [1]
xcvr container 0/4/4    May 11 2016 18:54:25  CRITICAL      Transceiver Missing - Link
  Down [1]
xcvr container 0/4/5    May 11 2016 18:54:25  CRITICAL      Transceiver Missing - Link
  Down [1]
xcvr container 0/4/6    May 11 2016 18:54:25  CRITICAL      Transceiver Missing - Link
  Down [1]
xcvr container 0/4/7    May 11 2016 18:54:25  CRITICAL      Transceiver Missing - Link
  Down [1]
TenGigabitEthernet0/4/8  May 11 2016 18:54:25  CRITICAL      Physical Port Link Down
[35]

```

### SPA Re-Inserted

```

Router# show facility-alarm status
System Totals Critical: 22 Major: 0 Minor: 0
Source          Time          Severity      Description [Index]
-----
TenGigabitEthernet0/0/0  May 18 2016 14:53:02  CRITICAL      Physical Port Link Down
[35]
GigabitEthernet0/1/0    May 11 2016 18:53:36  CRITICAL      Physical Port Link Down [1]
GigabitEthernet0/1/1    May 11 2016 18:53:36  CRITICAL      Physical Port Link Down [1]
GigabitEthernet0/1/2    May 11 2016 18:53:36  CRITICAL      Physical Port Link Down [1]
GigabitEthernet0/1/5    May 11 2016 18:53:36  CRITICAL      Physical Port Link Down [1]
GigabitEthernet0/1/6    May 11 2016 18:53:36  CRITICAL      Physical Port Link Down [1]
GigabitEthernet0/1/7    May 11 2016 18:53:36  CRITICAL      Physical Port Link Down [1]
xcvr container 0/2/0    May 11 2016 18:54:25  CRITICAL      Transceiver Missing - Link
  Down [1]
xcvr container 0/2/2    May 11 2016 18:54:25  CRITICAL      Transceiver Missing - Link
  Down [1]

```

```

GigabitEthernet0/2/3      May 11 2016 18:54:25  CRITICAL  Physical Port Link Down [1]
xcvr container 0/2/4      May 11 2016 18:54:25  CRITICAL  Transceiver Missing - Link
Down [1]
xcvr container 0/2/5      May 11 2016 18:54:25  CRITICAL  Transceiver Missing - Link
Down [1]
GigabitEthernet0/2/6      May 11 2016 18:54:25  CRITICAL  Physical Port Link Down [1]
SONET 0/3/0               May 11 2016 18:54:25  INFO      Physical Port Administrative
State Down [36]
xcvr container 0/3/1      May 11 2016 18:53:44  INFO      Transceiver Missing [0]
xcvr container 0/3/2      May 11 2016 18:53:44  INFO      Transceiver Missing [0]
xcvr container 0/3/3      May 11 2016 18:53:44  INFO      Transceiver Missing [0]
xcvr container 0/4/0      May 11 2016 18:54:25  CRITICAL  Transceiver Missing - Link
Down [1]
xcvr container 0/4/1      May 11 2016 18:54:25  CRITICAL  Transceiver Missing - Link
Down [1]
xcvr container 0/4/2      May 11 2016 18:54:25  CRITICAL  Transceiver Missing - Link
Down [1]
GigabitEthernet0/4/3      May 11 2016 18:54:25  CRITICAL  Physical Port Link Down [1]
xcvr container 0/4/4      May 11 2016 18:54:25  CRITICAL  Transceiver Missing - Link
Down [1]
xcvr container 0/4/5      May 11 2016 18:54:25  CRITICAL  Transceiver Missing - Link
Down [1]
xcvr container 0/4/6      May 11 2016 18:54:25  CRITICAL  Transceiver Missing - Link
Down [1]
xcvr container 0/4/7      May 11 2016 18:54:25  CRITICAL  Transceiver Missing - Link
Down [1]
TenGigabitEthernet0/4/8   May 11 2016 18:54:25  CRITICAL  Physical Port Link Down
[35]

```

To view critical alarms specifically, use the `show facility-alarm status critical` command:

```

Router# show facility-alarm status critical
System Totals  Critical: 22  Major: 0  Minor: 0
Source          Time                Severity            Description [Index]
-----
TenGigabitEthernet0/0/0  May 18 2016 14:53:02  CRITICAL            Physical Port Link Down
[35]
GigabitEthernet0/1/0     May 11 2016 18:53:36  CRITICAL            Physical Port Link Down [1]
GigabitEthernet0/1/1     May 11 2016 18:53:36  CRITICAL            Physical Port Link Down [1]
GigabitEthernet0/1/2     May 11 2016 18:53:36  CRITICAL            Physical Port Link Down [1]
GigabitEthernet0/1/5     May 11 2016 18:53:36  CRITICAL            Physical Port Link Down [1]
GigabitEthernet0/1/6     May 11 2016 18:53:36  CRITICAL            Physical Port Link Down [1]
GigabitEthernet0/1/7     May 11 2016 18:53:36  CRITICAL            Physical Port Link Down [1]
xcvr container 0/2/0      May 11 2016 18:54:25  CRITICAL            Transceiver Missing - Link
Down [1]
xcvr container 0/2/2      May 11 2016 18:54:25  CRITICAL            Transceiver Missing - Link
Down [1]
GigabitEthernet0/2/3      May 11 2016 18:54:25  CRITICAL            Physical Port Link Down [1]
xcvr container 0/2/4      May 11 2016 18:54:25  CRITICAL            Transceiver Missing - Link
Down [1]
xcvr container 0/2/5      May 11 2016 18:54:25  CRITICAL            Transceiver Missing - Link
Down [1]
GigabitEthernet0/2/6      May 11 2016 18:54:25  CRITICAL            Physical Port Link Down [1]
xcvr container 0/4/0      May 11 2016 18:54:25  CRITICAL            Transceiver Missing - Link
Down [1]
xcvr container 0/4/1      May 11 2016 18:54:25  CRITICAL            Transceiver Missing - Link
Down [1]
xcvr container 0/4/2      May 11 2016 18:54:25  CRITICAL            Transceiver Missing - Link
Down [1]
GigabitEthernet0/4/3      May 11 2016 18:54:25  CRITICAL            Physical Port Link Down [1]
xcvr container 0/4/4      May 11 2016 18:54:25  CRITICAL            Transceiver Missing - Link
Down [1]
xcvr container 0/4/5      May 11 2016 18:54:25  CRITICAL            Transceiver Missing - Link
Down [1]

```

```

xcvr container 0/4/6      May 11 2016 18:54:25  CRITICAL      Transceiver Missing - Link
  Down [1]
xcvr container 0/4/7      May 11 2016 18:54:25  CRITICAL      Transceiver Missing - Link
  Down [1]
TenGigabitEthernet0/4/8  May 11 2016 18:54:25  CRITICAL      Physical Port Link Down
[35]

```

To view the operational state of the major hardware components on the router, use the `show platform diag` command. This example shows the Power supply P0 has failed:

```

Router# show platform diag
Chassis type: ASR903
Slot: 1, A900-RSP2A-128
  Running state           : ok
  Internal state          : online
  Internal operational state : ok
  Physical insert detect time : 00:02:33 (00:57:31 ago)
  Software declared up time  : 00:03:41 (00:56:24 ago)
  CPLD version             : 15092360
  Firmware version         : 15.4(3r)S2
Sub-slot: 0/0, A900-IMA2Z
  Operational status       : ok
  Internal state           : inserted
  Physical insert detect time : 00:04:46 (00:55:19 ago)
  Logical insert detect time  : 00:04:46 (00:55:19 ago)
Sub-slot: 0/1, A900-IMA8T
  Operational status       : ok
  Internal state           : inserted
  Physical insert detect time : 00:04:46 (00:55:19 ago)
  Logical insert detect time  : 00:04:46 (00:55:19 ago)
Sub-slot: 0/2, A900-IMA8S
  Operational status       : ok
  Internal state           : inserted
  Physical insert detect time : 00:04:46 (00:55:19 ago)
  Logical insert detect time  : 00:04:46 (00:55:19 ago)
Sub-slot: 0/3, A900-IMA4OS
  Operational status       : ok
  Internal state           : inserted
  Physical insert detect time : 00:04:46 (00:55:18 ago)
  Logical insert detect time  : 00:04:46 (00:55:18 ago)
Sub-slot: 0/4, A900-IMA8S1Z
  Operational status       : ok
  Internal state           : inserted
  Physical insert detect time : 00:04:46 (00:55:18 ago)
  Logical insert detect time  : 00:04:46 (00:55:18 ago)
Sub-slot: 0/5, A900-IMASER14A/S
  Operational status       : ok
  Internal state           : inserted
  Physical insert detect time : 00:04:46 (00:55:19 ago)
  Logical insert detect time  : 00:04:46 (00:55:19 ago)
Slot: R0, A900-RSP2A-128
  Running state           : ok, standby
  Internal state          : online
  Internal operational state : ok
  Physical insert detect time : 00:24:37 (00:35:28 ago)
  Software declared up time  : 00:31:28 (00:28:36 ago)
  CPLD version             : 15092360
  Firmware version         : 15.4(3r)S2
Slot: R1, A900-RSP2A-128
  Running state           : ok, active
  Internal state          : online
  Internal operational state : ok
  Physical insert detect time : 00:02:33 (00:57:31 ago)
  Software declared up time  : 00:02:33 (00:57:31 ago)

```

```

    Became HA Active time      : 00:34:41 (00:25:23 ago)
    CPLD version               : 15092360
    Firmware version           : 15.4 (3r)S2
Slot: F0,
    Running state              : ok, standby
    Internal state             : online
    Internal operational state : ok
    Physical insert detect time : 00:24:37 (00:35:28 ago)
    Software declared up time   : 00:31:45 (00:28:20 ago)
    Hardware ready signal time  : 00:31:39 (00:28:25 ago)
    Packet ready signal time    : 00:33:25 (00:26:40 ago)
    CPLD version               : 15092360
    Firmware version           : 15.4 (3r)S2
Slot: F1,
    Running state              : ok, active
    Internal state             : online
    Internal operational state : ok
    Physical insert detect time : 00:02:33 (00:57:31 ago)
    Software declared up time   : 00:03:23 (00:56:42 ago)
    Hardware ready signal time  : 00:03:14 (00:56:51 ago)
    Packet ready signal time    : 00:04:19 (00:55:46 ago)
    Became HA Active time      : 00:33:25 (00:26:40 ago)
    CPLD version               : 15092360
    Firmware version           : 15.4 (3r)S2
Slot: P0, Unknown
    State                      : N/A
    Physical insert detect time : 00:00:00 (never ago)
Slot: P1, A900-PWR550-A
    State                      : ok
    Physical insert detect time : 00:03:17 (00:56:48 ago)
Slot: P2, A903-FAN-E
    State                      : ok
    Physical insert detect time : 00:03:21 (00:56:44 ago)

```

## Reviewing and Analyzing Alarm Messages

To facilitate the review of alarm messages, you can write scripts to analyze alarm messages sent to the console or syslog. Scripts can provide reports on events such as alarms, security alerts, and interface status.

Syslog messages can also be accessed through Simple Network Management Protocol (SNMP) using the history table defined in the CISCO-SYSLOG-MIB.

## Configuring External Alarm Trigger

For Cisco ASR 902 Series Router, the fan tray includes an alarm port that maps to two (0 and 1) dry contact alarm inputs. For Cisco ASR 903 Series Router, the fan tray includes an alarm port that maps to four (0 - 3) dry contact alarm inputs.

The pins on the alarm port are passive signals and can be configured as Open (an alarm generated when current is interrupted) or Closed (an alarm is generated when a circuit is established) alarms. You can configure each alarm input as critical, major, or minor. An alarm triggers alarm LEDs and alarm messages. The relay contacts can be controlled through any appropriate third-party relay controller. The open/close configuration is an option controlled in IOS.



## Approaches for Monitoring Hardware Alarms

### Onsite Network Administrator Responds to Audible or Visual Alarms

An external element can be connected to a power supply using the DB-25 alarm connector on the power supply. The external element is a DC light bulb for a visual alarm and a bell for an audible alarm.

If an alarm illuminates the CRIT, MIN, or MAJ LED on the Cisco ASR 900 Series Route Processor (RP) faceplate, and a visual or audible alarm is wired, the alarm also activates an alarm relay in the power supply DB-25 connector. The bell rings or the light bulb flashes.

#### Clearing Audible and Visual Alarms

To clear an audible alarm, do one of the following:

- Press the Audible Cut Off button on the RP faceplate.

To clear a visual alarm, you must resolve the alarm condition. For example, if a critical alarm LED is illuminated because an active SPA was removed without a graceful deactivation of the SPA, the only way to resolve that alarm is to replace the SPA.



**Note** The **clear facility-alarm** command is not supported. The **clear facility-alarm** command does not clear an alarm LED on the RP faceplate or turn off the DC lightbulb

## How to Configure External Alarms

#### Procedure

	Command or Action	Purpose
<b>Step 1</b>	<b>enable</b> <b>Example:</b> <pre>Router&gt; enable</pre>	Enables privileged EXEC mode. <ul style="list-style-type: none"> <li>• Enter your password if prompted.</li> </ul>
<b>Step 2</b>	<b>configure terminal</b> <b>Example:</b> <pre>Router# configure terminal</pre>	Enters global configuration mode.
<b>Step 3</b>	<b>alarm-contact <i>contact-number</i> <i>description string</i></b> <b>Example:</b> <pre>Router(config)#alarm-contact 2 description door sensor</pre>	(Optional) Configures a description for the alarm contact number. <ul style="list-style-type: none"> <li>• The contact-number can be from 1 to 4.</li> <li>• The description string can be up to 80 alphanumeric characters in length and is included in any generated system messages</li> </ul>

## Example

	Command or Action	Purpose
<b>Step 4</b>	<b>alarm-contact</b> { <i>contact-number</i>   <b>all</b> { <b>severity</b> { <b>critical</b>   <b>major</b>   <b>minor</b> }   <b>trigger</b> { <b>closed</b>   <b>open</b> }}  <b>Example:</b>  Router(config)#alarm-contact 2 severity major	Configures the trigger and severity for an alarm contact number or for all contact numbers. <ul style="list-style-type: none"> <li>• Enter a contact number (1 to 4) or specify that you are configuring <b>all</b> alarms.</li> <li>• For <b>severity</b>, enter <b>critical</b>, <b>major</b>, or <b>minor</b>. If you do not configure a severity, the default is <b>minor</b>.</li> <li>• For <b>trigger</b>, enter <b>open</b> or <b>closed</b>. If you do not configure a trigger, the alarm is triggered when the circuit is <b>closed</b>.</li> </ul>
<b>Step 5</b>	<b>exit</b>  <b>Example:</b>  Router#exit	Exits the configuration mode.
<b>Step 6</b>	<b>show facility-alarm status</b>  <b>Example:</b>  Router#show facility-alarm status	Displays configured alarms status.

## Example

```

Router>enable
Router#configure terminal
Router(config)#alarm-contact 2 description door sensor
Router(config)#alarm-contact 2 severity major
Router(config)#alarm-contact 2 trigger open
Router(config)#end
Router#show facility-alarm status
System Totals  Critical: 15  Major: 0  Minor: 0

```

```

Source                Time                Severity            Description [Index]
-----
subslot 0/0           Sep 21 2016 15:19:55  CRITICAL            Active Card Removed OIR
Alarm [0]
subslot 0/1           Sep 21 2016 15:19:12  CRITICAL            Active Card Removed OIR
Alarm [0]
subslot 0/2           Sep 21 2016 15:16:59  CRITICAL            Active Card Removed OIR
Alarm [0]
subslot 0/3           Sep 21 2016 15:18:10  CRITICAL            Active Card Removed OIR
Alarm [0]
subslot 0/5           Sep 21 2016 15:16:11  CRITICAL            Active Card Removed OIR
Alarm [0]
subslot 0/6           Sep 21 2016 15:15:45  CRITICAL            Active Card Removed OIR
Alarm [0]
subslot 0/7           Sep 21 2016 15:14:22  CRITICAL            Active Card Removed OIR
Alarm [0]
subslot 0/8           Sep 21 2016 15:10:33  CRITICAL            Active Card Removed OIR
Alarm [0]
subslot 0/9           Sep 21 2016 12:00:43  CRITICAL            Active Card Removed OIR
Alarm [0]
subslot 0/10          Sep 21 2016 15:11:49  CRITICAL            Active Card Removed OIR

```

```

Alarm [0]
subslot 0/13          Sep 21 2016 14:56:35  CRITICAL      Active Card Removed OIR
Alarm [0]
subslot 0/14          Sep 21 2016 14:56:29  CRITICAL      Active Card Removed OIR
Alarm [0]
subslot 0/15          Sep 21 2016 14:56:33  CRITICAL      Active Card Removed OIR
Alarm [0]
Fan Tray Bay 0       Sep 21 2016 11:50:39  CRITICAL      Fan Tray Module Missing [0]
Router(config)#

```



**Note** The external alarm trigger and syslog support configuration is supported from Cisco IOS XE Release 3.13.0S.

## Alarm Filtering Support

The Alarm Filtering Support in the Cisco Entity Alarm MIB feature implements the alarm filter profile capability defined in CISCO-ENTITY-ALARM-MIB. Also implemented are configuration commands to control the severity of syslog messages and SNMP notifications triggered by the alarms.

## Information About Alarm Filtering Support

### Overview of Alarm Filtering Support

To configure alarm filtering in the Cisco Entity Alarm MIB, you should understand the following concepts:

#### CISCO-ENTITY-ALARM-MIB

The CISCO-ENTITY-ALARM-MIB provides a management client with the capability to monitor alarms generated by physical entities in a network that are identified in the entPhysicalTable of the Entity-MIB (RFC 2737). Examples of these physical entities are chassis, fans, modules, ports, slots, and power supplies. The management client interfaces with an SNMP agent to request access to objects defined in the CISCO-ENTITY-ALARM-MIB.

#### ceAlarmGroup

The ceAlarmGroup is a group in the CISCO-ENTITY-ALARM-MIB that defines objects that provide current statuses of alarms and the capability to instruct an agent to stop (cut off) signaling for any or all external audible alarms.

Following are the objects in ceAlarmGroup:

- ceAlarmCriticalCount
- ceAlarmMajorCount
- ceAlarmMinorCount
- ceAlarmCutoff
- ceAlarmFilterProfile
- ceAlarmSeverity
- ceAlarmList

**ceAlarmFilterProfileTable**

The ceAlarmFilterProfileTable filters alarms according to configured alarm lists. The filtered alarms are then sent out as SNMP notifications or syslog messages, based on the alarm list enabled for each alarm type. This table is defined in the CISCO-ENTITY-ALARM-MIB and implemented in the group ceAlarmGroup.

**ceAlarmFilterProfile**

An alarm filter profile controls the alarm types that an agent monitors and signals for a corresponding physical entity. The ceAlarmFilterProfile object holds an integer value that uniquely identifies an alarm filter profile associated with a corresponding physical entity. When the value is zero, the agent monitors and signals all alarms associated with the corresponding physical entity.

**ceAlarmHistTable:**

This table contains the history of ceAlarmAsserted and ceAlarmCleared traps generated by the agent.

Each entry to the table will have physical index from entPhysicalTable and the severity of the alarm.

The ceAlarmAsserted and ceAlarmCleared trap varbinds are mostly from this table and the description from ceAlarmDescrTable.

**ceAlarmDescrTable:**

This table contains a description for each alarm type defined by each vendor type employed by the system.

This table has the list of possible severity levels and the description for the physical entity, Object “ceAlarmDescrSeverity” indicates the severity of an alarm (1 to 4 as above).

**ceAlarmTable:**

This table specifies alarm control and status information related to each physical entity contained by the system, including the alarms currently being asserted by each physical entity capable of generating alarms.

**Prerequisites for Alarm Filtering Support**

- SNMP is configured on your routing devices.
- Familiarity with the ENTITY-MIB and the CISCO-ENTITY-ALARM-MIB.

**Restrictions for Alarm Filtering Support**

- The CISCO-ENTITY-ALARM-MIB supports reporting of alarms for physical entities only, including chassis, slots, modules, ports, power supplies, and fans. In order to monitor alarms generated by a physical entity, it must be represented by a row in the entPhysicalTable .

**How to Configure Alarm Filtering for Syslog Messages and SNMP Notifications****Configuring Alarm Filtering for Syslog Messages**

This task describes how to configure the alarm severity threshold for generating syslog messages. When you use this command, the alarm severity threshold is included in the running configuration and automatically applied when the configuration is reloaded.

```
enable
configure terminal
```

```
logging alarm 2
show facility-alarm status
```

## Configuring Alarm Filtering for SNMP Notifications

This task describes how to configure the alarm severity threshold for generating SNMP notifications. When you use this command, the alarm severity threshold is included in the running configuration and automatically applied when the configuration is reloaded.

```
enable
configure terminal
snmp-server enable traps alarms 2
show facility-alarm status
```

## Configuration Examples for Alarm Filtering Support

### Configuring Alarm Filtering for Syslog Messages: Example

The following example shows how to configure an alarm filter for syslog messages:

### Configuring Alarm Filtering for SNMP Notifications: Example

The following example shows how to configure an alarm filter for SNMP notifications:

```
Router# enable
Router# configure terminal
Enter configuration commands, one per line. End with CNTL/Z.
Router(config)# snmp-server enable traps alarms 2
Router(config)#
Router(config)# exit
Router# show facility-alarm status
System Totals  Critical: 2  Major: 1  Minor: 0
Source                Time                Severity  Description [Index]
-----
Power Supply Bay 0    Jun 07 2016 13:36:49  CRITICAL  Power Supply/FAN Module
Missing [0]
Fan Tray/Ext. ALARM: Jun 07 2016 13:36:55  MAJOR     Fan Tray/Fan 8 Failure [15]
xcvr container 0/5/0  Jun 07 2016 13:37:43  CRITICAL  Transceiver Missing - Link
Down [1]
xcvr container 0/5/1  Jun 07 2016 13:37:43  INFO      Transceiver Missing [0]
xcvr container 0/5/2  Jun 07 2016 13:37:43  INFO      Transceiver Missing [0]
xcvr container 0/5/3  Jun 07 2016 13:37:43  INFO      Transceiver Missing [0]
xcvr container 0/5/4  Jun 07 2016 13:37:43  INFO      Transceiver Missing [0]
xcvr container 0/5/5  Jun 07 2016 13:37:43  INFO      Transceiver Missing [0]
xcvr container 0/5/6  Jun 07 2016 13:37:43  INFO      Transceiver Missing [0]
xcvr container 0/5/7  Jun 07 2016 13:37:43  INFO      Transceiver Missing [0]
```

## Facility Protocol Status Support

The routers report the protocol status using Syslog or Trap alarm notifications. Few Syslogs and Traps are not cleared when the router gets disconnected or reloaded. As a result, the alarms are not notified.

To avoid this, a new command, **show facility-protocol status**, is introduced that displays the output of the following routing protocols status at any interval of time:

- ISIS
- OSPF
- BGP
- TE Tunnels
- LDP
- Bundles
- PWs
- EVPN PWs
- CFM
- SYncE
- PTP
- HSRP
- BFD
- SensorThresholdViolations

## show facility protocol status

The **show facility-protocol status** command helps to backup the protocols syslog information by capturing the current status of the protocols on the system.

Also, when you add a new device, the command can be used to generate a list of the outstanding protocol alarms from the device.

## Restrictions

Only 14 routing protocols outputs can be displayed.

## Routing Protocols Outputs

The following are the outputs of different routing protocols:

### OSPF Output

```
#show facility-protocol status
```

Protocols	Pid	Ver	Interface	IP-address	Status	Adj-ID
Router-ID						
OSPF	22	V2	TenGigabitEthernet0/3/4	10.0.1.2	FULL	21.22.23.25
	15.88.15.89					
OSPF	100	V2	FortyGigabitEthernet0/8/1	192.168.1.1	DOWN	N/A
	100.100.100.100					

### MPLS Output

**#show facility-protocol status**

Protocols	Name	Interface	Src-IP	LDP_Neigh_IP	Status
MPLS-LDP	LDP	TenGigabitEthernet0/3/4	10.0.1.2	N/A	DOWN
MPLS-LDP	LDP	FortyGigabitEthernet0/8/1	192.168.1.1	N/A	DOWN
MPLS-LDP	LDP	GigabitEthernet0/2/0	22.1.4.1	7.7.7.7:0	UP
MPLS-LDP	LDP	GigabitEthernet0/2/4	22.0.1.1	6.6.6.6:0	UP
MPLS-LDP	LDP	Tunnel2001	5.5.5.5	2.2.2.2:0	DOWN
MPLS-LDP	LDP	Tunnel2002	5.5.5.5	2.2.2.2:0	DOWN
MPLS-LDP	LDP	Tunnel2003	5.5.5.5	2.2.2.2:0	DOWN
MPLS-LDP	LDP	Tunnel2004	5.5.5.5	2.2.2.2:0	DOWN
MPLS-LDP	LDP	Tunnel2005	5.5.5.5	2.2.2.2:0	DOWN
MPLS-LDP	LDP	Tunnel2006	5.5.5.5	2.2.2.2:0	DOWN
MPLS-LDP	LDP	Tunnel2007	5.5.5.5	2.2.2.2:0	DOWN
MPLS-LDP	LDP	Tunnel2008	5.5.5.5	2.2.2.2:0	DOWN
MPLS-LDP	LDP	Tunnel2009	5.5.5.5	2.2.2.2:0	DOWN

**ISIS Output****#show facility-protocol status**

Protocols	Interface	ISIS-Type	Neigh-IP	Net-ID	Status
Sys-ID	Hold-Time				
ISIS	HundredGigE0/7/0	Level-1	NA	NA	DOWN
	NA	NA			
ISIS	HundredGigE0/7/0	Level-2	NA	NA	DOWN
	NA	NA			
ISIS	GigabitEthernet0/3/4	Level-2	10.147.158.2	0000.0000.0158	UP
	NCS4206-158	26			
ISIS	BDI72	Level-2	10.10.72.2	0000.0000.0162	UP
	NCS4K-101-162	29			
ISIS	BDI27	Level-2	10.10.27.2	0000.0000.0162	UP
	NCS4K-101-162	23			
ISIS	GigabitEthernet0/0/7	Level-2	NA	NA	UP
	0000.0000.0152	250			
ISIS	TenGigabitEthernet0/3/0	Level-2	38.206.1.3	0000.0000.0023	UP
	C101_A	28			
ISIS	GigabitEthernet0/2/3	Level-2	38.76.1.3	0000.0000.0007	UP
	ASR9K_CORE	23			
ISIS	Tunnell1315	Level-2	7.7.15.2	0000.0000.0007	UP
	ASR9K_CORE	28			

**BGP Output****#show facility-protocol status**

Protocols	LocalAS	RemoteAS	NeighborIP	Status	Up/Down Time
Remote-RID	VRF-Inst-Name				

```

BGP          123          123          21.22.23.25          DOWN          never
0.0.0.0      NA
BGP          123          123          66.66.66.23          DOWN          never
0.0.0.0      CustomerA
BGP          500          500          1.1.1.158            DOWN          never
0.0.0.0      NA
BGP          500          100          10.147.158.2         DOWN          1
0.0.0.0      SENTHIL
BGP          500                                DOWN          1
0.0.0.0

```

### Pseudowire Output

```
#show facility-protocol status
```

```

=====
Protocols      Peer-IP          VC-ID          VC-Status      VC-Error
=====
PWS            1.1.1.146       2              ADMIN DOWN     NA
PWS            1.1.1.146       9              ADMIN DOWN     NA
PWS            1.1.1.146       10             ADMIN DOWN     NA
PWS            1.1.1.146       54             DOWN           NA
PWS            1.1.1.146       87             DOWN           NA
PWS            1.1.1.146       98             DOWN           NA

```

### SYncE Output

```
#show facility-protocol status
```

```

=====
Protocols      Interface          Mode/QL        QL-IN          QL-Rx-Config   QL-Rx-Overrided
=====
SyncE          GigabitEthernet0/1/7  Sync/En       QL-DNU         -               QL-DNU
SyncE          Sync/En           QL-DNU         -               QL-DNU
SyncE          Sync/En           QL-DNU         -               QL-DNU
SyncE          Sync/En           QL-DNU         -               QL-DNU

```

### Bundles Output

```
#show facility-protocol status
```

```

=====
Protocols      Port-Channel      Bundle-Status   Bundled-Ports   Min-Bundle
=====
BUNDLES        Po48              DOWN            0                2

```

### PTP Output

```
#show facility-protocol status
```

```

=====
Protocols      Event              Interface          Role          Clock-port-Name   State
Master-IP
=====
PTP CLK_MASTER_PORT_SELECTED  NA                slave         tomaster          NA
UNKNOWN
PTP CLK_STATUS_UPDATE         Loopback1588     slave         NA                FREERUN
NA
PTP CLK_MASTER_PORT_SELECTED  NA                slave         slave             NA
21.21.21.21
PTP CLK_STATUS_UPDATE         Loopback0        slave         NA                ACQUIRING
NA

```



**HSRP Output**

#show facility-protocol status

```

=====
Protocols  Interface                      Group      State
=====
HSRP       HundredGigE0/7/0              1          Init
=====

```

**TE Tunnels Output**

#show facility-protocol status

```

=====
Protocols      Tunnel-Interface      Status
=====
MPLS-TE        Tunnel0               DOWN
MPLS-TE        Tunnell               DOWN
=====

```

**BFD Output**

#show facility-protocol status

```

=====
Protocols  Interface                      Status      Neigh-Addr  Local-Discriminator
Interface_index
=====
BFD        FortyGigabitEthernet0/8/1     DOWN        NA           NA
          22
BFD        TenGigabitEthernet0/3/0       DOWN        NA           NA
          9
BFD        GigabitEthernet0/5/4         DOWN        NA           NA
          15
BFD        Tunnell1309                  DOWN        NA           NA
          1601
=====

```

**CFM Output**

#show facility-protocol status

```

=====
Protocols Event          Interface                      L-mpid Level Dir BD/VLAN/XCON  ID
Defect-Condition
=====
CFM  ENTER_AIS_INT  GigabitEthernet0/0/4  NA  NA  Up  NA  NA  AIS
CFM  ENTER_AIS      GigabitEthernet0/0/4  2   4   Up  XCON  NA  AIS
CFM  ENTER_AIS_INT  GigabitEthernet0/3/6  NA  NA  Up  NA  NA  AIS
CFM  ENTER_AIS      GigabitEthernet0/3/6  2   4   Up  XCON  NA  AIS
=====
Protocols Event          R-mpid Level EVC-NAME MA-NAME  Domain  MAC          Status Event-Code
=====
CFM  REMOTE_MEP_DOWN  1   NA  SEN_CFM  SEN_CFM  EVC      NA          UP  NA
CFM  REMOTE_MEP_UP    1   NA  SEN_CFM  SEN_CFM  EVC      NA          UP  NA
CFM  CROSSCHECK_MEP_UNKNOWN  1   NA  NA       SEN_CFM  EVC 0022.bdde.05be  NA  NA
CFM  CROSS_CONN_SERVICE  1   4   NA       SEN_CFM  EVC 0022.bdde.05be  NA  NA
CFM  CONFIG_ERROR     1   NA  NA       SEN_CFM  EVC 0022.bdde.05be  NA  NA
=====

```

**EVPN PWs Output**

#show facility-protocol status

```

=====
Protocols      EVPN-ID      Source      Target      Status
=====

```

## show facility-protocol status command

```

EVPN-PWs          100          41          30          DOWN

```

**Sensory Threshold Violations**

```
#show facility-protocol status
```

```

=====
Protocols PhylIndex SenValue SenType SenScale SenPrecision ThresIndex SenThrValue PhyEntryName
=====
SENSOR_THRESH 1211 -103 14 9 1 1 -120 subslot 0/2 transceiver 0 Rx Power Sensor
SENSOR_THRESH 1211 -103 14 9 1 2 -140 subslot 0/2 transceiver 0 Rx Power Sensor
SENSOR_THRESH 1253 -400 14 9 1 3 -310 subslot 0/2 transceiver 3 Rx Power Sensor
SENSOR_THRESH 1253 -400 14 9 1 4 -330 subslot 0/2 transceiver 3 Rx Power Sensor
SENSOR_THRESH 1267 -370 14 9 1 3 -296 subslot 0/2 transceiver 4 Rx Power Sensor
SENSOR_THRESH 1267 -370 14 9 1 4 -310 subslot 0/2 transceiver 4 Rx Power Sensor
SENSOR_THRESH 2001 73 6 9 0 1 0 subslot 0/4 power Sensor 0

```

## show facility-protocol status command

To backup the protocols syslog information by capturing the current status of the protocols on the system, use the **show facility-protocol status** command.

**Syntax Description**

**Syntax Description:**

There are no keywords.

**Command Default**

There is no default.

**Command Modes**

User EXEC (>) Privileged EXEC (#)

**Command History**

Release	Modification
Cisco IOS XE Amsterdam 17.1.x	Support for this command was introduced on ASR 900, ASR 920, and NCS 4200 Series.

**Examples**

```
Router# show facility-protocol status
```

```

=====
Protocols      Peer-IP          VC-ID          VC-Status      VC-Error
=====
PWs            1.1.1.146       2              ADMIN DOWN     NA
PWs            1.1.1.146       9              ADMIN DOWN     NA
PWs            1.1.1.146       10             ADMIN DOWN     NA
PWs            1.1.1.146       54             DOWN           NA
PWs            1.1.1.146       87             DOWN           NA
PWs            1.1.1.146       98             DOWN           NA

```



## CHAPTER 18

# OTN Wrapper Overview

Optical Transport Network (OTN) Wrapper feature provides robust transport services that leverage many of the benefits such as resiliency and performance monitoring, while adding enhanced multi-rate capabilities in support of packet traffic, plus the transparency required by Dense Wavelength Division Multiplexing (DWDM) networks. OTN is the ideal technology to bridge the gap between next generation IP and legacy Time Division Multiplexing (TDM) networks by acting as a converged transport layer for newer packet-based and existing TDM services. OTN is defined in ITU G.709 and allows network operators to converge networks through seamless transport of the numerous types of legacy protocols, while providing the flexibility required to support future client protocols.

OTN Wrapper feature is supported on the following interface modules:

- 8-port 10 Gigabit Ethernet Interface Module (8x10GE) (A900-IMA8Z) - The encapsulation type is OTU1e and OTU2e.
- 2-port 40 Gigabit Ethernet QSFP Interface Module (2x40GE) (A900-IMA2F) - The encapsulation type is OTU3.
- 1-port 100 Gigabit Ethernet Interface Module (1X100GE) (A900-IMA1C) - The encapsulation type is OTU4.

The chassis acts as an aggregator for ethernet, TDM, and SONET traffic to connect to an OTN network and vice versa. The ports on the interface modules are capable of OTN functionality. The OTN controller mode enables the IPoDWDM technology in the interface modules. The OTN Wrapper encapsulates 10G LAN, 40G LAN, and 100G LAN into the corresponding OTU1e or OTU2e, OTU3, and OTU4 containers, respectively. This enables the ports of the interface modules to work in layer 1 optical mode in conformance with standard G.709.

Figure 12: OTN Signal Structure

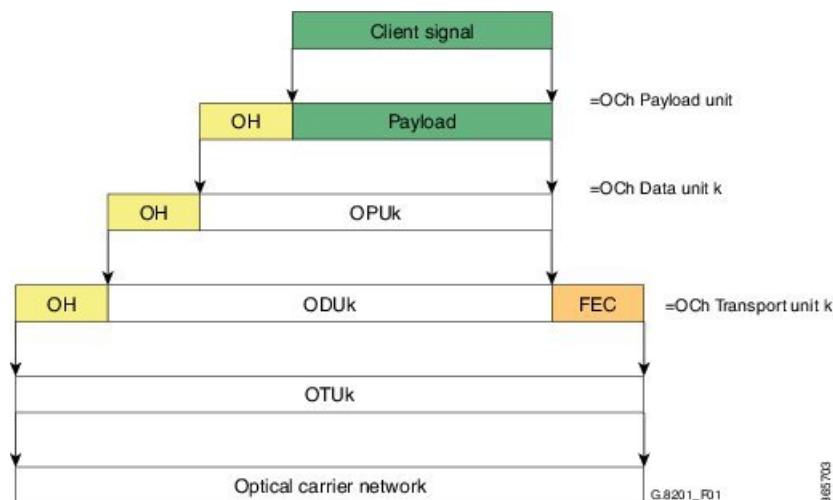

### OTN Frame

The key sections of the OTN frame are the Optical Channel Transport Unit (OTU) overhead section, Optical Channel Data Unit (ODU) overhead section, Optical Channel Payload Unit (OPU) overhead section, OPU payload section, and Forward Error Correction (FEC) overhead section. The network routes these OTN frames across the network in a connection-oriented way. The Overhead carries the information required to identify, control and manage the payload, which maintains the deterministic quality. The Payload is simply the data transported across the network, while the FEC corrects errors when they arrive at the receiver. The number of correctable errors depends on the FEC type.

- [Advantages of OTN, on page 283](#)
- [ODU and OTU, on page 283](#)
- [OTU1e and OTU 2e Support on 8x10GE Interface Module, on page 283](#)
- [Deriving OTU1e and OTU2e Rates, on page 284](#)
- [OTU3 Support in 2x40GE Interface Module, on page 285](#)
- [Supported Transceivers, on page 285](#)
- [OTN Specific Functions, on page 285](#)
- [Standard MIBS, on page 286](#)
- [Restrictions for OTN, on page 286](#)
- [DWDM Provisioning, on page 287](#)
- [Configuring Transport Mode in 8x10GE and 2x40GE Interface Modules, on page 287](#)
- [OTN Alarms, on page 290](#)
- [OTN Threshold, on page 293](#)
- [Configuring OTU Alerts, on page 295](#)
- [Configuring ODU Alerts, on page 295](#)
- [Configuring ODU Alerts, on page 295](#)
- [Loopback, on page 297](#)
- [Configuring Loopback, on page 297](#)
- [SNMP Support, on page 301](#)
- [Performance Monitoring, on page 302](#)
- [Troubleshooting Scenarios, on page 309](#)
- [Associated Commands, on page 309](#)

## Advantages of OTN

The following are the advantages of OTN:

- Provides multi-layer performance monitoring and enhanced maintenance capability for signals traversing multi-operator networks.
- Allows Forward Error Correction (FEC) to improve the system performance.
- Provides enhanced alarm handling capability.
- Insulates the network against uncertain service mix by providing transparent native transport of signals encapsulating all client-management information.
- Performs multiplexing for optimum capacity utilization, thereby improving network efficiency.
- Enables network scalability as well as support for dedicated Ethernet services with service definitions.

## ODU and OTU

Optical Channel Transport Unit (OTU) and Optical Channel Data Unit (ODU) are the two digital layer networks. All client signals are mapped into the optical channel via the ODU and OTU layer networks.

### OTU

The OTU section is composed of two main sections: the Frame Alignment section and the Section Monitoring (SM) section. The OTU Overhead (OH) provides the error detection correction as well as section-layer connection and monitoring functions on the section span. The OTU OH also includes framing bytes, enabling receivers to identify frame boundaries. For more information, see *G.709 document*.

### ODU

The ODU section is an internal element allowing mapping or switching between different rates, which is important in allowing operators the ability to understand how the end user pipe is transferred through to the higher network rates. The ODU OH contains path overhead bytes allowing the ability to monitor the performance, fault type and location, generic communication, and six levels of channel protection based on Tandem Connection Monitoring (TCM). For more information, see *G.709 document*.

## OTU1e and OTU 2e Support on 8x10GE Interface Module

The OTU1e and OTU2e are mapping mechanisms to map a client 10G Base-R signal to OTN frames transparently as per ITU-T G series Supplement 43 specification. Both these modes are over-clocked OTN modes. These mechanisms provide real bit transparency of 10 GbE LAN signals and are useful for deployment of 10G services.

The OTU1e and OTU2e are inherently intra-domain interfaces (IaDI) and are generally applicable only to a single vendor island within an operator's network to enable the use of unique optical technology. The OTU1e and OTU2e are not standard G.709 bit-rate signals and they do not interwork with the standard mappings of Ethernet using GFP-F. These two over-clocked mechanisms do not interwork with each other. As a result, such signals are only deployed in a point-to-point configuration between equipment that implements the same mapping.

The standard 10 GbE LAN has a data rate of 10.3125 Gbps. In the OTU1e and OTU2e mapping schemes, the full 10.3125 Gbit/s is transported including the 64B/66B coded information, IPG, MAC FCS, preamble, start-of-frame delimiter (SFD) and the ordered sets (to convey fault information). So, the effective OTU2e and OTU1e rates are:

- OTU1e: 11.0491 Gbits/s +/- 100ppm
- OTU2e: 11.0957 Gbits/s +/- 100ppm

The 10GBase-R client signal with fixed stuff bytes is accommodated into an OPU-like signal, then into an ODU-like signal, and further into an OTU-like signal. These signals are denoted as OPU2e, ODU2e and OTU2e, respectively. The OTU1e does not add 16 columns of fixed stuff bytes and hence overall data rate is relatively lesser at 11.0491 Gbps as compared to OTU2e which is 11.0957 Gbps.

The following table shows the standard OTU rates:

**Table 24: Standard OTU Rates**

G.709 Interface	Line Rate	Corresponding Ethernet Rate	Line Rate
OTU-1e	11.0491 Gbit/s without stuffing bits	10 Gig E-LAN	10.3125 Gbit/s
OTU-2e	11.0957 Gbit/s without stuffing bits	10 Gig E-LAN	10.3125 Gbit/s
OTU-3	43.018 Gbit/s	STM-256 or OC-768	39.813 Gbit/s

## Deriving OTU1e and OTU2e Rates

A standard OTN frame consists of 255 16-column blocks and the payload rate is 9953280 Kbit/s. This is because the overhead and stuffing in the OTN frames happen at a granularity of 16-column blocks. Thus, OPU payload occupies  $(3824-16)/16=238$  blocks. The ODU occupies 239 blocks and the OTU (including FEC) occupies 255 blocks. Hence, the multiplication factor in the G.709 spec is specified using numbers like 237, 238, 255.

Since OPU2e uses 16 columns that are reserved for stuffing and also for payload, the effective OPU2e frequency is:

- $OPU2e = 238/237 \times 10312500 \text{ Kbit/s} = 10.356012 \text{ Gbit/s}$
- $ODU2e = 239/237 \times 10312500 \text{ Kbit/s} = 10.399525 \text{ Gbit/s}$
- $OTU2e = 255/237 \times 10312500 \text{ Kbit/s} = 11.095727 \text{ Gbit/s}$

Since OPU1e uses 16 columns that are reserved for stuffing and also for payload, the effective OPU1e frequency is:

- $OPU1e = 238/238 \times 10312500 \text{ Kbit/s} = 10.3125 \text{ Gbit/s}$
- $ODU1e = 239/238 \times 10312500 \text{ Kbit/s} = 10.355829 \text{ Gbit/s}$
- $OTU1e = 255/238 \times 10312500 \text{ Kbit/s} = 11.049107 \text{ Gbit/s}$

## OTU3 Support in 2x40GE Interface Module

When 40GbE LAN is transported over OTN, there is no drop in line rate when the LAN client is mapped into the OPU3 using the standard CBR40G mapping procedure as specified in G.709 clause 17.2.3. The 40G Ethernet signal (41.25 Gbit/s) uses 64B/66B coding making it slightly larger than the OPU3 payload rate that is 40.15 Gbit/s. Hence, to transport 40G Ethernet service over ODU3, the 64B/66B blocks are transcoded into 1024B/1027B block code to reduce their size. The resulting 40.117 Gbit/s transcoded stream is then mapped in standard OPU3.

## Supported Transceivers

The OTN wrapper feature works with the standard transceiver types that are supported for the LAN mode of 10G, 40G and 100G on the interface modules. The SFP-10G-LR-X, QSFP-40G-LR4, and CPAK-100G-SR10 are used for 8x10GE, 2x40GE, and 1X100GE interface modules, respectively.

## OTN Specific Functions

The following figure shows the OTN specific functions related to overhead processing, alarm handling, FEC and TTI:

Figure 13: OTN Specific Functions

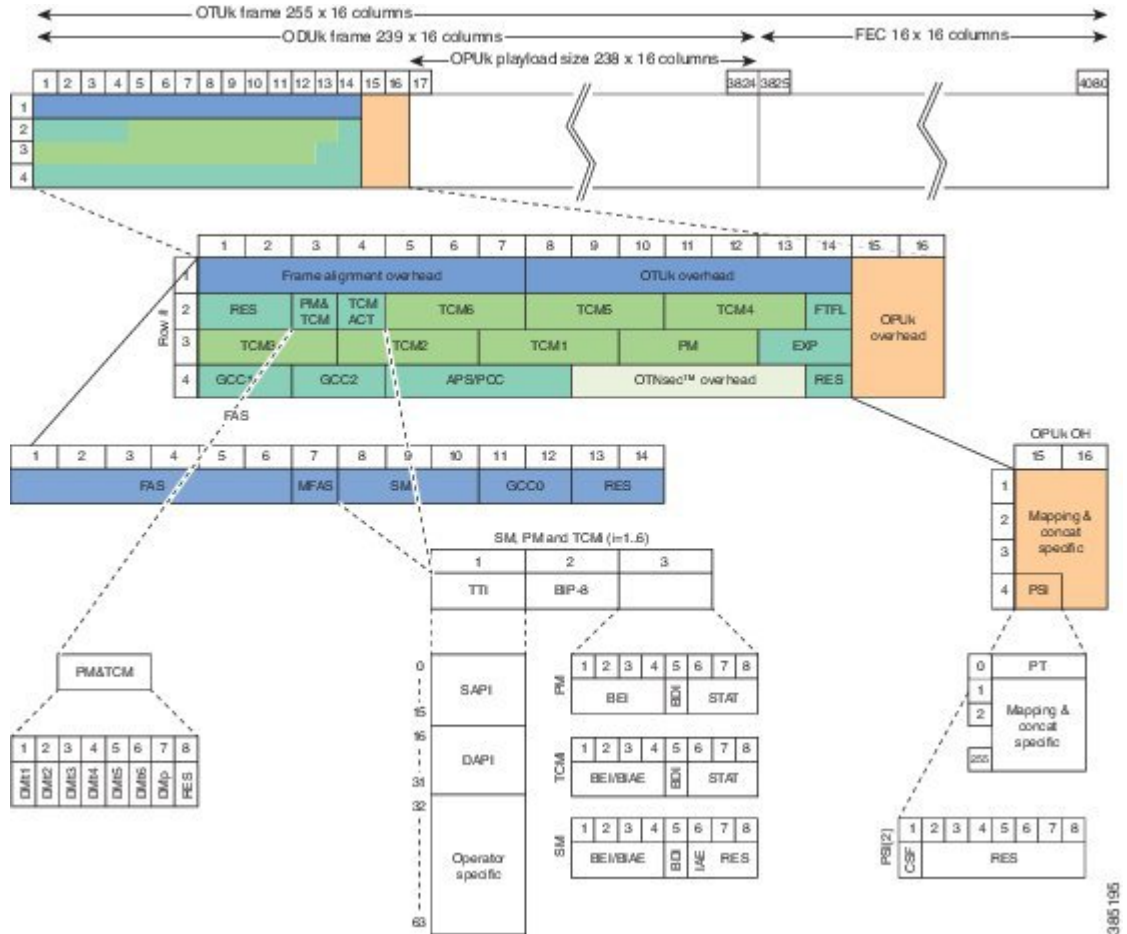

## Standard MIBS

The following are the standard MIBS:

- RFC2665
- RFC1213
- RFC2907
- RFC2233
- RFC3591

## Restrictions for OTN

The following are the restrictions for OTN:



- OTL alarms are not supported.
- FECMISMATCH alarm is not supported.
- Enhanced FEC is not supported.
- Alarm and error counters are visible when the controller is in shutdown state.

## DWDM Provisioning

All DWDM provisioning configurations take place on the controller. To configure a DWDM controller, use the controller `dwdm` command in global configuration mode.

### Prerequisites for DWDM Provisioning

The `g709` configuration commands can be used only when the controller is in the shutdown state. Use the **no shutdown** command after configuring the parameters, to remove the controller from shutdown state and to enable the controller to move to up state.

### Configuring DWDM Provisioning

Use the following commands to configure DWDM provisioning:

```
enable
configure terminal
controller dwdm 0/1/0
```

## Configuring Transport Mode in 8x10GE and 2x40GE Interface Modules

Use the **transport-mode** command in interface configuration mode to configure LAN and OTN transport modes in 8x10GE and 2x40GE interface modules. The **transport-mode** command **otn** option has the bit-transparent sub-option, using which bit transparent mapping into OPU1e or OPU2e can be configured.

Use the following commands to configure LAN and OTN transport modes:

```
enable
configure terminal
controller dwdm 0/0/0
transport-mode otn bit-transparent opu1e
```



---

**Note** LAN transport mode is the default mode.

---

To configure the transport administration state on a DWDM port, use the **admin-state** command in DWDM configuration mode. To return the administration state from a DWDM port to the default, use the **no** form of this command.

## Verification of LAN Transport Mode Configuration

Use the **show interfaces** command to verify the configuration of LAN transport mode:

```
Router#sh int te0/1/0
TenGigabitEthernet0/1/0 is up, line protocol is up
  MTU 1500 bytes, BW 10000000 Kbit/sec, DLY 10 usec,
    reliability 255/255, txload 8/255, rxload 193/255
  Encapsulation ARPA, loopback not set
  Keepalive set (10 sec)
  Full Duplex, 10000Mbps, link type is force-up, media type is SFP-SR
  output flow-control is unsupported, input flow-control is on
  Transport mode LAN
  ARP type: ARPA, ARP Timeout 04:00:00
  Last input 04:02:09, output 04:02:09, output hang never
  Last clearing of "show interface" counters 00:29:47
  Input queue: 0/375/0/0 (size/max/drops/flushes); Total output drops: 0
  Queueing strategy: fifo
  Output queue: 0/40 (size/max)
  5 minute input rate 7605807000 bits/sec, 14854906 packets/sec
  5 minute output rate 335510000 bits/sec, 655427 packets/sec
    26571883351 packets input, 1700600465344 bytes, 0 no buffer
    Received 0 broadcasts (0 IP multicasts)
    0 runts, 0 giants, 0 throttles
    0 input errors, 0 CRC, 0 frame, 0 overrun, 0 ignored
    0 watchdog, 0 multicast, 0 pause input
    10766634813 packets output, 689064271464 bytes, 0 underruns
    0 output errors, 0 collisions, 0 interface resets
    0 unknown protocol drops
    0 babbles, 0 late collision, 0 deferred
    0 lost carrier, 0 no carrier, 0 pause output
    0 output buffer failures, 0 output buffers swapped out
Router#
```

## Verification of OTN Transport Mode Configuration in 8x10GE Interface Modules

Use the **show interfaces** command to verify the configuration of OTN transport mode in 8x10GE interface modules:

```
Router#sh int te0/1/1
TenGigabitEthernet0/1/1 is up, line protocol is up
  MTU 1500 bytes, BW 10000000 Kbit/sec, DLY 10 usec,
    reliability 255/255, txload 193/255, rxload 7/255
  Encapsulation ARPA, loopback not set
  Keepalive set (10 sec)
  Full Duplex, 10000Mbps, link type is force-up, media type is SFP-SR
  output flow-control is unsupported, input flow-control is on
  Transport mode OTN (10GBASE-R over OPULe w/o fixed stuffing, 11.0491Gb/s)
  ARP type: ARPA, ARP Timeout 04:00:00
  Last input 03:28:14, output 03:28:14, output hang never
  Last clearing of "show interface" counters 00:30:47
  Input queue: 0/375/0/0 (size/max/drops/flushes); Total output drops: 0
  Queueing strategy: fifo
  Output queue: 0/40 (size/max)
  5 minute input rate 281326000 bits/sec, 549608 packets/sec
  5 minute output rate 7596663000 bits/sec, 14837094 packets/sec
    10766669034 packets input, 689066159324 bytes, 0 no buffer
    Received 0 broadcasts (0 IP multicasts)
    0 runts, 0 giants, 0 throttles
    0 input errors, 0 CRC, 0 frame, 0 overrun, 0 ignored
    0 watchdog, 0 multicast, 0 pause input
```

```

27457291925 packets output, 1757266795328 bytes, 0 underruns
0 output errors, 0 collisions, 0 interface resets
0 unknown protocol drops
0 babbles, 0 late collision, 0 deferred
0 lost carrier, 0 no carrier, 0 pause output
0 output buffer failures, 0 output buffers swapped out
Router#

```

## Verification of OTN Transport Mode Configuration in 2x40GE Interface Modules

Use the **show interfaces** command to verify the configuration of OTN transport mode in 2x40GE interface modules:

```

Router#show int fo0/4/0
FortyGigabitEthernet0/4/0 is up, line protocol is up
  MTU 1500 bytes, BW 40000000 Kbit/sec, DLY 10 usec,
    reliability 255/255, txload 1/255, rxload 1/255
  Encapsulation ARPA, loopback not set
  Keepalive set (10 sec)
  Full Duplex, 40000Mbps, link type is force-up, media type is QSFP_40GE_SR
  output flow-control is unsupported, input flow-control is on
  Transport mode OTN OTU3 (43.018Gb/s)
  ARP type: ARPA, ARP Timeout 04:00:00
  Last input never, output never, output hang never
  Last clearing of "show interface" counters never
  Input queue: 0/375/0/0 (size/max/drops/flushes); Total output drops: 0
  Queueing strategy: fifo
  Output queue: 0/40 (size/max)
  5 minute input rate 0 bits/sec, 0 packets/sec
  5 minute output rate 0 bits/sec, 0 packets/sec
    0 packets input, 0 bytes, 0 no buffer
    Received 0 broadcasts (0 IP multicasts)
    0 runs, 0 giants, 0 throttles
    0 input errors, 0 CRC, 0 frame, 0 overrun, 0 ignored
    0 watchdog, 0 multicast, 0 pause input
    0 packets output, 0 bytes, 0 underruns
    0 output errors, 0 collisions, 2 interface resets
    0 unknown protocol drops
    0 babbles, 0 late collision, 0 deferred
    0 lost carrier, 0 no carrier, 0 pause output
    0 output buffer failures, 0 output buffers swapped out

```

## Changing from OTN to LAN Mode

Use the following methods to change from OTN mode to LAN mode:

- Use the following commands to make the transport mode as LAN mode:

```

enable
configure terminal
controller dwdm 0/0/0
transport-mode lan

```

- Use the following commands to set the controller default transport mode as LAN mode:

```

enable
configure terminal

```

```
controller dwdm 0/0/0
default transport-mode
```

## Verification of Enabled Ports for Controller Configuration

Use the show controllers command to verify the enables ports for the controller configuration:

```
#show controllers
TenGigabitEthernet0/0/0
TenGigabitEthernet0/0/1
TenGigabitEthernet0/0/2
TenGigabitEthernet0/0/3
TenGigabitEthernet0/0/4
TenGigabitEthernet0/0/5
TenGigabitEthernet0/0/6
TenGigabitEthernet0/0/7
TenGigabitEthernet0/1/0
TenGigabitEthernet0/1/1
FortyGigabitEthernet0/4/0
FortyGigabitEthernet0/4/1
TenGigabitEthernet0/5/0
TenGigabitEthernet0/5/1
TenGigabitEthernet0/5/2
TenGigabitEthernet0/5/3
TenGigabitEthernet0/5/4
TenGigabitEthernet0/5/5
TenGigabitEthernet0/5/6
TenGigabitEthernet0/5/7
#
```

## OTN Alarms

OTN supports alarms in each layer of encapsulation. All the alarms follow an alarm hierarchy and the highest level of alarm is asserted and presented as a Syslog message or on the CLI.

### OTU Alarms

The types of alarms enabled for reporting:

- AIS - Alarm indication signal (AIS) alarms
- BDI - Backward defect indication (BDI) alarms
- IAE - Incoming alignment error (IAE) alarms
- LOF - Loss of frame (LOF) alarms
- LOM - Loss of multiple frames (LOM) alarms
- LOS - Loss of signal (LOS) alarms
- TIM - Type identifier mismatch (TIM) alarms
- SM - TCA - SM threshold crossing alert
- SD-BER - SM BER is in excess of the SD BER threshold
- SF-BER - SM BER is in excess of the SF BER threshold

### ODU Alarms

The types of alarms enabled for reporting:

- AIS - Alarm indication signal (AIS) alarms
- BDI - Backward defect indication (BDI) alarms
- LCK - Upstream connection locked (LCK) error status
- OCI - Open connection indication (OCI) error status
- PM-TCA - Performance monitoring (PM) threshold crossing alert (TCA)
- PTIM - Payload TIM error status
- SD-BER - SM BER is in excess of the SD BER threshold
- SF-BER - SM BER is in excess of the SF BER threshold
- TIM - Type identifier mismatch (TIM) alarms

## Configuring OTN Alarm Reports

By default, all the OTN alarm reports are enabled. To control OTN alarm reports, disable all the alarms and enable the specific alarms.



---

**Note** You need to shutdown the interface using the **shut** command to configure the alarms.

---

## Configuring OTU Alarm Reports

Use the following commands to configure OTU alarm reports:

```
enable
configure terminal
controller dwdm 0/4/1
shut
g709 otu report bdi
no shut
end
```



---

**Note** Fecmismatch is not supported.

---



---

**Note** Use **no g709 otu report** command to disable the OTU alarm reports.

---

### Verification of OTU Alarm Reports Configuration

Use the **show controllers** command to verify OTU alarm reports configuration:

```

#show controllers dwdm 0/4/1
G709 Information:

Controller dwdm 0/4/1, is up (no shutdown)

Transport mode OTN OTU3
Loopback mode enabled : None

TAS state is : IS
G709 status : Enabled
( Alarms and Errors )
OTU
      LOS = 3          LOF = 1          LOM = 0
      AIS = 0          BDI = 0          BIP = 74444
      TIM = 0          IAE = 0          BEI = 37032

ODU
      AIS = 0          BDI = 0          TIM = 0
      OCI = 0          LCK = 0          PTIM = 0
      BIP = 2          BEI = 0

FEC Mode: FEC

Remote FEC Mode: Unknown
      FECM                    = 0
      EC(current second)      = 0
      EC                       = 186
      UC                       = 10695

Detected Alarms: NONE
Asserted Alarms: NONE
Detected Alerts: NONE
Asserted Alerts: NONE
Alarm reporting enabled for: LOS LOF LOM OTU-AIS OTU-IAE OTU-BDI ODU-AIS ODU-OCI ODU-LCK
ODU-BDI ODU-PTIM ODU-BIP
Alert reporting enabled for: OTU-SD-BER OTU-SF-BER OTU-SM-TCA ODU-SD-BER ODU-SF-BER ODU-PM-TCA
BER thresholds: ODU-SF = 10e-3 ODU-SD = 10e-6 OTU-SF = 10e-3 OTU-SD = 10e-6
TCA thresholds: SM = 10e-3 PM = 10e-3

OTU TTI Sent      String SAPI ASCII      : Tx TTI Not Configured
OTU TTI Sent      String DAPI ASCII      : Tx TTI Not Configured
OTU TTI Sent      String OPERATOR ASCII   : Tx TTI Not Configured
OTU TTI Expected String SAPI ASCII      : Exp TTI Not Configured
OTU TTI Expected String DAPI ASCII      : Exp TTI Not Configured
OTU TTI Expected String OPERATOR ASCII   : Exp TTI Not Configured
OTU TTI Received String HEX      : 0000000000000000000000000000000000000000000000000000000000000000
                                0000000000000000000000000000000000000000000000000000000000000000
                                0000000000000000000000000000000000000000000000000000000000000000

ODU TTI Sent      String SAPI ASCII      : Tx TTI Not Configured
ODU TTI Sent      String DAPI ASCII      : Tx TTI Not Configured
ODU TTI Sent      String OPERATOR ASCII   : Tx TTI Not Configured
ODU TTI Expected String SAPI ASCII      : Exp TTI Not Configured
ODU TTI Expected String DAPI ASCII      : Exp TTI Not Configured
ODU TTI Expected String OPERATOR ASCII   : Exp TTI Not Configured
ODU TTI Received String HEX      : 0000000000000000000000000000000000000000000000000000000000000000
                                0000000000000000000000000000000000000000000000000000000000000000
                                0000000000000000000000000000000000000000000000000000000000000000

```

## Syslog Generation for LOS Alarm

The following example shows the syslog generation for LOS alarm:

```
(config-if)#
*Jan 16 06:32:50.487 IST: %DWDM-4-G709ALARM: dwdm-0/4/1: LOS declared
*Jan 16 06:32:51.048 IST: %LINK-3-UPDOWN: Interface FortyGigabitEthernet0/4/1, changed state
to down
*Jan 16 06:32:51.489 IST: %DWDM-4-G709ALARM: dwdm-0/4/1: LOF declared
*Jan 16 06:32:51.495 IST: %DWDM-4-G709ALARM: dwdm-0/4/1: LOS cleared
```

## Configuring ODU Alarm Report

Use the following commands to configure ODU alarm reports:

```
enable
configure terminal
controller dwdm 0/4/1
shut
g709 odu report ais
no shut
end
```



---

**Note** Use **no g709 odu report** command to disable the ODU alarm reports.

---

## OTN Threshold

The signal degrade and signal failure thresholds are configured for alerts.

The following types of thresholds are configured for alerts for OTU and ODU layers:

- SD-BER—Section Monitoring (SM) bit error rate (BER) is in excess of the signal degradation (SD) BER threshold.
- SF-BER—SM BER is in excess of the signal failure (SF) BER threshold.
- PM-TCA—Performance monitoring (PM) threshold crossing alert (TCA).
- SM-TCA—SM threshold crossing alert.

## Configuring OTU Threshold

To configure OTU threshold:

```
enable
configure terminal
controller dwdm 0/4/1
shut
g709 otu threshold sm-tca 3
no shut
end
```



---

**Note** Use **no g709 otu threshold** command to disable OTU threshold.

---

## Configuring ODU Threshold

To configure ODU threshold:

```
enable
configure terminal
controller dwdm 0/4/1
shut
g709 odu threshold sd-ber 3
no shut
end
```



---

**Note** Use **no g709 odu threshold** command to disable configuration of ODU threshold.

---

## Verification of OTU and ODU Threshold Configuration

Use the **show controllers** command to verify OTU and ODU threshold configuration:

```
Router#show controllers dwdm 0/1/2
G709 Information:

Controller dwdm 0/1/2, is up (no shutdown)

Transport mode OTN (10GBASE-R over OPU1e w/o fixed stuffing, 11.0491Gb/s)
Loopback mode enabled : None

TAS state is : UNKNWN
G709 status : Enabled

OTU
      LOS = 0          LOF = 0          LOM = 0
      AIS = 0          BDI = 0          BIP = 0
      TIM = 0          IAE = 0          BEI = 0

ODU
      AIS = 0          BDI = 0          TIM = 0
      OCI = 0          LCK = 0          PTIM = 0
      BIP = 0          BEI = 0

FEC Mode: FEC

Remote FEC Mode: Unknown
      FECM                    = 0
      EC(current second)      = 0
      EC                       = 0
      UC                       = 0

Detected Alarms: NONE
Asserted Alarms: NONE
Detected Alerts: NONE
Asserted Alerts: NONE
Alarm reporting enabled for: LOS LOF LOM OTU-AIS OTU-IAE OTU-BDI OTU-TIM ODU-AIS ODU-OCI
ODU-LCK ODU-BDI ODU-PTIM ODU-TIM ODU-BIP
Alert reporting enabled for: OTU-SD-BER OTU-SF-BER OTU-SM-TCA ODU-SD-BER ODU-SF-BER ODU-PM-TCA
BER thresholds: ODU-SF = 10e-3 ODU-SD = 10e-6 OTU-SF = 10e-3 OTU-SD = 10e-6
TCA thresholds: SM = 10e-3 PM = 10e-3
```



```

OTU TTI Sent      String SAPI ASCII      : AABBCDD
OTU TTI Sent      String DAPI ASCII     : AABBCDD
OTU TTI Sent      String OPERATOR ASCII : AABBCDD
OTU TTI Expected String SAPI ASCII     : AABBCDD
OTU TTI Expected String DAPI ASCII     : AABBCDD
OTU TTI Expected String OPERATOR HEX   : AABBCDD
OTU TTI Received String HEX : 0052414D455348000000000000000000052414D45534800
                                0000000000000004141424243434444000000000000000000
                                00000000000000000000000000000000

```

```

ODU TTI Sent      String SAPI ASCII      : AABBCDD
ODU TTI Sent      String DAPI ASCII     : AABBCDD
ODU TTI Sent      String OPERATOR HEX   : 11223344
ODU TTI Expected String SAPI ASCII     : AABBCDD
ODU TTI Expected String DAPI ASCII     : AABBCDD
ODU TTI Expected String OPERATOR HEX   : 11223344
ODU TTI Received String HEX : 0052414D455348000000000000000000052414D45534800
                                0000000000000001122334400000000000000000000000000
                                00000000000000000000000000000000

```

Router#

## Configuring OTU Alerts

To configure OTU alerts:

```

enable
configure terminal
controller dwdm 0/4/1
shutdown
g709 otu
g709 otu threshold
g709 otu threshold sd-ber
no shutdown
end

```

## Configuring ODU Alerts

To configure ODU alerts:

```

enable
configure terminal
controller dwdm 0/4/1
shutdown
g709 otu
g709 otu threshold
g709 otu threshold pm-tca
no shutdown
end

```

## Configuring ODU Alerts

To configure ODU alerts:

```

enable
configure terminal

```

```

controller dwdm 0/4/1
shutdown
g709 otu
g709 otu threshold
g709 otu threshold pm-tca
no shutdown
end

```

## Verifying Alerts Configuration

Use the show controllers command to verify the alerts configuration:

```

#show controllers dwdm 0/4/1
G709 Information:

Controller dwdm 0/4/1, is down (shutdown)

Transport mode OTN OTU3
Loopback mode enabled : Line

TAS state is : IS
G709 status : Enabled

OTU
      LOS = 5           LOF = 1           LOM = 0
      AIS = 0           BDI = 0           BIP = 149549
      TIM = 0           IAE = 0           BEI = 74685

ODU
      AIS = 0           BDI = 0           TIM = 0
      OCI = 0           LCK = 0           PTIM = 0
      BIP = 2           BEI = 0

FEC Mode: FEC

Remote FEC Mode: Unknown
      FECM                = 0
      EC(current second)  = 0
      EC                   = 856
      UC                   = 23165

Detected Alarms: NONE
Asserted Alarms: NONE
Detected Alerts: NONE
Asserted Alerts: NONE
Alarm reporting enabled for: LOS LOF LOM OTU-AIS OTU-IAE OTU-BDI ODU-AIS ODU-OCI ODU-LCK
ODU-BDI ODU-PTIM ODU-BIP
Alert reporting enabled for: OTU-SD-BER OTU-SF-BER OTU-SM-TCA ODU-SD-BER ODU-SF-BER ODU-PM-TCA
BER thresholds: ODU-SF = 10e-3 ODU-SD = 10e-6 OTU-SF = 10e-3 OTU-SD = 10e-5
TCA thresholds: SM = 10e-3 PM = 10e-4

OTU TTI Sent      String SAPI ASCII      : Tx TTI Not Configured
OTU TTI Sent      String DAPI ASCII      : Tx TTI Not Configured
OTU TTI Sent      String OPERATOR ASCII  : Tx TTI Not Configured
OTU TTI Expected String SAPI ASCII      : Exp TTI Not Configured
OTU TTI Expected String DAPI ASCII      : Exp TTI Not Configured
OTU TTI Expected String OPERATOR ASCII  : Exp TTI Not Configured
OTU TTI Received String HEX      : 0000000000000000000000000000000000000000000000000000000000000000
                                0000000000000000000000000000000000000000000000000000000000000000
                                0000000000000000000000000000000000000000000000000000000000000000

```

```

ODU TTI Sent      String SAPI ASCII      : Tx TTI Not Configured
ODU TTI Sent      String DAPI ASCII      : Tx TTI Not Configured
ODU TTI Sent      String OPERATOR ASCII   : Tx TTI Not Configured
ODU TTI Expected String SAPI ASCII      : Exp TTI Not Configured
ODU TTI Expected String DAPI ASCII      : Exp TTI Not Configured
ODU TTI Expected String OPERATOR ASCII   : Exp TTI Not Configured
ODU TTI Received String HEX      : 0000000000000000000000000000000000000000000000000000000000000000
                                0000000000000000000000000000000000000000000000000000000000000000
                                0000000000000000000000000000000000000000000000000000000000000000

```

## Loopback

Loopback provides a means for remotely testing the throughput of an Ethernet port on the router. You can verify the maximum rate of frame transmission with no frame loss. Two types of loopback is supported:

- Internal Loopback - All packets are looped back internally within the router before reaching an external cable. It tests the internal Rx to Tx path and stops the traffic to egress out from the Physical port.
- Line Loopback - Incoming network packets are looped back through the external cable.

## Configuring Loopback

To configure loopback:

```

enable
configure terminal
controller dwdm 0/4/1
shutdown
loopback line
no shutdown
end

```

## Forward Error Connection

Forward error correction (FEC) is a method of obtaining error control in data transmission in which the source (transmitter) sends redundant data and the destination (receiver) recognizes only the portion of the data that contains no apparent errors. FEC groups source packets into blocks and applies protection to generate a desired number of repair packets. These repair packets may be sent on demand or independently of any receiver feedback.

Standard FEC is supported on 8x10GE and 2x40GE interface modules.

The packets that can be corrected by FEC are known as Error Corrected Packets. The packets that cannot be corrected by FEC due to enhanced bit errors are known as Uncorrected Packets.

## Benefits of FEC

The following are the benefits of FEC:

- FEC reduces the number of transmission errors, extends the operating range, and reduces the power requirements for communications systems.
- FEC increases the effective systems throughput.

- FEC supports correction of bit errors occurring due to impairments in the transmission medium.

## Configuring FEC

To configure FEC:

```
enable
configure terminal
controller dwdm 0/4/1
shutdown
g709 fec standard
no shutdown
end
```

## Verifying FEC Configuration

Use the **show controllers** command to verify FEC configuration:

```
G709 Information:

Controller dwdm 0/4/1, is up (no shutdown)

Transport mode OTN OTU3
Loopback mode enabled : Line

TAS state is : IS
G709 status : Enabled

OTU
      LOS = 5          LOF = 1          LOM = 0
      AIS = 0          BDI = 0          BIP = 149549
      TIM = 0          IAE = 0          BEI = 74685

ODU
      AIS = 0          BDI = 0          TIM = 0
      OCI = 0          LCK = 0          PTIM = 0
      BIP = 2          BEI = 0

FEC Mode: FEC

Remote FEC Mode: Unknown <- This is a limitation by which we do not show the remote FEC
mode
      FECM                    = 0
      EC(current second)      = 0
      EC                       = 856          <- This is the counter for Error
corrected bits .
      UC                       = 23165       <- this is the counter for Uncorrected
alarms .

Detected Alarms: NONE
Asserted Alarms: NONE
Detected Alerts: NONE
Asserted Alerts: NONE
Alarm reporting enabled for: LOS LOF LOM OTU-AIS OTU-IAE OTU-BDI ODU-AIS ODU-OCI ODU-LCK
ODU-BDI ODU-PTIM ODU-BIP
Alert reporting enabled for: OTU-SD-BER OTU-SF-BER OTU-SM-TCA ODU-SD-BER ODU-SF-BER ODU-PM-TCA
BER thresholds: ODU-SF = 10e-3 ODU-SD = 10e-6 OTU-SF = 10e-3 OTU-SD = 10e-5
TCA thresholds: SM = 10e-3 PM = 10e-4

OTU TTI Sent      String SAPI ASCII      : Tx TTI Not Configured
```

```

OTU TTI Sent      String DAPI ASCII      : Tx TTI Not Configured
OTU TTI Sent      String OPERATOR ASCII : Tx TTI Not Configured
OTU TTI Expected String SAPI ASCII      : Exp TTI Not Configured
OTU TTI Expected String DAPI ASCII      : Exp TTI Not Configured
OTU TTI Expected String OPERATOR ASCII  : Exp TTI Not Configured
OTU TTI Received String HEX      : 0000000000000000000000000000000000000000000000000000000000000000
                                0000000000000000000000000000000000000000000000000000000000000000
                                0000000000000000000000000000000000000000000000000000000000000000

ODU TTI Sent      String SAPI ASCII      : Tx TTI Not Configured
ODU TTI Sent      String DAPI ASCII      : Tx TTI Not Configured
ODU TTI Sent      String OPERATOR ASCII  : Tx TTI Not Configured
ODU TTI Expected String SAPI ASCII      : Exp TTI Not Configured
ODU TTI Expected String DAPI ASCII      : Exp TTI Not Configured
ODU TTI Expected String OPERATOR ASCII  : Exp TTI Not Configured
ODU TTI Received String HEX      : 0000000000000000000000000000000000000000000000000000000000000000
                                0000000000000000000000000000000000000000000000000000000000000000
                                0000000000000000000000000000000000000000000000000000000000000000

```

## Trail Trace Identifier

The Trail Trace Identifier (TTI) is a 64-Byte signal that occupies one byte of the frame and is aligned with the OTUk multiframe. It is transmitted four times per multiframe. TTI is defined as a 64-byte string with the following structure:

- TTI [0] contains the Source Access Point Identifier (SAPI) [0] character, which is fixed to all-0s.
- TTI [1] to TTI [15] contain the 15-character source access point identifier (SAPI[1] to SAPI[15]).
- TTI [16] contains the Destination Access Point Identifier (DAPI) [0] character, which is fixed to all-0s.
- TTI [17] to TTI [31] contain the 15-character destination access point identifier (DAPI [1] to DAPI [15]).
- TTI [32] to TTI [63] are operator specific.

### TTI Mismatch

TTI mismatch occurs when you have enabled path trace and the "received string" is different from the "expected string". This alarm condition stops traffic.

When TTI mismatch occurs, the interface is brought to down state. This is only supported for SAPI and DAPI and is not supported for **User Operator Data** field.

## Configuring TTI

To configure TTI:

```

enable
configure terminal
controller dwdm 0/1/1
shutdown
g709 tti-processing enable
no shutdown
end

```

Trace Identifier Mismatch (TIM) is reported in the Detected Alarms where there is a mismatch in the expected and received string. Action on detection of TIM can be configured in ODU and OTU layers as follows:

```

enable
configure terminal
controller dwdm 0/1/1
shutdown
g709 tti-processing enable otu

```

```
no shutdown
end
```

### Configuring TTI for SAPI DAPI Operator Specific Fields

To configure TTI SAPI, DAPI, and operator specific fields for OTU and ODU layers:

```
enable
configure terminal
controller dwdm 0/1/1
g709 fec standard
g709 otu overhead tti sent ascii sapi AABCCDD
end
```

### Verification of TTI SAPI DAPI Operator Specific Fields Configuration

Use the show controller command to verify TTI SAPI, DAPI, Operator Specific fields configuration:

```
Router#show controllers dwdm 0/1/1
G709 Information:
Controller dwdm 0/1/1, is up (no shutdown)

Transport mode OTN (10GBASE-R over OPUle w/o fixed stuffing, 11.0491Gb/s)

<<truncated other output >>

OTU TTI Sent String SAPI ASCII : AABCCDD
OTU TTI Sent String DAPI ASCII : AABCCDD
OTU TTI Sent String OPERATOR ASCII : AABCCDD
OTU TTI Expected String SAPI ASCII : AABCCDD
OTU TTI Expected String DAPI ASCII : AABCCDD
OTU TTI Expected String OPERATOR HEX : AABCCDD
OTU TTI Received String HEX : 0052414D45534800000000000000000000052414D455348000
0000000000000004141424243444400000000000000000000
0000000000000000000000000000000000000000

ODU TTI Sent String SAPI ASCII : AABCCDD
ODU TTI Sent String DAPI ASCII : AABCCDD
ODU TTI Sent String OPERATOR HEX : 11223344
ODU TTI Expected String SAPI ASCII : AABCCDD
```

## Verifying Loopback Configuration

Use the **show controllers** command to verify the loopback configuration:

```
#show controllers dwdm 0/4/1
G709 Information:

Controller dwdm 0/4/1, is up (no shutdown)

Transport mode OTN OTU3
Loopback mode enabled : Line

TAS state is : IS
G709 status : Enabled

OTU
      LOS = 5           LOF = 1           LOM = 0
      AIS = 0           BDI = 0           BIP = 149549
      TIM = 0           IAE = 0           BEI = 74685

ODU
      AIS = 0           BDI = 0           TIM = 0
```

```

OCI = 0          LCK = 0          PTIM = 0
BIP = 2          BEI = 0

FEC Mode: FEC

Remote FEC Mode: Unknown
  FECM                    = 0
  EC (current second)     = 0
  EC                       = 856
  UC                      = 23165

Detected Alarms: NONE
Asserted Alarms: NONE
Detected Alerts: NONE
Asserted Alerts: NONE
Alarm reporting enabled for: LOS LOF LOM OTU-AIS OTU-IAE OTU-BDI ODU-AIS ODU-OCI ODU-LCK
ODU-BDI ODU-PTIM ODU-BIP
Alert reporting enabled for: OTU-SD-BER OTU-SF-BER OTU-SM-TCA ODU-SD-BER ODU-SF-BER ODU-PM-TCA
BER thresholds: ODU-SF = 10e-3 ODU-SD = 10e-6 OTU-SF = 10e-3 OTU-SD = 10e-4
TCA thresholds: SM = 10e-3 PM = 10e-3

OTU TTI Sent      String SAPI ASCII      : Tx TTI Not Configured
OTU TTI Sent      String DAPI ASCII      : Tx TTI Not Configured
OTU TTI Sent      String OPERATOR ASCII  : Tx TTI Not Configured
OTU TTI Expected String SAPI ASCII      : Exp TTI Not Configured
OTU TTI Expected String DAPI ASCII      : Exp TTI Not Configured
OTU TTI Expected String OPERATOR ASCII  : Exp TTI Not Configured
OTU TTI Received String HEX      : 0000000000000000000000000000000000000000000000000000000000000000
0000000000000000000000000000000000000000000000000000000000000000
0000000000000000000000000000000000

ODU TTI Sent      String SAPI ASCII      : Tx TTI Not Configured
ODU TTI Sent      String DAPI ASCII      : Tx TTI Not Configured
ODU TTI Sent      String OPERATOR ASCII  : Tx TTI Not Configured
ODU TTI Expected String SAPI ASCII      : Exp TTI Not Configured
ODU TTI Expected String DAPI ASCII      : Exp TTI Not Configured
ODU TTI Expected String OPERATOR ASCII  : Exp TTI Not Configured
ODU TTI Received String HEX      : 0000000000000000000000000000000000000000000000000000000000000000
0000000000000000000000000000000000000000000000000000000000000000
0000000000000000000000000000000000

#

```

## SNMP Support

Simple Network Management Protocol (SNMP) is an application-layer protocol that provides a message format for communication between SNMP managers and agents. SNMP provides a standardized framework and a common language that is used for monitoring and managing devices in a network.

SNMP sets are not supported for the following tables:

- `coiIfControllerTable`
- `coiOtnNearEndThresholdsTable`
- `coiOtnFarEndThresholdsTable`
- `coiFECThresholdsTable`

Refer to `CISCO-OTN-IF-MIB` and *SNMP Configuration Guide* for SNMP support.

# Performance Monitoring

Performance monitoring (PM) parameters are used by service providers to gather, store, set thresholds for, and report performance data for early detection of problems. Thresholds are used to set error levels for each PM parameter. During the accumulation cycle, if the current value of a performance monitoring parameter reaches or exceeds its corresponding threshold value, a threshold crossing alert (TCA) is generated. The TCAs provide early detection of performance degradation. PM statistics are accumulated on a 15-minute basis, synchronized to the start of each quarter-hour. Historical counts are maintained for 33 15-minute intervals and 2 daily intervals. PM parameters are collected for OTN and FEC.

Calculation and accumulation of the performance-monitoring data is in 15-minute and 24-hour intervals.

PM parameters require the errored ratio to be less than the standard reference that is dependent on the encapsulation. If any loss or error event does not happen within a second, it is called an error free second. If some error in transmission or alarm happens in a second, the second is called Errored Second. The error is termed as Errored Second or Severely Errored Second or Unavailable Second depending upon the nature of error. The error calculation depends on the Errored Blocks. Errored second is a second where one BIP error or BEI error occurs. Severely Errored Second occurs when the errored frames crosses a threshold or there is an alarm is generated. Unavailable Second occurs when there are 10 consecutive severely errored seconds.

**Figure 14: Performance Monitoring**

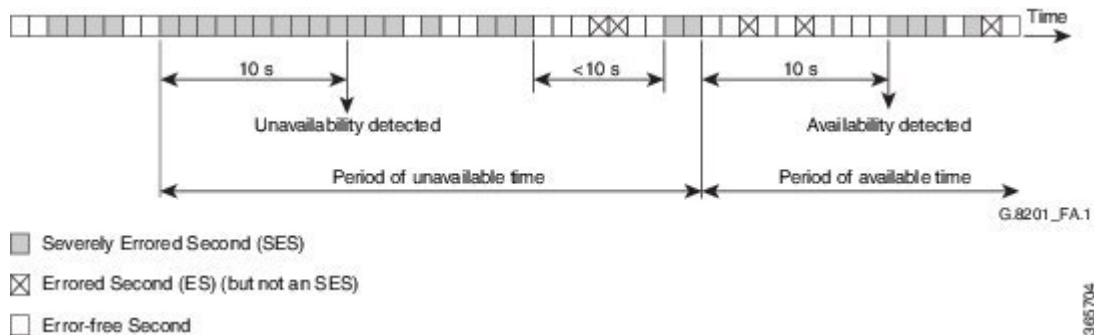

PM occurs in near end and far end for both encapsulations for ODUk and OTUk. ODU is referred as Path Monitoring (PM) and OTU is referred to as Section Monitoring (SM).

The following table shows the details of each type of PM parameter for OTN:

**Table 25: PM Parameters for OTN**

Parameter	Definition
BBE-PM	Path Monitoring Background Block Errors (BBE-PM) indicates the number of background block errors recorded in the optical transport network (OTN) path during the PM time interval.
BBE-SM	Section Monitoring Background Block Errors (BBE-SM) indicates the number of background block errors recorded in the OTN section during the PM time interval.



Parameter	Definition
BBER-PM	Path Monitoring Background Block Errors Ratio (BBER-PM) indicates the background block errors ratio recorded in the OTN path during the PM time interval.
BBER-SM	Section Monitoring Background Block Errors Ratio (BBER-SM) indicates the background block errors ratio recorded in the OTN section during the PM time interval.
ES-PM	Path Monitoring Errored Seconds (ES-PM) indicates the errored seconds recorded in the OTN path during the PM time interval.
ESR-PM	Path Monitoring Errored Seconds Ratio (ESR-PM) indicates the errored seconds ratio recorded in the OTN path during the PM time interval.
ESR-SM	Section Monitoring Errored Seconds Ratio (ESR-SM) indicates the errored seconds ratio recorded in the OTN section during the PM time interval.
ES-SM	Section Monitoring Errored Seconds (ES-SM) indicates the errored seconds recorded in the OTN section during the PM time interval.
FC-PM	Path Monitoring Failure Counts (FC-PM) indicates the failure counts recorded in the OTN path during the PM time interval.
FC-SM	Section Monitoring Failure Counts (FC-SM) indicates the failure counts recorded in the OTN section during the PM time interval.
SES-PM	Path Monitoring Severely Errored Seconds (SES-PM) indicates the severely errored seconds recorded in the OTN path during the PM time interval.
SES-SM	Section Monitoring Severely Errored Seconds (SES-SM) indicates the severely errored seconds recorded in the OTN section during the PM time interval.
SESR-PM	Path Monitoring Severely Errored Seconds Ratio (SESR-PM) indicates the severely errored seconds ratio recorded in the OTN path during the PM time interval.

Parameter	Definition
SESR-SM	Section Monitoring Severely Errored Seconds Ratio (SESR-SM) indicates the severely errored seconds ratio recorded in the OTN section during the PM time interval.
UAS-PM	Path Monitoring Unavailable Seconds (UAS-PM) indicates the unavailable seconds recorded in the OTN path during the PM time interval.
UAS-SM	Section Monitoring Unavailable Seconds (UAS-SM) indicates the unavailable seconds recorded in the OTN section during the PM time interval.

The following table shows the details of each type of PM parameter for FEC:

**Table 26: PM Parameters for FEC**

Parameter	Definition
EC	Bit Errors Corrected (BIEC) indicated the number of bit errors corrected in the DWDM trunk line during the PM time interval.
UC-WORDS	Uncorrectable Words (UC-WORDS) is the number of uncorrectable words detected in the DWDM trunk line during the PM time interval.

## OTUk Section Monitoring

Section Monitoring (SM) overhead for OTUk is terminated as follows:

- TTI
- BIP
- BEI
- BDI
- IAE
- BIAE

BIP and BEI counters are block error counters (block size equal to OTUk frame size). The counters can be read periodically by a PM thread to derive one second performance counts. They are sufficiently wide for software to identify a wrap-around with up to 1.5 sec between successive readings.

The following OTUk level defects are detected:

- dAIS
- dTIM
- dBDI

- dIAE
- dBIAE

Status of the defects is available through CPU readable registers, and a change of status of dLOF, dLOM, and dAIS will generate an interruption.

## ODUk Path Monitoring

Path Monitoring (PM) overhead for higher order ODUk and lower order ODUk is processed as follows:

- TTI
- BIP
- BEI
- BDI
- STAT including ODU LCK/OCI/AIS

The following ODUk defects are detected:

- dTIM
- dLCK and dAIS (from STAT field)
- dBDI

LOS, OTU LOF, OOF and ODU-AIS alarms bring down the interface in system.

## Configuring PM Parameters for FEC

To set TCA report status on FEC layer in 15-minute interval:

```
enable
configure terminal
controller dwdm 0/1/0
pm 15-min fec report ec-bits enable
pm 15-min fec report uc-words enable
end
```

To set TCA report status on FEC layer in 24-hour interval:

```
enable
configure terminal
controller dwdm 0/1/0
pm 24-hr fec report ec-bits enable
pm 24-hr fec report uc-words enable
end
```

To set threshold on FEC layer in 15-minute interval:

```
enable
configure terminal
controller dwdm 0/1/0
pm 15-min fec threshold ec-bits
pm 15-min fec threshold uc-words
end
```

To set threshold on FEC layer in 24-hour interval:

```
enable
configure terminal
controller dwdm 0/1/0
pm 24-hr fec threshold ec-bits
pm 24-hr fec threshold uc-words
end
```

## Configuring PM Parameters for OTN

To set OTN report status in 15-minute interval:

```
enable
configure terminal
controller dwdm 0/1/0
pm 15-min otn report es-pm-ne enable
end
```

To set OTN report status in 24-hour interval:

```
enable
configure terminal
controller dwdm slot/bay/port
pm 24-hr otn report es-pm-ne enable
end
```

To set OTN threshold in 15-minute interval:

```
enable
configure terminal
controller dwdm 0/1/0
pm 15-min otn threshold es-pm-ne
end
```

To set OTN threshold in 24-hour interval:

```
enable
configure terminal
controller dwdm 0/1/0
pm 24-hr otn threshold es-pm-ne
end
```

## Verifying PM Parameters Configuration

Use the **show controllers** command to verify PM parameters configuration for FEC in 15-minute interval:

```
Router#show controllers dwdm 0/1/0 pm interval 15-min fec 0
g709 FEC in the current interval [9 :15:00 - 09:16:40 Thu Jun 9 2016]

FEC current bucket type : INVALID
  EC-BITS      :          0  Threshold :          200  TCA(enable) : YES
  UC-WORDS    :          0  Threshold :          23   TCA(enable) : YES
```

```
Router#show controllers dwdm 0/1/0 pm interval 15-min fec 1
g709 FEC in interval 1 [9 :00:00 - 9 :15:00 Thu Jun 9 2016]

FEC current bucket type : VALID
  EC-BITS      :          0  UC-WORDS   :          0
```

Use the **show controllers** command to verify PM parameters configuration for FEC in 24-hour interval:

```

Router#show controllers dwdm 0/1/0 pm interval 24 fec 0
g709 FEC in the current interval [00:00:00 - 09:17:01 Thu Jun 9 2016]

FEC current bucket type : INVALID
EC-BITS      :          0      Threshold :          0      TCA(enable) : NO
UC-WORDS    :          0      Threshold :          0      TCA(enable) : NO

```

```

Router#show controllers dwdm 0/1/0 pm interval 24 fec 1
g709 FEC in interval 1 [00:00:00 - 24:00:00 Wed Jun 8 2016]

FEC current bucket type : VALID
EC-BITS      :          717      UC-WORDS    :          1188574

```

Use the **show controllers** command to verify PM parameters configuration for OTN in 15-minute interval:

```

Router#show controllers dwdm 0/1/0 pm interval 15-min otn 0
g709 OTN in the current interval [9 :15:00 - 09:15:51 Thu Jun 9 2016]

OTN current bucket type: INVALID

OTN Near-End Valid : YES
ES-SM-NE      :          0      Threshold :          0      TCA(enable) : NO
ESR-SM-NE     : 0.00000      Threshold : 0.00010      TCA(enable) : YES
SES-SM-NE     :          0      Threshold :          0      TCA(enable) : NO
SESR-SM-NE    : 0.00000      Threshold : 0.02300      TCA(enable) : NO
UAS-SM-NE     :          0      Threshold :          0      TCA(enable) : NO
BBE-SM-NE     :          0      Threshold :          0      TCA(enable) : NO
BBER-SM-NE    : 0.00000      Threshold : 0.02300      TCA(enable) : NO
FC-SM-NE     :          0      Threshold :          0      TCA(enable) : NO
ES-PM-NE     :          0      Threshold :          200      TCA(enable) : YES
ESR-PM-NE     : 0.00000      Threshold : 1.00000      TCA(enable) : NO
SES-PM-NE     :          0      Threshold :          0      TCA(enable) : NO
SESR-PM-NE    : 0.00000      Threshold : 0.02300      TCA(enable) : NO
UAS-PM-NE     :          0      Threshold :          0      TCA(enable) : NO
BBE-PM-NE     :          0      Threshold :          0      TCA(enable) : NO
BBER-PM-NE    : 0.00000      Threshold : 0.02300      TCA(enable) : NO
FC-PM-NE     :          0      Threshold :          0      TCA(enable) : NO

OTN Far-End Valid : YES
ES-SM-FE      :          0      Threshold :          0      TCA(enable) : NO
ESR-SM-FE     : 0.00000      Threshold : 1.00000      TCA(enable) : NO
SES-SM-FE     :          0      Threshold :          0      TCA(enable) : NO
SESR-SM-FE    : 0.00000      Threshold : 0.02300      TCA(enable) : NO
UAS-SM-FE     :          0      Threshold :          0      TCA(enable) : NO
BBE-SM-FE     :          0      Threshold :          0      TCA(enable) : NO
BBER-SM-FE    : 0.00000      Threshold : 0.02300      TCA(enable) : NO
FC-SM-FE     :          0      Threshold :          0      TCA(enable) : NO
ES-PM-FE     :          0      Threshold :          0      TCA(enable) : NO
ESR-PM-FE     : 0.00000      Threshold : 1.00000      TCA(enable) : NO
SES-PM-FE     :          0      Threshold :          0      TCA(enable) : NO
SESR-PM-FE    : 0.00000      Threshold : 0.02300      TCA(enable) : NO
UAS-PM-FE     :          0      Threshold :          0      TCA(enable) : NO
BBE-PM-FE     :          0      Threshold :          0      TCA(enable) : NO
BBER-PM-FE    : 0.00000      Threshold : 0.02300      TCA(enable) : NO
FC-PM-FE     :          0      Threshold :          0      TCA(enable) : NO

```

```

Router#show controllers dwdm 0/1/0 pm interval 15-min otn 1
g709 OTN in interval 1 [9 :00:00 - 9 :15:00 Thu Jun 9 2016]

OTN current bucket type: VALID

```

```

OTN Near-End Valid : YES
ES-SM-NE      :      0
ESR-SM-NE     : 0.00000
SES-SM-NE     :      0
SESR-SM-NE    : 0.00000
UAS-SM-NE     :      0
BBE-SM-NE     :      0
BBER-SM-NE    : 0.00000
FC-SM-NE      :      0
ES-PM-NE      :      0
ESR-PM-NE     : 0.00000
SES-PM-NE     :      0
SESR-PM-NE    : 0.00000
UAS-PM-NE     :      0
BBE-PM-NE     :      0
BBER-PM-NE    : 0.00000
FC-PM-NE      :      0

OTN Far-End Valid : YES
ES-SM-FE      :      0
ESR-SM-FE     : 0.00000
SES-SM-FE     :      0
SESR-SM-FE    : 0.00000
UAS-SM-FE     :      0
BBE-SM-FE     :      0
BBER-SM-FE    : 0.00000
FC-SM-FE      :      0
ES-PM-FE      :      0
ESR-PM-FE     : 0.00000
SES-PM-FE     :      0
SESR-PM-FE    : 0.00000
UAS-PM-FE     :      0
BBE-PM-FE     :      0
BBER-PM-FE    : 0.00000
FC-PM-FE      :      0

```

Use the **show controllers** command to verify PM parameters configuration for OTN in 24-hour interval:

```

Router#show controllers dwdm 0/1/0 pm interval 24-hour otn 0
g709 OTN in the current interval [00:00:00 - 09:16:10 Thu Jun 9 2016]

```

```
OTN current bucket type: INVALID
```

```

OTN Near-End Valid : YES
ES-SM-NE      :      0      Threshold :      0      TCA(enable) : NO
ESR-SM-NE     : 0.00000    Threshold : 0.00000  TCA(enable) : NO
SES-SM-NE     :      0      Threshold :      0      TCA(enable) : NO
SESR-SM-NE    : 0.00000    Threshold : 0.00000  TCA(enable) : NO
UAS-SM-NE     :      0      Threshold :      0      TCA(enable) : NO
BBE-SM-NE     :      0      Threshold :      0      TCA(enable) : NO
BBER-SM-NE    : 0.00000    Threshold : 0.00000  TCA(enable) : NO
FC-SM-NE      :      0      Threshold :      0      TCA(enable) : NO
ES-PM-NE      :      0      Threshold :      0      TCA(enable) : NO
ESR-PM-NE     : 0.00000    Threshold : 0.00000  TCA(enable) : NO
SES-PM-NE     :      0      Threshold :      0      TCA(enable) : NO
SESR-PM-NE    : 0.00000    Threshold : 0.00000  TCA(enable) : NO
UAS-PM-NE     :      0      Threshold :      0      TCA(enable) : NO
BBE-PM-NE     :      0      Threshold :      0      TCA(enable) : NO
BBER-PM-NE    : 0.00000    Threshold : 0.00000  TCA(enable) : NO
FC-PM-NE      :      0      Threshold :      0      TCA(enable) : NO

```

```

OTN Far-End Valid : YES
ES-SM-FE      :      0      Threshold :      0      TCA(enable) : NO
ESR-SM-FE     : 0.00000    Threshold : 0.00000  TCA(enable) : NO
SES-SM-FE     :      0      Threshold :      0      TCA(enable) : NO
SESR-SM-FE    : 0.00000    Threshold : 0.00000  TCA(enable) : NO
UAS-SM-FE     :      0      Threshold :      0      TCA(enable) : NO
BBE-SM-FE     :      0      Threshold :      0      TCA(enable) : NO
BBER-SM-FE    : 0.00000    Threshold : 0.00000  TCA(enable) : NO
FC-SM-FE      :      0      Threshold :      0      TCA(enable) : NO
ES-PM-FE      :      0      Threshold :      0      TCA(enable) : NO
ESR-PM-FE     : 0.00000    Threshold : 0.00000  TCA(enable) : NO
SES-PM-FE     :      0      Threshold :      0      TCA(enable) : NO
SESR-PM-FE    : 0.00000    Threshold : 0.00000  TCA(enable) : NO
UAS-PM-FE     :      0      Threshold :      0      TCA(enable) : NO
BBE-PM-FE     :      0      Threshold :      0      TCA(enable) : NO
BBER-PM-FE    : 0.00000    Threshold : 0.00000  TCA(enable) : NO
FC-PM-FE      :      0      Threshold :      0      TCA(enable) : NO

```

```
Router#show controllers dwdm 0/1/0 pm interval 24-hour otn 1
g709 OTN in interval 1 [00:00:00 - 24:00:00 Wed Jun 8 2016]
```

```
OTN current bucket type: INVALID
```

```
OTN Near-End Valid : YES          OTN Far-End Valid : NO
ES-SM-NE      :      7          ES-SM-FE      :      0
ESR-SM-NE     : 0.00000        ESR-SM-FE     : 0.00000
SES-SM-NE     :      7          SES-SM-FE     :      0
SESR-SM-NE    : 0.00000        SESR-SM-FE    : 0.00000
UAS-SM-NE     :     41          UAS-SM-FE     :      0
BBE-SM-NE     :      0          BBE-SM-FE     :      0
BBER-SM-NE    : 0.00000        BBER-SM-FE    : 0.00000
FC-SM-NE      :      3          FC-SM-FE      :      0
ES-PM-NE      :      2          ES-PM-FE      :      1
ESR-PM-NE     : 0.00000        ESR-PM-FE     : 0.00000
SES-PM-NE     :      0          SES-PM-FE     :      0
SESR-PM-NE    : 0.00000        SESR-PM-FE    : 0.00000
UAS-PM-NE     :      0          UAS-PM-FE     :      0
BBE-PM-NE     :      3          BBE-PM-FE     :      1
BBER-PM-NE    : 0.00000        BBER-PM-FE    : 0.00000
FC-PM-NE      :      0          FC-PM-FE      :      0
```

If TCA is enabled for OTN or FEC alarm, a syslog message is displayed for the 15-minute or 24-hour interval as follows:

```
*Jun  9 09:18:02.274: %PMDWDM-4-TCA: dwdm-0/1/0: G709 ESR-SM NE value (540) threshold (10)
15-min
```

## Troubleshooting Scenarios

The following table shows the troubleshooting solutions for the feature.

Problem	Solution
Link is not coming up	Perform shut and no shut actions of the interface. Check for TTI Mismatch. Verify the major alarms. Verify the FEC mode. Verify that Cisco supported transceiver list is only used on both sides .
Incrementing BIP Error	Verify FEC Mismatch.
FEC contains UC and EC errors and link is not coming up	Verify the FEC Mismatch.

## Associated Commands

The following commands are used to configure OTN Wrapper:

Commands	Links
<b>controller dwdm</b>	<a href="http://www.cisco.com/c/en/us/td/docs/ios-xml/ios/interface/command/ir-cr-book/ir-c2.html#wp1680149833">http://www.cisco.com/c/en/us/td/docs/ios-xml/ios/interface/command/ir-cr-book/ir-c2.html#wp1680149833</a>
<b>g709 disable</b>	<a href="http://www.cisco.com/c/en/us/td/docs/ios-xml/ios/interface/command/ir-cr-book/ir-f1.html#wp7175256270">http://www.cisco.com/c/en/us/td/docs/ios-xml/ios/interface/command/ir-cr-book/ir-f1.html#wp7175256270</a>
<b>g709 fec</b>	<a href="http://www.cisco.com/c/en/us/td/docs/ios-xml/ios/interface/command/ir-cr-book/ir-f1.html#wp3986227580">http://www.cisco.com/c/en/us/td/docs/ios-xml/ios/interface/command/ir-cr-book/ir-f1.html#wp3986227580</a>
<b>g709 odu report</b>	<a href="http://www.cisco.com/c/en/us/td/docs/ios-xml/ios/interface/command/ir-cr-book/ir-f1.html#wp3893551740">http://www.cisco.com/c/en/us/td/docs/ios-xml/ios/interface/command/ir-cr-book/ir-f1.html#wp3893551740</a>
<b>g709 odu threshold</b>	<a href="http://www.cisco.com/c/en/us/td/docs/ios-xml/ios/interface/command/ir-cr-book/ir-f1.html#wp3365653610">http://www.cisco.com/c/en/us/td/docs/ios-xml/ios/interface/command/ir-cr-book/ir-f1.html#wp3365653610</a>
<b>g709 otu report</b>	<a href="http://www.cisco.com/c/en/us/td/docs/ios-xml/ios/interface/command/ir-cr-book/ir-f1.html#wp3306168000">http://www.cisco.com/c/en/us/td/docs/ios-xml/ios/interface/command/ir-cr-book/ir-f1.html#wp3306168000</a>
<b>g709 otu threshold</b>	<a href="http://www.cisco.com/c/en/us/td/docs/ios-xml/ios/interface/command/ir-cr-book/ir-f1.html#wp2500217585">http://www.cisco.com/c/en/us/td/docs/ios-xml/ios/interface/command/ir-cr-book/ir-f1.html#wp2500217585</a>
<b>g709 overhead</b>	<a href="http://www.cisco.com/c/en/us/td/docs/ios-xml/ios/interface/command/ir-cr-book/ir-f1.html#wp6997702360">http://www.cisco.com/c/en/us/td/docs/ios-xml/ios/interface/command/ir-cr-book/ir-f1.html#wp6997702360</a>
<b>g709 tti processing</b>	<a href="http://www.cisco.com/c/en/us/td/docs/ios-xml/ios/interface/command/ir-cr-book/ir-f1.html#wp3679037909">http://www.cisco.com/c/en/us/td/docs/ios-xml/ios/interface/command/ir-cr-book/ir-f1.html#wp3679037909</a>
<b>pm fec threshold</b>	<a href="http://www.cisco.com/c/en/us/td/docs/ios-xml/ios/interface/command/ir-cr-book/ir-o1.html#wp8624772760">http://www.cisco.com/c/en/us/td/docs/ios-xml/ios/interface/command/ir-cr-book/ir-o1.html#wp8624772760</a>
<b>pm otn report</b>	<a href="http://www.cisco.com/c/en/us/td/docs/ios-xml/ios/interface/command/ir-cr-book/ir-o1.html#wp2518071708">http://www.cisco.com/c/en/us/td/docs/ios-xml/ios/interface/command/ir-cr-book/ir-o1.html#wp2518071708</a>
<b>pm otn threshold</b>	<a href="http://www.cisco.com/c/en/us/td/docs/ios-xml/ios/interface/command/ir-cr-book/ir-o1.html#wp1512678519">http://www.cisco.com/c/en/us/td/docs/ios-xml/ios/interface/command/ir-cr-book/ir-o1.html#wp1512678519</a>
<b>show controller dwdm</b>	<a href="http://www.cisco.com/c/en/us/td/docs/ios-xml/ios/interface/command/ir-cr-book/ir-s2.html#wp7346292950">http://www.cisco.com/c/en/us/td/docs/ios-xml/ios/interface/command/ir-cr-book/ir-s2.html#wp7346292950</a>



Commands	Links
<b>show interfaces</b>	<a href="http://www.cisco.com/c/en/us/td/docs/ios-xml/ios/interface/command/ir-cr-book/ir-s4.html#wp2987586133">http://www.cisco.com/c/en/us/td/docs/ios-xml/ios/interface/command/ir-cr-book/ir-s4.html#wp2987586133</a>
<b>transport-mode</b>	<a href="http://www.cisco.com/c/en/us/td/docs/ios-xml/ios/interface/command/ir-cr-book/ir-t1.html#wp3012872075">http://www.cisco.com/c/en/us/td/docs/ios-xml/ios/interface/command/ir-cr-book/ir-t1.html#wp3012872075</a>





## CHAPTER 19

# Using Zero Touch Provisioning

The router provides you the option of having the router auto configure. Field technicians need only mount the router, connect to the power and attach cables in easily-accessible ports, and initiate zero touch provisioning. This feature helps operators to reduce total cost of ownership (TCO) by simplifying the network deployment.



---

**Note** ZTP is supported only on the RSP3 module on the ASR 900 Series routers.

---



---

**Note** Routers running ZTP must be able to connect to a DHCP server and a TFTP server, download the configuration template, and begin operation.

---



---

**Note** ZTP must be initiated only from the R0 that has the active RSP module in a dual RSP scenario.

---

- [Prerequisites for Using ZTP, on page 313](#)
- [Restrictions for Using ZTP, on page 314](#)
- [Information About Using ZTP, on page 314](#)
- [Downloading the Initial Configuration, on page 316](#)
- [ZTP LED Behavior, on page 317](#)
- [Verifying the ZTP Configuration, on page 318](#)

## Prerequisites for Using ZTP

- The connection between the DHCP server or relay and TFTP server and router must be established.
- The TFTP server must have the required network configuration file stored and should be accessible to the router.

## Restrictions for Using ZTP

- ZTP is not supported on the LAN Management port—Gig0 on the router. ZTP is supported only on the Ethernet interfaces such as 1—Gige, 10—Gige ports, and so on.
- ZTP is not initialized if the ZTP button is pressed for more than eight seconds. In this case, the router goes through a normal reload process.
- ZTP is also not initialized when the router is already reloading or if the router is in ROMMON prompt.
- When the ZTP process is initialized all previous logs in the buffer are cleared.
- DHCP declines addresses when loading DHCP configuration through TFTP. It is strongly recommended to have only the CNS configuration present on the configuration file to avoid tampering with the ZTP BDI.
- After the ZTP process completes, you must save the configs using write memory and then reload the router.
- ZTP is not initialized if bootflash has files named as 'router-config'.
- Disabling gratuitous ARP is not supported.

## Information About Using ZTP

Figure 15: Sample ZTP Topology

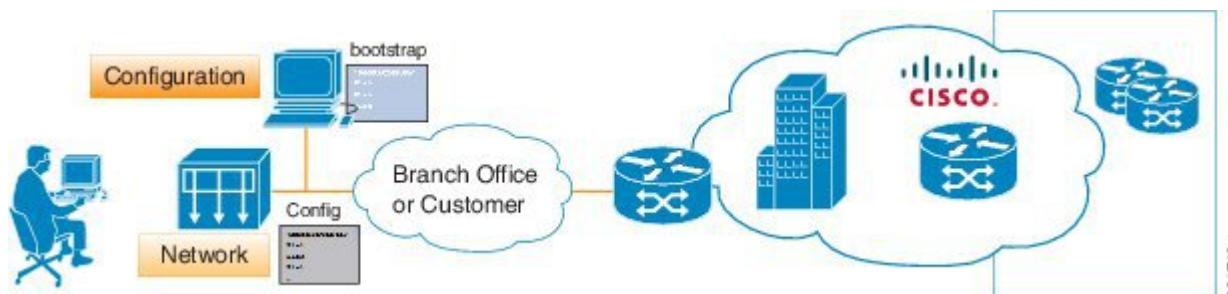

ZTP is triggered under any of the following conditions:

- A router without a start up configuration is powered on
- The **write erase** and **reload** commands are executed
- The **test platform hardware pp active ztp init** command is executed

The router does *not* have a ZTP or Reset button.

```
Router# write erase
System configuration has been modified. Save? [yes/no]: no
Router# reload
```



---

**Note** If you type **yes** at the prompt, the system configuration is saved in the nvRAM and the ZTP process terminates.

---

After the ZTP process initializes, the following sequence is initiated:

1. The router waits for any of the following packet types through data ports to detect the management VLAN:
  - Broadcast (Gratuitous ARP)
  - ISIS hello packets
  - OSPF hello packets
  - IPv6 router advertisement packets
  - VRRP



---

**Note** The operations center can initiate any of the above packets over the network to establish a connection to the DHCP server.

---

2. When the first packet on any VLAN is detected, the router initiates a DHCP session to a DHCP server over that VLAN.
3. After a DHCP session is established, the router uses the DHCP option 150 and initiates to download a configuration file from the TFTP server. The configuration file in the TFTP server should have anyone of the following naming format:
  - a. *PID-chassis-mac-address*

The PID specifies ASR and *chassis-mac-address* specifies the unique chassis MAC address printed on the chassis. For example, if the chassis mac-address is 00-01-02-03-04-06, then the config file would be ASR-00-01-02-03-04-05.
  - b. *network-config*
  - c. *router-config*
  - d. *ciscotr.cfg*
  - e. *cisconet.cfg*

When the ZTP process initiates, the router creates an Ethernet flow point (EFP) and associates a bridge domain interface (BDI) on the detected management VLAN.

The router creates the following configuration to establish a connection with the DHCP server and the TFTP server. The BDI created for this purpose has description **ZTP\_BDI** configured under the BDI interface.



---

**Note** Once the configuration file is downloaded successfully, you must save the configuration file (write memory) and reload the router.

---



---

**Caution** You may choose to remove the **ZTP\_BDI** configuration before reloading the router.

---

## Example ZTP Configuration

Let us assume that GigabitEthernet0/0/1 is connected to the DHCP server and is used to connect to the TFTP server. VLAN ID 1000 is used as the management VLAN.

```
Router# show running-config int gi0/0/1
Building configuration...
Current configuration : 216 bytes
!
interface GigabitEthernet0/0/1
  no ip address
  media-type auto-select
  no negotiation auto
  service instance 12 ethernet
    encapsulation dot1q 1000
    rewrite ingress tag pop 1 symmetric
    bridge-domain 12
!
end
!
interface BDI12
  description ZTP_BDI
  ip address dhcp
end
```

## Downloading the Initial Configuration

After the VLAN discovery process is complete, the configuration download process begins. The following sequence of events is initiated.

1. The router sends DHCP discover requests on each Ethernet interface. The serial number of the router is used as a client identifier.
2. The DHCP server allocates and sends an IP address, TFTP address (if configured with option 150) and default router address to the router.
3. If the TFTP option (150) is present, the router requests a bootstrap configuration that can be stored in any of the following files: , network-config, router-config, ciscotr.cfg, or cisconet.cfg.



---

**Note** Ensure to use hyphenated hexadecimal notation of MAC address (DOM-78-72-5D-00-A5-80) to name the files.

---

Effective Cisco IOS XE Amsterdam 17.3.2a, the router tries to learn the reachability to multiple DHCP servers during ZTP. Hence multiple DHCP discovery messages are sent out during this phase. The router goes through all the DHCP offer messages received and selects an appropriate DHCP server based on the priority decided based on below rules:

1. The DHCP server reachable via untagged interface have higher priority than the one via tagged. In case of tagged, the one reachable via an interface learned using VRRP packets has higher priority.
2. If multiple DHCP servers are reachable via similar interfaces mentioned in previous rule, the one reachable via higher physical port number has higher priority.

## DHCP Server

The following is a sample configuration to set up a Cisco router as a DHCP server:

```
ip dhcp excluded-address 30.30.1.6
ip dhcp excluded-address 30.30.1.20 30.30.1.255
!
ip dhcp pool mwrdhcp
network 30.30.1.0 255.255.255.0
option 150 ip 30.30.1.6
default-router 30.30.1.6
```

This configuration creates a DHCP pool of 30.30.1.x addresses with 30.30.1.0 as the subnet start. The IP address of the DHCP server is 30.30.1.6. Option 150 specifies the TFTP server address. In this case, the DHCP and TFTP server are the same.

The DHCP pool can allocate from 30.30.1.1 to 30.30.1.19 with the exception of 30.30.1.6, which is the DHCP server itself.

## TFTP Server

The TFTP server stores the bootstrap configuration file.

The following is a sample configuration (network– config file):

```
hostname test-router
!
{ asrrouter-specific configuration content}
!
end
```

## ZTP LED Behavior

Process	PWR LED	STAT LED
Press ZTP button	Green	Blinking Amber
Loading image	Blinking Green/Red	OFF
Image loaded	Green	Green
ZTP process running	Green	Blinking Amber
ZTP process success and config-file download completes	Green	Green

Process	PWR LED	STAT LED
ZTP process failure or terminated	Green	Red

## Verifying the ZTP Configuration

To verify if the ZTP configuration is successful, use the following command:

- `show running-config`





## CHAPTER 20

# Configuring 1G Traffic on 8-port 10 Gigabit Ethernet Interface Module

The 8-port 10 Gigabit Ethernet Interface Module (8X10GE) has eight ports and is supported on the RSP3 module. Prior to Cisco IOS XE Everest 16.5.1, 1G traffic support was provided only with the devices placed in the access layer. Effective Cisco IOS XE Everest 16.5.1, 1G traffic support is provided to devices in the distribution layer. Thus, all the eight ports provide support for 1G mode as well as 10G mode.

The configuration of 1G traffic on 8X10GE interface module provides cost-effective solution during migration from 1G mode to 10G mode as a single device supports both the modes.



**Note** By default, the 8X10GE interface module comes up in the 10G mode after reboot.

- [Restrictions for 1G Mode on 8X10 GE Interface Module, on page 319](#)
- [Configuring 1G Mode, on page 320](#)
- [Configuring 10G Mode from 1G Mode, on page 321](#)
- [Associated Commands, on page 322](#)
- [Overview of Over Subscription and Partial Port Modes on the 8-port 10 Gigabit Ethernet Interface Module, on page 323](#)

## Restrictions for 1G Mode on 8X10 GE Interface Module

- SFP+ is not supported on 1G mode, but the physical link with SFP+ in 1G mode comes up.
- Support of 1G mode on a port and 10G mode on another port in the same interface module is not supported.
- Precision Time Protocol (PTP) is not supported.
- Sync-E is not supported. However, Sync-E is supported in over subscription mode on the interface module.
- Port channel bundling on 1G mode is not supported.
- Although 1G mode is supported on the interface module, the interface is displayed as "Te0/X/Y" depending on the port numbers for both 1G and 10G modes.
- 10G mode support on 8X10GE interface module does not change with dual-rate support.

## Configuring 1G Mode

### Defaulting the Interface Module:

```
enable
hw-module subslot 0/4 default
end
```

### Changing the Mode:

```
enable
configure terminal
hw-module subslot 0/4 ether-mode 1G
end
```

### Configuring the Ports:

```
enable
configure terminal
interface te0/4/0
ip address 63.0.0.1 255.0.0.0
end
```

## Verifying 1G Mode Configuration

The transport mode is LAN (1GB/s). The speed and bandwidth are 1000 Mbps and 1000000 Kbit/sec, respectively.

To verify the configuration, use **show interface** command in privileged EXEC mode:

```
Router#show interface tengigabitethernet0/4/0

TenGigabitEthernet0/4/0 is up, line protocol is up
Hardware is A900-IMA8Z, address is c8f9.f98d.2024 (bia c8f9.f98d.2024)
Internet address is 50.0.0.1/8
MTU 1500 bytes, te0/4/0, DLY 10 usec,
    reliability 255/255, txload 1/255, rxload 1/255
Encapsulation ARPA, loopback not set
Keepalive set (10 sec)
Full Duplex, 1000Mbps, link type is auto, media type is SX
output flow-control is off, input flow-control is off
Transport mode LAN (1Gb/s)
ARP type: ARPA, ARP Timeout 04:00:00
Last input 00:08:24, output 00:08:24, output hang never
Last clearing of "show interface" counters 00:07:59
Input queue: 0/375/0/0 (size/max/drops/flushes); Total output drops: 0
Queueing strategy: fifo
....
```

To verify the slots configured in 1G mode, use the **show running-config | i ether-mode** command in privileged EXEC mode:

```
Router#show running-config | i ether-mode
hw-module subslot 0/3 ether-mode 1g
hw-module subslot 0/4 ether-mode 1g
hw-module subslot 0/11 ether-mode 1g
```

To verify the bandwidth and port speed, use the **show platform hardware pp active interface all** in privileged EXEC mode:

```

Router#show platform hardware pp active interface all
      Interface manager platform keys
-----

      Name: TenGigabitEthernet0/4/7, Asic: 0, hwidx: 9
      lpn: 0, ppn: 9, gid: 9, mac: c8f9.f98d.202b
      InLportId: 0, ELportId: 0, dpidx: 31, l3ID: 25
      port_flags: 0, port_speed: 1000 Mbps, efp_count: 0, destIndex: 9, intType: 1
      etherchnl: 0, efp: 0, bdi: 0, l2PhyIf: 0, l3PhyIf: 1, l3TDM: 0, loopBack: 0
      tunnel: 0, tunneltp: 0, icmp_flags: 0, icmp6_flags: 0
      bandwidth: 1000000, fcid: 0, cid: 0, mpls_tbid: 0, protocols: 4
      v4_netsmask: 8, v4_tableid: 8, v6_tableid: 65535, vrf_tbid_dstrm: , snmp_index: 0
      bd_id: 0, encap: 1, ip_mtu: 1500, l2_max_tu: 1500, l2_min_tu: 0
      vrfid: 8, enctype: 0, admin_state: 1, admin_state_oir: 0

      Name: TenGigabitEthernet0/4/6, Asic: 0, hwidx: 10
      lpn: 0, ppn: 10, gid: 10, mac: c8f9.f98d.202a
      InLportId: 0, ELportId: 0, dpidx: 30, l3ID: 24
      port_flags: 0, port_speed: 1000 Mbps, efp_count: 0, destIndex: 10, intType: 1
      etherchnl: 0, efp: 0, bdi: 0, l2PhyIf: 0, l3PhyIf: 1, l3TDM: 0, loopBack: 0
      tunnel: 0, tunneltp: 0, icmp_flags: 0, icmp6_flags: 0
      bandwidth: 1000000, fcid: 0, cid: 0, mpls_tbid: 0, protocols: 4
      v4_netsmask: 8, v4_tableid: 6, v6_tableid: 65535, vrf_tbid_dstrm: , snmp_index: 0
      bd_id: 0, encap: 1, ip_mtu: 1500, l2_max_tu: 1500, l2_min_tu: 0
      vrfid: 6, enctype: 0, admin_state: 1, admin_state_oir: 0

```

## Configuring 10G Mode from 1G Mode

### Deafulting the Interface Module:

```

enable
hw-module subslot 0/4 default
end

```

### Changing the Mode:

```

enable
configure terminal
hw-module subslot 0/4 ether-mode 10G
end

```



**Note** The default is 10G mode.

### Configuring the Ports:

```

enable
configure terminal
interface te0/4/0
ip address 63.0.0.1 255.0.0.0
end

```

## Verifying 10G Mode Configuration

To verify the configuration, use **show interface** command in privileged EXEC mode:

```

Router#show interface tengigabitethernet0/4/0
TenGigabitEthernet0/4/0 is up, line protocol is up

```

```

Hardware is A900-IMA8Z, address is c8f9.f98d.2024 (bia c8f9.f98d.2024)
Internet address is 50.0.0.1/8
MTU 1500 bytes, BW 10000000 Kbit/sec, DLY 10 usec,
    reliability 255/255, txload 1/255, rxload 1/255
Encapsulation ARPA, loopback not set
Keepalive set (10 sec)
Full Duplex, 10000Mbps, link type is auto, media type is SX
output flow-control is off, input flow-control is off
Transport mode LAN
ARP type: ARPA, ARP Timeout 04:00:00
Last input 00:08:24, output 00:08:24, output hang never
Last clearing of "show interface" counters 00:07:59
Input queue: 0/375/0/0 (size/max/drops/flushes); Total output drops: 0
Queueing strategy: fifo
....

```



**Note** For 10G mode, the **hw-module subslot 0/x ether-mode 10G** command is not displayed when you use **show running-config** command.

To verify the bandwidth and port speed, use the **show platform hardware pp active interface all** in privileged EXEC mode:

```

Router#show platform hardware pp active interface all
Interface manager platform keys
-----

Name: TenGigabitEthernet0/4/7, Asic: 0, hwidx: 9
lpn: 0, ppn: 9, gid: 9, mac: c8f9.f98d.202b
InLportId: 0, ELportId: 0, dpidx: 31, l3ID: 25
port_flags: 0, port_speed: 10000 Mbps, efp_count: 0, destIndex: 9, intType: 1
etherchnl: 0, efp: 0, bdi: 0, l2PhyIf: 0, l3PhyIf: 1, l3TDM: 0, loopBack: 0
tunnel: 0, tunneltp: 0, icmp_flags: 0, icmp6_flags: 0
bandwidth: 10000000, fcid: 0, cid: 0, mpls_tbid: 0, protocols: 4
v4_netsmask: 8, v4_tableid: 8, v6_tableid: 65535, vrf_tbid_dstrm: , snmp_index: 0
bd_id: 0, encap: 1, ip_mtu: 1500, l2_max_tu: 1500, l2_min_tu: 0
vrfid: 8, enctype: 0, admin_state: 1, admin_state_oir: 0

Name: TenGigabitEthernet0/4/6, Asic: 0, hwidx: 10
lpn: 0, ppn: 10, gid: 10, mac: c8f9.f98d.202a
InLportId: 0, ELportId: 0, dpidx: 30, l3ID: 24
port_flags: 0, port_speed: 10000 Mbps, efp_count: 0, destIndex: 10, intType: 1
etherchnl: 0, efp: 0, bdi: 0, l2PhyIf: 0, l3PhyIf: 1, l3TDM: 0, loopBack: 0
tunnel: 0, tunneltp: 0, icmp_flags: 0, icmp6_flags: 0
bandwidth: 10000000, fcid: 0, cid: 0, mpls_tbid: 0, protocols: 4
v4_netsmask: 8, v4_tableid: 6, v6_tableid: 65535, vrf_tbid_dstrm: , snmp_index: 0
bd_id: 0, encap: 1, ip_mtu: 1500, l2_max_tu: 1500, l2_min_tu: 0
vrfid: 6, enctype: 0, admin_state: 1, admin_state_oir: 0

```

## Associated Commands

The following commands are used to configure 8-port 10 Gigabit Ethernet Interface Module (8X10GE):

Commands	Links
hw-module subslot	<a href="http://www.cisco.com/c/en/us/td/docs/ios-xml/ios/interface/command/ir-cr-book/ir-fl.html#wp4618355370">http://www.cisco.com/c/en/us/td/docs/ios-xml/ios/interface/command/ir-cr-book/ir-fl.html#wp4618355370</a>

Commands	Links
show platform hardware pp active interface all	<a href="http://www.cisco.com/c/en/us/td/docs/ios-xml/ios/interface/command/ir-cr-book/ir-s5.html">http://www.cisco.com/c/en/us/td/docs/ios-xml/ios/interface/command/ir-cr-book/ir-s5.html</a>

## Overview of Over Subscription and Partial Port Modes on the 8-port 10 Gigabit Ethernet Interface Module

The 8-port 10 Gigabit Ethernet interface module (8X10GE) requires eight backplane XFI lines to the ASIC to operate efficiently. The chassis has different backplane capacity or bandwidth on each of its subslot. The 8X10GE interface module could only be used in subslots that offered the eight XFI backplane lines. The following table shows the slots that 8X10GE interface module support without over subscription mode:

Slot No	Slot 0	Slot 1	Slot 2	Slot 3	Slot 4	Slot 5	Slot 6	Slot 7	Slot 8	Slot 9	Slot 10	Slot 11	Slot 12	Slot 13	Slot 14	Slot 15
8X10GE	No	No	No	Yes	Yes	No	No	Yes	Yes	No	No	Yes	Yes	No	No	No



**Note** The router supports the 8X10GE interface module individually on the above slots, and offer eight XFI/SFI lines. But as a combination of slots to support 400G bandwidth, only five slots are supported for the 8X10GE interface module. With over subscription or partial mode enabled on the router six slots are available to support the bandwidth.

Over subscription mode enables the operation of the 8X10GE interface module in all subslots with a lesser backplane capacity. Hence, with over subscription mode enabled, all the front plane ports of the interface module are able to receive and transmit traffic.

Partial port mode is used to free the used serializer/deserializer (SerDes) lines to accommodate interface modules that support over subscription in those slots that may utilize the shared SerDes. The advantage of this mode is that the Channelized Network Interface Scheduler (CNIS) of ASIC, a limited resource, is not utilized, as compared to the over subscription mode.

Both these modes aid in increasing the number of interface modules in the maximum number of subslots on the chassis.

## Over Subscription Mode

Over subscription mode is introduced to support population of maximum number of interface modules on the chassis.

The 8X10GE interface module requires eight backplane XFI lines to operate, where each front plane port fully utilizes a backplane XFI line. Hence, it operates with an overall bandwidth of 80Gbps. When over subscription is enabled, a group of front plane ports are channelized onto a single backplane XFI line, which reduces the bandwidth based on the number of ports multiplexed onto the backplane XFI line.

When the 8X10GE interface module is in over subscribed mode, all the eight front plane ports are functional.

2:1 — Two front plane ports are multiplexed onto one backplane XFI. The overall bandwidth of the interface module is 40Gbps.

## Partial Port Mode

Partial port mode is also introduced to support maximum number of interface modules on the chassis.

This mode, unlike over subscription mode does not multiplex the front plane port, but blocks some front plane ports to free up the backplane XFI lines used by them.

Partial Port mode has one variant:

4 port mode — Only four front plane ports are enabled. Each port uses one backplane XFI line. Hence each port supports 10Gbps data rate, and the interface module supports 40Gbps datarate.

## Prerequisites for Over Subscription Mode on the 8-port 10 Gigabit Ethernet Interface Module

- FPGA must be upgraded to version 0.22. Use the **upgrade hw-module subslot 0/x fpd bundled reload** command to upgrade manually, before configuring over-subscription mode.

## Restrictions for Over Subscription Mode 8-port 10 Gigabit Ethernet Interface Module

The following restrictions are applicable for the over subscription mode on the 8-port 10 Gigabit Ethernet Interface Module (A900-IMA8Z) on the ASR 907 Router:

- Traffic prioritization is supported, but policing is not supported.
- PTP over over subscription mode is not supported.
- Dynamic over subscription mode change does not work. Reload the router after any mode change.

## Supported Features and Constraints

Following are the supported features and constraints for configuring over subscription and partial port mode on the 8X10 GE interface module.

*Table 27: Over Subscription Mode and Partial Port Mode Support Features and Constraints*

	<b>8X10 GE Over Subscription Mode</b>	<b>4 X10 G Partial Port Mode</b>
Supported Platforms	ASR 907 RSP3-400	ASR 907 RSP3-400
FPGA Mode	Supported only with XFI passthrough mode Minimum version 0.22	Supported on both XFI passthrough and port expansion mode
Subslots	Supported on only selected subslots	Supported on only selected subslots

	<b>8X10 GE Over Subscription Mode</b>	<b>4 X10 G Partial Port Mode</b>
Mode Enablement	Activated on router reload	Activated on router reload
Backplane SerDes Selection	Static; Cannot define backplane SerDes	Static; Cannot define backplane SerDes
Dual Rate Support (1G / 10G)	Not supported on 1G mode in Cisco IOS XE Fuji 16.9.1.	Not supported on 1G mode in Cisco IOS XE Fuji 16.9.1.
LAN/WAN/OTN Support	10G Eth (LAN) mode is supported in Cisco IOS XE Fuji 16.9.1.	Supports LAN/WAN/OTN modes

## Supported Subslots

The table shows the subslots of the different over subscription modes and also provides information about the SerDes line from the ASIC (multiplexed) to the frontplane ports on the chassis:

*Table 28: Supported Subslots and SerDes Lines used by the 8X10GE Interface Module with Over Subscription Modes*

<b>Mode</b>	<b>Supported Slots</b>	<b>SerDes Lines Used</b>	<b>Enabled Ports</b>
2:1 over subscription mode	3, 4	2, 3 6, 7	All ports
	11, 12	0, 1,2, 3	
4 Port Mode (Partial Port mode)	3,4	2,3,6,7	0,1,4,5



**Note** Serializer/Deserializer (SerDes) is not released when dependant slot interface modules are in shutdown unpowered state.

## FPGA Operating Mode

The FPGA operates in the following modes. The FPGA operating modes are selected by configuration.

- Port Expansion Mode — Allows port expansion on QSGMII based interface module such as the 8X1G interface module or 8x1G+10G combo interface module. The FPGA consumes the port expansion quad on ASIC.
- XFI Passthrough Mode — Supports XFI passthrough for enabling new XFI lines in certain slots of the chassis.



**Note** System reload is required after changing the FPGA mode .



**Note** Over subscription on the 8X10GE interface module is supported only with the XFI Passthrough mode.

The **license feature service-offload enable** command is used to change the FPGA mode to the XFI Passthrough mode.

The default setting of this command is the **no** form of the command. The default FPGA operation mode is XLAUI-QSGMII Port expansion mode.

## Maximum Slot Population of the 8-port 10 Gigabit Ethernet Interface Module

Over subscription and partial port mode is implemented to free up the shared SerDes lines to other interface modules, and to also populate the 8X10GE interface modules in maximum possible slots with an optimum bandwidth support.



**Note** A total of six 8x10GE interface modules are populated on the ASR 907 chassis with the RSP3-400 module.

The following table shows the modes selected on each subslot, and the CNIS utilized in that subslot in order to realise the maximum slot population of 8X10GE interface module.

**Table 29: Maximum Slot Population of the 8X10 GE Interface Module**

Subslot	8X10 GE Interface Module Mode	Port Numbers	SerDes Numbers	ASIC No.	CNIS Used
4	4X10G Partial Port	0	27	ASIC-1	0
		1	26		
		4	15		
		5	14		
8	8X10G Fully Subscribed Mode	0	7	ASIC-1	0
		1	6		
		2	5		
		3	4		
		4	3		
		5	2		
		6	1		
		7	0		



Subslot	8X10 GE Interface Module Mode	Port Numbers	SerDes Numbers	ASIC No.	CNIS Used
12	4X10G Partial Port	4	11	ASIC-1	0
		5	10		
		6	9		
		7	8		
3	4X10G Partial Port	0	27	ASIC-0	0
		1	26		
		4	15		
		5	14		
7	8X10G Fully Subscribed	0	7	ASIC-0	0
		1	6		
		2	5		
		3	4		
		4	3		
		5	2		
		6	1		
		7	0		
11	4X10G Partial Port	4	11	ASIC-0	0
		5	10		
		6	9		
		7	8		

## Configuring Over Subscription and Partial Mode

Use the **platform hw-module configuration** to configure the mode on the chassis.

- Example: Configuring over subscription mode

```
Router(config)#platform hw-module configuration
```

```
Router(config-plat-hw-conf)# hw-module 0/12 A900-IMA8Z mode 8x10G-2:1-OS
```

- Example: Configuring parital port mode

```
Example: Router(config)#platform hw-module configuration
Router(conf-plat-hw-conf)# hw-module 0/3 A900-IMA8Z mode 4-ports-only
```



## CHAPTER 21

# Configuring 8/16-port 1 Gigabit Ethernet (SFP / SFP) + 1-port 10 Gigabit Ethernet (SFP+) / 2-port 1 Gigabit Ethernet (CSFP) Interface Module

The 8/16-port 1 Gigabit Ethernet (SFP / SFP) + 1-port 10 Gigabit Ethernet (SFP+) / 2-port 1 Gigabit Ethernet (CSFP) Interface Module has 8 ports of 1 Gigabit Ethernet and 1 port of 10 Gigabit, similar to the Cisco ASR 900 Series 8-Port 1GE SFP and 1-Port 10GE SFP+ Module. The 8/16-port 1 Gigabit Ethernet (SFP / SFP) + 1-port 10 Gigabit Ethernet (SFP+) / 2-port 1 Gigabit Ethernet (CSFP) Interface Module operates on multiple port densities and operating modes. Each physical port can be extended to have 2 ports of 1 Gigabit Ethernet with the use of Compact Small Form-Factor Pluggable (CSFP) module to address high-density port requirements in FTTx deployments.

**Figure 16: 8/16-port 1 Gigabit Ethernet (SFP / SFP) + 1-port 10 Gigabit Ethernet (SFP+) / 2-port 1 Gigabit Ethernet (CSFP) Interface Module**

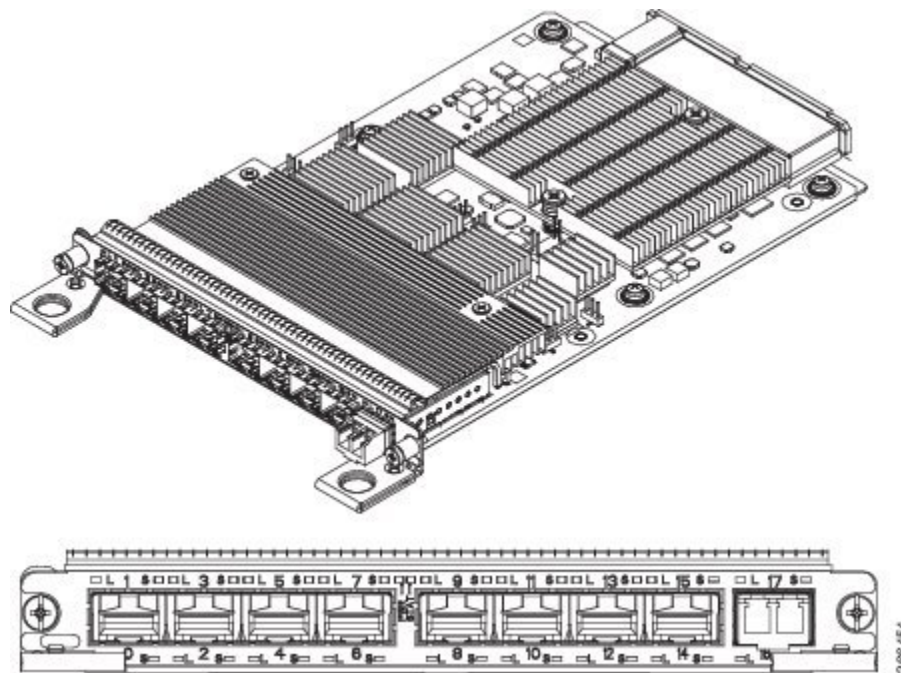

Each port on CSFP acts as Transmitter or Receiver and connects to GLC-BX-U SFPs using a single strand fiber. GLC-BX-U SFPs support digital optical monitoring (DOM) functions according to the industry-standard

SFF-8472 multisource agreement (MSA). This feature gives the end user the ability to monitor real-time parameters of the SFP, such as optical output power, optical input power, temperature, laser bias current, and transceiver supply voltage.



**Note** CSFP must be connected only to GLC-BX-U.

This interface module has 8 physical ports of 1 Gigabit Ethernet and 1 physical port of 10 Gigabit Ethernet, but with the support of CSFP, it can support a maximum of 18 ports of 1 Gigabit Ethernet. Thus, the interface module offers enhanced bandwidth.

The following table shows the type of SFPs for 1G and 10G Modules.

**Table 30: Type of SFPs for 1G and 10G Modules**

Module	Optics
1G Module	SFP
	CSFP
10G Module	SFP+
	SFP
	CSFP

- [Operating Modes, on page 330](#)
- [SADT Mode, on page 332](#)
- [Bandwidth Mode, on page 332](#)
- [IOS Port Numbering, on page 336](#)
- [Supported Features on the Interface Module, on page 337](#)
- [Benefits, on page 337](#)
- [Restrictions, on page 337](#)
- [Configuring Interface Module, on page 337](#)
- [Configuring Bandwidth Mode, on page 346](#)
- [Interface Module Rules, on page 347](#)
- [Associated Commands, on page 357](#)
- [Additional References, on page 357](#)

## Operating Modes

The interface module supports the following two operating modes:

- Full Subscription
- Over Subscription



---

**Note** The interface module supports 8 ports of 1 Gigabit Ethernet + 1 port of 10 Gigabit Ethernet mode by default (except the slots 0, 1, 6, and 9 with XFI Pass through mode).

---

## Full Subscription Mode

Full subscription operating mode supports the bandwidth equal to the number of ports configured.

For example, if you configure 8-port 1GE + 1-port 10GE in full subscription operating mode, then the supported bandwidth is 8 Gigabit Ethernet and 10 Gigabit Ethernet.

The supported operating modes of Full Subscription for ASR 903 Routers are:

- 16-port 1GE + 1-port 10GE
- 8-port 1GE + 1-port 10 GE
- 18-port 1GE

The supported operating modes of Full Subscription for ASR 907 Routers are:

- 8-port 1GE + 1-port 10GE
- 8-port 1GE + 1-port 1GE
- 8-port 1GE
- 1-port 10GE

## Over Subscription Mode

Over Subscription operating mode is applicable to 1 Gigabit Ethernet ports only. 16-port 1GE and 16-port 1GE + 1-port 10GE operating modes support 8 Gigabit Ethernet and 18 Gigabit Ethernet bandwidth, respectively. 18-port 1GE supports 9 Gigabit Ethernet bandwidth. But, if the total bandwidth exceeds the supported bandwidth, it results in low priority traffic drop.

For example, if you configure 16-port 1GE + 1-port 10GE over subscription operating mode, then 8GE bandwidth is supported for 16 ports of 1 Gigabit Ethernet and 10GE bandwidth is supported for 10 Gigabit Ethernet ports.

The following are the supported operating modes of Over Subscription for ASR 907 Routers:

- 16-port 1GE
- 16-port 1GE + 1-port 10GE
- 18-port 1GE



---

**Note** In 18-port 1GE mode, 10 Gigabit Ethernet physical port slot becomes 2 ports of 1 Gigabit Ethernet with insertion of CSFP.

---



---

**Note** By default, the interface module loads in 8-port 1GE + 1-port 10 GE modes (except the slots 0, 1, 6, and 9 with XFI-Pass Through mode. For more information, refer [Optics Matrix](#).

---



---

**Note** Over subscription mode is *not* supported on ASR 903 Routers.

---

Traffic is classified as follows:

- High Priority Traffic — Has high priority queue

This is classified as follows:

- DMAC=01-80-C2-xx-xx-xx
- Etype=0x8100, 9100, 9200, 88A8 Cos values=5, 6, 7
- Etype=0806 (ARP), 88F7 (PTP)
- Etype=0x800, TOS 5, 6, 7
- Etype=0x8847, MPLS EXP 5, 6, 7
- Low Priority Traffic — Traffic that does not satisfy the above conditions has low priority queue

## Egress Packet Classifiers

During oversubscription, the egress direction classifies the packet based on the following:

- The first 8 ports use the priority-based flow-control (PFC) to ensure that there are no drop in packets.
- The remaining ports do strict priority between High Priority and Low Priority counters.



---

**Note** The threshold value is 6 by default (packet with CoS/EXP/DSCP value greater than or equal to 6 is classified as High Priority).

---

## SADT Mode

For more information on SADT mode, see [IP SLA—Service Performance Testing](#).

## Bandwidth Mode

Each interface module subslot can be assigned a bandwidth. You can reserve the slots with specific bandwidth so that the interface module that consumes more than the configured bandwidth is not used.



**Note** The bandwidth mode is *not* supported on ASR 903 Routers and is *only* supported on ASR 907 Routers.

The following table shows the interface module slots for the bandwidth mode.

IM Subslot	Bandwidth Mode	SADT Operating Mode
0	8 Gbps	Port Expansion Mode or XFI-Pass Through Mode
	10 Gbps	XFI-Pass Through Mode
1	8 Gbps	Port Expansion Mode
	10 Gbps	XFI-Pass Through Mode
2	8 Gbps	Port Expansion Mode
	10 Gbps	Port Expansion Mode or XFI-Pass Through Mode
	18 Gbps	Port Expansion Mode
	20 Gbps	XFI-Pass Through Mode
3	Not Available	NA
4	Not Available	NA
5	8 Gbps	Port Expansion Mode
	10 Gbps	Port Expansion Mode or XFI-Pass Through Mode
	18 Gbps	Port Expansion Mode
	20 Gbps	XFI-Pass Through Mode
6	8 Gbps	Port Expansion Mode
	10 Gbps	Port Expansion Mode or XFI-Pass Through Mode
	18 Gbps	Port Expansion Mode
7	80 Gbps	Port Expansion Mode or XFI-Pass Through Mode
	100 Gbps	Port Expansion Mode or XFI-Pass Through Mode

IM Subslot	Bandwidth Mode	SADT Operating Mode
8	80 Gbps	Port Expansion Mode or XFI-Pass Through Mode
	100 Gbps	Port Expansion Mode or XFI-Pass Through Mode
9	8 Gbps	Port Expansion Mode
	10 Gbps	Port Expansion Mode or XFI-Pass Through Mode
	18 Gbps	Port Expansion Mode
10	8 Gbps	Port Expansion Mode
	10 Gbps	Port Expansion Mode or XFI-Pass Through Mode
	18 Gbps	Port Expansion Mode
	20 Gbps	XFI-Pass Through Mode
11	Not Available	NA
12	Not Available	NA
13	8 Gbps	Port Expansion Mode
	10 Gbps	Port Expansion Mode or XFI-Pass Through Mode
	18 Gbps	Port Expansion Mode
	20 Gbps	XFI-Pass Through Mode
14	8 Gbps	Port Expansion Mode
	10 Gbps	Port Expansion Mode or XFI-Pass Through Mode
	18 Gbps	Port Expansion Mode
	20 Gbps	XFI-Pass Through Mode
15	8 Gbps	Port Expansion Mode
	10 Gbps	Port Expansion Mode or XFI-Pass Through Mode
	18 Gbps	Port Expansion Mode
	20 Gbps	XFI-Pass Through Mode



## Slot Support on Operating Modes

The following table shows the slots supported on different operating modes on ASR 907 Routers.

IM Subslot	SADT Operating Mode	IM Operating Modes	
0, 1	Port Expansion Mode	Unsupported	
	XFI-Pass Through Mode	8-port 1GE + 1-port 1GE	
		8-port 1GE	
		16-port 1GE Over Subscribed	
		18-port 1GE Over Subscribed	
2, 5, 10, 13, 14, 15	XFI-Pass Through Mode	8-port 1GE + 1-port 10GE	
		16-port 1GE + 1-port 10GE Over Subscribed	
	Any	8-port 1GE + 1-port 1GE	
		8-port 1GE	
		16-port 1GE Over Subscribed	
		18-port 1GE Over Subscribed	
		1-port 10GE	
	3, 4, 7, 8, 11, 12	Any	8-port 1GE + 1-port 10GE
			8-port 1GE + 1-port 1GE
			8-port 1GE
1-port 10GE			
16-port 1GE + 1-port 10GE Over Subscribed			
16-port 1GE Over Subscribed			
18-port 1GE Over Subscribed			
6, 9	Any	8-port 1GE + 1-port 1GE	
		8-port 1GE	
		1-port 10GE	
		16-port 1GE Over Subscribed	
		18-port 1GE Over Subscribed	

The following table shows the slots supported for different operating modes for ASR 903 routers.

IM Subslot	IM Operating Modes
0, 3, 4, and 5	16-port 1GE + 1-port 10GE Fully Subscribed
	8-port 1GE + 1-port 10GE
	18-port 1GE Fully Subscribed
1, 2	Unsupported

## IOS Port Numbering

The IOS port numbers are different from other typical interface module because of the flexibility of optics choices and operating modes. The IOS port number is even numbered for SFP optics (for example, Gigabit Ethernet 0/x/0) and the additional port on CSFP insertion introduces the odd number (for example, Gigabit Ethernet 0/x/0 and Gigabit Ethernet 0/x/1) as enumerated in the table below.

**Table 31: IOS Port Number**

1G Face Plate Port	SFP Optics	CSFP Optics
0	Gigabit Ethernet 0/x/0	Gigabit Ethernet 0/x/0 and Gigabit Ethernet 0/x/1
1	Gigabit Ethernet 0/x/2	Gigabit Ethernet 0/x/2 and Gigabit Ethernet 0/x/3
2	Gigabit Ethernet 0/x/4	Gigabit Ethernet 0/x/4 and Gigabit Ethernet 0/x/5
3	Gigabit Ethernet 0/x/6	Gigabit Ethernet 0/x/6 and Gigabit Ethernet 0/x/7
4	Gigabit Ethernet 0/x/8	Gigabit Ethernet 0/x/8 and Gigabit Ethernet 0/x/9
5	Gigabit Ethernet 0/x/10	Gigabit Ethernet 0/x/10 and Gigabit Ethernet 0/x/11
6	Gigabit Ethernet 0/x/12	Gigabit Ethernet 0/x/12 and Gigabit Ethernet 0/x/13
7	Gigabit Ethernet 0/x/14	Gigabit Ethernet 0/x/14 and Gigabit Ethernet 0/x/15

Similarly, the IOS port number on the 10G module also has an even number and the additional port on CSFP insertion is odd numbered as listed in the table below.

Table 32: IOS Port Number

10G Face Plate Port	SFP+	SFP (1G BW)	CSFP (1G BW)
8	Ten Gigabit Ethernet 0/x/16	Ten Gigabit Ethernet 0/x/16	Ten Gigabit ethernet 0/x/16 and Gigabit Ethernet 0/x/17

## Supported Features on the Interface Module

- Supports PTP implementation. PTP is supported on 1G SFP, 10G SFP+, and CSFP ports.
- Supports SyncE.
- Supports both full subscription and over subscription modes.
- Provides multiple combinations of port density in Full subscription and Over Subscription modes.

## Benefits

- The interface module has enhanced port density.
- 10 GE port can also operate in 1GE mode.

## Restrictions

- In XFI Pass through mode, the interface module goes out of service without any mode configuration on slots 0, 1, 6, and 9. Configure the supported modes on the slots before inserting the interface module.
- This interface module is supported only on Cisco RSP3 module.
- OTN, Wan Phy, and MACsec are *not* supported.
- High Priority Traffic with frame size more than 4500 bytes is *not* supported for oversubscription mode.
- COS, EXP, and DSCP fields in frames with values 5, 6, and 7 respectively, are considered as High Priority Traffic for Oversubscription mode than other control packets.
- This interface module is *not* supported on Cisco ASR 902 Routers.
- 1 G Module ports must have symmetric configuration on both local and peer ends for the ports to come up on the router. For example, if autonegotiation is configured on the local end, it must be configured on the peer end.

## Configuring Interface Module

To configure interface module:

## Example: Configuring Full Subscription Modes

```

enable
hw-module subslot 0/4 default
Proceed with setting all interfaces as default for the module? [confirm]%Setting all
interfaces in 0/4 to default state
Interface GigabitEthernet 0/4/0 set to default configuration
Interface GigabitEthernet 0/4/1 set to default configuration
Interface GigabitEthernet 0/4/2 set to default configuration
Interface GigabitEthernet 0/4/3 set to default configuration
Interface GigabitEthernet 0/4/4 set to default configuration
Interface GigabitEthernet 0/4/5 set to default configuration
Interface GigabitEthernet 0/4/6 set to default configuration
Interface GigabitEthernet 0/4/7 set to default configuration
Interface GigabitEthernet 0/4/8 set to default configuration
Interface GigabitEthernet 0/4/9 set to default configuration
Interface GigabitEthernet 0/4/10 set to default configuration
Interface GigabitEthernet 0/4/11 set to default configuration
Interface GigabitEthernet 0/4/12 set to default configuration
Interface GigabitEthernet 0/4/13 set to default configuration
Interface GigabitEthernet 0/4/14 set to default configuration
Interface GigabitEthernet 0/4/15 set to default configuration
Interface GigabitEthernet 0/4/16 set to default configuration
Interface GigabitEthernet 0/4/17 set to default configuration
configure terminal
platform hw-module configuration
hw-module 0/4 A900-IMA8CS1Z-M mode mode
Interface configs would be defaulted before mode change followed by a soft reset of IM,
will take ~3min to complete initialization.
-----Do you wish to continue?-----? [yes]: y
Please wait ~3 mins before applying any configs on the IM
Interface GigabitEthernet 0/4/0 set to default configuration
Interface GigabitEthernet 0/4/1 set to default configuration
Interface GigabitEthernet 0/4/2 set to default configuration
Interface GigabitEthernet 0/4/3 set to default configuration
Interface GigabitEthernet 0/4/4 set to default configuration
Interface GigabitEthernet 0/4/5 set to default configuration
Interface GigabitEthernet 0/4/6 set to default configuration
Interface GigabitEthernet 0/4/7 set to default configuration
Interface GigabitEthernet 0/4/8 set to default configuration
Interface GigabitEthernet 0/4/9 set to default configuration
Interface GigabitEthernet 0/4/10 set to default configuration
Interface GigabitEthernet 0/4/11 set to default configuration
Interface GigabitEthernet 0/4/12 set to default configuration
Interface GigabitEthernet 0/4/13 set to default configuration
Interface GigabitEthernet 0/4/14 set to default configuration
Interface GigabitEthernet 0/4/15 set to default configuration
Interface GigabitEthernet 0/4/16 set to default configuration
Interface GigabitEthernet 0/4/17 set to default configuration

```

## Example: Configuring Full Subscription Modes

The following are the examples to configure different modes of full subscription.

### 8-port 1GE + 1-port 10GE Full Subscription Mode Configuration:

```

Router# enable
Router#hw-module subslot 0/4 default
Proceed with setting all interfaces as default for the module? [confirm]%Setting all
interfaces in 0/4 to default state
Interface GigabitEthernet 0/4/0 set to default configuration
Interface GigabitEthernet 0/4/1 set to default configuration

```

```

Interface GigabitEthernet 0/4/2 set to default configuration
Interface GigabitEthernet 0/4/3 set to default configuration
Interface GigabitEthernet 0/4/4 set to default configuration
Interface GigabitEthernet 0/4/5 set to default configuration
Interface GigabitEthernet 0/4/6 set to default configuration
Interface GigabitEthernet 0/4/7 set to default configuration
Interface GigabitEthernet 0/4/8 set to default configuration
Interface GigabitEthernet 0/4/9 set to default configuration
Interface GigabitEthernet 0/4/10 set to default configuration
Interface GigabitEthernet 0/4/11 set to default configuration
Interface GigabitEthernet 0/4/12 set to default configuration
Interface GigabitEthernet 0/4/13 set to default configuration
Interface GigabitEthernet 0/4/14 set to default configuration
Interface GigabitEthernet 0/4/15 set to default configuration
Interface TenGigabitEthernet 0/4/16 set to default configuration
Interface GigabitEthernet 0/4/17 set to default configuration

```

```

Router# configure terminal
Router(config)# platform hw-module configuration
Router(conf-plat-hw-conf)# hw-module 0/4 A900-IMA8CS1Z-M mode 8x1G+1x10G-FS
Interface configs would be defaulted before mode change followed by a soft reset of IM,
will take ~3min to complete initialization.
-----Do you wish to continue?-----? [yes]: y
Please wait ~3 mins before applying any configs on the IM
Interface GigabitEthernet 0/4/0 set to default configuration
Interface GigabitEthernet 0/4/1 set to default configuration
Interface GigabitEthernet 0/4/2 set to default configuration
Interface GigabitEthernet 0/4/3 set to default configuration
Interface GigabitEthernet 0/4/4 set to default configuration
Interface GigabitEthernet 0/4/5 set to default configuration
Interface GigabitEthernet 0/4/6 set to default configuration
Interface GigabitEthernet 0/4/7 set to default configuration
Interface GigabitEthernet 0/4/8 set to default configuration
Interface GigabitEthernet 0/4/9 set to default configuration
Interface GigabitEthernet 0/4/10 set to default configuration
Interface GigabitEthernet 0/4/11 set to default configuration
Interface GigabitEthernet 0/4/12 set to default configuration
Interface GigabitEthernet 0/4/13 set to default configuration
Interface GigabitEthernet 0/4/14 set to default configuration
Interface GigabitEthernet 0/4/15 set to default configuration
Interface TenGigabitEthernet 0/4/16 set to default configuration
Interface GigabitEthernet 0/4/17 set to default configuration
#

```

### 8-port 1GE + 1-port 10GE Full Subscription Mode Configuration:

```

Router# enable
Router#hw-module subslot 0/4 default
Proceed with setting all interfaces as default for the module? [confirm]%Setting all
interfaces in 0/4 to default state
Interface GigabitEthernet 0/4/0 set to default configuration
Interface GigabitEthernet 0/4/1 set to default configuration
Interface GigabitEthernet 0/4/2 set to default configuration
Interface GigabitEthernet 0/4/3 set to default configuration
Interface GigabitEthernet 0/4/4 set to default configuration
Interface GigabitEthernet 0/4/5 set to default configuration
Interface GigabitEthernet 0/4/6 set to default configuration
Interface GigabitEthernet 0/4/7 set to default configuration
Interface GigabitEthernet 0/4/8 set to default configuration
Interface GigabitEthernet 0/4/9 set to default configuration
Interface GigabitEthernet 0/4/10 set to default configuration
Interface GigabitEthernet 0/4/11 set to default configuration
Interface GigabitEthernet 0/4/12 set to default configuration
Interface GigabitEthernet 0/4/13 set to default configuration

```

## Example: Configuring Full Subscription Modes

```

Interface GigabitEthernet 0/4/14 set to default configuration
Interface GigabitEthernet 0/4/15 set to default configuration
Interface TenGigabitEthernet 0/4/16 set to default configuration
Interface GigabitEthernet 0/4/17 set to default configuration

Router# configure terminal
Router(config)# platform hw-module configuration
Router(conf-plat-hw-conf)# hw-module 0/4 A900-IMA8CS1Z-M mode 8x1G+1x1G-FS
Interface configs would be defaulted before mode change followed by a soft reset of IM,
will take ~3 min to complete initialization.
-----Do you wish to continue?-----? [yes]: y
Please wait ~3 mins before applying any configs on the IM
Interface GigabitEthernet 0/4/0 set to default configuration
Interface GigabitEthernet 0/4/1 set to default configuration
Interface GigabitEthernet 0/4/2 set to default configuration
Interface GigabitEthernet 0/4/3 set to default configuration
Interface GigabitEthernet 0/4/4 set to default configuration
Interface GigabitEthernet 0/4/5 set to default configuration
Interface GigabitEthernet 0/4/6 set to default configuration
Interface GigabitEthernet 0/4/7 set to default configuration
Interface GigabitEthernet 0/4/8 set to default configuration
Interface GigabitEthernet 0/4/9 set to default configuration
Interface GigabitEthernet 0/4/10 set to default configuration
Interface GigabitEthernet 0/4/11 set to default configuration
Interface GigabitEthernet 0/4/12 set to default configuration
Interface GigabitEthernet 0/4/13 set to default configuration
Interface GigabitEthernet 0/4/14 set to default configuration
Interface GigabitEthernet 0/4/15 set to default configuration
Interface TenGigabitEthernet 0/4/16 set to default configuration
Interface GigabitEthernet 0/4/17 set to default configuration

```

**8-port 1GE Full Subscription Mode Configuration:**

```

Router# enable
Router#hw-module subslot 0/4 default
Proceed with setting all interfaces as default for the module? [confirm]%Setting all
interfaces in 0/4 to default state
Interface GigabitEthernet 0/4/0 set to default configuration
Interface GigabitEthernet 0/4/1 set to default configuration
Interface GigabitEthernet 0/4/2 set to default configuration
Interface GigabitEthernet 0/4/3 set to default configuration
Interface GigabitEthernet 0/4/4 set to default configuration
Interface GigabitEthernet 0/4/5 set to default configuration
Interface GigabitEthernet 0/4/6 set to default configuration
Interface GigabitEthernet 0/4/7 set to default configuration
Interface GigabitEthernet 0/4/8 set to default configuration
Interface GigabitEthernet 0/4/9 set to default configuration
Interface GigabitEthernet 0/4/10 set to default configuration
Interface GigabitEthernet 0/4/11 set to default configuration
Interface GigabitEthernet 0/4/12 set to default configuration
Interface GigabitEthernet 0/4/13 set to default configuration
Interface GigabitEthernet 0/4/14 set to default configuration
Interface GigabitEthernet 0/4/15 set to default configuration
Interface TenGigabitEthernet 0/4/16 set to default configuration
Interface GigabitEthernet 0/4/17 set to default configuration

Router# configure terminal
Router(config)# platform hw-module configuration
Router(conf-plat-hw-conf)# hw-module 0/4 A900-IMA8CS1Z-M mode 8x1G-FS
Interface configs would be defaulted before mode change followed by a soft reset of IM,
will take ~3 min to complete initialization.
-----Do you wish to continue?-----? [yes]: y
Please wait ~3 mins before applying any configs on the IM
Interface GigabitEthernet 0/4/0 set to default configuration

```

```

Interface GigabitEthernet 0/4/1 set to default configuration
Interface GigabitEthernet 0/4/2 set to default configuration
Interface GigabitEthernet 0/4/3 set to default configuration
Interface GigabitEthernet 0/4/4 set to default configuration
Interface GigabitEthernet 0/4/5 set to default configuration
Interface GigabitEthernet 0/4/6 set to default configuration
Interface GigabitEthernet 0/4/7 set to default configuration
Interface GigabitEthernet 0/4/8 set to default configuration
Interface GigabitEthernet 0/4/9 set to default configuration
Interface GigabitEthernet 0/4/10 set to default configuration
Interface GigabitEthernet 0/4/11 set to default configuration
Interface GigabitEthernet 0/4/12 set to default configuration
Interface GigabitEthernet 0/4/13 set to default configuration
Interface GigabitEthernet 0/4/14 set to default configuration
Interface GigabitEthernet 0/4/15 set to default configuration
Interface TenGigabitEthernet 0/4/16 set to default configuration
Interface GigabitEthernet 0/4/17 set to default configuration
#

```

### 1-port 10GE Full Subscription Mode Configuration:

```

Router# enable
Router#hw-module subslot 0/4 default
Proceed with setting all interfaces as default for the module? [confirm]%Setting all
interfaces in 0/4 to default state
Interface GigabitEthernet 0/4/0 set to default configuration
Interface GigabitEthernet 0/4/1 set to default configuration
Interface GigabitEthernet 0/4/2 set to default configuration
Interface GigabitEthernet 0/4/3 set to default configuration
Interface GigabitEthernet 0/4/4 set to default configuration
Interface GigabitEthernet 0/4/5 set to default configuration
Interface GigabitEthernet 0/4/6 set to default configuration
Interface GigabitEthernet 0/4/7 set to default configuration
Interface GigabitEthernet 0/4/8 set to default configuration
Interface GigabitEthernet 0/4/9 set to default configuration
Interface GigabitEthernet 0/4/10 set to default configuration
Interface GigabitEthernet 0/4/11 set to default configuration
Interface GigabitEthernet 0/4/12 set to default configuration
Interface GigabitEthernet 0/4/13 set to default configuration
Interface GigabitEthernet 0/4/14 set to default configuration
Interface GigabitEthernet 0/4/15 set to default configuration
Interface TenGigabitEthernet 0/4/16 set to default configuration
Interface GigabitEthernet 0/4/17 set to default configuration

Router# configure terminal
Router(config)# platform hw-module configuration
Router(conf-plat-hw-conf)# hw-module 0/4 A900-IMA8CS1Z-M mode 1x10G-FS
Interface configs would be defaulted before mode change followed by a soft reset of IM,
will take ~3min to complete initialization.
-----Do you wish to continue?-----? [yes]: y
Please wait ~3 mins before applying any configs on the IM
Interface GigabitEthernet 0/4/0 set to default configuration
Interface GigabitEthernet 0/4/1 set to default configuration
Interface GigabitEthernet 0/4/2 set to default configuration
Interface GigabitEthernet 0/4/3 set to default configuration
Interface GigabitEthernet 0/4/4 set to default configuration
Interface GigabitEthernet 0/4/5 set to default configuration
Interface GigabitEthernet 0/4/6 set to default configuration
Interface GigabitEthernet 0/4/7 set to default configuration
Interface GigabitEthernet 0/4/8 set to default configuration
Interface GigabitEthernet 0/4/9 set to default configuration
Interface GigabitEthernet 0/4/10 set to default configuration
Interface GigabitEthernet 0/4/11 set to default configuration
Interface GigabitEthernet 0/4/12 set to default configuration

```

## Example: Configuring Over Subscription Modes

```

Interface GigabitEthernet 0/4/13 set to default configuration
Interface GigabitEthernet 0/4/14 set to default configuration
Interface GigabitEthernet 0/4/15 set to default configuration
Interface TenGigabitEthernet 0/4/16 set to default configuration
Interface GigabitEthernet 0/4/17 set to default configuration
#

```

## Example: Configuring Over Subscription Modes

The following are the examples to configure different modes of over subscription.

### 16-port 1GE + 1-port 10GE Over Subscription Mode Configuration:

```

Router# enable
Router#hw-module subslot 0/4 default
Proceed with setting all interfaces as default for the module? [confirm]%Setting all
interfaces in 0/4 to default state
Interface GigabitEthernet 0/4/0 set to default configuration
Interface GigabitEthernet 0/4/1 set to default configuration
Interface GigabitEthernet 0/4/2 set to default configuration
Interface GigabitEthernet 0/4/3 set to default configuration
Interface GigabitEthernet 0/4/4 set to default configuration
Interface GigabitEthernet 0/4/5 set to default configuration
Interface GigabitEthernet 0/4/6 set to default configuration
Interface GigabitEthernet 0/4/7 set to default configuration
Interface GigabitEthernet 0/4/8 set to default configuration
Interface GigabitEthernet 0/4/9 set to default configuration
Interface GigabitEthernet 0/4/10 set to default configuration
Interface GigabitEthernet 0/4/11 set to default configuration
Interface GigabitEthernet 0/4/12 set to default configuration
Interface GigabitEthernet 0/4/13 set to default configuration
Interface GigabitEthernet 0/4/14 set to default configuration
Interface GigabitEthernet 0/4/15 set to default configuration
Interface TenGigabitEthernet 0/4/16 set to default configuration
Interface GigabitEthernet 0/4/17 set to default configuration

Router# configure terminal
Router(config)# platform hw-module configuration
Router(conf-plat-hw-conf)# hw-module 0/4 A900-IMA8CS1Z-M mode 16x1G+1x10G-OS
Interface configs would be defaulted before mode change followed by a soft reset of IM,
will take ~3 min to complete initialization.
-----Do you wish to continue?-----? [yes]: y
Please wait ~3 mins before applying any configs on the IM
Interface GigabitEthernet 0/4/0 set to default configuration
Interface GigabitEthernet 0/4/1 set to default configuration
Interface GigabitEthernet 0/4/2 set to default configuration
Interface GigabitEthernet 0/4/3 set to default configuration
Interface GigabitEthernet 0/4/4 set to default configuration
Interface GigabitEthernet 0/4/5 set to default configuration
Interface GigabitEthernet 0/4/6 set to default configuration
Interface GigabitEthernet 0/4/7 set to default configuration
Interface GigabitEthernet 0/4/8 set to default configuration
Interface GigabitEthernet 0/4/9 set to default configuration
Interface GigabitEthernet 0/4/10 set to default configuration
Interface GigabitEthernet 0/4/11 set to default configuration
Interface GigabitEthernet 0/4/12 set to default configuration
Interface GigabitEthernet 0/4/13 set to default configuration
Interface GigabitEthernet 0/4/14 set to default configuration
Interface GigabitEthernet 0/4/15 set to default configuration
Interface TenGigabitEthernet 0/4/16 set to default configuration
Interface GigabitEthernet 0/4/17 set to default configuration

```



#

**18-port 1GE Over Subscription Mode Configuration:**

```

Router# enable
Router#hw-module subslot 0/4 default
Proceed with setting all interfaces as default for the module? [confirm]%Setting all
interfaces in 0/4 to default state
Interface GigabitEthernet 0/4/0 set to default configuration
Interface GigabitEthernet 0/4/1 set to default configuration
Interface GigabitEthernet 0/4/2 set to default configuration
Interface GigabitEthernet 0/4/3 set to default configuration
Interface GigabitEthernet 0/4/4 set to default configuration
Interface GigabitEthernet 0/4/5 set to default configuration
Interface GigabitEthernet 0/4/6 set to default configuration
Interface GigabitEthernet 0/4/7 set to default configuration
Interface GigabitEthernet 0/4/8 set to default configuration
Interface GigabitEthernet 0/4/9 set to default configuration
Interface GigabitEthernet 0/4/10 set to default configuration
Interface GigabitEthernet 0/4/11 set to default configuration
Interface GigabitEthernet 0/4/12 set to default configuration
Interface GigabitEthernet 0/4/13 set to default configuration
Interface GigabitEthernet 0/4/14 set to default configuration
Interface GigabitEthernet 0/4/15 set to default configuration
Interface TenGigabitEthernet 0/4/16 set to default configuration
Interface GigabitEthernet 0/4/17 set to default configuration

Router# configure terminal
Router(config)# platform hw-module configuration
Router(config-plat-hw-conf)# hw-module 0/4 A900-IMA8CS1Z-M mode 18x1G-OS
Interface configs would be defaulted before mode change followed by a soft reset of IM,
will take ~3 min to complete initialization.
-----Do you wish to continue?-----? [yes]: y
Please wait ~3 mins before applying any configs on the IM
Interface GigabitEthernet 0/4/0 set to default configuration
Interface GigabitEthernet 0/4/1 set to default configuration
Interface GigabitEthernet 0/4/2 set to default configuration
Interface GigabitEthernet 0/4/3 set to default configuration
Interface GigabitEthernet 0/4/4 set to default configuration
Interface GigabitEthernet 0/4/5 set to default configuration
Interface GigabitEthernet 0/4/6 set to default configuration
Interface GigabitEthernet 0/4/7 set to default configuration
Interface GigabitEthernet 0/4/8 set to default configuration
Interface GigabitEthernet 0/4/9 set to default configuration
Interface GigabitEthernet 0/4/10 set to default configuration
Interface GigabitEthernet 0/4/11 set to default configuration
Interface GigabitEthernet 0/4/12 set to default configuration
Interface GigabitEthernet 0/4/13 set to default configuration
Interface GigabitEthernet 0/4/14 set to default configuration
Interface GigabitEthernet 0/4/15 set to default configuration
Interface TenGigabitEthernet 0/4/16 set to default configuration
Interface GigabitEthernet 0/4/17 set to default configuration
#

```

**16-port 1GE Over Subscription Mode Configuration:**

```

Router# enable
Router#hw-module subslot 0/4 default
Proceed with setting all interfaces as default for the module? [confirm]%Setting all
interfaces in 0/4 to default state
Interface GigabitEthernet 0/4/0 set to default configuration
Interface GigabitEthernet 0/4/1 set to default configuration

```

## Example: Configuring Egress Classification

```

Interface GigabitEthernet 0/4/2 set to default configuration
Interface GigabitEthernet 0/4/3 set to default configuration
Interface GigabitEthernet 0/4/4 set to default configuration
Interface GigabitEthernet 0/4/5 set to default configuration
Interface GigabitEthernet 0/4/6 set to default configuration
Interface GigabitEthernet 0/4/7 set to default configuration
Interface GigabitEthernet 0/4/8 set to default configuration
Interface GigabitEthernet 0/4/9 set to default configuration
Interface GigabitEthernet 0/4/10 set to default configuration
Interface GigabitEthernet 0/4/11 set to default configuration
Interface GigabitEthernet 0/4/12 set to default configuration
Interface GigabitEthernet 0/4/13 set to default configuration
Interface GigabitEthernet 0/4/14 set to default configuration
Interface GigabitEthernet 0/4/15 set to default configuration
Interface TenGigabitEthernet 0/4/16 set to default configuration
Interface GigabitEthernet 0/4/17 set to default configuration

Router# configure terminal
Router(config)#platform hw-module configuration
Router(conf-plat-hw-conf)# hw-module 0/4 A900-IMA8CS1Z-M mode 16x1G-OS
Interface configs would be defaulted before mode change followed by a soft reset of IM,
will take ~3 min to complete initialization.
-----Do you wish to continue?-----? [yes]: y
Please wait ~3 mins before applying any configs on the IM
Interface GigabitEthernet 0/4/0 set to default configuration
Interface GigabitEthernet 0/4/1 set to default configuration
Interface GigabitEthernet 0/4/2 set to default configuration
Interface GigabitEthernet 0/4/3 set to default configuration
Interface GigabitEthernet 0/4/4 set to default configuration
Interface GigabitEthernet 0/4/5 set to default configuration
Interface GigabitEthernet 0/4/6 set to default configuration
Interface GigabitEthernet 0/4/7 set to default configuration
Interface GigabitEthernet 0/4/8 set to default configuration
Interface GigabitEthernet 0/4/9 set to default configuration
Interface GigabitEthernet 0/4/10 set to default configuration
Interface GigabitEthernet 0/4/11 set to default configuration
Interface GigabitEthernet 0/4/12 set to default configuration
Interface GigabitEthernet 0/4/13 set to default configuration
Interface GigabitEthernet 0/4/14 set to default configuration
Interface GigabitEthernet 0/4/15 set to default configuration
Interface TenGigabitEthernet 0/4/16 set to default configuration
Interface GigabitEthernet 0/4/17 set to default configuration
#

```

## Example: Configuring Egress Classification



**Note** PFC (priority-based flow-control) and egress classification are enabled by default.

The following configuration shows how to modify an egress classification:

```

int gi 0/15/8
flowcontrol egress classify all threshold 7

flowcontrol egress classify ?
    all    classify based on L2-CoS, MPLS-EXP and L3-DSCP
    l2     classify based on L2-CoS
    l3     classify based on L3-DSCP precedence bits
    mpls   classify based on MPLS-EXP

```

```
qos-overhead-accounting enable gigabitEthernet 0/15/1
qos-overhead-accounting positive 4
```

## Verifying PFC

Use the `show platform hardware pp active bshell` command to verify the PFC (priority-based flow-control).

```
show platform hardware pp active bshell "show counters full"
T_127.xl7 : 1,410,242,436 +2,365
903/sTPOK.xl7 : 1,410,242,436 +2,365
903/sTPKT.xl7 : 1,410,242,436 +2,365
903/sTUCA.xl7 : 1,410,242,436 +2,365
903/sTBYT.xl7 : 95,896,485,648 +160,820
61,375/sR_64.xe134 : 390,320 +786
299/sRPKT.xe134 : 916,242 +786
299/sRXCF.xe134 : 390,320 +786
299/sRXPP.xe134 : 390,320 +786
299/sRPFC_0.xe134 : 362,115 +786
299/sRPFC_1.xe134 : 362,925 +786
299/sRPFC_2.xe134 : 361,555 +786
299/sRPFC_3.xe134 : 362,454 +786
299/sRPFC_4.xe134 : 363,298 +786
299/sRPFC_5.xe134 : 361,532 +786
299/sRPFC_6.xe134 : 362,606 +786
299/sRPFC_7.xe134 : 362,034 +786
299/sRBYT.xe134 : 100,972,834 +50,304
```

## Verifying Configuration

Use the `show platform hw-configuration` command to verify the operating modes configured on the interface module.

```
Router#show platform hw-configuration
Slot  Cfg IM Type          Actual IM Type      Op State           Ad State Op Mode
-----
0/0   -                    -                   Empty              N/A         -
0/1   A900-IMA8CS1Z-M      A900-IMA8CS1Z-M    IS-NR              IS          16x1G-OS
0/2   A900-IMA8CS1Z-M      A900-IMA8CS1Z-M    IS-NR              IS          18x1G-OS
0/3   A900-IMA8CS1Z-M      A900-IMA8CS1Z-M    IS-NR              IS          16x1G+1x10G
0/4   -                    -                   Empty              N/A         -
0/5   A900-IMA8CS1Z-M      A900-IMA8CS1Z-M    IS-NR              IS          18x1G-OS
0/6   A900-IMA8CS1Z-M      A900-IMA8CS1Z-M    IS-NR              IS          16x1G-OS
0/7   -                    -                   Empty              N/A         -
0/8   -                    -                   Empty              N/A         -
0/9   -                    -                   Empty              N/A         -
0/10  A900-IMA8CS1Z-M      A900-IMA8CS1Z-M    IS-NR              IS          16x1G+1x10G-OS
0/11  -                    -                   Empty              N/A         -
```

0/12	-	-	Empty	N/A	-
0/13	A900-IMA8CS1Z-M	A900-IMA8CS1Z-M	IS-NR	IS	16x1G+1x10G-OS
0/14	A900-IMA8CS1Z-M	A900-IMA8CS1Z-M	IS-NR	IS	16x1G+1x10G-OS
0/15	A900-IMA8CS1Z-M	A900-IMA8CS1Z-M	IS-NR	IS	16x1G+1x10G-OS

## Verifying High Priority and Low Priority Counters Configuration

Use **show platform software agent iomd [IM module] fpga dump [port number]** to display the packets of High Priority and Low Priority traffic queue in Over Subscription mode.

```
#show platform software agent iomd 0/8 fpga dump 4
OS LP Drop Q Pkt Cnt :0x0
OS HP Drop Q Pkt Cnt :0x0
OS LP Q Pkt Cnt :0x22906bd0
OS HP Q Pkt Cnt :0x55fdd731
```

Use **show platform software agent iomd [IM module] fpga clear [port number]** to clear High Priority and Low Priority counters in Over Subscription mode.

```
#show platform software agent iomd 0/8 fpga clear 4
OS LP Drop Q Pkt Cnt :0x0
OS HP Drop Q Pkt Cnt :0x0
OS LP Q Pkt Cnt :0x0
OS HP Q Pkt Cnt :0x0
```

## Configuring Bandwidth Mode

To configure bandwidth mode:

```
enable
configure terminal
platform hw-module configuration
bandwidth 0/0 8-gbps
end
```

## Verifying Bandwidth Mode Configuration

Use **show platform hw-configuration** command to verify bandwidth mode configuration.

```
#show platform hw-configuration
Slot  Cfg IM Type          Actual IM Type          Op State          Ad State Op Mode          BW
-----
0/0   -                      -                      Empty            N/A      -
0/1   A900-IMA8CS1Z-M        A900-IMA8CS1Z-M        IS-NR            IS       16x1G-OS
0/2   A900-IMA8CS1Z-M        A900-IMA8CS1Z-M        IS-NR            IS       18x1G-OS
0/3   A900-IMA8CS1Z-M        A900-IMA8CS1Z-M        IS-NR            IS       16x1G+1x10G
0/4   -                      -                      Empty            N/A      -
0/5   A900-IMA8CS1Z-M        A900-IMA8CS1Z-M        IS-NR            IS       18x1G-OS
20-gbps
0/6   A900-IMA8CS1Z-M        A900-IMA8CS1Z-M        IS-NR            IS       16x1G-OS
0/7   -                      -                      Empty            N/A      -
0/8   -                      -                      Empty            N/A      -
0/9   -                      -                      Empty            N/A      -
```

0/10	A900-IMA8CS1Z-M	A900-IMA8CS1Z-M	IS-NR	IS	16x1G+1x10G-OS
0/11	-	-	Empty	N/A	-
0/12	-	-	Empty	N/A	-
0/13	A900-IMA8CS1Z-M	A900-IMA8CS1Z-M	IS-NR	IS	16x1G+1x10G-OS
0/14	A900-IMA8CS1Z-M	A900-IMA8CS1Z-M	IS-NR	IS	16x1G+1x10G-OS
0/15	A900-IMA8CS1Z-M	A900-IMA8CS1Z-M	IS-NR	IS	16x1G+1x10G-OS

#

## Interface Module Rules

### ASR 903 Routers or Cisco RSP3C-400-S Rules for A900-IMA8CS1Z

Slot Number	Supported IM Operating Modes	Restrictions
0	<ul style="list-style-type: none"> <li>8-port 1GE (SFP) + 1-port 10GE (SFP+) Fully subscribed</li> <li>16 x 1GigE (CSFP) + 1 x 10GigE (SFP+) Fully subscribed</li> <li>18-port 1GE Fully subscribed</li> </ul>	The IM cannot be in slot 0 if IMA1C is in slot 4
1	Not Supported	—
2	Not Supported	—
3	<ul style="list-style-type: none"> <li>8-port 1GE (SFP) + 1-port 10GE (SFP+) Fully subscribed</li> <li>16-port 1GE (CSFP) + 1 x 10GE (SFP+) Fully subscribed</li> <li>18-port 1GE Fully subscribed</li> </ul>	—
4	<ul style="list-style-type: none"> <li>8-port 1GE (SFP) + 1-port 10GE (SFP+) Fully subscribed</li> <li>16-port 1GE (CSFP) + 1-port 10GE (SFP+) Fully subscribed</li> <li>18-port 1GE Fully subscribed</li> </ul>	—

Slot Number	Supported IM Operating Modes	Restrictions
5	<ul style="list-style-type: none"> <li>• 8-port 1GE (SFP) + 1-port 10GE (SFP+) Fully subscribed</li> <li>• 16-port 1GE (CSFP) + 1-port 10GE (SFP+) Fully subscribed</li> <li>• 18-port 1GE Fully subscribed</li> </ul>	—

#### ASR 907 Routers or Cisco RSP3C (Port Expansion Mode) Rules for A900-IMA8CS1Z



#### Note

- If IMA8S, IMA8T, IMA8S1Z, and IMA8T1Z are in any slot, SADT cannot be configured.
- If the IMA8CS1Z interface module is not present in a slot, mode update through hw sub-slot mode is not allowed. The existing mode configuration applies to the interface module that is reinserted, and you can subsequently update the mode.

Slot Number	Supported IM Operating Modes	Restrictions
0	Not supported	—
1	Not supported	—
2	<ul style="list-style-type: none"> <li>• 8-port 1GE (SFP) Fully subscribed</li> <li>• 16-port 1GE (CSFP) Oversubscribed</li> <li>• 18-port 1GE (CSFP) Oversubscribed</li> <li>• 8-port 1GE + 1-port 1GE Fully subscribed</li> <li>• 1-port 10GE Fully subscribed</li> </ul>	For Slot 2 in 8-port 1GE Fully Subscribed or 16-port/18-port 1GE Oversubscribed mode or 8-port 1GE + 1-port 1GE Fully subscribed mode or 1-port 10GE Fully subscribed mode, IMA8Z or IMA2F cannot be in slot 4.
3	All modes are supported	If IMA8Z or IMA2F is present in slot 3, the IM cannot be used in slots 5, 9, 13 and 15.
4	All modes are supported	If IMA8Z or IMA2F is present in slot 4, the IM cannot be used in slots 2, 6, 10 and 14.

Slot Number	Supported IM Operating Modes	Restrictions
5	<ul style="list-style-type: none"> <li>• 8-port 1GE (SFP) Fully subscribed</li> <li>• 16-port 1GE (CSFP) Oversubscribed</li> <li>• 18-port 1GE (CSFP) Oversubscribed</li> <li>• 8-port 1GE + 1-port 1GE Fully subscribed</li> <li>• 1-port 10G Fully subscribed</li> </ul>	If IMA8Z or IMA2F is present in slot 3, the IM cannot be used in slots 5, 9, 13 and 15.
6	<ul style="list-style-type: none"> <li>• 8-port 1GE (SFP) Fully subscribed</li> <li>• 16-port 1GE (CSFP) Oversubscribed</li> <li>• 18-port 1GE (CSFP) Oversubscribed</li> <li>• 8-port 1GE + 1-port 1GE Fully subscribed</li> <li>• 1-port 10G Fully subscribed</li> </ul>	If IMA8Z or IMA2F is present in slot 4, the IM cannot be used in slots 2, 6, 10 and 14.
7	All modes are supported	—
8	All modes are supported	—
9	<ul style="list-style-type: none"> <li>• 8-port 1GE (SFP) Fully subscribed</li> <li>• 16-port 1GE (CSFP) Oversubscribed</li> <li>• 18-port 1GE (CSFP) Oversubscribed</li> <li>• 8-port 1GE + 1-port 1GE Fully subscribed</li> <li>• 1-port 10G Fully subscribed</li> </ul>	If IMA8Z or IMA2F is present in slot 3, the IM cannot be used in slots 5, 9, 13 and 15.

Slot Number	Supported IM Operating Modes	Restrictions
10	<ul style="list-style-type: none"> <li>• 8-port 1GE (SFP) Fully subscribed</li> <li>• 16-port 1GE (CSFP) Oversubscribed</li> <li>• 18-port 1GE (CSFP) Oversubscribed</li> <li>• 8-port 1GE + 1-port 1GE Fully subscribed</li> <li>• 1-port 10G Fully subscribed</li> </ul>	If IMA8Z or IMA2F is present in slot 4, the IM cannot be used in slots 2, 6, 10 and 14.
11	All modes are supported	If the IM is in slot 11, IMA8S, IMA8T, IMA8S1Z, and IMA8T1Z cannot be used in slots 1, 5, 9, 13 and 15.
12	All modes are supported	If the IM is in slot 12, IMA8S, IMA8T, IMA8S1Z, and IMA8T1Z cannot be used in slots 0, 2, 6, 10 and 14.
13	<ul style="list-style-type: none"> <li>• 8-port 1GE (SFP) Fully subscribed</li> <li>• 16-port 1GE (CSFP) Oversubscribed</li> <li>• 18-port 1GE (CSFP) Oversubscribed</li> <li>• 8-port 1GE + 1-port 1GE Fully subscribed</li> <li>• 1-port 10G Fully subscribed</li> </ul>	If IMA8Z or IMA2F is present in slot 3, the IM cannot be used in slots 5, 9, 13 and 15.
14	<ul style="list-style-type: none"> <li>• 8-port 1GE (SFP) Fully subscribed</li> <li>• 16-port 1GE (CSFP) Oversubscribed</li> <li>• 18-port 1GE (CSFP) Oversubscribed</li> <li>• 8-port 1GE + 1-port 1GE Fully subscribed</li> <li>• 1-port 10G Fully subscribed</li> </ul>	If IMA8Z or IMA2F is present in slot 4, the IM cannot be used in slots 2, 6, 10 and 14.



Slot Number	Supported IM Operating Modes	Restrictions
15	<ul style="list-style-type: none"> <li>• 8-port 1GE (SFP) Fully subscribed</li> <li>• 16-port 1GE (CSFP) Oversubscribed</li> <li>• 18-port 1GE (CSFP) Oversubscribed</li> <li>• 8-port 1GE + 1-port 1GE Fully subscribed</li> <li>• 1-port 10G Fully subscribed</li> </ul>	If IMA8Z or IMA2F is present in slot 3, the IM cannot be used in slots 5, 9, 13 and 15.

**ASR 907 Routers or Cisco RSP3C (XFI-Pass Through Mode) for A900-IMA8CS1Z**



**Note** IMA8S, IMA8T, IMA8S1Z, and IMA8T1Z cannot be used in any slot.

Slot Number	Supported IM Operating Modes	Restrictions
0	<ul style="list-style-type: none"> <li>• 8-port 1GE (SFP) Fully subscribed</li> <li>• 16-port 1GE (CSFP) Oversubscribed</li> <li>• 18-port 1GE (CSFP) Oversubscribed</li> <li>• 8-port 1GE + 1-port 1GE Fully subscribed</li> </ul>	<ul style="list-style-type: none"> <li>• If the IM is in slot 0 in 8-port 1GE Fully subscribed mode or in 16-port/18-port 1GE Oversubscribed mode or 8-port 1GE + 1-port 1GE Fully subscribed mode, the IM in Slot 12 can only be in 8-port 1GE (SFP) Fully subscribed mode or in 16-port/18-port 1GE (CSFP) Oversubscribed mode or 8-port 1GE + 1-port 1GE Fully subscribed mode, 1-port 10GE Fully subscribed mode.</li> <li>• If Slot 0 is in 8-port 1G Fully subscribed mode or 16-port/18-port 1GE, or 16-port/18-port 1G Over subscribed or 1-port 10G Fully subscribed mode or 8-port 1G + 1-port 1G Fully subscribed mode.</li> <li>• If Slot 0 is in 8-port 1G Fully subscribed mode or 16-port/18-port 1GE Oversubscribed mode or 8-port 1GE + 1-port 1GE Fully subscribed mode, then IMA8Z or IMA2F cannot be in slot 12.</li> </ul>
1	<ul style="list-style-type: none"> <li>• 8-port 1GE (SFP) Fully subscribed</li> <li>• 16-port 1GE (CSFP) Oversubscribed</li> <li>• 18-port 1GE (CSFP) Oversubscribed</li> <li>• 8-port 1GE + 1-port 1GE Fully subscribed</li> </ul>	<ul style="list-style-type: none"> <li>• If Slot 1 is in 8-port 1G Fully subscribed or 16-port/18-port 1GE Oversubscribed mode or 8-port 1GE + 1-port 1GE Fully subscribed mode, the IMA8Z or IMA2F or IMA2Z cannot be in slot 11.</li> </ul>

Slot Number	Supported IM Operating Modes	Restrictions
2	<ul style="list-style-type: none"> <li>• 8-port 1GE (SFP) + 1-port 10GE (SFP+) Fully subscribed</li> <li>• 16-port 1GE (CSFP) + 1-port 10GE (SFP+) Oversubscribed</li> <li>• 16-port/18-port 1GE (CSFP) Oversubscribed</li> <li>• 8-port 1GE + 1-port 1GE Fully subscribed</li> <li>• 1-port 10G Fully subscribed</li> <li>• 8-port 1GE Fully subscribed</li> </ul>	<ul style="list-style-type: none"> <li>• If Slot 2 is in 8-port 1G + 1-port 10G Fully subscribed mode, or 16-port 1G + 1-port 10G Over subscribed mode, then no IM can be present in slot 12.</li> <li>• If Slot 2 is in 8-port 1G + 1-port 10G Fully subscribed mode, or 16-port 1G + 1-port 10G Over subscribed mode, then IMA8Z or IMA2F cannot be in slot 4.</li> </ul>
3	All modes are supported.	<ul style="list-style-type: none"> <li>• If IMA8Z or IMA2F is in slot 3, then the IM is not supported on slots 5, 9, 13, and 15.</li> <li>• If Slot 3 has IMA8Z or IMA2F, then no IM can be present in slots 5, 9, 13, and 15.</li> </ul>
4	All modes are supported.	<ul style="list-style-type: none"> <li>• If IMA8Z or IMA2F is in slot 4, then the IM is not supported in slots 2, 6, 10, and 14.</li> <li>• If Slot 4 has IMA8Z or IMA2F, then no IM can be present in slots 2, 6, 10, and 14.</li> </ul>
5	<ul style="list-style-type: none"> <li>• 8-port 1GE (SFP) + 1-port 10GE (SFP+) Fully subscribed</li> <li>• 16-port 1GE (CSFP) + 1-port 10GE (SFP+) Oversubscribed</li> <li>• 16-port 1GE (CSFP) Oversubscribed</li> <li>• 18-port 1GE (CSFP) Over subscribed</li> <li>• 8-port 1GE + 1-port 1GE Fully subscribed</li> <li>• 1-port 10GE Fully subscribed</li> <li>• 8-port 1GE Fully subscribed</li> </ul>	<ul style="list-style-type: none"> <li>• If the IM is in slot 5 in 8-port 1GE + 1-port 10GE Fully subscribed mode or in 16-port 1GE + 1-port 10GE Oversubscribed mode, the the IM in slot 11 can only be in 8-port 1GE Fully subscribed mode or in 16-port/18-port 1GE (CSFP) Oversubscribed mode or 8-port 1GE + 1-port 1GE Fully subscribed mode, or 1-port 10 GE Fully subscribed mode.</li> <li>• If Slot 5 is in 8-port 1G + 1-port 10G Fully subscribed, or 16-port 1G + 1-port 10G Over subscribed mode, then IMA8Z or IMA2F cannot be in slot 3.</li> </ul>

Slot Number	Supported IM Operating Modes	Restrictions
6	<ul style="list-style-type: none"> <li>• 8-port 1GE (SFP) Fully subscribed mode</li> <li>• 16-port 1GE (CSFP) Oversubscribed</li> <li>• 18-port 1GE (CSFP) Oversubscribed</li> <li>• 8-port 1GE + 1-port 1GE Fully subscribed</li> <li>• 1-port 10 GE Fully subscribed</li> </ul>	<ul style="list-style-type: none"> <li>• If Slot 6 is in 8-port 1GE fully subscribed, or 16-port 1GE Over subscribed, or 18-port 1GE Over subscribed or 8-port 1GE + 1-port 1GE fully subscribed or 1-port 10GE Fully subscribed mode, then IMA8Z or IMA2F cannot be in slot 4.</li> </ul>
7	All modes are supported	—
8	All modes are supported	—
9	<ul style="list-style-type: none"> <li>• 8-port 1GE (SFP) Fully subscribed</li> <li>• 16-port/18-port 1GE (CSFP) Oversubscribed</li> <li>• 16-port 1GE (CSFP) Oversubscribed</li> <li>• 8-port 1GE + 1-port 1GE Fully subscribed</li> <li>• 1-port 10 GE Fully subscribed</li> </ul>	If Slot 9 is in 8-port 1GE fully subscribed, or 16-port 1GE Over subscribed mode, or 18-port 1GE Over subscribed mode or 8-port 1GE + 1-port 1GE fully subscribed or 1-port 10GE Fully subscribed mode, then IMA8Z or IMA2F cannot be in slot 3.
10	<ul style="list-style-type: none"> <li>• 8-port 1GE (SFP) + 1-port 10GE (SFP+) Fully subscribed</li> <li>• 16-port 1GE (CSFP) + 1-port 10GE (SFP+) Oversubscribed</li> <li>• 16-port/18-port 1GE (CSFP) Oversubscribed</li> <li>• 8-port 1GE+1-port 1GE Fully subscribed</li> <li>• 1-port 10 GE Fully subscribed</li> <li>• 8-port 1G Fully subscribed</li> </ul>	<ul style="list-style-type: none"> <li>• If Slot 10 and 14 are in 8-port 1GE + 1-port 10GE Fully subscribed, or 16-port 1GE + 1-port 10GE Over subscribed mode, then IMA8Z IMA2F cannot be in Slot 4.</li> </ul>

Slot Number	Supported IM Operating Modes	Restrictions
11	All modes are supported	<ul style="list-style-type: none"> <li>• IM can be in slot 11, only in 8-port 1GE (SFP) Fully subscribed mode, or in 16-port/18-port 1GE (CSFP) Oversubscribed mode or 8-port 1GE + 1-port 1GE Fully subscribed mode, or 1-port 10 GE Fully subscribed mode if IPSEC is used (FLSASR907-IPSEC).</li> <li>• If the IM is slot 11, and in 8-port 1GE + 1 x 10GigE Fully subscribed mode, or in 16-port 1GE + 1-port 10GE Oversubscribed mode, then the IM in Slots 5 and 15 can only be in 8-port 1GE (SFP) Fully subscribed mode, or in 16-port/18-port 1GE (CSFP) Oversubscribed mode or 8-port 1GE +1-port 1GE Fully subscribed or 1-port 10GE Fully subscribed mode.</li> <li>• If the IM is in slot 11, and in 8-port 1GE Fully subscribed mode, or in 16-port 1GE Oversubscribed mode, or in 18-port 1GE Oversubscribed mode or in 8-port 1GE + 1-port 1GE Fully subscribed or 1-port 10GE Fully subscribed, then the IM in Slot 15 can only be in 8-port 1GE (SFP) Fully subscribed mode, OR in 16-port/18-port 1GE (CSFP) Oversubscribed mode or 1-port 10GE Fully subscribed mode or 8-port 1GE + 1-port 1GE Fully subscribed mode.</li> <li>• IF IMA2Z is in slot 11, then the IM is in slot 15 only in 8-port 1GE (SFP) Fully subscribed mode, OR in 16-port/18-port 1GE (CSFP) Oversubscribed mode or 8-port 1GE + 1-port 1GE Fully subscribed mode or 1-port 10GE Fully subscribed mode, and no IM can be present in slot 1.</li> <li>• If IMA8Z or IMA2Fis in slot 11, then the IM is in slots 5, 13 and 15 in 8-port 1GE Fully Subscribed, or in 16-port/18-port 1GE Oversubscribed mode or 8-port 1GE + 1-port 1GE Fully subscribed mode or 1-port 10GE Fully subscribed mode, and no IM can be present in slot 1.</li> </ul>

Slot Number	Supported IM Operating Modes	Restrictions
12	All modes are supported	<ul style="list-style-type: none"> <li>• If the IM is in slot 12, and in 8-port 1GE + 1-port 10GE Fully subscribed mode, or in 16-port 1GE + 1-port 10GE Oversubscribed mode, then no IM can be present in Slot 0, and the IM in Slot 2 can only be in 8-port 1GE (SFP) Fully subscribed mode, OR in 16-port/18-port 1GE (CSFP) Oversubscribed mode or 8-port 1GE + 1-port 1GE Fully subscribed mode or 1-port 10GE Fully subscribed mode.</li> <li>• If the IM is in slot 12 and in 8-port 1GE Fully subscribed mode or in 16-port 1GE Oversubscribed mode, or in 18-port 1GE Oversubscribed mode or 8-port 1GE + 1-port 1GE Fully subscribed mode or 1-port 10GE Fully subscribed mode, then the IM in Slot 2 can only be in 8-port 1GE (SFP) Fully subscribed mode, OR in 16-port/18-port 1GE (CSFP) Oversubscribed mode or 8-port 1GE + 1-port 1GE Fully subscribed mode or 1-port 10GE Fully subscribed mode.</li> <li>• IF IMA2Z is in slot 12, then the IM is in slots 2 and 10 in 8-port 1GE (SFP) Fully subscribed mode, or in 16-port/18-port 1GE (CSFP) Oversubscribed mode or 8-port 1GE + 1-port 1GE Fully subscribed mode or 1-port 10GE Fully subscribed mode.</li> <li>• If Slot 12 has IMA2Z, then slots 2 and 10 in 8-port 1GE Fully subscribed mode, or 16-port/18-port 1GE Over subscribed mode or 1-port 10GE Fully subscribed mode or 8-port 1G + 1-port 1GE Fully subscribed mode.</li> <li>• If IMA8Z OR IMA2F is in slot 12, then the IM in slots 2, 10 and 14 in 8-port 1GE Fully Subscribed, or in 16-port/18-port 1GE Oversubscribed mode and 1-port 10GE Fully subscribed mode or 8-port 1GE + 1-port 1GE Fully subscribed mode, and no IM can be present from Slot 1 to Slot 0.</li> </ul>

Slot Number	Supported IM Operating Modes	Restrictions
13	<ul style="list-style-type: none"> <li>• 8-port 1GE (SFP) + 1-port 10GE (SFP+) Fully subscribed</li> <li>• 16-port 1GE (CSFP) + 1-port 10GE (SFP+) Oversubscribed</li> <li>• 16-port/18-port 1GE (CSFP) Oversubscribed</li> <li>• 8-port 1GE + 1-port 1GE Fully subscribed</li> <li>• 1-port 10 GE Fully subscribed</li> <li>• 8-port 1G Fully subscribed</li> </ul>	<ul style="list-style-type: none"> <li>• If IPSEC is used (FLSASR907-IPSEC) then the IM can be in slot 13, only in 8-port 1GE (SFP) Fully subscribed mode, or in 16-port/18-port 1GE (CSFP) Oversubscribed mode.</li> <li>• If the IM in slot 13 is configured in 8-port 1GE (SFP) + 1-port 10GE (SFP+) Fully subscribed mode, or in 16-port 1GE (CSFP) + 1-port 10GE (SFP+) Oversubscribed mode, or Fully Subscribed mode, then IPSEC cannot be configured.</li> </ul> <p>If Slot 13 is in 8-port 1GE + 1-port 10GE Fully subscribed mode, or 16-port 1GE + 1-port 10GE Over subscribed mode, then IMA8Z or IMA2F cannot be in slot 3.</p>
14	<ul style="list-style-type: none"> <li>• 8-port 1GE (SFP) + 1-port 10GE (SFP+) Fully subscribed</li> <li>• 16-port 1GE (CSFP) + 1-port 10GE (SFP+) Oversubscribed</li> <li>• 16-port/18-port 1GE (CSFP) Oversubscribed</li> <li>• 8-port 1GE + 1-port 1GE Fully subscribed</li> <li>• 1-port 10 GE Fully subscribed</li> <li>• 8-port 1GE Fully subscribed</li> </ul>	<ul style="list-style-type: none"> <li>• If 10G Y.1564/SADT is used, then the IM can be in slot 14 only in 8-port 1GE (SFP) Fully subscribed mode, or in 16-port/18-port 1GE (CSFP) Oversubscribed mode, or 8-port 1GE + 1-port 1GE Fully subscribed mode, or 1-port 10GE Fully subscribed mode.</li> <li>• If Slot 14 is in 8-port 1GE + 1-port 10GE Fully subscribed mode or 16-port 1GE + 1-port 10GE Over subscribed mode, then IMA8Z or IMA2F cannot be in slot 4.</li> </ul>

Slot Number	Supported IM Operating Modes	Restrictions
15	<ul style="list-style-type: none"> <li>• 8-port 1GE (SFP) + 1-port 10GE (SFP+) Fully subscribed</li> <li>• 16-port 1GE (CSFP) + 1-port 10GE (SFP+) Oversubscribed</li> <li>• 16-port/18-port 1GE (CSFP) Oversubscribed</li> <li>• 8-port 1GE + 1-port 1GE Fully subscribed</li> <li>• 1-port 10 GE Fully subscribed</li> <li>• 8-port 1GE Fully subscribed</li> </ul>	<ul style="list-style-type: none"> <li>• IF IMA8CS1Z-M is in slot 15 in 8-port 1GE + 1-port 10GE Fully subscribed mode, or in 16-port 1GE + 1-port 10GE Oversubscribed mode, then the IM cannot be present in slot 11.</li> <li>• If Slot 15 is in 8-port 1GE + 1-port 10GE Fully subscribed mode, or 16-port 1GE + 1-port 10GE Oversubscribed mode, then no IM is supported on slot 11.</li> <li>• If Slot 15 is in 8-port 1GE + 1-port 10GE Fully subscribed, Or 16-port 1GE + 1-port 10GE Oversubscribed mode, then IMA8Z or IMA2F cannot be in slot 3.</li> </ul>

## Associated Commands

The following table shows the Associated Commands for interface module configuration:

Commands	Links
<code>show platform software agent iomd [im module]</code> <code>dump fpga [port number]</code>	<a href="http://www.cisco.com/c/en/us/td/docs/ios-xml/ios/interface/command/ir-cr-book/ir-s5.html#wp6318513600">http://www.cisco.com/c/en/us/td/docs/ios-xml/ios/interface/command/ir-cr-book/ir-s5.html#wp6318513600</a>
<code>show platform software agent iomd [im module]</code> <code>clear fpga [port number]</code>	<a href="http://www.cisco.com/c/en/us/td/docs/ios-xml/ios/interface/command/ir-cr-book/ir-s5.html#wp6318513600">http://www.cisco.com/c/en/us/td/docs/ios-xml/ios/interface/command/ir-cr-book/ir-s5.html#wp6318513600</a>

## Additional References

### Related Documents

Related Topic	Document Title
Cisco IOS commands	<a href="#">Cisco IOS Master Commands List, All Releases</a>
Compact-SFP	<a href="#">Cisco SFP Modules for Gigabit Ethernet Applications Data Sheet</a>

**Standards and RFCs**

Standard/RFC	Title
—	<i>There are no standards and RFCs for this feature.</i>

**MIBs**

MIB	MIBs Link
—	<p><i>There are no MIBs for this feature.</i></p> <p><a href="http://www.cisco.com/go/mibs">http://www.cisco.com/go/mibs</a></p>

**Technical Assistance**

Description	Link
<p>The Cisco Support website provides extensive online resources, including documentation and tools for troubleshooting and resolving technical issues with Cisco products and technologies.</p> <p>To receive security and technical information about your products, you can subscribe to various services, such as the Product Alert Tool (accessed from Field Notices), the Cisco Technical Services Newsletter, and Really Simple Syndication (RSS) Feeds.</p> <p>Access to most tools on the Cisco Support website requires a Cisco.com user ID and password.</p>	<p><a href="http://www.cisco.com/cisco/web/support/index.html">http://www.cisco.com/cisco/web/support/index.html</a></p>