



Cisco ASR 920 Series Aggregation Services Router Hardware Installation Guide

First Published: 2023-08-04

Last Modified: 2017-05-05

Americas Headquarters

Cisco Systems, Inc.
170 West Tasman Drive
San Jose, CA 95134-1706
USA
<http://www.cisco.com>
Tel: 408 526-4000
800 553-NETS (6387)
Fax: 408 527-0883



CONTENTS

CHAPTER 1

Cisco ASR 920 Series Aggregation Services Router Overview 1

Cisco ASR 920 Router Features	1
GigabitEthernet Copper Ports	1
GE SFP Ports	2
SFP+ Ports	2
Limitation	6
External Interfaces	7
Network Interfaces	7
Network Timing Interfaces	7
External Alarm Inputs	7
Management Interfaces	7
Power Supply and Fans	8
Check LED Indicators	10
Online Insertion and Removal	13
Licensing the Cisco ASR 920 Router	14

CHAPTER 2

Preparing for Installation 15

Safety Guidelines	15
Standard Warning Statements	15
Safety Guidelines for Personal Safety and Equipment Protection	16
Safety Precautions for Module Installation and Removal	17
Safety with Electricity	17
Power Supply Considerations	21
Preventing ESD Damage	21
Site Planning	22
General Precautions	22

Site Planning Checklist	22
Site Selection Guidelines	22
Environmental Requirements	23
Physical Characteristics	23
Air Flow Guidelines	23
Airflow Guidelines for ETSI Rack Installation	24
Floor Loading Considerations	24
Site Power Guidelines	24
Electrical Circuit Requirements	25
Site Cabling Guidelines	25
Asynchronous Terminal Connections	26
Interference Considerations	26
Rack-Mounting Guidelines	27
Precautions for Rack-Mounting	27
Rack Selection Guidelines	27
Equipment Rack Guidelines	28
Installation Checklist	29
Creating a Site Log	29
Receiving the Cisco ASR 920 Series Router	30
Chassis-Lifting Guidelines	31
Tools and Equipment	31
Unpacking and Verifying the Shipped Contents	31
<hr/>	
CHAPTER 3	Installing the Cisco ASR 920 Series Router 33
Prerequisites	33
Installing the Router in a Rack	33
Installing the Chassis Brackets	34
Installing the Router Chassis in the Rack	37
Attaching the Cable Guides	38
Wall Mounting the Router	40
Attaching the Brackets to the Router for Wall-Mounting	40
Mounting the Router on the Wall	41
Install the AC Power Cables	43
Install the DC Power Supply	45

Power on the Device	48
Connect SFP Modules	48
Install SFP Modules	49
Remove SFP Modules	50
Connect Gigabit Ethernet Ports	51
Connect to SFP Modules	52
Connect Fiber Optic SFP Modules	52
Install the Chassis Ground Connection	53
Power Connection Guidelines	55
Guidelines for DC-Powered Systems	55
Guidelines for AC-Powered Systems	55
Prevent Power Loss	56
Activate DC Power Supply	56
Activate AC Power Supply	56
Connect Chassis to Network	57
Connecting Console Cables	57
Connecting to the USB Serial Port Using Microsoft Windows	57
Connecting to the Console Port Using Mac OS X	58
Connecting to the Console Port Using Linux	59
Installing the Cisco USB Device Driver	59
Uninstalling the Cisco USB Driver	60
Connect to the EIA Console Port	60
Connect a Management Ethernet Cable	62
Install and Remove SFP and SFP+ Modules	62
Connecting a USB Flash Device	62
Removing a USB Flash Device	63
Connecting Timing Cables	64
Connecting a Cable to the BITS Interface	64
Connecting Cables to a GPS Interface	64
Connect Cable to Copper Gigabit Ethernet Port	65
Connect Cables to SFP Modules	65
Connector and Cable Specifications	65

- Check Conditions Before System Startup 67
- Powering Up the Cisco ASR 920 Series Router 68
 - Verify the Front Panel LEDs 72
 - Verify the Hardware Configuration 72
 - Check Hardware and Software Compatibility 72
- Configure Device at Startup 73
 - Access the CLI Using the Console 73
 - Configure Global Parameters 74
 - Check the Running Configuration Settings 75
 - Save the Running Configuration to NVRAM 75
 - Safely Power Down the Device 75

CHAPTER 5

Troubleshooting 77

- Pinouts 77
 - BITS Port Pinouts 77
 - Time-of-Day Port Pinouts 77
 - Alarm Port Pinouts 78
 - Management Ethernet Port Pinouts 78
 - USB Console Port Pinouts 79
 - USB Flash or MEM Port Pinouts 79
 - Check Optical Fiber Specifications 80
 - Check Alarm Conditions 80

CHAPTER 6

Site Log 81

CHAPTER 7

Supported SFPs and PIDs 83

- Supported SFPs 83
- Supported PIDs 84



CHAPTER 1

Cisco ASR 920 Series Aggregation Services Router Overview

The Cisco ASR 920 Series Aggregation Services Router is a family of fixed configuration routers that enables Service Providers to provide business, residential, and mobile access services to their users. It is the Carrier Ethernet access platform providing Ethernet services.

The Cisco ASR 920 routers complement and extend Cisco's current and planned Carrier Ethernet routing portfolio providing a cost optimized, and extended temperature range access platform.

The Cisco ASR 920 routers do not have high availability features.

- [Cisco ASR 920 Router Features, on page 1](#)

Cisco ASR 920 Router Features

The Cisco ASR 920 family of routers includes:

- ASR 920-Indoor version [ASR-920-12CZ-A / ASR-920-12CZ-D]—This sub-family has fixed ENET interfaces (12 x 1GE + 2 x 10GE or 2 x 1GE or any combinations of 1 GE and 10 GE among the two ports available) and dual power supplies (AC/DC).
- ASR 920-Compact version [ASR-920-4SZ-A / ASR-920-4SZ-D]—This sub-family of routers have a compact form factor and configurable ports: 4 x 1 GE or 4 x 10 GE or any combinations of 1 GE and 10 GE among the four ports available. In addition, there are 2 x 1 GE copper ports available.

The following table provides snapshot of the number and type of supported ports:

ASR 920 Sub-family	1 GE Port	10 GE Port	Type of 1 GE Port	Type of 10 GE Port
ASR-920-12CZ-A / ASR-920-12CZ-D	12	2 ¹	8 Combo + 4 SFP	Built in 2 SFP+ (dual rate)
ASR-920-4SZ-A / ASR-920-4SZ-D	2	4 ¹	2 Copper	Built in 4 SFP+ (dual rate)

¹ Each port can operate at either 1G or 10 G.

GigabitEthernet Copper Ports

Fixed copper GigabitEthernet (GE) interfaces are provided through standard RJ-45 connectors. These ports support the following features:

- Standard 10/100/1000Base-T/TX operation with forced or auto-negotiation for speed and duplex.
- Automatic crossover (auto-MDIX) for straight-through and crossover connections.
- Pause flow control as defined by the 802.3x standard.
- Frame size of 9216 bytes.
- Synchronous ENET operation that provides its recovered receive clock as an input clock source for the SETS as well as uses the system-wide reference clock to derive its transmit clock.

GE SFP Ports

The GE SFP ports support the following features:

- 100Base-FX and 1000Base-X SFP modules.
- Digital optical monitoring as specified by the SFP.
- Any mix of SFPs is supported unless specifically noted.



Note Only six Smart SFPs are supported on the router.

- Pause flow control as defined by the 802.3x standard.
- Frame size of 9216 bytes.
- Synchronous ENET operation that provides its recovered receive clock as an input clock source for the SETS as well as uses the system-wide reference clock to derive its transmit clock.



Note Copper based SFPs and Smart SFPs do not support synchronous ENET operations.

SFP+ Ports

The SFP+ ports support the following features:

- Digital optical monitoring as specified by the optical transceiver module.
- Any mix of SFPs is supported unless specifically noted.
- Pause flow control as defined by the 802.3x standard.
- Frame size of 9216 bytes.
- Smart SFPs do not support synchronous ENET operations

The following figures show the port numbering for the Cisco ASR 920 router:

Figure 1: Front Panel of Cisco ASR-920-12CZ-A Route

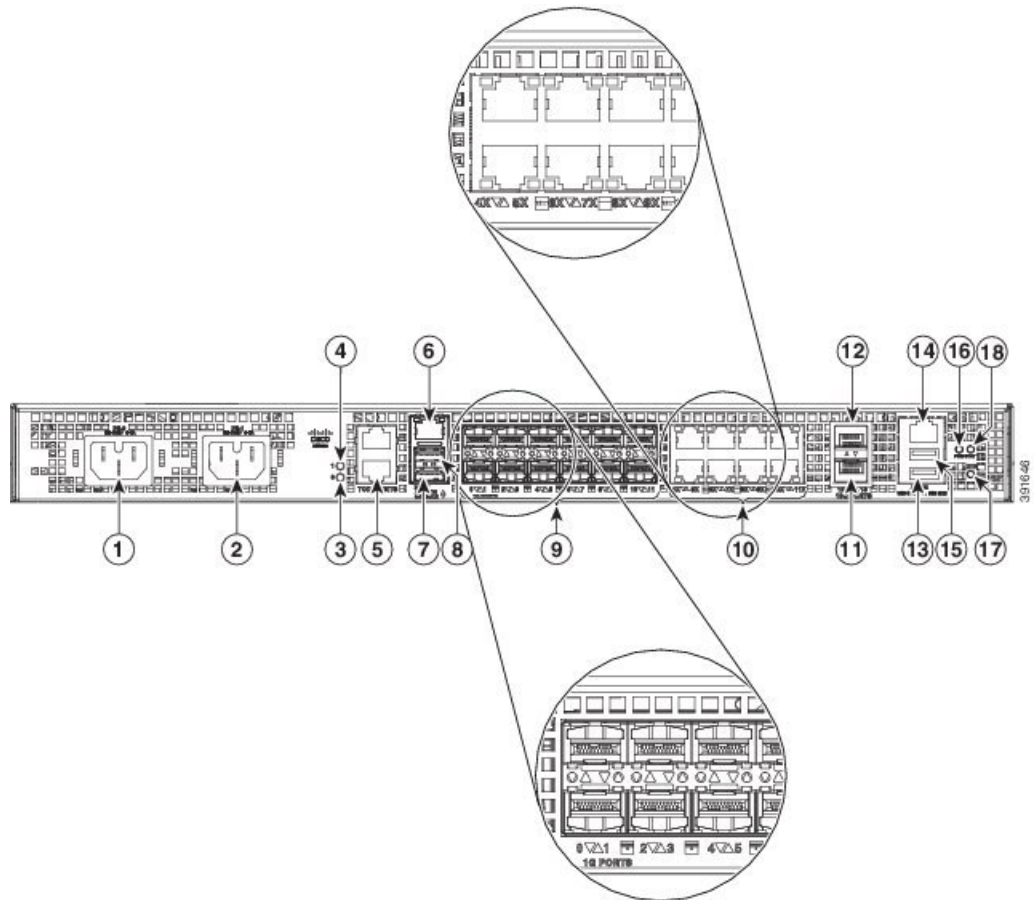
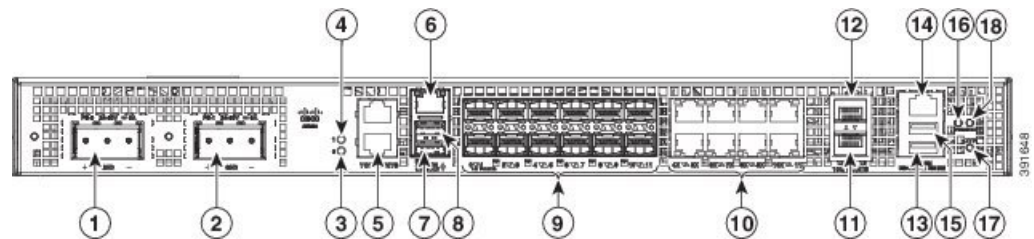

Figure 2: Front Panel of Cisco ASR-920-12CZ-D Router



1	Power Supply 0 (AC or DC)	10	Eight Copper port
2	Power Supply 1(AC or DC)	11	1G/10G Dual Rate port
3	Power Supply 0 LED (AC or DC)	12	1G/10G Dual Rate port
4	Power Supply 1 LED (AC or DC)	13	USB Console port
5	RJ-48 slots for BITS (upper slot) and ToD (lower slot)	14	Alarm port
6	Management port	15	USB Memory port

1	Power Supply 0 (AC or DC)	10	Eight Copper port
7	Console port (TIA/EIA-232F)	16	Board power LED
8	Auxiliary Console port	17	Zero Touch Provisioning button
9	4x1GE SFP + 8x1GE SFP combo ports Note Port 0 is located at the bottom left, port 1 is located at the top left, and so on.	18	System Status LED

Figure 3: Front Panel of Cisco ASR-920-4SZ-A Router

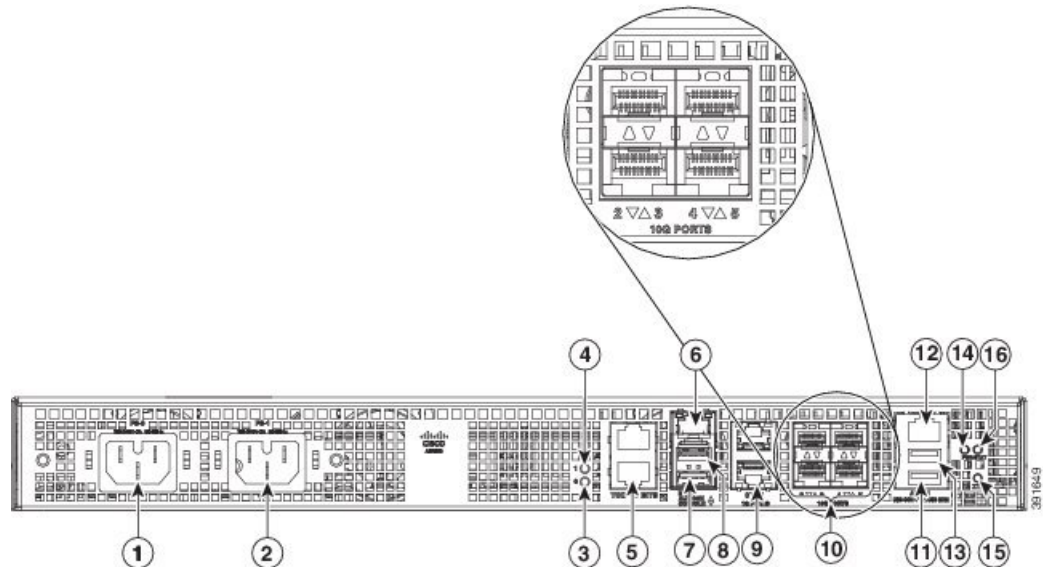
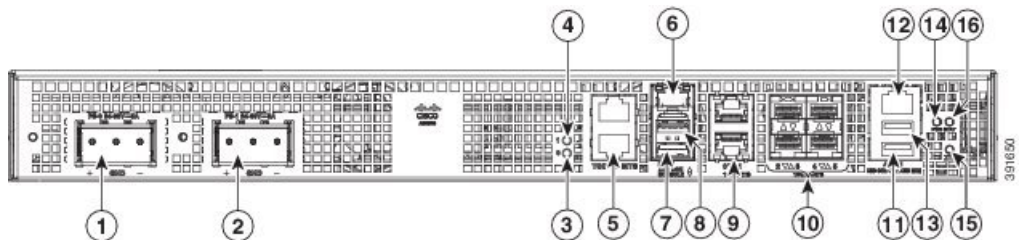

Figure 4: Front Panel of Cisco ASR-920-4SZ-D Router



1	Power Supply 0 (AC or DC)	9	2 1GE Copper ports
2	Power Supply 1 (AC or DC)	10	Four 1G/10G Dual Rate Ports Note Port 2 is located at the bottom left, port 3 is located at the top left, and so on.
3	Power Supply 0 LED (AC or DC)	11	USB Console port
4	Power Supply 1 LED (AC or DC)	12	Alarm port

1	Power Supply 0 (AC or DC)	9	2 1GE Copper ports
5	RJ-48 slots for BITS (upper slot) and ToD (lower slot)	13	USB Memory port
6	Management port	14	Board power LED
7	Console port (TIA/EIA-232F)	15	Zero Touch Provisioning button
8	Auxiliary Console port	16	System Status LED

The table below describes the other features of Cisco ASR-920-12CZ (AC and DC) and Cisco ASR-920-4SZ (AC and DC) Routers.

Table 1: Cisco ASR-920-12CZ and Cisco ASR-920-4SZ Router Specifications

Specification	ASR-920-12CZ-A/ASR-920-12CZ-D	ASR-920-4SZ-A/ASR-920-4SZ-D
Dimension Width x Depth x Height	17.5 x 9.25 x 1.75 inches	15.5 x 9.25 x 1.75 inches
Weight	ASR-920-12CZ-A: 3.80 kg ASR-920-12CZ-D: 3.54 kg	ASR-920-4SZ-A: 3.50 kg ASR-920-4SZ-D: 3.22 kg
Rack Unit	One RU	One RU
Airflow	Front to back	Front to back
Cable access	Front cable access	Front cable access
System throughput	32 Gbps	42 Gbps
Power Supply		
Modularity	None	None
Redundant	Yes	Yes
AC	Yes	Yes
Power Specification	115 W	105 W
DC	Yes	Yes
Power Specification	110 W	105 W

Specification	ASR-920-12CZ-A/ASR-920-12CZ-D	ASR-920-4SZ-A/ASR-920-4SZ-D
Operating Temperature	–40° C to 70° C Note When using Smart SFPs, the systems should not operate beyond 40° C. Note The temperature range will vary for supported SFP/SFP+ installed on the router. See the corresponding SFP/SFP+ documentation for more details.	–40° C to 70° C Note When using Smart SFPs, the systems should not operate beyond 40° C. Note The temperature range will vary for supported SFP/SFP+ installed on the router. See the corresponding SFP/SFP+ documentation for more details.
Alarms	<ul style="list-style-type: none"> • 4 alarm dry contact inputs (normally open) • LED indicators for critical, major and minor alarms 	<ul style="list-style-type: none"> • 4 alarm dry contact inputs (normally open) • LED indicators for critical, major and minor alarms
TDM Support	None	None
Mounting option	<ul style="list-style-type: none"> • Front or rear rail 19 inches or 23 inches • ETSI 300 mm cabinet • Wall Mount (with only side mount option). Note For more information, see Wall Mounting the Router .	<ul style="list-style-type: none"> • Front or rear rail 19 inches or 23 inches • ETSI 300 mm cabinet • Wall Mount (with only side mount option) Note For more information, see Wall Mounting the Router .
Port Configuration	12x1G and 2x10G/1G ports	2x1G and 4x10G/1G ports
Port Numbering	4x1G SFP – Port [0:3] 8x1G Combo – Port [4:11] 2x10G – Port [12-13]	2x1G Copper – Port [0:1] 4x10G – Port [2-5]
Combo Ports	Ports 4 to 11 are combo ports	No combo ports
Copper Port LEDs	Link/Activity/Duplex LED indication	Link/Activity/Duplex LED indication
Temperature Sensors	Four temperature sensors	Three temperature sensors
BITS/ToD	External ports for BITS/TOD	External ports for BITS/TOD

Limitation

When a P router acts as a mid-node and has a multicast receiver connected to it, for a default Multicast Distribution Tree (MDT), the packets that reach the multicast receiver from the ingress Provider Edge (PE)

receive Experimental Bits (EXP). But, marking is lost when the same stream egresses out from the P router towards another PE router that has the same multicast receiver connected to it .

External Interfaces

The Cisco ASR 920 routers have these external physical interfaces on the front panel:

Network Interfaces

The network interfaces are provided through these fixed ports:

- GE SFP ports—supports 100/1000 modes
- GE Copper RJ-45 ports—supports 10/100/1000 operation
- 10GE SFP+—supports 10G/1G mode depending on the SFP+/SFP in the network interface slot

Network Timing Interfaces

- BITS input or output—The BITS interfaces support clock recovery from either a T1 at 1.544 MHz or an E1 at 2.048 MHz, configurable by software. BITS interface is provided through a standard RJ-48 connector on the front panel.
- 1PPS input or output and ToD input or output—This shielded RJ-45 interface is used for input or output of time-of-day (ToD) and 1PPS pulses. ToD format includes both NTP and IEEE 1588-2008 time formats.

The same RS422 pins for 1PPS and TOD are shared between input and output directions. The direction for each can be independently configurable through software.

External Alarm Inputs

The device supports four dry contact alarm inputs through an RJ-45 jack on the front panel.

The alarm condition is normally open, which indicates that no current flows through the alarm circuit, and the alarm is generated when the current is flowing. Each alarm input can be provisioned as being critical, major, or minor.

Management Interfaces

The Cisco ASR 920 routers have the following management interfaces:

Management ENET Port

A single management copper ENET port supporting 10/100/1000Base-T operation is provided at the front panel. It uses a standard RJ-45 jack.



Note The management ENET port is not a data plane port.

RS232 Console Port

The RS232 console port provides transmission (Tx), reception (Rx), and grounding (Gnd).



Note The RS232 console port is enabled through only the Cisco-designed cable adapter USB type A cable to RJ-45 adapter cable. To use this port, disable the flow control on the terminal.

USB Console

A single USB 2.0 Type-A receptacle is provided on the front panel of the Cisco ASR 920 router for providing console access to ROMMON, Cisco IOS-XE and diagnostics. While it uses the Type-A connector, it operates as a USB peripheral only for connection to an external host computer. This interface requires the use of a Type-A to Type-A connector instead of a standard USB cable.



Note Use of the USB console is mutually exclusive of the RS232 console port. This interface requires the use of a Type-A to Type-A USB cable.

USB Mass Storage

A single USB 2.0 Type-A receptacle is provided on the front panel of the Cisco ASR 920 router for inserting external USB mass storage devices, such as standard USB flash drives. This interface is used to load images, load or store configurations, write logs, and so on. It supports operation up to 12Mbps.

Maximum memory supported in ROMmon is 8GB and in Cisco IOS is 16GB.

Zero Touch Provisioning Button

The Zero Touch Provisioning (ZTP) button on the front panel initiates the ZTP process on a short press of less than eight seconds. Pressing the ZTP button for more than eight seconds causes a system reset.

For more information on ZTP, see *Power and Status LED* section.

RS232 Auxiliary Console Port

The RS232 Aux console port provides transmission (Tx), reception (Rx), and ground (Gnd).



Note The RS232 Aux console port is enabled only through the Cisco-designed cable adapter from USB type A cable to RJ-45 adapter cable.



Note This is a debug-only port. It is recommended that this port be used by field service engineers only.

Power Supply and Fans

The routers support AC and DC power supplies in a 1+1 redundant configuration.

One AC and one DC power supply in the same router is also a supported configuration.



Note The power supply units are built-in and are not modular.

Table 2: Power Supply Specification

Specification	AC	DC
Voltage	100 V – 240 V	24 V – 60 V
Current	2A through a standard C16 type receptacle	6A through a three-position terminal block
Input Power	115 W (ASR-920-12CZ-A/ASR-920-4SZ-A)	105 W (ASR-920-12CZ-D/ASR-920-4SZ-D)



Note This product requires surge protection as part of the building installation. To comply with the Telcordia GR-1089 NEBS standard for electromagnetic compatibility and safety, an external surge protective device (SPD) is required at the AC power service equipment.



Note For DC systems, if a surge of more than 500 V is expected, add an appropriate external surge protective device.

The routers have fixed fans are part of the system. The system is designed to operate at its maximum operating temperature of 70° C and at 65° C in case of failure of a single fan, for a maximum of four hours. The fan is not removable and in case of a failure, the system must be replaced.



Caution In case of power supply or fan failure, it is highly recommended to let a Cisco technician replace the router.

Table 3: Feature History

Feature Name	Release Information	Description
Switching Fan Speed	Cisco IOS XE Cupertino 17.8.1	This feature enables the fan speed for Cisco ASR-920-12CZ-A/D and Cisco ASR-920-4SZ-A/D to switch from default dynamic fan speed to static fan speed in the presence of smart SFP. This enables the smart SFPs to function efficiently.

The dynamic fan-speed algorithm sets the fan speed based on the ASIC temperature.

Prior to Cisco IOS XE Cupertino Release 17.8.1, when the smart SFP was inserted, it would not function with the static fan-speed algorithm mode. This was resulting in the increase of the router's temperature.

Starting with Cisco IOS XE Cupertino Release 17.8.1, when the smart SFP is inserted, the switch from default dynamic fan-speed algorithm to static fan-speed algorithm helps the smart SFP to function efficiently.

Use the **show platform fan-algorithm** command to verify the fan-speed algorithm configuration for the router:

```
Router#show platform fan-algorithm
```

```
Fan Algorithm : Static
```

```
Router#
```

Check LED Indicators

This section describes the different types of front panel LEDs and their behavior.

PWR and STAT LEDs

The PWR and STAT LEDs are available on the front panel. These LEDs provide power on the board (PWR) and overall router health (STAT) status. During power up state, these LEDs provide booting status and report errors.



Note The digital code signing functionality validates the integrity and authenticity of the ROMMON image before booting it.

Table 4: PWR and STAT LED Indications

PWR LED State	STAT LED state	Indication	Comment
Amber	Off	Power in the system is all right and FPGA configuration is taking place.	Permanent Amber/Off indicates FPGA configuration failure.
Amber	Red	FPGA Image Validation Error.	System is in unresponsive state.
Flashing Amber and Green alternatively	Amber	Upgrade FPGA image error, continuing with Golden FPGA image.	—
Flashing Amber and Green alternatively	Off	FPGA configuration successful and Digital code signing successfully validated FPGA image. Digital code signing passed the control to Microloader to boot ROMMON.	—
Flashing Amber and Green alternatively	Red	Digital code signing reported failure in ROMMON image validation.	—
Flashing Amber	Flashing Amber	ZTP process has begun. Note A short press of the ZTP button triggers the provisioning. A longer press of more than eight seconds, resets the board.	Both LEDs turn Green once provisioning is complete.

PWR LED State	STAT LED state	Indication	Comment
Green	Off	IOS-XE image is booting.	
Green	Green	Successfully booted and system is operating normally.	—
Green	Amber	A minor alarm or synchronization is in Holdover or free-running mode	—
Green	Red	A major or critical alarm (high temperature reported for any sensor) or multiple fan failure.	—

CPU Management Port LEDs

The LED for the 10/100/1000 Management port is integrated on the connector itself. There are two LEDs in the connector—the LED on the left indicates the Link/Activity status and the LED on the right is non-functional.



Note The CPU management port LED on the right is non-functional and hence doesn't indicate any port status.

Table 5: CPU Management Port LED Indication

LED	LED State	Indication
Left	Green	Link up in 1000 Mbps
	Blinking Green	Activity in 1000 Mbps
	Orange	Link up in 100 Mbps
	Blinking Orange	Activity in 100 Mbps
	Off	Link down

SFP LEDs

Each SFP port has an LED indicator. The LED is configured such that the up arrow indicates the port on the upside and the down arrow indicates the port on the downside.

Table 6: SFP Port LED Indication

LED	LED State	Indication
Labeled same as the SFP port number	Green	Link up in 1000Base-X/100Base-FX
	Blinking Green	Activity in 1000 Base-X/100Base-FX
	Yellow	Fault/Error
	Off	Link down

SFP+ LEDs

Each port in sets of GE SFP+ ports has an LED indicator.

Table 7: SFP+ Port LED Indication

LED	LED State	Indication
GE / GE SFP	Green	Link up in 10G/1G
	Blinking Green	Activity in 10G/1G
	Yellow	Fault/Error/Link down
	Off	Admin down

RJ-45 LEDs

Each RJ-45 port has two LED indicators. Left LED indicates the Link status; right LED indicates the status of the duplex LED.

Table 8: RJ-45 LED Indication

LED	LED State	Indication
Left	Green	Link up in 10/100/1000Base-T
	Blinking Green	Activity in 10/100/1000Base-T
	Yellow	Fault/Error
	Off	Link down
Right	Green	Link up in full duplex
	Off	Link up in half duplex

Power Supply Unit LEDs

Each power supply unit has a corresponding LED on the front panel.

Table 9: PSU LED Indication

LED	LED State	Indication
OK	Green	Power Supply is working and 12V output is alright.
	Red	12V output failure (Either input not present or fault in the power supply unit).

System–Interface LED Behavior

Table 10: 1G Copper and 1G SFP LED Indication

Event	1G Copper Port LEDs (Link/Duplex)	1G SFP Port LEDs
ROMMON	Off/Off	Off
IOS Shut	Off/Off	Off
IOS No shut (cable disconnect)	Yellow/Off	Yellow
IOS No shut (cable connect) (media-type RJ-45)	Green/Green	Off
IOS No shut (cable connect) (media-type SFP)	Off/Off	Green
IOS No shut (cable connect) (media-type auto)	Off/Off	Green

Table 11: Dual Rate and Management Port LED Indication

Event	Dual Rate (1G/10G) Port LEDs	Management Port LEDs (Link/Duplex)
ROMMON	Off	Green/Off
IOS Shut	Off	Off/Off
IOS No shut (cable disconnect)	Orange	Orange/Off
IOS No shut (cable connect)	Green	Green/Green in 1G mode Orange/Green in 100M mode

Online Insertion and Removal

The Cisco ASR 920 router supports the following OIR operations:

- When an SFP is removed, there is no effect on traffic flowing on other ports.

- When an SFP is installed, the system initializes that port for operation based upon the current configuration. If the inserted SFP is incompatible with the current configuration for that port, the port does not become operational until the configuration is updated.
- Both power supplies are installed and active and the load may be shared between them or a single PSU could support the whole load. When a power supply is not working or the input cable is removed, the remaining power supply takes the entire load without disruption. If the power supply needs repair, the whole system must be replaced.

Licensing the Cisco ASR 920 Router

The Cisco ASR 920 Series Routers support the following types of licenses:

- Port Licensing—Port Upgrade license is available as a "Pay as you Grow" model.
 - 1G upgrade license
 - 10G upgrade license
- Bulk licensing—Bulk port licensing allows you to enable all the ports with a single license.
- Timing license (1588)—Timing license is required if the router is used as a master clock.
- Advanced Metro IP Access
- Metro IP Access
- Metro Access (default)

The following methods are used to activate the above licenses:

- Cisco Software Licensing—The Cisco Software License Activation feature is a set of processes and components to activate Cisco software feature sets by obtaining and validating fee-based Cisco software licenses.



Note Licenses generated by the Cisco Software Licensing are tied to the UDI of the chassis and a corresponding watchtower device certificate (WDC) is stored in the system.

- Cisco Smart Licensing—Smart Licensing is usage-based licensing where devices register with the Cisco Secure server.



CHAPTER 2

Preparing for Installation

This chapter describes how to prepare for the installation of the Cisco ASR 920 Series Aggregation Services Router at your site, and contains the following sections:

- [Safety Guidelines, on page 15](#)
- [Site Planning, on page 22](#)
- [Receiving the Cisco ASR 920 Series Router, on page 30](#)

Safety Guidelines

Before you begin the installation of the Cisco ASR 920 Series Router, review the safety guidelines in this chapter to avoid injuring yourself or damaging the equipment.

In addition, before replacing, configuring, or maintaining the Cisco ASR 920 Series Aggregation Services Router, review the safety warnings listed in the Regulatory Compliance and Safety Information for the Cisco ASR 920 Series Aggregation Services Router document.

The following sections describe the safety guidelines for the Cisco ASR 920 Series Router:

Standard Warning Statements

To see translations of the warnings that appear in this publication, see the Regulatory Compliance and Safety Information for the Cisco ASR 920 Series Aggregation Services Router document.



Warning

To prevent bodily injury when mounting or servicing this unit in a rack, you must take special precautions to ensure that the system remains stable. The following guidelines are provided to ensure your safety: This unit should be mounted at the bottom of the rack if it is the only unit in the rack. When mounting this unit in a partially filled rack, load the rack from the bottom to the top with the heaviest component at the bottom of the rack. If the rack is provided with stabilizing devices, install the stabilizers before mounting or servicing the unit in the rack. Statement 1006



Warning

This unit is intended for installation in restricted access areas. A restricted access area can be accessed only through the use of a special tool, lock and key, or other means of security. Statement 1017



Warning Ultimate disposal of this product should be handled according to all national laws and regulations. Statement 1040



Warning To prevent the system from overheating, do not operate it in an area that exceeds the maximum recommended ambient temperature of 158°F (70°C). Statement 1047



Warning The chassis should be mounted on a rack that is permanently affixed to the building. Statement 1049



Warning IMPORTANT SAFETY INSTRUCTIONS: This warning symbol means danger. You are in a situation that could cause bodily injury. Before you work on any equipment, be aware of the hazards involved with electrical circuitry and be familiar with standard practices for preventing accidents. Use the statement number provided at the end of each warning to locate its translation in the translated safety warnings that accompanied this device. Statement 1071



Warning This is a Class A Device and is registered for EMC requirements for industrial use. The seller or buyer should be aware of this. If this type was sold or purchased by mistake, it should be replaced with a residential-use type. Statement 294



Warning This is a class A product. In a domestic environment this product may cause radio interference in which case the user may be required to take adequate measures. Statement 340



Warning This equipment is in compliance with the essential requirements and other relevant provisions of Directive 1999/5/EC. Statement 287

Safety Guidelines for Personal Safety and Equipment Protection

The following guidelines ensure your safety and protect the equipment. This list does not include all the potentially hazardous situations. Therefore, you must be alert.

- Before moving the system, always disconnect all power cords and interface cables.
- Never assume that power is disconnected from a circuit; always check.
- Before and after installation, keep the chassis area clean and dust free.
- Keep tools and assembly components away from walk areas where you or others can trip over them.
- Do not work alone if potentially hazardous conditions exist.

- Do not perform any action that creates a potential hazard to people or makes the equipment unsafe.
- Do not wear loose clothing that may get caught in the chassis.
- When working under conditions that may be hazardous to your eyes, wear safety glasses.

Safety Precautions for Module Installation and Removal

Be sure to observe the following safety precautions when you work on the router.

To see the translations of the warnings that appear in this publication, see the Regulatory Compliance and Safety Information for the Cisco ASR 920 Series Aggregation Services Router document.



Warning Class 1 laser product. Statement 1008



Warning Do not stare into the beam or view it directly with optical instruments. Statement 1011



Warning Invisible laser radiation present. Statement 1016



Warning Invisible laser radiation may be emitted from disconnected fibers or connectors. Do not stare into beams or view directly with optical instruments. Statement 1051

Safety with Electricity



Warning Before working on a chassis or with power supplies, unplug the power cord on AC units. Disconnect the power at the circuit breaker on DC units. Statement 12



Warning Before working on equipment that is connected to power lines, remove jewelry (including rings, necklaces, and watches). Metal objects heat up when connected to power and ground and can cause serious burns or weld the metal object to the terminals. Statement 43



Warning Do not work on the system or connect or disconnect cables during periods of lightning activity. Statement 1001



Warning Before performing any of the following procedures, ensure that power is removed from the DC circuit. Statement 1003



Warning Read the installation instructions before connecting the system to the power source. Statement 1004



Warning This product relies on the building's installation for short-circuit (overcurrent) protection. For a DC installation, ensure that the branch circuit breaker is rated a maximum 15A for DC systems. For AC systems, 15A for voltages greater than 200 Vac; 20 A for voltages below 127 Vac. Statement 1005



Warning When you connect or disconnect the power and relay connector with power applied, an electrical arc can occur. This action can cause an explosion in hazardous area installations. Be sure that power is removed from the switch and alarm circuit. Be sure that power cannot be accidentally turned on or verify that the area is nonhazardous before proceeding. Failure to securely tighten the power and relay connector captive screws can result in an electrical arc if the connector is accidentally removed. Statement 1058



Warning Take care when connecting units to the supply circuit so that wiring is not overloaded. Statement 1018



Warning The plug-socket combination must be accessible always, because it serves as the main disconnecting device. Statement 1019



Warning To avoid electric shock, do not connect safety extra-low voltage (SELV) circuits to telephone-network voltage (TNV) circuits. LAN ports contain SELV circuits, and WAN ports contain TNV circuits. Some LAN and WAN ports both use RJ45 connectors. Use caution when connecting cables. Statement 1021



Warning A readily accessible two-poled disconnect device must be incorporated in the fixed wiring. Statement 1022



Warning To reduce the risk of fire, use only 26 AWG or larger telecommunication line cord. Statement 1023



Warning This equipment must be grounded. Never defeat the ground conductor or operate the equipment in the absence of a suitably installed ground conductor. Contact the appropriate electrical inspection authority or an electrician if you are uncertain that suitable grounding is available. Statement 1024



Warning Use copper conductors only. Statement 1025



Warning This unit may have more than one power supply connection. All connections must be removed to de-energize the unit. Statement 1028



Warning To prevent personal injury or damage to the chassis, never attempt to lift or tilt the chassis using the handles on modules (such as power supplies, fans, or cards). These types of handles are not designed to support the weight of the unit. Statement 1032



Warning Connect the unit only to the DC power source that complies with the safety extra-low voltage (SELV) requirements in IEC 60950 based safety standards. Statement 1033



Warning Do not use this product near water. For example, near a bath tub, wash bowl, kitchen sink or laundry tub, in a wet basement, or near a swimming pool. Statement 1035



Warning Before opening the unit, disconnect the telephone-network cables to avoid contact with telephone-network voltages. Statement 1041



Warning This equipment must be installed and maintained by service personnel as defined by AS/NZS 3260. Incorrectly connecting this equipment to a general-purpose outlet could be hazardous. The telecommunications lines must be disconnected 1) before unplugging the main power connector or 2) while the housing is open, or both. Statement 1043



Warning This product requires short-circuit (overturned) protection, to be provided as part of the building installation. Install only in accordance with national and local wiring regulations. Statement 1045



Warning When installing or replacing the unit, ensure the ground connection first and disconnected last. Statement 1046



Warning Failure to securely tighten the power and relay connector captive screws can result in an electrical arc if the connector is accidentally removed. Statement 1058



Warning This equipment is intended to be grounded. Ensure that the host is connected to earth ground during normal use. Statement 39



Warning If you connect or disconnect the console cable with power applied to the switch or any device on the network, an electrical arc can occur. This action could cause an explosion in hazardous location installations. Be sure that power is removed or the area is nonhazardous before proceeding. To verify the switch operation, perform POST on the switch in a nonhazardous location before installation. Statement 1065



Warning Installation of the equipment must comply with local and national electrical codes. Statement 1074



Warning Hazardous voltage or energy may be present on DC power terminals. Always replace cover when terminals are not in service. Be sure that uninsulated conductors are not accessible when cover is in place. Statement 1075

When working on equipment that is powered by electricity, follow these guidelines:

- Locate the room's emergency power-off switch. If an electrical accident occurs, you know where to quickly turn off the power.
- Before starting work on the system, turn off the DC main circuit breaker and disconnect the power terminal block cable.
- Disconnect all power when:
 - Working on or near power supplies
 - Installing or removing a device chassis or network processor module
 - Performing most hardware upgrades
- Never install equipment that appears damaged.
- Carefully examine your work area for possible hazards, such as moist floors, ungrounded power extension cables, and missing safety grounds.
- Never assume that power is disconnected from a circuit; always check.
- Never perform any action that creates a potential hazard to people or makes the equipment unsafe.
- If an electrical accident occurs and you are injured:
 - Use caution to avoid injuring yourself.
 - Turn off power to the device.
 - If possible, send another person to get medical aid. Otherwise, determine the condition of the victim, and then call for help.

- Determine whether the person needs rescue pulsing or external cardiac compressions; then take appropriate action.

Use the following guidelines when working with any equipment that is disconnected from a power source, but connected to telephone wiring or network cabling:

- When installing or modifying telephone lines, use caution.
- Never install telephone jacks in wet locations unless the jack is designed to handle such locations.
- Never install telephone wiring during a lightning storm.

Power Supply Considerations

Check the power at your site to ensure that you are receiving clean power (free of spikes and noise). If necessary, install a power conditioner.

Preventing ESD Damage

Electrostatic Discharge (ESD) can damage equipment and impair electrical circuitry. ESD may occur when electronic printed circuit cards are improperly handled and can cause complete or intermittent failures. When removing and replacing modules, always follow these ESD prevention procedures:

- Ensure that the device chassis is electrically connected to earth ground.
- Wear an ESD-preventive wrist strap, ensuring that it makes good skin contact. To channel unwanted ESD voltages safely to ground, connect the clip to an unpainted surface of the chassis frame. To guard against ESD damage and shocks, the wrist strap and cord must operate effectively.
- If no wrist strap is available, ground yourself by touching a metal part of the chassis.
- When installing a component, use any available ejector levers or captive installation screws to properly seat the bus connectors in the backplane or midplane. These devices prevent accidental removal, provide proper grounding for the system, and help to ensure that bus connectors are properly seated.
- When removing a component, use available ejector levers or captive installation screws, if any, to release the bus connectors from the backplane or midplane.
- Handle components by only their handles or edges; do not touch the printed circuit boards or connectors.
- Place a removed component board side up on an antistatic surface or in a static-shielding container. If you plan to return the component to the factory, immediately place it in a static-shielding container.
- Avoid contact between the printed circuit boards and clothing. The wrist strap only protects components from ESD voltages on the body; ESD voltages on clothing can still cause damage.
- Never attempt to remove the printed circuit board from the metal carrier.

For the safety of your equipment, periodically check the resistance value of the antistatic wrist strap. Maintain the value between 1 and 10 Mohm.

Site Planning

The following sections describe how to plan for the installation of the Cisco ASR 920 Series Router:

General Precautions

Observe the following general precautions when using and working with your Cisco ASR 920 Series Router system:

- Keep your system components away from radiators and heat sources and do not block cooling vents.
- Do not spill food or liquids on your system components and never operate the product in a wet environment.
- Do not push any objects into the openings of your system components. Doing so can cause fire or electric shock by shorting out interior components.
- Position system cables and power supply cable carefully. Route system cables and the power supply cable and plug so that they are not stepped on or tripped over. Be sure that nothing else rests on your system component cables or power cable.
- Do not modify power cables or plugs. Consult a licensed electrician or your power company for site modifications. Always follow your local and national wiring rules.
- If you turn off your system, wait at least 30 seconds before turning it on again to avoid damage of system components.

Site Planning Checklist

Use the following checklist to perform and account for all the site planning tasks described in this chapter:

- The site meets the environmental requirements.
- The site's air conditioning system can compensate for the heat dissipation of the Cisco ASR 920 Series Router.
- The floor space that the Cisco ASR 920 Series Router occupies can support the weight of the system.
- Electrical service to the site complies with the requirements.
- The electrical circuit servicing the Cisco ASR 920 Series Router complies with the requirements.
- Consideration has been given to the console port wiring and limitations of the cabling involved, according to TIA/EIA-232F.
- The Cisco ASR 920 Series Router Ethernet cabling distances are within the prescribed limitations.
- The equipment rack in which you plan to install the Cisco ASR 920 Series Router complies with prescribed requirements.
- When selecting the location of the rack, careful consideration must be given to safety, ease of maintenance, and proper airflow.

Site Selection Guidelines

The Cisco ASR 920 Series Router requires specific environmental operating conditions. Temperature, humidity, altitude, and vibration can affect the performance and reliability of the router. The following sections provide specific information to help you plan for the proper operating environment.

The Cisco ASR 920 Series Router is designed to meet the industry EMC, safety, and environmental standards described in the Regulatory Compliance and Safety Information for the Cisco ASR 920 Series Aggregation Services Router document.

Environmental Requirements

Environmental monitoring of the Cisco ASR 920 Series Router protects the system and components from damage caused by excessive voltage and temperature conditions. To ensure normal operation and avoid unnecessary maintenance, plan and prepare your site configuration *before* installation. After installation, make sure that the site maintains the environmental characteristics described in Table 1-1 .

For an outside plant installation (cell site cabinet, hut etc.), it is required that the Cisco ASR 920 Series Router be protected against airborne contaminants, dust, moisture, insects, pests, corrosive gases, polluted air or other reactive elements present in the outside air. To achieve this level of protection, we recommend that the unit be installed in a fully sealed enclosure or cabinet. Examples of such cabinets include IP65 cabinets with heat exchanger complying with Telecordia GR487. Temperature must be maintained within -40°C to 70°C .

The equipment shall be placed inside a space protected from direct outside weather and environmental stresses by an enclosure, and where the operating climate, as defined by Class 2 of GR-3108-CORE, is between

- -40°C (-40°F) and 70°C (158°F)
- 5 and 85% RH.

Physical Characteristics

Be familiar with the physical characteristics of the Cisco ASR 920 Series Router to assist you in placing the system in the proper location. For more information, see Table 1-1 .

Air Flow Guidelines

Cool air is circulated through the Cisco ASR 920 Series Router by fans located along the back side of the router.

The internal fans maintain acceptable operating temperatures for the internal components by drawing in cool air through the vents, and circulating the air through the chassis.

The direction of air flow is from front-to-back.

To ensure adequate air flow through the equipment rack, it is recommended that you maintain a minimum clearance distance as mentioned below, at all times.

- front clearance—12.7 cm
- rear clearance—10 cm

Note the following points:

- When installing Cisco ASR 920 Series Router in a back-to-back position with another device, ensure that there is a minimum of 10 cm air flow clearance between the two devices. Also ensure that the device behind the Cisco ASR 920 Series Router is not installed in a way that it blows air into the Cisco ASR 920 Series Router.
- If airflow through the equipment rack and the routers that occupy it is blocked or restricted, or if the ambient air being drawn into the rack is too warm, an overtemperature condition may occur within the rack and the routers that occupy it.

- The site should also be as dust-free as possible. Dust tends to clog the router fans, reducing the flow of cooling air through the equipment rack and the routers that occupy it, thus increasing the risk of an overtemperature condition.
- Enclosed racks must have adequate ventilation. Ensure that the rack is not congested because each router generates heat. An enclosed rack should have louvered sides and a fan to provide cooling air. Heat that is generated by the equipment near the bottom of the rack can be drawn upward into the intake ports of the equipment above.
- When mounting a chassis in an open rack, ensure that the rack frame does not block the exhaust fans.
- When rack-installed equipment fails, especially equipment in an enclosed rack, try operating the equipment by itself, if possible. Power off all the other equipment in the rack (and in adjacent racks) to give the router maximum cooling air and clean power.
- Avoid installing the Cisco ASR 920 Series Router in a location in which the chassis air intake vents may draw in the exhaust air from adjacent equipment. Consider how the air flows through the router; the airflow direction is front to back, with ambient air drawn in from the vents located on the sides of the chassis.

**Caution**

When mounting the router in any type of rack equipment, ensure that the inlet air to the router does not exceed 70° C.

Airflow Guidelines for ETSI Rack Installation

When you install a device on a 2 or 4-post rack, the front and rear doors of the cabinet must be removed. We recommended that you always maintain a minimum clearance distance as mentioned the following.

- Front clearance—5 inches (12.7 centimeters)
- Rear clearance—3.93 inches (10 centimeters)

To mount the chassis in a 4-post enclosed cabinet, ensure a minimum of 3.93 inches (10 centimeters) of clearance on each side of the chassis.

Floor Loading Considerations

Ensure that the floor under the rack supporting the Cisco ASR 920 Series Routers is capable of supporting the combined weight of the rack and all the other installed equipment.

To assess the weight of a fully configured Cisco ASR 920 Series Router, see the Table 1-1 .

For additional information about floor loading requirements, see the [GR-63-CORE, Network Equipment Building System \(NEBS\) Requirements: Physical Protection](#) document.

Site Power Guidelines

The Cisco ASR 920 Series Router has specific power and electrical wiring requirements. Adhering to these requirements ensures reliable operation of the system. Follow these precautions and recommendations when planning your site power for the Cisco ASR 920 Series Router:

- The redundant power option provides a second, identical power supply to ensure that power to the chassis continues uninterrupted if one power supply fails or input power on one line fails.
- Connect each of the two power supplies to a separate input power source. If you fail to do this, your system might be susceptible to total power failure due to a fault in the external wiring or a tripped circuit breaker.
- To prevent a loss of input power, be sure that the total maximum load on each circuit supplying the power supplies is within the current ratings of the wiring and the breakers.
- Check the power at your site before installation, and periodically after installation to ensure that you are receiving clean power. Install a power conditioner, if necessary.
- Provide proper grounding to avoid personal injury and damage to the equipment due to lightning striking power lines or due to power surges. The chassis ground must be attached to a central office or other interior ground system.

**Caution**

This product requires short-circuit (overcurrent) protection to be provided as part of the building installation. Install only in accordance with national and local wiring regulations.

**Note**

The Cisco ASR 920 Series Router installation must comply with all the applicable codes, and is approved for use with copper conductors only. The ground bond-fastening hardware should be of compatible material and preclude loosening, deterioration, and electrochemical corrosion of hardware and joined material. Attachment of the chassis ground to a central office or other interior ground system must be made with a 6-AWG gauge wire copper ground conductor at a minimum.

For information on power specifications, see Table 1-2 .

Electrical Circuit Requirements

Each Cisco ASR 920 Series Router requires a dedicated electrical circuit. If you equip the router with dual-power feeds, provide a separate circuit for each power supply to avoid compromising the power redundancy feature.

The Cisco ASR 920 Series Routers can be powered by a DC source or an AC source. Ensure that equipment grounding is present and observe the power-strip ratings. Make sure that the total ampere rating of all the products plugged into the power strip does not exceed 80% of the rating.

Site Cabling Guidelines

This section contains guidelines for wiring and cabling at your site. When preparing your site for network connections to the Cisco ASR 920 Series Router, consider the type of cable required for each component, and the cable limitations. Consider the distance limitations for signaling, electromagnetic interference (EMI), and connector compatibility. Possible cable types are fiber, thick or thin coaxial, foil twisted-pair, or unshielded twisted-pair cabling.

Also consider any additional interface equipment you need, such as transceivers, hubs, switches, modems, channel service units (CSU), or data service units (DSU).

Before you install the Cisco ASR 920 Series Router, have all the additional external equipment and cables on hand. For information about ordering, contact a Cisco customer service representative.

The extent of your network and the distances between the network interface connections depend, in part, on the following factors:

- Signal type
- Signal speed
- Transmission medium

The distance and rate limits referenced in the following sections are the IEEE-recommended maximum speeds and distances for signaling purposes. Use this information as a guideline when planning your network connections *>prior to* installing the Cisco ASR 920 Series Router.

If wires exceed the recommended distances, or if wires pass between buildings, give special consideration to the effect of a lightning strike in your vicinity. The electromagnetic pulse caused by lightning or other high-energy phenomena can easily couple enough energy into unshielded conductors to destroy electronic devices. If you have had problems of this sort in the past, you may want to consult experts in electrical surge suppression and shielding.

Asynchronous Terminal Connections

The Cisco ASR 920 Series Router provides a console port to connect a terminal or computer for local console access. The port has an RJ-45 connector and supports RS-232 asynchronous data with distance recommendations specified in the IEEE RS-232 standard.

Interference Considerations

When wires are run for any significant distance, there is a risk that stray signals will be induced on the wires as interference. If interference signals are strong, they may cause data errors or damage to the equipment.

The following sections describe the sources of interference and how to minimize their effects on the Cisco ASR 920 Series Router system.

Electromagnetic Interference

All the equipment powered by AC current can propagate electrical energy that can cause EMI and possibly affect the operation of other equipment. The typical sources of EMI are equipment power cords and power service cables from electric utility companies.

Strong EMI can destroy the signal drivers and receivers in the Cisco ASR 920 Series Router and even create an electrical hazard by causing power surges through the power lines into installed equipment. These problems are rare, but could be catastrophic.

To resolve these problems, you need specialized knowledge and equipment that could consume substantial time and money. However, you can ensure that you have a properly grounded and shielded electrical environment, paying special attention to the need for electrical surge suppression.

For information about the electrode magnetic compliance standards supported on the Cisco ASR 920 Series Router, see the Regulatory Compliance and Safety Information for the Cisco ASR 920 Series Aggregation Services Router document.

Radio Frequency Interference

When electromagnetic fields act over a long distance, radio frequency interference (RFI) may be propagated. Building wiring can often act as an antenna, receiving the RFI signals and creating more EMI on the wiring.

If you use a twisted-pair cable in your plant wiring with a good distribution of grounding conductors, the plant wiring is unlikely to emit radio interference. If you exceed the recommended distances, use a high-quality twisted-pair cable with one ground conductor for each data signal.

Lightning and AC Power Fault Interference

If signal wires exceed the recommended cabling distances, or if signal wires pass between buildings, you should consider the effect that a lightning strike in your vicinity might have on the Cisco ASR 920 Series Router.

The electromagnetic pulse (EMP) generated by lightning or other high-energy phenomena can couple enough energy into unshielded conductors to damage or destroy electronic equipment. If you have previously experienced such problems, you should consult with RFI and EMI experts to ensure that you have adequate electrical surge suppression and shielding of signal cables in your Cisco ASR 920 Series Router operating environment.

Rack-Mounting Guidelines

The following sections provide guidelines for rack-mounting the Cisco ASR 920 Series Router:

Precautions for Rack-Mounting

The following rack-mount guidelines are provided to ensure your safety:

- Ensure that the rack is level and stable before extending a component from the rack.
- Ensure that proper airflow is provided to the components in the rack.
- Do not step on or stand on any component or system when servicing other systems or components in a rack.
- When mounting the Cisco ASR 920 Series Router in a partially filled rack, load the rack from the bottom to the top, with the heaviest component at the bottom of the rack.
- If the rack is provided with stabilizing devices, install the stabilizers before mounting or servicing the unit in the rack.

Rack Selection Guidelines

The Cisco ASR 920 Series Router can be mounted in most two-post or four-post, 19-inch equipment racks that comply with the Electronic Industries Association (EIA) standard for equipment racks (EIA-310-D 19-inch). The rack must have at least two posts with mounting flanges to mount the chassis.



Caution When mounting a chassis in any type of rack equipment, ensure that the inlet air to the chassis does not exceed 70° C.

The distance between the center lines of the mounting holes on the two mounting posts must be 18.31 inch \pm 0.06 inch (46.50 cm \pm 0.15 cm). The rack-mounting hardware included with the chassis is suitable for most 19-inch equipment racks.

Consider installing the Cisco ASR 920 Series Router in a rack with the following features:

- NEBS-compliant, 19-inch wide (48.3-cm) rack.
- EIA or European Telecommunications Standards Institute (ETSI) hole patterns in the mounting rails. The required mounting hardware is shipped with the Cisco ASR 920 Series Router. If the rack that you

plan to install the system in has metric-threaded rails, you must provide your own metric-mounting hardware.

- Perforated top and open bottom for ventilation to prevent overheating.
- Leveling feet for stability.

The Cisco ASR 920 Series Router is not recommended to be installed in an enclosed rack because the chassis requires an unobstructed flow of cooling air to maintain acceptable operating temperatures for its internal components. If you use an enclosed rack, ensure that the air flow requirements are maintained as discussed in Air Flow Guidelines, page 2-11 .

Equipment Rack Guidelines

The placement of a rack can affect personnel safety, system maintenance, and the system's ability to operate within the environmental characteristics. Choose a proper location for the Cisco ASR 920 Series Router by following the guidelines described here.

Locating for Safety

If the Cisco ASR 920 Series Router is the heaviest or the only piece of equipment in the rack, consider installing it at or near the bottom to ensure that the rack's center of gravity is as low as possible.

For additional information about the proper placement of electronic equipment, consult the [GR-63-CORE, Network Equipment Building System \(NEBS\) Requirements: Physical Protection](#) document.

Locating for Easy Maintenance

It is recommended that you maintain a minimum clearance distance as mentioned below, at all times.

- front clearance—12.7 cm
- rear clearance—10 cm

This space ensures that you can remove the Cisco ASR 920 Series Router components and perform routine maintenance and upgrades easily.

Avoid installing the Cisco ASR 920 Series Router in a congested rack and consider how routing of cables from other pieces of equipment in the same rack could affect access to the router cards.

The front and rear of the chassis must remain unobstructed to ensure adequate airflow and prevent overheating inside the chassis.

To avoid problems during installation and ongoing operations, follow these general precautions when you plan equipment locations and connections:

- Use the **show environment all** command regularly to check the internal system status. The environmental monitor continually checks the interior chassis environment; it provides warnings about high temperature and creates reports on other potentially dangerous occurrences. If warning messages are displayed, take immediate action to identify the cause, and correct the problem.
- Keep the Cisco ASR 920 Series Router off the floor and out of areas that collect dust.
- Follow ESD-prevention procedures to avoid damage to equipment. Damage from static discharge can cause immediate or intermittent equipment failure.

Locating for Proper Airflow

Ensure that the Cisco ASR 920 Series Router location has enough airflow to keep the system operating within the environmental characteristics and the air temperature is sufficient to compensate for the heat dissipated by the system. For more information, see the "Air Flow Guidelines" section on page 11 .

Installation Checklist

To assist you with your installation and to provide a record of what was done by whom and when, photocopy the Cisco ASR 920 Series Router Installation Checklist shown in the table below. Use this to record the completion and verification of each procedure. After the checklist is completed, place it in your Site Log along with the other records pertaining to your new Cisco router.

Table 12: Cisco ASR 920 Series Router Installation Checklist

Task	Verified By	Date
Date on which chassis received		
Chassis and all accessories unpacked		
Types and numbers of interfaces verified		
Safety recommendations and guidelines reviewed		
Installation Checklist copied		
Site Log established and background information entered		
Site power voltages verified		
Site environmental specifications verified		
Required passwords, IP addresses, device names, and so on, available		
Required tools available		
Network connection equipment available		
Cable-management brackets installed (optional, but recommended)		
AC power cables connected to AC sources and router		
DC power cables connected to DC sources and router		
Network interface cables and devices connected		
System power turned on		
System boot complete (STATUS LED is on)		
Correct software configuration displayed after system banner appears		

Creating a Site Log

The Site Log provides a record of all the actions that are related to installing and maintaining the router. Keep it in an accessible place near the chassis so that anyone who performs tasks has access to it.

Create the Site Log before the installation. (See “Site Log” for more information about the Site Log and a sample Site Log that can be used to make copies.)

Receiving the Cisco ASR 920 Series Router

Each Cisco ASR 920 Series Router chassis is shipped in a container that is strapped to a pallet, as illustrated in the figure below.

Figure 5: Cisco ASR 920 Series Router Packaged for Shipping

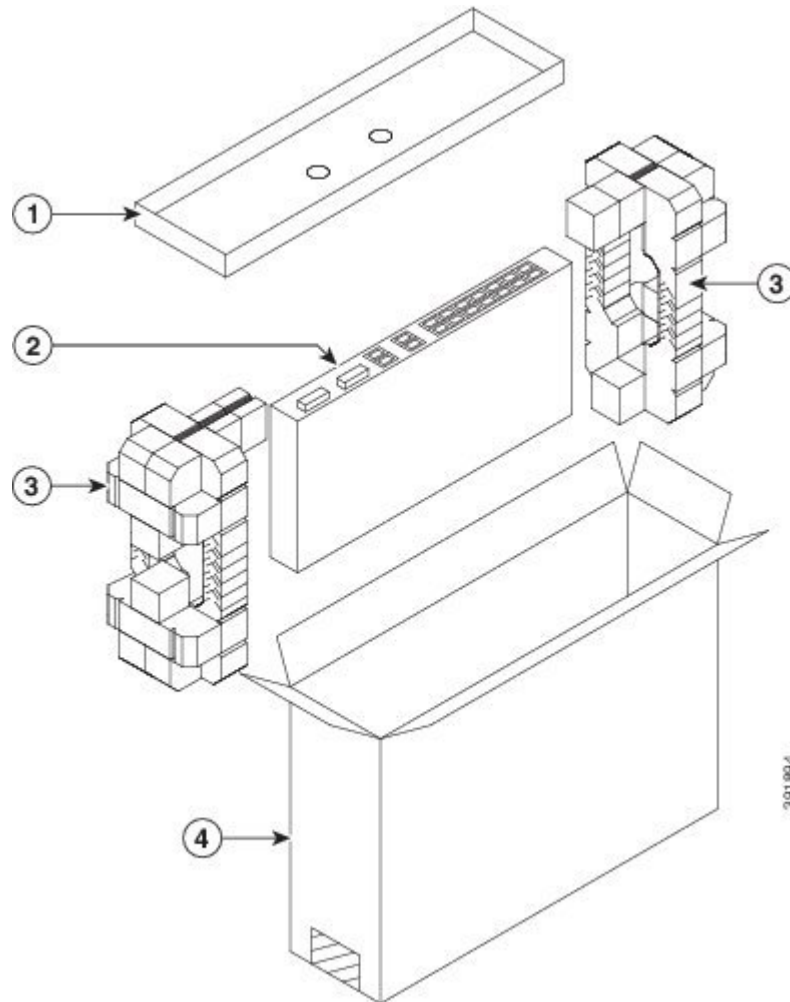

Label	Description	Label	Description
1	Outside carton for accessories	3	Assembly packaging material
2	Router	4	Packing carton

Chassis-Lifting Guidelines

The chassis is not intended to be moved frequently. Before you install the device, ensure that your site is properly prepared to accommodate power sources and network connections.

Each time that you lift the chassis or any heavy object, follow these guidelines:

- Ensure that your footing is solid, and balance the weight of the chassis between your feet.
- Lift the chassis slowly; never move suddenly or twist your body as you lift.
- Keep your back straight and lift with your legs, not your back. If you must bend down to lift the chassis, bend at the knees, not at the waist, to reduce the strain on your back muscles.
- Do not remove installed components from the chassis.
- Always disconnect all external cables before lifting or moving the chassis.



Warning

To prevent personal injury or damage to the device, never attempt to lift or tilt the device using the module handles (power supplies, fans, or cards). As these types of handles are not designed to support the weight of the unit. Lift the unit only by using handles that are part of the device, or by grasping the device underneath its lower edge. Statement 163

Tools and Equipment

You need the following tools and equipment to install and upgrade the device and its components:

- ESD-preventive cord and wrist strap
- Antistatic mat or antistatic foam
- Number 1 and Number 2 Phillips-head screwdrivers
- #12-24 pan-head screws to secure the device to the equipment rack.
- Cables for connecting to network ports (based on the configuration)
- Ethernet hub, switch, or PC with a network interface card for connecting to the Ethernet ports
- Console terminal that is configured for 9600 baud, 8 data bits, no parity, no flow control, and 1 stop bit.
- Console cable for connecting to the console port
- Ratcheting torque screwdriver with a Phillips head that exerts up to 30-pound force per square inch (0.02-kilograms force per square millimeter (kgf/mm²)) of pressure.
- Crimping tool as specified by the ground lug manufacturer
- Wire-stripping tools for stripping both 6 and 14-AWG wires
- Tape measure and level
- Ratcheting torque screwdriver with a Phillips head that exerts up to 15 inch-pounds (1.69 newton meters) of torque for attaching the ground wire to the device.

Unpacking and Verifying the Shipped Contents

When you receive your chassis, perform the following steps:

1. Inspect the box for any shipping damage. If there is obvious physical damage, contact your Cisco service representative.
2. Unpack the Cisco ASR 920 Series Router.
3. Perform a visual inspection of the chassis.

4. Use the table below to check the contents of the Cisco ASR 920 Series Router shipping container. Do not discard the shipping container. You will need the container if you move or ship the Cisco ASR 920 Series Router in the future.

Table 13: Cisco ASR 920 Series Router Default Shipping Container Contents

Component	Description
Chassis	Cisco ASR 920 Series Router chassis
Accessories kit	Chassis rack-mount brackets (19-inch EIA) with eight screws
	Two cable guides with two screws
	One earth lug with two 10-32 screws.
	USB Type-A to USB Type-A cable
ESD, wrist strap (disposable)	One disposable wrist strap (optional)
Documentation	Cisco ASR 920 Series Aggregation Services Router Pointer Card
Optional equipment	<p>Check the container for the following optional equipment:</p> <ul style="list-style-type: none"> • Power cord if an AC power supply was shipped. There are no cords for the DC power supply units. <p>Note If you do not specify the type of power cable, US power cable for the AC router variant is supplied.</p>



Note Most Cisco documentation is available online. The Cisco ASR 920 Series Aggregation Services Router Pointer Card that is shipped with your Cisco ASR 920 Series Router contains links and information about the various documents that are available online.



CHAPTER 3

Installing the Cisco ASR 920 Series Router

This chapter describes how to install the Cisco ASR 920 Series Router and includes the following sections:

- [Prerequisites, on page 33](#)
- [Installing the Router in a Rack, on page 33](#)
- [Wall Mounting the Router, on page 40](#)
- [Install the AC Power Cables, on page 43](#)
- [Install the DC Power Supply, on page 45](#)
- [Connect SFP Modules, on page 48](#)
- [Connect Gigabit Ethernet Ports, on page 51](#)
- [Install the Chassis Ground Connection, on page 53](#)
- [Power Connection Guidelines, on page 55](#)
- [Connect Chassis to Network, on page 57](#)

Prerequisites

Before installing the Cisco ASR 920 Series Router, it is important to prepare for the installation by:

- Preparing the site (site planning) and reviewing the installation plans or method of procedures (MOP). See “Site Planning” section on page 2-9 .
- Unpacking and inspecting the Cisco ASR 920 Series Router. See “Receiving the Cisco ASR 920 Series Router” section on page 2-20 .
- Gathering the tools and test equipment required to properly install the Cisco ASR 920 Series Router. See “Tools and Equipment” section on page 2-21 .

For more instructions on how to prepare for the installation of the Cisco ASR 920 Series Router, see Chapter 2, “Preparing for Installation.”

Installing the Router in a Rack

The following sections describe how to install the Cisco ASR 920 Series Router in a rack. The procedures in this section apply to both horizontal and vertical mounting of the router in a rack:

Installing the Chassis Brackets

The chassis is shipped with mounting brackets that can be installed on the front or rear of the chassis. To install the brackets on the front of the chassis, perform these steps:

Procedure

Step 1 Remove the rack-mount brackets from the accessory kit and position them beside the router chassis.

The figure below shows how to attach the brackets at the front, middle, and rear positions on the Cisco ASR 920 Series Router for a 19-inch EIA rack.

Figure 6: Attaching Mounting Brackets for a 19-inch EIA Rack (Front, Middle, and Rear Positions)

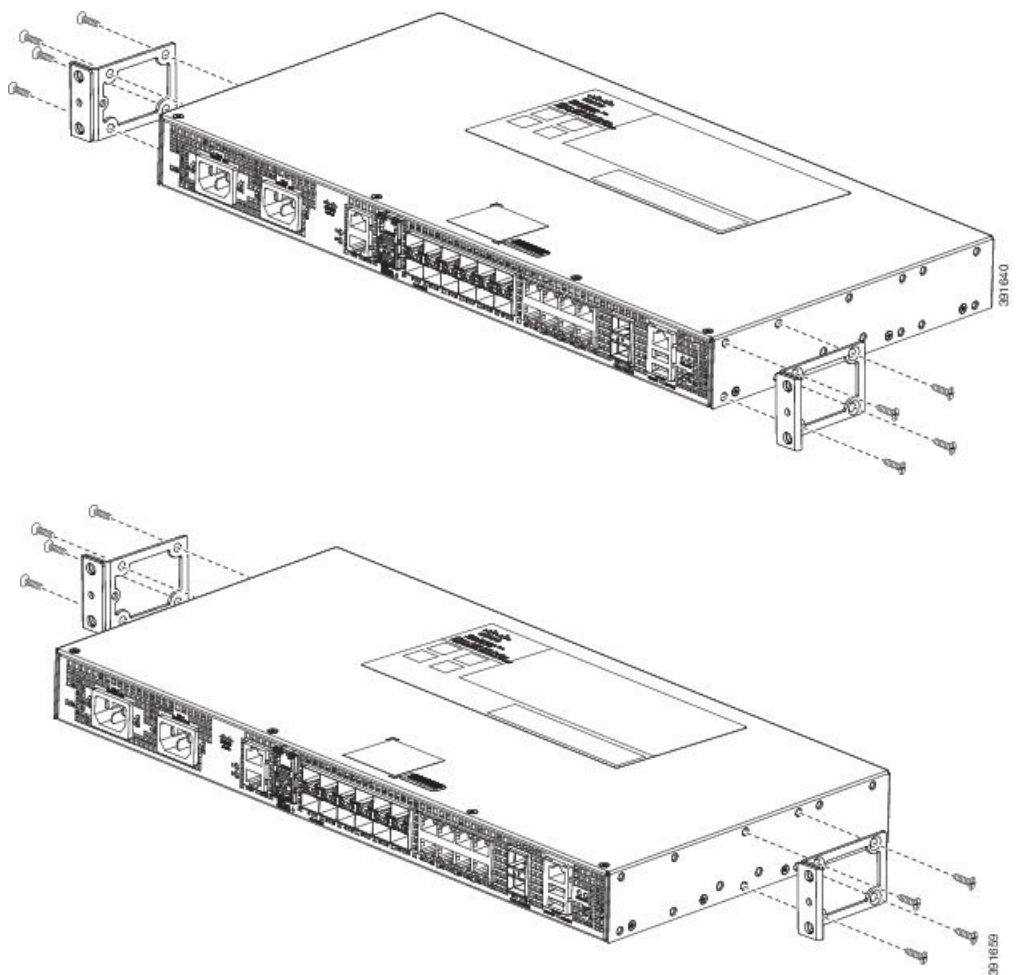

Figure 7: Shows how to attach the brackets on the Cisco ASR 920 Series Router for a 23-inch cabinet.

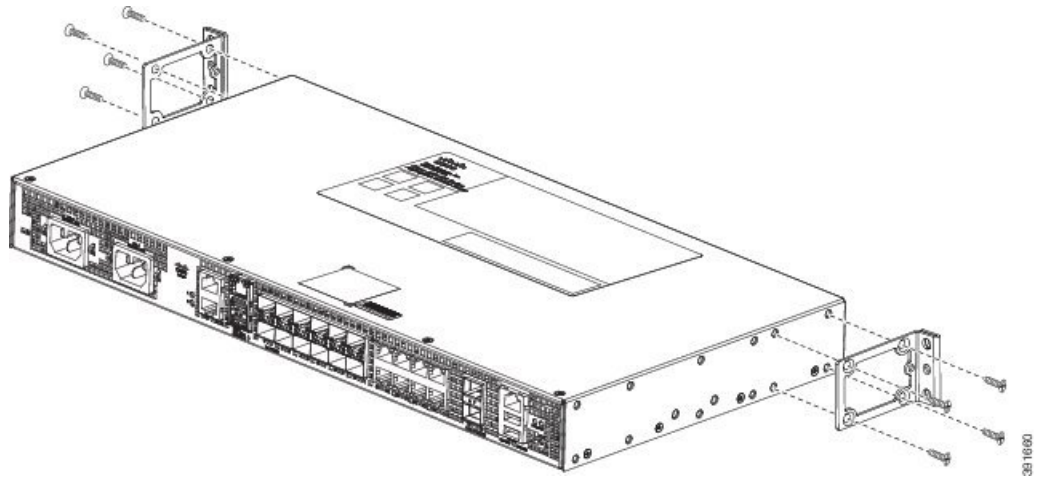
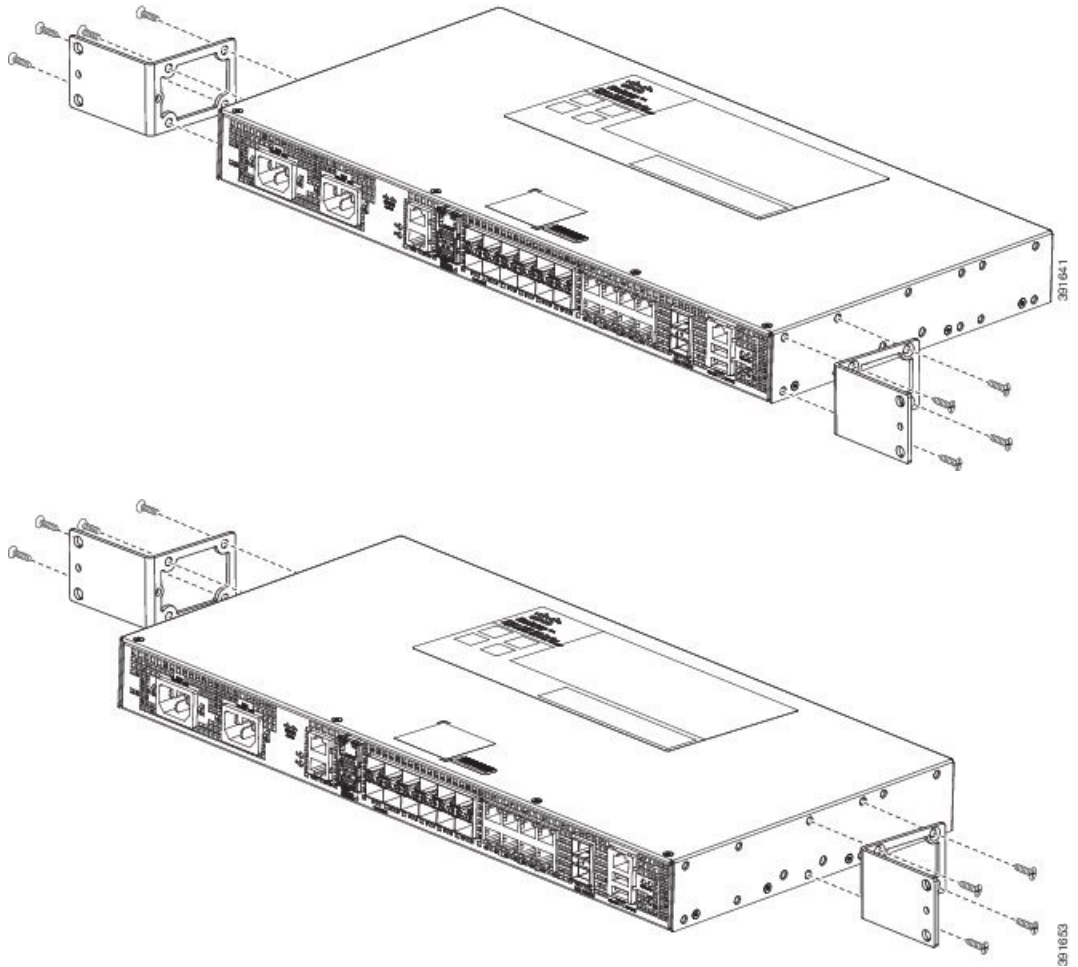

Figure 8: Attaching Mounting Brackets for a 23-inch Cabinet (Front, Middle, and Rear Positions)



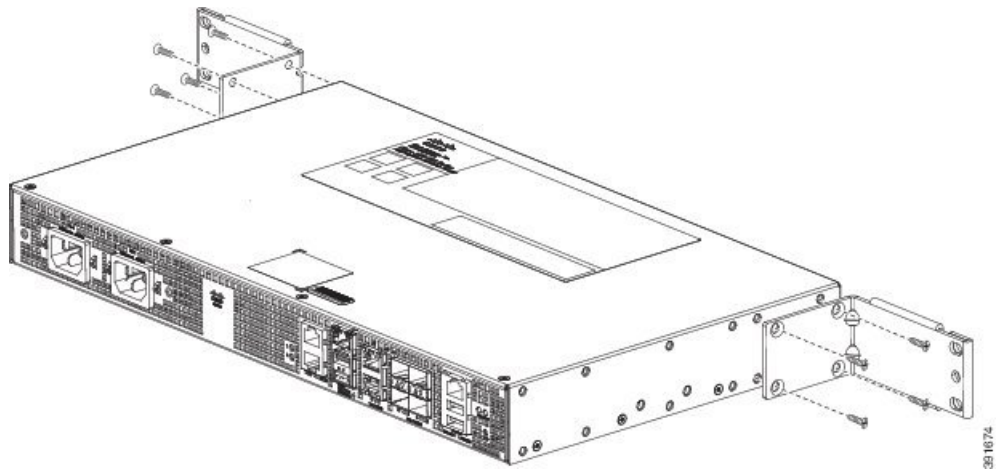
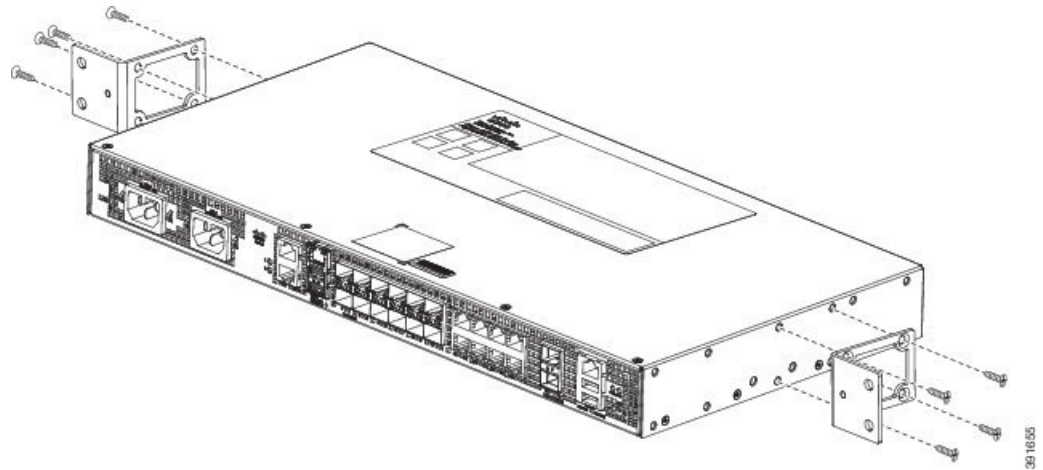
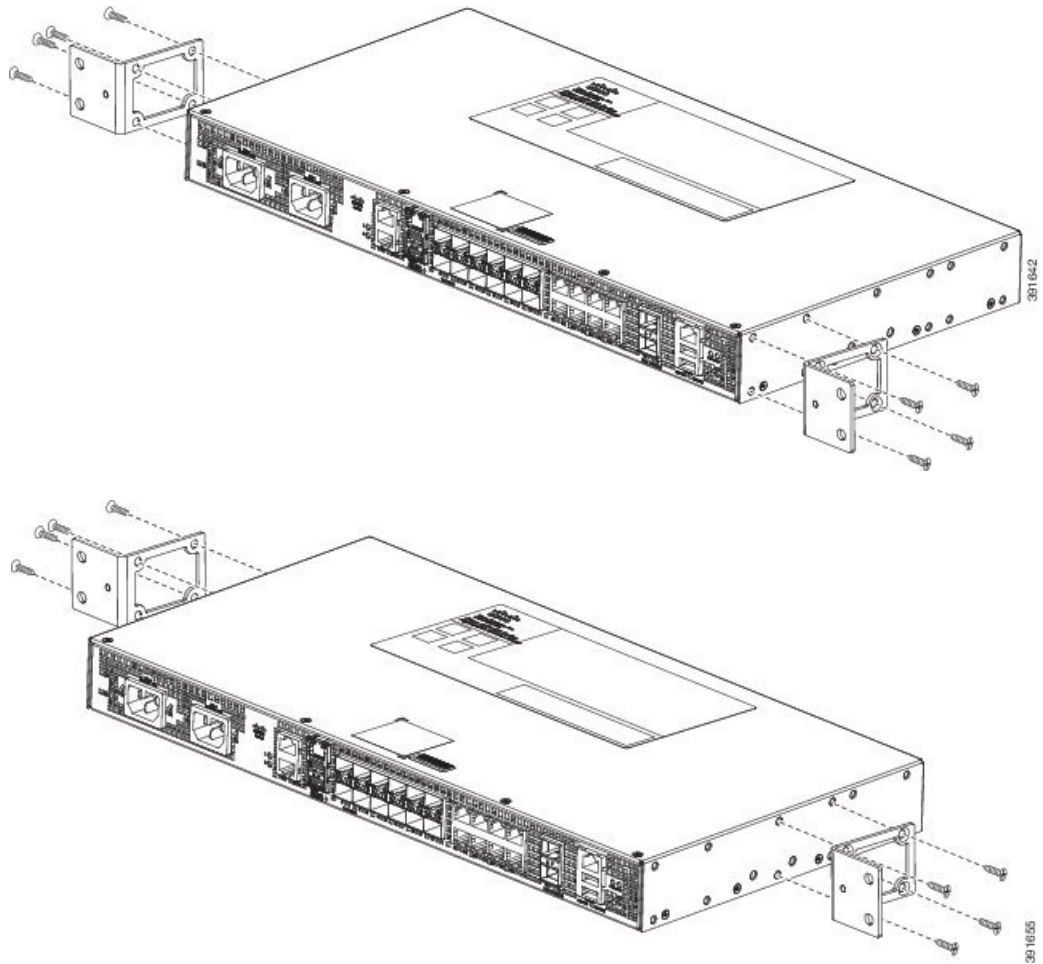
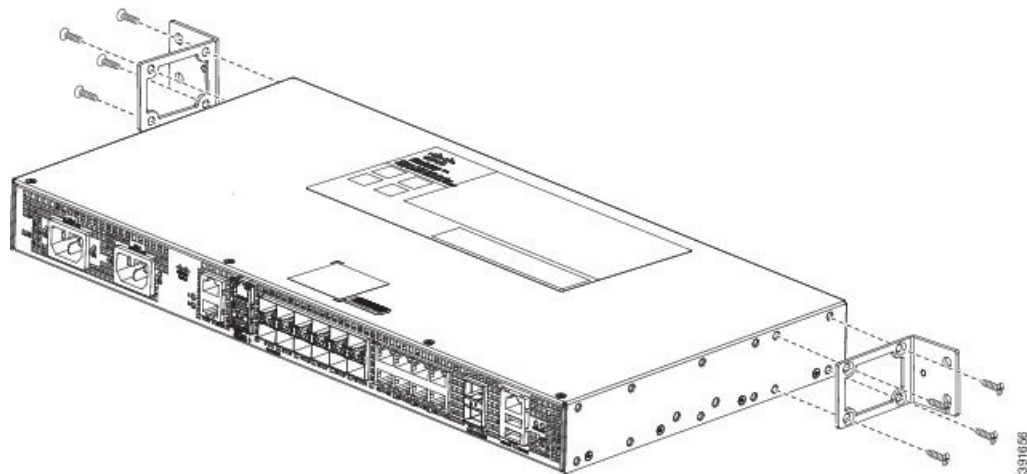

Figure 9: Attaching Mounting Brackets for a 300 mm ETSI Cabinet (Front, Middle, and Rear Positions)





- Step 2** Position one of the brackets against the chassis side, and align the screw holes.
- Step 3** Secure the bracket to the chassis with the screws removed when performing Step 1 . The recommended maximum torque is 10 in.-lb.
- Step 4** Repeat Step 2 and Step 3 for the other bracket.

Installing the Router Chassis in the Rack



Note Ensure adequate air flow when mounting the router in a rack. For more information, see the “Air Flow Guidelines” section on page 11 .



Note Install the cable guides before installing the router in a 19-inch EIA rack. See [Attaching the Cable Guides](#).

To install the router chassis in the equipment rack, perform these steps:

Procedure

- Step 1** Position the chassis in the rack as follows:
- If the front of the chassis (front panel) is at the front of the rack, insert the rear of the chassis between the mounting posts.
 - If the rear of the chassis is at the front of the rack, insert the front of the chassis between the mounting posts.
- Step 2** Align the mounting holes in the bracket (and optional cable guide) with the mounting holes in the equipment rack.

The following figure shows how to install the Cisco ASR 920 Series Router in a 19-inch EIA rack.

Figure 10: Installing the Chassis in a 19-inch EIA Rack

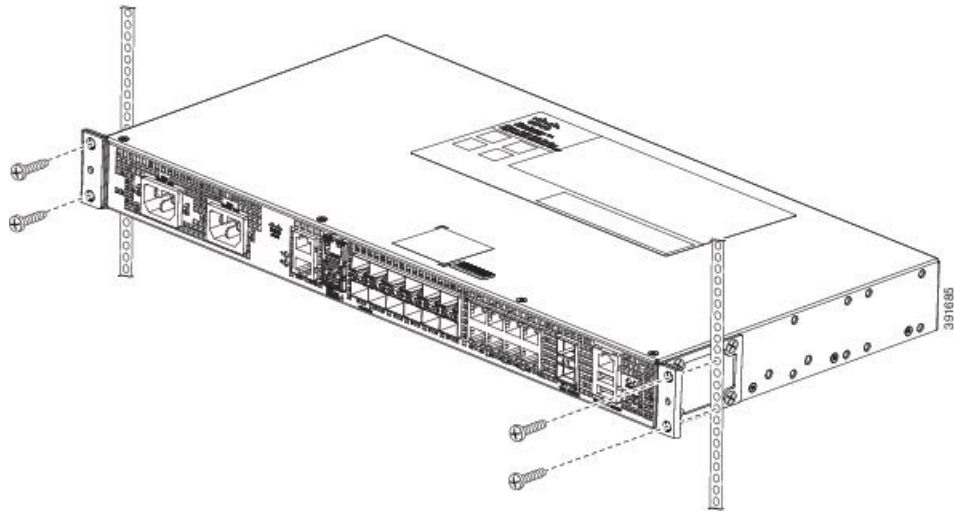

- Step 3** Install the four M6x12mm zinc-plated steel screws through the holes in the bracket and into the threaded holes in the equipment rack posts.
- Step 4** Use a tape measure and level to verify that the chassis is installed straight and level.

Attaching the Cable Guides

The Cisco ASR 920 Series Router supports the following cable guides:

- A920-CBL-GUIDE (left and right)—help in routing the cables from all components on the front panel thereby enabling a proper cable-bending radius.



Note If the chassis is mounted using 19-inch brackets, you must assemble the cable guides before installing the chassis on the rack.

To install the cable guides, perform these steps:

Procedure

- Step 1** Position the cable guide-left and cable guide-right against the front of the chassis and align the four screw holes, as shown in the figure below.

Figure 11: Cable Guide Installation For 19-inch Rack Brackets

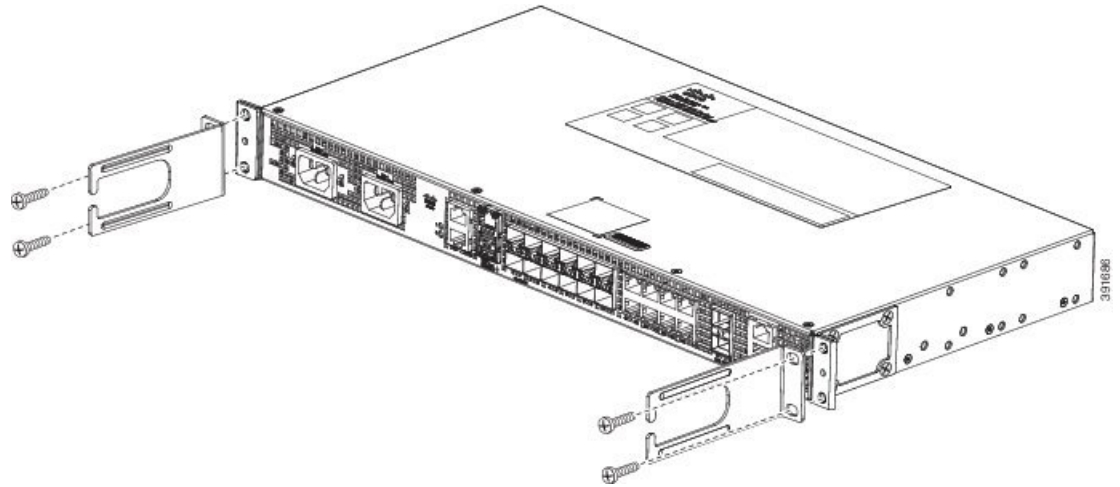
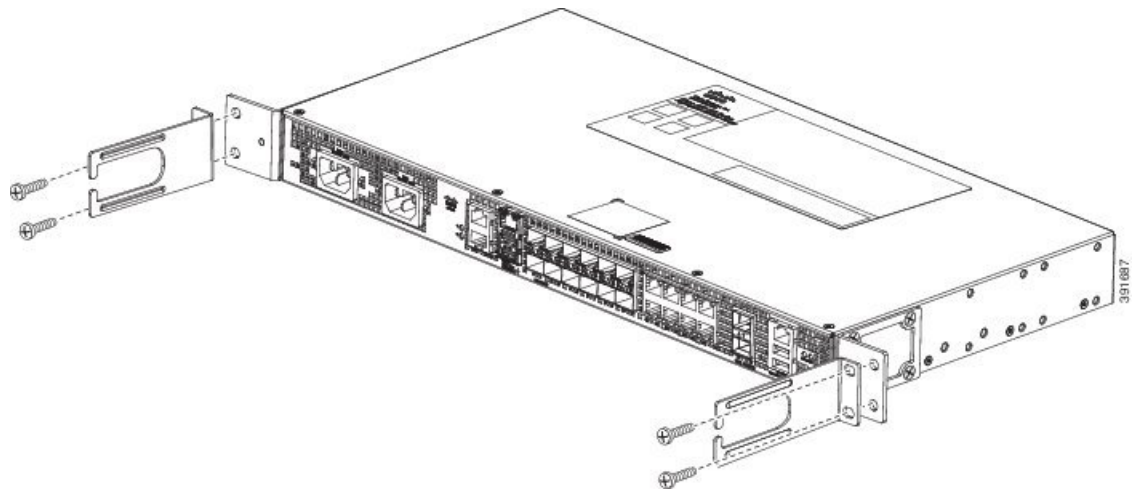
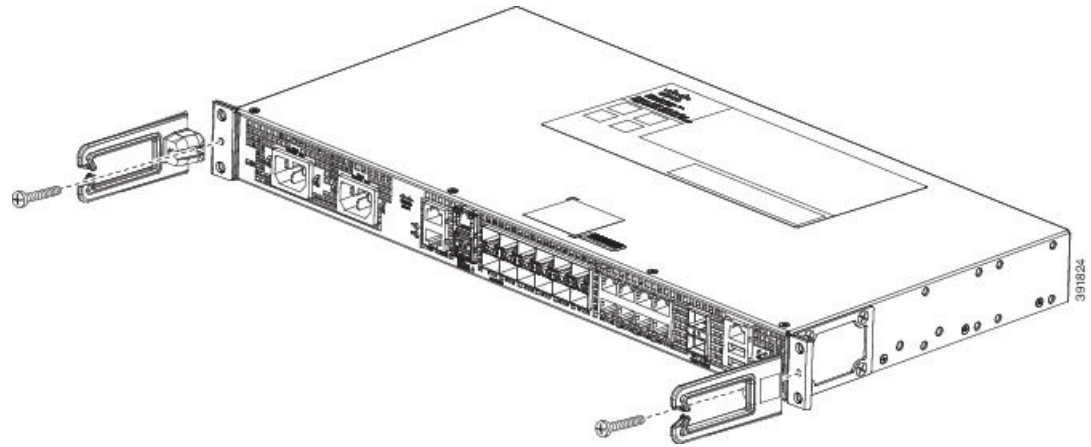

Figure 12: Cable Guide Installation For ETSI Rack Brackets



- Step 2** Secure the cable guides with the four M6x12mm screws supplied with the cable kit. The recommended maximum torque is 3N-m.

Figure 13: Installing the Cable Guides (As Per the Standard Kit)



Wall Mounting the Router

To install the router on a wall, follow the instructions in these procedures:

Attaching the Brackets to the Router for Wall-Mounting



Note While wall mounting the router, always ensure that the power supplies are at the top position.

The figure below shows how to attach a 19-inch bracket to one side of the router. Follow the same steps to attach the second bracket to the opposite side.

Figure 14: Attaching 19-inch Brackets for Wall Mounting

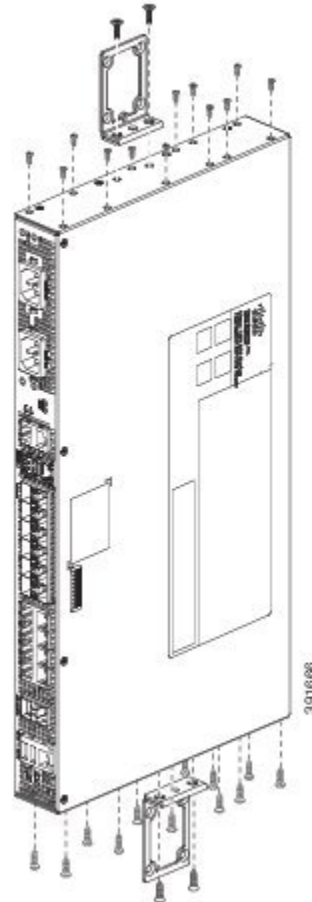

Mounting the Router on the Wall

For the best support of the router and cables, ensure the router is attached securely to wall studs or to a firmly attached plywood mounting backboard.



Warning Suitable for mounting on and over a concrete or other non-combustible surface only. Statement 345



Caution Before mounting the router, ensure that all unused holes at the sides of the router are always protected by screws.

Figure 15: Installing Screws in Unused Holes Before Wall Mounting the Router

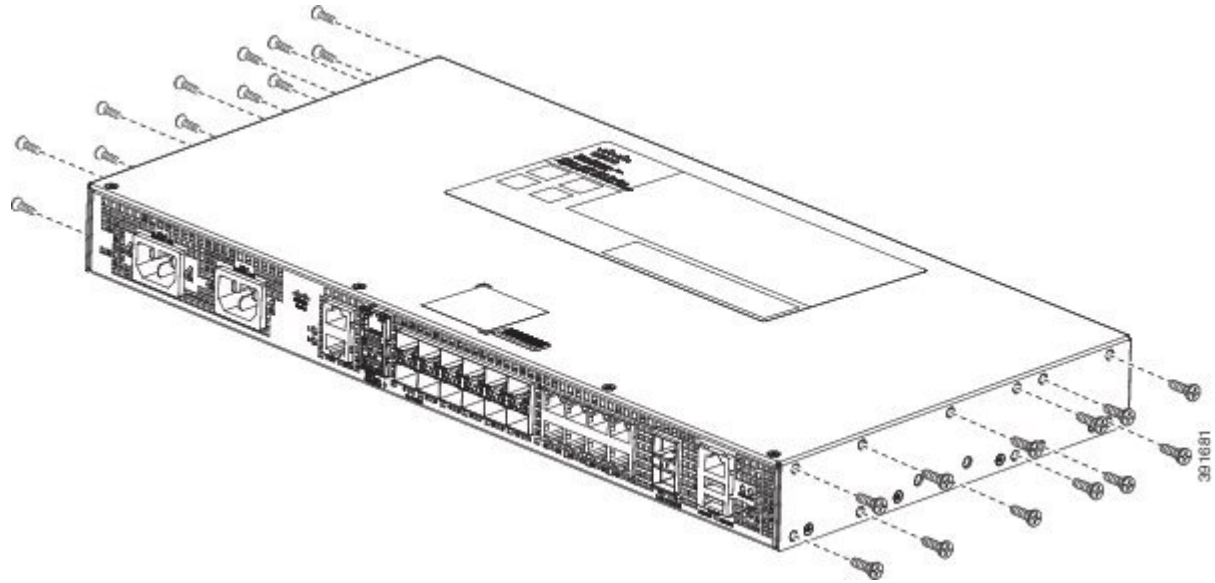

Mount the router with the front panel as shown in the following figure.

Figure 16: Mounting the Router on the Wall

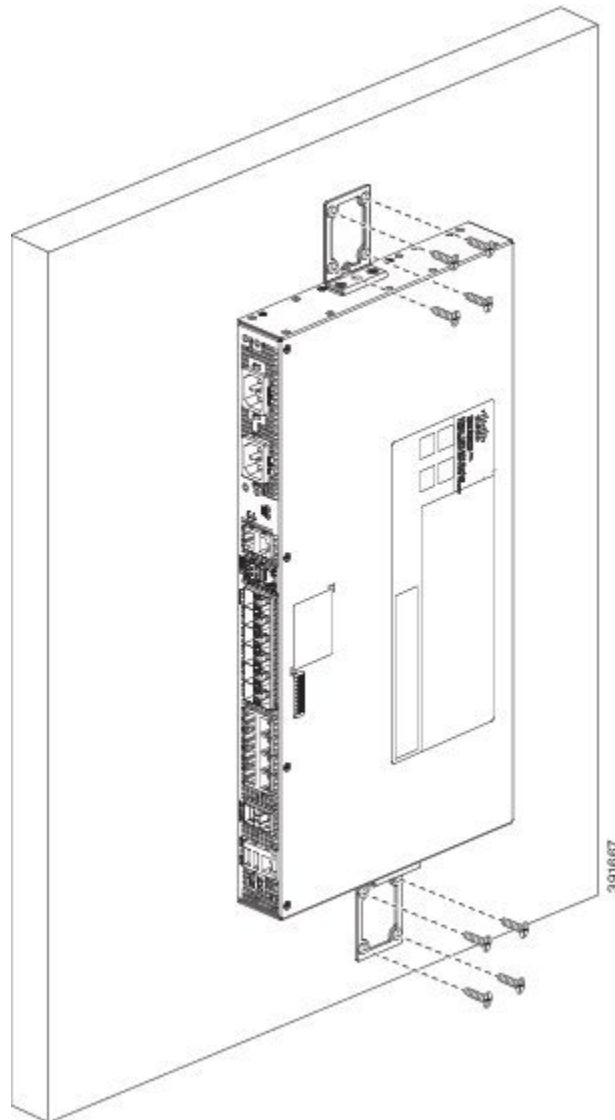

Caution When mounting the router vertically, ensure that the power supplies are at the top.

Install the AC Power Cables

To install the AC power cables in the power supply slots:



Note Ensure that the power cords are always secured with the help of a cable guide to avoid a cable overhang or any strain on the connector.

Procedure

Step 1 Attach the AC power retainer chord as shown in the figure below.

Figure 17: Attaching the AC Power Retainer Chord

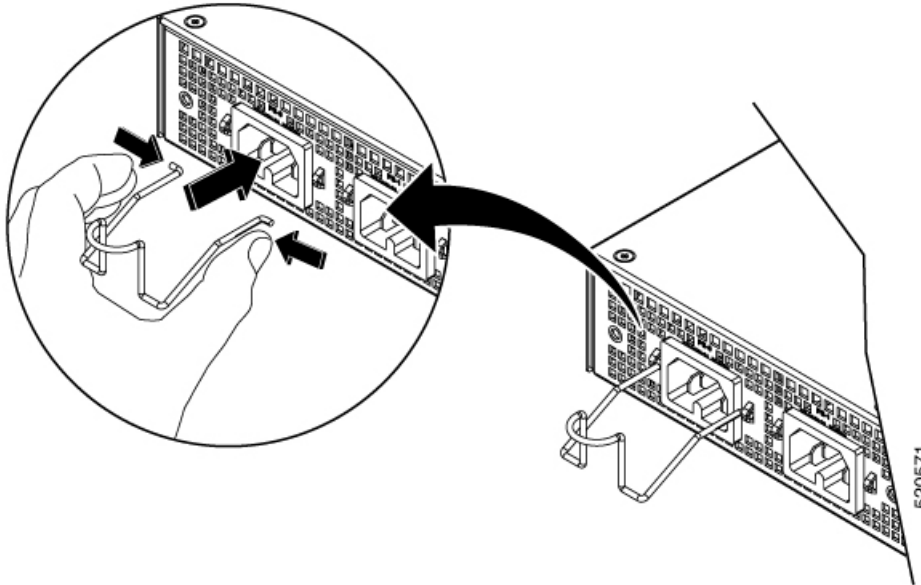

Step 2 Lift the power retainer and plug in the AC power supply.

Step 3 Push the retainer clip towards the power cord until it rests on the boot, this ensures accidental removal or drop-off of the power cord.

Figure 18: Locking the Power Retainer Chord

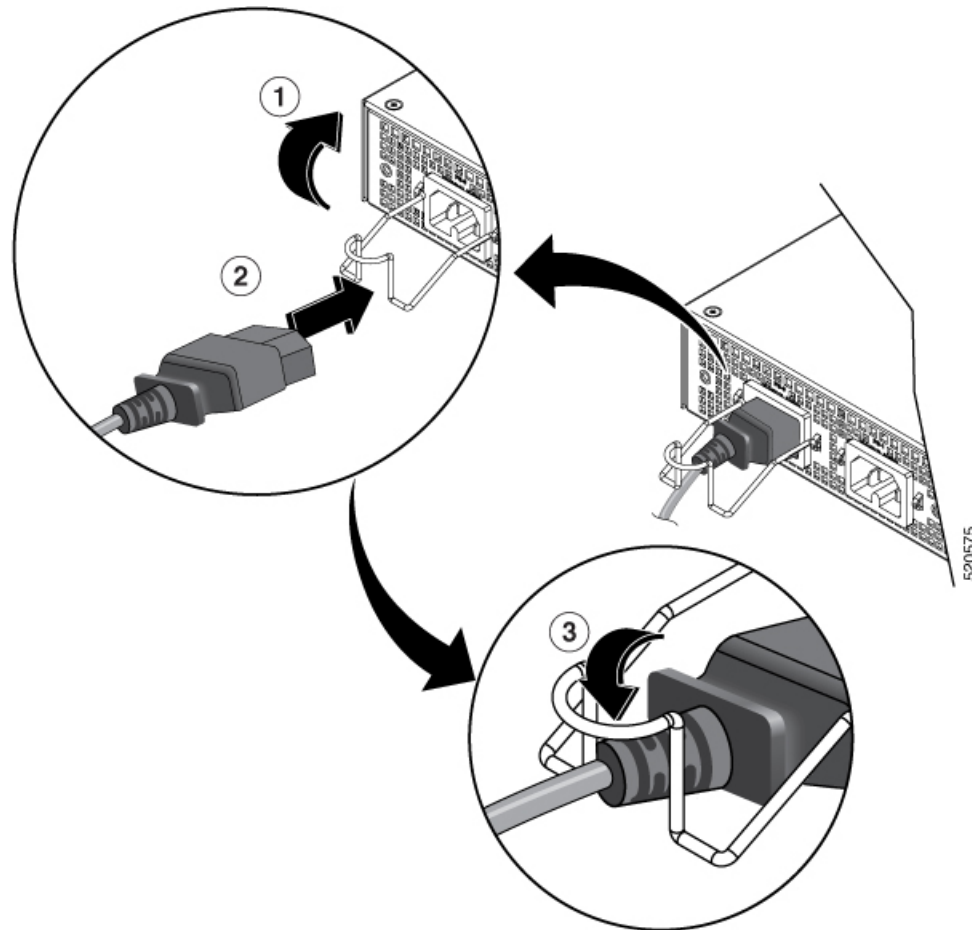

- Step 4** Connect the other end of the power cord to an AC-input power source.
- Step 5** Verify power supply operation by checking that the power supply LED is green.

Install the DC Power Supply



Note When installing DC power supply, use 14 AWG, 90°C wires. Always ensure that the building's installation for short-circuit (overcurrent) protection does not exceed 15A.



Note The DC connector or terminal block has an inbuilt screw and cage nut to which a torque of 1.3 to 1.8 N-m can be applied.

Figure 19: DC Connector With Inbuilt Screw

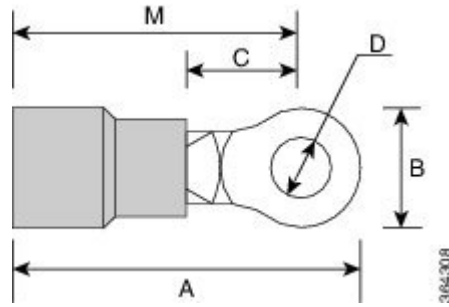

A	0.97 inches	C	0.27 inches
B	0.31 inches	M	0.81 inches

To attach the DC power supplies:

Procedure

-
- Step 1** Open the DC power supply guard.
- Step 2** Attach the DC supply wires in the designated screws. See the figure below.

Figure 20: Using the DC Power Supply Guard

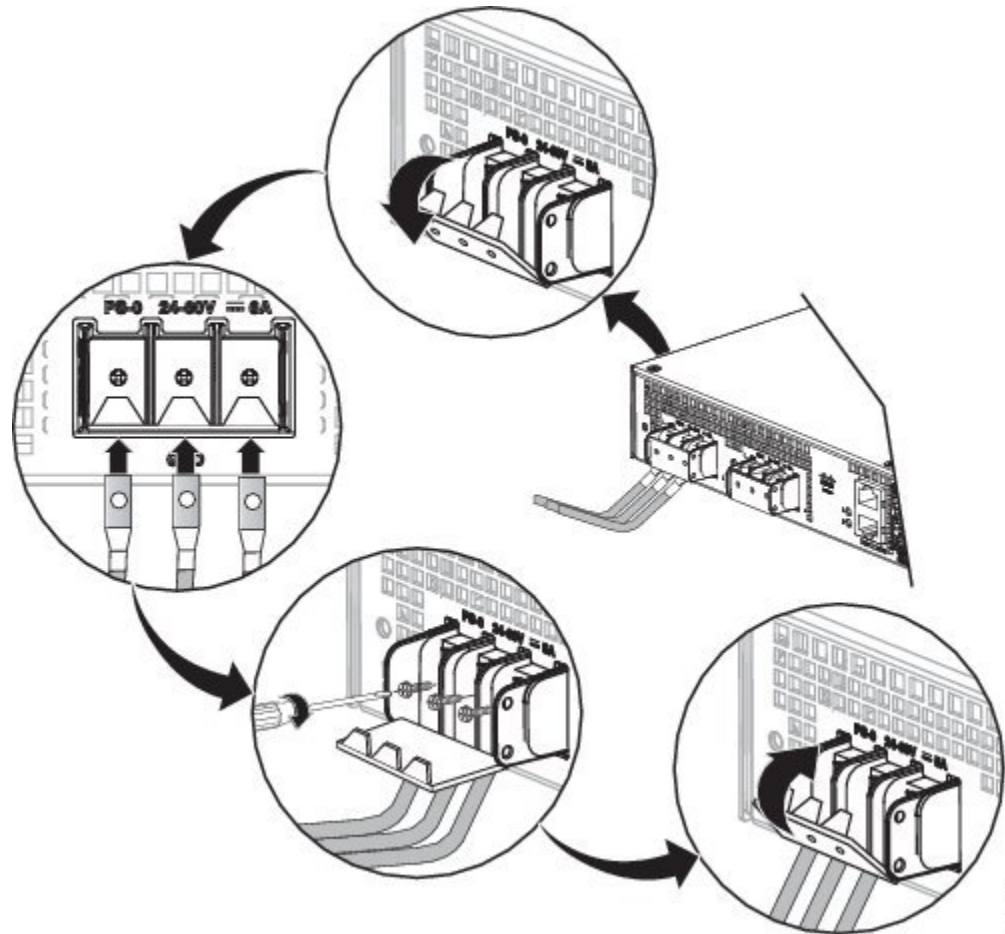
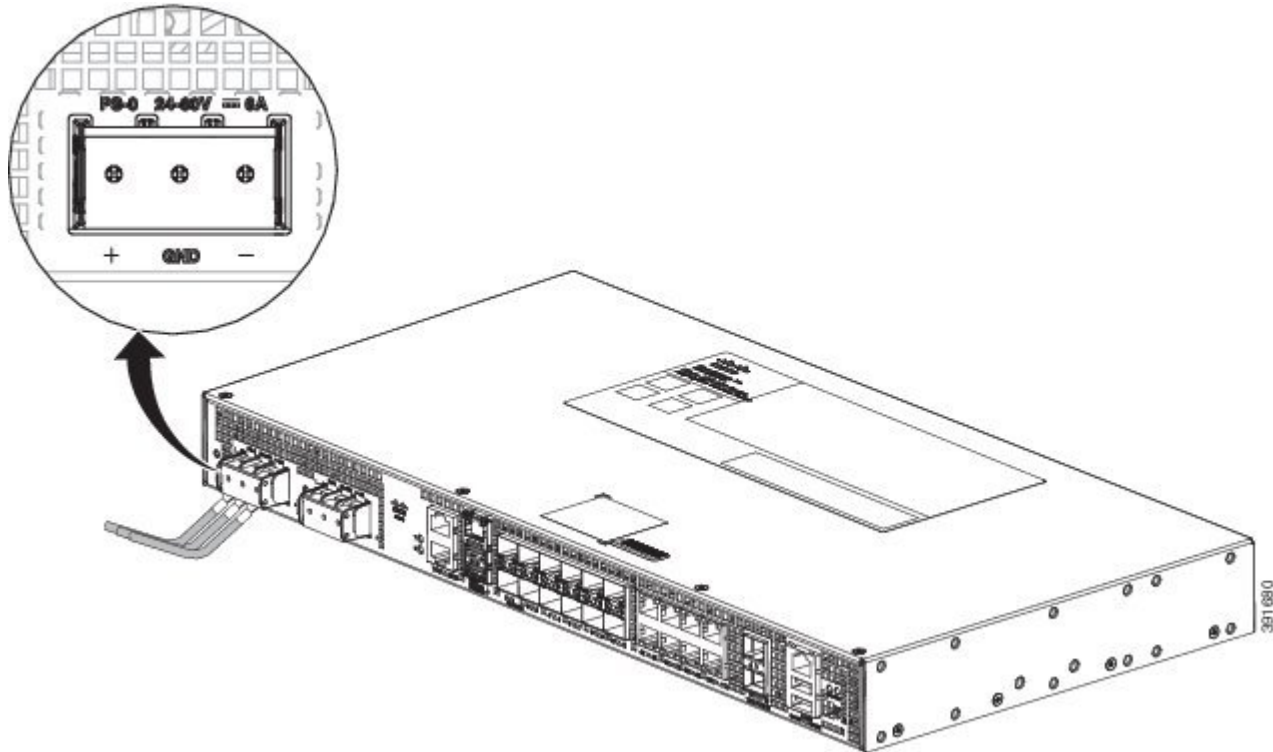

Figure 21: Attaching the DC Power Supply



Step 3 Close the DC power supply guard.

Power on the Device

After the device is mounted, perform these tasks to complete the installation:

- Power on the device.
- Connect the front-panel ports.

Connect SFP Modules

Before you begin this task, ensure that you have read and understood the safety warnings in the *Safety Precautions for Module Installation and Removal* section of the *Safety Warnings* chapter.

Use only Cisco SFP modules on a Cisco device. Each SFP module has an internal serial EEPROM that is encoded with security information. This encoding provides a way for Cisco to identify and validate that the SFP modules meet the requirements of the device.



Caution

We recommend that you wait for 30 seconds between the removal and insertion of an SFP module from the device. The wait period allows the transceiver software to initialize and synchronize with the device. Changing an SFP before this wait period could result in transceiver initialization issues that disable the SFP.

This section provides procedures for installing and connecting SFP modules. Also, it provides the procedure for removing SFP modules.

Install SFP Modules

The figure below shows an SFP module that has a bale-clasp latch.



Caution We strongly recommend that you do not install or remove fiber-optic SFP modules with cables attached because of the potential damage to the cables, the cable connector, or the optical interfaces in the SFP module. Disconnect all cables before removing or installing an SFP module.

Removing and installing an SFP module can shorten its useful life. Do not remove and insert SFP modules more often than is absolutely necessary.

Figure 22: SFP Module with a Bale-Clasp Latch

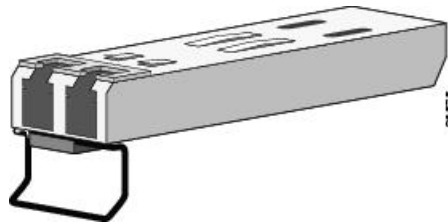

To insert an SFP module into the module slot, follow these steps:

Procedure

- Step 1** Attach an ESD-preventive wrist strap to your wrist and to a bare metal surface on the chassis.
Some SFP modules identify the top side of the module with send (TX) and receive (RX) markings or arrows that show the direction of the connection.
- Step 2** If the SFP module that you are using has the markings, use them to identify the top side of the module.
- Step 3** Align the SFP module in front of the slot opening.
- Step 4** Insert the SFP module into the slot until you feel the connector on the module snap into place in the rear of the slot.

Figure 23: Installing an SFP Module into an SFP Module Slot

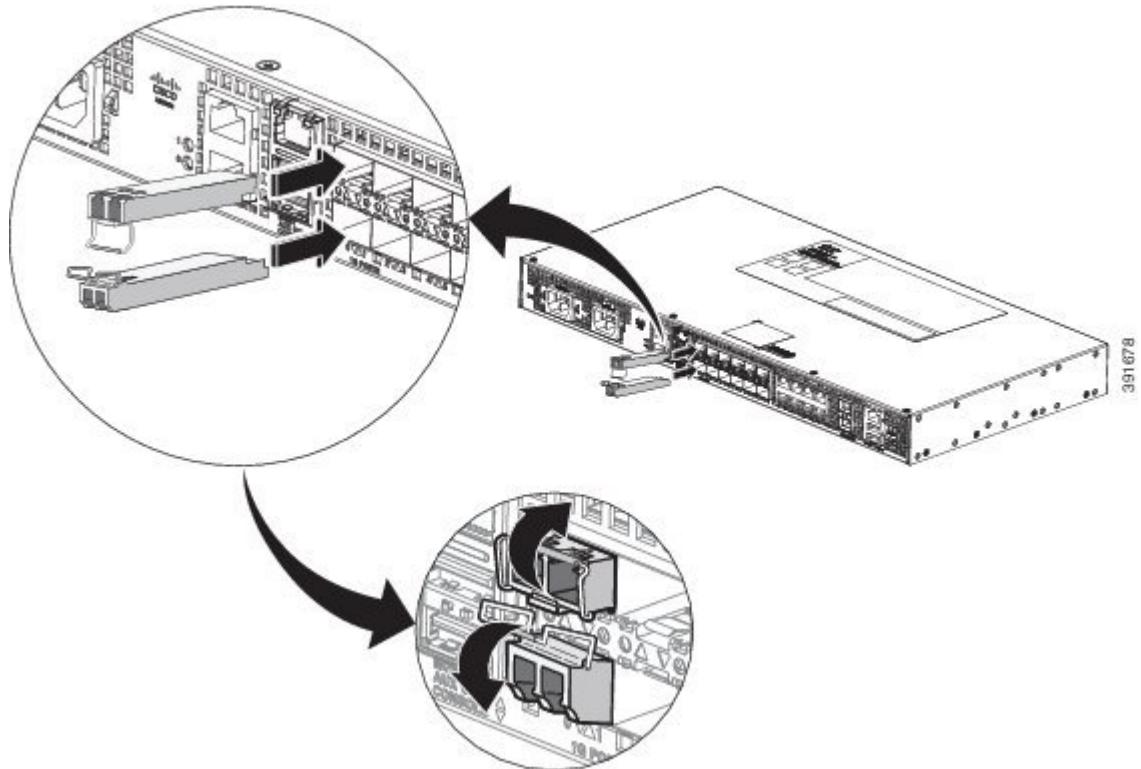

Caution Do not remove the dust plugs from the fiber-optic SFP module port or the rubber caps from the fiber-optic cable until you are ready to connect the cable. The plugs and caps protect the SFP module ports and cables from contamination and ambient light. Store the dust plugs for later use.

- Step 5** Insert the cable connector into the SFP module:
- For fiber-optic SFP modules, insert the LC cable into the SFP module.
 - For copper 1000BASE-T SFP modules, insert the RJ-45 cable connector into the SFP module.

Remove SFP Modules

To remove an SFP module from a module receptacle, follow these steps:

Procedure

- Step 1** Attach an ESD-preventive wrist strap to your wrist and to a bare metal surface on the chassis.
- Step 2** Disconnect the cable from the SFP module, and insert a dust plug into the cable end.
- Tip** For reattachment, note which cable connector plug is send (TX) and which is receive (RX).
- Step 3** Unlock and remove the SFP module, as shown in the following figure.

If the module has a bale-clasp latch, pull the bale out and down to eject the module. If the bale-clasp latch is obstructed and you cannot use your index finger to open it, use a small, flat-blade screwdriver or other long, narrow instrument to open the bale-clasp latch.

Figure 24: Removing a Bale-Clasp Latch SFP Module

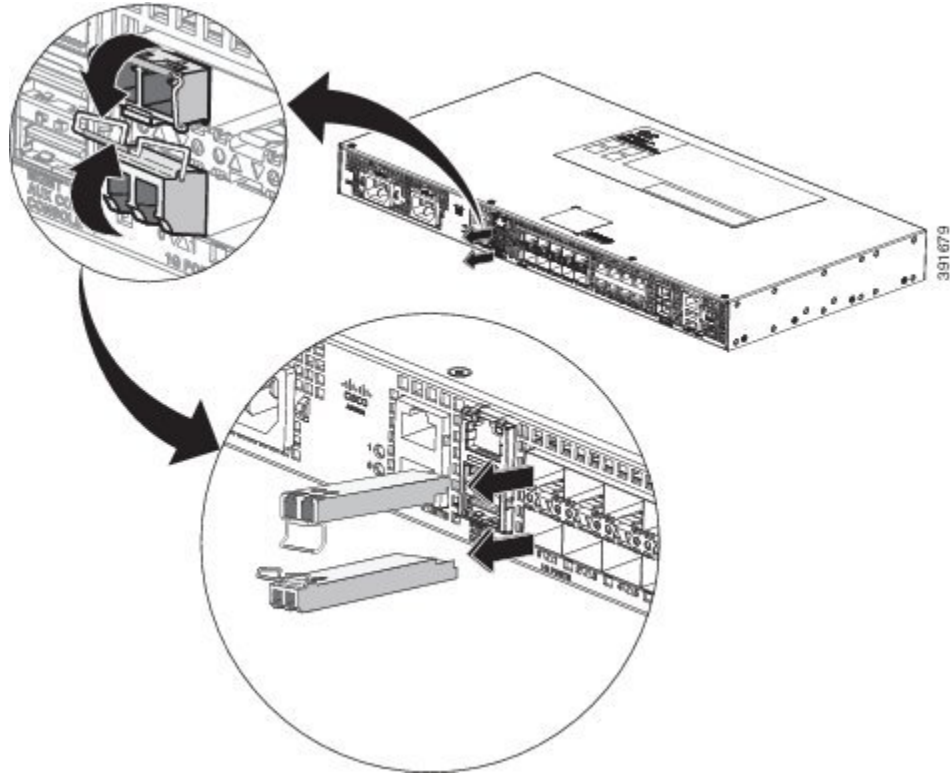

- Step 4** Grasp the SFP module between your thumb and index finger, and carefully remove it from the module slot.
- Step 5** For fiber-optic SFP modules, insert a dust plug into the optical ports of the SFP module to keep the optical interfaces clean.
- Step 6** Place the removed SFP module in an antistatic bag or other protective environment.

Connect Gigabit Ethernet Ports

You can choose to connect either a copper or a fiber cable in the Gigabit Ethernet ports.



Note The device 10/100/1000 ports configure themselves to operate at the speed of devices to which they are attached. Autonegotiation is enabled by default in the chassis. You can manually set the speed and the duplex parameters. If the device to which the ports are attached, does not autonegotiate, low performance or no linkage may result.

To maximize performance, choose one of these methods for configuring Ethernet ports:

- Have ports autonegotiate both speed and duplex.
- Set the port speed and duplex parameters on both ends of the connection.



Note You can use the **mdix auto** command in interface configuration mode in CLI to enable automatic media-dependent interface with crossover detection. After you enable, the device detects the required cable type for copper Ethernet connections and configures the interfaces accordingly. Therefore, you can use either a crossover or a straight-through cable for connecting to a copper 10/100/1000 port. If the **mdix auto** command is not enabled, connect the cable through SFP module.

Procedure

Step 1 Connect to workstations, servers, and devices, connect a straight-through cable to an RJ-45 connector on the front panel. When connecting to devices or repeaters, use a crossover cable.

Step 2 Connect the other end of the cable to an RJ-45 connector on the other device. The port LED turns on when both the device and the connected device have established a link.

If the port LED does not turn on, check whether the device at the other end is turned on or whether there is any failure.

Note On user network interface (UNI) ports, the port LED turns green after the link is established.

Step 3 Reconfigure and reboot the connected device if necessary.

Step 4 Repeat Steps 1 to 3 for each device that is to be connected.

Connect to SFP Modules

This section describes how to connect to SFP modules.

Connect Fiber Optic SFP Modules



Caution Do not remove the rubber plugs from the SFP module port or from the fiber optic cable until you are ready to connect the cable. The plugs and caps protect the SFP module ports and cables from contamination and ambient light.

Procedure

Step 1 Remove the rubber plugs from the module port and fiber optic cable, and store them for future use.

Step 2 Insert one end of the fiber optic cable into the SFP module port.

Step 3 Insert the other end into a fiber optic connector at a target device.

Step 4 Observe the port's LED status.

The LED turns green when the device and the target device establish a link.

If the LED is off, check whether the target device is turned on, or whether there is any failure in the target device.

Step 5 If necessary, reconfigure and restart the device or target device.

Install the Chassis Ground Connection

Before you connect the power or turn on the power to the router, you must provide an adequate chassis ground (earth) connection to your router.

This section describes how to ground the router chassis. The grounding lug location is on the back panel of the router.



Tip Ensure that the grounding lug wire does not cover the fan opening.

Figure 25: Attaching a Grounding Lug to the Rear of the Router

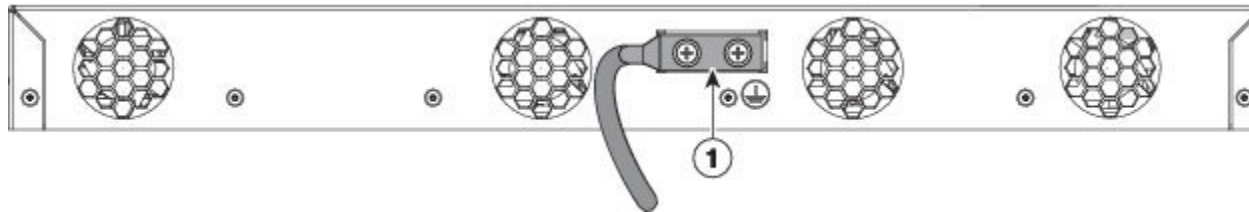

1 Grounding-lug

To ensure that the chassis ground connection that you provide is adequate, you need the following parts and tools:

- Ratcheting torque screwdriver with Phillips head that exerts up to 15 in.-lb (1.69 N-m) of torque for attaching the ground wire to the router
- Crimping tool as specified by the ground lug manufacturer
- 6-AWG or larger copper wire for the ground wire
- Wire-stripping tools appropriate to the wire you are using



Caution Before making connections to the router, ensure that you disconnect the power at the circuit breaker. Otherwise, severe injury to you or damage to the router may occur.



Warning This equipment must be grounded. Never defeat the ground conductor or operate the equipment in the absence of a suitably installed ground conductor. Contact the appropriate electrical inspection authority or an electrician if you are uncertain that suitable grounding is available. Statement 1024



Warning Use copper conductors only. Statement 1025



Warning When installing the unit, the ground connection must always be made first and disconnected last. Statement 42

This unit is to be installed in a restrictive access location and must be permanently grounded to a minimum 6-AWG copper ground wire.

Perform the following procedure to ground the router using a 2-hole lug and the corresponding mounting point. Most carriers require a minimum 6-AWG ground connection. Verify your carrier's requirements for the ground connection.

Procedure

- Step 1** If your ground wire is insulated, use a wire-stripping tool to strip the ground wire to 0.5 inch \pm 0.02 inch (12.7 mm \pm 0.5 mm) (See the figure below).

Figure 26: Stripping a Ground Wire

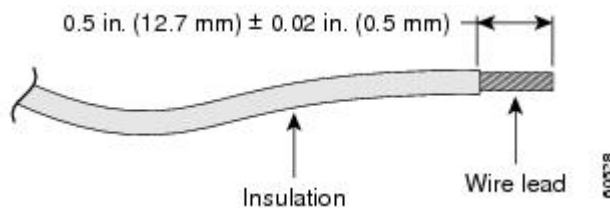

- Step 2** Slide the open end of your 2-hole ground lug over the exposed area of the ground wire.
- Step 3** Using a crimping tool (as specified by the ground lug manufacturer), crimp the ground lug to the ground wire as shown in the figure below.

Figure 27:

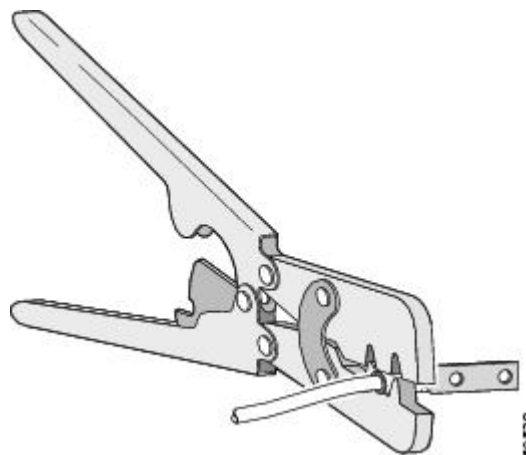

- Step 4** Use a Phillips head screwdriver to attach the 2-hole ground lug and wire assembly to the router with the 2 pan-head Phillips head screws.
- Step 5** Connect the other end of the ground wire to a suitable grounding point at your site.
-

Power Connection Guidelines

This section provides guidelines for connecting the device power supplies to the site power source.



Warning The plug-socket combination must be accessible at all times, because it serves as the main disconnecting device.



Warning This equipment must be grounded. To reduce the risk of electric shock, never defeat the ground conductor or operate the equipment in the absence of a suitably installed ground conductor. Contact the appropriate electrical inspection authority or an electrician if you are uncertain that suitable grounding is available.

Guidelines for DC-Powered Systems

Basic guidelines for DC-powered systems include the following:

- Each chassis power supply has its own dedicated input power source. The source must comply with the safety extra-low voltage (SELV) requirements in the UL 60950, CSA 60950, EN 60950, and IEC 60950 standards.
- Protect the circuit by a dedicated two-pole circuit breaker. Ensure that the circuit breaker is sized according to the power supply input rating and local or national code requirements.
- The circuit breaker is considered as the disconnect device and is easily accessible.
- The system ground is the power supply and chassis ground.
- Use the grounding lug to attach a wrist strap for ESD protection during servicing.
- Do not connect the DC return wire to the system frame or to the system-grounding equipment.
- Ensure that the DC return is grounded at the source side.
- Ensure that each power feed of the equipment is connected to different sources.

Guidelines for AC-Powered Systems

Basic guidelines for AC-powered systems include the following:

- Each chassis power supply has its own dedicated branch circuit.
- Ensure that the circuit breaker is sized according to the power supply input rating and local or national code requirements.

- The AC power receptacles that are used to plug in the chassis must be the grounding type. The grounding conductors that connect to the receptacles must connect to protective earth ground at the service equipment.

Prevent Power Loss

Use the following guidelines to prevent power loss to the device:

- To prevent input power loss, ensure that the maximum load on each circuit supplying the power is within the current ratings of the wiring and breakers.
- In some systems, you can use an UPS to protect against power failures at your site. Avoid UPS types that use ferroresonant technology. These UPS types can become unstable with systems such as the device, which can have substantial current-draw fluctuations due to bursty data traffic patterns.

Determining power requirements is useful for planning the power distribution system to support the device.

Activate DC Power Supply

Procedure

Step 1 Remove the tape from the circuit-breaker device handle, and restore power by moving the circuit-breaker device handle to the On (I) position.

Step 2 Verify the power supply operation by ascertaining that the front panel LED is green.

Step 3 If the LEDs indicate a power problem, see the *Troubleshooting Aids* chapter.

Step 4 If you are also connecting a redundant DC power supply, repeat these steps for the second power source.

Note When you connect a redundant DC power supply, ensure that each power supply is connected to a separate power source to prevent power loss during a failure.

Activate AC Power Supply

Procedure

Step 1 Plug the power cord into the power supply.

Step 2 Connect the other end of the power cord to an AC-input power source.

Step 3 Verify the power supply operation by ascertaining that the front panel LED is green.

Step 4 If the LEDs indicate a power problem, see the *Troubleshooting Aids* chapter.

Step 5 If you are also connecting a redundant AC power supply, repeat these steps for the second power source.

Note When you connect a redundant AC power supply, ensure that each power supply is connected to a separate power source to prevent power loss during failure.

Connect Chassis to Network



Note Connect only SELV services to all the device ports.

Connecting Console Cables

The following sections describe how to connect to the router using console cables:

Connecting to the USB Serial Port Using Microsoft Windows

This procedure shows how to connect to the USB serial port using Microsoft Windows.



Note Install the USB device driver before establishing a physical connection between the router and the PC, by using the USB console cable plugged into the USB serial port. Otherwise, the connection will fail. For more information, see the [Installing the Cisco USB Device Driver](#).

Procedure

	Command or Action	Purpose
Step 1	Connect a USB Type A-to-Type A cable to the USB console port, as shown in the figure below. If you are using the USB serial port for the first time on a Windows-based PC, install the USB driver now according to the instructions in the following sections:	<ul style="list-style-type: none"> Installing the Cisco Microsoft Windows XP USB Driver, page 3-29 Installing the Cisco Microsoft Windows 2000 USB Driver, page 3-29 Installing the Cisco Microsoft Windows Vista USB Driver, page 3-30 <p>Note You cannot use the USB port and the EIA port concurrently. When the USB port is used, it takes priority over the EIA port.</p>
Step 2	Connect the USB Type A cable to the PC.	
Step 3	To communicate with the router, start a terminal emulator application, such as Microsoft Windows HyperTerminal. This software should be configured with the following parameters:	<ul style="list-style-type: none"> 9600 baud 8 data bits no parity 1 stop-bit no flow control

	Command or Action	Purpose								
		<p data-bbox="987 279 1479 327"><i>Figure 28: Connecting the USB Console Cable to the Cisco ASR 920 Series Router</i></p>  <table border="1" data-bbox="987 1205 1485 1411"> <thead> <tr> <th data-bbox="993 1209 1049 1257">Label</th> <th data-bbox="1049 1209 1151 1257">Cable</th> <th data-bbox="1151 1209 1281 1257">Label</th> <th data-bbox="1281 1209 1479 1257">Cable</th> </tr> </thead> <tbody> <tr> <td data-bbox="993 1262 1049 1407">1</td> <td data-bbox="1049 1262 1151 1407">USB Type-A console port</td> <td data-bbox="1151 1262 1281 1407">2</td> <td data-bbox="1281 1262 1479 1407">USB USB Type-A to USB Type-A console cable</td> </tr> </tbody> </table>	Label	Cable	Label	Cable	1	USB Type-A console port	2	USB USB Type-A to USB Type-A console cable
Label	Cable	Label	Cable							
1	USB Type-A console port	2	USB USB Type-A to USB Type-A console cable							

Connecting to the Console Port Using Mac OS X

This procedure describes how to connect a Mac OS X system USB port to the console using the built-in OS X terminal utility.

Procedure

-
- Step 1** Use the Finder to choose Applications > Utilities > Terminal.
 - Step 2** Connect the OS X USB port to the router.
 - Step 3** Enter the following commands to find the OS X USB port number:

Example:

```
macbook:user$ cd /dev
macbook:user$ ls -ltr /dev/*usb*
crw-rw-rw- 1 root  wheel          9,  66 Apr  1 16:46 tty.usbmodem1a21 DT-macbook:dev user$
```

Step 4 Connect to the USB port with the following command followed by the router USB port speed:

Example:

```
macbook:user$ screen /dev/tty.usbmodem1a21 9600
```

To disconnect the OS X USB console from the terminal window, enter Ctrl-a followed by Ctrl-\

Connecting to the Console Port Using Linux

This procedure shows how to connect a Linux system USB port to the console using the built-in Linux terminal utility.

Procedure

- Step 1** Open the Linux terminal window.
- Step 2** Connect the Linux USB port to the router.
- Step 3** Enter the following commands to find the Linux USB port number:

Example:

```
root@usb-suse# cd /dev
root@usb-suse /dev# ls -ltr *ACM*
crw-r--r-- 1 root  root    188,  0 Jan 14 18:02 ttyACM0
root@usb-suse /dev#
```

Step 4 Connect to the USB port with the following command, followed by the router USB port speed:

Example:

```
root@usb-suse /dev# screen /dev/ttyACM0 9600
```

To disconnect the Linux USB console from the terminal window, enter Ctrl-a followed by : then quit

Installing the Cisco USB Device Driver

A USB device driver must be installed the first time a Microsoft Windows-based PC is connected to the USB serial port on the router.

This procedure describes how to install the Microsoft Windows USB device driver in Microsoft Windows XP, Windows Vista, Windows 2000, Windows 7, and Windows 8. Download the driver for your router model from the Tools and Resources Download Software site, USB Console Software category, at:

<https://software.cisco.com/download/detail?cid=28037604&fid=71056&softwareid=28285122&date=3.13&cid=AVAILABLE&filetype=txt>



Note To download the driver, you must have a valid service contract associated to your Cisco.com profile.

Procedure

- Step 1** Unzip the file asr-9xx_usbconsole_drivers.zip.
 - Step 2** Double-click xrusbser_ver2100_installer.exe in the XR21x141x-Win-DriversOnly-Vers2.1.0.0/EXE folder. Installation Wizard GUI is displayed.
 - Step 3** Click Next. The InstallShield Wizard Completed window is displayed.
 - Step 4** Click Finish.
 - Step 5** Connect the USB cable to the PC and router USB console ports. Follow the on-screen instructions to complete the installation of the driver.
 - Step 6** XR21V1401 USB UART Device driver successfully installed message is displayed.
The USB console is ready for use.
-

Uninstalling the Cisco USB Driver

This procedure describes how to uninstall the Microsoft Windows USB device driver in Microsoft Windows XP, Windows Vista, Windows 2000, Windows 7, and Windows 8.



Note Disconnect the router console terminal before uninstalling the driver.

Procedure

- Step 1** Choose Start > Control Panel > Add or Remove Programs.
 - Step 2** Scroll to **Windows Driver Package - Exar corporation (xrusbser) Ports** and click **Remove**. The **Program Maintenance** window is displayed.
 - Step 3** Click **Yes** to uninstall the driver.
-

Connect to the EIA Console Port



Note The US-to-RJ45 adapter cable and the DB9 console cable are not included with the router; they can be ordered separately from Cisco.



Note The serial console cable kit is not included with the router; it is ordered separately.

To connect a terminal to the EIA Console port on the router, follow these steps:

Procedure

- Step 1** Connect the USB end of the USB-to RJ-45 cable to the EIA Console port.
- Step 2** Connect the RJ-45 end of the DB-9 adapter cable to the USB-to RJ-45 cable, as shown in the figure below.

Figure 29: EIA Console Port

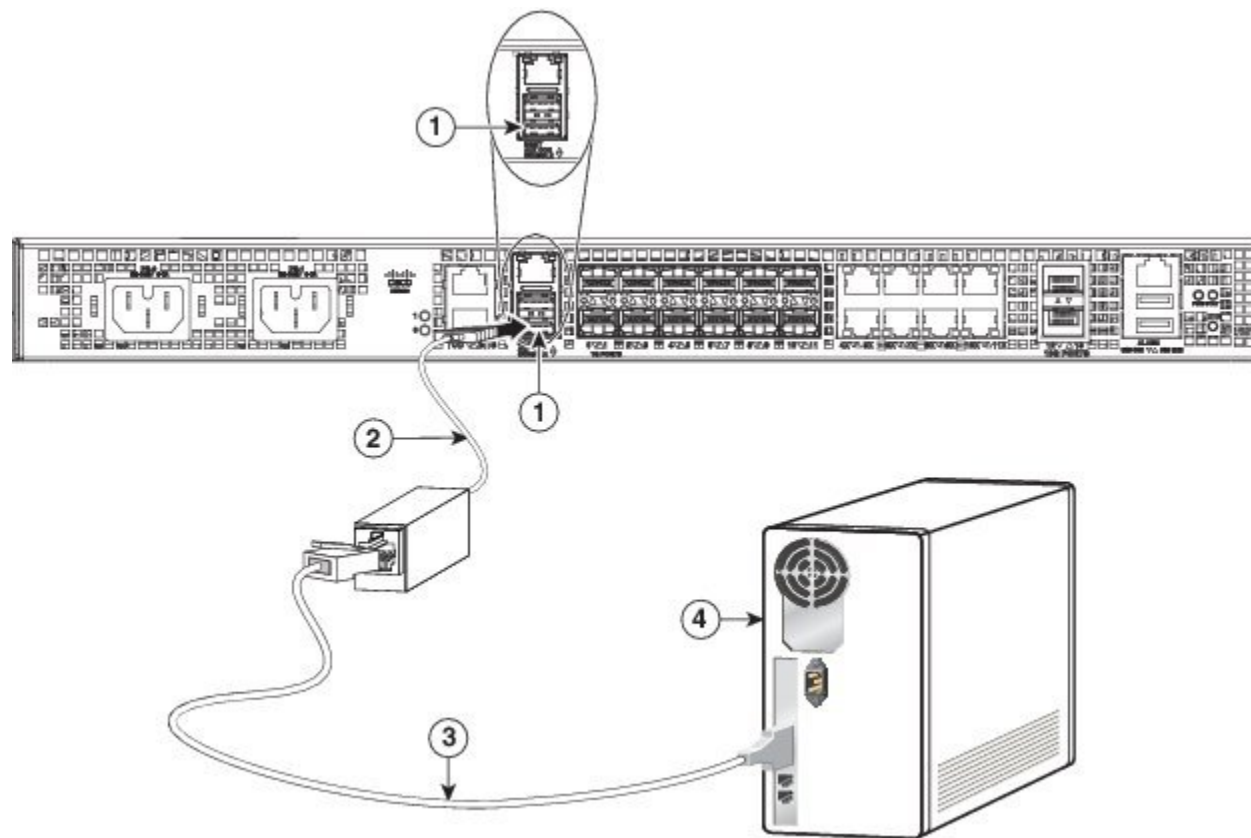

Table 14: EIA Console Port

Label	Component	Label	Component
1	EIA Console port	3	RJ-45 to DB-9 cable
2	USB-to-RJ45 adapter	4	Desktop or system

- Step 3** Connect the DB-9 end of the console cable to the DB-9 end of the terminal.

Step 4 To communicate with the router, start a terminal emulator application, such as Microsoft Windows HyperTerminal. This software should be configured with the following parameters:

- 9600 baud
 - 8 data bits
 - no parity
 - 1 stop-bit
 - no flow control
-

Connect a Management Ethernet Cable

When using the Ethernet Management port in the default mode (speed-auto and duplex-auto), the port operates in the auto-MDI/MDI-X mode. The port automatically provides the correct signal connectivity through the Auto-MDI/MDI-X feature, and senses a crossover or straight-through cable and adapts to it.

However, the Ethernet Management port may be configured to a fixed speed (10, 100, or 1000 Mbps) through command-line interface (CLI) commands. In such a case, the port is forced to operate in the MDI mode.

When in a fixed-speed configuration and MDI mode, use:

- a crossover cable to connect to an MDI port
- a straight-through cable to connect to an MDI-X port

Install and Remove SFP and SFP+ Modules

The router supports a variety of SFP and SFP+ modules, including optical and Ethernet modules. For information on how to install and remove SFP and SFP+ modules, see the documentation for the SFP or SFP+ module at:

http://www.cisco.com/en/US/partner/products/hw/modules/ps5455/prod_installation_guides_list.html.

For information about inspecting and cleaning fiber-optic connections, see:

http://www.cisco.com/en/US/partner/tech/tk482/tk876/technologies_white_paper09186a0080254eba.shtml.



Caution We recommend that you wait for 30 seconds between the removal and insertion of an SFP on an interface module. We recommend this to allow the transceiver software to initialize and synchronize with the router. Changing an SFP more quickly could result in transceiver initialization issues that disable the SFP.

Connecting a USB Flash Device

To connect a USB flash device to the Cisco ASR 920 Series Router, insert the memory stick in the USB port labeled USB MEM. The Flash memory module can be inserted only one way, and can be inserted or removed regardless of whether the router is powered up or not.

The figure below shows the USB port connector on the Cisco ASR 920 Series Router.

Figure 30: Cisco ASR 920 Series Router Flash Token Memory Stick



Removing a USB Flash Device

To remove and replace a USB flash token memory stick from and into a Cisco ASR 920 Series Router, follow these steps:



Note If the USB flash device is abruptly removed, the constant sync operations of the file system in progress fail due to the USB device removal. These errors occur with ext2 or ext3 or ext4 file systems and are not seen with fat32 file system. This is a default behavior on any Linux platform.

The following error messages are displayed when you remove the USB device:

```
*Jun 24 10:29:45.766: %IOSXE-3-PLATFORM: R0/0: kernel: EXT2-fs (sda1): previous I/O error
to superblock detected
*Jun 24 10:29:45.878: %IOSXE-3-PLATFORM: R0/0: kernel: EXT2-fs (sda1): previous I/O error
to superblock detected
*Jun 24 10:29:46.012: %IOSXE-3-PLATFORM: R0/0: kernel: EXT2-fs (sda1): previous I/O error
to superblock detected
*Jun 24 10:29:46.013: %IOSXE-3-PLATFORM: R0/0: kernel: EXT2-fs (sda1): previous I/O error
to superblock detected
```

Procedure

Step 1 Execute the `eject usb0:` command before removing the USB from the router.

Example:

```
rommon 2 > eject usb0
rommon 2 >
```

If you do not run this command before removing the USB, the following error message is displayed:

```
rommon 2 > dir usb0:
usb_stor_BBB_comdat:usb_bulk_msg error
failed to send CBW status 34
RESET:stall
usb_stor_BBB_comdat:usb_bulk_msg error
failed to send CBW status 34
RESET:stall
usb_stor_BBB_comdat:usb_bulk_msg error
```

Step 2 Pull the memory stick from the USB port.

Step 3 To replace the Cisco USB Flash memory stick, simply insert the module into the USB port labeled USB MEM, as shown in the figure above. The Flash memory module can be inserted only one way, and can be inserted or removed regardless of whether the router is powered up or not.

This completes the USB Flash memory installation procedure.

Connecting Timing Cables

The following sections describe how to connect timing cables to the Cisco ASR 920 Series Router:

Connecting a Cable to the BITS Interface

The following steps describe how to connect a cable to the router's BITS port:

Procedure

- Step 1** Confirm that the router is powered off.
- Step 2** Connect one end of the cable to the BITS port using a straight-through, shielded RJ48C-to-RJ48C cable.
- Step 3** Connect the other end to the BTS patch or demarcation panel at your site.
- Step 4** Turn on the power to the router.

For information about the BITS port pinouts, see [Troubleshooting](#)

Warning To comply with the Telcordia GR-1089 NEBS standard for electromagnetic compatibility and safety, connect the BITS ports only to intra-building or unexposed wiring or cable. The intrabuilding cable must be shielded and the shield must be grounded at both ends. The intra-building port(s) of the equipment or subassembly must not be metallicly connected to interfaces that connect to the OSP or its wiring. These interfaces are designed for use as intra-building interfaces only (Type 2 or Type 4 ports as described in GR-1089-CORE) and require isolation from the exposed OSP cabling. The addition of Primary Protectors is not sufficient protection in order to connect these interfaces metallicly to OSP wiring. Statement

Connecting Cables to a GPS Interface

The following sections describe how to connect cables from the Cisco ASR 920 Series Router to a GPS unit for input or output timing of frequency:

Connecting a Cable to the ToD Interface

Procedure

- Step 1** Connect one end of a straight-through Ethernet cable to the GPS unit.
- Step 2** Connect the other end of the straight-through Ethernet cable to the ToD/1-PPS port on the Cisco ASR 920 Series Router.

Warning To comply with the Telcordia GR-1089 NEBS standard for electromagnetic compatibility and safety, connect the ToD ports only to intra-building or unexposed wiring or cable. The intrabuilding cable must be shielded and the shield must be grounded at both ends. The intra-building port(s) of the equipment or subassembly must not be metalically connected to interfaces that connect to the OSP or its wiring. These interfaces are designed for use as intra-building interfaces only (Type 2 or Type 4 ports as described in GR-1089-CORE) and require isolation from the exposed OSP cabling. The addition of Primary Protectors is not sufficient protection in order to connect these interfaces metalically to OSP wiring.

Note For more information about GPS-port pinouts, see [Troubleshooting](#)

Connect Cable to Copper Gigabit Ethernet Port

The device interface modules support RJ-45 and Ethernet SFP ports.

The RJ-45 port supports standard straight-through and crossover Category 5 unshielded twisted-pair (UTP) cables. Cisco does not supply Category 5 UTP cables. These cables are available commercially.

Procedure

-
- Step 1** Confirm that the device is powered off.
 - Step 2** Connect one end of the cable to the Gigabit Ethernet port on the device.
 - Step 3** Connect the other end to the BTS patch or demarcation panel at your site.
-

You have successfully installed the device and you are now ready to carry out a basic device configuration.

Connect Cables to SFP Modules

For information on connecting cables to Cisco optical and Ethernet SFP interfaces, see:

http://www.cisco.com/en/US/partner/products/hw/modules/ps5455/prod_installation_guides_list.html.

Connector and Cable Specifications

For more information on cable specifications and pinouts, see [Troubleshooting](#).



CHAPTER 4

Configure the Device

This chapter guides you through a basic device configuration that you to require to access your network.

Complex configuration procedures are beyond the scope of this guide. Descriptions of these procedures can be found in the modular configuration and command reference guides of the Cisco IOS software configuration documentation set. See the set that corresponds to the installed software release.

To configure the device from a console, connect a terminal to the device console port.

This chapter describes:

- [Check Conditions Before System Startup](#) , on page 67
- [Powering Up the Cisco ASR 920 Series Router](#), on page 68
- [Configure Device at Startup](#), on page 73
- [Safely Power Down the Device](#), on page 75

Check Conditions Before System Startup

Ensure that the following conditions are checked before starting up the device:

- The chassis is securely mounted and grounded.
- Captive installation screws are secured tight on all removable components.
- The optional Gigabit Ethernet Management port cable is installed.
- Power and interface cables are connected.
- Your PC with a terminal emulation program (Hyper-Terminal or equivalent) is connected to the console port and powered up.
- Your PC terminal emulation program is configured for 9600 baud, 8 data bits, 1 stop-bit, and no parity. No flow control is set to none.
- Passwords for access control are selected.
- The console terminal is turned on.
- You have determined the IP addresses for the Ethernet and serial interfaces.

Powering Up the Cisco ASR 920 Series Router

After installing your Cisco ASR 920 Series Router and connecting cables, start the router and follow these steps:

Procedure

Step 1 Switch on the power supply.

Caution Do not press any keys on the keyboard until the messages stop and the PWR LED is solid green. Any keys pressed during this time are interpreted as the first command typed when the messages stop, which might cause the router to power off and start over. It takes a few minutes for the messages to stop.

Step 2 Observe the initialization process. When the system boot is complete (the process takes a few seconds), the Cisco ASR 920 Series Router begins to initialize, see the example below.

Example:

Loading the Default System Boot Image

```
System Bootstrap, Version 12.2(20140211:085836) [pbalakan-sb_romver_16 130], DEVELOPMENT
SOFTWARE
Copyright (c) 1994-2012 by cisco Systems, Inc.
Compiled Fri 28-Mar-14 18:57 by pbalakan-sb_romver_16
Boot ROM0
Last reset cause: RSP-Board
UEA platform with 2097152 Kbytes of main memory

rommon 1 > boot
tftp://tftpboot/master/PEGASUS/asr920-universalk9_npe.2014-05-24_13.14_gurathi.bin

      IP_ADDRESS: 7.43.18.118
      IP_SUBNET_MASK: 255.255.0.0
      DEFAULT_GATEWAY: 7.43.0.1
      TFTP_SERVER: 202.153.144.25
      TFTP_FILE: /tftpboot/master//asr920-universalk9_npe.2014-05-24_13.14_gurathi.bin

      TFTP_MACADDR: 00:00:00:aa:bb:cc
      TFTP_VERBOSE: Progress
      TFTP_RETRY_COUNT: 18
      TFTP_TIMEOUT: 7200
      TFTP_CHECKSUM: No
      ETHER_PORT: 2
      ETHER_SPEED_MODE: Auto Detect
link up 100Mbps/FD.....
TFTP error 1 received (File not found).
TFTP: Operation terminated.
boot: netboot failed
rommon 2 > boot
tftp://tftpboot/master/PEGASUS/asr920-universalk9_npe.2014-05-24_13.14_gurathi.bin

      IP_ADDRESS: 7.43.18.118
      IP_SUBNET_MASK: 255.255.0.0
      DEFAULT_GATEWAY: 7.43.0.1
      TFTP_SERVER: 202.153.144.25
      TFTP_FILE:
/tftpboot/master/PEGASUS/asr920-universalk9_npe.2014-05-24_13.14_gurathi.bin
```

```

TFTP_MACADDR: 00:00:00:aa:bb:cc
TFTP_VERBOSE: Progress
TFTP_RETRY_COUNT: 18
TFTP_TIMEOUT: 7200TFTP_CHECKSUM: No
ETHER_PORT: 2
ETHER_SPEED_MODE: Auto Detect
link up 100Mbps/FD.....
Receiving /tftpboot/master/PEGASUS/asr920-universalk9_npe.2014-05-24_13.14_gurathi.bin from
202.153.144.25
!!!!!!!!!!!!!!!!!!!!!!!!!!!!!!!!!!!!!!!!!!!!!!!!!!!!!!!!!!!!!!!!!!!!!!!!!!!!!!!!!!!!!!!!!!!!!!!!!!!!!!!!!!!!!!!!!!!!!!!!!!!!!!
File reception completed.
Boot image size = 257997384 (0xf60ba48) bytes

Package header rev 0 structure detected
Calculating SHA-1 hash...done
validate_package: SHA-1 hash:
    calculated ec733062:920bcf8a:84672876:3efde19d:4776fa0b
    expected   ec733062:920bcf8a:84672876:3efde19d:4776fa0b
Image validated
Passing control to the main image..
%IOSXEBOOT-4-DEBUG_CONF: (rp/0): Using DEBUG_CONF file /bootflash/debug.conf
%IOSXEBOOT-4-WATCHDOG_DISABLED: (rp/0): Hardware watchdog timer disabled: disabled by
BOOT_PARAM
Jul 15 20:21:13.690 R0/0: %PMAN-3-PROCFAIL_IGNORE: All process exits and failures are being
ignored due to debug settings. Normal router functionality will be affected. Critical
router functions like RP switchover, router reload, FRU resets, etc. may not function
properly.

```

Restricted Rights Legend

Use, duplication, or disclosure by the Government is subject to restrictions as set forth in subparagraph (c) of the Commercial Computer Software - Restricted Rights clause at FAR sec. 52.227-19 and subparagraph (c) (1) (ii) of the Rights in Technical Data and Computer Software clause at DFARS sec. 252.227-7013.

cisco Systems, Inc.
170 West Tasman Drive
San Jose, California 95134-1706

Cisco IOS Software, ASR920 Software (PPC_LINUX_IOSD-UNIVERSALK9_NPE-M), Experimental Version
15.5(20140522:163448) [mcp_dev-gurathi-SFPP_ios 120]
Copyright (c) 1986-2014 by Cisco Systems, Inc.
Compiled Sat 24-May-14 13:07 by gurathi

Cisco IOS-XE software, Copyright (c) 2005-2014 by cisco Systems, Inc.
All rights reserved. Certain components of Cisco IOS-XE software are licensed under the GNU General Public License ("GPL") Version 2.0. The software code licensed under GPL Version 2.0 is free software that comes with ABSOLUTELY NO WARRANTY. You can redistribute and/or modify such GPL code under the terms of GPL Version 2.0. For more details, see the documentation or "License Notice" file accompanying the IOS-XE software, or the applicable URL provided on the flyer accompanying the IOS-XE software.

This product contains cryptographic features and is subject to United States and local country laws governing import, export, transfer and use. Delivery of Cisco cryptographic products does not imply third-party authority to import, export, distribute or use encryption. Importers, exporters, distributors and users are responsible for compliance with U.S. and local country laws. By using this product you agree to comply with applicable laws and regulations. If you are unable

to comply with U.S. and local laws, return this product immediately.

A summary of U.S. laws governing Cisco cryptographic products may be found at:
<http://www.cisco.com/wwl/export/crypto/tool/stqrg.html>

If you require further assistance please contact us by sending email to
export@cisco.com.

cisco ASR-920 (Freescale P2020) processor (revision 1.0 GHz) with 706041K/6147K bytes of memory.

Processor board ID CAT1740U01B
 12 Gigabit Ethernet interfaces
 2 Ten Gigabit Ethernet interfaces
 32768K bytes of non-volatile configuration memory.
 2097152K bytes of physical memory.
 1328927K bytes of SD flash at bootflash:.

Warning: When Cisco determines that a fault or defect can be traced to the use of third-party transceivers installed by a customer or reseller, then, at Cisco's discretion, Cisco may withhold support under warranty or a Cisco support program. In the course of providing support for a Cisco networking product Cisco may require that the end user install Cisco transceivers if Cisco determines that removing third-party parts will assist Cisco in diagnosing the cause of a support issue.

Press RETURN to get started!

```
*Jul 15 20:22:08.531: %SMART_LIC-6-AGENT_READY: Smart Agent for Licensing is initialized
*Jul 15 20:22:08.564: %SMART_LIC-6-AGENT_ENABLED: Smart Agent for Licensing is enabled
Redundancy license not released

*Jul 15 20:22:24.239: dev_pluggable_optics_selftest attribute table internally inconsistent
@ 0x129

*Jul 15 20:22:24.821: pak_debug_init: Successfully initialized pak debug trace buffer
*Jul 15 20:22:25.466: %SPANTREE-5-EXTENDED_SYSID: Extended SysId enabled for type vlanCannot
Get the number of ports in MAC notification

*Jul 15 20:22:29.043: %LINK-3-UPDOWN: Interface Lsmpi0, changed state to up
*Jul 15 20:22:29.044: %LINK-3-UPDOWN: Interface EOBC0, changed state to up
*Jul 15 20:22:29.045: %LINEPROTO-5-UPDOWN: Line protocol on Interface LI-Null0, changed
state to up
*Jul 15 20:22:29.045: %LINK-5-CHANGED: Interface GigabitEthernet0, changed state to
administratively down
*Jul 15 20:22:29.046: %LINK-3-UPDOWN: Interface LIIN0, changed state to up
*Jul 15 20:22:29.793: %LINEPROTO-5-UPDOWN: Line protocol on Interface Lsmpi0, changed state
to up
*Jul 15 20:22:29.794: %LINEPROTO-5-UPDOWN: Line protocol on Interface EOBC0, changed state
to up
*Jul 15 20:22:29.794: %LINEPROTO-5-UPDOWN: Line protocol on Interface GigabitEthernet0,
changed state to down
*Jul 15 20:22:29.795: %LINEPROTO-5-UPDOWN: Line protocol on Interface LIIN0, changed state
to up
*Jul 15 20:22:33.724: Bulk port license Activated

*Jul 15 20:22:34.194: %SYS-5-CONFIG_I: Configured from memory by console
*Jul 15 20:22:34.333: %IOSXE_OIR-6-REMSPA: SPA removed from subslot 0/0, interfaces disabled
*Jul 15 20:22:34.479: %SPA_OIR-6-OFFLINECARD: SPA (12xGE-2x10GE-FIXED) offline in subslot
0/0
*Jul 15 20:22:34.495: %IOSXE_OIR-6-INSCARD: Card (fp) inserted in slot F0
*Jul 15 20:22:34.495: %IOSXE_OIR-6-ONLINECARD: Card (fp) online in slot F0
*Jul 15 20:22:34.496: %IOSXE_OIR-6-INSCARD: Card (cc) inserted in slot 0
*Jul 15 20:22:34.497: %IOSXE_OIR-6-ONLINECARD: Card (cc) online in slot 0
*Jul 15 20:22:34.563: %IOSXE_OIR-6-INSSPA: SPA inserted in subslot 0/0
```

```
*Jul 15 20:22:34.847: %SYS-5-RESTART: System restarted --
Cisco IOS Software, ASR920 Software (PPC_LINUX_IOSD-UNIVERSALK9_NPE-M), Experimental Version
 15.5(20140522:163448) [mcp_dev-gurathi-SFPP_ios 120]
Copyright (c) 1986-2014 by Cisco Systems, Inc.
Compiled Sat 24-May-14 13:07 by gurathi
Authentication passed

*Jul 15 20:22:46.780: %SYS-6-BOOTTIME: Time taken to reboot after reload = 868 seconds
*Jul 15 20:22:51.205: %CALL_HOME-6-CALL_HOME_ENABLED: Call-home is enabled by Smart Agent
for Licensing.
*Jul 15 20:22:51.209: %PKI-4-NOCONFIGAUTOSAVE: Configuration was modified. Issue "write
memory" to save new IOS PKI configuration
*Jul 15 20:23:18.504: %TRANSCEIVER-6-INSERTED:iomd: transceiver module inserted in
GigabitEthernet0/0/0
*Jul 15 20:23:18.517: %TRANSCEIVER-6-INSERTED:iomd: transceiver module inserted in
GigabitEthernet0/0/1
*Jul 15 20:23:18.536: %TRANSCEIVER-6-INSERTED:iomd: transceiver module inserted in
GigabitEthernet0/0/4
*Jul 15 20:23:18.542: %TRANSCEIVER-6-INSERTED:iomd: transceiver module inserted in
GigabitEthernet0/0/5
*Jul 15 20:23:18.548: %TRANSCEIVER-6-INSERTED:iomd: transceiver module inserted in
GigabitEthernet0/0/6
*Jul 15 20:23:18.554: %TRANSCEIVER-6-INSERTED:iomd: transceiver module inserted in
GigabitEthernet0/0/7
*Jul 15 20:23:18.586: %TRANSCEIVER-6-INSERTED:iomd: transceiver module inserted in
TenGigabitEthernet0/0/12
*Jul 15 20:23:18.593: %TRANSCEIVER-6-INSERTED:iomd: transceiver module inserted in
TenGigabitEthernet0/0/13
*Jul 15 20:23:20.525: %LINK-3-UPDOWN: Interface GigabitEthernet0/0/1, changed state to down
*Jul 15 20:23:20.525: %LINK-3-UPDOWN: Interface GigabitEthernet0/0/2, changed state to down
*Jul 15 20:23:20.525: %LINK-3-UPDOWN: Interface GigabitEthernet0/0/3, changed state to down
*Jul 15 20:23:20.573: %LINK-3-UPDOWN: Interface GigabitEthernet0/0/4, changed state to down
*Jul 15 20:23:20.574: %LINK-3-UPDOWN: Interface GigabitEthernet0/0/5, changed state to down
*Jul 15 20:23:20.574: %LINK-3-UPDOWN: Interface GigabitEthernet0/0/6, changed state to down
*Jul 15 20:23:20.574: %LINK-3-UPDOWN: Interface GigabitEthernet0/0/7, changed state to down
*Jul 15 20:23:20.574: %LINK-3-UPDOWN: Interface GigabitEthernet0/0/8, changed state to down
*Jul 15 20:23:20.574: %LINK-3-UPDOWN: Interface GigabitEthernet0/0/9, changed state to down
*Jul 15 20:23:20.574: %LINK-3-UPDOWN: Interface GigabitEthernet0/0/10, changed state to
down
*Jul 15 20:23:20.623: %LINK-3-UPDOWN: Interface GigabitEthernet0/0/11, changed state to
down
*Jul 15 20:23:20.623: %LINK-3-UPDOWN: Interface TenGigabitEthernet0/0/12, changed state to
down
*Jul 15 20:23:20.623: %LINK-3-UPDOWN: Interface TenGigabitEthernet0/0/13, changed state to
down
*Jul 15 20:23:22.318: %LINK-3-UPDOWN: Interface GigabitEthernet0/0/0, changed state to
down[OK]
*Jul 15 20:23:28.733: %SPA_OIR-6-ONLINECARD: SPA (12xGE-2x10GE-FIXED) online in subslot 0/0
*Jul 15 20:23:42.197: %TRANSCEIVER-3-NOT_COMPATIBLE:iomd: Detected for transceiver module
in GigabitEthernet0/0/6, module disabled
*Jul 15 20:23:42.212: %TRANSCEIVER-3-NOT_COMPATIBLE:iomd: Detected for transceiver module
in GigabitEthernet0/0/7, module disabled
*Jul 15 20:23:43.983: %LINK-3-UPDOWN: Interface TenGigabitEthernet0/0/12, changed state to
up
*Jul 15 20:23:45.106: %LINK-3-UPDOWN: Interface TenGigabitEthernet0/0/13, changed state to
up
*Jul 15 20:23:45.367: %LINK-3-UPDOWN: Interface GigabitEthernet0/0/0, changed state to up
*Jul 15 20:23:45.392: %LINK-3-UPDOWN: Interface GigabitEthernet0/0/1, changed state to up
*Jul 15 20:23:45.804: %LINEPROTO-5-UPDOWN: Line protocol on Interface
TenGigabitEthernet0/0/13, changed state to up
*Jul 15 20:23:46.067: %LINEPROTO-5-UPDOWN: Line protocol on Interface GigabitEthernet0/0/0,
changed state to up
*Jul 15 20:23:46.089: %LINEPROTO-5-UPDOWN: Line protocol on Interface GigabitEthernet0/0/1,
changed state to up
```

```
*Jul 15 20:23:46.736: %LINEPROTO-5-UPDOWN: Line protocol on Interface
TenGigabitEthernet0/0/12, changed state to up
*Jul 15 20:23:46.829: %LINK-3-UPDOWN: Interface GigabitEthernet0/0/4, changed state to up
*Jul 15 20:23:46.837: %LINK-3-UPDOWN: Interface GigabitEthernet0/0/5, changed state to up
*Jul 15 20:23:47.528: %LINEPROTO-5-UPDOWN: Line protocol on Interface GigabitEthernet0/0/4,
changed state to up
*Jul 15 20:23:47.537: %LINEPROTO-5-UPDOWN: Line protocol on Interface GigabitEthernet0/0/5,
changed state to up
```

During the boot process, observe the system LEDs. After the router has booted, the green STAT LED comes on and stays on.

Verify the Front Panel LEDs

The front-panel indicator LEDs provide power, activity, and status information useful during bootup. For more detailed information about the LEDs, see the *LED Indicators* section.

Verify the Hardware Configuration

To display and verify the hardware features, enter the following commands:

Table 15: Hardware Commands

Command	Description
show version	Displays the following information: <ul style="list-style-type: none"> • system hardware version • software version installed • configuration file names and source • boot image • DRAM space • NVRAM space • flash memory space
show diag slot	Displays IDPROM information for the assemblies in the device.

Check Hardware and Software Compatibility

To check the minimum software requirements of the Cisco IOS software, login to the Software Advisor tool at cisco.com. The tool provides the Cisco IOS minimum requirements for individual hardware modules and components.



Note To access this tool, you must have a cisco.com login credentials.

To access Software Advisor:

1. Click **Log In** at cisco.com.
2. Type your registered Username and Password and click **Log In**.
3. Type **Software Advisor** in the search box, and click the search icon.
4. From the displayed search result, select the Software Advisor Tool link.
5. Choose a product family or enter a specific product number to search for the minimum supported software that is needed for your hardware.

Configure Device at Startup

This section explains how to create a basic running configuration for your device.



Note Acquire the correct network addresses from your system administrator or consult your network plan before you create the basic running configuration.

Before continuing the configuration process, check the current state of the device by entering the **show version** command. This command displays the Cisco IOS software release that is available on the device.

For information on modifying the configuration you create, see the [Cisco IOS Master Command List, All Releases](#).

To configure a device from the console, you must connect a terminal or terminal server to the console port on the device. To configure the device using the management Ethernet port, you must have the device's IP address.

Access the CLI Using the Console

Procedure

Step 1 When your system is booting, enter *no* at the prompt.

Example:

```
--- System Configuration Dialog ---  
Would you like to enter the initial configuration dialog? [yes/no]: no
```

Step 2 Press Return to enter the user EXEC mode.

The following prompt is displayed:

```
Router>
```

Step 3 From the user EXEC mode, enter the enable command:

```
Router> enable
```

Step 4 At the password prompt, enter your system password (if a password has not been set on your system, you can skip this step.)

```
Password: enablepass
```

When your password is accepted, the privileged EXEC mode prompt is displayed:

```
Router#
```

You now have access to the CLI in privileged EXEC mode. You can enter necessary commands to complete required tasks.

Step 5 To exit the console session, enter the quit command:

```
Router# quit
```

Configure Global Parameters

When you first start the setup program, configure certain global parameters that are used for controlling system-wide settings. Perform the following steps to enter the global parameters:

Procedure

Step 1 Connect a console terminal to the console port, and then boot the device.

Note The following is only an example of the output display; prompts may vary.

When this information appears, it means that you have successfully booted your device:

Example:

```
Restricted Rights Legend
```

```
Use, duplication, or disclosure by the Government is
subject to restrictions as set forth in subparagraph
(c) of the Commercial Computer Software - Restricted
Rights clause at FAR sec. 52.227-19 and subparagraph
(c) (1) (ii) of the Rights in Technical Data and Computer
Software clause at DFARS sec. 252.227-7013.
```

```
cisco Systems, Inc.
170 West Tasman Drive
San Jose, California 95134-1706
```

```
.
.
.
--- System Configuration Dialog ---
```

```
Would you like to enter the initial configuration dialog? [yes/no]: yes
```

```
Press RETURN to get started!
```

- Step 2** The first sections of the configuration script appear only at an initial system startup. On subsequent uses, the script begins with a System Configuration Dialog as shown below. When prompted to enter the initial configuration dialog, enter *yes*.

```
Would you like to enter the initial configuration dialog? [yes/no] yes
```

```
At any point you may enter a question mark '?' for help.  
Use ctrl-c to abort configuration dialog at any prompt.  
Default settings are in square brackets '[]'.
```

```
Basic management setup configures only enough connectivity for management of the system,  
extended setup will ask you to configure each interface on the system.
```

The basic management setup configures enough connectivity for managing the system; the extended setup prompts you to configure each interface on the system.

Check the Running Configuration Settings

To view the value of the settings you have entered, enter the following command in privileged EXEC mode:

```
device# show running-config
```

To review the changes you have made to the configuration, enter the following command in EXEC mode and copy run-start stored in the NVRAM.

```
device# show startup-config
```

Save the Running Configuration to NVRAM

To store the configuration or changes to your startup configuration in NVRAM, enter the following command at the prompt:

```
device# copy running-config startup-config
```

This command saves the configuration settings that you create in the device using the configuration mode and the setup facility. If the save action fails, you lose your configuration, and it is not available during your next reload.

Safely Power Down the Device

This section explains how to shut down the device. We recommend that before turning off all power to the device, you issue the **reload** command. Running this command ensures that, the operating system cleans up all file systems. After the reload operation is complete, the device can be powered down safely.

To power down the device safely:

Procedure

- Step 1** Slip on the ESD-preventive wrist strap included in the accessory kit.
- Step 2** Enter the **reload** command.

- Step 3** Click the **Enter** key when prompted to confirm.
- Step 4** Wait for the system bootstrap message before powering down the system:
- Step 5** Remove power cables, if any, from the device:
- For power supplies with a circuit breaker switch, position the switch to the 'Off' (O) position.
 - For power supplies with a standby switch, place the standby switch in the 'Standby' position.

After powering down the device, wait for a minimum of 30 seconds before powering it on again.



CHAPTER 5

Troubleshooting

This chapter provides information about troubleshooting issues, if any, on the device:

- [Pinouts, on page 77](#)

Pinouts

The following sections describe the pinouts for the device interfaces:

BITS Port Pinouts

The following table summarizes the BITS port pinouts.

Table 16: BITS Port Pinouts

Pin	Signal Name	Direction	Description
1	RX Ring	Input	Receive Ring
2	RX Tip	Input	Receive Tip
3	—	—	Not used
4	TX Ring	Output	TX Ring
5	TX Tip	Output	TX Tip
6	—	—	Not used
7	—	—	Not used
8	—	—	Not used

Time-of-Day Port Pinouts

The following table summarizes the ToD/1-PPS port pinouts.

Table 17: RJ-45 1PPS/ToD Port Pinouts

Pin	Signal Name	Direction	Description
1	RESERVED	Output	Do Not Connect
2	RESERVED	Input	Do Not Connect
3	1PPS_N	Output or Input	1PPS RS422 signal
4	GND	—	—
5	GND	—	—
6	1PPS_P	Output or Input	1PPS RS422 signal
7	TOD_N	Output or Input	Time-of-Day character
8	TOD_P	Output or Input	Time-of-Day character

Alarm Port Pinouts

The following table summarizes the external alarm input pinouts.

Table 18: External Alarm Input Pinouts

Pin	Signal Name	Description
1	ALARM0_IN	Alarm input 0
2	ALARM1_IN	Alarm input 1
3	—	No connect
4	ALARM2_IN	Alarm input 2
5	ALARM3_IN	Alarm input 3
6	—	No connect
7	—	No connect
8	COMMON	Alarm common

Management Ethernet Port Pinouts

The following table summarizes the Management Ethernet port pinouts.

Table 19: Fan Alarm Port Pinout

Pin	Signal Name
1	TRP0+

Pin	Signal Name
2	TRP0-
3	TRP1+
4	TRP2+
5	TRP2-
6	TRP1-
7	TRP3+
8	TRP3-

USB Console Port Pinouts

The table below summarizes the USB console port pinouts.

Table 20: Single USB Console Port Pinouts

Pin	Signal Name	Description
A1	Vcc	+5VDC
A2	D-	Data -
A3	D+	Data +
A4	Gnd	Ground



Note The USB console port +5VDC is input, and operates as an USB peripheral device.

USB Flash or MEM Port Pinouts

The table below summarizes the USB flash or MEM port pinouts.

Table 21: Single USB Flash or MEM Port Pinouts

Pin	Signal Name	Description
A1	Vcc	+5VDC (500mA)
A2	D-	Data -
A3	D+	Data +
A4	Gnd	Ground



Note USB TYPE-A receptacle is used.



Note The USB flash or MEM port +5VDC is output. Cisco ASR 920 Series Aggregation Services Router provides power for USB flash or MEM port. This port operates as a USB host device.

Check Optical Fiber Specifications

Optical fiber transmission defines two types of fiber specification:

- Single mode with three transmission types: short reach, intermediate reach, and long reach.
- Multimode with only short reach.

Check Alarm Conditions

The following table summarizes the meaning of alarm conditions on the device.

Table 22: Alarm Conditions Summary

Alarm Type	Alarm Meaning
Critical	Port in down state. Environmental sensor threshold exceeded critical level (voltage, temperature).
Major	Environmental sensor threshold exceeded major level (voltage, temperature).
Info	Port is administratively shut down.



CHAPTER 7

Supported SFPs and PIDs

- [Supported SFPs, on page 83](#)
- [Supported PIDs, on page 84](#)

Supported SFPs

- GLC-LH-SMD
- GLC-SX-MMD
- GLC-SX-MM-RGD
- GLC-EX-SMD
- GLC-ZX-SM-RGD
- CWDM-SFP-xxxx (8 colors)
- GLC-BX-U
- GLC-BX-D
- SFP-GE-L
- SFP-GE-S
- SFP-GE-Z
- SFP-GE-T
- DWDM-SFP-xxxx (40 wavelengths)
- SFP-10G-SR
- SFP-10G-LR
- SFP-10G-ER
- SFP-10G-ZR
- SFP-10G-SR-X
- SFP-10G-LR-X
- GLC-FE-100FX
- GLC-FE-100FX-RGD
- GLC-FE-100EX
- GLC-FE-100ZX
- GLC-FE-100LX
- GLC-FE-100LX-RGD
- GLC-FE-100BX-U
- GLC-FE-100BX-D
- GLC-LH-LMM-TI

- GLC-ZX-LMM-TI
- GLC-BX40-U-I
- GLC-BX40-D-I
- GLC-BX40-DA-I
- GLC-BX80-U-I
- GLC-BX80-D-I
- SFP-10G-BXD-I
- SFP-10G-BXU-I
- SFP-10G-BX40D-I
- SFP-10G-BX40U-I
- CWDM-SFP10G-1470
- CWDM-SFP10G-1490
- CWDM-SFP10G-1510
- CWDM-SFP10G-1530
- CWDM-SFP10G-1550
- CWDM-SFP10G-1570
- CWDM-SFP10G-1590
- CWDM-SFP10G-1610

Supported PIDs

PID	Description
ASR920-S-M=	ASR 920 Metro Access Services Paper PAK
ASR920-S-I=	ASR 920 Metro IP Access Services Paper PAK
ASR920-S-A=	ASR 920 Advanced Metro IP Access Services Paper PAK
ASR920-ATM=	ASR 920 ATM License Paper PAK
ASR920-1588	ASR 920 IEEE 1588-2008 BC/MC License Paper PAK
ASR920-1588=	ASR 920 IEEE 1588-2008 BC/MC License Paper PAK
ASR920-1G-6=	Cisco ASR920 Series - 6 ports GE license Paper PAK
ASR920-1G-12	Cisco ASR920 Series - 12 ports GE license Paper PAK
ASR920-1G-12=	Cisco ASR920 Series - 12 ports GE license Paper PAK
ASR920-10G-2=	Cisco ASR920 Series - 2 ports 10GE license Paper PAK
ASR920-12G-2-10G	Cisco ASR920 Series - 12 ports 1GE and 2 ports 10GE license
ASR920-SHELL=	ASR 920 Shell Access Paper PAK
ASR920-S-I-A=	ASR 920 Metro IP to Advanced Metro IP Access Paper PAK
ASR920-S-M-I=	ASR 920 Metro Access to Metro IP Access Paper PAK

PID	Description
ASR920-S-M-A=	ASR 920 Metro Access to Advanced Metro IP Access Paper PAK
L-ASR920-S-M=	ASR 920 Metro Access Services E-Delivery PAK
L-ASR920-S-I=	ASR 920 Metro IP Access Services E-Delivery PAK
L-ASR920-S-A=	ASR 920 Advanced Metro IP Access Services E-Delivery PAK
L-ASR920-ATM=	ASR 920 ATM License E-Delivery PAK
L-ASR920-1588=	ASR 920 IEEE 1588-2008 BC/MC License E-Delivery PAK
L-ASR920-SHELL=	ASR 920 Shell Access E-Delivery
L-ASR920-S-M-A=	ASR 920 Metro Access to Adv Metro IP Access E-Delivery PAK
L-ASR920-S-I-A=	ASR 920 Metro IP to Advanced Metro IP Access E-Delivery PAK
L-ASR920-S-M-I=	ASR 920 Metro Access to Metro IP Access E-Delivery PAK
L-ASR920-1G-6=	Cisco ASR920 Series - 6 ports GE license E-Delivery PAK
L-ASR920-1G-12=	Cisco ASR920 Series - 12 ports GE license E-Delivery PAK
L-ASR920-10G-2=	Cisco ASR920 Series - 2 ports 10GE license E-Delivery PAK
Power Supply Cables	
CAB-AC-SA	Power Cord - South Africa, 16/10A,250V,1830mm, -40C to +85C
CAB-AC-ARG	Power Cord - Argentina, 10A,250V,2500mm, -40C to +85C
CAB-AC-ISR	Power Cord - Israel, 16/10A,250V,2500mm, -40C to +85C
CAB-AC-TAI	Power Cord - Taiwan, 15/10A,125V,2500mm, -40C to +85C
CAB-AC-CHI	Power Cord - China, 10A,250V,2500mm, -40C to +85C
CAB-AC-KOR	Power Cord - Korea, 16/10A,125V,2500mm, -40C to +85C
CAB-AC-EUR	Power Cord - Europe, 16/10A,250V, 2500mm, -40C to +85C
CAB-AC-ITL	Power Cord - Italy, 10A,250V, 2500mm, -40C to +85C
CAB-AC-UK	Power Cord - UK, 13/10A, 250V, 2500mm, -40C to +85C
CAB-AC-AUS	Power Cord - Australia, 10A,250V,2500mm, -40C to +85C
CAB-AC-US	Power Cord - US, 15A,125V,2500mm,-40C to +85C
CAB-AC-BRA	Power Cord - Brazil, 10A,250V,2500mm, -40C to +85C
CAB-AC-IND	Power Cord - India, 16/10A,250V,2500mm, -40C to +85C
CAB-AC-SUI	Power Cord - Swiss, 10A,250V,2500mm, -40C to +85C

Table 24: Supported PIDs—Default Accessory Kit

PID	Description
A900-CONS-KIT-U	USB Console Kit, USB-to-USB cable
A920-CONS-KIT-S	Serial Console Kit, USB-to-RJ45 cable
A920-RCKMT-ETSI ²	Rack Mount for ETSI for ASR-920-12CZ-A/D
A920-RCKMT-19	Rack Mount for 19-inch rack for ASR-920-12CZ-A/D
A920-RCKMT-23	Rack Mount for 23-inch rack for ASR-920-12CZ-A/D
A920-RCKMT-C-ETSI	Rack Mount for ETSI for ASR-920-4SZ-A/D
A920-RCKMT-C-19	Rack Mount for 19-inch rack for ASR-920-4SZ-A/D
A920-RCKMT-C-23	Rack Mount for 23-inch rack for ASR-920-4SZ-A/D
A920-CBL-BRKT	Cable brackets
A920-CBL-BRKT-E	Cable brackets for ETSI

² Grounding Lug will be included with the rack mount by default



INDEX

A

- airflow [28](#)
 - chassis clearance [28](#)
- altitude [22](#)

C

- chassis [24, 28](#)
 - ground connection description [24](#)
 - preventing overheating [28](#)
- coaxial cable [25](#)
- commands [28, 75](#)
 - show environment [28](#)
 - show running-config [75](#)
 - show startup-config [75](#)
- configuring [74–75](#)
 - global parameters [74](#)
 - reviewing changes [75](#)
- console port [73](#)

E

- electrical wiring requirements [24](#)

G

- global parameters, configuring [74](#)

H

- humidity [22](#)

I

- installation [68](#)
 - starting the router [68](#)
- installing [31](#)
 - lifting chassis [31](#)
- IP, device address [73](#)

L

- log [81](#)
 - site [81](#)

M

- modifications to configuration, reviewing [75](#)

P

- power lines (warning) [17](#)
- power supplies (warning) [17](#)
- procedures [68](#)
 - starting the router [68](#)

R

- restricted access (warning) [17](#)
- reviewing changes to configuration [75](#)
- RJ-45 connectors [26](#)
- RS-232 asynchronous data [26](#)

S

- sample configurations, global parameters [74](#)
- show commands [75](#)
 - show running-config [75](#)
 - show startup-config [75](#)
- show environment command [28](#)
- site [81](#)
 - log [81](#)
- site requirements, rack-mounting [27](#)
- startup system [68](#)

T

- terminal server connections [73](#)

