



MPLS Configuration Guide for the Cisco CRS Routers, Cisco IOS-XR Release 6.4.x

First Published: 2018-03-01

Americas Headquarters

Cisco Systems, Inc.
170 West Tasman Drive
San Jose, CA 95134-1706
USA
<http://www.cisco.com>
Tel: 408 526-4000
800 553-NETS (6387)
Fax: 408 527-0883

THE SPECIFICATIONS AND INFORMATION REGARDING THE PRODUCTS IN THIS MANUAL ARE SUBJECT TO CHANGE WITHOUT NOTICE. ALL STATEMENTS, INFORMATION, AND RECOMMENDATIONS IN THIS MANUAL ARE BELIEVED TO BE ACCURATE BUT ARE PRESENTED WITHOUT WARRANTY OF ANY KIND, EXPRESS OR IMPLIED. USERS MUST TAKE FULL RESPONSIBILITY FOR THEIR APPLICATION OF ANY PRODUCTS.

THE SOFTWARE LICENSE AND LIMITED WARRANTY FOR THE ACCOMPANYING PRODUCT ARE SET FORTH IN THE INFORMATION PACKET THAT SHIPPED WITH THE PRODUCT AND ARE INCORPORATED HEREIN BY THIS REFERENCE. IF YOU ARE UNABLE TO LOCATE THE SOFTWARE LICENSE OR LIMITED WARRANTY, CONTACT YOUR CISCO REPRESENTATIVE FOR A COPY.

The Cisco implementation of TCP header compression is an adaptation of a program developed by the University of California, Berkeley (UCB) as part of UCB's public domain version of the UNIX operating system. All rights reserved. Copyright © 1981, Regents of the University of California.

NOTWITHSTANDING ANY OTHER WARRANTY HEREIN, ALL DOCUMENT FILES AND SOFTWARE OF THESE SUPPLIERS ARE PROVIDED "AS IS" WITH ALL FAULTS. CISCO AND THE ABOVE-NAMED SUPPLIERS DISCLAIM ALL WARRANTIES, EXPRESSED OR IMPLIED, INCLUDING, WITHOUT LIMITATION, THOSE OF MERCHANTABILITY, FITNESS FOR A PARTICULAR PURPOSE AND NON-INFRINGEMENT OR ARISING FROM A COURSE OF DEALING, USAGE, OR TRADE PRACTICE.

IN NO EVENT SHALL CISCO OR ITS SUPPLIERS BE LIABLE FOR ANY INDIRECT, SPECIAL, CONSEQUENTIAL, OR INCIDENTAL DAMAGES, INCLUDING, WITHOUT LIMITATION, LOST PROFITS OR LOSS OR DAMAGE TO DATA ARISING OUT OF THE USE OR INABILITY TO USE THIS MANUAL, EVEN IF CISCO OR ITS SUPPLIERS HAVE BEEN ADVISED OF THE POSSIBILITY OF SUCH DAMAGES.

Any Internet Protocol (IP) addresses and phone numbers used in this document are not intended to be actual addresses and phone numbers. Any examples, command display output, network topology diagrams, and other figures included in the document are shown for illustrative purposes only. Any use of actual IP addresses or phone numbers in illustrative content is unintentional and coincidental.

All printed copies and duplicate soft copies of this document are considered uncontrolled. See the current online version for the latest version.

Cisco has more than 200 offices worldwide. Addresses and phone numbers are listed on the Cisco website at www.cisco.com/go/offices.

Cisco and the Cisco logo are trademarks or registered trademarks of Cisco and/or its affiliates in the U.S. and other countries. To view a list of Cisco trademarks, go to this URL: <https://www.cisco.com/c/en/us/about/legal/trademarks.html>. Third-party trademarks mentioned are the property of their respective owners. The use of the word partner does not imply a partnership relationship between Cisco and any other company. (1721R)

© 2018 Cisco Systems, Inc. All rights reserved.



CONTENTS

PREFACE

Preface	xix
Changes to This Document	xix
Communications, Services, and Additional Information	xix

CHAPTER 1

New and Changed MPLS Features	1
New and Changed MPLS Feature Information	1

CHAPTER 2

Implementing MPLS Label Distribution Protocol	3
Prerequisites for Implementing Cisco MPLS LDP	4
Information About Implementing Cisco MPLS LDP	5
Overview of Label Distribution Protocol	5
Label Switched Paths	5
LDP Control Plane	5
Exchanging Label Bindings	5
LDP Forwarding	6
LDP Graceful Restart	8
Control Plane Failure	8
Phases in Graceful Restart	9
Recovery with Graceful-Restart	10
Label Advertisement Control (Outbound Filtering)	11
Label Acceptance Control (Inbound Filtering)	12
Local Label Allocation Control	12
Session Protection	12
IGP Synchronization	13
IGP Auto-configuration	14
IGP Synchronization Process Restart Delay	14

LDP Nonstop Routing	15
IP LDP Fast Reroute Loop Free Alternate	15
Downstream on Demand	17
Explicit-Null and Implicit-Null Labels	17
MPLS over IRB	18
MPLS LDP Carrier Supporting Carrier for Multiple VRFs	18
MPLS Carrier Supporting Carrier L3VPN: Introduction	18
Benefits of MPLS LDP CSC	19
Multiple VRF Support	20
Restrictions and Recommendations	21
IPv6 Support in MPLS LDP	21
LDP IPv6 Functionality	22
Restrictions	25
Features Supported in LDP IPv6	26
Implicit IPv4 Disable	29
IPv6 Label Bindings	29
IPv6 Address Bindings	29
Default Transport Address	30
LDP Control Plane: Bindings Advertisement	30
LSP Mapping	30
Label Policies	30
IS-IS	31
Dual-Stack Capability TLV	31
Compliance Check	32
How to Implement MPLS LDP	32
Configuring LDP Discovery Parameters	32
Configure Label Distribution Protocol Targeted Neighbor	34
Configuration Example	34
Running Configuration	34
Configuring LDP Discovery Over a Link	35
Configuring LDP Discovery for Active Targeted Hellos	37
Configuring LDP Discovery for Passive Targeted Hellos	39
Configuring Label Advertisement Control (Outbound Filtering)	41
Setting Up LDP Neighbors	42

Setting Up LDP Forwarding	45
Configuring Global Transport Address	48
Setting Up LDP NSF Using Graceful Restart	49
Configuring Label Acceptance Control (Inbound Filtering)	52
Configuring Local Label Allocation Control	53
Configuring Session Protection	54
Configuring LDP IGP Synchronization: OSPF	55
Disabling LDP IGP Synchronization: OSPF	57
Configuring LDP IGP Synchronization: ISIS	58
Configuring LDP IGP Synchronization Delay Interval	59
Configuring LDP IGP Synchronization Process Restart Delay	60
Enabling LDP Auto-Configuration for a Specified OSPF Instance	61
Enabling LDP Auto-Configuration in an Area for a Specified OSPF Instance	62
Disabling LDP Auto-Configuration	63
Configuring LDP Nonstop Routing	64
Configuring LDP Downstream on Demand mode	66
Setting Up Implicit-Null-Override Label	67
Redistributing MPLS LDP Routes into BGP	68
Enabling MLDP	69
Enabling MLDP Make-Before-Break	70
Enabling MLDP MoFRR	72
Enabling MLDP Recursive FEC	73
Enabling MLDP Static Multipoint to Multipoint LSP	75
Enabling MLDP Static Point to Multipoint LSP	76
Disabling MLDP	77
LDP IPv6 Configuration	79
Enabling LDP IPv6 Native	79
Enabling LDP IPv6 Control Plane	80
Configuring IPv6-only LSR	81
Configuring Global Transport Address for IPV6	86
Disabling Implicit IPv4	87
Configuring IPv4 as Transport Preference	88
Configuring Transport Preference Maximum Wait Time	89
Configuration Examples for Implementing MPLS LDP	91

Configuring LDP with Graceful Restart: Example	91
Configuring LDP Discovery: Example	91
Configuring LDP Link: Example	91
Configuring LDP Discovery for Targeted Hellos: Example	91
Configuring Label Advertisement (Outbound Filtering): Example	92
Configuring LDP Neighbors: Example	93
Configuring LDP Forwarding: Example	93
Configuring LDP Nonstop Forwarding with Graceful Restart: Example	93
Configuring Label Acceptance (Inbound Filtering): Example	94
Configuring Local Label Allocation Control: Example	94
Configuring LDP Session Protection: Example	94
Configuring LDP IGP Synchronization—OSPF: Example	95
Configuring LDP IGP Synchronization—ISIS: Example	95
Configuring LDP Auto-Configuration: Example	95
Configure IP LDP Fast Reroute Loop Free Alternate: Examples	96
Verify IP LDP Fast Reroute Loop Free Alternate: Example	98
MPLS LDP CSC for Multiple VRFs Configuration: Examples	100
LDP IPv6 Configuration: Examples	113
Additional References	115

CHAPTER 3**Implementing MPLS Static Labeling 117**

Enable MPLS Encapsulation on an Interface	118
Define a Range for Static MPLS Labels	119
Setup a Static LSP	120
Allocate Static MPLS Label to an IP Prefix and Configure a LSP	121
Allocate Static MPLS Label for a Specific VRF	122
Verify MPLS Static Bindings	123
Identify and Clear Label Discrepancy	124

CHAPTER 4**Implementing RSVP for MPLS-TE and MPLS O-UNI 127**

Prerequisites for Implementing RSVP for MPLS-TE and MPLS O-UNI	128
Information About Implementing RSVP for MPLS-TE and MPLS O-UNI	128
Overview of RSVP for MPLS-TE and MPLS O-UNI	128
LSP Setup	129

High Availability	130
Graceful Restart	130
Graceful Restart: Standard and Interface-Based	130
Graceful Restart: Figure	131
ACL-based Prefix Filtering	132
RSVP MIB	133
Information About Implementing RSVP Authentication	133
RSVP Authentication Functions	133
RSVP Authentication Design	133
Global, Interface, and Neighbor Authentication Modes	134
Security Association	135
Key-source Key-chain	136
Guidelines for Window-Size and Out-of-Sequence Messages	137
Caveats for Out-of-Sequence	137
How to Implement RSVP	137
Configuring Traffic Engineering Tunnel Bandwidth	138
Confirming DiffServ-TE Bandwidth	138
Configuring MPLS O-UNI Bandwidth	139
Enabling Graceful Restart	139
Configuring ACL-based Prefix Filtering	140
Configuring ACLs for Prefix Filtering	140
Configuring RSVP Packet Dropping	141
Verifying RSVP Configuration	142
Enabling RSVP Traps	145
How to Implement RSVP Authentication	146
Configuring Global Configuration Mode RSVP Authentication	146
Enabling RSVP Authentication Using the Keychain in Global Configuration Mode	146
Configuring a Lifetime for RSVP Authentication in Global Configuration Mode	147
Configuring the Window Size for RSVP Authentication in Global Configuration Mode	148
Configuring an Interface for RSVP Authentication	149
Specifying the RSVP Authentication Keychain in Interface Mode	149
Configuring a Lifetime for an Interface for RSVP Authentication	150
Configuring the Window Size for an Interface for RSVP Authentication	151
Configuring RSVP Neighbor Authentication	152

Specifying the Keychain for RSVP Neighbor Authentication	152
Configuring a Lifetime for RSVP Neighbor Authentication	153
Configuring the Window Size for RSVP Neighbor Authentication	153
Verifying the Details of the RSVP Authentication	154
Eliminating Security Associations for RSVP Authentication	154
Configuration Examples for RSVP	155
Bandwidth Configuration (Prestandard): Example	155
Bandwidth Configuration (MAM): Example	155
Bandwidth Configuration (RDM): Example	155
Refresh Reduction and Reliable Messaging Configuration: Examples	156
Refresh Interval and the Number of Refresh Messages Configuration: Example	156
Retransmit Time Used in Reliable Messaging Configuration: Example	156
Acknowledgement Times Configuration: Example	156
Summary Refresh Message Size Configuration: Example	156
Disable Refresh Reduction: Example	157
Configure Graceful Restart: Examples	157
Enable Graceful Restart: Example	157
Enable Interface-Based Graceful Restart: Example	157
Change the Restart-Time: Example	157
Change the Hello Interval: Example	157
Configure ACL-based Prefix Filtering: Example	158
Set DSCP for RSVP Packets: Example	158
Enable RSVP Traps: Example	158
Configuration Examples for RSVP Authentication	159
RSVP Authentication Global Configuration Mode: Example	159
RSVP Authentication for an Interface: Example	159
RSVP Neighbor Authentication: Example	160
RSVP Authentication by Using All the Modes: Example	160
Additional References	161

CHAPTER 5
Implementing MPLS Forwarding 163

Prerequisites for Implementing Cisco MPLS Forwarding	163
Restrictions for Implementing Cisco MPLS Forwarding	164
Information About Implementing MPLS Forwarding	164

MPLS Forwarding Overview	164
Label Switching Functions	165
Distribution of Label Bindings	165
MFI Control-Plane Services	166
MFI Data-Plane Services	166
Time-to-Live Propagation in Hierarchical MPLS	166
MPLS Maximum Transmission Unit	166
How to Implement MPLS Forwarding	166
Configuring the Time-to-Live Propagation in Hierarchical MPLS	166
Configuring the Size of the Local Label	167
Additional References	168

CHAPTER 6**Implementing MPLS Traffic Engineering 169**

Prerequisites for Implementing Cisco MPLS Traffic Engineering	171
Information About Implementing MPLS Traffic Engineering	171
Overview of MPLS Traffic Engineering	171
Benefits of MPLS Traffic Engineering	172
How MPLS-TE Works	172
MPLS Traffic Engineering	173
Backup AutoTunnels	173
Periodic Backup Promotion	176
Protocol-Based CLI	177
Differentiated Services Traffic Engineering	177
Prestandard DS-TE Mode	177
IETF DS-TE Mode	178
Bandwidth Constraint Models	178
TE Class Mapping	179
Flooding	179
Flooding Triggers	180
Flooding Thresholds	180
Fast Reroute	180
IS-IS IP Fast Reroute Loop-free Alternative	181
MPLS-TE and Fast Reroute over Link Bundles	181
Ignore Intermediate System-to-Intermediate System Overload Bit Setting in MPLS-TE	182

DWDM Transponder Integration	183
GMPLS Benefits	183
GMPLS Support	183
GMPLS Protection and Restoration	184
GMPLS Prerequisites	185
Flexible Name-based Tunnel Constraints	185
MPLS Traffic Engineering Interarea Tunneling	185
Interarea Support	186
Multiarea Support	186
Loose Hop Expansion	187
Loose Hop Reoptimization	187
ABR Node Protection	188
Fast Reroute Node Protection	188
Make-Before-Break	188
MPLS-TE Forwarding Adjacency	188
MPLS-TE Forwarding Adjacency Benefits	189
MPLS-TE Forwarding Adjacency Restrictions	189
MPLS-TE Forwarding Adjacency Prerequisites	189
Unequal Load Balancing	189
Path Computation Element	190
Policy-Based Tunnel Selection	191
Policy-Based Tunnel Selection	191
Policy-Based Tunnel Selection Functions	192
PBTS Restrictions	192
Enabling Forward Class Zero in PBTS	193
Set DF Bit	193
Path Protection	193
Pre-requisites for Path Protection	193
Restrictions for Path Protection	194
Restrictions for Explicit Path Protection	194
Co-existence of Path Protection with Fast Reroute	195
MPLS-TE Automatic Bandwidth	195
MPLS-TE Automatic Bandwidth Overview	195
Adjustment Threshold	196

Overflow Detection	197
Underflow Detection	197
Restrictions for MPLS-TE Automatic Bandwidth	197
Point-to-Multipoint Traffic-Engineering	197
Point-to-Multipoint Traffic-Engineering Overview	197
Point-to-Multipoint RSVP-TE	199
Point-to-Multipoint Fast Reroute	200
Point-to-Multipoint Label Switch Path	200
Path Option for Point-to-Multipoint RSVP-TE	201
MPLS Traffic Engineering Shared Risk Link Groups	202
Explicit Path	203
Fast ReRoute with SRLG Constraints	203
Importance of Protection	205
SRLG Limitations	206
MPLS TE SRLG Scale Enhancements	207
Soft-Preemption	207
Path Option Attributes	207
Configuration Hierarchy of Path Option Attributes	208
Traffic Engineering Bandwidth and Bandwidth Pools	208
Path Option Switchover	209
Path Option and Path Protection	209
Auto-Tunnel Mesh	210
Destination List (Prefix-List)	210
P2MP-TE Auto-tunnels	211
PWHE over MPLS TE Tunnels	211
VRF Redirection to MPLS TE Tunnels	214
MPLS TE Extended Admin Groups	215
Stateful Path Computation Element	215
Stateful PCE State Reporting	216
Stateful PCE State Synchronization	216
Stateful PCE Delegation	216
Stateful PCE State Updating	217
Stateful PCE Creation of LSPs	217
Delegation of PCC Initiated Tunnels	217

MPLS TE Usability Enhancements	217
MPLS TE IPv6 Autoroute	217
MPLS TE IPv6 Autoroute Restrictions	218
MPLS TE Path Cost Limit	218
Soft-preemption over FRR Backup Tunnels	219
MPLS TE Auto-tunnel Mesh One-hop	219
Inter-area Traffic Engineering with Dynamic ABR Discovery	219
Named Tunnel	219
Named Path Option	220
How to Implement Traffic Engineering	220
Building MPLS-TE Topology	220
Creating an MPLS-TE Tunnel	222
Automatic Modification Of An MPLS-TE Tunnel's Metric	224
Configuring Forwarding over the MPLS-TE Tunnel	225
Protecting MPLS Tunnels with Fast Reroute	227
Enabling an AutoTunnel Backup	231
Removing an AutoTunnel Backup	232
Establishing MPLS Backup AutoTunnels to Protect Fast Reroutable TE LSPs	232
Establishing Next-Hop Tunnels with Link Protection	233
Configuring a Prestandard DS-TE Tunnel	235
Configuring an IETF DS-TE Tunnel Using RDM	236
Configuring an IETF DS-TE Tunnel Using MAM	238
Configuring MPLS -TE and Fast-Reroute on OSPF	241
Configuring the Ignore Integrated IS-IS Overload Bit Setting in MPLS-TE	242
Configuring GMPLS	243
Configuring IPCC Control Channel Information	243
Configuring Local and Remote TE Links	246
Configuring Numbered and Unnumbered Optical TE Tunnels	256
Configuring LSP Hierarchy	260
Configuring Border Control Model	261
Configuring Path Protection	261
Configuring Flexible Name-based Tunnel Constraints	264
Assigning Color Names to Numeric Values	264
Associating Affinity-Names with TE Links	265

Associating Affinity Constraints for TE Tunnels	266
Configuring IS-IS to Flood MPLS-TE Link Information	267
Configuring an OSPF Area of MPLS-TE	269
Configuring Explicit Paths with ABRs Configured as Loose Addresses	269
Configuring MPLS-TE Forwarding Adjacency	270
Configuring Unequal Load Balancing	271
Setting Unequal Load Balancing Parameters	271
Enabling Unequal Load Balancing	272
Configuring a Path Computation Client and Element	273
Configuring a Path Computation Client	273
Configuring a Path Computation Element Address	274
Configuring PCE Parameters	275
Configuring Policy-based Tunnel Selection	277
Configuring the Automatic Bandwidth	279
Configuring the Collection Frequency	279
Forcing the Current Application Period to Expire Immediately	280
Configuring the Automatic Bandwidth Functions	280
Configuring the Shared Risk Link Groups	283
Configuring the SRLG Values of Each Link that has a Shared Risk with Another Link	283
Creating an Explicit Path With Exclude SRLG	284
Using Explicit Path With Exclude SRLG	285
Creating a Link Protection on Backup Tunnel with SRLG Constraint	287
Creating a Node Protection on Backup Tunnel with SRLG Constraint	290
Configuring Point-to-Multipoint TE	292
Enabling Multicast Routing on the Router	292
Configuring the Static Group for the Point-to-Multipoint Interface	294
Configuring Destinations for the Tunnel Interface	296
Disabling Destinations	299
Logging Per Destinations for Point-to-Multipoint	300
Enabling Soft-Preemption on a Node	302
Enabling Soft-Preemption on a Tunnel	303
Configuring Attributes within a Path-Option Attribute	304
Configuring Auto-Tunnel Mesh Tunnel ID	305
Configuring Auto-tunnel Mesh Unused Timeout	306

Configuring Auto-Tunnel Mesh Group	307
Configuring Tunnel Attribute-Set Templates	308
Enabling LDP on Auto-Tunnel Mesh	310
Configuring P2MP TE Auto-tunnels	311
Enabling Stateful PCE Client	312
Configuring VRF Redirection	313
Configuring IPv6 Routing Over IPv4 MPLS-TE Tunnels	314
Configuring Path-selection Cost Limit	316
Configuring Global Path-selection Cost Limit on MPLS TE Tunnels	316
Configuring Path-selection Cost Limit per TE Tunnel	316
Configuring Path-selection Cost Limit per Path-option Attribute-set	317
Enabling Soft-preemption over FRR Backup Tunnels	318
Enabling Auto-onehop Tunnels to Next-hop Neighbors	318
Implementing Associated Bidirectional Label Switched Paths	320
Signaling Methods and Object Association for Bidirectional LSPs	320
Associated Bidirectional Non Co-routed and Co-routed LSPs	321
Configure Associated Bidirectional Co-routed LSPs	322
Path Protection	324
OAM Support for Associated Bidirectional LSPs	327
Pseudowire Call Admission Control	328
Configure Named Tunnel and Named Path Option	328
Verify Named Tunnel and Named Path Option Configuration: Example	330
Configuration Examples for Cisco MPLS-TE	331
Configure Fast Reroute and SONET APS: Example	331
Build MPLS-TE Topology and Tunnels: Example	331
Configure IETF DS-TE Tunnels: Example	332
Configure MPLS-TE and Fast-Reroute on OSPF: Example	333
Configure the Ignore IS-IS Overload Bit Setting in MPLS-TE: Example	333
Configure GMPLS: Example	334
Configure Flexible Name-based Tunnel Constraints: Example	336
Configure an Interarea Tunnel: Example	338
Configure Forwarding Adjacency: Example	339
Configure Unequal Load Balancing: Example	339
Configure PCE: Example	340

Configure Policy-based Tunnel Selection: Example	341
Configure Tunnels for Path Protection: Example	341
Configure Tunnels for Explicit Path Protection: Example	342
Configure Tunnels for Co-existence of Path Protection with Fast Reroute: Example	342
Configure Automatic Bandwidth: Example	342
Configure the MPLS-TE Shared Risk Link Groups: Example	342
Configure the MPLS-TE Auto-Tunnel Backup: Example	345
Configure Point-to-Multipoint TE: Examples	353
Configure Point-to-Multipoint for the Source: Example	353
Configure the Point-to-Multipoint Tunnel: Example	354
Disable a Destination: Example	354
Configure the Point-to-Multipoint Solution: Example	355
Configure MPLS TE Path-selection Cost Limit: Example	358
Configure Entropy Labels for MPLS TE Networks	359
Additional References	360

CHAPTER 7**GMPLS UNI 363**

Prerequisites for Implementing GMPLS UNI	363
Restrictions for Implementing GMPLS UNI	363
Information About Implementing GMPLS UNI	364
GMPLS UNI vs GMPLS NNI	364
GMPLS LSP Signaling	364
Path Message without an ERO	364
XRO Attribute-set	365
Connection Diversity	365
GMPLS RSVP VRF Signaling	365
DWDM Transponder Integration	365
nLight Enhancements	365
Explicit Route Object	366
Wavelength Specification	366
Multiple Path Options	367
Reoptimization	367
Manual Reoptimization	367
SRLG Discovery	367

Provision of Discovered SRLGs to RSI	368
SRLG Announce	368
SRLG Diversity	369
Head UNI-C Behavior	369
Tail UNI-C Behavior	369
Multi-Layer Restoration - Optical	369
Optical Restoration: Same Wavelength	369
Optical Restoration: Wavelength Change	370
How to Implement GMPLS UNI	370
Configuring TE for GMPLS UNI	370
Enabling GMPLS UNI Submode	370
Configuring GMPLS UNI Controller	371
Configuring the GMPLS UNI Controller as a Tunnel Head	372
Configuring Other Tunnel Properties for a GMPLS UNI Tunnel	373
Configuring LSP Diversity	375
Configuring LMP for GMPLS UNI	377
Configuring Optical Router ID	377
Configuring an LMP Neighbor	378
Configuring an LMP Controller	379
Configuring RSVP Optical Refresh Interval and Missed Count	380
nLight Enhancements: Configurations and Verifications	381
Configuring an ERO for a GMPLS Tunnel	381
Verifying an ERO Configuration: Example	383
Configuring Wavelength for a Path Option	384
Configuring and Verifying Wavelength Configuration: Examples	385
Configuring Multiple Path Options	388
Configuring and Verifying Multiple Path Options: Examples	391
Enabling SRLG Discovery	392
Verifying SRLG Discovery Configuration: Examples	394
Enabling SRLG Announce	395
Verifying SRLG Announce Configuration: Example	396
Configuring SRLG Diversity	397
Verifying SRLG Diversity Configuration: Example	399
Configuration Examples for GMPLS UNI	400

Configuring Head UNI-C for a GMPLS Tunnel: Example	400
Configuring Tail UNI-C for a GMPLS Tunnel: Example	401
Configuring LSP Diversity: Example	402
Additional References	402

CHAPTER 8**Implementing MPLS OAM 405**

Implementing MPLS OAM	405
MPLS LSP Ping	405
MPLS LSP Traceroute	407
Overview of P2MP TE Network	409
P2MP Ping	411
P2MP Traceroute	411
MPLS OAM Support for BGP 3107	411
Configuration Examples: P2MP Ping and P2MP Traceroute	411



Preface

The preface contains these sections:

- [Changes to This Document, on page xix](#)
- [Communications, Services, and Additional Information, on page xix](#)

Changes to This Document



Note *This software release has reached end-of-life status. For more information, see the [End-of-Life and End-of-Sale Notices](#).*

This table lists the technical changes made to this document since it was first released.

Table 1: Changes to This Document

Date	Change Summary
March 2018	Initial release of this document.

Communications, Services, and Additional Information

- To receive timely, relevant information from Cisco, sign up at [Cisco Profile Manager](#).
- To get the business impact you're looking for with the technologies that matter, visit [Cisco Services](#).
- To submit a service request, visit [Cisco Support](#).
- To discover and browse secure, validated enterprise-class apps, products, solutions and services, visit [Cisco Marketplace](#).
- To obtain general networking, training, and certification titles, visit [Cisco Press](#).
- To find warranty information for a specific product or product family, access [Cisco Warranty Finder](#).

Cisco Bug Search Tool

[Cisco Bug Search Tool](#) (BST) is a web-based tool that acts as a gateway to the Cisco bug tracking system that maintains a comprehensive list of defects and vulnerabilities in Cisco products and software. BST provides you with detailed defect information about your products and software.



CHAPTER 1

New and Changed MPLS Features

This table summarizes the new and changed feature information for the *Cisco IOS XR MPLS Configuration Guide for the Cisco CRS Router* and tells you where they are documented.

- [New and Changed MPLS Feature Information, on page 1](#)

New and Changed MPLS Feature Information

Table 2: New and Changed Features

Feature	Description	Changed in Release	Where Documented
Enabling Forward Class Zero in PBTS	This feature was introduced.	Release 6.4.1	<i>Implementing MPLS Traffic Engineering</i>



CHAPTER 2

Implementing MPLS Label Distribution Protocol

The Multiprotocol Label Switching (MPLS) is a standards-based solution driven by the Internet Engineering Task Force (IETF) that was devised to convert the Internet and IP backbones from best-effort networks into business-class transport mediums.

MPLS, with its label switching capabilities, eliminates the need for an IP route look-up and creates a virtual circuit (VC) switching function, allowing enterprises the same performance on their IP-based network services as with those delivered over traditional networks such as Frame Relay or ATM.

Label Distribution Protocol (LDP) performs label distribution in MPLS environments. LDP provides the following capabilities:

- LDP performs hop-by-hop or dynamic path setup; it does not provide end-to-end switching services.
- LDP assigns labels to routes using the underlying Interior Gateway Protocols (IGP) routing protocols.
- LDP provides constraint-based routing using LDP extensions for traffic engineering.

Finally, LDP is deployed in the core of the network and is one of the key protocols used in MPLS-based Layer 2 and Layer 3 virtual private networks (VPNs).

Feature History for Implementing MPLS LDP

Release	Modification
Release 2.0	This feature was introduced.
Release 3.0	No modification.
Release 3.2	Support was added for conceptual and configuration information about LDP label advertisement control (Outbound label filtering).
Release 3.3.0	Support was added for these features: <ul style="list-style-type: none">• Inbound Label Filtering• Local Label Allocation Control• Session Protection• LDP-IGP Synchronization
Release 3.4.0	No modification.

Release	Modification
Release 3.4.1	No modification.
Release 3.5.0	Support was added for LDP Auto-configuration.
Release 3.6.0	Support was added for LDP nonstop routing (NSR).
Release 3.7.0	No modification.
Release 3.8.0	The feature LDP IGP Synchronization Process Restart Delay was introduced.
Release 3.9.0	No modification.
Release 4.0.1	Support was added for these features: <ul style="list-style-type: none"> • IP LDP Fast Reroute Loop Free Alternate • Downstream on Demand
Release 4.2.1	Support was added for LDP Implicit Null for IGP Routes.
Release 5.1	Support was added for MPLS over IRB.
Release 5.1.1	The feature MPLS LDP Carrier Supporting Carrier for Multiple VRFs was introduced.
Release 5.3.0	IPv6 Support in MPLS LDP was introduced.

- [Prerequisites for Implementing Cisco MPLS LDP, on page 4](#)
- [Information About Implementing Cisco MPLS LDP, on page 5](#)
- [How to Implement MPLS LDP, on page 32](#)
- [Configuration Examples for Implementing MPLS LDP, on page 91](#)
- [Additional References, on page 115](#)

Prerequisites for Implementing Cisco MPLS LDP

These prerequisites are required to implement MPLS LDP:

- You must be in a user group associated with a task group that includes the proper task IDs. The command reference guides include the task IDs required for each command. If you suspect user group assignment is preventing you from using a command, contact your AAA administrator for assistance.
- You must be running Cisco IOS XR software.
- You must install a composite mini-image and the MPLS package.
- You must activate IGP.
- We recommend to use a lower session holdtime bandwidth such as neighbors so that a session down occurs before an adjacency-down on a neighbor. Therefore, the following default values for the hello times are listed:
 - Holdtime is 15 seconds.
 - Interval is 5 seconds.

For example, the LDP session holdtime can be configured as 30 seconds by using the **holdtime** command.

Information About Implementing Cisco MPLS LDP

To implement MPLS LDP, you should understand these concepts:

Overview of Label Distribution Protocol

LDP performs label distribution in MPLS environments. LDP uses hop-by-hop or dynamic path setup, but does not provide end-to-end switching services. Labels are assigned to routes that are chosen by the underlying IGP routing protocols. The Label Switched Paths (LSPs) that result from the routes, forward labeled traffic across the MPLS backbone to adjacent nodes.

Label Switched Paths

LSPs are created in the network through MPLS. They can be created statically, by RSVP traffic engineering (TE), or by LDP. LSPs created by LDP perform hop-by-hop path setup instead of an end-to-end path.

LDP Control Plane

The control plane enables label switched routers (LSRs) to discover their potential peer routers and to establish LDP sessions with those peers to exchange label binding information.

Related Topics

[Configuring LDP Discovery Parameters](#), on page 32

[Configuring LDP Discovery Over a Link](#), on page 35

[Configuring LDP Link: Example](#), on page 91

[Configuring LDP Discovery for Active Targeted Hellos](#), on page 37

[Configuring LDP Discovery for Passive Targeted Hellos](#), on page 39

[Configuring LDP Discovery for Targeted Hellos: Example](#), on page 91

Exchanging Label Bindings

LDP creates LSPs to perform the hop-by-hop path setup so that MPLS packets can be transferred between the nodes on the MPLS network.

Figure 1: Setting Up Label Switched Paths

This figure illustrates the process of label binding exchange for setting up LSPs.

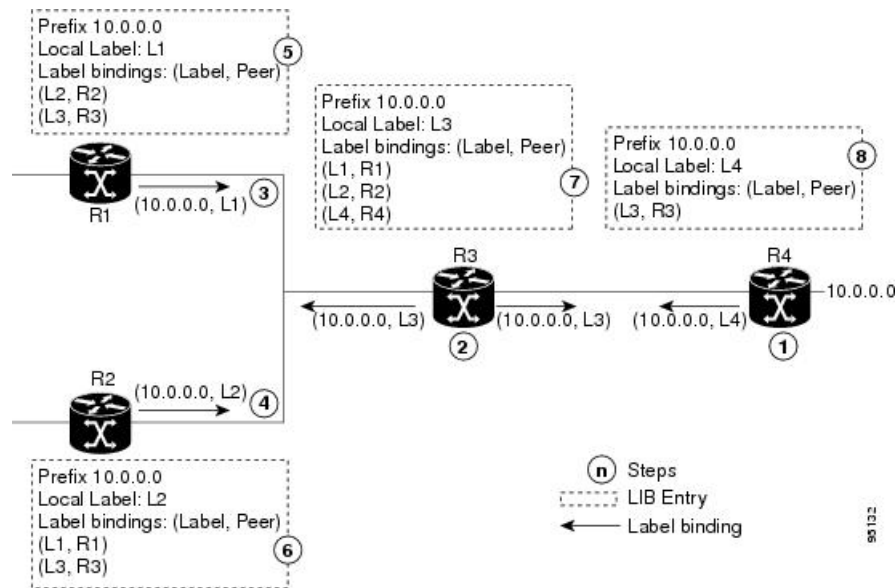

For a given network (10.0.0.0), hop-by-hop LSPs are set up between each of the adjacent routers (or, nodes) and each node allocates a local label and passes it to its neighbor as a binding:

1. R4 allocates local label L4 for prefix 10.0.0.0 and advertises it to its neighbors (R3).
2. R3 allocates local label L3 for prefix 10.0.0.0 and advertises it to its neighbors (R1, R2, R4).
3. R1 allocates local label L1 for prefix 10.0.0.0 and advertises it to its neighbors (R2, R3).
4. R2 allocates local label L2 for prefix 10.0.0.0 and advertises it to its neighbors (R1, R3).
5. R1's label information base (LIB) keeps local and remote labels bindings from its neighbors.
6. R2's LIB keeps local and remote labels bindings from its neighbors.
7. R3's LIB keeps local and remote labels bindings from its neighbors.
8. R4's LIB keeps local and remote labels bindings from its neighbors.

Related Topics

[Setting Up LDP Neighbors](#), on page 42

[Configuring LDP Neighbors: Example](#), on page 93

LDP Forwarding

Once label bindings are learned, the LDP control plane is ready to setup the MPLS forwarding plane as shown in the following figure.

Figure 2: Forwarding Setup

Once label bindings are learned, the LDP control plane is ready to setup the MPLS forwarding plane as shown in this figure.

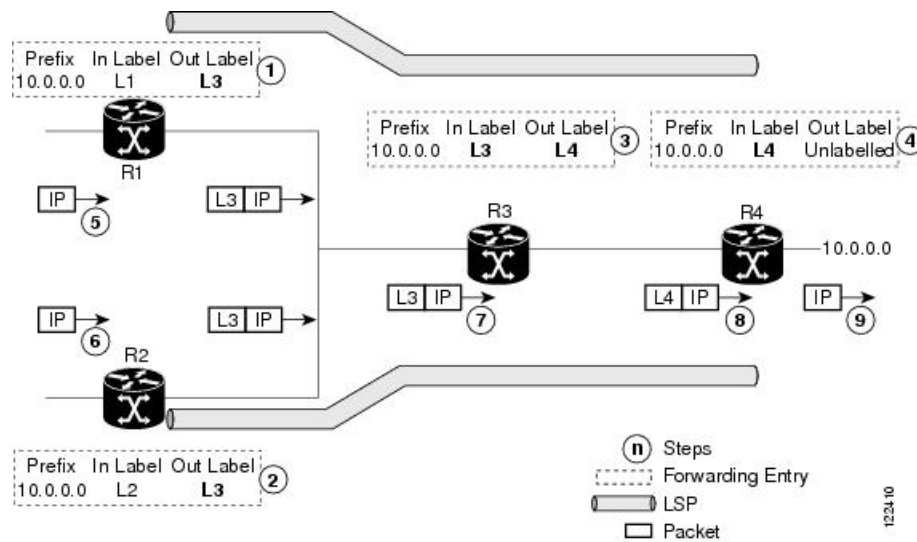

1. Because R3 is next hop for 10.0.0.0 as notified by the FIB, R1 selects label binding from R3 and installs forwarding entry (Layer 1, Layer 3).
2. Because R3 is next hop for 10.0.0.0 (as notified by FIB), R2 selects label binding from R3 and installs forwarding entry (Layer 2, Layer 3).
3. Because R4 is next hop for 10.0.0.0 (as notified by FIB), R3 selects label binding from R4 and installs forwarding entry (Layer 3, Layer 4).
4. Because next hop for 10.0.0.0 (as notified by FIB) is beyond R4, R4 uses NO-LABEL as the outbound and installs the forwarding entry (Layer 4); the outbound packet is forwarded IP-only.
5. Incoming IP traffic on ingress LSR R1 gets label-imposed and is forwarded as an MPLS packet with label L3.
6. Incoming IP traffic on ingress LSR R2 gets label-imposed and is forwarded as an MPLS packet with label L3.
7. R3 receives an MPLS packet with label L3, looks up in the MPLS label forwarding table and switches this packet as an MPLS packet with label L4.
8. R4 receives an MPLS packet with label L4, looks up in the MPLS label forwarding table and finds that it should be Unlabelled, pops the top label, and passes it to the IP forwarding plane.
9. IP forwarding takes over and forwards the packet onward.



Note For local labels, only up to 12000 rewrites are supported. If the rewrites exceed this limit, MPLS LSD or MPLS LDP or both the processes may crash.

Related Topics

- [Setting Up LDP Forwarding](#), on page 45
- [Configuring LDP Forwarding: Example](#), on page 93

LDP Graceful Restart

LDP (Label Distribution Protocol) graceful restart provides a control plane mechanism to ensure high availability and allows detection and recovery from failure conditions while preserving Nonstop Forwarding (NSF) services. Graceful restart is a way to recover from signaling and control plane failures without impacting forwarding.

Without LDP graceful restart, when an established session fails, the corresponding forwarding states are cleaned immediately from the restarting and peer nodes. In this case LDP forwarding restarts from the beginning, causing a potential loss of data and connectivity.

The LDP graceful restart capability is negotiated between two peers during session initialization time, in FT SESSION TLV. In this typed length value (TLV), each peer advertises the following information to its peers:

Reconnect time

Advertises the maximum time that other peer will wait for this LSR to reconnect after control channel failure.

Recovery time

Advertises the maximum time that the other peer has on its side to reinstate or refresh its states with this LSR. This time is used only during session reestablishment after earlier session failure.

FT flag

Specifies whether a restart could restore the preserved (local) node state for this flag.

Once the graceful restart session parameters are conveyed and the session is up and running, graceful restart procedures are activated.

When configuring the LDP graceful restart process in a network with multiple links, targeted LDP hello adjacencies with the same neighbor, or both, make sure that graceful restart is activated on the session before any hello adjacency times out in case of neighbor control plane failures. One way of achieving this is by configuring a lower session hold time between neighbors such that session timeout occurs before hello adjacency timeout. It is recommended to set LDP session hold time using the following formula:

```
Session Holdtime <= (Hello holdtime - Hello interval) * 3
```

This means that for default values of 15 seconds and 5 seconds for link Hello holdtime and interval respectively, session hold time should be set to 30 seconds at most.

For more information about LDP commands, see *MPLS Label Distribution Protocol Commands* module of the *MPLS Command Reference for the Cisco CRS Router*.

Related Topics

[Phases in Graceful Restart](#), on page 9

[Recovery with Graceful-Restart](#), on page 10

[Setting Up LDP NSF Using Graceful Restart](#), on page 49

[Configuring LDP Nonstop Forwarding with Graceful Restart: Example](#), on page 93

Control Plane Failure

When a control plane failure occurs, connectivity can be affected. The forwarding states installed by the router control planes are lost, and the in-transit packets could be dropped, thus breaking NSF.

Figure 3: Control Plane Failure

This figure illustrates a control plane failure and shows the process and results of a control plane failure leading to loss of connectivity.

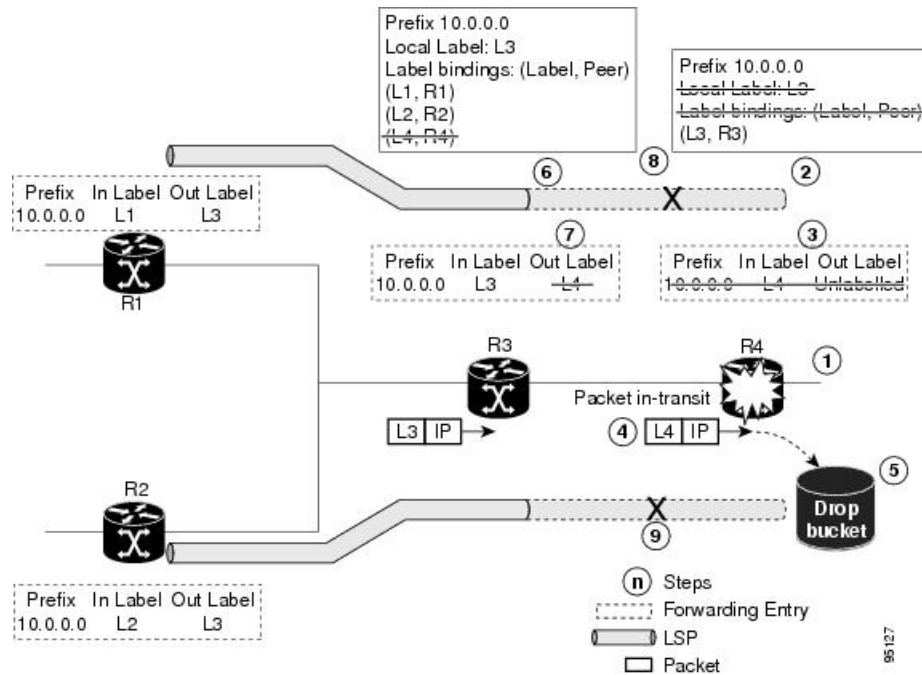

1. The R4 LSR control plane restarts.
2. LIB is lost when the control plane restarts.
3. The forwarding states installed by the R4 LDP control plane are immediately deleted.
4. Any in-transit packets flowing from R3 to R4 (still labeled with L4) arrive at R4.
5. The MPLS forwarding plane at R4 performs a lookup on local label L4 which fails. Because of this failure, the packet is dropped and NSF is not met.
6. The R3 LDP peer detects the failure of the control plane channel and deletes its label bindings from R4.
7. The R3 control plane stops using outgoing labels from R4 and deletes the corresponding forwarding state (rewrites), which in turn causes forwarding disruption.
8. The established LSPs connected to R4 are terminated at R3, resulting in broken end-to-end LSPs from R1 to R4.
9. The established LSPs connected to R4 are terminated at R3, resulting in broken LSPs end-to-end from R2 to R4.

Phases in Graceful Restart

The graceful restart mechanism is divided into different phases:

Control communication failure detection

Control communication failure is detected when the system detects either:

- Missed LDP hello discovery messages
- Missed LDP keepalive protocol messages
- Detection of Transmission Control Protocol (TCP) disconnection a with a peer

Forwarding state maintenance during failure

Persistent forwarding states at each LSR are achieved through persistent storage (checkpoint) by the LDP control plane. While the control plane is in the process of recovering, the forwarding plane keeps the forwarding states, but marks them as stale. Similarly, the peer control plane also keeps (and marks as stale) the installed forwarding rewrites associated with the node that is restarting. The combination of local node forwarding and remote node forwarding plane states ensures NSF and no disruption in the traffic.

Control state recovery

Recovery occurs when the session is reestablished and label bindings are exchanged again. This process allows the peer nodes to synchronize and to refresh stale forwarding states.

Related Topics

- [LDP Graceful Restart](#), on page 8
- [Recovery with Graceful-Restart](#), on page 10
- [Setting Up LDP NSF Using Graceful Restart](#), on page 49
- [Configuring LDP Nonstop Forwarding with Graceful Restart: Example](#), on page 93

Recovery with Graceful-Restart

Figure 4: Recovering with Graceful Restart

This figure illustrates the process of failure recovery using graceful restart.

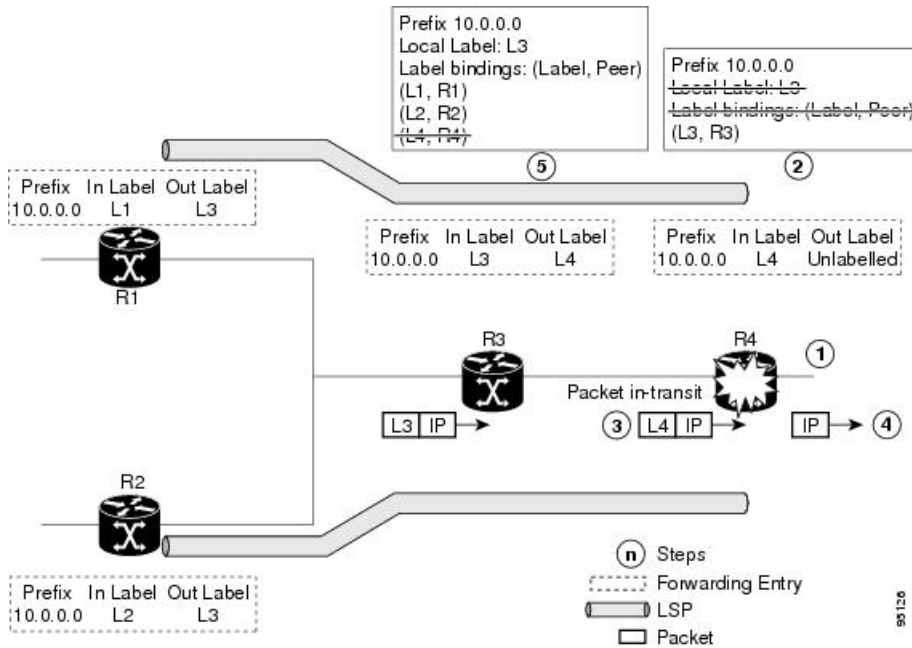

1. The router R4 LSR control plane restarts.

2. With the control plane restart, LIB is gone but forwarding states installed by R4's LDP control plane are not immediately deleted but are marked as stale.
3. Any in-transit packets from R3 to R4 (still labeled with L4) arrive at R4.
4. The MPLS forwarding plane at R4 performs a successful lookup for the local label L4 as forwarding is still intact. The packet is forwarded accordingly.
5. The router R3 LDP peer detects the failure of the control plane and channel and deletes the label bindings from R4. The peer, however, does not delete the corresponding forwarding states but marks them as stale.
6. At this point there are no forwarding disruptions.
7. The peer also starts the neighbor reconnect timer using the reconnect time value.
8. The established LSPs going toward the router R4 are still intact, and there are no broken LSPs.

When the LDP control plane recovers, the restarting LSR starts its forwarding state hold timer and restores its forwarding state from the checkpointed data. This action reinstates the forwarding state and entries and marks them as old.

The restarting LSR reconnects to its peer, indicated in the FT Session TLV, that it either was or was not able to restore its state successfully. If it was able to restore the state, the bindings are resynchronized.

The peer LSR stops the neighbor reconnect timer (started by the restarting LSR), when the restarting peer connects and starts the neighbor recovery timer. The peer LSR checks the FT Session TLV if the restarting peer was able to restore its state successfully. It reinstates the corresponding forwarding state entries and receives binding from the restarting peer. When the recovery timer expires, any forwarding state that is still marked as stale is deleted.

If the restarting LSR fails to recover (restart), the restarting LSR forwarding state and entries will eventually timeout and is deleted, while neighbor-related forwarding states or entries are removed by the Peer LSR on expiration of the reconnect or recovery timers.

Related Topics

[LDP Graceful Restart](#), on page 8

[Phases in Graceful Restart](#), on page 9

[Setting Up LDP NSF Using Graceful Restart](#), on page 49

[Configuring LDP Nonstop Forwarding with Graceful Restart: Example](#), on page 93

Label Advertisement Control (Outbound Filtering)

By default, LDP advertises labels for all the prefixes to all its neighbors. When this is not desirable (for scalability and security reasons), you can configure LDP to perform outbound filtering for local label advertisement for one or more prefixes to one more peers. This feature is known as *LDP outbound label filtering*, or *local label advertisement control*.

Related Topics

[Configuring Label Advertisement Control \(Outbound Filtering\)](#), on page 41

[Configuring Label Advertisement \(Outbound Filtering\): Example](#), on page 92

Label Acceptance Control (Inbound Filtering)

By default, LDP accepts labels (as remote bindings) for all prefixes from all peers. LDP operates in liberal label retention mode, which instructs LDP to keep remote bindings from all peers for a given prefix. For security reasons, or to conserve memory, you can override this behavior by configuring label binding acceptance for set of prefixes from a given peer.

The ability to filter remote bindings for a defined set of prefixes is also referred to as *LDP inbound label filtering*.



Note Inbound filtering can also be implemented using an outbound filtering policy; however, you may not be able to implement this system if an LDP peer resides under a different administration domain. When both inbound and outbound filtering options are available, we recommend that you use outbound label filtering.

Related Topics

[Configuring Label Acceptance Control \(Inbound Filtering\)](#), on page 52

[Configuring Label Acceptance \(Inbound Filtering\): Example](#), on page 94

Local Label Allocation Control

By default, LDP allocates local labels for all prefixes that are not Border Gateway Protocol (BGP) prefixes¹. This is acceptable when LDP is used for applications other than Layer 3 virtual private networks (L3VPN) core transport. When LDP is used to set up transport LSPs for L3VPN traffic in the core, it is not efficient or even necessary to allocate and advertise local labels for, potentially, thousands of IGP prefixes. In such a case, LDP is typically required to allocate and advertise local label for loopback /32 addresses for PE routers. This is accomplished using LDP local label allocation control, where an access list can be used to limit allocation of local labels to a set of prefixes. Limiting local label allocation provides several benefits, including reduced memory usage requirements, fewer local forwarding updates, and fewer network and peer updates.



Tip You can configure label allocation using an IP access list to specify a set of prefixes that local labels can allocate and advertise.

Related Topics

[Configuring Local Label Allocation Control](#), on page 53

[Configuring Local Label Allocation Control: Example](#), on page 94

Session Protection

When a link comes up, IP converges earlier and much faster than MPLS LDP and may result in MPLS traffic loss until MPLS convergence. If a link flaps, the LDP session will also flap due to loss of link discovery. LDP session protection minimizes traffic loss, provides faster convergence, and protects existing LDP (link) sessions by means of “parallel” source of targeted discovery hello. An LDP session is kept alive and neighbor label bindings are maintained when links are down. Upon reestablishment of primary link adjacencies, MPLS convergence is expedited as LDP need not relearn the neighbor label bindings.

¹ For L3VPN Inter-AS option C, LDP may also be required to assign local labels for some BGP prefixes.

LDP session protection lets you configure LDP to automatically protect sessions with all or a given set of peers (as specified by peer-acl). When configured, LDP initiates backup targeted hellos automatically for neighbors for which primary link adjacencies already exist. These backup targeted hellos maintain LDP sessions when primary link adjacencies go down.

The Session Protection figure illustrates LDP session protection between neighbors R1 and R3. The primary link adjacency between R1 and R3 is directly connected link and the backup; targeted adjacency is maintained between R1 and R3. If the direct link fails, LDP link adjacency is destroyed, but the session is kept up and running using targeted hello adjacency (through R2). When the direct link comes back up, there is no change in the LDP session state and LDP can converge quickly and begin forwarding MPLS traffic.

Figure 5: Session Protection

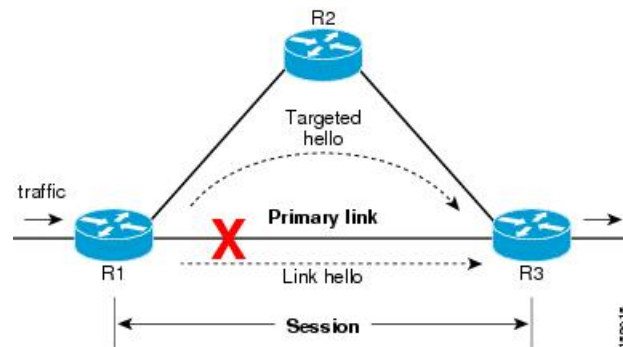

Note When LDP session protection is activated (upon link failure), protection is maintained for an unlimited period time.

Related Topics

[Configuring Session Protection](#), on page 54

[Configuring LDP Session Protection: Example](#), on page 94

IGP Synchronization

Lack of synchronization between LDP and IGP can cause MPLS traffic loss. Upon link up, for example, IGP can advertise and use a link before LDP convergence has occurred; or, a link may continue to be used in IGP after an LDP session goes down.

LDP IGP synchronization synchronizes LDP and IGP so that IGP advertises links with regular metrics only when MPLS LDP is converged on that link. LDP considers a link converged when at least one LDP session is up and running on the link for which LDP has sent its applicable label bindings and received at least one label binding from the peer. LDP communicates this information to IGP upon link up or session down events and IGP acts accordingly, depending on sync state.

In the event of an LDP graceful restart session disconnect, a session is treated as converged as long as the graceful restart neighbor is timed out. Additionally, upon local LDP restart, a checkpointed recovered LDP graceful restart session is used and treated as converged and is given an opportunity to connect and resynchronize.

Under certain circumstances, it might be required to delay declaration of resynchronization to a configurable interval. LDP provides a configuration option to delay declaring synchronization up for up to 60 seconds. LDP communicates this information to IGP upon linkup or session down events.



Note The configuration for LDP IGP synchronization resides in respective IGPs (OSPF and IS-IS) and there is no LDP-specific configuration for enabling of this feature. However, there is a specific LDP configuration for IGP sync delay timer.

Related Topics

- [Configuring LDP IGP Synchronization: OSPF](#), on page 55
- [Configuring LDP IGP Synchronization—OSPF: Example](#), on page 95
- [Configuring LDP IGP Synchronization: ISIS](#), on page 58
- [Configuring LDP IGP Synchronization—ISIS: Example](#), on page 95
- [Configuring LDP IGP Synchronization Delay Interval](#), on page 59

IGP Auto-configuration

To enable LDP on a large number of interfaces, IGP auto-configuration lets you automatically configure LDP on all interfaces associated with a specified IGP interface; for example, when LDP is used for transport in the core network. However, there needs to be one IGP set up to enable LDP auto-configuration.

Typically, LDP assigns and advertises labels for IGP routes and must often be enabled on all active interfaces by an IGP. Without IGP auto-configuration, you must define the set of interfaces under LDP, a procedure that is time-intensive and error-prone.



Note LDP auto-configuration is supported for IPv4 unicast family in the default VRF. The IGP is responsible for verifying and applying the configuration.

You can also disable auto-configuration on a per-interface basis. This permits LDP to enable all IGP interfaces except those that are explicitly disabled and prevents LDP from enabling an interface when LDP auto-configuration is configured under IGP.

Related Topics

- [Enabling LDP Auto-Configuration for a Specified OSPF Instance](#), on page 61
- [Enabling LDP Auto-Configuration in an Area for a Specified OSPF Instance](#), on page 62
- [Disabling LDP Auto-Configuration](#), on page 63
- [Configuring LDP Auto-Configuration: Example](#), on page 95

IGP Synchronization Process Restart Delay

In the LDP IGP synchronization process, failures and restarts bear a heavy stress on the network. Multiple IGP synchronization notifications from LDP to IGP, and potential generation of multiple SPF and LSAs are known to effect the CPU load considerably. This results in considerable traffic loss when the LDP process fails.

The LDP IGP Synchronization Process Restart Delay is a feature that enables a process-level delay for synchronization events when the LDP fails or restarts. This delay defers the sending of sync-up events to the

IGP until most or all the LDP sessions converge and also allows the LDP to stabilize. This allows the LDP process failure to be less stressful, since IGP's receive all the sync-up events in one bulk. This means that IGP is required to run the SPF and LSAs only one time with an overall view of the sync-up events.



Note By default the IGP Synchronization Process Restart Delay is disabled and can be enabled by running the configuration command **mpls ldp igp sync delay on-proc-restart** .

Related Topics

[Configuring LDP IGP Synchronization Process Restart Delay](#), on page 60

LDP Nonstop Routing

LDP nonstop routing (NSR) functionality makes failures, such as Route Processor (RP) or Distributed Route Processor (DRP) failover, invisible to routing peers with minimal to no disruption of convergence performance. By default, NSR is globally enabled on all LDP sessions except ATOM.

A disruption in service may include any of these events:

- Route processor (RP) or distributed route processor (DRP) failover
- LDP process restart
- In-service system upgrade (ISSU)
- Minimum disruption restart (MDR)



Note Unlike graceful restart functionality, LDP NSR does not require protocol extensions and does not force software upgrades on other routers in the network, nor does LDP NSR require peer routers to support NSR.

Process failures of active TCP or LDP results in session loss and, as a result, NSR cannot be provided unless RP switchover is configured as a recovery action. For more information about how to configure switchover as a recovery action for NSR, see *Configuring Transports* module in *IP Addresses and Services Configuration Guide for Cisco CRS Routers*.

Related Topics

[Configuring LDP Nonstop Routing](#), on page 64

IP LDP Fast Reroute Loop Free Alternate

The IP Fast Reroute is a mechanism that enables a router to rapidly switch traffic, after an adjacent link failure, node failure, or both, towards a pre-programmed loop-free alternative (LFA) path. This LFA path is used to switch traffic until the router installs a new primary next hop again, as computed for the changed network topology.

The goal of LFA FRR is to reduce failure reaction time to 50 milliseconds by using a pre-computed alternate next hop, in the event that the currently selected primary next hop fails, so that the alternate can be rapidly used when the failure is detected.

This feature targets to address the fast convergence ability by detecting, computing, updating or enabling prefix independent pre-computed alternate loop-free paths at the time of failure.

IGP pre-computes a backup path per IGP prefix. IGP selects one and only one backup path per primary path. RIB installs the best path and download path protection information to FIB by providing correct annotation for protected and protecting paths. FIB pre-installs the backup path in dataplane. Upon the link or node failure, the routing protocol detects the failure, all the backup paths of the impacted prefixes are enabled in a prefix-independent manner.

Prerequisites

The Label Distribution Protocol (LDP) can use the loop-free alternates as long as these prerequisites are met:

The Label Switching Router (LSR) running LDP must distribute its labels for the Forwarding Equivalence Classes (FECs) it can provide to all its neighbors, regardless of whether they are upstream, or not.

There are two approaches in computing LFAs:

- **Link-based (per-link)**--In link-based LFAs, all prefixes reachable through the primary (protected) link share the same backup information. This means that the whole set of prefixes, sharing the same primary, also share the repair or fast reroute (FRR) ability. The per-link approach protects only the next hop address. The per-link approach is suboptimal and not the best for capacity planning. This is because all traffic is redirected to the next hop instead of being spread over multiple paths, which may lead to potential congestion on link to the next hop. The per-link approach does not provide support for node protection.
- **Prefix-based (per-prefix)**--Prefix-based LFAs allow computing backup information per prefix. It protects the destination address. The per-prefix approach is the preferred approach due to its greater applicability, and the greater protection and better bandwidth utilization that it offers.



Note The repair or backup information computed for a given prefix using prefix-based LFA may be different from the computed by link-based LFA.

The per-prefix LFA approach is preferred for LDP IP Fast Reroute LFA for these reasons:

- Better node failure resistance
- Better capacity planning and coverage

Features Not Supported

These interfaces and features are not supported for the IP LDP Fast Reroute Loop Free Alternate feature:

- BVI interface (IRB) is not supported either as primary or backup path.
- GRE tunnel is not supported either as primary or backup path.
- In a multi-topology scenerio, the route in topology T can only use LFA within topology T. Hence, the availability of a backup path depends on the topology.

For more information about configuring the IP Fast Reroute Loop-free alternate , see Implementing IS-IS on Cisco IOS XR Software module of the *Routing Configuration Guide for Cisco CRS Routers*.

Related Topics

[Configure IP LDP Fast Reroute Loop Free Alternate: Examples](#), on page 96

[Verify IP LDP Fast Reroute Loop Free Alternate: Example](#), on page 98

Downstream on Demand

This Downstream on demand feature adds support for downstream-on-demand mode, where the label is not advertised to a peer, unless the peer explicitly requests it. At the same time, since the peer does not automatically advertise labels, the label request is sent whenever the next-hop points out to a peer that no remote label has been assigned.

To enable downstream-on-demand mode, this configuration must be applied at mpls ldp configuration mode:

```
mpls ldp downstream-on-demand with ACL
```

The ACL contains a list of peer IDs that are configured for downstream-on-demand mode. When the ACL is changed or configured, the list of established neighbors is traversed. If a session's downstream-on-demand configuration has changed, the session is reset in order that the new downstream-on-demand mode can be configured. The reason for resetting the session is to ensure that the labels are properly advertised between the peers. When a new session is established, the ACL is verified to determine whether the session should negotiate for downstream-on-demand mode. If the ACL does not exist or is empty, downstream-on-demand mode is not configured for any neighbor.

For it to be enabled, the Downstream on demand feature has to be configured on both peers of the session. If only one peer in the session has downstream-on-demand feature configured, then the session does not use downstream-on-demand mode.

If, after, a label request is sent, and no remote label is received from the peer, the router will periodically resend the label request. After the peer advertises a label after receiving the label request, it will automatically readvertise the label if any label attribute changes subsequently.

Related Topics

[Configuring LDP Downstream on Demand mode](#), on page 66

Explicit-Null and Implicit-Null Labels

Cisco MPLS LDP uses null label, implicit or explicit, as local label for routes or prefixes that terminate on the given LSR. These routes include all local, connected, and attached networks. By default, the null label is **implicit-null** that allows LDP control plane to implement penultimate hop popping (PHOP) mechanism.

When this is not desirable, you can configure **explicit-null** that allows LDP control plane to implement ultimate hop popping (UHOP) mechanism. You can configure this explicit-null feature on the ultimate hop LSR. This configuration knob includes an access-list to specify the IP prefixes for which PHOP is desired.

This new enhancement allows you to configure implicit-null local label for **non-egress (ultimate hop LSR)** prefixes by using the **implicit-null-override** command. This enforces implicit-null local label for a specific prefix even if the prefix requires a non-null label to be allocated by default. For example, by default, an LSR allocates and advertises a non-null label for an IGP route. If you wish to terminate LSP for this route on penultimate hop of the LSR, you can enforce implicit-null label allocation and advertisement for this prefix using **implicit-null-override** feature.



Note If a given prefix is permitted in both explicit-null and implicit-null-override feature, then implicit-null-override supercedes and an implicit-null label is allocated and advertised for the prefix.

In order to enable implicit-null-override mode, this configuration must be applied at MPLS LDP label configuration mode:

```
mpls ldp
  label
    implicit-null-override for <prefix><ACL>

!
```

This feature works with any prefix including static, IGP, and BGP, when specified in the ACL.

MPLS over IRB

The Integrated Routing and Bridging (IRB) feature in Cisco IOS XR Software enables routing of a given protocol between routed interfaces and bridge groups within a single router. IRB support for MPLS introduces these capabilities:

- Bridge-Group Virtual Interface (BVI) support under MPLS LDP
- Targeted LDP session to BVI neighbor
- MPLS OAM for BVI interfaces
- Netflow for BVI interfaces while MPLS is enabled
- L2VPN using targeted MPLS LDP to BVI destination
- L3VPN
- 6PE/6VPE

MPLS over IRB is supported completely on ASR 9000 Enhanced Ethernet Line Card and Cisco ASR 9001. MPLS over IRB is not supported on ASR 9000 Ethernet Line Card.

For more information on MPLS over IRB, see the *Implementing MPLS Label Distribution Protocol* chapter in the *MPLS Configuration Guide for the Cisco CRS Routers*. For more information on MPLS over IRB commands, see the *MPLS Label Distribution Protocol Commands* chapter in the *MPLS Command Reference for the Cisco CRS Router*.

MPLS LDP Carrier Supporting Carrier for Multiple VRFs

The carrier supporting carrier (CSC) support for MPLS LDP feature enables MPLS label distribution protocol (LDP) to provide CSC support for Layer 3 Virtual Private Networks (L3VPN). To support LDP as label distribution protocol between PE-CE devices in an MPLS CSC L3VPN, LDP is required to operate in multiple Virtual Private Network routing and forwarding (VRF) contexts.

MPLS Carrier Supporting Carrier L3VPN: Introduction

The carrier supporting carrier feature enables one MPLS VPN-based service provider to allow other service providers to use a segment of its backbone network. The service provider that provides the segment of the backbone network to the other provider is called the *backbone carrier*. The service provider that uses the segment of the backbone network is called the *customer carrier*.

A backbone carrier offers Border Gateway Protocol and Multiprotocol Label Switching (BGP/MPLS) VPN services. The customer carrier can be either:

- An Internet service provider (ISP)
- A BGP/MPLS VPN service provider

In either case, MPLS is run in the backbone network and between the backbone and customer carrier (the PE-CE link).

Figure 6: MPLS Carrier Supporting Carrier L3VPN

This figure illustrates an MPLS CSC L3VPN.

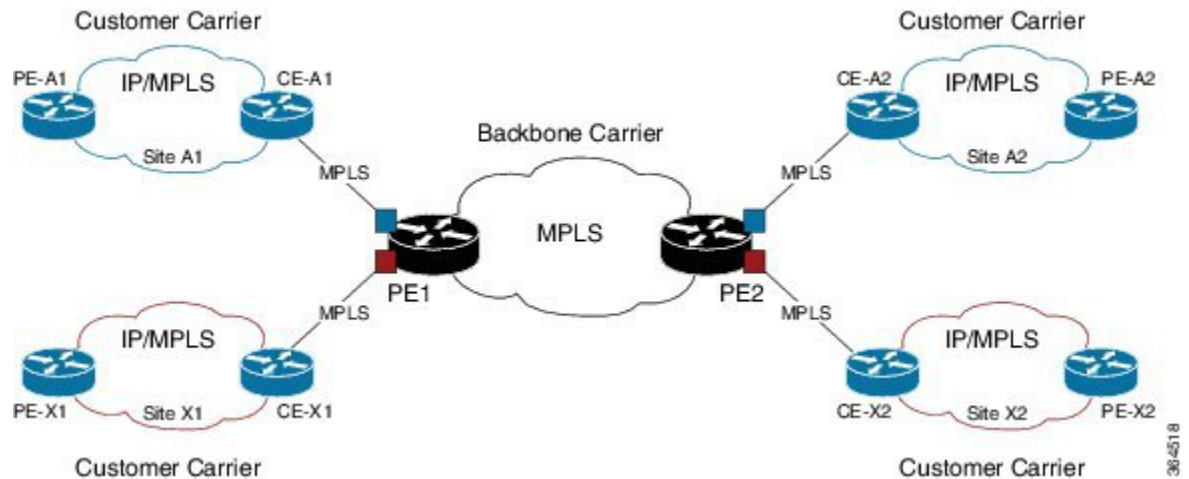

The figure shows two customers, A and X, connecting their remote sites through the backbone carrier. The PE device of the backbone network connects with both customers through MPLS but under different VRFs according to interface-VRF mapping. The MPLS label distribution protocol for PE-CE connectivity can be either BGP or LDP, and requires them to run in a customer VRF context on the PE device.

Benefits of MPLS LDP CSC

The MPLS LDP CSC provides the following benefits to service providers who are backbone carriers and to customer carriers.

Benefits to the Backbone Carrier

- The backbone carrier can accommodate many customer carriers and give them access to its backbone. The backbone carrier does not need to create and maintain separate backbones for its customer carriers. Using one backbone network to support multiple customer carriers simplifies the backbone carrier's VPN operations. The backbone carrier uses a consistent method for managing and maintaining the backbone network. This is also cheaper and more efficient than maintaining separate backbones.
- The MPLS LDP CSC feature is scalable. CSC can change the VPN to meet changing bandwidth and connectivity needs. The feature can accommodate unplanned growth and changes. The CSC feature enables tens of thousands of VPNs to be configured over the same network, and it allows a service provider to offer both VPN and internet services.
- The MPLS LDP CSC feature is a flexible solution. The backbone carrier can accommodate many types of customer carriers. The backbone carrier can accept customer carriers who are ISPs or VPN service providers or both. The backbone carrier can accommodate customer carriers that require security and various bandwidths.

Benefits to the Customer Carriers

- The MPLS LDP CSC feature removes from the customer carrier the burden of configuring, operating, and maintaining its own backbone. The customer carrier uses the backbone network of a backbone carrier, but the backbone carrier is responsible for network maintenance and operation.
- Customer carriers who use the VPN services provided by the backbone carrier receive the same level of security that Frame Relay or ATM-based VPNs provide. Customer carriers can also use IPsec in their VPNs for a higher level of security; it is completely transparent to the backbone carrier.
- Customer carriers can use any link layer technology (SONET, Digital Subscriber Line, Frame Relay, and so on) to connect the CE routers to the PE routers and the PE routers to the P routers. The MPLS LDP CSC feature is link layer independent. The CE routers and PE routers use IP or MPLS to communicate, and the backbone carrier uses MPLS.
- The customer carrier can use any addressing scheme and still be supported by a backbone carrier. The customer address space and routing information are independent of the address space and routing information of other customer carriers or the backbone provider.

Multiple VRF Support

To support multiple VRFs, IOS XR LDP configuration model is extended to allow VRF submode and per-VRF configuration and feature or interface enabling.

IOS XR LDP process is not distributed nor it is multi-instance, hence the single LDP process services all the configured VRFs. In large scale VRF deployment, it is recommended to enable VRF under LDP with appropriate policies and label filtering.

RSI

To obtain VRF and routing tables' related information, LDP interacts with the router space infrastructure (RSI) server. For every LDP enabled non-default VRF, LDP registers with RSI to get notifications upon VRF default (IPv4/IPv6) tables getting created or deleted, and populate the LDP VRF database accordingly.

VRF Table ID Database

A new database is added in the LDP process to keep track of all VRFs enabled under LDP. This database holds both active as well as forward-reference VRF records. In addition to serving as an LDP context, each active record of this database also holds VRF's default (IPv4/IPv6 unicast) table IDs.

VRF-Interface Mapping

To enable LDP on an interface for a given address family under a VRF context, it is required to list interface and its address family explicitly under a LDP VRF submode. LDP does not enforce or check correctness of the interface and VRF mapping at the time of configuration, and hence configuration may be accepted by LDP. The interface with incorrect VRF mapping is not made operational by LDP and remains down from the LDP point of view.

This means that an interface remains LDP operationally down for which either:

- LDP has not received any address update, or
- LDP has received update with different table-id (VRF) than configured under LDP.

Also, a user must not configure the same LDP interface under more than one VRF.

Context Isolation

Each active VRF under LDP points to a separate context under which LDP runs. This means that various variables, database, tables, FSM are kept separate in their respective VRF contexts and do not interfere or interact with each other. This allows the LDP to provide per-VRF isolation and support CSC with customers with overlapping addresses or routing information.

Default Context

The default (global) context is enabled at the time of the LDP process startup and remains enabled always. It is not possible to disable IPv4 for the default context. Also, it is required to explicitly enable IPv4 for non-default context. Therefore you can effectively disable IPv4 for non-default context by not configuring it. This means that, it is possible to enable or disable the non-default context under LDP, whereas the same is not possible for a default context.

Restrictions and Recommendations

The following restrictions and recommendations apply to the MPLS LDP CSC feature:

- Only IPv4 address family is supported for a default or a non-default VRF.
- No T-LDP support in a VRF context.
- An address family under VRF and VRF interface must be configured for non-default VRFs.
- Following scenarios are not supported :
 - Different VRFs between a given PE-CE device pair (VRFs configured on different links and interfaces)
 - LDP/BGP CSC co-existence on a given VRF between a given PE-CE device pair:
 - Single link
 - Parallel links: LDP CSC on one link and BGP CSC on the other
- LDP router-id must be configured per-VRF. If not configured for non-default VRF, LDP computes router-id from available loopback interfaces under the VRF.
- It is recommended to configure a routable discovery transport address under a VRF IPv4 address-family submode for deterministic transport endpoint and connection.
- When LDP CSC is configured and in use:
 - BGP label allocation policy for VRF prefixes must be per-prefix
 - Selective VRF Download (SVD) feature must be disabled

IPv6 Support in MPLS LDP

Internet Protocol version 6 (IPv6) support in MPLS LDP (Label Distribution Protocol) feature makes the LDP control plane to run on IPv6 in order to setup LSPs for IPv6 prefixes. This support enables most of the LDP functions supported on IPv4 to be extended to IPv6. In this context, support for native MPLS LDP over IPv6 is provided in order to seamlessly continue providing existing services while enabling new ones.

LDP associates a forwarding equivalence class (FEC) with each label switched path (LSP) it creates. The FEC associated with an LSP specifies which packets are mapped to that LSP. LDP establishes sessions with peers and exchanges FEC label bindings with them to enable creation of LSPs to carry MPLS traffic destined to IP prefixes.

LDP base specification, RFC 5036 defines procedures and messages for exchanging bindings for IPv4 and IPv6 addresses and routing prefixes. LDP IPv6 specification (draft-ietf-mpls-ldp-ipv6) updates LDP base specifications for IPv6 support, and further clarifies and focuses on the procedures for supporting LDP IPv6 control plane and binding advertisement.

The procedures of address bindings, label bindings, and forwarding setup are same for IPv4 and IPv6 address families in LDP. The only difference is that, a different address format is used according to the IP address family. While a single-stack IP address family (IPv4-only or IPv6-only) enabled interfaces between a set of routers is the most typical deployment, scenarios for LSR interconnections using both IPv4 and IPv6 interfaces are also supported.

IPv6 support in MPLS LDP implements draft-ietf-mpls-ldp-ipv6 version12 issued by the Internet Engineering Task Force (IETF).



Note The Cisco CRS-X, CRS-1 and CRS-3 cards support the LDP IPv6 feature.

LDP IPv6 Functionality

LDP functionality can be broadly divided into two categories:

- Control Plane

Control plane includes functions such as: neighbor discovery (hello adjacencies), transport connection/endpoint (TCP connection), session and peering, and bindings exchange.

- LSP Setup

LSP setup includes functions such as: acquire FEC information through RIB, assign and advertise local label bindings for FEC, advertise local (interface) IP address bindings and setup forwarding rewrites.

For the control plane, the underlying address family can be either IPv4-only, IPv6-only or both. Whereas for the LSP setup, an LSP is setup for IPv4 or IPv6 FEC prefix.

Figure 7: LDP IPv6 Architecture

This figure illustrates the main components that collaborate to achieve the required functionality for the LDP IPv6 feature.

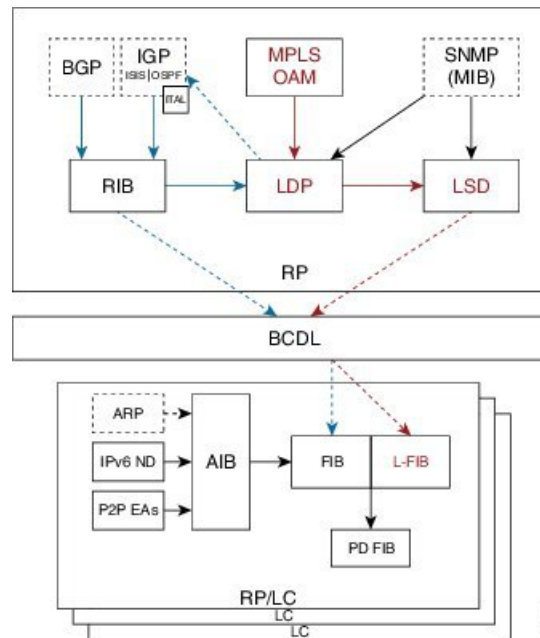

The functions of LDP in the MPLS LDP IPv6 setup are as follows:

- Receive routing updates from routing information base (RIB) for global IPv6 prefixes
- Assign local labels for IPv6 prefixes
- Receive IPv6 address or state notifications for local IPv6 enabled interfaces from IP Address Repository Manager (IP-ARM/IM) and LAS for IPv6 link-local unicast addresses
- Advertise/Accept IPv6 label bindings and address bindings to/from peers
- Setup MPLS forwarding to create IPv6 LSPs
- Provide IPv6 LSP information to MPLS OAM as and when requested
- Service MIB requests for IPv6 control plane queries and generate MIB traps
- Provide LDPv6 convergence status for a link to IGP for LDP-IGP Sync feature for IPv6
- Support IPv6 address family for all existing LDP features that intersect with prefixes and/or addresses

Figure 8: LDP IPv6 Control Plane and LSP Setup

This figure illustrates the high level functionality of LDP in terms of control plane and LSP setup in an IPv6 environment.

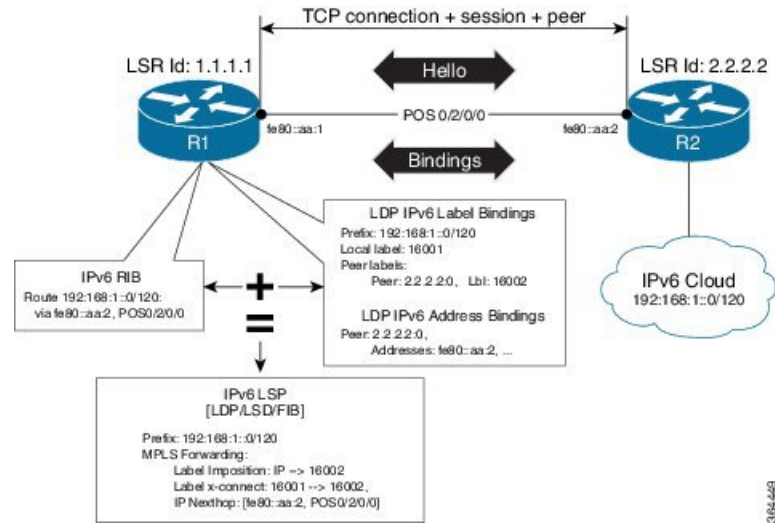

Topological Scenarios

A typical deployment scenario consists of single-stack IP address-family (IPv4-only or IPv6-only) enabled interfaces between a set of routers.

Three topology scenarios in which the LSRs are connected through one or more dual-stack LDP enabled interfaces, or one or more single-stack LDP enabled interfaces are defined as follows:



Note R2 is the main router.

1. One dual-stack interface/same neighbor:

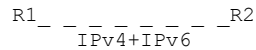

2. Two single-stack interfaces/same neighbor:

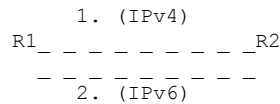

3. Two single-stack interfaces/different neighbors with different address families:

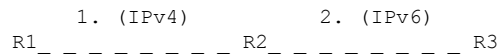

Case Study

A description of the control plane and LSP setup scenarios for the previously shown three configurations are as follows:

Case 1:

Neighbor Discovery: Both IPv4 and IPv6 Hellos sent on the interface to R1.

Transport Connection: IPv4 endpoints or IPv6 endpoints (as per user preference).

Label binding exchange: Both IPv4 and IPv6 prefixes.

Address binding exchange: Both IPv4 and IPv6 addresses.

LSPs: Both IPv4 and IPv6 over the same nexthop interface to R1.

Case 2:

Neighbor Discovery: IPv4 Hellos on interface-1 to R1 and IPv6 Hellos on interface-2 to R1.

Transport Connection: IPv4 endpoints or IPv6 endpoints (as per user preference).

Label binding exchange: Both IPv4 and IPv6 prefixes.

Address binding exchange: Both IPv4 and IPv6 addresses.

LSPs: IPv4 over nexthop interface-1 to R1 and IPv6 over nexthop interface-2 to R1.

Case 3:

Neighbor Discovery: IPv4 Hellos on interface-1 to R1 and IPv6 Hellos on interface-2 to R3.

Transport Connection: IPv4 endpoints with R1 and IPv6 endpoints with R3.

Label binding exchange: Both IPv4 and IPv6 prefixes to R1 and R3.



Note Even if all the three LSRs are dual-stack, traffic from R1 to R3 will not be completely labeled.

- If there is IPv6 traffic, it is unlabeled from R1 to R2. Labels are imposed only at R2 (although in this specific case implicit null imposition) to R3.
- If there is IPv4 traffic, it is labeled from R1 to R2. But the traffic will go unlabeled between R2 and R3 given that no IPv4 adjacency exists between R2 and R3.

Address binding exchange: Both IPv4 and IPv6 addresses to R1 and R3.

LSPs: IPv4 over nexthop interface-1 to R1 and IPv6 over nexthop interface-2 to R3.

Restrictions

IPv6 support in MPLS LDP has the following restrictions and constraints:

- IPv6 address family is supported only under default VRF
- Implicit enabling of IPv6 address family is not allowed. It needs explicit enabling.
- It is recommended to configure a routable IPv6 **discovery transport address** when only LDP IPv6 is configured without explicitly specifying a router-id

Features Supported in LDP IPv6

The following features are supported in LDP IPv6:

- Single-stack (native IPv6) and dual-stack (IPv4+IPv6) topologies
- New operating modes in LDP:
 - Native LDP IPv6
 - LDP IPv6 over IPv4 and LDP IPv4 over IPv6 connection endpoints

LDP Hellos carry optional transport address type length value (TLV) to notify a peer about TCP or transport connection endpoint. An LSR can include either IPv4 or IPv6 transport address TLV in an IPv4 or IPv6 Hello message. There is no difference in the TLV format of transport address for IPv4 and IPv6.

Only one transport connection is established between two discovered peers, whether there be single address family Hello adjacencies or multi-address family (both IPv4 and IPv6) Hello adjacencies.

In a dual-stack setup, when LDP has the option to establish transport connection either using IPv4 endpoints or IPv6 endpoints, IPv6 connection is preferred over IPv4 connection. If LDP is locally enabled for both IPv4 and IPv6 address families, every new session is treated as potential dual-stack connection. Under such circumstances, IPv6 preference is kept in place for maximum fifteen seconds for the session to establish, after which the LDP tries to establish a connection with the peer using IPv4. A user can override this default behavior by specifying the preference for a set of dual-stack peers to use IPv4 transport for the connection. Furthermore, a user may also specify maximum wait time to wait to establish the preferred transport connection. If the preferred transport establishment times out, LDP tries to establish connection with other non-preferred transport address families. This applies to both the cases when an LSR acts as active side or passive side for the TCP connection.

To override default IPv6 transport preference for dual-stack cases, use the **mpls ldp neighbor dual-stack transport-connection prefer ipv4 for-peers** command. To specify the maximum time the preferred address family connection must wait to establish a connection before resorting to a non-preferred address family, use the **mpls ldp neighbor dual-stack transport-connection max-wait** command.

Once a transport connection is established, it is not torn down depending on preferences. If the address family related to established transport connection is disabled under LDP, the corresponding transport connection is reset to reestablish the connection.

For a single-stack setup, there is no contention; the transport connection uses the given address family.

- LDP Control Plane is IPv6 aware
- LDP IPv6 LSP forwarding setup

LDP interacts with LSD in order to setup IPv6 LSP forwarding. The steps involved in this interaction are:

- Label allocation for an IPv6 prefix is learnt from RIB.
- Setup imposition and label switching forwarding path for given IPv6 prefix by creating IPv6 forwarding rewrites.
- Like LDP IPv4, rewrite delete and label free operations are performed when a route disappears or is disallowed under LDP due to label policy.

- There is no new requirement related to MPLS enabling or disabling. LDP also MPLS-enables in LSD (if not already) any LDP enabled interface, which is in the *UP* state for IPv4 and/or IPv6 and has IPv4 and/or IPv6 addresses assigned.
- In case of dual-stack LDP, a single Resource-Complete is sent by LDP to LSD once RIB-Converged notification is received for both IPv4 and IPv6 redistribute tables.
- Distribution of IPv4 and IPv6 bindings over a single LDP session established over IPv4 or IPv6
- LDP Downstream on Demand
- LDP session protection

LDP session protection is a feature to protect an IPv6 LDP session. In case of dual-stack hello adjacencies with a peer, there is only a single targeted hello adjacency to protect the session. Session protection forms targeted adjacency of address family same as the transport connection. For IPv6, the target of the session protection is the remote transport connection endpoint. For IPv4, the target of the session protection is remote LSR ID.

- LDP IGPv6 sync on IPv6 interface

This feature lets IGP support LDP IGP Sync feature for IPv6 address family. This means that Intermediate System-to-Intermediate System (IS-IS) allows IGP under an interface's IPv6 address family, whereas OSPFv3 implements it just like existing support in OSPF for IPv4. When the IGP Sync feature is enabled, LDP convergence status on an interface is considered by the IGP under the context of a given address family. This behavior applies to IGP Sync for both non-TE as well as TE tunnel interfaces.

- LDP Typed Wildcard for IPv6 prefix FEC

This feature adds support for Typed Wildcard for IPv6 Prefix FEC. The support includes:

- Being able to send or receive IPv6 Prefix Typed Wildcard FEC element in label messages.
- Respond to Typed Wildcard Label Requests received from peer by replaying its label database for IPv6 prefixes.
- Make use of Typed Wildcard Label Requests towards peers to request replay of peer label database for IPv6 prefixes. For example, on local inbound policy changes.
- Label allocation, advertisement and accept policies for IPv6 prefixes
- Local label assignment and advertisement for IPv6 default-route (::/0)
- Session MD5 authentication for IPv6 transport
- IPv6 Explicit-Null label

IPv6 explicit null label feature support includes:

- Advertisement and receipt of IPv6 explicit-null label to and from peers.
- IPv6 explicit-null outgoing label in forwarding setup.
- Explicit-null advertisement policy for a set of IPv6 prefixes and/or set of peers.
- Explicit-null configuration change. Change in explicit-null configuration is handled by first transferring a wildcard withdraw with null label to peer(s), followed by advertising the appropriate null (implicit or explicit) label to the peer(s) again. This works without any issue as long as a single IP address family is enabled. In case of a dual-stack LSR peer, a change of configuration related to

explicit-null advertisement for a given address family may cause unnecessary mix-up in the other address family.

- LDP IPv6 LFA FRR

Local LFA FRR for IPv6 is supported. However, it is required that the primary and backup paths are of the same address family type, that is, an IPv4 primary path must not have an IPv6 backup path.

- NSF for LDP IPv6 traffic

Non-stop forwarding (NSF) support is either provided through LDP NSR or graceful restart mechanisms.

- IGP/LDP NSR for IPv6

- IGP/LDP Graceful Restart for IPv6

- LDP ICCP IPv6 neighbor node

LDP Inter-Chassis Communication Protocol (ICCP) is supported with IPv6 neighbor node. ICCP is used as a mechanism for multi-chassis LACP.

- SSO/ISSU for LDP IPv6

- MPLS OAM: New FECs

LSPV supports two new FECs.

- LDP IPv6 Prefix FEC Encoding/Decoding

Label Switched Path Verification (LSPV) encodes/decodes the LDP IPv6 Prefix FEC. Prefix is in the network byte order and the trailing bits are to be set to zero when prefix length is shorter than 128 bits.

- Generic IPv6 Prefix FEC Encoding/Decoding

LSPV encodes/decodes the generic IPv6 Prefix FEC. Prefix is in the network byte order and the trailing bits are to be set to zero when prefix length is shorter than 128 bits.

Generic IPv6 FEC is used in addition to the LDP IPv6 FEC. This serves the following primary purposes:

- Allows user to perform LSP ping and traceroute to verify data plane without involving control plane of the FEC in echo request and response.
 - If support for a new FEC is preferred in the future, the generic FEC can be used until corresponding control plane is explicitly supported by LSPV.

- IPv6 LSR MIB

MPLS OAM LDP MIBS is extended to support IPv6. All LSR MIB objects that reference an InSegment prefix and OutSegment next hop address are modified to support IPv6.

- LSP ping support for LDP IPv6

- LSP trace-route support for LDP IPv6

- LSP tree-trace support for LDP IPv6

The following features are not supported in LDP IPv6:

- LDPv6 over TEv4 (traffic engineering)
- L2VPN/PW (over IPv6 LSPs)
- L3VPN (over IPv6 LSPs)
- LDP auto-config for IPv6 IGP/Interfaces
- LDP ICCP with IPv6 neighbor node
- Multicast extension to LDP (mLDP) for IPv6 FEC with label binding through IPv4 and IPv6 transport
- Native IPv4 and IPv6 L3VPN over LDP IPv6 core
- L2VPN signaling with LDP when the nexthop address is IPv6
- IPv6 LDP CSC

Implicit IPv4 Disable

The LDP configuration model was changed with the introduction of explicit address family enabling under LDP (VRF) global and LDP (VRF) interfaces. However, in order to support backward compatibility, the old configuration model was still supported for default VRF. There was, however, no option to disable the implicitly enabled IPv4 address family under default VRF's global or interface level.

A new configuration **mpls ldp default-vrf implicit-ipv4 disable** is now available to the user to disable the implicitly enabled IPv4 address family for the default VRF. The new configuration provides a step towards migration to new configuration model for the default VRF that mandates enabling address family explicitly. This means that if the new option is configured, the user has to explicitly enable IPv4 address family for default VRF global and interface levels. It is recommended to migrate to this explicitly enabled IPv4 configuration model.

For detailed configuration steps, see [Disabling Implicit IPv4, on page 87](#)

IPv6 Label Bindings

LDP stores label bindings associated with FEC prefix in its Label Information Base (LIB) [TIB in Cisco LDP]. An entry in LIB corresponds to a prefix and holds the following bindings:

- Local binding: Local label assigned for this prefix (which is learnt through local RIB).
- Remote bindings: Array of peer labels (prefix-label bindings received in label mapping message from peer(s)).

An entry in LIB can exist due to local binding presence, or due to remote binding(s) presence, or due to both local and remote bindings presence. The forwarding setup, however, mandates that local binding be present for a prefix.

Extensions have been implemented to support IPv6 prefixes for LIB in LDP. For per-address family convergence or preference reasons, separate or new LIB is implemented to keep and maintain IPv6 prefixes. In case of dual-stack LDP, LIBv4 is preferred over LIBv6 wherever possible. For example, during background *housekeeping* function, LIBv4 is processed before LIBv6.

IPv6 Address Bindings

LDP needs to maintain IPv6 address database for local and peer interface addresses. The IPv4 address module for local/peer addresses is extended to keep IPv4/IPv6 addresses in their respective databases, much like LIB

database. In case of a dual-stack LDP, IPv4 local address database function is preferred over IPv6 local address database function where ever possible.

Default Transport Address

LDP computes default local transport address for IPv6 from its IPv6 interface or address database by picking the lowest operational loopback interface with global unicast IPv6 address. This means that any change in this loopback state or address, flaps or changes the default transport address for IPv6 and may cause session flaps using such an address as transport endpoint. For example, if a session is currently active on Loopback2 as during its inception it was the lowest loopback with an IPv6 address, and a lower loopback, Loopback0, is configured with an IPv6 address, the session does not flap. However, if it does flap, the next time the session is attempted, Loopback0 is used.

The session flaps when configuring discovery transport address explicitly.

Use the **discovery transport-address** command under the LDP address family submode to specify the global transport address for IPv4 or IPv6.

It is recommended to configure global transport-address for IPv6 address family to avoid a potentially unstable default transport address.

LDP Control Plane: Bindings Advertisement

LDP base specification allows exchange of IPv4/IPv6 bindings (address/label) on an established session. When both IPv4 and IPv6 address families are enabled under LDP, LDP distributes address/label bindings for both address families to its established peer according to local policies. Following are a few significant points pertaining to bindings support for IPv6:

- LDP allocates/advertises local label bindings for link-local IPv6 address prefixes. If received, such FEC bindings are ignored.
- LDP sends only the Prefix FEC of the single address family type in a FEC TLV and not include both. If such a FEC binding is received, the entire message is ignored.
- LDP sends only the addresses belonging to same address family in a single address list TLV (in address or address withdraw message).

If an address family is not enabled on receiving LSR, LDP discards any bindings received from peer(s) for the address family. This means that when address family is enabled, LDP needs to reset existing sessions with the peers in order to re-learn the discarded bindings. The implementation is optimized to reset only those sessions which were previously known to be dual-stack and had sent bindings for both address families.

LSP Mapping

LDP uses IPv6 adjacency information instead of IP address to map an IPv6 link-local nexthop to an LDP peer.

In addition to other usual checks before using a label from nexthop LDP peer, LDP uses the nexthop label for a prefix of a given address family, if there are one or more LDP hello adjacencies of the same address family type established with the peer.

Label Policies

LDP allows a user to configure label policies for allocation, acceptance, receipt, and advertisement of labels for the given prefixes.

Following are the significant points pertaining to the IPv6 support for label policies:

- Label policies and their configurations are allowed under address family IPv6.
- Any policy that specifies prefix or a set of prefixes through an ACL, supports both IPv4 and IPv6 variants for address(s) or ACLs.
- Any policy that specifies peer address or set of peer addresses through an ACL, supports both IPv4 and IPv6 variant for peer address(s) or ACL.
- Any policy that specifies the peer's LSR ID in a peer ACL continues to take IPv4 ACL based policy irrespective of the feature configuration.

IS-IS

Intermediate System-to-Intermediate System (IS-IS) is an Interior Gateway Protocol (IGP) that advertises link-state information throughout the network to create a picture of the network topology. IPv6 IS-IS extends the address families supported by IS-IS to include IPv6, in addition to IPv4.

Previously, IS-IS supported registration of only LDP IPv4 sync status change. This has now been enhanced to support registration of notifications of LDP IPv6 sync status change. IS-IS determines the link-metrics to be advertised based on the LDP-IGP sync status on the IPv4 and IPv6 address families.

IS-IS supports non-stop forwarding (NSF) by preserving the LDPv6-IGP sync status across high availability (HA) events of IS-IS process restarts and failover.

IS-IS also supports LDPv6-IGP sync for LFA-FRR by checking the sync status of the backup interface (if it is configured with LDP IPv6 sync).

Dual-Stack Capability TLV

Clear rules are specified in RFC 5036 to determine transport connection roles in setting up a TCP connection for single-stack LDP. But RFC 5036 is not clear about dual-stack LDP, in which an LSR may assume different roles for different address families, causing issues in establishing LDP sessions.

To ensure a deterministic transport connection role for the dual-stack LDP, the dual-stack LSR conveys its transport connection preference in every LDP Hello message. This preference is encoded in a new TLV (Type Length Value) called the Dual-Stack Capability TLV. Dual-stack LSR always checks for the presence of the dual-stack capability TLV in the received LDP Hello messages and takes appropriate action for establishing or maintaining sessions.

RFC 7552 specifies more details about updates to LDP for IPv6.

Dual-Stack Capability TLV Format

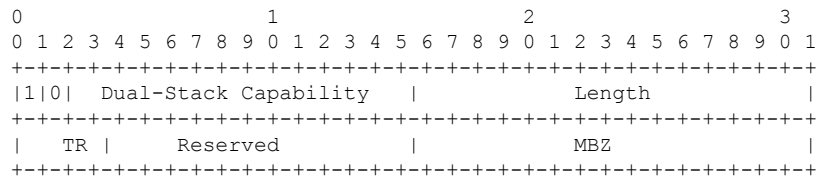

Dual-Stack Capability TLV Fields

Field	Description
U and F bits	1 and 0 (as specified by RFC 5036)
Dual-Stack Capability	TLV code point (0x0701)
TR: Transport Connection Preference	TR: Transport Connection Preference: <ul style="list-style-type: none"> • 0100: LDPoIPv4 connection • 0110: LDPoIPv6 connection (default)
Reserved	This field is reserved. It must be set to zero on transmission and ignored on receipt
MBZ	Must be zero

Compliance Check

The compliance check prevents sessions being formed with prior RFC 7552 implementation of LDP IPv6.

If the dual-stack capability TLV is not present in the received Hellos and the compliance check is configured, the local and remote preferences must match to establish a session. If the preferences do not match, the LDP Hellos are dropped and the session is not established. Compliance check has therefore been disabled by default.

Use the command **neighbor dual-stack tlv-compliance** in MPLS LDP configuration to enable the compliance check.

How to Implement MPLS LDP

A typical MPLS LDP deployment requires coordination among several global neighbor routers. Various configuration tasks are required to implement MPLS LDP :

Configuring LDP Discovery Parameters

Perform this task to configure LDP discovery parameters (which may be crucial for LDP operations).



Note

The LDP discovery mechanism is used to discover or locate neighbor nodes.

SUMMARY STEPS

1. **configure**
2. **mpls ldp**
3. **[vrf vrf-name] router-id ip-address lsr-id**
4. **discovery { hello | targeted-hello } holdtime seconds**
5. **discovery { hello | targeted-hello } interval seconds**
6. **commit**
7. (Optional) **show mpls ldp [vrf vrf-name] parameters**

DETAILED STEPS

	Command or Action	Purpose
Step 1	configure	
Step 2	mpls ldp Example: RP/0/RP0/CPU0:router(config)# mpls ldp	Enters MPLS LDP configuration mode.
Step 3	[vrf vrf-name] router-id ip-address lsr-id Example: RP/0/RP0/CPU0:router(config-ldp)# router-id 192.168.70.1	(Optional) Specifies a non-default VRF. Specifies the router ID of the local node. • In Cisco IOS XR software, the router ID is specified as an interface IP address. By default, LDP uses the global router ID (configured by the global router ID process).
Step 4	discovery { hello targeted-hello } holdtime seconds Example: RP/0/RP0/CPU0:router(config-ldp)# discovery hello holdtime 30 RP/0/RP0/CPU0:router(config-ldp)# discovery targeted-hello holdtime 180	Specifies the time that a discovered neighbor is kept without receipt of any subsequent hello messages. The default value for the <i>seconds</i> argument is 15 seconds for link hello and 90 seconds for targeted hello messages.
Step 5	discovery { hello targeted-hello } interval seconds Example: RP/0/RP0/CPU0:router(config-ldp)# discovery hello interval 15 RP/0/RP0/CPU0:router(config-ldp)# discovery targeted-hello interval 20	Selects the period of time between the transmission of consecutive hello messages. The default value for the <i>seconds</i> argument is 5 seconds for link hello messages and 10 seconds for targeted hello messages.
Step 6	commit	
Step 7	(Optional) show mpls ldp [vrf vrf-name] parameters Example: RP/0/RP0/CPU0:router # show mpls ldp parameters RP/0/RP0/CPU0:router # show mpls ldp vrf red parameters	Displays all the current MPLS LDP parameters. Displays the LDP parameters for the specified VRF.

Related Topics

[LDP Control Plane](#), on page 5

Configure Label Distribution Protocol Targeted Neighbor

LDP session between LSRs that are not directly connected is known as targeted LDP session. For LDP neighbors which are not directly connected, you must manually configure the LDP neighborhood on both the routers.

Configuration Example

This example shows how to configure LDP for non-directly connected routers.

```
RP/0/RSP0/CPU0:router# configure
RP/0/RSP0/CPU0:router(config)# mpls ldp
RP/0/RSP0/CPU0:router(config-ldp)# router-id 192.0.2.1
RP/0/RSP0/CPU0:router(config-ldp)# neighbor 198.51.100.1:0 password encrypted 13061E010803
RP/0/RSP0/CPU0:router(config-ldp)# address-family ipv4
RP/0/RSP0/CPU0:router(config-ldp-af)# discovery targeted-hello accept
RP/0/RSP0/CPU0:router(config-ldp-af)# neighbor 198.51.100.1 targeted
RP/0/RSP0/CPU0:router(config-ldp-af)# commit
```

Running Configuration

This section shows the LDP targeted neighbor running configuration.

```
mpls ldp
router-id 192.0.2.1
neighbor 198.51.100.1:0 password encrypted 13061E010803
address-family ipv4
  discovery targeted-hello accept
  neighbor 198.51.100.1 targeted
!
```

Verification

Verify LDP targeted neighbor configuration.

```
RP/0/RSP0/CPU0:router#show mpls ldp discovery
Wed Nov 28 04:30:31.862 UTC

Local LDP Identifier: 192.0.2.1:0
Discovery Sources:
  Targeted Hellos: <<< targeted hellos based session
    192.0.2.1 -> 198.51.100.1(active/passive), xmit/rcv <<< both transmit and receive
of targeted hellos between the neighbors
  LDP Id: 198.51.100.1:0
    Hold time: 90 sec (local:90 sec, peer:90 sec)
    Established: Nov 28 04:19:55.340 (00:10:36 ago)

RP/0/RSP0/CPU0:router#show mpls ldp neighbor
Wed Nov 28 04:30:38.272 UTC

Peer LDP Identifier: 198.51.100.1:0
TCP connection: 198.51.100.1:0:13183 - 192.0.2.1:646; MD5 on
Graceful Restart: No
Session Holdtime: 180 sec
State: Oper; Msgs sent/rcvd: 20/20; Downstream-Unsolicited
Up time: 00:10:30
LDP Discovery Sources:
  IPv4: (1)
```

```

    Targeted Hello (192.0.2.1 -> 198.51.100.1, active/passive) <<< targeted LDP based
session
IPv6: (0)
Addresses bound to this peer:
IPv4: (4)
  198.51.100.1      10.0.0.1      172.16.0.1      192.168.0.1
IPv6: (0)

```

Configuring LDP Discovery Over a Link

Perform this task to configure LDP discovery over a link.



Note There is no need to enable LDP globally.

Before you begin

A stable router ID is required at either end of the link to ensure the link discovery (and session setup) is successful. If you do not assign a router ID to the routers, the system will default to the global router ID. Default router IDs are subject to change and may cause an unstable discovery.

SUMMARY STEPS

1. **configure**
2. **mpls ldp**
3. **[vrf vrf-name] router-id ip-address lsr-id**
4. **interface type interface-path-id**
5. **commit**
6. (Optional) **show mpls ldp discovery**
7. (Optional) **show mpls ldp vrf vrf-name discovery**
8. (Optional) **show mpls ldp vrf all discovery summary**
9. (Optional) **show mpls ldp vrf all discovery brief**
10. (Optional) **show mpls ldp vrf all ipv4 discovery summary**
11. (Optional) **show mpls ldp discovery summary all**

DETAILED STEPS

	Command or Action	Purpose
Step 1	configure	
Step 2	mpls ldp Example: RP/0/RP0/CPU0:router(config)# mpls ldp	Enters MPLS LDP configuration mode.
Step 3	[vrf vrf-name] router-id ip-address lsr-id Example:	(Optional) Specifies a non-default VRF. Specifies the router ID of the local node.

	Command or Action	Purpose
	RP/0/RP0/CPU0:router(config-ldp)# router-id 192.168.70.1	<ul style="list-style-type: none"> In Cisco IOS XR software, the router ID is specified as an interface name or IP address. By default, LDP uses the global router ID (configured by the global router ID process).
Step 4	interface <i>type interface-path-id</i> Example: RP/0/RP0/CPU0:router(config-ldp)# interface tunnel-te 12001 RP/0/RP0/CPU0:router(config-ldp-if)#	Enters interface configuration mode for the LDP protocol. Interface type must be Tunnel-TE.
Step 5	commit	
Step 6	(Optional) show mpls ldp discovery Example: RP/0/RP0/CPU0:router# show mpls ldp discovery	Displays the status of the LDP discovery process. This command, without an interface filter, generates a list of interfaces over which the LDP discovery process is running. The output information contains the state of the link (xmt/rcv hellos), local LDP identifier, the discovered peer's LDP identifier, and holdtime values.
Step 7	(Optional) show mpls ldp vrf vrf-name discovery Example: RP/0/RP0/CPU0:router# show mpls ldp vrf red discovery	Displays the status of the LDP discovery process for the specified VRF.
Step 8	(Optional) show mpls ldp vrf all discovery summary Example: RP/0/RP0/CPU0:router# show mpls ldp vrf all discovery summary	Displays the summarized status of the LDP discovery process for all VRFs.
Step 9	(Optional) show mpls ldp vrf all discovery brief Example: RP/0/RP0/CPU0:router# show mpls ldp vrf all discovery brief	Displays the brief status of the LDP discovery process for all VRFs.
Step 10	(Optional) show mpls ldp vrf all ipv4 discovery summary Example: RP/0/RP0/CPU0:router# show mpls ldp vrf all ipv4 discovery summary	Displays the summarized status of the LDP discovery process for all VRFs for the IPv4 address family.
Step 11	(Optional) show mpls ldp discovery summary all Example:	Displays the aggregate summary across all the LDP discovery processes.

	Command or Action	Purpose
	RP/0/RP0/CPU0:router# <code>show mpls ldp discovery summary all</code>	

Related Topics

[LDP Control Plane](#), on page 5

[Configuring LDP Link: Example](#), on page 91

Configuring LDP Discovery for Active Targeted Hellos

Perform this task to configure LDP discovery for active targeted hellos.



Note The active side for targeted hellos initiates the unicast hello toward a specific destination.

Before you begin

These prerequisites are required to configure LDP discovery for active targeted hellos:

- Stable router ID is required at either end of the targeted session. If you do not assign a router ID to the routers, the system will default to the global router ID. Please note that default router IDs are subject to change and may cause an unstable discovery.
- One or more MPLS Traffic Engineering tunnels are established between non-directly connected LSRs.

SUMMARY STEPS

1. `configure`
2. `mpls ldp`
3. `[vrf vrf-name] router-id ip-address lsr-id`
4. `interface type interface-path-id`
5. `commit`
6. (Optional) `show mpls ldp discovery`
7. (Optional) `show mpls ldp vrf vrf-name discovery`
8. (Optional) `show mpls ldp vrf all discovery summary`
9. (Optional) `show mpls ldp vrf all discovery brief`
10. (Optional) `show mpls ldp vrf all ipv4 discovery summary`
11. (Optional) `show mpls ldp discovery summary all`

DETAILED STEPS

	Command or Action	Purpose
Step 1	<code>configure</code>	
Step 2	<code>mpls ldp</code> Example:	Enters MPLS LDP configuration mode.

	Command or Action	Purpose
	RP/0/RP0/CPU0:router(config)# mpls ldp	
Step 3	<p>[vrf vrf-name] router-id ip-address lsr-id</p> <p>Example:</p> <pre>RP/0/RP0/CPU0:router(config-ldp)# router-id 192.168.70.1</pre>	<p>(Optional) Specifies a non-default VRF.</p> <p>Specifies the router ID of the local node.</p> <p>In Cisco IOS XR software, the router ID is specified as an interface name or IP address or LSR ID. By default, LDP uses the global router ID (configured by global router ID process).</p>
Step 4	<p>interface type interface-path-id</p> <p>Example:</p> <pre>RP/0/RP0/CPU0:router(config-ldp)# interface tunnel-te 12001</pre>	Enters interface configuration mode for the LDP protocol.
Step 5	commit	
Step 6	<p>(Optional) show mpls ldp discovery</p> <p>Example:</p> <pre>RP/0/RP0/CPU0:router# show mpls ldp discovery</pre>	Displays the status of the LDP discovery process. This command, without an interface filter, generates a list of interfaces over which the LDP discovery process is running. The output information contains the state of the link (xmt/rcv hellos), local LDP identifier, the discovered peer's LDP identifier, and holdtime values.
Step 7	<p>(Optional) show mpls ldp vrf vrf-name discovery</p> <p>Example:</p> <pre>RP/0/RP0/CPU0:router# show mpls ldp vrf red discovery</pre>	Displays the status of the LDP discovery process for the specified VRF.
Step 8	<p>(Optional) show mpls ldp vrf all discovery summary</p> <p>Example:</p> <pre>RP/0/RP0/CPU0:router# show mpls ldp vrf all discovery summary</pre>	Displays the summarized status of the LDP discovery process for all VRFs.
Step 9	<p>(Optional) show mpls ldp vrf all discovery brief</p> <p>Example:</p> <pre>RP/0/RP0/CPU0:router# show mpls ldp vrf all discovery brief</pre>	Displays the brief status of the LDP discovery process for all VRFs.
Step 10	<p>(Optional) show mpls ldp vrf all ipv4 discovery summary</p> <p>Example:</p> <pre>RP/0/RP0/CPU0:router# show mpls ldp vrf all ipv4 discovery summary</pre>	Displays the summarized status of the LDP discovery process for all VRFs for the IPv4 address family.

	Command or Action	Purpose
Step 11	(Optional) show mpls ldp discovery summary all Example: <pre>RP/0/RP0/CPU0:router# show mpls ldp discovery summary all</pre>	Displays the aggregate summary across all the LDP discovery processes.

Related Topics

[LDP Control Plane](#), on page 5

[Configuring LDP Discovery for Targeted Hellos: Example](#), on page 91

Configuring LDP Discovery for Passive Targeted Hellos

Perform this task to configure LDP discovery for passive targeted hellos.

A passive side for targeted hello is the destination router (tunnel tail), which passively waits for an incoming hello message. Because targeted hellos are unicast, the passive side waits for an incoming hello message to respond with hello toward its discovered neighbor.

Before you begin

Stable router ID is required at either end of the link to ensure that the link discovery (and session setup) is successful. If you do not assign a router ID to the routers, the system defaults to the global router ID. Default router IDs are subject to change and may cause an unstable discovery.

SUMMARY STEPS

1. **configure**
2. **mpls ldp**
3. **[vrf vrf-name] router-id ip-address lsr-id**
4. **discovery targeted-hello accept**
5. **commit**
6. (Optional) **show mpls ldp discovery**
7. (Optional) **show mpls ldp vrf vrf-name discovery**
8. (Optional) **show mpls ldp vrf all discovery summary**
9. (Optional) **show mpls ldp vrf all discovery brief**
10. (Optional) **show mpls ldp vrf all ipv4 discovery summary**
11. (Optional) **show mpls ldp discovery summary all**

DETAILED STEPS

	Command or Action	Purpose
Step 1	configure	
Step 2	mpls ldp Example: <pre>RP/0/RP0/CPU0:router(config)# mpls ldp</pre>	Enters MPLS LDP configuration mode.

	Command or Action	Purpose
Step 3	<p>[vrf vrf-name] router-id ip-address lsr-id</p> <p>Example:</p> <pre>RP/0/RP0/CPU0:router(config-ldp)# router-id 192.168.70.1</pre>	<p>(Optional) Specifies a non-default VRF.</p> <p>Specifies the router ID of the local node.</p> <ul style="list-style-type: none"> In Cisco IOS XR software, the router ID is specified as an interface IP address or LSR ID. By default, LDP uses the global router ID (configured by global router ID process).
Step 4	<p>discovery targeted-hello accept</p> <p>Example:</p> <pre>RP/0/RP0/CPU0:router(config-ldp)# discovery targeted-hello accept</pre>	<p>Directs the system to accept targeted hello messages from any source and activates passive mode on the LSR for targeted hello acceptance.</p> <ul style="list-style-type: none"> This command is executed on the receiver node (with respect to a given MPLS TE tunnel). You can control the targeted-hello acceptance using the discovery targeted-hello accept command.
Step 5	commit	
Step 6	<p>(Optional) show mpls ldp discovery</p> <p>Example:</p> <pre>RP/0/RP0/CPU0:router# show mpls ldp discovery</pre>	<p>Displays the status of the LDP discovery process. This command, without an interface filter, generates a list of interfaces over which the LDP discovery process is running. The output information contains the state of the link (xmt/rcv hellos), local LDP identifier, the discovered peer's LDP identifier, and holdtime values.</p>
Step 7	<p>(Optional) show mpls ldp vrf vrf-name discovery</p> <p>Example:</p> <pre>RP/0/RP0/CPU0:router# show mpls ldp vrf red discovery</pre>	<p>Displays the status of the LDP discovery process for the specified VRF.</p>
Step 8	<p>(Optional) show mpls ldp vrf all discovery summary</p> <p>Example:</p> <pre>RP/0/RP0/CPU0:router# show mpls ldp vrf all discovery summary</pre>	<p>Displays the summarized status of the LDP discovery process for all VRFs.</p>
Step 9	<p>(Optional) show mpls ldp vrf all discovery brief</p> <p>Example:</p> <pre>RP/0/RP0/CPU0:router# show mpls ldp vrf all discovery brief</pre>	<p>Displays the brief status of the LDP discovery process for all VRFs.</p>
Step 10	<p>(Optional) show mpls ldp vrf all ipv4 discovery summary</p> <p>Example:</p>	<p>Displays the summarized status of the LDP discovery process for all VRFs for the IPv4 address family.</p>

	Command or Action	Purpose
	RP/0/RP0/CPU0:router# show mpls ldp vrf all ipv4 discovery summary	
Step 11	(Optional) show mpls ldp discovery summary all Example: RP/0/RP0/CPU0:router# show mpls ldp discovery summary all	Displays the aggregate summary across all the LDP discovery processes.

Related Topics

[LDP Control Plane](#), on page 5

[Configuring LDP Discovery for Targeted Hellos: Example](#), on page 91

Configuring Label Advertisement Control (Outbound Filtering)

Perform this task to configure label advertisement (outbound filtering).

By default, a label switched router (LSR) advertises all incoming label prefixes to each neighboring router. You can control the exchange of label binding information using the **mpls ldp label advertise** command. Using the optional keywords, you can advertise selective prefixes to all neighbors, advertise selective prefixes to defined neighbors, or disable label advertisement to all peers for all prefixes.



Note Prefixes and peers advertised selectively are defined in the access list.

Before you begin

Before configuring label advertisement, enable LDP and configure an access list.

SUMMARY STEPS

1. **configure**
2. **mpls ldp**
3. **[vrf vrf-name] address-family { ipv4 | ipv6}**
4. **label local advertise [to ldp-id for prefix-acl | interface type interface-path-id]**
5. **commit**

DETAILED STEPS

	Command or Action	Purpose
Step 1	configure	
Step 2	mpls ldp Example: RP/0/RP0/CPU0:router(config)# mpls ldp	Enters MPLS LDP configuration mode.

	Command or Action	Purpose
Step 3	<p>[vrf <i>vrf-name</i>] address-family { ipv4 ipv6 }</p> <p>Example:</p> <pre>RP/0/RP0/CPU0:router(config-ldp)# address-family ipv4</pre> <pre>RP/0/RP0/CPU0:router(config-ldp)# address-family ipv6</pre>	<p>(Optional) Specifies a non-default VRF.</p> <p>Enables the LDP IPv4 or IPv6 address family.</p>
Step 4	<p>label local advertise [to <i>ldp-id</i> for <i>prefix-acl</i> interface <i>type interface-path-id</i>]</p> <p>Example:</p> <pre>RP/0/RP0/CPU0:router(config-ldp-af)# label local advertise to 1.1.1.1:0 for pfx_acl1</pre> <pre>RP/0/RP0/CPU0:router(config-ldp-af)# label local advertise interface POS 0/1/0/0</pre>	<p>Configures outbound label advertisement control by specifying one of the following options:</p> <p>interface</p> <p>Specifies an interface for label advertisement.</p> <p>to <i>ldp-id</i> for <i>prefix-acl</i></p> <p>Specifies neighbors to advertise and receive label advertisements.</p>
Step 5	commit	

Related Topics

[Label Advertisement Control \(Outbound Filtering\)](#), on page 11

[Configuring Label Advertisement \(Outbound Filtering\): Example](#), on page 92

Setting Up LDP Neighbors

Perform this task to set up LDP neighbors.

Before you begin

Stable router ID is required at either end of the link to ensure the link discovery (and session setup) is successful. If you do not assign a router ID to the routers, the system will default to the global router ID. Default router IDs are subject to change and may cause an unstable discovery.

SUMMARY STEPS

- 1.** **configure**
- 2.** **mpls ldp**
- 3.** **interface** *type interface-path-id*
- 4.** **address-family** { **ipv4** | **ipv6** }
- 5.** **discovery transport-address** [*ip-address* | **interface**]
- 6.** **exit**
- 7.** **holdtime** *seconds*
- 8.** [vrf *vrf-name*] **neighbor** *ldp-id* **password** [**encrypted**] *password*

9. **backoff** *initial maximum*
10. **commit**
11. (Optional) **show mpls ldp neighbor**
12. (Optional) **show mpls ldp vrf** *vrf-name* **neighbor**
13. (Optional) **show mpls ldp vrf all neighbor brief**
14. (Optional) **clear mpls ldp neighbor**
15. (Optional) **clear mpls ldp vrf all neighbor**
16. (Optional) **clear mpls ldp vrf** *vrf-name* **neighbor**

DETAILED STEPS

	Command or Action	Purpose
Step 1	configure	
Step 2	mpls ldp Example: RP/0/RP0/CPU0:router (config)# mpls ldp	Enters MPLS LDP configuration mode.
Step 3	interface <i>type interface-path-id</i> Example: RP/0/RP0/CPU0:router (config-ldp)# interface POS 0/1/0/0	Enters interface configuration mode for the LDP protocol.
Step 4	address-family { ipv4 ipv6 } Example: RP/0/RP0/CPU0:router (config-ldp-if)# address-family ipv4 OR RP/0/RP0/CPU0:router (config-ldp-if)# address-family ipv6	Enables the LDP IPv4 or IPv6 address family.
Step 5	discovery transport-address [<i>ip-address</i> interface] Example: RP/0/RP0/CPU0:router (config-ldp-if-af)# discovery transport-address 192.168.1.42 RP/0/RP0/CPU0:router (config-ldp-if-af)# discovery transport-address 5:6::78 OR RP/0/RP0/CPU0:router (config-ldp-if-af)# discovery transport-address interface	Provides an alternative transport address for a TCP connection. <ul style="list-style-type: none"> • Default transport address advertised by an LSR (for TCP connections) to its peer is the router ID. • Transport address configuration is applied for a given LDP-enabled interface. • If the interface version of the command is used, the configured IP address of the interface is passed to its neighbors as the transport address.

	Command or Action	Purpose
Step 6	exit Example: RP/0/RP0/CPU0:router(config-ldp-if) # exit	Exits the current configuration mode.
Step 7	holdtime <i>seconds</i> Example: RP/0/RP0/CPU0:router(config-ldp) # holdtime 30	Changes the time for which an LDP session is maintained in the absence of LDP messages from the peer. <ul style="list-style-type: none"> • Outgoing keepalive interval is adjusted accordingly (to make three keepalives in a given holdtime) with a change in session holdtime value. • Session holdtime is also exchanged when the session is established. • In this example holdtime is set to 30 seconds, which causes the peer session to timeout in 30 seconds, as well as transmitting outgoing keepalive messages toward the peer every 10 seconds.
Step 8	[vrf vrf-name] neighbor ldp-id password [encrypted] password Example: RP/0/RP0/CPU0:router(config-ldp) # neighbor 192.168.2.44:0 password secretpasswd	(Optional) Specifies a non-default VRF. Configures password authentication (using the TCP MD5 option) for a given neighbor.
Step 9	backoff <i>initial maximum</i> Example: RP/0/RP0/CPU0:router(config-ldp) # backoff 10 20	Configures the parameters for the LDP backoff mechanism. The LDP backoff mechanism prevents two incompatibly configured LSRs from engaging in an unthrottled sequence of session setup failures. If a session setup attempt fails due to such incompatibility, each LSR delays its next attempt (backs off), increasing the delay exponentially with each successive failure until the maximum backoff delay is reached.
Step 10	commit	
Step 11	(Optional) show mpls ldp neighbor Example: RP/0/RP0/CPU0:router# show mpls ldp neighbor	Displays the status of the LDP session with its neighbors. This command can be run with various filters as well as with the brief option.
Step 12	(Optional) show mpls ldp vrf vrf-name neighbor Example: RP/0/RP0/CPU0:router# show mpls ldp vrf red neighbor	Displays the status of the LDP session with its neighbors for the specified VRF. This command can be run with the brief option.

	Command or Action	Purpose
Step 13	(Optional) show mpls ldp vrf all neighbor brief Example: RP/0/RP0/CPU0:router# show mpls ldp vrf all neighbor brief	Displays the brief LDP session neighbor information for all VRFs.
Step 14	(Optional) clear mpls ldp neighbor Example: RP/0/RP0/CPU0:router# clear mpls ldp neighbor	Resets an LDP session.
Step 15	(Optional) clear mpls ldp vrf all neighbor Example: RP/0/RP0/CPU0:router# clear mpls ldp vrf all neighbor	Resets LDP session for all VRFs.
Step 16	(Optional) clear mpls ldp vrf vrf-name neighbor Example: RP/0/RP0/CPU0:router# clear mpls ldp vrf red neighbor	Resets LDP session for the specified VRF.

Related Topics

[Configuring LDP Neighbors: Example](#), on page 93

Setting Up LDP Forwarding

Perform this task to set up LDP forwarding.

By default, the LDP control plane implements the penultimate hop popping (PHOP) mechanism. The PHOP mechanism requires that label switched routers use the implicit-null label as a local label for the given Forwarding Equivalence Class (FEC) for which LSR is the penultimate hop. Although PHOP has certain advantages, it may be required to extend LSP up to the ultimate hop under certain circumstances (for example, to propagate MPL QoS). This is done using a special local label (explicit-null) advertised to the peers after which the peers use this label when forwarding traffic toward the ultimate hop (egress LSR).

Before you begin

Stable router ID is required at either end of the link to ensure the link discovery (and session setup) is successful. If you do not assign a router ID to the routers, the system will default to the global router ID. Default router IDs are subject to change and may cause an unstable discovery.

SUMMARY STEPS

1. **configure**
2. **mpls ldp**
3. **[vrf vrf-name] address-family {ipv4 | ipv6 }**

4. **label local advertise explicit-null**
5. **commit**
6. (Optional) **show mpls ldp forwarding**
7. (Optional) **show mpls ldp vrf all forwarding**
8. (Optional) **show mpls ldp vrf all forwarding summary**
9. (Optional) **show mpls ldp vrf *vrf-name* ipv4 forwarding**
10. (Optional) **show mpls ldp forwarding summary all**
11. (Optional) **clear mpls ldp vrf *vrf-name* ipv4 forwarding**
12. (Optional) **clear mpls ldp [ipv4 | ipv6]forwarding**
13. (Optional) **show mpls ldp afi-all forwarding**
14. (Optional) **show mpls ldp ipv6 forwarding**
15. (Optional) **show mpls forwarding**
16. (Optional) **ping *ip-address***

DETAILED STEPS

	Command or Action	Purpose
Step 1	configure	
Step 2	mpls ldp Example: RP/0/RP0/CPU0:router(config)# mpls ldp	Enters MPLS LDP configuration mode.
Step 3	[vrf <i>vrf-name</i>] address-family {ipv4 ipv6 } Example: RP/0/RP0/CPU0:router(config-ldp)# address-family ipv4 or RP/0/RP0/CPU0:router(config-ldp)# address-family ipv6	(Optional) Specifies a non-default VRF. Enables the LDP IPv4 or IPv6 address family.
Step 4	label local advertise explicit-null Example: RP/0/RP0/CPU0:router(config-ldp-af)# label local advertise explicit-null	Causes a router to advertise an explicit null label in situations where it normally advertises an implicit null label (for example, to enable an ultimate-hop disposition instead of PHOP).
Step 5	commit	
Step 6	(Optional) show mpls ldp forwarding Example: RP/0/RP0/CPU0:router# show mpls ldp forwarding	Displays the MPLS LDP view of installed forwarding states (rewrites). Note For local labels, only up to 12000 rewrites are supported. If the rewrites exceed this limit, MPLS LSD or MPLS LDP or both the processes may crash.

	Command or Action	Purpose
Step 7	(Optional) show mpls ldp vrf all forwarding Example: RP/0/RP0/CPU0:router# show mpls ldp vrf all forwarding	Displays the forwarding setup information of all LDP configured VRFs.
Step 8	(Optional) show mpls ldp vrf all forwarding summary Example: RP/0/RP0/CPU0:router# show mpls ldp vrf all forwarding summary	Displays the forwarding setup summary of all LDP configured VRFs.
Step 9	(Optional) show mpls ldp vrf vrf-name ipv4 forwarding Example: RP/0/RP0/CPU0:router# show mpls ldp vrf red ipv4 forwarding	Displays the forwarding setup information for the specified VRF for IPv4.
Step 10	(Optional) show mpls ldp forwarding summary all Example: RP/0/RP0/CPU0:router# show mpls ldp forwarding summary all	Displays the aggregate summary across LDP processes and all VRFs.
Step 11	(Optional) clear mpls ldp vrf vrf-name ipv4 forwarding Example: RP/0/RP0/CPU0:router# clear mpls ldp vrf red ipv4 forwarding	Resets the MPLS forwarding rewrites for the specified VRF for IPv4.
Step 12	(Optional) clear mpls ldp [ipv4 ipv6]forwarding Example: RP/0/RP0/CPU0:router# clear mpls ldp ipv4 forwarding or RP/0/RP0/CPU0:router# clear mpls ldp ipv6 forwarding	Resets the MPLS forwarding rewrites for either IPv4 or IPv6 addresses.
Step 13	(Optional) show mpls ldp afi-all forwarding Example: RP/0/RP0/CPU0:router# show mpls ldp afi-all forwarding	Displays the forwarding setup information of all address families.

	Command or Action	Purpose
Step 14	(Optional) show mpls ldp ipv6 forwarding Example: RP/0/RP0/CPU0:router# show mpls ldp ipv6 forwarding	Displays the MPLS LDP view of installed forwarding states (rewrites) for IPv6.
Step 15	(Optional) show mpls forwarding Example: RP/0/RP0/CPU0:router# show mpls forwarding	Displays a global view of all MPLS installed forwarding states (rewrites) by various applications (LDP, TE, and static).
Step 16	(Optional) ping ip-address Example: RP/0/RP0/CPU0:router# ping 192.168.2.55	Checks for connectivity to a particular IP address (going through MPLS LSP as shown in the show mpls forwarding command).

Related Topics

[LDP Forwarding](#), on page 6

[Configuring LDP Forwarding: Example](#), on page 93

Configuring Global Transport Address

Perform this task to configure global transport address for the IPv4 address family.

SUMMARY STEPS

1. **configure**
2. **mpls ldp**
3. **address-family ipv4**
4. **discovery transport-address ip-address**
5. **end** or **commit**

DETAILED STEPS

	Command or Action	Purpose
Step 1	configure	
Step 2	mpls ldp Example: RP/0/RP0/CPU0:router(config)# mpls ldp	Enters MPLS LDP configuration mode.
Step 3	address-family ipv4 Example: RP/0/RP0/CPU0:router(config-ldp)# address-family	Enables LDP IPv4 address family.

	Command or Action	Purpose
	<code>ipv4</code>	
Step 4	<p>discovery transport-address <i>ip-address</i></p> <p>Example:</p> <pre>RP/0/RP0/CPU0:router(config-ldp-af)# discovery transport-address 192.168.1.42</pre>	<p>Provides an alternative transport address for a TCP connection.</p> <ul style="list-style-type: none"> • Default transport address advertised by an LSR (for TCP connections) to its peer is the router ID.
Step 5	<p>end or commit</p> <p>Example:</p> <pre>RP/0/RP0/RP0/CPU0:router (config-ldp-af)# end or RP/0/RP0/RP0/CPU0:router (config-ldp-af)# commit</pre>	<ul style="list-style-type: none"> • When you issue the end command, the system prompts you to commit changes: <p style="margin-left: 20px;">Uncommitted changes found, commit them before exiting (yes/no/cancel)? [cancel]:</p> • Entering yes saves configuration changes to the running configuration file, exits the configuration session, and returns the router to EXEC mode. • Entering no exits the configuration session and returns the router to EXEC mode without committing the configuration changes. • Entering cancel leaves the router in the current configuration session without exiting or committing the configuration changes. • Use the commit command to save the configuration changes to the running configuration file and remain within the configuration session.

Setting Up LDP NSF Using Graceful Restart

Perform this task to set up NSF using LDP graceful restart.

LDP graceful restart is a way to enable NSF for LDP. The correct way to set up NSF using LDP graceful restart is to bring up LDP neighbors (link or targeted) with additional configuration related to graceful restart.

Before you begin

Stable router ID is required at either end of the link to ensure the link discovery (and session setup) is successful. If you do not assign a router ID to the routers, the system will default to the global router ID. Default router IDs are subject to change and may cause an unstable discovery.

SUMMARY STEPS

1. **configure**
2. **mpls ldp**
3. **interface** *type interface-path-id*
4. **exit**

5. **graceful-restart**
6. **graceful-restart forwarding-state-holdtime** *seconds*
7. **graceful-restart reconnect-timeout** *seconds*
8. **commit**
9. (Optional) **show mpls ldp** [*vrf vrf-name*] **parameters**
10. (Optional) **show mpls ldp neighbor**
11. (Optional) **show mpls ldp graceful-restart**
12. (Optional) **show mpls ldp vrf all graceful-restart**
13. (Optional) **show mpls ldp vrf** *vrf-name* **graceful-restart**

DETAILED STEPS

	Command or Action	Purpose
Step 1	configure	
Step 2	mpls ldp Example: RP/0/RP0/CPU0:router(config)# mpls ldp	Enters MPLS LDP configuration mode.
Step 3	interface <i>type interface-path-id</i> Example: RP/0/RP0/CPU0:router(config-ldp)# interface POS 0/1/0/0 RP/0/RP0/CPU0:router(config-ldp-if)#	Enters interface configuration mode for the LDP protocol.
Step 4	exit Example: RP/0/RP0/CPU0:router(config-ldp-if)# exit	Exits the current configuration mode.
Step 5	graceful-restart Example: RP/0/RP0/CPU0:router(config-ldp)# graceful-restart	Enables the LDP graceful restart feature.
Step 6	graceful-restart forwarding-state-holdtime <i>seconds</i> Example: RP/0/RP0/CPU0:router(config-ldp)# graceful-restart forwarding-state-holdtime 180	Specifies the length of time that forwarding can keep LDP-installed forwarding states and rewrites, and specifies when the LDP control plane restarts. <ul style="list-style-type: none"> • After restart of the control plane, when the forwarding state holdtime expires, any previously installed LDP forwarding state or rewrite that is not yet refreshed is deleted from the forwarding. • Recovery time sent after restart is computed as the current remaining value of the forwarding state hold timer.

	Command or Action	Purpose
Step 7	graceful-restart reconnect-timeout <i>seconds</i> Example: RP/0/RP0/CPU0:router (config-ldp) # graceful-restart reconnect-timeout 169	Specifies the length of time a neighbor waits before restarting the node to reconnect before declaring an earlier graceful restart session as down. This command is used to start a timer on the peer (upon a neighbor restart). This timer is referred to as <i>Neighbor Liveness</i> timer.
Step 8	commit	
Step 9	(Optional) show mpls ldp [vrf vrf-name] parameters Example: RP/0/RP0/CPU0:router # show mpls ldp parameters RP/0/RP0/CPU0:router # show mpls ldp vrf red parameters	Displays all the current MPLS LDP parameters. Displays the LDP parameters for the specified VRF.
Step 10	(Optional) show mpls ldp neighbor Example: RP/0/RP0/CPU0:router# show mpls ldp neighbor	Displays the status of the LDP session with its neighbors. This command can be run with various filters as well as with the brief option.
Step 11	(Optional) show mpls ldp graceful-restart Example: RP/0/RP0/CPU0:router# show mpls ldp graceful-restart	Displays the status of the LDP graceful restart feature. The output of this command not only shows states of different graceful restart timers, but also a list of graceful restart neighbors, their state, and reconnect count.
Step 12	(Optional) show mpls ldp vrf all graceful-restart Example: RP/0/RP0/CPU0:router# show mpls ldp vrf all graceful-restart	Displays the status of the LDP graceful restart for all VRFs.
Step 13	(Optional) show mpls ldp vrf vrf-name graceful-restart Example: RP/0/RP0/CPU0:router# show mpls ldp vrf red graceful-restart	Displays the status of the LDP graceful restart for the specified VRF.

Related Topics

[LDP Graceful Restart](#), on page 8

[Phases in Graceful Restart](#), on page 9

[Recovery with Graceful-Restart](#), on page 10

[Configuring LDP Nonstop Forwarding with Graceful Restart: Example](#), on page 93

Configuring Label Acceptance Control (Inbound Filtering)

Perform this task to configure LDP inbound label filtering.



Note By default, there is no inbound label filtering performed by LDP and thus an LSR accepts (and retains) all remote label bindings from all peers.

SUMMARY STEPS

1. **configure**
2. **mpls ldp**
3. **label accept for** *prefix-acl* **from** *ip-address*
4. [**vrf** *vrf-name*] **address-family** { **ipv4** | **ipv6**}
5. **label remote accept from** *ldp-id* **for** *prefix-acl*
6. **commit**

DETAILED STEPS

	Command or Action	Purpose
Step 1	configure	
Step 2	mpls ldp Example: RP/0/RP0/CPU0:router(config)# mpls ldp	Enters the MPLS LDP configuration mode.
Step 3	label accept for <i>prefix-acl</i> from <i>ip-address</i> Example: RP/0/RP0/CPU0:router(config-ldp)# label accept for pfx_acl_1 from 192.168.1.1 RP/0/RP0/CPU0:router(config-ldp)# label accept for pfx_acl_2 from 192.168.2.2	Configures inbound label acceptance for prefixes specified by prefix-acl from neighbor (as specified by its IP address).
Step 4	[vrf <i>vrf-name</i>] address-family { ipv4 ipv6 }	(Optional) Specifies a non-default VRF.
	Example: RP/0/RP0/CPU0:router(config-ldp)# address-family ipv4 RP/0/RP0/CPU0:router(config-ldp)# address-family ipv6	Enables the LDP IPv4 or IPv6 address family.

	Command or Action	Purpose
Step 5	label remote accept from <i>ldp-id</i> for <i>prefix-acl</i> Example: <pre>RP/0/RP0/CPU0:router(config-ldp-af)# label remote accept from 192.168.1.1:0 for pfx_acl_1</pre>	Configures inbound label acceptance control for prefixes specified by prefix-acl from neighbor (as specified by its LDP ID).
Step 6	commit	

Related Topics

[Label Acceptance Control \(Inbound Filtering\)](#), on page 12

[Configuring Label Acceptance \(Inbound Filtering\): Example](#), on page 94

Configuring Local Label Allocation Control

Perform this task to configure label allocation control.



Note By default, local label allocation control is disabled and all non-BGP prefixes are assigned local labels.

SUMMARY STEPS

1. **configure**
2. **mpls ldp**
3. **[vrf vrf-name] address-family { ipv4 | ipv6}**
4. **label local allocate for prefix-acl**
5. **commit**

DETAILED STEPS

	Command or Action	Purpose
Step 1	configure	
Step 2	mpls ldp Example: <pre>RP/0/RP0/CPU0:router(config)# mpls ldp</pre>	Enters the MPLS LDP configuration mode.
Step 3	[vrf vrf-name] address-family { ipv4 ipv6} Example: <pre>RP/0/RP0/CPU0:router(config-ldp)# address-family ipv4 RP/0/RP0/CPU0:router(config-ldp)# address-family</pre>	(Optional) Specifies a non-default VRF. Enables the LDP IPv4 or IPv6 address family.

	Command or Action	Purpose
	ipv6	
Step 4	label local allocate for <i>prefix-acl</i> Example: <pre>RP/0/RP0/CPU0:router(config-ldp-af)# label local allocate for pfx_acl_1</pre>	Configures label allocation control for prefixes as specified by <i>prefix-acl</i> .
Step 5	commit	

Related Topics

[Local Label Allocation Control](#), on page 12

[Configuring Local Label Allocation Control: Example](#), on page 94

Configuring Session Protection

Perform this task to configure LDP session protection.

By default, there is no protection is done for link sessions by means of targeted hellos.

SUMMARY STEPS

1. **configure**
2. **mpls ldp**
3. **session protection [for *peer-acl*] [duration *seconds*]**
4. **commit**

DETAILED STEPS

	Command or Action	Purpose
Step 1	configure	
Step 2	mpls ldp Example: <pre>RP/0/RP0/CPU0:router(config)# mpls ldp</pre>	Enters the MPLS LDP configuration mode.
Step 3	session protection [for <i>peer-acl</i>] [duration <i>seconds</i>] Example: <pre>RP/0/RP0/CPU0:router(config-ldp)# session protection for peer_acl_1 duration 60</pre>	Configures LDP session protection for peers specified by <i>peer-acl</i> with a maximum duration, in seconds.
Step 4	commit	

Related Topics[Session Protection](#), on page 12[Configuring LDP Session Protection: Example](#), on page 94

Configuring LDP IGP Synchronization: OSPF

Perform this task to configure LDP IGP Synchronization under OSPF.



Note By default, there is no synchronization between LDP and IGP.

SUMMARY STEPS

1. **configure**
2. **router ospf** *process-name*
3. (Optional) **vrf** *vrf-name*
4. Use one of the following commands:
 - **mpls ldp sync**
 - **area** *area-id* **mpls ldp sync**
 - **area** *area-id* **interface** *name* **mpls ldp sync**
5. (Optional) Use one of the following commands:
 - **mpls ldp sync**
 - **area** *area-id* **mpls ldp sync**
 - **area** *area-id* **interface** *name* **mpls ldp sync**
6. **commit**
7. (Optional) **show mpls ldp vrf** *vrf-name* **ipv4 igp sync**
8. (Optional) **show mpls ldp vrf all ipv4 igp sync**
9. (Optional) **show mpls ldp { ipv4 | ipv6 } igp sync**

DETAILED STEPS

	Command or Action	Purpose
Step 1	configure	
Step 2	router ospf <i>process-name</i> Example: RP/0/RP0/CPU0:router(config)# router ospf 100	Identifies the OSPF routing process and enters OSPF configuration mode.
Step 3	(Optional) vrf <i>vrf-name</i> Example: RP/0/RP0/CPU0:router(config-ospf)# vrf red	Specifies the non-default VRF.

	Command or Action	Purpose
Step 4	<p>Use one of the following commands:</p> <ul style="list-style-type: none"> • mpls ldp sync • area <i>area-id</i> mpls ldp sync • area <i>area-id</i> interface <i>name</i> mpls ldp sync <p>Example:</p> <pre>RP/0/RP0/CPU0:router (config-ospf) # mpls ldp sync</pre>	Enables LDP IGP synchronization on an interface.
Step 5	<p>(Optional) Use one of the following commands:</p> <ul style="list-style-type: none"> • mpls ldp sync • area <i>area-id</i> mpls ldp sync • area <i>area-id</i> interface <i>name</i> mpls ldp sync <p>Example:</p> <pre>RP/0/RP0/CPU0:router (config-ospf-vrf) # mpls ldp sync</pre> <pre>RP/0/RP0/CPU0:router (config-ospf-vrf) # area 1 mpls ldp sync</pre> <pre>RP/0/RP0/CPU0:router (config-ospf-vrf) # area 1 interface POS 0/2/0/0 mpls ldp sync</pre>	Enables LDP IGP synchronization on an interface for the specified VRF.
Step 6	commit	
Step 7	<p>(Optional) show mpls ldp vrf <i>vrf-name</i> ipv4 igp sync</p> <p>Example:</p> <pre>RP/0/RP0/CPU0:router# show mpls ldp vrf red ipv4 igp sync</pre>	Displays the LDP IGP synchronization information for the specified VRF for address family IPv4.
Step 8	<p>(Optional) show mpls ldp vrf all ipv4 igp sync</p> <p>Example:</p> <pre>RP/0/RP0/CPU0:router# show mpls ldp vrf all ipv4 igp sync</pre>	Displays the LDP IGP synchronization information for all VRFs for address family IPv4.
Step 9	<p>(Optional) show mpls ldp { ipv4 ipv6 } igp sync</p> <p>Example:</p> <pre>RP/0/RP0/CPU0:router# show mpls ldp ipv4 igp sync</pre> <pre>RP/0/RP0/CPU0:router# show mpls ldp ipv6 igp sync</pre>	Displays the LDP IGP synchronization information for IPv4 or IPv6 address families.

Related Topics

[IGP Synchronization](#), on page 13

[Configuring LDP IGP Synchronization—OSPF: Example](#), on page 95

Disabling LDP IGP Synchronization: OSPF

Perform this task to disable LDP IGP Synchronization under OSPF.

You can disable LDP IGP synchronization on a per-interface basis. This lets LDP enable all IGP interfaces except those that are explicitly disabled.

SUMMARY STEPS

1. **configure**
2. **router ospf** *process-name*
3. (Optional) **vrf** *vrf-name*
4. Use one of the following commands:
 - **area** *area-id* **mpls ldp sync disable**
 - **area** *area-id* **interface** *name* **mpls ldp sync disable**
5. (Optional) Use one of the following commands:
 - **area** *area-id* **mpls ldp sync disable**
 - **area** *area-id* **interface** *name* **mpls ldp sync disable**
6. **commit**

DETAILED STEPS

	Command or Action	Purpose
Step 1	configure	
Step 2	router ospf <i>process-name</i> Example: RP/0/RP0/CPU0:router(config)# router ospf 109	Identifies the OSPF routing process and enters OSPF configuration mode.
Step 3	(Optional) vrf <i>vrf-name</i> Example: RP/0/RP0/CPU0:router(config-ospf)# vrf red	Specifies the non-default VRF.
Step 4	Use one of the following commands: <ul style="list-style-type: none">• area <i>area-id</i> mpls ldp sync disable• area <i>area-id</i> interface <i>name</i> mpls ldp sync disable Example: RP/0/RP0/CPU0:router(config-ospf)# area 1 mpls ldp sync disable	Disables LDP IGP synchronization on an interface.

	Command or Action	Purpose
	RP/0/RP0/CPU0:router(config-ospf)# area 1 interface POS 0/2/0/0 mpls ldp sync disable	
Step 5	(Optional) Use one of the following commands: <ul style="list-style-type: none"> • area <i>area-id</i> mpls ldp sync disable • area <i>area-id</i> interface <i>name</i> mpls ldp sync disable Example: RP/0/RP0/CPU0:router(config-ospf-vrf)# area 1 mpls ldp sync disable RP/0/RP0/CPU0:router(config-ospf-vrf)# area 1 interface POS 0/2/0/0 mpls ldp sync disable	Disables LDP IGP synchronization on an interface for the specified VRF.
Step 6	commit	

Configuring LDP IGP Synchronization: ISIS

Perform this task to configure LDP IGP Synchronization under ISIS.



Note By default, there is no synchronization between LDP and ISIS.

SUMMARY STEPS

1. **configure**
2. **router isis *instance-id***
3. **interface *type interface-path-id***
4. **address-family {ipv4 | ipv6} unicast**
5. **mpls ldp sync**
6. **commit**

DETAILED STEPS

	Command or Action	Purpose
Step 1	configure	
Step 2	router isis <i>instance-id</i> Example: RP/0/RP0/CPU0:router(config)# router isis 100 RP/0/RP0/CPU0:router(config-isis)#	Enables the Intermediate System-to-Intermediate System (IS-IS) routing protocol and defines an IS-IS instance.

	Command or Action	Purpose
Step 3	interface <i>type interface-path-id</i> Example: <pre>RP/0/RP0/CPU0:router(config-isis)# interface POS 0/2/0/0 RP/0/RP0/CPU0:router(config-isis-if)#</pre>	Configures the IS-IS protocol on an interface and enters ISIS interface configuration mode.
Step 4	address-family { ipv4 ipv6 } unicast Example: <pre>RP/0/RP0/CPU0:router(config-isis-if)# address-family ipv4 unicast RP/0/RP0/CPU0:router(config-isis-if-af)# RP/0/RP0/CPU0:router(config-isis-if)# address-family ipv6 unicast RP/0/RP0/CPU0:router(config-isis-if-af)#</pre>	Enters address family configuration mode for configuring IS-IS routing for a standard IP version 4 (IPv4) or IP version 6 (IPv6) address prefix.
Step 5	mpls ldp sync Example: <pre>RP/0/RP0/CPU0:router(config-isis-if-af)# mpls ldp sync</pre>	Enables LDP IGP synchronization.
Step 6	commit	

Related Topics

[IGP Synchronization](#), on page 13

[Configuring LDP IGP Synchronization—ISIS: Example](#), on page 95

Configuring LDP IGP Synchronization Delay Interval

Perform this task to configure the LDP IGP synchronization delay interval.

By default, LDP does not delay declaring sync up as soon as convergence conditions are met.

SUMMARY STEPS

1. **configure**
2. **mpls ldp**
3. **igp sync delay** *delay-time*
4. **commit**

DETAILED STEPS

	Command or Action	Purpose
Step 1	configure	

	Command or Action	Purpose
Step 2	mpls ldp Example: RP/0/RP0/CPU0:router(config)# mpls ldp	Enters the MPLS LDP configuration mode.
Step 3	igp sync delay <i>delay-time</i> Example: RP/0/RP0/CPU0:router(config-ldp)# igp sync delay 30	Configures LDP IGP synchronization delay in seconds.
Step 4	commit	

Related Topics

[IGP Synchronization](#), on page 13

Configuring LDP IGP Synchronization Process Restart Delay

Perform this task to enable process restart delay when an LDP fails or restarts.



Note By default, the LDP IGP Synchronization Process Restart Delay feature is disabled.

SUMMARY STEPS

1. **configure**
2. **mpls ldp**
3. Use one of the following commands:
 - **igp sync delay** *seconds*
 - **igp sync delay on-proc-restart** *delay-time*
4. **commit**

DETAILED STEPS

	Command or Action	Purpose
Step 1	configure	
Step 2	mpls ldp Example: RP/0/RP0/CPU0:router(config)# mpls ldp	Enters the MPLS LDP configuration mode.
Step 3	Use one of the following commands: • igp sync delay <i>seconds</i>	Configures LDP IGP delay in seconds.

	Command or Action	Purpose
	<ul style="list-style-type: none"> • <code>igp sync delay on-proc-restart delay-time</code> <p>Example:</p> <pre>RP/0/RP0/CPU0:router(config-ldp)# igp sync delay 30</pre>	
Step 4	commit	

Related Topics

[IGP Synchronization Process Restart Delay](#), on page 14

Enabling LDP Auto-Configuration for a Specified OSPF Instance

Perform this task to enable IGP auto-configuration globally for a specified OSPF process name.

You can disable auto-configuration on a per-interface basis. This lets LDP enable all IGP interfaces except those that are explicitly disabled.



Note This feature is supported for IPv4 unicast family in default VRF only.

SUMMARY STEPS

1. **configure**
2. **router ospf** *process-name*
3. **mpls ldp auto-config**
4. **area** *area-id*
5. **interface** *type interface-path-id*
6. **commit**

DETAILED STEPS

	Command or Action	Purpose
Step 1	configure	
Step 2	<p>router ospf <i>process-name</i></p> <p>Example:</p> <pre>RP/0/RP0/CPU0:router(config)# router ospf 190 RP/0/RP0/CPU0:router(config-ospf)#</pre>	Enters a uniquely identifiable OSPF routing process. The process name is any alphanumeric string no longer than 40 characters without spaces.
Step 3	<p>mpls ldp auto-config</p> <p>Example:</p> <pre>RP/0/RP0/CPU0:router(config-ospf)# mpls ldp auto-config</pre>	Enables LDP auto-configuration.

	Command or Action	Purpose
Step 4	area <i>area-id</i> Example: RP/0/RP0/CPU0:router(config-ospf)# area 8	Configures an OSPF area and identifier. area-id Either a decimal value or an IP address.
Step 5	interface <i>type interface-path-id</i> Example: RP/0/RP0/CPU0:router(config-ospf-ar)# interface pos 0/6/0/0	Enables LDP auto-configuration on the specified interface. Note LDP configurable limit for maximum number of interfaces does not apply to IGP auto-configuration interfaces.
Step 6	commit	

Related Topics

[IGP Auto-configuration](#), on page 14

[Configuring LDP Auto-Configuration: Example](#), on page 95

[Disabling LDP Auto-Configuration](#), on page 63

Enabling LDP Auto-Configuration in an Area for a Specified OSPF Instance

Perform this task to enable IGP auto-configuration in a defined area with a specified OSPF process name.

You can disable auto-configuration on a per-interface basis. This lets LDP enable all IGP interfaces except those that are explicitly disabled.



Note This feature is supported for IPv4 unicast family in default VRF only.

SUMMARY STEPS

1. **configure**
2. **router ospf** *process-name*
3. **area** *area-id*
4. **mpls ldp auto-config**
5. **interface** *type interface-path-id*
6. **commit**

DETAILED STEPS

	Command or Action	Purpose
Step 1	configure	

	Command or Action	Purpose
Step 2	router ospf <i>process-name</i> Example: RP/0/RP0/CPU0:router(config)# router ospf 100 RP/0/RP0/CPU0:router(config-ospf)#	Enters a uniquely identifiable OSPF routing process. The process name is any alphanumeric string no longer than 40 characters without spaces.
Step 3	area <i>area-id</i> Example: RP/0/RP0/CPU0:router(config-ospf)# area 8 RP/0/RP0/CPU0:router(config-ospf-ar)#	Configures an OSPF area and identifier. area-id Either a decimal value or an IP address.
Step 4	mpls ldp auto-config Example: RP/0/RP0/CPU0:router(config-ospf-ar)# mpls ldp auto-config	Enables LDP auto-configuration.
Step 5	interface <i>type interface-path-id</i> Example: RP/0/RP0/CPU0:router(config-ospf-ar)# interface pos 0/6/0/0 RP/0/RP0/CPU0:router(config-ospf-ar-if)	Enables LDP auto-configuration on the specified interface. The LDP configurable limit for maximum number of interfaces does not apply to IGP auto-config interfaces.
Step 6	commit	

Related Topics

[IGP Auto-configuration](#), on page 14

[Configuring LDP Auto-Configuration: Example](#), on page 95

[Disabling LDP Auto-Configuration](#), on page 63

Disabling LDP Auto-Configuration

Perform this task to disable IGP auto-configuration.

You can disable auto-configuration on a per-interface basis. This lets LDP enable all IGP interfaces except those that are explicitly disabled.

SUMMARY STEPS

1. **configure**
2. **mpls ldp**
3. **interface** *type interface-path-id*
4. **igp auto-config disable**
5. **commit**

DETAILED STEPS

	Command or Action	Purpose
Step 1	configure	
Step 2	mpls ldp Example: RP/0/RP0/CPU0:router(config)# mpls ldp RP/0/RP0/CPU0:router(config-ldp)#	Enters the MPLS LDP configuration mode.
Step 3	interface <i>type interface-path-id</i> Example: RP/0/RP0/CPU0:router(config-ldp)# interface pos 0/6/0/0	Enters interface configuration mode and configures an interface.
Step 4	igp auto-config disable Example: RP/0/RP0/CPU0:router(config-ldp-if)# igp auto-config disable	Disables auto-configuration on the specified interface.
Step 5	commit	

Related Topics

[IGP Auto-configuration](#), on page 14

[Configuring LDP Auto-Configuration: Example](#), on page 95

Configuring LDP Nonstop Routing

Perform this task to configure LDP NSR.



Note By default, NSR is globally-enabled on all LDP sessions except ATOM.

SUMMARY STEPS

1. **configure**
2. **mpls ldp**
3. **nsr**
4. **commit**
5. (Optional) **show mpls ldp [vrf vrf-name] nsr statistics**
6. (Optional) **show mpls ldp vrf vrf-name nsr statistics neighbor**
7. (Optional) **show mpls ldp [vrf vrf-name] nsr summary**
8. (Optional) **show mpls ldp [vrf vrf-name] nsr pending**
9. (Optional) **show mpls ldp vrf vrf-name nsr pending neighbor**
10. (Optional) **show mpls ldp vrf all nsr summary**

11. (Optional) **show mpls ldp nsr summary all**
12. (Optional) **clear mpls ldp vrf vrf-name nsr statistics neighbor**

DETAILED STEPS

	Command or Action	Purpose
Step 1	configure	
Step 2	mpls ldp Example: RP/0/RP0/CPU0:router(config)# mpls ldp	Enters the MPLS LDP configuration mode.
Step 3	nsr Example: RP/0/RP0/CPU0:router(config-ldp)# nsr	Enables LDP nonstop routing.
Step 4	commit	
Step 5	(Optional) show mpls ldp [vrf vrf-name] nsr statistics Example: RP/0/RP0/CPU0:router# show mpls ldp nsr statistics RP/0/RP0/CPU0:router# show mpls ldp vrf red nsr statistics	Displays MPLS LDP NSR statistics. Displays LDP NSR statistics for the specified VRF.
Step 6	(Optional) show mpls ldp vrf vrf-name nsr statistics neighbor Example: RP/0/RP0/CPU0:router# show mpls ldp vrf red nsr statistics neighbor 1.1.1.1	Displays LDP NSR statistics for the specified VRF for a given neighbor.
Step 7	(Optional) show mpls ldp [vrf vrf-name] nsr summary Example: RP/0/RP0/CPU0:router# show mpls ldp nsr summary RP/0/RP0/CPU0:router# show mpls ldp vrf red nsr summary	Displays MPLS LDP NSR summarized information. Displays LDP NSR summarized information for the specified VRF.
Step 8	(Optional) show mpls ldp [vrf vrf-name] nsr pending Example: RP/0/RP0/CPU0:router# show mpls ldp nsr pending	Displays MPLS LDP NSR pending information. Displays LDP NSR pending information for the specified VRF.

	Command or Action	Purpose
	<code>RP/0/RP0/CPU0:router# show mpls ldp vrf red nsr pending</code>	
Step 9	(Optional) show mpls ldp vrf <i>vrf-name</i> nsr pending neighbor Example: <code>RP/0/RP0/CPU0:router# show mpls ldp vrf red nsr pending neighbor 2.2.2.2</code>	Displays LDP NSR pending information for the specified VRF for a given neighbor.
Step 10	(Optional) show mpls ldp vrf all nsr summary Example: <code>RP/0/RP0/CPU0:router# show mpls ldp vrf all nsr summary</code>	Displays all LDP configured VRF (including default VRF) summarized information.
Step 11	(Optional) show mpls ldp nsr summary all Example: <code>RP/0/RP0/CPU0:router# show mpls ldp nsr summary all</code>	Displays aggregate summary across LDP processes and all VRFs.
Step 12	(Optional) clear mpls ldp vrf <i>vrf-name</i> nsr statistics neighbor Example: <code>RP/0/RP0/CPU0:router# clear mpls ldp vrf red nsr statistics neighbor</code>	Resets LDP NSR statistics for the specified VRF for neighbor.

Related Topics

[LDP Nonstop Routing](#), on page 15

Configuring LDP Downstream on Demand mode

SUMMARY STEPS

1. **configure**
2. **mpls ldp**
3. [**vrf *vrf-name* session**] **downstream-on-demand**
4. **commit**

DETAILED STEPS

	Command or Action	Purpose
Step 1	configure	

	Command or Action	Purpose
Step 2	mpls ldp Example: RP/0/RP0/CPU0:router(config)# mpls ldp	Enters MPLS LDP configuration mode.
Step 3	[vrf vrf-name session] downstream-on-demand Example: RP/0/RP0/CPU0:router(config-ldp)# vrf red session downstream-on-demand with ABC	(Optional) Enters downstream on demand label advertisement mode under the specified non-default VRF. Enters downstream on demand label advertisement mode. The ACL contains the list of peer IDs that are configured for downstream-on-demand mode. When the ACL is changed or configured, the list of established neighbor is traversed.
Step 4	commit	

Related Topics

[Downstream on Demand](#), on page 17

Setting Up Implicit-Null-Override Label

Perform this task to configure implicit-null label for non-egress prefixes.

SUMMARY STEPS

1. **configure**
2. **mpls ldp**
3. **[vrf vrf-name] address-family {ipv4 | ipv6 }**
4. **label**
5. **local implicit-null-override for access-list**
6. **commit**

DETAILED STEPS

	Command or Action	Purpose
Step 1	configure	
Step 2	mpls ldp Example: RP/0/RP0/CPU0:router(config)# mpls ldp	Enters MPLS LDP configuration mode.
Step 3	[vrf vrf-name] address-family {ipv4 ipv6 } Example: RP/0/RP0/CPU0:router(config-ldp)# address-family ipv4	(Optional) Specifies a non-default VRF. Enables the LDP IPv4 or IPv6 address family.

	Command or Action	Purpose
	or RP/0/RP0/CPU0:router(config-ldp)# address-family ipv6	
Step 4	label Example: RP/0/RP0/CPU0:router(config-ldp-af)# label	Configures the allocation, advertisement, and acceptance of labels.
Step 5	local implicit-null-override for access-list Example: RP/0/RP0/CPU0:router(config-ldp-af-lbl)# local implicit-null-override for 70	Configures implicit-null local label for non-egress prefixes. Note This feature works with any prefix including static, IGP, and BGP, when specified in the ACL.
Step 6	commit	

Redistributing MPLS LDP Routes into BGP

Perform this task to redistribute Border Gateway Protocol (BGP) autonomous system into an MPLS LDP.

SUMMARY STEPS

1. **configure**
2. **mpls ldp**
3. **redistribute bgp**
4. **end** or **commit**
5. **show run mpls ldp**

DETAILED STEPS

	Command or Action	Purpose
Step 1	configure Example: RP/0/RP0/CPU0:router# configure	Enters Global Configuration mode.
Step 2	mpls ldp Example: RP/0/RP0/CPU0:router(config)# mpls ldp	Enters MPLS LDP configuration mode.
Step 3	redistribute bgp Example:	Allows the redistribution of BGP routes into an MPLS LDP processes.

	Command or Action	Purpose
	<pre>RP/0/RP0/CPU0:router (config-ldp) # redistribute bgp advertise-to acl_1</pre>	<p>Note Autonomous system numbers (ASNs) are globally unique identifiers used to identify autonomous systems (ASs) and enable ASs to exchange exterior routing information between neighboring ASs. A unique ASN is allocated to each AS for use in BGP routing. ASNs are encoded as 2-byte numbers and 4-byte numbers in BGP.</p>
Step 4	end or commit	<ul style="list-style-type: none"> When you issue the end command, the system prompts you to commit changes: <pre>Uncommitted changes found, commit them before exiting (yes/no/cancel)? [cancel]:</pre> Entering yes saves configuration changes to the running configuration file, exits the configuration session, and returns the router to EXEC mode. Entering no exits the configuration session and returns the router to EXEC mode without committing the configuration changes. Entering cancel leaves the router in the current configuration session without exiting or committing the configuration changes. Use the commit command to save the configuration changes to the running configuration file and remain within the configuration session.
Step 5	<p>show run mpls ldp</p> <p>Example:</p> <pre>RP/0/RP0/CPU0:router# show run mpls ldp</pre>	Displays information about the redistributed route information.

Enabling MLDP

Perform this task to enable Multicast Label Distribution Protocol (MLDP) in MPLS LDP.

SUMMARY STEPS

1. **configure**
2. **mpls ldp**
3. **mldp**
4. **end** or **commit**

DETAILED STEPS

	Command or Action	Purpose
Step 1	configure	
Step 2	mpls ldp Example: RP/0/RP0/CPU0:router (config) # mpls ldp	Enters the MPLS LDP configuration mode.
Step 3	mldp Example: RP/0/RP0/CPU0:router (config-ldp) # mldp RP/0/RP0/CPU0:router (config-ldp-mldp) #	Enables MLDP.
Step 4	end or commit Example: RP/0/RP0/RP0/CPU0:router (config-ldp-mldp) # end or RP/0/RP0/RP0/CPU0:router (config-ldp-mldp) # commit	<ul style="list-style-type: none"> • When you issue the end command, the system prompts you to commit changes: Uncommitted changes found, commit them before exiting (yes/no/cancel)? [cancel]: • Entering yes saves configuration changes to the running configuration file, exits the configuration session, and returns the router to EXEC mode. • Entering no exits the configuration session and returns the router to EXEC mode without committing the configuration changes. • Entering cancel leaves the router in the current configuration session without exiting or committing the configuration changes. • Use the commit command to save the configuration changes to the running configuration file and remain within the configuration session.

Enabling MLDP Make-Before-Break

Perform this task to enable the make-before-break (MBB) feature in MPLS MLDP.

SUMMARY STEPS

1. **configure**
2. **mpls ldp**
3. **mldp**
4. **address-family ipv4**
5. **make-before-break** [delay *seconds*]

6. end or commit

DETAILED STEPS

	Command or Action	Purpose
Step 1	configure Example: RP/0/RP0/CPU0:router# configure	Enters Global Configuration mode.
Step 2	mpls ldp Example: RP/0/RP0/CPU0:router(config)# mpls ldp	Enters MPLS LDP configuration mode.
Step 3	mldp Example: RP/0/RP0/CPU0:router(config-ldp)# mldp	Enables MLDP.
Step 4	address-family ipv4 Example: RP/0/RP0/CPU0:router(config-ldp-mldp)# address-family ipv4	Enables MLDP for IPv4 address family.
Step 5	make-before-break [delay seconds] Example: RP/0/RP0/CPU0:router(config-ldp-mldp-af)# make-before-break delay 10	Enables the make-before-break feature. (Optional) Configures the MBB forwarding delay in seconds. Range is 0 to 600.
Step 6	end or commit Example: RP/0/RP0/RP0/CPU0:router (config-ldp-mldp-af)# end or RP/0/RP0/RP0/CPU0:router (config-ldp-mldp-af)# commit	<ul style="list-style-type: none"> When you issue the end command, the system prompts you to commit changes: Uncommitted changes found, commit them before exiting (yes/no/cancel)? [cancel]: Entering yes saves configuration changes to the running configuration file, exits the configuration session, and returns the router to EXEC mode. Entering no exits the configuration session and returns the router to EXEC mode without committing the configuration changes.

	Command or Action	Purpose
		<ul style="list-style-type: none"> • Entering cancel leaves the router in the current configuration session without exiting or committing the configuration changes. • Use the commit command to save the configuration changes to the running configuration file and remain within the configuration session.

Enabling MLDP MoFRR

Perform this task to enable multicast only fast reroute (MoFRR) support in MPLS MLDP.

SUMMARY STEPS

1. **configure**
2. **mpls ldp**
3. **mldp**
4. **address-family ipv4**
5. **mofrr**
6. **end** or **commit**

DETAILED STEPS

	Command or Action	Purpose
Step 1	configure Example: RP/0/RP0/CPU0:router# configure	Enters Global Configuration mode.
Step 2	mpls ldp Example: RP/0/RP0/CPU0:router(config)# mpls ldp	Enters MPLS LDP configuration mode.
Step 3	mldp Example: RP/0/RP0/CPU0:router(config-ldp)# mldp	Enables MLDP.
Step 4	address-family ipv4 Example: RP/0/RP0/CPU0:router(config-ldp-mldp)# address-family ipv4	Enables MLDP for IPv4 address family.

	Command or Action	Purpose
Step 5	mofrr Example: <pre>RP/0/RP0/CPU0:router(config-ldp-mldp-af)# mofrr</pre>	Enables MoFRR support.
Step 6	end or commit Example: <pre>RP/0/RP/0/RP0/CPU0:router (config-ldp-mldp-af)# end</pre> <p>OR</p> <pre>RP/0/RP/0/RP0/CPU0:router (config-ldp-mldp-af)# commit</pre>	<ul style="list-style-type: none"> When you issue the end command, the system prompts you to commit changes: <pre>Uncommitted changes found, commit them before exiting (yes/no/cancel)? [cancel]:</pre> Entering yes saves configuration changes to the running configuration file, exits the configuration session, and returns the router to EXEC mode. Entering no exits the configuration session and returns the router to EXEC mode without committing the configuration changes. Entering cancel leaves the router in the current configuration session without exiting or committing the configuration changes. Use the commit command to save the configuration changes to the running configuration file and remain within the configuration session.

Enabling MLDP Recursive FEC

Perform this task to enable recursive forwarding equivalence class (FEC) support in MPLS MLDP.

SUMMARY STEPS

1. **configure**
2. **mpls ldp**
3. **mldp**
4. **address-family ipv4**
5. **recursive-fec**
6. **end or commit**

DETAILED STEPS

	Command or Action	Purpose
Step 1	configure Example:	Enters Global Configuration mode.

	Command or Action	Purpose
	RP/0/RP0/CPU0:router# configure	
Step 2	mpls ldp Example: RP/0/RP0/CPU0:router(config)# mpls ldp	Enters MPLS LDP configuration mode.
Step 3	mldp Example: RP/0/RP0/CPU0:router(config-ldp)# mldp	Enables MLDP.
Step 4	address-family ipv4 Example: RP/0/RP0/CPU0:router(config-ldp-mldp)# address-family ipv4	Enables MLDP for IPv4 address family.
Step 5	recursive-fec Example: RP/0/RP0/CPU0:router(config-ldp-mldp-af)# recursive-fec	Enables recursive FEC support.
Step 6	end or commit Example: RP/0/RP0/RP0/CPU0:router (config-ldp-mldp-af)# end OR RP/0/RP0/RP0/CPU0:router (config-ldp-mldp-af)# commit	<ul style="list-style-type: none"> When you issue the end command, the system prompts you to commit changes: Uncommitted changes found, commit them before exiting (yes/no/cancel)? [cancel]: Entering yes saves configuration changes to the running configuration file, exits the configuration session, and returns the router to EXEC mode. Entering no exits the configuration session and returns the router to EXEC mode without committing the configuration changes. Entering cancel leaves the router in the current configuration session without exiting or committing the configuration changes. Use the commit command to save the configuration changes to the running configuration file and remain within the configuration session.

Enabling MLDP Static Multipoint to Multipoint LSP

Perform this task to enable static multipoint to multipoint (MP2MP) LSP support in MPLS MLDP.

SUMMARY STEPS

1. **configure**
2. **mpls ldp**
3. **mldp**
4. **address-family ipv4**
5. **static mp2mp ip-address**
6. **end** or **commit**

DETAILED STEPS

	Command or Action	Purpose
Step 1	configure Example: RP/0/RP0/CPU0:router# configure	Enters Global Configuration mode.
Step 2	mpls ldp Example: RP/0/RP0/CPU0:router(config)# mpls ldp	Enters MPLS LDP configuration mode.
Step 3	mldp Example: RP/0/RP0/CPU0:router(config-ldp)# mldp	Enables MLDP.
Step 4	address-family ipv4 Example: RP/0/RP0/CPU0:router(config-ldp-mldp)# address-family ipv4	Enables MLDP for IPv4 address family.
Step 5	static mp2mp ip-address Example: RP/0/RP0/CPU0:router(config-ldp-mldp-af)# static mp2mp 10.10.10.10 1	Enables static MP2MP LSP support and specifies MP2MP LSP root IP address followed by the number of LSPs in the range 1 to 1000.
Step 6	end or commit Example:	<ul style="list-style-type: none"> • When you issue the end command, the system prompts you to commit changes:

	Command or Action	Purpose
	<pre>RP/0/RP/0/RP0/CPU0:router (config-ldp-mldp-af) # end</pre> <p>or</p> <pre>RP/0/RP/0/RP0/CPU0:router (config-ldp-mldp-af) # commit</pre>	<p>Uncommitted changes found, commit them before exiting (yes/no/cancel)? [cancel]:</p> <ul style="list-style-type: none"> • Entering yes saves configuration changes to the running configuration file, exits the configuration session, and returns the router to EXEC mode. • Entering no exits the configuration session and returns the router to EXEC mode without committing the configuration changes. • Entering cancel leaves the router in the current configuration session without exiting or committing the configuration changes. • Use the commit command to save the configuration changes to the running configuration file and remain within the configuration session.

Enabling MLDP Static Point to Multipoint LSP

Perform this task to enable static point to multipoint (P2MP) LSP support in MPLS MLDP.

SUMMARY STEPS

1. **configure**
2. **mpls ldp**
3. **mldp**
4. **address-family ipv4**
5. **static p2mp** *ip-address*
6. **end** or **commit**

DETAILED STEPS

	Command or Action	Purpose
Step 1	<p>configure</p> <p>Example:</p> <pre>RP/0/RP0/CPU0:router# configure</pre>	Enters Global Configuration mode.
Step 2	<p>mpls ldp</p> <p>Example:</p> <pre>RP/0/RP0/CPU0:router (config) # mpls ldp</pre>	Enters MPLS LDP configuration mode.

	Command or Action	Purpose
Step 3	mldp Example: <pre>RP/0/RP0/CPU0:router(config-ldp)# mldp</pre>	Enables MLDP.
Step 4	address-family ipv4 Example: <pre>RP/0/RP0/CPU0:router(config-ldp-mldp)# address-family ipv4</pre>	Enables MLDP for IPv4 address family.
Step 5	static p2mp ip-address Example: <pre>RP/0/RP0/CPU0:router(config-ldp-mldp-af)# static p2mp 1.1.1.1 1</pre>	Enables static P2MP LSP support and specifies P2MP LSP root IP address followed by the number of LSPs in the range 1 to 1000.
Step 6	end or commit Example: <pre>RP/0/RP0/RP0/CPU0:router (config-ldp-mldp-af)# end</pre> <p>OR</p> <pre>RP/0/RP0/RP0/CPU0:router (config-ldp-mldp-af)# commit</pre>	<ul style="list-style-type: none"> When you issue the end command, the system prompts you to commit changes: <pre>Uncommitted changes found, commit them before exiting (yes/no/cancel)? [cancel]:</pre> Entering yes saves configuration changes to the running configuration file, exits the configuration session, and returns the router to EXEC mode. Entering no exits the configuration session and returns the router to EXEC mode without committing the configuration changes. Entering cancel leaves the router in the current configuration session without exiting or committing the configuration changes. Use the commit command to save the configuration changes to the running configuration file and remain within the configuration session.

Disabling MLDP

Perform this task to disable MLDP on Label Distribution Protocol (LDP) enabled interfaces.

SUMMARY STEPS

1. configure

2. `mpls ldp`
3. `interface type interface-path-id`
4. `address-family {ipv4 | ipv6 }`
5. `igp mldp disable`
6. `commit`

DETAILED STEPS

	Command or Action	Purpose
Step 1	configure Example: RP/0/RP0/CPU0:router# configure	Enters Global Configuration mode.
Step 2	mpls ldp Example: RP/0/RP0/CPU0:router(config)# mpls ldp	Enters MPLS LDP configuration mode.
Step 3	interface type interface-path-id Example: RP/0/RP0/CPU0:router(config-ldp)# interface POS 0/1/0/0	Enters interface configuration mode for the LDP protocol.
Step 4	address-family {ipv4 ipv6 } Example: RP/0/RP0/CPU0:router(config-ldp-if)# address-family ipv4 OR RP/0/RP0/CPU0:router(config-ldp-if)# address-family ipv6	Enables the LDP IPv4 or IPv6 address family.
Step 5	igp mldp disable Example: RP/0/RP0/CPU0:router(config-ldp-if-af)# igp mldp disable	Disables MLDP.
Step 6	commit	

LDP IPv6 Configuration

The LDP configuration model is extended to introduce IPv6 as an option under the address family submodes that reside under LDP global and interface configurations. Address family IPv6 is available as a submode under LDP global, LDP VRF global and interface configurations. LDP IPv6 is supported only under default VRF.

Enabling LDP IPv6 Native

Perform this task to enable LDP IPv6 native under LDP.

The user must enable IPv6 address family under LDP submodes.

SUMMARY STEPS

1. **configure**
2. **mpls ldp**
3. **address-family ipv6**
4. **end** or **commit**

DETAILED STEPS

	Command or Action	Purpose
Step 1	configure Example: RP/0/RP0/CPU0:router# configure	Enters global configuration mode.
Step 2	mpls ldp Example: RP/0/RP0/CPU0:router(config)# mpls ldp	Enters MPLS LDP configuration mode.
Step 3	address-family ipv6 Example: RP/0/RP0/CPU0:router(config-ldp)# address-family ipv6 RP/0/RP0/CPU0:router(config-ldp-af)#	Enables native LDP IPv6 address family.
Step 4	end or commit Example: RP/0/RP0/RP0/CPU0:router (config-ldp-af)# end or	<ul style="list-style-type: none"> • When you issue the end command, the system prompts you to commit changes: <pre>Uncommitted changes found, commit them before exiting (yes/no/cancel) ? [cancel]:</pre>

	Command or Action	Purpose
	RP/0/RP0/CPU0:router (config-ldp-af)# commit	<ul style="list-style-type: none"> • Entering yes saves configuration changes to the running configuration file, exits the configuration session, and returns the router to EXEC mode. • Entering no exits the configuration session and returns the router to EXEC mode without committing the configuration changes. • Entering cancel leaves the router in the current configuration session without exiting or committing the configuration changes. • Use the commit command to save the configuration changes to the running configuration file and remain within the configuration session.

Enabling LDP IPv6 Control Plane

Perform this task to enable LDP IPv6 control plane on an LDP interface.

SUMMARY STEPS

1. **configure**
2. **mpls ldp**
3. **interface** *type interface-path-id*
4. **address-family ipv6**
5. **end** or **commit**

DETAILED STEPS

	Command or Action	Purpose
Step 1	configure Example: RP/0/RP0/CPU0:router# configure	Enters global configuration mode.
Step 2	mpls ldp Example: RP/0/RP0/CPU0:router (config)# mpls ldp	Enters MPLS LDP configuration mode.
Step 3	interface <i>type interface-path-id</i> Example: RP/0/RP0/CPU0:router (config-ldp)# interface pos 0/6/0/0	Enters interface configuration mode for the LDP protocol.

	Command or Action	Purpose
Step 4	address-family ipv6 Example: <pre>RP/0/RP0/CPU0:router(config-ldp-if) # address-family ipv6</pre>	Enables LDP IPv6 control plane.
Step 5	end or commit Example: <pre>RP/0/RP0/RP0/CPU0:router (config-ldp-if-af) # end or RP/0/RP0/RP0/CPU0:router (config-ldp-if-af) # commit</pre>	<p>Note This configuration will be rejected if (mpls-ldp-af) for the given address family is not already enabled.</p> <ul style="list-style-type: none"> • When you issue the end command, the system prompts you to commit changes: <pre>Uncommitted changes found, commit them before exiting (yes/no/cancel)? [cancel]:</pre> • Entering yes saves configuration changes to the running configuration file, exits the configuration session, and returns the router to EXEC mode. • Entering no exits the configuration session and returns the router to EXEC mode without committing the configuration changes. • Entering cancel leaves the router in the current configuration session without exiting or committing the configuration changes. • Use the commit command to save the configuration changes to the running configuration file and remain within the configuration session.

Configuring IPv6-only LSR

Perform this task to configure IPv6-only LSR.

IPv4 is implicitly enabled under default VRF and any LDP interface under default VRF. In order to operate as an IPv6-only LSR, the user must also explicitly disable IPv4 address family.

SUMMARY STEPS

1. **configure**
2. **interface loopback** *number*
3. **ipv6 address** *prefix*
4. **exit**
5. **interface type** *interface-path-id*
6. **ipv6 address** *prefix*
7. **exit**

8. **router isis** *process-id*
9. **net** *network-entity-title*
10. **interface loopback** *number*
11. **address-family ipv6 unicast**
12. **exit**
13. **exit**
14. **interface type** *interface-path-id*
15. **address-family ipv6 unicast**
16. **exit**
17. **exit**
18. **mpls ldp**
19. **default-vrf implicit-ipv4 disable**
20. **router-id** *lsr id*
21. **address-family ipv6**
22. **exit**
23. **interface type** *interface-path-id*
24. **address-family ipv6**
25. **end** or **commit**

DETAILED STEPS

	Command or Action	Purpose
Step 1	configure Example: RP/0/RP0/CPU0:router# configure	Enters global configuration mode.
Step 2	interface loopback <i>number</i> Example: RP/0/RP0/CPU0:router(config)# interface Loopback 0	Enters interface configuration mode.
Step 3	ipv6 address <i>prefix</i> Example: RP/0/RP0/CPU0:router(config-if)# ipv6 address 6:6:6::6/128	Configures IPv6 address on interface.
Step 4	exit Example: RP/0/RP0/CPU0:router(config-if)# exit	Exits interface configuration mode and enters global configuration mode.

	Command or Action	Purpose
Step 5	interface <i>type interface-path-id</i> Example: RP/0/RP0/CPU0:router (config) # interface GigabitEthernet 0/0/0/0	Enters interface configuration mode for the LDP protocol.
Step 6	ipv6 address <i>prefix</i> Example: RP/0/RP0/CPU0:router (config-if) # ipv6 address 16:1::6/120	Configures IPv6 address on interface.
Step 7	exit Example: RP/0/RP0/CPU0:router (config-if) # exit	Exits interface configuration mode and enters global configuration mode.
Step 8	router isis <i>process-id</i> Example: RP/0/RP0/CPU0:router (config) # router isis 100	Enables IS-IS routing for the specified routing process.
Step 9	net <i>network-entity-title</i> Example: RP/0/RP0/CPU0:router (config-isis) # net 49.0000.0000.0000.0006.00	Configures the NET on the router. The NET identifies the router for IS-IS.
Step 10	interface loopback <i>number</i> Example: RP/0/RP0/CPU0:router (config-isis) # interface Loopback 0	Enters interface configuration mode.
Step 11	address-family ipv6 unicast Example: RP/0/RP0/CPU0:router (config-isis-if) # address-family ipv6 unicast	Enters the IS-IS interface IPv6 address family configuration submode. Specifies unicast topology.
Step 12	exit Example:	Exits address family configuration submode and enters interface configuration mode.

	Command or Action	Purpose
	<code>RP/0/RP0/CPU0:router(config-isis-if-af)# exit</code>	
Step 13	exit Example: <code>RP/0/RP0/CPU0:router(config-isis-if)# exit</code>	Exits interface configuration mode.
Step 14	interface <i>type interface-path-id</i> Example: <code>RP/0/RP0/CPU0:router(config-isis)# interface GigabitEthernet 0/0/0/0</code>	Enters interface configuration mode for the LDP protocol.
Step 15	address-family ipv6 unicast Example: <code>RP/0/RP0/CPU0:router(config-isis-if)# address-family ipv6 unicast</code>	Enters the IS-IS interface IPv6 address family configuration submode. Specifies unicast topology.
Step 16	exit Example: <code>RP/0/RP0/CPU0:router(config-isis-if-af)# exit</code>	Exits address family configuration submode and enters interface configuration mode.
Step 17	exit Example: <code>RP/0/RP0/CPU0:router(config-isis-if)# exit</code>	Exits interface configuration mode.
Step 18	mpls ldp Example: <code>RP/0/RP0/CPU0:router(config-isis)# mpls ldp</code>	Enters MPLS LDP configuration mode.
Step 19	default-vrf implicit-ipv4 disable Example: <code>RP/0/RP0/CPU0:router(config-ldp)# default-vrf implicit-ipv4 disable</code>	Disables the implicitly enabled IPv4 address family for default VRF.

	Command or Action	Purpose
Step 20	router-id <i>lsr id</i> Example: RP/0/RP0/CPU0:router (config-ldp) # router-id 5.5.5.5	Configures router ID.
Step 21	address-family ipv6 Example: RP/0/RP0/CPU0:router (config-ldp) # address-family ipv6	Enables native LDP IPv6 address family.
Step 22	exit Example: RP/0/RP0/CPU0:router (config-ldp-af) # exit	Exits the current configuration mode.
Step 23	interface <i>type interface-path-id</i> Example: RP/0/RP0/CPU0:router (config-ldp) # interface GigabitEthernet 0/0/0/0	Enters interface configuration mode for the LDP protocol.
Step 24	address-family ipv6 Example: RP/0/RP0/CPU0:router (config-ldp-if) # address-family ipv6	Enables LDP IPv6 control plane.
Step 25	end or commit Example: RP/0/RP0/RP0/CPU0:router (config-ldp-if-af) # end or RP/0/RP0/RP0/CPU0:router (config-ldp-if-af) # commit	<ul style="list-style-type: none"> When you issue the end command, the system prompts you to commit changes: Uncommitted changes found, commit them before exiting (yes/no/cancel)? [cancel]: <ul style="list-style-type: none"> Entering yes saves configuration changes to the running configuration file, exits the configuration session, and returns the router to EXEC mode. Entering no exits the configuration session and returns the router to EXEC mode without committing the configuration changes.

	Command or Action	Purpose
		<ul style="list-style-type: none"> • Entering cancel leaves the router in the current configuration session without exiting or committing the configuration changes. • Use the commit command to save the configuration changes to the running configuration file and remain within the configuration session.

Example

Configuring Global Transport Address for IPv6

Perform this task to configure global transport address for IPv6 address family.

SUMMARY STEPS

1. **configure**
2. **mpls ldp**
3. **address-family ipv6**
4. **discovery transport-address** *ip-address*
5. **end** or **commit**

DETAILED STEPS

	Command or Action	Purpose
Step 1	configure Example: RP/0/RP0/CPU0:router# configure	Enters Global Configuration mode.
Step 2	mpls ldp Example: RP/0/RP0/CPU0:router(config)# mpls ldp	Enters MPLS LDP configuration mode.
Step 3	address-family ipv6 Example: RP/0/RP0/CPU0:router(config-ldp)# address-family ipv6	Enables native LDP IPv6 address family.
Step 4	discovery transport-address <i>ip-address</i> Example:	Configures the global transport address for the specified IPv6 address.

	Command or Action	Purpose
	RP/0/RP0/CPU0:router(config-ldp-af)# discovery transport-address 5:6::78	
Step 5	<p>end or commit</p> <p>Example:</p> <pre>RP/0/RP/0/RP0/CPU0:router (config-ldp-af)# end</pre> <p>or</p> <pre>RP/0/RP/0/RP0/CPU0:router (config-ldp-af)# commit</pre>	<ul style="list-style-type: none"> When you issue the end command, the system prompts you to commit changes: <p>Uncommitted changes found, commit them before exiting (yes/no/cancel)? [cancel]:</p> Entering yes saves configuration changes to the running configuration file, exits the configuration session, and returns the router to EXEC mode. Entering no exits the configuration session and returns the router to EXEC mode without committing the configuration changes. Entering cancel leaves the router in the current configuration session without exiting or committing the configuration changes. Use the commit command to save the configuration changes to the running configuration file and remain within the configuration session.

Disabling Implicit IPv4

Perform this task to disable the implicitly enabled IPv4 address family for default VRF.

SUMMARY STEPS

1. **configure**
2. **mpls ldp**
3. **default-vrf implicit-ipv4 disable**
4. **end** or **commit**

DETAILED STEPS

	Command or Action	Purpose
Step 1	<p>configure</p> <p>Example:</p> <pre>RP/0/RP0/CPU0:router# configure</pre>	Enters global configuration mode.
Step 2	<p>mpls ldp</p> <p>Example:</p>	Enters MPLS LDP configuration mode.

	Command or Action	Purpose
	RP/0/RP0/CPU0:router(config)# mpls ldp	
Step 3	default-vrf implicit-ipv4 disable Example: RP/0/RP0/CPU0:router(config-ldp)# default-vrf implicit-ipv4 disable	Disables the implicitly enabled IPv4 address family for default VRF.
Step 4	end or commit Example: RP/0/RP0/RP0/CPU0:router (config-ldp)# end or RP/0/RP0/RP0/CPU0:router (config-ldp)# commit	<ul style="list-style-type: none"> • When you issue the end command, the system prompts you to commit changes: Uncommitted changes found, commit them before exiting (yes/no/cancel)? [cancel]: • Entering yes saves configuration changes to the running configuration file, exits the configuration session, and returns the router to EXEC mode. • Entering no exits the configuration session and returns the router to EXEC mode without committing the configuration changes. • Entering cancel leaves the router in the current configuration session without exiting or committing the configuration changes. • Use the commit command to save the configuration changes to the running configuration file and remain within the configuration session.

Configuring IPv4 as Transport Preference

Perform this task to configure IPv4 as the preferred transport (overriding the default setting of IPv6 as preferred transport) to establish connection for a set of dual-stack peers.

SUMMARY STEPS

1. **configure**
2. **mpls ldp**
3. **neighbor dual-stack transport-connection prefer ipv4 for-peers** *peer lsr-id*
4. **end or commit**

DETAILED STEPS

	Command or Action	Purpose
Step 1	configure Example: RP/0/RP0/CPU0:router# configure	Enters global configuration mode.
Step 2	mpls ldp Example: RP/0/RP0/CPU0:router(config)# mpls ldp	Enters MPLS LDP configuration mode.
Step 3	neighbor dual-stack transport-connection prefer ipv4 for-peers <i>peer lsr-id</i> Example: RP/0/RP0/CPU0:router(config-ldp)# neighbor dual-stack transport-connection prefer ipv4 for-peers 5.5.5.5	Configures IPv4 as the preferred transport connection for the specified peer.
Step 4	end or commit Example: RP/0/RP0/RP0/CPU0:router (config-ldp)# end or RP/0/RP0/RP0/CPU0:router (config-ldp)# commit	<ul style="list-style-type: none"> When you issue the end command, the system prompts you to commit changes: <pre>Uncommitted changes found, commit them before exiting (yes/no/cancel)? [cancel]:</pre> Entering yes saves configuration changes to the running configuration file, exits the configuration session, and returns the router to EXEC mode. Entering no exits the configuration session and returns the router to EXEC mode without committing the configuration changes. Entering cancel leaves the router in the current configuration session without exiting or committing the configuration changes. Use the commit command to save the configuration changes to the running configuration file and remain within the configuration session.

Configuring Transport Preference Maximum Wait Time

Perform this task to configure the maximum time (in seconds) the preferred address family connection must wait to establish transport connection before resorting to non-preferred address family.

SUMMARY STEPS

1. **configure**
2. **mpls ldp**
3. **neighbor dual-stack transport-connection max-wait *seconds***
4. **end** or **commit**

DETAILED STEPS

	Command or Action	Purpose
Step 1	configure Example: RP/0/RP0/CPU0:router# configure	Enters global configuration mode.
Step 2	mpls ldp Example: RP/0/RP0/CPU0:router (config)# mpls ldp	Enters MPLS LDP configuration mode.
Step 3	neighbor dual-stack transport-connection max-wait <i>seconds</i> Example: RP/0/RP0/CPU0:router (config-ldp)# neighbor dual-stack transport-connection max-wait 5	Configures the maximum wait time.
Step 4	end or commit Example: RP/0/RP0/RP0/CPU0:router (config-ldp)# end or RP/0/RP0/RP0/CPU0:router (config-ldp)# commit	<ul style="list-style-type: none"> • When you issue the end command, the system prompts you to commit changes: Uncommitted changes found, commit them before exiting (yes/no/cancel)? [cancel]: • Entering yes saves configuration changes to the running configuration file, exits the configuration session, and returns the router to EXEC mode. • Entering no exits the configuration session and returns the router to EXEC mode without committing the configuration changes. • Entering cancel leaves the router in the current configuration session without exiting or committing the configuration changes. • Use the commit command to save the configuration changes to the running configuration file and remain within the configuration session.

Configuration Examples for Implementing MPLS LDP

These configuration examples are provided to implement LDP:

Configuring LDP with Graceful Restart: Example

The example shows how to enable LDP with graceful restart on the POS interface 0/2/0/0.

```
mpls ldp
 graceful-restart
 interface pos0/2/0/0
 !
```

Configuring LDP Discovery: Example

The example shows how to configure LDP discovery parameters.

```
mpls ldp
 router-id 192.168.70.1
 discovery hello holdtime 15
 discovery hello interval 5
 !

show mpls ldp parameters
show mpls ldp discovery
```

Configuring LDP Link: Example

The example shows how to configure LDP link parameters.

```
mpls ldp
 interface pos 0/1/0/0
 !
 !

show mpls ldp discovery
```

Related Topics

[Configuring LDP Discovery Over a Link](#), on page 35

[LDP Control Plane](#), on page 5

Configuring LDP Discovery for Targeted Hellos: Example

The examples show how to configure LDP Discovery to accept targeted hello messages.

Active (tunnel head)

```
mpls ldp
router-id 192.168.70.1
interface tunnel-te 12001
!
!
```

Passive (tunnel tail)

```
mpls ldp
router-id 192.168.70.2
discovery targeted-hello accept
!
```

Related Topics

- [Configuring LDP Discovery for Active Targeted Hellos](#), on page 37
- [Configuring LDP Discovery for Passive Targeted Hellos](#), on page 39
- [LDP Control Plane](#), on page 5

Configuring Label Advertisement (Outbound Filtering): Example

The example shows how to configure LDP label advertisement control.

```
mpls ldp
address-family ipv4
label local advertise
disable
for pfx_acl_1 to peer_acl_1
for pfx_acl_2 to peer_acl_2
for pfx_acl_3
interface POS 0/1/0/0
interface POS 0/2/0/0
!
!

ipv4 access-list pfx_acl_1
10 permit ipv4 host 1.0.0.0 any
!
ipv4 access-list pfx_acl_2
10 permit ipv4 host 2.0.0.0 any
!
ipv4 access-list peer_acl_1
10 permit ipv4 host 1.1.1.1 any
20 permit ipv4 host 1.1.1.2 any
!
ipv4 access-list peer_acl_2
10 permit ipv4 host 2.2.2.2 any
!
!

show mpls ldp binding
```

Related Topics

- [Configuring Label Advertisement Control \(Outbound Filtering\)](#), on page 41

[Label Advertisement Control \(Outbound Filtering\)](#), on page 11

Configuring LDP Neighbors: Example

The example shows how to disable label advertisement.

```
mpls ldp
  address-family ipv4
    label local advertise
      disable
  !
!
```

Related Topics

[Setting Up LDP Neighbors](#), on page 42

Configuring LDP Forwarding: Example

The example shows how to configure LDP forwarding.

```
mpls ldp
  address-family ipv4
    label local advertise explicit-null
  !

show mpls ldp forwarding
show mpls forwarding
```

Related Topics

[Setting Up LDP Forwarding](#), on page 45

[LDP Forwarding](#), on page 6

Configuring LDP Nonstop Forwarding with Graceful Restart: Example

The example shows how to configure LDP nonstop forwarding with graceful restart.

```
mpls ldp
  log
  graceful-restart
  !
  graceful-restart
  graceful-restart forwarding state-holdtime 180
  graceful-restart reconnect-timeout 15
  interface pos0/1/0/0
  !

show mpls ldp graceful-restart
show mpls ldp neighbor gr
show mpls ldp forwarding
show mpls forwarding
```

Related Topics

- [Setting Up LDP NSF Using Graceful Restart](#), on page 49
- [LDP Graceful Restart](#), on page 8
- [Phases in Graceful Restart](#), on page 9
- [Recovery with Graceful-Restart](#), on page 10

Configuring Label Acceptance (Inbound Filtering): Example

The example shows how to configure inbound label filtering.

```

mpls ldp
 label
  accept
  for pfx_acl_2 from 192.168.2.2
  !
  !
  !

mpls ldp
 address-family ipv4
  label remote accept from 192.168.1.1:0 for pfx_acl_2
  !
  !
  !

```

Related Topics

- [Configuring Label Acceptance Control \(Inbound Filtering\)](#), on page 52
- [Label Acceptance Control \(Inbound Filtering\)](#), on page 12

Configuring Local Label Allocation Control: Example

The example shows how to configure local label allocation control.

```

mpls ldp
 address-family ipv4
  label local allocate for pfx_acl_1
  !
  !

```

Related Topics

- [Configuring Local Label Allocation Control](#), on page 53
- [Local Label Allocation Control](#), on page 12

Configuring LDP Session Protection: Example

The example shows how to configure session protection.

```

mpls ldp
 session protection for peer_acl_1 duration

```

```
60
!
```

Related Topics

[Configuring Session Protection](#), on page 54

[Session Protection](#), on page 12

Configuring LDP IGP Synchronization—OSPF: Example

The example shows how to configure LDP IGP synchronization for OSPF.

```
router ospf 100
mpls ldp sync
!
mpls ldp
  igp sync delay 30
!
```

Related Topics

[Configuring LDP IGP Synchronization: OSPF](#), on page 55

[IGP Synchronization](#), on page 13

Configuring LDP IGP Synchronization—ISIS: Example

The example shows how to configure LDP IGP synchronization.

```
router isis 100
  interface POS 0/2/0/0
  address-family ipv4 unicast
  mpls ldp sync
  !
  !
  !
mpls ldp
  igp sync delay 30
!
```

Related Topics

[Configuring LDP IGP Synchronization: ISIS](#), on page 58

[IGP Synchronization](#), on page 13

Configuring LDP Auto-Configuration: Example

The example shows how to configure the IGP auto-configuration feature globally for a specific OSPF interface ID.

```
router ospf 100
mpls ldp auto-config
area 0
  interface pos 1/1/1/1
```

The example shows how to configure the IGP auto-configuration feature on a given area for a given OSPF interface ID.

```
router ospf 100
  area 0
  mpls ldp auto-config
  interface pos 1/1/1/1
```

Related Topics

[Enabling LDP Auto-Configuration for a Specified OSPF Instance](#), on page 61

[Enabling LDP Auto-Configuration in an Area for a Specified OSPF Instance](#), on page 62

[Disabling LDP Auto-Configuration](#), on page 63

[IGP Auto-configuration](#), on page 14

Configure IP LDP Fast Reroute Loop Free Alternate: Examples

This example shows how to configure LFA FRR with default tie-break configuration:

```
router isis TEST
  net 49.0001.0000.0000.0001.00
  address-family ipv4 unicast
  metric-style wide

  interface GigabitEthernet0/6/0/13
  point-to-point
  address-family ipv4 unicast
  fast-reroute per-prefix
  # primary path GigabitEthernet0/6/0/13 will exclude the interface
  # GigabitEthernet0/6/0/33 in LFA backup path computation.
  fast-reroute per-prefix exclude interface GigabitEthernet0/6/0/33
!
  interface GigabitEthernet0/6/0/23
  point-to-point
  address-family ipv4 unicast
!
  interface GigabitEthernet0/6/0/24
  point-to-point
  address-family ipv4 unicast
!
  interface GigabitEthernet0/6/0/33
  point-to-point
  address-family ipv4 unicast
!
```

This example shows how to configure TE tunnel as LFA backup:

```
router isis TEST
  net 49.0001.0000.0000.0001.00
  address-family ipv4 unicast
  metric-style wide
```

```

interface GigabitEthernet0/6/0/13
  point-to-point
  address-family ipv4 unicast
  fast-reroute per-prefix
  # primary path GigabitEthernet0/6/0/13 will exclude the interface
  # GigabitEthernet0/6/0/33 in LFA backup path computation. TE tunnel 1001
  # is using the link GigabitEthernet0/6/0/33.
  fast-reroute per-prefix exclude interface GigabitEthernet0/6/0/33
  fast-reroute per-prefix lfa-candidate interface tunnel-te1001
!
interface GigabitEthernet0/6/0/33
  point-to-point
  address-family ipv4 unicast
!

```

This example shows how to configure LFA FRR with configurable tie-break configuration:

```

router isis TEST
  net 49.0001.0000.0000.0001.00
  address-family ipv4 unicast
  metric-style wide
  fast-reroute per-prefix tiebreaker ?
  downstream          Prefer backup path via downstream node
  lc-disjoint          Prefer line card disjoint backup path
  lowest-backup-metric Prefer backup path with lowest total metric
  node-protecting      Prefer node protecting backup path
  primary-path         Prefer backup path from ECMP set
  secondary-path       Prefer non-ECMP backup path

  fast-reroute per-prefix tiebreaker lc-disjoint index ?
  <1-255> Index
  fast-reroute per-prefix tiebreaker lc-disjoint index 10

```

Sample configuration:

```

router isis TEST
  net 49.0001.0000.0000.0001.00
  address-family ipv4 unicast
  metric-style wide
  fast-reroute per-prefix tiebreaker downstream index 60
  fast-reroute per-prefix tiebreaker lc-disjoint index 10
  fast-reroute per-prefix tiebreaker lowest-backup-metric index 40
  fast-reroute per-prefix tiebreaker node-protecting index 30
  fast-reroute per-prefix tiebreaker primary-path index 20
  fast-reroute per-prefix tiebreaker secondary-path index 50
!
interface GigabitEthernet0/6/0/13
  point-to-point
  address-family ipv4 unicast
  fast-reroute per-prefix
!
interface GigabitEthernet0/1/0/13
  point-to-point
  address-family ipv4 unicast
  fast-reroute per-prefix
!
interface GigabitEthernet0/3/0/0.1
  point-to-point
  address-family ipv4 unicast
!
interface GigabitEthernet0/3/0/0.2
  point-to-point
  address-family ipv4 unicast

```

Related Topics

[IP LDP Fast Reroute Loop Free Alternate](#), on page 15

Verify IP LDP Fast Reroute Loop Free Alternate: Example

The following examples show how to verify the IP LDP FRR LFA feature on the router.

The following example shows how to verify ISIS FRR output:

```
RP/0/RP0/CPU0:router#show isis fast-reroute summary
IS-IS 1 IPv4 Unicast FRR summary
```

	Critical Priority	High Priority	Medium Priority	Low Priority	Total
Prefixes reachable in L1					
All paths protected	0	0	4	1008	1012
Some paths protected	0	0	0	0	0
Unprotected	0	0	0	0	0
Protection coverage	0.00%	0.00%	100.00%	100.00%	100.00%
Prefixes reachable in L2					
All paths protected	0	0	1	0	1
Some paths protected	0	0	0	0	0
Unprotected	0	0	0	0	0
Protection coverage	0.00%	0.00%	100.00%	0.00%	100.00%

The following example shows how to verify the IGP route 211.1.1.1/24 in ISIS Fast Reroute output:

```
RP/0/RP0/CPU0:router#show isis fast-reroute 211.1.1.1/24
L1 211.1.1.1/24 [40/115]
  via 12.0.0.2, GigabitEthernet0/6/0/13, NORTH
  FRR backup via 14.0.2.2, GigabitEthernet0/6/0/0.3, SOUTH

RP/0/RP0/CPU0:router#show isis fast-reroute 211.1.1.1/24 detail
L1 211.1.1.1/24 [40/115] low priority
  via 12.0.0.2, GigabitEthernet0/6/0/13, NORTH
  FRR backup via 14.0.2.2, GigabitEthernet0/6/0/0.3, SOUTH
  P: No, TM: 130, LC: No, NP: Yes, D: Yes
  src srl.00-00, 173.1.1.2
  L2 adv [40] native, propagated
```

The following example shows how to verify the IGP route 211.1.1.1/24 in RIB output:

```
RP/0/RP0/CPU0:router#show route 211.1.1.1/24

Routing entry for 211.1.1.0/24
  Known via "isis 1", distance 115, metric 40, type level-1
  Installed Nov 27 10:22:20.311 for 1d08h
  Routing Descriptor Blocks
    12.0.0.2, from 173.1.1.2, via GigabitEthernet0/6/0/13, Protected
    Route metric is 40
    14.0.2.2, from 173.1.1.2, via GigabitEthernet0/6/0/0.3, Backup
    Route metric is 0
```

No advertising protos.

The following example shows how to verify the IGP route 211.1.1.1/24 in FIB output:

```
RP/0/RP0/CPU0:router#show cef 211.1.1.1/24
211.1.1.0/24, version 0, internal 0x40040001 (ptr 0x9d9e1a68) [1], 0x0 \
(0x9ce0ec40), 0x4500 (0x9e2c69e4)
Updated Nov 27 10:22:29.825
remote adjacency to GigabitEthernet0/6/0/13
Prefix Len 24, traffic index 0, precedence routine (0) \
via 12.0.0.2, GigabitEthernet0/6/0/13, 0 dependencies, weight 0, class 0, \
protected [flags 0x400]
  path-idx 0, bkup-idx 1 [0x9e5b71b4 0x0]
  next hop 12.0.0.2
    local label 16080      labels imposed {16082}
  via 14.0.2.2, GigabitEthernet0/6/0/0.3, 3 dependencies, weight 0, class 0, \
backup [flags 0x300]
  path-idx 1
  next hop 14.0.2.2
  remote adjacency
    local label 16080      labels imposed {16079}

RP/0/RP0/CPU0:router#show cef 211.1.1.1/24 detail
211.1.1.0/24, version 0, internal 0x40040001 (ptr 0x9d9e1a68) [1], 0x0 \
(0x9ce0ec40), 0x4500 (0x9e2c69e4)
Updated Nov 27 10:22:29.825
remote adjacency to GigabitEthernet0/6/0/13
Prefix Len 24, traffic index 0, precedence routine (0) \
gateway array (0x9cc622f0) reference count 1158, flags 0x28000d00, source lsd \
(2),
      [387 type 5 flags 0x101001 (0x9df32398) ext 0x0 (0x0)]
LW-LDI[type=5, refc=3, ptr=0x9ce0ec40, sh-ldi=0x9df32398]
via 12.0.0.2, GigabitEthernet0/6/0/13, 0 dependencies, weight 0, class 0, \
protected [flags 0x400]
  path-idx 0, bkup-idx 1 [0x9e5b71b4 0x0]
  next hop 12.0.0.2
    local label 16080      labels imposed {16082}
  via 14.0.2.2, GigabitEthernet0/6/0/0.3, 3 dependencies, weight 0, class 0, \
backup [flags 0x300]
  path-idx 1
  next hop 14.0.2.2
  remote adjacency
    local label 16080      labels imposed {16079}

Load distribution: 0 (refcount 387)

Hash OK Interface Address
0 Y GigabitEthernet0/6/0/13 remote
```

The following example shows how to verify the IGP route 211.1.1.1/24 in MPLS LDP output:

```
RP/0/RP0/CPU0:router#show mpls ldp forwarding 211.1.1.1/24
```

Prefix	Label In	Label Out	Outgoing Interface	Next Hop	GR Stale
211.1.1.0/24	16080	16082	Gi0/6/0/13	12.0.0.2	Y N

```
16079      Gi0/6/0/0.3  14.0.2.2 (!)      Y  N
```

```
RP/0/RP0/CPU0:router#show mpls ldp forwarding 211.1.1.1/24 detail
```

Prefix	Label In	Label Out	Outgoing Interface	Next Hop	GR Stale
211.1.1.0/24	16080	16082	Gi0/6/0/13	12.0.0.2	Y N
			[Protected; path-id 1 backup-path-id 33; peer 20.20.20.20:0]		
		16079	Gi0/6/0/0.3	14.0.2.2 (!)	Y N
			[Backup; path-id 33; peer 40.40.40.40:0]		
Routing update : Nov 27 10:22:19.560 (1d08h ago)					
Forwarding update: Nov 27 10:22:29.060 (1d08h ago)					

Related Topics

[IP LDP Fast Reroute Loop Free Alternate](#), on page 15

MPLS LDP CSC for Multiple VRFs Configuration: Examples

This figure shows a L3VPN LDP CSC topology that uses either BGP or LDP between PE and CE routers to distribute routes and MPLS labels.

L3VPN CSC VPN: LDP / BGP

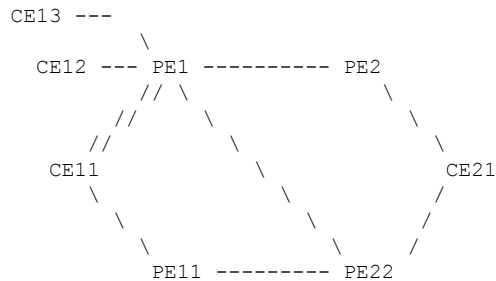

VRF red: CE11, CE21

VRF blue: CE12, CE13 (local only switching)

Multi-home CEs: CE11, CE21

LDP CSC: PE1/PE11 with CE1x

BGP CSC: PE2/PE22 with CE2x

CSC-CE11 Configuration

```
hostname cell1

interface Loopback0
  ipv4 address 11.11.11.11 255.255.255.255
!
interface POS0/2/0/0
  ipv4 address 192.168.1.11 255.255.255.0
```



```
!  
interface POS0/2/0/1  
  ipv4 address 192.168.2.11 255.255.255.0  
!  
interface POS0/2/0/2  
  ipv4 address 192.168.3.11 255.255.255.0  
!  
router ospf 100  
  log adjacency changes  
  router-id 11.11.11.11  
  area 0  
    interface Loopback0  
    !  
    interface POS0/2/0/0  
    !  
    interface POS0/2/0/1  
    !  
    interface POS0/2/0/2  
    !  
  !  
!  
mpls ldp  
  log  
  adjacency  
  neighbor  
!  
  router-id 11.11.11.11  
  address-family ipv4  
  !  
  interface POS0/2/0/0  
    address-family ipv4  
    !  
  !  
  interface POS0/2/0/1  
    address-family ipv4  
    !  
  !  
  interface POS0/2/0/2  
    address-family ipv4  
    !  
  !  
!  
no interface POS0/2/0/0 shut  
no interface POS0/2/0/1 shut  
no interface POS0/2/0/2 shut  
end
```

CSC-CE12 Configuration

```
hostname ce12  
  
interface Loopback0  
  ipv4 address 11.11.11.12 255.255.255.255  
!  
interface POS0/2/0/0  
  ipv4 address 192.169.1.12 255.255.255.0  
!  
router ospf 100  
  log adjacency changes  
  router-id 11.11.11.12  
  area 0  
    interface Loopback0
```

```

!
interface POS0/2/0/0
!
!
!
mpls ldp
log
adjacency
neighbor
!
router-id 11.11.11.12
address-family ipv4
!
interface POS0/2/0/0
address-family ipv4
!
!
!
no interface POS0/2/0/0 shut
end

```

CSC-CE13 Configuration

```

hostname ce13

interface Loopback0
ipv4 address 11.11.11.11 255.255.255.255
!
interface POS0/2/0/0
ipv4 address 192.170.1.12 255.255.255.0
!
router ospf 100
log adjacency changes
router-id 11.11.11.11
area 0
interface Loopback0
!
interface POS0/2/0/0
!
!
!
mpls ldp
log
adjacency
neighbor
!
router-id 11.11.11.11
address-family ipv4
!
interface POS0/2/0/0
address-family ipv4
!
!
!
no interface POS0/2/0/0 shut
end

```

CSC-CE21 Configuration

```
hostname ce21

interface Loopback0
  ipv4 address 21.21.21.21 255.255.255.255
  !
interface POS0/2/0/0
  ipv4 address 193.168.1.21 255.255.255.0
  !
interface POS0/2/0/1
  ipv4 address 193.169.1.21 255.255.255.0
  !
route-policy pass-all
  pass
end-policy
!
router static
  address-family ipv4 unicast
    193.168.1.2/32 POS0/2/0/0
    193.169.1.2/32 POS0/2/0/1
  !
  address-family ipv6 unicast
    1::1::1/128 POS0/2/0/0
  !
!
router bgp 2
  bgp router-id 21.21.21.21
  address-family ipv4 unicast
    redistribute connected
    allocate-label all
  !
  neighbor 193.168.1.2
    remote-as 100
    address-family ipv4 labeled-unicast
      route-policy pass-all in
      route-policy pass-all out
  !
!
  neighbor 193.169.1.22
    remote-as 100
    address-family ipv4 labeled-unicast
      route-policy pass-all in
      route-policy pass-all out
  !
!
no interface POS0/2/0/0 shut
no interface POS0/2/0/1 shut
end
```

CSC-PE1 Configuration

```
hostname pe1

vrf red
  address-family ipv4 unicast
    import route-target
      100:1
  !
  export route-target
    100:1
  !
!
```

```

!
vrf blue
  address-family ipv4 unicast
  !
!
interface Loopback0
  ipv4 address 1.1.1.1 255.255.255.255
  ipv6 address 1::1/128
!
interface Loopback1
  vrf red
  ipv4 address 1.1.1.1 255.255.255.255
!
interface Loopback2
  vrf blue
  ipv4 address 1.1.1.1 255.255.255.255
!
interface Loopback11
  ipv4 address 1.1.1.2 255.255.255.255
  ipv6 address 1::2/128
!
interface Loopback112
  vrf blue
  ipv4 address 1.1.1.112 255.255.255.255
!
interface POS0/2/0/0
  vrf red
  ipv4 address 192.168.1.1 255.255.255.0
!
interface POS0/2/0/1
  vrf red
  ipv4 address 192.168.2.1 255.255.255.0
!
interface POS0/2/0/2
  vrf blue
  ipv4 address 192.169.1.1 255.255.255.0
!
interface POS0/2/0/3
  vrf blue
  ipv4 address 192.170.1.1 255.255.255.0
!
interface POS0/2/0/4
  ipv4 address 12.1.0.1 255.255.255.0
  ipv6 address 12::1/120
!
interface POS0/2/0/5
  ipv4 address 122.1.0.1 255.255.255.0
!
router static
  address-family ipv6 unicast
    2::2::2/128 POS0/2/0/4
  !
!
router ospf 100
  log adjacency changes
  router-id 1.1.1.1
  area 0
    interface Loopback0
    !
    interface POS0/2/0/4
    !
    interface POS0/2/0/5
    !
  !
!

```

```
vrf red
  router-id 1.1.1.1
  redistribute bgp 100
  area 0
    interface Loopback1
    !
    interface POS0/2/0/0
    !
    interface POS0/2/0/1
    !
    !
  !
vrf blue
  router-id 1.1.1.1
  area 0
    interface Loopback2
    !
    interface POS0/2/0/2
    !
    interface POS0/2/0/3
    !
    !
  !
!
router bgp 100
  address-family ipv4 unicast
  !
  address-family vpnv4 unicast
  !
  neighbor 2.2.2.2
    remote-as 100
    update-source Loopback0
    address-family vpnv4 unicast
  !
  !
  neighbor 2.2.2.22
    remote-as 100
    update-source Loopback0
    address-family vpnv4 unicast
  !
  !
vrf red
  rd 1:1
  address-family ipv4 unicast
    maximum-paths eibgp 8
  redistribute ospf 100
  !
  !
!
mpls ldp
  log
  adjacency
  neighbor
  !
  nsr
  router-id 1.1.1.1
  address-family ipv4
    label
      local
        advertise
        explicit-null
    !
  !
  !
```

```

!
interface POS0/2/0/4
 address-family ipv4
!
!
interface POS0/2/0/5
 address-family ipv4
!
!
vrf red
 address-family ipv4
!
 interface POS0/2/0/0
  address-family ipv4
!
!
 interface POS0/2/0/1
  address-family ipv4
!
!
vrf blue
 router-id 1.1.1.2
 address-family ipv4
  discovery transport-address 1.1.1.1
  label
   local
    allocate for host-routes
!
!
!
 interface POS0/2/0/2
  address-family ipv4
!
!
 interface POS0/2/0/3
  address-family ipv4
!
!
!
no interface POS0/2/0/0 shut
no interface POS0/2/0/1 shut
no interface POS0/2/0/2 shut
no interface POS0/2/0/3 shut
no interface POS0/2/0/4 shut
no interface POS0/2/0/5 shut
end

```

CSC-PE2 Configuration

```

hostname pe2

vrf red
 address-family ipv4 unicast
  import route-target
   100:1
!
 export route-target
  100:1
!
!
```

```
!  
interface Loopback0  
  ipv4 address 2.2.2.2 255.255.255.255  
  ipv6 address 2:2:2::2/128  
!  
interface Loopback1  
  vrf red  
  ipv4 address 2.2.2.2 255.255.255.255  
!  
interface POS0/2/0/0  
  ipv4 address 12.1.0.2 255.255.255.0  
  ipv6 address 12:1::2/120  
!  
interface POS0/2/0/1  
  vrf red  
  ipv4 address 193.168.1.2 255.255.255.0  
!  
route-policy pass-all  
  pass  
end-policy  
!  
router static  
  address-family ipv6 unicast  
    1:1:1::1/128 POS0/2/0/0  
    1:1:1::2/128 POS0/2/0/0  
  !  
  vrf red  
    address-family ipv4 unicast  
      193.168.1.21/32 POS0/2/0/1  
  !  
!  
router ospf 100  
  log adjacency changes  
  router-id 2.2.2.2  
  area 0  
    interface Loopback0  
    !  
    interface POS0/2/0/0  
    !  
!  
router bgp 100  
  address-family ipv4 unicast  
  !  
  address-family vpnv4 unicast  
  !  
  neighbor 1.1.1.1  
    remote-as 100  
    update-source Loopback0  
    address-family vpnv4 unicast  
  !  
!  
vrf red  
  rd 1:1  
  address-family ipv4 unicast  
    allocate-label all  
  !  
  neighbor 193.168.1.21  
    remote-as 2  
    address-family ipv4 labeled-unicast  
    route-policy pass-all in  
    route-policy pass-all out  
  !
```

```

!
!
!
mpls ldp
log
  adjacency
  neighbor
!
router-id 2.2.2.2
address-family ipv4
  label
    local
      advertise
      explicit-null
    !
  !
!
!
interface POS0/2/0/0
  address-family ipv4
!
!
no interface POS0/2/0/0 shut
no interface POS0/2/0/1 shut
end

```

CSC-PE11 Configuration

```

hostname pe11

vrf red
  address-family ipv4 unicast
    import route-target
      100:1
    !
    export route-target
      100:1
    !
  !
!
interface Loopback0
  ipv4 address 1.1.1.11 255.255.255.255
!
interface Loopback1
  vrf red
  ipv4 address 1.1.1.11 255.255.255.255
!
interface POS0/2/0/0
  vrf red
  ipv4 address 192.168.3.1 255.255.255.0
!
interface POS0/2/0/1
  ipv4 address 112.1.0.1 255.255.255.0
!
router ospf 100
log adjacency changes
router-id 1.1.1.11
area 0
  interface Loopback0
  !
  interface POS0/2/0/1

```



```

!
!
vrf red
  router-id 1.1.1.11
  redistribute bgp 100
  area 0
    interface Loopback1
    !
    interface POS0/2/0/0
    !
  !
!
router bgp 100
  address-family ipv4 unicast
  !
  address-family vpnv4 unicast
  !
  neighbor 2.2.2.22
  remote-as 100
  update-source Loopback0
  address-family vpnv4 unicast
  !
!
vrf red
  rd 1:1
  address-family ipv4 unicast
  maximum-paths eibgp 8
  redistribute ospf 100
  !
!
mpls ldp
  log
  adjacency
  neighbor
  !
  router-id 1.1.1.11
  address-family ipv4
  !
  interface POS0/2/0/1
  address-family ipv4
  !
!
vrf red
  address-family ipv4
  !
  interface POS0/2/0/0
  address-family ipv4
  !
!
!
no interface POS0/2/0/0 shut
no interface POS0/2/0/1 shut
end

```

CSC-PE22 Configuration

```

hostname pe22

vrf red

```

```

address-family ipv4 unicast
import route-target
 100:1
!
export route-target
 100:1
!
!
!
interface Loopback0
ipv4 address 2.2.2.22 255.255.255.255
!
interface Loopback1
vrf red
ipv4 address 2.2.2.22 255.255.255.255
!
interface POS0/2/0/0
ipv4 address 122.1.0.22 255.255.255.0
!
interface POS0/2/0/1
vrf red
ipv4 address 193.169.1.22 255.255.255.0
!
interface POS0/2/0/2
ipv4 address 112.1.0.22 255.255.255.0
!
route-policy pass-all
pass
end-policy
!
router static
vrf red
address-family ipv4 unicast
 193.169.1.21/32 POS0/2/0/1
!
!
!
router ospf 100
log adjacency changes
router-id 2.2.2.22
area 0
interface Loopback0
!
interface POS0/2/0/0
!
interface POS0/2/0/2
!
!
!
router bgp 100
address-family ipv4 unicast
!
address-family vpnv4 unicast
!
neighbor 1.1.1.1
remote-as 100
update-source Loopback0
address-family vpnv4 unicast
!
!
neighbor 1.1.1.11
remote-as 100
update-source Loopback0
address-family vpnv4 unicast

```

```

!
!
vrf red
 rd 1:1
  address-family ipv4 unicast
   allocate-label all
  !
  neighbor 193.169.1.21
   remote-as 2
   address-family ipv4 labeled-unicast
    route-policy pass-all in
    route-policy pass-all out
  !
!
!
!
mpls ldp
 router-id 2.2.2.22
 address-family ipv4
 !
 interface POS0/2/0/0
  address-family ipv4
  !
 !
 interface POS0/2/0/2
  address-family ipv4
  !
 !
!
no interface POS0/2/0/0 shut
no interface POS0/2/0/1 shut
no interface POS0/2/0/2 shut
end

```

The following example shows the output for the **show running-config mpls ldp** command.

```
RP/0/RSP0/CPU0:router# show running-config mpls ldp
```

```

mpls ldp
 log
  adjacency
  neighbor
  nsr
  graceful-restart
  session-protection
 !
 nsr
 graceful-restart
 graceful-restart reconnect-timeout 60
 graceful-restart forwarding-state-holdtime 180
 igp sync delay on-proc-restart 300
 igp sync delay on-session-up 15
 discovery
  quick-start disable
  instance-tlv disable
  hello holdtime 30
  hello interval 10
  targeted-hello holdtime 180
  targeted-hello interval 20
 !
 session backoff 5 15
 session holdtime 300

```

```

signalling dscp 48
mldp
 logging notifications
 address-family ipv4
   static p2mp 1.1.1.1 1
   static mp2mp 10.10.10.10 1
   make-before-break delay 10
   mofrr
   recursive-fec
!
!
router-id 1.1.1.1
neighbor
 password encrypted 01100F17580454
 2.2.2.2:0 password disable
 3.3.3.3:0 password encrypted 02050D480809
!
session downstream-on-demand with peer_acl1
session protection for peer_acl2 duration 30
address-family ipv4
 discovery targeted-hello accept from peer_acl1
 neighbor 2.2.2.2 targeted
 traffic-eng
   auto-tunnel mesh
     group all
     group 10
     group 20
!
!
redistribute
 bgp
   as 100
   advertise-to peer_acl1
!
!
label
 local
 default-route
 implicit-null-override for pfx_acl1
 allocate for pfx_acl
 advertise
   disable
   for pfx_acl1 to peer_acl1
   for pfx_acl2 to peer_acl2
 interface GigabitEthernet0/0/0/0
   explicit-null for pfx_acl1 to peer_acl1
!
!
remote
 accept
   from 2.2.2.2:0 for pfx_acl2
   from 3.3.3.3:0 for pfx_acl3
!
!
!
interface GigabitEthernet0/0/0/0
 igp sync delay on-session-up disable
 discovery quick-start disable
 discovery hello holdtime 30
 discovery hello interval 10
 address-family ipv4
   igp auto-config disable
   discovery transport-address interface

```

```

    mldp disable
    !
    !
interface GigabitEthernet0/0/0/1
  igp sync delay on-session-up 10
  address-family ipv4
    discovery transport-address 1.1.1.1
  !
  !
interface GigabitEthernet0/0/0/2
  !
  !
!
```

LDP IPv6 Configuration: Examples

The following example shows how to enable LDP IPv6 native under LDP. The user must enable IPv6 address family under LDP submodes.

```

configure
  mpls ldp
    address-family ipv6
  !
  !
```

The following example shows how to enable LDP IPv6 control plane on an LDP interface:

```

configure
  mpls ldp
    interface pos 0/6/0/0
      address-family ipv6
    !
  !
```

The following examples shows how to configure IPv6-only LSR:



Note IPv4 is implicitly enabled under default VRF and any LDP interfaces under default VRF. In order to operate as an IPv6-only LSR, the user must also explicitly disable IPv4 address family.

Example 1:



Note In this example, there is no explicit IPv6 export address. The loopback's IPv6 address is used as the export address (6:6:6::6/128).

The router ID configured in MPLS LDP is not used in anyway for export. It is used only for LDP LSR identification.

```

configure
interface Loopback0
  ipv6 address 6:6:6::6/128
!
```

```

interface GigabitEthernet0/0/0/0
  ipv6 address 16:1::6/120
  !
router isis 100
  net 49.0000.0000.0000.0006.00
  interface Loopback0
    address-family ipv6 unicast
    !
  !
  interface GigabitEthernet0/0/0/0
    address-family ipv6 unicast
    !
  !
mpls ldp
  default-vrf implicit-ipv4 disable
  router-id 6.6.6.6
  address-family ipv6
  !
  interface GigabitEthernet0/0/0/0
    address-family ipv6
  !
  !

```

Example 2:

Note In this example, there is an explicit IPv6 export address. However, there is no IPv6 loopback. There is no router-id configured, but the loopback IPv4 address is used.

```

configure
interface Loopback0
  ipv4 address 6.6.6.6/32
  !
interface GigabitEthernet0/0/0/0
  ipv6 address 16:1::6/120
  !
router isis 100
  net 49.0000.0000.0000.0006.00
  interface Loopback0
    address-family ipv6 unicast
    !
  !
  interface GigabitEthernet0/0/0/0
    address-family ipv6 unicast
    !
  !
mpls ldp
  default-vrf implicit-ipv4 disable
  address-family ipv6
  discovery transport-address 6:6:6::6
  !
  interface GigabitEthernet0/0/0/0
    address-family ipv6
  !
  !

```

Additional References

For additional information related to Implementing MPLS Label Distribution Protocol, refer to the following references:

Related Documents

Related Topic	Document Title
LDP Commands	<i>MPLS Label Distribution Protocol Commands</i> module in <i>MPLS Command Reference for the Cisco CRS Router</i> .

Standards

Standards	Title
No new or modified standards are supported by this feature, and support for existing standards has not been modified by this feature.	—

MIBs

MIBs	MIBs Link
—	To locate and download MIBs using Cisco IOS XR software, use the Cisco MIB Locator found at the following URL and choose a platform under the Cisco Access Products menu: http://cisco.com/public/sw-center/netmgmt/cmtk/mibs.shtml

RFCs

RFCs	Title
Note Not all supported RFCs are listed.	
RFC 3031	<i>Multiprotocol Label Switching Architecture</i>
RFC 3036	<i>LDP Specification</i>
RFC 3037	<i>LDP Applicability</i>
RFC 3478	<i>Graceful Restart Mechanism for Label Distribution Protocol</i>
RFC 3815	<i>Definitions of Managed Objects for MPLS LDP</i>
RFC 5036	<i>Label Distribution and Management</i> <i>Downstream on Demand Label Advertisement</i>
RFC 5286	<i>Basic Specification for IP Fast Reroute: Loop-Free Alternates</i>

Technical Assistance

Description	Link
The Cisco Technical Support website contains thousands of pages of searchable technical content, including links to products, technologies, solutions, technical tips, and tools. Registered Cisco.com users can log in from this page to access even more content.	http://www.cisco.com/techsupport



CHAPTER 3

Implementing MPLS Static Labeling

The MPLS static feature enables you to statically assign local labels to an IPv4 prefix per VRF. Also, Label Switched Paths (LSPs) can be provisioned for these static labels by specifying the next-hop information that is required to forward the packets containing static label.

If there is any discrepancy between labels assigned statically and dynamically, the router issues a warning message in the console log. By means of this warning message, the discrepancy can be identified and resolved.

Static labels are more advantageous than dynamic labels because static labels:

- Improve security because the risk of receiving unwanted labels from peers (running a compromised MPLS dynamic labeling protocol) is reduced.
- Gives users full control over defined LSPs. Gives users full control over defined LSPs.
- Utilize system resources optimally because dynamic labeling is not processed.

To perform static binding of MPLS labels, you need to:

- [Enable MPLS Encapsulation on an Interface, on page 118](#)
- [Define a Range for Static MPLS Labels, on page 119](#)
- Allocate static label:
 - [Setup a Static LSP, on page 120](#)
 - or
 - [Allocate Static MPLS Label to an IP Prefix and Configure a LSP, on page 121](#)
 - [Allocate Static MPLS Label for a Specific VRF, on page 122](#)
- [Verify MPLS Static Bindings, on page 123](#)
- [Identify and Clear Label Discrepancy, on page 124](#)

Restrictions

- Static labeling on IPv6 packets is not supported.
- The router does not prevent label discrepancy at the time of configuring static labels. Any generated discrepancy needs to be subsequently cleared.
- Equal-cost multi-path routing (ECMP) is not supported.

- Interfaces must be explicitly configured to handle traffic with static MPLS labels.
- The MPLS per-VRF labels cannot be shared between MPLS static and other applications.

Feature History for Implementing MPLS Static Labeling

Release	Modification
Release 5.1.1	This feature was introduced.

- [Enable MPLS Encapsulation on an Interface, on page 118](#)
- [Define a Range for Static MPLS Labels, on page 119](#)
- [Setup a Static LSP, on page 120](#)
- [Allocate Static MPLS Label to an IP Prefix and Configure a LSP, on page 121](#)
- [Allocate Static MPLS Label for a Specific VRF, on page 122](#)
- [Verify MPLS Static Bindings, on page 123](#)
- [Identify and Clear Label Discrepancy, on page 124](#)

Enable MPLS Encapsulation on an Interface

By default, MPLS encapsulation is disabled on all interfaces. MPLS encapsulation has to be explicitly enabled on all ingress and egress MPLS interfaces through which the static MPLS labeled traffic travels.

SUMMARY STEPS

1. **configure**
2. **mpls static**
3. **interface** *interface*
4. **commit**

DETAILED STEPS

Step 1 **configure**

Step 2 **mpls static**

Example:

```
RP/0/RP0/CPU0:router(config)# mpls static
```

Enters MPLS-static configuration mode.

Step 3 **interface** *interface*

Example:

```
RP/0/RP0/CPU0:router(config-mpls-static)# interface gigabitethernet 0/0/0/3
```

Enables MPLS encapsulation on the specified interface.

Step 4 **commit****What to do next**

To verify the interfaces on which MPLS is enabled, use the **show mpls interfaces** command from the EXEC mode. For example:

```
RP/0/RP0/CPU0:router# show mpls interfaces
Mon May 12 06:21:30.937 DST
Interface                LDP          Tunnel      Static      Enabled
-----
GigabitEthernet0/0/0/3  No           No          Yes         Yes
```

For the interface on which MPLS static is enabled, the "Static" column displays "Yes".

Define a Range for Static MPLS Labels

The MPLS label range configuration defines the dynamic label range. Any label that falls outside this dynamic range is available for manually allocating as static labels. The router does not verify statically-configured labels against the specified label range. Therefore, to prevent label discrepancy, ensure that you do not configure static MPLS labels that fall within the dynamic label range.



Note The allocable range for MPLS labels is from 16 to 1048575. Label values from 0 to 15 are reserved according to [RFC-3032](#).

SUMMARY STEPS

1. **configure**
2. **mpls label range** *minimum_value maximum_value*
3. **commit**

DETAILED STEPS

Step 1 **configure**

Step 2 **mpls label range** *minimum_value maximum_value*

Example:

```
RP/0/RP0/CPU0:router(config)# mpls label range 20000 30000
```

Specifies the range through which dynamic MPLS labels are allocated. All labels falling outside this range (16 to 19999 and 30001 to 1048575) can be manually allocated as static labels.

Step 3 **commit**

Setup a Static LSP

In this task, a static MPLS LSP is setup for a specific ingress label.

SUMMARY STEPS

1. **configure**
2. **mpls static**
3. **address-family ipv4 unicast**
4. **local-label *label-value* allocate**
5. **forward path *path_id* nexthop *nexthop_address* interface_type *interface_id* out-label *outgoing_label***
6. **commit**

DETAILED STEPS

Step 1 **configure**

Step 2 **mpls static**

Example:

```
RP/0/RP0/CPU0:router(config)# mpls static
```

Enters MPLS-static configuration mode.

Step 3 **address-family ipv4 unicast**

Example:

```
RP/0/RP0/CPU0:router(config-mpls-static)# address-family ipv4 unicast
```

Applies the static configuration to an IPv4 address family in the default VRF.

Step 4 **local-label *label-value* allocate**

Example:

```
RP/0/RP0/CPU0:router(config-mpls-static-af)# local-label 30500 allocate
```

Specifies the incoming label value as 30500.

Step 5 **forward path *path_id* nexthop *nexthop_address* interface_type *interface_id* out-label *outgoing_label***

Example:

```
RP/0/RP0/CPU0:router(config-mpls-static-af-lbl)# forward path 1 nexthop 10.2.2.2 gigabitEthernet
0/0/0/1 out-label 30501
```

For packets that are received with the label, 30500, the MPLS protocol swaps labels and applies the label, 30501. After applying the new label, it forwards the packets to the next hop, 10.2.2.2, through the GigabitEthernet interface, 0/0/0/1.

Step 6 **commit**

Allocate Static MPLS Label to an IP Prefix and Configure a LSP

Static MPLS label bindings for IP prefixes are used by MPLS applications such as Label Distribution Protocol (LDP) or Border Gateway Protocol (BGP) for MPLS switching. It is possible to define a static LSP for the static label.

SUMMARY STEPS

1. **configure**
2. **mpls static**
3. **address-family ipv4 unicast**
4. **local-label *label-value* allocate per-prefix *IPv4_prefix_entry***
5. **forward path *path_id* nexthop *nexthop_address* out-label *outgoing_label***
6. **commit**

DETAILED STEPS

Step 1 **configure**

Step 2 **mpls static**

Example:

```
RP/0/RP0/CPU0:router(config)# mpls static
```

Enters MPLS-static configuration mode.

Step 3 **address-family ipv4 unicast**

Example:

```
RP/0/RP0/CPU0:router(config-mpls-static)# address-family ipv4 unicast
```

Applies the static configuration to an IPv4 address family in the default VRF.

Step 4 **local-label *label-value* allocate per-prefix *IPv4_prefix_entry***

Example:

```
RP/0/RP0/CPU0:router(config-mpls-static-af)# local-label 30500 allocate per-prefix 100.1.1.0/24
```

The MPLS protocol requests label 30500 to be statically bound as a local label for the prefix 100.1.1.0/24.

Step 5 **forward path *path_id* nexthop *nexthop_address* out-label *outgoing_label***

Example:

```
RP/0/RP0/CPU0:router(config-mpls-static-af-lbl)# forward path 1 nexthop 10.2.2.2 out-label 30501
```

For packets that are received with the label, 30500, the MPLS protocol swaps labels and applies the label, 30501. After applying the new label, it forwards the packets to the next hop, 10.2.2.2.

Example:

```
RP/0/RP0/CPU0:router(config-mpls-static-af-lbl)# forward path 1 nexthop gigabitEthernet 0/0/0/4 out-label pop
```

For packets that are received with the label, 30500, the MPLS protocol removes the existing label. After removing the label, it forwards the packets to the next hop through the egress interface, GigabitEthernet 0/0/0/4.

Step 6 **commit**

Allocate Static MPLS Label for a Specific VRF

In this task, a static MPLS label is allocated to an IP prefix for a specific VRF.



Note When a static MPLS label is allocated to an IP prefix for a specific VRF, it is not possible to define a static LSP for that static label.

SUMMARY STEPS

1. **configure**
2. **mpls static**
3. **vrf** *vrf_name* **address-family ipv4 unicast**
4. • **local-label** *label-value* **allocate per-prefix** *IPv4_prefix_entry*
 • **local-label** *label-value* **allocate per-vrf** forward **path** *path-id* **pop-and-lookup**
5. **commit**

DETAILED STEPS

Step 1 **configure**

Step 2 **mpls static**

Example:

```
RP/0/RP0/CPU0:router(config)# mpls static
```

Enters MPLS-static configuration mode.

Step 3 **vrf** *vrf_name* **address-family ipv4 unicast**

Example:

```
RP/0/RP0/CPU0:router(config-mpls-static)# vrf vrf1 address-family ipv4 unicast
```

Applies the static configuration to an IPv4 address family in the VRF named *vrf1*.

Step 4 • **local-label** *label-value* **allocate per-prefix** *IPv4_prefix_entry*
 • **local-label** *label-value* **allocate per-vrf** forward **path** *path-id* **pop-and-lookup**

Example:

```
RP/0/RP0/CPU0:router(config-mpls-static-vrf-af)# local-label 30500 allocate per-prefix 100.1.1.0/24
```

The MPLS protocol requests label 30500 to be statically bound as a local label for the prefix 100.1.1.0/24 in the VRF named *vrf1*.

Example:

```
RP/0/RP0/CPU0:router(config-mpls-static-vrf-af)# local-label 30500 allocate per-vrf forward path 1 pop-and-lookup
```

The MPLS protocol requests single label 30500 to be statically bound as a local label for all the prefixes in the VRF named *vrf1*. When the router receives packets with VRF label 30500, it removes the label and then performs IP-based lookup to forward the packets.

Step 5 **commit**

Verify MPLS Static Bindings

These are the show commands that can be used to verify MPLS static bindings and LSPs.

SUMMARY STEPS

1. **show mpls static local-label *label_value***
2. **show mpls label range**
3. **show mpls lsd forwarding**

DETAILED STEPS

Step 1 **show mpls static local-label *label_value***

Example:

```
RP/0/RP0/CPU0:router#show mpls static local-label 200
Tue Apr 22 18:21:55.764 UTC
Label   VRF           Type           Prefix           RW Configured   Status
-----
200     default       Per-Prefix     10.10.10.10/32   Yes              Created
```

Verifies that the status is "Created" for the specified label value.

Step 2 **show mpls label range**

Example:

```
RP/0/RP0/CPU0:router#show mpls label range
Mon Apr 28 19:56:00.596 IST
Range for dynamic labels: Min/Max: 16000/1048575
```

Checks the dynamic range and ensures that the specified local-label value is outside this range.

Step 3 **show mpls lsd forwarding**

Example:

```
RP/0/RP0/CPU0:router#show mpls lsd forwarding
Tue Apr 29 15:59:52.011 UTC
In_Label, (ID), Path_Info: <Type>
89, (IPv4, 'default':4U, 5.6.78.55/32), 1 Paths
  1/1: IPv4, 'default':4U, Gi0/0/0/21, nh=0.0.0.0, lbl=89, tun_id=0, flags=0x0 ()
110, (IPv4, 'default':4U, 2.2.2.2/32), 1 Paths
  1/1: IPv4, 'default':4U, Gi0/1/0/0, nh=1.12.1.2, lbl=Pop, tun_id=0, flags=0x0 ()
120, (IPv4, 'default':4U, 3.3.3.3/32), 1 Paths
  1/1: IPv4, 'default':4U, Gi0/1/0/0, nh=1.12.1.2, lbl=0, tun_id=0, flags=0x0 ()
130, (IPv4, 'default':4U, 4.4.4.4/32), 1 Paths
  1/1: IPv4, 'default':4U, Gi0/1/0/0, nh=1.12.1.2, lbl=200, tun_id=0, flags=0x0 ()
```

Verifies that the MPLS static configuration has taken effect, and the label forwarding is taking place.

Identify and Clear Label Discrepancy

During configuring or de-configuring static labels or a label range, a label discrepancy can get generated when:

- A static label is configured for an IP prefix (per VRF) that already has a binding with a dynamic label.
- A static label is configured for an IP prefix, when the same label value is dynamically allocated to another IP prefix.

Complete these steps to identify and clear the discrepancies.

Step 1 To identify a label discrepancy, execute one of these:

- **show mpls static local-label discrepancy**
- **show log**

Example:

```
RP/0/RP0/CPU0:router#show mpls static local-label discrepancy
Tue Apr 22 18:36:31.614 UTC
Label  VRF          Type          Prefix          RW Configured  Status
-----
16003  default       Per-Prefix    1.1.1.1/32      No              Discrepancy
```

Example:

```
RP/0/RP0/CPU0:router#show log
Thu Apr 24 14:18:57.655 UTC
Syslog logging: enabled (0 messages dropped, 0 flushes, 0 overruns)
  Console logging: level warnings, 199 messages logged
  Monitor logging: level debugging, 0 messages logged
  Trap logging: level informational, 0 messages logged
  Buffer logging: level debugging, 2 messages logged

Log Buffer (307200 bytes):

RP/0/RSP0/CPU0:Apr 24 14:18:53.743 : mpls_static[1043]:
%ROUTING-MPLS_STATIC-7-ERR_STATIC_LABEL_DISCREPANCY :
The system detected 1 label discrepancies (static label could not be allocated due to conflict with
other applications).
Please use 'clear mpls static local-label discrepancy' to fix this issue.
RP/0/RSP0/CPU0:Apr 24 14:18:53.937 : config[65762]: %MGBL-CONFIG-6-DB_COMMIT : Configuration committed
by user 'cisco'.
Use 'show configuration commit changes 1000000020' to view the changes.
```

Step 2 **clear mpls static local-label discrepancy all**

Example:

```
RP/0/RP0/CPU0:router# clear mpls static local-label discrepancy all
```

Clears label discrepancy by allocating a new label to those IP prefixes that are allocated dynamic label. The static label configuration takes precedence while clearing discrepancy. Traffic can be affected while clearing discrepancy.



CHAPTER 4

Implementing RSVP for MPLS-TE and MPLS O-UNI

The Multiprotocol Label Switching (MPLS) is a standards-based solution, driven by the Internet Engineering Task Force (IETF), devised to convert the Internet and IP backbones from best-effort networks into business-class transport media.

Resource Reservation Protocol (RSVP) is a signaling protocol that enables systems to request resource reservations from the network. RSVP processes protocol messages from other systems, processes resource requests from local clients, and generates protocol messages. As a result, resources are reserved for data flows on behalf of local and remote clients. RSVP creates, maintains, and deletes these resource reservations.

RSVP provides a secure method to control quality-of-service (QoS) access to a network.

MPLS Traffic Engineering (MPLS-TE) and MPLS Optical User Network Interface (MPLS O-UNI) use RSVP to signal label switched paths (LSPs).

Feature History for Implementing RSVP for MPLS-TE and MPLS O-UNI

Release	Modification
Release 2.0	This feature was introduced.
Release 3.0	No modification.
Release 3.2	Support was added for ACL-based prefix filtering.
Release 3.3.0	No modification.
Release 3.4.0	No modification.
Release 3.4.1	Support was added for RSVP authentication.
Release 3.5.0	No modification.
Release 3.6.0	No modification.
Release 3.7.0	No modification.
Release 3.8.0	No modification.
Release 3.9.0	The RSVP MIB feature was added.

- [Prerequisites for Implementing RSVP for MPLS-TE and MPLS O-UNI](#) , on page 128
- [Information About Implementing RSVP for MPLS-TE and MPLS O-UNI](#) , on page 128
- [Information About Implementing RSVP Authentication](#), on page 133
- [How to Implement RSVP](#), on page 137
- [How to Implement RSVP Authentication](#), on page 146
- [Configuration Examples for RSVP](#), on page 155
- [Configuration Examples for RSVP Authentication](#), on page 159
- [Additional References](#), on page 161

Prerequisites for Implementing RSVP for MPLS-TE and MPLS O-UNI

These prerequisites are required to implement RSVP for MPLS-TE and MPLS O-UNI:

- You must be in a user group associated with a task group that includes the proper task IDs. The command reference guides include the task IDs required for each command. If you suspect user group assignment is preventing you from using a command, contact your AAA administrator for assistance.
- Either a composite mini-image plus an MPLS package, or a full image, must be installed.

Information About Implementing RSVP for MPLS-TE and MPLS O-UNI

To implement MPLS RSVP, you must understand the these concepts:

Related Topics

[How to Implement RSVP Authentication](#), on page 146

Overview of RSVP for MPLS-TE and MPLS O-UNI

RSVP is a network control protocol that enables Internet applications to signal LSPs for MPLS-TE, and LSPs for O-UNI. The RSVP implementation is compliant with the IETF RFC 2205, RFC 3209, and OIF2000.125.7.

When configuring an O-UNI LSP, the RSVP session is bidirectional. The exchange of data between a pair of machines actually constitutes a single RSVP session. The RSVP session is established using an Out-Of-Band (OOB) IP Control Channel (IPCC) with the neighbor. The RSVP messages are transported over an interface other than the data interface.

RSVP supports extensions according to OIF2000.125.7 requirements, including:

- Generalized Label Request
- Generalized UNI Attribute
- UNI Session
- New Error Spec sub-codes

RSVP is automatically enabled on interfaces on which MPLS-TE is configured. For MPLS-TE LSPs with nonzero bandwidth, the RSVP bandwidth has to be configured on the interfaces. There is no need to configure RSVP, if all MPLS-TE LSPs have zero bandwidth. For O-UNI, there is no need for any RSVP configuration.

RSVP Refresh Reduction, defined in RFC 2961, includes support for reliable messages and summary refresh messages. Reliable messages are retransmitted rapidly if the message is lost. Because each summary refresh message contains information to refresh multiple states, this greatly reduces the amount of messaging needed to refresh states. For refresh reduction to be used between two routers, it must be enabled on both routers. Refresh Reduction is enabled by default.

Message rate limiting for RSVP allows you to set a maximum threshold on the rate at which RSVP messages are sent on an interface. Message rate limiting is disabled by default.

The process that implements RSVP is restartable. A software upgrade, process placement or process failure of RSVP or any of its collaborators, has been designed to ensure Nonstop Forwarding (NSF) of the data plane.

RSVP supports graceful restart, which is compliant with RFC 3473. It follows the procedures that apply when the node reestablishes communication with the neighbor's control plane within a configured restart time.

It is important to note that RSVP is not a routing protocol. RSVP works in conjunction with routing protocols and installs the equivalent of dynamic access lists along the routes that routing protocols calculate. Because of this, implementing RSVP in an existing network does not require migration to a new routing protocol.

Related Topics

- [Configuring RSVP Packet Dropping](#), on page 141
- [Set DSCP for RSVP Packets: Example](#), on page 158
- [Verifying RSVP Configuration](#), on page 142

LSP Setup

LSP setup is initiated when the LSP head node sends path messages to the tail node (see the RSVP Operation figure).

Figure 9: RSVP Operation

This figure illustrates an LSP setup for non-O-UNI applications. In the case of an O-UNI application, the RSVP signaling messages are exchanged on a control channel, and the corresponding data channel to be used is acquired from the LMP Manager module based on the control channel. Also the O-UNI LSP's are by default bidirectional while the MPLS-TE LSP's are uni-directional.

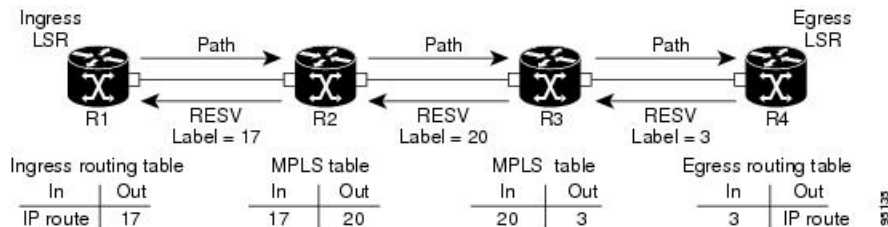

The Path messages reserve resources along the path to each node, creating Path soft states on each node. When the tail node receives a path message, it sends a reservation (RESV) message with a label back to the previous node. When the reservation message arrives at the previous node, it causes the reserved resources to be locked and forwarding entries are programmed with the MPLS label sent from the tail-end node. A new MPLS label is allocated and sent to the next node upstream.

When the reservation message reaches the head node, the label is programmed and the MPLS data starts to flow along the path.

High Availability

RSVP is designed to ensure nonstop forwarding under the following constraints:

- Ability to tolerate the failure of one or more MPLS/O-UNI processes.
- Ability to tolerate the failure of one RP of a 1:1 redundant pair.
- Hitless software upgrade.

The RSVP high availability (HA) design follows the constraints of the underlying architecture where processes can fail without affecting the operation of other processes. A process failure of RSVP or any of its collaborators does not cause any traffic loss or cause established LSPs to go down. When RSVP restarts, it recovers its signaling states from its neighbors. No special configuration or manual intervention are required. You may configure RSVP graceful restart, which offers a standard mechanism to recover RSVP state information from neighbors after a failure.

Graceful Restart

RSVP graceful restart provides a control plane mechanism to ensure high availability (HA), which allows detection and recovery from failure conditions while preserving nonstop forwarding services on the systems running Cisco IOS XR software.

RSVP graceful restart provides a mechanism that minimizes the negative effects on MPLS traffic caused by these types of faults:

- Disruption of communication channels between two nodes when the communication channels are separate from the data channels. This is called *control channel failure*.
- Control plane of a node fails but the node preserves its data forwarding states. This is called *node failure*.

The procedure for RSVP graceful restart is described in the “Fault Handling” section of RFC 3473, *Generalized MPLS Signaling, RSVP-TE Extensions*. One of the main advantages of using RSVP graceful restart is recovery of the control plane while preserving nonstop forwarding and existing labels.



Note

RSVP graceful restart feature is not supported when TE is running over multiple IGP instances which have different TE router-ids. This causes the TE tunnels to constantly flap.

Graceful Restart: Standard and Interface-Based

When you configure RSVP graceful restart, Cisco IOS XR software sends and expects node-id address based Hello messages (that is, Hello Request and Hello Ack messages). The RSVP graceful restart Hello session is not established if the neighbor router does not respond with a node-id based Hello Ack message.

You can also configure graceful restart to respond (send Hello Ack messages) to interface-address based Hello messages sent from a neighbor router in order to establish a graceful restart Hello session on the neighbor router. If the neighbor router does not respond with node-id based Hello Ack message, however, the RSVP graceful restart Hello session is not established.

Cisco IOS XR software provides two commands to configure graceful restart:

- **signalling hello graceful-restart**
- **signalling hello graceful-restart interface-based**



Note By default, graceful restart is disabled. To enable interface-based graceful restart, you must first enable standard graceful restart. You cannot enable interface-based graceful restart independently.

Related Topics

- [Enabling Graceful Restart](#), on page 139
- [Enable Graceful Restart: Example](#), on page 157
- [Enable Interface-Based Graceful Restart: Example](#), on page 157

Graceful Restart: Figure

Figure 10: Node Failure with RSVP

This figure illustrates how RSVP graceful restart handles a node failure condition.

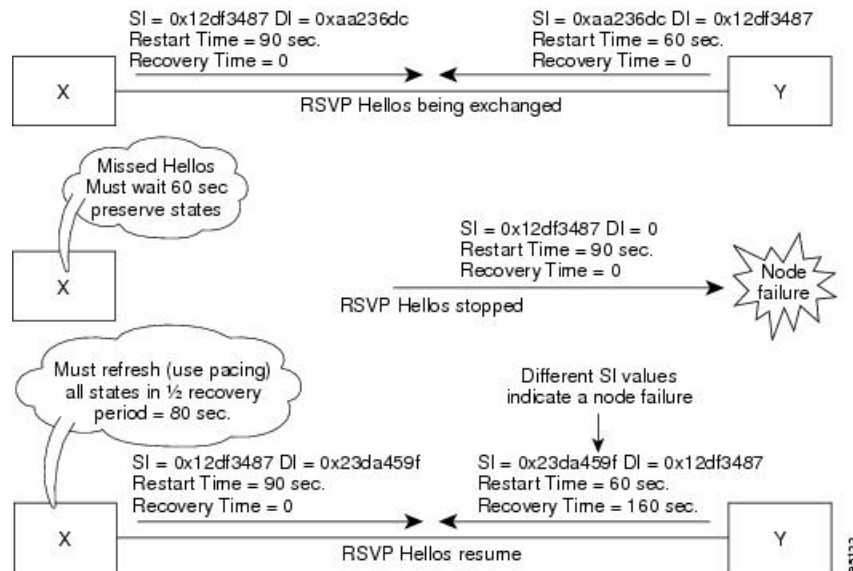

RSVP graceful restart requires the use of RSVP hello messages. Hello messages are used between RSVP neighbors. Each neighbor can autonomously issue a hello message containing a hello request object. A receiver that supports the hello extension replies with a hello message containing a hello acknowledgment (ACK) object. This means that a hello message contains either a hello Request or a hello ACK object. These two objects have the same format.

The restart cap object indicates a node’s restart capabilities. It is carried in hello messages if the sending node supports state recovery. The restart cap object has the following two fields:

Restart Time

Time after a loss in Hello messages within which RSVP hello session can be reestablished. It is possible for a user to manually configure the Restart Time.

Recovery Time

Time that the sender waits for the recipient to re-synchronize states after the re-establishment of hello messages. This value is computed and advertised based on number of states that existed before the fault occurred.

For graceful restart, the hello messages are sent with an IP Time to Live (TTL) of 64. This is because the destination of the hello messages can be multiple hops away. If graceful restart is enabled, hello messages (containing the restart cap object) are sent to an RSVP neighbor when RSVP states are shared with that neighbor.

Restart cap objects are sent to an RSVP neighbor when RSVP states are shared with that neighbor. If the neighbor replies with hello messages containing the restart cap object, the neighbor is considered to be graceful restart capable. If the neighbor does not reply with hello messages or replies with hello messages that do not contain the restart cap object, RSVP backs off sending hellos to that neighbor. If graceful restart is disabled, no hello messages (Requests or ACKs) are sent. If a hello Request message is received from an unknown neighbor, no hello ACK is sent back.

ACL-based Prefix Filtering

RSVP provides for the configuration of extended access lists (ACLs) to forward, drop, or perform normal processing on RSVP router-alert (RA) packets. Prefix filtering is designed for use at core access routers in order that RA packets (identified by a source/destination address) can be seamlessly forwarded across the core from one access point to another (or, conversely to be dropped at this node). RSVP applies prefix filtering rules only to RA packets because RA packets contain source and destination addresses of the RSVP flow.



Note

RA packets forwarded due to prefix filtering must not be sent as RSVP bundle messages, because bundle messages are hop-by-hop and do not contain RA. Forwarding a Bundle message does not work, because the node receiving the messages is expected to apply prefix filtering rules only to RA packets.

For each incoming RSVP RA packet, RSVP inspects the IP header and attempts to match the source/destination IP addresses with a prefix configured in an extended ACL. The results are as follows:

- If an ACL does not exist, the packet is processed like a normal RSVP packet.
- If the ACL match yields an explicit permit (and if the packet is not locally destined), the packet is forwarded. The IP TTL is decremented on all forwarded packets.
- If the ACL match yields an explicit deny, the packet is dropped.

If there is no explicit permit or explicit deny, the ACL infrastructure returns an implicit (default) deny. RSVP can be configured to drop the packet. By default, RSVP processes the packet if the ACL match yields an implicit (default) deny.

Related Topics

[Configuring ACLs for Prefix Filtering](#), on page 140

[Configure ACL-based Prefix Filtering: Example](#), on page 158

RSVP MIB

RFC 2206, RSVP Management Information Base Using SMIPv2 defines all the SNMP MIB objects that are relevant to RSVP. By implementing the RSVP MIB, you can perform these functions:

- Specifies two traps (NetFlow and LostFlow) which are triggered when a new flow is created or deleted.
- Lets you use SNMP to access objects belonging to RSVP.

Related Topics

[Enabling RSVP Traps](#), on page 145

[Enable RSVP Traps: Example](#), on page 158

Information About Implementing RSVP Authentication

Before implementing RSVP authentication, you must configure a keychain first. The name of the keychain must be the same as the one used in the keychain configuration. For more information about configuring keychains, see *System Security Configuration Guide for Cisco CRS Routers*.



Note RSVP authentication supports only keyed-hash message authentication code (HMAC) type algorithms.

To implement RSVP authentication on Cisco IOS XR software, you must understand the following concepts:

RSVP Authentication Functions

You can carry out these tasks with RSVP authentication:

- Set up a secure relationship with a neighbor by using secret keys that are known only to you and the neighbor.
- Configure RSVP authentication in global, interface, or neighbor configuration modes.
- Authenticate incoming messages by checking if there is a valid security relationship that is associated based on key identifier, incoming interface, sender address, and destination address.
- Add an integrity object with message digest to the outgoing message.
- Use sequence numbers in an integrity object to detect replay attacks.

RSVP Authentication Design

Network administrators need the ability to establish a security domain to control the set of systems that initiates RSVP requests.

The RSVP authentication feature permits neighbors in an RSVP network to use a secure hash to sign all RSVP signaling messages digitally, thus allowing the receiver of an RSVP message to verify the sender of the message without relying solely on the sender's IP address.

The signature is accomplished on a per-RSVP-hop basis with an RSVP integrity object in the RSVP message as defined in RFC 2747. This method provides protection against forgery or message modification. However,

the receiver must know the security key used by the sender to validate the digital signature in the received RSVP message.

Network administrators manually configure a common key for each RSVP neighbor on the shared network.

The following reasons explain how to choose between global, interface, or neighbor configuration modes:

- Global configuration mode is optimal when a router belongs to a single security domain (for example, part of a set of provider core routers). A single common key set is expected to be used to authenticate all RSVP messages.
- Interface, or neighbor configuration mode, is optimal when a router belongs to more than one security domain. For example, a provider router is adjacent to the provider edge (PE), or a PE is adjacent to an edge device. Different keys can be used but not shared.

Global configuration mode configures the defaults for interface and neighbor interface modes. These modes, unless explicitly configured, inherit the parameters from global configuration mode, as follows:

- Window-size is set to 1.
- Lifetime is set to 1800.
- **key-source key-chain** command is set to none or disabled.

Related Topics

[Configuring a Lifetime for an Interface for RSVP Authentication](#), on page 150

[RSVP Authentication by Using All the Modes: Example](#), on page 160

Global, Interface, and Neighbor Authentication Modes

You can configure global defaults for all authentication parameters including key, window size, and lifetime. These defaults are inherited when you configure authentication for each neighbor or interface. However, you can also configure these parameters individually on a neighbor or interface basis, in which case the global values (configured or default) are no longer inherited.



Note

RSVP uses the following rules when choosing which authentication parameter to use when that parameter is configured at multiple levels (interface, neighbor, or global). RSVP goes from the most specific to least specific; that is, neighbor, interface, and global.

Global keys simplify the configuration and eliminate the chances of a key mismatch when receiving messages from multiple neighbors and multiple interfaces. However, global keys do not provide the best security.

Interface keys are used to secure specific interfaces between two RSVP neighbors. Because many of the RSVP messages are IP routed, there are many scenarios in which using interface keys are not recommended. If all keys on the interfaces are not the same, there is a risk of a key mismatch for the following reasons:

- When the RSVP graceful restart is enabled, RSVP hello messages are sent with a source IP address of the local router ID and a destination IP address of the neighbor router ID. Because multiple routes can exist between the two neighbors, the RSVP hello message can traverse to different interfaces.
- When the RSVP fast reroute (FRR) is active, the RSVP Path and Resv messages can traverse multiple interfaces.

- When Generalized Multiprotocol Label Switching (GMPLS) optical tunnels are configured, RSVP messages are exchanged with router IDs as the source and destination IP addresses. Since multiple control channels can exist between the two neighbors, the RSVP messages can traverse different interfaces.

Neighbor-based keys are particularly useful in a network in which some neighbors support RSVP authentication procedures and others do not. When the neighbor-based keys are configured for a particular neighbor, you are advised to configure all the neighbor's addresses and router IDs for RSVP authentication.

Related Topics

[Configuring a Lifetime for RSVP Authentication in Global Configuration Mode](#), on page 147

[RSVP Authentication Global Configuration Mode: Example](#), on page 159

[Specifying the RSVP Authentication Keychain in Interface Mode](#), on page 149

[RSVP Authentication by Using All the Modes: Example](#), on page 160

Security Association

A security association (SA) is defined as a collection of information that is required to maintain secure communications with a peer to counter replay attacks, spoofing, and packet corruption.

This table lists the main parameters that define a security association.

Table 3: Security Association Main Parameters

Parameter	Description
src	IP address of the sender.
dst	IP address of the final destination.
interface	Interface of the SA.
direction	Send or receive type of the SA.
Lifetime	Expiration timer value that is used to collect unused security association data.
Sequence Number	Last sequence number that was either sent or accepted (dependent of the direction type).
key-source	Source of keys for the configurable parameter.
keyID	Key number (returned from the key-source) that was last used.
digest	Algorithm last used (returned from the key-source).
Window Size	Specifies the tolerance for the configurable parameter. The parameter is applicable when the direction parameter is the receive type.
Window	Specifies the last <i>window size</i> value sequence number that is received or accepted. The parameter is applicable when the direction parameter is the receive type.

An SA is created dynamically when sending and receiving messages that require authentication. The neighbor, source, and destination addresses are obtained either from the IP header or from an RSVP object, such as a HOP object, and whether the message is incoming or outgoing.

When the SA is created, an expiration timer is created. When the SA authenticates a message, it is marked as recently used. The lifetime timer periodically checks if the SA is being used. If so, the flag is cleared and is cleaned up for the next period unless it is marked again.

This table shows how to locate the source and destination address keys for an SA that is based on the message type.

Table 4: Source and Destination Address Locations for Different Message Types

Message Type	Source Address Location	Destination Address Location
Path	HOP object	SESSION object
PathTear	HOP object	SESSION object
PathError	HOP object	IP header
Resv	HOP object	IP header
ResvTear	HOP object	IP header
ResvError	HOP object	IP header
ResvConfirm	IP header	CONFIRM object
Ack	IP header	IP header
Srefresh	IP header	IP header
Hello	IP header	IP header
Bundle	—	—

Related Topics

[Specifying the Keychain for RSVP Neighbor Authentication](#), on page 152

[RSVP Neighbor Authentication: Example](#), on page 160

[Configuring a Lifetime for RSVP Neighbor Authentication](#), on page 153

[RSVP Authentication Global Configuration Mode: Example](#), on page 159

Key-source Key-chain

The key-source key-chain is used to specify which keys to use.

You configure a list of keys with specific IDs and have different lifetimes so that keys are changed at predetermined intervals automatically, without any disruption of service. Rollover enhances network security by minimizing the problems that could result if an untrusted source obtained, deduced, or guessed the current key.

RSVP handles rollover by using the following key ID types:

- On TX, use the youngest eligible key ID.
- On RX, use the key ID that is received in an integrity object.

For more information about implementing keychain management, see *System Security Configuration Guide for Cisco CRS Routers*.

Related Topics

- [Enabling RSVP Authentication Using the Keychain in Global Configuration Mode](#), on page 146
- [RSVP Authentication Global Configuration Mode: Example](#), on page 159
- [Specifying the Keychain for RSVP Neighbor Authentication](#), on page 152
- [RSVP Neighbor Authentication: Example](#), on page 160

Guidelines for Window-Size and Out-of-Sequence Messages

These guidelines are required for window-size and out-of-sequence messages:

- Default window-size is set to 1. If a single message is received out-of-sequence, RSVP rejects it and displays a message.
- When RSVP messages are sent in burst mode (for example, tunnel optimization), some messages can become out-of-sequence for a short amount of time.
- Window size can be increased by using the **window-size** command. When the window size is increased, replay attacks can be detected with duplicate sequence numbers.

Related Topics

- [Configuring the Window Size for RSVP Authentication in Global Configuration Mode](#), on page 148
- [Configuring the Window Size for an Interface for RSVP Authentication](#), on page 151
- [Configuring the Window Size for RSVP Neighbor Authentication](#), on page 153
- [RSVP Authentication by Using All the Modes: Example](#), on page 160
- [RSVP Authentication for an Interface: Example](#), on page 159

Caveats for Out-of-Sequence

These caveats are listed for out-of-sequence:

- When RSVP messages traverse multiple interface types with different maximum transmission unit (MTU) values, some messages can become out-of-sequence if they are fragmented.
- Packets with some IP options may be reordered.
- Change in QoS configurations may lead to a transient reorder of packets.
- QoS policies can cause a reorder of packets in a steady state.

Because all out-of-sequence messages are dropped, the sender must retransmit them. Because RSVP state timeouts are generally long, out-of-sequence messages during a transient state do not lead to a state timeout.

How to Implement RSVP

RSVP requires coordination among several routers, establishing exchange of RSVP messages to set up LSPs. Depending on the client application, RSVP requires some basic configuration, as described in these topics:

Configuring Traffic Engineering Tunnel Bandwidth

To configure traffic engineering tunnel bandwidth, you must first set up TE tunnels and configure the reserved bandwidth per interface (there is no need to configure bandwidth for the data channel or the control channel).

Cisco IOS XR software supports two MPLS DS-TE modes: Prestandard and IETF.



Note For prestandard DS-TE you do not need to configure bandwidth for the data channel or the control channel. There is no other specific RSVP configuration required for this application. When no RSVP bandwidth is specified for a particular interface, you can specify zero bandwidth in the LSP setup if it is configured under RSVP interface configuration mode or MPLS-TE configuration mode.

Related Topics

[Configuring a Prestandard DS-TE Tunnel](#), on page 235

[Configuring an IETF DS-TE Tunnel Using RDM](#), on page 236

[Configuring an IETF DS-TE Tunnel Using MAM](#), on page 238

Confirming DiffServ-TE Bandwidth

Perform this task to confirm DiffServ-TE bandwidth.

In RSVP global and subpools, reservable bandwidths are configured per interface to accommodate TE tunnels on the node. Available bandwidth from all configured bandwidth pools is advertised using IGP. RSVP signals the TE tunnel with appropriate bandwidth pool requirements.

SUMMARY STEPS

1. **configure**
2. **rsvp**
3. **interface** *type interface-path-id*
4. **bandwidth** *total-bandwidth max-flow sub-pool sub-pool-bw*
5. **commit**

DETAILED STEPS

	Command or Action	Purpose
Step 1	configure	
Step 2	rsvp Example: RP/0/RP0/CPU0:router (config) # rsvp	Enters RSVP configuration mode.
Step 3	interface <i>type interface-path-id</i> Example: RP/0/RP0/CPU0:router (config-rsvp) # interface pos	Enters interface configuration mode for the RSVP protocol.

	Command or Action	Purpose
	0/2/0/0	
Step 4	bandwidth total-bandwidth max-flow sub-pool sub-pool-bw Example: RP/0/RP0/CPU0:router(config-rsvp-if)# bandwidth 1000 100 sub-pool 150	Sets the reservable bandwidth, the maximum RSVP bandwidth available for a flow and the sub-pool bandwidth on this interface.
Step 5	commit	

Related Topics

- [Differentiated Services Traffic Engineering](#), on page 177
- [Bandwidth Configuration \(MAM\): Example](#), on page 155
- [Bandwidth Configuration \(RDM\): Example](#), on page 155

Configuring MPLS O-UNI Bandwidth

For this application you do not need to configure bandwidth for the data channel or the control channel. There is no other specific RSVP configuration needed for this application.

Enabling Graceful Restart

Perform this task to enable graceful restart for implementations using both node-id and interface-based hellos. RSVP graceful restart provides a control plane mechanism to ensure high availability, which allows detection and recovery from failure conditions while preserving nonstop forwarding services.

SUMMARY STEPS

1. **configure**
2. **rsvp**
3. **signalling graceful-restart**
4. **signalling graceful-restart interface-based**
5. **commit**

DETAILED STEPS

	Command or Action	Purpose
Step 1	configure	
Step 2	rsvp Example: RP/0/RP0/CPU0:router(config)# rsvp	Enters the RSVP configuration mode.

	Command or Action	Purpose
Step 3	signalling graceful-restart Example: <pre>RP/0/RP0/CPU0:router(config-rsvp)# signalling graceful-restart</pre>	Enables the graceful restart process on the node.
Step 4	signalling graceful-restart interface-based Example: <pre>RP/0/RP0/CPU0:router(config-rsvp)# signalling graceful-restart interface-based</pre>	Enables interface-based graceful restart process on the node.
Step 5	commit	

Related Topics

[Graceful Restart: Standard and Interface-Based](#), on page 130

[Enable Graceful Restart: Example](#), on page 157

[Enable Interface-Based Graceful Restart: Example](#), on page 157

Configuring ACL-based Prefix Filtering

Two procedures are provided to show how RSVP Prefix Filtering is associated:

- [Configuring ACLs for Prefix Filtering](#), on page 140
- [Configuring RSVP Packet Dropping](#), on page 141

Configuring ACLs for Prefix Filtering

Perform this task to configure an extended access list ACL that identifies the source and destination prefixes used for packet filtering.



Note The extended ACL needs to be configured separately using extended ACL configuration commands.

SUMMARY STEPS

1. **configure**
2. **rsvp**
3. **signalling prefix-filtering access-list**
4. **commit**

DETAILED STEPS

	Command or Action	Purpose
Step 1	configure	
Step 2	rsvp Example: RP/0/RP0/CPU0:router(config)# rsvp	Enters the RSVP configuration mode.
Step 3	signalling prefix-filtering access-list Example: RP/0/RP0/CPU0:router(config-rsvp)# signalling prefix-filtering access-list banks	Enter an extended access list name as a string.
Step 4	commit	

Related Topics

[ACL-based Prefix Filtering](#), on page 132

[Configure ACL-based Prefix Filtering: Example](#), on page 158

Configuring RSVP Packet Dropping

Perform this task to configure RSVP to drop RA packets when the ACL match returns an implicit (default) deny.

The default behavior performs normal RSVP processing on RA packets when the ACL match returns an implicit (default) deny.

SUMMARY STEPS

1. **configure**
2. **rsvp**
3. **signalling prefix-filtering default-deny-action**
4. **commit**

DETAILED STEPS

	Command or Action	Purpose
Step 1	configure	
Step 2	rsvp Example: RP/0/RP0/CPU0:router(config)# rsvp	Enters the RSVP configuration mode.

	Command or Action	Purpose
Step 3	signalling prefix-filtering default-deny-action Example: <pre>RP/0/RP0/CPU0:router(config-rsvp)# signalling prefix-filtering default-deny-action</pre>	Drops RA messages.
Step 4	commit	

Related Topics

[Overview of RSVP for MPLS-TE and MPLS O-UNI](#), on page 128

[Set DSCP for RSVP Packets: Example](#), on page 158

Verifying RSVP Configuration

Figure 11: Sample Topology

This figure illustrates the topology.

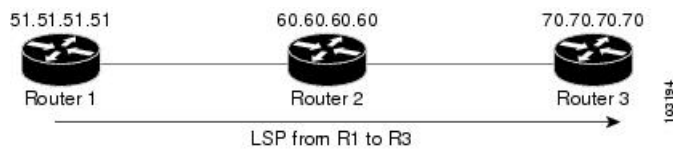

Perform the following steps to verify RSVP configuration.

SUMMARY STEPS

1. **show rsvp session**
2. **show rsvp counters messages summary**
3. **show rsvp counters events**
4. **show rsvp interface *type interface-path-id* [detail]**
5. **show rsvp graceful-restart**
6. **show rsvp graceful-restart [neighbors *ip-address* | detail]**
7. **show rsvp interface**
8. **show rsvp neighbor**

DETAILED STEPS

Step 1 **show rsvp session**

Verifies that all routers on the path of the LSP are configured with at least one Path State Block (PSB) and one Reservation State Block (RSB) per session.

Example:

```
RP/0/RP0/CPU0:router# show rsvp session
```

```
Type Destination Add DPort Proto/ExtTunID PSBs RSBs Reqs
```

```
----- LSP4
172.16.70.70 6 10.51.51.51 1 1 0
```

In the example, the output represents an LSP from ingress (head) router 10.51.51.51 to egress (tail) router 172.16.70.70. The tunnel ID (also called the *destination port*) is 6.

Example:

If no states can be found for a session that should be up, verify the application (for example, MPLS-TE and O-UNI) to see if everything is in order. If a session has one PSB but no RSB, this indicates that either the Path message is not making it to the egress (tail) router or the reservation message is not making it back to the router R1 in question.

Go to the downstream router R2 and display the session information:

Example:

If R2 has no PSB, either the path message is not making it to the router or the path message is being rejected (for example, due to lack of resources). If R2 has a PSB but no RSB, go to the next downstream router R3 to investigate. If R2 has a PSB and an RSB, this means the reservation is not making it from R2 to R1 or is being rejected.

Step 2 **show rsvp counters messages summary**

Verifies whether the RSVP message is being transmitted and received.

Example:

```
RP/0/RP0/CPU0:router# show rsvp counters messages summary

All RSVP Interfaces Recv Xmit Recv Xmit Path 0 25
  Resv 30 0 PathError 0 0 ResvError 0 1 PathTear 0 30 ResvTear 12 0
  ResvConfirm 0 0 Ack 24 37 Bundle 0 Hello 0 5099 SRefresh 8974 9012
  OutOfOrder 0 Retransmit 20 Rate Limited 0
```

Step 3 **show rsvp counters events**

Verifies how many RSVP states have expired. Because RSVP uses a soft-state mechanism, some failures will lead to RSVP states to expire due to lack of refresh from the neighbor.

Example:

```
RP/0/RP0/CPU0:router# show rsvp counters events

mgmtEthernet0/0/0/0 tunnel6 Expired Path states 0 Expired
  Path states 0 Expired Resv states 0 Expired Resv states 0 NACKs received 0
  NACKs received 0 POS0/3/0/0                                POS0/3/0/1 Expired
  Path states 0 Expired Path states 0 Expired Resv states 0 Expired Resv
  states 0 NACKs received 0 NACKs received 0 POS0/3/0/2
                                POS0/3/0/3 Expired Path states 0 Expired Path
  states 0 Expired Resv states 0 Expired Resv states 1 NACKs received 0 NACKs
  received 1
```

Step 4 **show rsvp interface type interface-path-id [detail]**

Verifies that refresh reduction is working on a particular interface.

Example:

```
RP/0/RP0/CPU0:router# show rsvp interface pos0/3/0/3 detail

INTERFACE: POS0/3/0/3 (ifh=0x4000D00). BW
(bits/sec): Max=1000M. MaxFlow=1000M. Allocated=1K (0%). MaxSub=0.
Signalling: No DSCP marking. No rate limiting. States in: 1. Max missed
msgs: 4. Expiry timer: Running (every 30s). Refresh interval: 45s. Normal
Refresh timer: Not running. Summary refresh timer: Running. Refresh
reduction local: Enabled. Summary Refresh: Enabled (4096 bytes max).
Reliable summary refresh: Disabled. Ack hold: 400 ms, Ack max size: 4096
bytes. Retransmit: 900ms. Neighbor information: Neighbor-IP Nbor-MsgIds
States-out Refresh-Reduction Expiry(min::sec) -----
----- 64.64.64.65 1 1 Enabled
14::45
```

Step 5 **show rsvp graceful-restart**

Verifies that graceful restart is enabled locally.

Example:

```
RP/0/RP0/CPU0:router# show rsvp graceful-restart

Graceful restart: enabled Number of global
neighbors: 1 Local MPLS router id: 10.51.51.51 Restart time: 60 seconds
Recovery time: 0 seconds Recovery timer: Not running Hello interval: 5000
milliseconds Maximum Hello miss-count: 3
```

Step 6 **show rsvp graceful-restart [neighbors ip-address | detail]**

Verifies that graceful restart is enabled on the neighbor(s). These examples show that neighbor 192.168.60.60 is not responding to hello messages.

Example:

```
RP/0/RP0/CPU0:router# show rsvp graceful-restart neighbors 192.168.60.60

Neighbor App State Recovery Reason
Since LostCnt -----
----- 192.168.60.60 MPLS INIT DONE N/A 12/06/2003
19:01:49 0
RP/0/RP0/CPU0:router# show rsvp graceful-restart neighbors detail

Neighbor: 192.168.60.60 Source: 10.51.51.51
(MPLS) Hello instance for application MPLS Hello State: INIT (for 3d23h)
Number of times communications with neighbor lost: 0 Reason: N/A Recovery
State: DONE Number of Interface neighbors: 1 address: 10.64.64.65 Restart
time: 0 seconds Recovery time: 0 seconds Restart timer: Not running Recovery
timer: Not running Hello interval: 5000 milliseconds Maximum allowed missed
Hello messages: 3
```

Step 7 **show rsvp interface**

Verifies the available RSVP bandwidth.

Example:

```
RP/0/RP0/CPU0:router# show rsvp interface
```

```
Interface MaxBW MaxFlow Allocated MaxSub -----
----- Et0/0/0/0 0 0 0 ( 0%) 0 PO0/3/0/0
1000M 1000M 0 ( 0%) 0 PO0/3/0/1 1000M 1000M 0 ( 0%) 0 PO0/3/0/2 1000M 1000M
0 ( 0%) 0 PO0/3/0/3 1000M 1000M 1K ( 0%) 0
```

Step 8 show rsvp neighbor

Verifies the RSVP neighbors.

Example:

```
RP/0/RP0/CPU0:router# show rsvp neighbor detail
Global Neighbor: 40.40.40.40 Interface Neighbor: 1.1.1.1
Interface: POS0/0/0/0 Refresh Reduction: "Enabled" or "Disabled". Remote
epoch: 0XXXXXXXXX Out of order messages: 0 Retransmitted messages: 0
Interface Neighbor: 2.2.2.2 Interface: POS0/1/0/0 Refresh Reduction:
"Enabled" or "Disabled". Remote epoch: 0XXXXXXXXX Out of order messages: 0
Retransmitted messages: 0
```

Related Topics

[Overview of RSVP for MPLS-TE and MPLS O-UNI](#) , on page 128

Enabling RSVP Traps

With the exception of the RSVP MIB traps, no action is required to activate the MIBs. This MIB feature is automatically enabled when RSVP is turned on; however, RSVP traps must be enabled.

Perform this task to enable all RSVP MIB traps, NewFlow traps, and LostFlow traps.

SUMMARY STEPS

1. **configure**
2. **snmp-server traps rsvp lost-flow**
3. **snmp-server traps rsvp new-flow**
4. **snmp-server traps rsvp all**
5. **commit**

DETAILED STEPS

	Command or Action	Purpose
Step 1	configure	
Step 2	snmp-server traps rsvp lost-flow Example: RP/0/RP0/CPU0:router(config)# snmp-server traps rsvp lost-flow	Sends RSVP notifications to enable RSVP LostFlow traps.

	Command or Action	Purpose
Step 3	snmp-server traps rsvp new-flow Example: <pre>RP/0/RP0/CPU0:router(config)# snmp-server traps rsvp new-flow</pre>	Sends RSVP notifications to enable RSVP NewFlow traps.
Step 4	snmp-server traps rsvp all Example: <pre>RP/0/RP0/CPU0:router(config)# snmp-server traps rsvp all</pre>	Sends RSVP notifications to enable all RSVP MIB traps.
Step 5	commit	

Related Topics

[RSVP MIB](#), on page 133

[Enable RSVP Traps: Example](#), on page 158

How to Implement RSVP Authentication

There are three types of RSVP authentication modes—global, interface, and neighbor. These topics describe how to implement RSVP authentication for each mode:

Configuring Global Configuration Mode RSVP Authentication

These tasks describe how to configure RSVP authentication in global configuration mode:

Enabling RSVP Authentication Using the Keychain in Global Configuration Mode

Perform this task to enable RSVP authentication for cryptographic authentication by specifying the keychain in global configuration mode.



Note You must configure a keychain before completing this task (see *System Security Configuration Guide for Cisco CRS Routers*).

SUMMARY STEPS

1. **configure**
2. **rsvp authentication**
3. **key-source key-chain** *key-chain-name*
4. **commit**

DETAILED STEPS

	Command or Action	Purpose
Step 1	configure	
Step 2	rsvp authentication Example: RP/0/RP0/CPU0:router(config)# rsvp authentication RP/0/RP0/CPU0:router(config-rsvp-auth)#	Enters RSVP authentication configuration mode.
Step 3	key-source key-chain <i>key-chain-name</i> Example: RP/0/RP0/CPU0:router(config-rsvp-auth)# key-source key-chain mpls-keys	Specifies the source of the key information to authenticate RSVP signaling messages. <i>key-chain-name</i> Name of the keychain. The maximum number of characters is 32.
Step 4	commit	

Related Topics

[Key-source Key-chain](#), on page 136

[RSVP Authentication Global Configuration Mode: Example](#), on page 159

Configuring a Lifetime for RSVP Authentication in Global Configuration Mode

Perform this task to configure a lifetime value for RSVP authentication in global configuration mode.

SUMMARY STEPS

1. **configure**
2. **rsvp authentication**
3. **life-time** *seconds*
4. **commit**

DETAILED STEPS

	Command or Action	Purpose
Step 1	configure	
Step 2	rsvp authentication Example: RP/0/RP0/CPU0:router(config)# rsvp authentication RP/0/RP0/CPU0:router(config-rsvp-auth)#	Enters RSVP authentication configuration mode.
Step 3	life-time <i>seconds</i> Example:	Controls how long RSVP maintains security associations with other trusted RSVP neighbors.

	Command or Action	Purpose
	RP/0/RP0/CPU0:router(config-rsvp-auth)# life-time 2000	<i>seconds</i> Length of time (in seconds) that RSVP maintains idle security associations with other trusted RSVP neighbors. Range is from 30 to 86400. The default value is 1800.
Step 4	commit	

Related Topics

[Global, Interface, and Neighbor Authentication Modes](#), on page 134

[RSVP Authentication Global Configuration Mode: Example](#), on page 159

Configuring the Window Size for RSVP Authentication in Global Configuration Mode

Perform this task to configure the window size for RSVP authentication in global configuration mode.

SUMMARY STEPS

1. **configure**
2. **rsvp authentication**
3. **window-size *N***
4. **commit**

DETAILED STEPS

	Command or Action	Purpose
Step 1	configure	
Step 2	rsvp authentication Example: RP/0/RP0/CPU0:router(config)# rsvp authentication RP/0/RP0/CPU0:router(config-rsvp-auth)#	Enters RSVP authentication configuration mode.
Step 3	window-size <i>N</i> Example: RP/0/RP0/CPU0:router(config-rsvp-auth)# window-size 33	Specifies the maximum number of RSVP authenticated messages that can be received out-of-sequence. <i>N</i> Size of the window to restrict out-of-sequence messages. The range is from 1 to 64. The default value is 1, in which case all out-of-sequence messages are dropped.
Step 4	commit	

Related Topics

[Guidelines for Window-Size and Out-of-Sequence Messages](#), on page 137

[RSVP Authentication by Using All the Modes: Example](#), on page 160

[RSVP Authentication for an Interface: Example](#), on page 159

Configuring an Interface for RSVP Authentication

These tasks describe how to configure an interface for RSVP authentication:

Specifying the RSVP Authentication Keychain in Interface Mode

Perform this task to specify RSVP authentication keychain in interface mode.

You must configure a keychain first (see *System Security Configuration Guide for Cisco CRS Routers*).

SUMMARY STEPS

1. **configure**
2. **rsvp interface** *type interface-path-id*
3. **authentication**
4. **key-source key-chain** *key-chain-name*
5. **commit**

DETAILED STEPS

	Command or Action	Purpose
Step 1	configure	
Step 2	rsvp interface <i>type interface-path-id</i> Example: <pre>RP/0/RP0/CPU0:router(config)# rsvp interface POS 0/2/1/0 RP/0/RP0/CPU0:router(config-rsvp-if)#</pre>	Enters RSVP interface configuration mode.
Step 3	authentication Example: <pre>RP/0/RP0/CPU0:router(config-rsvp-if)# authentication RP/0/RP0/CPU0:router(config-rsvp-if-auth)#</pre>	Enters RSVP authentication configuration mode.
Step 4	key-source key-chain <i>key-chain-name</i> Example: <pre>RP/0/RP0/CPU0:router(config-rsvp-if-auth)# key-source key-chain mpls-keys</pre>	Specifies the source of the key information to authenticate RSVP signaling messages. key-chain-name Name of the keychain. The maximum number of characters is 32.
Step 5	commit	

Related Topics

[Global, Interface, and Neighbor Authentication Modes](#), on page 134

[RSVP Authentication by Using All the Modes: Example](#), on page 160

Configuring a Lifetime for an Interface for RSVP Authentication

Perform this task to configure a lifetime for the security association for an interface.

SUMMARY STEPS

1. **configure**
2. **rsvp interface** *type interface-path-id*
3. **authentication**
4. **life-time** *seconds*
5. **commit**

DETAILED STEPS

	Command or Action	Purpose
Step 1	configure	
Step 2	rsvp interface <i>type interface-path-id</i> Example: RP/0/RP0/CPU0:router (config) # rsvp interface POS 0/2/1/0 RP/0/RP0/CPU0:router (config-rsvp-if) #	Enters RSVP interface configuration mode.
Step 3	authentication Example: RP/0/RP0/CPU0:router (config-rsvp-if) # authentication RP/0/RP0/CPU0:router (config-rsvp-if-auth) #	Enters RSVP authentication configuration mode.
Step 4	life-time <i>seconds</i> Example: RP/0/RP0/CPU0:router (config-rsvp-if-auth) # life-time 2000	Controls how long RSVP maintains security associations with other trusted RSVP neighbors. seconds Length of time (in seconds) that RSVP maintains idle security associations with other trusted RSVP neighbors. Range is from 30 to 86400. The default value is 1800.
Step 5	commit	

Related Topics

[RSVP Authentication Design](#), on page 133

[RSVP Authentication by Using All the Modes: Example](#), on page 160

Configuring the Window Size for an Interface for RSVP Authentication

Perform this task to configure the window size for an interface for RSVP authentication to check the validity of the sequence number received.

SUMMARY STEPS

1. **configure**
2. **rsvp interface** *type interface-path-d*
3. **authentication**
4. **window-size** *N*
5. **commit**

DETAILED STEPS

	Command or Action	Purpose
Step 1	configure	
Step 2	rsvp interface <i>type interface-path-d</i> Example: <pre>RP/0/RP0/CPU0:router(config)# rsvp interface POS 0/2/1/0 RP/0/RP0/CPU0:router(config-rsvp-if)#</pre>	Enters RSVP interface configuration mode.
Step 3	authentication Example: <pre>RP/0/RP0/CPU0:router(config-rsvp-if)# authentication RP/0/RP0/CPU0:router(config-rsvp-if-auth)#</pre>	Enters RSVP interface authentication configuration mode.
Step 4	window-size <i>N</i> Example: <pre>RP/0/RP0/CPU0:router(config-rsvp-if-auth)# window-size 33</pre>	Specifies the maximum number of RSVP authenticated messages that can be received out-of-sequence. <i>N</i> Size of the window to restrict out-of-sequence messages. The range is from 1 to 64. The default value is 1, in which case all out-of-sequence messages are dropped.
Step 5	commit	

Related Topics

[Guidelines for Window-Size and Out-of-Sequence Messages](#), on page 137

[RSVP Authentication by Using All the Modes: Example](#), on page 160

[RSVP Authentication for an Interface: Example](#), on page 159

Configuring RSVP Neighbor Authentication

These tasks describe how to configure the RSVP neighbor authentication:

- [Specifying the Keychain for RSVP Neighbor Authentication, on page 152](#)
- [Configuring a Lifetime for RSVP Neighbor Authentication, on page 153](#)
- [Configuring the Window Size for RSVP Neighbor Authentication, on page 153](#)

Specifying the Keychain for RSVP Neighbor Authentication

Perform this task to specify the keychain RSVP neighbor authentication.

You must configure a keychain first (see *System Security Configuration Guide for Cisco CRS Routers*).

SUMMARY STEPS

1. **configure**
2. **rsvp neighbor *IP-address* authentication**
3. **key-source key-chain *key-chain-name***
4. **commit**

DETAILED STEPS

	Command or Action	Purpose
Step 1	configure	
Step 2	rsvp neighbor <i>IP-address</i> authentication Example: RP/0/RP0/CPU0:router (config) # rsvp neighbor 1.1.1.1 authentication RP/0/RP0/CPU0:router (config-rsvp-nbor-auth) #	Enters neighbor authentication configuration mode. Use the rsvp neighbor command to activate RSVP cryptographic authentication for a neighbor. IP address IP address of the neighbor. A single IP address for a specific neighbor; usually one of the neighbor's physical or logical (loopback) interfaces. authentication Configures the RSVP authentication parameters.
Step 3	key-source key-chain <i>key-chain-name</i> Example: RP/0/RP0/CPU0:router (config-rsvp-nbor-auth) # key-source key-chain mpls-keys	Specifies the source of the key information to authenticate RSVP signaling messages. key-chain-name Name of the keychain. The maximum number of characters is 32.
Step 4	commit	

Related Topics

- [Key-source Key-chain, on page 136](#)
- [Security Association, on page 135](#)

[RSVP Neighbor Authentication: Example](#), on page 160

Configuring a Lifetime for RSVP Neighbor Authentication

Perform this task to configure a lifetime for security association for RSVP neighbor authentication mode.

SUMMARY STEPS

1. **configure**
2. **rsvp neighbor *IP-address* authentication**
3. **life-time *seconds***
4. **commit**

DETAILED STEPS

	Command or Action	Purpose
Step 1	configure	
Step 2	rsvp neighbor <i>IP-address</i> authentication Example: <pre>RP/0/RP0/CPU0:router(config)# rsvp neighbor 1.1.1.1 authentication RP/0/RP0/CPU0:router(config-rsvp-nbor-auth)#</pre>	Enters RSVP neighbor authentication configuration mode. Use the rsvp neighbor command to specify a neighbor under RSVP. <i>IP address</i> IP address of the neighbor. A single IP address for a specific neighbor; usually one of the neighbor's physical or logical (loopback) interfaces. authentication Configures the RSVP authentication parameters.
Step 3	life-time <i>seconds</i> Example: <pre>RP/0/RP0/CPU0:router(config-rsvp-nbor-auth)# life-time 2000</pre>	Controls how long RSVP maintains security associations with other trusted RSVP neighbors. The argument specifies the <i>seconds</i> Length of time (in seconds) that RSVP maintains idle security associations with other trusted RSVP neighbors. Range is from 30 to 86400. The default value is 1800.
Step 4	commit	

Related Topics

[Security Association](#), on page 135

[RSVP Authentication Global Configuration Mode: Example](#), on page 159

Configuring the Window Size for RSVP Neighbor Authentication

Perform this task to configure the RSVP neighbor authentication window size to check the validity of the sequence number received.

SUMMARY STEPS

1. **configure**
2. **rsvp neighbor** *IP address* **authentication**
3. **window-size** *N*
4. **commit**

DETAILED STEPS

	Command or Action	Purpose
Step 1	configure	
Step 2	rsvp neighbor <i>IP address</i> authentication Example: <pre>RP/0/RP0/CPU0:router(config)# rsvp neighbor 1.1.1.1 authentication RP/0/RP0/CPU0:router(config-rsvp-nbor-auth)#</pre>	Enters RSVP neighbor authentication configuration mode. Use the rsvp neighbor command to specify a neighbor under RSVP. IP address IP address of the neighbor. A single IP address for a specific neighbor; usually one of the neighbor's physical or logical (loopback) interfaces. authentication Configures the RSVP authentication parameters.
Step 3	window-size <i>N</i> Example: <pre>RP/0/RP0/CPU0:router(config-rsvp-nbor-auth)# window-size 33</pre>	Specifies the maximum number of RSVP authenticated messages that is received out-of-sequence. <i>N</i> Size of the window to restrict out-of-sequence messages. The range is from 1 to 64. The default value is 1, in which case all out-of-sequence messages are dropped.
Step 4	commit	

Related Topics

[Guidelines for Window-Size and Out-of-Sequence Messages](#), on page 137

[RSVP Authentication by Using All the Modes: Example](#), on page 160

[RSVP Authentication for an Interface: Example](#), on page 159

Verifying the Details of the RSVP Authentication

To display the security associations that RSVP has established with other RSVP neighbors, use the **show rsvp authentication** command.

Eliminating Security Associations for RSVP Authentication

To eliminate RSVP authentication SA's, use the **clear rsvp authentication** command. To eliminate RSVP counters for each SA, use the **clear rsvp counters authentication** command.

Configuration Examples for RSVP

Sample RSVP configurations are provided for some of the supported RSVP features.

- [#unique_186](#)
- [#unique_187](#)
- [#unique_188](#)
- [Refresh Reduction and Reliable Messaging Configuration: Examples, on page 156](#)
- [Configure Graceful Restart: Examples, on page 157](#)
- [Configure ACL-based Prefix Filtering: Example, on page 158](#)
- [Set DSCP for RSVP Packets: Example, on page 158](#)
- [Enable RSVP Traps: Example, on page 158](#)

Bandwidth Configuration (Prestandard): Example

The example shows the configuration of bandwidth on an interface using prestandard DS-TE mode. The example configures an interface for a reservable bandwidth of 7500, specifies the maximum bandwidth for one flow to be 1000 and adds a sub-pool bandwidth of 2000.

```
rsvp interface hundredGigE 0/0/0/0
bandwidth 7500 1000 sub-pool 2000
```

Bandwidth Configuration (MAM): Example

The example shows the configuration of bandwidth on an interface using MAM. The example shows how to limit the total of all RSVP reservations on the hundredGigE 0/0/0/0 interface to 7500 kbps, and allow each single flow to reserve no more than 1000 kbps.

```
rsvp interface hundredGigE 0/0/0/0
bandwidth mam 7500 1000
```

Related Topics

- [Confirming DiffServ-TE Bandwidth, on page 138](#)
- [Differentiated Services Traffic Engineering, on page 177](#)

Bandwidth Configuration (RDM): Example

The example shows the configuration of bandwidth on an interface using RDM. The example shows how to limit the total of all RSVP reservations on the hundredGigE 0/0/0/0 interface to 7500 kbps, and allows each single flow to reserve no more than 1000 kbps.

```
rsvp interface hundredGigE 0/0/0/0
```

```
bandwidth rdm 7500 1000
```

Related Topics

[Confirming DiffServ-TE Bandwidth](#), on page 138

[Differentiated Services Traffic Engineering](#), on page 177

Refresh Reduction and Reliable Messaging Configuration: Examples

Refresh reduction feature as defined by RFC 2961 is supported and enabled by default. The examples illustrate the configuration for the refresh reduction feature. Refresh reduction is used with a neighbor only if the neighbor supports it also.

Refresh Interval and the Number of Refresh Messages Configuration: Example

The example shows how to configure the refresh interval to 30 seconds on POS 0/3/0/0 and how to change the number of refresh messages the node can miss before cleaning up the state from the default value of 4 to 6.

```
rsvp interface pos 0/3/0/0
 signalling refresh interval 30
 signalling refresh missed 6
```

Retransmit Time Used in Reliable Messaging Configuration: Example

The example shows how to set the retransmit timer to 2 seconds. To prevent unnecessary retransmits, the retransmit time value configured on the interface must be greater than the ACK hold time on its peer.

```
rsvp interface pos 0/4/0/1
 signalling refresh reduction reliable retransmit-time 2000
```

Acknowledgement Times Configuration: Example

The example shows how to change the acknowledge hold time from the default value of 400 ms, to delay or speed up sending of ACKs, and the maximum acknowledgment message size from default size of 4096 bytes. The example shows how to change the acknowledge hold time from the default value of 400 ms and how to delay or speed up sending of ACKs. The maximum acknowledgment message default size is from 4096 bytes.

```
rsvp interface pos 0/4/0/1
 signalling refresh reduction reliable ack-hold-time 1000
rsvp interface pos 0/4/0/1
 signalling refresh reduction reliable ack-max-size 1000
```



Note Ensure retransmit time on the peers' interface is at least twice the amount of the ACK hold time to prevent unnecessary retransmissions.

Summary Refresh Message Size Configuration: Example

The example shows how to set the summary refresh message maximum size to 1500 bytes.

```

rsvp interface pos 0/4/0/1
  signalling refresh reduction summary max-size 1500

```

Disable Refresh Reduction: Example

If the peer node does not support refresh reduction, or for any other reason you want to disable refresh reduction on an interface, the example shows how to disable refresh reduction on that interface.

```

rsvp interface pos 0/4/0/1
  signalling refresh reduction disable

```

Configure Graceful Restart: Examples

RSVP graceful restart is configured globally or per interface (as are refresh-related parameters). These examples show how to enable graceful restart, set the restart time, and change the hello message interval.

Enable Graceful Restart: Example

The example shows how to enable the RSVP graceful restart by default. If disabled, enable it with the following command.

```

rsvp signalling graceful-restart

```

Related Topics

[Enabling Graceful Restart](#), on page 139

[Graceful Restart: Standard and Interface-Based](#), on page 130

Enable Interface-Based Graceful Restart: Example

The example shows how to enable the RSVP graceful restart feature on an interface.

```

RP/0/RP0/CPU0:router#configure
RP/0/RP0/CPU0:router(config-rsvp)#interface bundle-ether 17
RP/0/RP0/CPU0:router(config-rsvp-if)#signalling hello graceful-restart ?
  interface-based  Configure Interface-based Hello
RP/0/RP0/CPU0:router(config-rsvp-if)#signalling hello graceful-restart interface-based
RP/0/RP0/CPU0:router(config-rsvp-if)#

```

Related Topics

[Enabling Graceful Restart](#), on page 139

[Graceful Restart: Standard and Interface-Based](#), on page 130

Change the Restart-Time: Example

The example shows how to change the restart time that is advertised in hello messages sent to neighbor nodes.

```

rsvp signalling graceful-restart restart-time 200

```

Change the Hello Interval: Example

The example shows how to change the interval at which RSVP graceful restart hello messages are sent per neighbor, and change the number of hellos missed before the neighbor is declared down.

```

rsvp signalling hello graceful-restart refresh interval 4000
rsvp signalling hello graceful-restart refresh misses 4

```

Configure ACL-based Prefix Filtering: Example

The example shows when RSVP receives a Router Alert (RA) packet from source address 1.1.1.1 and 1.1.1.1 is not a local address. The packet is forwarded with IP TTL decremented. Packets destined to 2.2.2.2 are dropped. All other RA packets are processed as normal RSVP packets.

```

show run ipv4 access-list
  ipv4 access-list rsvpacl
  10 permit ip host 1.1.1.1 any
  20 deny ip any host 2.2.2.2
  !
show run rsvp
  rsvp
  signalling prefix-filtering access-list rsvpacl
  !

```

Related Topics

[Configuring ACLs for Prefix Filtering](#), on page 140

[ACL-based Prefix Filtering](#), on page 132

Set DSCP for RSVP Packets: Example

The configuration example sets the Differentiated Services Code Point (DSCP) field in the IP header of RSVP packets.

```

rsvp interface pos0/2/0/1
  signalling dscp 20

```

Related Topics

[Configuring RSVP Packet Dropping](#), on page 141

[Overview of RSVP for MPLS-TE and MPLS O-UNI](#), on page 128

Enable RSVP Traps: Example

The example enables the router to send all RSVP traps:

```

configure
  snmp-server traps rsvp all

```

The example enables the router to send RSVP LostFlow traps:

```

configure
  snmp-server traps rsvp lost-flow

```

The example enables the router to send RSVP RSVP NewFlow traps:

```
configure
snmp-server traps rsvp new-flow
```

Related Topics

- [Enabling RSVP Traps](#), on page 145
- [RSVP MIB](#), on page 133

Configuration Examples for RSVP Authentication

These configuration examples are used for RSVP authentication:

- [RSVP Authentication Global Configuration Mode: Example](#), on page 159
- [RSVP Authentication for an Interface: Example](#), on page 159
- [RSVP Neighbor Authentication: Example](#), on page 160
- [RSVP Authentication by Using All the Modes: Example](#), on page 160

RSVP Authentication Global Configuration Mode: Example

The configuration example enables authentication of all RSVP messages and increases the default lifetime of the SAs.

```
rsvp
authentication
  key-source key-chain default_keys
  life-time 3600
!
```



Note The specified keychain (default_keys) must exist and contain valid keys, or signaling will fail.

Related Topics

- [Enabling RSVP Authentication Using the Keychain in Global Configuration Mode](#), on page 146
- [Key-source Key-chain](#), on page 136
- [Configuring a Lifetime for RSVP Authentication in Global Configuration Mode](#), on page 147
- [Global, Interface, and Neighbor Authentication Modes](#), on page 134
- [Configuring a Lifetime for RSVP Neighbor Authentication](#), on page 153
- [Security Association](#), on page 135

RSVP Authentication for an Interface: Example

The configuration example enables authentication of all RSVP messages that are being sent or received on one interface only, and sets the window-size of the SAs.

```
rsvp
```

```
interface GigabitEthernet0/6/0/0
 authentication
  window-size 64
 !
 !
```



Note Because the key-source keychain configuration is not specified, the global authentication mode keychain is used and inherited. The global keychain must exist and contain valid keys or signaling fails.

Related Topics

- [Configuring the Window Size for RSVP Authentication in Global Configuration Mode](#), on page 148
- [Configuring the Window Size for an Interface for RSVP Authentication](#), on page 151
- [Configuring the Window Size for RSVP Neighbor Authentication](#), on page 153
- [Guidelines for Window-Size and Out-of-Sequence Messages](#), on page 137

RSVP Neighbor Authentication: Example

The configuration example enables authentication of all RSVP messages that are being sent to and received from only a particular IP address.

```
rsvp
 neighbor 10.0.0.1
 authentication
  key-source key-chain nbr_keys
 !
 !
 !
```

Related Topics

- [Specifying the Keychain for RSVP Neighbor Authentication](#), on page 152
- [Key-source Key-chain](#), on page 136
- [Security Association](#), on page 135

RSVP Authentication by Using All the Modes: Example

The configuration example shows how to perform the following functions:

- Authenticates all RSVP messages.
- Authenticates the RSVP messages to or from 10.0.0.1 by setting the keychain for the **key-source key-chain** command to `nbr_keys`, SA lifetime is set to 3600, and the default window-size is set to 1.
- Authenticates the RSVP messages not to or from 10.0.0.1 by setting the keychain for the **key-source key-chain** command to `default_keys`, SA lifetime is set to 3600, and the window-size is set 64 when using GigabitEthernet0/6/0/0; otherwise, the default value of 1 is used.

```
rsvp
 interface GigabitEthernet0/6/0/0
 authentication
```

```

    window-size 64
    !
    !
neighbor 10.0.0.1
  authentication
    key-source key-chain nbr_keys
    !
    !
  authentication
    key-source key-chain default_keys
    life-time 3600
    !
    !

```



Note If a keychain does not exist or contain valid keys, this is considered a configuration error because signaling fails. However, this can be intended to prevent signaling. For example, when using the above configuration, if the `nbr_keys` does not contain valid keys, all signaling with 10.0.0.1 fails.

Related Topics

- [Configuring the Window Size for RSVP Authentication in Global Configuration Mode](#), on page 148
- [Configuring the Window Size for an Interface for RSVP Authentication](#), on page 151
- [Configuring the Window Size for RSVP Neighbor Authentication](#), on page 153
- [Guidelines for Window-Size and Out-of-Sequence Messages](#), on page 137
- [Specifying the RSVP Authentication Keychain in Interface Mode](#), on page 149
- [Global, Interface, and Neighbor Authentication Modes](#), on page 134
- [Configuring a Lifetime for an Interface for RSVP Authentication](#), on page 150
- [RSVP Authentication Design](#), on page 133

Additional References

For additional information related to implementing GMPLS UNI, refer to the following references:

Related Documents

Related Topic	Document Title
GMPLS UNI commands	<i>GMPLS UNI Commands</i> module in <i>MPLS Command Reference for the Cisco CRS Router</i>
MPLS Traffic Engineering commands	<i>MPLS Traffic Engineering commands</i> module in <i>MPLS Command Reference for the Cisco CRS Router</i>
RSVP commands	<i>RSVP commands</i> module in <i>MPLS Command Reference for the Cisco CRS Router</i>
Getting started material	<i>Cisco IOS XR Getting Started Guide for the Cisco CRS Router</i>
Information about user groups and task IDs	<i>Configuring AAA Services</i> module in <i>System Security Configuration Guide for Cisco CRS Routers</i>

Standards

Standard	Title
OIF UNI 1.0	<i>User Network Interface (UNI) 1.0 Signaling Specification</i>

MIBs

MIBs	MIBs Link
—	To locate and download MIBs using Cisco IOS XR software, use the Cisco MIB Locator found at the following URL and choose a platform under the Cisco Access Products menu: http://cisco.com/public/sw-center/netmgmt/cmtk/mibs.shtml

RFCs

RFCs	Title
RFC 3471	<i>Generalized Multi-Protocol Label Switching (GMPLS) Signaling Functional Description</i>
RFC 3473	<i>Generalized Multi-Protocol Label Switching (GMPLS) Signaling Resource ReserVation Protocol-Traffic Engineering (RSVP-TE) Extensions</i>
RFC 4208	<i>Generalized Multiprotocol Label Switching (GMPLS) User-Network Interface (UNI): Resource ReserVation Protocol-Traffic Engineering (RSVP-TE) Support for the Overlay Model</i>
RFC 4872	<i>RSVP-TE Extensions in Support of End-to-End Generalized Multi-Protocol Label Switching (GMPLS) Recovery</i>
RFC 4874	<i>Exclude Routes - Extension to Resource ReserVation Protocol-Traffic Engineering (RSVP-TE)</i>
RFC 6205	<i>Generalized Labels for Lambda-Switch-Capable (LSC) Label Switching Routers</i>

Technical Assistance

Description	Link
The Cisco Technical Support website contains thousands of pages of searchable technical content, including links to products, technologies, solutions, technical tips, and tools. Registered Cisco.com users can log in from this page to access even more content.	http://www.cisco.com/techsupport



CHAPTER 5

Implementing MPLS Forwarding

All Multiprotocol Label Switching (MPLS) features require a core set of MPLS label management and forwarding services; the MPLS Forwarding Infrastructure (MFI) supplies these services.

Feature History for Implementing MPLS-TE

Release	Modification
Release 2.0	This feature was introduced.
Release 3.0	No modification.
Release 3.2	No modification.
Release 3.3.0	No modification.
Release 3.4.0	No modification.
Release 3.5.0	No modification.
Release 3.6.0	No modification.
Release 3.7.0	No modification.
Release 3.8.0	No modification.
Release 3.9.0	The MPLS IP Time-to-Live Propagation feature was added.

- [Prerequisites for Implementing Cisco MPLS Forwarding, on page 163](#)
- [Restrictions for Implementing Cisco MPLS Forwarding, on page 164](#)
- [Information About Implementing MPLS Forwarding, on page 164](#)
- [How to Implement MPLS Forwarding, on page 166](#)
- [Additional References, on page 168](#)

Prerequisites for Implementing Cisco MPLS Forwarding

These prerequisites are required to implement MPLS Forwarding:

- You must be in a user group associated with a task group that includes the proper task IDs. The command reference guides include the task IDs required for each command. If you suspect user group assignment is preventing you from using a command, contact your AAA administrator for assistance.
- Router that runs Cisco IOS XR software.
- Installed composite mini-image and the MPLS package, or a full composite image.

Restrictions for Implementing Cisco MPLS Forwarding

- Label switching on a Cisco router requires that Cisco Express Forwarding (CEF) be enabled.
- CEF is mandatory for Cisco IOS XR software and it does not need to be enabled explicitly.

Information About Implementing MPLS Forwarding

To implement MPLS Forwarding, you should understand these concepts:

MPLS Forwarding Overview

MPLS combines the performance and capabilities of Layer 2 (data link layer) switching with the proven scalability of Layer 3 (network layer) routing. MPLS enables service providers to meet the challenges of growth in network utilization while providing the opportunity to differentiate services without sacrificing the existing network infrastructure. The MPLS architecture is flexible and can be employed in any combination of Layer 2 technologies. MPLS support is offered for all Layer 3 protocols, and scaling is possible well beyond that typically offered in today's networks.

Based on routing information that is stored in the VRF IP routing table and VRF CEF table, packets are forwarded to their destination using MPLS.

A PE router binds a label to each customer prefix learned from a CE router and includes the label in the network reachability information for the prefix that it advertises to other PE routers. When a PE router forwards a packet received from a CE router across the provider network, it labels the packet with the label learned from the destination PE router. When the destination PE router receives the labeled packet it pops the label and uses it to direct the packet to the correct CE router. Label forwarding across the provider backbone, is based on either dynamic label switching or traffic engineered paths. A customer data packet carries two levels of labels when traversing the backbone:

- Top label directs the packet to the correct PE router
- Second label indicates how that PE router should forward the packet to the CE router

Related Topics

[Configuring the Size of the Local Label](#), on page 167

Label Switching Functions

In conventional Layer 3 forwarding mechanisms, as a packet traverses the network, each router extracts all the information relevant to forwarding the packet from the Layer 3 header. This information is then used as an index for a routing table lookup to determine the next hop for the packet.

In the most common case, the only relevant field in the header is the destination address field, but in some cases, other header fields might also be relevant. As a result, the header analysis must be done independently at each router through which the packet passes. In addition, a complicated table lookup must also be done at each router.

In label switching, the analysis of the Layer 3 header is done only once. The Layer 3 header is then mapped into a fixed-length, unstructured value called a *label*.

Many different headers can map to the same label, as long as those headers always result in the same choice of next hop. In effect, a label represents a forwarding equivalence class—that is, a set of packets which, however different they may be, are indistinguishable by the forwarding function.

The initial choice of a label need not be based exclusively on the contents of the Layer 3 packet header; for example, forwarding decisions at subsequent hops can also be based on routing policy.

Once a label is assigned, a short label header is added at the front of the Layer 3 packet. This header is carried across the network as part of the packet. At subsequent hops through each MPLS router in the network, labels are swapped and forwarding decisions are made by means of MPLS forwarding table lookup for the label carried in the packet header. Hence, the packet header does not need to be reevaluated during packet transit through the network. Because the label is of fixed length and unstructured, the MPLS forwarding table lookup process is both straightforward and fast.

Distribution of Label Bindings

Each label switching router (LSR) in the network makes an independent, local decision as to which label value to use to represent a forwarding equivalence class. This association is known as a label binding.



Note The distribution of label bindings cannot be done statically for the Layer 2 VPN pseudowire.

Each LSR informs its neighbors of the label bindings it has made. This awareness of label bindings by neighboring routers is facilitated by these protocols:

Label Distribution Protocol (LDP)

Supports MPLS forwarding along normally routed paths.

Resource Reservation Protocol (RSVP)

Supports MPLS traffic engineering.

Border Gateway Protocol (BGP)

Supports MPLS virtual private networks (VPNs).

When a labeled packet is sent from LSR A to the neighboring LSR B, the label value carried by the IP packet is the label value that LSR B assigned to represent the forwarding equivalence class of the packet. Thus, the label value changes as the IP packet traverses the network.

MFI Control-Plane Services

The MFI control-plane provides services to MPLS applications, such as Label Distribution Protocol (LDP) and Traffic Engineering (TE), that include enabling and disabling MPLS on an interface, local label allocation, MPLS rewrite setup (including backup links), management of MPLS label tables, and the interaction with other forwarding paths (IP Version 4 [IPv4] for example) to set up imposition and disposition.

MFI Data-Plane Services

The MFI data-plane provides a software implementation of MPLS forwarding in all of these forms:

- Imposition
- Disposition
- Label swapping

Time-to-Live Propagation in Hierarchical MPLS

Cisco IOS XR software provides the flexibility to enable or disable the time-to-live (TTL) propagation for locally generated packets that are independent of packets forwarded from a customer edge (CE) device.

The IP header contains a field of 8 bits that signifies the time that a packet still has before its life ends and is dropped. When an IP packet is sent, its TTL is usually 255 and is then decremented by 1 at each hop. When the TTL field is decremented down to zero, the datagram is discarded. In such a case, the router that dropped the IP packet for which the TTL reached 0 sends an Internet Control Message Protocol (ICMP) message type 11 and code 0 (time exceeded) to the originator of the IP packet.

Related Topics

[Configuring the Time-to-Live Propagation in Hierarchical MPLS](#), on page 166

MPLS Maximum Transmission Unit

MPLS maximum transmission unit (MTU) indicates that the maximum size of the IP packet can still be sent on a data link, without fragmenting the packet. In addition, data links in MPLS networks have a specific MTU, but for labeled packets. All IPv4 packets have one or more labels. This does imply that the labeled packets are slightly bigger than the IP packets, because for every label, four bytes are added to the packet. So, if n is the number of labels, $n * 4$ bytes are added to the size of the packet when the packet is labeled. The MPLS MTU parameter pertains to labeled packets.

How to Implement MPLS Forwarding

These topics explain how to configure a router for MPLS forwarding.

Configuring the Time-to-Live Propagation in Hierarchical MPLS

Perform this task to enable or disable the time-to-live (TTL) propagation for locally generated packets that are independent of packets forwarded from a customer edge (CE) device.

SUMMARY STEPS

1. `configure`
2. `mpls ip-ttl-propagate disable [forwarded | local]`
3. `commit`

DETAILED STEPS

	Command or Action	Purpose
Step 1	<code>configure</code>	
Step 2	<p><code>mpls ip-ttl-propagate disable [forwarded local]</code></p> <p>Example:</p> <pre>RP/0/RP0/CPU0:router(config)# mpls ip-ttl-propagate disable forwarded</pre>	<p>Stops the propagation of IP TTL to and from the MPLS header. The example shows how to disable IP TTL propagation for forwarded MPLS packets.</p> <p>forwarded</p> <p>Prevents the traceroute command from showing the hops for the forwarded packets.</p> <p>local</p> <p>Prevents the traceroute command from showing the hops only for local packets.</p>
Step 3	<code>commit</code>	

Related Topics

[Time-to-Live Propagation in Hierarchical MPLS](#), on page 166

Configuring the Size of the Local Label

Perform this task to configure the dynamic range of local labels that are available on packet interfaces.

SUMMARY STEPS

1. `configure`
2. `mpls label range table table-id {minimum maximum}`
3. `commit`
4. `show mpls label range`

DETAILED STEPS

	Command or Action	Purpose
Step 1	<code>configure</code>	
Step 2	<p><code>mpls label range table <i>table-id</i> {<i>minimum</i> <i>maximum</i>}</code></p> <p>Example:</p> <pre>RP/0/RP0/CPU0:router(config)# mpls label range 16200 120000</pre>	<p>Configures the size of the local label space. The example shows how to configure the size of the local label space using a minimum of 16200 and a maximum of 120000.</p>

	Command or Action	Purpose
Step 3	<code>commit</code>	
Step 4	show mpls label range Example: <pre>RP/0/RP0/CPU0:router# show mpls label range</pre>	Displays the range of local labels available for use on packet interfaces.

Related Topics

[MPLS Forwarding Overview](#), on page 164

Additional References

For additional information related to implementing MPLS Forwarding, refer to the following references:

Related Documents**Standards**

Standards	Title
	—

MIBs

MIBs	MIBs Link
—	To locate and download MIBs using Cisco IOS XR software, use the Cisco MIB Locator found at the following URL and choose a platform under the Cisco Access Products menu: http://cisco.com/public/sw-center/netmgmt/cmtk/mibs.shtml

RFCs

RFCs	Title
RFC 3031	<i>Multiprotocol Label Switching Architecture</i>
RFC 3443	<i>Time to Live (TTL) Processing in Multi-Protocol Label Switching (MPLS) Networks</i>
RFC 4105	<i>Requirements for Inter-Area MPLS Traffic Engineering</i>



CHAPTER 6

Implementing MPLS Traffic Engineering

Multiprotocol Label Switching (MPLS) is a standards-based solution driven by the Internet Engineering Task Force (IETF) that was devised to convert the Internet and IP backbones from best-effort networks into business-class transport mediums.

MPLS, with its label switching capabilities, eliminates the need for an IP route look-up and creates a virtual circuit (VC) switching function, allowing enterprises the same performance on their IP-based network services as with those delivered over traditional networks such as Frame Relay or Asynchronous Transfer Mode (ATM).

MPLS traffic engineering (MPLS-TE) software enables an MPLS backbone to replicate and expand upon the TE capabilities of Layer 2 ATM and Frame Relay networks. MPLS is an integration of Layer 2 and Layer 3 technologies. By making traditional Layer 2 features available to Layer 3, MPLS enables traffic engineering. Thus, you can offer in a one-tier network what now can be achieved only by overlaying a Layer 3 network on a Layer 2 network.



Note The LMP and GMPLS-NNI features are not supported on PRP hardware.

Feature History for Implementing MPLS-TE

Release	Modification
Release 2.0	This feature was introduced.
Release 3.0	No modification.
Release 3.2	No modification.
Release 3.3.0	Support was added for Generalized MPLS.
Release 3.4.0	Support was added for Flexible Name-based Tunnel Constraints, Interarea MPLS-TE, MPLS-TE Forwarding Adjacency, GMPLS Protection and Restoration, and GMPLS Path Protection.
Release 3.4.1	Support was added for MPLS-TE and fast reroute link bundling.
Release 3.5.0	Support was added for Unequal Load Balancing, IS-IS IP Fast Reroute Loop-free Alternative routing functionality, and Path Computation Element (PCE).
Release 3.6.0	No modification.

Release	Modification
Release 3.7.0	Support was added for the following features: <ul style="list-style-type: none"> • Ignore Intermediate System-to-Intermediate System (IS-IS) overload bit setting in MPLS-TE. • MPLS-TE/Fast Reroute (FRR) over Virtual Local Area Network (VLAN) interfaces.
Release 3.8.0	Support was added for the following features: <ul style="list-style-type: none"> • MPLS-TE Automatic Bandwidth. • SRLG (Shared Risk Link Groups). • Policy Based Tunnel Selection (PBTs) IPv6 that includes the Interior Gateway Protocol (IGP) default path.
Release 3.9.0	The Point-to-Multipoint TE feature was added.
Release 4.0.0	Support was added for the following features: <ul style="list-style-type: none"> • AutoTunnel Backup • SRLG (Shared Risk Link Groups)
Release 4.1.0	Support was added for the following features: <ul style="list-style-type: none"> • Ignore Intermediate System-to-Intermediate System Overload Bit Setting in MPLS-TE
Release 4.1.1	The Auto-Tunnel Mesh feature was added.
Release 4.2.0	Support was added for the following features: <ul style="list-style-type: none"> • Soft-Preemption • Path Option Attributes
Release 4.2.1	The Auto-Tunnel Attribute-set feature was added for auto-backup tunnels.
Release 4.2.3	Support was added for the following features: <ul style="list-style-type: none"> • End-to-End TE Path Protection Enhancements — Explicit Path Protection and Co-existence of Path Protection with Fast Reroute • P2MP-TE Inter-area Enhancements
	Support was added for the following features: <ul style="list-style-type: none"> • P2MP-TE Auto-tunnels • Set DF Bit
Release 5.2.2	Make-Before-Break feature was added.
Release 6.1.2	Named Tunnel feature was added.

Release	Modification
Release 6.4.1	Enabling Forward Class Zero in PBTS feature was added.

- [Prerequisites for Implementing Cisco MPLS Traffic Engineering](#), on page 171
- [Information About Implementing MPLS Traffic Engineering](#), on page 171
- [How to Implement Traffic Engineering](#), on page 220
- [Configuration Examples for Cisco MPLS-TE](#), on page 331
- [Configure Entropy Labels for MPLS TE Networks](#), on page 359
- [Additional References](#), on page 360

Prerequisites for Implementing Cisco MPLS Traffic Engineering

These prerequisites are required to implement MPLS TE:

- You must be in a user group associated with a task group that includes the proper task IDs. The command reference guides include the task IDs required for each command. If you suspect user group assignment is preventing you from using a command, contact your AAA administrator for assistance.
- Router that runs Cisco IOS XR software .
- Installed composite mini-image and the MPLS package, or a full composite image.
- IGP activated.
- To configure Point-to-Multipoint (P2MP)-TE, a base set of RSVP and TE configuration parameters on ingress, midpoint, and egress nodes in the MPLS network is required. In addition, Point-to-Point (P2P) parameters are required.

Information About Implementing MPLS Traffic Engineering

To implement MPLS-TE, you should understand these concepts:

Overview of MPLS Traffic Engineering

MPLS-TE software enables an MPLS backbone to replicate and expand upon the traffic engineering capabilities of Layer 2 ATM and Frame Relay networks. MPLS is an integration of Layer 2 and Layer 3 technologies. By making traditional Layer 2 features available to Layer 3, MPLS enables traffic engineering. Thus, you can offer in a one-tier network what now can be achieved only by overlaying a Layer 3 network on a Layer 2 network.

MPLS-TE is essential for service provider and Internet service provider (ISP) backbones. Such backbones must support a high use of transmission capacity, and the networks must be very resilient so that they can withstand link or node failures. MPLS-TE provides an integrated approach to traffic engineering. With MPLS, traffic engineering capabilities are integrated into Layer 3, which optimizes the routing of IP traffic, given the constraints imposed by backbone capacity and topology.

Related Topics

[Configuring Forwarding over the MPLS-TE Tunnel](#) , on page 225

Benefits of MPLS Traffic Engineering

MPLS-TE enables ISPs to route network traffic to offer the best service to their users in terms of throughput and delay. By making the service provider more efficient, traffic engineering reduces the cost of the network.

Currently, some ISPs base their services on an overlay model. In the overlay model, transmission facilities are managed by Layer 2 switching. The routers see only a fully meshed virtual topology, making most destinations appear one hop away. If you use the explicit Layer 2 transit layer, you can precisely control how traffic uses available bandwidth. However, the overlay model has numerous disadvantages. MPLS-TE achieves the TE benefits of the overlay model without running a separate network and without a non-scalable, full mesh of router interconnects.

How MPLS-TE Works

MPLS-TE automatically establishes and maintains label switched paths (LSPs) across the backbone by using RSVP. The path that an LSP uses is determined by the LSP resource requirements and network resources, such as bandwidth. Available resources are flooded by means of extensions to a link-state-based Interior Gateway Protocol (IGP).

MPLS-TE tunnels are calculated at the LSP headend router, based on a fit between the required and available resources (constraint-based routing). The IGP automatically routes the traffic to these LSPs.

Typically, a packet crossing the MPLS-TE backbone travels on a single LSP that connects the ingress point to the egress point. MPLS-TE is built on these mechanisms:

Tunnel interfaces

From a Layer 2 standpoint, an MPLS tunnel interface represents the headend of an LSP. It is configured with a set of resource requirements, such as bandwidth and media requirements, and priority. From a Layer 3 standpoint, an LSP tunnel interface is the headend of a unidirectional virtual link to the tunnel destination.

MPLS-TE path calculation module

This calculation module operates at the LSP headend. The module determines a path to use for an LSP. The path calculation uses a link-state database containing flooded topology and resource information.

RSVP with TE extensions

RSVP operates at each LSP hop and is used to signal and maintain LSPs based on the calculated path.

MPLS-TE link management module

This module operates at each LSP hop, performs link call admission on the RSVP signaling messages, and performs bookkeeping on topology and resource information to be flooded.

Link-state IGP (Intermediate System-to-Intermediate System [IS-IS] or Open Shortest Path First [OSPF])—each with traffic engineering extensions

These IGPs are used to globally flood topology and resource information from the link management module.

Enhancements to the shortest path first (SPF) calculation used by the link-state IGP (IS-IS or OSPF)

The IGP automatically routes traffic to the appropriate LSP tunnel, based on tunnel destination. Static routes can also be used to direct traffic to LSP tunnels.

Label switching forwarding

This forwarding mechanism provides routers with a Layer 2-like ability to direct traffic across multiple hops of the LSP established by RSVP signaling.

One approach to engineering a backbone is to define a mesh of tunnels from every ingress device to every egress device. The MPLS-TE path calculation and signaling modules determine the path taken by the LSPs for these tunnels, subject to resource availability and the dynamic state of the network.

The IGP (operating at an ingress device) determines which traffic should go to which egress device, and steers that traffic into the tunnel from ingress to egress. A flow from an ingress device to an egress device might be so large that it cannot fit over a single link, so it cannot be carried by a single tunnel. In this case, multiple tunnels between a given ingress and egress can be configured, and the flow is distributed using load sharing among the tunnels.



Note GRE over MPLS-TE tunnel is not supported. Hence, you cannot carry GRE traffic over an LSP established for MPLS-TE tunnel using RSVP-TE. This restriction also applies to SR-TE tunnels.

Related Topics

[Building MPLS-TE Topology](#), on page 220

[Creating an MPLS-TE Tunnel](#), on page 222

[Build MPLS-TE Topology and Tunnels: Example](#), on page 331

MPLS Traffic Engineering

Multiprotocol Label Switching (MPLS) is an Internet Engineering Task Force (IETF)-specified framework that provides efficient designation, routing, forwarding, and switching of traffic flows through the network.

TE is the process of adjusting bandwidth allocations to ensure that enough bandwidth is available for high-priority traffic.

In MPLS TE, the upstream router creates a network tunnel for a particular traffic stream and sets the bandwidth available for that tunnel.

Backup AutoTunnels

The MPLS Traffic Engineering AutoTunnel Backup feature enables a router to dynamically build backup tunnels on the interfaces that are configured with MPLS TE tunnels. This feature enables a router to dynamically build backup tunnels when they are needed. This prevents you from having to build MPLS TE tunnels **statically**.

The MPLS Traffic Engineering (TE)—AutoTunnel Backup feature has these benefits:

- Backup tunnels are built automatically, eliminating the need for users to preconfigure each backup tunnel and then assign the backup tunnel to the protected interface.
- Protection is expanded—FRR does not protect IP traffic that is not using the TE tunnel or Label Distribution Protocol (LDP) labels that are not using the TE tunnel.

This feature protects against these failures:

- **P2P Tunnel NHOP protection**—Protects against link failure for the associated P2P protected tunnel
- **P2P Tunnel NNHOP protection**—Protects against node failure for the associated P2P protected tunnel

- **P2MP Tunnel NHOP protection**—Protects against link failure for the associated P2MP protected tunnel

Related Topics

[Enabling an AutoTunnel Backup](#), on page 231

[Removing an AutoTunnel Backup](#), on page 232

[Establishing MPLS Backup AutoTunnels to Protect Fast Reroutable TE LSPs](#), on page 232

[Establishing Next-Hop Tunnels with Link Protection](#), on page 233

[Configure the MPLS-TE Auto-Tunnel Backup: Example](#), on page 345

AutoTunnel Attribute-set

This feature supports auto-tunnels configuration using attribute templates, known as attribute-set. The TE attribute-set template that specifies a set of TE tunnel attributes, is locally configured at the head-end of auto-tunnels. The control plane triggers the automatic provisioning of a corresponding TE tunnel, whose characteristics are specified in the respective attribute-set.

Currently, auto-tunnel backups are created with the default values of all tunnel attributes. To support configurable attributes for auto-tunnel backup, it is required to configure attribute-set and assign it to the backup tunnels. The attribute-set consists of a set of tunnel attributes such as priority, affinity, signaled bandwidth, logging, policy-class, record-route and so on.

The following rules (consistent across all auto-tunnels) apply while configuring the attribute-set:

- If no attribute-set template is defined, the auto-tunnels is created using default attribute values.
- If an attribute-set is defined and the attribute-set template is already configured, the auto-tunnel is created using the attributes specified in the associated attribute-set.
- If an attribute-set is assigned, but it is not defined or configured, auto-tunnel is not created.
- Any number of attribute-sets can be configured with same attribute settings.
- Empty tunnel attribute implies all parameters have default values.
- When specific attribute is not specified in the attribute-set, a default value for that attribute is used.

Link Protection

The backup tunnels that bypass only a single link of the LSP path provide link protection. They protect LSPs, if a link along their path fails, by rerouting the LSP traffic to the next hop, thereby bypassing the failed link. These are referred to as NHOP backup tunnels because they terminate at the LSP's next hop beyond the point of failure.

This figure illustrates link protection.

Figure 12: Link Protection

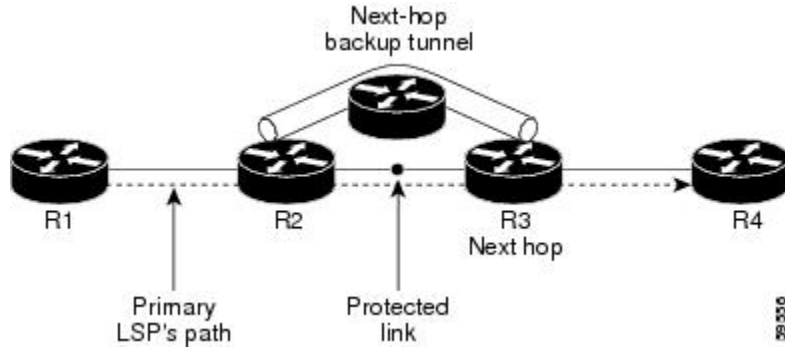

Node Protection

The backup tunnels that bypass next-hop nodes along LSP paths are called NNHOP backup tunnels because they terminate at the node following the next-hop node of the LSPs, thereby bypassing the next-hop node. They protect LSPs by enabling the node upstream of a link or node failure to reroute the LSPs and their traffic around a node failure to the next-hop node. NNHOP backup tunnels also provide protection from link failures because they bypass the failed link and the node.

This figure illustrates node protection.

Figure 13: Node Protection

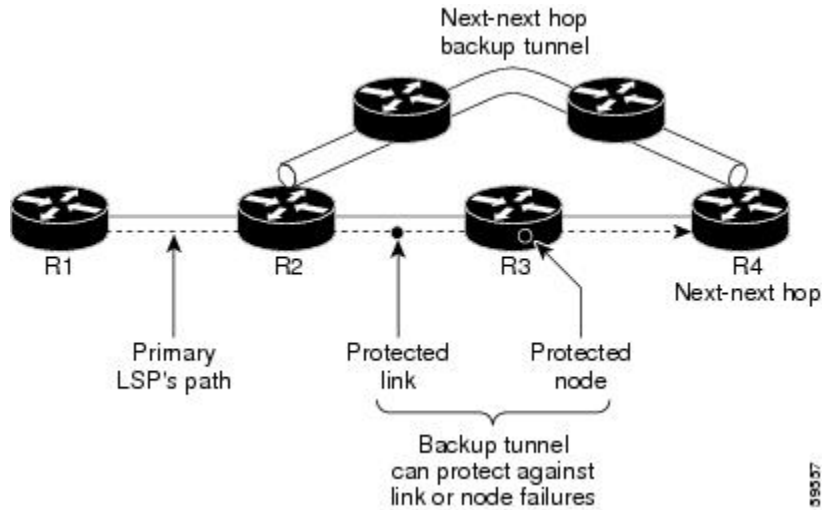

Backup AutoTunnel Assignment

At the head or mid points of a tunnel, the backup assignment finds an appropriate backup to protect a given primary tunnel for FRR protection.

The backup assignment logic is performed differently based on the type of backup configured on the output interface used by the primary tunnel. Configured backup types are:

- Static Backup
- AutoTunnel Backup

- No Backup (In this case no backup assignment is performed and the tunnels is unprotected.)



Note Static backup and Backup AutoTunnel cannot exist together on the same interface or link.



Note Node protection is always preferred over link protection in the Backup AutoTunnel assignment.

In order that the Backup AutoTunnel feature operates successfully, the following configuration must be applied at global configuration level:

```
ipv4 unnumbered mpls traffic-eng Loopback 0
```



Note The Loopback 0 is used as router ID.

Explicit Paths

Explicit paths are used to create backup autotunnels as follows:

For NHOP Backup Autotunnels:

- NHOP excludes the protected link's local IP address.
- NHOP excludes the protected link's remote IP address.
- The explicit-path name is `_autob_nhop_tunnelxxx`, where xxx matches the dynamically created backup tunnel ID.

For NNHOP Backup Autotunnels:

- NNHOP excludes the protected link's local IP address.
- NNHOP excludes the protected link's remote IP address (link address on next hop).
- NNHOP excludes the NHOP router ID of the protected primary tunnel next hop.
- The explicit-path name is `_autob_nnhop_tunnelxxx`, where xxx matches the dynamically created backup tunnel ID.

Periodic Backup Promotion

The periodic backup promotion attempts to find and assign a better backup for primary tunnels that are already protected.

With AutoTunnel Backup, the only scenario where two backups can protect the same primary tunnel is when both an NHOP and NNHOP AutoTunnel Backups get created. The backup assignment takes place as soon as the NHOP and NNHOP backup tunnels come up. So, there is no need to wait for the periodic promotion.

Although there is no exception for AutoTunnel Backups, periodic backup promotion has no impact on primary tunnels protected by AutoTunnel Backup.

One exception is when a manual promotion is triggered by the user using the **mpls traffic-eng fast-reroute timers promotion** command, where backup assignment or promotion is triggered on all FRR protected primary tunnels—even unprotected ones. This may trigger the immediate creation of some AutoTunnel Backup, if the command is entered within the time window when a required AutoTunnel Backup has not been yet created.

You can configure the periodic promotion timer using the global configuration **mpls traffic-eng fast-reroute timers promotion sec** command. The range is 0 to 604800 seconds.



Note A value of 0 for the periodic promotion timer disables the periodic promotion.

Protocol-Based CLI

Cisco IOS XR software provides a protocol-based command line interface. The CLI provides commands that can be used with the multiple IGP protocols supported by MPLS-TE.

Differentiated Services Traffic Engineering

MPLS Differentiated Services (Diff-Serv) Aware Traffic Engineering (DS-TE) is an extension of the regular MPLS-TE feature. Regular traffic engineering does not provide bandwidth guarantees to different traffic classes. A single bandwidth constraint is used in regular TE that is shared by all traffic. To support various classes of service (CoS), users can configure multiple bandwidth constraints. These bandwidth constraints can be treated differently based on the requirement for the traffic class using that constraint.

MPLS DS-TE provides the ability to configure multiple bandwidth constraints on an MPLS-enabled interface. Available bandwidths from all configured bandwidth constraints are advertised using IGP. TE tunnel is configured with bandwidth value and class-type requirements. Path calculation and admission control take the bandwidth and class-type into consideration. RSVP is used to signal the TE tunnel with bandwidth and class-type requirements.

MPLS DS-TE is deployed with either Russian Doll Model (RDM) or Maximum Allocation Model (MAM) for bandwidth calculations.

Cisco IOS XR software supports two DS-TE modes: Prestandard and IETF.

Related Topics

[Confirming DiffServ-TE Bandwidth](#), on page 138

[Bandwidth Configuration \(MAM\): Example](#), on page 155

[Bandwidth Configuration \(RDM\): Example](#), on page 155

Prestandard DS-TE Mode

Prestandard DS-TE uses the Cisco proprietary mechanisms for RSVP signaling and IGP advertisements. This DS-TE mode does not interoperate with third-party vendor equipment. Note that prestandard DS-TE is enabled only after configuring the sub-pool bandwidth values on MPLS-enabled interfaces.

Prestandard Diff-Serve TE mode supports a single bandwidth constraint model a Russian Doll Model (RDM) with two bandwidth pools: global-pool and sub-pool.

TE class map is not used with Prestandard DS-TE mode.

Related Topics

[Configuring a Prestandard DS-TE Tunnel](#), on page 235

[Configure IETF DS-TE Tunnels: Example](#), on page 332

IETF DS-TE Mode

IETF DS-TE mode uses IETF-defined extensions for RSVP and IGP. This mode interoperates with third-party vendor equipment.

IETF mode supports multiple bandwidth constraint models, including RDM and MAM, both with two bandwidth pools. In an IETF DS-TE network, identical bandwidth constraint models must be configured on all nodes.

TE class map is used with IETF DS-TE mode and must be configured the same way on all nodes in the network.

Bandwidth Constraint Models

IETF DS-TE mode provides support for the RDM and MAM bandwidth constraints models. Both models support up to two bandwidth pools.

Cisco IOS XR software provides global configuration for the switching between bandwidth constraint models. Both models can be configured on a single interface to preconfigure the bandwidth constraints before swapping to an alternate bandwidth constraint model.



Note NSF is not guaranteed when you change the bandwidth constraint model or configuration information.

By default, RDM is the default bandwidth constraint model used in both pre-standard and IETF mode.

Maximum Allocation Bandwidth Constraint Model

The MAM constraint model has the following characteristics:

- Easy to use and intuitive.
- Isolation across class types.
- Simultaneously achieves isolation, bandwidth efficiency, and protection against QoS degradation.

Related Topics

[Configuring an IETF DS-TE Tunnel Using MAM](#), on page 238

Russian Doll Bandwidth Constraint Model

The RDM constraint model has these characteristics:

- Allows greater sharing of bandwidth among different class types.
- Ensures bandwidth efficiency simultaneously and protection against QoS degradation of all class types.
- Specifies that it is used in conjunction with preemption to simultaneously achieve isolation across class-types such that each class-type is guaranteed its share of bandwidth, bandwidth efficiency, and protection against QoS degradation of all class types.



Note We recommend that RDM not be used in DS-TE environments in which the use of preemption is precluded. Although RDM ensures bandwidth efficiency and protection against QoS degradation of class types, it does guarantee isolation across class types.

Related Topics

[Configuring an IETF DS-TE Tunnel Using RDM](#), on page 236

TE Class Mapping

Each of the eight available bandwidth values advertised in the IGP corresponds to a TE class. Because the IGP advertises only eight bandwidth values, there can be a maximum of only eight TE classes supported in an IETF DS-TE network.

TE class mapping must be exactly the same on all routers in a DS-TE domain. It is the responsibility of the operator configure these settings properly as there is no way to automatically check or enforce consistency.

The operator must configure TE tunnel class types and priority levels to form a valid TE class. When the TE class map configuration is changed, tunnels already up are brought down. Tunnels in the down state, can be set up if a valid TE class map is found.

The default TE class and attributes are listed. The default mapping includes four class types.

Table 5: TE Classes and Priority

TE Class	Class Type	Priority
0	0	7
1	1	7
2	Unused	—
3	Unused	—
4	0	0
5	1	0
6	Unused	—
7	Unused	—

Flooding

Available bandwidth in all configured bandwidth pools is flooded on the network to calculate accurate constraint paths when a new TE tunnel is configured. Flooding uses IGP protocol extensions and mechanisms to determine when to flood the network with bandwidth.

Flooding Triggers

TE Link Management (TE-Link) notifies IGP for both global pool and sub-pool available bandwidth and maximum bandwidth to flood the network in these events:

- Periodic timer expires (this does not depend on bandwidth pool type).
- Tunnel origination node has out-of-date information for either available global pool or sub-pool bandwidth, causing tunnel admission failure at the midpoint.
- Consumed bandwidth crosses user-configured thresholds. The same threshold is used for both global pool and sub-pool. If one bandwidth crosses the threshold, both bandwidths are flooded.

Flooding Thresholds

Flooding frequently can burden a network because all routers must send out and process these updates. Infrequent flooding causes tunnel heads (tunnel-originating nodes) to have out-of-date information, causing tunnel admission to fail at the midpoints.

You can control the frequency of flooding by configuring a set of thresholds. When locked bandwidth (at one or more priority levels) crosses one of these thresholds, flooding is triggered.

Thresholds apply to a percentage of the maximum available bandwidth (the global pool), which is locked, and the percentage of maximum available guaranteed bandwidth (the sub-pool), which is locked. If, for one or more priority levels, either of these percentages crosses a threshold, flooding is triggered.



Note Setting up a global pool TE tunnel can cause the locked bandwidth allocated to sub-pool tunnels to be reduced (and hence to cross a threshold). A sub-pool TE tunnel setup can similarly cause the locked bandwidth for global pool TE tunnels to cross a threshold. Thus, sub-pool TE and global pool TE tunnels can affect each other when flooding is triggered by thresholds.

Fast Reroute

Fast Reroute (FRR) provides link protection to LSPs enabling the traffic carried by LSPs that encounter a failed link to be rerouted around the failure. The reroute decision is controlled locally by the router connected to the failed link. The headend router on the tunnel is notified of the link failure through IGP or through RSVP. When it is notified of a link failure, the headend router attempts to establish a new LSP that bypasses the failure. This provides a path to reestablish links that fail, providing protection to data transfer.

FRR (link or node) is supported over sub-pool tunnels the same way as for regular TE tunnels. In particular, when link protection is activated for a given link, TE tunnels eligible for FRR are redirected into the protection LSP, regardless of whether they are sub-pool or global pool tunnels.



Note The ability to configure FRR on a per-LSP basis makes it possible to provide different levels of fast restoration to tunnels from different bandwidth pools.

You should be aware of these requirements for the backup tunnel path:

- Backup tunnel must not pass through the element it protects.

- Primary tunnel and a backup tunnel should intersect at least at two points (nodes) on the path: point of local repair (PLR) and merge point (MP). PLR is the headend of the backup tunnel, and MP is the tailend of the backup tunnel.



Note When you configure TE tunnel with multiple protection on its path and merge point is the same node for more than one protection, you must configure record-route for that tunnel.



Note If FRR is greater than 50ms, it might lead to a loss of traffic.

Related Topics

[Protecting MPLS Tunnels with Fast Reroute](#), on page 227

IS-IS IP Fast Reroute Loop-free Alternative

For bandwidth protection, there must be sufficient backup bandwidth available to carry primary tunnel traffic. Use the **ipfrr lfa** command to compute loop-free alternates for all links or neighbors in the event of a link or node failure. To enable node protection on broadcast links, IPRR and bidirectional forwarding detection (BFD) must be enabled on the interface under IS-IS.



Note MPLS FRR and IPFRR cannot be configured on the same interface at the same time.

For information about configuring BFD, see *Cisco IOS XR Interface and Hardware Configuration Guide for the Cisco CRS-1 Router*.

MPLS-TE and Fast Reroute over Link Bundles

MPLS Traffic Engineering (TE) and Fast Reroute (FRR) are supported over bundle interfaces. MPLS-TE/FRR over virtual local area network (VLAN) interfaces is supported. Bidirectional forwarding detection (BFD) over VLAN is used as an FRR trigger to obtain less than 50 milliseconds of switchover time.

These link bundle types are supported for MPLS-TE/FRR:

- Over POS link bundles.
- Over Ethernet link bundles.
- Over VLANs over Ethernet link bundles.
- Number of links are limited to 100 for MPLS-TE and FRR.
- VLANs go over any Ethernet interface (for example, GigabitEthernet, TenGigE, and FastEthernet, so forth).

FRR is supported over bundle interfaces in the following ways:

- Uses minimum links as a threshold to trigger FRR over a bundle interface.

- Uses the minimum total available bandwidth as a threshold to trigger FRR.

Ignore Intermediate System-to-Intermediate System Overload Bit Setting in MPLS-TE

The Ignore Intermediate System-to-Intermediate System (IS-IS) overload bit avoidance feature allows network administrators to prevent RSVP-TE label switched paths (LSPs) from being disabled, when a router in that path has its Intermediate System-to-Intermediate System (IS-IS) overload bit set.

The IS-IS overload bit avoidance feature is activated using this command:

```
mpls traffic-eng path-selection ignore overload
```

The IS-IS overload bit avoidance feature is deactivated using the **no** form of this command:

```
no mpls traffic-eng path-selection ignore overload
```

When the IS-IS overload bit avoidance feature is activated, all nodes, including head nodes, mid nodes, and tail nodes, with the overload bit set, are ignored. This means that they are still available for use with RSVP-TE label switched paths (LSPs). This feature enables you to include an overloaded node in CSPF.

Enhancement Options of IS-IS OLA

You can restrict configuring IS-IS overload bit avoidance with the following enhancement options:

- **path-selection ignore overload head**

The tunnels stay up if **set-overload-bit** is set by IS-IS on the head router. Ignores overload during CSPF for LSPs originating from an overloaded node. In all other cases (mid, tail, or both), the tunnel stays down.

- **path-selection ignore overload mid**

The tunnels stay up if **set-overload-bit** is set by IS-IS on the mid router. Ignores overload during CSPF for LSPs transiting from an overloaded node. In all other cases (head, tail, or both), the tunnel stays down.

- **path-selection ignore overload tail**

The tunnels stay up if **set-overload-bit** is set by IS-IS on the tail router. Ignores overload during CSPF for LSPs terminating at an overloaded node. In all other cases (head, mid, or both), the tunnel stays down.

- **path-selection ignore overload**

The tunnels stay up irrespective of on which router the **set-overload-bit** is set by IS-IS.



Note When you do not select any of the options, including head nodes, mid nodes, and tail nodes, you get a behavior that is applicable to all nodes. This behavior is backward compatible in nature.

For more information related to IS-IS overload avoidance related commands, see *MPLS Command Reference for the Cisco CRS Router*.

Related Topics

- [Configuring the Ignore Integrated IS-IS Overload Bit Setting in MPLS-TE](#), on page 242
- [Configure the Ignore IS-IS Overload Bit Setting in MPLS-TE: Example](#), on page 333

DWDM Transponder Integration

A GMPLS UNI based solution preserves all the advantages of the integration of the DWDM transponder into the router blade. These advantages include:

- improved CAPEX and OPEX models
- component, space and power savings
- improved IP availability through pro-active protection.

GMPLS Benefits

GMPLS bridges the IP and photonic layers, thereby making possible interoperable and scalable parallel growth in the IP and photonic dimensions.

This allows for rapid service deployment and operational efficiencies, as well as for increased revenue opportunities. A smooth transition becomes possible from a traditional segregated transport and service overlay model to a more unified peer model.

By streamlining support for multiplexing and switching in a hierarchical fashion, and by utilizing the flexible intelligence of MPLS-TE, optical switching GMPLS becomes very helpful for service providers wanting to manage large volumes of traffic in a cost-efficient manner.

GMPLS Support

GMPLS-TE provides support for:

- Open Shortest Path First (OSPF) for bidirectional TE tunnel
- Frame, lambda, and port (fiber) labels
- Numbered or Unnumbered links
- OSPF extensions—Route computation with optical constraints
- RSVP extensions—Graceful Restart
- Graceful deletion
- LSP hierarchy
- Peer model
- Border model Control plane separation
- Interarea or AS-Verbatim
- BGP4 or MPLS
- Restoration—Dynamic path computation
- Control channel manager

- Link summary
- Protection and restoration

Related Topics

[Configuring Router IDs](#), on page 243

[Configuring OSPF over IPCC](#), on page 245

GMPLS Protection and Restoration

GMPLS provides protection against failed channels (or links) between two adjacent nodes (span protection) and end-to-end dedicated protection (path protection). After the route is computed, signaling to establish the backup paths is carried out through RSVP-TE or CR-LDP. For span protection, 1+1 or M:N protection schemes are provided by establishing secondary paths through the network. In addition, you can use signaling messages to switch from the failed primary path to the secondary path.



Note Only 1:1 end-to-end path protection is supported.

The restoration of a failed path refers to the dynamic establishment of a backup path. This process requires the dynamic allocation of resources and route calculation. The following restoration methods are described:

- Line restoration—Finds an alternate route at an intermediate node.
- Path restoration—Initiates at the source node to route around a failed path within the path for a specific LSP.

Restoration schemes provide more bandwidth usage, because they do not preallocate any resource for an LSP. GMPLS combines MPLS-FRR and other types of protection, such as SONET/SDH and wavelength.

In addition to SONET alarms in POS links, protection and restoration is also triggered by bidirectional forwarding detection (BFD).

1:1 LSP Protection

When one specific protecting LSP or span protects one specific working LSP or span, 1:1 protection scheme occurs. However, normal traffic is transmitted only over one LSP at a time for working or recovery.

1:1 protection with extra traffic refers to the scheme in which extra traffic is carried over a protecting LSP when the protecting LSP is not being used for the recovery of normal traffic. For example, the protecting LSP is in standby mode. When the protecting LSP is required to recover normal traffic from the failed working LSP, the extra traffic is preempted. Extra traffic is not protected, but it can be restored. Extra traffic is transported using the protected LSP resources.

Shared Mesh Restoration and M:N Path Protection

Both shared mesh restoration and M:N (1:N is more practical) path protection offers sharing for protection resources for multiple working LSPs. For 1:N protection, a specific protecting LSP is dedicated to the protection of up to N working LSPs and spans. Shared mesh is defined as preplanned LSP rerouting, which reduces the restoration resource requirements by allowing multiple restoration LSPs to be initiated from distinct ingress nodes to share common resources, such as links and nodes.

End-to-end Recovery

End-to-end recovery refers to an entire LSP from the source for an ingress router endpoint to the destination for an egress router endpoint.

GMPLS Protection Requirements

The GMPLS protection requirements are specific to the protection scheme that is enabled at the data plane. For example, SONET APS or MPLS-FRR are identified as the data level for GMPLS protection.

GMPLS Prerequisites

The following prerequisites are required to implement GMPLS on Cisco IOS XR software:

- You must be in a user group associated with a task group that includes the proper task IDs for **GMPLS** commands.
- Router that runs Cisco IOS XR software.
- Installation of the Cisco IOS XR softwaremini-image on the router.

Flexible Name-based Tunnel Constraints

MPLS-TE Flexible Name-based Tunnel Constraints provides a simplified and more flexible means of configuring link attributes and path affinities to compute paths for MPLS-TE tunnels.

In the traditional TE scheme, links are configured with attribute-flags that are flooded with TE link-state parameters using Interior Gateway Protocols (IGPs), such as Open Shortest Path First (OSPF).

MPLS-TE Flexible Name-based Tunnel Constraints lets you assign, or map, up to 32 color names for affinity and attribute-flag attributes instead of 32-bit hexadecimal numbers. After mappings are defined, the attributes can be referred to by the corresponding color name in the command-line interface (CLI). Furthermore, you can define constraints using *include*, *include-strict*, *exclude*, and *exclude-all* arguments, where each statement can contain up to 10 colors, and define include constraints in both loose and strict sense.



Note You can configure affinity constraints using attribute flags or the Flexible Name Based Tunnel Constraints scheme; however, when configurations for both schemes exist, only the configuration pertaining to the new scheme is applied.

Related Topics

- [Assigning Color Names to Numeric Values](#), on page 264
- [Associating Affinity-Names with TE Links](#), on page 265
- [Associating Affinity Constraints for TE Tunnels](#), on page 266
- [Configure Flexible Name-based Tunnel Constraints: Example](#), on page 336

MPLS Traffic Engineering Interarea Tunneling

These topics describe the following new extensions of MPLS-TE:

- [Interarea Support](#), on page 186

- [Multiarea Support, on page 186](#)
- [Loose Hop Expansion, on page 187](#)
- [Loose Hop Reoptimization, on page 187](#)
- [Fast Reroute Node Protection, on page 188](#)

Interarea Support

The MPLS-TE interarea tunneling feature allows you to establish P2P and P2MP TE tunnels spanning multiple Interior Gateway Protocol (IGP) areas and levels, thereby eliminating the requirement that headend and tailend routers reside in a single area.

Interarea support allows the configuration of a TE LSP that spans multiple areas, where its headend and tailend label switched routers (LSRs) reside in different IGP areas.

Multiarea and Interarea TE are required by the customers running multiple IGP area backbones (primarily for scalability reasons). This lets you limit the amount of flooded information, reduces the SPF duration, and lessens the impact of a link or node failure within an area, particularly with large WAN backbones split in multiple areas.

Figure 14: Interarea (OSPF) TE Network Diagram

This figure shows a typical interarea TE network.

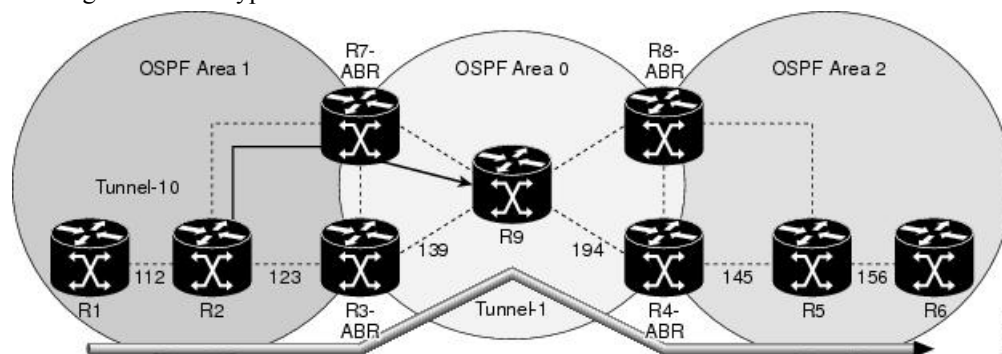

Multiarea Support

Multiarea support allows an area border router (ABR) LSR to support MPLS-TE in more than one IGP area. A TE LSP is still confined to a single area.

Multiarea and Interarea TE are required when you run multiple IGP area backbones. The Multiarea and Interarea TE allows you to:

- Limit the volume of flooded information.
- Reduce the SPF duration.
- Decrease the impact of a link or node failure within an area.

Figure 15: Interlevel (IS-IS) TE Network

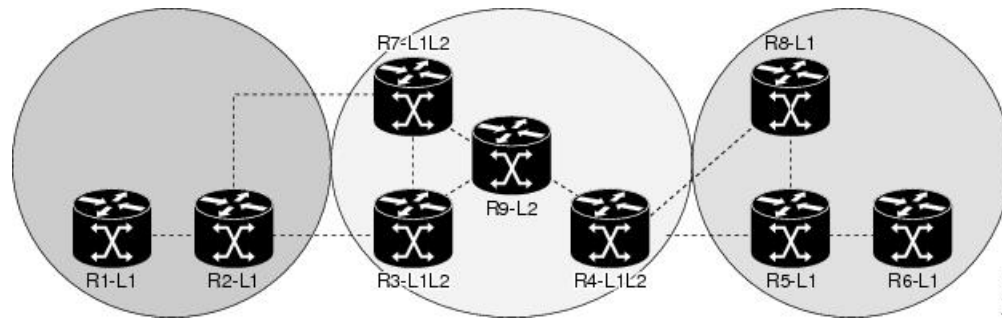

As shown in the figure, R2, R3, R7, and R4 maintain two databases for routing and TE information. For example, R3 has TE topology information related to R2, flooded through Level-1 IS-IS LSPs plus the TE topology information related to R4, R9, and R7, flooded as Level 2 IS-IS Link State PDUs (LSPs) (plus, its own IS-IS LSP).



Note You can configure multiple areas within an IS-IS Level 1. This is transparent to TE. TE has topology information about the IS-IS level, but not the area ID.

Loose Hop Expansion

Loose hop optimization allows the reoptimization of tunnels spanning multiple areas and solves the problem which occurs when an MPLS-TE LSP traverses hops that are not in the LSP's headend's OSPF area and IS-IS level.

Interarea MPLS-TE allows you to configure an interarea traffic engineering (TE) label switched path (LSP) by specifying a loose source route of ABRs along the path. It is then the responsibility of the ABR (having a complete view of both areas) to find a path obeying the TE LSP constraints within the next area to reach the next hop ABR (as specified on the headend). The same operation is performed by the last ABR connected to the tailend area to reach the tailend LSR.

For P2MP-TE tunnels, ABRs support loose hop ERO expansion to find path to the next ABR until it reaches to the tail-end LSR, without introducing remerge.

You must be aware of these considerations when using loose hop optimization:

- You must specify the router ID of the ABR node (as opposed to a link address on the ABR).
- When multiarea is deployed in a network that contains subareas, you must enable MPLS-TE in the subarea for TE to find a path when loose hop is specified.
- You must specify the reachable explicit path for the interarea tunnel.

Loose Hop Reoptimization

Loose hop reoptimization allows the reoptimization of the tunnels spanning multiple areas and solves the problem which occurs when an MPLS-TE headend does not have visibility into other IGP areas.

Whenever the headend attempts to reoptimize a tunnel, it tries to find a better path to the ABR in the headend area. If a better path is found then the headend initiates the setup of a new LSP. In case a suitable path is not found in the headend area, the headend initiates a querying message. The purpose of this message is to query

the ABRs in the areas other than the headend area to check if there exist any better paths in those areas. The purpose of this message is to query the ABRs in the areas other than the headend area, to check if a better path exists. If a better path does not exist, ABR forwards the query to the next router downstream. Alternatively, if better path is found, ABR responds with a special Path Error to the headend to indicate the existence of a better path outside the headend area. Upon receiving the Path Error that indicates the existence of a better path, the headend router initiates the reoptimization.

ABR Node Protection

Because one IGP area does not have visibility into another IGP area, it is not possible to assign backup to protect ABR node. To overcome this problem, node ID sub-object is added into the record route object of the primary tunnel so that at a PLR node, backup destination address can be checked against primary tunnel record-route object and assign a backup tunnel.

Fast Reroute Node Protection

If a link failure occurs within an area, the upstream router directly connected to the failed link generates an RSVP path error message to the headend. As a response to the message, the headend sends an RSVP path tear message and the corresponding path option is marked as invalid for a specified period and the next path-option (if any) is evaluated.

To retry the ABR immediately, a second path option (identical to the first one) should be configured. Alternatively, the retry period (path-option hold-down, 2 minutes by default) can be tuned to achieve a faster retry.

Related Topics

[Protecting MPLS Tunnels with Fast Reroute](#), on page 227

Make-Before-Break

The MPLS TE Make-Before-Break (MBB) explicit path and path option feature allows tunnels whose explicit paths or path options are modified to be reoptimized without losing any data. An explicit path or a path option modification is entirely configuration driven. Any change to an in-use path option or an in-use explicit path of a tunnel triggers the MBB procedure.

MBB lets the LSP hold on to the existing resources until the new path is successfully established and traffic has been directed over to the new LSP before the original LSP is torn down. This ensures that no data packets are lost during the transition to the new LSP.

With this feature the flapping of tunnels whose explicit paths or path options are modified, is avoided. This feature is enabled by default.

MPLS-TE Forwarding Adjacency

The MPLS-TE Forwarding Adjacency feature allows a network administrator to handle a traffic engineering, label-switched path (LSP) tunnel as a link in an Interior Gateway Protocol (IGP) network based on the Shortest Path First (SPF) algorithm. A forwarding adjacency can be created between routers regardless of their location in the network.

MPLS-TE Forwarding Adjacency Benefits

TE tunnel interfaces are advertised in the IGP network just like any other links. Routers can then use these advertisements in their IGPs to compute the SPF even if they are not the head end of any TE tunnels.

Related Topics

[Configuring MPLS-TE Forwarding Adjacency](#), on page 270

[Configure Forwarding Adjacency: Example](#), on page 339

MPLS-TE Forwarding Adjacency Restrictions

The MPLS-TE Forwarding Adjacency feature has these restrictions:

- Using the MPLS-TE Forwarding Adjacency increases the size of the IGP database by advertising a TE tunnel as a link.
- The MPLS-TE Forwarding Adjacency is supported by Intermediate System-to-Intermediate System (IS-IS).
- When the MPLS-TE Forwarding Adjacency is enabled on a TE tunnel, the link is advertised in the IGP network as a Type-Length-Value (TLV) 22 without any TE sub-TLV.
- MPLS-TE forwarding adjacency tunnels must be configured bidirectionally.
- Multicast intact is not supported with MPLS-TE Forwarding Adjacency.

MPLS-TE Forwarding Adjacency Prerequisites

Your network must support the following features before enabling the MPLS -TE Forwarding Adjacency feature:

- MPLS
- IP Cisco Express Forwarding
- Intermediate System-to-Intermediate System (IS-IS)
- OSPF

Unequal Load Balancing

Unequal load balancing permits the routing of unequal proportions of traffic through tunnels to a common destination. Load shares on tunnels to the same destination are determined by TE from the tunnel configuration and passed through the MPLS Label Switching Database (LSD) to the Forwarding Information Base (FIB).



Note Load share values are renormalized by the FIB using values suitable for use by the forwarding code. The exact traffic ratios observed may not, therefore, exactly mirror the configured traffic ratios. This effect is more pronounced if there are many parallel tunnels to a destination, or if the load shares assigned to those tunnels are very different. The exact renormalization algorithm used is platform-dependent.

There are two ways to configure load balancing:

Explicit configuration

Using this method, load shares are explicitly configured on each tunnel.

Bandwidth configuration

If a tunnel is not configured with load-sharing parameters, the tunnel bandwidth and load-share values are considered equivalent for load-share calculations between tunnels, and a direct comparison between bandwidth and load-share configuration values is calculated.



Note Load shares are not dependent on any configuration other than the load share and bandwidth configured on the tunnel and the state of the global configuration switch.

Related Topics

[Setting Unequal Load Balancing Parameters](#), on page 271

[Enabling Unequal Load Balancing](#), on page 272

[Configure Unequal Load Balancing: Example](#), on page 339

Path Computation Element

Path Computation Element (PCE) solves the specific issue of inter-domain path computation for MPLS-TE label switched path (LSPs), when the head-end router does not possess full network topology information (for example, when the head-end and tail-end routers of an LSP reside in different IGP areas).

PCE uses area border routers (ABRs) to compute a TE LSP spanning multiple IGP areas as well as computation of Inter-AS TE LSP.

PCE is usually used to define an overall architecture, which is made of several components, as follows:

Path Computation Element (PCE)

Represents a software module (which can be a component or application) that enables the router to compute paths applying a set of constraints between any pair of nodes within the router's TE topology database. PCEs are discovered through IGP.

Path Computation Client (PCC)

Represents a software module running on a router that is capable of sending and receiving path computation requests and responses to and from PCEs. The PCC is typically an LSR (Label Switching Router).

PCC-PCE communication protocol (PCEP)

Specifies that PCEP is a TCP-based protocol defined by the IETF PCE WG, and defines a set of messages and objects used to manage PCEP sessions and to request and send paths for multi-domain TE LSPs. PCEP is used for communication between PCC and PCE (as well as between two PCEs) and employs IGP extensions to dynamically discover PCE.

Figure 16: Path Computation Element Network Diagram

This figure shows a typical PCE implementation.

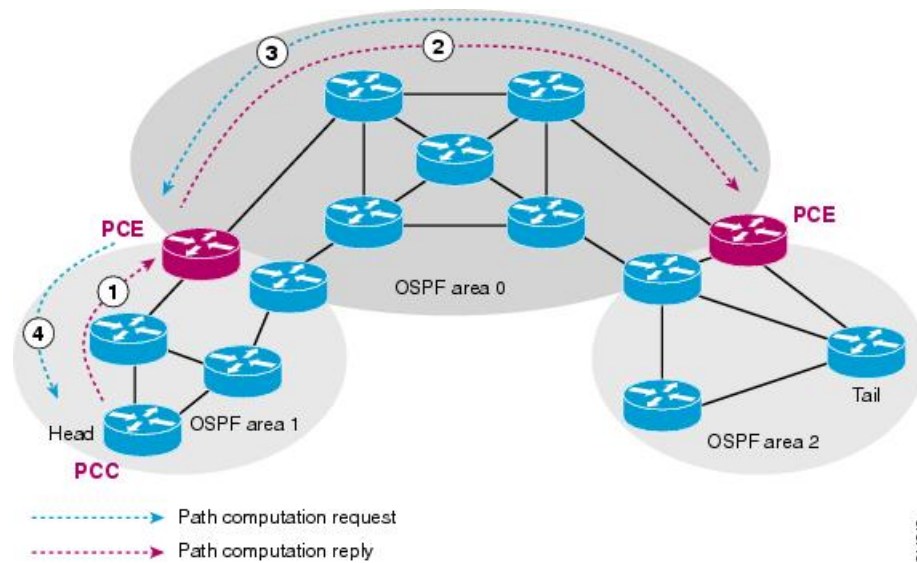

Path computation elements provides support for the following message types and objects:

- Message types: Open, PCReq, PCRep, PCErr, Close
- Objects: OPEN, CLOSE, RP, END-POINT, LSPA, BANDWIDTH, METRIC, and NO-PATH

Related Topics

- [Configuring a Path Computation Client](#), on page 273
- [Configuring a Path Computation Element Address](#), on page 274
- [Configuring PCE Parameters](#), on page 275
- [Configure PCE: Example](#), on page 340

Policy-Based Tunnel Selection

These topics provide information about policy-based tunnel selection (PBTS):

Policy-Based Tunnel Selection

Policy-Based Tunnel Selection (PBTS) provides a mechanism that lets you direct traffic into specific TE tunnels based on different criteria. PBTS will benefit Internet service providers (ISPs) who carry voice and data traffic through their MPLS and MPLS/VPN networks, who want to route this traffic to provide optimized voice service.

PBTS works by selecting tunnels based on the classification criteria of the incoming packets, which are based on the IP precedence, experimental (EXP), or type of service (ToS) field in the packet. When there are no paths with a default class configured, this traffic is forwarded using the paths with the lowest class value. PBTS supports up to seven (exp 1 - 7) EXP values associated with a single TE tunnel.

Figure 17: Policy-Based Tunnel Selection Implementation

This figure illustrates a PBTS implementation.

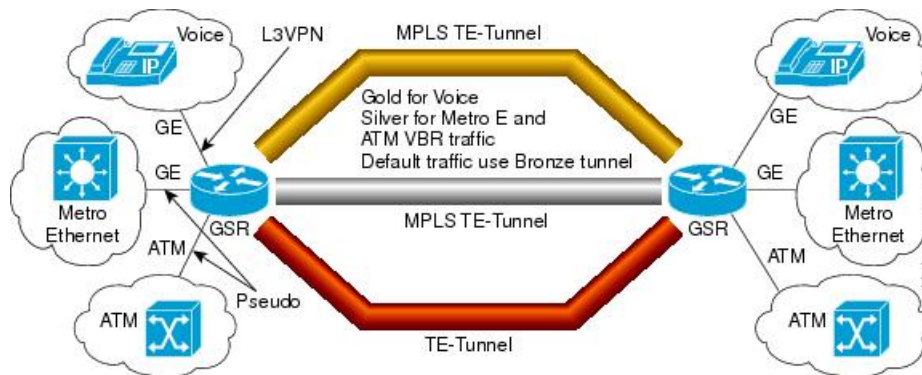

Related Topics

[Configuring Policy-based Tunnel Selection](#), on page 277

Policy-Based Tunnel Selection Functions

The following PBTS functions are supported:

- IPv4 traffic arrives unlabeled on the VRF interface and the non-VRF interface.
- MPLS traffic is supported on the VRF interface and the non-VRF interface.
- Load balancing across multiple TE tunnels with the same traffic class attribute is supported.
- Selected TE tunnels are used to service the lowest tunnel class as default tunnels.
- LDP over TE tunnel and single-hop TE tunnel are supported.
- Both Interior Gateway Protocol (IGP) and Label Distribution Protocol (LDP) paths are used as the default path for all traffic that belongs to a class that is not configured on the TE tunnels.
- According to the quality-of-service (QoS) policy, tunnel selection is based on the outgoing experimental (EXP) value and the remarked EXP value.
- L2VPN preferred path selection lets traffic be directed to a particular TE tunnel.
- IPv6 traffic for both 6VPE and 6PE scenarios are supported.

Related Topics

[Configuring Policy-based Tunnel Selection](#), on page 277

PBTS Restrictions

When implementing PBTS, the following restrictions are listed:

- When QoS EXP remarking on an interface is enabled, the EXP value is used to determine the egress tunnel interface, not the incoming EXP value.
- Egress-side remarking does not affect PBTS tunnel selection.
- When no default tunnel is available for forwarding, traffic is dropped.

Enabling Forward Class Zero in PBTS

This PBTS feature enhancement allows you to configure forward class zero or the default class as a PBTS forwarding class effective with Cisco IOS-XR release 6.4.1. Earlier, only values from one to seven were configurable as PBTS forwarding classes.

Set DF Bit

The Set DF Bit feature enables to apply 'set df (do not fragment)' policy to an interface. Any packet that matches with the set df policy will either clear the bit or set the bit.

The set df bit policy can be enabled to clear the df bit before forwarding the packet in IPv4 traffic.

For more information on Set DF Bit, see the *Implementing MPLS Traffic Engineering* chapter in the *MPLS Configuration Guide for the Cisco CRS Routers*. For more information on Set DF Bit commands, see the *MPLS Traffic Engineering Commands* chapter in the *MPLS Command Reference for the Cisco CRS Router*.

Path Protection

Path protection provides an end-to-end failure recovery mechanism (that is, a full path protection) for MPLS-TE tunnels. A secondary Label Switched Path (LSP) is established, in advance, to provide failure protection for the protected LSP that is carrying a tunnel's TE traffic. When there is a failure on the protected LSP, the source router immediately enables the secondary LSP to temporarily carry the tunnel's traffic. If there is a failure on the secondary LSP, the tunnel no longer has path protection until the failure along the secondary path is cleared. Path protection can be used within a single area (OSPF or IS-IS), external BGP [eBGP], and static routes.

The failure detection mechanisms triggers a switchover to a secondary tunnel by:

- Path error or resv-tear from Resource Reservation Protocol (RSVP) signaling
- Notification from the Bidirectional Forwarding Detection (BFD) protocol that a neighbor is lost
- Notification from the Interior Gateway Protocol (IGP) that the adjacency is down
- Local teardown of the protected tunnel's LSP due to preemption in order to signal higher priority LSPs, a Packet over SONET (POS) alarm, online insertion and removal (OIR), and so on

An alternate recovery mechanism is Fast Reroute (FRR), which protects MPLS-TE LSPs only from link and node failures, by locally repairing the LSPs at the point of failure. Co-existence of FRR and path protection is supported; this means FRR and path-protection can be configured on the same tunnel at the same time.

Although not as fast as link or node protection, presignaling a secondary LSP is faster than configuring a secondary primary path option, or allowing the tunnel's source router to dynamically recalculate a path. The actual recovery time is topology-dependent, and affected by delay factors such as propagation delay or switch fabric latency.

Related Topics

[Configure Tunnels for Path Protection: Example](#), on page 341

Pre-requisites for Path Protection

These are the pre-requisites for enabling path protection:

- Ensure that your network supports MPLS-TE, Cisco Express Forwarding, and Intermediate System-to-Intermediate System (IS-IS) or Open Shortest Path First (OSPF).

- Enable MPLS.
- Configure TE on the routers.
- Configure a TE tunnel with a dynamic path option by using the **path-option** command with the **dynamic** keyword.

Related Topics

[Configure Tunnels for Path Protection: Example](#), on page 341

Restrictions for Path Protection

- Only Point-to-Point (P2P) tunnels are supported.
- Point-to-Multipoint (P2MP) TE tunnels are not supported.
- A maximum of one standby LSP is supported.
- There can be only one secondary path for each dynamic path option.
- Explicit path option can be configured for the path protected TE with the secondary path option as dynamic.
- A maximum number of path protected tunnel TE heads is 2000.
- A maximum number of TE tunnel heads is equal to 4000.
- When path protection is enabled for a tunnel, and the primary label switched path (LSP) is not assigned a backup tunnel, but the standby LSP is assigned fast-reroute (FRR), the MPLS TE FRR protected value displayed is different from the Cisco express forwarding (CEF) fast-reroute value.
- Inter-area is not supported for path protection.

Related Topics

[Configure Tunnels for Path Protection: Example](#), on page 341

Restrictions for Explicit Path Protection

Explicit paths are used to create backup autotunnels. Explicit path protection provides a recovery mechanism to protect explicit paths for MPLS-TE tunnels. These restrictions are listed to protect an explicit path:

- Only one explicit protecting path is supported per path-option.
- Link or node path diversity is not ensured for explicit protecting paths.
- An explicit protecting path cannot protect a dynamic path option.
- All options such as **verbatim**, **lockdown** are supported for the protecting path as long as it's explicit.
- An explicit path cannot be protected by its own path option level.
- An explicit path can be protected by a path option level that references the same explicit path name or identifier, because it is considered another path-option.
- Enhanced path protection is not supported.

Related Topics

[Configure Tunnels for Path Protection: Example](#), on page 341

Co-existence of Path Protection with Fast Reroute

Path protection and FRR can be configured on the same tunnel at the same time. The co-existence of path protection and FRR on the same tunnel provides these benefits:

- Protection is expanded — having an FRR protected tunnel that is also path-protected ensures that failures of non-protected links on the primary path are handled more efficiently by a quick switch-over to the pre-sigaled standby LSP.
- Quick and effective re-optimization — having a pre-computed standby LSP allows the system to minimize re-optimization LSP path calculation and signaling, by simply switching over to the pre-sigaled standby LSP. Effectively, path protection switch over replaces the post-FRR LSP down event re-optimization.
- Total time on backup is reduced — handling FRR failure using a path protection switch over reduces total time on backup because the traffic is diverted from the backup to the standby, as soon as the head-end receives the FRR LSP down notification, without having to wait for a re-optimization LSP.

MPLS-TE Automatic Bandwidth

The MPLS-TE automatic bandwidth feature measures the traffic in a tunnel and periodically adjusts the signaled bandwidth for the tunnel.

These topics provide information about MPLS-TE automatic bandwidth:

MPLS-TE Automatic Bandwidth Overview

MPLS-TE automatic bandwidth is configured on individual Label Switched Paths (LSPs) at every head-end. MPLS-TE monitors the traffic rate on a tunnel interface. Periodically, MPLS-TE resizes the bandwidth on the tunnel interface to align it closely with the traffic in the tunnel. MPLS-TE automatic bandwidth can perform these functions:

- Monitors periodic polling of the tunnel output rate
- Resizes the tunnel bandwidth by adjusting the highest rate observed during a given period

For every traffic-engineered tunnel that is configured for an automatic bandwidth, the average output rate is sampled, based on various configurable parameters. Then, the tunnel bandwidth is readjusted automatically based upon either the largest average output rate that was noticed during a certain interval, or a configured maximum bandwidth value.

This table lists the automatic bandwidth functions.

Table 6: Automatic Bandwidth Variables

Function	Command	Description	Default Value
Application frequency	application command	Configures how often the tunnel bandwidths changed for each tunnel. The application period is the period of A minutes between the bandwidth applications during which the output rate collection is done.	24 hours

Function	Command	Description	Default Value
Requested bandwidth	bw-limit command	Limits the range of bandwidth within the automatic-bandwidth feature that can request a bandwidth.	0 Kbps
Collection frequency	auto-bw collect command	Configures how often the tunnel output rate is polled globally for all tunnels.	5 min
Highest collected bandwidth	—	You cannot configure this value.	—
Delta	—	You cannot configure this value.	—

The output rate on a tunnel is collected at regular intervals that are configured by using the **application** command in MPLS-TE auto bandwidth interface configuration mode. When the application period timer expires, and when the difference between the measured and the current bandwidth exceeds the adjustment threshold, the tunnel is reoptimized. Then, the bandwidth samples are cleared to record the new largest output rate at the next interval.

When reoptimizing the LSP with the new bandwidth, a new path request is generated. If the new bandwidth is not available, the last good LSP continues to be used. This way, the network experiences no traffic interruptions.

If minimum or maximum bandwidth values are configured for a tunnel, the bandwidth, which the automatic bandwidth signals, stays within these values.



Note When more than 100 tunnels are **auto-bw** enabled, the algorithm will jitter the first application of every tunnel by a maximum of 20% (max 1 hour). The algorithm does this to avoid too many tunnels running auto bandwidth applications at the same time.

If a tunnel is shut down, and is later brought again, the adjusted bandwidth is lost and the tunnel is brought back with the initial configured bandwidth. In addition, the application period is reset when the tunnel is brought back.

Related Topics

[Configuring the Collection Frequency](#), on page 279

[Configuring the Automatic Bandwidth Functions](#), on page 280

[Configure Automatic Bandwidth: Example](#), on page 342

Adjustment Threshold

Adjustment Threshold is defined as a percentage of the current tunnel bandwidth and an absolute (minimum) bandwidth. Both thresholds must be fulfilled for the automatic bandwidth to resignal the tunnel. The tunnel bandwidth is resized only if the difference between the largest sample output rate and the current tunnel bandwidth is larger than the adjustment thresholds.

For example, assume that the automatic bandwidth is enabled on a tunnel in which the highest observed bandwidth B is 30 Mbps. Also, assume that the tunnel was initially configured for 45 Mbps. Therefore, the difference is 15 mbit/s. Now, assuming the default adjustment thresholds of 10% and 10kbps, the tunnel is

signalled with 30 Mbps when the application timer expires. This is because 10% of 45Mbit/s is 4.5 Mbit/s, which is smaller than 15 Mbit/s. The absolute threshold, which by default is 10kbps, is also crossed.

Overflow Detection

Overflow detection is used if a bandwidth must be resized as soon as an overflow condition is detected, without having to wait for the expiry of an automatic bandwidth application frequency interval.

For overflow detection one configures a limit N, a percentage threshold Y% and optionally, a minimum bandwidth threshold Z. The percentage threshold is defined as the percentage of the actual signalled tunnel bandwidth. When the difference between the measured bandwidth and the actual bandwidth are both larger than Y% and Z threshold, for N consecutive times, then the system triggers an overflow detection.

The bandwidth adjustment by the overflow detection is triggered only by an increase of traffic volume through the tunnel, and not by a decrease in the traffic volume. When you trigger an overflow detection, the automatic bandwidth application interval is reset.

By default, the overflow detection is disabled and needs to be manually configured.

Underflow Detection

Underflow detection is used when the bandwidth on a tunnel drops significantly, which is similar to overflow but in reverse.

Underflow detection applies the highest bandwidth value from the samples which triggered the underflow. For example, if you have an underflow limit of three, and the following samples trigger the underflow for 10 kbps, 20 kbps, and 15 kbps, then, 20 kbps is applied.

Unlike overflow, the underflow count is not reset across an application period. For example, with an underflow limit of three, you can have the first two samples taken at the end of an application period and then the underflow gets triggered by the first sample of the next application period.

Restrictions for MPLS-TE Automatic Bandwidth

When the automatic bandwidth cannot update the tunnel bandwidth, the following restrictions are listed:

- Tunnel is in a fast reroute (FRR) backup, active, or path protect active state. This occurs because of the assumption that protection is a temporary state, and there is no need to reserve the bandwidth on a backup tunnel. You should prevent taking away the bandwidth from other primary or backup tunnels.
- Reoptimization fails to occur during a lockdown. In this case, the automatic bandwidth does not update the bandwidth unless the bandwidth application is manually triggered by using the **mpls traffic-eng auto-bw apply** command in EXEC mode.

Related Topics

[Forcing the Current Application Period to Expire Immediately](#), on page 280

Point-to-Multipoint Traffic-Engineering

Point-to-Multipoint Traffic-Engineering Overview

The Point-to-Multipoint (P2MP) Resource Reservation Protocol-Traffic Engineering (RSVP-TE) solution allows service providers to implement IP multicast applications, such as IPTV and real-time video, broadcast

over the MPLS label switch network. The RSVP-TE protocol is extended to signal point-to-point (P2P) and P2MP label switched paths (LSPs) across the MPLS and GMPLS networks.

By using RSVP-TE extensions as defined in RFC 4875, multiple subLSPs are signaled for a given TE source. The P2MP tunnel is considered as a set of Source-to-Leaf (S2L) subLSPs that connect the TE source to multiple leaf Provider Edge (PE) nodes.

At the TE source, the ingress point of the P2MP-TE tunnel, IP multicast traffic is encapsulated with a unique MPLS label, which is associated with the P2MP-TE tunnel. The traffic continues to be label-switched in the P2MP tree. If needed, the labeled packet is replicated at branch nodes along the P2MP tree. When the labeled packet reaches the egress leaf (PE) node, the MPLS label is removed and forwarded onto the IP multicast tree across the PE-CE link.

To enable end-to-end IP multicast connectivity, RSVP is used in the MPLS-core for P2MP-TE signaling and PIM is used for PE-CE link signaling.

- All edge routers are running PIM-SSM or Source-Specific Multicast (SSM) to exchange multicast routing information with the directly-connected Customer Edge (CE) routers.
- In the MPLS network, RSVP P2MP-TE replaces PIM as the tree building mechanism, RSVP-TE grafts or prunes a given P2MP tree when the end-points are added or removed in the TE source configuration (explicit user operation).

These are the definitions for Point-to-Multipoint (P2MP) tunnels:

Source

Configures the node in which Label Switched Path (LSP) signaling is initiated.

Mid-point

Specifies the transit node in which LSP signaling is processed (for example, not a source or receiver).

Receiver, Leaf, and Destination

Specifies the node in which LSP signaling ends.

Branch Point

Specifies the node in which packet replication is performed.

Source-to-Leaf (S2L) SubLSP

Specifies the P2MP-TE LSP segment that runs from the source to one leaf.

Point-to-Multipoint Traffic-Engineering Features

- P2MP RSVP-TE (RFC 4875) is supported. RFC 4875 is based on nonaggregate signaling; for example, per S2L signaling. Only P2MP LSP is supported.
- **interface tunnel-mte** command identifies the P2MP interface type .
- P2MP tunnel setup is supported with label replication.
- Fast-Reroute (FRR) protection is supported with sub-50 msec for traffic loss.
- Explicit routing is supported by using under utilized links.
- Reoptimization is supported by calculating a better set of paths to the destination with no traffic loss.



Note Per-S2L reoptimization is not supported.

- IPv4 and IPv6 payloads are supported.
- IPv4 and IPv6 multicast forwarding are supported on a P2MP tunnel interface through a static IGMP and MLD group configuration .
- Both IP multicast and P2MP Label Switch Multicast (LSM) coexist in the same network; therefore, both use the same forwarding plane (LFIB or MPLS Forwarding Infrastructure [MFI]).
- P2MP label replication supports only Source-Specific Multicast (SSM) traffic. SSM configuration supports the default value, none.
- Static mapping for multicast groups to the P2MP-TE tunnel is required .

Point-to-Multipoint Traffic-Engineering Benefits

- Single point of traffic control ensures that signaling and path engineering parameters (for example, protection and diversity) are configured only at the TE source node.
- Ability to configure explicit paths to enable optimized traffic distribution and prevention of single point of failures in the network.
- Link protection of MPLS-labeled traffic traversing branch paths of the P2MP-TE tree.
- Ability to do bandwidth Admission Control (AC) during set up and signaling of P2MP-TE paths in the MPLS network.

Related Topics

[Enabling Multicast Routing on the Router](#), on page 292

[Configure Point-to-Multipoint for the Source: Example](#), on page 353

[Configure the Point-to-Multipoint Solution: Example](#), on page 355

[Disabling Destinations](#), on page 299

[Disable a Destination: Example](#), on page 354

[Logging Per Destinations for Point-to-Multipoint](#) , on page 300

[Configure the Point-to-Multipoint Tunnel: Example](#), on page 354

[Point-to-Multipoint RSVP-TE](#) , on page 199

Point-to-Multipoint RSVP-TE

RSVP-TE signals a P2MP tunnel base that is based on a manual configuration. If all Source-to-Leaf (S2L)s use an explicit path, the P2MP tunnel creates a static tree that follows a predefined path based on a constraint such as a deterministic Label Switched Path (LSP). If the S2L uses a dynamic path, RSVP-TE creates a P2MP tunnel base on the best path in the RSVP-TE topology. RSVP-TE supports bandwidth reservation for constraint-based routing.

When an explicit path option is used, specify both the local and peer IP addresses in the explicit path option, provided the link is a GigabitEthernet or a TenGigE based interface. For point-to-point links like POS or bundle POS, it is sufficient to mention the remote or peer IP address in the explicit path option.

RSVP-TE distributes stream information in which the topology tree does not change often (where the source and receivers are). For example, large scale video distribution between major sites is suitable for a subset of multicast applications. Because multicast traffic is already in the tunnel, the RSVP-TE tree is protected as long as you build a backup path.

Fast-Reroute (FRR) capability is supported for P2MP RSVP-TE by using the unicast link protection. You can choose the type of traffic to go to the backup link.

The P2MP tunnel is applicable for all TE Tunnel destination (IntraArea and InterArea). Inter-AS is not supported.

The P2MP tunnel is signaled by the dynamic and explicit path option in the IGP intra area. Only interArea and interAS, which are used for the P2MP tunnels, are signaled by the verbatim path option.

Related Topics

[Configuring the Static Group for the Point-to-Multipoint Interface](#), on page 294

[Configure Point-to-Multipoint for the Source: Example](#), on page 353

[Configure the Point-to-Multipoint Solution: Example](#), on page 355

[Point-to-Multipoint Fast Reroute](#), on page 200

Point-to-Multipoint Fast Reroute

MPLS-TE Fast Reroute (FRR) is a mechanism to minimize interruption in traffic delivery to a TE Label Switched Path (LSP) destination as a result of link failures. FRR enables temporarily fast switching of LSP traffic along an alternative backup path around a network failure, until the TE tunnel source signals a new end-to-end LSP.

Both Point-to-Point (P2P) and P2MP-TE support only the Facility FRR method from RFC 4090.

P2P LSPs are used to backup P2MP S2L (source 2 Leaf). Only link and bandwidth protection for P2MP S2Ls are supported. Node protection is not supported.

MPLS-TE link protection relies on the fact that labels for all primary LSPs and subLSPs are using the MPLS global label allocation. For example, one single (global) label space is used for all MPLS-TE enabled physical interfaces on a given MPLS LSP.

Related Topics

[Point-to-Multipoint Traffic-Engineering Overview](#), on page 197

[Point-to-Multipoint RSVP-TE](#) , on page 199

Point-to-Multipoint Label Switch Path

The Point-to-Multipoint Label Switch Path (P2MP LSP) has only a single root, which is the Ingress Label Switch Router (LSR). The P2MP LSP is created based on a receiver that is connected to the Egress LSR. The Egress LSR initiates the creation of the tree (for example, tunnel grafting or pruning is done by performing an individual sub-LSP operation) by creating the Forwarding Equivalency Class (FEC) and Opaque Value.



Note Grafting and pruning operate on a per destination basis.

The Opaque Value contains the stream information that uniquely identifies the tree to the root. To receive label switched multicast packets, the Egress Provider Edge (PE) indicates to the upstream router (the next hop closest to the root) which label it uses for the multicast source by applying the label mapping message.

The upstream router does not need to have any knowledge of the source; it needs only the received FEC to identify the correct P2MP LSP. If the upstream router does not have any FEC state, it creates it and installs the assigned downstream outgoing label into the label forwarding table. If the upstream router is not the root of the tree, it must forward the label mapping message to the next hop upstream. This process is repeated hop-by-hop until the root is reached.

By using downstream allocation, the router that wants to receive the multicast traffic assigns the label for it. The label request, which is sent to the upstream router, is similar to an unsolicited label mapping (that is, the upstream does not request it). The upstream router that receives that label mapping uses the specific label to send multicast packets downstream to the receiver. The advantage is that the router, which allocates the labels, does not get into a situation where it has the same label for two different multicast sources. This is because it manages its own label space allocation locally.

Path Option for Point-to-Multipoint RSVP-TE

P2MP tunnels are signaled by using the dynamic and explicit path-options in an IGP intra area. InterArea cases for P2MP tunnels are signaled by the verbatim path option.

Path options for P2MP tunnels are individually configured for each sub-LSP. Only one path option per sub-LSP (destination) is allowed. You can choose whether the corresponding sub-LSP is dynamically or explicitly routed. For the explicit option, you can configure the verbatim path option to bypass the topology database lookup and verification for the specified destination.

Both dynamic and explicit path options are supported on a per destination basis by using the **path-option (P2MP-TE)** command. In addition, you can combine both path options.

Explicit Path Option

Configures the intermediate hops that are traversed by a sub-LSP going from the TE source to the egress MPLS node. Although an explicit path configuration enables granular control sub-LSP paths in an MPLS network, multiple explicit paths are configured for specific network topologies with a limited number of (equal cost) links or paths.

Dynamic Path Option

Computes the IGP path of a P2MP tree sub-LSP that is based on the OSPF and ISIS algorithm. The TE source is dynamically calculated based on the IGP topology.



Note Dynamic path option can only compute fully-diverse standby paths. While, explicit path option supports partially diverse standby paths as well.

Dynamic Path Calculation Requirements

Dynamic path calculation for each sub-LSP uses the same path parameters as those for the path calculation of regular point-to-point TE tunnels. As part of the sub-LSP path calculation, the link resource (bandwidth) is included, which is flooded throughout the MPLS network through the existing RSVP-TE extensions to OSPF and ISIS. Instead of dynamic calculated paths, explicit paths are also configured for one or more sub-LSPs that are associated with the P2MP-TE tunnel.

- OSPF or ISIS are used for each destination.
- TE topology and tunnel constraints are used to input the path calculation.
- Tunnel constraints such as affinity, bandwidth, and priorities are used for all destinations in a tunnel.

- Path calculation yields an explicit route to each destination.

Static Path Calculation Requirements

The static path calculation does not require any new extensions to IGP to advertise link availability.

- Explicit path is required for every destination.
- Offline path calculation is used.
- TE topology database is not needed.
- If the topology changes, reoptimization is not required.

Related Topics

[Configuring Destinations for the Tunnel Interface](#), on page 296

[Configure the Point-to-Multipoint Tunnel: Example](#), on page 354

[Configure the Point-to-Multipoint Solution: Example](#), on page 355

[Point-to-Multipoint Traffic-Engineering Overview](#), on page 197

[Point-to-Multipoint RSVP-TE](#), on page 199

MPLS Traffic Engineering Shared Risk Link Groups

Shared Risk Link Groups (SRLG) in MPLS traffic engineering refer to situations in which links in a network share a common fiber (or a common physical attribute). These links have a shared risk, and that is when one link fails, other links in the group might fail too.

OSPF and Intermediate System-to-Intermediate System (IS-IS) flood the SRLG value information (including other TE link attributes such as bandwidth availability and affinity) using a sub-type length value (sub-TLV), so that all routers in the network have the SRLG information for each link.

To activate the SRLG feature, configure the SRLG value of each link that has a shared risk with another link. A maximum of 30 SRLGs per interface is allowed. You can configure this feature on multiple interfaces including the bundle interface.

[Figure 18: Shared Risk Link Group](#) illustrates the MPLS TE SRLG values configured on the bundle interface.

Figure 18: Shared Risk Link Group

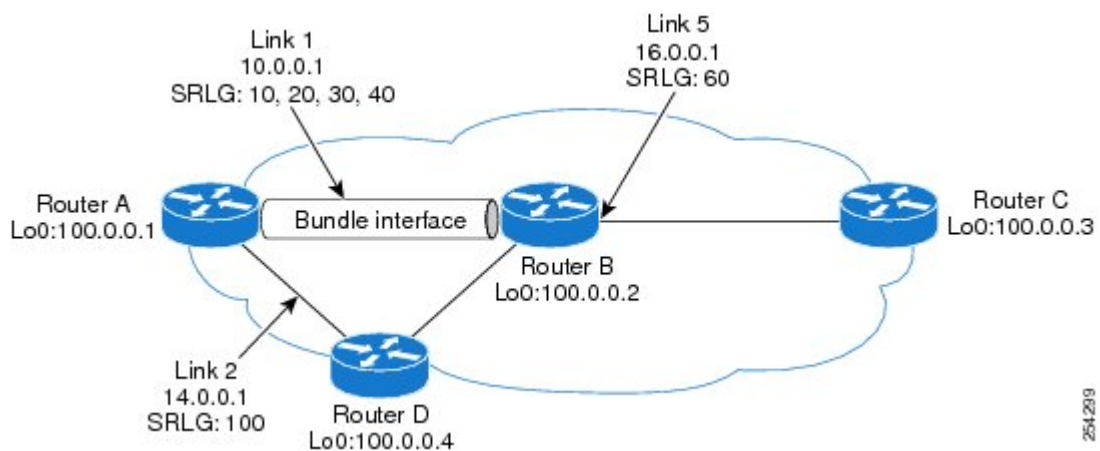

254/299

Related Topics

- [Configuring the SRLG Values of Each Link that has a Shared Risk with Another Link](#), on page 283
- [Creating an Explicit Path With Exclude SRLG](#), on page 284
- [Using Explicit Path With Exclude SRLG](#), on page 285
- [Creating a Link Protection on Backup Tunnel with SRLG Constraint](#), on page 287
- [Creating a Node Protection on Backup Tunnel with SRLG Constraint](#), on page 290
- [Configure the MPLS-TE Shared Risk Link Groups: Example](#), on page 342

Explicit Path

The Explicit Path configuration allows you to configure the explicit path. An IP explicit path is a list of IP addresses, each representing a node or link in the explicit path.

The MPLS Traffic Engineering (TE)—IP Explicit Address Exclusion feature provides a means to exclude a link or node from the path for an Multiprotocol Label Switching (MPLS) TE label-switched path (LSP).

This feature is enabled through the **explicit-path** command that allows you to create an IP explicit path and enter a configuration submode for specifying the path. The feature adds to the submode commands of the **exclude-address** command for specifying addresses to exclude from the path.

The feature also adds to the submode commands of the **exclude-srlg** command that allows you to specify the IP address to get SRLGs to be excluded from the explicit path.

If the excluded address or excluded srlg for an MPLS TE LSP identifies a flooded link, the constraint-based shortest path first (CSPF) routing algorithm does not consider that link when computing paths for the LSP. If the excluded address specifies a flooded MPLS TE router ID, the CSPF routing algorithm does not allow paths for the LSP to traverse the node identified by the router ID.

Related Topics

- [Configuring the SRLG Values of Each Link that has a Shared Risk with Another Link](#), on page 283
- [Creating an Explicit Path With Exclude SRLG](#), on page 284
- [Using Explicit Path With Exclude SRLG](#), on page 285
- [Creating a Link Protection on Backup Tunnel with SRLG Constraint](#), on page 287
- [Creating a Node Protection on Backup Tunnel with SRLG Constraint](#), on page 290
- [Configure the MPLS-TE Shared Risk Link Groups: Example](#), on page 342

Fast ReRoute with SRLG Constraints

Fast ReRoute (FRR) protects MPLS TE Label Switch Paths (LSPs) from link and node failures by locally repairing the LSPs at the point of failure. This protection allows data to continue to flow on LSPs, while their headend routers attempt to establish new end-to-end LSPs to replace them. FRR locally repairs the protected LSPs by rerouting them over backup tunnels that bypass failed links or nodes.

Backup tunnels that bypass only a single link of the LSP's path provide Link Protection. They protect LSPs by specifying the protected link IP addresses to extract SRLG values that are to be excluded from the explicit path, thereby bypassing the failed link. These are referred to as **next-hop (NHOP) backup tunnels** because they terminate at the LSP's next hop beyond the point of failure. [Figure 19: NHOP Backup Tunnel with SRLG constraint](#) illustrates an NHOP backup tunnel.

Figure 19: NHOP Backup Tunnel with SRLG constraint

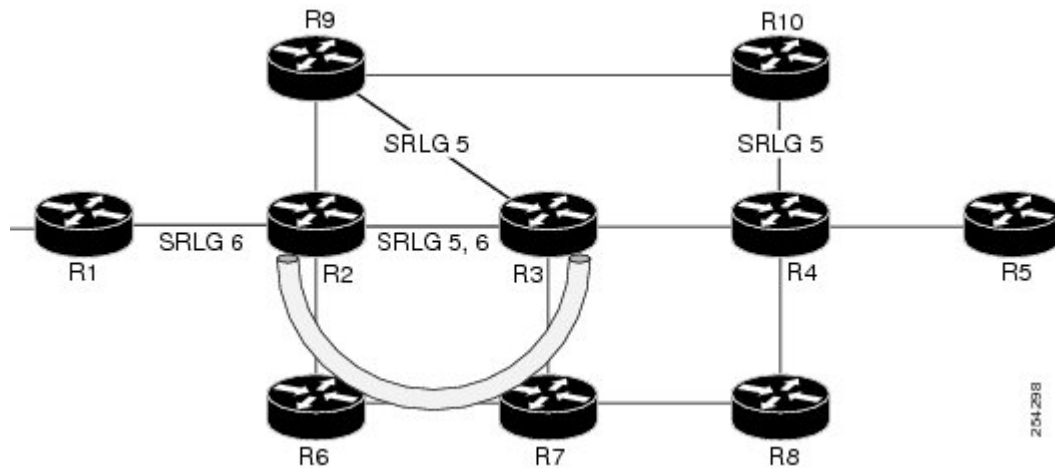

In the topology shown in the above figure, the backup tunnel path computation can be performed in this manner:

- Get all SRLG values from the exclude-SRLG link (SRLG values 5 and 6)
- Mark all the links with the same SRLG value to be excluded from SPF
- Path computation as CSPF R2->R6->R7->R3

FRR provides Node Protection for LSPs. Backup tunnels that bypass next-hop nodes along LSP paths are called **NNHOP backup tunnels** because they terminate at the node following the next-hop node of the LSP paths, thereby bypassing the next-hop node. They protect LSPs when a node along their path fails, by enabling the node upstream to the point of failure to reroute the LSPs and their traffic, around the failed node to the next-next hop. They also protect LSPs by specifying the protected link IP addresses that are to be excluded from the explicit path, and the SRLG values associated with the IP addresses excluded from the explicit path. NNHOP backup tunnels also provide protection from link failures by bypassing the failed link as well as the node. [Figure 20: NNHOP Backup Tunnel with SRLG constraint](#) illustrates an NNHOP backup tunnel.

Figure 20: NNHOP Backup Tunnel with SRLG constraint

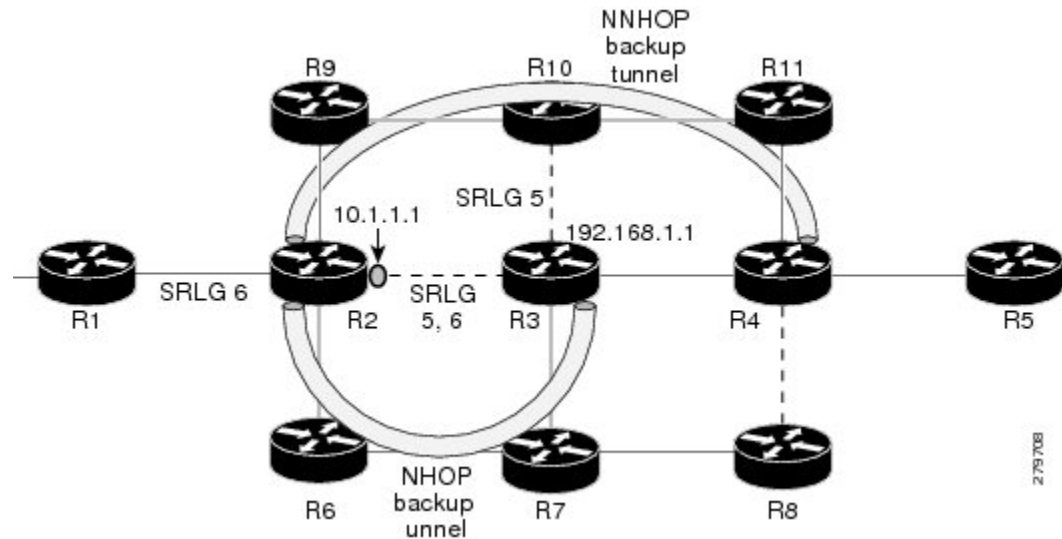

In the topology shown in the above figure, the backup tunnel path computation can be performed in this manner:

- Get all SRLG values from the exclude-SRLG link (SRLG values 5 and 6)
- Mark all links with the same SRLG value to be excluded from SPF
- Verify path with SRLG constraint
- Path computation as CSPF R2->R9->R10->R4

Related Topics

- [Configuring the SRLG Values of Each Link that has a Shared Risk with Another Link](#), on page 283
- [Creating an Explicit Path With Exclude SRLG](#), on page 284
- [Using Explicit Path With Exclude SRLG](#), on page 285
- [Creating a Link Protection on Backup Tunnel with SRLG Constraint](#), on page 287
- [Creating a Node Protection on Backup Tunnel with SRLG Constraint](#), on page 290
- [Configure the MPLS-TE Shared Risk Link Groups: Example](#), on page 342

Importance of Protection

This section describes the following:

- Delivery of Packets During a Failure
- Multiple Backup Tunnels Protecting the Same Interface

Related Topics

- [Configuring the SRLG Values of Each Link that has a Shared Risk with Another Link](#), on page 283
- [Creating an Explicit Path With Exclude SRLG](#), on page 284
- [Using Explicit Path With Exclude SRLG](#), on page 285
- [Creating a Link Protection on Backup Tunnel with SRLG Constraint](#), on page 287
- [Creating a Node Protection on Backup Tunnel with SRLG Constraint](#), on page 290

[Configure the MPLS-TE Shared Risk Link Groups: Example](#), on page 342

Delivery of Packets During a Failure

Backup tunnels that terminate at the NNHOP protect both the downstream link and node. This provides protection for link and node failures.

Related Topics

[Configuring the SRLG Values of Each Link that has a Shared Risk with Another Link](#), on page 283

[Creating an Explicit Path With Exclude SRLG](#), on page 284

[Using Explicit Path With Exclude SRLG](#), on page 285

[Creating a Link Protection on Backup Tunnel with SRLG Constraint](#), on page 287

[Creating a Node Protection on Backup Tunnel with SRLG Constraint](#), on page 290

[Configure the MPLS-TE Shared Risk Link Groups: Example](#), on page 342

Multiple Backup Tunnels Protecting the Same Interface

- Redundancy—If one backup tunnel is down, other backup tunnels protect LSPs.
- Increased backup capacity—If the protected interface is a high-capacity link and no single backup path exists with an equal capacity, multiple backup tunnels can protect that one high-capacity link. The LSPs using this link falls over to different backup tunnels, allowing all of the LSPs to have adequate bandwidth protection during failure (rerouting). If bandwidth protection is not desired, the router spreads LSPs across all available backup tunnels (that is, there is load balancing across backup tunnels).

Related Topics

[Configuring the SRLG Values of Each Link that has a Shared Risk with Another Link](#), on page 283

[Creating an Explicit Path With Exclude SRLG](#), on page 284

[Using Explicit Path With Exclude SRLG](#), on page 285

[Creating a Link Protection on Backup Tunnel with SRLG Constraint](#), on page 287

[Creating a Node Protection on Backup Tunnel with SRLG Constraint](#), on page 290

[Configure the MPLS-TE Shared Risk Link Groups: Example](#), on page 342

SRLG Limitations

There are few limitations to the configured SRLG feature:

- The **exclude-address** and **exclude-srlg** options are not allowed in the IP **explicit path strict-address** network.
- Whenever SRLG values are modified after tunnels are signalled, they are verified dynamically in the next path verification cycle.

Related Topics

[Configuring the SRLG Values of Each Link that has a Shared Risk with Another Link](#), on page 283

[Creating an Explicit Path With Exclude SRLG](#), on page 284

[Using Explicit Path With Exclude SRLG](#), on page 285

[Creating a Link Protection on Backup Tunnel with SRLG Constraint](#), on page 287

[Creating a Node Protection on Backup Tunnel with SRLG Constraint](#), on page 290

[Configure the MPLS-TE Shared Risk Link Groups: Example](#), on page 342

MPLS TE SRLG Scale Enhancements

MPLS Traffic Engineering Shared Risk Link Groups (SRLG) feature has been enhanced to support:

- Increase from 32 to 64 (59 for ISIS) groups.
- Increase from 250 to 500 interfaces.

Related Topics

[Configuring the SRLG Values of Each Link that has a Shared Risk with Another Link](#), on page 283

[Creating an Explicit Path With Exclude SRLG](#), on page 284

[Using Explicit Path With Exclude SRLG](#), on page 285

[Creating a Link Protection on Backup Tunnel with SRLG Constraint](#), on page 287

[Creating a Node Protection on Backup Tunnel with SRLG Constraint](#), on page 290

[Configure the MPLS-TE Shared Risk Link Groups: Example](#), on page 342

Soft-Preemption

MPLS-TE preemption consists of freeing the resources of an established LSP, and assigning them to a new LSP. The freeing of resources causes a traffic disruption to the LSP that is being preempted. Soft preemption is an extension to the RSVP-TE protocol to minimize and even eliminate such traffic disruption over the preempted LSP.

The soft-preemption feature attempts to preempt the LSPs in a graceful manner to minimize or eliminate traffic loss. However, the link might be over-subscribed for a period of time.

In a network that implements soft preemption, zero traffic loss is achieved in this manner:

- When signaling a new LSP, the ingress router indicates to all the intermediate nodes that the existing LSP is to be softly preempted, in case its resources are needed and is to be reassigned.
- When a given intermediate node needs to soft-preempt the existing LSP, it sends a new or special path error (preemption pending) to the ingress router. The intermediate node does not dismantle the LSP and maintains its state.
- When the ingress router receives the path error (preemption pending) from the intermediate node, it immediately starts a re-optimization that avoids the link that caused the preemption.
- When the re-optimization is complete, the ingress router tears down the soft-preempted LSP.

Related Topics

[Enabling Soft-Preemption on a Node](#), on page 302

[Enabling Soft-Preemption on a Tunnel](#), on page 303

Path Option Attributes

The path option attributes are configurable through a template configuration. This template, named **attribute-set**, is configured globally in the MPLS traffic-engineering mode.

You can apply an **attribute-set** to a path option on a per-LSP basis. The path option configuration is extended to take a path option attribute name. LSPs computed with a particular path option uses the attributes as specified by the attribute-set under that path option.

These prerequisites are required to implement path option attributes:

- Path option type attribute-set is configured in the MPLS TE mode
- Path option CLI extended to accept an attribute-set name



Note The **signalled-bandwidth** and **affinity** attributes are supported under the attribute-set template.

Related Topics

[Configuring Attributes within a Path-Option Attribute](#), on page 304

Configuration Hierarchy of Path Option Attributes

You can specify a value for an attribute within a path option **attribute-set** template. This does not prevent the configuring of the same attribute at a tunnel level. However, it is important to note that only one level is taken into account. So, the configuration at the LSP level is considered more specific than the one at the level of the tunnel, and it is used from this point onwards.

Attributes that are not specified within an attribute-set take their values as usual--configuration at the tunnel level, configuration at the global MPLS level, or default values. Here is an example:

```
attribute-set path-option MYSET
  affinity 0xBEEF mask 0xBEEF

interface tunnel-te 10
  affinity 0xCAFE mask 0xCAFE
  signalled-bandwidth 1000
  path-option 1 dynamic attribute-set name MYSET
  path-option 2 dynamic
```

In this example, the attribute-set named **MYSET** is specifying affinity as 0xBEEF. The signalled bandwidth has not been configured in this **MYSET**. The **tunnel 10**, meanwhile, has affinity 0xCAFE configured. LSPs computed from path-option 1 uses the affinity 0xBEEF/0xBEEF, while LSPs computed from path-option 2 uses the affinity 0xCAFE/0xCAFE. All LSPs computed using any of these path-options use **signalled-bandwidth** as 1000, as this is the only value that is specified only at the tunnel level.



Note The attributes configured in a path option **attribute-set** template takes precedence over the same attribute configured under a tunnel. An attribute configured under a tunnel is used only if the equivalent attribute is **not** specified by the in-use path option **attribute-set** template.

Related Topics

[Configuring Attributes within a Path-Option Attribute](#), on page 304

Traffic Engineering Bandwidth and Bandwidth Pools

MPLS traffic engineering allows constraint-based routing (CBR) of IP traffic. One of the constraints satisfied by CBR is the availability of required bandwidth over a selected path. Regular TE tunnel bandwidth is called the **global pool**. The **subpool bandwidth** is a portion of the global pool. If it is not in use, the subpool bandwidth is not reserved from the global pool. Therefore, subpool tunnels require a priority higher than that of non-subpool tunnels.

You can configure the signalled-bandwidth path option attribute to use either the global pool (default) or the subpool bandwidth. The signalled-bandwidth value for the path option may be any valid value and the pool does not have to be the same as that which is configured on the tunnel.



Note When you configure signalled-bandwidth for path options with the **signalled-bandwidth bandwidth [sub-pool | global] kbps** command, use either all subpool bandwidths or all global-pool bandwidth values.

Related Topics

[Configuring Attributes within a Path-Option Attribute](#), on page 304

Path Option Switchover

Reoptimization to a particular path option is not possible if the in-use path option and the new path option do not share the same bandwidth class. The path option switchover operation would fail in such a scenario. Use this command at the EXEC configuration mode to switchover to a newer path option :

```
mpls traffic-eng switchover tunnel-xx ID path-option index
```

The switchover to a newer path option is achieved, in these instances:

- when a lower index path option is available
- when any signalling message or topology update causes the primary LSP to go down
- when a local interface fails on the primary LSP or a path error is received on the primary LSP



Note Path option switchover between various path options with different bandwidth classes is not allowed.

Related Topics

[Configuring Attributes within a Path-Option Attribute](#), on page 304

Path Option and Path Protection

When path-protection is enabled, a standby LSP is established to protect traffic going over the tunnel. The standby LSP may be established using either the same path option as the primary LSP, or a different one.

The standby LSP is computed to be diverse from the primary LSP, so bandwidth class differences does not matter. This is true in all cases of diversity except node-diversity. With node diversity, it is possible for the standby LSP to share up to two links with the primary LSP, the link exiting the head node, and the link entering the tail node.

If you want to switchover from one path option to another path option and these path options have different classes, the path option switchover is rejected. However, the path option switchover can not be blocked in the path-protection feature. When the standby LSP becomes active using another path option of a different class type, the path option switchover cannot be rejected at the head end. It might get rejected by the downstream node.

Node-diversity is only possible under limited conditions. The conditions that must be met are:

- there is no second path that is both node and link diverse
- the current LSP uses a shared-media link at the head egress or tail ingress
- the shared-media link used by the current LSP permits computation of a node-diverse path

In Cisco IOS XR, reoptimization between different class types would actually be rejected by the next hop. This rejection will occur by an admission failure.

Related Topics

[Configuring Attributes within a Path-Option Attribute](#), on page 304

Auto-Tunnel Mesh

The MPLS traffic engineering auto-tunnel mesh (Auto-mesh) feature allows you to set up full mesh of TE P2P tunnels automatically with a minimal set of MPLS traffic engineering configurations. You may configure one or more mesh-groups. Each mesh-group requires a destination-list (IPv4 prefix-list) listing destinations, which are used as destinations for creating tunnels for that mesh-group.

You may configure MPLS TE auto-mesh type attribute-sets (templates) and associate them to mesh-groups. LSR creates tunnels using the tunnel properties defined in the attribute-set.

Auto-Tunnel mesh provides benefits:

- Minimizes the initial configuration of the network.
You may configure tunnel properties template and mesh-groups or destination-lists on each TE LSRs that further creates full mesh of TE tunnels between those LSRs.
- Minimizes future configurations resulting due to network growth.
It eliminates the need to reconfigure each existing TE LSR in order to establish a full mesh of TE tunnels whenever a new TE LSR is added in the network.

Related Topics

[Configuring Auto-Tunnel Mesh Tunnel ID](#), on page 305

[Configuring Auto-tunnel Mesh Unused Timeout](#), on page 306

[Configuring Auto-Tunnel Mesh Group](#), on page 307

[Configuring Tunnel Attribute-Set Templates](#), on page 308

[Enabling LDP on Auto-Tunnel Mesh](#), on page 310

Destination List (Prefix-List)

Auto-mesh tunnels can be automatically created using prefix-list. Each TE enabled router in the network learns about the TE router IDs through a existing IGP extension.

You can view the router IDs on the router using this command:

```
show mpls traffic-eng topology | include TE Id
IGP Id: 0001.0000.0010.00, MPLS TE Id:100.1.1.1 Router Node (ISIS 1 level-2)
IGP Id: 0001.0000.0011.00, MPLS TE Id:100.2.2.2 Router Node (ISIS 1 level-2)
IGP Id: 0001.0000.0012.00, MPLS TE Id:100.3.3.3 Router Node (ISIS 1 level-2)
```

A prefix-list may be configured on each TE router to match a desired set of router IDs (MPLS TE ID as shown in the above output). For example, if a prefix-list is configured to match addresses of 100.0.0.0 with wildcard 0.255.255.255, then all 100.x.x.x router IDs are included in the auto-mesh group.

When a new TE router is added in the network and its router ID is also in the block of addresses described by the prefix-list, for example, 100.x.x.x, then it is added in the auto-mesh group on each existing TE router without having to explicitly modify the prefix-list or perform any additional configuration.

Auto-mesh does not create tunnels to its own (local) TE router IDs.



Note When prefix-list configurations on all routers are not identical, it can result in non-symmetrical mesh of tunnels between those routers.

Related Topics

- [Configuring Auto-Tunnel Mesh Tunnel ID](#), on page 305
- [Configuring Auto-tunnel Mesh Unused Timeout](#), on page 306
- [Configuring Auto-Tunnel Mesh Group](#), on page 307
- [Configuring Tunnel Attribute-Set Templates](#), on page 308
- [Enabling LDP on Auto-Tunnel Mesh](#), on page 310

P2MP-TE Auto-tunnels

The MPLS point-to-multi point traffic-engineering auto-tunnels (P2MP-TE Auto-tunnels) feature enables dynamic creation and management of P2MP auto-tunnels for the transport of VPLS traffic on Cisco IOS XR Software. The P2MP-TE auto-tunnel configuration is disabled by default. Use the **auto-tunnel p2mp-te tunnel-id** configuration to enable P2MP-TE Auto-tunnel. This configures the tunnel ID range that can be allocated to P2MP auto-tunnels. This also determines the maximum number of P2MP auto-tunnels that can be created.

For more information on P2MP-TE Auto-tunnels, see the *Implementing MPLS Traffic Engineering* chapter in the *MPLS Configuration Guide for the Cisco CRS Routers*. For more information on Set DF Bit commands, see the *MPLS Traffic Engineering Commands* chapter in the *MPLS Command Reference for the Cisco CRS Router*.

Related Topics

- [Configuring P2MP TE Auto-tunnels](#), on page 311

PWHE over MPLS TE Tunnels

The Pseudowire Headend (PWHE) over MPLS TE Tunnels feature enables the PWHE traffic to pass through MPLS traffic engineering (TE) tunnels.

The PWHE and the MPLS TE tunnels are configured independently. No specific configuration is required for a TE tunnel to forward PWHE traffic through it. The pseudowire traffic automatically passes through the TE tunnel, after the routing protocol is configured in such a way that the routing algorithm considers the TE tunnel as the route to reach the pseudowire endpoint.

Figure 21: PWHE over MPLS TE Tunnel

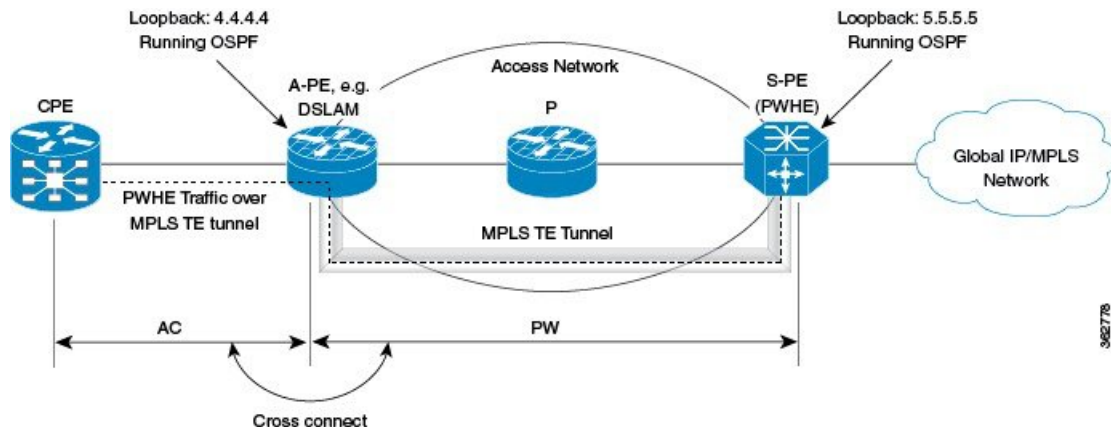

In this figure, S-PE is the PWHE and OSPF manages the routing. A MPLS TE tunnel is configured between A-PE and S-PE. After the MPLS TE tunnel is defined (either by defining a static route or using the **autoroute announce** command) as the path through which to forward traffic to S-PE, the PWHE traffic passes through that tunnel.

Workflow - Sending PWHE Traffic over MPLS TE Tunnels

Complete these configurations on the S-PE to enable PWHE traffic to flow through the MPLS TE tunnel.

Task Number	Task Description	Sample Configuration	Details
1	Configure interfaces that connect to A-PE.	<pre>interface Bundle-Ether1 description TO-APE ipv4 address 145.0.2.5 255.255.255.0 load-interval 30 ! interface TenGigE0/2/1/2 description TO-APE-VKG4-0-1-1-0 bundle id 1 mode on load-interval 30 ! interface TenGigE0/2/1/3 description TO-APE-VKG4-0-1-1-1 bundle id 1 mode on load-interval 30</pre>	<p>See the <i>Configuring Ethernet Link Bundles</i> task in Chapter <i>Configuring Link Bundling of Interface and Hardware Component Configuration Guide for Cisco CRS Routers</i>.</p> <p>Note You can configure any supported interface; not just bundle interfaces.</p>
2	Define loopback address.	<pre>interface Loopback0 ipv4 address 5.5.5.5 255.255.255.255 !</pre>	

Task Number	Task Description	Sample Configuration	Details
3	Configure tunnel interface. TE tunnels can be configured with either an "explicit" or a "dynamic" path.	<pre>interface tunnel-te1 bandwidth 10000000 ipv4 unnumbered Loopback0 autoroute announce destination 4.4.4.4 fast-reroute path-option 10 explicit name main-path !</pre>	See Creating an MPLS-TE Tunnel , on page 222
4	Provide path definition of path that the tunnel uses as the forwarding path.	<pre>explicit-path name main-path index 10 next-address strict ipv4 unicast 145.0.2.4 !</pre>	See Configuring Explicit Paths with ABRs Configured as Loose Addresses , on page 269
5	Specify tunnel bandwidth.	<pre>rsvp interface Bundle-Ether1 bandwidth mam max-reservable-bw 10000000 1000000 ! signalling graceful-restart ! mpls traffic-eng interface Bundle-Ether1 !</pre>	See Configuring an IETF DS-TE Tunnel Using MAM , on page 238
6	Configure PWHE.	<pre>interface PW-Ether1 mtu 1518 mac-address 4000.5.1 load-interval 30 attach generic-interface-list ill !</pre>	See the <i>Configuring PWHE Interfaces</i> task in Chapter <i>Implementing Multipoint Layer 2 Services of</i> .
7	Define, for PWHE, the list of interfaces that PW uses to forward traffic.	<pre>generic-interface-list ill interface Bundle-Ether1 !</pre>	See the <i>Configuring Generic Interface List</i> task in Chapter <i>Implementing Multipoint Layer 2 Services of</i> .
8	Define PW source address.	<pre>l2vpn pw-class pwhe encapsulation mpls control-word ipv4 source 5.5.5.5 ! !</pre>	See the <i>Configuring the Source Address</i> task in Chapter <i>Implementing Multipoint Layer 2 Services of</i> .
9	Define PWHE cross-connect.	<pre>xconnect group xc452 p2p pwhe452 interface PW-Ether2 neighbor ipv4 4.4.4.4 pw-id 452 mpls static label local 5542 remote 5452 pw-class pwhe !</pre>	See the <i>Configuring PWHE Crossconnect</i> task in Chapter <i>Implementing Multipoint Layer 2 Services of</i> .

Task Number	Task Description	Sample Configuration	Details
10	Setup interfaces running LDP.	<pre>mpls ldp nsr graceful-restart graceful-restart reconnect-timeout 60 graceful-restart forwarding-state-holdtime 60 interface Bundle-Ether1 ! !</pre>	See Setting Up LDP NSF Using Graceful Restart , on page 49
11	Configure routing.	<pre>router ospf 100 nsr router-id 5.5.5.5 nsf cisco area 0 mpls traffic-eng interface Bundle-Ether1 ! interface Loopback0 ! mpls traffic-eng router-id 192.168.70.1 !</pre>	See the <i>Configuring OSPF Version 2 for MPLS Traffic Engineering</i> task in Chapter <i>Implementing OSPF of Routing Configuration Guide for Cisco CRS Routers</i> .



Note A-PE has a similar configuration, except for the fact that there is no PWHE defined on it.

In a PWHE-based pseudowire configuration, the TE tunnel cannot be configured as the preferred-path for pseudowire traffic. Therefore, the preferred-path tunnel-te option under the L2VPN XConnect PW-Class is not supported. However, the TE tunnel redundancy and TE fast-reroute mechanisms are supported with PWHE over MPLS TE tunnels.

VRF Redirection to MPLS TE Tunnels

The VRF redirection to MPLS TE tunnels feature adds automatic route MPLS TE tunnels through autoroute destination configuration. The VRF redirection to MPLS TE tunnels maps VRF prefixes over TE tunnels in the core to reach the same egress provider edge (PE). This enables to load-balance prefix traffic on multiple tunnels based on equal cost multi-path (ECMP). The ECMP is used to load-share the flow(s) on multiple available paths towards the destination PE. The route added by autoroute destination inherits the same IGP computed metric to the tunnel endpoint. Any changes to the IGP route metric to the tunnel endpoint is automatically reflected on the autoroute destination route too.

In a typical VPN deployment over a TE core network, an operator creates a mesh of TE tunnels between PE routers and then configures autoroute announce to these tunnels. This leads to a mix of default VRF and VPNv4 traffic on the same tunnel connecting the PE routers. An operator may want to segregate their VPNv4 traffic on different tunnels. This can be achieved by creating multiple tunnels to the egress PE(s). The limitation of this approach is that the static routes are added with zero metrics. The VRF Redirection to MPLS TE Tunnels feature is a solution to resolve this limitation. Multiple VRFs can be mapped on the same tunnel by adding multiple autoroute destination addresses (BGP next-hops) to the same tunnel.

Routes added by static route are always added with zero cost metric. This results in traffic that is mapped on multiple tunnels to always load-balance due to ECMP. This may be undesirable when some of those tunnels have sub-optimal paths (have higher underlying cost to the endpoint). With autoroute destination, only the tunnel whose IGP cost to its endpoint is lowest will be considered for carrying traffic.

VRF redirection over TE tunnels feature supports:

- Automatic redirection of VRF traffic over TE tunnels.
- Multiple autoroute destinations under one tunnel to aggregate VRF traffic. If two VRFs are to be mapped on same tunnel, then two autoroute destination prefixes (BGP next-hops) will be configured under the tunnel.
- One autoroute destination under multiple tunnels to enable ECMP load-balance of VRF traffic.
- Implicit /32 mask for each route. Only host addresses residing on the tunnel endpoint are supported.
- High availability, RP failover, and non-stop forwarding (NSF) scenarios by proving hitless to traffic mechanisms.

For more information on VRF Redirection to MPLS TE Tunnels, see the *Implementing MPLS Traffic Engineering* chapter in the *MPLS Configuration Guide for the Cisco CRS Routers*. For more information on VRF Redirection to MPLS TE Tunnels commands, see the *MPLS Traffic Engineering Commands* chapter in the *MPLS Command Reference for the Cisco CRS Router*.

MPLS TE Extended Admin Groups

The MPLS TE extended admin groups (EAG) configuration assigns EAG/AG name to bit-position and associates affinity-names with TE links. The configuration extends to assign names, up to 256, to TE links over the selected interface and assigns 32 names per attribute-set and index.

For more information on MPLS TE Extended Admin Groups, see the *Implementing MPLS Traffic Engineering* chapter in the *MPLS Configuration Guide for the Cisco CRS Routers*. For more information on MPLS TE Extended Admin Groups commands, see the *MPLS Traffic Engineering Commands* chapter in the *MPLS Command Reference for the Cisco CRS Router*.

Stateful Path Computation Element

The stateful path computation element (PCE) describes a set of procedures by which a path computation client (PCC) can report and delegate control of head-end tunnels sourced from the PCC to a PCE peer. The PCE peer can request the PCC to update and modify parameters of label switched paths (LSPs) it controls. The stateful model also enables a PCC to allow the PCE to initiate computations allowing the PCE to perform network-wide orchestration.

For more information on Stateful PCE, see the *Implementing MPLS Traffic Engineering* chapter in the *MPLS Configuration Guide for the Cisco CRS Routers*. For more information on Stateful PCE commands, see the *MPLS Traffic Engineering Commands* chapter in the *MPLS Command Reference for the Cisco CRS Router*.

- Request types
 - PCReq—requests used by current stateless PCE implementation
 - PCCreate—LSP instantiation requests
 - PCUpd—LSP update requests
- LSP Objects

- Operational flag
 - Delegation flag
 - Remove flag
 - Symbolic path name
 - LSP Identifiers
- Path List
 - ERO

Stateful PCE State Reporting

State reporting refers to the PCC sending information to PCEs about the state of LSPs. This is done as state changes occur and is used to keep PCEs informed of changes to the LSP as they occur. State reporting is also used as part of *state synchronization* and *delegation*.

A state report is a message sent by a PCC to a PCE reporting on the state of one or more TE tunnels. This allows the PCE to stay abreast of changes as they occur. Reports are triggered when the PCE needs to be informed of state. These occur when:

- State synchronization happens
- The PCC attempts to delegate control of a tunnel to a PCE
- The PCC revokes control of a tunnel from a PCE
- The PCC deletes a tunnel
- A signalling error occurs on a tunnel
- Reportable information about a tunnel changes

Stateful PCE State Synchronization

Synchronization refers to a procedure that occurs after a PCEP session is established between a PCE and a PCC. The purpose of state synchronization is to download the current LSP database of the PCC to a PCE. This is done through a set of state reports which are marked as *synchronizations*. This is the first communication to occur after the session is brought up. A full re-send of state reports can also be avoided when the PCE already has an up-to-date version of the LSP database as the version number can be indicated by the PCE during PCEP session establishment.

Stateful PCE Delegation

Delegation is the action by which control of a state is granted to a PCE by the PCC. A PCE to which control was delegated can alter attributes of the LSP. Control is only delegated to one PCE at a time.

- Delegation of control can be revoked from a PCE by the PCC.
- Delegation of control can also be returned to the PCC by the PCE.

Stateful PCE State Updating

State updating refers to the PCE sending information to a PCC to alter the attributes of an LSP. A state update is a message sent by a PCE to a PCC to alter the state of one or more TE tunnels. State updating is allowed only if the PCE has previously been delegated control of the LSP. State updating is also used to return delegated control.

Stateful PCE Creation of LSPs

Creation (or instantiation) of an LSP is a procedure by which a PCE instructs a PCC to create an LSP respecting certain attributes. For LSPs created in this manner, the PCE is delegated control automatically. Stateful PCE procedures enable a PCE to instruct a PCC to create a locally sourced tunnel.

Delegation of PCC Initiated Tunnels

The delegation of path computation client (PCC) initiated tunnels feature enables the ability to control PCC initiated tunnels through stateful path computation element (PCE).

When a PCC is connected to multiple PCEs, use the **precedence** command to select stateful PCEs for delegating LSPs. Precedence can take any value between 0 and 255. The default precedence value is 255. When there are multiple stateful PCEs with active PCEP sessions, PCC selects the PCE with the lowest precedence value. If multiple PCEs have the same precedence, PCC selects a PCE with the lowest IP address. A PCC considers only the PCEs with active PCEP session for delegating LSPs.

When a PCEP session over which tunnels have been delegated is terminated, the PCC waits till the re-delegation timer expires before re-delegating tunnels. If a PCEP session comes back up within re-delegation timer expiration, tunnels will be delegated back to the same PCE.

For information on PCC, see [Path Computation Element, on page 190](#).

MPLS TE Usability Enhancements

MPLS traffic engineering command line interface and logging output messages are enhanced as follows:

- The **show mpls traffic engineering** commands display **signaled-name** and supports **signaled-name** filter.
- Ability to allow immediate teardown of all labelled switched paths (LSPs) of the specified tunnel and to create new LSPs.
- Default behavior when affinity check fails at head-end is to reoptimize all LSP types.
- Logging output messages include MPLS TE tunnel signaled name.
- Logging of path change events and available bandwidth on the new for all auto-bandwidth operations.
- Auto-bandwidth logging output includes signaled name.

MPLS TE IPv6 Autoroute

The MPLS TE IPv6 Autoroute feature enables the use of IPv4 MPLS TE tunnels for IPv6 routing. The routing protocol IGP (IS-IS) considers the IPv4 MPLS TE tunnel for IPv6 routing path calculation only if the tunnel is advertised to carry IPv6 traffic. To advertise the tunnel, either IPv6 autoroute announce (AA) configuration

or IPv6 forwarding adjacency (FA) configuration should be made on the tunnel. Also, the IPv6 has to be enabled on the tunnel so that the tunnel can handle IPv6 traffic.

For more information on MPLS TE IPv6 Autoroute, see the *Implementing MPLS Traffic Engineering* chapter in the *MPLS Configuration Guide for the Cisco CRS Routers*. For more information on MPLS TE IPv6 Autoroute commands, see the *MPLS Traffic Engineering Commands* chapter in the *MPLS Command Reference for the Cisco CRS Router*.

MPLS TE IPv6 Autoroute Restrictions

- IGP support is only for IS-IS.
- IS-IS IPv4 and IPv6 must be configured under the same IS-IS instance.
- Unequal load balancing (UELB) does not apply to IPv6 traffic. While it may still be configured and used for IPv4 traffic, IPv6 traffic does not acknowledge the UELB configuration. However, equal loadsharing works for IPv6.
- Policy-based tunnel selection (PBTS) does not apply for IPv6 traffic. While it may still be configured and used for IPv4 traffic, IPv6 traffic does not acknowledge the PBTS configuration.
- MPLS auto tunnels do not support IPv6 autoroute announce and IPv6 forwarding adjacency configurations.

MPLS TE Path Cost Limit

The MPLS TE path cost limit feature enables graceful migration of TE label switched paths (LSPs) away from a link without affecting the traffic. This is useful when a link is scheduled to be decommissioned or brought down for maintenance.

In order to take a link out of service and gracefully migrate the LSPs away from it, the cost assigned to the link is to be set higher than the path cost limit (path aggregate admin-weight) assigned at the LSP headend. The cost of the tunnel is equal to the aggregate cost of the links through which the tunnel passes. The headend routers recalculate the total path costs at the time of periodic path verification. At this stage, the headend routers automatically check if the path limit is crossed and reroute the LSPs away from the out-of-service link.

This sample illustration explains the TE path cost limit application:

Figure 22: MPLS TE path cost limit application

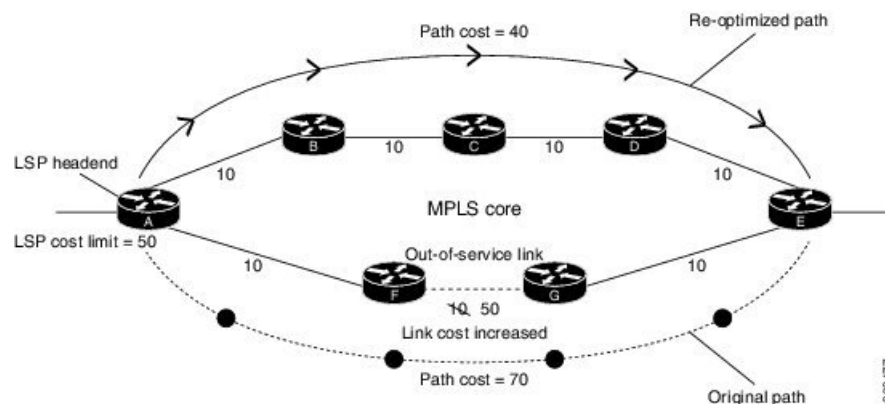

Here, the path cost limit for the LSP is set at 50. To move the LSP away from the link between F and G, the link cost is increased to 50.

For more information on MPLS TE Path Cost Limit, see the *Implementing MPLS Traffic Engineering* chapter in the *MPLS Configuration Guide for the Cisco CRS Routers*. For more information on MPLS TE Path Cost Limit commands, see the *MPLS Traffic Engineering Commands* chapter in the *MPLS Command Reference for the Cisco CRS Router*.

Soft-preemption over FRR Backup Tunnels

The soft-preemption over FRR backup tunnels feature enables to move LSP traffic over the backup tunnels when the LSP is soft-preempted. MPLS TE tunnel soft-preemption allows removal of extra TE traffic in a graceful manner, by giving the preempted LSP a grace period to move away from the link. Though this mechanism saves the traffic of the preempted LSP from being dropped, this might cause traffic drops due to congestion as more bandwidth is reserved on the link than what is available. When the soft-preemption over FRR backup tunnel is enabled, the traffic of the preempted LSP is moved onto the FRR backup, if it is available and ready. This way, the capacity of the backup tunnel is used to remove the potential congestion that might be caused by soft-preemption.

For more information on Soft-Preemption over FRR Backup, see the *Implementing MPLS Traffic Engineering* chapter in the *MPLS Configuration Guide for the Cisco CRS Routers*. For more information on Soft-Preemption over FRR Backup commands, see the *MPLS Traffic Engineering Commands* chapter in the *MPLS Command Reference for the Cisco CRS Router*.

MPLS TE Auto-tunnel Mesh One-hop

The MPLS TE Auto-tunnel primary one-hop feature allows automatic creation of tunnels over TE enabled interfaces to next hop neighbors. The Auto-tunnel primary one-hop is configurable under the MPLS TE Auto-tunnel mesh group mode and for each mesh group. The Auto-tunnel primary one-hop configuration automatically creates one-hop tunnels to next hop neighbors. A router that becomes a next hop neighbor will have a set of one-hop tunnels created automatically.

For more information on MPLS TE Auto-tunnel Primary One-hop, see the *Implementing MPLS Traffic Engineering* chapter in the *MPLS Configuration Guide for the Cisco CRS Routers*. For more information on MPLS TE Auto-tunnel Primary One-hop commands, see the *MPLS Traffic Engineering Commands* chapter in the *MPLS Command Reference for the Cisco CRS Router*.

Inter-area Traffic Engineering with Dynamic ABR Discovery

The inter-area traffic engineering with dynamic ABR discovery feature adds support for inter-area point-to-point (P2P) and point-to-multi-point (P2MP) traffic engineering with dynamic ABR discovery. With this feature, there is no need to specify transit ABR addresses in the explicit paths to allow for dynamic/best path computation for inter-area tunnels.

For more information on Inter-area Traffic Engineering with Dynamic ABR Discovery, see the *Implementing MPLS Traffic Engineering* chapter in the *MPLS Configuration Guide for the Cisco CRS Routers*.

Named Tunnel

The Named Tunnel feature provides a simplified and flexible means of naming MPLS-TE tunnels.

In the traditional TE tunnel naming scheme, the tunnels are configured with IDs, where an ID is a 16-bit number. With increased TE tunnel scale in the network, and with the 64K limit, there is scarcity of unique tunnel IDs.

The Named Tunnel feature lets you name the TE tunnels in the network with unique tunnel IDs, which lets you manage the network more efficiently. This feature allows you to provision TE tunnels using STRING names.

For example: TUNNEL-NY-TO-LA

Named Path Option

For a given tunnel, you can configure one or more path options - each identified by a unique name. The path option expresses the preference for the path; lower numbers have a higher preference, with 1 having the highest preference. You can also configure the computation method for the path.

How to Implement Traffic Engineering

Traffic engineering requires coordination among several global neighbor routers, creating traffic engineering tunnels, setting up forwarding across traffic engineering tunnels, setting up FRR, and creating differential service.

These procedures are used to implement MPLS-TE:

Building MPLS-TE Topology

Perform this task to configure MPLS-TE topology (required for traffic engineering tunnel operations).

Before you begin

Before you start to build the MPLS-TE topology, you must have enabled:

- IGP such as OSPF or IS-IS for MPLS-TE.
- MPLS Label Distribution Protocol (LDP).
- RSVP on the port interface.
- Stable router ID is required at either end of the link to ensure that the link is successful. If you do not assign a router ID, the system defaults to the global router ID. Default router IDs are subject to change, which can result in an unstable link.
- If you are going to use nondefault holdtime or intervals, you must decide the values to which they are set.

SUMMARY STEPS

1. **configure**
2. **mpls traffic-eng**
3. **interface** *type interface-path-id*
4. **exit**
5. **exit**

6. **router ospf** *process-name*
7. **area** *area-id*
8. **exit**
9. **mpls traffic-eng router-id** *ip-address*
10. **commit**
11. (Optional) **show mpls traffic-eng topology**
12. (Optional) **show mpls traffic-eng link-management advertisements**

DETAILED STEPS

	Command or Action	Purpose
Step 1	configure	
Step 2	mpls traffic-eng Example: RP/0/RP0/CPU0:router(config)# mpls traffic-eng RP/0/RP0/CPU0:router(config-mpls-te)#	Enters MPLS-TE configuration mode.
Step 3	interface <i>type interface-path-id</i> Example: RP/0/RP0/CPU0:router(config-mpls-te)# interface POS0/6/0/0 RP/0/RP0/CPU0:router(config-mpls-te-if)#	Enables traffic engineering on a particular interface on the originating node and enters MPLS-TE interface configuration mode.
Step 4	exit Example: RP/0/RP0/CPU0:router(config-mpls-te-if)# exit RP/0/RP0/CPU0:router(config-mpls-te)#	Exits the current configuration mode.
Step 5	exit Example: RP/0/RP0/CPU0:router(config-mpls-te)# exit RP/0/RP0/CPU0:router(config)#	Exits the current configuration mode.
Step 6	router ospf <i>process-name</i> Example: RP/0/RP0/CPU0:router(config)# router ospf 1	Enters a name for the OSPF process.
Step 7	area <i>area-id</i> Example:	Configures an area for the OSPF process. <ul style="list-style-type: none"> • Backbone areas have an area ID of 0.

	Command or Action	Purpose
	<code>RP/0/RP0/CPU0:router(config-router)# area 0</code>	<ul style="list-style-type: none"> Non-backbone areas have a non-zero area ID.
Step 8	exit Example: <code>RP/0/RP0/CPU0:router(config-ospf-ar)# exit</code> <code>RP/0/RP0/CPU0:router(config-ospf)#</code>	Exits the current configuration mode.
Step 9	mpls traffic-eng router-id ip-address Example: <code>RP/0/RP0/CPU0:router(config-ospf)# mpls</code> <code>traffic-eng router-id 192.168.70.1</code>	Sets the MPLS-TE loopback interface.
Step 10	commit	
Step 11	(Optional) show mpls traffic-eng topology Example: <code>RP/0/RP0/CPU0:router# show mpls traffic-eng</code> <code>topology</code>	Verifies the traffic engineering topology.
Step 12	(Optional) show mpls traffic-eng link-management advertisements Example: <code>RP/0/RP0/CPU0:router# show mpls traffic-eng</code> <code>link-management advertisements</code>	Displays all the link-management advertisements for the links on this node.

Related Topics

[How MPLS-TE Works](#), on page 172

[Build MPLS-TE Topology and Tunnels: Example](#), on page 331

Creating an MPLS-TE Tunnel

Creating an MPLS-TE tunnel is a process of customizing the traffic engineering to fit your network topology. Perform this task to create an MPLS-TE tunnel after you have built the traffic engineering topology.

Before you begin

The following prerequisites are required to create an MPLS-TE tunnel:

- You must have a router ID for the neighboring router.

- Stable router ID is required at either end of the link to ensure that the link is successful. If you do not assign a router ID to the routers, the system defaults to the global router ID. Default router IDs are subject to change, which can result in an unstable link.
- If you are going to use nondefault holdtime or intervals, you must decide the values to which they are set.

SUMMARY STEPS

1. **configure**
2. **interface tunnel-te** *tunnel-id*
3. **destination** *ip-address*
4. **ipv4 unnumbered** *type interface-path-id*
5. **path-option** *preference - priority* **dynamic**
6. **signalled-** **bandwidth** {*bandwidth [class-type ct]* | **sub-pool** *bandwidth*}
7. **commit**
8. (Optional) **show mpls traffic-eng tunnels**
9. (Optional) **show ipv4 interface brief**
10. (Optional) **show mpls traffic-eng link-management admission-control**

DETAILED STEPS

	Command or Action	Purpose
Step 1	configure	
Step 2	interface tunnel-te <i>tunnel-id</i> Example: RP/0/RP0/CPU0:router# interface tunnel-te 1	Configures an MPLS-TE tunnel interface.
Step 3	destination <i>ip-address</i> Example: RP/0/RP0/CPU0:router (config-if)# destination 192.168.92.125	Assigns a destination address on the new tunnel. The destination address is the remote node's MPLS-TE router ID.
Step 4	ipv4 unnumbered <i>type interface-path-id</i> Example: RP/0/RP0/CPU0:router (config-if)# ipv4 unnumbered Loopback0	Assigns a source address so that forwarding can be performed on the new tunnel. Loopback is commonly used as the interface type.
Step 5	path-option <i>preference - priority</i> dynamic Example: RP/0/RP0/CPU0:router (config-if)# path-option 1	Sets the path option to dynamic and assigns the path ID.

	Command or Action	Purpose
	<code>dynamic</code>	
Step 6	<p>signalled- bandwidth {<i>bandwidth</i> [class-type <i>ct</i>] sub-pool <i>bandwidth</i>}</p> <p>Example:</p> <pre>RP/0/RP0/CPU0:router(config-if)# signalled-bandwidth 100</pre>	Sets the CT0 bandwidth required on this interface. Because the default tunnel priority is 7, tunnels use the default TE class map (namely, class-type 1, priority 7).
Step 7	<code>commit</code>	
Step 8	<p>(Optional) show mpls traffic-eng tunnels</p> <p>Example:</p> <pre>RP/0/RP0/CPU0:router# show mpls traffic-eng tunnels</pre>	Verifies that the tunnel is connected (in the UP state) and displays all configured TE tunnels.
Step 9	<p>(Optional) show ipv4 interface brief</p> <p>Example:</p> <pre>RP/0/RP0/CPU0:router# show ipv4 interface brief</pre>	Displays all TE tunnel interfaces.
Step 10	<p>(Optional) show mpls traffic-eng link-management admission-control</p> <p>Example:</p> <pre>RP/0/RP0/CPU0:router# show mpls traffic-eng link-management admission-control</pre>	Displays all the tunnels on this node.

Related Topics

[How MPLS-TE Works](#), on page 172

[Build MPLS-TE Topology and Tunnels: Example](#), on page 331

[Building MPLS-TE Topology](#), on page 220

Automatic Modification Of An MPLS-TE Tunnel's Metric

If the IGP calculation on a router results in an equal cost multipath (ECMP) scenario where next-hop interfaces are a mix of MPLS-TE tunnels and physical interfaces, you may want to ensure that a TE tunnel is preferred. Consider this topology:

Figure 23: MPLS-TE Tunnel

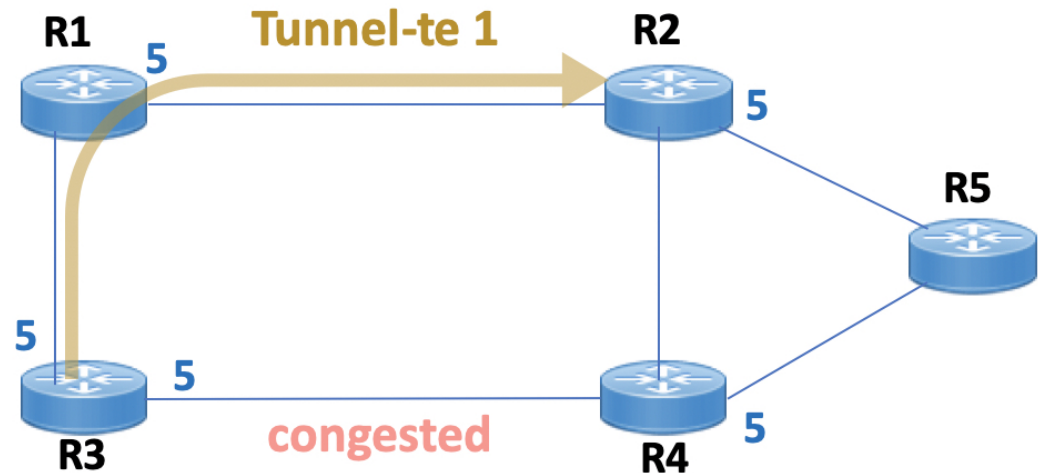

1. All links in the network have a metric of 5.
2. To offload a congested link between R3 and R4, an MPLS-TE tunnel is created from R3 to R2.
3. If the metric of the tunnel is also 5, traffic from R3 to R5 is load-balanced between the tunnel and the physical R3-R4 link.

To ensure that the MPLS-TE tunnel is preferred in such scenarios, configure the **autoroute metric** command on the tunnel interface. The modified metric is applied in the routing information base (RIB), and the tunnel is preferred over the physical path of the same metric. Sample configuration:

```
Router# configure
Router(config)# interface tunnel-te 1
Router(config-if)# autoroute metric relative -1
```

The **autoroute metric** command syntax is **autoroute metric {absolute|relative} value**

- **absolute** enables the absolute metric mode, for a metric range between 1 and 2147483647.
- **relative** enables the relative metric mode, for a metric range between -10 and 10, including zero.



Note Since the **relative** metric is not saved in the IGP database, the advertised metric of the MPLS-TE tunnel remains 5, and doesn't affect SPF calculation outcomes on other nodes.

Configuring Forwarding over the MPLS-TE Tunnel

Perform this task to configure forwarding over the MPLS-TE tunnel created in the previous task. This task allows MPLS packets to be forwarded on the link between network neighbors.

Before you begin

The following prerequisites are required to configure forwarding over the MPLS-TE tunnel:

- You must have a router ID for the neighboring router.
- Stable router ID is required at either end of the link to ensure that the link is successful. If you do not assign a router ID to the routers, the system defaults to the global router ID. Default router IDs are subject to change, which can result in an unstable link.

SUMMARY STEPS

1. **configure**
2. **interface tunnel-te *tunnel-id***
3. **ipv4 unnumbered *type interface-path-id***
4. **autoroute announce**
5. **exit**
6. **router static address-family ipv4 unicast *prefix mask ip-address interface type***
7. **commit**
8. (Optional) **ping {*ip-address* | *hostname*}**
9. (Optional) **show mpls traffic-eng autoroute**

DETAILED STEPS

	Command or Action	Purpose
Step 1	configure	
Step 2	interface tunnel-te <i>tunnel-id</i> Example: RP/0/RP0/CPU0:router(config)# interface tunnel-te 1	Enters MPLS-TE interface configuration mode.
Step 3	ipv4 unnumbered <i>type interface-path-id</i> Example: RP/0/RP0/CPU0:router(config-if)# ipv4 unnumbered Loopback0	Assigns a source address so that forwarding can be performed on the new tunnel.
Step 4	autoroute announce Example: RP/0/RP0/CPU0:router(config-if)# autoroute announce	Enables messages that notify the neighbor nodes about the routes that are forwarding.
Step 5	exit Example:	Exits the current configuration mode.

	Command or Action	Purpose
	<pre>RP/0/RP0/CPU0:router(config-if)# exit</pre>	
Step 6	<p>router static address-family ipv4 unicast <i>prefix mask ip-address interface type</i></p> <p>Example:</p> <pre>RP/0/RP0/CPU0:router(config)# router static address-family ipv4 unicast 2.2.2.2/32 tunnel-te 1</pre>	<p>Enables a route using IP version 4 addressing, identifies the destination address and the tunnel where forwarding is enabled.</p> <p>This configuration is used for static routes when the autoroute announce command is not used.</p>
Step 7	commit	
Step 8	<p>(Optional) ping {<i>ip-address hostname</i>}</p> <p>Example:</p> <pre>RP/0/RP0/CPU0:router# ping 192.168.12.52</pre>	Checks for connectivity to a particular IP address or host name.
Step 9	<p>(Optional) show mpls traffic-eng autoroute</p> <p>Example:</p> <pre>RP/0/RP0/CPU0:router# show mpls traffic-eng autoroute</pre>	Verifies forwarding by displaying what is advertised to IGP for the TE tunnel.

Related Topics

[Overview of MPLS Traffic Engineering](#), on page 171

[Creating an MPLS-TE Tunnel](#), on page 222

Protecting MPLS Tunnels with Fast Reroute

Perform this task to protect MPLS-TE tunnels, as created in the previous task.



Note Although this task is similar to the previous task, its importance makes it necessary to present as part of the tasks required for traffic engineering on Cisco IOS XR software.

Before you begin

The following prerequisites are required to protect MPLS-TE tunnels:

- You must have a router ID for the neighboring router.
- Stable router ID is required at either end of the link to ensure that the link is successful. If you do not assign a router ID to the routers, the system defaults to the global router ID. Default router IDs are subject to change, which can result in an unstable link.

- You must first configure a primary tunnel.

SUMMARY STEPS

1. **configure**
2. **interface tunnel-te** *tunnel-id*
3. **fast-reroute**
4. **exit**
5. **mpls traffic-eng**
6. **interface type** *interface-path-id*
7. **backup-path tunnel-te** *tunnel-number*
8. **exit**
9. **exit**
10. **interface tunnel-te** *tunnel-id*
11. **backup-bw** {*backup bandwidth* | **sub-pool** {*bandwidth* | **unlimited**} | **global-pool** {*bandwidth* | **unlimited**} }
12. **ipv4 unnumbered type** *interface-path-id*
13. **path-option preference-priority** {**explicit name** *explicit-path-name*}
14. **destination** *ip-address*
15. **commit**
16. (Optional) **show mpls traffic-eng tunnels backup**
17. (Optional) **show mpls traffic-eng tunnels protection fr**
18. (Optional) **show mpls traffic-eng fast-reroute database**

DETAILED STEPS

	Command or Action	Purpose
Step 1	configure	
Step 2	interface tunnel-te <i>tunnel-id</i> Example: RP/0/RP0/CPU0:router# interface tunnel-te 1	Configures an MPLS-TE tunnel interface.
Step 3	fast-reroute Example: RP/0/RP0/CPU0:router(config-if)# fast-reroute	Enables fast reroute.
Step 4	exit Example: RP/0/RP0/CPU0:router(config-if)# exit	Exits the current configuration mode.

	Command or Action	Purpose
Step 5	mpls traffic-eng Example: <pre>RP/0/RP0/CPU0:router(config)# mpls traffic-eng RP/0/RP0/CPU0:router(config-mpls-te)#</pre>	Enters MPLS-TE configuration mode.
Step 6	interface type interface-path-id Example: <pre>RP/0/RP0/CPU0:router(config-mpls-te)# interface pos0/6/0/0 RP/0/RP0/CPU0:router(config-mpls-te-if)#</pre>	Enables traffic engineering on a particular interface on the originating node.
Step 7	backup-path tunnel-te tunnel-number Example: <pre>RP/0/RP0/CPU0:router(config-mpls-te-if)# backup-path tunnel-te 2</pre>	Sets the backup path to the backup tunnel.
Step 8	exit Example: <pre>RP/0/RP0/CPU0:router(config-mpls-te-if)# exit RP/0/RP0/CPU0:router(config-mpls-te)#</pre>	Exits the current configuration mode.
Step 9	exit Example: <pre>RP/0/RP0/CPU0:router(config-mpls-te)# exit RP/0/RP0/CPU0:router(config)#</pre>	Exits the current configuration mode.
Step 10	interface tunnel-te tunnel-id Example: <pre>RP/0/RP0/CPU0:router(config)# interface tunnel-te 2</pre>	Configures an MPLS-TE tunnel interface.
Step 11	backup-bw {backup bandwidth sub-pool {bandwidth unlimited} global-pool {bandwidth unlimited} } Example: <pre>RP/0/RP0/CPU0:router(config-if)#backup-bw global-pool 5000</pre>	Sets the CT0 bandwidth required on this interface. Note Because the default tunnel priority is 7, tunnels use the default TE class map.

	Command or Action	Purpose
Step 12	ipv4 unnumbered <i>type interface-path-id</i> Example: <pre>RP/0/RP0/CPU0:router(config-if)# ipv4 unnumbered Loopback0</pre>	Assigns a source address to set up forwarding on the new tunnel.
Step 13	path-option <i>preference-priority {explicit name explicit-path-name}</i> Example: <pre>RP/0/RP0/CPU0:router(config-if)# path-option 1 explicit name backup-path</pre>	Sets the path option to explicit with a given name (previously configured) and assigns the path ID.
Step 14	destination <i>ip-address</i> Example: <pre>RP/0/RP0/CPU0:router(config-if)# destination 192.168.92.125</pre>	Assigns a destination address on the new tunnel. <ul style="list-style-type: none"> • Destination address is the remote node's MPLS-TE router ID. • Destination address is the merge point between backup and protected tunnels. <p>Note When you configure TE tunnel with multiple protection on its path and merge point is the same node for more than one protection, you must configure record-route for that tunnel.</p>
Step 15	commit	
Step 16	(Optional) show mpls traffic-eng tunnels backup Example: <pre>RP/0/RP0/CPU0:router# show mpls traffic-eng tunnels backup</pre>	Displays the backup tunnel information.
Step 17	(Optional) show mpls traffic-eng tunnels protection frr Example: <pre>RP/0/RP0/CPU0:router# show mpls traffic-eng tunnels protection frr</pre>	Displays the tunnel protection information for Fast-Reroute (FRR).
Step 18	(Optional) show mpls traffic-eng fast-reroute database Example: <pre>RP/0/RP0/CPU0:router# show mpls traffic-eng fast-reroute database</pre>	Displays the protected tunnel state (for example, the tunnel's current ready or active state).

Related Topics

[Fast Reroute](#), on page 180

[Fast Reroute Node Protection](#), on page 188

[Creating an MPLS-TE Tunnel](#), on page 222

[Configuring Forwarding over the MPLS-TE Tunnel](#), on page 225

Enabling an AutoTunnel Backup

Perform this task to configure the AutoTunnel Backup feature. By default, this feature is disabled. You can configure the AutoTunnel Backup feature for each interface. It has to be explicitly enabled for each interface or link.

SUMMARY STEPS

1. **configure**
2. **ipv4 unnumbered mpls traffic-eng Loopback 0**
3. **mpls traffic-eng**
4. **auto-tunnel backup timers removal unused *frequency***
5. **auto-tunnel backup tunnel-id min *minmax* *max***
6. **commit**
7. **show mpls traffic-eng auto-tunnel backup summary**

DETAILED STEPS

	Command or Action	Purpose
Step 1	configure	
Step 2	ipv4 unnumbered mpls traffic-eng Loopback 0 Example: RP/0/RP0/CPU0:router(config)#ipv4 unnumbered mpls traffic-eng Loopback 0	Configures the globally configured IPv4 address that can be used by the AutoTunnel Backup Tunnels. Note Loopback 0 is the router ID. The AutoTunnel Backup tunnels will not come up until a global IPv4 address is configured.
Step 3	mpls traffic-eng Example: RP/0/RP0/CPU0:router(config)# mpls traffic-eng	Enters MPLS-TE configuration mode.
Step 4	auto-tunnel backup timers removal unused <i>frequency</i> Example: RP/0/RP0/CPU0:router(config-mpls-te)# auto-tunnel backup timers removal unused 20	Configures how frequently a timer scans the backup automatic tunnels and removes tunnels that are not in use. • Use the frequency argument to scan the backup automatic tunnel. Range is 0 to 10080. Note You can also configure the auto-tunnel backup command at mpls traffic-eng interface mode.
Step 5	auto-tunnel backup tunnel-id min <i>minmax</i> <i>max</i> Example:	Configures the range of tunnel interface numbers to be used for automatic backup tunnels. Range is 0 to 65535.

	Command or Action	Purpose
	RP/0/RP0/CPU0:router(config-mpls-te)# auto-tunnel backup tunnel-id min 6000 max 6500	
Step 6	commit	
Step 7	show mpls traffic-eng auto-tunnel backup summary Example: RP/0/RP0/CPU0:router# show mpls traffic-eng auto-tunnel backup summary	Displays information about configured MPLS-TE backup autotunnels.

Related Topics

[Backup AutoTunnels](#), on page 173

[Configure the MPLS-TE Auto-Tunnel Backup: Example](#), on page 345

Removing an AutoTunnel Backup

To remove all the backup autotunnels, perform this task to remove the AutoTunnel Backup feature.

SUMMARY STEPS

1. **clear mpls traffic-eng auto-tunnel backup unused { all | tunnel-tenumber }**
2. **commit**
3. **show mpls traffic-eng auto-tunnel summary**

DETAILED STEPS

	Command or Action	Purpose
Step 1	clear mpls traffic-eng auto-tunnel backup unused { all tunnel-tenumber } Example: RP/0/RP0/CPU0:router# clear mpls traffic-eng auto-tunnel backup unused all	Clears all MPLS-TE automatic backup tunnels from the EXEC mode. You can also remove the automatic backup tunnel marked with specific tunnel-te, provided it is currently unused.
Step 2	commit	
Step 3	show mpls traffic-eng auto-tunnel summary Example: RP/0/RP0/CPU0:router# show mpls traffic-eng auto-tunnel summary	Displays information about MPLS-TE autotunnels including the ones removed.

Related Topics

[Backup AutoTunnels](#), on page 173

[Configure the MPLS-TE Auto-Tunnel Backup: Example](#), on page 345

Establishing MPLS Backup AutoTunnels to Protect Fast Reroutable TE LSPs

To establish an MPLS backup autotunnel to protect fast reroutable TE LSPs, perform these steps:

SUMMARY STEPS

1. **configure**
2. **mpls traffic-eng**
3. **interface** *type interface-path-id*
4. **auto-tunnel backup**
5. **attribute-set** *attribute-set-name*
6. **commit**
7. **show mpls traffic-eng auto-tunnel backup summary**

DETAILED STEPS

	Command or Action	Purpose
Step 1	configure	
Step 2	mpls traffic-eng Example: RP/0/RP0/CPU0:router(config)# mpls traffic-eng	Enters MPLS-TE configuration mode.
Step 3	interface <i>type interface-path-id</i> Example: RP/0/RP0/CPU0:router(config-mpls-te)# interface POS 0/6/0/0	Enables traffic engineering on a specific interface on the originating node.
Step 4	auto-tunnel backup Example: RP/0/RP0/CPU0:router(config-mpls-te-if)# auto-tunnel backup	Enables an auto-tunnel backup feature for the specified interface. Note You cannot configure the static backup on the similar link.
Step 5	attribute-set <i>attribute-set-name</i> Example: RP/0/RP0/CPU0:router(config-mpls-te-if-auto-backup)#attribute-set ab	Configures attribute-set template for auto-tunnel backup tunnels.
Step 6	commit	
Step 7	show mpls traffic-eng auto-tunnel backup summary Example: RP/0/RP0/CPU0:router# show mpls traffic auto-tunnel backup summary	Displays information about configured MPLS-TE backup autotunnels.

Related Topics

[Backup AutoTunnels](#), on page 173

[Configure the MPLS-TE Auto-Tunnel Backup: Example](#), on page 345

Establishing Next-Hop Tunnels with Link Protection

To establish a next-hop tunnel and link protection on the primary tunnel, perform these steps:

SUMMARY STEPS

1. **configure**
2. **mpls traffic-eng**
3. **interface** *type interface-path-id*
4. **auto-tunnel backup nhop-only**
5. **auto-tunnel backup exclude srlg** [preferred]
6. **attribute-set** *attribute-set-name*
7. **commit**
8. **show mpls traffic-eng tunnels** *number detail*

DETAILED STEPS

	Command or Action	Purpose
Step 1	configure	
Step 2	mpls traffic-eng Example: RP/0/RP0/CPU0:router(config)# mpls traffic-eng	Enters MPLS-TE configuration mode.
Step 3	interface <i>type interface-path-id</i> Example: RP/0/RP0/CPU0:router(config-mpls-te)# interface POS 0/6/0/0	Enables traffic engineering on a specific interface on the originating node.
Step 4	auto-tunnel backup nhop-only Example: RP/0/RP0/CPU0:router(config-mpls-te-if)# auto-tunnel backup nhop-only	Enables the creation of dynamic NHOP backup tunnels. By default, both NHOP and NNHOP protection are enabled. Note Using this nhop-only option, only link protection is provided.
Step 5	auto-tunnel backup exclude srlg [preferred] Example: RP/0/RP0/CPU0:router(config-mpls-te-if)# auto-tunnel backup exclude srlg preferred	Enables the exclusion of SRLG values on a given link for the AutoTunnel backup associated with a given interface. The preferred option allows the AutoTunnel Backup tunnels to come up even if no path excluding all SRLG is found.
Step 6	attribute-set <i>attribute-set-name</i> Example: RP/0/RP0/CPU0:router(config-mpls-te-if-auto-backup)#attribute-set ab	Configures attribute-set template for auto-tunnel backup tunnels.
Step 7	commit	
Step 8	show mpls traffic-eng tunnels <i>number detail</i> Example: RP/0/RP0/CPU0:router# show mpls traffic-eng tunnels 1 detail	Displays information about configured NHOP tunnels and SRLG information.

Related Topics

[Backup AutoTunnels](#), on page 173

[Configure the MPLS-TE Auto-Tunnel Backup: Example](#), on page 345

Configuring a Prestandard DS-TE Tunnel

Perform this task to configure a Prestandard DS-TE tunnel.

Before you begin

The following prerequisites are required to configure a Prestandard DS-TE tunnel:

- You must have a router ID for the neighboring router.
- Stable router ID is required at either end of the link to ensure that the link is successful. If you do not assign a router ID to the routers, the system defaults to the global router ID. Default router IDs are subject to change, which can result in an unstable link.

SUMMARY STEPS

1. **configure**
2. **rsvp interface** *type interface-path-id*
3. **bandwidth** [*total reservable bandwidth*] [**bc0** *bandwidth*] [**global-pool** *bandwidth*] [**sub-pool** *reservable-bw*]
4. **exit**
5. **exit**
6. **interface tunnel-te** *tunnel-id*
7. **signalled-bandwidth** {*bandwidth* [**class-type** *ct*] | **sub-pool** *bandwidth*}
8. **commit**

DETAILED STEPS

	Command or Action	Purpose
Step 1	configure	
Step 2	rsvp interface <i>type interface-path-id</i> Example: RP/0/RP0/CPU0:router(config)# rsvp interface pos0/6/0/0	Enters RSVP configuration mode and selects an RSVP interface.
Step 3	bandwidth [<i>total reservable bandwidth</i>] [bc0 <i>bandwidth</i>] [global-pool <i>bandwidth</i>] [sub-pool <i>reservable-bw</i>] Example: RP/0/RP0/CPU0:router(config-rsvp-if)# bandwidth 100 150 sub-pool 50	Sets the reserved RSVP bandwidth available on this interface by using the prestandard DS-TE mode. The range for the <i>total reserve bandwidth</i> argument is 0 to 4294967295. Physical interface bandwidth is not used by MPLS-TE.

	Command or Action	Purpose
Step 4	exit Example: <pre>RP/0/RP0/CPU0:router(config-rsvp-if)# exit RP/0/RP0/CPU0:router(config-rsvp)#</pre>	Exits the current configuration mode.
Step 5	exit Example: <pre>RP/0/RP0/CPU0:router(config-rsvp)# exit RP/0/RP0/CPU0:router(config)#</pre>	Exits the current configuration mode.
Step 6	interface tunnel-te <i>tunnel-id</i> Example: <pre>RP/0/RP0/CPU0:router(config)# interface tunnel-te 2</pre>	Configures an MPLS-TE tunnel interface.
Step 7	signalled-bandwidth {<i>bandwidth</i> [class-type <i>ct</i>] sub-pool <i>bandwidth</i>} Example: <pre>RP/0/RP0/CPU0:router(config-if)# signalled-bandwidth sub-pool 10</pre>	Sets the bandwidth required on this interface. Because the default tunnel priority is 7, tunnels use the default TE class map (namely, class-type 1, priority 7).
Step 8	commit	

Related Topics

- [Configuring Traffic Engineering Tunnel Bandwidth](#), on page 138
- [Prestandard DS-TE Mode](#), on page 177
- [Configure IETF DS-TE Tunnels: Example](#), on page 332

Configuring an IETF DS-TE Tunnel Using RDM

Perform this task to create an IETF mode DS-TE tunnel using RDM.

Before you begin

The following prerequisites are required to create an IETF mode DS-TE tunnel using RDM:

- You must have a router ID for the neighboring router.
- Stable router ID is required at either end of the link to ensure that the link is successful. If you do not assign a router ID to the routers, the system defaults to the global router ID. Default router IDs are subject to change, which can result in an unstable link.

SUMMARY STEPS

1. **configure**
2. **rsvp interface** *type interface-path-id*
3. **bandwidth rdm** *{total-reservable-bw | bc0 | global-pool} {sub-pool | bc1 reservable-bw}*
4. **exit**
5. **exit**
6. **mpls traffic-eng**
7. **ds-te mode ietf**
8. **exit**
9. **interface tunnel-te** *tunnel-id*
10. **signalled-bandwidth** *{bandwidth [class-type ct] | sub-pool bandwidth}*
11. **commit**

DETAILED STEPS

	Command or Action	Purpose
Step 1	configure	
Step 2	rsvp interface <i>type interface-path-id</i> Example: RP/0/RP0/CPU0:router (config)# rsvp interface pos0/6/0/0	Enters RSVP configuration mode and selects an RSVP interface.
Step 3	bandwidth rdm <i>{total-reservable-bw bc0 global-pool} {sub-pool bc1 reservable-bw}</i> Example: RP/0/RP0/CPU0:router (config-rsvp-if)# bandwidth rdm 100 150	Sets the reserved RSVP bandwidth available on this interface by using the Russian Doll Model (RDM) bandwidth constraints model. The range for the <i>total reserve bandwidth</i> argument is 0 to 4294967295. Note Physical interface bandwidth is not used by MPLS-TE.
Step 4	exit Example: RP/0/RP0/CPU0:router (config-rsvp-if)# exit RP/0/RP0/CPU0:router (config-rsvp)	Exits the current configuration mode.
Step 5	exit Example: RP/0/RP0/CPU0:router (config-rsvp) exit RP/0/RP0/CPU0:router (config)	Exits the current configuration mode.
Step 6	mpls traffic-eng Example:	Enters MPLS-TE configuration mode.

	Command or Action	Purpose
	RP/0/RP0/CPU0:router(config)# mpls traffic-eng RP/0/RP0/CPU0:router(config-mpls-te)#	
Step 7	ds-te mode ietf Example: RP/0/RP0/CPU0:router(config-mpls-te)# ds-te mode ietf	Enables IETF DS-TE mode and default TE class map. IETF DS-TE mode is configured on all network nodes.
Step 8	exit Example: RP/0/RP0/CPU0:router(config-mpls-te)# exit	Exits the current configuration mode.
Step 9	interface tunnel-te <i>tunnel-id</i> Example: RP/0/RP0/CPU0:router(config)# interface tunnel-te 4 RP/0/RP0/CPU0:router(config-if)#	Configures an MPLS-TE tunnel interface.
Step 10	signalled-bandwidth {<i>bandwidth</i> [class-type <i>ct</i>] sub-pool <i>bandwidth</i>} Example: RP/0/RP0/CPU0:router(config-if)# signalled-bandwidth 10 class-type 1	Configures the bandwidth required for an MPLS TE tunnel. Because the default tunnel priority is 7, tunnels use the default TE class map (namely, class-type 1, priority 7).
Step 11	commit	

Related Topics

[Configuring Traffic Engineering Tunnel Bandwidth](#), on page 138

[Russian Doll Bandwidth Constraint Model](#), on page 178

Configuring an IETF DS-TE Tunnel Using MAM

Perform this task to configure an IETF mode differentiated services traffic engineering tunnel using the Maximum Allocation Model (MAM) bandwidth constraint model.

Before you begin

The following prerequisites are required to configure an IETF mode differentiated services traffic engineering tunnel using the MAM bandwidth constraint model:

- You must have a router ID for the neighboring router.

- Stable router ID is required at either end of the link to ensure that the link is successful. If you do not assign a router ID to the routers, the system defaults to the global router ID. Default router IDs are subject to change, which can result in an unstable link.

SUMMARY STEPS

1. **configure**
2. **rsvp interface** *type interface-path-id*
3. **bandwidth mam** {*total reservable bandwidth* | **max-reservable-bw** *maximum-reservable-bw*} [**bc0** *reservable bandwidth*] [**bc1** *reservable bandwidth*]
4. **exit**
5. **exit**
6. **mpls traffic-eng**
7. **ds-te mode ietf**
8. **ds-te bc-model mam**
9. **exit**
10. **interface tunnel-te** *tunnel-id*
11. **signalled-bandwidth** {*bandwidth* [**class-type** *ct*] | **sub-pool** *bandwidth*}
12. **commit**

DETAILED STEPS

	Command or Action	Purpose
Step 1	configure	
Step 2	rsvp interface <i>type interface-path-id</i> Example: RP/0/RP0/CPU0:router(config)# rsvp interface pos0/6/0/0	Enters RSVP configuration mode and selects the RSVP interface.
Step 3	bandwidth mam { <i>total reservable bandwidth</i> max-reservable-bw <i>maximum-reservable-bw</i> } [bc0 <i>reservable bandwidth</i>] [bc1 <i>reservable bandwidth</i>] Example: RP/0/RP0/CPU0:router(config-rsvp-if)# bandwidth mam max-reservable-bw 400 bc0 300 bc1 200	Sets the reserved RSVP bandwidth available on this interface. Note Physical interface bandwidth is not used by MPLS-TE.
Step 4	exit Example: RP/0/RP0/CPU0:router(config-rsvp-if)# exit RP/0/RP0/CPU0:router(config-rsvp)#	Exits the current configuration mode.

	Command or Action	Purpose
Step 5	exit Example: <pre>RP/0/RP0/CPU0:router(config-rsvp)# exit RP/0/RP0/CPU0:router(config)#</pre>	Exits the current configuration mode.
Step 6	mpls traffic-eng Example: <pre>RP/0/RP0/CPU0:router(config)# mpls traffic-eng RP/0/RP0/CPU0:router(config-mpls-te)#</pre>	Enters MPLS-TE configuration mode.
Step 7	ds-te mode ietf Example: <pre>RP/0/RP0/CPU0:router(config-mpls-te)# ds-te mode ietf</pre>	Enables IETF DS-TE mode and default TE class map. Configure IETF DS-TE mode on all nodes in the network.
Step 8	ds-te bc-model mam Example: <pre>RP/0/RP0/CPU0:router(config-mpls-te)# ds-te bc-model mam</pre>	Enables the MAM bandwidth constraint model globally.
Step 9	exit Example: <pre>RP/0/RP0/CPU0:router(config-mpls-te)# exit</pre>	Exits the current configuration mode.
Step 10	interface tunnel-te <i>tunnel-id</i> Example: <pre>RP/0/RP0/CPU0:router(config)# interface tunnel-te 4 RP/0/RP0/CPU0:router(config-if)#</pre>	Configures an MPLS-TE tunnel interface.
Step 11	signalled-bandwidth {<i>bandwidth</i> [class-type <i>ct</i>] sub-pool <i>bandwidth</i>} Example: <pre>RP/0/RP0/CPU0:router(config-rsvp-if)# signalled-bandwidth 10 class-type 1</pre>	Configures the bandwidth required for an MPLS TE tunnel. Because the default tunnel priority is 7, tunnels use the default TE class map (namely, class-type 1, priority 7).

	Command or Action	Purpose
Step 12	commit	

Related Topics

[Configuring Traffic Engineering Tunnel Bandwidth](#), on page 138

[Maximum Allocation Bandwidth Constraint Model](#), on page 178

Configuring MPLS -TE and Fast-Reroute on OSPF

Perform this task to configure MPLS-TE and Fast Reroute (FRR) on OSPF.

Before you begin



Note Only point-to-point (P2P) interfaces are supported for OSPF multiple adjacencies. These may be either native P2P interfaces or broadcast interfaces on which the **OSPF P2P configuration** command is applied to force them to behave as P2P interfaces as far as OSPF is concerned. This restriction does not apply to IS-IS.

The tunnel-te interface is not supported under IS-IS.

SUMMARY STEPS

1. **configure**
2. **interface tunnel-te** *tunnel-id*
3. **path-option** [**protecting**] *preference-priority* {**dynamic** [**pce** [**address ipv4 address**] | **explicit** {**name** *pathname* | **identifier** *path-number* } } [**isis** *instance name* {**level** *level*}] [**ospf** *instance name* {**area** *area ID*}]] [**verbatim**] [**lockdown**]
4. Repeat Step 3 as many times as needed.
5. **commit**
6. **show mpls traffic-eng tunnels** [*tunnel-number*]

DETAILED STEPS

	Command or Action	Purpose
Step 1	configure	
Step 2	interface tunnel-te <i>tunnel-id</i> Example: RP/0/RP0/CPU0:router(config)# interface tunnel-te 1 RP/0/RP0/CPU0:router(config-if)#	Configures an MPLS-TE tunnel interface. The range for the tunnel ID number is 0 to 65535.
Step 3	path-option [protecting] <i>preference-priority</i> { dynamic [pce [address ipv4 address] explicit { name <i>pathname</i> identifier <i>path-number</i> } } [isis <i>instance name</i> { level <i>level</i> }] [ospf <i>instance name</i> { area <i>area ID</i> }]] [verbatim] [lockdown]	Configures an explicit path option for an MPLS-TE tunnel. OSPF is limited to a single OSPF instance and area.

	Command or Action	Purpose
	<pre>] [ospf instance name {area area ID}]] [verbatim] [lockdown] Example: RP/0/RP0/CPU0:router(config-if)# path-option 1 explicit identifier 6 ospf green area 0</pre>	
Step 4	Repeat Step 3 as many times as needed. Example: <pre>RP/0/RP0/CPU0:router(config-if)# path-option 2 explicit name 234 ospf 3 area 7 verbatim</pre>	Configures another explicit path option.
Step 5	commit	
Step 6	<pre>show mpls traffic-eng tunnels [tunnel-number] Example: RP/0/RP0/CPU0:router# show mpls traffic-eng tunnels 1</pre>	Displays information about MPLS-TE tunnels.

Related Topics

[Configure MPLS-TE and Fast-Reroute on OSPF: Example](#), on page 333

Configuring the Ignore Integrated IS-IS Overload Bit Setting in MPLS-TE

Perform this task to configure an overload node avoidance in MPLS-TE. When the overload bit is enabled, tunnels are brought down when the overload node is found in the tunnel path.

SUMMARY STEPS

1. **configure**
2. **mpls traffic-eng**
3. **path-selection ignore overload {head | mid | tail}**
4. **commit**

DETAILED STEPS

	Command or Action	Purpose
Step 1	configure	
Step 2	<pre>mpls traffic-eng Example: RP/0/RP0/CPU0:router(config)# mpls traffic-eng</pre>	Enters MPLS-TE configuration mode.

	Command or Action	Purpose
	RP/0/RP0/CPU0:router(config-mpls-te)#	
Step 3	path-selection ignore overload {head mid tail} Example: RP/0/RP0/CPU0:router(config-mpls-te)# path-selection ignore overload head	Ignores the Intermediate System-to-Intermediate System (IS-IS) overload bit setting for MPLS-TE. If set-overload-bit is set by IS-IS on the head router, the tunnels stay up.
Step 4	commit	

Related Topics

- [Ignore Intermediate System-to-Intermediate System Overload Bit Setting in MPLS-TE](#), on page 182
- [Configure the Ignore IS-IS Overload Bit Setting in MPLS-TE: Example](#), on page 333

Configuring GMPLS

To fully configure GMPLS, you must complete these high-level tasks in order:

- [Configuring IPCC Control Channel Information](#), on page 243
- [Configuring Local and Remote TE Links](#), on page 246
- [Configuring Numbered and Unnumbered Optical TE Tunnels](#), on page 256
- [Configuring LSP Hierarchy](#), on page 260
- [Configuring Border Control Model](#), on page 261
- [Configuring Path Protection](#), on page 261



Note These high-level tasks are broken down into, in some cases, several subtasks.

Configuring IPCC Control Channel Information

To configure IPCC control channel information, complete these subtasks:

- [Configuring Router IDs](#), on page 243
- [Configuring OSPF over IPCC](#), on page 245



Note You must configure each subtask on both the headend and tailend router.

Configuring Router IDs

Perform this task to configure the router ID for the headend and tailend routers.

SUMMARY STEPS

1. **configure**
2. **interface** *type interface-path-id*
3. **ipv4 address** *ipv4-address mask*
4. **exit**
5. **router ospf** *process-name*
6. **mpls traffic-eng router-id** *type interface-path-id*
7. **commit**

DETAILED STEPS

	Command or Action	Purpose
Step 1	configure	
Step 2	interface <i>type interface-path-id</i> Example: RP/0/RP0/CPU0:router(config)# interface POS0/6/0/0	Enters MPLS-TE interface configuration mode and enables traffic engineering on a particular interface on the originating node.
Step 3	ipv4 address <i>ipv4-address mask</i> Example: RP/0/RP0/CPU0:router(config-if)# ipv4 address 192.168.1.27 255.0.0.0	Specifies a primary or secondary IPv4 address for an interface. <ul style="list-style-type: none"> • Network mask can be a four-part dotted decimal address. For example, 255.0.0.0 indicates that each bit equal to 1 means that the corresponding address bit belongs to the network address. • Network mask can be indicated as a slash (/) and a number (prefix length). The prefix length is a decimal value that indicates how many of the high-order contiguous bits of the address compose the prefix (the network portion of the address). A slash must precede the decimal value, and there is no space between the IP address and the slash.
Step 4	exit Example: RP/0/RP0/CPU0:router(config-if)# exit RP/0/RP0/CPU0:router(config)#	Exits the current configuration mode.
Step 5	router ospf <i>process-name</i> Example: RP/0/RP0/CPU0:router(config)# router ospf 1 RP/0/RP0/CPU0:router(config-ospf)#	Configures an Open Shortest Path First (OSPF) routing process. The process name is any alphanumeric string no longer than 40 characters without spaces.

	Command or Action	Purpose
Step 6	mpls traffic-eng router-id <i>type interface-path-id</i> Example: <pre>RP/0/RP0/CPU0:router(config-ospf)# mpls traffic-eng router id Loopback0</pre>	Specifies that the TE router identifier for the node is the IP address that is associated with a given interface. The router ID is specified with an interface name or an IP address. By default, MPLS uses the global router ID.
Step 7	commit	

Related Topics

[GMPLS Support](#), on page 183

Configuring OSPF over IPCC

Perform this task to configure OSPF over IPCC on both the headend and tailend routers. The IGP interface ID is configured for control network, specifically for the signaling plane in the optical domain.



Note IPCC support is restricted to routed, out-of-fiber, and out-of-band.

SUMMARY STEPS

1. **configure**
2. **router ospf** *process-name*
3. **area** *area-id*
4. **interface** *type interface-path-id*
5. **exit**
6. **exit**
7. **mpls traffic-eng router-id** {*type interface-path-id* | *ip-address*}
8. **area** *area-id*
9. **commit**

DETAILED STEPS

	Command or Action	Purpose
Step 1	configure	
Step 2	router ospf <i>process-name</i> Example: <pre>RP/0/RP0/CPU0:router(config)# router ospf 1</pre>	Configures OSPF routing and assigns a process name.
Step 3	area <i>area-id</i> Example:	Configures an area ID for the OSPF process (either as a decimal value or IP address): <ul style="list-style-type: none"> • Backbone areas have an area ID of 0.

	Command or Action	Purpose
	<code>RP/0/RP0/CPU0:router (config-ospf) # area 0</code>	<ul style="list-style-type: none"> Non-backbone areas have a nonzero area ID.
Step 4	interface <i>type interface-path-id</i> Example: <code>RP/0/RP0/CPU0:router (config-ospf-ar) # interface Loopback0</code>	Enables IGP on the interface. This command is used to configure any interface included in the control network.
Step 5	exit Example: <code>RP/0/RP0/CPU0:router (config-ospf-ar-if) # exit</code> <code>RP/0/RP0/CPU0:router (config-ospf-ar) #</code>	Exits the current configuration mode.
Step 6	exit Example: <code>RP/0/RP0/CPU0:router (config-ospf-ar) # exit</code> <code>RP/0/RP0/CPU0:router (config-ospf) #</code>	Exits the current configuration mode.
Step 7	mpls traffic-eng router-id { <i>type interface-path-id</i> <i>ip-address</i> } Example: <code>RP/0/RP0/CPU0:router (config-ospf) # mpls traffic-eng router-id 192.168.25.66</code>	Configures a router ID for the OSPF process using an IP address.
Step 8	area <i>area-id</i> Example: <code>RP/0/RP0/CPU0:router (config-ospf) # area 0</code> <code>RP/0/RP0/CPU0:router (config-ospf-ar) #</code>	Configures the MPLS-TE area.
Step 9	commit	

Related Topics

[GMPLS Support](#), on page 183

Configuring Local and Remote TE Links

These subtasks describe how to configure local and remote MPLS-TE link parameters for numbered and unnumbered TE links on both headend and tailend routers.

- [Configuring Numbered and Unnumbered Links, on page 247](#)

- [Configuring Local Reservable Bandwidth, on page 248](#)
- [Configuring Local Switching Capability Descriptors, on page 249](#)
- [Configuring Persistent Interface Index, on page 250](#)
- [Enabling LMP Message Exchange, on page 250](#)
- [Disabling LMP Message Exchange, on page 251](#)
- [Configuring Remote TE Link Adjacency Information for Numbered Links, on page 253](#)
- [Configuring Remote TE Link Adjacency Information for Unnumbered Links, on page 254](#)

Configuring Numbered and Unnumbered Links

Perform this task to configure numbered and unnumbered links.



Note Unnumbered TE links use the IP address of the associated interface.

SUMMARY STEPS

1. **configure**
2. **interface** *type interface-path-id*
3. Do one of the following:
 - **ipv4 address** *ipv4-address mask*
 - **ipv4 unnumbered interface** *type interface-path-id*
4. **commit**

DETAILED STEPS

	Command or Action	Purpose
Step 1	configure	
Step 2	interface <i>type interface-path-id</i> Example: RP/0/RP0/CPU0:router(config)# interface POS0/6/0/0	Enters MPLS-TE interface configuration mode and enables traffic engineering on a particular interface on the originating node.
Step 3	Do one of the following: <ul style="list-style-type: none"> • ipv4 address <i>ipv4-address mask</i> • ipv4 unnumbered interface <i>type interface-path-id</i> Example: RP/0/RP0/CPU0:router(config-if)# ipv4 address 192.168.1.27 255.0.0.0	Specifies a primary or secondary IPv4 address for an interface. <ul style="list-style-type: none"> • Network mask is a four-part dotted decimal address. For example, 255.0.0.0 indicates that each bit equal to 1 means that the corresponding address bit belongs to the network address. • Network mask is indicated as a slash (/) and a number (prefix length). The prefix length is a decimal value

	Command or Action	Purpose
		<p>that indicates how many of the high-order contiguous bits of the address compose the prefix (the network portion of the address). A slash must precede the decimal value, and there is no space between the IP address and the slash.</p> <p>or</p> <ul style="list-style-type: none"> Enables IPv4 processing on a point-to-point interface without assigning an explicit IPv4 address to that interface. <p>Note If you configured a unnumbered GigabitEthernet interface in Step 2 and selected the <code>ipv4 unnumbered</code> interface command type option in this step, you must enter the ipv4 point-to-point command to configure point-to-point interface mode.</p>
Step 4	<code>commit</code>	

Configuring Local Reservable Bandwidth

Perform this task to configure the local reservable bandwidth for the data bearer channels.

SUMMARY STEPS

- configure**
- rsvp interface** *type interface-path-id*
- bandwidth** [*total reservable bandwidth*] [**bc0 bandwidth**] [**global-pool bandwidth**] [**sub-pool reservable-bw**]
- commit**

DETAILED STEPS

	Command or Action	Purpose
Step 1	<code>configure</code>	
Step 2	<p>rsvp interface <i>type interface-path-id</i></p> <p>Example:</p> <pre>RP/0/RP0/CPU0:router (config) # rsvp interface POS0/6/0/0</pre>	Enters RSVP configuration mode and selects an RSVP interface ID.
Step 3	<p>bandwidth [<i>total reservable bandwidth</i>] [bc0 bandwidth] [global-pool bandwidth] [sub-pool reservable-bw]</p> <p>Example:</p>	Sets the reserved RSVP bandwidth available on this interface.

	Command or Action	Purpose
	RP/0/RP0/CPU0:router(config-rsvp-if) # bandwidth 2488320 2488320	Note MPLS-TE can use only the amount of bandwidth specified using this command on the configured interface.
Step 4	commit	

Configuring Local Switching Capability Descriptors

Perform this task to configure the local switching capability descriptor.

SUMMARY STEPS

1. **configure**
2. **mpls traffic-eng**
3. **interface** *type interface-path-id*
4. **flooding-igp ospf** *instance-id area area-id*
5. **switching key** *value [encoding encoding type]*
6. **switching key** *value [capability {pscl | lsc | fsc}]*
7. **commit**

DETAILED STEPS

	Command or Action	Purpose
Step 1	configure	
Step 2	mpls traffic-eng Example: RP/0/RP0/CPU0:router(config) # mpls traffic-eng	Enters MPLS-TE configuration mode.
Step 3	interface <i>type interface-path-id</i> Example: RP/0/RP0/CPU0:router(config-mpls-te) # interface POS0/6/0/0	Enters MPLS-TE interface configuration mode and enables traffic engineering on a particular interface on the originating node.
Step 4	flooding-igp ospf <i>instance-id area area-id</i> Example: RP/0/RP0/CPU0:router(config-mpls-te-if) # flooding-igp ospf 0 area 1	Specifies the IGP OSPF interface ID and area where the TE links are to be flooded.
Step 5	switching key <i>value [encoding encoding type]</i> Example: RP/0/RP0/CPU0:router(config-mpls-te-if) # switching	Specifies the switching configuration for the interface and enters switching key mode where you will configure encoding and capability. Note The recommended switch key value is 0.

	Command or Action	Purpose
	<code>key 1 encoding ethernet</code>	
Step 6	<p><code>switching key value [capability {psc1 lsc fsc}]</code></p> <p>Example:</p> <pre>RP/0/RP0/CPU0:router(config-mpls-te-if)# switching key 1 capability psc1</pre>	Specifies the interface switching capability type. The recommended switch capability type is psc1 .
Step 7	<code>commit</code>	

Configuring Persistent Interface Index

Perform this task to preserve the LMP interface index across all interfaces on the router.

SUMMARY STEPS

1. `configure`
2. `snmp-server ifindex persist`
3. `commit`

DETAILED STEPS

	Command or Action	Purpose
Step 1	<code>configure</code>	
Step 2	<p><code>snmp-server ifindex persist</code></p> <p>Example:</p> <pre>RP/0/RP0/CPU0:router(config)# snmp-server ifindex persist</pre>	Enables ifindex persistence globally on all Simple Network Management Protocol (SNMP) interfaces.
Step 3	<code>commit</code>	

Enabling LMP Message Exchange

Perform the following task to enable LMP message exchange. LMP is enabled by default. You can disable LMP on a per neighbor basis using the **lmp static** command in LMP protocol neighbor mode.



Note LMP is recommended unless the peer optical device does not support LMP (in which case it is necessary to disable it at both ends).

SUMMARY STEPS

1. `configure`
2. `mpls traffic-eng`

3. **lmp neighbor** *name*
4. **ipcc routed**
5. **remote node-id** *node-id*
6. **commit**

DETAILED STEPS

	Command or Action	Purpose
Step 1	configure	
Step 2	mpls traffic-eng Example: RP/0/RP0/CPU0:router(config)# mpls traffic-eng	Enters MPLS-TE configuration mode.
Step 3	lmp neighbor <i>name</i> Example: RP/0/RP0/CPU0:router(config-mpls-te)# lmp neighbor OXC1	Configures or updates a LMP neighbor and its associated parameters.
Step 4	ipcc routed Example: RP/0/RP0/CPU0:router(config-mpls-te-nbr-OXC1)# ipcc routed	Configures a routable Internet Protocol Control Channel (IPCC).
Step 5	remote node-id <i>node-id</i> Example: RP/0/RP0/CPU0:router(config-mpls-te-nbr-OXC1)# remote node-id 2.2.2.2	Configures the remote node ID for an LMP neighbor. In addition, the <i>node-id</i> value can be an IPv4 address.
Step 6	commit	

Disabling LMP Message Exchange

Perform the following task to disable LMP message exchange. LMP is enabled by default. You can disable LMP on a per neighbor basis using the **lmp static** command in LMP protocol neighbor mode.



Note LMP is recommended unless the peer optical device does not support LMP (in which case it is necessary to disable it at both ends).

SUMMARY STEPS

1. **configure**
2. **mpls traffic-eng**
3. **lmp neighbor *name***
4. **lmp static**
5. **ipcc routed**
6. **remote node-id *node-id***
7. **commit**

DETAILED STEPS

	Command or Action	Purpose
Step 1	configure	
Step 2	mpls traffic-eng Example: RP/0/RP0/CPU0:router(config)# mpls traffic-eng	Enters MPLS-TE configuration mode.
Step 3	lmp neighbor <i>name</i> Example: RP/0/RP0/CPU0:router(config-mpls-te)# lmp neighbor OXC1	Configures or updates a LMP neighbor and its associated parameters.
Step 4	lmp static Example: RP/0/RP0/CPU0:router(config-mpls-te-nbr-OXC1)# lmp static	Disables dynamic LMP procedures for the specified neighbor, including LMP hello and LMP link summary. This command is used for neighbors that do not support dynamic LMP procedures.
Step 5	ipcc routed Example: RP/0/RP0/CPU0:router(config-mpls-te-nbr-OXC1)# ipcc routed	Configures a routable IPCC.
Step 6	remote node-id <i>node-id</i> Example: RP/0/RP0/CPU0:router(config-mpls-te-nbr-OXC1)# remote node-id 2.2.2.2	Configures the remote node ID for an LMP neighbor. The node ID value must be an IPv4 address.
Step 7	commit	

Configuring Remote TE Link Adjacency Information for Numbered Links

Perform this task to configure remote TE link adjacency information for numbered links.

SUMMARY STEPS

1. **configure**
2. **mpls traffic-eng**
3. **interface** *type interface-path-id*
4. **lmp data-link adjacency**
5. **remote switching-capability** {fsc | lsc | psc1}
6. **remote interface-id unnum** *value*
7. **remote node-id** *node-id*
8. **neighbor** *name*
9. **remote node-id** *address*
10. **commit**
11. **show mpls lmp**

DETAILED STEPS

	Command or Action	Purpose
Step 1	configure	
Step 2	mpls traffic-eng Example: RP/0/RP0/CPU0:router (config) # mpls traffic-eng	Enters MPLS-TE configuration mode.
Step 3	interface <i>type interface-path-id</i> Example: RP/0/RP0/CPU0:router (config-mpls-te) # interface POS0/6/0/0	Enters MPLS-TE interface configuration mode and enables TE on a particular interface on the originating node.
Step 4	lmp data-link adjacency Example: RP/0/RP0/CPU0:router (config-mpls-te-if) # lmp data-link adjacency	Configures LMP neighbor remote TE links.
Step 5	remote switching-capability {fsc lsc psc1} Example: RP/0/RP0/CPU0:router (config-mpls-te-if-adj) # remote switching-capability lsc	Configures the remote LMP MPLS-TE interface switching capability.

	Command or Action	Purpose
Step 6	remote interface-id unnum <i>value</i> Example: <pre>RP/0/RP0/CPU0:router(config-mpls-te-if-adj)# remote interface-id unnum 7</pre>	Configures the unnumbered interface identifier. Identifiers, which you specify by using this command, are the values assigned by the neighbor at the remote side.
Step 7	remote node-id <i>node-id</i> Example: <pre>RP/0/RP0/CPU0:router(config-mpls-te-if-adj)# remote node-id 10.10.10.10</pre>	Configures the remote node ID.
Step 8	neighbor <i>name</i> Example: <pre>RP/0/RP0/CPU0:router(config-mpls-te-if-adj)# neighbor OXC1</pre>	Configures or updates an LMP neighbor and its associated parameters.
Step 9	remote node-id <i>address</i> Example: <pre>RP/0/RP0/CPU0:router(config-mpls-te-if-adj)# remote node-id 10.10.10.10</pre>	Configures the remote node ID.
Step 10	commit	
Step 11	show mpls lmp Example: <pre>RP/0/RP0/CPU0:router# show mpls lmp</pre>	Verifies the assigned value for the local interface identifiers.

Configuring Remote TE Link Adjacency Information for Unnumbered Links

Perform this task to configure remote TE link adjacency information for unnumbered links.



Note To display the assigned value for the local interface identifiers, use the **show mpls lmp** command.

SUMMARY STEPS

1. **configure**
2. **mpls traffic-eng**
3. **interface** *type interface-path-id*
4. **lmp data link adjacency**

5. **neighbor** *name*
6. **remote te-link-id unnum**
7. **remote interface-id unnum** *interface-identifier*
8. **remote switching-capability** {fsc | lsc | psc1}
9. **commit**

DETAILED STEPS

	Command or Action	Purpose
Step 1	configure	
Step 2	mpls traffic-eng Example: RP/0/RP0/CPU0:router(config)# mpls traffic-eng	Enters MPLS-TE configuration mode.
Step 3	interface <i>type interface-path-id</i> Example: RP/0/RP0/CPU0:router(config-mpls-te) # interface POS0/6/0/0	Enters MPLS-TE interface configuration mode and enables TE on a particular interface on the originating node.
Step 4	lmp data link adjacency Example: RP/0/RP0/CPU0:router(config-mpls-te-if) # lmp data-link adjacency	Configures LMP neighbor remote TE links.
Step 5	neighbor <i>name</i> Example: RP/0/RP0/CPU0:router(config-mpls-te-if-adj) # neighbor OXC1	Configures or updates a LMP neighbor and its associated parameters.
Step 6	remote te-link-id unnum Example: RP/0/RP0/CPU0:router(config-mpls-te-if-adj) # remote te-link-id unnum 111	Configures the unnumbered interface and identifier.
Step 7	remote interface-id unnum <i>interface-identifier</i> Example: RP/0/RP0/CPU0:router(config-mpls-te-if-adj) # remote interface-id unnum 7	Configures the unnumbered interface identifier. Identifiers, which you specify by using this command, are the values assigned by the neighbor at the remote side.

	Command or Action	Purpose
Step 8	remote switching-capability {fsc lsc psc1} Example: <pre>RP/0/RP0/CPU0:router(config-mpls-te-if-adj) # remote switching-capability lsc</pre>	Configures remote the LMP MPLS-TE interface switching capability.
Step 9	commit	

Configuring Numbered and Unnumbered Optical TE Tunnels

These subtasks are included:

- [Configuring an Optical TE Tunnel Using Dynamic Path Option, on page 256](#)
- [Configuring an Optical TE Tunnel Using Explicit Path Option, on page 258](#)



Note Before you can successfully bring optical TE tunnels “up,” you must complete the procedures in the preceding sections.

The following characteristics can apply to the headend (or, signaling) router:

- Tunnels can be numbered or unnumbered.
- Tunnels can be dynamic or explicit.

The following characteristics can apply to the tailend (or, passive) router:

- Tunnels can be numbered or unnumbered.
- Tunnels must use the explicit path-option.

Configuring an Optical TE Tunnel Using Dynamic Path Option

Perform this task to configure a numbered or unnumbered optical tunnel on a router; in this example, the dynamic path option on the headend router. The dynamic option does not require that you specify the different hops to be taken along the way. The hops are calculated automatically.



Note The examples describe how to configure optical tunnels. It does not include procedures for every option available on the headend and tailend routers.

SUMMARY STEPS

1. **configure**
2. **interface tunnel-gte** *tunnel-id*
3. **ipv4 address** *ip-address/prefix* or **ipv4 unnumbered** *type interface-path-id*
4. **switching transit** *switching type encoding encoding type*

5. **priority** *setup-priority hold-priority*
6. **signalled-bandwidth** {*bandwidth [class-type ct] | sub-pool bandwidth*}
7. **destination** *ip-address*
8. **path-option** *path-id* **dynamic**
9. **direction** [**bidirectional**]
10. **commit**

DETAILED STEPS

	Command or Action	Purpose
Step 1	configure	
Step 2	interface tunnel-gte <i>tunnel-id</i> Example: RP/0/RP0/CPU0:router (config)# interface tunnel-gte1	Configures an MPLS-TE tunnel for GMPLS interfaces.
Step 3	ipv4 address <i>ip-address/prefix</i> or ipv4 unnumbered <i>type interface-path-id</i> Example: RP/0/RP0/CPU0:router (config-if)# ipv4 address 192.168.1.27 255.0.0.0	Specifies a primary or secondary IPv4 address for an interface. <ul style="list-style-type: none"> • Network mask can be a four-part dotted decimal address. For example, 255.0.0.0 indicates that each bit equal to 1 means that the corresponding address bit belongs to the network address. • Network mask can be indicated as a slash (/) and a number (prefix length). The prefix length is a decimal value that indicates how many of the high-order contiguous bits of the address compose the prefix (the network portion of the address). A slash must precede the decimal value, and there is no space between the IP address and the slash. or <ul style="list-style-type: none"> • Enables IPv4 processing on a point-to-point interface without assigning an explicit IPv4 address to that interface.
Step 4	switching transit <i>switching type</i> encoding <i>encoding type</i> Example: RP/0/RP0/CPU0:router (config-if)# switching transit lsc encoding sonetsdh	Specifies the switching capability and encoding types for all transit TE links used to signal the optical tunnel.
Step 5	priority <i>setup-priority hold-priority</i> Example:	Configures setup and reservation priorities for MPLS-TE tunnels.

	Command or Action	Purpose
	<code>RP/0/RP0/CPU0:router(config-if)# priority 1 1</code>	
Step 6	<p>signalled-bandwidth {<i>bandwidth</i> [class-type <i>ct</i>] sub-pool <i>bandwidth</i>}</p> <p>Example:</p> <pre>RP/0/RP0/CPU0:router(config-if)# signalled-bandwidth 10 class-type 1</pre>	Sets the CT0 bandwidth required on this interface. Because the default tunnel priority is 7, tunnels use the default TE class map (namely, class-type 1, priority 7).
Step 7	<p>destination <i>ip-address</i></p> <p>Example:</p> <pre>RP/0/RP0/CPU0:router(config-if)# destination 192.168.92.125</pre>	<p>Assigns a destination address on the new tunnel.</p> <ul style="list-style-type: none"> • Destination address is the remote node's MPLS-TE router ID. • Destination address is the merge point between backup and protected tunnels.
Step 8	<p>path-option <i>path-id</i> dynamic</p> <p>Example:</p> <pre>RP/0/RP0/CPU0:router(config-if)# path-option 1 dynamic</pre>	Configures the dynamic path option and path ID.
Step 9	<p>direction [bidirectional]</p> <p>Example:</p> <pre>RP/0/RP0/CPU0:router(config-if)# direction bidirection</pre>	Configures a bidirectional optical tunnel for GMPLS.
Step 10	commit	

Configuring an Optical TE Tunnel Using Explicit Path Option

Perform this task to configure a numbered or unnumbered optical TE tunnel on a router. This task can be applied to both the headend and tailend router.



Note You cannot configure dynamic tunnels on the tailend router.

SUMMARY STEPS

1. **configure**
2. **interface tunnel-gte** *tunnel-id*
3. **ipv4 address** *ipv4-address mask* or **ipv4 unnumbered** *type interface-path-id*
4. **passive**

5. **match identifier** *tunnel number*
6. **destination** *ip-address*
7. **commit**

DETAILED STEPS

	Command or Action	Purpose
Step 1	configure	
Step 2	interface tunnel-gte <i>tunnel-id</i> Example: <pre>RP/0/RP0/CPU0:router(config)# interface tunnel-gte 1 RP/0/RP0/CPU0:router(config-if)#</pre>	Configures an MPLS-TE tunnel interface for GMPLS interfaces.
Step 3	ipv4 address <i>ipv4-address mask</i> or ipv4 unnumbered <i>type interface-path-id</i> Example: <pre>RP/0/RP0/CPU0:router(config-if)# ipv4 address 127.0.0.1 255.0.0.0</pre>	<p>Specifies a primary or secondary IPv4 address for an interface.</p> <ul style="list-style-type: none"> • Network mask can be a four-part dotted decimal address. For example, 255.0.0.0 indicates that each bit equal to 1 means that the corresponding address bit belongs to the network address. • Network mask can be indicated as a slash (/) and a number (prefix length). The prefix length is a decimal value that indicates how many of the high-order contiguous bits of the address compose the prefix (the network portion of the address). A slash must precede the decimal value, and there is no space between the IP address and the slash. <p>or</p> <ul style="list-style-type: none"> • Enables IPv4 processing on a point-to-point interface without assigning an explicit IPv4 address to that interface.
Step 4	passive Example: <pre>RP/0/RP0/CPU0:router(config-if)# passive</pre>	<p>Configures a passive interface.</p> <p>Note The tailend (passive) router does not signal the tunnel, it simply accepts a connection from the headend router. The tailend router supports the same configuration as the headend router.</p>
Step 5	match identifier <i>tunnel number</i> Example: <pre>RP/0/RP0/CPU0:router(config-if)# match identifier gmpls1_t1</pre>	Configures the match identifier. You must enter the hostname for the head router then underscore _t, and the tunnel number for the head router. If tunnel-te1 is configured on the head router with a hostname of gmpls1, CLI is match identifier gmpls1_t1.

	Command or Action	Purpose
		<p>Note The match identifier must correspond to the tunnel-gte number configured on the headend router. Together with the address specified using the destination command, this identifier uniquely identifies acceptable incoming tunnel requests.</p>
Step 6	<p>destination <i>ip-address</i></p> <p>Example:</p> <pre>RP/0/RP0/CPU0:router(config-if)# destination 10.1.1.1</pre>	<p>Assigns a destination address on the new tunnel.</p> <ul style="list-style-type: none"> • Destination address is the remote node's MPLS-TE router ID. • Destination address is the merge point between backup and protected tunnels.
Step 7	commit	

Configuring LSP Hierarchy

These tasks describe the high-level steps that are required to configure LSP hierarchy.

LSP hierarchy allows standard MPLS-TE tunnels to be established over GMPLS-TE tunnels.

Consider the following information when configuring LSP hierarchy:

- LSP hierarchy supports numbered optical TE tunnels with IPv4 addresses only.
- LSP hierarchy supports numbered optical TE tunnels using numbered or unnumbered TE links.



Note Before you can successfully configure LSP hierarchy, you must first establish a numbered optical tunnel between the headend and tailend routers.

To configure LSP hierarchy, you must perform a series of tasks that have been previously described in this GMPLS configuration section. The tasks, which must be completed in the order presented, are as follows:

1. Establish an optical TE tunnel.
2. Configure an optical TE tunnel under IGP.
3. Configure the bandwidth on the optical TE tunnel.
4. Configure the optical TE tunnel as a TE link.
5. Configure an MPLS-TE tunnel.

Related Topics

[Configuring Numbered and Unnumbered Optical TE Tunnels](#), on page 256

Configuring Border Control Model

Border control model lets you specify the optical core tunnels to be advertised to edge packet topologies. Using this model, the entire topology is stored in a separate packet instance, allowing packet networks where these optical tunnels are advertised to use LSP hierarchy to signal an MPLS tunnel over the optical tunnel.

Consider the following information when configuring protection and restoration:

- GMPLS optical TE tunnel must be numbered and have a valid IPv4 address.
- Router ID, which is used for the IGP area and interface ID, must be consistent in all areas.
- OSPF interface ID may be a numeric or alphanumeric.



Note Border control model functionality is provided for multiple IGP instances in one area or in multiple IGP areas.

To configure border control model functionality, you will perform a series of tasks that have been previously described in this GMPLS configuration section. The tasks, which must be completed in the order presented, are as follows:

1. Configure two optical tunnels on different interfaces.



Note When configuring IGP, you must keep the optical and packet topology information in separate routing tables.

2. Configure OSPF adjacency on each tunnel.
3. Configure bandwidth on each tunnel.
4. Configure packet tunnels.

Configuring Path Protection

These tasks describe how to configure path protection:

- [Configuring an LSP, on page 261](#)
- [Forcing Reversion of the LSP, on page 264](#)

Configuring an LSP

Perform this task to configure an LSP for an explicit path. Path protection is enabled on a tunnel by adding an additional path option configuration at the active end. The path can be configured either explicitly or dynamically.



Note When the dynamic option is used for both working and protecting LSPs, CSPF extensions are used to determine paths with different degrees of diversity. When the paths are computed, they are used over the lifetime of the LSPs. The nodes on the path of the LSP determine if the PSR is or is not for a given LSP. This determination is based on information that is obtained at signaling.

SUMMARY STEPS

1. **configure**
2. **interface tunnel-gte** *number*
3. **ipv4 address** *ipv4-address mask* or **ipv4 unnumbered** *type interface-path-id*
4. **signalled-name** *name*
5. **switching transit** *capability-switching-type* **encoding** *encoding-type*
6. **switching endpoint** *capability-switching -ype* **encoding** *encoding-type*
7. **priority** *setup-priority hold-priority*
8. **signalled-bandwidth** {*bandwidth [class-type ct]* | **sub-pool** *bandwidth*}
9. **destination** *ip-address*
10. **path-option** *path-id explicit* {**name** *pathname* | *path-number* }
11. **path-option protecting** *path-id explicit* {**name** *pathname* | *path-number* }
12. **commit**

DETAILED STEPS

	Command or Action	Purpose
Step 1	configure	
Step 2	interface tunnel-gte <i>number</i> Example: RP/0/RP0/CPU0:router(config)# interface tunnel-gte 1	Configures an MPLS-TE tunnel interface for GMPLS interfaces.
Step 3	ipv4 address <i>ipv4-address mask</i> or ipv4 unnumbered <i>type interface-path-id</i> Example: RP/0/RP0/CPU0:router(config-if)# ipv4 address 99.99.99.2 255.255.255.254	Specifies a primary or secondary IPv4 address for an interface. <ul style="list-style-type: none"> • Network mask can be a four-part dotted decimal address. For example, 255.0.0.0 indicates that each bit equal to 1 means that the corresponding address bit belongs to the network address. • Network mask can be indicated as a slash (/) and a number (prefix length). The prefix length is a decimal value that indicates how many of the high-order contiguous bits of the address compose the prefix (the network portion of the address). A slash must precede the decimal value, and there is no space between the IP address and the slash. or <ul style="list-style-type: none"> • Enables IPv4 processing on a point-to-point interface without assigning an explicit IPv4 address to that interface.

	Command or Action	Purpose
Step 4	<p>signalled-name <i>name</i></p> <p>Example:</p> <pre>RP/0/RP0/CPU0:router(config-if)# signalled-name tunnel-gtel</pre>	Configures the name of the tunnel required for an MPLS TE tunnel. The <i>name</i> argument specifies the signal for the tunnel.
Step 5	<p>switching transit <i>capability-switching-type encoding encoding-type</i></p> <p>Example:</p> <pre>RP/0/RP0/CPU0:router(config-if)# switching transit lsc encoding sonetsdh</pre>	Specifies the switching capability and encoding types for all transit TE links used to signal the optical tunnel to configure an optical LSP.
Step 6	<p>switching endpoint <i>capability-switching -ype encoding encoding-type</i></p> <p>Example:</p> <pre>RP/0/RP0/CPU0:router(config-if)# switching endpoint psc1 encoding sonetsdh</pre>	Specifies the switching capability and encoding types for all endpoint TE links used to signal the optical tunnel that is mandatory to set up the GMPLS LSP.
Step 7	<p>priority <i>setup-priority hold-priority</i></p> <p>Example:</p> <pre>RP/0/RP0/CPU0:router(config-if)# priority 2 2</pre>	Configures setup and reservation priorities for MPLS-TE tunnels.
Step 8	<p>signalled-bandwidth {<i>bandwidth [class-type ct] sub-pool bandwidth</i>}</p> <p>Example:</p> <pre>RP/0/RP0/CPU0:router(config-if)# signalled-bandwidth 2488320</pre>	Configures the bandwidth required for an MPLS TE tunnel. The signalled-bandwidth command supports two bandwidth pools (class-types) for the Diff-Serv Aware TE (DS-TE) feature.
Step 9	<p>destination <i>ip-address</i></p> <p>Example:</p> <pre>RP/0/RP0/CPU0:router(config-if)# destination 24.24.24.24</pre>	<p>Assigns a destination address on the new tunnel.</p> <ul style="list-style-type: none"> • Destination address is the remote node's MPLS-TE router ID. • Destination address is the merge point between backup and protected tunnels.
Step 10	<p>path-option <i>path-id explicit {name pathname path-number }</i></p> <p>Example:</p> <pre>RP/0/RP0/CPU0:router(config-if)# path-option 1</pre>	Configures the explicit path option and path ID.

	Command or Action	Purpose
	<code>explicit name po4</code>	
Step 11	<p>path-option protecting <i>path-id</i> explicit {<i>name pathname</i> <i>path-number</i>}</p> <p>Example:</p> <pre>RP/0/RP0/CPU0:router(config-if)# path-option protecting 1 explicit name po6</pre>	Configures the path setup option to protect a path.
Step 12	<code>commit</code>	

Forcing Reversion of the LSP

Perform this task to allow a forced reversion of the LSPs, which is only applicable to 1:1 LSP protection.

SUMMARY STEPS

1. `mpls traffic-eng path-protection switchover` {*gmpls tunnel-name* | **tunnel-te** *tunnel-id* }
2. `commit`

DETAILED STEPS

	Command or Action	Purpose
Step 1	<p>mpls traffic-eng path-protection switchover {<i>gmpls tunnel-name</i> tunnel-te <i>tunnel-id</i> }</p> <p>Example:</p> <pre>RP/0/RP0/CPU0:router# mpls traffic-eng path-protection switchover tunnel-te 1</pre>	<p>Specifies a manual switchover for path protection for a GMPLS optical LSP. The tunnel ID is configured for a switchover.</p> <p>The mpls traffic-eng path-protection switchover command must be issued on both head and tail router of the GMPLS LSP to achieve the complete path switchover at both ends.</p>
Step 2	<code>commit</code>	

Configuring Flexible Name-based Tunnel Constraints

To fully configure MPLS-TE flexible name-based tunnel constraints, you must complete these high-level tasks in order:

1. [Assigning Color Names to Numeric Values, on page 264](#)
2. [Associating Affinity-Names with TE Links, on page 265](#)
3. [Associating Affinity Constraints for TE Tunnels, on page 266](#)

Assigning Color Names to Numeric Values

The first task in enabling the new coloring scheme is to assign a numerical value (in hexadecimal) to each value (color).



Note An affinity color name cannot exceed 64 characters. An affinity value cannot exceed a single digit. For example, magenta1.

SUMMARY STEPS

1. **configure**
2. **mpls traffic-eng**
3. **affinity-map** *affinity name* {*affinity value* | **bit-position** *value*}
4. **commit**

DETAILED STEPS

	Command or Action	Purpose
Step 1	configure	
Step 2	mpls traffic-eng Example: RP/0/RP0/CPU0:router(config)# mpls traffic-eng RP/0/RP0/CPU0:router(config-mpls-te)#	Enters MPLS-TE configuration mode.
Step 3	affinity-map <i>affinity name</i> { <i>affinity value</i> bit-position <i>value</i> } Example: RP/0/RP0/CPU0:router(config-mpls-te)# affinity-map red 1	Enters an affinity name and a map value by using a color name (repeat this command to assign multiple colors up to a maximum of 64 colors). An affinity color name cannot exceed 64 characters. The value you assign to a color name must be a single digit.
Step 4	commit	

Related Topics

[Flexible Name-based Tunnel Constraints](#), on page 185

[Configure Flexible Name-based Tunnel Constraints: Example](#), on page 336

Associating Affinity-Names with TE Links

The next step in the configuration of MPLS-TE Flexible Name-based Tunnel Constraints is to assign affinity names and values to TE links. You can assign up to a maximum of 32 colors. Before you assign a color to a link, you must define the name-to-value mapping for each color.

SUMMARY STEPS

1. **configure**
2. **mpls traffic-eng**
3. **interface** *type interface-path-id*
4. **attribute-names** *attribute name*

5. commit

DETAILED STEPS

	Command or Action	Purpose
Step 1	<code>configure</code>	
Step 2	mpls traffic-eng Example: <pre>RP/0/RP0/CPU0:router(config)# mpls traffic-eng RP/0/RP0/CPU0:router(config-mpls-te)#</pre>	Enters MPLS-TE configuration mode.
Step 3	interface <i>type interface-path-id</i> Example: <pre>RP/0/RP0/CPU0:router(config-mpls-te)# interface tunnel-te 2 RP/0/RP0/CPU0:router(config-mpls-te-if)#</pre>	Enables MPLS-TE on an interface and enters MPLS-TE interface configuration mode.
Step 4	attribute-names <i>attribute name</i> Example: <pre>RP/0/RP0/CPU0:router(config-mpls-te-if)# attribute-names red</pre>	Assigns colors to TE links over the selected interface.
Step 5	<code>commit</code>	

Related Topics

[Flexible Name-based Tunnel Constraints](#), on page 185

[Configure Flexible Name-based Tunnel Constraints: Example](#), on page 336

[Assigning Color Names to Numeric Values](#), on page 264

Associating Affinity Constraints for TE Tunnels

The final step in the configuration of MPLS-TE Flexible Name-based Tunnel Constraints requires that you associate a tunnel with affinity constraints.

Using this model, there are no masks. Instead, there is support for four types of affinity constraints:

- include
- include-strict
- exclude
- exclude-all



Note For the affinity constraints above, all but the exclude-all constraint may be associated with up to 10 colors.

SUMMARY STEPS

1. **configure**
2. **interface tunnel-te** *tunnel-id*
3. **affinity** {*affinity-value* **mask** *mask-value* | **exclude** *name* | **exclude -all** | **include** *name* | **include-strict** *name*}
4. **commit**

DETAILED STEPS

	Command or Action	Purpose
Step 1	configure	
Step 2	interface tunnel-te <i>tunnel-id</i> Example: RP/0/RP0/CPU0:router(config)# interface tunnel-te 1	Configures an MPLS-TE tunnel interface.
Step 3	affinity { <i>affinity-value</i> mask <i>mask-value</i> exclude <i>name</i> exclude -all include <i>name</i> include-strict <i>name</i> }	Configures link attributes for links comprising a tunnel. You can have up to ten colors.
	Example: RP/0/RP0/CPU0:router(config-if)# affinity include red	Multiple include statements can be specified under tunnel configuration. With this configuration, a link is eligible for CSPF if it has at least a red color or has at least a green color. Thus, a link with red and any other colors as well as a link with green and any additional colors meet the above constraint.
Step 4	commit	

Related Topics

[Flexible Name-based Tunnel Constraints](#), on page 185

[Configure Flexible Name-based Tunnel Constraints: Example](#), on page 336

Configuring IS-IS to Flood MPLS-TE Link Information

Perform this task to configure a router running the Intermediate System-to-Intermediate System (IS-IS) protocol to flood MPLS-TE link information into multiple IS-IS levels.

This procedure shows how to enable MPLS-TE in both IS-IS Level 1 and Level 2.

SUMMARY STEPS

1. **configure**

2. **router isis** *instance-id*
3. **net** *network-entity-title*
4. **address-family** {*ipv4* | *ipv6*} {*unicast*}
5. **metric-style** *wide*
6. **mpls traffic-eng** *level*
7. **commit**

DETAILED STEPS

	Command or Action	Purpose
Step 1	configure	
Step 2	router isis <i>instance-id</i> Example: RP/0/RP0/CPU0:router(config)# router isis 1	Enters an IS-IS instance.
Step 3	net <i>network-entity-title</i> Example: RP/0/RP0/CPU0:router(config-isis)# net 47.0001.0000.0000.0002.00	Enters an IS-IS network entity title (NET) for the routing process.
Step 4	address-family { <i>ipv4</i> <i>ipv6</i> } { <i>unicast</i> } Example: RP/0/RP0/CPU0:router(config-isis)# address-family <i>ipv4 unicast</i>	Enters address family configuration mode for configuring IS-IS routing that uses IPv4 and IPv6 address prefixes.
Step 5	metric-style <i>wide</i> Example: RP/0/RP0/CPU0:router(config-isis-af)# metric-style <i>wide</i>	Enters the new-style type, length, and value (TLV) objects.
Step 6	mpls traffic-eng <i>level</i> Example: RP/0/RP0/CPU0:router(config-isis-af)# mpls traffic-eng level-1-2	Enters the required MPLS-TE level or levels.
Step 7	commit	

Configuring an OSPF Area of MPLS-TE

Perform this task to configure an OSPF area for MPLS-TE in both the OSPF backbone area 0 and area 1.

SUMMARY STEPS

1. **configure**
2. **router ospf** *process-name*
3. **mpls traffic-eng router-id** *ip-address*
4. **area** *area-id*
5. **interface** *type interface-path-id*
6. **commit**

DETAILED STEPS

	Command or Action	Purpose
Step 1	configure	
Step 2	router ospf <i>process-name</i> Example: RP/0/RP0/CPU0:router(config)# router ospf 100	Enters a name that uniquely identifies an OSPF routing process. <i>process-name</i> Any alphanumeric string no longer than 40 characters without spaces.
Step 3	mpls traffic-eng router-id <i>ip-address</i> Example: RP/0/RP0/CPU0:router(config-ospf)# mpls traffic-eng router-id 192.168.70.1	Enters the MPLS interface type. For more information, use the question mark (?) online help function.
Step 4	area <i>area-id</i> Example: RP/0/RP0/CPU0:router(config-ospf)# area 0	Enters an OSPF area identifier. <i>area-id</i> Either a decimal value or an IP address.
Step 5	interface <i>type interface-path-id</i> Example: RP/0/RP0/CPU0:router(config-ospf-ar)# interface POS 0/2/0/0	Identifies an interface ID. For more information, use the question mark (?) online help function.
Step 6	commit	

Configuring Explicit Paths with ABRs Configured as Loose Addresses

Perform this task to specify an IPv4 explicit path with ABRs configured as loose addresses.

SUMMARY STEPS

1. **configure**
2. **explicit-path name** *name*
3. **index** *index-id* **next-address** [*loose*] **ipv4 unicast** *ip-address*
4. **commit**

DETAILED STEPS

	Command or Action	Purpose
Step 1	configure	
Step 2	explicit-path name <i>name</i> Example: RP/0/RP0/CPU0:router (config) # explicit-path name interareal	Enters a name for the explicit path.
Step 3	index <i>index-id</i> next-address [<i>loose</i>] ipv4 unicast <i>ip-address</i> Example: RP/0/RP0/CPU0:router (config-expl-path) # index 1 next-address loose ipv4 unicast 10.10.10.10	Includes an address in an IP explicit path of a tunnel.
Step 4	commit	

Configuring MPLS-TE Forwarding Adjacency

Perform this task to configure forwarding adjacency on a specific tunnel-te interface.

SUMMARY STEPS

1. **configure**
2. **interface tunnel-te** *tunnel-id*
3. **forwarding-adjacency holdtime** *value*
4. **commit**

DETAILED STEPS

	Command or Action	Purpose
Step 1	configure	
Step 2	interface tunnel-te <i>tunnel-id</i> Example: RP/0/RP0/CPU0:router (config) # interface tunnel-te	Enters MPLS-TE interface configuration mode.

	Command or Action	Purpose
	1	
Step 3	forwarding-adjacency holdtime <i>value</i> Example: <pre>RP/0/RP0/CPU0:router(config-if)# forwarding-adjacency holdtime 60</pre>	Configures forwarding adjacency using an optional specific holdtime value. By default, this value is 0 (milliseconds).
Step 4	commit	

Related Topics

[MPLS-TE Forwarding Adjacency Benefits](#), on page 189

[Configure Forwarding Adjacency: Example](#), on page 339

Configuring Unequal Load Balancing

Perform these tasks to configure unequal load balancing:

- [Setting Unequal Load Balancing Parameters](#), on page 271
- [Enabling Unequal Load Balancing](#), on page 272

Setting Unequal Load Balancing Parameters

The first step you must take to configure unequal load balancing requires that you set the parameters on each specific interface. The default load share for tunnels with no explicit configuration is the configured bandwidth.



Note Equal load-sharing occurs if there is no configured bandwidth.

SUMMARY STEPS

1. **configure**
2. **interface tunnel-te** *tunnel-id*
3. **load-share** *value*
4. **commit**
5. **show mpls traffic-eng tunnels**

DETAILED STEPS

	Command or Action	Purpose
Step 1	configure	

	Command or Action	Purpose
Step 2	interface tunnel-te <i>tunnel-id</i> Example: RP/0/RP0/CPU0:router(config)# interface tunnel-te 1	Configures an MPLS-TE tunnel interface configuration mode and enables traffic engineering on a particular interface on the originating node. Note Only tunnel-te interfaces are permitted.
Step 3	load-share <i>value</i> Example: RP/0/RP0/CPU0:router(config-if)# load-share 1000	Configures the load-sharing parameters for the specified interface.
Step 4	commit	
Step 5	show mpls traffic-eng tunnels Example: RP/0/RP0/CPU0:router# show mpls traffic-eng tunnels	Verifies the state of unequal load balancing, including bandwidth and load-share values.

Related Topics

[Unequal Load Balancing](#), on page 189

[Configure Unequal Load Balancing: Example](#), on page 339

Enabling Unequal Load Balancing

This task describes how to enable unequal load balancing. (For example, this is a global switch used to turn unequal load-balancing on or off.)

SUMMARY STEPS

1. **configure**
2. **mpls traffic-eng**
3. **load-share unequal**
4. **commit**
5. **show mpls traffic-eng tunnels**

DETAILED STEPS

	Command or Action	Purpose
Step 1	configure	
Step 2	mpls traffic-eng Example: RP/0/RP0/CPU0:router(config)# mpls traffic-eng	Enters the MPLS-TE configuration mode.

	Command or Action	Purpose
Step 3	load-share unequal Example: <pre>RP/0/RP0/CPU0:router(config-mpls-te) # load-share unequal</pre>	Enables unequal load sharing across TE tunnels to the same destination.
Step 4	commit	
Step 5	show mpls traffic-eng tunnels Example: <pre>RP/0/RP0/CPU0:router# show mpls traffic-eng tunnels</pre>	Verifies the state of unequal load balancing, including bandwidth and load-share values.

Related Topics

[Unequal Load Balancing](#), on page 189

[Configure Unequal Load Balancing: Example](#), on page 339

Configuring a Path Computation Client and Element

Perform these tasks to configure Path Computation Client (PCC) and Path Computation Element (PCE):

- [Configuring a Path Computation Client](#), on page 273
- [Configuring a Path Computation Element Address](#), on page 274
- [Configuring PCE Parameters](#), on page 275

Configuring a Path Computation Client

Perform this task to configure a TE tunnel as a PCC.



Note Only one TE-enabled IGP instance can be used at a time.

SUMMARY STEPS

1. **configure**
2. **interface tunnel-te** *tunnel-id*
3. **path-option** *preference-priority* **dynamic pce**
4. **commit**

DETAILED STEPS

	Command or Action	Purpose
Step 1	<code>configure</code>	
Step 2	interface tunnel-te <i>tunnel-id</i> Example: RP/0/RP0/CPU0:router(config)# <code>interface tunnel-te 6</code>	Enters MPLS-TE interface configuration mode and enables traffic engineering on a particular interface on the originating node.
Step 3	path-option <i>preference-priority</i> dynamic pce Example: RP/0/RP0/CPU0:router(config-if)# <code>path-option 1 dynamic pce</code>	Configures a TE tunnel as a PCC.
Step 4	<code>commit</code>	

Related Topics

[Path Computation Element](#), on page 190

[Configure PCE: Example](#), on page 340

Configuring a Path Computation Element Address

Perform this task to configure a PCE address.



Note Only one TE-enabled IGP instance can be used at a time.

SUMMARY STEPS

1. `configure`
2. `mpls traffic-eng`
3. `pce address ipv4 address`
4. `commit`

DETAILED STEPS

	Command or Action	Purpose
Step 1	<code>configure</code>	
Step 2	mpls traffic-eng Example: RP/0/RP0/CPU0:router(config)# <code>mpls traffic-eng</code>	Enters the MPLS-TE configuration mode.

	Command or Action	Purpose
Step 3	<p>pce address ipv4 <i>address</i></p> <p>Example:</p> <pre>RP/0/RP0/CPU0:router(config-mpls-te) # pce address ipv4 10.1.1.1</pre>	Configures a PCE IPv4 address.
Step 4	commit	

Related Topics

[Path Computation Element](#), on page 190

[Configure PCE: Example](#), on page 340

Configuring PCE Parameters

Perform this task to configure PCE parameters, including a static PCE peer, periodic reoptimization timer values, and request timeout values.

SUMMARY STEPS

1. **configure**
2. **mpls traffic-eng**
3. **pce address ipv4** *address*
4. **pce peer ipv4** *address*
5. **pce keepalive** *interval*
6. **pce deadtimer** *value*
7. **pce reoptimize** *value*
8. **pce request-timeout** *value*
9. **pce tolerance keepalive** *value*
10. **commit**
11. **show mpls traffic-eng pce peer** [*address* | **all**]
12. **show mpls traffic-eng pce tunnels**

DETAILED STEPS

	Command or Action	Purpose
Step 1	configure	
Step 2	<p>mpls traffic-eng</p> <p>Example:</p> <pre>RP/0/RP0/CPU0:router(config)# mpls traffic-eng</pre>	Enters MPLS-TE configuration mode.
Step 3	<p>pce address ipv4 <i>address</i></p> <p>Example:</p>	Configures a PCE IPv4 address.

	Command or Action	Purpose
	RP/0/RP0/CPU0:router(config-mpls-te)# pce address ipv4 10.1.1.1	
Step 4	<p>pce peer ipv4 address</p> <p>Example:</p> <pre>RP/0/RP0/CPU0:router(config-mpls-te)# pce peer address ipv4 10.1.1.1</pre>	Configures a static PCE peer address. PCE peers are also discovered dynamically through OSPF or ISIS.
Step 5	<p>pce keepalive interval</p> <p>Example:</p> <pre>RP/0/RP0/CPU0:router(config-mpls-te)# pce keepalive 10</pre>	Configures a PCEP keepalive interval. The range is from 0 to 255 seconds. When the keepalive interval is 0, the LSR does not send keepalive messages.
Step 6	<p>pce deadtimer value</p> <p>Example:</p> <pre>RP/0/RP0/CPU0:router(config-mpls-te)# pce deadtimer 50</pre>	Configures a PCE deadtimer value. The range is from 0 to 255 seconds. When the dead interval is 0, the LSR does not timeout a PCEP session to a remote peer.
Step 7	<p>pce reoptimize value</p> <p>Example:</p> <pre>RP/0/RP0/CPU0:router(config-mpls-te)# pce reoptimize 200</pre>	Configures a periodic reoptimization timer value. The range is from 60 to 604800 seconds. When the dead interval is 0, the LSR does not timeout a PCEP session to a remote peer.
Step 8	<p>pce request-timeout value</p> <p>Example:</p> <pre>RP/0/RP0/CPU0:router(config-mpls-te)# pce request-timeout 10</pre>	Configures a PCE request-timeout. Range is from 5 to 100 seconds. PCC or PCE keeps a pending path request only for the request-timeout period.
Step 9	<p>pce tolerance keepalive value</p> <p>Example:</p> <pre>RP/0/RP0/CPU0:router(config-mpls-te)# pce tolerance keepalive 10</pre>	Configures a PCE tolerance keepalive value (which is the minimum acceptable peer proposed keepalive).
Step 10	commit	
Step 11	<p>show mpls traffic-eng pce peer [address all]</p> <p>Example:</p>	Displays the PCE peer address and state.

	Command or Action	Purpose
	RP/0/RP0/CPU0:router# show mpls traffic-eng pce peer	
Step 12	show mpls traffic-eng pce tunnels Example: RP/0/RP0/CPU0:router# show mpls traffic-eng pce tunnels	Displays the status of the PCE tunnels.

Related Topics

[Path Computation Element](#), on page 190

[Configure PCE: Example](#), on page 340

Configuring Policy-based Tunnel Selection

Perform this task to configure policy-based tunnel selection (PBTS).

SUMMARY STEPS

1. **configure**
2. **interface tunnel-te** *tunnel-id*
3. **ipv4 unnumbered** *type interface-path-id*
4. **signalled-bandwidth** {*bandwidth* [*class-type ct*] | *sub-pool bandwidth*}
5. **autoroute announce**
6. **destination** *ip-address*
7. **policy-class** {*1 - 7*} | {*default*}
8. **path-option** *preference-priority* {**explicit name** *explicit-path-name*}
9. **commit**

DETAILED STEPS

	Command or Action	Purpose
Step 1	configure	
Step 2	interface tunnel-te <i>tunnel-id</i> Example: RP/0/RP0/CPU0:router(config)# interface tunnel-te 6	Configures an MPLS-TE tunnel interface and enables traffic engineering on a particular interface on the originating node.
Step 3	ipv4 unnumbered <i>type interface-path-id</i> Example: RP/0/RP0/CPU0:router(config-if)# ipv4 unnumbered	Assigns a source address so that forwarding can be performed on the new tunnel.

	Command or Action	Purpose
	Loopback0	
Step 4	<p>signalled-bandwidth {<i>bandwidth</i> [<i>class-type</i> <i>cf</i>] <i>sub-pool</i> <i>bandwidth</i>}</p> <p>Example:</p> <pre>RP/0/RP0/CPU0:router(config-if)# signalled-bandwidth 10 class-type 1</pre>	Configures the bandwidth required for an MPLS TE tunnel. Because the default tunnel priority is 7, tunnels use the default TE class map (namely, class-type 1, priority 7).
Step 5	<p>autoroute announce</p> <p>Example:</p> <pre>RP/0/RP0/CPU0:router(config-if)# autoroute announce</pre>	Enables messages that notify the neighbor nodes about the routes that are forwarding.
Step 6	<p>destination <i>ip-address</i></p> <p>Example:</p> <pre>RP/0/RP0/CPU0:router(config-if)# destination 10.1.1.1</pre>	<p>Assigns a destination address on the new tunnel.</p> <ul style="list-style-type: none"> • Destination address is the remote node's MPLS-TE router ID. • Destination address is the merge point between backup and protected tunnels.
Step 7	<p>policy-class {<i>1 - 7</i>} {default}</p> <p>Example:</p> <pre>RP/0/RP0/CPU0:router(config-if)# policy-class 1</pre>	<p>Configures PBTS to direct traffic into specific TE tunnels or default class.</p> <p>Multiple EXP values can be specified as part of a policy-class, separated by spaces. The EXP values configured to a TE tunnel effectively form a monolithic policy-class, which should not overlap with other policy-classes. Once an EXP value is used in a policy-class configuration, it can only be reused if the subsequent policy-class configurations containing that EXP value are identical. For example, if the configuration policy-class 1 2 3 is applied to one or more tunnels, configurations such as policy-class 1, policy-class 2 3, or policy-class 3 4 5 become invalid.</p>
Step 8	<p>path-option <i>preference-priority</i> {explicit name <i>explicit-path-name</i>}</p> <p>Example:</p> <pre>RP/0/RP0/CPU0:router(config-if)# path-option 1 explicit name backup-path</pre>	Sets the path option to explicit with a given name (previously configured) and assigns the path ID.
Step 9	commit	

Related Topics

[Policy-Based Tunnel Selection Functions](#), on page 192

[Policy-Based Tunnel Selection](#), on page 191

Configuring the Automatic Bandwidth

Perform these tasks to configure the automatic bandwidth:

Configuring the Collection Frequency

Perform this task to configure the collection frequency. You can configure only one global collection frequency.

SUMMARY STEPS

1. **configure**
2. **mpls traffic-eng**
3. **auto-bw collect frequency** *minutes*
4. **commit**
5. **show mpls traffic-eng tunnels** [auto-bw]

DETAILED STEPS

	Command or Action	Purpose
Step 1	configure	
Step 2	mpls traffic-eng Example: RP/0/RP0/CPU0:router(config)# mpls traffic-eng RP/0/RP0/CPU0:router(config-mpls-te)#	Enters MPLS-TE configuration mode.
Step 3	auto-bw collect frequency <i>minutes</i> Example: RP/0/RP0/CPU0:router(config-mpls-te)# auto-bw collect frequency 1	Configures the automatic bandwidth collection frequency, and controls the manner in which the bandwidth for a tunnel collects output rate information; but does not adjust the tunnel bandwidth. <i>minutes</i> Configures the interval between automatic bandwidth adjustments in minutes. Range is from 1 to 10080.
Step 4	commit	
Step 5	show mpls traffic-eng tunnels [auto-bw] Example: RP/0/RP0/CPU0:router# show mpls traffic tunnels auto-bw	Displays information about MPLS-TE tunnels for the automatic bandwidth. The globally configured collection frequency is displayed.

Related Topics

[MPLS-TE Automatic Bandwidth Overview](#), on page 195

[Configure Automatic Bandwidth: Example](#), on page 342

Forcing the Current Application Period to Expire Immediately

Perform this task to force the current application period to expire immediately on the specified tunnel. The highest bandwidth is applied on the tunnel before waiting for the application period to end on its own.

SUMMARY STEPS

1. `mpls traffic-eng auto-bw apply {all | tunnel-te tunnel-number}`
2. `commit`
3. `show mpls traffic-eng tunnels [auto-bw]`

DETAILED STEPS

	Command or Action	Purpose
Step 1	<p><code>mpls traffic-eng auto-bw apply {all tunnel-te tunnel-number}</code></p> <p>Example:</p> <pre>RP/0/RP0/CPU0:router# mpls traffic-eng auto-bw apply tunnel-te 1</pre>	<p>Configures the highest bandwidth available on a tunnel without waiting for the current application period to end.</p> <p>all</p> <p>Configures the highest bandwidth available instantly on all the tunnels.</p> <p>tunnel-te</p> <p>Configures the highest bandwidth instantly to the specified tunnel. Range is from 0 to 65535.</p>
Step 2	<code>commit</code>	
Step 3	<p><code>show mpls traffic-eng tunnels [auto-bw]</code></p> <p>Example:</p> <pre>RP/0/RP0/CPU0:router# show mpls traffic-eng tunnels auto-bw</pre>	Displays information about MPLS-TE tunnels for the automatic bandwidth.

Related Topics

[Restrictions for MPLS-TE Automatic Bandwidth](#), on page 197

Configuring the Automatic Bandwidth Functions

Perform this task to configure the following automatic bandwidth functions:

Application frequency

Configures the application frequency in which a tunnel bandwidth is updated by the automatic bandwidth.

Bandwidth collection

Configures only the bandwidth collection.

Bandwidth parameters

Configures the minimum and maximum automatic bandwidth to set on a tunnel.

Adjustment threshold

Configures the adjustment threshold for each tunnel.

Overflow detection

Configures the overflow detection for each tunnel.

SUMMARY STEPS

1. **configure**
2. **interface tunnel-te** *tunnel-id*
3. **auto-bw**
4. **application** *minutes*
5. **bw-limit** {**min** *bandwidth* } {**max** *bandwidth*}
6. **adjustment-threshold** *percentage* [**min** *minimum-bandwidth*]
7. **overflow threshold** *percentage* [**min** *bandwidth*] **limit** *limit*
8. **commit**
9. **show mpls traffic-eng tunnels** [**auto-bw**]

DETAILED STEPS

	Command or Action	Purpose
Step 1	configure	
Step 2	interface tunnel-te <i>tunnel-id</i> Example: <pre>RP/0/RP0/CPU0:router(config)# interface tunnel-te 6 RP/0/RP0/CPU0:router(config-if)#</pre>	Configures an MPLS-TE tunnel interface and enables traffic engineering on a particular interface on the originating node.
Step 3	auto-bw Example: <pre>RP/0/RP0/CPU0:router(config-if)# auto-bw RP/0/RP0/CPU0:router(config-if-tunte-autobw)#</pre>	Configures automatic bandwidth on a tunnel interface and enters MPLS-TE automatic bandwidth interface configuration mode.
Step 4	application <i>minutes</i> Example: <pre>RP/0/RP0/CPU0:router(config-if-tunte-autobw)# application 1000</pre>	Configures the application frequency in minutes for the applicable tunnel. minutes Frequency in minutes for the automatic bandwidth application. Range is from 5 to 10080 (7 days). The default value is 1440 (24 hours).

	Command or Action	Purpose
Step 5	bw-limit { <i>min bandwidth</i> } { <i>max bandwidth</i> } Example: <pre>RP/0/RP0/CPU0:router(config-if-tunte-autobw)# bw-limit min 30 max 80</pre>	Configures the minimum and maximum automatic bandwidth set on a tunnel. min Applies the minimum automatic bandwidth in kbps on a tunnel. Range is from 0 to 4294967295. max Applies the maximum automatic bandwidth in kbps on a tunnel. Range is from 0 to 4294967295.
Step 6	adjustment-threshold <i>percentage</i> [min <i>minimum-bandwidth</i>] Example: <pre>RP/0/RP0/CPU0:router(config-if-tunte-autobw)# adjustment-threshold 50 min 800</pre>	Configures the tunnel bandwidth change threshold to trigger an adjustment. percentage Bandwidth change percent threshold to trigger an adjustment if the largest sample percentage is higher or lower than the current tunnel bandwidth. Range is from 1 to 100 percent. The default value is 5 percent. min Configures the bandwidth change value to trigger an adjustment. The tunnel bandwidth is changed only if the largest sample is higher or lower than the current tunnel bandwidth. Range is from 10 to 4294967295 kilobits per second (kbps). The default value is 10 kbps.
Step 7	overflow threshold <i>percentage</i> [min <i>bandwidth</i>] limit <i>limit</i> Example: <pre>RP/0/RP0/CPU0:router(config-if-tunte-autobw)# overflow threshold 100 limit 1</pre>	Configures the tunnel overflow detection. percentage Bandwidth change percent to trigger an overflow. Range is from 1 to 100 percent. limit Configures the number of consecutive collection intervals that exceeds the threshold. The bandwidth overflow triggers an early tunnel bandwidth update. Range is from 1 to 10 collection periods. The default value is none. min Configures the bandwidth change value in kbps to trigger an overflow. Range is from 10 to 4294967295. The default value is 10.
Step 8	commit	
Step 9	show mpls traffic-eng tunnels [auto-bw] Example:	Displays the MPLS-TE tunnel information only for tunnels in which the automatic bandwidth is enabled.

	Command or Action	Purpose
	RP/0/RP0/CPU0:router# show mpls traffic-eng tunnels auto-bw	

Related Topics

[MPLS-TE Automatic Bandwidth Overview](#), on page 195

[Configure Automatic Bandwidth: Example](#), on page 342

Configuring the Shared Risk Link Groups

To activate the MPLS traffic engineering SRLG feature, you must configure the SRLG value of each link that has a shared risk with another link.

Configuring the SRLG Values of Each Link that has a Shared Risk with Another Link

Perform this task to configure the SRLG value for each link that has a shared risk with another link.



Note You can configure up to 30 SRLGs per interface.

SUMMARY STEPS

1. **configure**
2. **srlg**
3. **interface** *type interface-path-id*
4. **value** *value*
5. **commit**
6. **show srlg interface** *type interface-path-id*
7. **show srlg**

DETAILED STEPS

	Command or Action	Purpose
Step 1	configure	
Step 2	srlg Example: RP/0/RP0/CPU0:router(config)# srlg	Configures SRLG configuration commands on a specific interface configuration mode and assigns this SRLG a value.
Step 3	interface <i>type interface-path-id</i> Example: RP/0/RP0/CPU0:router(config-srlg)# interface POS 0/6/0/0	Configures an interface type and path ID to be associated with an SRLG and enters SRLG interface configuration mode.

	Command or Action	Purpose
Step 4	value <i>value</i> Example: RP/0/RP0/CPU0:router(config-srlg-if)# value 100 RP/0/RP0/CPU0:router (config-srlg-if)# value 200 RP/0/RP0/CPU0:router(config-srlg-if)# value 300	Configures SRLG network values for a specific interface. Range is 0 to 4294967295. Note You can also set SRLG values on multiple interfaces including bundle interface.
Step 5	commit	
Step 6	show srlg interface <i>type interface-path-id</i> Example: RP/0/RP0/CPU0:router# show srlg interface POS 0/6/0/0	(Optional) Displays the SRLG values configured for a specific interface.
Step 7	show srlg Example: RP/0/RP0/CPU0:router# show srlg	(Optional) Displays the SRLG values for all the configured interfaces. Note You can configure up to 250 interfaces.

Related Topics

- [MPLS Traffic Engineering Shared Risk Link Groups](#), on page 202
- [Explicit Path](#), on page 203
- [Fast ReRoute with SRLG Constraints](#), on page 203
- [Importance of Protection](#), on page 205
- [Delivery of Packets During a Failure](#), on page 206
- [Multiple Backup Tunnels Protecting the Same Interface](#), on page 206
- [SRLG Limitations](#), on page 206
- [MPLS TE SRLG Scale Enhancements](#), on page 207
- [Configure the MPLS-TE Shared Risk Link Groups: Example](#), on page 342

Creating an Explicit Path With Exclude SRLG

Perform this task to create an explicit path with the exclude SRLG option.

SUMMARY STEPS

1. **configure**
2. **explicit-path** {**identifier number** [**disable** | **index**]} {**name** *explicit-path-name*}
3. **index 1** **exclude-address** 192.168.92.1
4. **index 2** **exclude-srlg** 192.168.92.2
5. **commit**

DETAILED STEPS

	Command or Action	Purpose
Step 1	configure	

	Command or Action	Purpose
Step 2	explicit-path {identifier number [disable index]}{ name explicit-path-name} Example: RP/0/RP0/CPU0:router(config)# explicit-path name backup-srlg	Enters the explicit path configuration mode. Identifier range is 1 to 65535.
Step 3	index 1 exclude-address 192.168.92.1 Example: RP/0/RP0/CPU0:router router(config-expl-path)# index 1 exclude-address 192.168.92.1	Specifies the IP address to be excluded from the explicit path.
Step 4	index 2 exclude-srlg 192.168.92.2 Example: RP/0/RP0/CPU0:router(config-expl-path)# index 2 exclude-srlg 192.168.192.2	Specifies the IP address to extract SRLGs to be excluded from the explicit path.
Step 5	commit	

Related Topics

- [MPLS Traffic Engineering Shared Risk Link Groups](#), on page 202
- [Explicit Path](#), on page 203
- [Fast ReRoute with SRLG Constraints](#), on page 203
- [Importance of Protection](#), on page 205
- [Delivery of Packets During a Failure](#), on page 206
- [Multiple Backup Tunnels Protecting the Same Interface](#), on page 206
- [SRLG Limitations](#), on page 206
- [MPLS TE SRLG Scale Enhancements](#), on page 207
- [Configure the MPLS-TE Shared Risk Link Groups: Example](#), on page 342

Using Explicit Path With Exclude SRLG

Perform this task to use an explicit path with the exclude SRLG option on the static backup tunnel.

SUMMARY STEPS

1. **configure**
2. **mpls traffic-eng**
3. **interface** *type interface-path-id*
4. **backup-path tunnel-te** *tunnel-number*
5. **exit**
6. **exit**
7. **interface** *tunnel-tetunnel-id*
8. **ipv4 unnumbered** *type interface-path-id*
9. **path-option** *preference-priority* { **dynamic** | **explicit** { **identifier** | **name** *explicit-path-name* } }
10. **destination** *ip-address*
11. **exit**

12. **commit**
13. **show run explicit-path name** *name*
14. **show mpls traffic-eng topology path destination** *name explicit-path name*

DETAILED STEPS

	Command or Action	Purpose
Step 1	configure	
Step 2	mpls traffic-eng Example: RP/0/RP0/CPU0:router(config)# mpls traffic-eng	Enters MPLS-TE configuration mode.
Step 3	interface <i>type interface-path-id</i> Example: RP/0/RP0/CPU0:router(config-mpls-te)# interface POS 0/6/0/0	Enables traffic engineering on a specific interface on the originating node.
Step 4	backup-path tunnel-te <i>tunnel-number</i> Example: RP/0/RP0/CPU0:router(config-mpls-te)# backup-path tunnel-te 2	Configures an MPLS TE backup path for a specific interface.
Step 5	exit Example: RP/0/RP0/CPU0:router(config-mpls-te-if)# exit	Exits the current configuration mode.
Step 6	exit Example: RP/0/RP0/CPU0:router(config-mpls-te)# exit	Exits the current configuration mode.
Step 7	interface tunnel-te <i>tunnel-id</i> Example: RP/0/RP0/CPU0:router(config)# interface tunnel-te 2	Configures an MPLS-TE tunnel interface.
Step 8	ipv4 unnumbered <i>type interface-path-id</i> Example: RP/0/RP0/CPU0:router(config-if)# ipv4 unnumbered Loopback0	Assigns a source address to set up forwarding on the new tunnel.
Step 9	path-option <i>preference-priority</i> { dynamic explicit } { identifier name <i>explicit-path-name</i> } Example: RP/0/RP0/CPU0:router(config-if)# path-option 1 explicit name backup-srlg	Sets the path option to explicit with a given name (previously configured) and assigns the path ID. Note You can use the dynamic option to dynamically assign a path.
Step 10	destination <i>ip-address</i>	Assigns a destination address on the new tunnel.

	Command or Action	Purpose
	<p>Example:</p> <pre>RP/0/RP0/CPU0:router(config-if)# destination 192.168.92.125</pre>	<ul style="list-style-type: none"> • Destination address is the remote node's MPLS-TE router ID. • Destination address is the merge point between backup and protected tunnels. <p>Note When you configure TE tunnel with multiple protection on its path and merge point is the same node for more than one protection, you must configure record-route for that tunnel.</p>
Step 11	<p>exit</p> <p>Example:</p> <pre>RP/0/RP0/CPU0:router(config-if)# exit</pre>	Exits the current configuration mode.
Step 12	commit	
Step 13	<p>show run explicit-path name <i>name</i></p> <p>Example:</p> <pre>RP/0/RP0/CPU0:router# show run explicit-path name backup-srlg</pre>	Displays the SRLG values that are configured for the link.
Step 14	<p>show mpls traffic-eng topology path destination <i>name</i> explicit-path <i>name</i></p> <p>Example:</p> <pre>RP/0/RP0/CPU0:router#show mpls traffic-eng topology path destination 192.168.92.125 explicit-path backup-srlg</pre>	Displays the SRLG values that are configured for the link.

Related Topics

- [MPLS Traffic Engineering Shared Risk Link Groups](#), on page 202
- [Explicit Path](#), on page 203
- [Fast ReRoute with SRLG Constraints](#), on page 203
- [Importance of Protection](#), on page 205
- [Delivery of Packets During a Failure](#), on page 206
- [Multiple Backup Tunnels Protecting the Same Interface](#), on page 206
- [SRLG Limitations](#), on page 206
- [MPLS TE SRLG Scale Enhancements](#), on page 207
- [Configure the MPLS-TE Shared Risk Link Groups: Example](#), on page 342

Creating a Link Protection on Backup Tunnel with SRLG Constraint

Perform this task to create an explicit path with the exclude SRLG option on the static backup tunnel.

SUMMARY STEPS

1. **configure**
2. **mpls traffic-eng**

3. **interface** *type interface-path-id*
4. **backup-path tunnel-te** *tunnel-number*
5. **exit**
6. **exit**
7. **interface tunnel-te***tunnel-id*
8. **ipv4 unnumbered** *type interface-path-id*
9. **path-option** *preference-priority*{ **dynamic** | **explicit** {**identifier** | **name** *explicit-path-name*}}
10. **destination** *ip-address*
11. **exit**
12. **explicit-path** {**identifier** **number** [**disable** | **index**]}{ **name** *explicit-path-name*}
13. **index 1** **exclude-srlg** 192.168.92.2
14. **commit**
15. **show mpls traffic-eng tunnel***tunnel-number* **detail**

DETAILED STEPS

	Command or Action	Purpose
Step 1	configure	
Step 2	mpls traffic-eng Example: RP/0/RP0/CPU0:router(config)# mpls traffic-eng	Enters MPLS-TE configuration mode.
Step 3	interface <i>type interface-path-id</i> Example: RP/0/RP0/CPU0:router(config-mpls-te)# interface POS 0/6/0/0	Enables traffic engineering on a particular interface on the originating node.
Step 4	backup-path tunnel-te <i>tunnel-number</i> Example: RP/0/RP0/CPU0:router(config-mpls-te)# backup-path tunnel-te 2	Sets the backup path to the primary tunnel outgoing interface.
Step 5	exit Example: RP/0/RP0/CPU0:router(config-mpls-te-if)# exit	Exits the current configuration mode.
Step 6	exit Example: RP/0/RP0/CPU0:router(config-mpls-te)# exit	Exits the current configuration mode.
Step 7	interface tunnel-te <i>tunnel-id</i> Example: RP/0/RP0/CPU0:router(config)# interface tunnel-te 2	Configures an MPLS-TE tunnel interface.

	Command or Action	Purpose
Step 8	ipv4 unnumbered <i>type interface-path-id</i> Example: RP/0/RP0/CPU0:router(config-if)# ipv4 unnumbered Loopback0	Assigns a source address to set up forwarding on the new tunnel.
Step 9	path-option preference-priority { dynamic explicit } { identifier name explicit-path-name } Example: RP/0/RP0/CPU0:router(config-if)# path-option 1 explicit name backup-srlg	Sets the path option to explicit with a given name (previously configured) and assigns the path ID. Identifier range is from 1 to 4294967295. Note You can use the dynamic option to dynamically assign a path.
Step 10	destination ip-address Example: RP/0/RP0/CPU0:router(config-if)# destination 192.168.92.125	Assigns a destination address on the new tunnel. <ul style="list-style-type: none"> • Destination address is the remote node's MPLS-TE router ID. • Destination address is the merge point between backup and protected tunnels. Note When you configure TE tunnel with multiple protection on its path and merge point is the same node for more than one protection, you must configure record-route for that tunnel.
Step 11	exit Example: RP/0/RP0/CPU0:router(config-if)# exit	Exits the current configuration mode.
Step 12	explicit-path { identifier number [disable index] } { name explicit-path-name } Example: RP/0/RP0/CPU0:router(config)# explicit-path name backup-srlg-noddep	Enters the explicit path configuration mode. Identifier range is 1 to 65535.
Step 13	index 1 exclude-srlg 192.168.92.2 Example: RP/0/RP0/CPU0:router:router(config-if)# index 1 exclude-srlg 192.168.192.2	Specifies the protected link IP address to get SRLGs to be excluded from the explicit path.
Step 14	commit	
Step 15	show mpls traffic-eng tunnelstunnel-number detail Example: RP/0/RP0/CPU0:router# show mpls traffic-eng tunnels 2 detail	Display the tunnel details with SRLG values that are configured for the link.

Related Topics

[MPLS Traffic Engineering Shared Risk Link Groups](#), on page 202

- [Explicit Path](#), on page 203
- [Fast ReRoute with SRLG Constraints](#), on page 203
- [Importance of Protection](#), on page 205
- [Delivery of Packets During a Failure](#), on page 206
- [Multiple Backup Tunnels Protecting the Same Interface](#), on page 206
- [SRLG Limitations](#), on page 206
- [MPLS TE SRLG Scale Enhancements](#), on page 207
- [Configure the MPLS-TE Shared Risk Link Groups: Example](#), on page 342

Creating a Node Protection on Backup Tunnel with SRLG Constraint

Perform this task to configure node protection on backup tunnel with SRLG constraint.

SUMMARY STEPS

1. **configure**
2. **mpls traffic-eng**
3. **interface** *type interface-path-id*
4. **backup-path tunnel-te** *tunnel-number*
5. **exit**
6. **exit**
7. **interface tunnel-te***tunnel-id*
8. **ipv4 unnumbered** *type interface-path-id*
9. **path-option** *preference-priority*{ **dynamic** | **explicit** {**identifier** | **name** *explicit-path-name*}}
10. **destination** *ip-address*
11. **exit**
12. **explicit-path** {**identifier number** [**disable** | **index**]}{ **name** *explicit-path-name*}
13. **index 1** **exclude-address** *192.168.92.1*
14. **index 2** **exclude-srlg** *192.168.92.2*
15. **commit**
16. **show mpls traffic-eng tunnels topology path destination** *ip-address explicit-path-name name*

DETAILED STEPS

	Command or Action	Purpose
Step 1	configure	
Step 2	mpls traffic-eng Example: RP/0/RP0/CPU0:router(config)# mpls traffic-eng	Enters MPLS-TE configuration mode.
Step 3	interface <i>type interface-path-id</i> Example: RP/0/RP0/CPU0:router(config-mpls-te)# interface POS 0/6/0/0	Enables traffic engineering on a particular interface on the originating node.

	Command or Action	Purpose
Step 4	backup-path tunnel-te <i>tunnel-number</i> Example: RP/0/RP0/CPU0:router(config-mpls-te)# backup-path tunnel-te 2	Sets the backup path for the primary tunnel outgoing interface.
Step 5	exit Example: RP/0/RP0/CPU0:router(config-mpls-te-if)# exit	Exits the current configuration mode.
Step 6	exit Example: RP/0/RP0/CPU0:router(config-mpls-te)# exit	Exits the current configuration mode.
Step 7	interface tunnel-te <i>tunnel-id</i> Example: RP/0/RP0/CPU0:router(config)# interface tunnel-te 2	Configures an MPLS-TE tunnel interface.
Step 8	ipv4 unnumbered <i>type interface-path-id</i> Example: RP/0/RP0/CPU0:router(config-if)# ipv4 unnumbered Loopback0	Assigns a source address to set up forwarding on the new tunnel.
Step 9	path-option <i>preference-priority</i> { dynamic explicit } { identifier name <i>explicit-path-name</i> } Example: RP/0/RP0/CPU0:router(config-if)# path-option 1 explicit name backup-srlg	Sets the path option to explicit with a given name (previously configured) and assigns the path ID. Identifier range is 1 to 4294967295. Note You can use the dynamic option to dynamically assign path.
Step 10	destination <i>ip-address</i> Example: RP/0/RP0/CPU0:router(config-if)# destination 192.168.92.125	Assigns a destination address on the new tunnel. <ul style="list-style-type: none"> • Destination address is the remote node's MPLS-TE router ID. • Destination address is the merge point between backup and protected tunnels. Note When you configure TE tunnel with multiple protection on its path and merge point is the same node for more than one protection, you must configure record-route for that tunnel.
Step 11	exit Example: RP/0/RP0/CPU0:router(config-if)# exit	Exits the current configuration mode.

	Command or Action	Purpose
Step 12	explicit-path {identifier number [disable index]}{ name explicit-path-name} Example: RP/0/RP0/CPU0:router(config)# explicit-path name backup-srlg-nodep	Enters the explicit path configuration mode. Identifier range is 1 to 65535.
Step 13	index 1 exclude-address 192.168.92.1 Example: RP/0/RP0/CPU0:router:router(config-if)# index 1 exclude-address 192.168.92.1	Specifies the protected node IP address to be excluded from the explicit path.
Step 14	index 2 exclude-srlg 192.168.92.2 Example: RP/0/RP0/CPU0:router(config-if)# index 2 exclude-srlg 192.168.192.2	Specifies the protected link IP address to get SRLGs to be excluded from the explicit path.
Step 15	commit	
Step 16	show mpls traffic-eng tunnels topology path destination ip-address explicit-path-name name Example: RP/0/RP0/CPU0:router# show mpls traffic-eng tunnels topology path destination 192.168.92.125 explicit-path-name backup-srlg-nodep	Displays the path to the destination with the constraint specified in the explicit path.

Related Topics

- [MPLS Traffic Engineering Shared Risk Link Groups](#), on page 202
- [Explicit Path](#), on page 203
- [Fast ReRoute with SRLG Constraints](#), on page 203
- [Importance of Protection](#), on page 205
- [Delivery of Packets During a Failure](#), on page 206
- [Multiple Backup Tunnels Protecting the Same Interface](#), on page 206
- [SRLG Limitations](#), on page 206
- [MPLS TE SRLG Scale Enhancements](#), on page 207
- [Configure the MPLS-TE Shared Risk Link Groups: Example](#), on page 342

Configuring Point-to-Multipoint TE

You must enable multicast routing on the edge router before performing Point-to-Multipoint (P2MP) TE configurations. To configure Point-to-Multipoint TE, perform these procedures:

Enabling Multicast Routing on the Router

Perform this task to enable multicast routing on the router to configure P2MP tunnels.

Before you begin

- To configure Point-to-Multipoint (P2MP) tunnels, you must enable multicast routing on the router.
- The customer-facing interface must enable multicast.

SUMMARY STEPS

1. **configure**
2. **multicast-routing**
3. **address-family { ipv4 | ipv6 }**
4. **interface tunnel-mte *tunnel-id***
5. **enable**
6. **exit**
7. **interface *type interface-path-id***
8. **enable**
9. **commit**
10. **show pim ipv6 interface *type interface-path-id***

DETAILED STEPS

	Command or Action	Purpose
Step 1	configure	
Step 2	multicast-routing Example: RP/0/RP0/CPU0:router (config) # multicast-routing RP/0/RP0/CPU0:router (config-mcast) #	Enters multicast routing configuration mode.
Step 3	address-family { ipv4 ipv6 } Example: RP/0/RP0/CPU0:router (config-mcast) # address-family ipv6 RP/0/RP0/CPU0:router (config-mcast-default-ipv6) #	Configures the available IPv4 or IPv6 address prefixes to enable multicast routing and forwarding on all router interfaces.
Step 4	interface tunnel-mte <i>tunnel-id</i> Example: RP/0/RP0/CPU0:router (config-mcast-default-ipv6) # interface tunnel-mte 1 RP/0/RP0/CPU0:router (config-mcast-default-ipv6-if) #	Configures an MPLS-TE P2MP tunnel interface.
Step 5	enable Example:	Enables multicast routing on the tunnel-mte interface.

	Command or Action	Purpose
	RP/0/RP0/CPU0:router(config-mcast-default-ipv6-if)# enable	
Step 6	exit Example: RP/0/RP0/CPU0:router(config-mcast-default-ipv6-if)# exit RP/0/RP0/CPU0:router(config-mcast-default-ipv6)#	Exits the current configuration mode.
Step 7	interface type interface-path-id Example: RP/0/RP0/CPU0:router(config-mcast-default-ipv6)# interface GigabitEthernet0/2/0/3 RP/0/RP0/CPU0:router(config-mcast-default-ipv6-if)#	Configures multicast routing on the GigabitEthernet interface.
Step 8	enable Example: RP/0/RP0/CPU0:router(config-mcast-default-ipv6-if)# enable	Enables multicast routing on the GigabitEthernet interface.
Step 9	commit	
Step 10	show pim ipv6 interface type interface-path-id Example: RP/0/RP0/CPU0:router# show pim ipv6 interface tunnel-mte 1	Displays the output for the P2MP-TE tunnel interface that has IPv6 multicast enabled.

Related Topics

[Point-to-Multipoint Traffic-Engineering Overview](#), on page 197

[Configure Point-to-Multipoint for the Source: Example](#), on page 353

[Configure the Point-to-Multipoint Solution: Example](#), on page 355

[Configuring the Static Group for the Point-to-Multipoint Interface](#), on page 294

Configuring the Static Group for the Point-to-Multipoint Interface

Perform this task to configure the static group on the Point-to-Multipoint (P2MP) interface to forward specified multicast traffic over P2MP LSP.

SUMMARY STEPS

1. **configure**
2. **router mld**
3. **vrf vrf-name**
4. **interface tunnel-mte tunnel-id**
5. **static-group group-address**
6. **commit**
7. **show mrib ipv6 route source-address**

DETAILED STEPS

	Command or Action	Purpose
Step 1	configure	
Step 2	router mld Example: RP/0/RP0/CPU0:router(config)# router mld RP/0/RP0/CPU0:router(config-mld)#	Enters router MLD configuration mode.
Step 3	vrf vrf-name Example: RP/0/RP0/CPU0:router(config-mld)# vrf default RP/0/RP0/CPU0:router(config-mld-default)#	Configures a virtual private network (VRF) instance.
Step 4	interface tunnel-mte tunnel-id Example: RP/0/RP0/CPU0:router(config-mld-default)# interface tunnel-mte 1 RP/0/RP0/CPU0:router(config-mld-default-if)#	Configures an MPLS-TE P2MP tunnel interface.
Step 5	static-group group-address Example: RP/0/RP0/CPU0:router(config-mld-default-if)# static-group ff35::1 2000::1	Configures the multicast group address in the Source-Specific Multicast (SSM) address range (ff35::/16) for the IPv6 address prefix.
Step 6	commit	
Step 7	show mrib ipv6 route source-address Example: RP/0/RP0/CPU0:router# show mrib ipv6 route ff35::1	Verifies the multicast static mapping.

Related Topics

[Point-to-Multipoint RSVP-TE](#), on page 199

[Configure Point-to-Multipoint for the Source: Example](#), on page 353

[Configure the Point-to-Multipoint Solution: Example](#), on page 355

[Enabling Multicast Routing on the Router](#), on page 292

Configuring Destinations for the Tunnel Interface

Perform this task to configure three destinations for the tunnel interface for Point-to-Multipoint (P2MP).

These variations are listed to ensure that the destination and path option configurations are separate from the tunnel interface.

- Different path option is used for different destinations. This task shows three destinations.
- Explicit path option is based on an ID or a name.
- Default path option is similar to the Point-to-Point (P2P) LSP.

Before you begin

These prerequisites are required to configure destinations for the tunnel interface.

- Multicast routing must be enabled on both the tunnel-mte interface and customer-facing interface from the source.
- Static-group must be configured on the tunnel-mte interface to forward specified multicast traffic over P2MP LSP.

SUMMARY STEPS

1. **configure**
2. **interface tunnel-mte** *tunnel-id*
3. **destination** *ip-address*
4. **path-option** *preference-priority* **explicit identifier** *path-number*
5. **path-option** *preference-priority* **dynamic**
6. **exit**
7. **destination** *ip-address*
8. **path-option** *preference-priority* **explicit name** *pathname*
9. **path-option** *preference-priority* **dynamic**
10. **exit**
11. **destination** *ip-address*
12. **path-option** *preference-priority* **explicit name** *pathname* [**verbatim**]
13. **commit**
14. **show mpls traffic-eng tunnels** [**brief**] [**p2mp** *tunnel-number*]

DETAILED STEPS

	Command or Action	Purpose
Step 1	configure	

	Command or Action	Purpose
Step 2	<p>interface tunnel-mte <i>tunnel-id</i></p> <p>Example:</p> <pre>RP/0/RP0/CPU0:router (config) # interface tunnel-mte 10 RP/0/RP0/CPU0:router (config-if) #</pre>	Configures an MPLS-TE P2MP tunnel interface.
Step 3	<p>destination <i>ip-address</i></p> <p>Example:</p> <pre>RP/0/RP0/CPU0:router (config-if) # destination 172.16.255.1 RP/0/RP0/CPU0:router (config-if-p2mp-dest) #</pre>	Sets the destination address for tunnel-mte 10 to 172.16.255.1. This destination uses the explicit path identified by explicit path ID 10. If destination 172.16.255.1 cannot come with explicit path ID 10, the fall back path option is dynamic.
Step 4	<p>path-option <i>preference-priority explicit identifier path-number</i></p> <p>Example:</p> <pre>RP/0/RP0/CPU0:router (config-if-p2mp-dest) # path-option 1 explicit identifier 10</pre>	Configures the path number of the IP explicit path.
Step 5	<p>path-option <i>preference-priority dynamic</i></p> <p>Example:</p> <pre>RP/0/RP0/CPU0:router (config-if-p2mp-dest) # path-option 2 dynamic</pre>	Specifies that label switched paths (LSP) are dynamically calculated.
Step 6	<p>exit</p> <p>Example:</p> <pre>RP/0/RP0/CPU0:router (config-if-p2mp-dest) # exit RP/0/RP0/CPU0:router (config-if) #</pre>	Exits the current configuration mode.
Step 7	<p>destination <i>ip-address</i></p> <p>Example:</p> <pre>RP/0/RP0/CPU0:router (config-if) # destination 172.16.255.2 RP/0/RP0/CPU0:router (config-if-p2mp-dest) #</pre>	Sets the destination address for tunnel-mte 10 to 172.16.255.2.
Step 8	<p>path-option <i>preference-priority explicit name pathname</i></p> <p>Example:</p> <pre>RP/0/RP0/CPU0:router (config-if-p2mp-dest) # path-option 1 explicit name</pre>	Specifies the path name of the IP explicit path. Destination 172.16.255.2 uses the explicit path that is identified by the explicit path name "how-to-get-to-172.16.255.2."

	Command or Action	Purpose
	<code>how-to-get-to-172.16.255.2</code>	
Step 9	<p>path-option preference-priority dynamic</p> <p>Example:</p> <pre>RP/0/RP0/CPU0:router(config-if-p2mp-dest)# path-option 2 dynamic</pre>	Sets the fall back path option as dynamic when the destination cannot come to the explicit path.
Step 10	<p>exit</p> <p>Example:</p> <pre>RP/0/RP0/CPU0:router(config-if-p2mp-dest)# exit RP/0/RP0/CPU0:router(config-if)#</pre>	Exits the current configuration mode.
Step 11	<p>destination ip-address</p> <p>Example:</p> <pre>RP/0/RP0/CPU0:router(config-if)# destination 172.16.255.3 RP/0/RP0/CPU0:router(config-if-p2mp-dest)#</pre>	Specifies that destination 172.16.255.3 uses only the dynamically computed path.
Step 12	<p>path-option preference-priority explicit name pathname [verbatim]</p> <p>Example:</p> <pre>RP/0/RP0/CPU0:router(config-if-p2mp-dest)# path-option 1 explicit name how-to-get-to-172.16.255.3 verbatim</pre>	Specifies that destination 172.16.255.3 uses the explicit path identified by the explicit path name "how-to-get-to-172.16.255.3" in verbatim mode.
Step 13	commit	
Step 14	<p>show mpls traffic-eng tunnels [brief] [p2mp tunnel-number]</p> <p>Example:</p> <pre>RP/0/RP0/CPU0:router# show mpls traffic-eng tunnels brief p2mp 10</pre>	Displays the brief summary of the P2MP tunnel status and configuration.

Related Topics

- [Path Option for Point-to-Multipoint RSVP-TE](#), on page 201
- [Configure the Point-to-Multipoint Tunnel: Example](#), on page 354
- [Configure the Point-to-Multipoint Solution: Example](#), on page 355
- [Enabling Multicast Routing on the Router](#), on page 292
- [Configuring the Static Group for the Point-to-Multipoint Interface](#), on page 294

Disabling Destinations

Perform this task to disable the given destination for the Point-to-Multipoint (P2MP) tunnel interface.

SUMMARY STEPS

1. **configure**
2. **interface tunnel-mte** *tunnel-id*
3. **ipv4 unnumbered** *type interface-path-id*
4. **destination** *ip-address*
5. **disable**
6. **path-option** *preference-priority* **dynamic**
7. **path-option** *preference-priority* **explicit name** *pathname*
8. **commit**

DETAILED STEPS

	Command or Action	Purpose
Step 1	configure	
Step 2	interface tunnel-mte <i>tunnel-id</i> Example: RP/0/RP0/CPU0:router(config)# interface tunnel-mte 101 RP/0/RP0/CPU0:router(config-if)#	Configures an MPLS-TE P2MP tunnel interface.
Step 3	ipv4 unnumbered <i>type interface-path-id</i> Example: RP/0/RP0/CPU0:router(config-if)# ipv4 unnumbered Loopback0	Assigns a source address so that forwarding can be performed on the new tunnel. Loopback is commonly used as the interface type.
Step 4	destination <i>ip-address</i> Example: RP/0/RP0/CPU0:router(config-if)# destination 140.140.140.140 RP/0/RP0/CPU0:router(config-if-p2mp-dest)#	Sets the destination address for tunnel-mte 10 to 140.140.140.140.
Step 5	disable Example: RP/0/RP0/CPU0:router(config-if-p2mp-dest)# disable	Disables destination 140.140.140.140 for tunnel-mte 10.
Step 6	path-option <i>preference-priority</i> dynamic Example:	Specifies that label switched paths (LSP) are dynamically calculated.

	Command or Action	Purpose
	RP/0/RP0/CPU0:router (config-if-p2mp-dest) # path-option 1 dynamic	
Step 7	path-option <i>preference-priority</i> explicit name <i>pathname</i> Example: RP/0/RP0/CPU0:router (config-if-p2mp-dest) # path-option 2 explicit name to4	Specifies that destination 140.140.140.140 uses the explicit path identified by the explicit path name "to4."
Step 8	commit	

Related Topics

[Point-to-Multipoint Traffic-Engineering Overview](#), on page 197

[Disable a Destination: Example](#), on page 354

Logging Per Destinations for Point-to-Multipoint

Perform this task to log destinations for Point-to-Multipoint (P2MP).

SUMMARY STEPS

1. **configure**
2. **interface tunnel-mte** *tunnel-id*
3. **ipv4 unnumbered** *type interface-path-id*
4. **destination** *ip-address*
5. **logging events lsp-status state**
6. **logging events lsp-status reroute**
7. **path-option** *preference-priority* **explicit name** *pathname*
8. **exit**
9. **fast-reroute**
10. **commit**
11. **show mpls traffic-eng tunnels [p2mp]**

DETAILED STEPS

	Command or Action	Purpose
Step 1	configure	
Step 2	interface tunnel-mte <i>tunnel-id</i> Example: RP/0/RP0/CPU0:router (config) # interface tunnel-mte 1000 RP/0/RP0/CPU0:router (config-if) #	Configures an MPLS-TE P2MP tunnel interface.

	Command or Action	Purpose
Step 3	ipv4 unnumbered <i>type interface-path-id</i> Example: <pre>RP/0/RP0/CPU0:router(config-if)# ipv4 unnumbered loopback0</pre>	Configures the MPLS-TE tunnel to use the IPv4 address on loopback interface 0.
Step 4	destination <i>ip-address</i> Example: <pre>RP/0/RP0/CPU0:router(config-if)# destination 100.0.0.3 RP/0/RP0/CPU0:router(config-if-p2mp-dest)#</pre>	Sets the destination address for tunnel-mte from 1000 to 100.0.0.3.
Step 5	logging events lsp-status state Example: <pre>RP/0/RP0/CPU0:router(config-if-p2mp-dest)# logging events lsp-status state</pre>	Sends out the log message when the tunnel LSP goes up or down when the software is enabled.
Step 6	logging events lsp-status reroute Example: <pre>RP/0/RP0/CPU0:router(config-if-p2mp-dest)# logging events lsp-status reroute</pre>	Sends out the log message when the tunnel LSP is rerouted due to an FRR event when the software is enabled.
Step 7	path-option <i>preference-priority explicit name pathname</i> Example: <pre>RP/0/RP0/CPU0:router(config-if-p2mp-dest)# path-option 1 explicit name path123</pre>	Specifies the path name of the IP explicit path. Destination 100.0.0.3 uses the explicit path that is identified by the explicit path name "path123."
Step 8	exit Example: <pre>RP/0/RP0/CPU0:router(config-if-p2mp-dest)# exit RP/0/RP0/CPU0:router(config-if)#</pre>	Exits the current configuration mode.
Step 9	fast-reroute Example: <pre>RP/0/RP0/CPU0:router(config-if)# fast-reroute</pre>	Enables fast-reroute (FRR) protection for a P2MP TE tunnel.
Step 10	commit	

	Command or Action	Purpose
Step 11	show mpls traffic-eng tunnels [p2mp] Example: RP/0/RP0/CPU0:router# show mpls traffic-eng tunnels p2mp	Displays the information for all P2MP tunnels.

Related Topics

[Point-to-Multipoint Traffic-Engineering Overview](#), on page 197

[Configure the Point-to-Multipoint Tunnel: Example](#), on page 354

[Configure the Point-to-Multipoint Solution: Example](#), on page 355

Enabling Soft-Preemption on a Node

Perform this task to enable the soft-preemption feature in the MPLS TE configuration mode. By default, this feature is disabled. You can configure the soft-preemption feature for each node. It has to be explicitly enabled for each node.

SUMMARY STEPS

1. **configure**
2. **mpls traffic-eng**
3. **soft-preemption**
4. **timeout** *seconds*
5. **commit**

DETAILED STEPS

	Command or Action	Purpose
Step 1	configure	
Step 2	mpls traffic-eng Example: RP/0/RP0/CPU0:router(config)# mpls traffic-eng	Enters MPLS-TE configuration mode.
Step 3	soft-preemption Example: RP/0/RP0/CPU0:router(config-mpls-te)# soft-preemption	Enables soft-preemption on a node. Note If soft-preemption is enabled, the head-end node tracks whether an LSP desires the soft-preemption treatment. However, when a soft-preemption feature is disabled on a node, this node continues to track all LSPs desiring soft-preemption. This is needed in a case when soft-preemption is re-enabled, TE will have the property of the existing LSPs without any re-signaling.

	Command or Action	Purpose
Step 4	timeout <i>seconds</i> Example: RP/0/RP0/CPU0:router(config-soft-preemption)# timeout 20	Specifies the timeout for the soft-preempted LSP, in seconds. The range is from 1 to 300.
Step 5	commit	

Related Topics

[Soft-Preemption](#), on page 207

Enabling Soft-Preemption on a Tunnel

Perform this task to enable the soft-preemption feature on a MPLS TE tunnel. By default, this feature is disabled. It has to be explicitly enabled.

SUMMARY STEPS

1. **configure**
2. **interface tunnel-te** *tunnel-id*
3. **soft-preemption**
4. **commit**

DETAILED STEPS

	Command or Action	Purpose
Step 1	configure	
Step 2	interface tunnel-te <i>tunnel-id</i> Example: RP/0/RP0/CPU0:router# interface tunnel-te 10	Configures an MPLS-TE tunnel interface.
Step 3	soft-preemption Example: RP/0/RP0/CPU0:router(config-if)# soft-preemption	Enables soft-preemption on a tunnel. When soft preemption is enabled on a tunnel, these actions occur: <ul style="list-style-type: none"> • A path-modify message is sent for the current LSP with the soft preemption desired property. • A path-modify message is sent for the reopt LSP with the soft preemption desired property. • A path-modify message is sent for the path protection LSP with the soft preemption desired property. • A path-modify message is sent for the current LSP in FRR active state with the soft preemption desired property.

	Command or Action	Purpose
		Note The soft-preemption is not available in the interface tunnel-mte and interface tunnel-gte configuration modes.
Step 4	commit	

Related Topics

[Soft-Preemption](#), on page 207

Configuring Attributes within a Path-Option Attribute

Perform this task to configure attributes within a path option attribute-set template.

SUMMARY STEPS

1. **configure**
2. **mpls traffic-eng**
3. **attribute-set path-option** *attribute-set-name*
4. **affinity** *affinity-value* **mask** *mask-value*
5. **signalled-bandwidth** *kbps* **class-type** *class-type number*
6. **commit**
7. **show mpls traffic-eng attribute-set**
8. **show mpls traffic-eng tunnels***detail*

DETAILED STEPS

	Command or Action	Purpose
Step 1	configure	
Step 2	mpls traffic-eng Example: RP/0/RP0/CPU0:router(config)# mpls traffic-eng	Enters MPLS-TE configuration mode.
Step 3	attribute-set path-option <i>attribute-set-name</i> Example: RP/0/RP0/CPU0:router(config-mpls-te)# attribute-set path-option myset	Enters attribute-set path option configuration mode. Note The configuration at the path-option level takes precedence over the values configured at the level of the tunnel, and therefore is applied.
Step 4	affinity <i>affinity-value</i> mask <i>mask-value</i> Example: RP/0/RP0/CPU0:router(config-te-attribute-set)# affinity 0xBEEF mask 0xBEEF	Configures affinity attribute under a path option attribute-set. The attribute values that are required for links to carry this tunnel.
Step 5	signalled-bandwidth <i>kbps</i> class-type <i>class-type number</i> Example:	Configures the bandwidth attribute required for an MPLS-TE tunnel under a path option attribute-set.

	Command or Action	Purpose
	RP/0/RP0/CPU0:router(config-te-attribute-set)# signalled-bandwidth 1000 class-type 0	Note You can configure the class type of the tunnel bandwidth request. The class-type 0 is strictly equivalent to global-pool and class-type 1 is strictly equivalent to subpool .
Step 6	commit	
Step 7	show mpls traffic-eng attribute-set Example: RP/0/RP0/CPU0:router# show mpls traffic-eng attribute-set	Displays the attributes that are defined in the attribute-set for the link.
Step 8	show mpls traffic-eng tunnelsdetail Example: RP/0/RP0/CPU0:router# show mpls traffic-eng tunnels detail	Displays the attribute-set path option information on a specific tunnel.

Related Topics

- [Path Option Attributes](#), on page 207
- [Configuration Hierarchy of Path Option Attributes](#), on page 208
- [Traffic Engineering Bandwidth and Bandwidth Pools](#), on page 208
- [Path Option Switchover](#), on page 209
- [Path Option and Path Protection](#), on page 209

Configuring Auto-Tunnel Mesh Tunnel ID

Perform this activity to configure the tunnel ID range that can be allocated to Auto-tunnel mesh tunnels.

SUMMARY STEPS

1. configure
2. mpls traffic-eng
3. auto-tunnel mesh
4. tunnel-id min *value* max *value*
5. commit

DETAILED STEPS

	Command or Action	Purpose
Step 1	configure	
Step 2	mpls traffic-eng Example: RP/0/RP0/CPU0:router(config)# mpls traffic-eng	Enters MPLS TE configuration mode.

	Command or Action	Purpose
Step 3	auto-tunnel mesh Example: RP/0/RP0/CPU0:router(config-mpls-te)# auto-tunnel mesh	Enters auto-tunnel mesh configuration mode. You can configure auto-tunnel mesh related options from this mode.
Step 4	tunnel-id min value max value Example: RP/0/RP0/CPU0:router(config-te-auto-mesh)# tunnel-id min 10 max 50	Specifies the minimum and maximum number of auto-tunnel mesh tunnels that can be created on this router. The range of tunnel ID is from 0 to 65535.
Step 5	commit	

Related Topics

[Auto-Tunnel Mesh](#), on page 210

[Destination List \(Prefix-List\)](#), on page 210

Configuring Auto-tunnel Mesh Unused Timeout

Perform this task to configure a global timer to remove unused auto-mesh tunnels.

SUMMARY STEPS

1. **configure**
2. **mpls traffic-eng**
3. **auto-tunnel mesh**
4. **timer removal unused *timeout***
5. **commit**

DETAILED STEPS

	Command or Action	Purpose
Step 1	configure	
Step 2	mpls traffic-eng Example: RP/0/RP0/CPU0:router(config)# mpls traffic-eng	Enters MPLS-TE configuration mode.
Step 3	auto-tunnel mesh Example: RP/0/RP0/CPU0:router(config-mpls-te)# auto-tunnel mesh	Enables auto-tunnel mesh groups globally.

	Command or Action	Purpose
Step 4	timer removal unused <i>timeout</i> Example: <pre>RP/0/RP0/CPU0:router(config-mpls-te-auto-mesh)# timers removal unused 10</pre>	<p>Specifies a timer, in minutes, after which a down auto-tunnel mesh gets deleted whose destination was not in TE topology. The default value for this timer is 60.</p> <p>The timer gets started when these conditions are met:</p> <ul style="list-style-type: none"> • Tunnel destination node is removed from the topology • Tunnel is in down state <p>Note The unused timer runs per tunnel because the same destination in different mesh-groups may have different tunnels created.</p>
Step 5	commit	

Related Topics

[Auto-Tunnel Mesh](#), on page 210

[Destination List \(Prefix-List\)](#), on page 210

Configuring Auto-Tunnel Mesh Group

Perform this task to configure an auto-tunnel mesh group globally on the router.

SUMMARY STEPS

1. **configure**
2. **mpls traffic-eng**
3. **auto-tunnel mesh**
4. **group** *value*
5. **disable**
6. **attribute-setname**
7. **destination-list**
8. **commit**

DETAILED STEPS

	Command or Action	Purpose
Step 1	configure	
Step 2	mpls traffic-eng Example: <pre>RP/0/RP0/CPU0:router(config)# mpls traffic-eng</pre>	Enters MPLS-TE configuration mode.
Step 3	auto-tunnel mesh Example:	Enables auto-tunnel mesh groups globally.

	Command or Action	Purpose
	RP/0/RP0/CPU0:router(config-mpls-te)# auto-tunnel mesh	
Step 4	group <i>value</i> Example: RP/0/RP0/CPU0:router(config-mpls-te-auto-mesh)# group 65	Specifies the membership of auto-tunnel mesh. The range is from 0 to 4294967295. Note When the destination-list is not supplied, head-end will automatically build destination list belonging for the given mesh-group membership using TE topology.
Step 5	disable Example: RP/0/RP0/CPU0:router(config-mpls-te-auto-mesh-group)# disable	Disables the meshgroup and deletes all tunnels created for this meshgroup.
Step 6	attribute-set <i>name</i> Example: RP/0/RP0/CPU0:router(config-mpls-te-auto-mesh-group)# attribute-set am-65	Specifies the attributes used for all tunnels created for the meshgroup. If it is not defined, this meshgroup does not create any tunnel.
Step 7	destination-list Example: RP/0/RP0/CPU0:router(config-mpls-te-auto-mesh-group)# destination-list dl-65	This is a mandatory configuration under a meshgroup. If a given destination-list is not defined as a prefix-list, this meshgroup create tunnels to all nodes available in TE topology.
Step 8	commit	

Related Topics

[Auto-Tunnel Mesh](#), on page 210

[Destination List \(Prefix-List\)](#), on page 210

Configuring Tunnel Attribute-Set Templates

Perform this task to define attribute-set templates for auto-mesh tunnels.

SUMMARY STEPS

1. **configure**
2. **mpls traffic-eng**
3. **attribute-set auto-mesh** *attribute-set-name*
4. **affinity** *value mask mask-value*
5. **signalled-bandwidth** *kbps class-type class-type number*
6. **autoroute announce**
7. **fast-reroute protect bandwidth node**

8. `auto-bw collect-bw-only`
9. `logging events lsp-status {state | insufficient-bandwidth | reoptimize | reroute }`
10. `commit`

DETAILED STEPS

	Command or Action	Purpose
Step 1	<code>configure</code>	
Step 2	mpls traffic-eng Example: RP/0/RP0/CPU0:router(config)# <code>mpls traffic-eng</code>	Enters MPLS-TE configuration mode.
Step 3	attribute-set auto-mesh <i>attribute-set-name</i> Example: RP/0/RP0/CPU0:router(config-te)# <code>attribute-set auto-mesh attribute-set-mesh</code>	Specifies name of the attribute-set of auto-mesh type.
Step 4	affinity <i>value mask mask-value</i> Example: RP/0/RP0/CPU0:router(config-te)# <code>affinity 0101 mask 320</code>	Configures the affinity properties the tunnel requires in its links for an MPLS-TE tunnel under an auto-mesh attribute-set.
Step 5	signalled-bandwidth <i>kbps class-type class-type number</i> Example: RP/0/RP0/CPU0:router(config-te-attribute-set)# <code>signalled-bandwidth 1000 class-type 0</code>	Configures the bandwidth attribute required for an MPLS-TE tunnel under an auto-mesh attribute-set. Because the default tunnel priority is 7, tunnels use the default TE class map (namely, class-type 0, priority 7). Note You can configure the class type of the tunnel bandwidth request. The class-type 0 is strictly equivalent to global-pool and class-type 1 is strictly equivalent to subpool .
Step 6	autoroute announce Example: RP/0/RP0/CPU0:router(config-te-attribute-set)# <code>autoroute announce</code>	Enables parameters for IGP routing over tunnel.
Step 7	fast-reroute protect bandwidth node Example: RP/0/RP0/CPU0:router(config-te-attribute-set)# <code>fast-reroute</code>	Enables fast-reroute bandwidth protection and node protection for auto-mesh tunnels.
Step 8	auto-bw collect-bw-only Example:	Enables automatic bandwidth collection frequency, and controls the manner in which the bandwidth for a tunnel

	Command or Action	Purpose
	<code>RP/0/RP0/CPU0:router (config-te-attribute-set) # auto-bw collect-bw-only</code>	collects output rate information, but does not adjust the tunnel bandwidth.
Step 9	<p>logging events lsp-status {state insufficient-bandwidth reoptimize reroute }</p> <p>Example:</p> <pre>RP/0/RP0/CPU0:router (config-te-attribute-set) # logging events lsp-status state</pre>	<p>Sends out the log message when the tunnel LSP goes up or down when the software is enabled.</p> <p>Sends out the log message when the tunnel LSP undergoes setup or reoptimize failure due to bandwidth issues.</p> <p>Sends out the log message for the LSP reoptimize change alarms.</p> <p>Sends out the log message for the LSP reroute change alarms.</p>
Step 10	<code>commit</code>	

Related Topics

[Auto-Tunnel Mesh](#), on page 210

[Destination List \(Prefix-List\)](#), on page 210

Enabling LDP on Auto-Tunnel Mesh

Perform this task to enable LDP on auto-tunnel mesh group.

SUMMARY STEPS

1. `configure`
2. `mpls ldp`
3. `traffic-eng auto-tunnel mesh`
4. `group idall`
5. `commit`

DETAILED STEPS

	Command or Action	Purpose
Step 1	<code>configure</code>	
Step 2	<p>mpls ldp</p> <p>Example:</p> <pre>RP/0/RP0/CPU0:router (config-ldp) # mpls ldp</pre>	Enters MPLS LDP configuration mode.
Step 3	<p>traffic-eng auto-tunnel mesh</p> <p>Example:</p> <pre>RP/0/RP0/CPU0:router (config-ldp-te-auto-mesh) # traffic-eng auto-tunnel mesh</pre>	Enters auto-tunnel mesh configuration mode. You can configure TE auto-tunnel mesh groups from this mode.

	Command or Action	Purpose
Step 4	group id all Example: <pre>RP/0/RP0/CPU0:router(config-ldp-te-auto-mesh) # group all</pre>	Configures an auto-tunnel mesh group of interfaces in LDP. You can enable LDP on all TE meshgroup interfaces or you can specify the TE mesh group ID on which the LDP is enabled. The range of group ID is from 0 to 4294967295.
Step 5	commit	

Related Topics

[Auto-Tunnel Mesh](#), on page 210

[Destination List \(Prefix-List\)](#), on page 210

Configuring P2MP TE Auto-tunnels

Perform these tasks to enable P2MP TE Auto-tunnels. These steps configure the tunnel ID range to be allocated to P2MP auto-tunnels and determine the maximum number of P2MP auto-tunnels that can be created.

Before you begin

The P2MP TE Auto-tunnel configuration is disabled by default.

SUMMARY STEPS

1. **configure**
2. **mpls traffic-eng**
3. **auto-tunnel p2mp**
4. **tunnel-id min number max value**
5. **commit**

DETAILED STEPS

	Command or Action	Purpose
Step 1	configure	
Step 2	mpls traffic-eng Example: <pre>RP/0/RP0/CPU0:router(config)#mpls traffic-eng</pre>	Enables MPLS traffic engineering (TE) configuration mode.
Step 3	auto-tunnel p2mp Example: <pre>RP/0/RP0/CPU0:router(config-mpls-te)#auto-tunnel p2mp</pre>	Enables automatically created tunnel configuration and enters the auto-tunnel P2MP configuration mode.
Step 4	tunnel-id min number max value Example: <pre>RP/0/RP0/CPU0:router(config-te-auto-p2mp)#tunnel-id min 10000 max 11000</pre>	Configures the tunnel ID range that can be allocated to P2MP auto-tunnels and determines the maximum number of P2MP auto-tunnels that can be created.

	Command or Action	Purpose
Step 5	commit	

Related Topics

[P2MP-TE Auto-tunnels](#), on page 211

Enabling Stateful PCE Client

Perform these steps to enable stateful PCE client.

SUMMARY STEPS

1. **configure**
2. **mpls traffic-eng**
3. **pce**
4. **stateful-client**
5. **capabilities { instantiation | update }**
6. **commit**

DETAILED STEPS

	Command or Action	Purpose
Step 1	configure	
Step 2	mpls traffic-eng Example: RP/0/RP0/CPU0:router(config)#mpls traffic-eng	Enters MPLS TE configuration mode.
Step 3	pce Example: RP/0/RP0/CPU0:router(config-mpls-te)#pce	Enters PCE configuration mode.
Step 4	stateful-client Example: RP/0/RP0/CPU0:router(config-mpls-te-pce)#stateful-client	Enters stateful PCE client configuration mode. When the stateful-client configuration is added to the node, it will close all existing PCEP peer connections, and add the stateful capabilities TLV to the OPEN object it exchanges during the PCEP session establishment. When the stateful-client configuration is removed from the node, it will delete all PCE instantiated tunnels, close all existing PCEP connections, and no longer add the stateful capabilities TLV to the OPEN object it exchanges during the PCEP session establishment.
Step 5	capabilities { instantiation update } Example: RP/0/RP0/CPU0:router(config-mpls-te-pce-stateful)#capabilities instantiation	Enables stateful client capabilities. <ul style="list-style-type: none"> • instantiation—enables stateful instantiate capability • update—enables stateful update capability

	Command or Action	Purpose
Step 6	commit	

Configuring VRF Redirection

Perform these steps to configure VRF redirection by installing multiple routes in the routing information base (RIB) per MPLS TE tunnel:

SUMMARY STEPS

1. **configure**
2. **interface tunnel-te** *tunnel-id*
3. **autoroute destination** *ip-address*
4. **commit**

DETAILED STEPS

	Command or Action	Purpose
Step 1	configure	
Step 2	interface tunnel-te <i>tunnel-id</i> Example: RP/0/RP0/CPU0:router(config)#interface tunnel-te 10	Configures an MPLS-TE tunnel interface.
Step 3	autoroute destination <i>ip-address</i> Example: RP/0/RP0/CPU0:router(config-if)#autoroute destination 192.168.1.2 RP/0/RP0/CPU0:router(config-if)#autoroute destination 192.168.2.2 RP/0/RP0/CPU0:router(config-if)#autoroute destination 192.168.3.2 RP/0/RP0/CPU0:router(config-if)#autoroute destination 192.168.4.2	Adds a route (ip-address) in RIB with TE tunnel as outgoing interface. to the tunnel destination.
Step 4	commit	

Example

This example shows how to configure installing four autoroute destination routes into the RIB along with the default route:

```
interface tunnel-te10
  autoroute destination 192.168.1.2
  autoroute destination 192.168.2.2
  autoroute destination 192.168.3.2
```

```
autoroute destination 192.168.4.2
```

Configuring IPv6 Routing Over IPv4 MPLS-TE Tunnels

Perform these steps to configure IPv6 routing over IPv4 MPLS-TE tunnels:

SUMMARY STEPS

1. **configure**
2. **interface tunnel-te** *tunnel-id*
3. **ipv4 unnumbered** *type interface-path-id*
4. **ipv6 enable**
5. **signalled-bandwidth** *bandwidth*
6. **destination** *ip-address*
7. Use one of these options:
 - **autoroute announce include-ipv6**
 - **forwarding-adjacency include-ipv6**
8. **path-option preference-priority dynamic**
9. **commit**
10. (Optional) **show mpls traffic-eng autoroute**
11. (Optional) **show mpls traffic-eng forwarding-adjacency**

DETAILED STEPS

	Command or Action	Purpose
Step 1	configure	
Step 2	interface tunnel-te <i>tunnel-id</i> Example: RP/0/RP0/CPU0:router# interface tunnel-te 1	Configures an MPLS-TE tunnel interface.
Step 3	ipv4 unnumbered <i>type interface-path-id</i> Example: RP/0/RP0/CPU0:router(config-if)#ipv4 unnumbered Loopback 0	Assigns a source address so that forwarding can be performed on the new tunnel. Loopback is the commonly-used interface type.
Step 4	ipv6 enable Example: RP/0/RP0/CPU0:router(config-if)#ipv6 enable	Enables IPv6 on interface.
Step 5	signalled-bandwidth <i>bandwidth</i> Example: RP/0/RP0/CPU0:router(config-if)# signalled-bandwidth 10	Sets the tunnel bandwidth requirement to be signalled in Kbps.

	Command or Action	Purpose
Step 6	<p>destination <i>ip-address</i></p> <p>Example:</p> <pre>RP/0/RP0/CPU0:router (config-if)#destination 3.3.3.3</pre>	Specifies tunnel destination.
Step 7	<p>Use one of these options:</p> <ul style="list-style-type: none"> • autoroute announce include-ipv6 • forwarding-adjacency include-ipv6 <p>Example:</p> <pre>RP/0/RP0/CPU0:router (config-if)#autoroute announce include-ipv6</pre> <p>Or</p> <pre>RP/0/RP0/CPU0:router (config-if)#forwarding-adjacency include-ipv6</pre>	Announces the tunnel as an IPv6 autoroute or an IPv6 forwarding adjacency.
Step 8	<p>path-option <i>preference-priority</i> dynamic</p> <p>Example:</p> <pre>RP/0/RP0/CPU0:router (config-if)#path-option 1 dynamic</pre>	Sets the path option to dynamic and assigns the path ID.
Step 9	commit	
Step 10	<p>(Optional) show mpls traffic-eng autoroute</p> <p>Example:</p> <pre>RP/0/RP0/CPU0:router#show mpls traffic-eng autoroute Destination 192.168.0.2 has 1 tunnels in IS-IS ring level 1 tunnel-tel (traffic share 0, nexthop 192.168.0.2) (IPv4 unicast) (IPv6 unicast)</pre>	Verifies that the tunnel announces IPv6 autoroute information.
Step 11	<p>(Optional) show mpls traffic-eng forwarding-adjacency</p> <p>Example:</p> <pre>RP/0/RP0/CPU0:router#show mpls traffic-eng forwarding-adjacency destination 3.3.3.3 has 1 tunnels tunnel-tel0 (traffic share 0, next-hop 3.3.3.3) (Adjacency Announced: yes, holdtime 0) (IS-IS 100, IPv4 unicast)</pre>	Verifies that the tunnel announces IPv6 forwarding adjacency information.

	Command or Action	Purpose
	(IS-IS 100, IPv6 unicast)	

Configuring Path-selection Cost Limit

Apply the path-selection cost-limit configuration to set the upper limit on the path aggregate admin-weight when computing paths for MPLS-TE LSPs. Once the path-selection cost is configured, the periodic path verification will check if the cost-limit is crossed. Path-selection cost limit can be configured at global MPLS TE, per interface tunnel, and per path-option attribute set. The path-selection cost limit per path-option attribute set takes the highest priority, followed by per interface and MPLS TE global path-selection cost limit values.

Configuring Global Path-selection Cost Limit on MPLS TE Tunnels

Perform these steps to configure path-selection cost limit globally for MPLS TE tunnels:

SUMMARY STEPS

1. **configure**
2. **mpls traffic-eng**
3. **path-selection cost-limit *cost-limit***
4. **commit**

DETAILED STEPS

	Command or Action	Purpose
Step 1	configure	
Step 2	mpls traffic-eng Example: RP/0/RP0/CPU0:router(config)# mpls traffic-eng	Enters MPLS-TE configuration mode.
Step 3	path-selection cost-limit <i>cost-limit</i> Example: RP/0/RP0/CPU0:router(config-mpls-te)# path-selection cost-limit 3	Sets the upper limit on the path aggregate admin-weight when computing paths for MPLS TE LSPs.
Step 4	commit	

Configuring Path-selection Cost Limit per TE Tunnel

Perform these steps to configure path-selection cost limit per MPLS TE tunnel:

SUMMARY STEPS

1. **configure**
2. **interface tunnel-te *tunnel-id***
3. **path-selection cost-limit *cost-limit***
4. **commit**

DETAILED STEPS

	Command or Action	Purpose
Step 1	configure	
Step 2	interface tunnel-te <i>tunnel-id</i> Example: RP/0/RP0/CPU0:router(config)#interface tunnel-te 1	Configures an MPLS-TE tunnel interface.
Step 3	path-selection cost-limit <i>cost-limit</i> Example: RP/0/RP0/CPU0:router(config-if)# path-selection cost-limit 2	Sets the upper limit on the path aggregate admin-weight when computing paths for MPLS TE LSPs for the specified MPLS TE tunnel.
Step 4	commit	

Configuring Path-selection Cost Limit per Path-option Attribute-set

Perform these steps to configure path-selection cost limit per path-option attribute-set:

SUMMARY STEPS

1. **configure**
2. **mpls traffic-eng**
3. **attribute-set path-option** *attribute-set-name*
4. **path-selection cost-limit** 3

DETAILED STEPS

	Command or Action	Purpose
Step 1	configure	
Step 2	mpls traffic-eng Example: RP/0/RP0/CPU0:router(config)# mpls traffic-eng	Enters MPLS-TE configuration mode.
Step 3	attribute-set path-option <i>attribute-set-name</i> Example: RP/0/RP0/CPU0:router(config-mpls-te)# attribute-set path-option PO3AttrSet	Enters attribute-set path option configuration mode. Note The configuration at the attribute-set path-option level takes precedence over the values configured at global and interface tunnel level.
Step 4	path-selection cost-limit 3 Example: RP/0/RP0/CPU0:router(config-te-attribute-set)# path-selection cost-limit 3	Sets the upper limit on the path aggregate admin-weight when computing paths for MPLS TE LSPs per path-option attribute set.

Enabling Soft-preemption over FRR Backup Tunnels

Perform these tasks to enable LSP traffic to be moved over the backup tunnel when the LSP is soft-preempted. With this configuration, when there is a soft-preemption, the MPLS TE process triggers a rewrite to move the traffic on the backup tunnel, if the backup tunnel is ready. The rest of the soft-preemption process remains unchanged.

Before you begin

Ensure that the following configurations are enabled before enabling soft-preemption over FRR backup:

- Soft-preemption enabled.
- Fast-reroute (FRR) backup tunnel is activated.

SUMMARY STEPS

1. **configure**
2. **mpls traffic-eng**
3. **soft-preemption frr-rewrite**
4. **commit**

DETAILED STEPS

	Command or Action	Purpose
Step 1	configure	
Step 2	mpls traffic-eng Example: RP/0/RP0/CPU0:router(config)#mpls traffic-eng	Enters MPLS-TE configuration mode.
Step 3	soft-preemption frr-rewrite Example: RP/0/RP0/CPU0:router(config-mpls-te)#soft-preemption frr-rewrite	Moves FRR LSP traffic over the backup tunnel, when LSP is soft-preempted.
Step 4	commit	

Enabling Auto-onehop Tunnels to Next-hop Neighbors

Perform these tasks to enable automatic creation of one-hop tunnels over MPLS traffic-engineering enabled interfaces to nexthop neighbors. A router that becomes a next hop neighbor will have a set of one-hop tunnels created automatically.

Before you begin

The **ipv4 unnumbered mpls traffic-eng Loopback Number** configuration must be applied at the global configuration level.

SUMMARY STEPS

1. **configure**
2. **ipv4 unnumbered mpls traffic-eng Loopback *N***
3. **mpls traffic-eng**
4. **auto-tunnel mesh**
5. **tunne-id min *value* max *value***
6. **group *group-id***
7. **onehop**
8. **commit**

DETAILED STEPS

	Command or Action	Purpose
Step 1	configure	
Step 2	ipv4 unnumbered mpls traffic-eng Loopback <i>N</i> Example: RP/0/RP0/CPU0:router(config)#ipv4 unnumbered mpls traffic-eng loopback 0	Configures the globally configured IPv4 address that can be used by the Auto-tunnel backup tunnels.
Step 3	mpls traffic-eng Example: RP/0/RP0/CPU0:router(config)#mpls traffic-eng	Enters the MPLS-TE submodule.
Step 4	auto-tunnel mesh Example: RP/0/RP0/CPU0:router(config-mpls-te)#auto-tunnel mesh	Enters the auto-tunnel mesh configuration submodule.
Step 5	tunne-id min <i>value</i> max <i>value</i> Example: RP/0/0/CPU0:ios(config-te-auto-mesh)# tunnel-id min 4000 max 6000	Specifies the minimum and maximum number of auto-tunnel mesh tunnels that can be created on this router. The range of tunnel ID is from 0 to 65535.
Step 6	group <i>group-id</i> Example: RP/0/RP0/CPU0:router(config-te-auto-mesh)#group 50	Enters the auto-tunnel mesh group configuration submodule and creates a group ID.
Step 7	onehop Example: RP/0/RP0/CPU0:router(config-te-mesh-group)#onehop	Enables automatic creation of one-hop tunnels to all next hop neighbors. The onehop keyword can be applied to as many mesh groups as desired.
Step 8	commit	

Implementing Associated Bidirectional Label Switched Paths

Associated Bidirectional Label Switched Paths are LSP instances where the forward and the reverse direction paths are setup, monitored and protected independently and associated together during signaling. You use a RSVP Association object to bind the two forward and reverse LSPs together to form either a co-routed or non co-routed associated bidirectional TE tunnel.

You can associate a protecting MPLS-TE tunnel with either a working MPLS-TE LSP, protecting MPLS-TE LSP, or both. The working LSP is the primary LSP backed up by the protecting LSP. When a working LSP goes down, the protecting LSP is automatically activated. You can configure a MPLS-TE tunnel to operate without protection as well.

For more information on Associated Bidirectional Co-routed LSPs, see the *Cisco ASR 9000 Series Aggregation Services Router MPLS Configuration Guide, Release 5.2.x*. For information on the commands used for Associated Bidirectional Co-routed LSPs, see the *Cisco ASR 9000 Series Aggregation Services Router MPLS Command Reference, Release 5.2.x*.

Signaling Methods and Object Association for Bidirectional LSPs

This section provides an overview of the association signaling methods for the bidirectional LSPs. Two unidirectional LSPs can be bound to form an associated bidirectional LSP in the following scenarios:

- No unidirectional LSP exists, and both must be established.
- Both unidirectional LSPs exist, but the association must be established.
- One unidirectional LSP exists, but the reverse associated LSP must be established.

Configuration information regarding the LSPs can be provided at one or both endpoints of the associated bidirectional LSP. Depending on the method chosen, there are two models of creating an associated bidirectional LSP; single-sided provisioning, and double-sided provisioning.

- **Single-sided Provisioning:** For the single-sided provisioning, the TE tunnel is configured only on one side. An LSP for this tunnel is initiated by the initiating endpoint with the Association Object inserted in the Path message. The other endpoint then creates the corresponding reverse TE tunnel and signals the reverse LSP in response to this. Currently, there is no support available for configuring single-sided provisioning.
- **Double-sided Provisioning:** For the double-sided provisioning, two unidirectional TE tunnels are configured independently on both sides. The LSPs for the tunnels are signaled with Association Objects inserted in the Path message by both sides to indicate that the two LSPs are to be associated to form a bidirectional LSP.

Consider this topology (an example of associated bidirectional LSP):

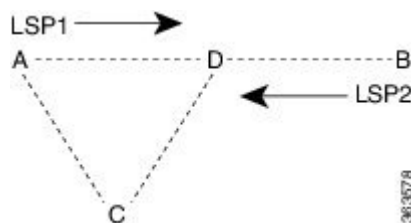

Here, LSP1 from A to B, takes the path A,D,B and LSP2 from B to A takes the path B,D,C,A. These two LSPs, once established and associated, form an associated bidirectional LSP between node A and node B. For the double sided provisioning model, both LSP1 and LSP2 are signaled independently with (Extended) Association Object inserted in the Path message, in which the Association Type indicating double-sided

provisioning. In this case, the two unidirectional LSPs are bound together to form an associated bidirectional LSP based on identical Association Objects in the two LSPs' Path messages.

Association Object: An Association Object is used to bind unidirectional LSPs originating from both endpoints. The Association Object takes the following values:

- **Association Type:** In order to bind two reverse unidirectional LSPs to be an associated bidirectional LSP, the Association Type must be set to indicate either single sided or double sided LSPs.
- **Association ID:** For both single sided and double sided provisioning, Association ID must be set to a value assigned by the node that originates the association for the bidirectional LSP. This is set to the Tunnel ID of the bound LSP or the Tunnel ID of the binding LSP.
- **Association Source:** For double sided provisioning, Association Source must be set to an address selected by the node that originates the association for the bidirectional LSP. For single sided provisioning, Association Source must be set to an address assigned to the node that originates the LSP.
- **Global ID:** This is the global ID for the association global source. This must be set to the global ID of the node that originates the association for the bidirectional LSP.



Note You must provide identical values for the content of the Association Object on either end of the participating LSPs to ensure successful binding of the LSPs.

[Configure Associated Bidirectional Co-routed LSPs, on page 322](#) describes the procedure to create associated bidirectional co-routed LSPs.

Associated Bidirectional Non Co-routed and Co-routed LSPs

This section provides an overview of associated bidirectional non co-routed and co-routed LSPs. Establishment of MPLS TE-LSP involves computation of a path between a head-end node to a tail-end node, signaling along the path, and modification of intermediate nodes along the path. The signaling process ensures bandwidth reservation (if signaled bandwidth is lesser than 0 and programming of forwarding entries.

Path computation is performed by the head-end nodes of both the participating LSPs using Constrained Shortest Path First (CSPF). CSPF is the 'shortest path (measured in terms of cost) that satisfies all relevant LSP TE constraints or attributes, such as required bandwidth, priority and so on.

Associated Bidirectional Non Co-routed LSPs: A non co-routed bidirectional TE LSP follows two different paths, that is, the forward direction LSP path is different than the reverse direction LSP path. Here is an illustration.

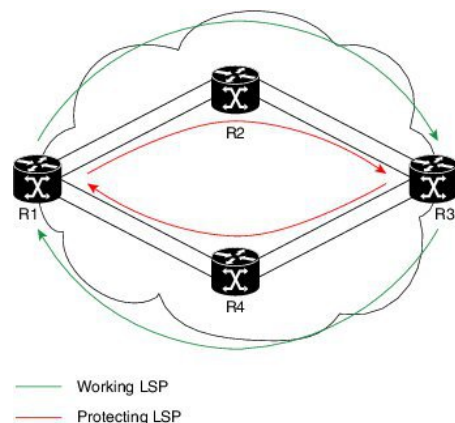

In the above topology:

- The outer paths (in green) are working LSP pairs.
- The inner paths (in red) are protecting LSP pairs.
- Router 1 sets up working LSP to Router 3 and protecting LSP to Router 3 independently.
- Router 3 sets up working LSP to Router 1 and protecting LSP to Router 1 independently.

Non co-routed bidirectional TE LSP is available by default, and no configuration is required.



Note In case of non co-routed LSPs, the head-end nodes relax the constraint on having identical forward and reverse paths. Hence, depending on network state you can have identical forward and reverse paths, though the bidirectional LSP is co-routed.

Associated Bidirectional Co-routed LSPs: A co-routed bidirectional TE LSP denotes a bidirectional tunnel where the forward direction LSP and reverse direction LSP must follow the same path, for example, the same nodes and paths. Here is an illustration.

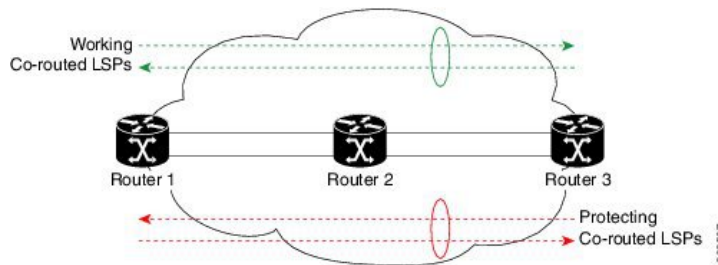

In the above topology:

- Paths at the top of the figure (in green) indicate working co-routed LSP pairs.
- Paths at the bottom of the figure (in red) indicate protecting co-routed LSP pairs.
- Router 1 sets up working LSP to Router 3 (in red) after performing bidirectional CSPF and sends reverse explicit route object (ERO) to Router 3. Node Router 3 uses the received reverse ERO to set up reverse red working LSP to Router 1.
- Router 3 sets up protecting LSP to Router 1 (in green) after performing bidirectional CSPF and sends reverse ERO to Router 1. Node Router 1 uses the received reverse ERO to set up reverse green protecting LSP to Router 3.

[Configure Associated Bidirectional Co-routed LSPs, on page 322](#) describes the procedure to configure an associated bidirectional co-routed LSP.

Configure Associated Bidirectional Co-routed LSPs

A co-routed bidirectional packet LSP is a combination of two LSPs (one in the forward direction and the other in reverse direction) sharing the same path between a pair of ingress and egress nodes. It is established using the extensions to RSVP-TE. This type of LSP can be used to carry any of the standard types of MPLS-based traffic, including Layer 2 VPNs, Layer 2 circuits, and Layer 3 VPNs. You can configure a single BFD session for the bidirectional LSP (that is, you do not need to configure a BFD session for each LSP in each direction). You can also configure a single standby bidirectional LSP to provide a backup for the primary bidirectional LSP.

Before you begin

- You must have symmetric source and destination TE router IDs in order for bidirectional LSPs to be associated.
- Tunnels attributes must be configured identically on both sides of co-routed bidirectional LSP.

SUMMARY STEPS

1. **configure**
2. **interface tunnel-te** *tunnel-id*
3. **bidirectional**
4. **association** {id <0-65535> | **source-address** <IP address>} [**global-id** <0-4294967295>]
5. **association type co-routed**
6. **commit**
7. **show mpls traffic-eng tunnels bidirectional-associated co-routed**

DETAILED STEPS

	Command or Action	Purpose
Step 1	configure	
Step 2	interface tunnel-te <i>tunnel-id</i> Example: RP/0/RSP0/CPU0:router# interface tunnel-te 1	Configures an MPLS-TE tunnel interface.
Step 3	bidirectional Example: RP/0/0/CPU0:router(config-if)# bidirectional	Configure the ingress router for the LSP and include the bidirectional statement to specify that the LSP be established as a bidirectional LSP.
Step 4	association {id <0-65535> source-address <IP address>} [global-id <0-4294967295>] Example: RP/0/0/CPU0:router(config-if-bidir)# association id 1 source-address 11.0.0.1	Set the association ID that uniquely identifies the association of LSPs, which is the tunnel ID of the bound LSP or the tunnel ID of the binding LSP. Also, set the source address to the tunnel sender address of the bound LSP or the tunnel sender address of the binding LSP. Optionally, specify the global ID for association global source. Note Association ID, association source and global ID must be configured identically on both the endpoints.
Step 5	association type co-routed Example: RP/0/0/CPU0:router(config-if-bidir)#association type co-routed	Specify that the LSP be established as a associated co-routed bidirectional LSP.
Step 6	commit	
Step 7	show mpls traffic-eng tunnels bidirectional-associated co-routed Example:	Shows details of an associated co-routed bidirectional LSP.

Command or Action	Purpose
RP/0/0/CPU0:router#show mpls traffic-eng tunnels bidirectional-associated co-routed	

Show output for an associated co-routed bidirectional LSP configuration

This is a sample of the output for the **show mpls traffic-eng tunnels role head** command.

```
RP/0/RSP0/CPU0:router# show mpls traffic-eng tunnels role head

Name: tunnel-tel  Destination: 49.49.49.2
  Signalled-Name: IMC0_t1
  Status:
    Admin:      up Oper:      up Path:  valid Signalling: connected

    path option 1,  type dynamic (Basis for Setup, path weight 20 (reverse 20))
    path option 1,  type dynamic (Basis for Standby, path weight 20 (reverse 20))
    G-PID: 0x0800 (derived from egress interface properties)
    Bandwidth Requested: 0 kbps CT0
    Creation Time: Sun May  4 12:09:56 2014 (03:24:11 ago)
  Config Parameters:
    Bandwidth:      0 kbps (CT0) Priority:  7 7 Affinity: 0x0/0xffff
    Metric Type: TE (default)
    Hop-limit: disabled
    Cost-limit: disabled
    AutoRoute: disabled LockDown: disabled Policy class: not set
    Forward class: 0 (default)
    Forwarding-Adjacency: disabled
    Loadshare:      0 equal loadshares
    Auto-bw: disabled
    Fast Reroute: Disabled, Protection Desired: None
    Path Protection: Enabled
    Association Type: Single Sided Bidirectional LSPs, Co-routed: YES
    Association ID: 100, Source: 49.49.49.2
    Reverse Bandwidth: 0 kbps (CT0), Standby: 0 kbps (CT0)
    BFD Fast Detection: Enabled
    BFD Parameters: Min-interval 100 ms (default), Multiplier 3 (default)
    BFD Bringup Timeout: Interval 60 seconds (default)
    BFD Initial Dampening: 16000 ms (default)
    BFD Maximum Dampening: 600000 ms (default)
    BFD Secondary Dampening: 20000 ms (default)
    Periodic LSP Ping: Interval 120 seconds (default)
    Session Down Action: ACTION_REOPTIMIZE, Reopt Timeout: 300
    BFD Encap Mode: GAL
    Reoptimization after affinity failure: Enabled
    Soft Preemption: Disabled
```

Path Protection

Path protection provides an end-to-end failure recovery mechanism (that is, full path protection) for associated bidirectional MPLS-TE LSPs. Associated bidirectional MPLS-TE LSPs support 1:1 path protection. You can configure the working and protecting LSPs as part of configuring the MPLS-TE tunnel. The working LSP is the primary LSP used to route traffic, while the protecting LSP is a backup for a working LSP. If the working LSP fails, traffic is switched to the protecting LSP until the working LSP is restored, at which time traffic forwarding reverts back to the working LSP.

When FRR is not enabled on a tunnel, and when GAL-BFD and/or Fault OAM is enabled on an associated bidirectional co-routed LSP, path-protection is activated by the FIB running on the line card that hosts the working LSP. The failure on the working LSP can be detected using BFD or Fault OAM.

[Configure Path Protection for Associated Bidirectional LSPs, on page 325](#) provides procedural details.

You can use the **show mpls traffic-eng fast-reroute log** command to confirm whether protection switching has been activated by FIB.

Configure Path Protection for Associated Bidirectional LSPs

SUMMARY STEPS

1. **configure**
2. **interface tunnel-te** *tunnel-id*
3. **ipv4 unnumbered** *type interface-path-id*
4. **bfd** {fast-detect | encap-mode}
5. **destination** *ip-address*
6. **bidirectional**
7. **bidirectional association** {**id** <0-65535> | **source-address** <IP address>} [**global-id** <0-4294967295>]
8. **association type co-routed**
9. **path-protection**
10. **path-option** *preference - priority* {**dynamic** | **explicit**}
11. **commit**

DETAILED STEPS

	Command or Action	Purpose
Step 1	configure	
Step 2	interface tunnel-te <i>tunnel-id</i> Example: RP/0/RSP0/CPU0:router# interface tunnel-te 1	Configures an MPLS-TE tunnel interface.
Step 3	ipv4 unnumbered <i>type interface-path-id</i> Example: RP/0/RP0/CPU0:router (config-if)# ipv4 unnumbered Loopback0	Assigns a source address so that forwarding can be performed on the new tunnel. Loopback is commonly used as the interface type.
Step 4	bfd {fast-detect encap-mode} Example: RP/0/RSP0/CPU0:IMC0 (config-if)#bfd RP/0/RSP0/CPU0:IMC0 (config-if-tunte-bfd)#fast-detect RP/0/RSP0/CPU0:IMC0 (config-if-tunte-bfd)#encap-mode gal	Specify if you want BFD enabled for the LSP over a Generic Associated Channel (G-ACh) or over a IP channel. IP channel is the default.
Step 5	destination <i>ip-address</i> Example:	Assigns a destination address on the new tunnel.

	Command or Action	Purpose
	RP/0/RP0/CPU0:router(config-if)# destination 49.49.49.2	The destination address is the remote node's MPLS-TE router ID.
Step 6	bidirectional Example: Router(config-if)# bidirectional	Configure the ingress router for the LSP and include the bidirectional statement to specify that the LSP be established as a bidirectional LSP.
Step 7	bidirectional association {id <0-65535> source-address <IP address>} [global-id <0-4294967295>} Example: Router(config-if-bidir)# association id 1 source-address 11.0.0.1	Set the association ID that uniquely identifies the association of LSPs, which is the tunnel ID of the bound LSP or the tunnel ID of the binding LSP. Also, set the source address to the tunnel sender address of the bound LSP or the tunnel sender address of the binding LSP. Also, set the ID for associating the global source. Note Association ID, association source and optional global-id must be configured identically on both the endpoints.
Step 8	association type co-routed Example: Router(config-if-bidir)#association type co-routed	Specify that the LSP be established as a associated co-routed bidirectional LSP.
Step 9	path-protection Example: RP/0/RSP0/CPU0:IMC0(config-if-bidir-co-routed)#path-protection	Enable path protection.
Step 10	path-option preference - priority {dynamic explicit} Example: RP/0/RP0/CPU0:router(config-if)# path-option 1 dynamic	Sets the path option and assigns the path-option ID. Both sides of the co-routed bidirectional LSPs must use dynamic or matching co-routed strict-hop explicit path-option.
Step 11	commit	

Example

Here is a sample configuration with path protection defined for the Associated Bidirectional LSP.

```
RP/0/RSP0/CPU0:IMC0#config
RP/0/RSP0/CPU0:IMC0(config)#interface tunnel-te 1
RP/0/RSP0/CPU0:IMC0(config-if)#ipv4 unnumbered loopback0
RP/0/RSP0/CPU0:IMC0(config-if)#destination 49.49.49.2
RP/0/RSP0/CPU0:IMC0(config-if)#bidirectional
RP/0/RSP0/CPU0:IMC0(config-if-bidir)#association id 100 source-address 49.49.49.2
RP/0/RSP0/CPU0:IMC0(config-if-bidir)#association type co-routed
RP/0/RSP0/CPU0:IMC0(config-if-bidir-co-routed)#path-protection
RP/0/RSP0/CPU0:IMC0(config-if)#path-option 1 dynamic
RP/0/RSP0/CPU0:IMC0(config-if)#commit
```

OAM Support for Associated Bidirectional LSPs

You can opt to configure operations, administration and management (OAM) support for Associated Bidirectional LSPs in the following areas:

- **Continuity check:** You can configure bidirectional forwarding detection (BFD) over a Generic Associated Channel (G-ACh) with hardware assist. This allows for BFD Hello packets to be generated and processed in hardware making smaller Hello intervals such as 3.3 ms feasible. For more information on BFD and BFD hardware offload see *Implementing BFD* module in the *Cisco ASR 9000 Series Aggregation Services Router Routing Configuration Guide*.
- **Fault notification:** You can run Fault OAM over associated bidirectional co-routed LSPs to convey fault notification from mid-point to end-point of the LSP. The following fault OAM messages are supported:

- **Link Down Indication (LDI):** generated when an interface goes down (for example, to fiber-cut) at mid-point.
- **Lock Report (LKR):** generated when an interface is shutdown at mid-point.

You can configure fault OAM to generate OAM message at mid-point or enable protection switching due to fault OAM at end-point. [Generate Fault OAM Messages at Mid-point, on page 327](#) and [Generate Fault OAM Messages at End-point, on page 328](#) provides procedural details.

- **Fault diagnostics:** You can use the ping and traceroute features as a means to check connectivity and isolate failure points for both co-routed and non-co-routed bidirectional TE tunnels. *MPLS Network Management with MPLS LSP Ping and MPLS SP Traceroute* provides details.

Generate Fault OAM Messages at Mid-point

To program all bi-directional LSPs to generate fault OAM message at mid-point use the following steps:

SUMMARY STEPS

1. **configure**
2. **mpls traffic-eng**
3. **fault-oam**
4. **commit**

DETAILED STEPS

	Command or Action	Purpose
Step 1	configure	
Step 2	mpls traffic-eng Example: RP/0/RSP0/CPU0:IMO(config)# mpls traffic-eng	Configures an MPLS-TE tunnel interface.
Step 3	fault-oam Example: RP/0/RSP0/CPU0:IMC0(config-mpls-te)#fault-oam	Enable fault OAM for an associated bidirectional LSP.
Step 4	commit	

Generate Fault OAM Messages at End-point

In order to enable protection switching due to fault OAM at end-point use the following steps:

SUMMARY STEPS

1. **configure**
2. **interface tunnel-te *tunnel-id***
3. **bidirectional association type co-routed fault-oam**
4. **commit**

DETAILED STEPS

	Command or Action	Purpose
Step 1	configure	
Step 2	interface tunnel-te <i>tunnel-id</i> Example: RP/0/RSP0/CPU0:IMC0(config)#interface tunnel-te 1	Configures an MPLS-TE tunnel interface.
Step 3	bidirectional association type co-routed fault-oam Example: RP/0/RSP0/CPU0:IMC0(config-if)#bidirectional association type co-routed fault-oam	Enable fault OAM for an associated co-routed bidirectional LSP.
Step 4	commit	

Pseudowire Call Admission Control

You can use the Pseudowire Call Admission Control (PW CAC) process to check for bandwidth constraints and ensure that once the path is signaled, the links (pseudowires) participating in the bidirectional LSP association have the required bandwidth. Only pseudowires with sufficient bandwidth are admitted in the bidirectional LSP association process. *Configure Pseudowire Bandwidth* in the *Cisco ASR 9000 Series Aggregation Services Router L2VPN and Ethernet Services Configuration Guide* provides procedural details.

Configure Named Tunnel and Named Path Option

Perform this task to uniquely name TE (Traffic Engineering) tunnels in a network and their path options using STRING names.

SUMMARY STEPS

1. **configure**
2. **mpls traffic-eng**
3. **named-tunnels**
4. **tunnel-te *tunnel-name***
5. **destination *address***
6. **path-option *path-name***
7. **preference *value***

8. **computation** { **explicit** *explicit-path-name* | **dynamic** }
9. **root**
10. **ipv4 unnumbered mpls traffic-engloopback** *loopback-number*
11. **commit**

DETAILED STEPS

	Command or Action	Purpose
Step 1	configure Example: RP/0/RP0/CPU0:router# <code>configure</code>	Enters global configuration mode.
Step 2	mpls traffic-eng Example: RP/0/RP0/CPU0:router (config)# <code>mpls traffic-eng</code>	Enters MPLS-TE configuration mode.
Step 3	named-tunnels Example: RP/0/RP0/CPU0:router (config-mpls-te)# named-tunnels	Enters the named tunnels configuration sub-mode.
Step 4	tunnel-te <i>tunnel-name</i> Example: RP/0/RP0/CPU0:router (config-mpls-te-named-tunnels)# tunnel-te FROM-NY-TO-LA	Specifies the TE tunnel name using STRING characters. The STRING limit is 59.
Step 5	destination <i>address</i> Example: RP/0/RP0/CPU0:router (config-mpls-te-tunnel-name)# destination 192.168.0.1	Assigns a destination address to the new tunnel.
Step 6	path-option <i>path-name</i> Example: RP/0/RP0/CPU0:router (config-mpls-te-tunnel-name)# path-option VIA_DC	Specifies the path option name.
Step 7	preference <i>value</i> Example: RP/0/RP0/CPU0:router (config-path-option-name)#	Specifies the path option preference. The range is from 1 to 4294967295. Lower values have a higher preference.

	Command or Action	Purpose
	<code>preference 10</code>	
Step 8	computation { explicit <i>explicit-path-name</i> dynamic } Example: <pre>RP/0/RP0/CPU0:router(config-path-option-name)# computation explicit MY_EXPLICIT_PATH</pre>	Sets the path computation method as explicit (Computation is based on the preconfigured path). Note You can use the <i>dynamic</i> option as the path computation method, where the path is dynamically calculated.
Step 9	<code>root</code>	
Step 10	ipv4 unnumbered mpls traffic-eng loopback <i>loopback-number</i> Example: <pre>RP/0/RP0/CPU0:router(config)# ipv4 unnumbered mpls traffic-eng loopback 0</pre>	Enables IPv4 processing without an explicit address.
Step 11	<code>commit</code>	

Verify Named Tunnel and Named Path Option Configuration: Example

Use the `show mpls traffic-eng tunnels name tunnel-name` command to verify the named tunnel configuration. The following example shows sample output for this command:

```
show mpls traffic-eng tunnels name FROM-NY-TO-LA

Name: FROM-NY-TO-LA Destination: 192.168.0.1 Ifhandle:0x580
Tunnel-ID: 32769
Status:
  Admin:      up Oper: down Path: valid Signalling: connected

  path option VIA_DC, preference 10, type explicit MY_EXPLICIT_PATH

  G-PID: 0x0800 (derived from egress interface properties)
  Bandwidth Requested: 0 kbps CT0
  Creation Time: Fri Jun 10 15:32:00 2016 (00:36:10 ago)
Config Parameters:
  Bandwidth:      0 kbps (CT0) Priority: 7 7 Affinity: 0x0/0xffff
  Metric Type: TE (global)
  Path Selection:
    Tiebreaker: Min-fill (default)
  Hop-limit: disabled
  Cost-limit: disabled
  Path-invalidation timeout: 10000 msec (default), Action: Tear (default)
  AutoRoute: disabled LockDown: disabled Policy class: not set
  Forward class: 0 (default)
  Forwarding-Adjacency: disabled
  Autoroute Destinations: 0
  Loadshare:      0 equal loadshares
  Auto-bw: disabled
  Fast Reroute: Disabled, Protection Desired: None
  Path Protection: Not Enabled
  BFD Fast Detection: Disabled
```

```

Reoptimization after affinity failure: Enabled
Soft Preemption: Disabled
Displayed 1 (of 3) heads, 0 (of 0) midpoints, 0 (of 0) tails
Displayed 0 up, 1 down, 0 recovering, 0 recovered head

```

Configuration Examples for Cisco MPLS-TE

These configuration examples are used for MPLS-TE:

Configure Fast Reroute and SONET APS: Example

When SONET Automatic Protection Switching (APS) is configured on a router, it does not offer protection for tunnels; because of this limitation, fast reroute (FRR) still remains the protection mechanism for MPLS-TE.

When APS is configured in a SONET core network, an alarm might be generated toward a router downstream. If this router is configured with FRR, the hold-off timer must be configured at the SONET level to prevent FRR from being triggered while the core network is performing a restoration. Enter the following commands to configure the delay:

```

RP/0/RP0/CPU0:router(config)# controller sonet 0/6/0/0 delay trigger line 250
RP/0/RP0/CPU0:router(config)# controller sonet 0/6/0/0 path delay trigger 300

```

Build MPLS-TE Topology and Tunnels: Example

The following examples show how to build an OSPF and IS-IS topology:

```

(OSPF)
...
configure
  mpls traffic-eng
  interface pos 0/6/0/0
  router id loopback 0
  router ospf 1
  router-id 192.168.25.66
  area 0
  interface pos 0/6/0/0
  interface loopback 0
  mpls traffic-eng router-id 192.168.70.1
  mpls traffic-eng area 0
  rsvp
  interface pos 0/6/0/0
  bandwidth 100
  commit
show mpls traffic-eng topology
show mpls traffic-eng link-management advertisement
!
(IS-IS)
...
configure
  mpls traffic-eng
  interface pos 0/6/0/0
  router id loopback 0
  router isis lab
  address-family ipv4 unicast
  mpls traffic-eng level 2

```

```

mpls traffic-eng router-id 192.168.70.2
!
interface POS0/0/0/0
address-family ipv4 unicast
!

```

The following example shows how to configure tunnel interfaces:

```

interface tunnel-te1
destination 192.168.92.125
ipv4 unnumbered loopback 0
path-option 1 dynamic
bandwidth 100
commit
show mpls traffic-eng tunnels
show ipv4 interface brief
show mpls traffic-eng link-management admission-control
!
interface tunnel-te1
autoroute announce
route ipv4 192.168.12.52/32 tunnel-te1
commit
ping 192.168.12.52
show mpls traffic autoroute
!
interface tunnel-te1
fast-reroute
mpls traffic-eng interface pos 0/6/0/0
backup-path tunnel-te 2
interface tunnel-te2
backup-bw global-pool 5000
ipv4 unnumbered loopback 0
path-option 1 explicit name backup-path
destination 192.168.92.125
commit
show mpls traffic-eng tunnels backup
show mpls traffic-eng fast-reroute database
!
rsvp
interface pos 0/6/0/0
bandwidth 100 150 sub-pool 50
interface tunnel-te1
bandwidth sub-pool 10
commit

```

Related Topics

[Building MPLS-TE Topology](#), on page 220

[Creating an MPLS-TE Tunnel](#), on page 222

[How MPLS-TE Works](#), on page 172

Configure IETF DS-TE Tunnels: Example

The following example shows how to configure DS-TE:

```

rsvp
interface pos 0/6/0/0
bandwidth rdm 100 150 bc1 50

```



```

mpls traffic-eng
ds-te mode ietf
interface tunnel-te 1
bandwidth 10 class-type 1
commit

configure
 rsvp interface 0/6/0/0
bandwidth mam max-reservable-bw 400 bc0 300 bc1 200
mpls traffic-eng
ds-te mode ietf
ds-te model mam
interface tunnel-te 1 bandwidth 10 class-type 1
commit

rsvp
interface pos 0/6/0/0
bandwidth rdm percentage bc0 100 bc1 50
bandwidth 10 class-type 1
commit

configure
 rsvp interface 0/6/0/0
bandwidth mam percentage bc0 100 bc1 50
ds-te mode ietf
ds-te model mam
bandwidth 10 class-type 1
commit

```

Related Topics

[Configuring a Prestandard DS-TE Tunnel](#), on page 235

[Prestandard DS-TE Mode](#), on page 177

Configure MPLS-TE and Fast-Reroute on OSPF: Example

CSPF areas are configured on a per-path-option basis. The following example shows how to use the traffic-engineering tunnels (tunnel-te) interface and the active path for the MPLS-TE tunnel:

```

configure
interface tunnel-te 0
 path-option 1 explicit id 6 ospf 126 area 0
 path-option 2 explicit name 234 ospf 3 area 7 verbatim
 path-option 3 dynamic isis mtbf level 1 lockdown
commit

```

Related Topics

[Configuring MPLS -TE and Fast-Reroute on OSPF](#), on page 241

Configure the Ignore IS-IS Overload Bit Setting in MPLS-TE: Example

This example shows how to configure the IS-IS overload bit setting in MPLS-TE:

This figure illustrates the IS-IS overload bit scenario:

Figure 24: IS-IS overload bit

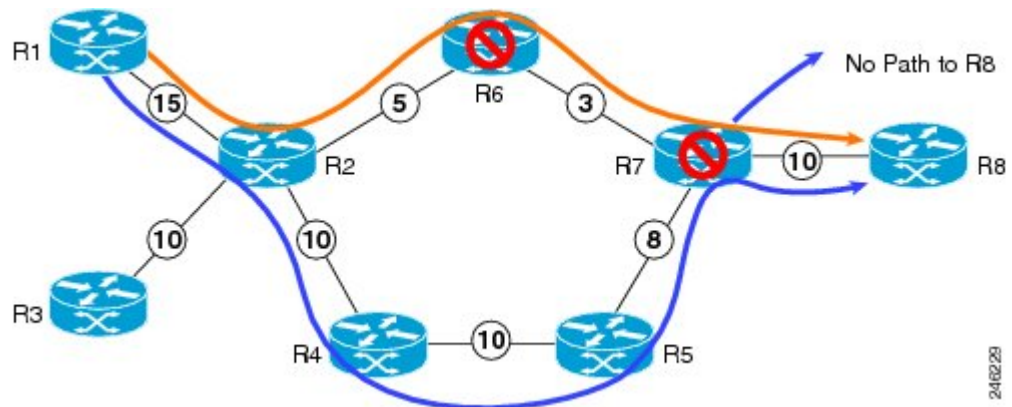

Consider a MPLS TE topology in which usage of nodes that indicated an overload situation was restricted. In this topology, the router R7 exhibits overload situation and hence this node can not be used during TE CSPF. To overcome this limitation, the IS-IS overload bit avoidance (OLA) feature was introduced. This feature allows network administrators to prevent RSVP-TE label switched paths (LSPs) from being disabled when a router in that path has its Intermediate System-to-Intermediate System (IS-IS) overload bit set.

The IS-IS overload bit avoidance feature is activated at router R1 using this command:

```
mpls traffic-eng path-selection ignore overload
```

```
configure
mpls traffic-eng
path-selection ignore overload
commit
```

Related Topics

[Configuring the Ignore Integrated IS-IS Overload Bit Setting in MPLS-TE](#), on page 242

[Ignore Intermediate System-to-Intermediate System Overload Bit Setting in MPLS-TE](#), on page 182

Configure GMPLS: Example

This example shows how to set up headend and tailend routers with bidirectional optical unnumbered tunnels using numbered TE links:

Headend Router

```
router ospf roswell
router-id 11.11.11.11
nsf cisco
area 23
!
area 51
interface Loopback 0
!
interface MgmtEth0/0/CPU0/1
!
```

```

        interface POS0/4/0/1
        !
        !
        mpls traffic-eng router-id Loopback 0
        mpls traffic-eng area 51
        !

    rsvp
    interface POS0/2/0/3
        bandwidth 2000
    !
    !
    interface tunnel-gte 1
    ipv4 unnumbered Loopback 0
    switching transit fsc encoding
sonetsdh
    switching endpoint pscl encoding packet
    priority 3 3
    signalled-bandwidth 500
    destination 55.55.55.55
    path-option 1 dynamic
    !

    mpls traffic-eng
    interface POS0/2/0/3
        flooding-igp ospf roswell area 51
        switching key 1
        encoding packet
        capability pscl
    !
    switching link
    encoding
sonetsdh
    capability fsc
    !
    lmp data-link adjacency
    neighbor gmpls5
    remote te-link-id ipv4 10.0.0.5
    remote interface-id unnum 12
    remote switching-capability pscl
    !
    !
    lmp neighbor gmpls5
    ipcc routed
    remote node-id 55.55.55.55
    !
    !

```

Tailend Router

```

router ospf roswell
router-id 55.55.55.55
nsf cisco
area 23
!
area 51
interface Loopback 0
!
interface MgmtEth0/0/CPU0/1
!
interface POS0/4/0/2
!

```

```

!
mpls traffic-eng router-id Loopback 0
mpls traffic-eng area 51
!

mpls traffic-eng
interface POS0/2/0/3
  flooding-igp ospf roswell area 51
  switching key 1
  encoding packet
  capability psc1
  !
  switching link
  encoding
sonetsdh
  capability fsc
  !
  lmp data-link adjacency
  neighbor gmpls1
  remote te-link-id ipv4 10.0.0.1
  remote interface-id unnum 12
  remote switching-capability psc1
  !
  !
  lmp neighbor gmpls1
  ipcc routed
  remote node-id 11.11.11.11
  !
!
rsvp
interface POS0/2/0/3
  bandwidth 2000
  !
!
interface tunnel-gte 1
  ipv4 unnumbered Loopback 0
  passive
  match identifier head_router_hostname_t1
  destination 11.11.11.11
  !
!

```

Configure Flexible Name-based Tunnel Constraints: Example

The following configuration shows the three-step process used to configure flexible name-based tunnel constraints.

```

R2
line console
  exec-timeout 0 0
  width 250
  !
logging console debugging
explicit-path name mypath
  index 1 next-address loose ipv4 unicast 3.3.3.3 !
explicit-path name ex_path1
  index 10 next-address loose ipv4 unicast 2.2.2.2 index 20 next-address loose ipv4 unicast
3.3.3.3 !
interface Loopback0
  ipv4 address 22.22.22.22 255.255.255.255 !
interface tunnel-tel
  ipv4 unnumbered Loopback0

```

```
signalled-bandwidth 1000000
destination 3.3.3.3
affinity include green
affinity include yellow
affinity exclude indigo
affinity exclude orange
path-option 1 dynamic
!
router isis 1
is-type level-1
net 47.0001.0000.0000.0001.00
nsf cisco
address-family ipv4 unicast
metric-style wide
mpls traffic-eng level-1
mpls traffic-eng router-id 192.168.70.1
!
interface Loopback0
passive
address-family ipv4 unicast
!
!
interface GigabitEthernet0/1/0/0
address-family ipv4 unicast
!
!
interface GigabitEthernet0/1/0/1
address-family ipv4 unicast
!
!
interface GigabitEthernet0/1/0/2
address-family ipv4 unicast
!
!
interface GigabitEthernet0/1/0/3
address-family ipv4 unicast
!
!
!
rsvp
interface GigabitEthernet0/1/0/0
bandwidth 1000000 1000000
!
interface GigabitEthernet0/1/0/1
bandwidth 1000000 1000000
!
interface GigabitEthernet0/1/0/2
bandwidth 1000000 1000000
!
interface GigabitEthernet0/1/0/3
bandwidth 1000000 1000000
!
!
mpls traffic-eng
interface GigabitEthernet0/1/0/0
attribute-names red purple
!
interface GigabitEthernet0/1/0/1
attribute-names red orange
!
interface GigabitEthernet0/1/0/2
attribute-names green purple
!
interface GigabitEthernet0/1/0/3
```

```

    attribute-names green orange
    !
    affinity-map red 1
    affinity-map blue 2
    affinity-map teal 80
    affinity-map green 4
    affinity-map indigo 40
    affinity-map orange 20
    affinity-map purple 10
    affinity-map yellow 8
    !

```

Related Topics

- [Assigning Color Names to Numeric Values](#), on page 264
- [Associating Affinity-Names with TE Links](#), on page 265
- [Associating Affinity Constraints for TE Tunnels](#), on page 266
- [Flexible Name-based Tunnel Constraints](#), on page 185

Configure an Interarea Tunnel: Example

The following configuration example shows how to configure a traffic engineering interarea tunnel. Router R1 is the headend for tunnel1, and router R2 (20.0.0.20) is the tailend. Tunnel1 is configured with a path option that is loosely routed through Ra and Rb.



Note Specifying the tunnel tailend in the loosely routed path is optional.

```

configure
  interface Tunnel-te1
    ipv4 unnumbered Loopback0
    destination 192.168.20.20
    signalled-bandwidth 300
    path-option 1 explicit name path-tunnell

  explicit-path name path-tunnell
    index 10 next-address loose ipv4 unicast 192.168.40.40
    index 20 next-address loose ipv4 unicast 192.168.60.60
    index 30 next-address loose ipv4 unicast 192.168.20.20

```

The following configuration example shows how to configure loose-path retry period (range is 30 to 600 seconds) on headend router.

```

config
  mpls traffic-eng
    timers loose-path retry-period 120

```

The following configuration example shows the global configuration for loose hop expansion affinity or metric on ABR.

```

config
  mpls traffic-eng path-selection loose-expansion affinity 0xff
  mpls traffic-eng path-selection loose-expansion metric te class-type 5

```

Configure Forwarding Adjacency: Example

The following configuration example shows how to configure an MPLS-TE forwarding adjacency on tunnel-te 68 with a holdtime value of 60:

```
configure
interface tunnel-te 68
forwarding-adjacency holdtime 60
commit
```

Related Topics

[Configuring MPLS-TE Forwarding Adjacency](#), on page 270

[MPLS-TE Forwarding Adjacency Benefits](#), on page 189

Configure Unequal Load Balancing: Example

The following configuration example illustrates unequal load balancing configuration:

```
configure
interface tunnel-te0
destination 1.1.1.1
path-option 1 dynamic
ipv4 unnumbered Loopback0
interface tunnel-te1
destination 1.1.1.1
path-option 1 dynamic
ipv4 unnumbered Loopback0
load-share 5
interface tunnel-te2
destination 1.1.1.1
path-option 1 dynamic
ipv4 unnumbered Loopback0
signalled-bandwidth 5
interface tunnel-te10
destination 2.2.2.2
path-option 1 dynamic
ipv4 unnumbered Loopback0
signalled-bandwidth 10
interface tunnel-te11
destination 2.2.2.2
path-option 1 dynamic
ipv4 unnumbered Loopback0
signalled-bandwidth 10
interface tunnel-te12
destination 2.2.2.2
path-option 1 dynamic
ipv4 unnumbered Loopback0
signalled-bandwidth 20
interface tunnel-te20
destination 3.3.3.3
path-option 1 dynamic
ipv4 unnumbered Loopback0
signalled-bandwidth 10
interface tunnel-te21
destination 3.3.3.3
path-option 1 dynamic
ipv4 unnumbered Loopback0
```

```

        signalled-bandwidth 10
        load-share 20
    interface tunnel-te30
        destination 4.4.4.4
        path-option 1 dynamic
        ipv4 unnumbered Loopback0
        signalled-bandwidth 10
        load-share 5
    interface tunnel-te31
        destination 4.4.4.4
        path-option 1 dynamic
        ipv4 unnumbered Loopback0
        signalled-bandwidth 10
        load-share 20
    mpls traffic-eng
        load-share unequal
end

```

Related Topics

[Setting Unequal Load Balancing Parameters](#), on page 271

[Enabling Unequal Load Balancing](#), on page 272

[Unequal Load Balancing](#), on page 189

Configure PCE: Example

The following configuration example illustrates a PCE configuration:

```

configure
mpls traffic-eng
    interface pos 0/6/0/0
    pce address ipv4 192.168.25.66
    router id loopback 0
    router ospf 1
    router-id 192.168.25.66
    area 0
    interface pos 0/6/0/0
    interface loopback 0
    mpls traffic-eng router-id 192.168.70.1
    mpls traffic-eng area 0
    rsvp
    interface pos 0/6/0/0
    bandwidth 100
commit

```

The following configuration example illustrates PCC configuration:

```

configure
    interface tunnel-te 10
    ipv4 unnumbered loopback 0
    destination 1.2.3.4
    path-option 1 dynamic pce
    mpls traffic-eng
    interface pos 0/6/0/0
    router id loopback 0
    router ospf 1
    router-id 192.168.25.66

```



```
area 0
interface pos 0/6/0/0
interface loopback 0
mpls traffic-eng router-id 192.168.70.1
mpls traffic-eng area 0
rsvp
interface pos 0/6/0/0
bandwidth 100
commit
```

Related Topics

- [Configuring a Path Computation Client](#), on page 273
- [Configuring a Path Computation Element Address](#), on page 274
- [Configuring PCE Parameters](#), on page 275
- [Path Computation Element](#), on page 190

Configure Policy-based Tunnel Selection: Example

The following configuration example illustrates a PBTS configuration:

```
configure
interface tunnel-te0
ipv4 unnumbered Loopback3
signalled-bandwidth 50000
autoroute announce
destination 1.5.177.2
policy-class 2
path-option 1 dynamic
```

Configure Tunnels for Path Protection: Example

The path protection feature is configured on only the source router. The dynamic path option is a prerequisite to configure a path protection.

```
interface tunnel-te150
ipv4 unnumbered Loopback150
autoroute announce
destination 151.151.151.151
affinity 11 mask 11
path-protection
path-option 2 explicit name p2mp3-p2mp4-p2mp5_1
path-option 10 dynamic
```

Related Topics

- [Path Protection](#), on page 193
- [Pre-requisites for Path Protection](#), on page 193
- [Restrictions for Path Protection](#), on page 194
- [Restrictions for Explicit Path Protection](#), on page 194

Configure Tunnels for Explicit Path Protection: Example

The path protection feature is configured on only the source router. The **protected-by** keyword configures path protection for an explicit path that is protected by another explicit path.

```
interface tunnel-te150
  ipv4 unnumbered Loopback150
  autoroute announce
  destination 151.151.151.151
  affinity 11 mask 11
  path-protection
  path-option 2 explicit name p2mp3-p2mp4-p2mp5_1 protected-by 10
  path-option 10 explicit
```

Configure Tunnels for Co-existence of Path Protection with Fast Reroute: Example

The path protection feature is configured on only the source router. The dynamic path option is a prerequisite to configure a path protection.

```
interface tunnel-te1
  fast-reroute
  ipv4 unnumbered Loopback150
  autoroute announce
  destination 151.151.151.151
  affinity 11 mask 11
  path-protection
  path-option 2 explicit name p2mp3-p2mp4-p2mp5_1
  path-option 10 dynamic
```

Configure Automatic Bandwidth: Example

The following configuration example illustrates an automatic bandwidth configuration:

```
configure
  interface tunnel-te6
    auto-bw
    bw-limit min 10000 max 500000
    overflow threshold 50 min 1000 limit 3
    adjustment-threshold 20 min 1000
    application 180
```

Related Topics

- [Configuring the Collection Frequency](#), on page 279
- [Configuring the Automatic Bandwidth Functions](#), on page 280
- [MPLS-TE Automatic Bandwidth Overview](#), on page 195

Configure the MPLS-TE Shared Risk Link Groups: Example

The following configuration example shows how to specify the SRLG value of each link that has a shared risk with another link:

```

config t
srlg
  interface POS0/4/0/0
    value 10
    value 11
  |
  interface POS0/4/0/1
    value 10
  |

```

The following example shows the SRLG values configured on a specific link.

```

RP/0/RP0/CPU0:router# show mpls traffic-eng topology brief
My_System_id: 100.0.0.2 (OSPF 0 area 0)
My_System_id: 0000.0000.0002.00 (IS-IS 1 level-1)
My_System_id: 0000.0000.0002.00 (IS-IS 1 level-2)
My_BC_Model_Type: RDM

Signalling error holddown: 10 sec Global Link Generation 389225

IGP Id: 0000.0000.0002.00, MPLS TE Id: 100.0.0.2 Router Node (IS-IS 1 level-1)
IGP Id: 0000.0000.0002.00, MPLS TE Id: 100.0.0.2 Router Node (IS-IS 1 level-2)

Link[1]:Broadcast, DR:0000.0000.0002.07, Nbr Node Id:21, gen:389193
  Frag Id:0, Intf Address:51.2.3.2, Intf Id:0
  Nbr Intf Address:51.2.3.2, Nbr Intf Id:0
  TE Metric:10, IGP Metric:10, Attribute Flags:0x0
  Attribute Names:
  SRLGs: 1, 4, 5
  Switching Capability:, Encoding:
  BC Model ID:RDM
  Physical BW:1000000 (kbps), Max Reservable BW Global:10000 (kbps)
  Max Reservable BW Sub:10000 (kbps)

```

The following example shows the configured tunnels and associated SRLG values.

```

RP/0/RP0/CPU0:router# show mpls traffic-eng tunnels

<snip>
Signalling Summary:
  LSP Tunnels Process: running
  RSVP Process: running
  Forwarding: enabled
  Periodic reoptimization: every 3600 seconds, next in 1363 seconds
  Periodic FRR Promotion: every 300 seconds, next in 181 seconds
  Auto-bw enabled tunnels: 0 (disabled)

Name: tunnel-te1 Destination: 100.0.0.3
Status:
  Admin: up Oper: up Path: valid Signalling: recovered

  path option 1, type explicit path123 (Basis for Setup, path weight 2)
  OSPF 0 area 0
  G-PID: 0x0800 (derived from egress interface properties)
  SRLGs excluded: 2,3,4,5
  6,7,8,9
  Bandwidth Requested: 0 kbps CT0

```

<snip>

The following example shows all the interfaces associated with SRLG.

```
RP/0/RP0/CPU0:router# show mpls traffic-eng topo srlg
My_System_id: 100.0.0.5 (OSPF 0 area 0)
My_System_id: 0000.0000.0005.00 (IS-IS 1 level-2)
My_System_id: 0000.0000.0005.00 (IS-IS ISIS-instance-123 level-2)
```

SRLG	Interface Addr	TE Router ID	IGP Area ID
10	50.4.5.5	100.0.0.5	IS-IS ISIS-instance-123 level-2
11	50.2.3.3	100.0.0.3	IS-IS 1 level-2
12	50.2.3.3	100.0.0.3	IS-IS 1 level-2
30	50.4.5.5	100.0.0.5	IS-IS ISIS-instance-123 level-2
77	50.4.5.5	100.0.0.5	IS-IS ISIS-instance-123 level-2
88	50.4.5.5	100.0.0.5	IS-IS ISIS-instance-123 level-2
1500	50.4.5.5	100.0.0.5	IS-IS ISIS-instance-123 level-2
10000000	50.4.5.5	100.0.0.5	IS-IS ISIS-instance-123 level-2
4294967290	50.4.5.5	100.0.0.5	IS-IS ISIS-instance-123 level-2
4294967295	50.4.5.5	100.0.0.5	IS-IS ISIS-instance-123 level-2

The following example shows the NHOP and NNHOP backup tunnels with excluded SRLG values.

```
RP/0/RP0/CPU0:router# show mpls traffic-eng topology path dest 100.0.0.5 exclude-srlg ipaddr

Path Setup to 100.0.0.2:
bw 0 (CT0), min_bw 0, metric: 30
setup_pri 7, hold_pri 7
affinity_bits 0x0, affinity_mask 0xffff
Exclude SRLG Intf Addr : 50.4.5.5
SRLGs Excluded : 10, 30, 1500, 10000000, 4294967290, 4294967295
Hop0:50.5.1.5
Hop1:50.5.1.1
Hop2:50.1.3.1
Hop3:50.1.3.3
Hop4:50.2.3.3
Hop5:50.2.3.2
Hop6:100.0.0.2
```

The following example shows an extract of explicit-path set to protect a specific interface.

```
RP/0/RP0/CPU0:router#sh mpls traffic-eng topology path dest 10.0.0.5 explicit-path name
name

Path Setup to 100.0.0.5:
bw 0 (CT0), min_bw 9999, metric: 2
setup_pri 7, hold_pri 7
affinity_bits 0x0, affinity_mask 0xffff
SRLGs Excluded: 10, 30, 77, 88, 1500, 10000000
                4294967290, 4294967295

Hop0:50.3.4.3
Hop1:50.3.4.4
Hop2:50.4.5.4
Hop3:50.4.5.5
```

Hop4:100.0.0.5

Related Topics

- [Configuring the SRLG Values of Each Link that has a Shared Risk with Another Link](#), on page 283
- [Creating an Explicit Path With Exclude SRLG](#), on page 284
- [Using Explicit Path With Exclude SRLG](#), on page 285
- [Creating a Link Protection on Backup Tunnel with SRLG Constraint](#), on page 287
- [Creating a Node Protection on Backup Tunnel with SRLG Constraint](#), on page 290
- [MPLS Traffic Engineering Shared Risk Link Groups](#), on page 202
- [Explicit Path](#), on page 203
- [Fast ReRoute with SRLG Constraints](#), on page 203
- [Importance of Protection](#), on page 205
- [Delivery of Packets During a Failure](#), on page 206
- [Multiple Backup Tunnels Protecting the Same Interface](#), on page 206
- [SRLG Limitations](#), on page 206
- [MPLS TE SRLG Scale Enhancements](#), on page 207

Configure the MPLS-TE Auto-Tunnel Backup: Example

The following example shows the auto-tunnel backup configuration for core or edge routers.

```
RP/0/RP0/CPU0:router(config)#
mpls traffic-eng
  auto-tunnel backup
    tunnel-id min 60000 max 61000

  interface pos 0/1/0/0
    auto-tunnel backup
      attribute-set ab
```

The following example shows the protection (NNHOP and SRLG) that was set on the auto-tunnel backup.

```
RP/0/RP0/CPU0:router# show mpls traffic-eng tunnels 1
Signalling Summary:
  LSP Tunnels Process:  running
  RSVP Process:        running
  Forwarding:          enabled
  Periodic reoptimization: every 3600 seconds, next in 2524 seconds
  Periodic FRR Promotion: every 300 seconds, next in 49 seconds
  Auto-bw enabled tunnels: 1

Name: tunnel-te1 Destination: 200.0.0.3 (auto backup)
Status:
  Admin:  up Oper:  up Path:  valid Signalling: connected

  path option 10, type explicit (autob_nnhop_srlg_tunnel1) (Basis for Setup, path weight
11)
  path option 20, type explicit (autob_nnhop_tunnel1)
  G-PID: 0x0800 (derived from egress interface properties)
  Bandwidth Requested: 0 kbps CT0
  Creation Time: Fri Jul 10 01:53:25.581 PST (1h 25m 17s ago)

Config Parameters:
```

```

Bandwidth:          0 kbps (CT0) Priority:  7  7 Affinity: 0x0/0xffff
Metric Type: TE (default)
AutoRoute: disabled LockDown: disabled  Policy class: not set
Forwarding-Adjacency: disabled
Loadshare:          0 equal loadshares
Auto-bw: disabled
Fast Reroute: Disabled, Protection Desired: None
Path Protection: Not Enabled
Auto Backup:
  Protected LSPs: 4
  Protected S2L Sharing Families: 0
  Protected S2Ls: 0
  Protected i/f: Gi0/1/0/0      Protected node: 20.0.0.2
  Protection: NNHOP+SRLG
  Unused removal timeout: not running
History:
  Tunnel has been up for: 00:00:08
  Current LSP:
    Uptime: 00:00:08
  Prior LSP:
    ID: path option 1 [545]
    Removal Trigger: configuration changed

Path info (OSPF 0 area 0):
Hop0: 10.0.0.2
Hop1: 100.0.0.2
Hop2: 100.0.0.3
Hop3: 200.0.0.3

```

The following example shows automatically created path options for this backup auto-tunnel.

```

RP/0/RP0/CPU0:router# show mpls traffic-eng tunnels 1 detail
Signalling Summary:
  LSP Tunnels Process: running
  RSVP Process: running
  Forwarding: enabled
  Periodic reoptimization: every 3600 seconds, next in 2524 seconds
  Periodic FRR Promotion: every 300 seconds, next in 49 seconds
  Auto-bw enabled tunnels: 1

Name: tunnel-tel Destination: 200.0.0.3 (auto backup)
Status:
  Admin: up Oper: up Path: valid Signalling: connected

  path option 10, type explicit (autob_nnhop_srlg_tunnell) (Basis for Setup, path weight
  11)
  path option 20, type explicit (autob_nnhop_tunnell)
  G-PID: 0x0800 (derived from egress interface properties)
  Bandwidth Requested: 0 kbps CT0
  Creation Time: Fri Jul 10 01:53:25.581 PST (1h 25m 17s ago)

Config Parameters:
  Bandwidth:          0 kbps (CT0) Priority:  7  7 Affinity: 0x0/0xffff
  Metric Type: TE (default)
  AutoRoute: disabled LockDown: disabled  Policy class: not set
  Forwarding-Adjacency: disabled
  Loadshare:          0 equal loadshares
  Auto-bw: disabled
  Fast Reroute: Disabled, Protection Desired: None
  Path Protection: Not Enabled
Auto Backup (NNHOP+SRLG):
  Protected LSPs: 4

```

```

Protected S2L Sharing Families: 0
Protected S2Ls: 0
Protected i/f: Gi0/1/0/0      Protected node: 20.0.0.2
Protection: NNHOP+SRLG
Unused removal timeout: not running

Path Options Details:
 10: Explicit Path Name: (autob_nnhop_srlg_tel)
    1: exclude-srlg 50.0.0.1
    2: exclude-address 50.0.0.2
    3: exclude-node 20.0.0.2
 20: Explicit Path Name: (autob_nnhop_tel)
    1: exclude-address 50.0.0.1
    2: exclude-address 50.0.0.2
    3: exclude-node 20.0.0.2
History:
Tunnel has been up for: 00:00:08
Current LSP:
  Uptime: 00:00:08
Prior LSP:
  ID: path option 1 [545]
  Removal Trigger: configuration changed

Path info (OSPF 0 area 0):
Hop0: 10.0.0.2
Hop1: 100.0.0.2
Hop2: 100.0.0.3
Hop3: 200.0.0.3

```

This example shows the automatically created backup tunnels.

```
RP/0/RP0/CPU0:router# show mpls traffic-eng tunnels brief
```

TUNNEL NAME	DESTINATION	STATUS	STATE
tunnel-te0	200.0.0.3	up	up
tunnel-te1	200.0.0.3	up	up
tunnel-te2	200.0.0.3	up	up
tunnel-te50	200.0.0.3	up	up
*tunnel-te60	200.0.0.3	up	up
*tunnel-te70	200.0.0.3	up	up
*tunnel-te80	200.0.0.3	up	up

```
RP/0/RP0/CPU0:router# show mpls traffic-eng tunnels tabular
```

Tunnel Name	LSP ID	Destination Address	Source Address	State	FRR State	LSP Role	Path Prot
tunnel-te0	549	200.0.0.3	200.0.0.1	up	Inact	Head	InAct
tunnel-te1	546	200.0.0.3	200.0.0.1	up	Inact	Head	InAct
tunnel-te2	6	200.0.0.3	200.0.0.1	up	Inact	Head	InAct
tunnel-te50	6	200.0.0.3	200.0.0.1	up	Active	Head	InAct
tunnel-te60	4	200.0.0.3	200.0.0.1	up	Active	Head	InAct
tunnel-te70	4	200.0.0.3	200.0.0.1	up	Active	Head	InAct
tunnel-te80	3	200.0.0.3	200.0.0.1	up	Active	Head	InAct

This example shows the auto-tunnel backup details.

```
RP/0/RP0/CPU0:router# show mpls traffic-eng tunnels auto-tunnel backup detail
```

```

Name: tunnel-te400 Destination: 1.1.1.1 (auto-tunnel backup)
Status:
  Admin:    up Oper:    up Path:  valid Signalling: connected

```

```

path option 20, type explicit (autob_nnhop_te400) (Basis for Setup, path weight 2)
path option 10, type explicit (autob_nnhop_srlg_te400) [disabled]
G-PID: 0x0800 (derived from egress interface properties)
Bandwidth Requested: 0 kbps CT0
Creation Time: Thu Aug 16 18:30:41 2012 (00:01:28 ago)
Config Parameters:
  Bandwidth: 0 kbps (CT0) Priority: 7 7 Affinity: 0x0/0xffff
  Metric Type: TE (default)
  Metric Type: TE (default)
  Hop-limit: disabled
  AutoRoute: disabled LockDown: disabled Policy class: not set
  Forwarding-Adjacency: disabled
  Loadshare: 0 equal loadshares
  Auto-bw: disabled
  Fast Reroute: Disabled, Protection Desired: None
  Path Protection: Not Enabled
  Soft Preemption: Disabled
Auto Backup:
  Protected LSPs: 1
  Protected S2L Sharing Families: 0
  Protected S2L: 0
  Protected i/f: Gi0/1/0/3 Protected node: 3.3.3.3
  Attribute-set: ab1
  Protection: NNHOP
  Unused removal timeout: not running
Path Option Details:
  10: Explicit Path Name: (autob_nnhop_srlg_te400)
     1: exclude-srlg 34.9.0.4
     2: exclude-address 34.9.0.3
     3: exclude-node 3.3.3.3
  20: Explicit Path Name: (autob_nnhop_te400)
     1: exclude-address 34.9.0.4
     2: exclude-address 34.9.0.3
     3: exclude-node 3.3.3.3
SNMP Index: 221
History:
  Tunnel has been up for: 00:00:34 (since Thu Aug 16 18:31:35 EST 2012)
  Current LSP:
    Uptime: 00:00:34 (since Thu Aug 16 18:31:35 EST 2012)
Current LSP Info:
  Instance: 2, Signaling Area: OSPF 100 area 1.2.3.4
  Uptime: 00:00:34 (since Thu Aug 16 18:31:35 EST 2012)
  Outgoing Interface: GigabitEthernet0/1/0/2, Outgoing Label: 16000
  Router-IDs: local 4.4.4.4
              downstream 2.2.2.2
  Soft Preemption: None
  Path Info:
    Outgoing:
      Explicit Route:
        Strict, 24.9.0.2
        Strict, 12.9.1.1
        Strict, 1.1.1.1

    Record Route: Empty
    Tspec: avg rate=0 kbits, burst=1000 bytes, peak rate=0 kbits
    Session Attributes: Local Prot: Not Set, Node Prot: Not Set, BW Prot: Not Set
                     Soft Preemption Desired: Not Set
  Resv Info:
    Record Route:
      IPv4 24.9.0.2, flags 0x0
      IPv4 12.9.1.1, flags 0x0
    Fspec: avg rate=0 kbits, burst=1000 bytes, peak rate=0 kbits
  Displayed 1 (of 104) heads, 0 (of 0) midpoints, 0 (of 201) tails

```

Displayed 1 up, 0 down, 0 recovering, 0 recovered heads

This example shows the automatically created backup tunnels.

```
RP/0/RP0/CPU0:router# show mpls traffic-eng tunnels auto-tunnel backup tabular
```

Tunnel Name	LSP ID	Destination Address	Source Address	Tun State	FRR State	LSP Role	Path Prot
*tunnel-te400	2	1.1.1.1	4.4.4.4	up	Inact	Head	Inact
*tunnel-te401	2	3.3.3.3	4.4.4.4	up	Inact	Head	Inact

* = automatically created backup tunnel

```
RP/0/RP0/CPU0:router# show mpls traffic-eng tunnels auto-tunnel backup brief
```

TUNNEL NAME	DESTINATION	STATUS	STATE
*tunnel-te400	1.1.1.1	up	up
*tunnel-te401	3.3.3.3	up	up

* = automatically created backup tunnel

Displayed 2 (of 104) heads, 0 (of 0) midpoints, 0 (of 201) tails
 Displayed 2 up, 0 down, 0 recovering, 0 recovered heads

This example shows the attribute-set for auto-backup tunnels.

```
RP/0/RP0/CPU0:router# show mpls traffic-eng attribute-set auto-backup
```

Attribute Set Name: ab (Type: auto-backup)

Number of affinity constraints: 2

- Include bit map : 0x4
- Include name : blue
- Exclude bit map : 0x2
- Exclude name : red

Priority: 7 7 (Default)

Record-route: Enabled

Policy-class: 1

Logging: reoptimize, state

List of protected interfaces (count 1)

- POS0_3_0_1

List of tunnel IDs (count 1)

- 3000

This example shows the attribute-set for auto-mesh tunnels.

```
RP/0/RP0/CPU0:router# show mpls traffic-eng attribute-set auto-mesh
```

Attribute Set Name: am (Type: auto-mesh)

Bandwidth: 100 kbps (CT0)

Number of affinity constraints: 2

- Include bit map : 0x8
- Include name : yellow
- Exclude bit map : 0x2
- Exclude name : red

Priority: 2 2

Interface Bandwidth: 0 kbps (Default)

AutoRoute Announce: Disabled

Auto-bw: Disabled

Soft Preemption: Disabled

Fast Reroute: Enabled, Protection Desired: Node, Bandwidth

Record-route: Enabled

Policy-class: 0 (Not configured)

Logging: None

List of Mesh Groups (count 1)

1

This example shows the details about the tunnel that is using auto-backup type of attribute-set.

```
RP/0/RP0/CPU0:router# show mpls traffic-eng tunnels attribute-set auto-backup ab
```

```
Name: tunnel-te3000 Destination: 1.1.1.1 (auto-tunnel backup)
Status:
  Admin:      up Oper:      up Path:  valid Signalling: connected

  path option 20, type explicit (autob_nhop_te3000) (Basis for Setup, path weight 2)
  path option 10, type explicit (autob_nhop_srlg_te3000) [disabled]
  G-PID: 0x0800 (derived from egress interface properties)
  Bandwidth Requested: 0 kbps CT0
  Creation Time: Tue Aug 14 23:24:27 2012 (00:05:28 ago)
Config Parameters:
  Bandwidth:      0 kbps (CT0) Priority:  7  7
  Number of affinity constraints: 2
    Include bit map      : 0x4
    Include name         : blue
    Exclude bit map     : 0x2
    Exclude name        : red

  Metric Type: TE (default)
  Hop-limit: disabled
  AutoRoute: disabled LockDown: disabled Policy class: 1
  Forwarding-Adjacency: disabled
  Loadshare:      0 equal loadshares
  Auto-bw: disabled
  Fast Reroute: Disabled, Protection Desired: None
  Path Protection: Not Enabled
  Soft Preemption: Disabled
Auto Backup:
  Protected LSPs: 2
  Protected S2L Sharing Families: 0
  Protected S2L: 0
  Protected i/f: PO0/3/0/1
  Attribute-set: ab
  Protection: NHOP
  Unused removal timeout: not running
History:
  Tunnel has been up for: 00:04:57 (since Tue Aug 14 23:24:58 EST 2012)
  Current LSP:
    Uptime: 00:04:57 (since Tue Aug 14 23:24:58 EST 2012)

  Path info (OSPF 100 area 16909060):
  Node hop count: 2
  Hop0: 23.9.0.2
  Hop1: 12.9.0.2
  Hop2: 12.9.0.1
  Hop3: 1.1.1.1
Displayed 1 (of 7) heads, 0 (of 3) midpoints, 0 (of 0) tails Displayed 1 up, 0 down, 0
recovering, 0 recovered heads
```

This example shows the protected interface for auto-backup auto-tunnels.

```
RP/0/RP0/CPU0:router# show mpls traffic-eng tunnels backup protected-interface
```

```
Interface: Gi0/2/0/1 (auto-tunnel backup)
  SRLG: N/A, NHOP-only: No
  Attribute-set: Not configured
  Auto-tunnel backup recreate time remaining: timer not running
  No backup tunnel found
```

```

Interface: Gi0/2/0/3
  tunnel-te340   PROTECTED : out i/f:   PO0/3/0/2   Admin:   up Oper:   up

Interface: PO0/3/0/1 (auto-tunnel backup)
  SRLG: N/A, NHOP-only: No
  Attribute-set: ab
  Auto-tunnel backup recreate time remaining: timer not running
  *tunnel-te3000      NHOP : out i/f:   Gi0/2/0/2   Admin:   up Oper:   up

* = automatically created backup tunnel

```

This example shows the details about all the tunnels that are using auto-mesh type of attribute-set.

```
RP/0/RP0/CPU0:router# show mpls traffic-eng tunnels attribute-set auto-mesh all
```

```

Name: tunnel-te3501 Destination: 1.1.1.1 (auto-tunnel mesh)
Status:
  Admin:   up Oper:   up Path: valid Signalling: connected

  path option 10, type dynamic (Basis for Setup, path weight 2)
  G-PID: 0x0800 (derived from egress interface properties)
  Bandwidth Requested: 100 kbps CT0
  Creation Time: Tue Aug 14 23:25:41 2012 (00:06:13 ago)
Config Parameters:
  Bandwidth:      100 kbps (CT0) Priority:  2 2
  Number of affinity constraints: 2
    Include bit map      : 0x8
    Include name         : yellow
    Exclude bit map     : 0x2
    Exclude name        : red

  Metric Type: TE (default)
  Hop-limit: disabled
  AutoRoute: disabled LockDown: disabled Policy class: not set
  Forwarding-Adjacency: disabled
  Loadshare:      0 equal loadshares
  Auto-bw: disabled
  Fast Reroute: Enabled, Protection Desired: Node, Bandwidth
  Path Protection: Not Enabled
  Attribute-set: am (type auto-mesh)
  Soft Preemption: Disabled
Auto-tunnel Mesh:
  Group ID: 1
  Destination list: blah
  Unused removal timeout: not running
History:
  Tunnel has been up for: 00:06:13 (since Tue Aug 14 23:25:41 EST 2012)
  Current LSP:
    Uptime: 00:06:13 (since Tue Aug 14 23:25:41 EST 2012)

Path info (OSPF 100 area 16909060):
  Node hop count: 2
  Hop0: 23.9.0.2
  Hop1: 12.9.0.2
  Hop2: 12.9.0.1
  Hop3: 1.1.1.1

```

```

Name: tunnel-te3502 Destination: 2.2.2.2 (auto-tunnel mesh)
Status:
  Admin:   up Oper:   up Path: valid Signalling: connected

  path option 10, type dynamic (Basis for Setup, path weight 1)
  G-PID: 0x0800 (derived from egress interface properties)
  Bandwidth Requested: 100 kbps CT0

```

```

Creation Time: Tue Aug 14 23:25:41 2012 (00:06:13 ago)
Config Parameters:
  Bandwidth:      100 kbps (CT0) Priority:  2  2
  Number of affinity constraints: 2
    Include bit map      : 0x8
    Include name         : yellow
    Exclude bit map     : 0x2
    Exclude name        : red

Metric Type: TE (default)
Hop-limit: disabled
AutoRoute: disabled LockDown: disabled Policy class: not set
Forwarding-Adjacency: disabled
Loadshare:      0 equal loadshares
Auto-bw: disabled
Fast Reroute: Enabled, Protection Desired: Node, Bandwidth
Path Protection: Not Enabled
Attribute-set: am (type auto-mesh)
Soft Preemption: Disabled
Auto-tunnel Mesh:
  Group ID: 1
  Destination list: blah
  Unused removal timeout: not running
History:
  Tunnel has been up for: 00:06:13 (since Tue Aug 14 23:25:41 EST 2012)
  Current LSP:
    Uptime: 00:06:13 (since Tue Aug 14 23:25:41 EST 2012)

Path info (OSPF 100 area 16909060):
Node hop count: 1
Hop0: 23.9.0.2
Hop1: 2.2.2.2

Name: tunnel-te3503 Destination: 4.4.4.4 (auto-tunnel mesh)
Status:
  Admin:      up Oper: down Path: not valid Signalling: Down

path option 10, type dynamic
Last PCALC Error: Tue Aug 14 23:31:26 2012
  Info: No path to destination, 4.4.4.4 (affinity)
G-PID: 0x0800 (derived from egress interface properties)
Bandwidth Requested: 100 kbps CT0
Creation Time: Tue Aug 14 23:25:41 2012 (00:06:13 ago)
Config Parameters:
  Bandwidth:      100 kbps (CT0) Priority:  2  2
  Number of affinity constraints: 2
    Include bit map      : 0x8
    Include name         : yellow
    Exclude bit map     : 0x2
    Exclude name        : red

Metric Type: TE (default)
Hop-limit: disabled
AutoRoute: disabled LockDown: disabled Policy class: not set
Forwarding-Adjacency: disabled
Loadshare:      0 equal loadshares
Auto-bw: disabled
Fast Reroute: Enabled, Protection Desired: Node, Bandwidth
Path Protection: Not Enabled
Attribute-set: am (type auto-mesh)
Soft Preemption: Disabled
Auto-tunnel Mesh:
  Group ID: 1
  Destination list: blah

```

```
Unused removal timeout: not running
Displayed 3 (of 7) heads, 0 (of 3) midpoints, 0 (of 0) tails Displayed 2 up, 1 down, 0
recovering, 0 recovered heads
```

Related Topics

[Enabling an AutoTunnel Backup](#), on page 231

[Removing an AutoTunnel Backup](#), on page 232

[Establishing MPLS Backup AutoTunnels to Protect Fast Reroutable TE LSPs](#), on page 232

[Establishing Next-Hop Tunnels with Link Protection](#), on page 233

[Backup AutoTunnels](#), on page 173

Configure Point-to-Multipoint TE: Examples

These configuration examples show how to configure Point-to-Multipoint TE:

Configure Point-to-Multipoint for the Source: Example

At the source, multicast routing must be enabled on both the tunnel-mte interface and customer-facing interface. Then, the static-group must be configured on the tunnel-mte interface to forward specified multicast traffic over P2MP LSP.



Note The multicast group address, which is in Source-Specific Multicast (SSM) address range (ff35::/16), must be used on the static-group configuration because Cisco IOS XR software supports only SSM for Label Switch Multicast (LSM). Additionally, the customer-facing interface must have an IPv6 address.

```
multicast-routing
 address-family ipv6
   interface tunnel-mte 1
     enable
   !
   interface GigabitEthernet0/2/0/3
     enable
   !
   !
   !
 router mld
  vrf default
   interface tunnel-mte 1
     static-group ff35::1 2000::1 3eFF::A
   !
   !
 interface tunnel-mte 1
   ipv4 unnumbered Loopback0
   destination 3.3.3.3
     path-option 1 dynamic
   destination 4.4.4.4
     path-option 1 dynamic
   !
 !
```

Related Topics

[Enabling Multicast Routing on the Router](#), on page 292

[Point-to-Multipoint Traffic-Engineering Overview](#), on page 197

[Configuring the Static Group for the Point-to-Multipoint Interface](#), on page 294
[Point-to-Multipoint RSVP-TE](#), on page 199

Configure the Point-to-Multipoint Tunnel: Example

There is no difference between logging events at the tunnel level for both P2P and P2MP. The P2MP tunnel reoptimizes only at the per tunnel level.

```
interface tunnel-mte1
  ipv4 unnumbered Loopback0
  destination 60.60.60.60
  logging events lsp-status state
  logging events lsp-status reroute
  path-option 10 explicit name toR6_via_R2andR3
  !
  logging events lsp-status reoptimize
  logging events lsp-status state
  logging events lsp-status reroute
  fast-reroute
  record-route
  !
explicit-path name PATH7
  index 1 next-address strict ipv4 unicast 192.168.7.2
  index 2 next-address strict ipv4 unicast 192.168.7.1
  index 3 next-address strict ipv4 unicast 192.168.16.1
  index 4 next-address strict ipv4 unicast 192.168.16.2
  !
```

Related Topics

[Configuring Destinations for the Tunnel Interface](#), on page 296
[Path Option for Point-to-Multipoint RSVP-TE](#), on page 201
[Logging Per Destinations for Point-to-Multipoint](#), on page 300
[Point-to-Multipoint Traffic-Engineering Overview](#), on page 197

Disable a Destination: Example

From the tunnel-mte interface, you can disable the destination.

```
interface tunnel-mte101
  ipv4 unnumbered Loopback0
  destination 150.150.150.150
  disable
  path-option 10 dynamic
  !
  destination 150.150.150.150
  path-option 2 dynamic
  !
  !
```

Related Topics

[Disabling Destinations](#), on page 299
[Point-to-Multipoint Traffic-Engineering Overview](#), on page 197

Configure the Point-to-Multipoint Solution: Example

Requirements for MPLS-TE Configuration

Before the Point-to-Multipoint (P2MP) tunnel is defined, these MPLS-TE requirements must be configured:

- Multiprotocol Label Switching traffic engineering (MPLS-TE)
- Resource ReSerVation Protocol (RSVP)
- Open Shortest Path First (OSPF)

This example shows the entire P2MP solution:

- Source is the location where the P2MP-TE tunnel interface is created.
- Tunnel contains multiple destinations. For example, the P2MP-TE tunnel is configured with two leaf node destinations by using the dynamic and explicit path options.
- Fast-Reroute (FRR) is specified on the P2MP tunnel.
- All regular TE tunnel options such as affinity or bandwidth are configured.
- Static mapping of the group address to the P2MP tunnel is done in IGMP.
Internet Group Management Protocol (IGMP).
- The P2MP-TE midpoint configuration requires only TE and Interior Gateway Protocol (IGP) information.
- The P2MP-TE receiver configuration requires a static group and RPF map.

```

!
explicit-path name g2-r2-r1
  index 1 next-address strict ipv4 unicast 10.2.15.1
!
explicit-path name g2-r2-r3
  index 1 next-address strict ipv4 unicast 10.2.25.1
  index 2 next-address strict ipv4 unicast 10.2.23.2
!
explicit-path name g2-r2-r4
  index 1 next-address strict ipv4 unicast 10.2.25.1
  index 2 next-address strict ipv4 unicast 10.2.24.2
!
ipv4 access-list ssm
  10 permit ipv4 232.1.0.0/16 any
  20 permit ipv4 232.3.0.0/16 any
  30 permit ipv4 232.4.0.0/16 any
!
ipv4 access-list ssm-test
  10 permit ipv4 235.0.0.0/8 any
!
interface Loopback0
  ipv4 address 192.168.1.2 255.255.255.255
!
interface tunnel-mte221
  ipv4 unnumbered Loopback0
  destination 192.168.1.1
  path-option 1 dynamic
!
  destination 192.168.1.3
  path-option 1 dynamic
!

```

```

destination 192.168.1.4
  path-option 1 dynamic
!
!
interface tunnel-mte222
  ipv4 unnumbered Loopback0
  destination 192.168.1.1
  path-option 1 explicit name g2-r2-r1
!
  destination 192.168.1.3
  path-option 1 explicit name g2-r2-r3
!
  destination 192.168.1.4
  path-option 1 explicit name g2-r2-r4
!
  signalled-bandwidth 1000
!
interface MgmtEth0/RP0/CPU0/0
  ipv4 address 172.20.163.12 255.255.255.128
!
interface MgmtEth0/RP1/CPU0/0
  shutdown
!
interface GigabitEthernet0/0/0/0
  ipv4 address 172.2.1.2 255.255.255.0
  load-interval 30
!
interface GigabitEthernet0/0/0/1
  ipv4 address 10.1.15.2 255.255.255.0
!
interface GigabitEthernet0/0/0/1.2
  ipv4 address 10.2.15.2 255.255.255.0
  encapsulation dot1q 2
!
interface GigabitEthernet0/0/0/2
  ipv4 address 10.1.25.2 255.255.255.0
!
interface GigabitEthernet0/0/0/2.2
  ipv4 address 10.2.25.2 255.255.255.0
  encapsulation dot1q 2
!
interface GigabitEthernet0/0/0/3
  shutdown
!
interface GigabitEthernet0/0/0/4
  shutdown
!
interface GigabitEthernet0/0/0/5
  shutdown
!
interface GigabitEthernet0/0/0/6
  shutdown
!
interface GigabitEthernet0/0/0/7
  shutdown
!
router static
  address-family ipv4 unicast
    0.0.0.0/0 1.56.0.1
    0.0.0.0/0 172.20.163.1
!
!
router ospf 100
  nsr

```



```
router-id 192.168.70.1
area 0
 mpls traffic-eng
 interface Loopback0
 !
 interface GigabitEthernet0/0/0/0
 !
 interface GigabitEthernet0/0/0/1
 !
 interface GigabitEthernet0/0/0/1.2
 !
 interface GigabitEthernet0/0/0/2
 !
 interface GigabitEthernet0/0/0/2.2
 !
 !
 mpls traffic-eng router-id 192.168.70.1
 !
 mpls oam
 !
 rsvp
 interface GigabitEthernet0/0/0/0
 bandwidth 20000
 !
 interface GigabitEthernet0/0/0/1
 bandwidth 20000
 !
 interface GigabitEthernet0/0/0/2
 bandwidth 20000
 !
 interface GigabitEthernet0/0/0/1.2
 bandwidth 20000
 !
 interface GigabitEthernet0/0/0/2.2
 bandwidth 20000
 !
 !
 mpls traffic-eng
 interface GigabitEthernet0/0/0/0
 !
 interface GigabitEthernet0/0/0/1
 !
 interface GigabitEthernet0/0/0/2
 !
 interface GigabitEthernet0/0/0/1.2
 !
 interface GigabitEthernet0/0/0/2.2
 !
 !
 mpls ldp
 router-id 192.168.1.2
 nsr
 graceful-restart
 interface GigabitEthernet0/0/0/0
 !
 interface GigabitEthernet0/0/0/1
 !
 interface GigabitEthernet0/0/0/1.2
 !
 interface GigabitEthernet0/0/0/2
 !
 interface GigabitEthernet0/0/0/2.2
 !
 !
```

```

multicast-routing
 address-family ipv4
   core-tree-protocol rsvp-te
   ssm range ssm
   static-rpf 172.1.1.1 32 mpls 192.168.1.1
   static-rpf 172.3.1.1 32 mpls 192.168.1.3
   static-rpf 172.4.1.1 32 mpls 192.168.1.4
   interface all enable
 !
!
router igmp
!
 interface tunnel-mte221
   static-group 232.2.2.1 172.2.1.1
 !
 interface tunnel-mte222
   static-group 232.2.2.2 172.2.1.1
 !
 interface GigabitEthernet0/0/0/0
   static-group 232.1.2.1 172.1.1.1
   static-group 232.1.2.2 172.1.1.1
   static-group 232.3.2.1 172.3.1.1
   static-group 232.3.2.2 172.3.1.1
   static-group 232.4.2.1 172.4.1.1
   static-group 232.4.2.2 172.4.1.1
 !
!
end

```

Related Topics

- [Enabling Multicast Routing on the Router](#), on page 292
- [Point-to-Multipoint Traffic-Engineering Overview](#), on page 197
- [Configuring the Static Group for the Point-to-Multipoint Interface](#), on page 294
- [Point-to-Multipoint RSVP-TE](#) , on page 199
- [Configuring Destinations for the Tunnel Interface](#), on page 296
- [Path Option for Point-to-Multipoint RSVP-TE](#), on page 201
- [Logging Per Destinations for Point-to-Multipoint](#) , on page 300

Configure MPLS TE Path-selection Cost Limit: Example

This example shows how to set the path-selection cost limit for MPLS TE tunnels at global, TE tunnel interface, and path-option attribute-set levels. By default, the cost-limit set at path-option attribute set takes the priority, if all options are configured and per tunnel interface level takes priority over global cost-limit. At per tunnel interface level, the global cost-limit takes the priority.

```

interface tunnel-tel
 path-selection cost-limit 2
!
mpls traffic-eng
 attribute-set path-option P03AttrSet
   path-selection cost-limit 3
!
 path-selection cost-limit 1
!
!

```

Configure Entropy Labels for MPLS TE Networks

Most MPLS networks use load balancing techniques for traffic engineering. What causes latency in such widespread networks is the time taken to inspect the label stack at each transit Label Switching Router (LSR) to determine the next hop or path.

The latency can be reduced by inserting a label known as the *entropy label* on top of the label stack at the ingress LSR. The entropy label contains the keys required by the load balancing function, and thus eliminates the need for deep packet inspection at transit LSRs. The ingress LSR, which has all the information about incoming packets, extracts the load balancing keys from the entropy label and decides the optimum paths for the packets. The transit LSRs use the rest of the label stack to forward the packets along the pre-determined paths.

The advantages of using entropy labels in MPLS networks are:

- Ingress LSRs operate at lower bandwidths than transit LSRs, and are hence the ideal choice for load balancing.
- Transit LSRs do not need to perform deep packet inspection and can effectively load balance the packets as decided by the Ingress LSRs.
- Transit LSRs are spared from the problem of misinterpreting the protocol denoted in the label stack and thereby causing inequitable distribution of traffic across equal cost paths exiting from the LSR.

The following illustration shows the transit of a packet through the MPLS network. The entropy label is attached at the ingress router for load balancing. When the optimum path is determined for the packet, which contains the payload (data) and the label stack, the entropy label is no longer required.

Figure 25: Transit of an MPLS Packet with an Entropy Label

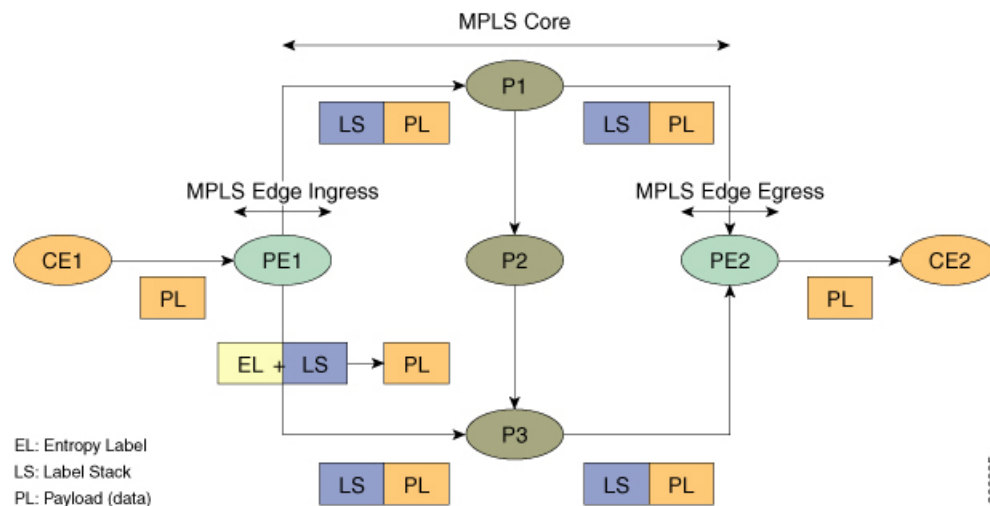

Configuration

1. To configure an MPLS entropy label, use the following configuration.

```
RP/0/RP0/CPU0:router(config)# mpls ldp
RP/0/RP0/CPU0:router(config-ldp)# entropy-label
```

```
RP/0/RP0/CPU0:router(config-ldp)# commit
RP/0/RP0/CPU0:router(config-ldp)# end
```

2. Locate the route that needs to use the entropy label for load balancing.

```
RP/0/RP0/CPU0:router# show cef exact-route 10.1.6.1 10.1.1.1

10.1.1.1/32, version 40, internal 0x1000001 0x0 (ptr 0x8d42b4d8) [1], 0x0 (0x8d5c5020),
0xa20 (0x8e1c0098)
...
Prefix Len 32, traffic index 0, precedence n/a, priority 4
via Bundle-Ether613
  via 11.1.5.1/32, Bundle-Ether613, 2 dependencies, weight 0, class 0 [flags 0x0]
  path-idx 2 NHID 0x0 [0x8dd02920 0x8dd02810]
  next hop 11.1.5.1/32
  local adjacency
  local label 24002          labels imposed {ImplNull}
```

3. Use the route to pass the entropy label for load balancing.

You are prompted for the option of entering the entropy label for multiple source-destination pairs.

```
RP/0/RP0/CPU0:router# bundle-hash bundle-Ether 613
Specify load-balance configuration (L3/3-tuple or L4/7-tuple) (L3,L4): L3
Single SA/DA pair (IPv4,IPv6) or range (IPv4 only) or Entropy Label (MPLS only): S/R/E
[S]: E

Enter Entropy Label(in network byte order): 14001

Entropy Label 14001 -- Link hashed to is TenGigE0/1/0/8/8

Another? [y]:
```

4. Verify if traffic is getting load balanced with the MPLS entropy label configuration.

```
RP/0/RP0/CPU0:router# show mpls forwarding exact-route label 24002 entropy-label 14001

Local   Outgoing   Prefix           Outgoing   Next Hop       Bytes
Label   Label      or ID            Interface   Interface       Switched
-----
24002  24010    10.1.1.1/32     BE613      11.1.5.1/32   N/A
Via: BE613, Next Hop: 11.1.5.1/32
Label Stack (Top -> Bottom): { 24010 }
NHID: 0x0, Encap-ID: N/A, Path idx: 0, Backup path idx: 0, Weight: 0
MAC/Encaps: 0/4, MTU: 1500
```

You have successfully configured an MPLS entropy label in your network.

Additional References

For additional information related to implementing MPLS-TE, refer to the following references:

Related Documents

Related Topic	Document Title
MPLS-TE commands	<i>MPLS Traffic Engineering Commands</i> module in <i>MPLS Command Reference for the Cisco CRS Router</i> .

Standards

Standards	Title
No new or modified standards are supported by this feature, and support for existing standards has not been modified by this feature.	—

MIBs

MIBs	MIBs Link
—	To locate and download MIBs using Cisco IOS XR software, use the Cisco MIB Locator found at the following URL and choose a platform under the Cisco Access Products menu: http://cisco.com/public/sw-center/netmgmt/cmtk/mibs.shtml

RFCs

RFCs	Title
RFC 4124	<i>Protocol Extensions for Support of Diffserv-aware MPLS Traffic Engineering</i> , F. Le Faucheur, Ed. June 2005. (Format: TXT=79265 bytes) (Status: PROPOSED STANDARD)
RFC 4125	<i>Maximum Allocation Bandwidth Constraints Model for Diffserv-aware MPLS Traffic Engineering</i> , F. Le Faucheur, W. Lai. June 2005. (Format: TXT=22585 bytes) (Status: EXPERIMENTAL)
RFC 4127	<i>Russian Dolls Bandwidth Constraints Model for Diffserv-aware MPLS Traffic Engineering</i> , F. Le Faucheur, Ed. June 2005. (Format: TXT=23694 bytes) (Status: EXPERIMENTAL)

Technical Assistance

Description	Link
The Cisco Technical Support website contains thousands of pages of searchable technical content, including links to products, technologies, solutions, technical tips, and tools. Registered Cisco.com users can log in from this page to access even more content.	http://www.cisco.com/techsupport



CHAPTER 7

GMPLS UNI

The Generalized Multiprotocol Label Switching (GMPLS) User Network Interface (UNI) creates a circuit connection between two clients (UNI-C) of an optical network. This connection is achieved by signaling exchanges between UNI Client (UNI-C) and UNI Network (UNI-N) nodes. The UNI-C nodes are router nodes and UNI-N nodes are optical nodes.

- [Prerequisites for Implementing GMPLS UNI, on page 363](#)
- [Restrictions for Implementing GMPLS UNI, on page 363](#)
- [Information About Implementing GMPLS UNI , on page 364](#)
- [nLight Enhancements, on page 365](#)
- [How to Implement GMPLS UNI, on page 370](#)
- [Configuration Examples for GMPLS UNI, on page 400](#)
- [Additional References, on page 402](#)

Prerequisites for Implementing GMPLS UNI

The following prerequisites are required to implement GMPLS UNI:

- You must be in a user group associated with a task group that includes the proper task IDs. The command reference guides include the task IDs required for each command. If you suspect user group assignment is preventing you from using a command, contact your AAA administrator for assistance.
- Router that runs Cisco IOS XR software.
- Installation of the Cisco IOS XR software mini-image on the router.
- Installation of the Cisco IOS XR MPLS software package on the router.

Restrictions for Implementing GMPLS UNI

- The total number of configured GMPLS UNI controllers should not exceed the platform scale limit of 500 GMPLS interfaces.
- Each UNI-N (ingress or egress) should be routable from its adjacent UNI-C. The UNI-C nodes need to be routable from the UNI-N nodes too.
- GMPLS UNI is supported only over DWDM controllers and so, over POS and GigabitEthernet interfaces.

- GMPLS UNI is supported only with these Cisco CRS Line Cards:
 - Cisco CRS-1 OC768 (C/L-band) DWDM PLIM
 - Cisco CRS-1 OC768 DPSK (C/L-band) STD CHAN PLIM
 - Cisco CRS-1 4 port 10GE (C/L-band) DWDM PLIM
 - Cisco CRS 1-Port 100GE CP-DQSPK Full C-Band Tunable DWDM Interface Module

Information About Implementing GMPLS UNI

To implement GMPLS UNI, you should understand these concepts:

GMPLS UNI vs GMPLS NNI

In case of GMPLS NNI, the optical network topology is known and path calculations are performed at the NNI head. In case of GMPLS UNI, the optical network topology is unknown to the UNI-C nodes and path calculations are performed by the UNI-N nodes.

GMPLS LSP Signaling

The GMPLS overlay model architecture is used for LSP signaling for GMPLS connections. In GMPLS UNI, UNI-C nodes send a request for a connection to UNI-N node. The connection request does not contain an end-to-end path. This is because, as mentioned previously, UNI-C nodes do not have knowledge of the topology of the optical network and therefore cannot determine the end-to-end path. The UNI-C node signals a connection request without an ERO.

The LSP diversity is signaled on a GMPLS UNI tunnel with a path-option. A path-option is permitted on a GMPLS UNI tunnel with a "no ERO" and an optional "XRO" attribute sets to specify LSP diversity requirements. If multiple LSP exclusions are configured in the attribute-set, they can be added to the path message along with an appropriate LSP connection diversity sub-object.

Path Message without an ERO

In GMPLS UNI, UNI-C nodes send a request for a connection to UNI-N node. The connection request does not contain an end-to-end path, because, UNI-C nodes do not have knowledge of the topology of the optical network and therefore cannot determine the end-to-end path. The UNI-C node signals a connection request without an ERO.

When no ERO is present in a received path message, the UNI-N node calculates a route to the destination and includes that route in an ERO, before forwarding the path message. If no route is found, the UNI-N returns a path error message with an error code and subcode of 24,5 - *"No route available toward destination"*.

The destination address of a GMPLS LSP can be either the optical router-id of the tail UNI-C node, or the optical address of the ingress interface to the tail UNI-C node. Supplying the router-id allows the UNI-N to route the tunnel to the tail UNI-C node via any attached UNI-N node; supplying the UNI-C's ingress interface address forces the tunnel's path to traverse the UNI-N node attached to that interface.



Note The optical router-ids and interface addresses may or may not be the same as the packet ones.

XRO Attribute-set

An optional XRO attribute-set can be specified as part of the path-option to specify LSP diversity requirements. An empty XRO attribute set results in the GMPLS tunnel being signaled with no exclusions, and therefore no XRO.



Note A non-existent XRO attribute-set can be configured in the GMPLS UNI tunnel path-option; in this case no attempt will be made to bring up the GMPLS tunnel until the configuration is complete.

Connection Diversity

Connection diversity is required to ensure that GMPLS tunnels can be established without sharing resources, thus, greatly reducing the probability of simultaneous connection failures. For example, an edge-node wishes to establish multiple LSPs towards the same destination edge-node, and these LSPs need to have few or no resources in common.

Connection diversity supports the establishment of a GMPLS LSP which is diverse from the path taken by an existing LSP. An XRO is added to the tunnel's path message with appropriate LSP diversity sub-objects or exclusions. A maximum of 20 connection diversity exclusions per XRO is supported.

GMPLS RSVP VRF Signaling

The Cisco IOS XR software supports a single non-default VRF for the GMPLS RSVP signaling. This allows GMPLS signaling to work even when the only available communication between the UNI-C and UNI-N nodes is through a VRF. This non-default VRF is supported only for GMPLS signaling; whereas the MPLS-TE signaling continues to support only the default VRF.

DWDM Transponder Integration

A GMPLS UNI based solution preserves all the advantages of the integration of the DWDM transponder into the router blade. These advantages include:

- improved CAPEX and OPEX models
- component, space and power savings
- improved IP availability through pro-active protection.

nLight Enhancements

These topics describe the enhancements made to nLight (also known as GMPLS UNI):

Explicit Route Object

Explicit Route Objects (EROs) limit LSP routing to a specified list of LSRs. Formerly, the UNI Client (UNI-C) node signaled a connection request, without an ERO, to the UNI Network (UNI-N) node. In this IOS XR Software release, the UNI-C node provides support for path message with ERO for GMPLS tunnels. This includes the capability to specify either a strict or a loose ERO to a path option to be included in the path message for processing by the ingress UNI-N.

An ERO is constructed using the strict and loose hops, specified in the explicit path, by the path option.

When a loose hop is configured, it identifies one or more transit LSRs which suggests the preferred path for the LSP. If a suggested path fails, another LSR is tried.

When a strict hop is configured, it identifies an exact path through which the LSP must be routed. Strict hop EROs specify the exact sequence of LSRs in the LSP.

As a result of these operations, a LSP is established from the sender to the destination of the session, following the explicitly routed path specified in the ERO.



Note

- *lockdown* and *verbatim* are mandatory in ERO path option.
 - A path option may still be configured to use no ERO.
 - In no ERO, *lockdown* is mandatory.
-

Wavelength Specification

The wavelength (also called label) specification enhancement enables the network planning tool to determine the wavelength, and specify the same at the UNI-C. The UNI-N then accepts the label provided by the UNI-C, or rejects the path entirely. Previously, the wavelength to be used for the GMPLS UNI tunnel was determined by the UNI-N, taking into account the headend UNI-C's capabilities.

The wavelength to be used is added to the path option configuration. This optional configuration allows a fixed wavelength to be specified for the path option.

When signaling using a path option with the specified wavelength takes place, the following changes happen because of the wavelength specification enhancement:

- The configured wavelength is validated against the controller's capabilities; signaling fails if the wavelength cannot be used by the controller.
- The upstream label is set to the specified wavelength.
- The label-set in the Path message, instead of containing one label for each supported wavelength, contains only the specified wavelength.
- A path-error message with error code 25 and subcode 6 no longer receives special handling. If a suggested label is supplied, it is ignored.



Note A suggested label received in response to signaling with a path option that specifies a different label, is not stored for future use. Other path options, in general, have different constraints and therefore require path calculation to be redone.

Multiple Path Options

Multiple path options are permitted per GMPLS UNI tunnel. The index given to each path option indicates its relative preference level, with lower indices being preferred. This is similar to the existing multiple path option functionality available for packet TE. This allows the provision of multiple path options with, for example, progressively free constraints.

The path-option index is no longer fixed to ten and is now set by the user and distinguishes path options in the same manner as for packet tunnels. In all situations where a tunnel is being brought up or reoptimized, the path-option with the lowest index is tried first; if no LSP can be established with this path option, then subsequent path options are tried in ascending order. This also applies to recovery from failures, unless any recovery path option is specified.

Reoptimization

Reoptimization differs from restoration though the mechanisms involved are similar. Reoptimization occurs without the original connection having failed.

Unlike packet tunnels, reoptimization in GMPLS tunnels is not supposed to be loss free.

Manual Reoptimization

Manual reoptimization of a single GMPLS UNI tunnel can be triggered from the UNI-C node (headend). Use the **mpls traffic-eng optical-uni reoptimize tunnel-id** command to trigger manual reoptimization of a GMPLS UNI tunnel.

The manual trigger for reoptimization causes the currently established LSP to be torn down and signals a new LSP using the normal bring-up process (though the new LSP is same as the current one).

It is not possible to trigger reoptimization for multiple GMPLS UNI tunnels or at the tailend of a tunnel.

SRLG Discovery



Note SRLG (Shared Risk Link Group) discovery, SRLG collection and SRLG recording represent the same function.

The head and tail UNI-C routers have no direct knowledge of the path taken through the optical network by a GMPLS UNI tunnel, or of the properties of that path. All information about the path of a particular GMPLS UNI connection must therefore be explicitly requested and learned during the signaling process.

A key property of a GMPLS UNI connection is the set of SRLGs used by the optical links along the connection. It is necessary for the UNI-C routers to learn the set of SRLGs associated with a connection, so that this

information can be used, both by GMPLS UNI in the specification of diversity requirements for other connections and by Layer-3 applications for effecting routing and protection decision making.

The learning of SRLGs during GMPLS UNI LSP signaling is done by requesting SRLG collection when LSP signaling is initiated, and by the addition of SRLG RRO sub-objects to the Path and Resv messages during signaling as described in IETF draft *SRLG-collect*. Path message learns egress interfaces from head to tail and Resv message learns egress interfaces from tail to head

Provision of Discovered SRLGs to RSI

Once the SRLGs used by a GMPLS UNI connection are collected during signaling as in SRLG discovery, they are made available to the Layer-3 processes. This is done through RSI (Router Space Infrastructure), as illustrated in the following diagram:

Figure 26: SRLG Communication

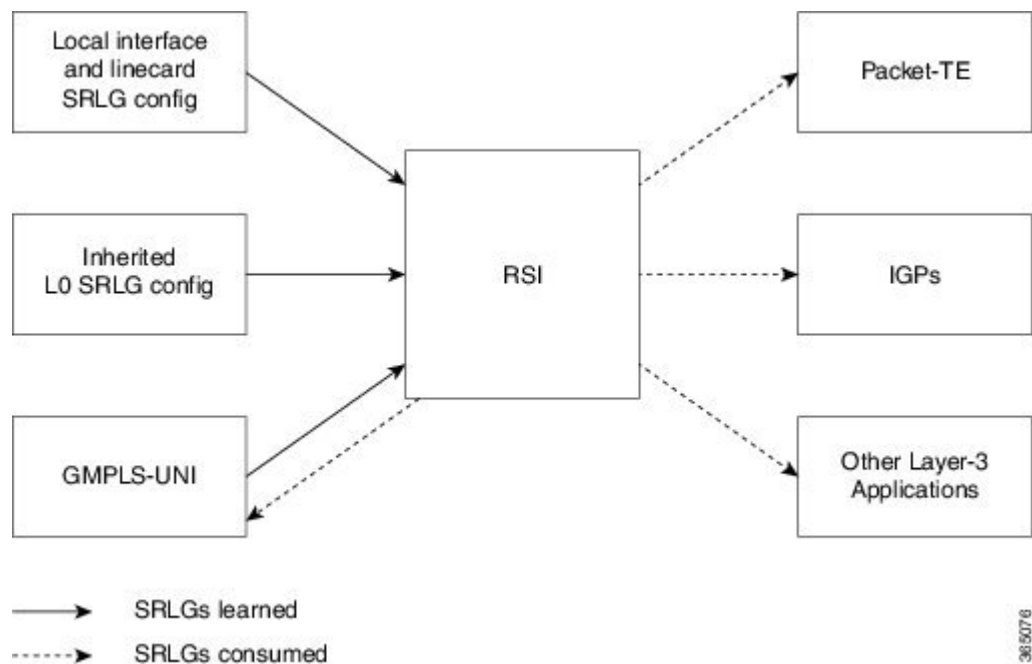

An API is provided by the RSI component to allow SRLGs discovered during GMPLS UNI signaling to be communicated to RSI, as documented in IETF draft *RSI-SRLG*. RSI combines the SRLG sets learned from GMPLS and configuration for an interface and deliver a single set of SRLGs to applications registered as SRLG clients.

The SRLGs discovered during GMPLS UNI signaling are given to RSI for application to the Layer-3 interface of the DWDM controller associated with the GMPLS UNI tunnel. This may be a POS, GigE or an OTN interface.

SRLG Announce

All SRLGs discovered through GMPLS signaling are announced to RSI once the tunnel is up. These SRLGs are withdrawn from RSI when the tunnel goes down.

SRLG Diversity



Note SRLG diversity and SRLG exclusion represent the same function.

Support is added for signaling SRLG based diversity requirements, based on the XRO SRLG sub-object defined in RFC 4874. The use of SRLGs removes the restrictions of LSP based diversity, as SRLGs are flooded throughout the optical network, and by their very nature, reduce the risk of concurrent failure.

SRLG diversity is configured under the XRO attribute-set.

Head UNI-C Behavior

SRLG diversity is configured at the tunnel head. Individual SRLG exclusions are added to an XRO attribute-set; each is specified as either *best-effort* or mandatory (*strict*). Whenever any exclusion is specified, an XRO object is added to the Path message by the head UNI-C. The XRO contains a SRLG sub-object for each specified SRLG. The SRLG exclusions may coexist in the same XRO with LSP exclusions.

The XRO attribute-set is associated with tunnel path options in the same manner as for LSP exclusions.

If a SRLG with a strict exclusion matches an SRLG configured on the local DWDM controller, the bring-up attempt fails.

The SRLG exclusions requested by the head UNI-C are processed by the ingress UNI-N node during path calculation for the tunnel.

Tail UNI-C Behavior

On receiving a Path message containing an XRO, the tail UNI-C inspects each SRLG sub-object. If a SRLG sub-object, with a strict exclusion, matches an SRLG configured on the local DWDM controller, the Path message is rejected and a path-error is generated with error codes. No action is taken if the SRLG sub-object specifies a *best-effort* exclusion.

Multi-Layer Restoration - Optical

Multi-Layer Restoration-Optical (MLR-O) involves restoration from failures in the optical network that can leverage the same router interfaces at both ends.

Optical restoration involves the repair of a failure by the optical network locally. Although the routers may see loss of light until the failure is repaired, there is no signaling involving the routers, and from the routers perspective the GMPLS UNI LSP remains unchanged.

Optical Restoration: Same Wavelength

When a failure occurs on a physical link within the optical network, the routers identify that the link is down and Layer 3 protection mechanisms, such as FRR, are used to minimize the traffic loss. The optical network re-routes the GMPLS connection to an alternative path. This is done without any involvement of the routers.

Limitation

A significant limitation of optical restoration in this case, is that the wavelength in use for the connection cannot be changed. This is because the wavelength must be the same along the entire path and cannot be

changed without end-to-end signaling. The constraints imposed on the connection during its initial signaling are also unchanged, which may reduce the chance of finding an alternative path.

Optical Restoration: Wavelength Change

Optical restoration may occur with an associated wavelength change, in the case where the optical network finds an alternative path with the same constraints as were originally signaled, but using a different wavelength. Some signaling is required, since the wavelength (and therefore the labels) used by the GMPLS connection are to change.

Consider a failure within the optical network on the path of a GMPLS UNI LSP. The restoration proceeds as in the previous case (same wavelength), but the new path found, uses a different wavelength. The ingress UNI-N then sends a path-error message indicating the new wavelength to be used; this has error code 24 (routing), sub-error 6 (unacceptable label set) and contains a suggested-label sub-object with the new label to be used. The head UNI-C then signals a new LSP with the new wavelength.

Although the wavelength in use may change in this case, the constraints used in signaling the original LSP remain unchanged.

How to Implement GMPLS UNI

A new submode is introduced under the main TE submode to enable GMPLS UNI and to contain GMPLS UNI configuration.

To implement GMPLS UNI, follow these procedures:

Configuring TE for GMPLS UNI

TE configuration specific to packet tunnels does not affect GMPLS UNI tunnels.

To implement TE configuration for GMPLS UNI, follow these procedures:

Enabling GMPLS UNI Submode

Perform this task to enable GMPLS UNI configuration submode and to configure GMPLS UNI tunnels.



Note

Removal of the GMPLS UNI submode results in the removal of all configuration within it, including any other parser submode, and the immediate destruction of all GMPLS UNI tunnels.

SUMMARY STEPS

1. **configure**
2. **mpls traffic-eng**
3. **gmpls optical-uni**
4. **commit**

DETAILED STEPS

	Command or Action	Purpose
Step 1	configure	
Step 2	mpls traffic-eng Example: RP/0/RP0/CPU0:router(config)# mpls traffic-eng	Enters MPLS-TE configuration mode.
Step 3	gmpls optical-uni Example: RP/0/RP0/CPU0:router(config-mpls-te)# gmpls optical-uni RP/0/RP0/CPU0:router(config-te-gmpls)#	Enters GMPLS UNI configuration submode.
Step 4	commit	

Configuring GMPLS UNI Controller

Perform this task to setup a GMPLS tail in MPLS-TE configuration. This task enables GMPLS UNI controller submode to configure controllers for establishing GMPLS UNI tunnels. This is the minimal configuration required at the tunnel tail.



Note Removal of the GMPLS UNI controller submode results in the immediate destruction of any GMPLS tunnel established over the controller referenced.

SUMMARY STEPS

1. **configure**
2. **mpls traffic-eng**
3. **gmpls optical-uni**
4. **controller dwdm** *interface*
5. **commit**

DETAILED STEPS

	Command or Action	Purpose
Step 1	configure	
Step 2	mpls traffic-eng Example: RP/0/RP0/CPU0:router(config)# mpls traffic-eng	Enters MPLS-TE configuration mode.

	Command or Action	Purpose
Step 3	gmpls optical-uni Example: RP/0/RP0/CPU0:router(config-mpls-te)# gmpls optical-uni	Enters GMPLS UNI configuration submode.
Step 4	controller dwdm interface Example: RP/0/RP0/CPU0:router(config-te-gmpls)# controller dwdm 0/1/0/1 RP/0/RP0/CPU0:router(config-te-gmpls-cntl)#	Enters GMPLS UNI controller submode.
Step 5	commit	

Configuring the GMPLS UNI Controller as a Tunnel Head

Perform this task to configure the tunnel properties for a GMPLS UNI controller.

This configuration designates the controller as a tunnel-head, rather than a tunnel tail. After you configure the tunnel properties, the incoming path messages are rejected and any existing tailend tunnel is torn down.

SUMMARY STEPS

1. **configure**
2. **mpls traffic-eng**
3. **gmpls optical-uni**
4. **controller dwdm interface**
5. **tunnel-properties**
6. **tunnel-id number**
7. **destination ipv4 unicast address**
8. **path-option 10 no-ero lockdown**
9. **commit**

DETAILED STEPS

	Command or Action	Purpose
Step 1	configure	
Step 2	mpls traffic-eng Example: RP/0/RP0/CPU0:router(config)# mpls traffic-eng	Enters MPLS-TE configuration mode.
Step 3	gmpls optical-uni Example:	Enters GMPLS UNI configuration submode.

	Command or Action	Purpose
	RP/0/RP0/CPU0:router(config-mpls-te) # gmpls optical-uni	
Step 4	controller <i>dwdm interface</i> Example: RP/0/RP0/CPU0:router(config-te-gmpls) # controller <i>dwdm 0/1/0/1</i> RP/0/RP0/CPU0:router(config-te-gmpls-ctrl) #	Enters GMPLS UNI controller submode.
Step 5	tunnel-properties Example: RP/0/RP0/CPU0:router(config-te-gmpls-ctrl) # tunnel-properties RP/0/RP0/CPU0:router(config-te-gmpls-tun) #	Enters the submode to configure tunnel-specific information for a GMPLS UNI controller.
Step 6	tunnel-id <i>number</i> Example: RP/0/RP0/CPU0:router(config-te-gmpls-tun) # tunnel-id 100	Specifies a tunnel-id for a headend router of a GMPLS tunnel. The tunnel-id is a 16-bit number ranging 0–65535.
Step 7	destination <i>ipv4 unicast address</i> Example: RP/0/RP0/CPU0:router(config-te-gmpls-tun) # destination ipv4 unicast 10.10.3.4	Specifies a tunnel destination for a headend router of a GMPLS tunnel. The destination argument is an IPv4 address.
Step 8	path-option 10 no-ero lockdown Example: RP/0/RP0/CPU0:router(config-te-gmpls-tun) # path-option 10 no-ero lockdown	Specifies the path-option for a headend router of a GMPLS tunnel. Note You can specify an XRO attribute-set as part of the path-option.
Step 9	commit	

Configuring Other Tunnel Properties for a GMPLS UNI Tunnel

Perform this task to configure the optional tunnel properties for a GMPLS UNI tunnel. This configuration is optional, and if omitted, the GMPLS tunnel is established with the default property values.

SUMMARY STEPS

1. **configure**
2. **mpls traffic-eng**
3. **gmpls optical-uni**
4. **controller *dwdm interface***

5. **tunnel-properties**
6. **priority** *setup-priority hold-priority*
7. **record-route**
8. **signalled-name** *name*
9. **logging events** *lsp-status state*
10. **commit**

DETAILED STEPS

	Command or Action	Purpose
Step 1	configure	
Step 2	mpls traffic-eng Example: <pre>RP/0/RP0/CPU0:router(config)# mpls traffic-eng</pre>	Enters MPLS-TE configuration mode.
Step 3	gmpls optical-uni Example: <pre>RP/0/RP0/CPU0:router(config-mpls-te)# gmpls optical-uni</pre>	Enters GMPLS UNI configuration submode.
Step 4	controller dwdm interface Example: <pre>RP/0/RP0/CPU0:router(config-te-gmpls)# controller dwdm 0/1/0/1</pre>	Enters GMPLS UNI controller submode.
Step 5	tunnel-properties Example: <pre>RP/0/RP0/CPU0:router(config-te-gmpls-ctrl)# tunnel-properties</pre>	Enters the submode to configure tunnel-specific information for a GMPLS UNI controller.
Step 6	priority <i>setup-priority hold-priority</i> Example: <pre>RP/0/RP0/CPU0:router(config-te-gmpls-tun)# priority 3 2</pre>	Specifies the priority for a GMPLS tunnel. The default priority value is 7 for both setup and hold priorities. Note The setup-priority and hold-priority values are numbers ranging from 0 to 7, where 0 represents the highest priority. The hold-priority must be equal or higher (numerically less) than the setup-priority.
Step 7	record-route Example: <pre>RP/0/RP0/CPU0:router(config-te-gmpls-tun)# record-route</pre>	Enables record-route functionality for a GMPLS tunnel.

	Command or Action	Purpose
Step 8	signalled-name <i>name</i> Example: RP/0/RP0/CPU0:router(config-te-gmpls-tun)# signalled-name <i>sign1</i>	Configures signalled-name for a GMPLS tunnel. Note If no signalled name is configured, TE will generate a default name in the form of <i>router-name_tunnel-id_destination-address</i> , for example, <i>te-ma1_123_10.10.10.10</i> .
Step 9	logging events lsp-status state Example: RP/0/RP0/CPU0:router(config-te-gmpls-tun)# logging events lsp-status state	Configure events to generate system log messages when state changes occur on the GMPLS tunnel. If omitted, no events will result in the generation of system log messages.
Step 10	commit	

Configuring LSP Diversity

To configure an XRO attribute-set as part of the path-option for MPLS-TE, and to specify exclusions for an attribute set for LSP diversity, follow these procedures:

Configuring XRO Attribute-set

Perform this task to configure XRO attribute set in the GMPLS UNI tunnel path-option, under MPLS-TE submode.

SUMMARY STEPS

1. **configure**
2. **mpls traffic-eng**
3. **gmpls optical-uni**
4. **controller dwdm** *interface*
5. **tunnel-properties**
6. **path-option 10 no-ero** [*xro-attribute-set name*] **lockdown**
7. **commit**

DETAILED STEPS

	Command or Action	Purpose
Step 1	configure	
Step 2	mpls traffic-eng Example: RP/0/RP0/CPU0:router(config)# mpls traffic-eng	Enters MPLS-TE configuration mode.
Step 3	gmpls optical-uni Example:	Enters GMPLS UNI configuration submode.

	Command or Action	Purpose
	RP/0/RP0/CPU0:router(config-mpls-te)# gmpls optical-uni	
Step 4	controller dwdm interface Example: RP/0/RP0/CPU0:router(config-te-gmpls)# controller dwdm 0/1/0/1	Enters GMPLS UNI controller submode.
Step 5	tunnel-properties Example: RP/0/RP0/CPU0:router(config-te-gmpls-ctrl)# tunnel-properties	Enters the submode to configure tunnel-specific information for a GMPLS UNI controller.
Step 6	path-option 10 no-ero [xro-attribute-set name] lockdown Example: RP/0/RP0/CPU0:router(config-te-gmpls-tun)# path-option 10 no-ero xro-attribute-set A01 lockdown	Specifies the path-option for a headend router of a GMPLS tunnel.
Step 7	commit	

Configuring Connection Diversity

Perform this task to specify exclusions for an attribute set for LSP diversity, under MPLS-TE attribute-set configuration mode.

SUMMARY STEPS

1. **configure**
2. **mpls traffic-eng**
3. **attribute-set xro name**
4. **exclude {best-effort | strict} lsp source source-address destination destination-address tunnel-id tunnel-id extended-tunnel-id extended-tunnel-id [lsp-id lsp-id]**
5. **commit**

DETAILED STEPS

	Command or Action	Purpose
Step 1	configure	
Step 2	mpls traffic-eng Example: RP/0/RP0/CPU0:router(config)# mpls traffic-eng	Enters MPLS-TE configuration mode.

	Command or Action	Purpose
Step 3	attribute-set <i>xro name</i> Example: <pre>RP/0/RP0/CPU0:router(config-mpls-te)# attribute-set xro attrset01</pre>	Configures an XRO attribute-set for a GMPLS tunnel.
Step 4	exclude { <i>best-effort</i> <i>strict</i> } lsp source <i>source-address</i> destination <i>destination-address</i> tunnel-id <i>tunnel-id</i> extended-tunnel-id <i>extended-tunnel-id</i> [lsp-id <i>lsp-id</i>] Example: <pre>RP/0/RP0/CPU0:router(config-te-attribute-set)# exclude best-effort lsp source 10.10.1.2 destination 10.20.4.4 tunnel-id 17 extended-tunnel-id 10.20.3.3 lsp-id 17 RP/0/RP0/CPU0:router(config-te-attribute-set)#</pre>	Specifies exclusions for an attribute set for LSP diversity. Note A maximum of 20 LSP exclusions per XRO is supported.
Step 5	commit	

Configuring LMP for GMPLS UNI

To implement LMP configuration for GMPLS UNI, follow these procedures:

Configuring Optical Router ID

Perform this task to enable GMPLS UNI LMP functionality and to configure LMP unicast router ID.

SUMMARY STEPS

1. **configure**
2. **lmp**
3. **gmpls optical-uni**
4. **router-id ipv4 unicast** *address*
5. **commit**

DETAILED STEPS

	Command or Action	Purpose
Step 1	configure	
Step 2	lmp Example: <pre>RP/0/RP0/CPU0:router(config)# lmp</pre>	Enters LMP configuration mode.
Step 3	gmpls optical-uni Example:	Enters GMPLS UNI configuration submenu.

	Command or Action	Purpose
	RP/0/RP0/CPU0:router(config-lmp)# gmpls optical-uni	
Step 4	router-id ipv4 unicast address Example: RP/0/RP0/CPU0:router(config-lmp-gmpls-uni)# router-id ipv4 unicast 10.10.4.4	Configures the LMP unicast router ID for GMPLS.
Step 5	commit	

Configuring an LMP Neighbor

Perform this task to configure an LMP neighbor for a GMPLS UNI tunnel.

SUMMARY STEPS

1. **configure**
2. **lmp**
3. **gmpls optical-uni**
4. **neighbor name**
5. **ipcc routed**
6. **router-id ipv4 unicast address**
7. **commit**

DETAILED STEPS

	Command or Action	Purpose
Step 1	configure	
Step 2	lmp Example: RP/0/RP0/CPU0:router(config)# lmp	Enters LMP configuration mode.
Step 3	gmpls optical-uni Example: RP/0/RP0/CPU0:router(config-lmp)# gmpls optical-uni	Enters GMPLS UNI configuration submenu.
Step 4	neighbor name Example: RP/0/RP0/CPU0:router(config-lmp-gmpls-uni)# neighbor nbr1	Specifies an LMP neighbor for GMPLS and enters the LMP GMPLS UNI neighbor configuration submenu.

	Command or Action	Purpose
Step 5	ipcc routed Example: <pre>RP/0/RP0/CPU0:router(config-lmp-gmpls-uni-nbr-nbr1)# ipcc routed</pre>	Specifies the LMP neighbor IPCC configuration for GMPLS UNI.
Step 6	router-id ipv4 unicast address Example: <pre>RP/0/RP0/CPU0:router(config-lmp-gmpls-uni-nbr-nbr1)# router-id ipv4 unicast 10.10.4.5</pre>	Configures the LMP unicast router ID for GMPLS.
Step 7	commit	

Configuring an LMP Controller

Perform this task to configure an LMP link for a GMPLS UNI controller.

SUMMARY STEPS

1. **configure**
2. **lmp**
3. **gmpls optical-uni**
4. **controller dwdm controller**
5. **neighbor name**
6. **link-id ipv4 unicast address**
7. **neighbor link-id ipv4 unicast address**
8. **neighbor interface-id unnumbered interface-id**
9. **commit**

DETAILED STEPS

	Command or Action	Purpose
Step 1	configure	
Step 2	lmp Example: <pre>RP/0/RP0/CPU0:router(config)# lmp</pre>	Enters LMP configuration mode.
Step 3	gmpls optical-uni Example: <pre>RP/0/RP0/CPU0:router(config-lmp)# gmpls optical-uni</pre>	Enters GMPLS UNI configuration submode.

	Command or Action	Purpose
Step 4	controller dwdm <i>controller</i> Example: RP/0/RP0/CPU0:router(config-lmp-gmpls-uni)# controller dwdm 0/4/0/0	Specifies a controller for GMPLS UNI.
Step 5	neighbor <i>name</i> Example: RP/0/RP0/CPU0:router(config-lmp-gmpls-uni-ctrl)# neighbor nbr1	Specifies an LMP neighbor for GMPLS and enters the LMP GMPLS UNI neighbor configuration submenu.
Step 6	link-id ipv4 unicast <i>address</i> Example: RP/0/RP0/CPU0:router(config-lmp-gmpls-uni-ctrl)# link-id ipv4 unicast 10.2.2.4	Specifies the optical interface address for an LMP link for a GMPLS UNI controller.
Step 7	neighbor link-id ipv4 unicast <i>address</i> Example: RP/0/RP0/CPU0:router(config-lmp-gmpls-uni-ctrl)# neighbor link-id ipv4 unicast 10.2.2.5	Specifies the neighbor's optical address of an LMP link for a GMPLS UNI controller.
Step 8	neighbor interface-id unnumbered <i>interface-id</i> Example: RP/0/RP0/CPU0:router(config-lmp-gmpls-uni-ctrl)# neighbor interface-id unnumbered 17	Specifies the neighbor's optical interface ID of an LMP link for a GMPLS UNI controller.
Step 9	commit	

Configuring RSVP Optical Refresh Interval and Missed Count

Perform this task to configure optical refresh interval under the RSVP controller submenu and to configure the number of missed refresh messages allowed before optical tunnel states are deleted.

SUMMARY STEPS

1. **configure**
2. **rsvp**
3. **controller dwdm** *interface*
4. **signalling refresh out-of-band interval** *interval*
5. **signalling refresh out-of-band missed** *miss-count*

6. commit

DETAILED STEPS

	Command or Action	Purpose
Step 1	<code>configure</code>	
Step 2	rsvp Example: RP/0/RP0/CPU0:router(config)# <code>rsvp</code>	Enters RSVP configuration mode.
Step 3	controller dwdm interface Example: RP/0/RP0/CPU0:router(config-rsvp)# <code>controller dwdm 0/1/0/1</code>	Configures a controller for establishing a GMPLS UNI tunnel.
Step 4	signalling refresh out-of-band interval interval Example: RP/0/RP0/CPU0:router(config-rsvp-ctrl)# <code>signalling refresh out-of-band interval 200</code>	Configures optical refresh interval. The interval argument is the interval (in seconds) at which refresh messages are sent and expected to be received. The range is 180 to 86400 (a refresh-interval of 1 day).
Step 5	signalling refresh out-of-band missed miss-count Example: RP/0/RP0/CPU0:router(config-rsvp-ctrl)# <code>signalling refresh out-of-band missed 30</code>	Configures number of missed refresh messages allowed before optical tunnel states are deleted. The miss-count argument is the number of refresh messages, expected at the configured refresh-interval, which can be missed before optical tunnel states time out. The accepted range is 1 to 48. The default value is 12.
Step 6	<code>commit</code>	

nLight Enhancements: Configurations and Verifications

These topics describe the configurations and verifications for the nLight enhancements made:

Configuring an ERO for a GMPLS Tunnel

Perform this task to configure an ERO for a GMPLS tunnel.

SUMMARY STEPS

1. `configure`
2. `mpls traffic-eng`
3. `gmpls optical-uni`
4. `controller dwdm interface`

5. **tunnel-properties**
6. **tunnel-id** *number*
7. **logging events** *lsp-status state*
8. **destination ipv4 unicast** *address*
9. **path-option** *number explicit name name lockdown verbatim*
10. **commit**

DETAILED STEPS

	Command or Action	Purpose
Step 1	configure Example: RP/0/RP0/CPU0:router# configure	Enters Global Configuration mode.
Step 2	mpls traffic-eng Example: RP/0/RP0/CPU0:router(config)# mpls traffic-eng	Enters MPLS-TE configuration mode.
Step 3	gmpls optical-uni Example: RP/0/RP0/CPU0:router(config-mpls-te)# gmpls optical-uni	Enters GMPLS UNI configuration submode.
Step 4	controller dwdm interface Example: RP/0/RP0/CPU0:router(config-te-gmpls-uni)# controller dwdm 0/2/1/1	Enters GMPLS UNI controller submode.
Step 5	tunnel-properties Example: RP/0/RP0/CPU0:router(config-te-gmpls-ctrl)# tunnel-properties RP/0/RP0/CPU0:router(config-te-gmpls-tun)#	Enters the submode to configure tunnel-specific information for a GMPLS UNI controller.
Step 6	tunnel-id <i>number</i> Example: RP/0/RP0/CPU0:router(config-te-gmpls-tun)# tunnel-id 1001	Specifies a tunnel-ID for a headend router of a GMPLS tunnel. The tunnel-ID is a 16-bit number ranging from 0 to 65535.

	Command or Action	Purpose
Step 7	logging events lsp-status state Example: RP/0/RP0/CPU0:router(config-te-gmpls-tun)# logging events lsp-status state	Configure events to generate system log messages when state changes occur on the GMPLS tunnel. If omitted, no events will result in the generation of system log messages.
Step 8	destination ipv4 unicast address Example: RP/0/RP0/CPU0:router(config-te-gmpls-tun)# destination ipv4 unicast 102.3.233.1	Specifies a tunnel destination for a headend router of a GMPLS tunnel. The destination argument is an IPv4 address.
Step 9	path-option number explicit name name lockdown verbatim Example: RP/0/RP0/CPU0:router(config-te-gmpls-tun)# path-option 10 explicit name explicit_path_a lockdown verbatim	Specifies an explicit path for a headend router of a GMPLS tunnel. The path-option range is 1 to 1000. Note lockdown and verbatim are mandatory in ERO path option.
Step 10	commit	

Verifying an ERO Configuration: Example

The following example shows how to verify an ERO configuration:

```
RP/0/RP0/CPU0:router# show mpls traffic-eng tunnels 1001 detail

Name: GMPLS-UNI-dwdm0_3_0_0 Destination: 2.2.2.2
  Signalled-Name: head_ot1001_2.2.2.2
  GMPLS UNI tunnel controlling link dwdm0/3/0/0, tunnel-id: 1001
  Status:
    Admin:    up Oper:    up Path:  valid Signalling: connected

    path option 10, (LOCKDOWN verbatim) type explicit explicit_path_a (Basis for Setup,
    path weight 0)
    G-PID: 0x0800 (derived from egress interface properties)
    Creation Time: Fri Jul 17 08:41:21 ---- (3d07h ago)
.....
Current LSP Info:
  Instance: 20
  Uptime: 00:00:33 (since Mon Jul 20 ---- 15:45:22)
  Upstream label:
    Optical label:
      Grid           : DWDM
      Channel spacing : 50 GHz
      Identifier      : 0
      Channel Number  : 60
  Downstream label:
    Optical label:
      Grid           : DWDM
      Channel spacing : 50 GHz
      Identifier      : 0
      Channel Number  : 60
```

```

Router-IDs: local      1.1.1.1
             downstream 2.2.2.2
Soft Preemption: None
SRLGs: not collected
Path Info:
  Outgoing:
    Explicit Route:
      Strict, 10.10.10.2
      Strict, 11.11.11.3
      Strict, 12.12.12.3

```

.....

Configuring Wavelength for a Path Option

Perform this task to configure wavelength for a path option for a GMPLS tunnel.

SUMMARY STEPS

1. **configure**
2. **mpls traffic-eng**
3. **gmpls optical-uni**
4. **controller dwdm interface**
5. **tunnel-properties**
6. **tunnel-id number**
7. **destination ipv4 unicast address**
8. **path-option number explicit name name signaled-label dwdm wavelength dwdm channel number lockdown verbatim**
9. **commit**

DETAILED STEPS

	Command or Action	Purpose
Step 1	configure Example: RP/0/RP0/CPU0:router# configure	Enters Global Configuration mode.
Step 2	mpls traffic-eng Example: RP/0/RP0/CPU0:router(config)# mpls traffic-eng	Enters MPLS-TE configuration mode.
Step 3	gmpls optical-uni Example: RP/0/RP0/CPU0:router(config-mpls-te)# gmpls optical-uni	Enters GMPLS UNI configuration submode.

	Command or Action	Purpose
Step 4	controller dwdm <i>interface</i> Example: <pre>RP/0/RP0/CPU0:router(config-te-gmpls-uni)# controller dwdm 0/3/0/0</pre>	Enters GMPLS UNI controller submode.
Step 5	tunnel-properties Example: <pre>RP/0/RP0/CPU0:router(config-te-gmpls-ctrl)# tunnel-properties RP/0/RP0/CPU0:router(config-te-gmpls-tun)#</pre>	Enters the submode to configure tunnel-specific information for a GMPLS UNI controller.
Step 6	tunnel-id <i>number</i> Example: <pre>RP/0/RP0/CPU0:router(config-te-gmpls-tun)# tunnel-id 1001</pre>	Specifies a tunnel-ID for a headend router of a GMPLS tunnel. The tunnel-ID is a 16-bit number ranging from 0 to 65535.
Step 7	destination ipv4 unicast <i>address</i> Example: <pre>RP/0/RP0/CPU0:router(config-te-gmpls-tun)# destination ipv4 unicast 2.2.2.2</pre>	Specifies a tunnel destination for a headend router of a GMPLS tunnel. The destination argument is an IPv4 address.
Step 8	path-option <i>number</i> explicit name <i>name</i> signaled-label <i>dwdm wavelength</i> <i>dwdm channel number</i> lockdown verbatim Example: <pre>RP/0/RP0/CPU0:router(config-te-gmpls-tun)# path-option 10 explicit name exp_all_loose_hop signaled-label dwdm wavelength 10 lockdown verbatim</pre>	<p>Specifies a wavelength for the path option.</p> <p>The DWDM channel number range is 1 to 89.</p> <p>The DWDM channel number configured is formulated as 61-channel number. So, if we want channel number 42 (in the supported channel list), the configured "DWDM channel number" will be 61 - 42 = 19.</p>
Step 9	commit	

Configuring and Verifying Wavelength Configuration: Examples

The following sequence of examples show how to add a wavelength to a path option for a GMPLS tunnel and verify the outgoing label is set accordingly.

This example shows how to configure a GMPLS tunnel with no ERO path option.

```
gmpls optical-uni
 controller dwdm0/3/0/0
 tunnel-properties
 tunnel-id 1001
```

```

    destination ipv4 unicast 2.2.2.2
    path-option 10 no-ero lockdown
  !
!
!

```

This example shows how to verify the default values for the outgoing label (UNI-N source, channel number same as Default Channel) and the list of valid wavelengths.

```
RP/0/RP0/CPU0:router#show mpls traffic-eng link-management optical-uni controller dwdm
0/3/0/0
```

```

Optical interface: dwdm0/3/0/0
Overview:
  IM state: Up
  Child interface: POS0_3_0_0: IM state Up
  OLM/LMP state: Up
  Optical tunnel state: up
Connection:
  Tunnel role: Head
  Tunnel-id: 1001, LSP-id 21, Extended tunnel-id 1.1.1.1
  Tunnel source: 1.1.1.1, destination: 2.2.2.2
  Optical router-ids: Local: 1.1.1.1, Remote: 2.2.2.2
  Label source: UNI-N
  Upstream label:
    Optical label:
      Grid           : DWDM
      Channel spacing : 50 GHz
      Identifier      : 0
      Channel Number  : 60
  Downstream label:
    Optical label:
      Grid           : DWDM
      Channel spacing : 50 GHz
      Identifier      : 0
      Channel Number  : 60
  SRLG discovery: Disabled
  SRLG announcement: None
...
Optical capabilities:
  Controller type: DWDM
  Channel spacing: 50 GHz
  Default channel: 60
  89 supported channels:
    -28, -27, -26, -25, -24, -23, -22, -21
    -20, -19, -18, -17, -16, -15, -14, -13
    -12, -11, -10, -9, -8, -7, -6, -5
    -4, -3, -2, -1, 0, 1, 2, 3
    4, 5, 6, 7, 8, 9, 10, 11
    12, 13, 14, 15, 16, 17, 18, 19
    20, 21, 22, 23, 24, 25, 26, 27
    28, 29, 30, 31, 32, 33, 34, 35
    36, 37, 38, 39, 40, 41, 42, 43
    44, 45, 46, 47, 48, 49, 50, 51
    52, 53, 54, 55, 56, 57, 58, 59
    60
  Controller SRLGs
  None

```

This example shows how to set valid wavelength 10 (61 - 51) for the current path.

```

gmppls optical-uni
  controller dwdm0/3/0/0
  tunnel-properties
    tunnel-id 1001
    destination ipv4 unicast 2.2.2.2
    path-option 10 explicit name explicit_all_loose_multi_hop signaled-label dwdm wavelength
  10 lockdown verbatim
  !
  !
  !

```

This example shows how to verify that the tunnel is up and the specified wavelength is used (label source is UNI-C and outgoing label is 51).

```

RP/0/RP0/CPU0:router#show mpls traffic-eng link-management optical-uni controller dwdm
0/3/0/0

```

```

Optical interface: dwdm0/3/0/0
  Overview:
    IM state: Up
    Child interface: POS0_3_0_0: IM state Up
    OLM/LMP state: Up
    Optical tunnel state: up
  Connection:
    Tunnel role: Head
    Tunnel-id: 1001, LSP-id 23, Extended tunnel-id 1.1.1.1
    Tunnel source: 1.1.1.1, destination: 2.2.2.2
    Optical router-ids: Local: 1.1.1.1, Remote: 2.2.2.2
    Label source: UNI-C
    Upstream label:
      Optical label:
        Grid           : DWDM
        Channel spacing : 50 GHz
        Identifier      : 0
        Channel Number  : 51
    Downstream label:
      Optical label:
        Grid           : DWDM
        Channel spacing : 50 GHz
        Identifier      : 0
        Channel Number  : 51
    SRLG discovery: Disabled
    SRLG announcement: None
  ...
  Optical capabilities:
    Controller type: DWDM
    Channel spacing: 50 GHz
    Default channel: 60
    89 supported channels:
      -28, -27, -26, -25, -24, -23, -22, -21
      -20, -19, -18, -17, -16, -15, -14, -13
      -12, -11, -10, -9, -8, -7, -6, -5
      -4, -3, -2, -1, 0, 1, 2, 3
      4, 5, 6, 7, 8, 9, 10, 11
      12, 13, 14, 15, 16, 17, 18, 19
      20, 21, 22, 23, 24, 25, 26, 27
      28, 29, 30, 31, 32, 33, 34, 35
      36, 37, 38, 39, 40, 41, 42, 43
      44, 45, 46, 47, 48, 49, 50, 51
      52, 53, 54, 55, 56, 57, 58, 59
      60

```

```

Controller SRLGs
None

```

This example shows how to verify the upstream label on the tunnel tail.

```

RP/0/RP0/CPU0:router#show mpls traffic-eng link-management optical-uni controller dwdm
0/3/0/0

```

```

Optical interface: dwdm0/3/0/0
Overview:
  IM state: Up
  Child interface: POS0_3_0_0: IM state Up
  OLM/LMP state: Up
  Optical tunnel state: up
Connection:
  Tunnel role: Tail
  Tunnel-id: 1001, LSP-id 23, Extended tunnel-id 1.1.1.1
  Tunnel source: 1.1.1.1, destination: 2.2.2.2
  Optical router-ids: Local: 2.2.2.2, Remote: 1.1.1.1
  Label source: UNI-N
  Upstream label:
    Optical label:
      Grid          : DWDM
      Channel spacing : 50 GHz
      Identifier     : 0
      Channel Number : 51
  Downstream label:
    Optical label:
      Grid          : DWDM
      Channel spacing : 50 GHz
      Identifier     : 0
      Channel Number : 51
  SRLG discovery: Disabled
  SRLG announcement: None
...
Optical capabilities:
  Controller type: DWDM
  Channel spacing: 50 GHz
  Default channel: 60
  89 supported channels:
    -28, -27, -26, -25, -24, -23, -22, -21
    -20, -19, -18, -17, -16, -15, -14, -13
    -12, -11, -10, -9, -8, -7, -6, -5
    -4, -3, -2, -1, 0, 1, 2, 3
    4, 5, 6, 7, 8, 9, 10, 11
    12, 13, 14, 15, 16, 17, 18, 19
    20, 21, 22, 23, 24, 25, 26, 27
    28, 29, 30, 31, 32, 33, 34, 35
    36, 37, 38, 39, 40, 41, 42, 43
    44, 45, 46, 47, 48, 49, 50, 51
    52, 53, 54, 55, 56, 57, 58, 59
    60
  Controller SRLGs
  None

```

Configuring Multiple Path Options

Perform this task to configure multiple path options for a single tunnel.



Note If a tunnel is up and a lower index path option is configured, the tunnel does not try the lower index path option, unless for some reason the tunnel is flapped or reoptimized.

SUMMARY STEPS

1. **configure**
2. **mpls traffic-eng**
3. **gmpls optical-uni**
4. **controller dwdm** *interface*
5. **tunnel-properties**
6. **tunnel-id** *number*
7. **logging events lsp-status** *state*
8. **destination ipv4 unicast** *address*
9. **path-option** *number* **explicit name** *name* **lockdown** **verbatim**
10. **path-option** *number* **explicit name** *name* **lockdown** **verbatim**
11. **path-option** *number* **no-ero** **lockdown**
12. **commit**

DETAILED STEPS

	Command or Action	Purpose
Step 1	configure Example: RP/0/RP0/CPU0:router# configure	Enters Global Configuration mode.
Step 2	mpls traffic-eng Example: RP/0/RP0/CPU0:router(config)# mpls traffic-eng	Enters MPLS-TE configuration mode.
Step 3	gmpls optical-uni Example: RP/0/RP0/CPU0:router(config-mpls-te)# gmpls optical-uni	Enters GMPLS UNI configuration submode.
Step 4	controller dwdm <i>interface</i> Example: RP/0/RP0/CPU0:router(config-te-gmpls-uni)# controller dwdm 0/3/0/0	Enters GMPLS UNI controller submode.

	Command or Action	Purpose
Step 5	tunnel-properties Example: <pre>RP/0/RP0/CPU0:router(config-te-gmpls-ctrl)# tunnel-properties RP/0/RP0/CPU0:router(config-te-gmpls-tun)#</pre>	Enters the submode to configure tunnel-specific information for a GMPLS UNI controller.
Step 6	tunnel-id <i>number</i> Example: <pre>RP/0/RP0/CPU0:router(config-te-gmpls-tun)# tunnel-id 1001</pre>	Specifies a tunnel-ID for a headend router of a GMPLS tunnel. The tunnel-ID is a 16-bit number ranging from 0 to 65535.
Step 7	logging events lsp-status state Example: <pre>RP/0/RP0/CPU0:router(config-te-gmpls-tun)# logging events lsp-status state</pre>	Configure events to generate system log messages when state changes occur on the GMPLS tunnel. If omitted, no events will result in the generation of system log messages.
Step 8	destination ipv4 unicast <i>address</i> Example: <pre>RP/0/RP0/CPU0:router(config-te-gmpls-tun)# destination ipv4 unicast 2.2.2.2</pre>	Specifies a tunnel destination for a headend router of a GMPLS tunnel. The destination argument is an IPv4 address.
Step 9	path-option <i>number</i> explicit name <i>name</i> lockdown verbatim Example: <pre>RP/0/RP0/CPU0:router(config-te-gmpls-tun)# path-option 10 explicit name explicit_path_a lockdown verbatim</pre>	<p>Specifies a path option for a headend router of a GMPLS tunnel.</p> <p>The path-option range is 1 to 1000.</p>
Step 10	path-option <i>number</i> explicit name <i>name</i> lockdown verbatim Example: <pre>RP/0/RP0/CPU0:router(config-te-gmpls-tun)# path-option 20 explicit name explicit_path_b lockdown verbatim</pre>	<p>Specifies a path option.</p> <p>The path-option range is 1 to 1000.</p>
Step 11	path-option <i>number</i> no-ero lockdown Example: <pre>RP/0/RP0/CPU0:router(config-te-gmpls-tun)# path-option 30 no-ero lockdown</pre>	Specifies a path option with no ERO.

	Command or Action	Purpose
Step 12	commit	

Configuring and Verifying Multiple Path Options: Examples

This example shows how to configure multiple path options.

```
mpls traffic-eng
gmpls optical-uni
  controller dwdm0/2/0/2
  tunnel-properties
    path-option 10 explicit name explicit_path_a lockdown verbatim
    path-option 20 explicit name explicit_path_b lockdown verbatim
    path-option 30 no-ero lockdown
  !
!
```

The following sequence of examples show how to configure a GMPLS tunnel, add a new path option with a lower index than the path option in use, flap the tunnel and verify that the new path option (with a lower index) is used .

This example shows how to configure a GMPLS tunnel with one path option.

```
gmpls optical-uni
  controller dwdm0/3/0/0
  tunnel-properties
    tunnel-id 1001
    destination ipv4 unicast 2.2.2.2
    path-option 10 explicit name explicit_path_a lockdown verbatim
  !
!
```

This example shows how to verify the tunnel path and status with a show command.

```
RP/0/RP0/CPU0:router#show mpls traffic-eng tunnels 1001 detail

Name: GMPLS-UNI-dwdm0_3_0_0 Destination: 2.2.2.2
  Signalled-Name: head_ot1001_2.2.2.2
GMPLS UNI tunnel controlling link dwdm0/3/0/0, tunnel-id: 1001
Status:
  Admin:    up Oper:    up Path:    valid Signalling: connected

  path option 10, (LOCKDOWN verbatim) type explicit explicit_path_a (Basis for Setup,
path weight 0)
  G-PID: 0x0800 (derived from egress interface properties)
  Creation Time: Fri Jul 17 08:41:21 ---- (3d06h ago)
...
```

This example shows how to add another path option with a lower index.

```
gmpls optical-uni
  controller dwdm0/3/0/0
  tunnel-properties
    tunnel-id 1001
    destination ipv4 unicast 2.2.2.2
    path-option 1 no-ero lockdown
```

```

    path-option 10 explicit name explicit_path_a lockdown verbatim
    !
    !

```

Flag the tunnel (or trigger reoptimization) and verify that the tunnel comes up on the path with a lower index.

```

RP/0/RP0/CPU0:router#show mpls traffic-eng tunnels 1001 detail

Name: GMPLS-UNI-dwdm0_3_0_0 Destination: 2.2.2.2
Signalled-Name: head_ot1001_2.2.2.2
GMPLS UNI tunnel controlling link dwdm0/3/0/0, tunnel-id: 1001
Status:
  Admin:    up Oper:    up Path:  valid Signalling: connected

  path option 1, (LOCKDOWN) type no-ero (Basis for Setup, path weight 0)
  Last Signalled Error : Mon Jul 20 17:03:00 2015
    Info: [24] PathErr(2,2)-(Admin, reason unknown) at 50.0.0.2
  path option 10, (LOCKDOWN verbatim) type explicit explicit_all_loose_multi_hop
  Last Signalled Error : Mon Jul 20 17:03:00 ----
    Info: [25] PathErr(2,2)-(Admin, reason unknown) at 50.0.0.2

```

Enabling SRLG Discovery

Perform this task to enable SRLG discovery on the head node of a nLight tunnel.



Note

- SRLG discovery/recording is enabled only on the headend for each tunnel.
- SRLG discovery/recording allows a maximum of 62 SRLGs in RSVP, which is different from the maximum count of 64 in RSI.

SUMMARY STEPS

1. **configure**
2. **mpls traffic-eng**
3. **gmpls optical-uni**
4. **controller dwdm** *interface*
5. **tunnel-properties**
6. **logging events lsp-status state**
7. **tunnel-id** *number*
8. **record srlg**
9. **destination ipv4 unicast** *address*
10. **path-option** *number* **no-ero lockdown**
11. **commit**

DETAILED STEPS

	Command or Action	Purpose
Step 1	configure Example: RP/0/RP0/CPU0:router# <code>configure</code>	Enters Global Configuration mode.
Step 2	mpls traffic-eng Example: RP/0/RP0/CPU0:router(config)# <code>mpls traffic-eng</code>	Enters MPLS-TE configuration mode.
Step 3	gmpls optical-uni Example: RP/0/RP0/CPU0:router(config-mpls-te)# <code>gmpls optical-uni</code>	Enters GMPLS UNI configuration submode.
Step 4	controller <i>dwdm interface</i> Example: RP/0/RP0/CPU0:router(config-te-gmpls-uni)# <code>controller dwdm 0/2/0/0</code>	Enters GMPLS UNI controller submode.
Step 5	tunnel-properties Example: RP/0/RP0/CPU0:router(config-te-gmpls-ctrl)# <code>tunnel-properties</code> RP/0/RP0/CPU0:router(config-te-gmpls-tun)#	Enters the submode to configure tunnel-specific information for a GMPLS UNI controller.
Step 6	logging events <i>lsp-status state</i> Example: RP/0/RP0/CPU0:router(config-te-gmpls-tun)# <code>logging events lsp-status state</code>	Configure events to generate system log messages when state changes occur on the GMPLS tunnel. If omitted, no events will result in the generation of system log messages.
Step 7	tunnel-id <i>number</i> Example: RP/0/RP0/CPU0:router(config-te-gmpls-tun)# <code>tunnel-id 100</code>	Specifies a tunnel-ID for a headend router of a GMPLS tunnel. The tunnel-ID is a 16-bit number ranging from 0 to 65535.
Step 8	record srlg Example:	Enables SRLG recording.

	Command or Action	Purpose
	RP/0/RP0/CPU0:router (config-te-gmpls-tun) # record srlg	
Step 9	destination ipv4 unicast address Example: RP/0/RP0/CPU0:router (config-te-gmpls-tun) # destination ipv4 unicast 192.168.1.2	Specifies a tunnel destination for a headend router of a GMPLS tunnel. The destination argument is an IPv4 address.
Step 10	path-option number no-ero lockdown Example: RP/0/RP0/CPU0:router (config-te-gmpls-tun) # path-option 10 no-ero lockdown	Specifies the path option for a headend router of a nLight (GMPLS) tunnel. The path-option range is 1 to 1000.
Step 11	commit	

Verifying SRLG Discovery Configuration: Examples

This example shows how to verify SRLG discovery configuration.

```
RP/0/0/CPU0:router#show mpls traffic-eng tunnels 100 detail

Name: GMPLS-UNI-dwdm0_2_0_0 Destination: 192.168.1.2
  Signalled-Name: rtrA_ot100_192.168.1.2
GMPLS UNI tunnel controlling link dwdm0/2/0/0, tunnel-id: 100
Status:
  Admin:    up Oper:    up Path:  valid Signalling: connected

  path option 10, (LOCKDOWN) type no-ero (Basis for Setup, path weight 0)
  G-PID: 0x0800 (derived from egress interface properties)
  Creation Time: Mon Jul 20 19:32:03 ---- (00:48:02 ago)
Config Parameters:
  Priority:  7 7 Affinity: 0x0/0xffff
  Path Protection: Not Enabled
  BFD Fast Detection: Disabled
  Reoptimization after affinity failure: Enabled
SRLG discovery: Enabled
...
Soft Preemption: None
SRLGs: mandatory collection
Path Info:
...
Resv Info:
  Record Route:
    IPv4 10.10.10.2, flags 0x0
    SRLGs: 21, 22, 23, 24
    Fspec: avg rate=10000 kbits, burst=1000 bytes, peak rate=10000 kbits
Displayed 1 (of 3) heads, 0 (of 0) midpoints, 0 (of 2) tails
Displayed 1 up, 0 down, 0 recovering, 0 recovered heads
```

This example shows how to verify SRLG discovery configuration at the headend and the tailend. The output shows the list of SRLGs.

```
RP/0/0/CPU0:router#show srlg

System Information::
Interface Count      : 4 (Maximum Interfaces Supported 512)
Group Count          : 0 (Maximum Groups Supported 50)
Inherit Location Count : 0 (Maximum Inherit Locations Supported 10)
Optical Interfaces Count : 4 (Maximum Optical Interfaces Supported 500)

Interface      : GigabitEthernet0/2/0/0, Value Count : 10, Registrations : 2
SRLG Values    : 11, 12, 13, 14, 15
                21, 22, 23, 24, 25
These are announced srlgs.                                     -> Note:

Interface      : GigabitEthernet0/2/0/2, Value Count : 0, Registrations : 1
SRLG Values    :

Interface      : GigabitEthernet0/2/0/4, Value Count : 0, Registrations : 2
SRLG Values    :

Interface      : GigabitEthernet0/2/0/5, Value Count : 0, Registrations : 2
SRLG Values    :

Optical Interface: dwdm0/2/0/0, Value Count : 5, References: 2
SRLG Values      : 11, 12, 13, 14, 15
These are locally configured srlgs for controller (dwdm)     -> Note:

Optical Interface: dwdm0/2/0/1, Value Count : 0, References: 1
SRLG Values      :

Optical Interface: dwdm0/2/0/2, Value Count : 0, References: 1
SRLG Values      :

Optical Interface: dwdm0/2/0/3, Value Count : 0, References: 1
SRLG Values      :
```

Enabling SRLG Announce

Perform this task to enable SRLG announce. SRLG announce can be enabled on both headend and tailend.

SUMMARY STEPS

1. **configure**
2. **mpls traffic-eng**
3. **gmpls optical-uni**
4. **controller dwdm *interface***
5. **announce srlgs**
6. **commit**

DETAILED STEPS

	Command or Action	Purpose
Step 1	configure Example: RP/0/RP0/CPU0:router# configure	Enters Global Configuration mode.

	Command or Action	Purpose
Step 2	mpls traffic-eng Example: RP/0/RP0/CPU0:router(config)# mpls traffic-eng	Enters MPLS-TE configuration mode.
Step 3	gmpls optical-uni Example: RP/0/RP0/CPU0:router(config-mpls-te)# gmpls optical-uni	Enters GMPLS UNI configuration submode.
Step 4	controller dwdm interface Example: RP/0/RP0/CPU0:router(config-te-gmpls-uni)# controller dwdm 0/1/0/1	Enters GMPLS UNI controller submode.
Step 5	announce srlgs Example: RP/0/RP0/CPU0:router(config-te-gmpls-cntl)# announce srlgs	Announces discovered SRLGs to the system.
Step 6	commit	

Verifying SRLG Announce Configuration: Example

The following example shows how to verify SRLG announce configuration:

```
RP/0/0/CPU0:router#show srlg

System Information::
Interface Count      : 2 (Maximum Interfaces Supported 512)
Group Count          : 0 (Maximum Groups Supported 50)
Inherit Location Count : 0 (Maximum Inherit Locations Supported 10)
Optical Interfaces Count : 5 (Maximum Optical Interfaces Supported 500)

Interface      : GigabitEthernet0/2/0/4, Value Count : 0, Registrations : 2
SRLG Values    :

Interface      : GigabitEthernet0/2/0/5, Value Count : 0, Registrations : 2
SRLG Values    :

Interface: GigabitEthernet0/2/0/0, Value Count : 4, References: 1
SRLG Values    : 21, 22, 23, 24

Optical Interface: dwdm0/2/0/0, Value Count : 3, References: 2
SRLG Values    : 11, 12, 13

Optical Interface: dwdm0/2/0/1, Value Count : 0, References: 1
SRLG Values    :
```



```
Optical Interface: dwdm0/2/0/2, Value Count : 0, References: 1
SRLG Values      :
```

```
Optical Interface: dwdm0/2/0/3, Value Count : 0, References: 1
SRLG Values      :
```

Configuring SRLG Diversity

Perform this task to configure SRLG diversity with the best-effort or strict exclusion.

SUMMARY STEPS

1. **configure**
2. **mpls traffic-eng**
3. **attribute-set xro** *name*
4. **exclude** [best-effort | strict] srlg value *number*
5. **exit**
6. **gmpls optical-uni**
7. **controller dwdm** *interface*
8. **announce srlgs**
9. **tunnel-properties**
10. **logging events lsp-status** *state*
11. **tunnel-id** *number*
12. **record srlg**
13. **destination ipv4 unicast** *address*
14. **path-option** *number* **no-ero xro-attribute-set exclude_srlgs lockdown**
15. **commit**

DETAILED STEPS

	Command or Action	Purpose
Step 1	configure Example: RP/0/RP0/CPU0:router# configure	Enters Global Configuration mode.
Step 2	mpls traffic-eng Example: RP/0/RP0/CPU0:router(config)# mpls traffic-eng	Enters MPLS-TE configuration mode.
Step 3	attribute-set xro <i>name</i> Example: RP/0/RP0/CPU0:router(config-te)# attribute-set xro exclude_srlgs	Enters the attribute set submode and specifies the attribute set name.

	Command or Action	Purpose
Step 4	exclude [best-effort strict] srlg value <i>number</i> Example: <pre>RP/0/RP0/CPU0:router(config-te-attribute-set)# exclude best-effort srlg value 21</pre>	Specifies path diversity based on SRLG.
Step 5	exit Example: <pre>RP/0/RP0/CPU0:router(config-te-attribute-set)# exit</pre>	Exits attribute-set submode.
Step 6	gmpls optical-uni Example: <pre>RP/0/RP0/CPU0:router(config-mpls-te)# gmpls optical-uni</pre>	Enters GMPLS UNI configuration submode.
Step 7	controller dwdm <i>interface</i> Example: <pre>RP/0/RP0/CPU0:router(config-te-gmpls-uni)# controller dwdm 0/2/0/0</pre>	Enters GMPLS UNI controller submode.
Step 8	announce srlgs Example: <pre>RP/0/RP0/CPU0:router(config-te-gmpls-cntl)# announce srlgs</pre>	Announces discovered SRLGs to the system.
Step 9	tunnel-properties Example: <pre>RP/0/RP0/CPU0:router(config-te-gmpls-cntl)# tunnel-properties RP/0/RP0/CPU0:router(config-te-gmpls-tun)#</pre>	Enters the submode to configure tunnel-specific information for a GMPLS UNI controller.
Step 10	logging events lsp-status state Example: <pre>RP/0/RP0/CPU0:router(config-te-gmpls-tun)# logging events lsp-status state</pre>	Configure events to generate system log messages when state changes occur on the GMPLS tunnel. If omitted, no events will result in the generation of system log messages.

	Command or Action	Purpose
Step 11	tunnel-id <i>number</i> Example: RP/0/RP0/CPU0:router(config-te-gmpls-tun)# tunnel-id 100	Specifies a tunnel-ID for a headend router of a GMPLS tunnel. The tunnel-ID is a 16-bit number ranging from 0 to 65535.
Step 12	record srlg Example: RP/0/RP0/CPU0:router(config-te-gmpls-tun)# record srlg	Enables SRLG recording.
Step 13	destination ipv4 unicast <i>address</i> Example: RP/0/RP0/CPU0:router(config-te-gmpls-tun)# destination ipv4 unicast 192.168.1.2	Specifies a tunnel destination for a headend router of a GMPLS tunnel. The destination argument is an IPv4 address.
Step 14	path-option <i>number</i> no-ero xro-attribute-set exclude_srlgs lockdown Example: RP/0/RP0/CPU0:router(config-te-gmpls-tun)# path-option 10 no-ero xro-attribute-set exclude_srlgs lockdown	The XRO attribute set is attached to the GMPLS UNI tunnel through the path option. The path-option range is 1 to 1000.
Step 15	commit	

Verifying SRLG Diversity Configuration: Example

The following example shows how to verify SRLG diversity configuration:

```
RP/0/0/CPU0:router#show mpls traffic-eng tunnels 100 detail

Name: GMPLS-UNI-dwdm0_2_0_0 Destination: 192.168.1.2
  Signalled-Name: rtrA_ot100_192.168.1.2
GMPLS UNI tunnel controlling link dwdm0/2/0/0, tunnel-id: 100
Status:
  Admin:    up Oper:    up Path:  valid Signalling: connected

  path option 10, (LOCKDOWN) type no-ero (Basis for Setup, path weight 0)
    XRO attribute-set: exclude_srlgs
      Best-effort, SRLG id 21
  Last Signalled Error : Mon Jul 20 20:55:33 ----
    Info: [5] PathErr(24,67)-(routing, route blocked by exclude route) at 10.10.10.2
  G-PID: 0x0800 (derived from egress interface properties)
  Creation Time: Mon Jul 20 19:32:03 2015 (01:25:19 ago)
Config Parameters:
  Priority: 7 7 Affinity: 0x0/0xffff
  Path Protection: Not Enabled
  BFD Fast Detection: Disabled
  Reoptimization after affinity failure: Enabled
  SRLG discovery: Enabled
```

```

Binding Label: 0
History:
  Tunnel has been up for: 00:00:23 (since Mon Jul 20 20:56:59 EDT 2015)
  Current LSP:
    Uptime: 00:00:23 (since Mon Jul 20 20:56:59 EDT ----)
Current LSP Info:
  Instance: 6
  Uptime: 00:00:23 (since Mon Jul 20 20:56:59 EDT ----)
  Upstream label:
    Optical label:
      Grid           : DWDM
      Channel spacing : 50 GHz
      Identifier      : 0
      Channel Number  : 16
  Downstream label:
    Optical label:
      Grid           : DWDM
      Channel spacing : 50 GHz
      Identifier      : 0
      Channel Number  : 16
  Router-IDs: local      192.168.1.1
              downstream 192.168.1.2
  Soft Preemption: None
  SRLGs: mandatory collection
  Path Info:
    Outgoing:
      No ERO
    Route Exclusions:
      Best-effort, SRLG id 21
      Record Route: Disabled
      Tspec: avg rate=10000 kbits, burst=1000 bytes, peak rate=10000 kbits
      Session Attributes: Local Prot: Not Set, Node Prot: Not Set, BW Prot: Not Set
  Resv Info:
    Record Route:
      IPv4 10.10.10.2, flags 0x0
      SRLGs: 21, 22, 23, 24
      Espec: avg rate=10000 kbits, burst=1000 bytes, peak rate=10000 kbits
  Displayed 1 (of 3) heads, 0 (of 0) midpoints, 0 (of 2) tails
  Displayed 1 up, 0 down, 0 recovering, 0 recovered heads

```

Configuration Examples for GMPLS UNI

These configuration examples are provided for GMPLS UNI:

Configuring Head UNI-C for a GMPLS Tunnel: Example

This example shows the minimal head UNI-C configuration require to establish a GMPLS tunnel:

```

rsvp
  controller dwdm 0/1/0/1
    signalling refresh out-of-band interval 3600
    signalling refresh out-of-band missed 24
  !
mpls traffic-eng
  gmpls optical-uni
    controller dwdm 0/1/0/1
    tunnel-properties

```

!

Configuring LSP Diversity: Example

This example shows the configuration for two diverse LSPs:

```

mpls traffic-eng
  attribute-set xro exclude-tun1
    exclude best-effort lsp source 88.0.0.8 destination 10.0.0.2 tunnel-id 1
  extended-tunnel-id 88.0.0.8
  !
  attribute-set xro exclude-tun2
    exclude strict lsp source 88.0.0.8 destination 10.0.1.2 tunnel-id 2 extended-tunnel-id
  88.0.0.8 lsp-id 2
  !
  gmpls optical-uni
    controller dwdm 0/1/0/0
    tunnel-properties
      logging events lsp-status state
      tunnel-id 1
      destination ipv4 unicast 10.0.0.2
      path-option 10 no-ero xro-attribute-set exclude-tun2
    !
  !
  controller dwdm 0/1/0/1
    tunnel-properties
      logging events lsp-status state
      tunnel-id 2
      destination ipv4 unicast 10.0.1.2
      path-option 10 no-ero xro-attribute-set exclude-tun1
    !
  !
  !
  !

```

Additional References

For additional information related to implementing GMPLS UNI, refer to the following references:

Related Documents

Related Topic	Document Title
GMPLS UNI commands	<i>GMPLS UNI Commands</i> module in <i>MPLS Command Reference for the Cisco CRS Router</i>
MPLS Traffic Engineering commands	<i>MPLS Traffic Engineering commands</i> module in <i>MPLS Command Reference for the Cisco CRS Router</i>
RSVP commands	<i>RSVP commands</i> module in <i>MPLS Command Reference for the Cisco CRS Router</i>
Getting started material	<i>Cisco IOS XR Getting Started Guide for the Cisco CRS Router</i>

Related Topic	Document Title
Information about user groups and task IDs	<i>Configuring AAA Services module in System Security Configuration Guide for Cisco CRS Routers</i>

Standards

Standard	Title
OIF UNI 1.0	<i>User Network Interface (UNI) 1.0 Signaling Specification</i>

MIBs

MIBs	MIBs Link
—	To locate and download MIBs using Cisco IOS XR software, use the Cisco MIB Locator found at the following URL and choose a platform under the Cisco Access Products menu: http://cisco.com/public/sw-center/netmgmt/cmtk/mibs.shtml

RFCs

RFCs	Title
RFC 3471	<i>Generalized Multi-Protocol Label Switching (GMPLS) Signaling Functional Description</i>
RFC 3473	<i>Generalized Multi-Protocol Label Switching (GMPLS) Signaling Resource ReserVation Protocol-Traffic Engineering (RSVP-TE) Extensions</i>
RFC 4208	<i>Generalized Multiprotocol Label Switching (GMPLS) User-Network Interface (UNI): Resource ReserVation Protocol-Traffic Engineering (RSVP-TE) Support for the Overlay Model</i>
RFC 4872	<i>RSVP-TE Extensions in Support of End-to-End Generalized Multi-Protocol Label Switching (GMPLS) Recovery</i>
RFC 4874	<i>Exclude Routes - Extension to Resource ReserVation Protocol-Traffic Engineering (RSVP-TE)</i>
RFC 6205	<i>Generalized Labels for Lambda-Switch-Capable (LSC) Label Switching Routers</i>

Technical Assistance

Description	Link
The Cisco Technical Support website contains thousands of pages of searchable technical content, including links to products, technologies, solutions, technical tips, and tools. Registered Cisco.com users can log in from this page to access even more content.	http://www.cisco.com/techsupport



CHAPTER 8

Implementing MPLS OAM

- [Implementing MPLS OAM, on page 405](#)

Implementing MPLS OAM

MPLS Operations, Administration, and Maintenance (OAM) helps service providers to monitor label-switched paths (LSPs) and quickly isolate MPLS forwarding problems to assist with fault detection and troubleshooting in an MPLS network. This module describes MPLS LSP Ping and Traceroute features which can be used for failure detection and troubleshooting of MPLS networks.

MPLS LSP Ping

The MPLS LSP Ping feature is used to check the connectivity between Ingress LSR and egress LSRs along an LSP. MPLS LSP ping uses MPLS echo request and reply messages, similar to Internet Control Message Protocol (ICMP) echo request and reply messages, to validate an LSP. While ICMP echo request and reply messages validate IP networks, MPLS echo and reply messages validate MPLS networks. The MPLS echo request packet is sent to a target router through the use of the appropriate label stack associated with the LSP to be validated. Use of the label stack causes the packet to be forwarded over the LSP itself. The destination IP address of the MPLS echo request packet is different from the address used to select the label stack. The destination IP address is defined as a 127.x.y.z/8 address and it prevents the IP packet from being IP switched to its destination, if the LSP is broken.

An MPLS echo reply is sent in response to an MPLS echo request. The reply is sent as an IP packet and it is forwarded using IP, MPLS, or a combination of both types of switching. The source address of the MPLS echo reply packet is an address obtained from the router generating the echo reply. The destination address is the source address of the router that originated the MPLS echo request packet. The MPLS echo reply destination port is set to the echo request source port.

The following figure shows MPLS LSP ping echo request and echo reply paths.

Figure 27: MPLS LSP Ping Echo Request and Reply Paths



By default, the `ping mpls ipv4` command tries to determine the Forwarding Equivalence Class (FEC) being used automatically. However, this is only applicable at head-end and works only if the FEC at the destination is same as the source. If the source and destination FEC types are not the same, the `ping mpls ipv4` command may fail to identify the targeted FEC type. You can overcome this limitation by specifying the FEC type in MPLS LSP ping using the `fec-type` command option. If the user is not sure about the FEC type at the transit or the destination, or it may change through network, use of the `generic` FEC type command option is recommended. Generic FEC is not coupled to a particular control plane and allows path verification when the advertising protocol is unknown, or may change during the path of the echo request. If you are aware of the destination FEC type, specify the target FEC as BGP or LDP.

Configuration Examples

This example shows how to use MPLS LSP ping to test the connectivity of an IPv4 LDP LSP. The destination is specified as a Label Distribution Protocol (LDP) IPv4 address.

```
RP/0/RP0/CPU0:router# ping mpls ipv4 10.1.1.2/32 verbose
```

```
Sun Nov 15 11:27:43.070 UTC
```

```
Sending 5, 100-byte MPLS Echos to 10.1.1.2/32,
  timeout is 2 seconds, send interval is 0 msec:
```

```
Codes: '!' - success, 'Q' - request not sent, '.' - timeout,
  'L' - labeled output interface, 'B' - unlabeled output interface,
  'D' - DS Map mismatch, 'F' - no FEC mapping, 'f' - FEC mismatch,
  'M' - malformed request, 'm' - unsupported tlvs, 'N' - no rx label,
  'P' - no rx intf label prot, 'p' - premature termination of LSP,
  'R' - transit router, 'I' - unknown upstream index,
  'X' - unknown return code, 'x' - return code 0
```

```
Type escape sequence to abort.
```

```
!      size 100, reply addr 10.1.0.2, return code 3
!      size 100, reply addr 10.1.0.2, return code 3
!      size 100, reply addr 10.1.0.2, return code 3
!      size 100, reply addr 10.1.0.2, return code 3
!      size 100, reply addr 10.1.0.2, return code 3
```

```
Success rate is 100 percent (5/5), round-trip min/avg/max = 2/2/4 ms
```

In this example, the destination is specified as a Label Distribution Protocol (LDP) IPv4 prefix and Forwarding Equivalence Class (FEC) type is specified as generic.

```
RP/0/RP0/CPU0:router# ping mpls ipv4 10.1.1.2/32 fec-type generic
```

```
Wed Nov 25 03:36:33.143 UTC
```

```
Sending 5, 100-byte MPLS Echos to 10.1.1.2/32,
  timeout is 2 seconds, send interval is 0 msec:
```

```
Codes: '!' - success, 'Q' - request not sent, '.' - timeout,
'L' - labeled output interface, 'B' - unlabeled output interface,
'D' - DS Map mismatch, 'F' - no FEC mapping, 'f' - FEC mismatch,
'M' - malformed request, 'm' - unsupported tlvs, 'N' - no rx label,
'P' - no rx intf label prot, 'p' - premature termination of LSP,
'R' - transit router, 'I' - unknown upstream index,
'X' - unknown return code, 'x' - return code 0
```

Type escape sequence to abort.

```
!!!!!
Success rate is 100 percent (5/5), round-trip min/avg/max = 2/2/3 ms
```

In this example, the destination is specified as a Label Distribution Protocol (LDP) IPv4 prefix and the FEC type is specified as BGP.

```
RP/0/RP0/CPU0:router# ping mpls ipv4 10.1.1.2/32 fec-type bgp
```

```
Wed Nov 25 03:38:33.143 UTC
Sending 5, 100-byte MPLS Echos to 10.1.1.2/32,
  timeout is 2 seconds, send interval is 0 msec:
```

```
Codes: '!' - success, 'Q' - request not sent, '.' - timeout,
'L' - labeled output interface, 'B' - unlabeled output interface,
'D' - DS Map mismatch, 'F' - no FEC mapping, 'f' - FEC mismatch,
'M' - malformed request, 'm' - unsupported tlvs, 'N' - no rx label,
'P' - no rx intf label prot, 'p' - premature termination of LSP,
'R' - transit router, 'I' - unknown upstream index,
'X' - unknown return code, 'x' - return code 0
```

Type escape sequence to abort.

```
!!!!!
Success rate is 100 percent (5/5), round-trip min/avg/max = 2/2/3 ms
```

MPLS LSP Traceroute

The MPLS LSP Traceroute feature is used to isolate the failure point of an LSP. It is used for hop-by-hop fault localization and path tracing. The MPLS LSP Traceroute feature relies on the expiration of the Time to Live (TTL) value of the packet that carries the echo request. When the MPLS echo request message hits a transit node, it checks the TTL value and if it is expired, the packet is passed to the control plane, else the message is forwarded. If the echo message is passed to the control plane, a reply message is generated based on the contents of the request message.

The following figure shows an MPLS LSP traceroute example with an LSP from LSR1 to LSR4.

Figure 28: MPLS LSP Traceroute



By default, the **traceroute mpls ipv4** command tries to determine the Forwarding Equivalence Class (FEC) being used automatically. However, this is only applicable at head-end and works only if the FEC at the destination is the same as the source. If the source and destination FEC types are not the same, the **traceroute mpls ipv4** command may fail to identify the targeted FEC type. You can overcome this limitation by specifying the FEC type in MPLS LSP traceroute using the **fec-type** command option. If the user is not sure about the FEC type at the transit or the destination, or it may change through network, use of the **generic** FEC type command option is recommended. Generic FEC is not coupled to a particular control plane and allows path verification when the advertising protocol is unknown, or may change during the path of the echo request. If you are aware of the destination FEC type, specify the target FEC as BGP or LDP.

Configuration Examples

This example shows how to use the **traceroute** command to trace to a destination.

```
RP/0/RP0/CPU0:router# traceroute mpls ipv4 10.1.1.2/32 destination 127.0.0.3 127.0.0.6 2
Sat Jan 27 03:50:23.746 UTC
```

```
Tracing MPLS Label Switched Path to 10.1.1.2/32, timeout is 2 seconds
```

```
Codes: '!' - success, 'Q' - request not sent, '.' - timeout,
'L' - labeled output interface, 'B' - unlabeled output interface,
'D' - DS Map mismatch, 'F' - no FEC mapping, 'f' - FEC mismatch,
'M' - malformed request, 'm' - unsupported tlvs, 'N' - no rx label,
'P' - no rx intf label prot, 'p' - premature termination of LSP,
'R' - transit router, 'I' - unknown upstream index,
'X' - unknown return code, 'x' - return code 0
```

```
Type escape sequence to abort.
```

```
Destination address 127.0.0.3
 0 10.2.1.2 MRU 1500 [Labels: 24000 Exp: 0]
L 1 10.2.1.1 MRU 1500 [Labels: implicit-null Exp: 0] 8 ms
! 2 10.1.0.2 3 ms
```

```
Destination address 127.0.0.5
 0 10.2.1.2 MRU 1500 [Labels: 24000 Exp: 0]
L 1 10.2.1.1 MRU 1500 [Labels: implicit-null Exp: 0] 5 ms
! 2 10.1.0.2 2 ms
```

This example shows how to use the **traceroute** command and how to specify the maximum number of hops for the traceroute to traverse by specifying the **tth** value.

```

RP/0/RP0/CPU0:router# traceroute mpls ipv4 10.1.1.2/32 ttl 1
Sun Nov 15 12:20:14.145 UTC
Tracing MPLS Label Switched Path to 10.1.1.2/32, timeout is 2 seconds

Codes: '!' - success, 'Q' - request not sent, '.' - timeout,
'L' - labeled output interface, 'B' - unlabeled output interface,
'D' - DS Map mismatch, 'F' - no FEC mapping, 'f' - FEC mismatch,
'M' - malformed request, 'm' - unsupported tlvs, 'N' - no rx label,
'P' - no rx intf label prot, 'p' - premature termination of LSP,
'R' - transit router, 'I' - unknown upstream index,
'X' - unknown return code, 'x' - return code 0

Type escape sequence to abort.

 0 10.1.0.1 MRU 1500 [Labels: implicit-null Exp: 0]
! 1 10.1.0.2 3 ms

```

This example shows how to use the **traceroute** command to trace to a destination and FEC type is specified as generic.

```

RP/0/RP0/CPU0:router# traceroute mpls ipv4 10.1.1.2/32 fec-type generic
Sun Nov 15 12:25:14.145 UTC
Tracing MPLS Label Switched Path to 10.1.1.2/32, timeout is 2 seconds

Codes: '!' - success, 'Q' - request not sent, '.' - timeout,
'L' - labeled output interface, 'B' - unlabeled output interface,
'D' - DS Map mismatch, 'F' - no FEC mapping, 'f' - FEC mismatch,
'M' - malformed request, 'm' - unsupported tlvs, 'N' - no rx label,
'P' - no rx intf label prot, 'p' - premature termination of LSP,
'R' - transit router, 'I' - unknown upstream index,
'X' - unknown return code, 'x' - return code 0

Type escape sequence to abort.
 0 10.12.12.1 MRU 1500 [Labels: implicit-null Exp: 0]
! 1 10.12.12.2 2 ms

```

This example shows how to use the **traceroute** command to trace to a destination and FEC type is specified as BGP.

```

RP/0/RP0/CPU0:router# traceroute mpls ipv4 10.1.1.2/32 fec-type bgp
Sun Nov 15 12:25:14.145 UTC
Tracing MPLS Label Switched Path to 10.1.1.2/32, timeout is 2 seconds

Codes: '!' - success, 'Q' - request not sent, '.' - timeout,
'L' - labeled output interface, 'B' - unlabeled output interface,
'D' - DS Map mismatch, 'F' - no FEC mapping, 'f' - FEC mismatch,
'M' - malformed request, 'm' - unsupported tlvs, 'N' - no rx label,
'P' - no rx intf label prot, 'p' - premature termination of LSP,
'R' - transit router, 'I' - unknown upstream index,
'X' - unknown return code, 'x' - return code 0

Type escape sequence to abort.
 0 10.12.12.1 MRU 1500 [Labels: implicit-null Exp: 0]
! 1 10.12.12.2 2 ms

```

Overview of P2MP TE Network

A Point to Multipoint (P2MP) TE network contains the following elements:

- *Headend Router*

The headend router, also called the source or ingress router, is responsible for initiating the signaling messages that set up the P2MP TE LSP. The headend router can also be a branch point, which means the router performs packet replication and the sub-LSPs split into different directions.

- *Midpoint Router*

The midpoint router is where the sub-LSP signaling is processed. The midpoint router can be a branch point.

- *Tailend Router*

The tailend router, also called the destination, egress, or leaf-node router, is where sub-LSP signaling ends. The router which is one of potentially many destinations of the P2MP TE LSP.

- *Bud Router*

A bud router is a midpoint and tailend router at the same time. An LSR that is an egress LSR, but also has one or more directly connected downstream LSRs.

- *Branch Router*

A branch router is either a midpoint or tailend router at any given time.

- *Transit Router*

A transit router is an LSR that is not an egress router, but also has one or more directly connected downstream routers.

- A P2MP tunnel consists of one or more sub-LSPs. All sub-LSPs belonging to the same P2MP tunnel employ the same constraints, protection policies, and so on, which are configured at the headend router.

Figure 29: Elements of P2MP TE Network illustrates the elements of P2MP TE network.

Figure 29: Elements of P2MP TE Network

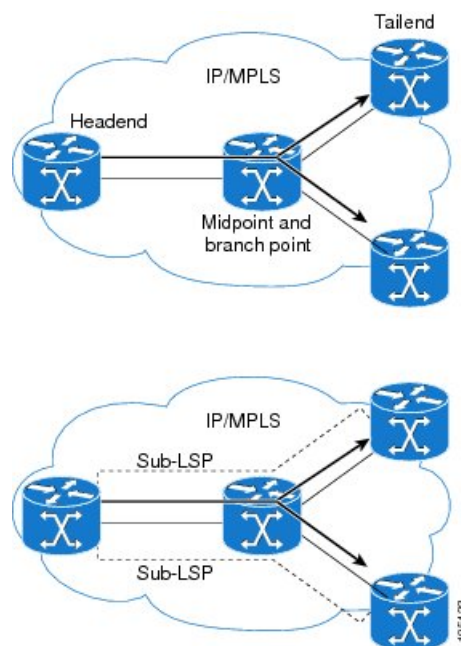

P2MP TE tunnels build on the features that exist in basic point-to-point TE tunnels. The P2MP TE tunnels have the following characteristics:

- There is one source (headend) but more than one destination (tailend).
- They are unidirectional.

- They are explicitly routed.
- Multiple sub-LSPs connect the headend router to various tailend routers.

P2MP Ping

The P2MP ping feature is used to check the connectivity between Ingress LSR and egress LSR, along a P2MP LSP. The Ingress LSR sends the P2MP echo request message along the specified P2MP LSP. All egress LSRs which receive the P2MP echo request message from the ingress LSR must send a P2MP echo reply message to the ingress LSR, according to the reply mode specified in the P2MP echo request message.

P2MP Traceroute

The P2MP traceroute feature is used to isolate the failure point of a P2MP LSP.

Traceroute can be applied to all nodes in the P2MP tree. However, you can select a specific traceroute target through the P2MP Responder Identifier TLV. An entry in this TLV represents a responder-id or a transit node. This is only the case for P2MP TE LSPs.



Note Only P2MP TE LSP IPv4 is supported. If the Responder Identifier TLV is missing, the **echo request** requests information from all responder-ids.

MPLS OAM Support for BGP 3107

The MPLS OAM Support for BGP 3107 feature provides support for ping, traceroute and tree-trace (traceroute multipath) operations for LSPs signaled via BGP for the IPv4 unicast prefix FECs in the default VRF, according to the *RFC 3107 - Carrying Label Information in BGP-4*. This feature adds support for MPLS OAM operations in the seamless MPLS architecture deployments, i.e., combinations of BGP and LDP signaled LSPs.

For more information about ping and traceroute, see *Implementing MPLS OAM* chapter in the *MPLS Configuration Guide for the Cisco CRS Routers*. For more information about ping and traceroute commands, see *MPLS OAM Commands* chapter in the *MPLS Command Reference for the Cisco CRS Router*.

Configuration Examples: P2MP Ping and P2MP Traceroute

This example shows an extract of the P2MP ping command.

```
RP/0/RP0/CPU0:router# ping mpls traffic-eng tunnel-mte 10
Sending 1, 100-byte MPLS Echos to tunnel-mte10,
      timeout is 2.2 seconds, send interval is 0 msec, jitter value is 200 msec:
```

```
Codes: '!' - success, 'Q' - request not sent, '.' - timeout,
       'L' - labeled output interface, 'B' - unlabeled output interface,
       'D' - DS Map mismatch, 'F' - no FEC mapping, 'f' - FEC mismatch,
       'M' - malformed request, 'm' - unsupported tlvs, 'N' - no rx label,
       'P' - no rx intf label prot, 'p' - premature termination of LSP,
       'R' - transit router, 'I' - unknown upstream index,
       'X' - unknown return code, 'x' - return code 0, 'd' - DDMAP
```

Type escape sequence to abort.

```
Request #1
! reply addr 192.168.222.2
! reply addr 192.168.140.2
! reply addr 192.168.170.1

Success rate is 100 percent (3 received replies/3 expected replies),
  round-trip min/avg/max = 154/232/302 ms
```

This example shows an extract of the P2MP ping command with the jitter option.

```
RP/0/RP0/CPU0:router# ping mpls traffic-eng tunnel-mte 10 jitter 300

Sending 1, 100-byte MPLS Echos to tunnel-mte10,
  timeout is 2.3 seconds, send interval is 0 msec, jitter value is 300 msec:

Codes: '!' - success, 'Q' - request not sent, '.' - timeout,
  'L' - labeled output interface, 'B' - unlabeled output interface,
  'D' - DS Map mismatch, 'F' - no FEC mapping, 'f' - FEC mismatch,
  'M' - malformed request, 'm' - unsupported tlvs, 'N' - no rx label,
  'P' - no rx intf label prot, 'p' - premature termination of LSP,
  'R' - transit router, 'I' - unknown upstream index,
  'X' - unknown return code, 'x' - return code 0, 'd' - DDMAP

Type escape sequence to abort.

Request #1
! reply addr 192.168.222.2
! reply addr 192.168.140.2
! reply addr 192.168.170.1

Success rate is 100 percent (3 received replies/3 expected replies),
  round-trip min/avg/max = 148/191/256 ms
```

This example shows an extract of the P2MP ping command with the ddmapp option.

```
RP/0/RP0/CPU0:router# ping mpls traffic-eng tunnel-mte 10 ddmapp

Sending 1, 100-byte MPLS Echos to tunnel-mte10,
  timeout is 2.2 seconds, send interval is 0 msec, jitter value is 200 msec:

Codes: '!' - success, 'Q' - request not sent, '.' - timeout,
  'L' - labeled output interface, 'B' - unlabeled output interface,
  'D' - DS Map mismatch, 'F' - no FEC mapping, 'f' - FEC mismatch,
  'M' - malformed request, 'm' - unsupported tlvs, 'N' - no rx label,
  'P' - no rx intf label prot, 'p' - premature termination of LSP,
  'R' - transit router, 'I' - unknown upstream index,
  'X' - unknown return code, 'x' - return code 0, 'd' - DDMAP

Type escape sequence to abort.

Request #1
! reply addr 192.168.222.2
! reply addr 192.168.140.2
! reply addr 192.168.170.1

Success rate is 100 percent (3 received replies/3 expected replies),
  round-trip min/avg/max = 105/178/237 ms
```



```

RP/0/RP0/CPU0:router# show mpls traffic-eng tunnels p2mp 10
Mon Apr 12 12:13:55.075 EST
Signalling Summary:
    LSP Tunnels Process:  running
        RSVP Process:    running
            Forwarding:  enabled
    Periodic reoptimization: every 3600 seconds, next in 654 seconds
    Periodic FRR Promotion:  every 300 seconds, next in 70 seconds
    Auto-bw enabled tunnels:  0 (disabled)

Name: tunnel-mtel0
Status:
    Admin: up  Oper: up (Up for 12w4d)

Config Parameters:
    Bandwidth: 0 kbps (CT0) Priority: 7 7 Affinity: 0x0/0xffff
    Metric Type: TE (default)
    Fast Reroute: Not Enabled, Protection Desired: None
    Record Route: Not Enabled

Destination summary: (3 up, 0 down, 0 disabled) Affinity: 0x0/0xffff
Auto-bw: disabled
Destination: 10.1.0.1
    State: Up for 12w4d
    Path options:
        path-option 1 dynamic      [active]
Destination: 10.2.0.1
    State: Up for 12w4d
    Path options:
        path-option 1 dynamic      [active]
Destination: 10.3.0.1
    State: Up for 12w4d
    Path options:
        path-option 1 dynamic      [active]

History:
    Reopt. LSP:
        Last Failure:
            LSP not signalled, identical to the [CURRENT] LSP
            Date/Time: Thu Jan 14 02:49:22 EST 2010 [12w4d ago]

Current LSP:
    lsp-id: 10002 p2mp-id: 10 tun-id: 10 src: 10.0.0.1 extid: 10.0.0.1
    LSP up for: 12w4d
    Reroute Pending: No
    Inuse Bandwidth: 0 kbps (CT0)
    Number of S2Ls: 3 connected, 0 signaling proceeding, 0 down

S2L Sub LSP: Destination 10.1.0.1 Signaling Status: connected
    S2L up for: 12w4d
    Sub Group ID: 1 Sub Group Originator ID: 10.1.0.1
    Path option path-option 1 dynamic      (path weight 1)
    Path info (OSPF 1 area 0)
        192.168.222.2
        10.1.0.1

S2L Sub LSP: Destination 10.2.0.1 Signaling Status: connected
    S2L up for: 12w4d
    Sub Group ID: 2 Sub Group Originator ID: 10.0.0.1
    Path option path-option 1 dynamic      (path weight 2)
    Path info (OSPF 1 area 0)
        192.168.222.2
        192.168.140.3

```

```

192.168.140.2
10.2.0.1

S2L Sub LSP: Destination 10.3.0.1 Signaling Status: connected
S2L up for: 12w4d
Sub Group ID: 3 Sub Group Originator ID: 10.0.0.1
Path option path-option 1 dynamic (path weight 2)
Path info (OSPF 1 area 0)
192.168.222.2
192.168.170.3
192.168.170.1
10.3.0.1

Reoptimized LSP (Install Timer Remaining 0 Seconds):
None
Cleaned LSP (Cleanup Timer Remaining 0 Seconds):
None
Displayed 1 (of 16) heads, 0 (of 0) midpoints, 0 (of 0) tails
Displayed 1 up, 0 down, 0 recovering, 0 recovered heads

RP/0/RP0/CPU0:router# ping mpls traffic-eng tunnel-mte 10 lsp id 10002
Mon Apr 12 12:14:04.532 EST

Sending 1, 100-byte MPLS Echos to tunnel-mte10,
timeout is 2.2 seconds, send interval is 0 msec, jitter value is 200 msec:

Codes: '!' - success, 'Q' - request not sent, '.' - timeout,
'L' - labeled output interface, 'B' - unlabeled output interface,
'D' - DS Map mismatch, 'F' - no FEC mapping, 'f' - FEC mismatch,
'M' - malformed request, 'm' - unsupported tlvs, 'N' - no rx label,
'P' - no rx intf label prot, 'p' - premature termination of LSP,
'R' - transit router, 'I' - unknown upstream index,
'X' - unknown return code, 'x' - return code 0, 'd' - DDMAP

Type escape sequence to abort.

Request #1
! reply addr 192.168.222.2
! reply addr 192.168.170.1
! reply addr 192.168.140.2

Success rate is 100 percent (3 received replies/3 expected replies),
round-trip min/avg/max = 128/153/167 ms

```

This example shows an extract of the P2MP ping command with the responder-id.

```

RP/0/RP0/CPU0:router# ping mpls traffic-eng tunnel-mte 10 responder-id 10.3.0.1
Mon Apr 12 12:15:34.205 EST

Sending 1, 100-byte MPLS Echos to tunnel-mte10,
timeout is 2.2 seconds, send interval is 0 msec, jitter value is 200 msec:

Codes: '!' - success, 'Q' - request not sent, '.' - timeout,
'L' - labeled output interface, 'B' - unlabeled output interface,
'D' - DS Map mismatch, 'F' - no FEC mapping, 'f' - FEC mismatch,
'M' - malformed request, 'm' - unsupported tlvs, 'N' - no rx label,
'P' - no rx intf label prot, 'p' - premature termination of LSP,
'R' - transit router, 'I' - unknown upstream index,
'X' - unknown return code, 'x' - return code 0, 'd' - DDMAP

Type escape sequence to abort.

Request #1

```

```
! reply addr 192.168.170.1

Success rate is 100 percent (1 received reply/1 expected reply),
  round-trip min/avg/max = 179/179/179 ms
```

This example shows an extract of the P2MP traceroute command with the ttl option.

```
RP/0/RP0/CPU0:router# traceroute mpls traffic-eng tunnel-mte 10 ttl 4
Mon Apr 12 12:16:50.095 EST

Tracing MPLS MTE Label Switched Path on tunnel-mte10, timeout is 2.2 seconds

Codes: '!' - success, 'Q' - request not sent, '.' - timeout,
'L' - labeled output interface, 'B' - unlabeled output interface,
'D' - DS Map mismatch, 'F' - no FEC mapping, 'f' - FEC mismatch,
'M' - malformed request, 'm' - unsupported tlvs, 'N' - no rx label,
'P' - no rx intf label prot, 'p' - premature termination of LSP,
'R' - transit router, 'I' - unknown upstream index,
'X' - unknown return code, 'x' - return code 0, 'd' - DDMAP

Type escape sequence to abort.

! 1 192.168.222.2 186 ms [Estimated Role: Bud]
  [L] DDMAP 0: 192.168.140.2 192.168.140.2 MRU 1500 [Labels: 16001 Exp: 0]
  [L] DDMAP 1: 192.168.170.1 192.168.170.1 MRU 1500 [Labels: 16000 Exp: 0]

! 2 192.168.222.2 115 ms [Estimated Role: Bud]
  [L] DDMAP 0: 192.168.140.2 192.168.140.2 MRU 1500 [Labels: 16001 Exp: 0]
  [L] DDMAP 1: 192.168.170.1 192.168.170.1 MRU 1500 [Labels: 16000 Exp: 0]
! 2 192.168.140.2 213 ms [Estimated Role: Egress]
! 2 192.168.170.1 254 ms [Estimated Role: Egress]

! 3 192.168.222.2 108 ms [Estimated Role: Bud]
  [L] DDMAP 0: 192.168.140.2 192.168.140.2 MRU 1500 [Labels: 16001 Exp: 0]
  [L] DDMAP 1: 192.168.170.1 192.168.170.1 MRU 1500 [Labels: 16000 Exp: 0]
! 3 192.168.170.1 164 ms [Estimated Role: Egress]
! 3 192.168.140.2 199 ms [Estimated Role: Egress]

! 4 192.168.170.1 198 ms [Estimated Role: Egress]
! 4 192.168.222.2 206 ms [Estimated Role: Bud]
  [L] DDMAP 0: 192.168.140.2 192.168.140.2 MRU 1500 [Labels: 16001 Exp: 0]
  [L] DDMAP 1: 192.168.170.1 192.168.170.1 MRU 1500
```

This example shows an extract of the P2MP traceroute command with the responder-id option.

```
RP/0/RP0/CPU0:router# traceroute mpls traffic-eng tunnel-mte 10 responder-id 10.3.0.1
Mon Apr 12 12:18:01.994 EST

Tracing MPLS MTE Label Switched Path on tunnel-mte10, timeout is 2.2 seconds

Codes: '!' - success, 'Q' - request not sent, '.' - timeout,
'L' - labeled output interface, 'B' - unlabeled output interface,
'D' - DS Map mismatch, 'F' - no FEC mapping, 'f' - FEC mismatch,
'M' - malformed request, 'm' - unsupported tlvs, 'N' - no rx label,
'P' - no rx intf label prot, 'p' - premature termination of LSP,
'R' - transit router, 'I' - unknown upstream index,
'X' - unknown return code, 'x' - return code 0, 'd' - DDMAP

Type escape sequence to abort.
```

```

d 1 192.168.222.2 113 ms [Estimated Role: Branch]
  [L] DDMAP 0: 192.168.140.2 192.168.140.2 MRU 1500 [Labels: 16001 Exp: 0]
  [L] DDMAP 1: 192.168.170.1 192.168.170.1 MRU 1500 [Labels: 16000 Exp: 0]

d 2 192.168.222.2 118 ms [Estimated Role: Branch]
  [L] DDMAP 0: 192.168.140.2 192.168.140.2 MRU 1500 [Labels: 16001 Exp: 0]
  [L] DDMAP 1: 192.168.170.1 192.168.170.1 MRU 1500 [Labels: 16000 Exp: 0]
! 2 192.168.170.1 244 ms [Estimated Role: Egress]

d 3 192.168.222.2 141 ms [Estimated Role: Branch]
  [L] DDMAP 0: 192.168.140.2 192.168.140.2 MRU 1500 [Labels: 16001 Exp: 0]
  [L] DDMAP 1: 192.168.170.1 192.168.170.1 MRU 1500 [Labels: 16000 Exp: 0]
! 3 192.168.170.1 204 ms [Estimated Role: Egress]

d 4 192.168.222.2 110 ms [Estimated Role: Branch]
  [L] DDMAP 0: 192.168.140.2 192.168.140.2 MRU 1500 [Labels: 16001 Exp: 0]
  [L] DDMAP 1: 192.168.170.1 192.168.170.1 MRU 1500 [Labels: 16000 Exp: 0]
! 4 192.168.170.1 174 ms [Estimated Role: Egress]

```

This example shows an extract of the P2MP traceroute command with the jitter option.

```

RP/0/RP0/CPU0:router# traceroute mpls traffic-eng tunnel-mte 10 responder-id 10.3.0.1 ttl
4 jitter 500
Mon Apr 12 12:19:00.292 EST

```

Tracing MPLS MTE Label Switched Path on tunnel-mte10, timeout is 2.5 seconds

```

Codes: '!' - success, 'Q' - request not sent, '.' - timeout,
'L' - labeled output interface, 'B' - unlabeled output interface,
'D' - DS Map mismatch, 'F' - no FEC mapping, 'f' - FEC mismatch,
'M' - malformed request, 'm' - unsupported tlvs, 'N' - no rx label,
'P' - no rx intf label prot, 'p' - premature termination of LSP,
'R' - transit router, 'I' - unknown upstream index,
'X' - unknown return code, 'x' - return code 0, 'd' - DDMAP

```

Type escape sequence to abort.

```

d 1 192.168.222.2 238 ms [Estimated Role: Branch]
  [L] DDMAP 0: 192.168.140.2 192.168.140.2 MRU 1500 [Labels: 16001 Exp: 0]
  [L] DDMAP 1: 192.168.170.1 192.168.170.1 MRU 1500 [Labels: 16000 Exp: 0]

d 2 192.168.222.2 188 ms [Estimated Role: Branch]
  [L] DDMAP 0: 192.168.140.2 192.168.140.2 MRU 1500 [Labels: 16001 Exp: 0]
  [L] DDMAP 1: 192.168.170.1 192.168.170.1 MRU 1500 [Labels: 16000 Exp: 0]
! 2 192.168.170.1 290 ms [Estimated Role: Egress]

d 3 192.168.222.2 115 ms [Estimated Role: Branch]
  [L] DDMAP 0: 192.168.140.2 192.168.140.2 MRU 1500 [Labels: 16001 Exp: 0]
  [L] DDMAP 1: 192.168.170.1 192.168.170.1 MRU 1500 [Labels: 16000 Exp: 0]
! 3 192.168.170.1 428 ms [Estimated Role: Egress]

d 4 192.168.222.2 127 ms [Estimated Role: Branch]
  [L] DDMAP 0: 192.168.140.2 192.168.140.2 MRU 1500 [Labels: 16001 Exp: 0]
  [L] DDMAP 1: 192.168.170.1 192.168.170.1 MRU 1500 [Labels: 16000 Exp: 0]
! 4 192.168.170.1 327 ms [Estimated Role: Egress]

```