



Cisco ASA 5506-X, ASA 5506W-X, and ASA 5506H-X Hardware Installation Guide

First Published: 2015-04-07

Last Modified: 2021-11-22

Americas Headquarters

Cisco Systems, Inc.
170 West Tasman Drive
San Jose, CA 95134-1706
USA
<http://www.cisco.com>
Tel: 408 526-4000
800 553-NETS (6387)
Fax: 408 527-0883

Text Part Number: Online Only

THE SPECIFICATIONS AND INFORMATION REGARDING THE PRODUCTS IN THIS MANUAL ARE SUBJECT TO CHANGE WITHOUT NOTICE. ALL STATEMENTS, INFORMATION, AND RECOMMENDATIONS IN THIS MANUAL ARE BELIEVED TO BE ACCURATE BUT ARE PRESENTED WITHOUT WARRANTY OF ANY KIND, EXPRESS OR IMPLIED. USERS MUST TAKE FULL RESPONSIBILITY FOR THEIR APPLICATION OF ANY PRODUCTS.

THE SOFTWARE LICENSE AND LIMITED WARRANTY FOR THE ACCOMPANYING PRODUCT ARE SET FORTH IN THE INFORMATION PACKET THAT SHIPPED WITH THE PRODUCT AND ARE INCORPORATED HEREIN BY THIS REFERENCE. IF YOU ARE UNABLE TO LOCATE THE SOFTWARE LICENSE OR LIMITED WARRANTY, CONTACT YOUR CISCO REPRESENTATIVE FOR A COPY.

The Cisco implementation of TCP header compression is an adaptation of a program developed by the University of California, Berkeley (UCB) as part of UCB's public domain version of the UNIX operating system. All rights reserved. Copyright © 1981, Regents of the University of California.

NOTWITHSTANDING ANY OTHER WARRANTY HEREIN, ALL DOCUMENT FILES AND SOFTWARE OF THESE SUPPLIERS ARE PROVIDED "AS IS" WITH ALL FAULTS. CISCO AND THE ABOVE-NAMED SUPPLIERS DISCLAIM ALL WARRANTIES, EXPRESSED OR IMPLIED, INCLUDING, WITHOUT LIMITATION, THOSE OF MERCHANTABILITY, FITNESS FOR A PARTICULAR PURPOSE AND NON-INFRINGEMENT OR ARISING FROM A COURSE OF DEALING, USAGE, OR TRADE PRACTICE.

IN NO EVENT SHALL CISCO OR ITS SUPPLIERS BE LIABLE FOR ANY INDIRECT, SPECIAL, CONSEQUENTIAL, OR INCIDENTAL DAMAGES, INCLUDING, WITHOUT LIMITATION, LOST PROFITS OR LOSS OR DAMAGE TO DATA ARISING OUT OF THE USE OR INABILITY TO USE THIS MANUAL, EVEN IF CISCO OR ITS SUPPLIERS HAVE BEEN ADVISED OF THE POSSIBILITY OF SUCH DAMAGES.

Any Internet Protocol (IP) addresses and phone numbers used in this document are not intended to be actual addresses and phone numbers. Any examples, command display output, network topology diagrams, and other figures included in the document are shown for illustrative purposes only. Any use of actual IP addresses or phone numbers in illustrative content is unintentional and coincidental.

All printed copies and duplicate soft copies of this document are considered uncontrolled. See the current online version for the latest version.

Cisco has more than 200 offices worldwide. Addresses and phone numbers are listed on the Cisco website at www.cisco.com/go/offices.

Cisco and the Cisco logo are trademarks or registered trademarks of Cisco and/or its affiliates in the U.S. and other countries. To view a list of Cisco trademarks, go to this URL: <https://www.cisco.com/c/en/us/about/legal/trademarks.html>. Third-party trademarks mentioned are the property of their respective owners. The use of the word partner does not imply a partnership relationship between Cisco and any other company. (1721R)

© 2015-2021 Cisco Systems, Inc. All rights reserved.



CONTENTS

CHAPTER 1

Overview 1

About the ASA 5506-X, ASA 5506W-X, and ASA 5506H-X	1
Package Contents	3
Front Panel	4
Rear Panel	5
LEDs	8
Network Ports	10
Console Ports	10
Internal and External Flash Storage	11
Solid State Drive	11
Power Supply Modules	11
Hardware Specifications	12
Power Cord Specifications	13

CHAPTER 2

Installation Preparation 19

Installation Warnings	19
Position the ASA	20
Mount and Deployment Preparation for the ASA 5506W-X	21
Safety Recommendations	21
Maintain Safety with Electricity	22
Prevent ESD Damage	22
Site Environment	22
Site Considerations	23
Power Supply Considerations	23
Rack Configuration Considerations	23

CHAPTER 3	Mount the Chassis	25
	Desktop-Mount the Chassis	25
	Wall-Mount the Chassis	26
	Rack-Mount the Chassis	27
	Install the ASA 5506H-X in a DIN Rail	32

CHAPTER 4	Connect to the Console Port	35
	Connect to the Console Port with Microsoft Windows	35
	Connect to the Console Port with Mac OS X	38
	Connect to the Console Port with Linux	38

CHAPTER 5	Installation, Maintenance, and Upgrade	41
	Connect the DC Adapter for the 5506H-X	41



CHAPTER 1

Overview

- [About the ASA 5506-X, ASA 5506W-X, and ASA 5506H-X, on page 1](#)
- [Package Contents, on page 3](#)
- [Front Panel, on page 4](#)
- [Rear Panel, on page 5](#)
- [LEDs, on page 8](#)
- [Network Ports, on page 10](#)
- [Console Ports, on page 10](#)
- [Internal and External Flash Storage, on page 11](#)
- [Solid State Drive, on page 11](#)
- [Power Supply Modules, on page 11](#)
- [Hardware Specifications, on page 12](#)
- [Power Cord Specifications, on page 13](#)

About the ASA 5506-X, ASA 5506W-X, and ASA 5506H-X

The Cisco ASA 5506-X, ASA 5506W-X, and ASA 5506H-X adaptive security appliances are part of the ASA 5500-X of next-generation mid-range ASAs and are built on the same security platform as the rest of the ASA family.



Note Your ASA 5506-X ships with either ASA or Firepower Threat Defense software preinstalled. To reimage your device, see [Reimage the Cisco ASA or Firepower Threat Defense Device](#).

This next-generation ASA delivers unprecedented levels of defense against threats to the network with deeper web inspection and flow-specific analysis, improved secure connectivity via end-point security posture validation, and voice and video over VPN support. It also provides enhanced support for intelligent information networks through improved network integration, resiliency, and scalability.

This ASA is a smaller form-factor chassis, intended primarily for desktop or wall-mounting, although one or two can be mounted in a single rack shelf. The ASA has a standard 1 RU chassis. See [Cisco ASA 5500-X Series Next-Generation Firewalls](#) to compare the performance metrics and capabilities of the 5500-X ASAs.

Figure 1: Do Not Stack the ASA Chassis

Note Do not stack the ASA chassis on top of another ASA chassis. If you stack the units, they will overheat, which causes the units to power cycle.

The ASA 5506-X, 5506W-X, and ASA 5506H-X have been validated for the following security standards certifications:

- Federal Information Processing Standards (FIPS) 140-2 for ASA 9.12.x
- Common Criteria (CC) certification for the Network Device Collaborative Protection Profile, (NDcPPv2.1), VPN Gateway Module (VPNGW_MOD_v1.0), and Firewall Module (FW_MOD_v1.3) for ASA 9.12.x
- Common Criteria (CC) certification for the Network Device Collaborative Protection Profile, (NDcPPv2.2E), the IPS Extended Profile (IPSEP 2.11), Firewall Collaborative Protection Profile Module (MOD_FW_v1.4e), and Virtual Private Network Gateway Protection Profile Module (MOD_VPNGW_v1.1) for FTD 6.4.x

ASA 5506W-X Wireless Features

The ASA 5506W-X supports two high-performing spatial stream rates over a deployable distance with high reliability when serving clients. The ASA 5506W-X contains two simultaneous dual-band radios (2.4-GHz and 5-GHz 802.11n MIMO radios) in a controller-based mode or autonomous mode. It has integrated internal antennas that support full interoperability with leading 802.11n clients. The radio hardware supports Unified, FlexConnect, and Monitor-mode.

The ASA 5506W-X has the following processor features:

- 128 MB NAND flash size
- 1 MB NOR flash size
- 128 MB DDR2 memory bus, x32

The 2.4 GHz and 5 GHz 802.11n radios have the following features:

- 802.11n standard compliant
- A-MPDU TX
- HT Duplicate Mode

- 2TX x 2RX
- 2-spatial streams, 300 Mbps PHY rate
- Maximal ratio combining (MRC)
- Cyclic Shift Diversity (CSD)
- MCS0-MCS15; Short or Long Guard Intervals
- DFS for UNII-2 and UNII-2 Extended channels, including 0.5us radar pulse detection

The ASA 5506W-X is configured with four single-band, inverted-F antennas (two 2.4-GHz and two 5-GHz), which are evenly spaced inside the top of the chassis. Peak gains are approximately 3 dBi in the 2.4-GHz band and 5 dBi in the 5-GHz band.

ASA 5506H-X Features

The ASA 5506H-X is a hardened version of the 5506-X with a ruggedized chassis, power supply, SSD, and four ports instead of eight. It is ruggedized because it supports a much wider industrial operational temperature range (-20C to 60C), meets the harsh EMI and environmental criteria for the IEC1613 and IEC 61850-3 power substation standards, and meets IEC60529 IP40 for ingress protection.

The ASA 5506H-X ships with a ruggedized 5V-5.3V barrel power supply that provides 22 W. Or you can order an optional DC power supply that supplies 24V DC (part number PWR2-20W-24VDC) or 20W 20-60V DC (part number PWR2-22W-20-60VDC).



Note Before beginning any of the procedures described in this book, be sure to read the [Regulatory and Compliance Safety Information](#) for the Cisco ASA 5506-X series and follow proper safety procedures.

Package Contents

The following figure shows the package contents for the ASA 5506-X and ASA 5506W-X. Note that the contents are subject to change and your exact contents might contain additional or fewer items.

Figure 2: ASA 5506-X and 5506W-X Package Contents

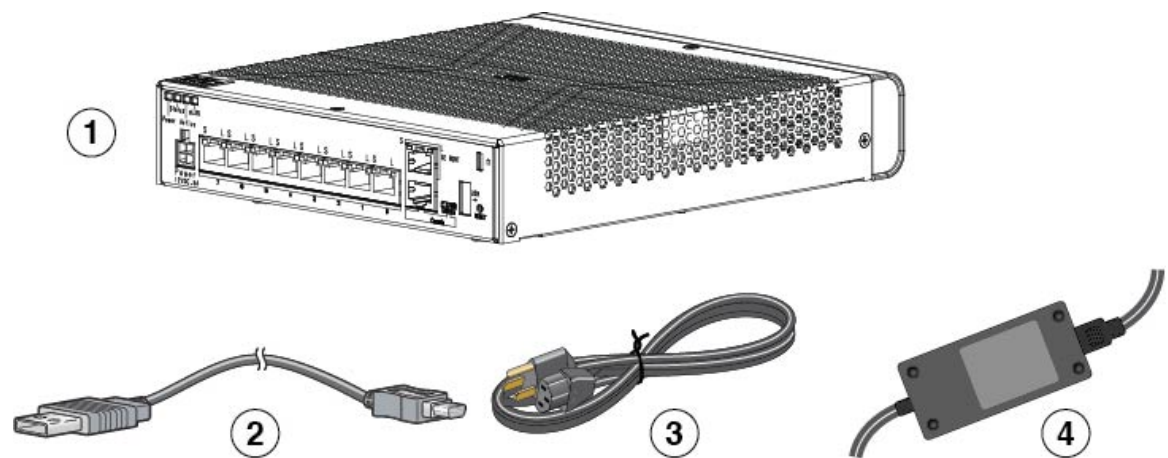

1	Chassis	2	USB console cable (Type A to Type B)
3	Power cord	4	Brick power supply

The following figure shows the package contents for the ASA 5506H-X. Note that the contents are subject to change and your exact contents might contain additional or fewer items.

Figure 3: ASA 5506H-X Package Contents

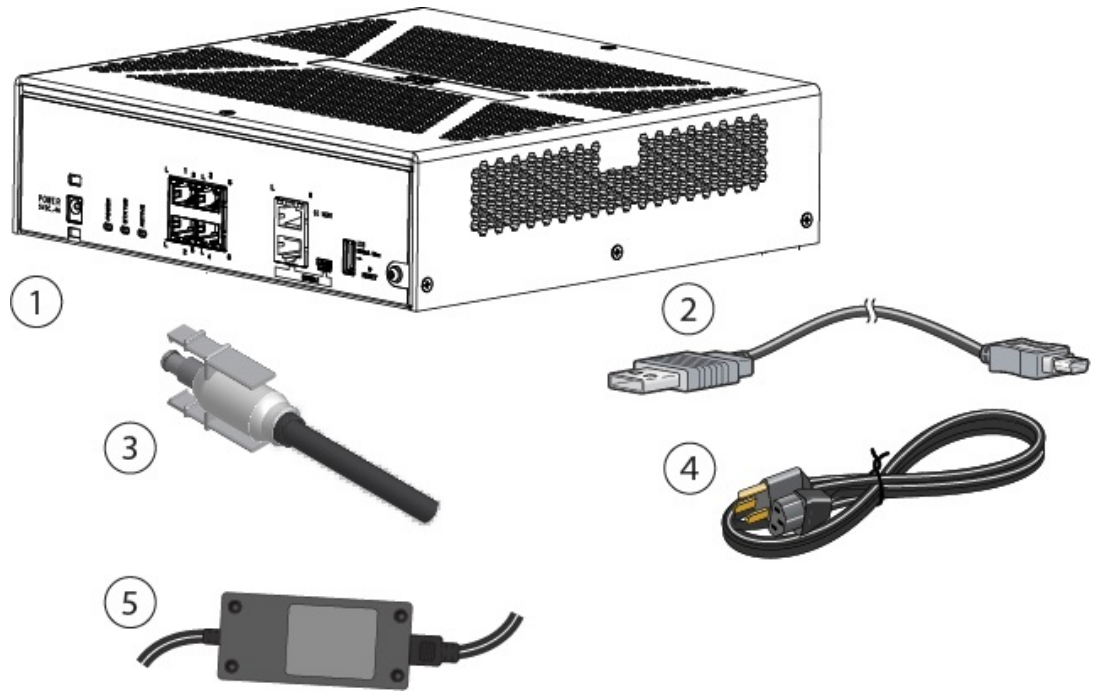

1	Chassis	2	USB console cable (Type A to Type B)
3	Power cord retention lock	4	Power cord
5	Power supply		—

Front Panel

The following figure shows the front panel of the ASA 5506-X. The ASA 5506W-X has an identical front panel. Note that there are no connectors or LEDs on the front panel.

Figure 4: 5506-X and 5506W-X Front Panel

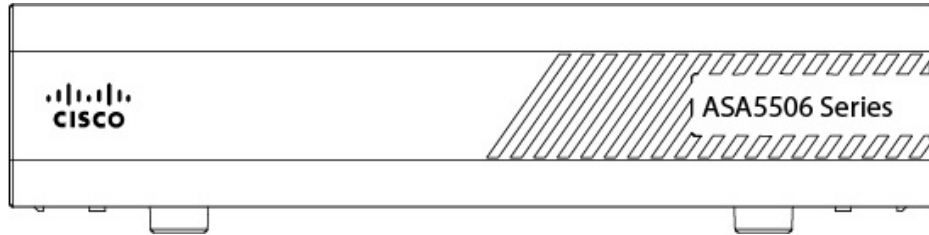

The following figure shows the front panel of the ASA 5506H-X. Note that there are no connectors or LEDs on the front panel.

Figure 5: 5506H-X Front Panel



Rear Panel

The following figure shows the rear panel of the ASA 5506-X. The 5506W-X has an identical rear panel.

Figure 6: ASA 5506-X and 5506W-X Rear Panel

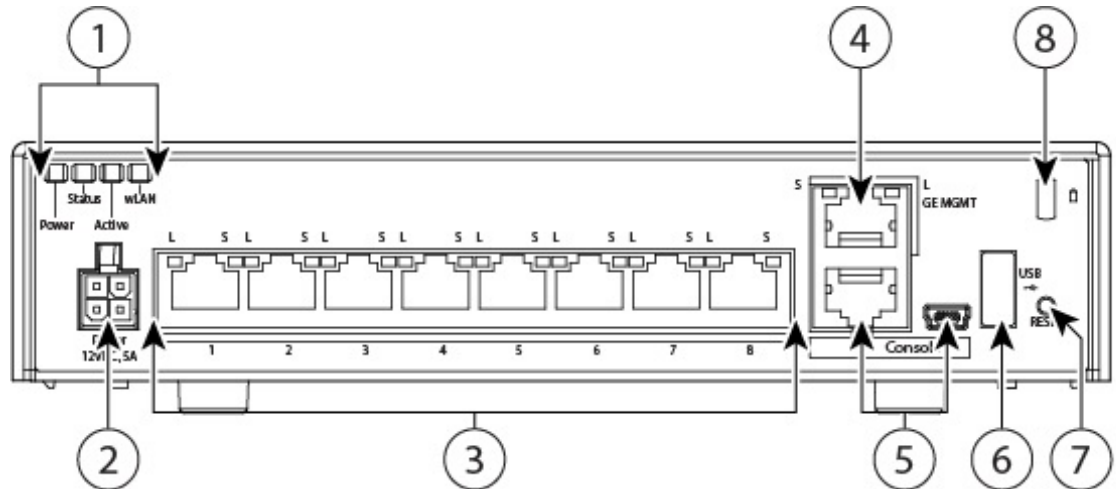

<p>1 Status LEDs</p> <p>The locations and meanings of the status LEDs are described in LEDs, on page 8.</p>	<p>2 Power cord socket</p> <p>The chassis power-supply socket. See Power Supply Modules, on page 11 for more information about the chassis power supply.</p> <p>Note The ASA is powered on when you plug in the AC power supply.</p>
<p>3 Network data ports</p> <p>Eight Gigabit Ethernet RJ-45 (8P8C) network I/O interfaces. The ports are numbered (from left to right) 1, 2, 3, 4, 5, 6, 7, 8. Each port includes a pair of LEDs, one each for connection status and link status. The ports are named and numbered Gigabit Ethernet 1/1 through Gigabit Ethernet 1/8. See Network Ports, on page 10 for additional information.</p>	<p>4 Management port</p> <p>A Gigabit Ethernet interface restricted to network management access only. Connect with an RJ-45 cable.</p>
<p>5 Console ports</p> <p>Two serial ports, a mini USB Type B, and a standard RJ-45 (8P8C), are provided for management access via an external system. See Console Ports, on page 10 for additional information.</p>	<p>6 USB port</p> <p>A standard USB Type A port is provided that allows the attachment of an external device, such as mass storage. See Internal and External Flash Storage, on page 11 for additional information.</p>
<p>7 Reset button</p> <p>A small recessed button that if pressed for longer than three seconds resets the ASA to its default “as-shipped” state following the next reboot. Configuration variables are reset to factory default. However, the flash is not erased and no files are removed.</p> <p>Note You can use the service sw-reset-button command to disable the reset button. The default is enabled.</p> <p>Note Pressing the reset button on the ASA 5506W-X does not affect the AP configuration, but it causes any unsaved AP configuration to be lost, because the system has rebooted. After the system reboots, if you want a default AP configuration, use the hw-module module wlan recover configuration command to recover the AP configuration.</p>	<p>8 Lock slot</p> <p>The slot accepts a standard Kensington T-bar locking mechanism for securing the ASA.</p>

The following figure shows the rear panel of the 5506H-X.

Figure 7: ASA 5506H-X Rear Panel

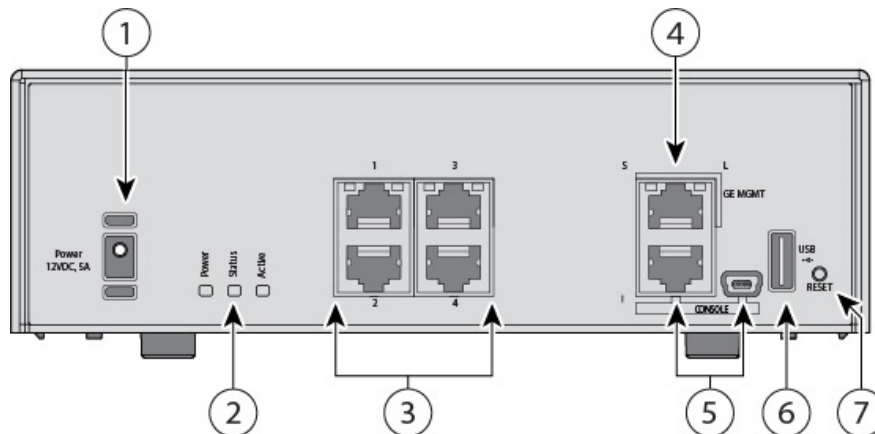

<p>1 Power cord socket</p> <p>The chassis power-supply socket; see Power Supply Modules, on page 11 for more information about the chassis power supply.</p> <p>Note The ASA is powered on when you plug in the AC power supply.</p>	<p>2 Status LEDs</p> <p>The locations and meanings of the status LEDs are described in LEDs, on page 8.</p>
<p>3 Network data ports</p> <p>Four Gigabit Ethernet RJ-45 (8P8C) network I/O interfaces. The ports are numbered (from top to bottom) 1, 2, 3, 4,. Each port includes a pair of LEDs, one each for connection status and link status. The ports are named and numbered Gigabit Ethernet 1/1 through Gigabit Ethernet 1/4. See Network Ports, on page 10 for additional information.</p>	<p>4 Management port</p> <p>A Gigabit Ethernet interface restricted to network management access only. Connect with an RJ-45 cable.</p>
<p>5 Console ports</p> <p>Two serial ports, a standard RJ-45 (8P8C), and a mini USB Type B, are provided for management access via an external system. See Console Ports, on page 10 for additional information.</p>	<p>6 USB port</p> <p>A standard USB Type A port is provided that allows the attachment of an external device, such as mass storage. See Internal and External Flash Storage, on page 11 for additional information.</p>

<p>7 Reset button</p> <p>A small recessed button that if pressed for longer than three seconds resets the ASA to its default “as-shipped” state following the next reboot. Configuration variables are reset to factory default. However, the flash is not erased and no files are removed.</p> <p>Note You can use the service sw-reset-button command to disable the reset button. The default is enabled.</p>	
---	--

LEDs

Facing the rear of the ASA 5506-X and ASA 5506W-X chassis, the LEDs are located on the top left edge (facing the front of the chassis, they are in the back right corner of the top). Facing the rear of the ASA 5506H-X, the LEDs are located on the bottom left of the chassis. The network port LEDs are at the top sides of each network port. See [Rear Panel, on page 5](#) for more information.

The following figure shows the LEDs on the top left edge.

Figure 8: LEDs

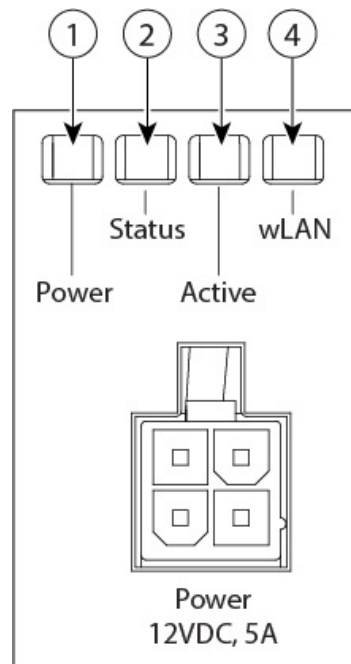

1	<p>Power</p> <p>Power supply status:</p> <ul style="list-style-type: none"> • Unlit—Power supply off. • Green—Power supply on. <p>See Power Supply Modules, on page 11 for additional power information specific to your specific ASA.</p>	2	<p>Status</p> <p>System operating status:</p> <ul style="list-style-type: none"> • Green—Normal system function. • Amber—Critical alarm indicating one or more of the following: <ul style="list-style-type: none"> • Major failure of a hardware or software component. • Over-temperature condition. • Power voltage outside the tolerance range.
3	<p>Active</p> <p>Status of the failover pair:</p> <ul style="list-style-type: none"> • Green—Failover pair operating normally. The LED is green always unless the ASA in an HA pair. • Amber—When the ASA is in an HA pair, the LED is amber for the Standby unit. • Unlit—Failover is not operational. 	4	<p>wLAN</p> <p>Not in use on the ASA 5506-X or the ASA 5506-H.</p> <p>Association status of the wireless connection on the ASA 5506W-X:</p> <ul style="list-style-type: none"> • Green, flashing—Normal operating condition, but no wireless client is present. • Green—Normal operating condition, at least one wireless client is associated. • Amber, flashing—Software upgrade in progress. • Green, red, amber sequence—Discovery/join process in progress. • Red, flashing —Ethernet link not operational. • Unlit—Wireless is not operational.

Network Port Status

On the rear panel of the ASA 5506-X and ASA 5506W-X, a pair of LEDs (link status and connection status) for each of the eight Gigabit Ethernet network ports, and the Gigabit Ethernet management port.

On the rear panel of the ASA 5506H-X, a pair of LEDs (link status and connection status) for each of the four Gigabit Ethernet network ports, and the Gigabit Ethernet Management port.

Link status (L):

- Unlit—No link, or port is not in use.
- Green—Link established.
- Green, flashing—Link activity.

Connection-speed status (S):

- One flash every three seconds—10 Mbps.
- Two rapid flashes—100 Mbps.
- Three rapid flashes—1000 Mbps.

Network Ports

There are eight 10/100/1000 baseT Ethernet network ports on the ASA 5506-X and ASA 5506W-X. Each RJ-45 (8P8C) copper port supports auto MDI/X as well as auto-negotiation for interface speed, duplex, and other negotiated parameters, and are MDI/MDIX compliant.

In addition, the ASA 5506W-X has a Gigabit Ethernet 1/9 port that is internal and connects to the WLAN module.

The ASA 5506H-X has four 10/100/1000 baseT Ethernet network ports. Each RJ-45 (8P8C) copper port supports auto MDI/X as well as auto-negotiation for interface speed, duplex, and other negotiated parameters, and are MDI/MDIX compliant.

Looking at the rear of the ASA 5506-X and ASA 5506W-X, where the ports are located, port 1 is on the left, and port 8 is on the right, next to the console and management ports. Each port is accompanied by a pair of LEDs, one each for link status (L) and connection status (S). The ports are named and numbered Gigabit Ethernet 1/1 through Gigabit Ethernet 1/8. The ports are named and numbered Gigabit Ethernet 1/1 through Gigabit Ethernet 1/4.

The four ports on the ASA 5506H-X are numbered differently. Looking at the rear of the ASA 5506H-X where the ports are located, ports 1 and 3 are at the top from left to right. Ports 2 and 4 are on the bottom from left to right. The ports are between the Status LEDs and the console and management ports. The ports are named and numbered Gigabit Ethernet 1/1 through Gigabit Ethernet 1/4.

Console Ports

The ASA has two external console ports, a standard RJ-45 port and a Mini USB Type B serial port. Only one console port can be active at a time. When a cable is plugged into the USB console port, the RJ-45 port becomes inactive. Conversely, when the USB cable is removed from the USB port, the RJ-45 port becomes active. The console ports do not have any hardware flow control. You can use the command-line interface (CLI) to configure your ASA through either serial console port by using a terminal server or a terminal emulation program on a computer.

In addition, the AP module inside the ASA 5506W-X has a console port, which is accessible by sessioning to the module's console via the **session wlan console** command in the ASA CLI.

RJ-45 Port

The RJ-45 (8P8C) port supports RS-232 signaling to an internal UART controller. The RJ-45 console port does not support a remote dial-in modem. You can use a standard management cable (Cisco part number 72-3383-01) to convert the RJ45-to-DB9 connection if necessary.

Mini USB Type B Port

The Mini USB Type B port lets you connect to a USB port on an external computer. For Linux and Macintosh systems, no special driver is required. For Windows systems, you must download and install

a USB driver (available on software.cisco.com). You can plug and unplug the USB cable from the console port without affecting Windows HyperTerminal operations. We recommend shielded USB cables with properly terminated shields. Baud rates for the USB console port are 1200, 2400, 4800, 9600, 19200, 38400, 57600, and 115200 bps.



Note For Windows operating systems, you must install a Cisco Windows USB Console Driver on any PC connected to the console port before using the USB console port. See [Connect to the Console Port with Microsoft Windows, on page 35](#) for information on installing the driver.

Internal and External Flash Storage

The ASA contains one internal USB flash drive, and a standard USB Type A port that you can use to attach an external device. The USB port can provide output power of 5 volts, up to a maximum of 500 mA (5 USB power units).

Internal USB Device

An embedded eUSB device is used as the internal flash; it is identified as *disk0*.

External USB Drive (Optional)

You can use the external Type A USB port to attach a data-storage device. The external USB drive identifier is *disk1*. When the ASA is powered on, a connected USB drive is mounted as *disk1* and is available for you to use. Additionally, the file-system commands that are available to *disk0* are also available to *disk1*, including **copy**, **format**, **delete**, **mkdir**, **pwd**, **cd**, and so on.

If you insert a USB drive with more than one partition, only the first partition is mounted.

FAT-32 File System

The ASA only supports FAT-32-formatted file systems for the internal eUSB and external USB drives. If you insert an external USB drive that is not in FAT-32 format, the system mounting process fails, and you receive an error message. You can enter the command **format disk1**: to format the partition to FAT-32 and mount the partition to *disk1* again; however, data might be lost.

Solid State Drive

The ASA 5506-X and ASA 5506W-X ship with an SSD installed that provides storage support. The SSD has 50 GB of useable space and is not field-replaceable. You must return the entire ASA to Cisco for drive replacement. The SSD is used by the software; there is no user access to the SSD.

The ASA 5506H-X ships with a ruggedized SSD installed that provides storage support. The SSD is an industrial-rated part so that it operates over the extended temperature range that the ASA 5506H-X supports. The SSD has 50 GB of useable space and is not field-replaceable. You must return the entire ASA to Cisco for drive replacement. The SSD is used by the software; there is no user access to the SSD.

Power Supply Modules

The ASA 5506-X and ASA 5506W-X ship with a 12-V brick power supply that provides 60 W.

The ASA 5506H-X ships with a ruggedized 5-V to 5.3-V barrel power supply that provides 22 W. The power supply supports an extended temperature range of -25 to 60°C. Or you can order an optional DC power supply that supplies 24 V DC (part number PWR2-20W-24VDC) or 20 W 20-60 V DC (part number PWR2-22W-20-60VDC).

Hardware Specifications

The following table contains hardware specifications for the ASA.

Mounting	<ul style="list-style-type: none"> • Desk mountable; see Desktop-Mount the Chassis, on page 25 for more information. <p>Caution Do not stack the ASA chassis on top of another ASA chassis. If you stack the units, they overheat, which causes the units to power cycle.</p> <ul style="list-style-type: none"> • Rack mountable in a rack tray. You can place two chassis side by side. See Rack-Mount the Chassis, on page 27 for more information. <p>Note One ASA 5506H-X fits in the rack tray. See Rack-Mount the Chassis, on page 27 for more information.</p> <ul style="list-style-type: none"> • Wall mountable (ASA 5506-X and ASA 5506W-X only); see Wall-Mount the Chassis, on page 26 for more information. • DIN rail mountable (ASA 5506H-X only); the DIN rail is available for order from Cisco Systems. See Install the ASA 5506H-X in a DIN Rail, on page 32.
Dimensions	<p>7.87 x 9.23 x 1.94 inches (19.99 x 23.44 x 4.93 cm) including the feet (ASA 5506-X and ASA 5506W-X).</p> <p>9.1 x 9.1 x 2.8 inches (23.11 x 23.11 x 7.11 cm) including the feet (ASA 5506H-X).</p>
Weight	<p>4 lb (ASA 5506-X and ASA 5506W-X)</p> <p>6.7 lb (ASA 5506H-X)</p>
DRAM	<p>Total: 4 GB</p> <p>Allotted to FW/VPN: 1.8 GB</p> <p>Allotted to Module: 2.2 GB</p> <p>Note The total memory is divided between the OS/Lina/SFR. These percentages may vary depending on your ASA software version.</p>
Internal flash	8 GB
Power	<p>60 W (ASA 5506-X and ASA 5506W-X)</p> <p>22 W (5506H-X)</p>

Temperature	Operating: 32 to 104°F (0 to 40°C) (ASA 5506-X and ASA 5506W-X) ¹ -4 to 140°F (-20 to 60°C) (ASA 5506H-X) ² Nonoperating: -13 to 158°F (-25 to 70°C) (ASA 5506-X and ASA 5506W-X) -40 to +185°F (-40 to +85° C) (ASA 5506H-X)
Relative humidity	Operating: 90% (ASA 5506-X and ASA 5506W-X) Operating: 95% (ASA 5506H-X) Nonoperating: 10 to 90%
Maximum altitude	Operating: 10,000 ft (3048 m) Nonoperating: 15,000 ft (4572 m)
IP rating	IP40 per IEC60529 (ASA 5506H-X)
Extended vibe and shock	IEEE1613, IEC60068-2, IEC 61850-3 (ASA 5506H-X)

¹ Derate the maximum operating temperature 1.5 degrees C per 1000 ft above sea level.

² Derate the maximum operating temperature 1.5 degrees C per 1000 ft above 6,000 feet elevation.

Power Cord Specifications



Note This section applies only to the ASA 5506-X and ASA 5506W-X. It does *not* apply to the ASA 5506H-X.

Each power supply has a separate power cord. Standard power cords are available for connection to the security appliance.

If you do not order the optional power cord with the system, you are responsible for selecting the appropriate power cord for the product. Using an incompatible power cord with this product may result in electrical safety hazard. Orders delivered to Argentina, Brazil, and Japan must have the appropriate power cord ordered with the system.



Note Only the approved power cords provided with the security appliance are supported. The following table lists the supported power cords.

The following illustrations show the cord, connector, and plug for each country listed in the table above.

Figure 9: Argentina (CAB-ACR)

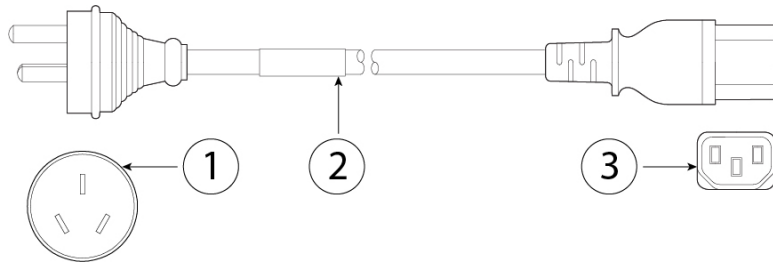

1	Plug: IRAM 2073	2	Cord set rating: 10 A, 250 V
3	Connector: IEC 60320/C13		—

Figure 10: Australia (CAB-ACA)

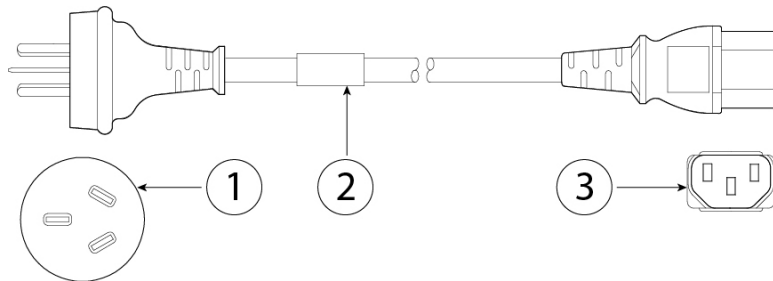

1	Plug: A.S. 3112	2	Cord set rating: 10 A, 250 V
3	Connector: IEC 60320/C13		—

Figure 11: Brazil (CAB-C13-ACB)

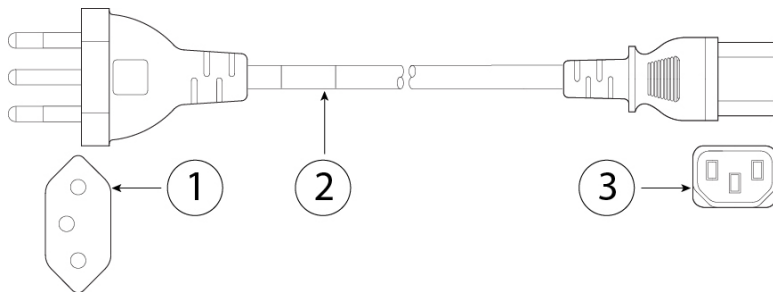

1	Plug: NBR 14136	2	Cord set rating: 10 A, 250 V
3	Connector: IEC 60320/C13		—

Figure 12: China (CAB-ACC)

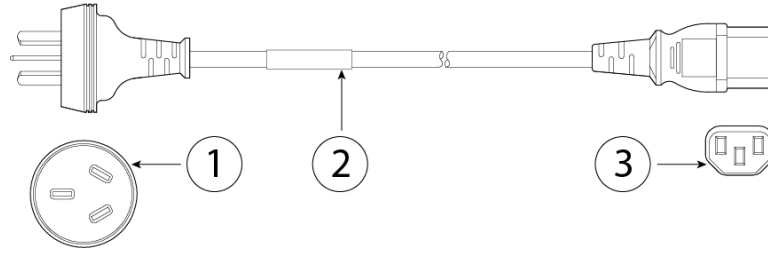

1	Plug: GB2009.1-2008	2	Cord set rating: 10 A, 250 V
3	Connector: IEC 60320/C13		—

Figure 13: Europe (CAB-ACE)

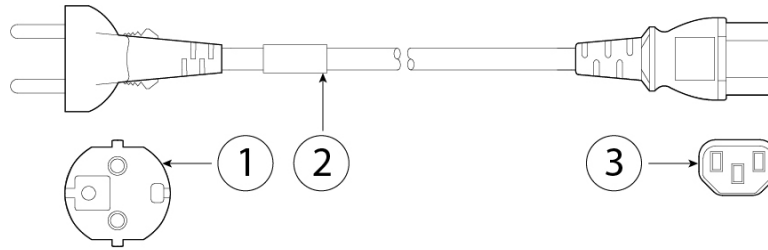

1	Plug: CEE 7 VII	2	Cord set rating: 10 A, 250 V
3	Connector: IEC 60320/C13		—

Figure 14: India (CAB-IND-10A)

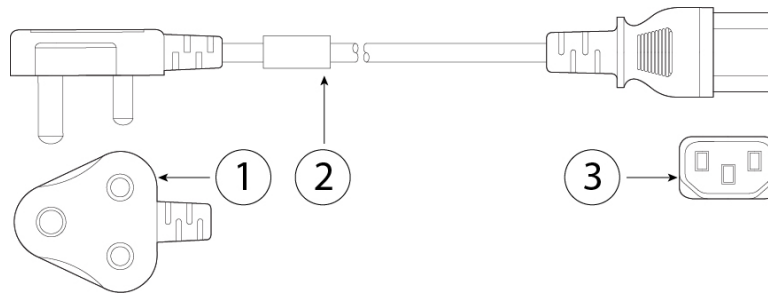

1	Plug: IS 6538-1971	2	Cord set rating: 10 A, 250 V
3	Connector: IEC 60320/C13		—

Figure 15: Italy (CAB-ACI)

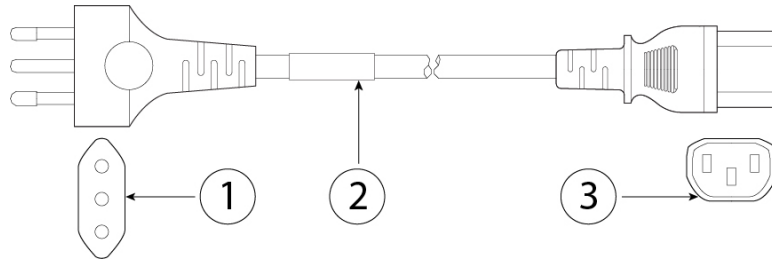

1	Plug: CE123-16-VII	2	Cord set rating: 10 A, 250 V
3	Connector: IEC 60320/C13		—

Figure 16: Japan (CAB-JPN-3PIN)

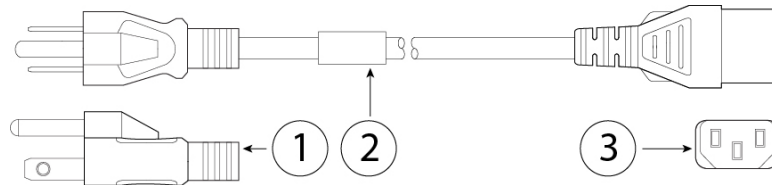

1	Plug: JIS C8303	2	Cord set rating: 12 A, 125 V
3	Connector: IEC 60320/C13		—

Figure 17: Korea (CAB-AC-C13-KOR)

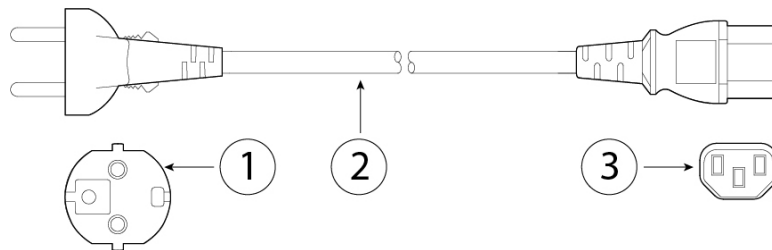

1	Plug: KSC8305	2	Cord set rating: 10 A, 250 V
3	Connector: IEC 60320/C13		—

Figure 18: North America (CAB-AC)

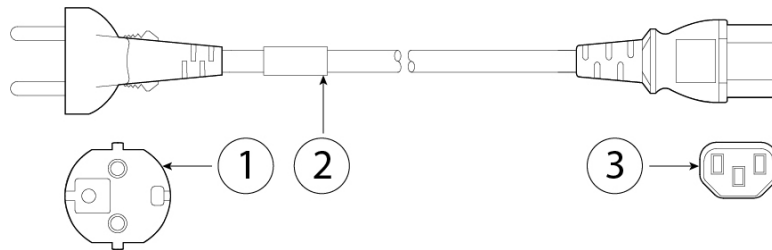

1	Plug: NEMA 5-15P	2	Cord set rating: 10 A, 125 V
3	Connector: IEC 60320/C13		—

Figure 19: South Africa (AIR-PWR-CORD-SA)

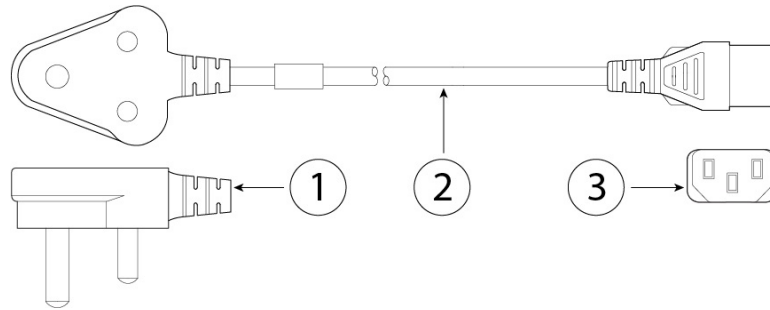

1	Plug: SABS 1661	2	Cord set rating: 10 A, 250 V
3	Connector: IEC 60320/C13		—

Figure 20: Switzerland (CAB-ACS)

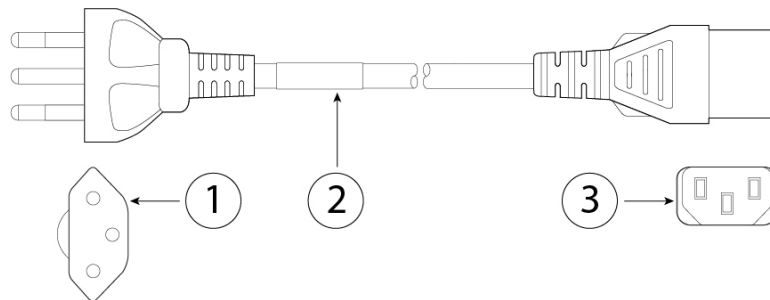

1	Plug: SEV 1011	2	Cord set rating: 10 A, 250 V
3	Connector: IEC 60320/C13		—

Figure 21: Taiwan (CAB-ACTW)

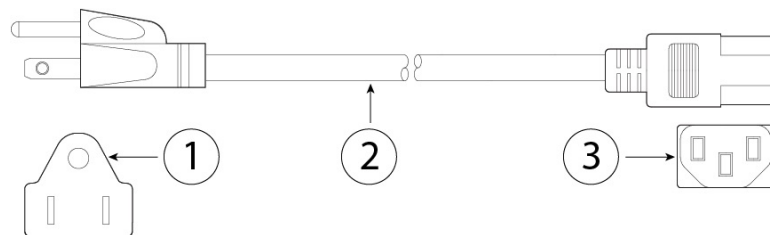

1	Plug: CNS10917	2	Cord set rating: 10 A, 250 V
3	Connector: IEC 60320/C13		—

Figure 22: United Kingdom (CAB-ACU)

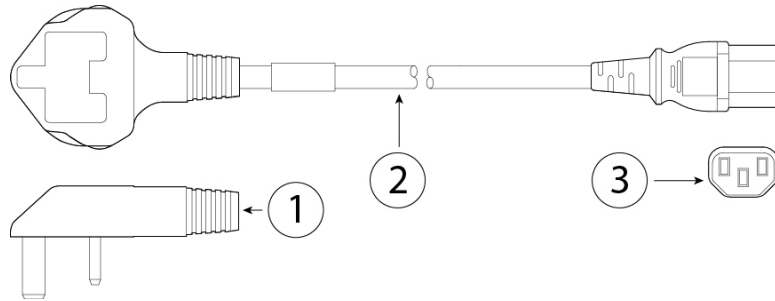

1	Plug: BS1363a/SS145	2	Cord set rating: 10 A, 250 V
3	Connector: IEC 60320/C13		—



CHAPTER 2

Installation Preparation

- [Installation Warnings, on page 19](#)
- [Position the ASA, on page 20](#)
- [Mount and Deployment Preparation for the ASA 5506W-X, on page 21](#)
- [Safety Recommendations, on page 21](#)
- [Maintain Safety with Electricity , on page 22](#)
- [Prevent ESD Damage , on page 22](#)
- [Site Environment , on page 22](#)
- [Site Considerations, on page 23](#)
- [Power Supply Considerations, on page 23](#)
- [Rack Configuration Considerations, on page 23](#)

Installation Warnings

Be sure to read the [Regulatory Compliance and Safety Information](#) document before installing the ASA.

Take note of the following warnings:



Warning

Read the installation instructions before using, installing, or connecting the system to the power source.



Warning

Before working on a chassis or working near power supplies, unplug the power cord on AC units. Disconnect the power at the circuit breaker on DC units.



Warning

Before working on equipment that is connected to power lines, remove jewelry including rings, necklaces, and watches. Metal objects heat up when connected to power and ground and can cause serious burns or weld the metal object to the terminals.



Warning

During this procedure, wear grounding wrist straps to avoid ESD damage to the card. Do not directly touch the backplane with your hand or any metal tool, or you could shock yourself.



Warning This product requires short-circuit (overcurrent) protection to be provided as part of the building installation. Install only in accordance with national and local wiring regulations.



Warning To avoid electric shock, do not connect safety extra-low voltage (SELV) circuits to telephone-network voltage (TNV) circuits. LAN ports contain SELV circuits, and WAN ports contain TNV circuits. Some LAN and WAN ports both use RJ-45 connectors. Use caution when connecting cables.



Warning This equipment must be grounded. To reduce the risk of electric shock, never defeat the ground conductor or operate the equipment in the absence of a suitably installed ground conductor. Contact the appropriate electrical inspection authority or an electrician if you are uncertain that suitable grounding is available.



Warning Ultimate disposal of this product should be handled according to all national laws and regulations.



Warning To reduce risk of electric shock or fire, installation of the equipment must comply with local and national electrical codes.



Warning The device is designed to work with TN power systems.

Position the ASA

Figure 23: Do Not Stack the Chassis



**Caution**

Do not stack the ASA chassis on top of another ASA chassis. If you stack the units, they will overheat, which causes the units to power cycle.

Whether positioning the ASA on a desktop, on a nonrack closet shelf, or mounting it on a wall, consider the following:

- Be sure to choose an area where the ASA is out of the way to make sure it is not bumped or accidentally dislodged. The appliance has “feet” on the bottom so it does not sit flush where placed, thus allowing proper air circulation through and around it. Make sure that the appliance is not tightly enclosed or crowded by other objects that might impede proper circulation.
- Choose a location that lets you easily bring the power cord and Ethernet and console cables to the ASA, with plenty of slack and yet tucked away, so they cannot be inadvertently unplugged.

Mount and Deployment Preparation for the ASA 5506W-X

Before you mount and deploy the ASA 5506W-X, we recommend that you perform a site survey (or use the site planning tool) to determine the best location to install your wireless ASA.

Make sure you have the following information about your wireless network available:

- ASA 5506W-X locations
- ASA 5506W-X mounting options (see [Position the ASA, on page 20](#) for mounting options)
- ASA 5506W-X power options

**Note**

We recommend that you make a site map showing the ASA 5506W-X locations so you can record the device MAC addresses from each location and provide them to the person who is planning or manage your wireless network.

Safety Recommendations

Observe these safety guidelines:

- Keep the area clear and dust-free before, during, and after installation.
- Keep tools away from walkways, where you and others might trip over them.
- Do not wear loose clothing or jewelry, such as earrings, bracelets, or chains that could get caught in the chassis.
- Wear safety glasses if you are working under any conditions that might be hazardous to your eyes.
- Do not perform any action that creates a potential hazard to people or makes the equipment unsafe.
- Never attempt to lift an object that is too heavy for one person.

Maintain Safety with Electricity

**Warning**

Before working on a chassis, be sure the power cord is unplugged.

Follow these guidelines when working on equipment powered by electricity:

- Before beginning procedures that require access to the interior of the chassis, locate the emergency power-off switch for the room in which you are working. Then, if an electrical accident occurs, you can act quickly to turn off the power.
- Do not work alone if potentially hazardous conditions exist anywhere in your work space.
- Never assume that power is disconnected; always check.
- Look carefully for possible hazards in your work area, such as moist floors, ungrounded power extension cables, frayed power cords, and missing safety grounds.
- If an electrical accident occurs:
 - Use caution; do not become a victim yourself.
 - Disconnect power from the system.
 - If possible, send another person to get medical aid. Otherwise, assess the condition of the victim, and then call for help.
 - Determine whether the person needs rescue breathing or external cardiac compressions; then take appropriate action.
- Use the chassis within its marked electrical ratings and product usage instructions.

Prevent ESD Damage

ESD occurs when electronic components are improperly handled, and it can damage equipment and impair electrical circuitry, resulting in intermittent or complete failure.

Always follow ESD-prevention procedures when removing and replacing components. Ensure that the chassis is electrically connected to an earth ground. Wear an ESD-preventive wrist strap, ensuring that it makes good skin contact. Connect the grounding clip to an unpainted surface of the chassis frame to safely ground ESD voltages. To properly guard against ESD damage and shocks, the wrist strap and cord must operate effectively. If no wrist strap is available, ground yourself by touching the metal part of the chassis.

For safety, periodically check the resistance value of the antistatic strap, which should be between one and 10 megohms.

Site Environment

You can place the chassis on a desktop, mount it on a wall, or on a rack shelf. The location of the chassis and the layout of the equipment rack or wiring room are extremely important for proper system operation. Placing

equipment too close together with inadequate ventilation and inaccessible panels can cause system malfunctions and shutdowns. Improper placement can also make it difficult for you to access the chassis for maintenance.

**Warning**

Under no circumstances should you stack more than one chassis on top of one another. This disrupts cooling air flow to the ASAs and causes damage to the hardware.

See [Hardware Specifications, on page 12](#) for information about physical specifications.

When planning the site layout and equipment locations, consider the information in the next section to help avoid equipment failures and reduce the possibility of environmentally caused shutdowns. If you are currently experiencing shutdowns or unusually high error rates with your existing equipment, these considerations may help you isolate the cause of failures and prevent future problems.

Site Considerations

Considering the following helps you plan an acceptable operating environment for the chassis, and avoid environmentally caused equipment failures.

- Electrical equipment generates heat. Ambient air temperature might not be adequate to cool equipment to acceptable operating temperatures without adequate circulation. Ensure that the room in which you operate your system has adequate air circulation.
- Ensure that the chassis cover is secure. The chassis is designed to allow cooling air to flow effectively within it. An open chassis allows air leaks, which may interrupt and redirect the flow of cooling air from the internal components.
- Always follow the ESD-prevention procedures described previously to avoid damage to equipment. Damage from static discharge can cause immediate or intermittent equipment failure.

Power Supply Considerations

When installing the chassis, consider the following:

- Check the power at the site before installing the chassis to ensure that it is “clean” (free of spikes and noise). Install a power conditioner, if necessary, to ensure proper voltages and power levels in the appliance input voltage.
- Install proper grounding for the site to avoid damage from lightning and power surges.
- The chassis does not have a user-selectable operating range. Refer to the label on the chassis for the correct appliance input-power requirement.
- Install an uninterruptible power source for your site, if possible.

Rack Configuration Considerations

Consider the following when planning an equipment-rack configuration:

- If you are mounting a chassis in an open rack, make sure that the rack frame does not block the intake or exhaust ports.
- The rack-mounting posts need to be 2 to 3.5 mm thick to work with the slide rail rack mounting.
- Front and rear doors—If your rack includes closing front and rear doors, the doors must have 65 percent open perforated area evenly distributed from top to bottom to permit adequate airflow.
- Be sure enclosed racks have adequate ventilation. Make sure that the rack is not overly congested as each chassis generates heat. An enclosed rack should have louvered sides and a fan to provide cooling air.
- In an enclosed rack with a ventilation fan in the top, heat generated by equipment near the bottom of the rack can be drawn upward and into the intake ports of the equipment above it in the rack. Ensure that you provide adequate ventilation for equipment at the bottom of the rack.
- Baffles can help to isolate exhaust air from intake air, which also helps to draw cooling air through the chassis. The best placement of the baffles depends on the airflow patterns in the rack. Experiment with different arrangements to position the baffles effectively.



CHAPTER 3

Mount the Chassis



Note Do not remove the rubber feet included with the ASA because they are needed for proper cooling for all mounting orientations.

- [Desktop-Mount the Chassis, on page 25](#)
- [Wall-Mount the Chassis, on page 26](#)
- [Rack-Mount the Chassis, on page 27](#)
- [Install the ASA 5506H-X in a DIN Rail, on page 32](#)

Desktop-Mount the Chassis

You can mount the chassis on a desktop by placing it on a desk in a horizontal position. Make sure there are no blockages or obstructions within one inch of the top of the chassis or within .5 inch of the sides and back, so that nothing interferes with cooling. Do not remove the rubber feet included with the chassis. They are also needed for proper cooling.

Figure 24: Do Not Stack the Chassis



Caution Do not stack the chassis on top of another chassis. If you stack the units, they overheat, which causes the units to power cycle.

Wall-Mount the Chassis

Follow these steps to mount the chassis on a wall. You can purchase a wall-mount kit. The part number for the wall-mount kit is ASA5506-WALL-MNT= .

Step 1 Choose a location on the wall for the chassis.

Step 2 Use the two Cisco-provided screws and anchors from the optional wall-mount kit.

If you are mounting the chassis onto something other than drywall, such as wood or sheet metal, anchors may not be required.

Step 3 Use a pencil, ruler, and level to mark locations for the two mounting screws.

The width and length of the chassis are 7.87 x 9.23 inches (20 x 23.44 cm). The mounting holes in the chassis are in the middle length-wise (that is, 6.372 inches from front and back), while the holes are inset from the opposite edges 0.75 inches (1.9 cm).

Thus, you need to make two level marks 6.37, or approximately 6-3/8, inches (16.18 cm) apart.

Figure 25: Mark the Locations of the Two Mounting Screws

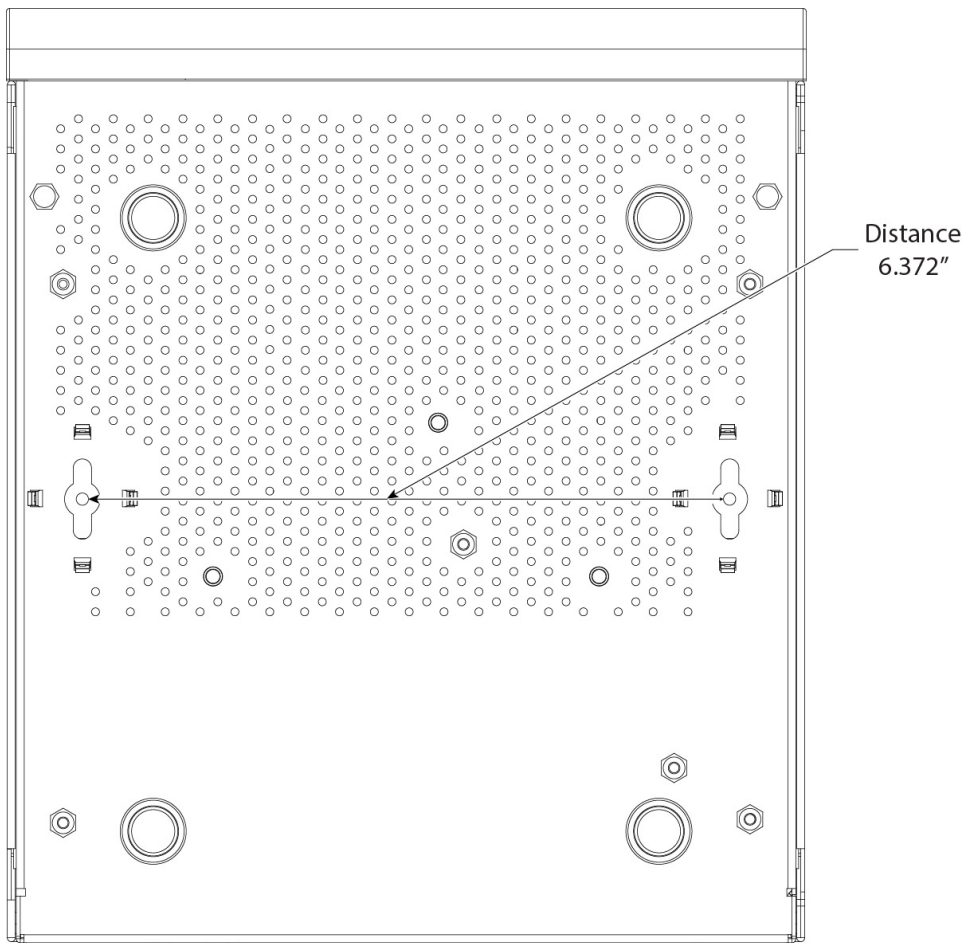

- Step 4** Drill a hole into the wall at each mark.
These holes should be slightly smaller in diameter than your anchors. The recommended drill hole size is 3/16".
- Step 5** Insert the anchors into the holes and be sure they are properly seated.
- Step 6** Fasten each screw into its anchor until it protrudes about 1/4 inch.
- Step 7** Pick up the chassis, align the screws in the anchors with the holes in the bottom of the chassis, move the chassis toward the wall until the screw heads are in the chassis, and then slide the chassis down until it rests on the screws.
You can only mount the chassis with the front panel oriented toward either the ceiling or the floor. Wall mounting in other orientation is not supported.

What to do next

Install the cables as described in [Quick Start Guide](#) for your default software configuration.

Rack-Mount the Chassis

The rack-shelf kit (part number 800-107605-01) contains the following items:



Note There are two sets of four screws that you can use to secure the chassis to your rack. Chose the screws that fit your rack.

- Rack shelf (part number 700-122662-01)
- Two sliding rack trays (part number 800-107648-01)
- Two cable guides (part number 700-122664-01)
- Twelve Phillips M3 x 7-mm screws (part number 48-1921-01); use these screws to install the cable guides.
- Four Phillips 12-24 x 0.75-inch screws (part number 48-0440-01); depending on your rack type, use these screws to secure the sliding-rack tray to your rack.
- Four Phillips 10-32 x 0.75-inch screws (part number 48-0441-01); depending on your rack type, use these screws to secure the sliding-rack tray to your rack.



Note You need six Phillips 6-32 x 0.25-inch screws (part number 48-0421-01) to secure the sliding rack tray onto the chassis. These screws may be in the kit, but if not, you must provide them. Also there will be six extra Phillips M3 x 7-mm screws. Do not use these to secure the sliding rack onto the chassis, because these screws are bigger and will not be as tight.



Note You mount only one ASA 5506H-X in the rack-mount shelf.
 The dimensions of the ASA 5506H-X are 3.46 x 18.3 x 19.5 inches (8.79 x 46.48 x 49.52 cm). The PID is asa5506h-rack-mnt=.

Step 1 Install the cable guides on the rack shelf:

Figure 26: Attach the Cable Guides to the Rack Shelf Flange

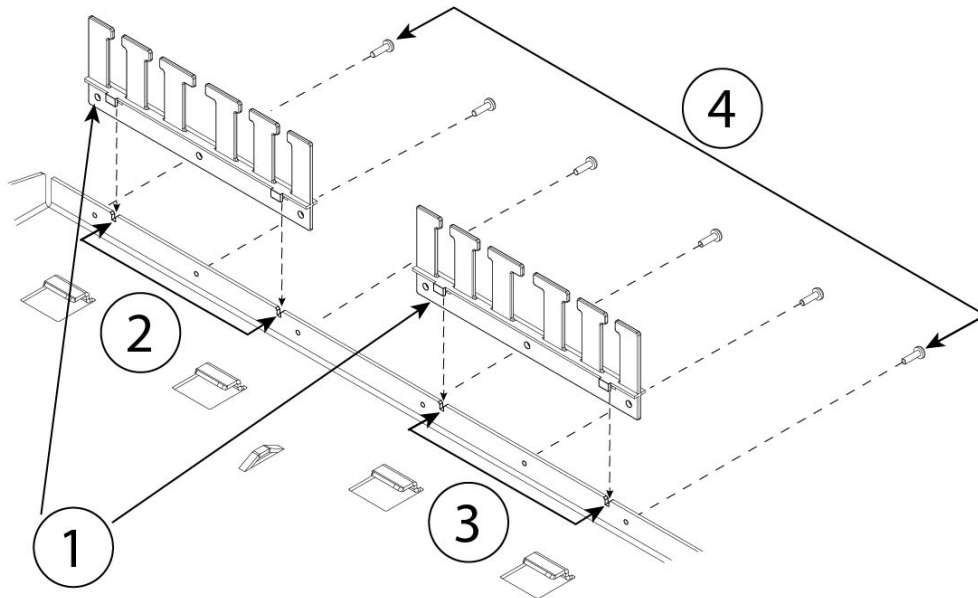

1	Two cable guides (part number 700-122664-01)	Left cable guide rack shelf cutouts
3	Right cable guide rack shelf cutouts	4 Six of the twelve Phillips M3 x 7-mm screws (part number 48-1921-01)

- a) Align the cable guides with the cutouts on the rack shelf flange (see figure above).
- b) At the rear of the rack shelf, attach the left and right cable guides using six of the twelve Phillips M3 x 7-mm screws (part number 48-1921-01).

Note Drive the screws in while facing the back of the rack shelf.

- c) Set the rack shelf aside. Continue with Step 2 to install the sliding rack tray on the chassis.

The figure in Step 8 shows the rack shelf with the cable guides attached.

Step 2 Place the chassis with the top facing down on a large, stable work area.

Step 3 Invert the sliding rack tray and position it on the chassis. You can mount the chassis with the front or rear panel facing front.

Figure 27: Install the Sliding Rack Tray on the Chassis

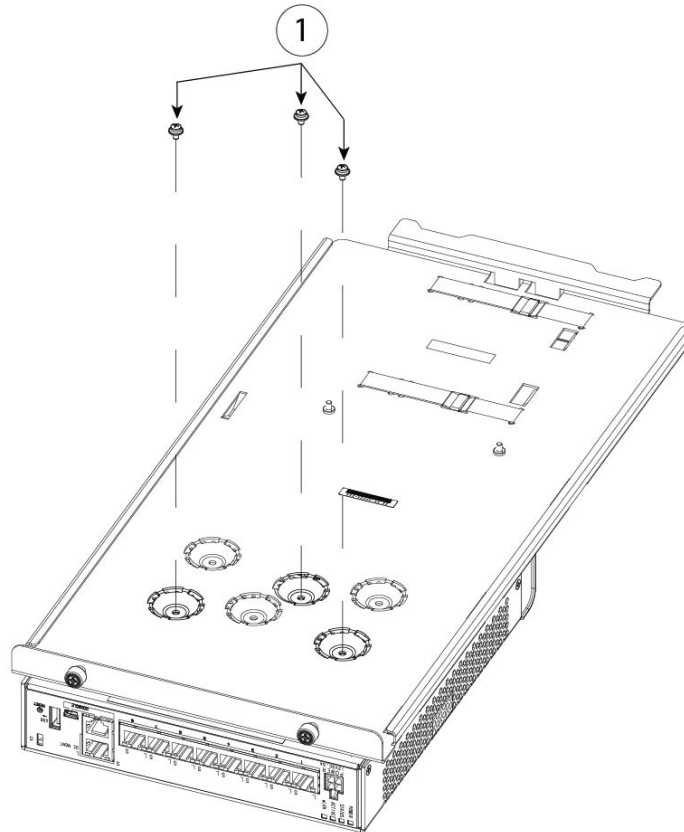

1	Three of the six 6-32 x 0.25-inch screws (part number 48-0421-01) (you may have to provide these)	—
----------	---	---

- Step 4** Adjust the position of the chassis and the sliding rack tray until the three mounting holes in the dimples in the bottom of the sliding rack tray are aligned with the mounting holes in the bottom of the chassis.
- Step 5** Tighten the screws to lock the chassis into place on the sliding rack tray.
- Step 6** Carefully turn the sliding rack tray right-side up.
- Step 7** Install the power supply on the sliding rack tray behind the chassis.

Figure 28: Install the Power Supply in the Sliding Rack Tray

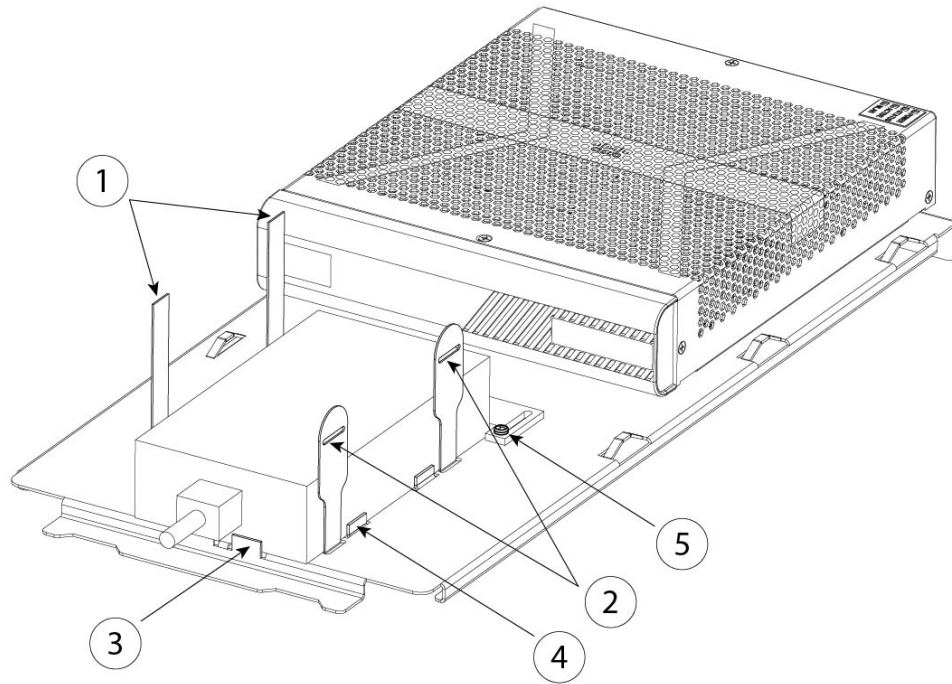

1	Velcro straps for power supply	2	Velcro straps for power supply
3	Power supply stop	4	Power supply stop
5	Rear sliding stop and screw (one of two screws on the sliding stop)		—

- a) Loosen the Velcro straps and place the power supply on the sliding rack tray behind the chassis. Make sure the AC inlet cord faces the rear.
- b) Align the power supply to the side and rear stops.
If the rear sliding stop is not touching the power supply, loosen the two screws, slide the stop up to touch the power supply, and then retighten screws.
- c) Re-engage the Velcro straps and tighten them to secure the power supply.

Figure 29: Tighten the Velcro Straps

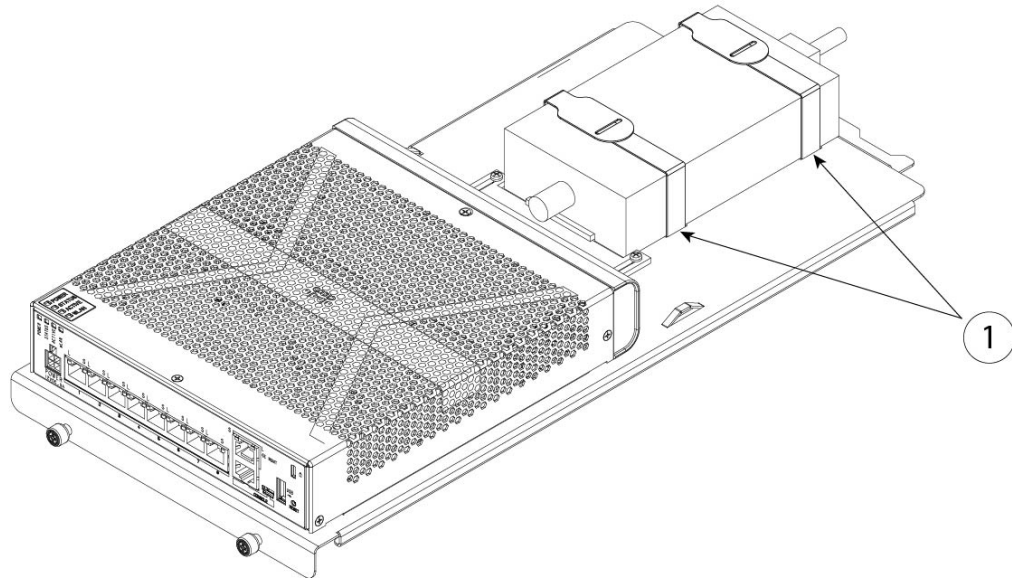

1	Velcro straps tightened over power supply	—
----------	---	---

Step 8

Slide the sliding-rack tray into the rack shelf.

Figure 30: Slide the Sliding-Rack into the Tray Rack Shelf

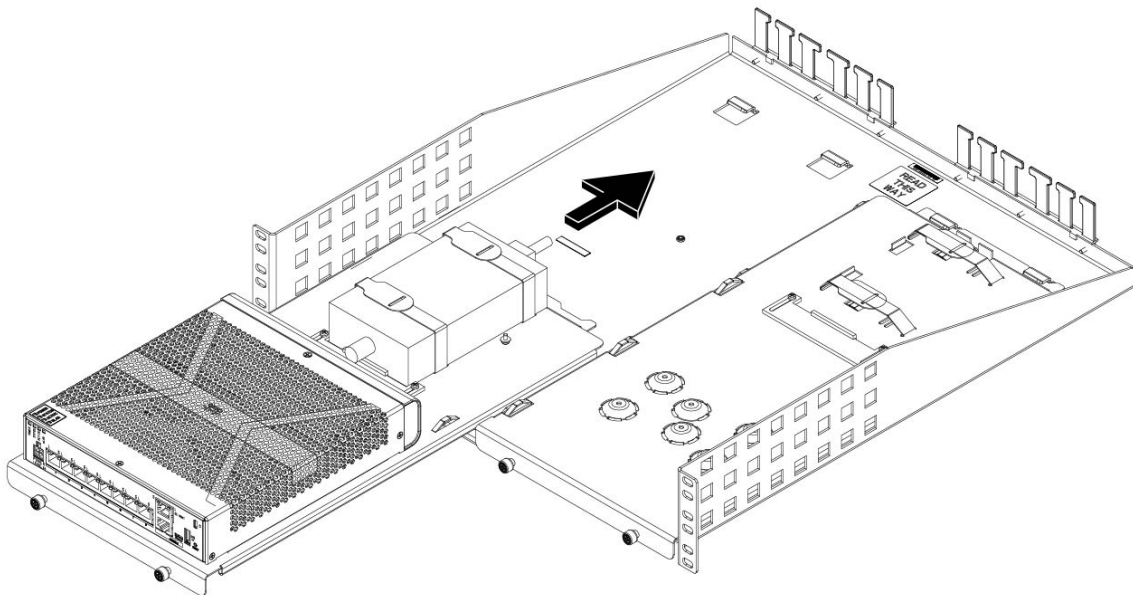

Step 9

The chassis is now installed in the sliding-rack tray, which is installed in the rack shelf. Repeat Steps 1 through 8 to install a second chassis. Use the second sliding rack tray and three more 6-32 x 0.25-inch screws to install a second chassis to sliding rack tray and then onto the rack shelf (see Step 3).

Figure 31: Completed Sliding Rack Tray in Rack Shelf Installation

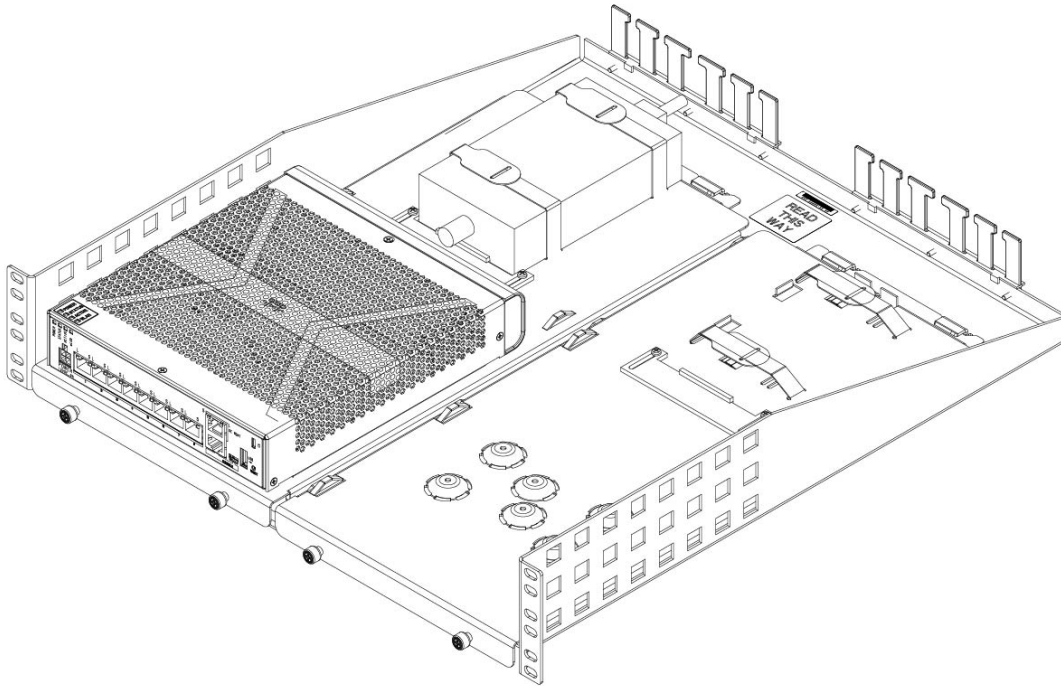

Step 10 Install the rack shelf into your rack using the correct screws (12-24 x 0.75 inch or 10-32 x 0.75 inch) from the rack-mount kit that fit your rack type.

You can now attach your power supply cord and run it through the cable guides.

What to do next

Install the cables according to your default software configuration as described in the [Cisco ASA 5506-X Series Quick Start Guide](#).

Install the ASA 5506H-X in a DIN Rail

You can use the 7.5-mm thick 45-mm wide top hat DIN rail for the ASA 5506H-X. Secure the DIN rail to the mounting surface approximately every 7.8 inches (200 mm) and use end-anchors appropriately.



Note We recommend that you install the ASA 5506H-X on a steel DIN rail for extra stability.

To attach the ASA 5506H-X to a 35-mm wide DIN rail, follow these steps:

Step 1 Attach the DIN rail bracket to the back of the chassis using the four screws provided.

Figure 32: Attach the DIN Rail Bracket to the ASA 5506H-X

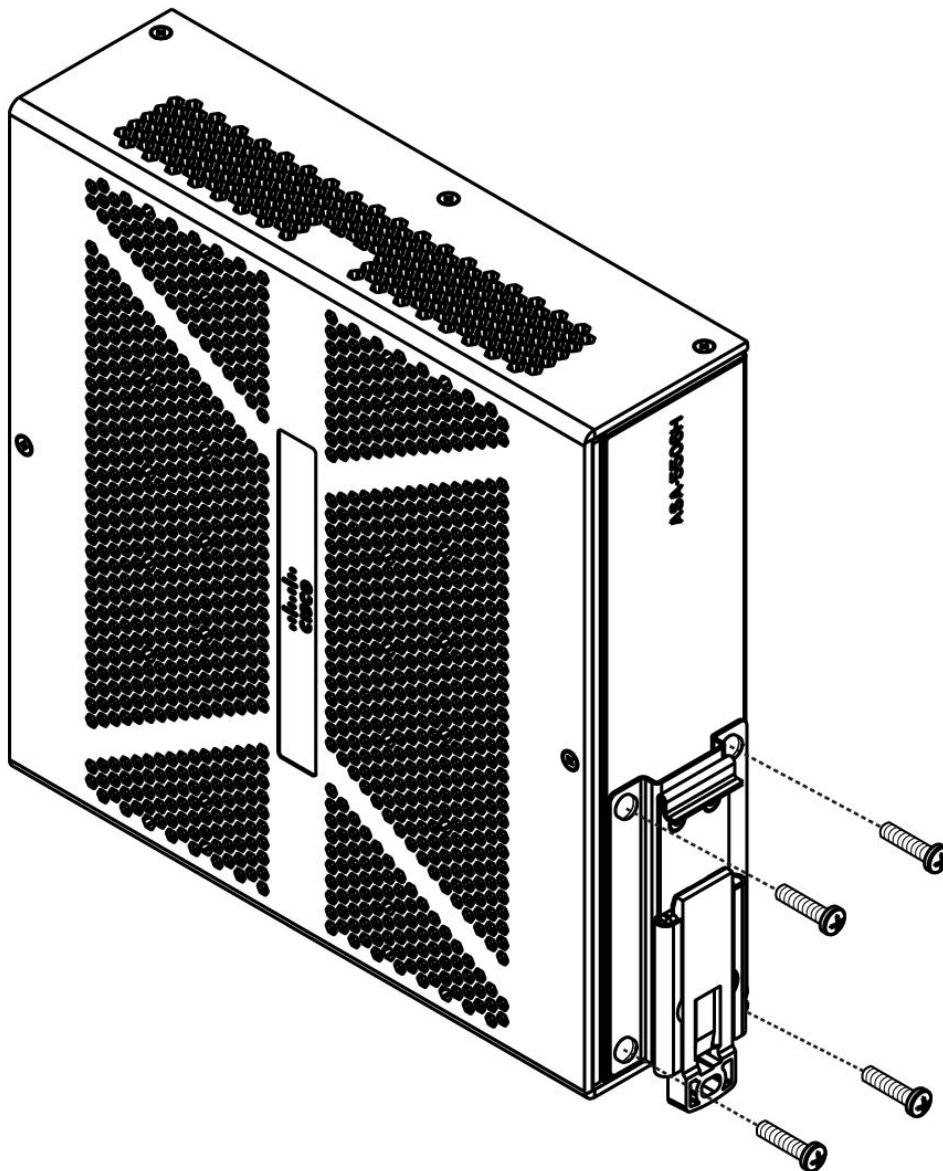

- Step 2** Locate the plastic tab on the end of the DIN rail bracket that extends past the chassis. Press the tab in and slide the plastic latch piece out while the tab is pressed down to put it into the locked position.
- Step 3** Turn the chassis sideways so that the power connector is near the top.
- Step 4** Position the rear edge of the chassis directly in front of the DIN rail making sure that the DIN rail fits in the space between the plastic latch and the metal hook.
- Step 5** Position the chassis so that the hook on the DIN rail bracket hooks onto the top edge of the DIN rail. The weight of the chassis can rest on the hook temporarily while the DIN rail bracket latches are secured.
- Step 6** Push the DIN rail bracket latch up when the chassis is over the DIN rail to secure it. This snaps the latch into the closed position which locks it onto the DIN rail.

Figure 33: ASA 5506H-X Installed with the DIN Rail

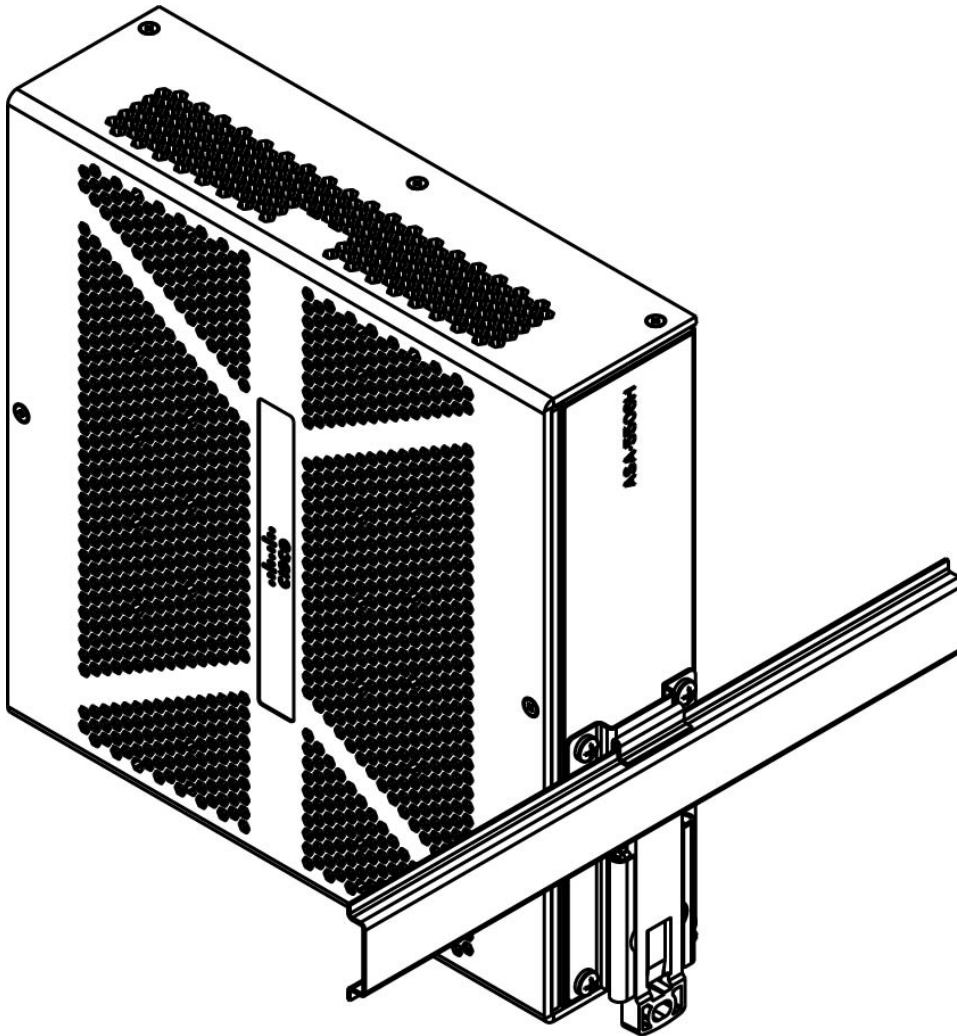

The chassis is now installed in the DIN rail.

What to do next

Install the cables as described in the [Cisco ASA 5506-X Series Quick Start Guide](#).



CHAPTER 4

Connect to the Console Port

The serial ports provide administrative access to the ASA either with a console terminal or a PC. To configure the ASA through the CLI, you must establish a connection between the ASA console port and either a terminal or a PC.

- [Connect to the Console Port with Microsoft Windows, on page 35](#)
- [Connect to the Console Port with Mac OS X, on page 38](#)
- [Connect to the Console Port with Linux, on page 38](#)

Connect to the Console Port with Microsoft Windows

You must install a USB device driver the first time a Microsoft Windows-based PC is connected to the USB serial port on the ASA, otherwise the connection fails.

To uninstall the driver, use the Add Remove Programs utility or the Setup-exe program.



Note Disconnect the ASA console terminal before uninstalling the driver.

-
- Step 1** Obtain the appropriate driver (Cisco_usbconsole_driver_X_X.zip, where X is a revision number) for your ASA model from the Cisco [Download Software](#) site, USB Console Software category.
 - Step 2** Install the driver.
 - Step 3** Connect a USB 5-pin Mini USB Type B to the USB console port as shown in the following figure.

Figure 34: ASA 5506-X and ASA 5506W-X Console Port Connection

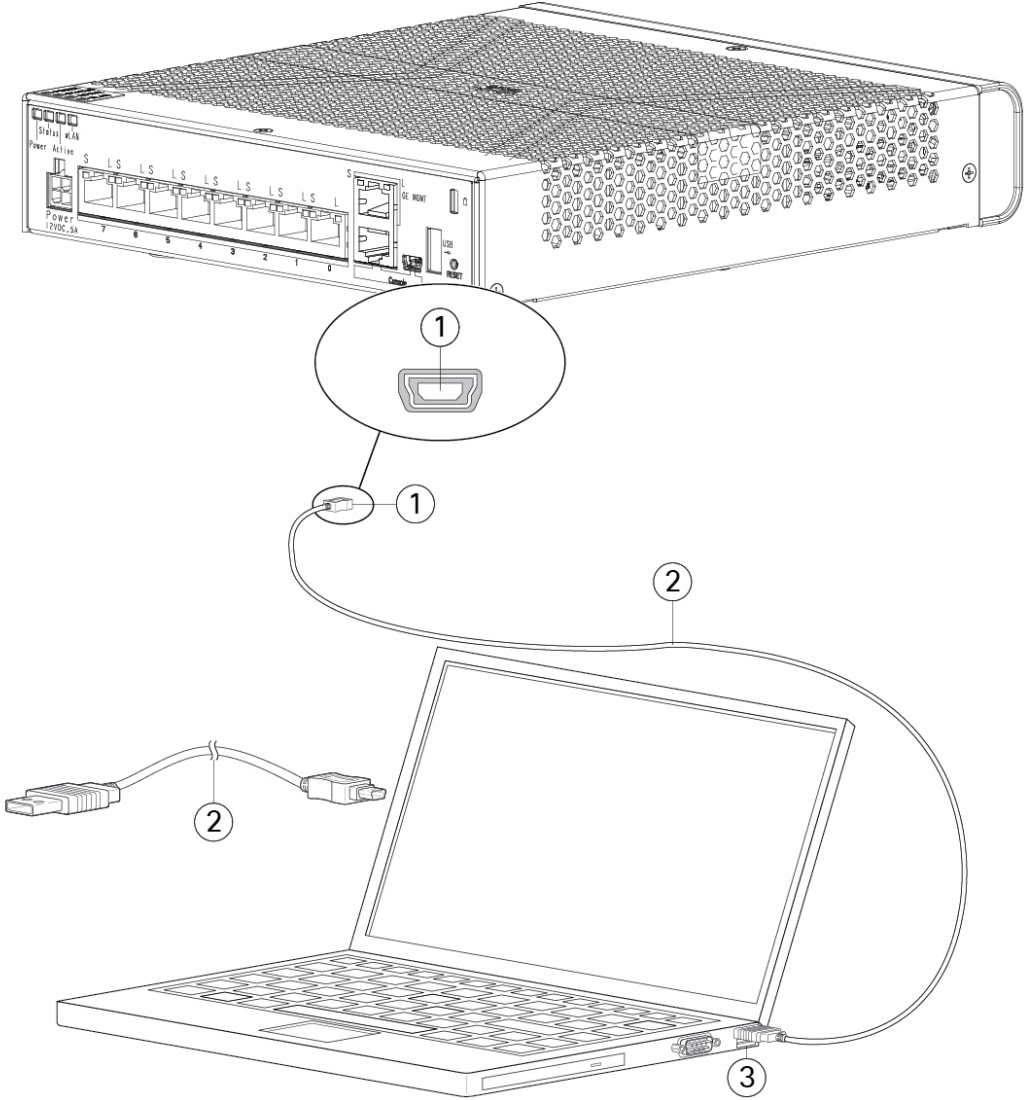

1	Mini USB Type B console port	2	Mini USB Type B to USB Type A console cable
3	USB Type A		

Figure 35: ASA 5506H-X Console Port Connection

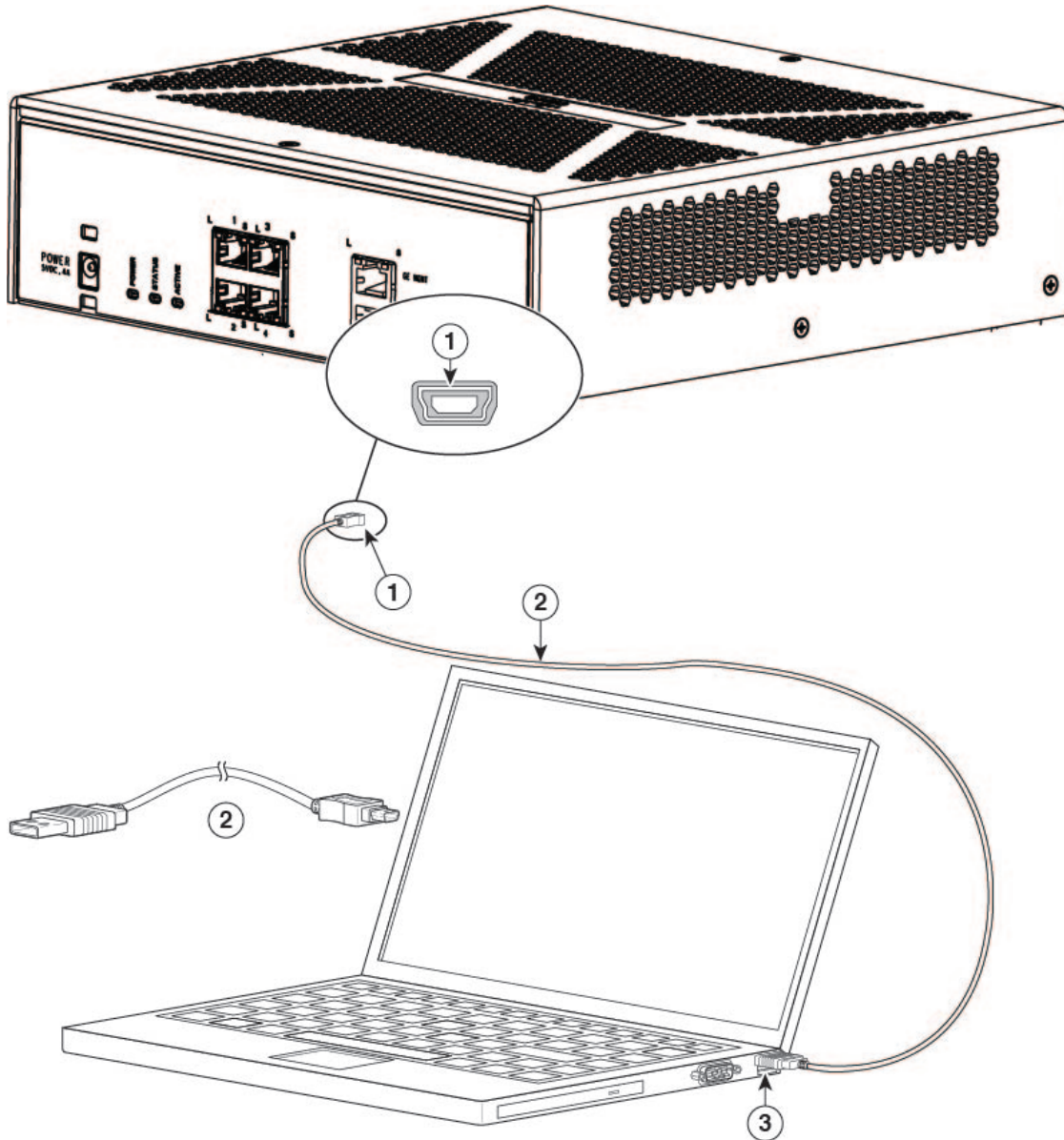

404463

1	Mini USB Type B console port	2	Mini USB Type B to USB Type A console cable
3	USB Type A		

Step 4 Connect the end of the cable with the DB-9 connector (or USB Type A) to the terminal or PC. If your terminal or PC has a console port that does not accommodate a DB-9 connector, you must provide an appropriate adapter for that port. The LED for the console port turns green and within a few moments the Found New Hardware Wizard appears.

Step 5 Follow the instructions to complete the driver installation.

Step 6 To communicate with the ASA, start a terminal emulator application. This software should be configured with the following parameters:

- 9600 baud
 - 8 data bits
 - no parity
 - 1 stop bit
 - no flow control
-

Connect to the Console Port with Mac OS X

Follow these steps to connect a Mac OS X system USB port to the console using the built-in OS X Terminal utility, or alternatively you can use a separate terminal emulator application.

Step 1 Use the Finder to go to **Applications > Utilities > Terminal**.

Step 2 Connect the OS X USB port to the ASA.

Step 3 Enter the following commands to find the OS X USB port number:

Example:

```
macbook:user$ cd /dev
macbook:user$ ls -ltr /dev/*usb*
crw-rw-rw- 1 root wheel 9, 66 Apr 1 16:46 tty.usbmodem1a21
DT-macbook:dev user$
```

Step 4 Connect to the USB port with the following command followed by the ASA USB port speed:

Example:

```
macbook:user$ screen /dev/tty.usbmodem1a21 9600
```

Step 5 Enter **Ctrl-z** followed by **Ctrl-** to disconnect the OS X USB console from the Terminal window.

Connect to the Console Port with Linux

Follow these steps to connect a Linux system USB port to the console using the built-in Linux Terminal utility.

Step 1 Open the Linux Terminal window.

Step 2 Connect the Linux USB port to the ASA.

Step 3 Enter the following commands to find the Linux USB port number:

Example:

```
root@usb-suse# cd /dev
root@usb-suse /dev# ls -ltr *ACM*
crw-r--r-- 1 root root 188, 0 Jan 14 18:02 ttyACM0
root@usb-suse /dev#
```

Step 4 Connect to the USB port with the following command followed by the ASA USB port speed

Example:

```
root@usb-suse /dev# screen /dev/ttyACM0 9600
```

Step 5 To disconnect the Linux USB console from the Terminal window, enter **Ctrl-a** followed by **:** then **quit**.



CHAPTER 5

Installation, Maintenance, and Upgrade

- [Connect the DC Adapter for the 5506H-X, on page 41](#)

Connect the DC Adapter for the 5506H-X

You can order an optional DC power supply that supplies 24 V DC (part number PWR2-20W-24VDC) or 20 W 20-60 V DC (part number PWR2-22W-20-60VDC).

Safety Warnings



Warning Statement 1005

This product relies on the building's installation for short-circuit (overcurrent) protection. Ensure that the protective device is rated not greater than 36 VDC, 5A.



Warning This product requires short-circuit (overcurrent) protection to be provided as part of the building installation. Install only in accordance with national and local wiring regulations.

Warning The device is designed to work with TN power systems.

Step 1 Connect the black and white lead wires to a 12 V DC source.

The black lead is negative or ground and the white lead is positive. The output cable is 1.3 meters and the input cable is 1 meter in length.

Figure 36: DC Power Adapter

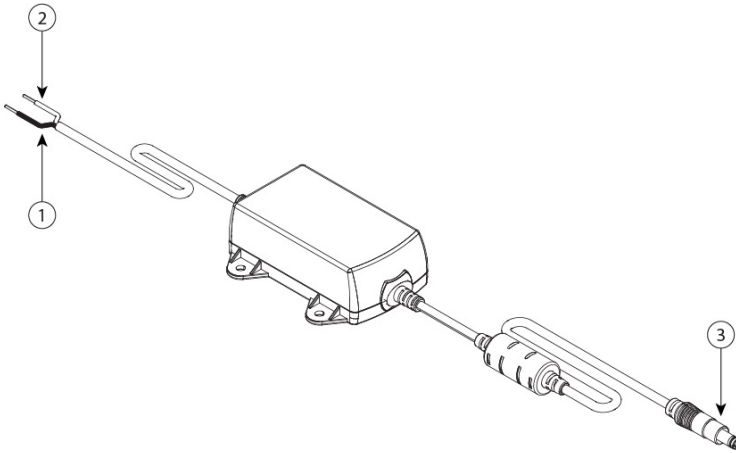

1	Black wire (negative)	2	White wire (positive)
3	Adapter		—

Step 2 Plug the adapter cord into the chassis.

Note The power adapters have 18 AWG wires for the input connection. Tinned bare wires are used for the input connection because there is no standard established for connector type. Screw terminal blocks are most often used.

Step 3 Power on the chassis and check that it has power. See [LEDs, on page 8](#) for information on the power LED.