



Regular Firewall Interfaces

This chapter includes regular firewall threat defense interface configuration including EtherChannels, VLAN subinterfaces, IP addressing, and more.



Note For initial interface configuration on the Firepower 4100/9300, see [Configure Interfaces](#).

- [Requirements and Prerequisites for Regular Firewall Interfaces, on page 1](#)
- [Configure Firepower 1010 Switch Ports, on page 1](#)
- [Configure Loopback Interfaces, on page 12](#)
- [Configure VLAN Subinterfaces and 802.1Q Trunking, on page 18](#)
- [Configure VXLAN Interfaces, on page 21](#)
- [Configure Routed and Transparent Mode Interfaces, on page 34](#)
- [Configure Advanced Interface Settings, on page 57](#)
- [History for Regular Firewall Interfaces for Secure Firewall Threat Defense, on page 67](#)

Requirements and Prerequisites for Regular Firewall Interfaces

Model Support

Threat Defense

User Roles

- Admin
- Access Admin
- Network Admin

Configure Firepower 1010 Switch Ports

You can configure each Firepower 1010 interface to run as a regular firewall interface or as a Layer 2 hardware switch port. This section includes tasks for starting your switch port configuration, including enabling or

disabling the switch mode and creating VLAN interfaces and assigning them to switch ports. This section also describes how to customize Power over Ethernet (PoE) on supported interfaces.

About Firepower 1010 Switch Ports

This section describes the switch ports of the Firepower 1010.

Understanding Switch Ports and Interfaces

Ports and Interfaces

For each physical Firepower 1010 interface, you can set its operation as a firewall interface or as a switch port. See the following information about physical interface and port types as well as logical VLAN interfaces to which you assign switch ports:

- **Physical firewall interface**—In routed mode, these interfaces forward traffic between networks at Layer 3, using the configured security policy to apply firewall and VPN services. In transparent mode, these interfaces are bridge group members that forward traffic between the interfaces on the same network at Layer 2, using the configured security policy to apply firewall services. In routed mode, you can also use Integrated Routing and Bridging with some interfaces as bridge group members and others as Layer 3 interfaces. By default, the Ethernet 1/1 interface is configured as a firewall interface. You can also configure these interfaces to be IPS-only (inline sets and passive interfaces).
- **Physical switch port**—Switch ports forward traffic at Layer 2, using the switching function in hardware. Switch ports on the same VLAN can communicate with each other using hardware switching, and traffic is not subject to the threat defense security policy. Access ports accept only untagged traffic, and you can assign them to a single VLAN. Trunk ports accept untagged and tagged traffic, and can belong to more than one VLAN. By default, Ethernet 1/2 through 1/8 are configured as access switch ports on VLAN 1. You cannot configure the Management interface as a switch port.
- **Logical VLAN interface**—These interfaces operate the same as physical firewall interfaces, with the exception being that you cannot create subinterfaces, IPS-only interfaces (inline sets and passive interfaces), or EtherChannel interfaces. When a switch port needs to communicate with another network, then the threat defense device applies the security policy to the VLAN interface and routes to another logical VLAN interface or firewall interface. You can even use Integrated Routing and Bridging with VLAN interfaces as bridge group members. Traffic between switch ports on the same VLAN are not subject to the threat defense security policy, but traffic between VLANs in a bridge group are subject to the security policy, so you may choose to layer bridge groups and switch ports to enforce the security policy between certain segments.

Power Over Ethernet

Power over Ethernet+ (PoE+) is supported on Ethernet 1/7 and Ethernet 1/8 on the Firepower 1010.

Auto-MDI/MDIX Feature

For all switch ports, the default auto-negotiation setting also includes the Auto-MDI/MDIX feature. Auto-MDI/MDIX eliminates the need for crossover cabling by performing an internal crossover when a straight cable is detected during the auto-negotiation phase. Either the speed or duplex must be set to auto-negotiate to enable Auto-MDI/MDIX for the interface. If you explicitly set both the speed and duplex to a fixed value, thus disabling auto-negotiation for both settings, then Auto-MDI/MDIX is also disabled.

When the speed and duplex are set to 1000 and full, then the interface always auto-negotiates; therefore Auto-MDI/MDIX is always enabled and you cannot disable it.

Guidelines and Limitations for Switch Ports

High Availability and Clustering

- No cluster support.
- You should not use the switch port functionality when using High Availability. Because the switch ports operate in hardware, they continue to pass traffic on both the active *and* the standby units. High Availability is designed to prevent traffic from passing through the standby unit, but this feature does not extend to switch ports. In a normal High Availability network setup, active switch ports on both units will lead to network loops. We suggest that you use external switches for any switching capability. Note that VLAN interfaces can be monitored by failover, while switch ports cannot. Theoretically, you can put a single switch port on a VLAN and successfully use High Availability, but a simpler setup is to use physical firewall interfaces instead.
- You can only use a firewall interface as the failover link.

Logical VLAN Interfaces

- You can create up to 60 VLAN interfaces.
- If you also use VLAN subinterfaces on a firewall interface, you cannot use the same VLAN ID as for a logical VLAN interface.
- MAC Addresses:
 - Routed firewall mode—All VLAN interfaces share a MAC address. Ensure that any connected switches can support this scenario. If the connected switches require unique MAC addresses, you can manually assign MAC addresses. See [Configure the MAC Address, on page 63](#).
 - Transparent firewall mode—Each VLAN interface has a unique MAC address. You can override the generated MAC addresses if desired by manually assigning MAC addresses. See [Configure the MAC Address, on page 63](#).

Bridge Groups

You cannot mix logical VLAN interfaces and physical firewall interfaces in the same bridge group.

VLAN Interface and Switch Port Unsupported Features

VLAN interfaces and switch ports do not support:

- Dynamic routing
- Multicast routing
- Equal-Cost Multi-Path routing (ECMP)
- Inline sets or Passive interfaces
- EtherChannels

- Failover and state link
- Security group tagging (SGT)

Other Guidelines and Limitations

- You can configure a maximum of 60 named interfaces on the Firepower 1010.
- You cannot configure the Management interface as a switch port.

Default Settings

- Ethernet 1/1 is a firewall interface.
- Ethernet 1/2 through Ethernet 1/8 are switch ports assigned to VLAN 1.
- Default Speed and Duplex—By default, the speed and duplex are set to auto-negotiate.

Configure Switch Ports and Power Over Ethernet

To configure switch ports and PoE, complete the following tasks.

Enable or Disable Switch Port Mode

You can set each interface independently to be either a firewall interface or a switch port. By default, Ethernet 1/1 is a firewall interface, and the remaining Ethernet interfaces are configured as switch ports.

Procedure

-
- Step 1** Select **Devices > Device Management** and click **Edit** (✎) for your threat defense device. The **Interfaces** page is selected by default.
- Step 2** Set the switch port mode by clicking the slider in the **SwitchPort** column so it shows as **Slider enabled** (🔵) or **Slider disabled** (⚪).

By default, switch ports are set to access mode in VLAN 1. You must manually add a logical VLAN 1 interface (or whichever VLAN you set for these switch ports) for traffic to be routed and to participate in the threat defense security policy (see [Configure a VLAN Interface, on page 5](#)). You cannot set the Management interface to switch port mode. When you change the switch port mode, all unsupported configuration is removed:

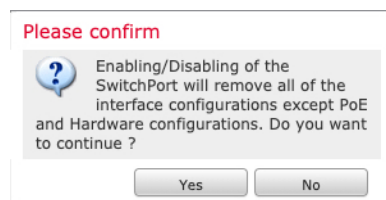

Configure a VLAN Interface

This section describes how to configure VLAN interfaces for use with associated switch ports. By default, switch ports are assigned to VLAN1; however, you must manually add the logical VLAN1 interface (or whichever VLAN you set for these switch ports) for traffic to be routed and to participate in the threat defense security policy.

Procedure

- Step 1** Select **Devices > Device Management** and click **Edit** (✎) for your threat defense device. The **Interfaces** page is selected by default.
- Step 2** Click **Add Interfaces > VLAN Interface**.
- Step 3** On **General**, set the following VLAN-specific parameters:

Add VLAN Interface ?

General
IPv4
IPv6
Advanced

Name:

Enabled

Description:

Mode:

Security Zone:

MTU:

(64 - 9198)

Priority:
 (0 - 65535)

VLAN ID *:

(1 - 4070)

Disable Forwarding on Interface VLAN:

Associated Interface	Port Mode
No records to display	

If you are editing an existing VLAN interface, the **Associated Interface** table shows switch ports on this VLAN.

- a) Set the **VLAN ID**, between 1 and 4070, excluding IDs in the range 3968 to 4047, which are reserved for internal use.

You cannot change the VLAN ID after you save the interface; the VLAN ID is both the VLAN tag used, and the interface ID in your configuration.

- b) (Optional) Choose a VLAN ID for **Disable Forwarding on Interface VLAN** to disable forwarding to another VLAN.

For example, you have one VLAN assigned to the outside for internet access, one VLAN assigned to an inside business network, and a third VLAN assigned to your home network. The home network does not need to access the business network, so you can disable forwarding on the home VLAN; the business network can access the home network, but the home network cannot access the business network.

- Step 4** To complete the interface configuration, see one of the following procedures:
- [Configure Routed Mode Interfaces, on page 37](#)
 - [Configure General Bridge Group Member Interface Parameters, on page 42](#)

Step 5 Click **OK**.

Step 6 Click **Save**.

You can now go to **Deploy > Deployment** and deploy the policy to assigned devices. The changes are not active until you deploy them.

Configure Switch Ports as Access Ports

To assign a switch port to a single VLAN, configure it as an access port. Access ports accept only untagged traffic. By default, Ethernet1/2 through Ethernet 1/8 switch ports are assigned to VLAN 1.



Note The device does not support Spanning Tree Protocol for loop detection in the network. Therefore you must ensure that any connection with the threat defense does not end up in a network loop.

Procedure

- Step 1** Select **Devices > Device Management** and click **Edit** (✎) for your threat defense device. The **Interfaces** page is selected by default.
- Step 2** Click **Edit** (✎) for the interface you want to edit.

Figure 1: Edit Physical Interface

Edit Physical Interface

General Hardware Configuration

Interface ID:
Ethernet1/2

Enabled

Description:

Port Mode:
Access

VLAN ID:
1
(1 - 4070)

Protected:

Step 3 Enable the interface by checking the **Enabled** check box.

Step 4 (Optional) Add a description in the **Description** field.

The description can be up to 200 characters on a single line, without carriage returns.

Step 5 Set the **Port Mode** to **Access**.

Step 6 In the **VLAN ID** field, set the VLAN for this switch port, between 1 and 4070.

The default VLAN ID is 1.

Step 7 (Optional) Check the **Protected** check box to set this switch port as protected, so you can prevent the switch port from communicating with other protected switch ports on the same VLAN.

You might want to prevent switch ports from communicating with each other if: the devices on those switch ports are primarily accessed from other VLANs; you do not need to allow intra-VLAN access; and you want to isolate the devices from each other in case of infection or other security breach. For example, if you have a DMZ that hosts three web servers, you can isolate the web servers from each other if you enable **Protected** on each switch port. The inside and outside networks can both communicate with all three web servers, and vice versa, but the web servers cannot communicate with each other.

Step 8 (Optional) Set the duplex and speed by clicking **Hardware Configuration**.

Figure 2: Hardware Configuration

The screenshot shows the 'Edit Physical Interface' configuration window. The 'Hardware Configuration' tab is selected. Under the 'Speed' section, the 'Duplex' dropdown is set to 'full' and the 'Speed' dropdown is set to '1gbps'. The 'Auto-negotiation' checkbox is checked.

Check the **Auto-negotiation** check box (the default) to auto-detect the speed and duplex. If you uncheck it, you can set the speed and duplex manually:

- **Duplex**—Choose **Full** or **Half**.
- **Speed**—Choose **10mbps**, **100mbps**, or **1gbps**.

Step 9 Click **OK**.

Step 10 Click **Save**.

You can now go to **Deploy > Deployment** and deploy the policy to assigned devices. The changes are not active until you deploy them.

Configure Switch Ports as Trunk Ports

This procedure describes how to create a trunk port that can carry multiple VLANs using 802.1Q tagging. Trunk ports accept untagged and tagged traffic. Traffic on allowed VLANs pass through the trunk port unchanged.

When the trunk receives untagged traffic, it tags it to the native VLAN ID so that the ASA can forward the traffic to the correct switch ports, or can route it to another firewall interface. When the ASA sends native VLAN ID traffic out of the trunk port, it removes the VLAN tag. Be sure to set the same native VLAN on the trunk port on the other switch so that the untagged traffic will be tagged to the same VLAN.

Procedure

Step 1 Select **Devices > Device Management** and click **Edit** (✎) for your threat defense device. The **Interfaces** page is selected by default.

Step 2 Click **Edit** (✎) for the interface you want to edit.

Figure 3: Set Trunk Port Mode

Edit Physical Interface

General Hardware Configuration

Interface ID:
Ethernet1/2

Enabled

Description:

Port Mode:
Trunk ▼

Native VLAN ID:
1
(1 - 4070)

Allowed VLAN IDs:
100,200,300
(1 - 4070)

Protected:

Step 3 Enable the interface by checking the **Enabled** check box.

Step 4 (Optional) Add a description in the **Description** field.

The description can be up to 200 characters on a single line, without carriage returns.

Step 5 Set the **Port Mode** to **Trunk**.

Step 6 In the **Native VLAN ID** field, set the native VLAN for this switch port, between 1 and 4070.

The default native VLAN ID is 1.

Each port can only have one native VLAN, but every port can have either the same or a different native VLAN.

Step 7 In the **Allowed VLAN IDs** field, enter the VLANs for this trunk port between 1 and 4070.

You can identify up to 20 IDs in one of the following ways:

- A single number (n)
- A range (n-x)
- Numbers and ranges separated by commas, for example:

5,7-10,13,45-100

You can enter spaces instead of commas.

If you include the native VLAN in this field, it is ignored; the trunk port always removes the VLAN tagging when sending native VLAN traffic out of the port. Moreover, it will not receive traffic that still has native VLAN tagging.

Step 8 (Optional) Check the **Protected** check box to set this switch port as protected, so you can prevent the switch port from communicating with other protected switch ports on the same VLAN.

You might want to prevent switch ports from communicating with each other if: the devices on those switch ports are primarily accessed from other VLANs; you do not need to allow intra-VLAN access; and you want to isolate the devices from each other in case of infection or other security breach. For example, if you have a DMZ that hosts three web servers, you can isolate the web servers from each other if you enable **Protected** on each switch port. The inside and outside networks can both communicate with all three web servers, and vice versa, but the web servers cannot communicate with each other.

Step 9 (Optional) Set the duplex and speed by clicking **Hardware Configuration**.

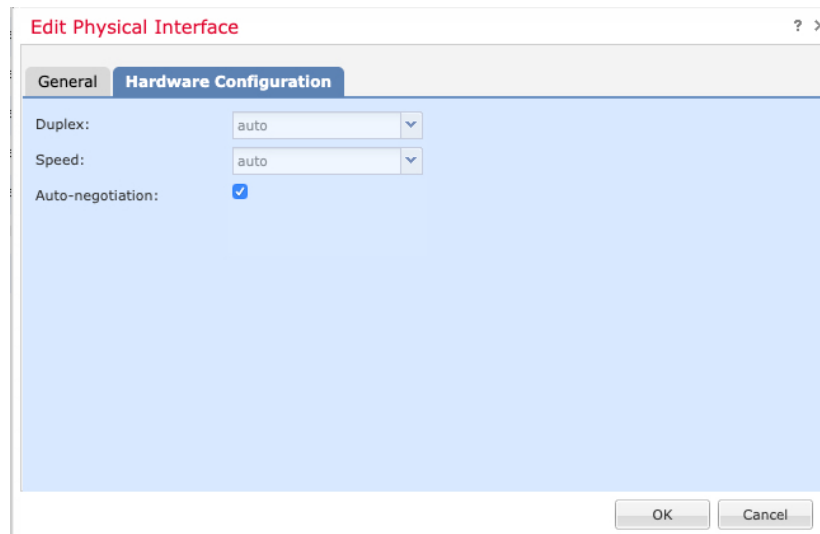

The screenshot shows a window titled "Edit Physical Interface" with a "Hardware Configuration" tab selected. Under "Duplex:", the dropdown menu is set to "auto". Under "Speed:", the dropdown menu is also set to "auto". The "Auto-negotiation:" checkbox is checked. At the bottom right, there are "OK" and "Cancel" buttons.

Check the **Auto-negotiation** check box (the default) to auto-detect the speed and duplex. If you uncheck it, you can set the speed and duplex manually:

- **Duplex**—Choose **Full** or **Half**.
- **Speed**—Choose **10mbps**, **100mbps**, or **1gbps**.

Step 10 Click **OK**.

Step 11 Click **Save**.

You can now go to **Deploy > Deployment** and deploy the policy to assigned devices. The changes are not active until you deploy them.

Configure Power Over Ethernet

Ethernet 1/7 and Ethernet 1/8 support Power over Ethernet (PoE) for devices such as IP phones or wireless access points. The Firepower 1010 supports both IEEE 802.3af (PoE) and 802.3at (PoE+). PoE+ uses Link Layer Discovery Protocol (LLDP) to negotiate the power level. PoE+ can deliver up to 30 watts to a powered device. Power is only supplied when needed.

If you shut down the switch port, or configure the port as a firewall interface, then you disable power to the device.

PoE is enabled by default on Ethernet 1/7 and Ethernet 1/8. This procedure describes how to disable and enable PoE and how to set optional parameters.

Procedure

Step 1 Select **Devices > Device Management** and click **Edit** (✎) for your threat defense device. The **Interfaces** page is selected by default.

Step 2 Click **Edit** (✎) for Ethernet1/7 or 1/8.

Step 3 Click **PoE**.

Figure 4: PoE

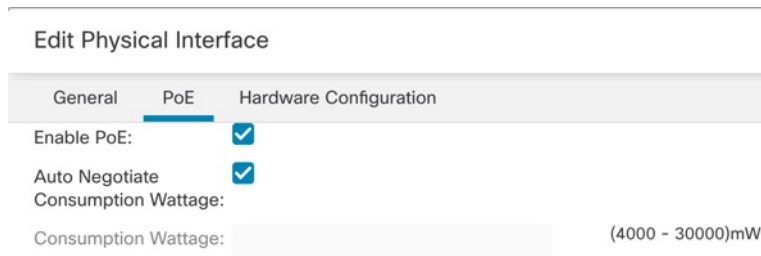

Step 4 Check the **Enable PoE** check box.

PoE is enabled by default.

Step 5 (Optional) Uncheck the **Auto Negotiate Consumption Wattage** check box, and enter the **Consumption Wattage** if you know the exact wattage you need.

By default, PoE delivers power automatically to the powered device using a wattage appropriate to the class of the powered device. The Firepower 1010 uses LLDP to further negotiate the correct wattage. If you know the specific wattage and want to disable LLDP negotiation, enter a value from 4000 to 30000 milliwatts.

Step 6 Click **OK**.

Step 7 Click **Save**.

You can now go to **Deploy > Deployment** and deploy the policy to assigned devices. The changes are not active until you deploy them.

Configure Loopback Interfaces

This section tells how to configure loopback interfaces.

About Loopback Interfaces

A loopback interface is a software-only interface that emulates a physical interface. This interface is reachable on IPv4 and IPv6 through multiple physical interfaces. The loopback interface helps to overcome path failures; it is accessible from any physical interface, so if one goes down, you can access the loopback interface from another.

Loopback interfaces can be used for:

- AAA

- BGP
- DNS
- HTTP
- ICMP
- IPsec flow offload—Secure Firewall 3100 and 4200 only
- NetFlow
- SNMP
- SSH
- Static and dynamic VTI tunnels
- Syslog

The threat defense can distribute the loopback address using dynamic routing protocols, or you can configure a static route on the peer device to reach the loopback IP address through one of the threat defense's physical interfaces. You cannot configure a static route on the threat defense that specifies the loopback interface.

Related Topics

[Guidelines and Limitations for Loopback Interfaces](#), on page 13

[Configure a Loopback Interface](#), on page 13

Guidelines and Limitations for Loopback Interfaces

Firewall Mode

- Supported in routed mode only.

High Availability and Clustering

- No clustering support.

Additional Guidelines and Limitations

- TCP sequence randomization is always disabled for traffic from the physical interface to the loopback interface.

Configure a Loopback Interface

To add a loopback interface for a device:

Procedure

- Step 1** Select **Devices > Device Management** and click **Edit** (✎) for your threat defense device. The **Interfaces** page is selected by default.

- Step 2** From the **Add Interfaces** drop-down list, choose **Loopback Interface**.
- Step 3** In the **General** tab, configure the following parameters:
- Name**—Enter a name for the loopback interface.
 - Enabled**—Check the check box to enable the loopback interface.
 - Loopback ID**—Enter the loopback ID between 1 to 1024.
 - Description**—Enter a description for the loopback interface.
- Step 4** Configure the routed mode interface parameters. See [Configure Routed Mode Interfaces, on page 37](#).

Rate-Limit Traffic to the Loopback Interface

Before you begin

You should rate-limit traffic going to the loopback interface IP address to prevent excessive load on the system. You can add a connection limit rule to the global service policy.

Procedure

- Step 1** Create an extended access list identifying traffic to the loopback interface IP address(es).
- Choose **Objects > Object Management** and choose **Access Control Lists > Extended** from the table of contents.
 - Click **Add Extended Access List** to create a new ACL.
 - In the **New Extended Access List Object** dialog box, enter a name for the ACL (no spaces allowed), and click **Add** to create a new entry.

Figure 5: Name ACL and Add Entry

The screenshot shows a dialog box titled "New Extended Access List Object". It has a "Name" input field containing the text "rate-limiting", which is highlighted with a red rectangular box. Below the name field is a label "Entries (0)". To the right of the dialog box is a blue "Add" button, also highlighted with a red rectangular box.

- Configure the source (any) and destination addresses (loopback IP addresses) on the **Network** tab.

Figure 6: Source and Destination Networks

Add Extended Access List Entry

Action:

Logging:

Log Level:

Log Interval: 300 Sec.

Network Port Application Users Security Group Tag

Available Networks

- any
- any-ipv4
- any-ipv6
- IPv4-Benchmark-Tests
- IPv4-Link-Local
- IPv4-Multicast
- IPv4-Private-10.0.0.0-8
- IPv4-Private-172.16.0.0-12

Source Networks (1)

any

Destination Networks (1)

10.1.1.1

Enter an IP address

Note Keep the default **Action** as **Allow** (match) and other settings as-is.

- Source—Select **any** from the **Available Networks** list, and click **Add to Source**. You can also narrow this access list by specifying the source IP addresses instead of **any**.
- Destination—Type an address in the edit box below the **Destination Networks** list and click **Add**. Repeat for each loopback interface.

- Click **Add** to add the entry to the ACL.
- Click **Save** to save the ACL.

Figure 7: Save ACL

Edit Extended Access List Object

Name

Entries (1)

Sequence	Action	Source	Source Port	Destination	Destination Port	Application	Users	SGT	
1	<input type="button" value="Allow"/>	any	Any	10.1.1.1 10.2.1.1	Any	Any	Any	Any	<input type="button" value="Edit"/> <input type="button" value="Delete"/>

Allow Overrides

Step 2 Choose **Policies > Access Control > Access Control**, and click **Edit** (✎) for the access control policy assigned to your device.

Step 3 Click **Advanced Settings** from the **More** drop-down arrow at the end of the packet flow line.

Figure 8: Advanced Settings

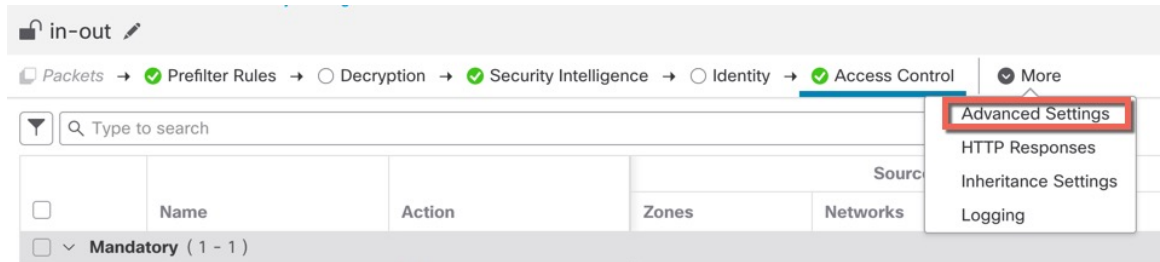

Step 4 Click **Edit** (✎) in the **Threat Defense Service Policy** group.

Figure 9: Threat Defense Service Policy

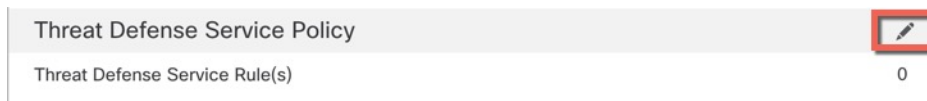

Step 5 Click **Add Rule** to create a new rule.

Figure 10: Add Rule

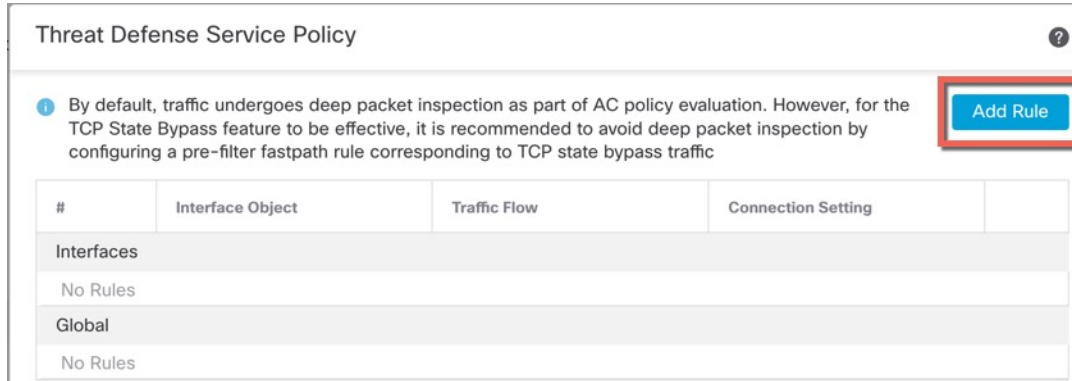

The service policy rule wizard opens to step you through the process of configuring the rule.

Step 6 In the **Interface Object** step, click **Global** to create a global rule, which applies to all interfaces, then click **Next**.

Figure 11: Global Policy

Threat Defense Service Policy

1 Interface Object

Global

Select Interface Objects

Step 7 In the **Traffic Flow** step, select the extended access list object you created in [Step 1, on page 14](#), and then click **Next**.

Figure 12: Choose Extended Access List

Threat Defense Service Policy

1 Interface Object — 2 Traffic Flow

Extended Access List:

rate-limiting

Step 8 In the **Connection Setting** step, set the **Connections** limits.

Figure 13: Set Connection Limits

Threat Defense Service Policy

1 Interface Object — 2 Traffic Flow — 3 Connection Setting

Enable TCP State Bypass Randomize TCP Sequence Number Enable Decrement TTL

Connections:

	Maximum TCP & UDP	Maximum Embryonic
	24	12

Connections Per Client:

	Maximum TCP & UDP	Maximum Embryonic
	0	0

Set the **Maximum TCP & UDP** connections to the expected number of connections for the loopback interface, and the **Maximum Embryonic** connections to a lower number. For example, you can set it to 5/2, or 10/5, or 1024/512, depending on the expected loopback interface sessions you need.

Setting the embryonic connection limit enables TCP Intercept, which protects the system from a DoS attack perpetrated by flooding an interface with TCP SYN packets.

Step 9 Click **Finish** to save your changes.

Step 10 Click **OK**.

Step 11 Click **Save** on the **Advanced Settings** window.

Step 12 You can now deploy the changes to the affected devices.

Configure VLAN Subinterfaces and 802.1Q Trunking

VLAN subinterfaces let you divide a physical, redundant, or EtherChannel interface into multiple logical interfaces that are tagged with different VLAN IDs. An interface with one or more VLAN subinterfaces is automatically configured as an 802.1Q trunk. Because VLANs let you keep traffic separate on a given physical interface, you can increase the number of interfaces available to your network without adding additional physical interfaces or devices.

Guidelines and Limitations for VLAN Subinterfaces

Model Support

- Firepower 1010—VLAN subinterfaces are not supported on switch ports or VLAN interfaces.

High Availability and Clustering

You cannot use a subinterface for the failover or state link or for the cluster control link. The exception is for multi-instance mode: you can use a *chassis*-defined subinterface for these links.

Additional Guidelines

- Preventing untagged packets on the physical interface—If you use subinterfaces, you typically do not also want the physical interface to pass traffic, because the physical interface passes untagged packets. This property is also true for the active physical interface in a redundant interface pair and for EtherChannel links. Because the physical, redundant, or EtherChannel interface must be enabled for the subinterface to pass traffic, ensure that the physical, redundant, or EtherChannel interface does not pass traffic by not configuring a name for the interface. If you want to let the physical, redundant, or EtherChannel interface pass untagged packets, you can configure the name as usual.
- You cannot configure subinterfaces on the Management interface, either the dedicated Management interface configured at the CLI nor a data interface used for manager access.
- All subinterfaces on the same parent interface must be either bridge group members or routed interfaces; you cannot mix and match.
- The threat defense does not support the Dynamic Trunking Protocol (DTP), so you must configure the connected switch port to trunk unconditionally.
- You might want to assign unique MAC addresses to subinterfaces defined on the threat defense, because they use the same burned-in MAC address of the parent interface. For example, your service provider might perform access control based on the MAC address. Also, because IPv6 link-local addresses are generated based on the MAC address, assigning unique MAC addresses to subinterfaces allows for unique IPv6 link-local addresses, which can avoid traffic disruption in certain instances on the threat defense.

Maximum Number of VLAN Subinterfaces by Device Model

The device model limits the maximum number of VLAN subinterfaces that you can configure. Note that you can configure subinterfaces on data interfaces only, you cannot configure them on the management interface.

The following table explains the limits for each device model.

Model	Maximum VLAN Subinterfaces
Firepower 1010	60
Firepower 1120	512
Firepower 1140, 1150	1024
Secure Firewall 3100, 4200	1024
Firepower 4100	1024
Firepower 9300	1024
Threat Defense Virtual	50
ISA 3000	100

Add a Subinterface

Add one or more subinterfaces to a physical, redundant, or port-channel interface.

For the Firepower 4100/9300, you can configure subinterfaces in FXOS for use with container instances; see [Add a VLAN Subinterface for Container Instances](#). These subinterfaces appear in the management center interface list. You can also add subinterfaces in management center, but only on parent interfaces that do not already have subinterfaces defined in FXOS.



Note The parent physical interface passes untagged packets. You may not want to pass untagged packets, so be sure not to include the parent interface in your security policy.

Procedure

- Step 1** Select **Devices > Device Management** and click **Edit** (✎) for your threat defense device. The **Interfaces** page is selected by default.
- Step 2** Enable the parent interface according to [Enable the Physical Interface and Configure Ethernet Settings](#).
- Step 3** Click **Add Interfaces > Sub Interface**.
- Step 4** On **General**, set the following parameters:

Figure 14: Add Subinterface

Add Sub Interface ?

General IPv4 IPv6 Path Monitoring Advanced

Name:

Enabled
 Management Only

Description:

Security Zone:

MTU:

(64 - 9198)

Priority:

(0 - 65535)

Propagate Security Group Tag:

Interface *:

Enabled

Sub-Interface ID *:

(1 - 4294967295)

VLAN ID:

(1 - 4094)

- Interface**—Choose the physical, redundant, or port-channel interface to which you want to add the subinterface.
- Sub-Interface ID**—Enter the subinterface ID as an integer between 1 and 4294967295. The number of subinterfaces allowed depends on your platform. You cannot change the ID after you set it.
- VLAN ID**—Enter the VLAN ID between 1 and 4094 that will be used to tag the packets on this subinterface.

This VLAN ID must be unique.

Step 5 Click **OK**.

Step 6 Click **Save**.

You can now go to **Deploy > Deployment** and deploy the policy to assigned devices. The changes are not active until you deploy them.

- Step 7** Configure the routed or transparent mode interface parameters. See [Configure Routed Mode Interfaces, on page 37](#) or [Configure Bridge Group Interfaces, on page 42](#).
-

Configure VXLAN Interfaces

This chapter tells how to configure Virtual eXtensible LAN (VXLAN) interfaces. VXLAN interfaces act as Layer 2 virtual networks over Layer 3 physical networks to stretch Layer 2 networks.

About VXLAN Interfaces

VXLAN provides the same Ethernet Layer 2 network services as VLAN does, but with greater extensibility and flexibility. Compared to VLAN, VXLAN offers the following benefits:

- Flexible placement of multitenant segments throughout the data center.
- Higher scalability to address more Layer 2 segments: up to 16 million VXLAN segments.

This section describes how VXLAN works. For detailed information about VXLAN, see RFC 7348. For detailed information about Geneve, see RFC 8926.

Encapsulation

The threat defense supports two types of VXLAN encapsulation:

- VXLAN (all models)—VXLAN uses MAC Address-in-User Datagram Protocol (MAC-in-UDP) encapsulation. The original Layer 2 frame has a VXLAN header added and is then placed in a UDP-IP packet.
- Geneve (threat defense virtual only)—Geneve has a flexible inner header that is not limited to the MAC address. Geneve encapsulation is required for transparent routing of packets between an Amazon Web Services (AWS) Gateway Load Balancer and appliances, and for sending extra information.

VXLAN Tunnel Endpoint

VXLAN tunnel endpoint (VTEP) devices perform VXLAN encapsulation and decapsulation. Each VTEP has two interface types: one or more virtual interfaces called VXLAN Network Identifier (VNI) interfaces to which you apply your security policy, and a regular interface called the VTEP source interface that tunnels the VNI interfaces between VTEPs. The VTEP source interface is attached to the transport IP network for VTEP-to-VTEP communication.

The following figure shows two threat defenses and Virtual Server 2 acting as VTEPs across a Layer 3 network, extending the VNI 1, 2, and 3 networks between sites. The threat defenses act as bridges or gateways between VXLAN and non-VXLAN networks.

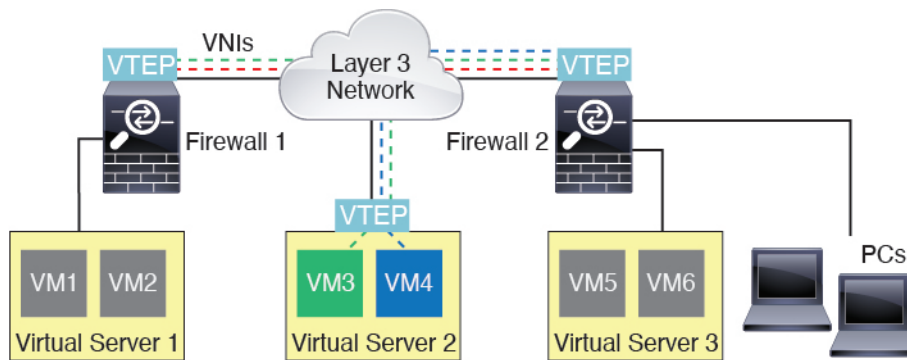

The underlying IP network between VTEPs is independent of the VXLAN overlay. Encapsulated packets are routed based on the outer IP address header, which has the initiating VTEP as the source IP address and the terminating VTEP as the destination IP address. For VXLAN encapsulation: The destination IP address can be a multicast group when the remote VTEP is not known. With Geneve, the threat defense only supports static peers. The destination port for VXLAN is UDP port 4789 by default (user configurable). The destination port for Geneve is 6081.

VTEP Source Interface

The VTEP source interface is a regular interface (physical, EtherChannel, or even VLAN) with which you plan to associate all VNI interfaces. You can configure one VTEP source interface per threat defense virtual. Because you can only configure one VTEP source interface, you cannot configure both VXLAN and Geneve interfaces on the same device. There is an exception for threat defense virtual clustering on AWS or Azure, where you can have two VTEP source interfaces: a VXLAN interface is used for the cluster control link, and a Geneve (AWS) or VXLAN (Azure) interface can be used for the Gateway Load Balancer.

The VTEP source interface can be devoted wholly to VXLAN traffic, although it is not restricted to that use. If desired, you can use the interface for regular traffic and apply a security policy to the interface for that traffic. For VXLAN traffic, however, all security policy must be applied to the VNI interfaces. The VTEP interface serves as a physical port only.

In transparent firewall mode, the VTEP source interface is not part of a BVI, and you do configure an IP address for it, similar to the way the management interface is treated.

VNI Interfaces

VNI interfaces are similar to VLAN interfaces: they are virtual interfaces that keep network traffic separated on a given physical interface by using tagging. You apply your security policy directly to each VNI interface.

You can only add one VTEP interface, and all VNI interfaces are associated with the same VTEP interface. There is an exception for threat defense virtual clustering on AWS or Azure. For AWS clustering, you can have two VTEP source interfaces: a VXLAN interface is used for the cluster control link, and a Geneve interface can be used for the AWS Gateway Load Balancer. For Azure clustering, you can have two VTEP source interfaces: a VXLAN interface is used for the cluster control link, and a second VXLAN interface can be used for the Azure Gateway Load Balancer.

VXLAN Packet Processing

VXLAN

Traffic entering and exiting the VTEP source interface is subject to VXLAN processing, specifically encapsulation or decapsulation.

Encapsulation processing includes the following tasks:

- The VTEP source interface encapsulates the inner MAC frame with the VXLAN header.
- The UDP checksum field is set to zero.
- The Outer frame source IP is set to the VTEP interface IP.
- The Outer frame destination IP is decided by a remote VTEP IP lookup.

Decapsulation; the threat defense only decapsulates a VXLAN packet if:

- It is a UDP packet with the destination port set to 4789 (this value is user configurable).
- The ingress interface is the VTEP source interface.
- The ingress interface IP address is the same as the destination IP address.
- The VXLAN packet format is compliant with the standard.

Geneve

Traffic entering and exiting the VTEP source interface is subject to Geneve processing, specifically encapsulation or decapsulation.

Encapsulation processing includes the following tasks:

- The VTEP source interface encapsulates the inner MAC frame with the Geneve header.
- The UDP checksum field is set to zero.
- The Outer frame source IP is set to the VTEP interface IP.
- The Outer frame destination IP is set the peer IP address that you configured.

Decapsulation; the ASA only decapsulates a Geneve packet if:

- It is a UDP packet with the destination port set to 6081 (this value is user configurable).
- The ingress interface is the VTEP source interface.
- The ingress interface IP address is the same as the destination IP address.
- The Geneve packet format is compliant with the standard.

Peer VTEPs

When the threat defense sends a packet to a device behind a peer VTEP, the threat defense needs two important pieces of information:

- The destination MAC address of the remote device

- The destination IP address of the peer VTEP

The threat defense maintains a mapping of destination MAC addresses to remote VTEP IP addresses for the VNI interfaces.

VXLAN Peer

There are two ways in which the threat defense can find this information:

- A single peer VTEP IP address can be statically configured on the threat defense.

For IPv4: The threat defense then sends a VXLAN-encapsulated ARP broadcast to the VTEP to learn the end node MAC address.

For IPv6: The threat defense then sends an IPv6 Neighbor Solicitation message to the IPv6 solicited-node multicast address. The peer VTEP responds with an IPv6 Neighbor Advertisement message with its link-local address.

- A group of peer VTEP IP addresses can be statically configured on the threat defense.

For IPv4: The threat defense then sends a VXLAN-encapsulated ARP broadcast to the VTEP to learn the end node MAC addresses.

For IPv6: The threat defense then sends an IPv6 Neighbor Solicitation message to the IPv6 solicited-node multicast address. The peer VTEP responds with an IPv6 Neighbor Advertisement message with its link-local address.

- A multicast group can be configured on each VNI interface (or on the VTEP as a whole).

For IPv4: The threat defense sends a VXLAN-encapsulated ARP broadcast packet within an IP multicast packet through the VTEP source interface. The response to this ARP request enables the threat defense to learn both the remote VTEP IP address along with the destination MAC address of the remote end node.

For IPv6: The threat defense sends a Multicast Listener Discovery (MLD) Report message through the VTEP source interface to indicate that the threat defense is listening on the VTEP interface for the multicast address traffic.

This option is not supported with Geneve.

Geneve Peer

The threat defense virtual only supports statically defined peers. You can define the threat defense virtual peer IP address on the AWS Gateway Load Balancer. Because the threat defense virtual never initiates traffic to the Gateway Load Balancer, you do not also have to specify the Gateway Load Balancer IP address on the threat defense virtual; it learns the peer IP address when it receives Geneve traffic. Multicast groups are not supported with Geneve.

VXLAN Use Cases

This section describes the use cases for implementing VXLAN on the threat defense.

VXLAN Bridge or Gateway Overview

Each threat defense VTEP acts as a bridge or gateway between end nodes such as VMs, servers, and PCs and the VXLAN overlay network. For incoming frames received with VXLAN encapsulation over the VTEP

source interface, the threat defense strips out the VXLAN header and forwards it to a physical interface connected to a non-VXLAN network based on the destination MAC address of the inner Ethernet frame.

The threat defense always processes VXLAN packets; it does not just forward VXLAN packets untouched between two other VTEPs.

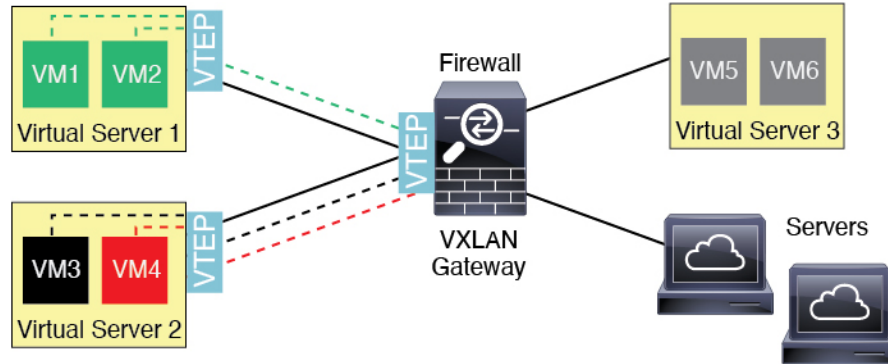

VXLAN Bridge

When you use a bridge group (transparent firewall mode, or optionally routed mode), the threat defense can serve as a VXLAN bridge between a (remote) VXLAN segment and a local segment where both are in the same network. In this case, one member of the bridge group is a regular interface while the other member is a VNI interface.

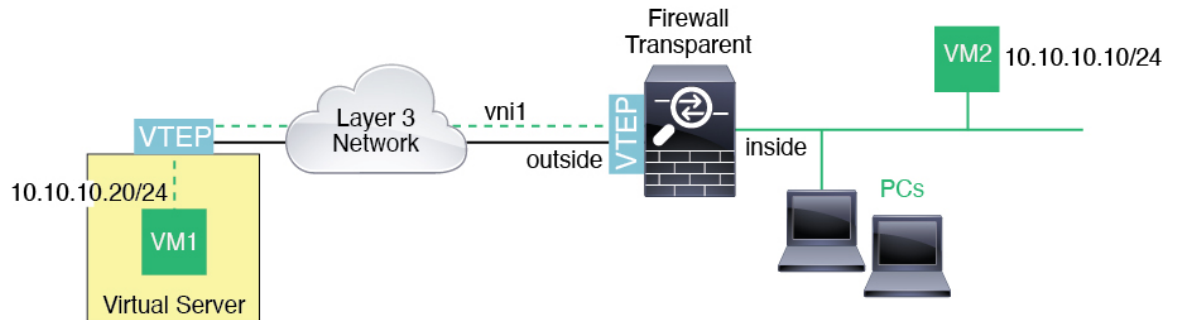

VXLAN Gateway (Routed Mode)

The threat defense can serve as a router between VXLAN and non-VXLAN domains, connecting devices on different networks.

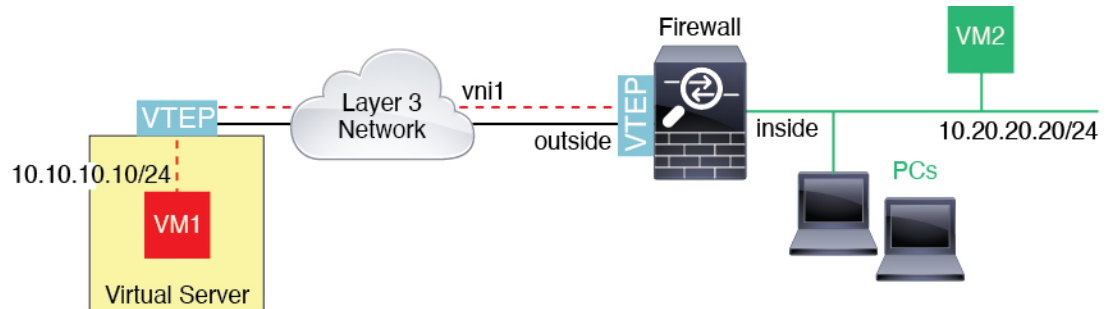

Router Between VXLAN Domains

With a VXLAN-stretched Layer 2 domain, a VM can point to an threat defense as its gateway while the threat defense is not on the same rack, or even when the threat defense is far away over the Layer 3 network.

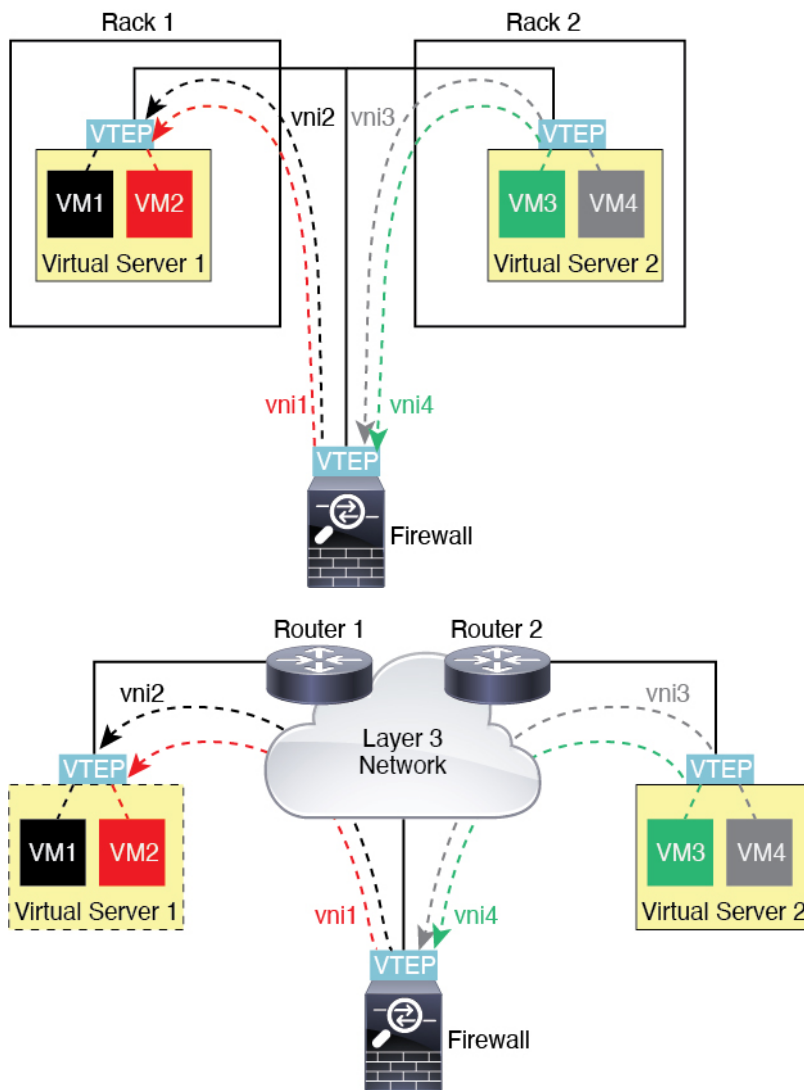

See the following notes about this scenario:

1. For packets from VM3 to VM1, the destination MAC address is the threat defense MAC address, because the threat defense is the default gateway.
2. The VTEP source interface on Virtual Server 2 receives packets from VM3, then encapsulates the packets with VNI 3's VXLAN tag and sends them to the threat defense.
3. When the threat defense receives the packets, it decapsulates the packets to get the inner frames.
4. The threat defense uses the inner frames for route lookup, then finds that the destination is on VNI 2. If it does not already have a mapping for VM1, the threat defense sends an encapsulated ARP broadcast on the multicast group IP on VNI 2.



Note The threat defense must use dynamic VTEP peer discovery because it has multiple VTEP peers in this scenario.

5. The threat defense encapsulates the packets again with the VXLAN tag for VNI 2 and sends the packets to Virtual Server 1. Before encapsulation, the threat defense changes the inner frame destination MAC address to be the MAC of VM1 (multicast-encapsulated ARP might be needed for the threat defense to learn the VM1 MAC address).
6. When Virtual Server 1 receives the VXLAN packets, it decapsulates the packets and delivers the inner frames to VM1.

Geneve Single-Arm Proxy



Note This use case is the only currently supported use case for Geneve interfaces.

The AWS Gateway Load Balancer combines a transparent network gateway and a load balancer that distributes traffic and scales virtual appliances on demand. The threat defense virtual supports the Gateway Load Balancer centralized control plane with a distributed data plane (Gateway Load Balancer endpoint). The following figure shows traffic forwarded to the Gateway Load Balancer from the Gateway Load Balancer endpoint. The Gateway Load Balancer balances traffic among multiple threat defense virtuals, which inspect the traffic before either dropping it or sending it back to the Gateway Load Balancer (U-turn traffic). The Gateway Load Balancer then sends the traffic back to the Gateway Load Balancer endpoint and to the destination.

Figure 15: Geneve Single-Arm Proxy

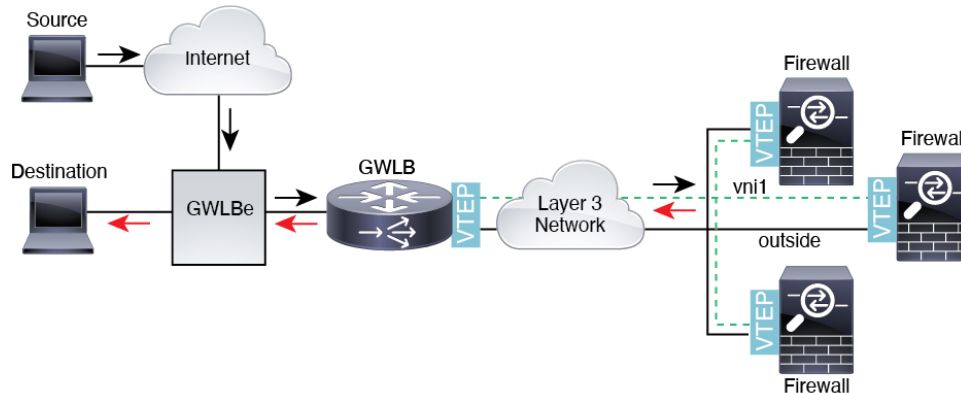

Azure Gateway Load Balancer and Paired Proxy

In an Azure service chain, threat defense virtuals act as a transparent gateway that can intercept packets between the internet and the customer service. The threat defense virtual defines an external interface and an internal interface on a single NIC by utilizing VXLAN segments in a paired proxy.

The following figure shows traffic forwarded to the Azure Gateway Load Balancer from the Public Gateway Load Balancer on the external VXLAN segment. The Gateway Load Balancer balances traffic among multiple threat defense virtuals, which inspect the traffic before either dropping it or sending it back to the Gateway Load Balancer on the internal VXLAN segment. The Azure Gateway Load Balancer then sends the traffic back to the Public Gateway Load Balancer and to the destination.

Figure 16: Azure Gateway Load Balancer with Paired Proxy

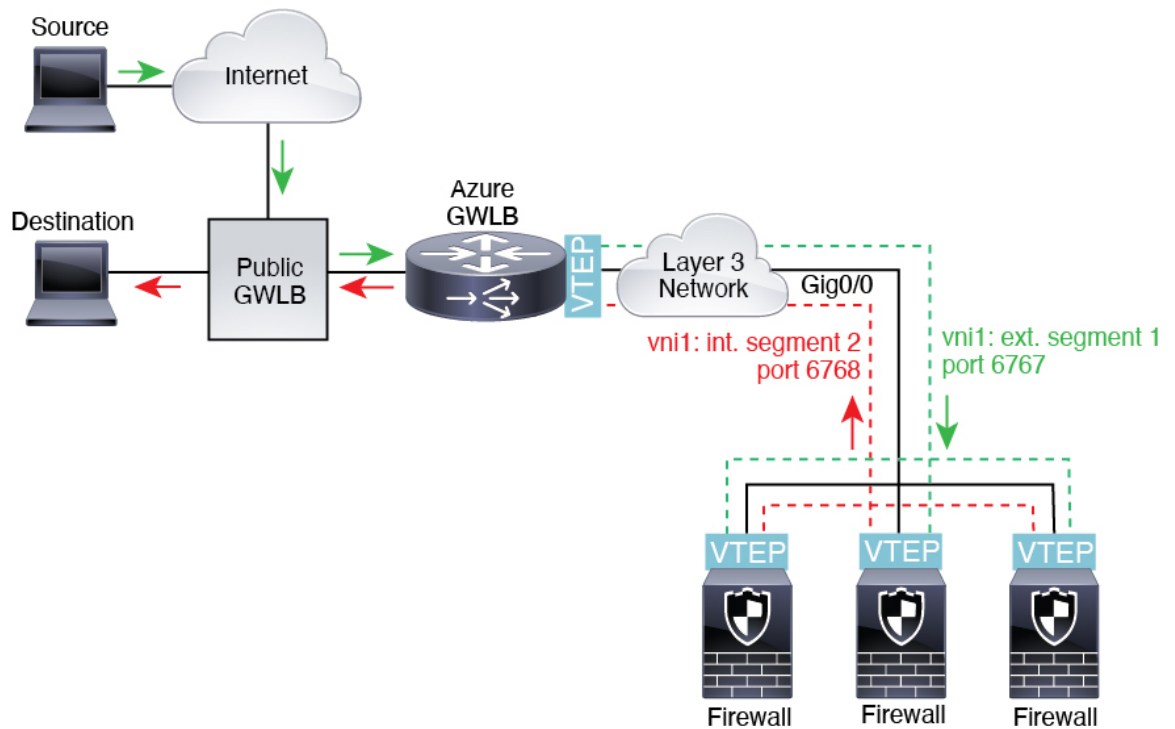

Requirements and Prerequisites for VXLAN Interfaces

Model Requirements

- VXLAN encapsulation is supported on all models.
- Geneve encapsulation is supported for the following models:
 - Threat Defense Virtual in Amazon Web Services (AWS)
- VXLAN in *paired proxy mode* is supported for the following models:
 - Threat Defense Virtual in Azure
- Firepower 1010 switch ports and VLAN interfaces are not supported as VTEP interfaces.

Guidelines for VXLAN Interfaces

Firewall Mode

- Geneve interfaces are only supported in routed firewall mode.
- Paired proxy VXLAN interfaces are only supported in routed firewall mode.

IPv6

- The VNI interface supports both IPv4 and IPv6 traffic.
- For VXLAN encapsulation, the VTEP source interface supports both IPv4 and IPv6. The threat defense virtual cluster control link VTEP source interface only supports IPv4.

For Geneve, the VTEP source interface only supports IPv4.

Clustering

- Clustering does not support VXLAN in Individual Interface mode except for the cluster control link (threat defense virtual only) Only Spanned EtherChannel mode supports VXLAN.

An exception is made for AWS, which can use an additional Geneve interface for use with the GWLB and for Azure, which can use an additional paired proxy VXLAN interface for use with the GWLB.

Routing

- Only static routing or Policy Based Routing is supported on the VNI interface; dynamic routing protocols are not supported.

MTU

- VXLAN encapsulation—If the source interface MTU is less than 1554 bytes for IPv4 or 1574 bytes for IPv6, then the threat defense automatically raises the MTU to 1554 bytes or 1574 bytes. In this case, the entire Ethernet datagram is being encapsulated, so the new packet is larger and requires a larger MTU. If the MTU used by other devices is larger, then you should set the source interface MTU to be the network MTU + 54 bytes for IPv4 or +64 bytes for IPv6. For the threat defense virtual, this MTU requires a restart to enable jumbo frame reservation.
- Geneve encapsulation—If the source interface MTU is less than 1806 bytes, then the threat defense automatically raises the MTU to 1806 bytes. In this case, the entire Ethernet datagram is being encapsulated, so the new packet is larger and requires a larger MTU. If the MTU used by other devices is larger, then you should set the source interface MTU to be the network MTU + 306 bytes. This MTU requires a restart to enable jumbo frame reservation.

Configure VXLAN or Geneve Interfaces

You can configure either VXLAN or Geneve interfaces.

Configure VXLAN Interfaces

To configure VXLAN, perform the following steps.



Note You can configure either VXLAN or Geneve (threat defense virtual only). For Geneve interfaces, see [Configure Geneve Interfaces, on page 32](#).



Note For Azure GWLB, the VXLAN interface is configured when you deploy the VM using the ARM template. You can use this section to change your configuration.

1. [Configure the VTEP Source Interface, on page 30.](#)
2. [Configure the VNI Interface, on page 31.](#)
3. (Azure GWLB) [Allow Gateway Load Balancer Health Checks, on page 33.](#)

Configure the VTEP Source Interface

You can configure one VTEP source interface per threat defense device. The VTEP is defined as a Network Virtualization Endpoint (NVE). VXLAN is the default encapsulation type. An exception is made for clustering on the threat defense virtual in Azure, where you can use one VTEP source interface for the cluster control link and a second one for the data interface connected to the Azure GWLB.

Procedure

- Step 1** If you want to specify a group of peer VTEPs, add a network object with the peer IP addresses. See [Creating Network Objects](#).
- Step 2** Choose **Devices > Device Management**.
- Step 3** Click **Edit** (✎) next to the device on which you want to configure VXLAN.
- Step 4** (Optional) Specify that the source interface is NVE-only.
- This setting is optional for routed mode where this setting restricts traffic to VXLAN and common management traffic only on this interface. This setting is automatically enabled for transparent firewall mode.
- a) Click **Interfaces**.
 - b) Click **Edit** (✎) for the VTEP source interface.
 - c) On the **General** page, check the check box of **NVE Only**.
- Step 5** Click **VTEP** if it is not already displaying.
- Step 6** Check **Enable NVE**.
- Step 7** Click **Add VTEP**.
- Step 8** For the **Encapsulation Type**, choose **VxLAN**.
- For AWS, you can choose between **VxLAN** and **Geneve**. Other platforms have **VxLAN** chosen automatically.
- Step 9** Enter the value for the **Encapsulation port** within the specified range.
- The default value is 4789.
- Step 10** Select the **VTEP Source Interface**.
- Select from the list of available physical interfaces present on the device. If the source interface MTU is less than 1554 bytes for IPv4 or 1574 bytes for IPv6, then the management center automatically raises the MTU to 1554 bytes or 1574 bytes.
- Step 11** Select the **Neighbor Address**. The available options are:

- **None**—No neighbor address is specified.
- **Peer VTEP**—Specify a peer VTEP address.
- **Peer Group**—Specify a network object with the peer IP addresses.
- **Default Multicast**—Specify a default multicast group for all associated VNI interfaces. If you do not configure the multicast group per VNI interface, then this group is used. If you configure a group at the VNI interface level, then that group overrides this setting.

- Step 12** Click **OK**.
- Step 13** Click **Save**.
- Step 14** Configure the routed interface parameters. See [Configure Routed Mode Interfaces](#).

Configure the VNI Interface

Add a VNI interface, associate it with the VTEP source interface, and configure basic interface parameters.

For the threat defense virtual in Azure, you can configure either a regular VXLAN interface, or you can configure a paired proxy mode VXLAN interface for use with the Azure GWLB. Paired proxy mode is the only supported mode with clustering.

Procedure

- Step 1** Choose **Devices > Device Management**.
- Step 2** Click **Edit** (✎) next to the device on which you want to configure VXLAN.
- Step 3** Click **Interfaces**.
- Step 4** Click **Add Interfaces**, and then choose **VNI Interface**.
- Step 5** Enter the interface **Name** and **Description**.
- Step 6** From the **Security Zone** drop-down list, choose a security zone or add a new one by clicking **New**.
- Step 7** Enter a value for the **Priority** field within the specified range. By default, 0 is selected.
- Step 8** Enter a value for the **VNI ID** between 1 and 10000.
This ID is only an internal interface identifier.
- Step 9** (Paired Proxy VXLAN for Azure GWLB) Enable proxy paired mode and set the required parameters.
- Check **Proxy Paired**.
 - Set the **Internal Port** between 1024 and 65535.
 - Set the **Internal Segment ID** between 1 and 16777215.
 - Set the **External Port** between 1024 and 65535.
 - Set the **External Segment ID** between 1 and 16777215.
- Step 10** (Regular VXLAN) Enter a value for the **VNI Segment ID** between 1 and 16777215.
The segment ID is used for VXLAN tagging.
- Step 11** Enter the **Multicast Group IP Address**.

If you do not set the multicast group for the VNI interface, the default group from the VTEP source interface configuration is used, if available. If you manually set a VTEP peer IP for the VTEP source interface, you cannot specify a multicast group for the VNI interface.

- Step 12** Check **NVE Mapped to VTEP Interface**.
This option associates this interface with the VTEP source interface.
- Step 13** Click **OK**.
- Step 14** Click **Save** to save the interface configuration.
- Step 15** Configure the routed or transparent interface parameters. See [Configure Routed and Transparent Mode Interfaces, on page 34](#).

Configure Geneve Interfaces

To configure Geneve interfaces for threat defense virtual, perform the following steps.



Note You can configure either VXLAN or Geneve. For information about VXLAN interfaces, see [Configure VXLAN Interfaces, on page 29](#).

1. [Configure the VTEP Source Interface, on page 32](#).
2. [Configure the VNI, on page 33](#).
3. [Allow Gateway Load Balancer Health Checks, on page 33](#).

Configure the VTEP Source Interface

You can configure one VTEP source interface per threat defense virtual device. The VTEP is defined as a Network Virtualization Endpoint (NVE).

Procedure

- Step 1** Choose **Devices > Device Management**.
- Step 2** Click **Edit** (✎) next to the device on which you want to configure Geneve.
- Step 3** Click **VTEP**.
- Step 4** Check **Enable NVE**.
- Step 5** Click **Add VTEP**.
- Step 6** For the **Encapsulation Type**, choose **Geneve**.
- Step 7** Enter the value for the **Encapsulation port** within the specified range.
We do not recommend changing the Geneve port; AWS requires a port of 6081.
- Step 8** Select the **VTEP Source Interface**.
You can select from the list of available physical interfaces present on the device. If the source interface MTU is less than 1806 bytes, then the management center automatically raises the MTU to 1806 bytes.

- Step 9** Click **OK**.
 - Step 10** Click **Save**.
 - Step 11** Configure the routed interface parameters. See [Configure Routed Mode Interfaces](#).
-

Configure the VNI

Add a VNI, associate it with (VTEP) source interface, and configure basic interface parameters.

Procedure

- Step 1** Choose **Devices > Device Management**.
 - Step 2** Click **Edit** (✎) next to the device on which you want to configure Geneve.
 - Step 3** Click **Interfaces**.
 - Step 4** Click **Add Interfaces**, and then choose **VNI Interface**.
 - Step 5** In the **Name** and **Description** fields, provide relevant information.
 - Step 6** In the **VNI ID** field, enter a value between 1 and 10000.
Note This ID is only an internal interface identifier.

 - Step 7** Check the **Enable Proxy** check box.

This option enables single-arm proxy, and allows traffic to exit the same interface it entered (U-turn traffic). If you later edit the interface, you cannot disable single-arm proxy. To do that, you need to delete the existing interface and create a new VNI interface.

This option is only available for a Geneve VTEP.

 - Step 8** Select **NVE Mapped to VTEP Interface**.

This option associates this interface with the VTEP source interface.

 - Step 9** Click **OK**.
 - Step 10** Click **Save**.
-

What to do next

Configure the routed interface parameters. See [Configure Routed Mode Interfaces](#).

Allow Gateway Load Balancer Health Checks

The AWS or Azure GWLB requires appliances to answer a health check properly. The GWLB will only send traffic to appliances that are considered healthy. You must configure the threat defense virtual to respond to an SSH, HTTP, or HTTPS health check.

Configure one of the following methods.

Procedure

Step 1

Configure SSH. See [Configure Secure Shell](#)

Allow SSH from the GWLB IP address. The GWLB will attempt to establish a connection to the threat defense virtual, and the threat defense virtual's prompt to log in is taken as proof of health. An SSH login attempt will time out after 1 minute. You will need to configure a longer health check interval on the GWLB to accommodate this timeout.

Step 2

Configure HTTP(S) Redirection Using Static Interface NAT with Port Translation.

You can configure the threat defense virtual to redirect health checks to a metadata HTTP(S) server. For HTTP(S) health checks, the HTTP(S) server must reply to the GWLB with a status code in the range 200 to 399. Because the threat defense virtual has limits on the number of simultaneous management connections, you may choose to offload the health check to an external server.

Static interface NAT with port translation lets you redirect a connection to a port (such as port 80) to a different IP address. For example, translate an HTTP packet from the GWLB with a destination of the threat defense virtual outside interface so that it appears to be from the threat defense virtual outside interface with a destination of the HTTP server. The threat defense virtual then forwards the packet to the mapped destination address. The HTTP server responds to the threat defense virtual outside interface, and then the threat defense virtual forwards the response back to the GWLB. You need an access rule that allows traffic from the GWLB to the HTTP server.

- a) Permit HTTP(S) traffic on the outside interface from the GWLB network in an access rule. See [Access Control Rules](#).
 - b) For HTTP(S), translate the source GWLB IP address to the threat defense virtual outside interface IP address; then translate the destination of the outside interface IP address to the HTTP(S) server IP address. See [Configure Static Manual NAT](#).
-

Configure Routed and Transparent Mode Interfaces

This section includes tasks to complete the regular interface configuration for all models in routed or transparent firewall mode.

About Routed and Transparent Mode Interfaces

Firewall mode interfaces subject traffic to firewall functions such as maintaining flows, tracking flow states at both IP and TCP layers, IP defragmentation, and TCP normalization. You can also optionally configure IPS functions for this traffic according to your security policy.

The types of firewall interfaces you can configure depends on the firewall mode set for the device: routed or transparent mode. See [Transparent or Routed Firewall Mode](#) for more information.

- Routed mode interfaces (routed firewall mode only)—Each interface that you want to route between is on a different subnet.
- Bridge group interfaces (routed and transparent firewall mode)—You can group together multiple interfaces on a network, and the threat defense device uses bridging techniques to pass traffic between the interfaces. Each bridge group includes a Bridge Virtual Interface (BVI) to which you assign an IP

address on the network. In routed mode, the threat defense device routes between BVIs and regular routed interfaces. In transparent mode, each bridge group is separate and cannot communicate with each other.

Dual IP Stack (IPv4 and IPv6)

The threat defense device supports both IPv6 and IPv4 addresses on an interface. Make sure you configure a default route for both IPv4 and IPv6.

31-Bit Subnet Mask

For routed interfaces, you can configure an IP address on a 31-bit subnet for point-to-point connections. The 31-bit subnet includes only 2 addresses; normally, the first and last address in the subnet is reserved for the network and broadcast, so a 2-address subnet is not usable. However, if you have a point-to-point connection and do not need network or broadcast addresses, a 31-bit subnet is a useful way to preserve addresses in IPv4. For example, the failover link between 2 threat defenses only requires 2 addresses; any packet that is transmitted by one end of the link is always received by the other, and broadcasting is unnecessary. You can also have a directly-connected management station running SNMP or Syslog.

31-Bit Subnet and Clustering

You can use a 31-bit subnet mask for cluster interfaces, excluding the management interface and the Cluster Control Link.

31-Bit Subnet and Failover

For failover, when you use a 31-bit subnet for the threat defense interface IP address, you cannot configure a standby IP address for the interface because there are not enough addresses. Normally, an interface for failover should have a standby IP address so the active unit can perform interface tests to ensure standby interface health. Without a standby IP address, the threat defense cannot perform any network tests; only the link state can be tracked.

For the failover and optional separate state link, which are point-to-point connections, you can also use a 31-bit subnet.

31-Bit Subnet and Management

If you have a directly-connected management station, you can use a point-to-point connection for SSH or HTTP on the threat defense, or for SNMP or Syslog on the management station.

31-Bit Subnet Unsupported Features

The following features do not support the 31-Bit subnet:

- BVI interfaces for bridge groups—The bridge group requires at least 3 host addresses: the BVI, and two hosts connected to two bridge group member interfaces. you must use a /29 subnet or smaller.
- Multicast Routing

Guidelines and Limitations for Routed and Transparent Mode Interfaces

High Availability, Clustering, and Multi-Instance

- Do not configure failover links with the procedures in this chapter. See the High Availability chapter for more information.
- For cluster interfaces, see the clustering chapter for requirements.
- For multi-instance mode, shared interfaces are not supported for bridge group member interfaces (in transparent mode or routed mode).
- When you use High Availability, you must set the IP address and standby address for data interfaces manually; DHCP and PPPoE are not supported. Set the standby IP addresses on the **Devices > Device Management > High Availability** tab in the **Monitored Interfaces** area. See the High Availability chapter for more information.

IPv6

- IPv6 is supported on all interfaces.
- You can only configure IPv6 addresses manually in transparent mode.
- The threat defense device does not support IPv6 anycast addresses.
- DHCPv6 and prefix delegation options are not supported with transparent mode, clustering, or High Availability.

Model Guidelines

- For the threat defense virtual on VMware with bridged ixgbevf interfaces, bridge groups are not supported.
- For the Firepower 2100 series, bridge groups are not supported in routed mode.

Transparent Mode and Bridge Group Guidelines

- You can create up to 250 bridge groups, with 64 interfaces per bridge group.
- Each directly-connected network must be on the same subnet.
- The threat defense device does not support traffic on secondary networks; only traffic on the same network as the BVI IP address is supported.
- An IP address for the BVI is required for each bridge group for to-the-device and from-the-device management traffic, as well as for data traffic to pass through the threat defense device. For IPv4 traffic, specify an IPv4 address. For IPv6 traffic, specify an IPv6 address.
- You can only configure IPv6 addresses manually.
- The BVI IP address must be on the same subnet as the connected network. You cannot set the subnet to a host subnet (255.255.255.255).
- Management interfaces are not supported as bridge group members.

- For multi-instance mode, shared interfaces are not supported for bridge group member interfaces (in transparent mode or routed mode).
- For the threat defense virtual on VMware with bridged ixgbevf interfaces, transparent mode is not supported, and bridge groups are not supported in routed mode.
-
- For the Firepower 1010, you cannot mix logical VLAN interfaces and physical firewall interfaces in the same bridge group.
- For the Firepower 4100/9300, data-sharing interfaces are not supported as bridge group members.
- In transparent mode, you must use at least 1 bridge group; data interfaces must belong to a bridge group.
- In transparent mode, do not specify the BVI IP address as the default gateway for connected devices; devices need to specify the router on the other side of the threat defense as the default gateway.
- In transparent mode, the *default* route, which is required to provide a return path for management traffic, is only applied to management traffic from one bridge group network. This is because the default route specifies an interface in the bridge group as well as the router IP address on the bridge group network, and you can only define one default route. If you have management traffic from more than one bridge group network, you need to specify a regular static route that identifies the network from which you expect management traffic.
- Transparent mode is not supported on threat defense virtual instances deployed on Amazon Web Services, Microsoft Azure, Google Cloud Platform, and Oracle Cloud Infrastructure.
- In routed mode, to route between bridge groups and other routed interfaces, you must name the BVI.
- In routed mode, threat defense-defined EtherChannel interfaces are not supported as bridge group members. EtherChannels on the Firepower 4100/9300 can be bridge group members.
- Bidirectional Forwarding Detection (BFD) echo packets are not allowed through the threat defense when using bridge group members. If there are two neighbors on either side of the threat defense running BFD, then the threat defense will drop BFD echo packets because they have the same source and destination IP address and appear to be part of a LAND attack.

Additional Guidelines and Requirements

- The threat defense supports only one 802.1Q header in a packet and does not support multiple headers (known as Q-in-Q support) for firewall interfaces. **Note:** For inline sets and passive interfaces, the FTD supports Q-in-Q up to two 802.1Q headers in a packet, with the exception of the Firepower 4100/9300, which only supports one 802.1Q header.

Configure Routed Mode Interfaces

This procedure describes how to set the name, security zone, and IPv4 address.



Note Not all fields are supported for all interface types.

Before you begin

- **Firepower 4100/9300**

1. [Configure a Physical Interface](#)
2. (Optional) Configure any special interfaces.
 - [Add an EtherChannel \(Port Channel\)](#)
 - [Add a VLAN Subinterface for Container Instances](#) in FXOS
 - [Configure a Loopback Interface](#), on page 13
 - [Add a Subinterface](#), on page 19 in management center
 - [Configure VXLAN Interfaces](#), on page 29

- (Optional) **All other models:**

- [Configure an EtherChannel](#)
- [Configure a Loopback Interface](#), on page 13
- [Add a Subinterface](#), on page 19
- [Configure VXLAN Interfaces](#), on page 29
- Threat Defense Virtual on AWS: [Configure Geneve Interfaces](#), on page 32
- Firepower 1010: [Configure a VLAN Interface](#), on page 5

Procedure

- Step 1** Select **Devices > Device Management** and click **Edit** (✎) for your threat defense device. The **Interfaces** page is selected by default.
- Step 2** Click **Edit** (✎) for the interface you want to edit.
- Step 3** In the **Name** field, enter a name up to 48 characters in length.
You cannot start the name with the phrase "cluster". It is reserved for internal use.
- Step 4** Enable the interface by checking the **Enabled** check box.
- Step 5** (Optional) Set this interface to **Management Only** to limit traffic to management traffic; through-the-box traffic is not allowed.
- Step 6** (Optional) Add a description in the **Description** field.
The description can be up to 200 characters on a single line, without carriage returns.
- Step 7** In the **Mode** drop-down list, choose **None**.
Regular firewall interfaces have the mode set to None. The other modes are for IPS-only interface types.
- Step 8** From the **Security Zone** drop-down list, choose a security zone or add a new one by clicking **New**.
The routed interface is a Routed-type interface, and can only belong to Routed-type zones.

Step 9 See [Configure the MTU, on page 62](#) for information about the **MTU**.

Step 10 In the **Priority** field, enter a number ranging from 0–65535.

This value is used in the policy based routing configuration. The priority is used to determine how you want to route the traffic across multiple egress interfaces. For more information, see [Configure Policy-Based Routing Policy](#).

Step 11 Click the **IPv4** tab. To set the IP address, use one of the following options from the **IP Type** drop-down list.

High Availability, clustering, and loopback interfaces only support static IP address configuration; DHCP and PPPoE are not supported.

- **Use Static IP**—Enter the IP address and subnet mask. For point-to-point connections, you can specify a 31-bit subnet mask (255.255.255.254 or /31). In this case, no IP addresses are reserved for the network or broadcast addresses. You cannot set the standby IP address in this case. For High Availability, you can only use a static IP address. Set the standby IP address on the **Devices > Device Management > High Availability** tab in the **Monitored Interfaces** area. If you do not set the standby IP address, the active unit cannot monitor the standby interface using network tests; it can only track the link state.
- **Use DHCP**—Configure the following optional parameters:
 - **Obtain default route using DHCP**—Obtains the default route from the DHCP server.
 - **DHCP route metric**—Assigns an administrative distance to the learned route, between 1 and 255. The default administrative distance for the learned routes is 1.

- **Use PPPoE**—If the interface is connected to a DSL, cable modem, or other connection to your ISP, and your ISP uses PPPoE to provide your IP address, configure the following parameters:

- **VPDN Group Name**—Specify a group name of your choice to represent this connection.
- **PPPoE User Name**—Specify the username provided by your ISP.
- **PPPoE Password/Confirm Password**—Specify and confirm the password provided by your ISP.
- **PPP Authentication**—Choose **PAP**, **CHAP**, or **MSCHAP**.

PAP passes a cleartext username and password during authentication and is not secure. With CHAP, the client returns the encrypted [challenge plus password], with a cleartext username in response to the server challenge. CHAP is more secure than PAP, but it does not encrypt data. MSCHAP is similar to CHAP but is more secure because the server stores and compares only encrypted passwords rather than cleartext passwords as in CHAP. MSCHAP also generates a key for data encryption by MPPE.

- **PPPoE route metric**—Assign an administrative distance to the learned route. Valid values are from 1 to 255. By default, the administrative distance for the learned routes is 1.
- **Enable Route Settings**—To manually configure the PPPoE IP address, check this box and then enter the **IP Address**.

If you select the **Enable Route Settings** check box and leave the **IP Address** blank, the **ip address pppoe setroute** command is applied as shown in this example:

```
interface GigabitEthernet0/2
nameif inside2_pppoe
cts manual
  propagate sgt preserve-untag
  policy static sgt disabled trusted
security-level 0
```

```
pppoe client vpdn group test
pppoe client route distance 10
ip address pppoe setroute
```

- **Store Username and Password in Flash**—Stores the username and password in flash memory.

The threat defense device stores the username and password in a special location of NVRAM.

Step 12 (Optional) See [Configure IPv6 Addressing, on page 46](#) to configure IPv6 addressing on the **IPv6** tab.

Step 13 (Optional) See [Configure the MAC Address, on page 63](#) to manually configure the MAC address on the **Advanced** tab.

Step 14 (Optional) Set the duplex and speed by clicking **Hardware Configuration > Speed**.

- **Duplex**—Choose **Full** or **Half**. SFP interfaces only support **Full** duplex.
- **Speed**—Choose a speed (varies depending on the model). (Secure Firewall 3100/4200 only) Choose **Detect SFP** to detect the speed of the installed SFP module and use the appropriate speed. Duplex is always Full, and auto-negotiation is always enabled. This option is useful if you later change the network module to a different model, and want the speed to update automatically.
- **Auto-negotiation**—Set the interface to negotiate the speed, link status, and flow control.
- **Forward Error Correction Mode**—(Secure Firewall 3100/4200 only) For 25 Gbps and higher interfaces, enable Forward Error Correction (FEC). For an EtherChannel member interface, you must configure FEC before you add it to the EtherChannel. The setting chosen when you use **Auto** depends on the transceiver type and whether the interface is fixed (built-in) or on a network module.

Table 1: Default FEC for Auto Setting

Transceiver Type	Fixed Port Default FEC (Ethernet 1/9 through 1/16)	Network Module Default FEC
25G-SR	Clause 74 FC-FEC	Clause 108 RS-FEC
25G-LR	Clause 74 FC-FEC	Clause 108 RS-FEC
10/25G-CSR	Clause 74 FC-FEC	Clause 74 FC-FEC
25G-AOCxM	Clause 74 FC-FEC	Clause 74 FC-FEC
25G-CU2.5/3M	Auto-Negotiate	Auto-Negotiate
25G-CU4/5M	Auto-Negotiate	Auto-Negotiate
25/50/100G	Clause 91 RS-FEC	Clause 91 RS-FEC

Step 15 (Optional) Enable management center manager access on a data interface on the **Manager Access** page.

You can enable manager access from a data interface when you first setup the threat defense. If you want to enable or disable manager access after you added the threat defense to the management center, see:

- Enable manager access: [Change the Manager Access Interface from Management to Data](#)

Note You cannot enable manager access unless you first initiate the manager interface migration from Management to a data interface. After you initiate the migration, you can enable manager access on the **Manager Access** page and save the configuration successfully.

- Disable manager access: [Change the Manager Access Interface from Data to Management](#)

If you want to change the manager access interface from one data interface to another data interface, you must disable manager access on the original data interface, but do not disable the interface itself yet; the original data interface must be used to perform the deployment. If you want to use the same IP address on the new manager access interface, you can delete or change the IP configuration on the original interface; this change should not affect the deployment. If you use a different IP address for the new interface, then also change the device IP address shown in the management center; see [Update the Hostname or IP Address in the Management Center](#). Be sure to also update related configuration to use the new interface such as static routes, DDNS, and DNS settings.

Manager access from a data interface has the following limitations:

- You can only enable manager access on a physical, data interface. You cannot use a subinterface or EtherChannel, nor can you create a subinterface on the manager access interface. You can also use the management center to enable manager access on a single secondary interface for redundancy.
- This interface cannot be management-only.
- Routed firewall mode only, using a routed interface.
- PPPoE is not supported. If your ISP requires PPPoE, you will have to put a router with PPPoE support between the threat defense and the WAN modem.
- The interface must be in the global VRF only.
- SSH is not enabled by default for data interfaces, so you will have to enable SSH later using the management center. Because the Management interface gateway will be changed to be the data interfaces, you also cannot SSH to the Management interface from a remote network unless you add a static route for the Management interface using the **configure network static-routes** command. For threat defense virtual on Amazon Web Services, a console port is not available, so you should maintain your SSH access to the Management interface: add a static route for Management before you continue with your configuration. Alternatively, be sure to finish all CLI configuration (including the **configure manager add** command) before you configure the data interface for manager access and you are disconnected.
- Clustering is not supported. You must use the Management interface in this case.

Figure 17: Manager Access

The screenshot shows the 'Edit Physical Interface' configuration window with the 'Manager Access' tab selected. The 'Enable management on this interface for the Manager' checkbox is checked. Below it, there are two main sections: 'Available Networks' and 'Allowed Management Networks'. The 'Available Networks' section has a search bar and a list of network types: any-ipv4, any-ipv6, IPv4-Benchmark-Tests, IPv4-Link-Local, IPv4-Multicast, and IPv4-Private-10.0.0.0-8. An 'Add' button is positioned between the two lists. The 'Allowed Management Networks' section contains a single entry 'any'. At the bottom right, there are 'Cancel' and 'OK' buttons.

- Check **Enable management on this interface for the manager** to use this data interface for management instead of the dedicated Management interface.
- (Optional) In the **Allowed Management Networks** box, add the networks from which you want to allow manager access. By default, any networks are allowed.

Step 16 Click **OK**.

Step 17 Click **Save**.

You can now go to **Deploy > Deployment** and deploy the policy to assigned devices. The changes are not active until you deploy them.

Configure Bridge Group Interfaces

A bridge group is a group of interfaces that the Secure Firewall Threat Defense device bridges instead of routes. Bridge groups are supported in both transparent and routed firewall mode. For more information about bridge groups, see [About Bridge Groups](#).

To configure bridge groups and associated interfaces, perform these steps.

Configure General Bridge Group Member Interface Parameters

This procedure describes how to set the name and security zone for each bridge group member interface. The same bridge group can include different types of interfaces: physical interfaces, VLAN subinterfaces, Firepower 1010 VLAN interfaces, EtherChannels, and redundant interfaces. The Management interface is not supported. In routed mode, EtherChannels are not supported. For the Firepower 4100/9300, data-sharing type interfaces are not supported.

Before you begin

- **Firepower 4100/9300**
 1. [Configure a Physical Interface](#)
 2. (Optional) Configure any special interfaces.
 - [Add an EtherChannel \(Port Channel\)](#)
 - [Add a VLAN Subinterface for Container Instances](#) in FXOS
 - [Add a Subinterface, on page 19](#) in management center

- (Optional) **All other models:**
 - [Configure an EtherChannel](#)
 - [Add a Subinterface, on page 19](#)
 - Firepower 1010: [Configure a VLAN Interface, on page 5](#)

Procedure

- Step 1** Select **Devices > Device Management** and click **Edit** (✎) for your threat defense device. The **Interfaces** page is selected by default.
- Step 2** Click **Edit** (✎) for the interface you want to edit.
- Step 3** In the **Name** field, enter a name up to 48 characters in length.
You cannot start the name with the phrase "cluster". It is reserved for internal use.
- Step 4** Enable the interface by checking the **Enabled** check box.
- Step 5** (Optional) Set this interface to **Management Only** to limit traffic to management traffic; through-the-box traffic is not allowed.
- Step 6** (Optional) Add a description in the **Description** field.
The description can be up to 200 characters on a single line, without carriage returns.
- Step 7** In the **Mode** drop-down list, choose **None**.
Regular firewall interfaces have the mode set to None. The other modes are for IPS-only interface types. After you assign this interface to a bridge group, the mode will show as **Switched**.
- Step 8** From the **Security Zone** drop-down list, choose a security zone or add a new one by clicking **New**.
The bridge group member interface is a Switched-type interface, and can only belong to Switched-type zones. Do not configure any IP address settings for this interface. You will set the IP address for the Bridge Virtual Interface (BVI) only. Note that the BVI does not belong to a zone, and you cannot apply access control policies to the BVI.
- Step 9** See [Configure the MTU, on page 62](#) for information about the **MTU**.
- Step 10** (Optional) Set the duplex and speed by clicking **Hardware Configuration > Speed**.
 - **Duplex**—Choose **Full** or **Half**. SFP interfaces only support **Full** duplex.

- **Speed**—Choose a speed (varies depending on the model). (Secure Firewall 3100/4200 only) Choose **Detect SFP** to detect the speed of the installed SFP module and use the appropriate speed. Duplex is always Full, and auto-negotiation is always enabled. This option is useful if you later change the network module to a different model, and want the speed to update automatically.
- **Auto-negotiation**—Set the interface to negotiate the speed, link status, and flow control.
- **Forward Error Correction Mode**—(Secure Firewall 3100/4200 only) For 25 Gbps and higher interfaces, enable Forward Error Correction (FEC). For an EtherChannel member interface, you must configure FEC before you add it to the EtherChannel. The setting chosen when you use **Auto** depends on the transceiver type and whether the interface is fixed (built-in) or on a network module.

Table 2: Default FEC for Auto Setting

Transceiver Type	Fixed Port Default FEC (Ethernet 1/9 through 1/16)	Network Module Default FEC
25G-SR	Clause 74 FC-FEC	Clause 108 RS-FEC
25G-LR	Clause 74 FC-FEC	Clause 108 RS-FEC
10/25G-CSR	Clause 74 FC-FEC	Clause 74 FC-FEC
25G-AOCxM	Clause 74 FC-FEC	Clause 74 FC-FEC
25G-CU2.5/3M	Auto-Negotiate	Auto-Negotiate
25G-CU4/5M	Auto-Negotiate	Auto-Negotiate
25/50/100G	Clause 91 RS-FEC	Clause 91 RS-FEC

Step 11 (Optional) See [Configure IPv6 Addressing, on page 46](#) to configure IPv6 addressing on the **IPv6** tab.

Step 12 (Optional) See [Configure the MAC Address, on page 63](#) to manually configure the MAC address on the **Advanced** tab.

Step 13 Click **OK**.

Step 14 Click **Save**.

You can now go to **Deploy > Deployment** and deploy the policy to assigned devices. The changes are not active until you deploy them.

Configure the Bridge Virtual Interface (BVI)

Each bridge group requires a BVI for which you configure an IP address. The threat defense uses this IP address as the source address for packets originating from the bridge group. The BVI IP address must be on the same subnet as the connected network. For IPv4 traffic, the BVI IP address is required to pass any traffic. For IPv6 traffic, you must, at a minimum, configure the link-local addresses to pass traffic, but a global management address is recommended for full functionality, including remote management and other management operations.

For routed mode, if you provide a name for the BVI, then the BVI participates in routing. Without a name, the bridge group remains isolated as in transparent firewall mode.

Before you begin

You cannot add the BVI to a security zone; therefore, you cannot apply Access Control policies to the BVI. You must apply your policy to the bridge group member interfaces based on their zones.

Procedure

-
- Step 1** Select **Devices > Device Management** and click **Edit** (✎) for your threat defense device. The **Interfaces** page is selected by default.
- Step 2** Choose **Add Interfaces > Bridge Group Interface**.
- Step 3** (Routed Mode) In the **Name** field, enter a name up to 48 characters in length.
- You must name the BVI if you want to route traffic outside the bridge group members, for example, to the outside interface or to members of other bridge groups. The name is not case-sensitive.
- Step 4** In the **Bridge Group ID** field, enter the bridge group ID between 1 and 250.
- Step 5** In the **Description** field, enter a description for this bridge group.
- Step 6** On the **Interfaces** tab, click an interface and then click **Add** to move it to the **Selected Interfaces** area. Repeat for all interfaces that you want to make members of the bridge group.
- Step 7** (Transparent Mode) Click the **IPv4** tab. In the **IP Address** field, enter the IPv4 address and subnet mask.
- Do not assign a host address (/32 or 255.255.255.255) to the BVI. Also, do not use other subnets that contain fewer than 3 host addresses (one each for the upstream router, downstream router, and transparent firewall) such as a /30 subnet (255.255.255.252). The threat defense device drops all ARP packets to or from the first and last addresses in a subnet. For example, if you use a /30 subnet and assign a reserved address from that subnet to the upstream router, then the threat defense device drops the ARP request from the downstream router to the upstream router.
- For High Availability, set the standby IP address on the **Devices > Device Management > High Availability** tab in the **Monitored Interfaces** area. If you do not set the standby IP address, the active unit cannot monitor the standby interface using network tests; it can only track the link state.
- Step 8** (Routed Mode) Click the **IPv4** tab. To set the IP address, use one of the following options from the **IP Type** drop-down list.
- High Availability and clustering interfaces only support static IP address configuration; DHCP is not supported.
- **Use Static IP**—Enter the IP address and subnet mask. For High Availability, you can only use a static IP address. Set the standby IP address on the **Devices > Device Management > High Availability** tab in the **Monitored Interfaces** area. If you do not set the standby IP address, the active unit cannot monitor the standby interface using network tests; it can only track the link state.
 - **Use DHCP**—Configure the following optional parameters:
 - **Obtain default route using DHCP**—Obtains the default route from the DHCP server.
 - **DHCP route metric**—Assigns an administrative distance to the learned route, between 1 and 255. The default administrative distance for the learned routes is 1.
- Step 9** (Optional) See [Configure IPv6 Addressing, on page 46](#) to configure IPv6 addressing.
- Step 10** (Optional) See [Add a Static ARP Entry, on page 64](#) and [Add a Static MAC Address and Disable MAC Learning for a Bridge Group, on page 65](#) (for transparent mode only) to configure the **ARP** and **MAC** settings.

Step 11 Click **OK**.

Step 12 Click **Save**.

You can now go to **Deploy > Deployment** and deploy the policy to assigned devices. The changes are not active until you deploy them.

Configure IPv6 Addressing

This section describes how to configure IPv6 addressing in routed and transparent mode.

About IPv6

This section includes information about IPv6.

IPv6 Addressing

You can configure two types of unicast addresses for IPv6:

- **Global**—The global address is a public address that you can use on the public network. For a bridge group, this address needs to be configured for the BVI, and not per member interface. You can also configure a global IPv6 address for the management interface in transparent mode.
- **Link-local**—The link-local address is a private address that you can only use on the directly-connected network. Routers do not forward packets using link-local addresses; they are only for communication on a particular physical network segment. They can be used for address configuration or for the Neighbor Discovery functions such as address resolution. In a bridge group, only member interfaces have link-local addresses; the BVI does not have a link-local address.

At a minimum, you need to configure a link-local address for IPv6 to operate. If you configure a global address, a link-local address is automatically configured on the interface, so you do not also need to specifically configure a link-local address. For bridge group member interfaces, when you configure the global address on the BVI, the threat defense device automatically generates link-local addresses for member interfaces. If you do not configure a global address, then you need to configure the link-local address, either automatically or manually.

Modified EUI-64 Interface IDs

RFC 3513: Internet Protocol Version 6 (IPv6) Addressing Architecture requires that the interface identifier portion of all unicast IPv6 addresses, except those that start with binary value 000, be 64 bits long and be constructed in Modified EUI-64 format. The threat defense device can enforce this requirement for hosts attached to the local link.

When this feature is enabled on an interface, the source addresses of IPv6 packets received on that interface are verified against the source MAC addresses to ensure that the interface identifiers use the Modified EUI-64 format. If the IPv6 packets do not use the Modified EUI-64 format for the interface identifier, the packets are dropped and the following system log message is generated:

```
325003: EUI-64 source address check failed.
```

The address format verification is only performed when a flow is created. Packets from an existing flow are not checked. Additionally, the address verification can only be performed for hosts on the local link.

Configure the IPv6 Prefix Delegation Client

The threat defense can act as a DHCPv6 Prefix Delegation client so that the client interface, for example the outside interface connected to a cable modem, can receive one or more IPv6 prefixes that the threat defense can then subnet and assign to its inside interfaces.

About IPv6 Prefix Delegation

The threat defense can act as a DHCPv6 Prefix Delegation client so that the client interface, for example the outside interface connected to a cable modem, can receive one or more IPv6 prefixes that the threat defense can then subnet and assign to its inside interfaces. Hosts connected to the inside interfaces can then use Stateless Address Auto Configuration (SLAAC) to obtain global IPv6 addresses. Note that the inside threat defense interfaces do not in turn act as Prefix Delegation servers; the threat defense can only provide global IP addresses to SLAAC clients. For example, if a router is connected to the threat defense, it can act as a SLAAC client to obtain its IP address. But if you want to use a subnet of the delegated prefix for the networks behind the router, you must manually configure those addresses on the router's inside interfaces.

The threat defense includes a light DHCPv6 server so the threat defense can provide information such as the DNS server and domain name to SLAAC clients when they send Information Request (IR) packets to the threat defense. The threat defense only accepts IR packets, and does not assign addresses to the clients. You will configure the client to generate its own IPv6 address by enabling IPv6 autoconfiguration on the client. Enabling stateless autoconfiguration on a client configures IPv6 addresses based on prefixes received in Router Advertisement messages; in other words, based on the prefix that the threat defense received using Prefix Delegation.

IPv6 Prefix Delegation /64 Subnet Example

The following example shows the threat defense receiving an IP address on the outside interface using the DHCPv6 address client. It also gets a delegated prefix using the DHCPv6 Prefix Delegation client. The threat defense subnets the delegated prefix into /64 networks and assigns global IPv6 addresses to its inside interfaces dynamically using the delegated prefix plus a manually configured subnet (::0, ::1, or ::2) and IPv6 address (0:0:0:1) per interface. SLAAC clients connected to those inside interfaces obtain IPv6 addresses on each /64 subnet.

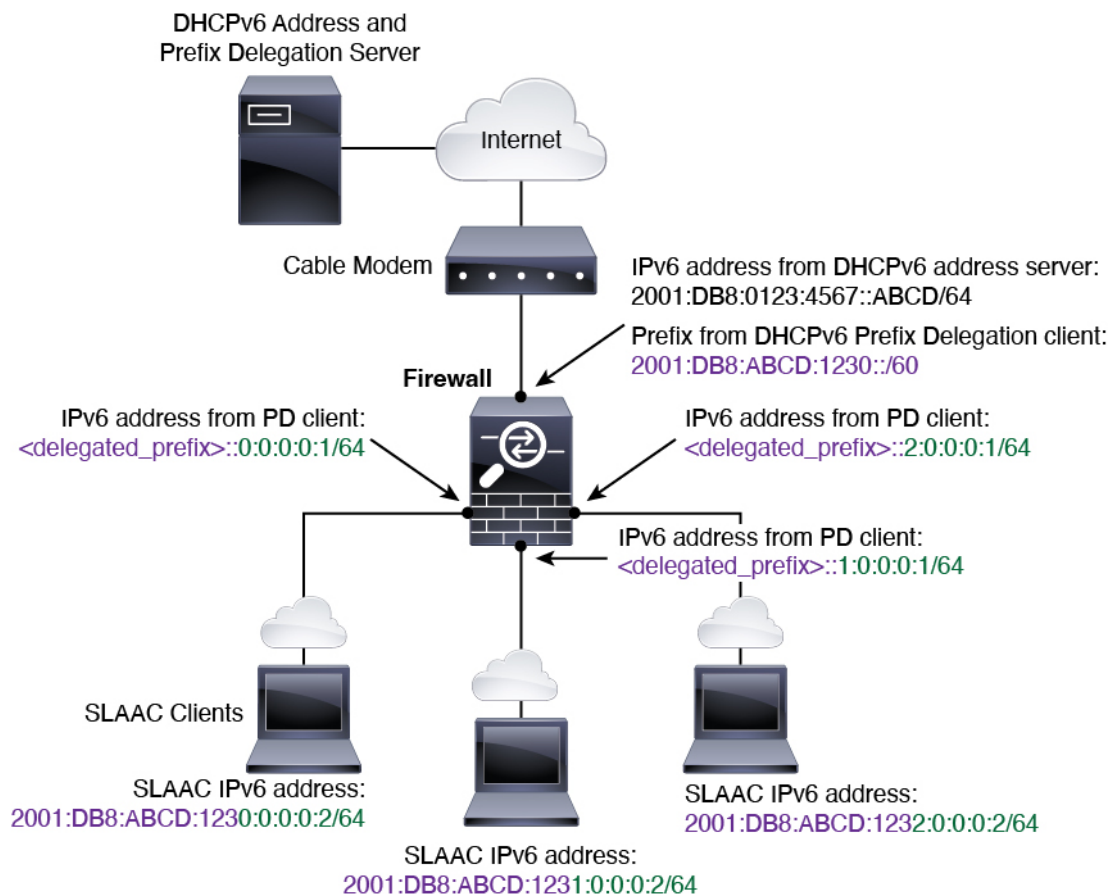

IPv6 Prefix Delegation /62 Subnet Example

The following example shows the threat defense subnetting the prefix into 4 /62 subnets: `2001:DB8:ABCD:1230::/62`, `2001:DB8:ABCD:1234::/62`, `2001:DB8:ABCD:1238::/62`, and `2001:DB8:ABCD:123C::/62`. The threat defense uses one of 4 available /64 subnets on `2001:DB8:ABCD:1230::/62` for its inside network (::0). You can then manually use additional /62 subnets for downstream routers. The router shown uses 3 of 4 available /64 subnets on `2001:DB8:ABCD:1234::/62` for its inside interfaces (::4, ::5, and ::6). In this case, the inside router interfaces cannot dynamically obtain the delegated prefix, so you need to view the delegated prefix on the threat defense, and then use that prefix for your router configuration. Usually, ISPs delegate the same prefix to a given client when the lease expires, but if the threat defense receives a new prefix, you will have to modify the router configuration to use the new prefix. The DHCP unique identifier (DUID) is persistent across reboots.

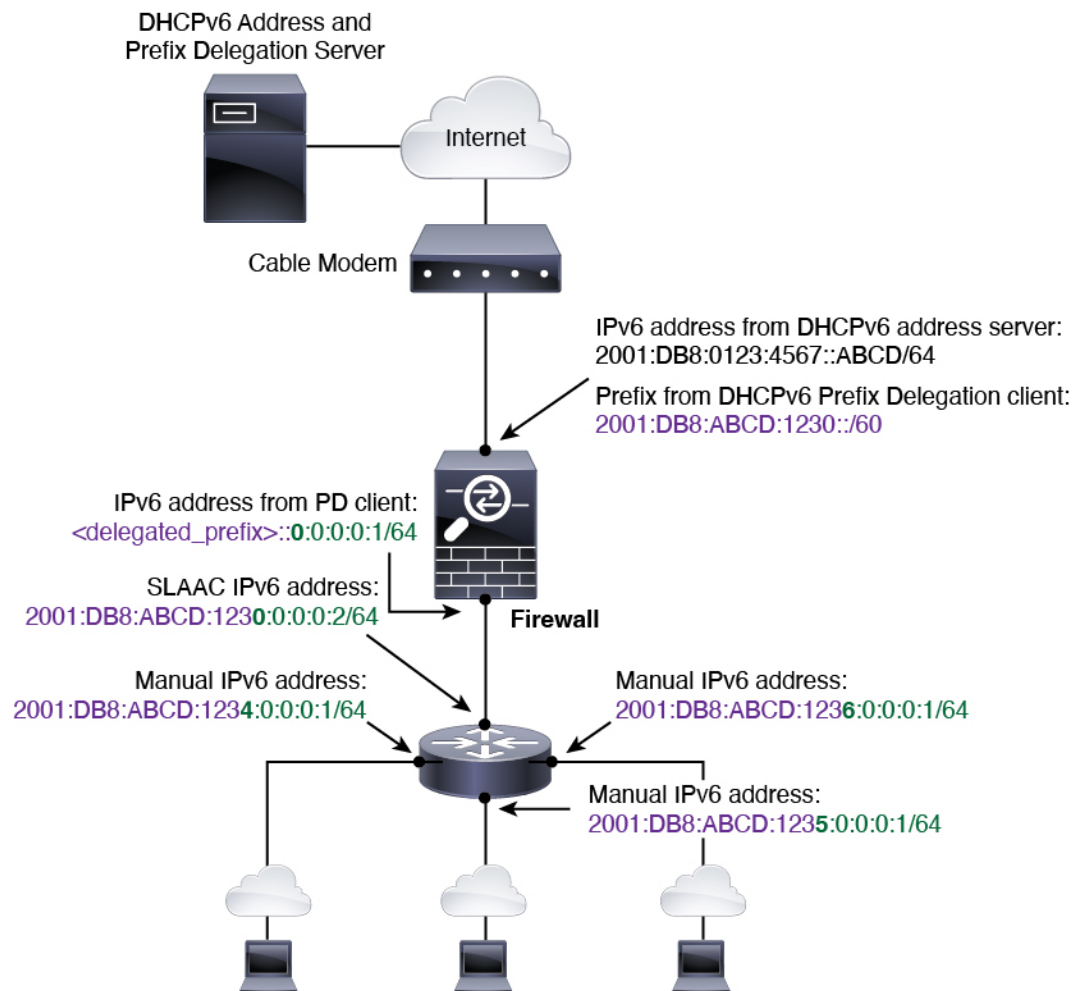

Enable the IPv6 Prefix Delegation Client

Enable the DHCPv6 Prefix Delegation client on one or more interfaces. The threat defense obtains one or more IPv6 prefixes that it can subnet and assign to inside networks. Typically, the interface on which you enable the prefix delegation client obtains its IP address using the DHCPv6 address client; only other threat defense interfaces use addresses derived from the delegated prefix.

This feature is only supported in routed mode. This feature is not supported in clustering or High Availability.

Before you begin

When you use Prefix Delegation, you must set the threat defense IPv6 neighbor discovery router advertisement interval to be much lower than the preferred lifetime of the prefix assigned by the DHCPv6 Server to prevent IPv6 traffic interruption. For example, if the DHCPv6 server sets the preferred Prefix Delegation lifetime to 300 seconds, you should set the threat defense RA interval to be 150 seconds. To set the preferred lifetime, use the **show ipv6 general-prefix** command. To set the threat defense RA interval, see [Configure IPv6 Neighbor Discovery, on page 55](#); the default is 200 seconds.

Procedure

- Step 1** Select **Devices > Device Management** and click **Edit** (✎) for your threat defense device. The **Interfaces** page is selected by default.
- Step 2** Click **Edit** (✎) for the interface you want to edit.
- Step 3** Click the **IPv6** page, and then click **DHCP**.
- Step 4** Click **Client PD Prefix Name** and enter a name for this prefix.

Figure 18: Enable the Prefix Delegation Client

Client PD Prefix Name

 Client PD Hint Prefixes

 2001:DB8:ABCD:1230::/60

The name can be up to 200 characters.

- Step 5** (Optional) Enter the prefix and prefix length in the **Client PD Hint Prefixes** field to provide one or more hints to the DHCP server about the delegated prefix you want to receive, then click **Add**.
- Typically you want to request a particular prefix length, such as `::/60`, or if you have received a particular prefix before and want to ensure you get it again when the lease expires, you can enter the whole prefix as the hint. If you enter multiple hints (different prefixes or lengths), then it is up to the DHCP server which hint to honor, or whether to honor the hint at all.
- Step 6** Click **OK**.
- Step 7** Click **Save**.

You can now go to **Deploy > Deployment** and deploy the policy to assigned devices. The changes are not active until you deploy them.

Configure a Global IPv6 Address

To configure a global IPv6 address for any routed mode interface and for the transparent or routed mode BVI, perform the following steps.



Note Configuring the global address automatically configures the link-local address, so you do not need to configure it separately. For bridge groups, configuring the global address on the BVI automatically configures link-local addresses on all member interfaces.

For subinterfaces defined on the threat defense, we recommend that you also set the MAC address manually, because they use the same burned-in MAC address of the parent interface. IPv6 link-local addresses are generated based on the MAC address, so assigning unique MAC addresses to subinterfaces allows for unique IPv6 link-local addresses, which can avoid traffic disruption in certain instances on the threat defense. See [Configure the MAC Address, on page 63](#).

Before you begin

For IPv6 neighbor discovery for bridge groups, you must explicitly allow Neighbor Solicitation (ICMPv6 type 135) and Neighbor Advertisement (ICMPv6 type 136) packets through the threat defense bridge group member interfaces using a bidirectional access rule.

Procedure

-
- Step 1** Select **Devices > Device Management** and click **Edit** (✎) for your threat defense device. The **Interfaces** page is selected by default.
- Step 2** Click **Edit** (✎) for the interface you want to edit.
- Step 3** Click the **IPv6** page.
- For routed mode, the **Basic** page is selected by default. For transparent mode, the **Address** page is selected by default.
- Step 4** (Optional) On the **Basic** page, check **Enable IPv6**.
- Use this option if you want to only configure the link-local addresses. Otherwise, configuring an IPv6 address enabled IPv6 processing automatically.
- Step 5** Configure the global IPv6 address using one of the following methods.
- For failover and clustering, and for loopback interfaces, you must set the IP address manually. For clustering, manually configuring the link-local address is also not supported.
- (Routed interface) Stateless autoconfiguration—Check the **Autoconfiguration** check box.

Enabling stateless autoconfiguration on the interface configures IPv6 addresses based upon prefixes received in Router Advertisement messages. A link-local address, based on the Modified EUI-64 interface ID, is automatically generated for the interface when stateless autoconfiguration is enabled.

Although RFC 4862 specifies that hosts configured for stateless autoconfiguration do not send Router Advertisement messages, the threat defense device does send Router Advertisement messages in this case. Uncheck the **IPv6 > Settings > Enable RA** check box to suppress messages.
 - Manual configuration—To manually configure a global IPv6 address:
 - a. Click the **Address** page, and click (⊕) **Add Address**.

The **Add Address** dialog box appears.

- b. In the **Address** field, enter either a full global IPv6 address, including the interface ID, or enter the IPv6 prefix, along with the IPv6 prefix length. (Routed Mode) If you only enter the prefix, then be sure to check the **Enforce EUI 64** check box to generate the interface ID using the Modified EUI-64 format. For example, 2001:0DB8::BA98:0:3210/48 (full address) or 2001:0DB8::/48 (prefix, with EUI 64 checked).

For High Availability (if you did not set **Enforce EUI 64**), set the standby IP address on the **Devices > Device Management > High Availability** page in the **Monitored Interfaces** area. If you do not set the standby IP address, the active unit cannot monitor the standby interface using network tests; it can only track the link state.

- (Routed interface) Obtain an address using DHCPv6—To use DHCPv6:

Figure 19: Enable the DHCPv6 Client

The screenshot shows the 'Edit Physical Interface' configuration page. The 'IPv6' tab is selected, and the 'DHCP' sub-tab is active. Two checkboxes are checked: 'Enable DHCP Client' and 'Enable default route using DHCP'. There are also two unchecked checkboxes labeled 'Enable' on the right side of the page.

- a. Click the **DHCP** page.
- b. Check the check box of **Enable DHCP Client**.
- c. (Optional) Check the check box of **Enable default route using DHCP** to obtain a default route from Router Advertisements.

- (Routed interface) Use a delegated prefix—To assign an IPv6 address using the delegated prefix:

This feature requires the threat defense to have the DHCPv6 Prefix Delegation client enabled *on a different interface*. See [Enable the IPv6 Prefix Delegation Client, on page 49](#).

- a. Click the **DHCP** page.
- b. Click **Add (+)**.

Figure 20: Use a Delegated Prefix

Edit Physical Interface

General IPv4 IPv6 Path Monitoring Hardware Configuration Manager Access Adva

Basic Address Prefixes Settings DHCP

No records to display

+ Add

Prefix Name	Prefix Length
No records to display	

- c. Enter the **Prefix Name** that you specified for the Prefix Delegation client (see [Enable the IPv6 Prefix Delegation Client, on page 49](#)) on another interface.

Figure 21: Specify the Prefix Name and Address

Prefixes

Prefix Name:

Prefix Length:

Cancel OK

- d. Enter the IPv6 address and **Prefix Length**.

Typically, the delegated prefix will be /60 or smaller so you can subnet to multiple /64 networks. /64 is the supported subnet length if you want to support SLAAC for connected clients. You should specify an address that completes the /60 subnet, for example ::1:0:0:0:1. Enter :: before the address in case the prefix is smaller than /60. For example, if the delegated prefix is 2001:DB8:1234:5670::/60, then the global IP address assigned to this interface is 2001:DB8:1234:5671::1/64. The prefix that is advertised in router advertisements is 2001:DB8:1234:5671::/64. In this example, if the prefix is smaller than /60, the remaining bits of the prefix will be 0's as indicated by the leading ::. For example, if the prefix is 2001:DB8:1234::/48, then the IPv6 address will be 2001:DB8:1234::1:0:0:0:1/64.

- e. Click **OK**.

Figure 22: Prefix Delegation Table

Prefix Name	Prefix Length	
Outside-Prefix	::1:0:0:1/64	

+ Add

- f. Optionally enable the DHCPv6 stateless server on this interface (see [Enable the DHCPv6 Stateless Server](#)). If you do so, we recommend that you also check the **Enable DHCP for non-address config** option.

Step 6 For Routed interfaces, you can optionally set the following values on the **Basic** page:

- To enforce the use of Modified EUI-64 format interface identifiers in IPv6 addresses on a local link, check the **Enforce EUI-64** check box.
- To manually set the link-local address, enter an address in the **Link-Local address** field.

A link-local address should start with FE8, FE9, FEA, or FEB, for example fe80::20d:88ff:fee:6a82. If you do not want to configure a global address, and only need to configure a link-local address, you have the option of manually defining the link-local address. Note that we recommend automatically assigning the link-local address based on the Modified EUI-64 format. For example, if other devices enforce the use of the Modified EUI-64 format, then a manually-assigned link-local address may cause packets to be dropped.

Clustering does not support manual link-local addresses.

Step 7 For Routed interfaces, you can optionally set the following values on the **DHCP** page:

- Check the **Enable DHCP for address config** check box to set the Managed Address Config flag in the IPv6 router advertisement packet.

This flag in IPv6 router advertisements informs IPv6 autoconfiguration clients that they should use DHCPv6 to obtain addresses, in addition to the derived stateless autoconfiguration address.

- Check the **Enable DHCP for non-address config** check box to set the Other Address Config flag in the IPv6 router advertisement packet.

This flag in IPv6 router advertisements informs IPv6 autoconfiguration clients that they should use DHCPv6 to obtain additional information from DHCPv6, such as the DNS server address. Use this option when using the DHCPv6 stateless server with DHCPv6 prefix delegation.

Step 8 For Routed interfaces, see [Configure IPv6 Neighbor Discovery, on page 55](#) to configure settings on the **Prefixes** and **Settings** pages. For BVI interfaces, see the following parameters on the **Settings** page:

- **DAD attempts**—The maximum number of DAD attempts, between 1 and 600. Set the value to 0 to disable duplicate address detection (DAD) processing. This setting configures the number of consecutive neighbor solicitation messages that are sent on an interface while DAD is performed on IPv6 addresses. 1 attempt is the default.
- **NS Interval**—The interval between IPv6 neighbor solicitation retransmissions on an interface, between 1000 and 3600000 ms. The default value is 1000 ms.

- **Reachable Time**—The amount of time that a remote IPv6 node is considered reachable after a reachability confirmation event has occurred, between 0 and 3600000 ms. The default value is 0 ms. When 0 is used for the value, the reachable time is sent as undetermined. It is up to the receiving devices to set and track the reachable time value. The neighbor reachable time enables detecting unavailable neighbors. Shorter configured times enable detecting unavailable neighbors more quickly, however, shorter times consume more IPv6 network bandwidth and processing resources in all IPv6 network devices. Very short configured times are not recommended in normal IPv6 operation.

Step 9 Click **OK**.

Step 10 Click **Save**.

You can now go to **Deploy > Deployment** and deploy the policy to assigned devices. The changes are not active until you deploy them.

Configure IPv6 Neighbor Discovery

The IPv6 neighbor discovery process uses ICMPv6 messages and solicited-node multicast addresses to determine the link-layer address of a neighbor on the same network (local link), verify the readability of a neighbor, and keep track of neighboring routers.

Nodes (hosts) use neighbor discovery to determine the link-layer addresses for neighbors known to reside on attached links and to quickly purge cached values that become invalid. Hosts also use neighbor discovery to find neighboring routers that are willing to forward packets on their behalf. In addition, nodes use the protocol to actively keep track of which neighbors are reachable and which are not, and to detect changed link-layer addresses. When a router or the path to a router fails, a host actively searches for functioning alternates.

Before you begin

Supported in Routed mode only. For IPv6 neighbor settings supported in transparent mode, see [Configure a Global IPv6 Address, on page 50](#).

Procedure

- Step 1** Select **Devices > Device Management** and click **Edit** (✎) for your threat defense device. The **Interfaces** page is selected by default.
- Step 2** Click **Edit** (✎) for the interface you want to edit.
- Step 3** Click **IPv6**, and then **Prefixes**.
- Step 4** (Optional) To configure which IPv6 prefixes are included in IPv6 router advertisements, perform the following steps:
- Click (+) **Add Prefix**.
 - In the **Address** field, enter the IPv6 address with the prefix length or check the **Default** check box to use the default prefix.
 - (Optional) Uncheck the **Advertisement** check box to indicate that the IPv6 prefix is not advertised.
 - Check the **Off Link** check box to indicate that the specified prefix is assigned to the link. Nodes sending traffic to addresses that contain the specified prefix consider the destination to be locally reachable on the link. This prefix should not be used for on-link determination.

- e) To use the specified prefix for autoconfiguration, check the **Autoconfiguration** check box.
- f) For the **Prefix Lifetime**, click **Duration** or **Expiration Date**.
 - **Duration**—Enter a **Preferred Lifetime** for the prefix in seconds. This setting is the amount of time that the specified IPv6 prefix is advertised as being valid. The maximum value represents infinity. Valid values are from 0 to 4294967295. The default is 2592000 (30 days). Enter a **Valid Lifetime** for the prefix in seconds. This setting is the amount of time that the specified IPv6 prefix is advertised as being preferred. The maximum value represents infinity. Valid values are from 0 to 4294967295. The default setting is 604800 (seven days). Alternatively, check the **Infinite** check box to set an unlimited duration.
 - **Expiration Date**—Choose a **Valid** and **Preferred** date and time.
- g) Click **OK**.

Step 5

Click **Settings**.

Step 6

(Optional) Set the maximum number of **DAD attempts**, between 1 and 600. 1 attempt is the default. Set the value to 0 to disable duplicate address detection (DAD) processing.

This setting configures the number of consecutive neighbor solicitation messages that are sent on an interface while DAD is performed on IPv6 addresses.

During the stateless autoconfiguration process, Duplicate Address Detection verifies the uniqueness of new unicast IPv6 addresses before the addresses are assigned to interfaces.

When a duplicate address is identified, the state of the address is set to **DUPLICATE**, the address is not used, and the following error message is generated:

```
325002: Duplicate address ipv6_address/MAC_address on interface
```

If the duplicate address is the link-local address of the interface, the processing of IPv6 packets is disabled on the interface. If the duplicate address is a global address, the address is not used.

Step 7

(Optional) Configure the interval between IPv6 neighbor solicitation retransmissions in the **NS Interval** field, between 1000 and 3600000 ms.

The default value is 1000 ms.

Neighbor solicitation messages (ICMPv6 Type 135) are sent on the local link by nodes attempting to discover the link-layer addresses of other nodes on the local link. After receiving a neighbor solicitation message, the destination node replies by sending a neighbor advertisement message (ICPMv6 Type 136) on the local link.

After the source node receives the neighbor advertisement, the source node and destination node can communicate. Neighbor solicitation messages are also used to verify the reachability of a neighbor after the link-layer address of a neighbor is identified. When a node wants to verifying the reachability of a neighbor, the destination address in a neighbor solicitation message is the unicast address of the neighbor.

Neighbor advertisement messages are also sent when there is a change in the link-layer address of a node on a local link.

Step 8

(Optional) Configure the amount of time that a remote IPv6 node is considered reachable after a reachability confirmation event has occurred in the **Reachable Time** field, between 0 and 3600000 ms.

The default value is 0 ms. When 0 is used for the value, the reachable time is sent as undetermined. It is up to the receiving devices to set and track the reachable time value.

The neighbor reachable time enables detecting unavailable neighbors. Shorter configured times enable detecting unavailable neighbors more quickly, however, shorter times consume more IPv6 network bandwidth and processing resources in all IPv6 network devices. Very short configured times are not recommended in normal IPv6 operation.

Step 9 (Optional) To suppress the router advertisement transmissions, uncheck the **Enable RA** check box. If you enable router advertisement transmissions, you can set the RA lifetime and interval.

Router advertisement messages (ICMPv6 Type 134) are automatically sent in response to router solicitation messages (ICMPv6 Type 133). Router solicitation messages are sent by hosts at system startup so that the host can immediately autoconfigure without needing to wait for the next scheduled router advertisement message.

You may want to disable these messages on any interface for which you do not want the threat defense to supply the IPv6 prefix (for example, the outside interface).

- **RA Lifetime**—Configure the router lifetime value in IPv6 router advertisements, between 0 and 9000 seconds.

The default is 1800 seconds.

- **RA Interval**—Configure the interval between IPv6 router advertisement transmissions, between 3 and 1800 seconds.

The default is 200 seconds.

Step 10 Click **OK**.

Step 11 Click **Save**.

You can now go to **Deploy > Deployment** and deploy the policy to assigned devices. The changes are not active until you deploy them.

Configure Advanced Interface Settings

This section describes how to configure MAC addresses for regular firewall mode interfaces, how to set the maximum transmission unit (MTU), and how to set other advanced parameters.

About Advanced Interface Configuration

This section describes advanced interface settings.

About MAC Addresses

You can manually assign MAC addresses to override the default. For container instances, the FXOS chassis automatically generates unique MAC addresses for all interfaces.



Note You might want to assign unique MAC addresses to subinterfaces defined on the threat defense, because they use the same burned-in MAC address of the parent interface. For example, your service provider might perform access control based on the MAC address. Also, because IPv6 link-local addresses are generated based on the MAC address, assigning unique MAC addresses to subinterfaces allows for unique IPv6 link-local addresses, which can avoid traffic disruption in certain instances on the threat defense device.



Note For container instances, even if you are not sharing a subinterface, if you manually configure MAC addresses, make sure you use unique MAC addresses for all subinterfaces on the same parent interface to ensure proper classification.

Default MAC Addresses

For native instances:

Default MAC address assignments depend on the type of interface.

- Physical interfaces—The physical interface uses the burned-in MAC address.
- VLAN interfaces (Firepower 1010)—Routed firewall mode: All VLAN interfaces share a MAC address. Ensure that any connected switches can support this scenario. If the connected switches require unique MAC addresses, you can manually assign MAC addresses. See [Configure the MAC Address, on page 63](#).

Transparent firewall mode: Each VLAN interface has a unique MAC address. You can override the generated MAC addresses if desired by manually assigning MAC addresses. See [Configure the MAC Address, on page 63](#).
- EtherChannels (Firepower Models)—For an EtherChannel, all interfaces that are part of the channel group share the same MAC address. This feature makes the EtherChannel transparent to network applications and users, because they only see the one logical connection; they have no knowledge of the individual links. The port-channel interface uses a unique MAC address from a pool; interface membership does not affect the MAC address.
- EtherChannels (ASA Models)—The port-channel interface uses the lowest-numbered channel group interface MAC address as the port-channel MAC address. Alternatively you can configure a MAC address for the port-channel interface. We recommend configuring a unique MAC address in case the group channel interface membership changes. If you remove the interface that was providing the port-channel MAC address, then the port-channel MAC address changes to the next lowest numbered interface, thus causing traffic disruption.
- Subinterfaces (threat defense-defined)—All subinterfaces of a physical interface use the same burned-in MAC address. You might want to assign unique MAC addresses to subinterfaces. For example, your service provider might perform access control based on the MAC address. Also, because IPv6 link-local addresses are generated based on the MAC address, assigning unique MAC addresses to subinterfaces allows for unique IPv6 link-local addresses, which can avoid traffic disruption in certain instances on the threat defense.

For container instances:

- MAC addresses for all interfaces are taken from a MAC address pool. For subinterfaces, if you decide to manually configure MAC addresses, make sure you use unique MAC addresses for all subinterfaces on the same parent interface to ensure proper classification. See [Automatic MAC Addresses for Container Instance Interfaces](#).

About the MTU

The MTU specifies the maximum frame *payload* size that the threat defense device can transmit on a given Ethernet interface. The MTU value is the frame size *without* Ethernet headers, VLAN tagging, or other overhead. For example, when you set the MTU to 1500, the expected frame size is 1518 bytes including the headers, or 1522 when using VLAN. Do not set the MTU value higher to accommodate these headers.

For Geneve, the entire Ethernet datagram is being encapsulated, so the new IP packet is larger and requires a larger MTU: you should set the ASA VTEP source interface MTU to be the network MTU + 306 bytes.

Path MTU Discovery

The threat defense device supports Path MTU Discovery (as defined in RFC 1191), which lets all devices in a network path between two hosts coordinate the MTU so they can standardize on the lowest MTU in the path.

Default MTU

The default MTU on the threat defense device is 1500 bytes. This value does not include the 18-22 bytes for the Ethernet header, VLAN tagging, or other overhead.

MTU and Fragmentation

For IPv4, if an outgoing IP packet is larger than the specified MTU, it is fragmented into 2 or more frames. Fragments are reassembled at the destination (and sometimes at intermediate hops), and fragmentation can cause performance degradation. For IPv6, packets are typically not allowed to be fragmented at all. Therefore, your IP packets should fit within the MTU size to avoid fragmentation.

For TCP packets, the endpoints typically use their MTU to determine the TCP maximum segment size (MTU - 40, for example). If additional TCP headers are added along the way, for example for site-to-site VPN tunnels, then the TCP MSS might need to be adjusted down by the tunneling entity. See [About the TCP MSS, on page 60](#).

For UDP or ICMP, the application should take the MTU into account to avoid fragmentation.



Note The threat defense device can receive frames larger than the configured MTU as long as there is room in memory.

MTU and Jumbo Frames

A larger MTU lets you send larger packets. Larger packets might be more efficient for your network. See the following guidelines:

- Matching MTUs on the traffic path—We recommend that you set the MTU on all threat defense interfaces and other device interfaces along the traffic path to be the same. Matching MTUs prevents intermediate devices from fragmenting the packets.

- Accommodating jumbo frames—You can set the MTU 9000 bytes or higher when you enable jumbo frames. The maximum depends on the model.

About the TCP MSS

The TCP maximum segment size (MSS) is the size of the TCP payload *before* any TCP and IP headers are added. UDP packets are not affected. The client and the server exchange TCP MSS values during the three-way handshake when establishing the connection.

You can set the TCP MSS on the threat defense device for through traffic using the Sysopt_Basic object in FlexConfig; see [#unique_508](#); by default, the maximum TCP MSS is set to 1380 bytes. This setting is useful when the threat defense device needs to add to the size of the packet for IPsec VPN encapsulation. However, for non-IPsec endpoints, you should disable the maximum TCP MSS on the threat defense device.

If you set a maximum TCP MSS, if either endpoint of a connection requests a TCP MSS that is larger than the value set on the threat defense device, then the threat defense device overwrites the TCP MSS in the request packet with the threat defense device maximum. If the host or server does not request a TCP MSS, then the threat defense device assumes the RFC 793-default value of 536 bytes (IPv4) or 1220 bytes (IPv6), but does not modify the packet. For example, you leave the default MTU as 1500 bytes. A host requests an MSS of 1500 minus the TCP and IP header length, which sets the MSS to 1460. If the threat defense device maximum TCP MSS is 1380 (the default), then the threat defense device changes the MSS value in the TCP request packet to 1380. The server then sends packets with 1380-byte payloads. The threat defense device can then add up to 120 bytes of headers to the packet and still fit in the MTU size of 1500.

You can also configure the minimum TCP MSS; if a host or server requests a very small TCP MSS, the threat defense device can adjust the value up. By default, the minimum TCP MSS is not enabled.

For to-the-box traffic, including for SSL VPN connections, this setting does not apply. The threat defense device uses the MTU to derive the TCP MSS: MTU - 40 (IPv4) or MTU - 60 (IPv6).

Default TCP MSS

By default, the maximum TCP MSS on the threat defense device is 1380 bytes. This default accommodates IPv4 IPsec VPN connections where the headers can equal up to 120 bytes; this value fits within the default MTU of 1500 bytes.

Suggested Maximum TCP MSS Setting

The default TCP MSS assumes the threat defense device acts as an IPv4 IPsec VPN endpoint and has an MTU of 1500. When the threat defense device acts as an IPv4 IPsec VPN endpoint, it needs to accommodate up to 120 bytes for TCP and IP headers.

If you change the MTU value, use IPv6, or do not use the threat defense device as an IPsec VPN endpoint, then you should change the TCP MSS setting using the Sysopt_Basic object in FlexConfig.



Note Even if you explicitly set an MSS, if a component such as TLS/SSL decryption or server discovery needs a particular MSS, it will set that MSS based on the interface MTU and ignore your MSS setting.

See the following guidelines:

- Normal traffic—Disable the TCP MSS limit and accept the value established between connection endpoints. Because connection endpoints typically derive the TCP MSS from the MTU, non-IPsec packets usually fit this TCP MSS.

- IPv4 IPsec endpoint traffic—Set the maximum TCP MSS to the MTU - 120. For example, if you use jumbo frames and set the MTU to 9000, then you need to set the TCP MSS to 8880 to take advantage of the new MTU.
- IPv6 IPsec endpoint traffic—Set the maximum TCP MSS to the MTU - 140.

ARP Inspection for Bridge Group Traffic

By default, all ARP packets are allowed between bridge group members. You can control the flow of ARP packets by enabling ARP inspection.

ARP inspection prevents malicious users from impersonating other hosts or routers (known as ARP spoofing). ARP spoofing can enable a “man-in-the-middle” attack. For example, a host sends an ARP request to the gateway router; the gateway router responds with the gateway router MAC address. The attacker, however, sends another ARP response to the host with the attacker MAC address instead of the router MAC address. The attacker can now intercept all the host traffic before forwarding it on to the router.

ARP inspection ensures that an attacker cannot send an ARP response with the attacker MAC address, so long as the correct MAC address and the associated IP address are in the static ARP table.

When you enable ARP inspection, the threat defense device compares the MAC address, IP address, and source interface in all ARP packets to static entries in the ARP table, and takes the following actions:

- If the IP address, MAC address, and source interface match an ARP entry, the packet is passed through.
- If there is a mismatch between the MAC address, the IP address, or the interface, then the threat defense device drops the packet.
- If the ARP packet does not match any entries in the static ARP table, then you can set the threat defense device to either forward the packet out all interfaces (flood), or to drop the packet.



Note The dedicated Management interface never floods packets even if this parameter is set to flood.

MAC Address Table

When you use bridge groups, the threat defense learns and builds a MAC address table in a similar way as a normal bridge or switch: when a device sends a packet through the bridge group, the threat defense adds the MAC address to its table. The table associates the MAC address with the source interface so that the threat defense knows to send any packets addressed to the device out the correct interface. Because traffic between bridge group members is subject to the threat defense security policy, if the destination MAC address of a packet is not in the table, the threat defense does not flood the original packet on all interfaces as a normal bridge does. Instead, it generates the following packets for directly-connected devices or for remote devices:

- Packets for directly-connected devices—The threat defense generates an ARP request for the destination IP address, so that it can learn which interface receives the ARP response.
- Packets for remote devices—The threat defense generates a ping to the destination IP address so that it can learn which interface receives the ping reply.

The original packet is dropped.

Default Settings

- If you enable ARP inspection, the default setting is to flood non-matching packets.
- The default timeout value for dynamic MAC address table entries is 5 minutes.
- By default, each interface automatically learns the MAC addresses of entering traffic, and the threat defense device adds corresponding entries to the MAC address table.



Note Secure Firewall Threat Defense device generates a reset packet to reset a connection that is denied by a stateful inspection engine. Here, the destination MAC address of the packet is not determined based on the ARP table lookup but instead it is taken directly from the packets (connections) that are being denied.

Guidelines for ARP Inspection and the MAC Address Table

- ARP inspection is only supported for bridge groups.
- MAC address table configuration is only supported for bridge groups.

Configure the MTU

Customize the MTU on the interface, for example, to allow jumbo frames.

For the ISA 3000 and the threat defense virtual: Changing the MTU above 1500 bytes automatically enables jumbo-frame reservation. You must restart the system before you can use jumbo frames. For the threat defense virtual that supports clustering, you can enable jumbo-frame reservation in the Day0 configuration, so in that case, you do not need to restart. After you restart, you cannot disable jumbo-frame reservation. An exception is for the threat defense virtual, where you can disable jumbo-frame reservation in the Day0 configuration, if supported. If you use an interface in an inline set, the MTU setting is not used. However, the jumbo-frame reservation setting *is* relevant to inline sets; jumbo frames enable the inline interfaces to receive packets up to 9000 bytes. To enable jumbo-frame reservation, you must set the MTU of *any* interface above 1500 bytes.

Jumbo frames are enabled by default on other platforms.



Caution Changing the highest MTU value on the device for a data interface restarts the Snort process when you deploy configuration changes, temporarily interrupting traffic inspection. Inspection is interrupted on all data interfaces, not just the interface you modified. Whether this interruption drops traffic or passes it without further inspection depends on the model of the managed device and the interface type. This caution does not apply to management-only interfaces. See [Snort Restart Traffic Behavior](#) for more information.

Procedure

- Step 1** Select **Devices > Device Management** and click **Edit** (✎) for your threat defense device. The **Interfaces** page is selected by default.

- Step 2** Click **Edit** (✎) for the interface you want to edit.
- Step 3** On the **General** tab, set the **MTU**. The minimum and maximum depends on your platform.
The default is 1500 bytes.
- Step 4** Click **OK**.
- Step 5** Click **Save**.
You can now go to **Deploy > Deployment** and deploy the policy to assigned devices. The changes are not active until you deploy them.
- Step 6** For the ISA 3000 and the threat defense virtual, if you set the MTU above 1500 bytes, restart the system to enable jumbo-frame reservation. See [Shut Down or Restart the Device](#).

Configure the MAC Address

You might need to manually assign a MAC address. You can also set the Active and Standby MAC addresses on the **Devices > Device Management > High Availability** tab. If you set the MAC address for an interface on both screens, the addresses on the **Interfaces > Advanced** tab take precedence.



Note For container instances, even if you are not sharing a subinterface, if you manually configure MAC addresses, make sure you use unique MAC addresses for all subinterfaces on the same parent interface to ensure proper classification.

Procedure

- Step 1** Select **Devices > Device Management** and click **Edit** (✎) for your threat defense device. The **Interfaces** page is selected by default.
- Step 2** Click **Edit** (✎) for the interface you want to edit.
- Step 3** Click the **Advanced** tab.
The **Information** tab is selected.
- Step 4** Set the active and standby MAC addresses.
- In the **Active MAC Address** field, enter a MAC address in H.H.H format, where H is a 16-bit hexadecimal digit.

For example, the MAC address 00-0C-F1-42-4C-DE would be entered as 000C.F142.4CDE. The MAC address must not have the multicast bit set, that is, the second hexadecimal digit from the left cannot be an odd number.
 - In the **Standby MAC Address** field, enter a MAC address for use with High Availability.

If the active unit fails over and the standby unit becomes active, the new active unit starts using the active MAC addresses to minimize network disruption, while the old active unit uses the standby address.
- Step 5** Click **OK**.
- Step 6** Click **Save**.

You can now go to **Deploy > Deployment** and deploy the policy to assigned devices. The changes are not active until you deploy them.

Add a Static ARP Entry

By default, all ARP packets are allowed between bridge group members. You can control the flow of ARP packets by enabling ARP inspection (see [ARP Inspection](#)). ARP inspection compares ARP packets with *static* ARP entries in the ARP table.

For routed interfaces, you can enter static ARP entries, but normally dynamic entries are sufficient. For routed interfaces, the ARP table is used to deliver packets to directly-connected hosts. Although senders identify a packet destination by an IP address, the actual delivery of the packet on Ethernet relies on the Ethernet MAC address. When a router or host wants to deliver a packet on a directly connected network, it sends an ARP request asking for the MAC address associated with the IP address, and then delivers the packet to the MAC address according to the ARP response. The host or router keeps an ARP table so it does not have to send ARP requests for every packet it needs to deliver. The ARP table is dynamically updated whenever ARP responses are sent on the network, and if an entry is not used for a period of time, it times out. If an entry is incorrect (for example, the MAC address changes for a given IP address), the entry needs to time out before it can be updated with the new information.

For transparent mode, the threat defense only uses dynamic ARP entries in the ARP table for traffic to and from the threat defense device, such as management traffic.

Before you begin

This screen is only available for named interfaces.

Procedure

-
- Step 1** Select **Devices > Device Management** and click **Edit** (✎) for your threat defense device. The **Interfaces** page is selected by default.
 - Step 2** Click **Edit** (✎) for the interface you want to edit.
 - Step 3** Click the **Advanced** tab, and then click the **ARP** tab (called **ARP and MAC** for transparent mode).
 - Step 4** Click (+) **Add ARP Config**.
The **Add ARP Config** dialog box appears.
 - Step 5** In the **IP Address** field, enter the IP address of the host.
 - Step 6** In the **MAC Address** field, enter the MAC address of the host; for example, 00e0.1e4e.3d8b.
 - Step 7** To perform proxy ARP for this address, check the **Enable Alias** check box.

If the threat defense device receives an ARP request for the specified IP address, then it responds with the specified MAC address.
 - Step 8** Click **OK**, and then click **OK** again to exit the Advanced settings.
 - Step 9** Click **Save**.

You can now go to **Deploy > Deployment** and deploy the policy to assigned devices. The changes are not active until you deploy them.

Add a Static MAC Address and Disable MAC Learning for a Bridge Group

Normally, MAC addresses are added to the MAC address table dynamically as traffic from a particular MAC address enters an interface. You can disable MAC address learning; however, unless you statically add MAC addresses to the table, no traffic can pass through the threat defense device. You can also add static MAC addresses to the MAC address table. One benefit to adding static entries is to guard against MAC spoofing. If a client with the same MAC address as a static entry attempts to send traffic to an interface that does not match the static entry, then the threat defense device drops the traffic and generates a system message. When you add a static ARP entry (see [Add a Static ARP Entry, on page 64](#)), a static MAC address entry is automatically added to the MAC address table.

Before you begin

This screen is only available for named BVIs in transparent mode.

Procedure

- Step 1** Select **Devices > Device Management** and click **Edit** (✎) for your threat defense device. The **Interfaces** page is selected by default.
- Step 2** Click **Edit** (✎) for the interface you want to edit.
- Step 3** Click the **Advanced** tab, and then click the **ARP and MAC** tab.
- Step 4** (Optional) Disable MAC learning by unchecking the **Enable MAC Learning** check box.
- Step 5** To add a static MAC address, click **Add MAC Config**.
The **Add MAC Config** dialog box appears.
- Step 6** In the **MAC Address** field, enter the MAC address of the host; for example, 00e0.1e4e.3d8b. Click **OK**.
- Step 7** Click **OK** to exit the Advanced settings.
- Step 8** Click **Save**.

You can now go to **Deploy > Deployment** and deploy the policy to assigned devices. The changes are not active until you deploy them.

Set Security Configuration Parameters

This section describes how to prevent IP spoofing, allow full fragment reassembly, and override the default fragment setting set for at the device level in **Platform Settings**.

Anti-Spoofing

This section lets you enable Unicast Reverse Path Forwarding on an interface. Unicast RPF guards against IP spoofing (a packet uses an incorrect source IP address to obscure its true source) by ensuring that all packets have a source IP address that matches the correct source interface according to the routing table.

Normally, the threat defense device only looks at the destination address when determining where to forward the packet. Unicast RPF instructs the device to also look at the source address; this is why it is called Reverse Path Forwarding. For any traffic that you want to allow through the threat defense device, the device routing table must include a route back to the source address. See RFC 2267 for more information.

For outside traffic, for example, the threat defense device can use the default route to satisfy the Unicast RPF protection. If traffic enters from an outside interface, and the source address is not known to the routing table, the device uses the default route to correctly identify the outside interface as the source interface.

If traffic enters the outside interface from an address that is known to the routing table, but is associated with the inside interface, then the threat defense device drops the packet. Similarly, if traffic enters the inside interface from an unknown source address, the device drops the packet because the matching route (the default route) indicates the outside interface.

Unicast RPF is implemented as follows:

- ICMP packets have no session, so each packet is checked.
- UDP and TCP have sessions, so the initial packet requires a reverse route lookup. Subsequent packets arriving during the session are checked using an existing state maintained as part of the session. Non-initial packets are checked to ensure they arrived on the same interface used by the initial packet.

Fragment per Packet

By default, the threat defense device allows up to 24 fragments per IP packet, and up to 200 fragments awaiting reassembly. You might need to let fragments on your network if you have an application that routinely fragments packets, such as NFS over UDP. However, if you do not have an application that fragments traffic, we recommend that you do not allow fragments through the threat defense device. Fragmented packets are often used as DoS attacks.

Fragment Reassembly

The threat defense device performs the following fragment reassembly processes:

- IP fragments are collected until a fragment set is formed or until a timeout interval has elapsed.
- If a fragment set is formed, integrity checks are performed on the set. These checks include no overlapping, no tail overflow, and no chain overflow.
- IP fragments that terminate at the threat defense device are always fully reassembled.
- If **Full Fragment Reassembly** is disabled (the default), the fragment set is forwarded to the transport layer for further processing.
- If **Full Fragment Reassembly** is enabled, the fragment set is first coalesced into a single IP packet. The single IP packet is then forwarded to the transport layer for further processing.

Before you begin

This screen is only available for named interfaces.

Procedure

- Step 1** Select **Devices > Device Management** and click **Edit** (✎) for your threat defense device. The **Interfaces** page is selected by default.

- Step 2** Click **Edit** (✎) for the interface you want to edit.
- Step 3** Click the **Advanced** tab, and then click the **Security Configuration** tab.
- Step 4** To enable Unicast Reverse Path Forwarding, check the **Enable Anti Spoofing** check box.
- Step 5** To enable full fragment reassembly, check the **Allow Full Fragment Reassembly** check box.
- Step 6** To change the number of fragments allowed per packet, check the **Override Default Fragment Setting** check box, and set the following values:
- **Size**—Set the maximum number of packets that can be in the IP reassembly database waiting for reassembly. The default is 200. Set this value to 1 to disable fragments.
 - **Chain**—Set the maximum number of packets into which a full IP packet can be fragmented. The default is 24 packets.
 - **Timeout**—Set the maximum number of seconds to wait for an entire fragmented packet to arrive. The timer starts after the first fragment of a packet arrives. If all fragments of the packet do not arrive by the number of seconds specified, all fragments of the packet that were already received will be discarded. The default is 5 seconds.
- Step 7** Click **OK**.
- Step 8** Click **Save**.

You can now go to **Deploy > Deployment** and deploy the policy to assigned devices. The changes are not active until you deploy them.

History for Regular Firewall Interfaces for Secure Firewall Threat Defense

Feature	Minimum Management Center	Minimum Threat Defense	Details
VXLAN VTEP IPv6 support	7.4	Any	<p>You can now specify an IPv6 address for the VXLAN VTEP interface. IPv6 is not supported for the threat defense virtual cluster control link or for Geneve encapsulation.</p> <p>New/Modified screens:</p> <ul style="list-style-type: none"> • Devices > Device Management > Edit > VTEP > Add VTEP • Devices > Device Management > Edit > Interfaces > Add Interfaces > VNI Interface <p>Requires threat defense version 7.4.</p> <p>You can specify an IPv6 address for the VXLAN VTEP interface for Secure Firewall 4200 Series devices only.</p>

Feature	Minimum Management Center	Minimum Threat Defense	Details
Loopback interface support for BGP and management traffic	7.4	Any	<p>You can use a loopback interface for:</p> <ul style="list-style-type: none"> • AAA • BGP • DNS • HTTP • ICMP • IPsec Flow Offload • NetFlow • SNMP • SSH • Syslog <p>Requires threat defense version 7.4.</p>
Loopback interface support for VTI	7.3	Any	<p>You can now add a loopback interface. The loopback interface helps to overcome path failures. If an interface goes down, you can access all interfaces through the IP address assigned to the loopback interface. For VTI, in addition to setting a loopback interface as the source interface, support has also been added to inherit the IP address from a loopback interface instead of a statically configured IP address.</p> <p>New/Modified screens:</p> <p>Devices > Device Management > Interfaces > Add Interfaces > Add Loopback Interface</p>

Feature	Minimum Management Center	Minimum Threat Defense	Details
IPv6 DHCP	7.3	Any	<p>The threat defense now supports the following features for IPv6 addressing:</p> <ul style="list-style-type: none"> • DHCPv6 Address client—The threat defense obtains an IPv6 global address and optional default route from the DHCPv6 server. • DHCPv6 Prefix Delegation client—The threat defense obtains delegated prefix(es) from a DHCPv6 server. The threat defense can then use these prefixes to configure other threat defense interface addresses so that StateLess Address Auto Configuration (SLAAC) clients can autoconfigure IPv6 addresses on the same network. • BGP router advertisement for delegated prefixes • DHCPv6 stateless server—The threat defense provides other information such as the domain name to SLAAC clients when they send Information Request (IR) packets to the threat defense. The threat defense only accepts IR packets, and does not assign addresses to the clients. <p>New/Modified screens:</p> <ul style="list-style-type: none"> • Devices > Device Management > Interfaces > Add/Edit Interfaces > IPv6 > DHCP • Objects > Object Management > DHCP IPv6 Pool <p>New/Modified commands: show bgp ipv6 unicast, show ipv6 dhcp, show ipv6 general-prefix</p>
Paired proxy VXLAN for the threat defense virtual for the Azure Gateway Load Balancer	7.3	Any	<p>You can configure a paired proxy mode VXLAN interface for the threat defense virtual in Azure for use with the Azure Gateway Load Balancer (GWLB). The threat defense virtual defines an external interface and an internal interface on a single NIC by utilizing VXLAN segments in a paired proxy.</p> <p>New/Modified screens:</p> <ul style="list-style-type: none"> • Devices > Device Management > Device > Interfaces > Add Interfaces > VNI Interface <p>Supported platforms: Threat Defense Virtual in Azure</p>
VXLAN support	7.2	Any	<p>VXLAN encapsulation support was added.</p> <p>New/Modified screens:</p> <ul style="list-style-type: none"> • Devices > Device Management > Device > VTEP • Devices > Device Management > Device > Interfaces > Add Interfaces > VNI Interface • Devices > Device Management > Device > Interfaces edit physical interface > General <p>Supported platforms: All.</p>

Feature	Minimum Management Center	Minimum Threat Defense	Details
Geneve support for the Threat Defense Virtual	7.1	Any	<p>Geneve encapsulation support was added for the threat defense virtual to support single-arm proxy for the Amazon Web Services (AWS) Gateway Load Balancer. The AWS Gateway Load Balancer combines a transparent network gateway (with a single entry and exit point for all traffic) and a load balancer that distributes traffic and scales threat defense virtual to match the traffic demand.</p> <p>This feature requires Snort 3.</p> <p>New/Modified screens:</p> <ul style="list-style-type: none"> • Devices > Device Management > Device > VTEP • Devices > Device Management > Device > Interfaces > Add Interfaces > VNI Interface • Devices > Device Management > Device > Interfaces edit physical interface > General <p>Supported platforms: Threat Defense Virtual in AWS</p>
31-bit Subnet Mask	7.0	Any	<p>For routed interfaces, you can configure an IP address on a 31-bit subnet for point-to-point connections. The 31-bit subnet includes only 2 addresses; normally, the first and last address in the subnet is reserved for the network and broadcast, so a 2-address subnet is not usable. However, if you have a point-to-point connection and do not need network or broadcast addresses, a 31-bit subnet is a useful way to preserve addresses in IPv4. For example, the failover link between 2 FTDs only requires 2 addresses; any packet that is transmitted by one end of the link is always received by the other, and broadcasting is unnecessary. You can also have a directly-connected management station running SNMP or Syslog. This feature is not supported for BVIs for bridge groups or with multicast routing.</p> <p>New/Modified screens:</p> <p>Devices > Device Management > Interfaces</p>

Feature	Minimum Management Center	Minimum Threat Defense	Details
Synchronization between the threat defense operational link state and the physical link state for the Firepower 4100/9300	6.7	Any	<p>The Firepower 4100/9300 chassis can now synchronize the threat defense operational link state with the physical link state for data interfaces. Currently, interfaces will be in an Up state as long as the FXOS admin state is up and the physical link state is up. The threat defense application interface admin state is not considered. Without synchronization from threat defense, data interfaces can be in an Up state physically before the threat defense application has completely come online, for example, or can stay Up for a period of time after you initiate a threat defense shutdown. For inline sets, this state mismatch can result in dropped packets because external routers may start sending traffic to the threat defense before the threat defense can handle it. This feature is disabled by default, and can be enabled per logical device in FXOS.</p> <p>Note This feature is not supported for clustering, container instances, or threat defense with a Radware vDP decorator. It is also not supported for ASA.</p> <p>New/Modified Firepower Chassis Manager screens: Logical Devices > Enable Link State</p> <p>New/Modified FXOS commands: set link-state-sync enabled, show interface expand detail</p> <p>Supported platforms: Firepower 4100/9300</p>
Firepower 1010 hardware switch support	6.5	Any	<p>The Firepower 1010 supports setting each Ethernet interface to be a switch port or a firewall interface.</p> <p>New/Modified screens:</p> <ul style="list-style-type: none"> • Devices > Device Management > Interfaces • Devices > Device Management > Interfaces > Edit Physical Interface • Devices > Device Management > Interfaces > Add VLAN Interface
Firepower 1010 PoE+ support on Ethernet 1/7 and Ethernet 1/8	6.5	Any	<p>The Firepower 1010 supports Power over Ethernet+ (PoE+) on Ethernet 1/7 and Ethernet 1/8 when they are configured as switch ports.</p> <p>New/Modified screens:</p> <p>Devices > Device Management > Interfaces > Edit Physical Interface > PoE</p>

Feature	Minimum Management Center	Minimum Threat Defense	Details
VLAN subinterfaces for use with container instances	6.3.0	Any	<p>To provide flexible physical interface use, you can create VLAN subinterfaces in FXOS and also share interfaces between multiple instances.</p> <p>New/Modified Secure Firewall Management Center screens: Devices > Device Management > Edit icon > Interfaces tab</p> <p>New/Modified Secure Firewall chassis manager screens: Interfaces > All Interfaces > Add New drop-down menu > Subinterface</p> <p>New/Modified FXOS commands: create subinterface, set vlan, show interface, show subinterface</p> <p>Supported platforms: Firepower 4100/9300</p>
Data-sharing interfaces for container instances	6.3.0	Any	<p>To provide flexible physical interface use, you can share interfaces between multiple instances.</p> <p>New/Modified Secure Firewall chassis manager screens: Interfaces > All Interfaces > Type</p> <p>New/Modified FXOS commands: set port-type data-sharing, show interface</p> <p>Supported platforms: Firepower 4100/9300</p>

Feature	Minimum Management Center	Minimum Threat Defense	Details
Integrated Routing and Bridging	6.2.0	Any	<p>Integrated Routing and Bridging provides the ability to route between a bridge group and a routed interface. A bridge group is a group of interfaces that the threat defense bridges instead of routes. The threat defense is not a true bridge in that the threat defense continues to act as a firewall: access control between interfaces is controlled, and all of the usual firewall checks are in place.</p> <p>Previously, you could only configure bridge groups in transparent firewall mode, where you cannot route between bridge groups. This feature lets you configure bridge groups in routed firewall mode, and to route between bridge groups and between a bridge group and a routed interface. The bridge group participates in routing by using a Bridge Virtual Interface (BVI) to act as a gateway for the bridge group. Integrated Routing and Bridging provides an alternative to using an external Layer 2 switch if you have extra interfaces on the threat defense to assign to the bridge group. In routed mode, the BVI can be a named interface and can participate separately from member interfaces in some features, such as access rules and DHCP server.</p> <p>The following features that are supported in transparent mode are not supported in routed mode: clustering. The following features are also not supported on BVIs: dynamic routing and multicast routing.</p> <p>New/Modified screens:</p> <ul style="list-style-type: none"> • Devices > Device Management > Interfaces > Edit Physical Interface • Devices > Device Management > Interfaces > Add Interfaces > Bridge Group Interface <p>Supported platforms: All except for the Firepower 2100 and the threat defense virtual</p>

