



## **Cisco Video Surveillance 6030 IP Camera Installation Guide**

### **Americas Headquarters**

Cisco Systems, Inc.  
170 West Tasman Drive  
San Jose, CA 95134-1706  
USA  
<http://www.cisco.com>  
Tel: 408 526-4000  
800 553-NETS (6387)  
Fax: 408 527-0883

NOTICE. ALL STATEMENTS, INFORMATION, AND RECOMMENDATIONS IN THIS MANUAL ARE BELIEVED TO BE ACCURATE BUT ARE PRESENTED WITHOUT WARRANTY OF ANY KIND, EXPRESS OR IMPLIED. USERS MUST TAKE FULL RESPONSIBILITY FOR THEIR APPLICATION OF ANY PRODUCTS.

THE SOFTWARE LICENSE AND LIMITED WARRANTY FOR THE ACCOMPANYING PRODUCT ARE SET FORTH IN THE INFORMATION PACKET THAT SHIPPED WITH THE PRODUCT AND ARE INCORPORATED HEREIN BY THIS REFERENCE. IF YOU ARE UNABLE TO LOCATE THE SOFTWARE LICENSE OR LIMITED WARRANTY, CONTACT YOUR CISCO REPRESENTATIVE FOR A COPY.

The Cisco implementation of TCP header compression is an adaptation of a program developed by the University of California, Berkeley (UCB) as part of UCB's public domain version of the UNIX operating system. All rights reserved. Copyright © 1981, Regents of the University of California.

NOTWITHSTANDING ANY OTHER WARRANTY HEREIN, ALL DOCUMENT FILES AND SOFTWARE OF THESE SUPPLIERS ARE PROVIDED "AS IS" WITH ALL FAULTS. CISCO AND THE ABOVE-NAMED SUPPLIERS DISCLAIM ALL WARRANTIES, EXPRESSED OR IMPLIED, INCLUDING, WITHOUT LIMITATION, THOSE OF MERCHANTABILITY, FITNESS FOR A PARTICULAR PURPOSE AND NONINFRINGEMENT OR ARISING FROM A COURSE OF DEALING, USAGE, OR TRADE PRACTICE.

IN NO EVENT SHALL CISCO OR ITS SUPPLIERS BE LIABLE FOR ANY INDIRECT, SPECIAL, CONSEQUENTIAL, OR INCIDENTAL DAMAGES, INCLUDING, WITHOUT LIMITATION, LOST PROFITS OR LOSS OR DAMAGE TO DATA ARISING OUT OF THE USE OR INABILITY TO USE THIS MANUAL, EVEN IF CISCO OR ITS SUPPLIERS HAVE BEEN ADVISED OF THE POSSIBILITY OF SUCH DAMAGES.

Cisco and the Cisco Logo are trademarks of Cisco Systems, Inc. and/or its affiliates in the U.S. and other countries. A listing of Cisco's trademarks can be found at [www.cisco.com/go/trademarks](http://www.cisco.com/go/trademarks). Third party trademarks mentioned are the property of their respective owners. The use of the word partner does not imply a partnership relationship between Cisco and any other company. (1005R)

*Cisco Video Surveillance 6030 IP Camera Installation Guide*  
Copyright © 2012 Cisco Systems, Inc. All rights reserved.



# CONTENTS

## **Preface** v

Overview v

Organization v

Obtaining Documentation, Obtaining Support, and Security Guidelines v

---

## **CHAPTER 1**

### **Overview** 1-1

Introduction 1-1

Package Contents 1-2

IP Camera Physical Details 1-3

General Purpose I/O Terminal Block 1-5

---

## **CHAPTER 2**

### **Camera Installation** 2-1

Installation Guidelines 2-1

Warnings Before Installation 2-1

Installing the IP Camera with a Vandal Resistant Enclosure 2-4

---

## **CHAPTER 3**

### **Performing the Initial Setup of the IP Camera** 3-1

---

## **CHAPTER 4**

### **Camera Management** 4-1

Understanding the IP Camera User Interface 4-1

IP Camera Window Links 4-1

IP Camera Windows 4-2

Adjusting the IP Camera Focus and Zoom 4-3

Powering the IP Camera On or Off 4-4

Resetting the IP Camera 4-4

Viewing Live Video 4-5

---

## **INDEX**





## Preface

---

### Overview

This document, *Cisco Video Surveillance 6030 IP Camera Installation Guide*, provides information about installing and deploying the Cisco Video Surveillance 6030 High-Definition IP Camera.

### Organization

This manual is organized as follows:

<a href="#">Chapter 1, “Overview”</a>	Provides an overview of the IP camera and its features.
<a href="#">Chapter 2, “Camera Installation”</a>	Provides instructions for physically installing the IP camera.
<a href="#">Chapter 3, “Performing the Initial Setup of the IP Camera”</a>	Provides instructions for performing the initial network setup of the IP camera.
<a href="#">Chapter 4, “Camera Management”</a>	Provides instructions for accessing and understanding the IP camera user interface, adjusting its focus and, powering the IP camera on and off, and resetting the IP camera.

## Obtaining Documentation, Obtaining Support, and Security Guidelines

For information about obtaining documentation, submitting a service request, and gathering additional information, see the monthly *What’s New in Cisco Product Documentation*, which also lists all new and revised Cisco technical documentation, at:

<http://www.cisco.com/en/US/docs/general/whatsnew/whatsnew.html>

Subscribe to the *What’s New in Cisco Product Documentation* as a Really Simple Syndication (RSS) feed and set content to be delivered directly to your desktop using a reader application. The RSS feeds are a free service and Cisco currently supports RSS version 2.0.





# CHAPTER 1

## Overview

---

This chapter describes the Cisco Video Surveillance 6030 High-Definition IP Camera, and includes the following topics:

- [Introduction, page 1-1](#)
- [Package Contents, page 1-2](#)
- [IP Camera Physical Details, page 1-3](#)

## Introduction

The Cisco Video Surveillance 6030 IP camera is an outdoor, high definition, professional fixed dome IP camera with industry-leading image quality and processing power. The 2.1 megapixel (MP) IP camera offers 1080p full HD resolution (1920 x 1080) with superb image quality up to 30 frames per second (FPS) while optimizing network usage with either H.264 or MJPEG compression. It can capture a much more comprehensive area than a standard VGA model, significantly reducing the number of units required. It is especially suitable for monitoring wide open outdoor areas such as building entrances, airports, or applications requiring accurate identification.

For installers, properly adjusting the focus of an HD IP camera can be difficult due to the image detail. To make installation and adjustment easier, the 6030 IP camera incorporates built-in stepping motors that the installer can use to remotely control the focal length and precisely adjust the camera focus, offering hassle-free installation and maintenance.

For complete installation and tampering prevention, the 6030 IP camera also fits different conduits and corrugated tubes sizes for cable installation. Its IP66-rated housing is designed to help the camera body withstand rain and dust and ensures operation under a multitude of harsh weather conditions. The wide temperature range further enhances the 6030 IP camera performance and reliability in extremely cold and warm weather. Additionally, the metal vandal-proof housing effectively provides robust protection from vandalism.

With other advanced features such 802.3af compliant PoE, micro SD/SDHC card for local storage, and e-PTZ functionality, the 6030 IP camera provides the most robust solution suitable for any demanding outdoor environment.

# Package Contents

The Cisco Video Surveillance IP Camera package includes the following items:

- Cisco Video Surveillance 6030 IP Camera (1)
- Installation template and alignment sticker (1)
- Mounting plate (1)
- Black cover (1)
- Bushing (1)
- Waterproof connector (1)
- L type hex key (allen wrench) (1)
- Screws (t4x32) (4)
- Wall anchors (4)
- Hex nut (1)
- Double sided tape (1)
- Silica gel (10)
- Extra set of labels (3)
- Cisco documentation pointer card (1)
- Cisco RoHS document (1)



# IP Camera Physical Details

Figure 1-1 and the table that follows describe the physical features of the 6030 IP camera.

**Figure 1-1** IP Camera Physical Features

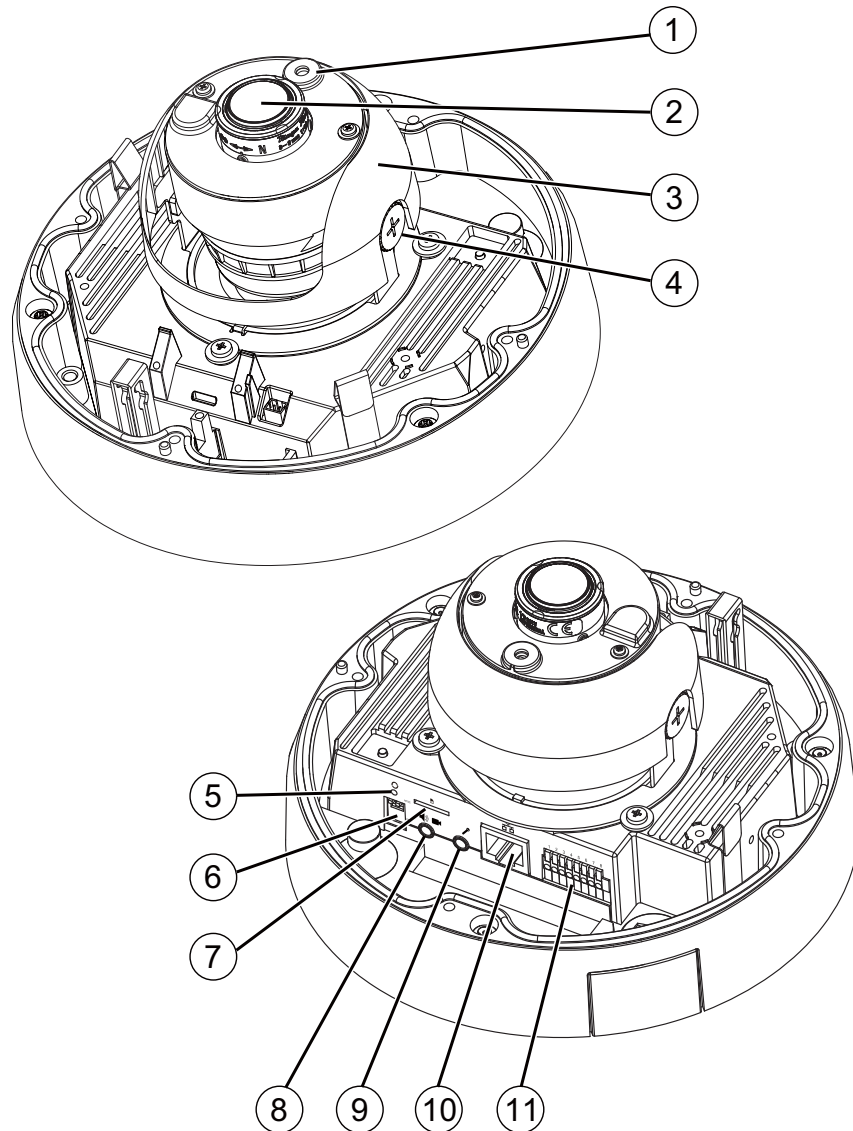

1	Light sensor	Senses the level of ambient light to determine when to switch day/night mode.
2	Varifocal lens	IP camera lens that changes focus as the focal length changes.
3	Black cover	
4	Tilt adjustment screw	Used when tilting the camera to set the field of view.

5	Recessed Reset button	Recessed button that reboots the IP camera or resets it to a default state. You can use a pin or paper clip to depress it. It can be used any time that the IP camera is on and can have various effects, as described in the “Resetting the IP Camera” section on page 2-11.
6	Microphone and Video Output switches	<p><b>Microphone</b></p> <ul style="list-style-type: none"> <li>• Internal (up)—switches to the built-in internal microphone on the IP camera. Support for the internal microphone will be in future releases.</li> <li>• External (down)—switches to the external Microphone In connector.</li> </ul> <p><b>Video Output</b></p> <ul style="list-style-type: none"> <li>• NTSC 60Hz (up)—switches camera operation to the National Television System Committee (NTSC) standard.</li> <li>• PAL 50Hz (down)—switches camera operation to the Phase Alternating Line (PAL) standard.</li> </ul>
7	SD/SDHC card slot	Support for the SD/SDHC card slot will be available in future releases.
8	Audio/Video out (green)	<p>Allows the connection of an optional Y cable or mini cable with BNC connector. You can connect a video monitor to the mini cable with BNC connector. Both cables are included in the optional audio/video cables accessory kit can be purchased from Cisco (Cisco part number CIVS-AVCABLE).</p> <p><b>Note</b> Support for audio will be in future releases.</p>
9	Microphone In (pink)	Connection for an external microphone.
10	Ethernet 10/100 RJ45 socket	Accepts a standard LAN cable to connect the IP camera to a 10/100BaseT router or switch.
11	General Purpose I/O Terminal Block	General purpose input/output (GPIO) terminal block that is used to connect external input and output devices. For more information, see <a href="#">Figure 1-2</a> .

# General Purpose I/O Terminal Block

Figure 1-2 shows the GPIO terminal block pin locations and descriptions.

**Figure 1-2** GPIO Terminal Block Pin Locations and Descriptions

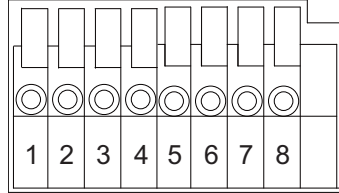

Pin	Description
1	12 VDC-
2	12 VDC+
3	24 VAC
4	24 VAC
5	DI-
6	DI+
7	DO-
8	DO+

**Note**

The maximum output load from pins 7 and 8 is 400mA.





## CHAPTER 2

# Camera Installation

---

This chapter provides information and instructions for installing the Cisco Video Surveillance 6030 IP Camera, and includes the following topics:

- [Installation Guidelines, page 2-1](#)
- [Warnings Before Installation, page 2-1](#)
- [Installing the IP Camera with a Vandal Resistant Enclosure, page 2-4](#)

## Installation Guidelines

This section describes how to install the IP camera. Before installing, review these guidelines:

- The IP camera requires a network cable and a connection to a standard 10/100BaseT router or switch. To power the IP camera with Power over Ethernet (PoE), a switch must be 802.3af compliant.
- If you are using the IP camera on a network connection that does not provide PoE, you must use a Cisco 12 VDC power adapter (Cisco part number CIVS-PWRPAC-12V) or a third-party 24 VAC power adapter.
- If you are using an external speaker, microphone, input device, output device, or pan/tilt control device, you must configure additional settings after installing and performing the initial set up of the IP camera before the external device can fully operate. For detailed information about these settings, see the *Cisco Video Surveillance 6000 Series IP Camera Configuration Guide*.
- If you do not connect an external device (speaker, microphone, input, output, or pan/tilt control) when you perform the following installation procedure, you can install any of these devices later.

## Warnings Before Installation

- **Power off the IP Camera as soon as smoke or unusual odors are detected.**  
Contact your distributor in the event of this happening.
- **Keep the IP Camera away from water. If the IP Camera becomes wet, power off immediately.**  
Contact your distributor in the event of this happening.

- Do not place the IP Camera around heat sources, such as a television or oven.

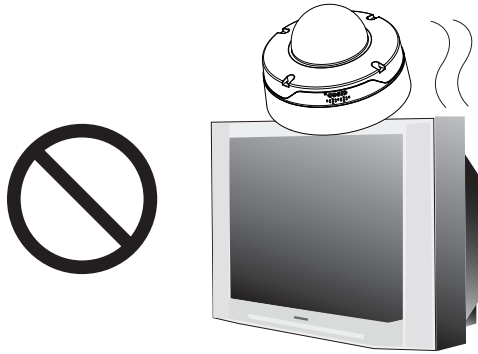

- Refer to your user's manual for the operating temperature.

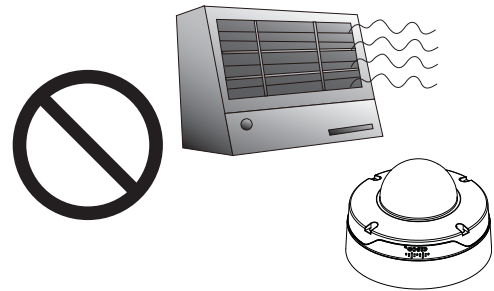

- Keep the IP Camera away from direct sunlight.

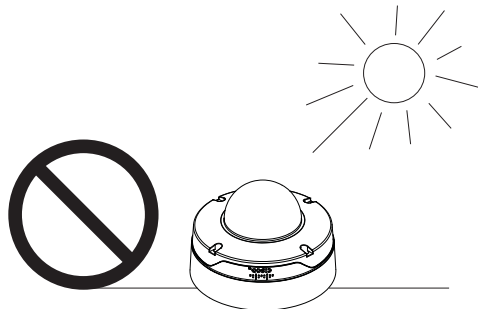

- Do not place the IP Camera in high humidity environments.

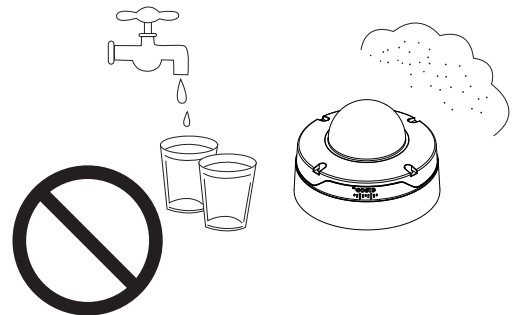

- Do not place the IP Camera on unsteady surfaces.

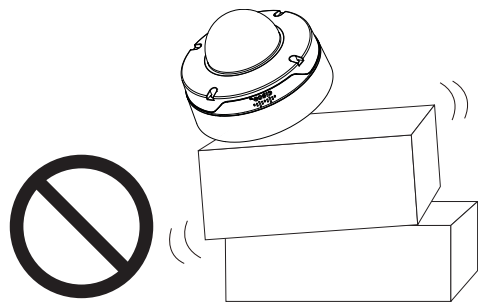

- Do not touch the IP Camera during a lightning storm.

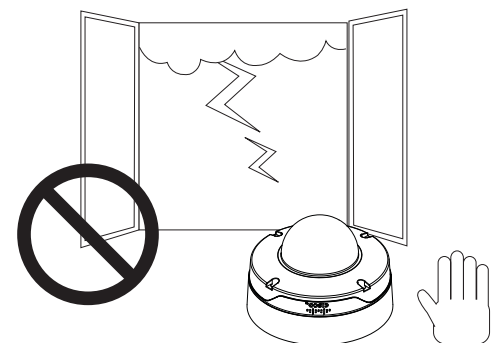

- Do not disassemble the IP Camera.

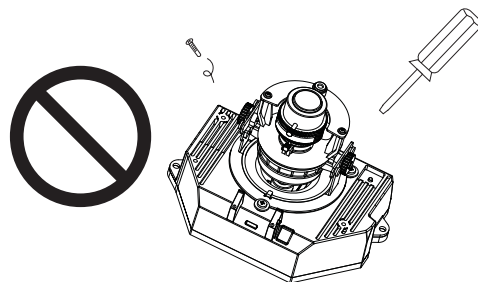

- Do not drop the IP Camera.

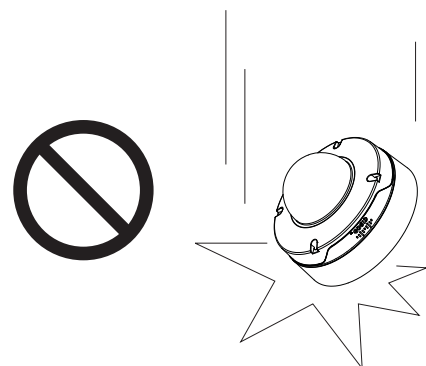

- Do not insert sharp or tiny objects into the IP Camera.

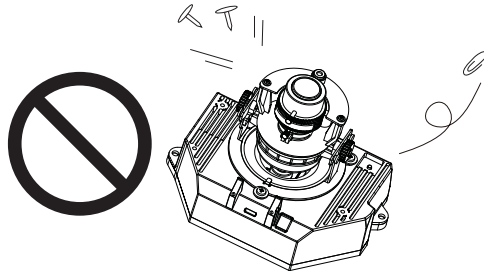

  
**Warning**

**Installation of the equipment must comply with local and national electrical codes.** Statement 1074

  
**Warning**

**The power supply must be placed indoors.** Statement 331



**Note** If you use the IP camera outdoors, place the camera and the power supply in a suitable NEMA enclosure.

  
**Warning**

**This product must be connected to a power-over-ethernet (PoE) IEEE 802.3af compliant power source or an IEC60950 compliant limited power source.** Statement 353

  
**Caution**

Inline power circuits provide current through the communication cable. Use the Cisco provided cable or a minimum 24AWG communication cable.



**Note**

The power adapter that you use with the IP camera must provide power that is within +/-10% of the required power.



**Note**

The equipment is to be connected to a Listed class 2, limited power source.

# Installing the IP Camera with a Vandal Resistant Enclosure

To install the IP camera to using a vandal resistant (VR) enclosure, perform the following steps.

## Procedure

- Step 1** Attach the included alignment sticker to the ceiling or wall.
- Step 2** Using the circle marks on the sticker, drill at least two pilot holes symmetrically on each side (four holes total) into the ceiling or wall. Then hammer the included wall anchors into the holes.
- Step 3** Secure the mounting plate to the ceiling or wall with the four included screws.

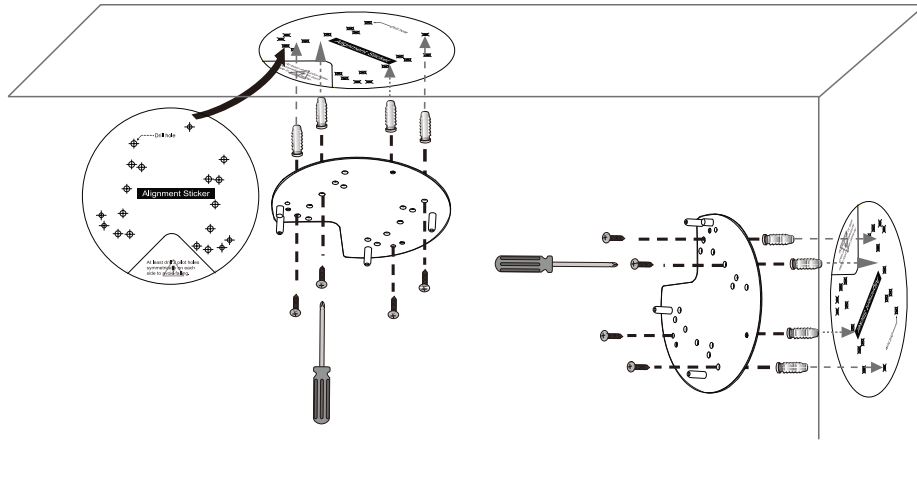

- Step 4** Do one of the following to feed the cables to the IP camera:
- Cut out a section of the ceiling or wall that corresponds to the triangular cutout on the alignment sticker, and feed cables through a ceiling or wall.
  - Use a screwdriver to remove the cutout on the side of the conduit base, connect a cable conduit, and feed the cables through the side of the conduit base.
- Step 5** Perform the following steps to install and connect an RJ45 Ethernet cable (24AWG [0.51 mm] gauge recommended).
- a. Drill a hole on the rubber seal plug and insert an Ethernet cable (without a connector) through the opening.

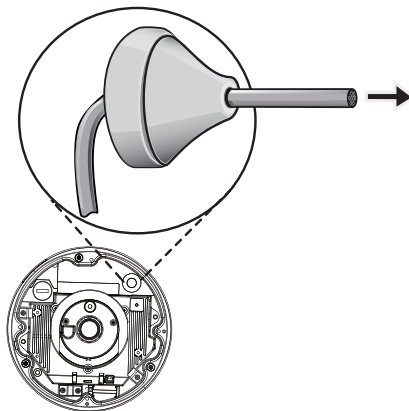



- b. Strip about 1/2 inch (12 mm) of the sheath from the Ethernet cable.
- c. Use an RJ45 crimping tool to attach the Ethernet wires to a connector. When done, connect the cable to the camera's Ethernet RJ45 socket.

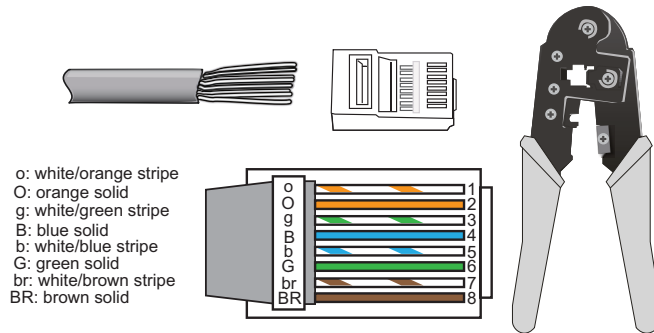

- d. Press the Ethernet cable into the routing path at the bottom of the camera so that the cable will not get in the way when the metal mounting plate is attached.

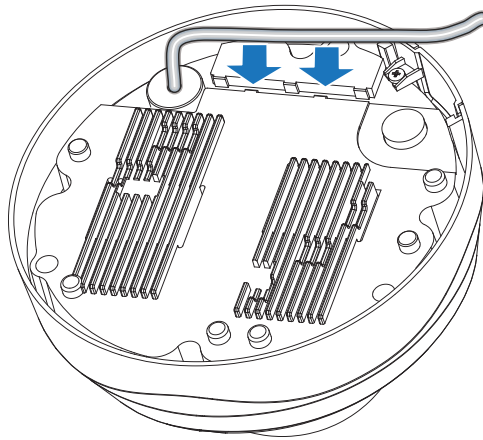

**Step 6** (Optional) Perform the following steps to install and connect an external power cable and I/O cables for external devices:

- a. Disassemble the components of the waterproof connector into parts (A) ~ (F).

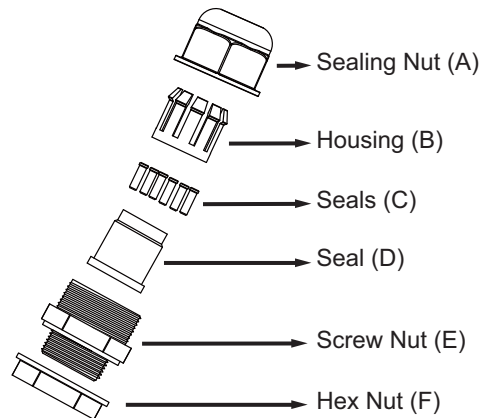

- b. Place the screw nut (E) on the power and I/O cable opening.

- c. Feed the power cable through the waterproof connector (F --> E --> D --> B --> A). Be sure to feed enough power cable length through the waterproof connector to connect the power cable to the GPIO block.

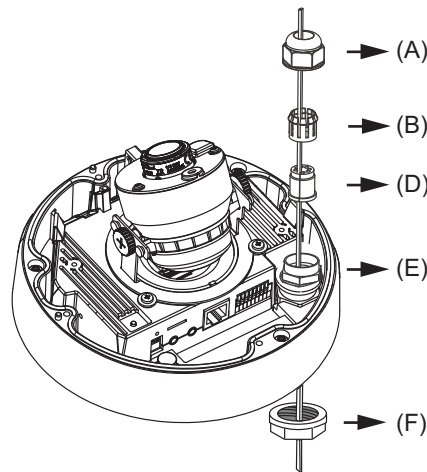

**Note** There are 8 holes on the seal (D), and the widest holes with a crack on the side are specific for power cables.

- d. Feed the I/O cables through the waterproof connector (F --> E --> D --> B --> A). Be sure to feed enough I/O cable length through the waterproof connector to connect the I/O cable to the GPIO block.

The recommended cable gauge is 2.0 ~ 2.8 mm.

- e. Push the seal (D) into the housing (B).  
 f. Insert the seals (C) into unused holes on the seal (D) to avoid moisture.  
 g. Secure the sealing nut (A) tightly and hex nut (F) from the bottom of the camera.

- h. Connect the power and I/O cables to the GPIO terminal block

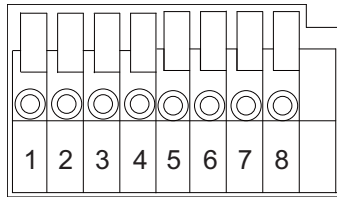

Pin	Description
1	12 VDC-
2	12 VDC+
3	24 VAC
4	24 VAC
5	DI-
6	DI+
7	DO-
8	DO+

- Step 7** Use the included L-type wrench to secure the conduit base to the mounting plate with the three included screws.

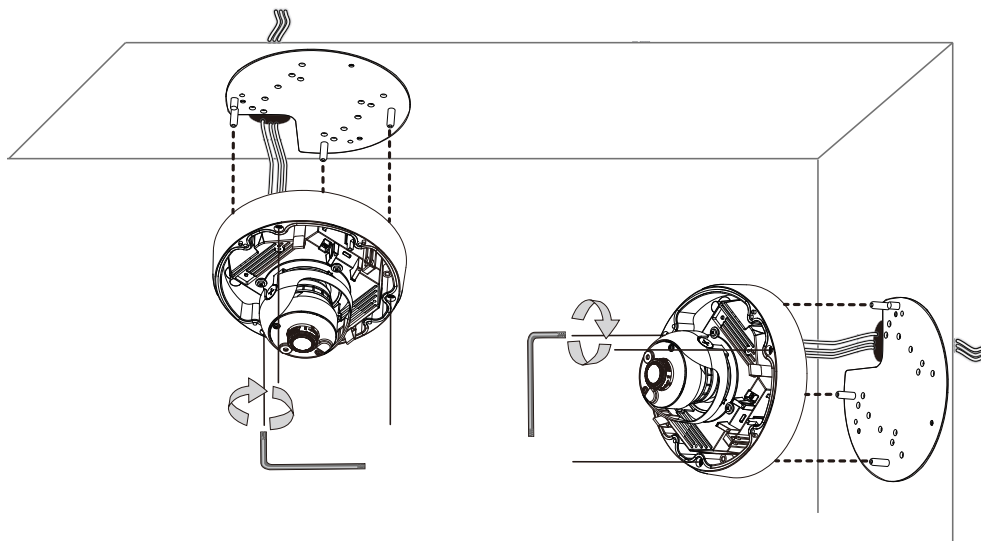

- Step 8** Remove the black cover.

- Step 9** (Optional) Use mini cable with BNC connector to temporarily attach an NTSC or PAL compliant analog video display device to the analog video out port on the rear of the IP camera.



**Note** The mini cable with BNC adapter is included in the audio/video cables accessory kit, which you can purchase from Cisco (Cisco part number CIVS-AVCABLE).

Analog video is enabled by default to allow you to adjust the camera field of view during installation. However, it is not supported as a normal camera feed and is automatically disabled when any of the following camera settings are made:

- The primary video stream frame rate must be set higher than 15 fps.
- The secondary video stream must be enabled.



**Note** We recommend that you disable analog video after installation. To disable analog video, see the *Cisco Video Surveillance 6000 Series IP Camera Configuration Guide*.

- Step 10** While viewing video from the IP camera, perform the following steps to adjust the 3-axis field of view:
- Grip the two tilt adjustment screws and pan the IP camera left or right.
  - Loosen the two tilt adjustment screws, tilt the IP camera, then tighten the screws.
  - Rotate the IP camera to adjust the horizontal orientation until you achieve a level image.

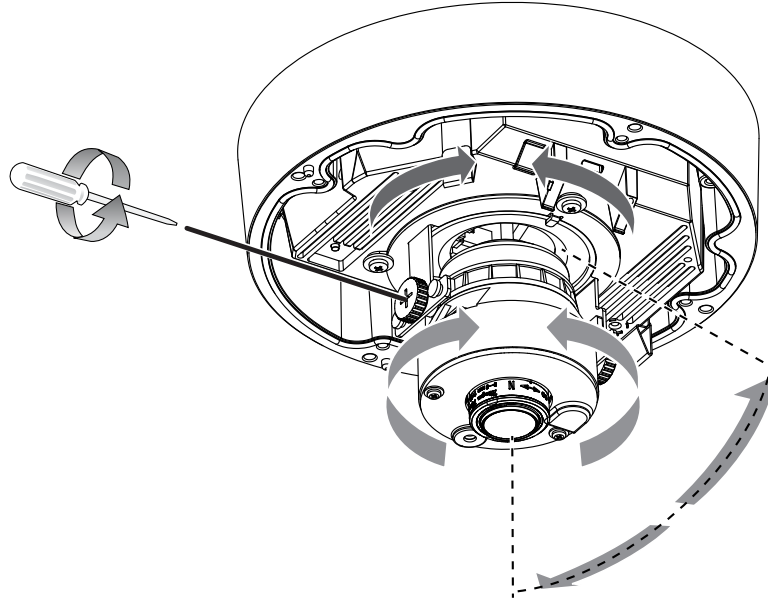

- Step 11** (Optional) If the IP camera is installed in a high humidity environment, remove the wrapper from the included silica gel pack and place the pack with the camera inside the VR housing. Ensure that the silica gel pack does not obstruct the IP camera field of view.
- Step 12** Install the black cover.
- Step 13** Attach the dome cover to the camera by aligning it with the mounting holes.

- Step 14** Use the included wrench and tighten the four dome cover screws to secure the dome cover to the camera. Make sure all parts of the camera are securely installed.

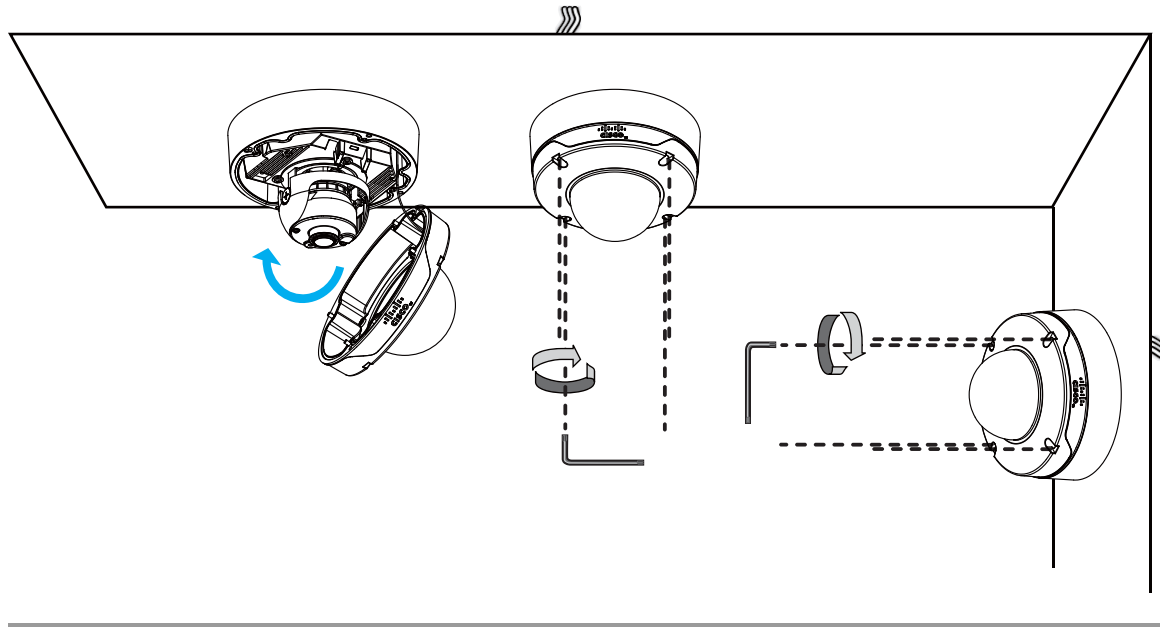

#### What to do next

Complete the following procedures:

- After you install the IP camera, follow the instructions in the [“Performing the Initial Setup of the IP Camera”](#) section on page 3-1 to access the IP camera through your network.
- After completing the initial setup, use the IP camera user interface to adjust the focal length and zoom factor. For more information, see the [“Adjusting the IP Camera Focus and Zoom”](#) section on page 4-3.





## CHAPTER 3

# Performing the Initial Setup of the IP Camera

---

After you install IP camera as described in the [Chapter 2, “Camera Installation,”](#) or after you perform a factory reset procedure, you must access the IP camera and make initial configuration settings. These settings include administrator and root passwords, and whether the IP camera can be accessed through an HTTP connection in addition to the default HTTPS (HTTP secure) connection.

To make these configuration settings, you connect to the IP camera from any PC that is on the same network as the IP camera. The PC must meet these requirements:

- Operating system—Microsoft Windows 7 (32-bit and 64-bit)
- Browser—Internet Explorer 8.0 (32-bit only)

In addition, you must know the IP address and default login credentials of the IP camera. By default, when the IP camera powers on, it attempts to obtain an IP address from a DHCP server in your network. If the camera cannot obtain an IP address through DHCP within 90 seconds, it uses a default IP address of 192.168.0.100. The default login credentials (Username/Password) are admin/admin.

To connect to the IP camera for the first time and make initial configuration settings, perform the following steps. You can change these configuration settings in the future as described in the *Cisco Video Surveillance 6000 Series IP Camera Configuration Guide*.

### Before you Begin

The Microsoft .NET Framework version 2.0 or later must be installed on the PC that you use to connect to the IP camera. You can download the .NET Framework from the Microsoft website.

### Procedure

---

- Step 1** Start Internet Explorer, enter **HTTPS://ip\_address** in the address field, and press **Enter**.  
Replace *ip\_address* with the IP address that the IP camera obtained through DHCP or, if the camera was unable to obtain this IP address, enter **192.168.0.100**.  
The Login window appears.
- Step 2** Enter the default login credentials:  
Username: **admin**  
Password: **admin**  
The Initialization window appears.

- Step 3** In the Password and Confirm Password fields of the admin row, enter a password for the IP camera administrator.
- You must enter the same password in both fields. The password is case sensitive and must contain at least eight characters, which can be letters, numbers, and special characters, but no spaces. Special characters are: ! " # \$ % & ' ( ) \* + , - . : ; < = > ? @ [ \ ] ^ \_ ` { | } ~.
- Step 4** In the Password and Confirm Password fields of the Root row, enter a password that is used when accessing the IP camera through a Secure Shell (SSH) connection.
- You must enter the same password in both fields. The password is case sensitive and must contain at least eight characters, which can be letters, numbers, and special characters, but no spaces. Special characters are: ! " # \$ % & ' ( ) \* + , - . : ; < = > ? @ [ \ ] ^ \_ ` { | } ~.
- You use the root password if you need to troubleshoot the IP camera through a SSH connection with the assistance of the Cisco Technical Assistance Center.
- Step 5** In the Access Protocols area, check the **Enable HTTP** check box if you want to allow both HTTP and HTTPS connections to the IP camera.
- By default, only the Enable HTTPS check box is checked, which allows only HTTPS (secure) connections to the IP camera.
- Step 6** Click **Apply**.
- The IP camera reboots and the Login window appears.
- Step 7** After the IP camera reboots, start Internet Explorer and, in the Address field, enter the following:  
*protocol://ip\_address*  
 where:
- *protocol* is **HTTPS** or **HTTP**. (You can use HTTP only if you enabled it in [Step 5](#).)
  - *ip\_address* is the IP address that you used in [Step 1](#).
- Step 8** If you are prompted to install ActiveX controls, which are required to view video from the IP camera, follow the on-screen prompts to do so.
- The Home window appears.
-





# CHAPTER 4

## Camera Management

This chapter provides information and instructions for managing the Cisco Video Surveillance 2620 IP Camera, and includes the following topics:

- [Understanding the IP Camera User Interface, page 4-1](#)
- [Adjusting the IP Camera Focus and Zoom, page 4-3](#)
- [Powering the IP Camera On or Off, page 4-4](#)
- [Resetting the IP Camera, page 4-4](#)
- [Viewing Live Video, page 4-5](#)

## Understanding the IP Camera User Interface

After you log in to the IP camera, you can access the IP camera windows and perform a variety of administrative and user procedures.

The links and activities that you can see and access in the IP camera windows depend on your IP camera privilege level.

- **Administrator**—Can access all IP camera windows, features, and functions.
- **Viewer**—Can access the Camera Video & Control window with limited controls, and can access the **Refresh**, **Logout**, **About**, and **Help** links from that window.

## IP Camera Window Links

The IP Camera user interface includes links that you use to access various windows and perform other activities. [Table 4-1](#) describes each link and lists the IP camera privilege level that you must have to access the link.

**Table 4-1** *Links in the IP Camera Windows*

Link	Description	Privilege Level
<b>Refresh</b>	Updates the information in the window that is currently displayed.	Administrator User
<b>Home</b>	Displays the Home window.	Administrator

**Table 4-1** *Links in the IP Camera Windows (continued)*

Link	Description	Privilege Level
<b>View Video</b>	Displays the Camera Video & Control window. You may be prompted to install ActiveX controls when trying to access this window for the first time. ActiveX controls are required to view video from the IP camera. Follow the on-screen prompts to install ActiveX controls.	Administrator User
<b>Setup</b>	Provides access to the configuration menus for the IP camera.	Administrator
<b>Logout</b>	Logs you out from the IP camera.	Administrator User
<b>About</b>	Displays a pop-up window with model, version, and copyright information for the IP camera.	Administrator User
<b>Help</b>	Displays reference information for the window that is currently displayed.	Administrator User

## IP Camera Windows

The IP camera user interface includes these main windows:

- Home window—Displays the system information that is described in [Table 4-2](#).
- Setup window—Provides access to the IP camera configuration windows.
- Camera Video & Control window—Displays live video from the camera and lets you control a variety of camera and display functions.

**Table 4-2** *Home Window Information*

Field	Description
<b>General Information</b>	
ID	Identifier of the IP camera.
Name	Name of the IP camera.
Current Time	Current date and time of the IP camera.
S/N	Serial number of the IP camera.
Firmware	Version of the firmware that is installed on the IP camera.
Codec	Version of the codec that is running on the IP camera.
Part Number	Cisco manufacturing part number of the IP camera.
Top Assembly Revision	Cisco assembly revision number.
<b>Network Status</b>	
MAC Address	MAC address of the IP camera.
Configuration Type	Method by which the IP camera obtains its IP address.
LAN IP	IP address of the LAN to which the IP camera is connected.
Subnet Mask	Subnet mask of the LAN to which the IP camera is connected.

**Table 4-2 Home Window Information (continued)**

Field	Description
Gateway Address	IP address of the gateway through which the IP camera is connected.
Primary DNS	IP address of the primary DNS server, if configured for the IP camera.
Secondary DNS	IP address of the secondary DNS server, if configured for the IP camera.
<b>IO Port Status</b>	
Input Port 1	Current state of input port 1 on the IP camera.
Output Port 1	Current state of output port 1 on the IP camera.
<b>Stream 1 and Stream 2</b>	
User	IP camera user name of each user who is accessing the primary video stream (Stream 1) or the secondary video stream (Stream 2) through a client PC or a third-party device.  By default, users appear in order of start time. To display users in ascending order of any information in any corresponding column, click the column heading. Click a column heading again to reverse the display order.
IP Address	IP address of the client device.
Start Time	Time and date that the client accessed the video stream for this session.
Elapsed Time	Length of time that the client has been accessing the video stream.
Codec	Video codec being used for the stream.

## Adjusting the IP Camera Focus and Zoom

To adjust the IP camera focus and zoom, perform the following steps while viewing video from the camera. For information about viewing video, see [“Viewing Live Video” section on page 4-5](#).

### Procedure

- 
- Step 1** Login to the IP camera.  
The Home window appears.
- Step 2** Click the **View Video** link.  
The Camera Video & Control window appears.
- Step 3** Verify that the field of view is correctly set.
- Step 4** Click the **Focus/Zoom** toggle button located below the video pane.
- Step 5** The focus and zoom controls appear.
- Step 6** While watching the video pane, perform the following steps:
- Move the **Zoom** slider until you achieve the desired zoom level.
  - Move the **Focus** slider until the video image is at its sharpest.

- Step 7** (Optional) Click **Auto Focus** to have the IP camera automatically adjust its focus. To automatically adjust the focus to a particular region in the field of view, check the **Specify Region** check box and draw or select a region before clicking Auto Focus.

## Powering the IP Camera On or Off

The IP camera does not include an on/off switch. You power it on or off by connecting it to or disconnecting it from a power source. When you power off the IP camera, configuration settings are retained.

To power on the IP camera, take either of these actions:

- Use an STP (shielded twisted pair) Category 5 or higher network cable to connect the IP camera to a network switch that provides 802.3af compliant PoE.
- Use an optional 12 VDC or 24VAC power adapter to connect the IP camera to a wall outlet

To power off the IP camera, take either of these actions:

- If the IP camera is receiving PoE, disconnect the network cable
- If the IP camera is receiving power through the power adapter, unplug the adapter from the wall or disconnect it from the camera

## Resetting the IP Camera

You reset the IP camera by pressing the Reset button on the IP Camera (see [Figure 1-1 on page 1-3](#)). There are various reset types, as described in [Table 4-3](#).

You also can also perform these reset operations from the Maintenance Settings window as described in the *Cisco Video Surveillance 6000 Series IP Camera Configuration Guide*.

**Table 4-3**      **Resetting the IP Camera**

Reset Type	Procedure	Remarks
Reboot.	Press and immediately release the Reset button.	This action is equivalent to powering the IP camera down and then powering it up. Settings that are configured for the IP camera are retained.
Factory reset.	Press and hold the button for at least 15 seconds.	Sets all IP camera options to their default values. After you perform this procedure, follow the steps in the <a href="#">“Performing the Initial Setup of the IP Camera”</a> section on page 3-1.

# Viewing Live Video

After you install and set up the Cisco Video Surveillance IP Camera, you can connect to the IP camera through Internet Explorer and access the Camera Video & Control window to view live video.

The Camera Video & Control window also provides for controlling the video display, configuring preset positions, and controlling certain IP camera functions. Available controls depend on the privilege level of the user.





To view live video, log in to the IP camera, then click **View Video** in the IP camera Main window menu bar. The Camera Video & Control window appears. This window displays live video from the camera and lets you control a variety of camera and display functions.

The controls that you see in the Camera Video & Control window depend on your IP camera privilege level and the configurations settings for the IP camera. Users with the Administrator privilege can access all controls. Users with the Viewer privilege do not have access to the following controls:

- Video image controls
- Motion detection controls

Table 4-4 describes the controls in the Camera Video & Control window.

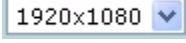
**Table 4-4** Camera Video & Control Window Controls

Control	Description
<b>Video controls</b>	
Video Codec drop-down list 	Choose the codec for video transmission (H.264 or MJPEG). You can choose H.264 only if the primary video stream (channel 1) is enabled. You can choose MJPEG only if the secondary video stream (channel 2) is enabled.
Video Resolution drop-down list 	Choose the resolution for video transmission. The resolutions in this drop-down list depend on the video standard that you selected. The default value for H.264 is 1920 x 1080. The default value for MJPEG is 704 x 480. You cannot configure a secondary stream if you configure this resolution for 1920 x 1080.
Right Arrow toggle button 	Click the Right Arrow to display the video image controls. The button changes to the Left Arrow button.
Left Arrow toggle button 	Click the Left Arrow button to hide the video image controls. The button changes to the Right Arrow button.

### Video image controls

**Note** These controls appear when you click the Right Arrow in the Video Control area.

Brightness slider 	To control the brightness of the video image, drag the slider, or enter a value from 1 through 10 and press the <b>Enter</b> key. A higher value increases the brightness and a lower value decreases the brightness. For example, if the IP camera is facing a bright light and the video appears too dark, you can increase the brightness. The default value is 5.
--	--

Table 4-4 Camera Video &amp; Control Window Controls (continued)





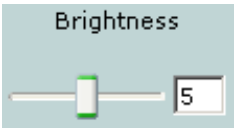

Control	Description
Contrast slider 	To control contrast of the video image, drag the slider, or enter a value from 1 through 10 and press the <b>Enter</b> key. A higher value increases the contrast and a lower value decreases the contrast.  The default value is 5.
Sharpness slider 	To control the sharpness of the video from the IP camera, drag the slider, or enter a value from 1 through 100 and press the <b>Enter</b> key. A higher value increases the sharpness and a lower value decreases the sharpness.  The default value is 50.
Saturation slider 	To control the saturation of the video from the IP camera, drag the slider, or enter a value from 1 through 100 and press the <b>Enter</b> key. A higher value increases the saturation and a lower value decreases the saturation.  High saturation provides a vivid, intense color for a video image. With less saturation, the video image appears more muted and gray.  The default value is 50.
<b>Restore</b> button	Resets white balance, brightness, contrast, sharpness, saturation, and hue to their default values.
<b>Image tools</b>	
<b>Hotspot Zoom</b> button 	Click this latch button to enables the digital zoom feature, which provides five-step digital zooming in for the normal (not full screen) video display. Click this button again to disable the digital zoom feature.  To perform a digital zoom, engage the <b>Hotspot Zoom</b> button and click the video display. The first five clicks zoom the display. The sixth click returns to unzoomed display.
<b>Hotspot Pan/Tilt</b> button 	Click this latch button to enable the hotspot pan/tilt feature, which lets you pan and tilt the IP camera toward a point that you click in the video display.  To perform a hotspot pan/tilt action, engage the <b>Hotspot Pan/Tilt</b> button, then click the video image at the location toward which you want the IP camera to pan and tilt.  This feature require that the IP camera be installed with a pan/tilt mount that supports the Pelco D protocol and that pan and tilt functions are enabled.
<b>Save Snapshot</b> button 	Captures and saves a the current video image as a .gif file or a .jpg file in the location of your choice and with the file name of your choice.  When you click this button, the Snapshot window appears. Click <b>Save</b> and follow the on-screen prompts to save the image with the name and in the location that you want.
<b>Flip</b> button 	Rotates the video image by 180 degrees.
<b>Mirror</b> button 	Reverses the video image.

Table 4-4 Camera Video &amp; Control Window Controls (continued)

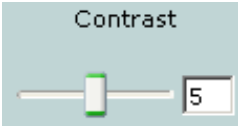
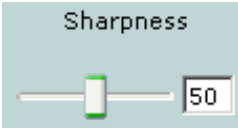
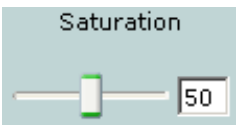



Control	Description
<b>Restore</b> button 	Displays the default video image, which is not rotated and not reversed.
<b>Full Screen</b> button 	<p>Displays the video image in full screen mode.</p> <p>To return to normal display mode, click the full screen image.</p>
<b>Motion detection</b>	
Up Arrow toggle button 	Click the Up Arrow to display the motion detection controls. The button changes to the Down Arrow button.
Down Arrow toggle button 	Click the Down Arrow button to hide the motion detection controls. The button changes to the Up Arrow button.
<b>Motion detection controls</b>	
<p><b>Note</b> These controls appear when you click the Up Arrow in the Motion Detection area and are available only viewing the primary (H.264) stream.</p>	
<b>Enable Motion Detection</b> check box	<p>Enables the motion detection feature and displays a grid over the video image.</p> <p>When motion detection is enabled, the IP camera monitors activity in the video field areas that you specify. If activity at a defined level occurs in any of these areas, the IP camera generates an alert and takes the configured actions.</p> <p>To designate specific areas that the IP camera monitors for activity, select the areas by clicking each grid cell over the area. A red border indicates a selected area. To deselect an area, click it again.</p> <p>You can configure the following levels for areas that the IP camera monitors for activity:</p> <ul style="list-style-type: none"> <li>• <b>Sensitivity</b>—Designates the relative amount of activity that the IP camera must detect in the area before it generates an alert. A lower value means that more, or faster, activity is required to trigger an alert. A higher value means that less, or slower, activity is required. The default value is 80.</li> <li>• <b>Threshold</b>—Designates the percentage of pixels that the IP camera must identify as changed in the area before it generates an alert. The camera detects pixel changes at the defined sensitivity level. The default threshold value is 10.</li> </ul> <p>To configure sensitivity or threshold, right-click a grid cell that has a red border and then drag the Sensitivity and Threshold sliders to the desired values. Alternatively, enter a value from 1 through 100 for an option and press the <b>Enter</b> key. To reset the sensitivity and threshold to their default values of 50, click <b>Restore</b>. These configuration settings affect the cell that you select. If the cell is part of a group of horizontally or vertically (but not diagonally) adjacent cells, the settings affect all cells in the group.</p>

Table 4-4 Camera Video &amp; Control Window Controls (continued)

Control	Description
<b>Full Screen</b> check box	<p>Becomes available when you click check <b>Enable Motion Detection</b> check box. Check the <b>Full Screen</b> check box to cause the IP camera to examine the entire video field for activity.</p> <p>You can configure the following items for this video field:</p> <ul style="list-style-type: none"> <li>• <b>Sensitivity</b>—Designates the relative amount of activity that the IP camera must detect in the area before it generates an alert. A lower value means that more, or faster, activity is required to trigger an alert. A higher value means that less, or slower, activity is required. The default value is 80.</li> <li>• <b>Threshold</b>—Designates the percentage of pixels that the IP camera must identify as changed in the area before it generates an alert. The camera monitors for pixel changes at the defined sensitivity level. The default threshold value is 10.</li> </ul> <p>To configure sensitivity or threshold, right-click anywhere in the video field border and then drag the <b>Sensitivity</b> and <b>Threshold</b> sliders to the desired values. Alternatively, enter a value from 1 through 100 for an option and press the <b>Enter</b> key. To reset the sensitivity and threshold to their default values of 50, click <b>Restore</b>.</p>
<b>Restore</b> button	<p>Deselects all areas in the video field that you have selected for motion detection monitoring.</p>
<b>Save Settings</b> button 	<p>Save the current motion detection configuration.</p>
<b>Focus/Zoom</b>	
<p><b>Note</b> The <b>Focus/Zoom</b> feature is available only on the Cisco Video Surveillance 6020, 6030, and 6400 IP cameras.</p>	
<b>Up Arrow</b> toggle button 	<p>Click the <b>Up Arrow</b> to display the focus/zoom controls. The button changes to the <b>Down Arrow</b> button.</p>
<b>Down Arrow</b> toggle button 	<p>Click the <b>Down Arrow</b> button to hide the focus/zoom controls. The button changes to the <b>Up Arrow</b> button.</p>
<b>Focus/Zoom controls</b>	
<p><b>Note</b> These controls appear when you click the <b>Up Arrow</b> in the <b>Focus/Zoom</b> area.</p>	
<b>Zoom</b> slider	<p>To control the field of view zoom factor, drag the slider left to zoom out (wide), or drag the slider to the right to zoom in (telephoto).</p>
<b>Focus</b> slider	<p>To control the field of view focus, drag the slider left to focus on near objects, or drag the slider to the right to focus on far objects.</p>
<b>Auto Focus</b> button	<p>Click to automatically focus the IP camera for the selected zoom.</p>
<b>Specify Region</b> check box	<p>Used in conjunction with the <b>Auto Focus</b> option. Check <b>Specify Region</b> check box and click <b>Auto Focus</b> to focus the IP camera with priority to a selected region in the field of view. The region is user configurable and can be moved around the screen.</p>
<b>Reset</b> button	<p>Resets the lens position and slider control positions to their default values (full wide and near).</p>

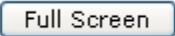

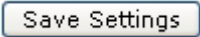

## INDEX

---

### A

- About link [4-2](#)
- ActiveX controls [4-2](#)

---

### B

- brightness [4-5](#)

---

### C

- camera
  - See* IP camera
- Camera Video/Control window
  - accessing [4-5](#)
  - description [4-2](#)
  - displaying [4-2](#)
- connecting, to the IP camera
  - for the first time [3-1](#)
  - PC requirements for [3-1](#)
- contrast [4-6](#)

---

### D

- DHCP, obtaining IP address through [3-1](#)

---

### F

- factory reset [4-4](#)
- focus/zoom
  - accessing controls [4-8](#)
  - controls [4-8](#)

---

### G

- GPIO terminal block [2-7](#)

---

### H

- help, for IP camera windows [4-2](#)
- Home window
  - description [4-2](#)
  - displaying [4-1](#)
- HTTP, allowing access through [3-2](#)

---

### I

- installing
  - GPIO terminal block [2-7](#)
  - IP camera [2-1](#)
  - mounting to ceiling or wall [2-4](#)
  - warnings [2-1](#)
  - waterproof connector [2-6](#)
- IP address
  - default for IP camera [3-1](#)
  - obtaining from DHCP server [3-1](#)
- IP camera
  - accessing through a web browser [3-1](#)
  - connecting to for the first time [3-1](#)
  - installation [2-1](#)
    - GPIO terminal block [2-7](#)
    - mounting to ceiling or wall [2-4](#)
    - warnings [2-1](#)
    - waterproof connector [2-6](#)
  - logging out of [4-2](#)
  - panning [4-6](#)

powering off [4-4](#)  
 powering on [4-4](#)  
 tilting [4-6](#)  
 windows [4-2](#)

---

## L

live video  
   viewing  
     through home window [4-5](#)  
     through third-party device or software [4-5](#)  
     *See also* video  
 log out, of IP camera [4-2](#)

---

## M

motion detection  
   accessing controls [4-7](#)  
   controls [4-7](#)  
   enabling [4-7](#)  
   sensitivity [4-7, 4-8](#)  
   threshold [4-7, 4-8](#)  
 mounting to ceiling or wall [2-4](#)

---

## P

panning [4-6](#)  
 password  
   requirements for [3-2](#)  
 password, requirements for [3-2](#)  
 power  
   adapter [2-1](#)  
   powering off the IP camera [4-4](#)  
   powering on the IP camera [4-4](#)  
   Power over Ethernet (PoE) [2-1](#)  
 Power over Ethernet (PoE) [2-1](#)

---

## R

rebooting, IP camera [4-4](#)  
 Refresh link [4-1](#)  
 reset  
   factory default values [4-4](#)  
   reboot [4-4](#)

---

## S

saturation [4-6](#)  
 sensitivity, for motion detection [4-7, 4-8](#)  
 Setup window  
   description [4-2](#)  
   displaying [4-2](#)  
 sharpness [4-6](#)

---

## T

terminal block [2-7](#)  
 threshold, for motion detection [4-7, 4-8](#)  
 tilting [4-6](#)

---

## V

video  
   viewing live  
     through Home window [4-5](#)  
     through third-party device or software [4-5](#)  
     *See also* live video  
 video codec  
   controls in Camera Video/Control window [4-5](#)  
 video image  
   controls in Camera Video/Control window [4-5](#)  
 video resolution  
   controls in Camera Video/Control window [4-5](#)  
 View Video link [4-2](#)

---

**W**

warnings before installation [2-1](#)

waterproof connector [2-6](#)

---

**Z**

zoom

    accessing controls [4-8](#)

zoom controls [4-8](#)

