



## **Cisco Secure Firewall 3100 Getting Started Guide**

**First Published:** 2022-02-24

**Last Modified:** 2024-06-21

### **Americas Headquarters**

Cisco Systems, Inc.  
170 West Tasman Drive  
San Jose, CA 95134-1706  
USA  
<http://www.cisco.com>  
Tel: 408 526-4000  
800 553-NETS (6387)  
Fax: 408 527-0883





# CHAPTER 1

## Which Application and Manager is Right for You?

Your hardware platform can run one of two applications: Secure Firewall Threat Defense or ASA. For each application, you have a choice of managers. This chapter explains the application and manager choices.

- [Applications, on page 1](#)
- [Managers, on page 1](#)

### Applications

You can use either of the following applications on your hardware platform:

- **Threat Defense**—The threat defense (formerly Firepower Threat Defense) is a next-generation firewall that combines an advanced stateful firewall, VPN concentrator, and next generation IPS.
- **ASA**—The ASA is a traditional, advanced stateful firewall and VPN concentrator.

Cisco provides ASA-to-threat defense migration tools to help you convert your ASA to the threat defense if you start with ASA and later reimage to threat defense.

To reimage between the ASA and the threat defense, see the [Cisco Secure Firewall ASA and Secure Firewall Threat Defense Reimage Guide](#).

### Managers

The threat defense and ASA support multiple managers.

## Threat Defense Managers

Table 1: Threat Defense Managers

Manager	Description
Secure Firewall Management Center (formerly Firepower Management Center)	<p>The management center is a multi-device manager that runs on its own server hardware, or as a virtual device on a hypervisor.</p> <p>For a local management center, see <a href="#">Threat Defense Deployment with the Management Center, on page 5</a>.</p> <p>For a remote management center, see <a href="#">Threat Defense Deployment with a Remote Management Center, on page 45</a>.</p>
Cisco Defense Orchestrator (CDO) Cloud-delivered Firewall Management Center	<p>CDO's cloud-delivered Firewall Management Center has all of the configuration functionality of an on-premises management center. For the analytics functionality, you can use a cloud solution or an on-prem management center. CDO also manages other security devices, such as ASAs.</p> <p>See <a href="#">Threat Defense Deployment with CDO, on page 123</a>.</p>
Secure Firewall Device Manager (formerly Firepower Device Manager)	<p>The device manager is a simplified, on-device manager. Some threat defense features are not supported using the device manager.</p> <p>See <a href="#">Threat Defense Deployment with the Device Manager, on page 97</a>.</p>
Secure Firewall Threat Defense REST API	<p>The threat defense REST API lets you automate direct configuration of the threat defense. You cannot use this API if you are managing the threat defense using the management center or CDO.</p> <p>The threat defense REST API is not covered in this guide. For more information, see the <a href="#">Cisco Secure Firewall Threat Defense REST API Guide</a>.</p>
Secure Firewall Management Center REST API	<p>The management center REST API lets you automate configuration of management center policies that can then be applied to managed threat defenses. This API does not manage the threat defense directly.</p> <p>The management center REST API is not covered in this guide. For more information, see the <a href="#">Secure Firewall Management Center REST API Quick Start Guide</a>.</p>

## ASA Managers

Table 2: ASA Managers

Manager	Description
CLI	<p>You can use the CLI to configure all ASA functionality.</p> <p>The CLI is not covered in this guide. For more information, see the <a href="#">ASA configuration guides</a>.</p>

Manager	Description
Adaptive Security Device Manager (ASDM)	ASDM is a Java-based, on-device manager that provides full ASA functionality. See <a href="#">ASA Deployment with ASDM, on page 169</a> .
CDO	CDO is a cloud-based, multi-device manager. CDO also manages other security devices, such as threat defenses. CDO for ASA is not covered in this guide. To get started with CDO, see the <a href="#">CDO home page</a> .
Cisco Security Manager (CSM)	CSM is a multi-device manager that runs on its own server hardware. CSM does not support managing the threat defenses. CSM is not covered in this guide. For more information, see the <a href="#">CSM user guide</a> .
ASA HTTP Interface	Using HTTP, an automation tool can execute commands on the ASAs by accessing specifically formatted URLs. The ASA HTTP interface is not covered in this guide. For more information, see the <a href="#">Cisco Secure Firewall ASA HTTP Interface for Automation</a> .





## CHAPTER 2

# Threat Defense Deployment with the Management Center

---

### Is This Chapter for You?

To see all available applications and managers, see [Which Application and Manager is Right for You?](#), on page 1. This chapter applies to the threat defense with the management center.

This chapter explains how to manage the threat defense with a management center located on your management network. For remote branch deployment, where the management center resides at a central headquarters, see [Threat Defense Deployment with a Remote Management Center](#), on page 45.

### About the Firewall

The hardware can run either threat defense software or ASA software. Switching between threat defense and ASA requires you to reimage the device. You should also reimage if you need a different software version than is currently installed. See [Cisco Secure Firewall ASA and Secure Firewall Threat Defense Reimage Guide](#).

The firewall runs an underlying operating system called the Secure Firewall eXtensible Operating System (FXOS). The firewall does not support the FXOS Secure Firewall chassis manager; only a limited CLI is supported for troubleshooting purposes. See the [Cisco FXOS Troubleshooting Guide for the Firepower 1000/2100 and Secure Firewall 3100/4200 with Firepower Threat Defense](#) for more information.

**Privacy Collection Statement**—The firewall does not require or actively collect personally identifiable information. However, you can use personally identifiable information in the configuration, for example for usernames. In this case, an administrator might be able to see this information when working with the configuration or when using SNMP.

- [Before You Start](#), on page 6
- [End-to-End Tasks](#), on page 6
- [Review the Network Deployment](#), on page 7
- [Cable the Firewall](#), on page 9
- [Power on the Firewall](#), on page 11
- [\(Optional\) Check the Software and Install a New Version](#), on page 12
- [Complete the Threat Defense Initial Configuration](#), on page 14
- [Log Into the Management Center](#), on page 22
- [Obtain Licenses for the Management Center](#), on page 22
- [Register the Threat Defense with the Management Center](#), on page 24
- [Configure a Basic Security Policy](#), on page 27

- [Access the Threat Defense and FXOS CLI](#), on page 42
- [Power Off the Firewall](#), on page 43
- [What's Next?](#), on page 44

## Before You Start

Deploy and perform initial configuration of the management center. See the getting started guide for your model.

## End-to-End Tasks

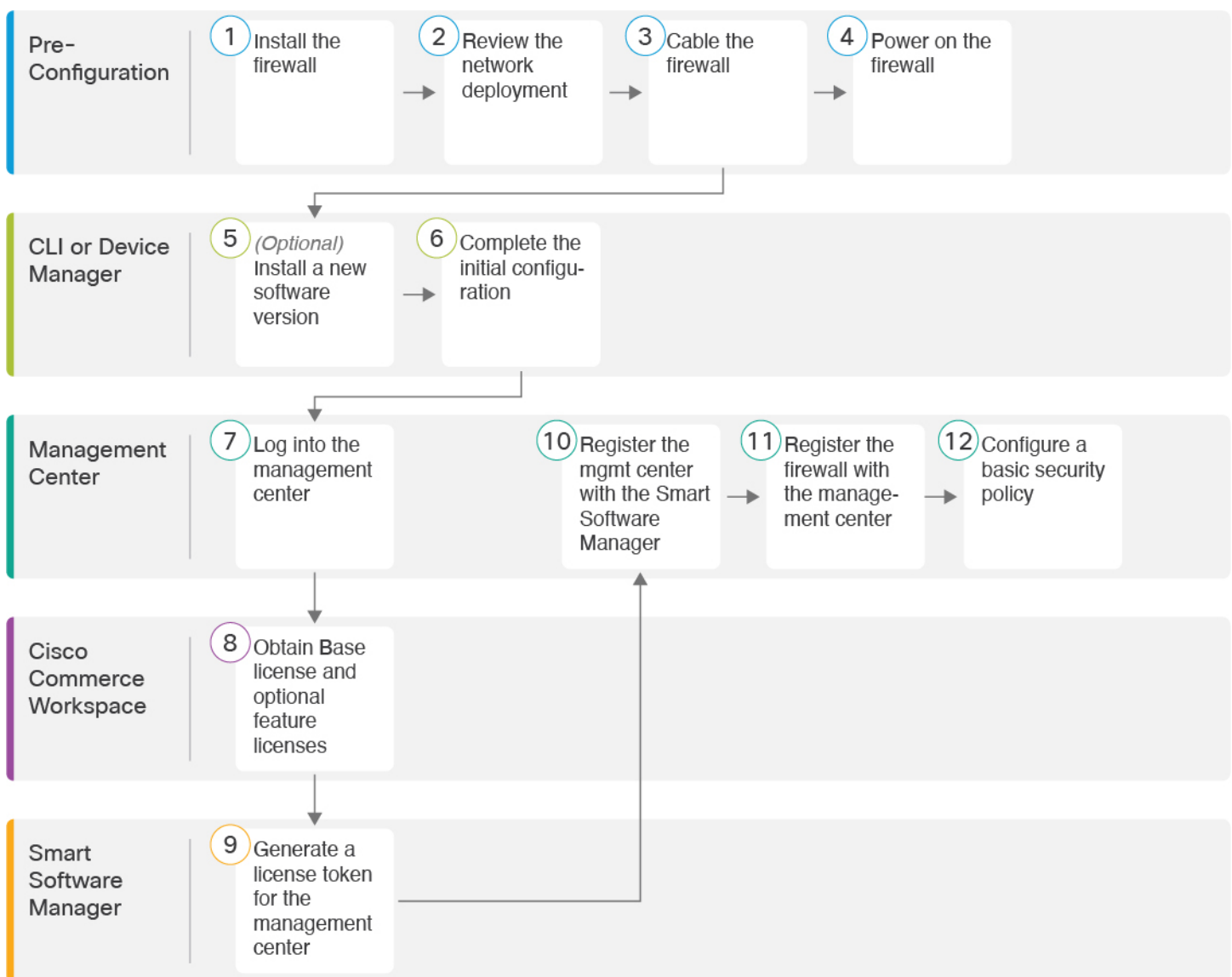



1	Pre-Configuration	Install the firewall. See the <a href="#">hardware installation guide</a> .
2	Pre-Configuration	<a href="#">Review the Network Deployment, on page 7</a> .
3	Pre-Configuration	<a href="#">Cable the Firewall, on page 9</a> .
4	Pre-Configuration	<a href="#">Power on the Firewall, on page 11</a> .
5	CLI	<a href="#">(Optional) Check the Software and Install a New Version, on page 12</a> .
6	CLI or Device Manager	<a href="#">Complete the Threat Defense Initial Configuration, on page 14</a> .
7	Management Center	<a href="#">Log Into the Management Center, on page 22</a> .
8	Cisco Commerce Workspace	Buy Base license and optional feature licenses ( <a href="#">Obtain Licenses for the Management Center, on page 22</a> ).
9	Smart Software Manager	Generate a license token for the management center ( <a href="#">Obtain Licenses for the Management Center, on page 22</a> ).
10	Management Center	Register the management center with the Smart Licensing server ( <a href="#">Obtain Licenses for the Management Center, on page 22</a> ).
11	Management Center	<a href="#">Register the Threat Defense with the Management Center, on page 24</a> .
12	Management Center	<a href="#">Configure a Basic Security Policy, on page 27</a> .

## Review the Network Deployment

### Management Interface

The management center communicates with the threat defense on the Management interface.

The dedicated Management interface is a special interface with its own network settings:

- By default, the Management 1/1 interface is enabled and configured as a DHCP client. If your network does not include a DHCP server, you can set the Management interface to use a static IP address during initial setup at the console port.
- Both the threat defense and the management center require internet access from their management interfaces for licensing and updates.



**Note** The management connection is a secure, TLS-1.3-encrypted communication channel between itself and the device. You do not need to run this traffic over an additional encrypted tunnel such as Site-to-Site VPN for security purposes. If the VPN goes down, for example, you will lose your management connection, so we recommend a simple management path.

### Data Interfaces

You can configure other interfaces after you connect the threat defense to the management center.

### Typical Separate Management Network Deployment

The following figure shows a typical network deployment for the firewall where the threat defense, management center, and management computer connect to the management network.

The management network has a path to the internet for licensing and updates.

**Figure 1: Separate Management Network**

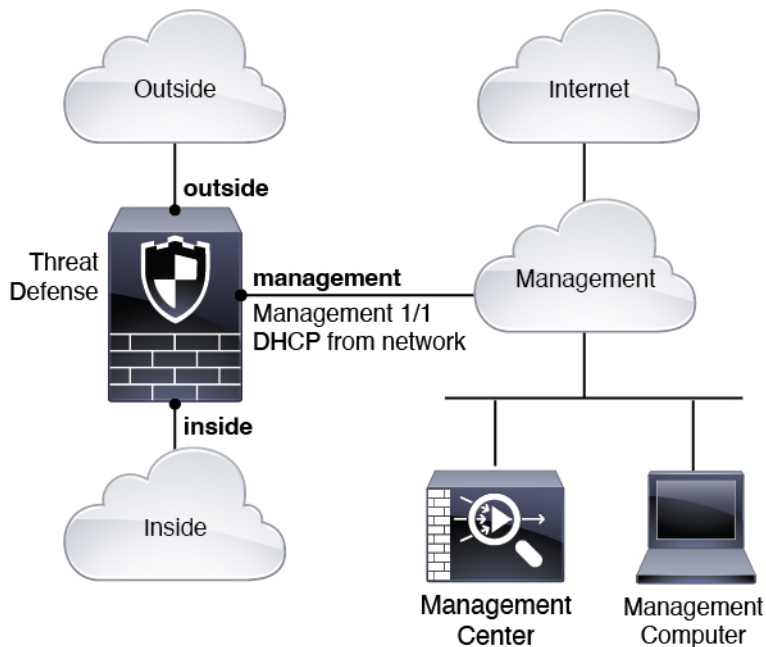

### Typical Edge Network Deployment

The following figure shows a typical network deployment for the firewall where:

- Inside acts as the internet gateway for Management and for the management center.
- Management 1/1 connects to an inside interface through a Layer 2 switch.
- The management center and management computer connect to the switch.

This direct connection is allowed because the Management interface has separate routing from the other interfaces on the threat defense.

Figure 2: Edge Network Deployment

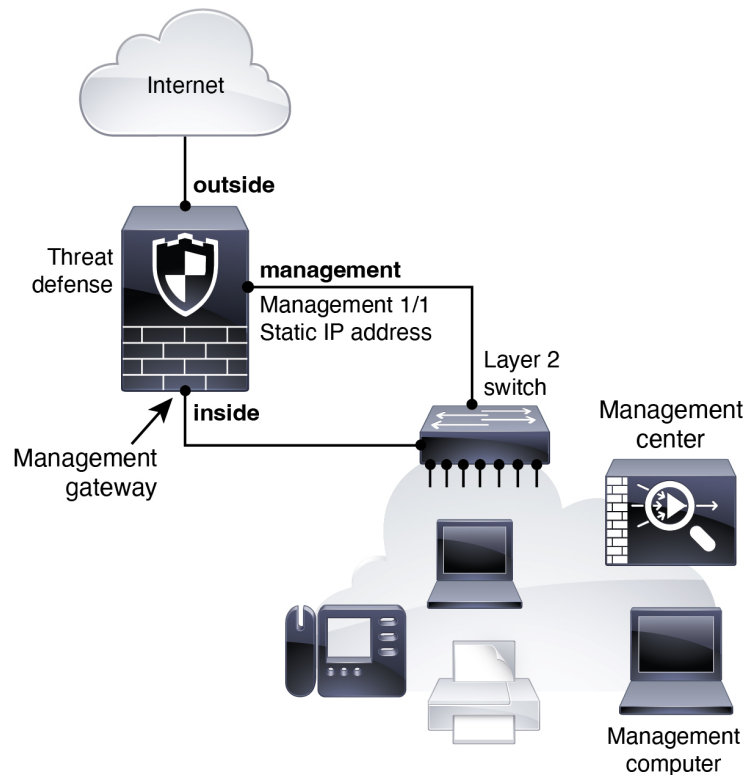

## Cable the Firewall

To cable one of the recommended scenarios on the Secure Firewall 3100, see the following steps.



**Note** Other topologies can be used, and your deployment will vary depending on your basic logical network connectivity, ports, addressing, and configuration requirements.

### Before you begin

- Install an SFP for the Management port—The Management port is a 1/10-Gb SFP port that requires an SFP module.
- Obtain a console adapter—The Secure Firewall 3100 ships with a DB-9 to RJ-45 serial cable, so you may need to buy a third party DB-9-to-USB serial cable to make the connection.

### Procedure

- Step 1** Install the chassis. See the [hardware installation guide](#).
- Step 2** Cable for a separate management network:

Figure 3: Cabling a Separate Management Network

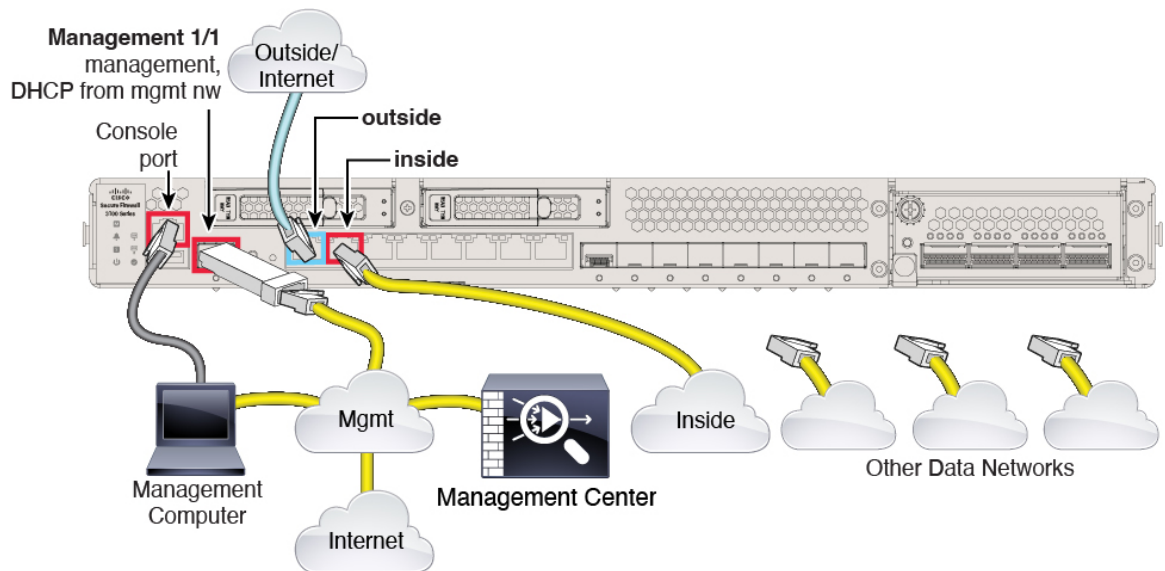

- Cable the following to your management network:
  - Management 1/1 interface
  - Secure Firewall Management Center
  - Management computer
- Connect the management computer to the console port. You need to use the console port to access the CLI for initial setup if you do not use SSH to the Management interface.
- Connect the inside interface (for example, Ethernet 1/2) to your inside router.
- Connect the outside interface (for example, Ethernet 1/1) to your outside router.
- Connect other networks to the remaining interfaces.

**Step 3** Cable for an edge deployment:

Figure 4: Cabling an Edge Deployment

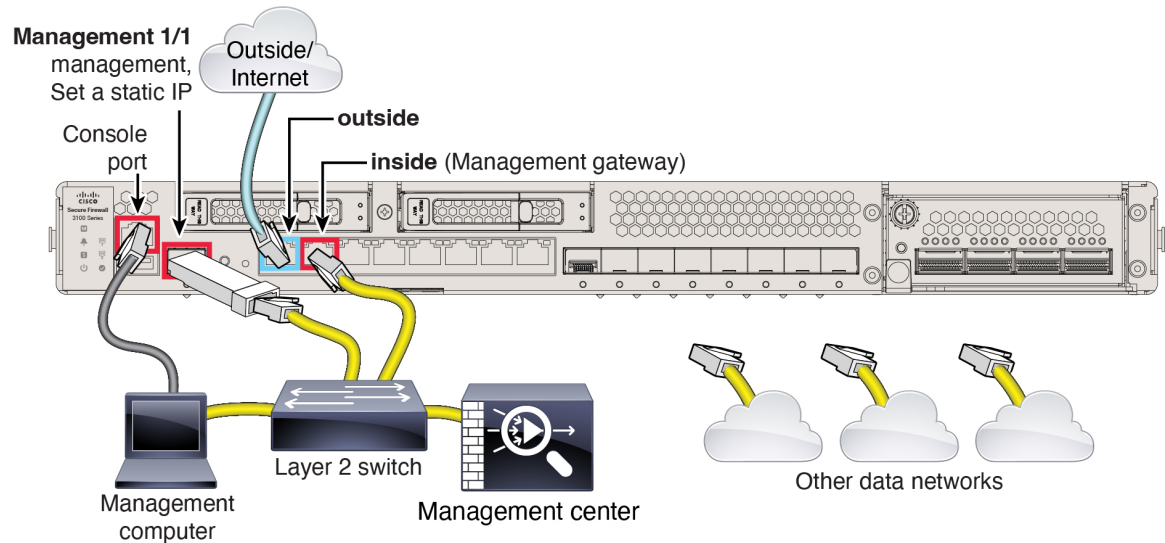

- Cable the following to a Layer 2 Ethernet switch:
  - Inside interface (for example, Ethernet 1/2)
  - Management 1/1 interface
  - Secure Firewall Management Center
  - Management computer
- Connect the management computer to the console port. You need to use the console port to access the CLI for initial setup.
- Connect the outside interface (for example, Ethernet 1/1) to your outside router.
- Connect other networks to the remaining interfaces.

## Power on the Firewall

System power is controlled by a rocker power switch located on the rear of the firewall. The power switch is implemented as a soft notification switch that supports graceful shutdown of the system to reduce the risk of system software and data corruption.



**Note** The first time you boot up the threat defense, initialization can take approximately 15 to 30 minutes.

### Before you begin

It's important that you provide reliable power for your firewall (for example, using an uninterruptible power supply (UPS)). Loss of power without first shutting down can cause serious file system damage. There are

many processes running in the background all the time, and losing power does not allow the graceful shutdown of your system.

### Procedure

- 
- Step 1** Attach the power cord to the firewall, and connect it to an electrical outlet.
  - Step 2** Turn the power on using the standard rocker-type power on/off switch located on the rear of the chassis, adjacent to the power cord.
  - Step 3** Check the Power LED on the back of the firewall; if it is solid green, the firewall is powered on.

*Figure 5: System and Power LEDs*

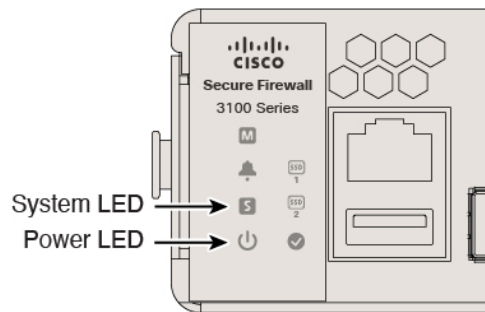

- Step 4** Check the System LED on the back of the firewall; after it is solid green, the system has passed power-on diagnostics.

**Note** When the switch is toggled from ON to OFF, it may take several seconds for the system to eventually power off. During this time, the Power LED on the front of the chassis blinks green. Do not remove the power until the Power LED is completely off.

---

## (Optional) Check the Software and Install a New Version

To check the software version and, if necessary, install a different version, perform these steps. We recommend that you install your target version before you configure the firewall. Alternatively, you can perform an upgrade after you are up and running, but upgrading, which preserves your configuration, may take longer than using this procedure.

### What Version Should I Run?

Cisco recommends running a Gold Star release indicated by a gold star next to the release number on the software download page. You can also refer to the release strategy described in <https://www.cisco.com/c/en/us/products/collateral/security/firewalls/bulletin-c25-743178.html>; for example, this bulletin describes short-term release numbering (with the latest features), long-term release numbering (maintenance releases and patches for a longer period of time), or extra long-term release numbering (maintenance releases and patches for the longest period of time, for government certification).

## Procedure

**Step 1** Connect to the console port. See [Access the Threat Defense and FXOS CLI, on page 42](#) for more information.

Log in with the **admin** user and the default password, **Admin123**.

You connect to the FXOS CLI. The first time you log in, you are prompted to change the password. This password is also used for the threat defense login for SSH.

**Note** If the password was already changed, and you do not know it, you must perform a factory reset to reset the password to the default. See the [FXOS troubleshooting guide](#) for the [factory reset procedure](#).

### Example:

```
firepower login: admin
Password: Admin123
Successful login attempts for user 'admin' : 1

[...]

Hello admin. You must change your password.
Enter new password: *****
Confirm new password: *****
Your password was updated successfully.

[...]

firepower#
```

**Step 2** At the FXOS CLI, show the running version.

**scope ssa**

**show app-instance**

### Example:

```
Firepower# scope ssa
Firepower /ssa # show app-instance

Application Name      Slot ID   Admin State   Operational State   Running Version   Startup
Version Cluster Oper State
-----
ftd                   1         Enabled       Online               7.6.0.65          7.6.0.65
                    Not Applicable
```

**Step 3** If you want to install a new version, perform these steps.

- If you need to set a static IP address for the Management interface, see [Complete the Threat Defense Initial Configuration Using the CLI, on page 14](#). By default, the Management interface uses DHCP. You will need to download the new image from a server accessible from the Management interface.
- Perform the [reimage procedure](#) in the [FXOS troubleshooting guide](#). After the firewall reboots, you connect to the FXOS CLI again.

- c) At the FXOS CLI, you are prompted to set the admin password again.

## Complete the Threat Defense Initial Configuration

You can complete the threat defense initial configuration using the CLI or device manager.

### Complete the Threat Defense Initial Configuration Using the CLI

Set the Management IP address, gateway, and other basic networking settings using the setup wizard. The dedicated Management interface is a special interface with its own network settings. If you do not want to use the Management interface for the manager access, you can use the CLI to configure a data interface instead. You will also configure the management center communication settings. When you perform initial setup using the device manager, *all* interface configuration completed in the device manager is retained when you switch to the management center for management, in addition to the Management interface and manager access interface settings. Note that other default configuration settings, such as the access control policy, are not retained.

#### Procedure

- Step 1** Connect to the threat defense CLI, either from the console port or using SSH to the Management interface, which obtains an IP address from a DHCP server by default. If you intend to change the network settings, we recommend using the console port so you do not get disconnected.

The console port connects to the FXOS CLI. The SSH session connects directly to the threat defense CLI.

- Step 2** Log in with the username **admin** and the password **Admin123**.

At the console port, you connect to the FXOS CLI. The first time you log in to FXOS, you are prompted to change the password. This password is also used for the threat defense login for SSH.

**Note** If the password was already changed, and you do not know it, you must reimage the device to reset the password to the default. See the [FXOS troubleshooting guide](#) for the [reimage procedure](#).

#### Example:

```
firepower login: admin
Password: Admin123
Successful login attempts for user 'admin' : 1

[...]

Hello admin. You must change your password.
Enter new password: *****
Confirm new password: *****
Your password was updated successfully.

[...]

firepower#
```



**Step 3** If you connected to FXOS on the console port, connect to the threat defense CLI.

**connect ftd**

**Example:**

```
firepower# connect ftd
>
```

**Step 4** The first time you log in to the threat defense, you are prompted to accept the End User License Agreement (EULA) and, if using an SSH connection, to change the admin password. You are then presented with the CLI setup script.

**Note** You cannot repeat the CLI setup wizard unless you clear the configuration; for example, by reimaging. However, all of these settings can be changed later at the CLI using **configure network** commands. See [Cisco Secure Firewall Threat Defense Command Reference](#).

Defaults or previously entered values appear in brackets. To accept previously entered values, press **Enter**.

See the following guidelines:

- **Do you want to configure IPv4?** and/or **Do you want to configure IPv6?**—Enter **y** for at least one of these types of addresses. For the edge deployment example shown in the network deployment section, set a static IP address because the gateway inside interface does not yet have a DHCP server running.
- **Enter the IPv4 default gateway for the management interface** and/or **Enter the IPv6 gateway for the management interface**—Set a gateway IP address for Management 1/1 on the management network. In the edge deployment example shown in the network deployment section, the inside interface acts as the management gateway. In this case, you should set the gateway IP address to be the *intended* inside interface IP address; you must later use the management center to set the inside IP address. The **data-interfaces** setting applies only to the remote management center or device manager management.
- **If your networking information has changed, you will need to reconnect**—If you are connected with SSH but you change the IP address at initial setup, you will be disconnected. Reconnect with the new IP address and password. Console connections are not affected.
- **Manage the device locally?**—Enter **no** to use the management center. A **yes** answer means you will use the device manager instead.
- **Configure firewall mode?**—We recommend that you set the firewall mode at initial configuration. Changing the firewall mode after initial setup erases your running configuration.

**Example:**

```
You must accept the EULA to continue.
Press <ENTER> to display the EULA:
End User License Agreement
[...]

Please enter 'YES' or press <ENTER> to AGREE to the EULA:

System initialization in progress. Please stand by.
You must change the password for 'admin' to continue.
Enter new password: *****
Confirm new password: *****
You must configure the network to continue.
Configure at least one of IPv4 or IPv6 unless managing via data interfaces.
Do you want to configure IPv4? (y/n) [y]:
```

```

Do you want to configure IPv6? (y/n) [y]:n
Configure IPv4 via DHCP or manually? (dhcp/manual) [manual]:
Enter an IPv4 address for the management interface [192.168.45.45]: 10.10.10.15
Enter an IPv4 netmask for the management interface [255.255.255.0]: 255.255.255.192
Enter the IPv4 default gateway for the management interface [data-interfaces]: 10.10.10.1
Enter a fully qualified hostname for this system [firepower]: ftd-1.cisco.com
Enter a comma-separated list of DNS servers or 'none'
[208.67.222.222,208.67.220.220,2620:119:35::35]:
Enter a comma-separated list of search domains or 'none' []:cisco.com
If your networking information has changed, you will need to reconnect.
Disabling IPv6 configuration: management0
Setting DNS servers: 208.67.222.222,208.67.220.220,2620:119:35::35
Setting DNS domains:cisco.com
Setting hostname as ftd-1.cisco.com
Setting static IPv4: 10.10.10.15 netmask: 255.255.255.192 gateway: 10.10.10.1 on management0
Updating routing tables, please wait...
All configurations applied to the system. Took 3 Seconds.
Saving a copy of running network configuration to local disk.
For HTTP Proxy configuration, run 'configure network http-proxy'

Manage the device locally? (yes/no) [yes]: no
DHCP server is already disabled
DHCP Server Disabled
Configure firewall mode? (routed/transparent) [routed]:
Configuring firewall mode ...

Device is in OffBox mode - disabling/removing port 443 from iptables.
Update policy deployment information
  - add device configuration
  - add network discovery
  - add system policy

You can register the sensor to a Firepower Management Center and use the
Firepower Management Center to manage it. Note that registering the sensor
to a Firepower Management Center disables on-sensor Firepower Services
management capabilities.

When registering the sensor to a Firepower Management Center, a unique
alphanumeric registration key is always required. In most cases, to register
a sensor to a Firepower Management Center, you must provide the hostname or
the IP address along with the registration key.
'configure manager add [hostname | ip address ] [registration key ]'

However, if the sensor and the Firepower Management Center are separated by a
NAT device, you must enter a unique NAT ID, along with the unique registration
key.
'configure manager add DONTRESOLVE [registration key ] [ NAT ID ]'

Later, using the web interface on the Firepower Management Center, you must
use the same registration key and, if necessary, the same NAT ID when you add
this sensor to the Firepower Management Center.
>

```

### Step 5 Identify the management center that will manage this threat defense.

```
configure manager add {hostname | IPv4_address | IPv6_address | DONTRESOLVE} reg_key [nat_id]
```

- {hostname | IPv4\_address | IPv6\_address | DONTRESOLVE}—Specifies either the FQDN or IP address of the management center. If the management center is not directly addressable, use **DONTRESOLVE** and also specify the *nat\_id*. At least one of the devices, either the management center or the threat defense, must have a reachable IP address to establish the two-way, SSL-encrypted communication channel

between the two devices. If you specify **DONTRESOLVE** in this command, then the threat defense must have a reachable IP address or hostname.

- *reg\_key*—Specifies a one-time registration key of your choice that you will also specify on the management center when you register the threat defense. The registration key must not exceed 37 characters. Valid characters include alphanumeric characters (A–Z, a–z, 0–9) and the hyphen (-).
- *nat\_id*—Specifies a unique, one-time string of your choice that you will also specify on the management center when you register the threat defense when one side does not specify a reachable IP address or hostname. It is required if you set the management center to **DONTRESOLVE**. The NAT ID must not exceed 37 characters. Valid characters include alphanumeric characters (A–Z, a–z, 0–9) and the hyphen (-). This ID cannot be used for any other devices registering to the management center.

**Example:**

```
> configure manager add MC.example.com 123456
Manager successfully configured.
```

If the management center is behind a NAT device, enter a unique NAT ID along with the registration key, and specify **DONTRESOLVE** instead of the hostname, for example:

**Example:**

```
> configure manager add DONTRESOLVE regk3y78 natid90
Manager successfully configured.
```

If the threat defense is behind a NAT device, enter a unique NAT ID along with the management center IP address or hostname, for example:

**Example:**

```
> configure manager add 10.70.45.5 regk3y78 natid56
Manager successfully configured.
```

**What to do next**

Register your firewall to the management center.

## Complete the Threat Defense Initial Configuration Using the Device Manager

When you use the device manager for initial setup, the following interfaces are preconfigured in addition to the Management interface and manager access settings. Note that other settings, such as the DHCP server on inside, access control policy, or security zones, are not configured.

- Ethernet 1/1—"outside", IP address from DHCP, IPv6 autoconfiguration
- Ethernet 1/2—"inside", 192.168.95.1/24
- Default route—Obtained through DHCP on the outside interface

If you perform additional interface-specific configuration within device manager before registering with the management center, then that configuration is preserved.

When you use the CLI, only the Management interface and manager access settings are retained (for example, the default inside interface configuration is not retained).

## Procedure

### Step 1

Log in to the device manager.

a) Enter one of the following URLs in your browser.

- Inside (Ethernet 1/2)—**https://192.168.95.1**.
- Management—**https://management\_ip**. The Management interface is a DHCP client, so the IP address depends on your DHCP server. You might have to set the Management IP address to a static address as part of this procedure, so we recommend that you use the inside interface so you do not become disconnected.

b) Log in with the username **admin**, and the default password **Admin123**.

c) You are prompted to read and accept the General Terms and change the admin password.

### Step 2

Use the setup wizard when you first log into the device manager to complete the initial configuration. You can optionally skip the setup wizard by clicking **Skip device setup** at the bottom of the page.

After you complete the setup wizard, in addition to the default configuration for the inside interface (Ethernet1/2), you will have configuration for an outside (Ethernet1/1) interface that will be maintained when you switch to management center management.

a) Configure the following options for the outside and management interfaces and click **Next**.

1. **Outside Interface Address**—This interface is typically the internet gateway, and might be used as your manager access interface. You cannot select an alternative outside interface during initial device setup. The first data interface is the default outside interface.

If you want to use a different interface from outside (or inside) for manager access, you will have to configure it manually after completing the setup wizard.

**Configure IPv4**—The IPv4 address for the outside interface. You can use DHCP or manually enter a static IP address, subnet mask, and gateway. You can also select **Off** to not configure an IPv4 address. You cannot configure PPPoE using the setup wizard. PPPoE may be required if the interface is connected to a DSL modem, cable modem, or other connection to your ISP, and your ISP uses PPPoE to provide your IP address. You can configure PPPoE after you complete the wizard.

**Configure IPv6**—The IPv6 address for the outside interface. You can use DHCP or manually enter a static IP address, prefix, and gateway. You can also select **Off** to not configure an IPv6 address.

2. **Management Interface**

You will not see Management Interface settings if you performed initial setup at the CLI. Note that setting the Management interface IP address is not part of the setup wizard. See Step [Step 3, on page 19](#) to set the Management IP address.

**DNS Servers**—The DNS server for the firewall's Management interface. Enter one or more addresses of DNS servers for name resolution. The default is the OpenDNS public DNS servers. If you edit the fields and want to return to the default, click **Use OpenDNS** to reload the appropriate IP addresses into the fields.

**Firewall Hostname**—The hostname for the firewall's Management interface.

- b) Configure the **Time Setting (NTP)** and click **Next**.
  - 1. **Time Zone**—Select the time zone for the system.
  - 2. **NTP Time Server**—Select whether to use the default NTP servers or to manually enter the addresses of your NTP servers. You can add multiple servers to provide backups.
- c) Select **Start 90 day evaluation period without registration**.

Do not register the threat defense with the Smart Software Manager; all licensing is performed on the management center.
- d) Click **Finish**.
- e) You are prompted to choose **Cloud Management** or **Standalone**. For management center management, choose **Standalone**, and then **Got It**.

**Step 3** (Might be required) Configure a static IP address for the Management interface. Choose **Device**, then click the **System Settings > Management Interface** link.

If you want to configure a static IP address, for example for an edge deployment where there is not DHCP server on the network yet, be sure to also set the default gateway to be a unique gateway instead of the data interfaces. If you use DHCP, you do not need to configure anything.

**Step 4** If you want to configure additional interfaces, including an interface other than outside or inside, choose **Device**, and then click the link in the **Interfaces** summary.

See [Configure the Firewall in the Device Manager, on page 116](#) for more information about configuring interfaces in the device manager. Other device manager configuration will not be retained when you register the device to the management center.

**Step 5** Choose **Device > System Settings > Central Management**, and click **Proceed** to set up the management center management.

**Step 6** Configure the **Management Center/CDO Details**.

Figure 6: Management Center/CDO Details

### Configure Connection to Management Center or CDO

Provide details to register to the management center/CDO.

**Management Center/CDO Details**

Do you know the Management Center/CDO hostname or IP address?

Yes    No

**Threat Defense**



10.89.5.16  
fe80::6a87:c6ff:fea6:4c00/64

→

**Management Center/CDO**



10.89.5.35

Management Center/CDO Hostname or IP Address

10.89.5.35

Management Center/CDO Registration Key

••••

NAT ID

*Required when the management center/CDO hostname or IP address is not provided. We recommend always setting the NAT ID even when you specify the management center/CDO hostname or IP address.*

11203

---

**Connectivity Configuration**

Threat Defense Hostname

1120-3

DNS Server Group

CustomDNSServerGroup

Management Center/CDO Access Interface

Data Interface

Please select an interface

Management Interface [View details](#)

CANCEL
CONNECT

- a) For **Do you know the Management Center/CDO hostname or IP address**, click **Yes** if you can reach the management center using an IP address or hostname, or **No** if the management center is behind NAT or does not have a public IP address or hostname.

At least one of the devices, either the management center or the threat defense device, must have a reachable IP address to establish the two-way, TLS-1.3-encrypted communication channel between the two devices.

- b) If you chose **Yes**, then enter the **Management Center/CDO Hostname/IP Address**.
- c) Specify the **Management Center/CDO Registration Key**.

This key is a one-time registration key of your choice that you will also specify on the management center when you register the threat defense device. The registration key must not exceed 37 characters. Valid characters include alphanumerical characters (A–Z, a–z, 0–9) and the hyphen (-). This ID can be used for multiple devices registering to the management center.

- d) Specify a **NAT ID**.

This ID is a unique, one-time string of your choice that you will also specify on the management center. This field is required if you only specify the IP address on one of the devices; but we recommend that you specify the NAT ID even if you know the IP addresses of both devices. The NAT ID must not exceed 37 characters. Valid characters include alphanumerical characters (A–Z, a–z, 0–9) and the hyphen (-). This ID *cannot* be used for any other devices registering to the management center. The NAT ID is used in combination with the IP address to verify that the connection is coming from the correct device; only after authentication of the IP address/NAT ID will the registration key be checked.

**Step 7** Configure the **Connectivity Configuration**.

- a) Specify the **FTD Hostname**.
- b) Specify the **DNS Server Group**.

Choose an existing group, or create a new one. The default DNS group is called **CiscoUmbrellaDNSServerGroup**, which includes the OpenDNS servers.

- c) For the **Management Center/CDO Access Interface**, choose **management**.

**Step 8** Click **Connect**. The **Registration Status** dialog box shows the current status of the switch to the management center. After the **Saving Management Center/CDO Registration Settings** step, go to the management center, and add the firewall.

If you want to cancel the switch to the management center, click **Cancel Registration**. Otherwise, do not close the device manager browser window until after the **Saving Management Center/CDO Registration Settings** step. If you do, the process will be paused, and will only resume when you reconnect to the device manager.

If you remain connected to the device manager after the **Saving Management Center/CDO Registration Settings** step, you will eventually see the **Successful Connection with Management Center or CDO** dialog box, after which you will be disconnected from the device manager.

Figure 7: Successful Connection

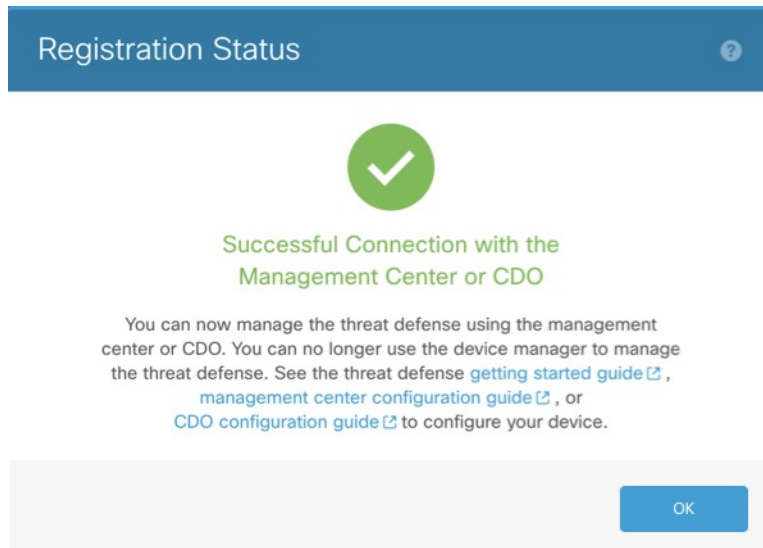

## Log Into the Management Center

Use the management center to configure and monitor the threat defense.

### Procedure

- 
- Step 1** Using a supported browser, enter the following URL.  
**https://fmc\_ip\_address**
- Step 2** Enter your username and password.
- Step 3** Click **Log In**.
- 

## Obtain Licenses for the Management Center

All licenses are supplied to the threat defense by the management center. You can purchase the following licenses:

- **Essentials**—(Required) Essentials license.
- **IPS**—Security Intelligence and Next-Generation IPS
- **Malware Defense**—Malware defense
- **URL Filtering**—URL Filtering



- **Cisco Secure Client**—Secure Client Advantage, Secure Client Premier, or Secure Client VPN Only
- **Carrier**—Diameter, GTP/GPRS, M3UA, SCTP

For a more detailed overview on Cisco Licensing, go to [cisco.com/go/licensingguide](https://cisco.com/go/licensingguide)

### Before you begin

- Have an account on the [Smart Software Manager](#).  
If you do not yet have an account, click the link to [set up a new account](#). The Smart Software Manager lets you create an account for your organization.
- Your Smart Software Licensing account must qualify for the Strong Encryption (3DES/AES) license to use some features (enabled using the export-compliance flag).

### Procedure

**Step 1** Make sure your Smart Licensing account contains the available licenses you need.

When you bought your device from Cisco or a reseller, your licenses should have been linked to your Smart Software License account. However, if you need to add licenses yourself, use the **Search All** field on the [Cisco Commerce Workspace](#).

**Figure 8: License Search**

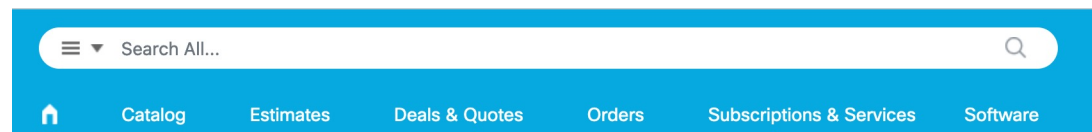

Choose **Products & Services** from the results.

**Figure 9: Results**

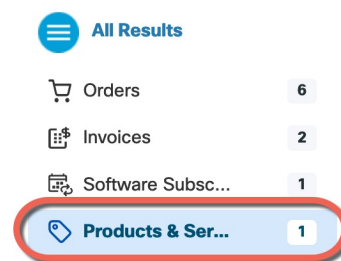

Search for the following license PIDs:

**Note** If a PID is not found, you can add the PID manually to your order.

- Essentials license:
  - L-FPR3110-BSE=
  - L-FPR3120-BSE=

- L-FPR3130-BSE=
- L-FPR3140-BSE=
- IPS, Malware Defense, and URL license combination:
  - L-FPR3110T-TMC=
  - L-FPR3120T-TMC=
  - L-FPR3130T-TMC=
  - L-FPR3140T-TMC=

When you add one of the above PIDs to your order, you can then choose a term-based subscription corresponding with one of the following PIDs:

- L-FPR3110T-TMC-1Y
- L-FPR3110T-TMC-3Y
- L-FPR3110T-TMC-5Y
- L-FPR3120T-TMC-1Y
- L-FPR3120T-TMC-3Y
- L-FPR3120T-TMC-5Y
- L-FPR3130T-TMC-1Y
- L-FPR3130T-TMC-3Y
- L-FPR3130T-TMC-5Y
- L-FPR3140T-TMC-1Y
- L-FPR3140T-TMC-3Y
- L-FPR3140T-TMC-5Y
- Carrier license:
  - L-FPR3K-FTD-CAR=
- Cisco Secure Client—See the [Cisco Secure Client Ordering Guide](#).

**Step 2** If you have not already done so, register the management center with the Smart Licensing server.

Registering requires you to generate a registration token in the Smart Software Manager. See the [Cisco Secure Firewall Management Center Administration Guide](#) for detailed instructions.

---

## Register the Threat Defense with the Management Center

Register the threat defense to the management center manually using the device IP address or hostname.

## Before you begin

### Procedure

- Step 1** In the management center, choose **Devices > Device Management**.
- Step 2** From the **Add** drop-down list, choose **Add Device**.

**Figure 10: Add Device**

Add Device
?

---

CDO Managed Device

Host:†

Display Name:

Registration Key:†

Group:

Access Control Policy:†

Smart Licensing

Note: All virtual Firewall Threat Defense devices require a performance tier license. Make sure your Smart Licensing account contains the available licenses you need. It's important to choose the tier that matches the license you have in your account. Click [here](#) for information about the Firewall Threat Defense performance-tiered licensing. Until you choose a tier, your Firewall Threat Defense virtual defaults to the FTDv50 selection.

Performance Tier (only for Firewall Threat Defense virtual 7.0 and above):

Malware  
 Threat  
 URL Filtering

Advanced

Unique NAT ID:†

Transfer Packets

Set the following parameters:

- **Host**—Enter the IP address or hostname of the threat defense you want to add. You can leave this field blank if you specified both the management center IP address and a NAT ID in the threat defense initial configuration.
- **Note** In an HA environment, when both the management centers are behind a NAT, you can register the threat defense without a host IP or name in the primary management center. However, for registering the threat defense in a secondary management center, you must provide the IP address or hostname for the threat defense.
- **Display Name**—Enter the name for the threat defense as you want it to display in the management center.
- **Registration Key**—Enter the same registration key that you specified in the threat defense initial configuration.
- **Domain**—Assign the device to a leaf domain if you have a multidomain environment.
- **Group**—Assign it to a device group if you are using groups.
- **Access Control Policy**—Choose an initial policy. Unless you already have a customized policy you know you need to use, choose **Create new policy**, and choose **Block all traffic**. You can change this later to allow traffic; see [Allow Traffic from Inside to Outside, on page 39](#).

Figure 11: New Policy

New Policy ?

Name:

Description:

Select Base Policy:

Default Action:  
 Block all traffic  
 Intrusion Prevention  
 Network Discovery

- **Smart Licensing**—Assign the Smart Licenses you need for the features you want to deploy. **Note:** You can apply the Secure Client remote access VPN license after you add the device, from the **System > Licenses > Smart Licenses** page.
- **Unique NAT ID**—Specify the NAT ID that you specified in the threat defense initial configuration.
- **Transfer Packets**—Allow the device to transfer packets to the management center. When events like IPS or Snort are triggered with this option enabled, the device sends event metadata information and packet data to the management center for inspection. If you disable it, only event information will be sent to the management center, but packet data is not sent.

**Step 3** Click **Register**, and confirm a successful registration.

If the registration succeeds, the device is added to the list. If it fails, you will see an error message. If the threat defense fails to register, check the following items:

- Ping—Access the threat defense CLI, and ping the management center IP address using the following command:

```
ping system ip_address
```

If the ping is not successful, check your network settings using the **show network** command. If you need to change the threat defense Management IP address, use the **configure network {ipv4 | ipv6} manual** command.

- Registration key, NAT ID, and the management center IP address—Make sure you are using the same registration key, and if used, NAT ID, on both devices. You can set the registration key and NAT ID on the threat defense using the **configure manager add** command.

For more troubleshooting information, see <https://cisco.com/go/fmc-reg-error>.

## Configure a Basic Security Policy

This section describes how to configure a basic security policy with the following settings:

- Inside and outside interfaces—Assign a static IP address to the inside interface, and use DHCP for the outside interface.
- DHCP server—Use a DHCP server on the inside interface for clients.
- Default route—Add a default route through the outside interface.
- NAT—Use interface PAT on the outside interface.
- Access control—Allow traffic from inside to outside.

To configure a basic security policy, complete the following tasks.

1	Configure Interfaces, on page 28.
2	Configure the DHCP Server, on page 32.
3	Add the Default Route, on page 34.
4	Configure NAT, on page 36.
5	Allow Traffic from Inside to Outside, on page 39.
6	Deploy the Configuration, on page 40.

## Configure Interfaces

When you use the device manager for initial setup, the following interfaces are preconfigured:

- Ethernet 1/1—"outside", IP address from DHCP, IPv6 autoconfiguration
- Ethernet 1/2—"inside", 192.168.95.1/24
- Default route—Obtained through DHCP on the outside interface

If you performed additional interface-specific configuration within device manager before registering with the management center, then that configuration is preserved.

In any case, you need to perform additional interface configuration after you register the device. Enable the threat defense interfaces, assign them to security zones, and set the IP addresses. Also configure breakout interfaces.

The following example configures a routed mode inside interface with a static address and a routed mode outside interface using DHCP.

### Procedure

**Step 1** Choose **Devices > Device Management**, and click the **Edit** (✎) for the firewall.

**Step 2** Click **Interfaces**.

**Figure 12: Interfaces**

Interface	Logical Name	Type	Security Zones	MAC Address (Active/Standby)	IP Address	Path Monitoring	Virtual Router	
Management0/0	management	Physical				Disabled	Global	🔍 ↶
<input checked="" type="checkbox"/> GigabitEthernet0/0		Physical				Disabled		✎
<input checked="" type="checkbox"/> GigabitEthernet0/1		Physical				Disabled		✎
<input checked="" type="checkbox"/> GigabitEthernet0/2		Physical				Disabled		✎
<input checked="" type="checkbox"/> GigabitEthernet0/3		Physical				Disabled		✎
<input checked="" type="checkbox"/> GigabitEthernet0/4		Physical				Disabled		✎
<input checked="" type="checkbox"/> GigabitEthernet0/5		Physical				Disabled		✎
<input checked="" type="checkbox"/> GigabitEthernet0/6		Physical				Disabled		✎
<input checked="" type="checkbox"/> GigabitEthernet0/7		Physical				Disabled		✎

**Step 3** To create breakout ports from a 40-Gb or larger interface, click the **Break** icon for the interface.

If you already used the full interface in your configuration, you will have to remove the configuration before you can proceed with the breakout.

**Step 4** Click **Edit** (✎) for the interface that you want to use for *inside*.

The **General** tab appears.

Figure 13: General Tab

Edit Physical Interface

General IPv4 IPv6 Path Monitoring

Name:

Enabled  
 Management Only

Description:

Mode:

Security Zone:

Interface ID:

MTU:  
  
(64 - 9000)

Priority:  
 (0 - 65535)

Propagate Security Group Tag:

NVE Only:

- a) Enter a **Name** up to 48 characters in length.  
For example, name the interface **inside**.
- b) Check the **Enabled** check box.
- c) Leave the **Mode** set to **None**.
- d) From the **Security Zone** drop-down list, choose an existing inside security zone or add a new one by clicking **New**.

For example, add a zone called **inside\_zone**. Each interface must be assigned to a security zone and/or interface group. An interface can belong to only one security zone, but can also belong to multiple interface groups. You apply your security policy based on zones or groups. For example, you can assign the inside interface to the inside zone; and the outside interface to the outside zone. Then you can configure your access control policy to enable traffic to go from inside to outside, but not from outside to inside. Most policies only support security zones; you can use zones or interface groups in NAT policies, prefilter policies, and QoS policies.

- e) Click the **IPv4** and/or **IPv6** tab.
  - **IPv4**—Choose **Use Static IP** from the drop-down list, and enter an IP address and subnet mask in slash notation.  
For example, enter **192.168.1.1/24**

Figure 14: IPv4 Tab

The screenshot shows the 'Edit Physical Interface' window with the 'IPv4' tab selected. The 'IP Type' dropdown is set to 'Use Static IP'. The 'IP Address' field contains '192.168.1.1/24'. Below the field, there is a note: 'eg. 192.0.2.1/255.255.255.128 or 192.0.2.1/25'.

- **IPv6**—Check the **Autoconfiguration** check box for stateless autoconfiguration.

Figure 15: IPv6 Tab

The screenshot shows the 'Edit Physical Interface' window with the 'IPv6' tab selected. The 'Basic' sub-tab is active. The 'Enable IPV6' checkbox is unchecked. The 'Enforce EUI 64' checkbox is unchecked. The 'Link-Local address' field is empty. The 'Autoconfiguration' checkbox is checked. The 'Obtain Default Route' checkbox is unchecked.

f) Click **OK**.

- Step 5** Click the **Edit** (✎) for the interface that you want to use for *outside*. The **General** tab appears.



Figure 16: General Tab

Edit Physical Interface

General IPv4 IPv6 Path Monitoring Hardware

Name:

Enabled  
 Management Only

Description:

Mode:

Security Zone:

Interface ID:

MTU:  
  
(64 - 9000)

Priority:  
 (0 - 65535)

Propagate Security Group Tag:

NVE Only:

- a) Enter a **Name** up to 48 characters in length.  
 For example, name the interface **outside**.
- b) Check the **Enabled** check box.
- c) Leave the **Mode** set to **None**.
- d) From the **Security Zone** drop-down list, choose an existing outside security zone or add a new one by clicking **New**.  
 For example, add a zone called **outside\_zone**.
- e) Click the **IPv4** and/or **IPv6** tab.
  - **IPv4**—Choose **Use DHCP**, and configure the following optional parameters:
    - **Obtain default route using DHCP**—Obtains the default route from the DHCP server.
    - **DHCP route metric**—Assigns an administrative distance to the learned route, between 1 and 255. The default administrative distance for the learned routes is 1.

Figure 17: IPv4 Tab

Edit Physical Interface

General IPv4 IPv6 Path Monitoring

IP Type:  
Use DHCP

Obtain default route using DHCP:

DHCP route metric:  
1

(1 - 255)

- **IPv6**—Check the **Autoconfiguration** check box for stateless autoconfiguration.

Figure 18: IPv6 Tab

Edit Physical Interface

General IPv4 IPv6 Path Monitoring Hardware Configuration

Basic Address Prefixes Settings DHCP

Enable IPv6:

Enforce EUI 64:

Link-Local address:

Autoconfiguration:

Obtain Default Route:

f) Click **OK**.

**Step 6** Click **Save**.

## Configure the DHCP Server

Enable the DHCP server if you want clients to use DHCP to obtain IP addresses from the threat defense.

### Procedure

- Step 1** Choose **Devices > Device Management**, and click **Edit** (✎) for the device.
- Step 2** Choose **DHCP > DHCP Server**.

Figure 19: DHCP Server

The screenshot shows the DHCP Server configuration page. The left sidebar contains a navigation menu with 'DHCP Server' selected. The main content area has tabs for 'Device', 'Routing', 'Interfaces', 'Inline Sets', 'DHCP', and 'VTEP'. The 'DHCP' tab is active, showing settings for Ping Timeout (50 ms), Lease Length (3600 sec), and an unchecked 'Auto-Configuration' checkbox. Below these are fields for Domain Name, Primary and Secondary DNS Servers, and Primary and Secondary WINS Servers. At the bottom, there are tabs for 'Server' and 'Advanced'. A table below the tabs is currently empty, with a '+ Add' button highlighted in a red box in the top right corner of the table area.

**Step 3** On the **Server** page, click **Add**, and configure the following options:

Figure 20: Add Server

The 'Add Server' dialog box is shown. It has a title bar with a question mark icon. The 'Interface\*' field is a dropdown menu with 'inside' selected. The 'Address Pool\*' field is a text input containing '10.9.7.9-10.9.7.25' with a hint '(2.2.2.10-2.2.2.20)' below it. There is a checked checkbox for 'Enable DHCP Server'. At the bottom, there are 'Cancel' and 'OK' buttons.

- **Interface**—Choose the interface from the drop-down list.
- **Address Pool**—Set the range of IP addresses from lowest to highest that are used by the DHCP server. The range of IP addresses must be on the same subnet as the selected interface and cannot include the IP address of the interface itself.
- **Enable DHCP Server**—Enable the DHCP server on the selected interface.

**Step 4** Click **OK**.

**Step 5** Click **Save**.

## Add the Default Route

The default route normally points to the upstream router reachable from the outside interface. If you use DHCP for the outside interface, your device might have already received a default route. If you need to manually add the route, complete this procedure. If you received a default route from the DHCP server, it will show in the **IPv4 Routes** or **IPv6 Routes** table on the **Devices > Device Management > Routing > Static Route** page.

### Procedure

- Step 1** Choose **Devices > Device Management**, and click **Edit** (✎) for the device.  
**Step 2** Choose **Routing > Static Route**.

*Figure 21: Static Route*

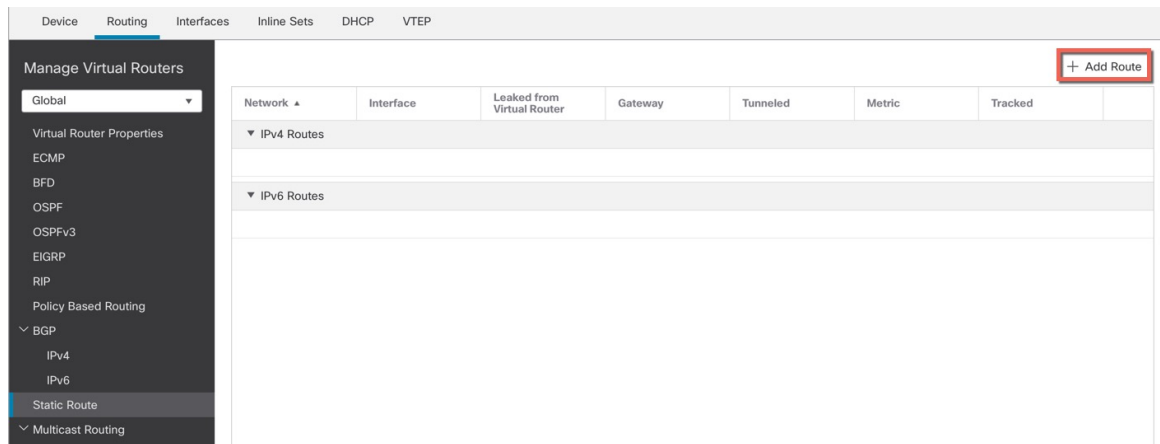

- Step 3** Click **Add Route**, and set the following:

Figure 22: Add Static Route Configuration

- **Type**—Click the **IPv4** or **IPv6** radio button depending on the type of static route that you are adding.
- **Interface**—Choose the egress interface; typically the outside interface.
- **Available Network**—Choose **any-ipv4** for an IPv4 default route, or **any-ipv6** for an IPv6 default route, and click **Add** to move it to the **Selected Network** list.
- **Gateway** or **IPv6 Gateway**—Enter or choose the gateway router that is the next hop for this route. You can provide an IP address or a Networks/Hosts object.
- **Metric**—Enter the number of hops to the destination network. Valid values range from 1 to 255; the default value is 1.

**Step 4** Click **OK**.

The route is added to the static route table.

**Step 5** Click **Save**.

## Configure NAT

A typical NAT rule converts internal addresses to a port on the outside interface IP address. This type of NAT rule is called *interface Port Address Translation (PAT)*.

### Procedure

- Step 1** Choose **Devices > NAT**, and click **New Policy > Threat Defense NAT**.
- Step 2** Name the policy, select the device(s) that you want to use the policy, and click **Save**.

**Figure 23: New Policy**

The screenshot shows the 'New Policy' configuration interface. The 'Name' field is populated with 'interface\_PAT'. The 'Description' field is empty. Under 'Targeted Devices', the instruction 'Select devices to which you want to apply this policy.' is followed by an unchecked checkbox. The 'Available Devices' list contains '10.10.0.6' and '10.10.0.7', both of which are highlighted in blue. An 'Add to Policy' button is positioned between the available and selected device lists. The 'Selected Devices' list contains '10.10.0.6' and '10.10.0.7'. At the bottom right, there are 'Cancel' and 'Save' buttons.

The policy is added the management center. You still have to add rules to the policy.

Figure 24: NAT Policy

interface\_PAT

Enter Description

Show Warnings Save Cancel

NAT Exemptions Policy Assignments (2)

Rules

Filter by Device Filter Rules X Add Rule

	#	Direction	Type	Source Interface Objects	Destination Interface Objects	Original Packet			Translated Packet			Options
						Original Sources	Original Destinations	Original Services	Translated Sources	Translated Destinations	Translated Services	
NAT Rules Before												
Auto NAT Rules												
NAT Rules After												

**Step 3** Click **Add Rule**.

The **Add NAT Rule** dialog box appears.

**Step 4** Configure the basic rule options:

Figure 25: Basic Rule Options

Add NAT Rule

NAT Rule:  
Auto NAT Rule

Type:  
Dynamic

Enable

Interface Objects Translation PAT Pool Advanced

- **NAT Rule**—Choose **Auto NAT Rule**.
- **Type**—Choose **Dynamic**.

**Step 5** On the **Interface Objects** page, add the outside zone from the **Available Interface Objects** area to the **Destination Interface Objects** area.

Figure 26: Interface Objects

**Add NAT Rule**

NAT Rule: Auto NAT Rule

Type: Dynamic

Enable

Interface Objects   Translation   PAT Pool   Advanced

Available Interface Objects

- inside\_zone
- 1** outside\_zone **2** Add to Destination
- wfxAutomationZone

Source Interface Objects (0)

Destination Interface Objects (1)

- 3** outside\_zone

**Step 6** On the **Translation** page, configure the following options:

Figure 27: Translation

**Add NAT Rule**

NAT Rule: Auto NAT Rule

Type: Dynamic

Enable

Interface Objects   **Translation**   PAT Pool   Advanced

Original Packet

Original Source:\* all-ipv4 +

Original Port: TCP

Translated Packet

Translated Source: Destination Interface IP

**1** The values selected for Destination Interface Objects in 'Interface Objects' tab will be used

Translated Port:

- **Original Source**—Click **Add (+)** to add a network object for all IPv4 traffic (0.0.0.0/0).



Figure 28: New Network Object

**Note** You cannot use the system-defined **any-ipv4** object, because Auto NAT rules add NAT as part of the object definition, and you cannot edit system-defined objects.

- **Translated Source**—Choose **Destination Interface IP**.

**Step 7** Click **Save** to add the rule.

The rule is saved to the **Rules** table.

**Step 8** Click **Save** on the **NAT** page to save your changes.

## Allow Traffic from Inside to Outside

If you created a basic **Block all traffic** access control policy when you registered the threat defense, then you need to add rules to the policy to allow traffic through the device. The following procedure adds a rule to allow traffic from the inside zone to the outside zone. If you have other zones, be sure to add rules allowing traffic to the appropriate networks.

### Procedure

**Step 1** Choose **Policy > Access Policy > Access Policy**, and click **Edit** (✎) for the access control policy assigned to the threat defense.

**Step 2** Click **Add Rule**, and set the following parameters:

Figure 29: Add Rule

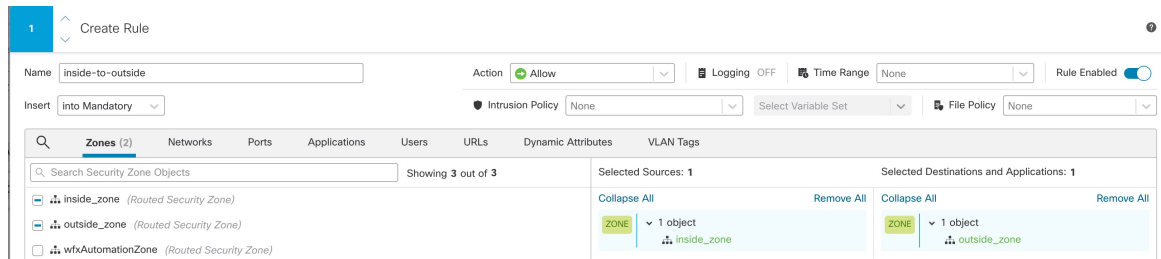

- **Name**—Name this rule, for example, **inside-to-outside**.
- **Selected Sources**—Select the inside zone from **Zones**, and click **Add Source Zone**.
- **Selected Destinations and Applications**—Select the outside zone from **Zones**, and click **Add Destination Zone**.

Leave the other settings as is.

**Step 3** Click **Apply**.

The rule is added to the **Rules** table.

**Step 4** Click **Save**.

## Deploy the Configuration

Deploy the configuration changes to the threat defense; none of your changes are active on the device until you deploy them.

### Procedure

**Step 1** Click **Deploy** in the upper right.

Figure 30: Deploy

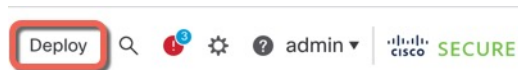

**Step 2** For a quick deployment, check specific devices and then click **Deploy**, or click **Deploy All** to deploy to all devices. Otherwise, for additional deployment options, click **Advanced Deploy**.

Figure 31: Deploy All

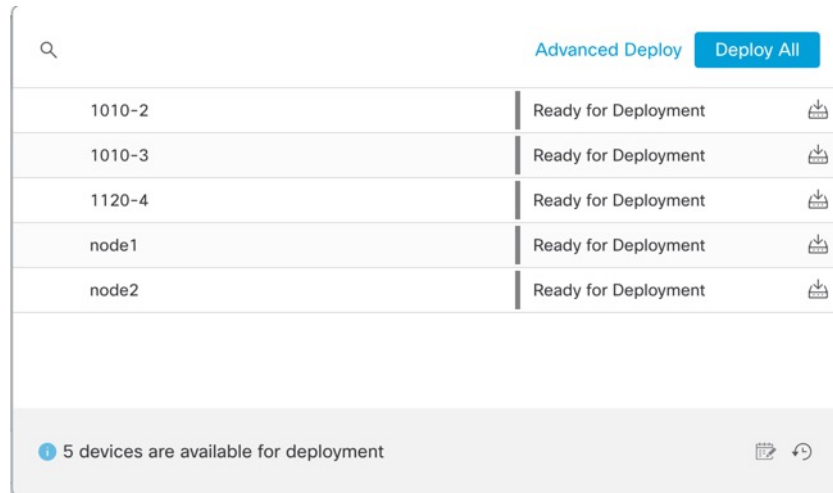
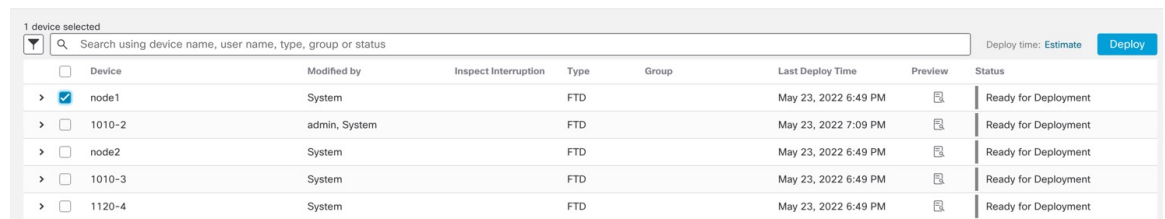

Figure 32: Advanced Deploy



**Step 3**

Ensure that the deployment succeeds. Click the icon to the right of the **Deploy** button in the menu bar to see status for deployments.

Figure 33: Deployment Status

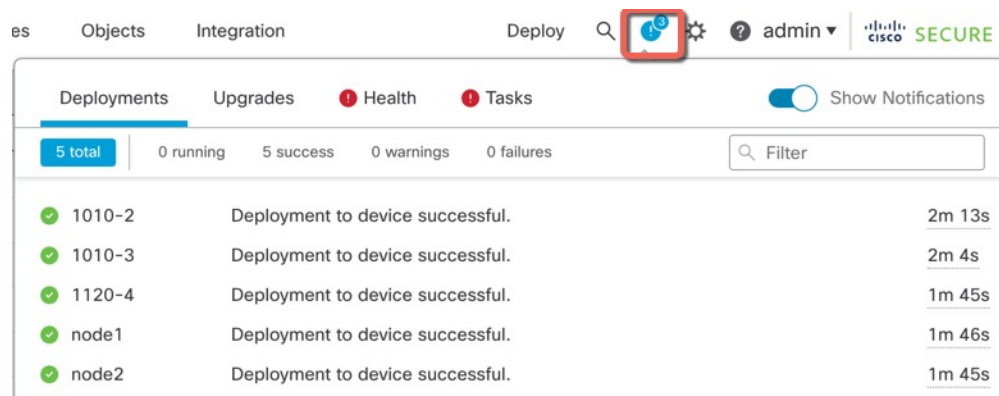

# Access the Threat Defense and FXOS CLI

Use the command-line interface (CLI) to set up the system and do basic system troubleshooting. You cannot configure policies through a CLI session. You can access the CLI by connecting to the console port.

You can also access the FXOS CLI for troubleshooting purposes.



**Note** You can alternatively SSH to the Management interface of the threat defense device. Unlike a console session, the SSH session defaults to the threat defense CLI, from which you can connect to the FXOS CLI using the **connect fxos** command. You can later connect to the address on a data interface if you open the interface for SSH connections. SSH access to data interfaces is disabled by default. This procedure describes console port access, which defaults to the FXOS CLI.

## Procedure

**Step 1** To log into the CLI, connect your management computer to the console port. The Secure Firewall 3100 ships with a DB-9 to RJ-45 serial cable, so you may need to buy a third party DB-9-to-USB serial cable to make the connection. Be sure to install any necessary USB serial drivers for your operating system. The console port defaults to the FXOS CLI. Use the following serial settings:

- 9600 baud
- 8 data bits
- No parity
- 1 stop bit

You connect to the FXOS CLI. Log in to the CLI using the **admin** username and the password you set at initial setup (the default is **Admin123**).

### Example:

```
firepower login: admin
Password:
Last login: Thu May 16 14:01:03 UTC 2019 on ttyS0
Successful login attempts for user 'admin' : 1

firepower#
```

**Step 2** Access the threat defense CLI.

**connect ftd**

### Example:

```
firepower# connect ftd
>
```

After logging in, for information on the commands available in the CLI, enter **help** or **?**. For usage information, see [Cisco Secure Firewall Threat Defense Command Reference](#).

**Step 3** To exit the threat defense CLI, enter the **exit** or **logout** command.

This command returns you to the FXOS CLI prompt. For information on the commands available in the FXOS CLI, enter **?**.

**Example:**

```
> exit
firepower#
```

---

## Power Off the Firewall

It's important that you shut down your system properly. Simply unplugging the power or pressing the power switch can cause serious file system damage. Remember that there are many processes running in the background all the time, and unplugging or shutting off the power does not allow the graceful shutdown of your firewall system.

You can power off the device using the management center device management page, or you can use the FXOS CLI.

## Power Off the Firewall Using the Management Center

It's important that you shut down your system properly. Simply unplugging the power or pressing the power switch can cause serious file system damage. Remember that there are many processes running in the background all the time, and unplugging or shutting off the power does not allow the graceful shutdown of your firewall.

You can shut down your system properly using the management center.

**Procedure**

---

- Step 1** Choose **Devices > Device Management**.
- Step 2** Next to the device that you want to restart, click **Edit** (✎).
- Step 3** Click the **Device** tab.
- Step 4** Click **Shut Down Device** (⊗) in the **System** section.
- Step 5** When prompted, confirm that you want to shut down the device.
- Step 6** If you have a console connection to the firewall, monitor the system prompts as the firewall shuts down. You will see the following prompt:

```
System is stopped.
It is safe to power off now.

Do you want to reboot instead? [y/N]
```

If you do not have a console connection, wait approximately 3 minutes to ensure the system has shut down.

- Step 7** You can now turn off the power switch and unplug the power to physically remove power from the chassis if necessary.
- 

## Power Off the Firewall at the CLI

You can use the FXOS CLI to safely shut down the system and power off the device. You access the CLI by connecting to the console port; see [Access the Threat Defense and FXOS CLI, on page 42](#).

### Procedure

---

- Step 1** In the FXOS CLI, connect to local-mgmt:

```
firepower # connect local-mgmt
```

- Step 2** Issue the **shutdown** command:

```
firepower(local-mgmt) # shutdown
```

#### Example:

```
firepower(local-mgmt)# shutdown
This command will shutdown the system. Continue?
Please enter 'YES' or 'NO': yes
INIT: Stopping Cisco Threat Defense.....ok
```

- Step 3** Monitor the system prompts as the firewall shuts down. You will see the following prompt:

```
System is stopped.
It is safe to power off now.
Do you want to reboot instead? [y/N]
```

- Step 4** You can now turn off the power switch and unplug the power to physically remove power from the chassis if necessary.
- 

## What's Next?

To continue configuring your threat defense, see the documents available for your software version at [Navigating the Cisco Secure Firewall Threat Defense Documentation](#).

For information related to using the management center, see the [Cisco Secure Firewall Management Center Device Configuration Guide](#).



## CHAPTER 3

# Threat Defense Deployment with a Remote Management Center

---

### Is This Chapter for You?

To see all available applications and managers, see [Which Application and Manager is Right for You?](#), on page 1. This chapter applies to the threat defense with the management center.

This chapter explains how to manage the threat defense with a management center located at a central headquarters. For local deployment, where the management center resides on your local management network, see [Threat Defense Deployment with the Management Center](#), on page 5.

### About the Firewall

The hardware can run either threat defense software or ASA software. Switching between threat defense and ASA requires you to reimage the device. You should also reimage if you need a different software version than is currently installed. See [Cisco Secure Firewall ASA and Secure Firewall Threat Defense Reimage Guide](#).

The firewall runs an underlying operating system called the Secure Firewall eXtensible Operating System (FXOS). The firewall does not support the FXOS Secure Firewall chassis manager; only a limited CLI is supported for troubleshooting purposes. See the [Cisco FXOS Troubleshooting Guide for the Firepower 1000/2100 and Secure Firewall 3100/4200 with Firepower Threat Defense](#) for more information.

**Privacy Collection Statement**—The firewall does not require or actively collect personally identifiable information. However, you can use personally identifiable information in the configuration, for example for usernames. In this case, an administrator might be able to see this information when working with the configuration or when using SNMP.

- [How Remote Management Works](#), on page 46
- [Before You Start](#), on page 49
- [End-to-End Tasks: Zero-Touch Provisioning](#), on page 49
- [End-to-End Tasks: Manual Provisioning](#), on page 51
- [Central Administrator Pre-Configuration](#), on page 53
- [Branch Office Installation](#), on page 66
- [Central Administrator Post-Configuration](#), on page 68

# How Remote Management Works

To allow the management center to manage the threat defense over the internet, use the outside interface for management center manager access instead of the Management interface. Because most remote branch offices only have a single internet connection, outside manager access makes centralized management possible.



---

**Note** The management connection is a secure, TLS-1.3-encrypted communication channel between itself and the device. You do not need to run this traffic over an additional encrypted tunnel such as Site-to-Site VPN for security purposes. If the VPN goes down, for example, you will lose your management connection, so we recommend a simple management path.

---

## Registration Methods

Use one of the following methods to provision your threat defense:

### Zero-Touch Provisioning (Management Center 7.4 and later, Threat Defense 7.2 and later)

1. Send the threat defense to the remote branch office. Do not configure anything on the device, because zero-touch provisioning may not work with pre-configured devices.



---

**Note** You can preregister the threat defense on the management center using the threat defense serial number before sending the device to the branch office. The management center integrates with the Cisco Security Cloud and CDO for this functionality.

---

2. At the branch office, cable and power on the threat defense.
3. Finish registering the threat defense using the CDO.

## Manual Provisioning

1. Pre-configure the threat defense at the CLI or using the device manager, and then send the threat defense to the remote branch office.
2. At the branch office, cable and power on the threat defense.
3. Finish registering the threat defense using the management center.

## Threat Defense Manager Access Interface

This guide covers **outside** interface access because it is the most likely scenario for remote branch offices. Although manager access occurs on the outside interface, the dedicated Management interface is still relevant. The Management interface is a special interface configured separately from the threat defense data interfaces, and it has its own network settings.

- The Management interface network settings are still used even though you are enabling manager access on a data interface.
- All management traffic continues to be sourced from or destined to the Management interface.



- When you enable manager access on a data interface, the threat defense forwards incoming management traffic over the backplane to the Management interface.
- For outgoing management traffic, the Management interface forwards the traffic over the backplane to the data interface.

### Manager Access Requirements

Manager access from a data interface has the following limitations:

- You can only enable manager access on a physical, data interface. You cannot use a subinterface or EtherChannel. You can also use the management center to enable manager access on a single secondary interface for redundancy.
- This interface cannot be management-only.
- Routed firewall mode only, using a routed interface.
- PPPoE is not supported. If your ISP requires PPPoE, you will have to put a router with PPPoE support between the threat defense and the WAN modem.
- The interface must be in the global VRF only.
- SSH is not enabled by default for data interfaces, so you will have to enable SSH later using the management center. Because the Management interface gateway will be changed to be the data interfaces, you also cannot SSH to the Management interface from a remote network unless you add a static route for the Management interface using the **configure network static-routes** command.
- Clustering is not supported. You must use the Management interface in this case.
- High availability is not supported. You must use the Management interface in this case.

### Zero-Touch Provisioning Network

The following figure shows a typical network deployment for the firewall where:

- The management center is at central headquarters.
- The threat defense uses the outside interface for manager access.
- Either the threat defense or management center needs a public IP address or hostname to allow the inbound management connection, although you do not need to know the IP address for registration. For pre-7.2(4) and 7.3 threat defense versions, the management center needs to be publicly reachable.
- Both the management center and threat defense initially communicate with the Cisco Security Cloud and CDO to establish the management connection
- After initial establishment, CDO is used to reestablish the management connection if it is disrupted; for example, if the threat defense IP address changes due to a new DHCP assignment, CDO will inform the management center of the change.

Figure 34: Zero-Touch Provisioning Network

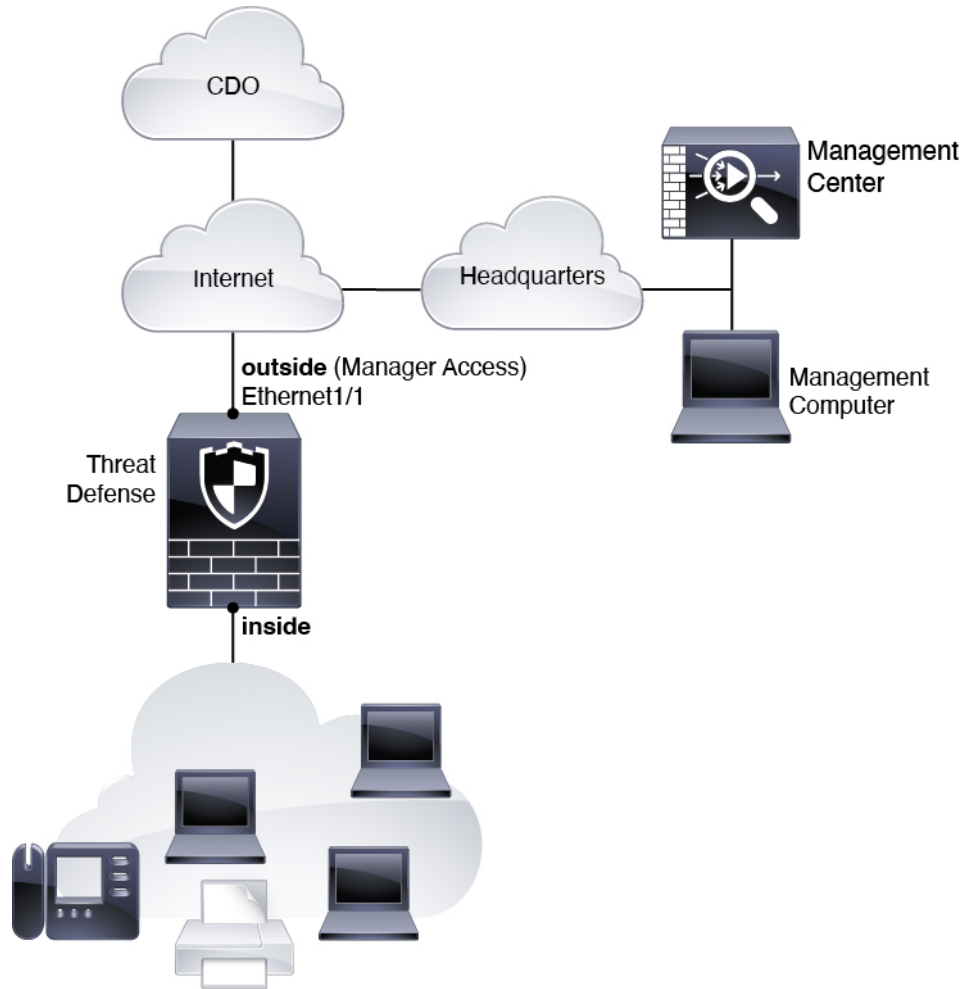

### Manual Provisioning Network

The following figure shows a typical network deployment for the firewall where:

- The management center is at central headquarters.
- The threat defense uses the outside interface for manager access.
- Either the threat defense or management center needs a public IP address or hostname to allow to allow the inbound management connection; you need to know this IP address for initial setup. You can also optionally configure Dynamic DNS (DDNS) for the outside interface to accommodate changing DHCP IP assignments.

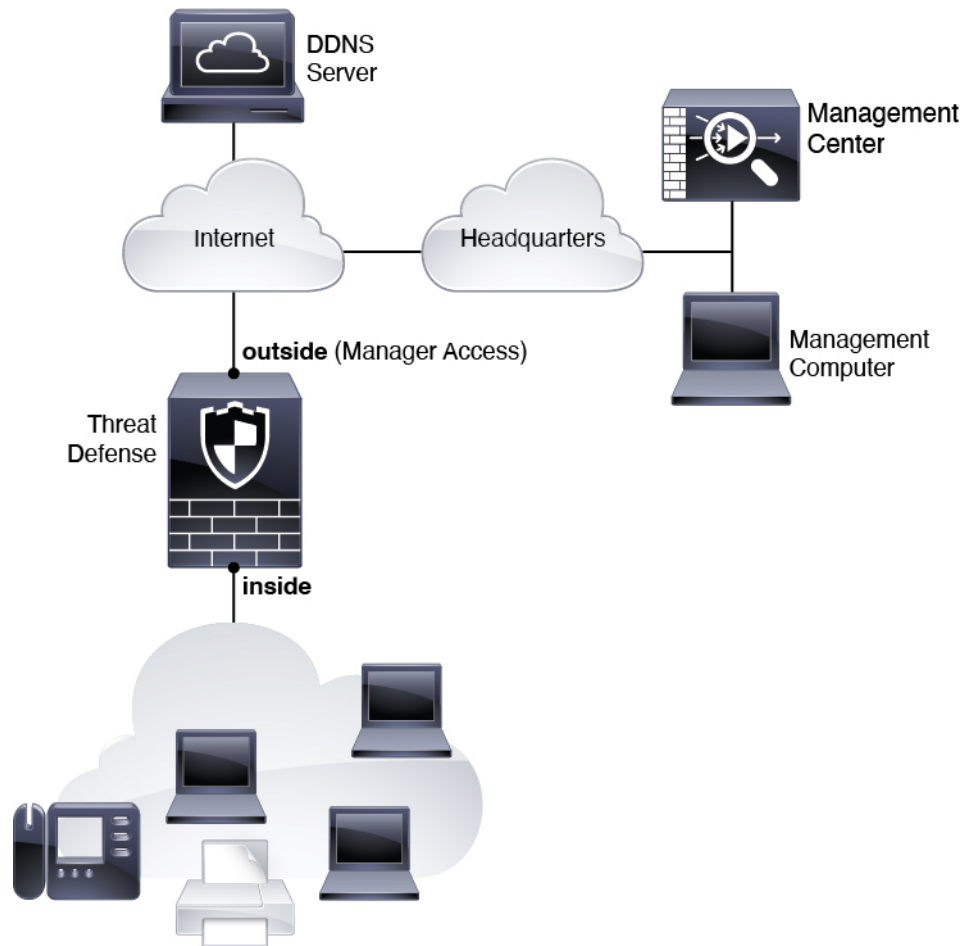
*Figure 35: Manual Provisioning Network*

## Before You Start

Deploy and perform initial configuration of the management center. See the getting started guide for your model.

## End-to-End Tasks: Zero-Touch Provisioning

See the following tasks to deploy the threat defense with management center using zero-touch provisioning.

Figure 36: End-to-End Tasks: Zero-Touch Provisioning

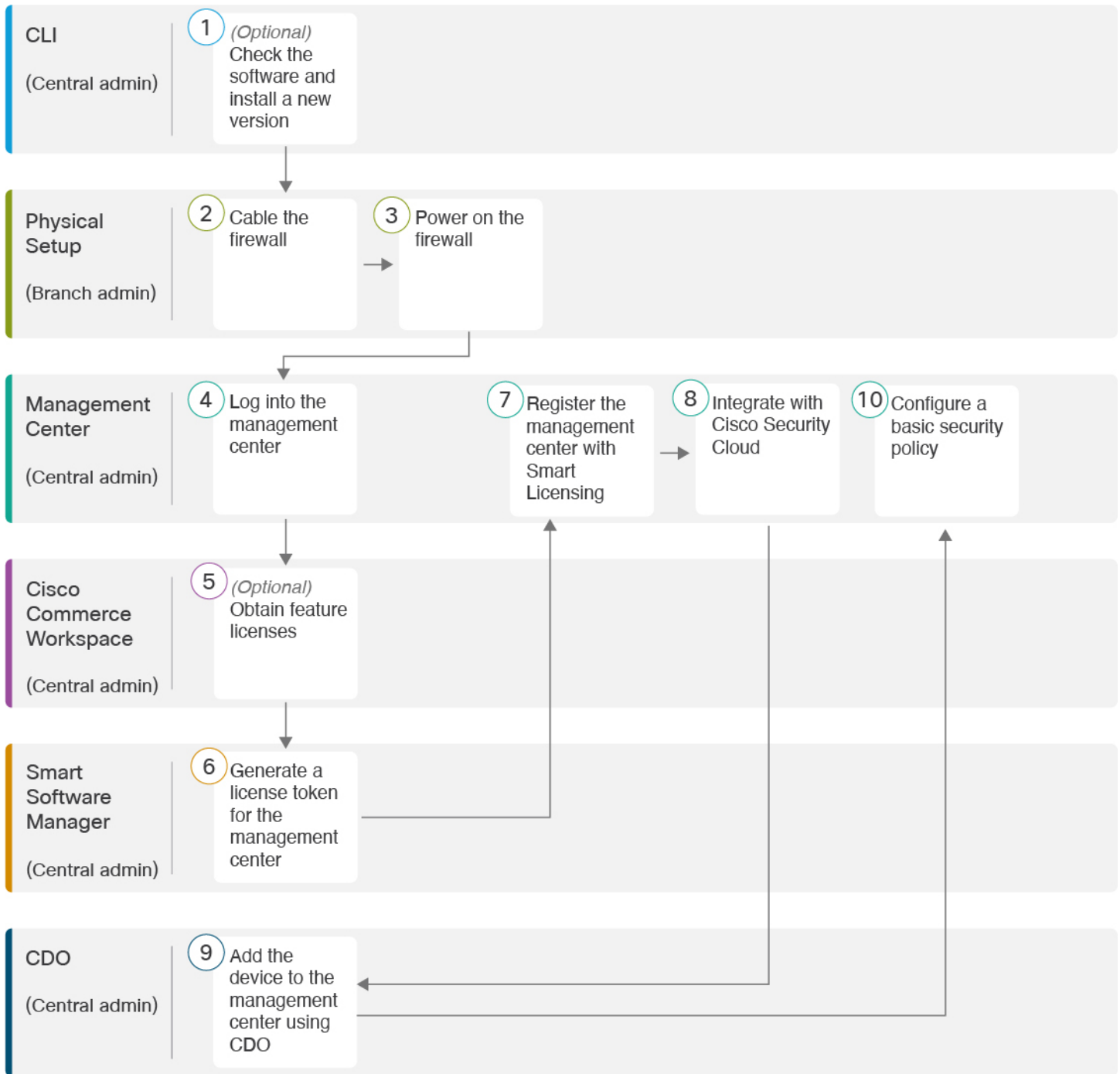

1	CLI (Central administrator)	(Optional) Check the Software and Install a New Version, on page 53.
---	--------------------------------	--

2	Physical Setup (Branch administrator)	<a href="#">Cable the Firewall, on page 66.</a>
3	Physical Setup (Branch administrator)	<a href="#">Power on the Firewall, on page 67.</a>
4	Management Center (Central administrator)	<a href="#">Log Into the Management Center, on page 68.</a>
5	Cisco Commerce Workspace (Central administrator)	<a href="#">Obtain Licenses for the Management Center, on page 68:</a> Buy feature licenses.
6	Smart Software Manager (Central administrator)	<a href="#">Obtain Licenses for the Management Center, on page 68:</a> Generate a license token for the management center.
7	Management Center (Central administrator)	<a href="#">Obtain Licenses for the Management Center, on page 68:</a> Register the management center with the Smart Licensing server.
8	Management Center (Central administrator)	<a href="#">Add a Device to the Management Center Using Zero-Touch Provisioning, on page 70:</a> Integrate the management center with Cisco Security Cloud, including obtaining a CDO account.
9	CDO (Central administrator)	<a href="#">Add a Device to the Management Center Using Zero-Touch Provisioning, on page 70.</a>
10	Management Center (Central administrator)	<a href="#">Configure a Basic Security Policy, on page 27.</a>

## End-to-End Tasks: Manual Provisioning

See the following tasks to deploy the threat defense with management center using manual provisioning.

Figure 37: End-to-End Tasks: Manual Provisioning

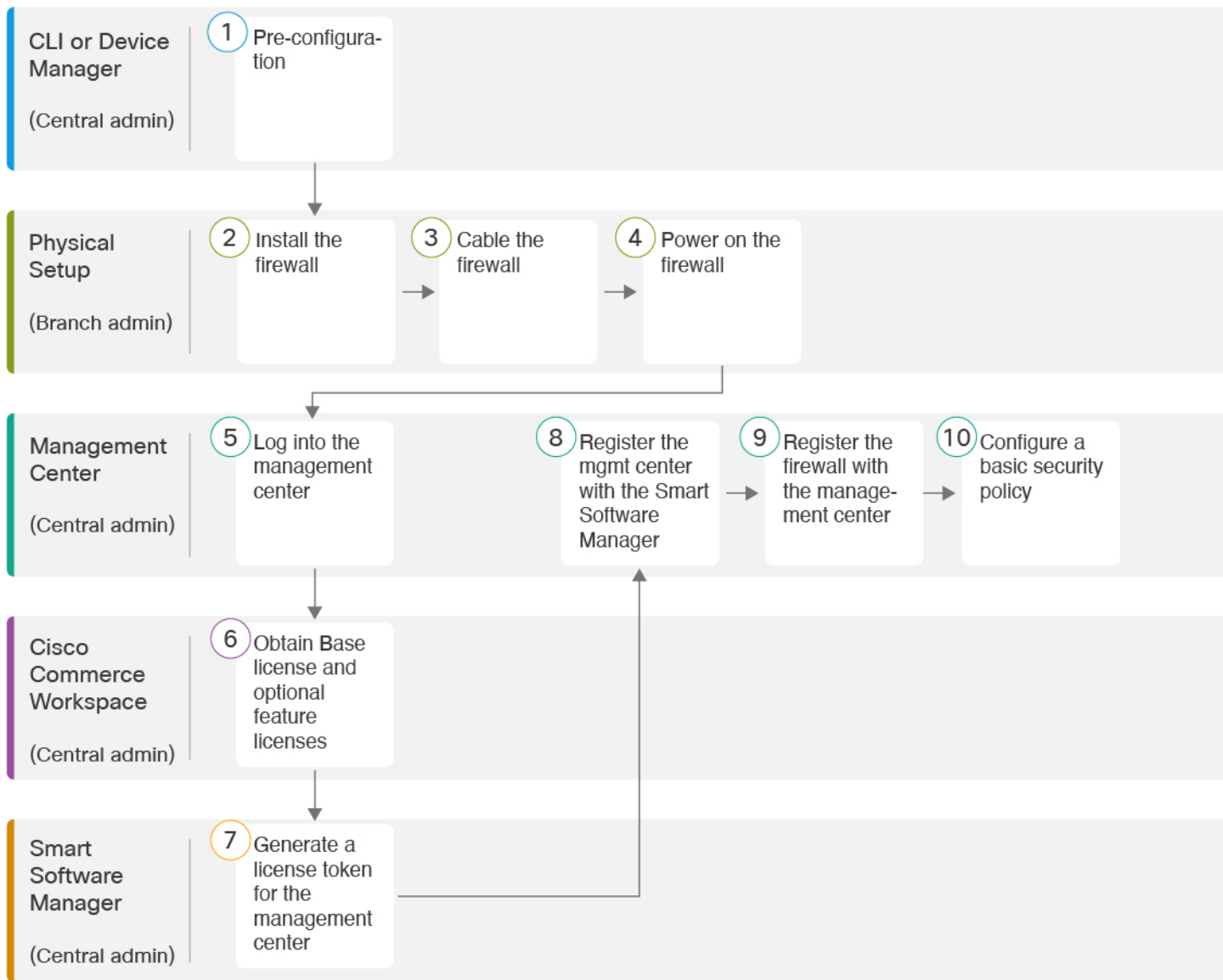

1	CLI or Device Manager (Central admin)	<ul style="list-style-type: none"> <li>• (Optional) <a href="#">Check the Software and Install a New Version, on page 53</a></li> <li>• <a href="#">Pre-Configuration Using the CLI, on page 60.</a></li> <li>• <a href="#">Pre-Configuration Using the Device Manager, on page 55</a></li> </ul>
2	Physical Setup (Branch admin)	Install the firewall. See the <a href="#">hardware installation guide</a> .
3	Physical Setup (Branch admin)	<a href="#">Cable the Firewall, on page 66.</a>

4	Physical Setup (Branch admin)	<a href="#">Power on the Firewall, on page 67</a>
5	Management Center (Central admin)	<a href="#">Log Into the Management Center, on page 22.</a>
6	Cisco Commerce Workspace (Central admin)	Buy an Essentials license and optional feature licenses ( <a href="#">Obtain Licenses for the Management Center, on page 68</a> ).
7	Smart Software Manager (Central admin)	Generate a license token for the management center ( <a href="#">Obtain Licenses for the Management Center, on page 68</a> ).
8	Management Center (Central admin)	Register the management center with the Smart Licensing server ( <a href="#">Obtain Licenses for the Management Center, on page 68</a> ).
9	Management Center (Central admin)	<a href="#">Add a Device to the Management Center Manually, on page 76.</a>
10	Management Center (Central admin)	<a href="#">Configure a Basic Security Policy, on page 79.</a>

## Central Administrator Pre-Configuration

You might need to manually pre-configure the threat defense before you send it to the branch office.

### (Optional) Check the Software and Install a New Version

To check the software version and, if necessary, install a different version, perform these steps. We recommend that you install your target version before you configure the firewall. Alternatively, you can perform an upgrade after you are up and running, but upgrading, which preserves your configuration, may take longer than using this procedure.

#### What Version Should I Run?

Cisco recommends running a Gold Star release indicated by a gold star next to the release number on the software download page. You can also refer to the release strategy described in <https://www.cisco.com/c/en/us/products/collateral/security/firewalls/bulletin-c25-743178.html>; for example, this bulletin describes short-term release numbering (with the latest features), long-term release numbering (maintenance releases and patches for a longer period of time), or extra long-term release numbering (maintenance releases and patches for the longest period of time, for government certification).

#### Procedure

- 
- Step 1** Connect to the console port. See [Access the Threat Defense and FXOS CLI, on page 92](#) for more information.

Log in with the **admin** user and the default password, **Admin123**.

You connect to the FXOS CLI. The first time you log in, you are prompted to change the password. This password is also used for the threat defense login for SSH.

**Note** If the password was already changed, and you do not know it, you must perform a factory reset to reset the password to the default. See the [FXOS troubleshooting guide](#) for the [factory reset procedure](#).

**Example:**

```
firepower login: admin
Password: Admin123
Successful login attempts for user 'admin' : 1

[...]

Hello admin. You must change your password.
Enter new password: *****
Confirm new password: *****
Your password was updated successfully.

[...]

firepower#
```

**Step 2** At the FXOS CLI, show the running version.

**scope ssa**

**show app-instance**

**Example:**

```
Firepower# scope ssa
Firepower /ssa # show app-instance

Application Name      Slot ID      Admin State      Operational State      Running Version Startup
Version Cluster Oper State
-----
ftd                    1            Enabled           Online                   7.6.0.65             7.6.0.65
                        Not Applicable
```

**Step 3** If you want to install a new version, perform these steps.

- a) If you need to set a static IP address for the Management interface, see [Pre-Configuration Using the CLI, on page 60](#). By default, the Management interface uses DHCP.

You will need to download the new image from a server accessible from the Management interface.

- b) Perform the [reimage procedure](#) in the [FXOS troubleshooting guide](#).

After the firewall reboots, you connect to the FXOS CLI again.

- c) At the FXOS CLI, you are prompted to set the admin password again.

For zero-touch provisioning, when you onboard the device, for the **Password Reset** area, be sure to choose **No...** because you already set the password.



- d) Shut down the device. See [Power Off the Firewall at the CLI, on page 94](#).
- 

## Perform Initial Configuration (Manual Provisioning)

For manual provisioning, perform initial configuration of the threat defense using the CLI or using the device manager.

### Pre-Configuration Using the Device Manager

When you use the device manager for initial setup, the following interfaces are preconfigured in addition to the Management interface and manager access settings:

- Ethernet 1/1—"outside", IP address from DHCP, IPv6 autoconfiguration
- Ethernet 1/2—"inside", 192.168.95.1/24
- Default route—Obtained through DHCP on the outside interface

Note that other settings, such as the DHCP server on inside, access control policy, or security zones, are not configured.

If you perform additional interface-specific configuration within device manager before registering with the management center, then that configuration is preserved.

When you use the CLI, only the Management interface and manager access settings are retained (for example, the default inside interface configuration is not retained).

#### Procedure

---

- Step 1** Connect your management computer to the Inside (Ethernet 1/2) interface.
- Step 2** Power on the firewall.
- Note** The first time you boot up the threat defense, initialization can take approximately 15 to 30 minutes.
- Step 3** Log in to the device manager.
- a) Enter the following URL in your browser: **https://192.168.95.1**
  - b) Log in with the username **admin**, and the default password **Admin123**.
  - c) You are prompted to read and accept the End User License Agreement and change the admin password.
- Step 4** Use the setup wizard when you first log into the device manager to complete the initial configuration. You can optionally skip the setup wizard by clicking **Skip device setup** at the bottom of the page.
- After you complete the setup wizard, in addition to the default configuration for the inside interface (Ethernet1/2), you will have configuration for an outside (Ethernet1/1) interface that will be maintained when you switch to management center management.
- a) Configure the following options for the outside and management interfaces and click **Next**.
    1. **Outside Interface Address**—This interface is typically the internet gateway, and might be used as your manager access interface. You cannot select an alternative outside interface during initial device setup. The first data interface is the default outside interface.

If you want to use a different interface from outside (or inside) for manager access, you will have to configure it manually after completing the setup wizard.

**Configure IPv4**—The IPv4 address for the outside interface. You can use DHCP or manually enter a static IP address, subnet mask, and gateway. You can also select **Off** to not configure an IPv4 address. You cannot configure PPPoE using the setup wizard. PPPoE may be required if the interface is connected to a DSL modem, cable modem, or other connection to your ISP, and your ISP uses PPPoE to provide your IP address. You can configure PPPoE after you complete the wizard.

**Configure IPv6**—The IPv6 address for the outside interface. You can use DHCP or manually enter a static IP address, prefix, and gateway. You can also select **Off** to not configure an IPv6 address.

## 2. Management Interface

You will not see Management Interface settings if you performed initial setup at the CLI.

The Management interface settings are used even though you are enabling the manager access on a data interface. For example, the management traffic that is routed over the backplane through the data interface will resolve FQDNs using the Management interface DNS servers, and not the data interface DNS servers.

**DNS Servers**—The DNS server for the system's management address. Enter one or more addresses of DNS servers for name resolution. The default is the OpenDNS public DNS servers. If you edit the fields and want to return to the default, click **Use OpenDNS** to reload the appropriate IP addresses into the fields.

**Firewall Hostname**—The hostname for the system's management address.

b) Configure the **Time Setting (NTP)** and click **Next**.

1. **Time Zone**—Select the time zone for the system.

2. **NTP Time Server**—Select whether to use the default NTP servers or to manually enter the addresses of your NTP servers. You can add multiple servers to provide backups.

c) Select **Start 90 day evaluation period without registration**.

Do not register the threat defense with the Smart Software Manager; all licensing is performed on the management center.

d) Click **Finish**.

e) You are prompted to choose **Cloud Management** or **Standalone**. For management center management, choose **Standalone**, and then **Got It**.

**Step 5** (Might be required) Configure the Management interface. See the Management interface on **Device > Interfaces**.

The Management interface must have the gateway set to data interfaces. By default, the Management interface receives an IP address and gateway from DHCP. If you do not receive a gateway from DHCP (for example, you did not connect this interface to a network), then the gateway will default to data interfaces, and you do not need to configure anything. If you did receive a gateway from DHCP, then you need to instead configure this interface with a static IP address and set the gateway to data interfaces.

**Step 6** If you want to configure additional interfaces, including an interface other than outside or inside that you want to use for the manager access, choose **Device**, and then click the link in the **Interfaces** summary.

See [Configure the Firewall in the Device Manager, on page 116](#) for more information about configuring interfaces in the device manager. Other device manager configuration will not be retained when you register the device to the management center.

- Step 7** Choose **Device > System Settings > Central Management**, and click **Proceed** to set up the management center management.
- Step 8** Configure the **Management Center/CDO Details**.

Figure 38: Management Center/CDO Details

### Configure Connection to Management Center or CDO

Provide details to register to the management center/CDO.

**Management Center/CDO Details**

Do you know the Management Center/CDO hostname or IP address?

Yes     No

**Threat Defense**



10.89.5.16  
fe80::6a87:c6ff:fea6:4c00/64

→

**Management Center/CDO**



10.89.5.35

Management Center/CDO Hostname or IP Address

10.89.5.35

Management Center/CDO Registration Key

••••

NAT ID

Required when the management center/CDO hostname or IP address is not provided. We recommend always setting the NAT ID even when you specify the management center/CDO hostname or IP address.

11203

---

**Connectivity Configuration**

Threat Defense Hostname

1120-3

DNS Server Group

CustomDNSServerGroup

Management Center/CDO Access Interface

Data Interface

Please select an interface

Management Interface [View details](#)

CANCEL
CONNECT

- a) For **Do you know the Management Center/CDO hostname or IP address**, click **Yes** if you can reach the management center using an IP address or hostname, or **No** if the management center is behind NAT or does not have a public IP address or hostname.

At least one of the devices, either the management center or the threat defense device, must have a reachable IP address to establish the two-way, TLS-1.3-encrypted communication channel between the two devices.

- b) If you chose **Yes**, then enter the **Management Center/CDO Hostname/IP Address**.
- c) Specify the **Management Center/CDO Registration Key**.

This key is a one-time registration key of your choice that you will also specify on the management center when you register the threat defense device. The registration key must not exceed 37 characters. Valid characters include alphanumerical characters (A–Z, a–z, 0–9) and the hyphen (-). This ID can be used for multiple devices registering to the management center.

- d) Specify a **NAT ID**.

This ID is a unique, one-time string of your choice that you will also specify on the management center. This field is required if you only specify the IP address on one of the devices; but we recommend that you specify the NAT ID even if you know the IP addresses of both devices. The NAT ID must not exceed 37 characters. Valid characters include alphanumerical characters (A–Z, a–z, 0–9) and the hyphen (-). This ID *cannot* be used for any other devices registering to the management center. The NAT ID is used in combination with the IP address to verify that the connection is coming from the correct device; only after authentication of the IP address/NAT ID will the registration key be checked.

### Step 9 Configure the **Connectivity Configuration**.

- a) Specify the **FTD Hostname**.

This FQDN will be used for the outside interface, or whichever interface you choose for the **Management Center/CDO Access Interface**.

- b) Specify the **DNS Server Group**.

Choose an existing group, or create a new one. The default DNS group is called **CiscoUmbrellaDNSServerGroup**, which includes the OpenDNS servers.

This setting sets the *data* interface DNS server. The Management DNS server that you set with the setup wizard is used for management traffic. The data DNS server is used for DDNS (if configured) or for security policies applied to this interface. You are likely to choose the same DNS server group that you used for Management, because both management and data traffic reach the DNS server through the outside interface.

On the management center, the data interface DNS servers are configured in the Platform Settings policy that you assign to this threat defense. When you add the threat defense to the management center, the local setting is maintained, and the DNS servers are *not* added to a Platform Settings policy. However, if you later assign a Platform Settings policy to the threat defense that includes a DNS configuration, then that configuration will overwrite the local setting. We suggest that you actively configure the DNS Platform Settings to match this setting to bring the management center and the threat defense into sync.

Also, local DNS servers are only retained by the management center if the DNS servers were discovered at initial registration.

- c) For the **Management Center/CDO Access Interface**, choose **outside**.

You can choose any configured interface, but this guide assumes you are using outside.

### Step 10 If you chose a different data interface from outside, then add a default route.

You will see a message telling you to check that you have a default route through the interface. If you chose outside, you already configured this route as part of the setup wizard. If you chose a different interface, then you need to manually configure a default route before you connect to the management center. See [Configure](#)

the [Firewall in the Device Manager](#), on page 116 for more information about configuring static routes in the device manager.

**Step 11** Click **Add a Dynamic DNS (DDNS) method**.

DDNS ensures the management center can reach the threat defense at its Fully-Qualified Domain Name (FQDN) if the threat defense's IP address changes. See **Device > System Settings > DDNS Service** to configure DDNS.

If you configure DDNS before you add the threat defense to the management center, the threat defense automatically adds certificates for all of the major CAs from the Cisco Trusted Root CA bundle so that the threat defense can validate the DDNS server certificate for the HTTPS connection. The threat defense supports any DDNS server that uses the DynDNS Remote API specification (<https://help.dyn.com/remote-access-api/>).

**Step 12** Click **Connect**. The **Registration Status** dialog box shows the current status of the switch to the management center. After the **Saving Management Center/CDO Registration Settings** step, go to the management center, and add the firewall.

If you want to cancel the switch to the management center, click **Cancel Registration**. Otherwise, do not close the device manager browser window until after the **Saving Management Center/CDO Registration Settings** step. If you do, the process will be paused, and will only resume when you reconnect to the device manager.

If you remain connected to the device manager after the **Saving Management Center/CDO Registration Settings** step, you will eventually see the **Successful Connection with Management Center or CDO** dialog box, after which you will be disconnected from the device manager.

*Figure 39: Successful Connection*

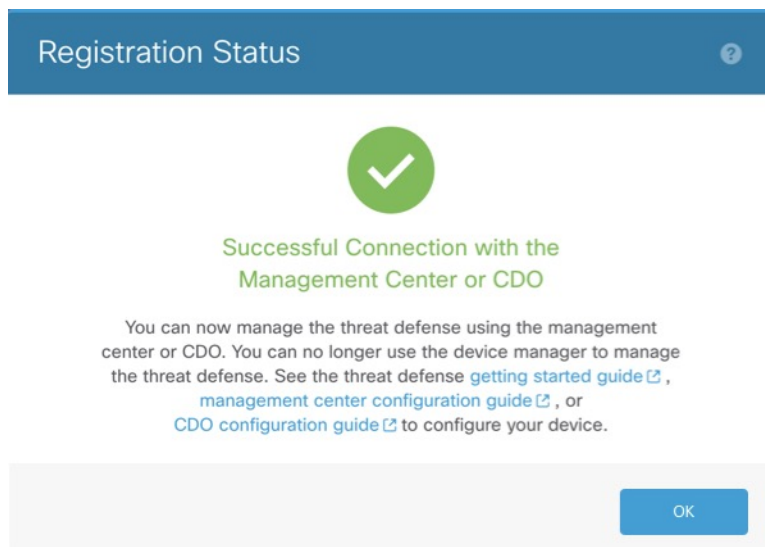

## Pre-Configuration Using the CLI

Set the Management IP address, gateway, and other basic networking settings using the setup wizard. When you use the CLI for initial configuration, only the Management interface and manager access interface settings are retained. When you perform initial setup using the device manager, *all* interface configuration completed

in the device manager is retained when you switch to the management center for management, in addition to the Management interface and manager access interface settings. Note that other default configuration settings, such as the access control policy, are not retained.

## Procedure

---

**Step 1** Power on the firewall.

**Note** The first time you boot up the threat defense, initialization can take approximately 15 to 30 minutes.

**Step 2** Connect to the threat defense CLI on the console port.

The console port connects to the FXOS CLI.

**Step 3** Log in with the username **admin** and the password **Admin123**.

The first time you log in to the FXOS, you are prompted to change the password. This password is also used for the threat defense login for SSH.

**Note** If the password was already changed, and you do not know it, then you must reimage the device to reset the password to the default. See the [FXOS troubleshooting guide](#) for the [reimage procedure](#).

### Example:

```
firepower login: admin
Password: Admin123
Successful login attempts for user 'admin' : 1

[...]

Hello admin. You must change your password.
Enter new password: *****
Confirm new password: *****
Your password was updated successfully.

[...]

firepower#
```

**Step 4** Connect to the threat defense CLI.

**connect ftd**

### Example:

```
firepower# connect ftd
>
```

**Step 5** The first time you log in to the threat defense, you are prompted to accept the End User License Agreement (EULA) and, if using an SSH connection, to change the admin password. You are then presented with the CLI setup script for the Management interface settings.

The Management interface settings are used even though you are enabling manager access on a data interface.

**Note** You cannot repeat the CLI setup wizard unless you clear the configuration; for example, by reimaging. However, all of these settings can be changed later at the CLI using **configure network** commands. See [Cisco Secure Firewall Threat Defense Command Reference](#).

Defaults or previously entered values appear in brackets. To accept previously entered values, press **Enter**.

See the following guidelines:

- **Do you want to configure IPv4?** and/or **Do you want to configure IPv6?**—Enter **y** for at least one of these types of addresses. Although you do not plan to use the Management interface, you must set an IP address, for example, a private address.
- **Configure IPv4 via DHCP or manually?** and/or **Configure IPv6 via DHCP, router, or manually?**—Choose **manual**. You cannot configure a data interface for management if the management interface is set to DHCP, because the default route, which must be **data-interfaces** (see the next bullet), might be overwritten with one received from the DHCP server.
- **Enter the IPv4 default gateway for the management interface** and/or **Enter the IPv6 gateway for the management interface**—Set the gateway to be **data-interfaces**. This setting forwards management traffic over the backplane so it can be routed through the manager access data interface.
- **Manage the device locally?**—Enter **no** to use the management center. A **yes** answer means you will use the device manager instead.
- **Configure firewall mode?**—Enter **routed**. Outside manager access is only supported in routed firewall mode.

### Example:

```
You must accept the EULA to continue.
Press <ENTER> to display the EULA:
End User License Agreement
[...]

Please enter 'YES' or press <ENTER> to AGREE to the EULA:

System initialization in progress. Please stand by.
You must configure the network to continue.
Configure at least one of IPv4 or IPv6 unless managing via data interfaces.
Do you want to configure IPv4? (y/n) [y]:
Do you want to configure IPv6? (y/n) [y]: n
Configure IPv4 via DHCP or manually? (dhcp/manual) [manual]:
Enter an IPv4 address for the management interface [192.168.45.61]: 10.89.5.17
Enter an IPv4 netmask for the management interface [255.255.255.0]: 255.255.255.192
Enter the IPv4 default gateway for the management interface [data-interfaces]:
Enter a fully qualified hostname for this system [firepower]: 1010-3
Enter a comma-separated list of DNS servers or 'none'
[208.67.222.222,208.67.220.220,2620:119:35::35]:
Enter a comma-separated list of search domains or 'none' []: cisco.com
If your networking information has changed, you will need to reconnect.
Disabling IPv6 configuration: management0
Setting DNS servers: 208.67.222.222,208.67.220.220,2620:119:35::35
Setting DNS domains:cisco.com
Setting hostname as 1010-3
Setting static IPv4: 10.89.5.17 netmask: 255.255.255.192 gateway: data on management0
Updating routing tables, please wait...
All configurations applied to the system. Took 3 Seconds.
Saving a copy of running network configuration to local disk.
For HTTP Proxy configuration, run 'configure network http-proxy'
```



```

Manage the device locally? (yes/no) [yes]: no
DHCP server is already disabled
DHCP Server Disabled
Configure firewall mode? (routed/transparent) [routed]:
Configuring firewall mode ...

```

```

Device is in OffBox mode - disabling/removing port 443 from iptables.
Update policy deployment information
- add device configuration
- add network discovery
- add system policy

```

You can register the sensor to a Firepower Management Center and use the Firepower Management Center to manage it. Note that registering the sensor to a Firepower Management Center disables on-sensor Firepower Services management capabilities.

When registering the sensor to a Firepower Management Center, a unique alphanumeric registration key is always required. In most cases, to register a sensor to a Firepower Management Center, you must provide the hostname or the IP address along with the registration key.

```
'configure manager add [hostname | ip address ] [registration key ]'
```

However, if the sensor and the Firepower Management Center are separated by a NAT device, you must enter a unique NAT ID, along with the unique registration key.

```
'configure manager add DONTRESOLVE [registration key ] [ NAT ID ]'
```

Later, using the web interface on the Firepower Management Center, you must use the same registration key and, if necessary, the same NAT ID when you add this sensor to the Firepower Management Center.

```
>
```

## Step 6 Configure the outside interface for manager access.

### **configure network management-data-interface**

You are then prompted to configure basic network settings for the outside interface. See the following details for using this command:

- The Management interface cannot use DHCP if you want to use a data interface for management. If you did not set the IP address manually during initial setup, you can set it beforehand using the **configure network {ipv4 | ipv6} manual** command. If you did not already set the Management interface gateway to **data-interfaces**, this command will set it now.
- When you add the threat defense to the management center, the management center discovers and maintains the interface configuration, including the following settings: interface name and IP address, static route to the gateway, DNS servers, and DDNS server. For more information about the DNS server configuration, see below. In the management center, you can later make changes to the manager access interface configuration, but make sure you don't make changes that can prevent the threat defense or the management center from re-establishing the management connection. If the management connection is disrupted, the threat defense includes the **configure policy rollback** command to restore the previous deployment.
- If you configure a DDNS server update URL, the threat defense automatically adds certificates for all of the major CAs from the Cisco Trusted Root CA bundle so that the threat defense can validate the DDNS server certificate for the HTTPS connection. The threat defense supports any DDNS server that uses the DynDNS Remote API specification (<https://help.dyn.com/remote-access-api/>).

- This command sets the *data* interface DNS server. The Management DNS server that you set with the setup script (or using the **configure network dns servers** command) is used for management traffic. The data DNS server is used for DDNS (if configured) or for security policies applied to this interface.

On the management center, the data interface DNS servers are configured in the Platform Settings policy that you assign to this threat defense. When you add the threat defense to the management center, the local setting is maintained, and the DNS servers are *not* added to a Platform Settings policy. However, if you later assign a Platform Settings policy to the threat defense that includes a DNS configuration, then that configuration will overwrite the local setting. We suggest that you actively configure the DNS Platform Settings to match this setting to bring the management center and the threat defense into sync.

Also, local DNS servers are only retained by the management center if the DNS servers were discovered at initial registration. For example, if you registered the device using the Management interface, but then later configure a data interface using the **configure network management-data-interface** command, then you must manually configure all of these settings in the management center, including the DNS servers, to match the threat defense configuration.

- You can change the management interface after you register the threat defense to the management center, to either the Management interface or another data interface.
- The FQDN that you set in the setup wizard will be used for this interface.
- You can clear the entire device configuration as part of the command; you might use this option in a recovery scenario, but we do not suggest you use it for initial setup or normal operation.
- To disable data management, enter the **configure network management-data-interface disable** command.

### Example:

```
> configure network management-data-interface
Data interface to use for management: ethernet1/1
Specify a name for the interface [outside]:
IP address (manual / dhcp) [dhcp]:
DDNS server update URL [none]:
https://dwinchester:pa$$w0rd17@domains.example.com/nic/update?hostname=<h>&myip=<a>
Do you wish to clear all the device configuration before applying ? (y/n) [n]:

Configuration done with option to allow manager access from any network, if you wish to
change the manager access network
use the 'client' option in the command 'configure network management-data-interface'.

Setting IPv4 network configuration.
Network settings changed.

>
```

### Example:

```
> configure network management-data-interface
Data interface to use for management: ethernet1/1
Specify a name for the interface [outside]: internet
IP address (manual / dhcp) [dhcp]: manual
IPv4/IPv6 address: 10.10.6.7
Netmask/IPv6 Prefix: 255.255.255.0
Default Gateway: 10.10.6.1
Comma-separated list of DNS servers [none]: 208.67.222.222,208.67.220.220
DDNS server update URL [none]:
Do you wish to clear all the device configuration before applying ? (y/n) [n]:
```

Configuration done with option to allow manager access from any network, if you wish to change the manager access network use the 'client' option in the command 'configure network management-data-interface'.

Setting IPv4 network configuration.  
Network settings changed.

>

**Step 7** (Optional) Limit data interface access to the management center on a specific network.

**configure network management-data-interface client** *ip\_address netmask*

By default, all networks are allowed.

**Step 8** Identify the management center that will manage this threat defense.

**configure manager add** {*hostname* | *IPv4\_address* | *IPv6\_address* | **DONTRESOLVE**} *reg\_key* [*nat\_id*]

- {*hostname* | *IPv4\_address* | *IPv6\_address* | **DONTRESOLVE**}—Specifies either the FQDN or IP address of the management center. If the management center is not directly addressable, use **DONTRESOLVE**. At least one of the devices, either the management center or the threat defense, must have a reachable IP address to establish the two-way, SSL-encrypted communication channel between the two devices. If you specify **DONTRESOLVE** in this command, then the threat defense must have a reachable IP address or hostname.
- *reg\_key*—Specifies a one-time registration key of your choice that you will also specify on the management center when you register the threat defense. The registration key must not exceed 37 characters. Valid characters include alphanumeric characters (A–Z, a–z, 0–9) and the hyphen (-).
- *nat\_id*—Specifies a unique, one-time string of your choice that you will also specify on the management center. When you use a data interface for management, then you must specify the NAT ID on *both* the threat defense and the management center for registration. The NAT ID must not exceed 37 characters. Valid characters include alphanumeric characters (A–Z, a–z, 0–9) and the hyphen (-). This ID cannot be used for any other devices registering to the management center.

**Example:**

```
> configure manager add fmc-1.example.com regk3y78 natid56
Manager successfully configured.
```

**Step 9** Shut down the threat defense so you can send the device to the remote branch office.

It's important that you shut down your system properly. Simply unplugging the power or pressing the power switch can cause serious file system damage. Remember that there are many processes running in the background all the time, and unplugging or shutting off the power does not allow the graceful shutdown of your system.

- Enter the **shutdown** command.
- Observe the Power LED and Status LED to verify that the chassis is powered off (appear unlit).
- After the chassis has successfully powered off, you can then unplug the power to physically remove power from the chassis if necessary.

## Branch Office Installation

After you receive the threat defense from central headquarters, you only need to cable and power on the firewall so that it has internet access from the outside interface. The central administrator can then complete the configuration.

### Cable the Firewall

The management center and your management computer reside at a remote headquarters and can reach the threat defense over the internet. To cable the Secure Firewall 3100, see the following steps.

**Figure 40: Cabling a Remote Management Deployment**

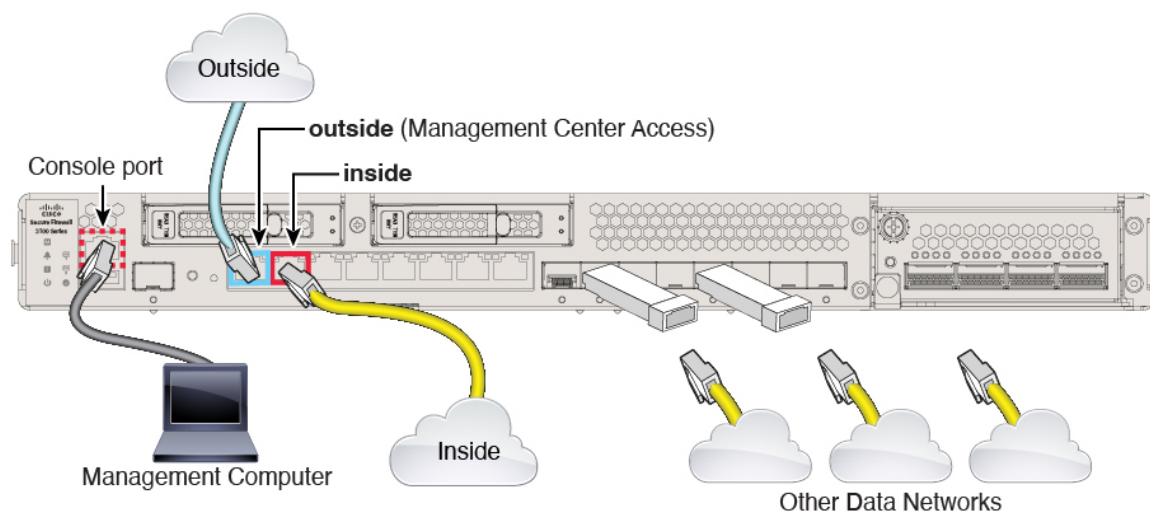

#### Before you begin

(Optional) Obtain a console adapter—The Secure Firewall 3100 ships with a DB-9 to RJ-45 serial cable, so you may need to buy a third party DB-9-to-USB serial cable to make the connection.

#### Procedure

- 
- Step 1** Install the chassis. See the [hardware installation guide](#).
  - Step 2** Connect the outside interface (Ethernet 1/1) to your outside router.
  - Step 3** Connect the inside interface (for example, Ethernet 1/2) to your inside switch or router.  
You can choose any interface for inside.
  - Step 4** Connect other networks to the remaining interfaces.
  - Step 5** (Optional) Connect the management computer to the console port.

At the branch office, the console connection is not required for everyday use; however, it may be required for troubleshooting purposes.

## Power on the Firewall

System power is controlled by a rocker power switch located on the rear of the firewall. The power switch is implemented as a soft notification switch that supports graceful shutdown of the system to reduce the risk of system software and data corruption.



**Note** The first time you boot up the threat defense, initialization can take approximately 15 to 30 minutes.

### Before you begin

It's important that you provide reliable power for your firewall (for example, using an uninterruptable power supply (UPS)). Loss of power without first shutting down can cause serious file system damage. There are many processes running in the background all the time, and losing power does not allow the graceful shutdown of your system.

### Procedure

- Step 1** Attach the power cord to the firewall, and connect it to an electrical outlet.
- Step 2** Turn the power on using the standard rocker-type power on/off switch located on the rear of the chassis, adjacent to the power cord.
- Step 3** Check the Power LED on the back of the firewall; if it is solid green, the firewall is powered on.

*Figure 41: System and Power LEDs*

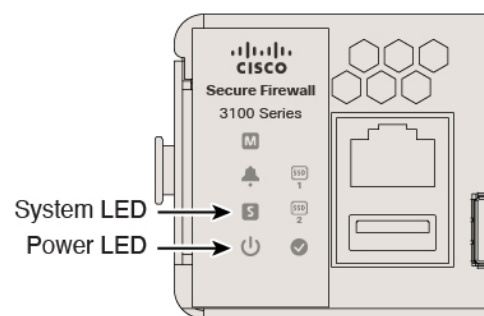

- Step 4** Check the System LED on the back of the firewall; after it is solid green, the system has passed power-on diagnostics.

**Note** When the switch is toggled from ON to OFF, it may take several seconds for the system to eventually power off. During this time, the Power LED on the front of the chassis blinks green. Do not remove the power until the Power LED is completely off.

---

## Central Administrator Post-Configuration

After the remote branch administrator cables the threat defense so it has internet access from the outside interface, you can register the threat defense to the management center and complete configuration of the device.

### Log Into the Management Center

Use the management center to configure and monitor the threat defense.

#### Procedure

---

**Step 1** Using a supported browser, enter the following URL.

**https://fmc\_ip\_address**

**Step 2** Enter your username and password.

**Step 3** Click **Log In**.

---

### Obtain Licenses for the Management Center

All licenses are supplied to the threat defense by the management center. You can optionally purchase the following feature licenses:

- **Essentials**—(Required) Essentials license.
- **IPS**—Security Intelligence and Next-Generation IPS
- **Malware Defense**—Malware defense
- **URL Filtering**—URL Filtering
- **Cisco Secure Client**—Secure Client Advantage, Secure Client Premier, or Secure Client VPN Only
- **Carrier**—Diameter, GTP/GPRS, M3UA, SCTP

For a more detailed overview on Cisco Licensing, go to [cisco.com/go/licensingguide](https://www.cisco.com/go/licensingguide)

#### Before you begin

- Have an account on the [Smart Software Manager](#).

If you do not yet have an account, click the link to [set up a new account](#). The Smart Software Manager lets you create an account for your organization.

- Your Smart Software Licensing account must qualify for the Strong Encryption (3DES/AES) license to use some features (enabled using the export-compliance flag).

## Procedure

**Step 1** Make sure your Smart Licensing account contains the available licenses you need.

When you bought your device from Cisco or a reseller, your licenses should have been linked to your Smart Software License account. However, if you need to add licenses yourself, use the **Search All** field on the [Cisco Commerce Workspace](#).

*Figure 42: License Search*

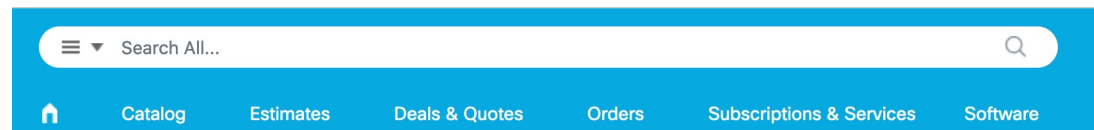

Choose **Products & Services** from the results.

*Figure 43: Results*

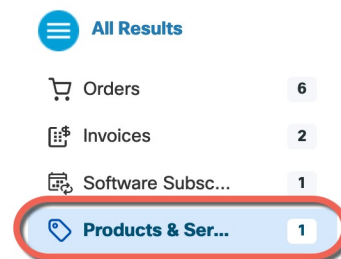

Search for the following license PIDs:

**Note** If a PID is not found, you can add the PID manually to your order.

- Essentials license:
  - L-FPR3110-BSE=
  - L-FPR3120-BSE=
  - L-FPR3130-BSE=
  - L-FPR3140-BSE=
- IPS, Malware Defense, and URL license combination:
  - L-FPR3110T-TMC=
  - L-FPR3120T-TMC=

- L-FPR3130T-TMC=
- L-FPR3140T-TMC=

When you add one of the above PIDs to your order, you can then choose a term-based subscription corresponding with one of the following PIDs:

- L-FPR3110T-TMC-1Y
- L-FPR3110T-TMC-3Y
- L-FPR3110T-TMC-5Y
- L-FPR3120T-TMC-1Y
- L-FPR3120T-TMC-3Y
- L-FPR3120T-TMC-5Y
- L-FPR3130T-TMC-1Y
- L-FPR3130T-TMC-3Y
- L-FPR3130T-TMC-5Y
- L-FPR3140T-TMC-1Y
- L-FPR3140T-TMC-3Y
- L-FPR3140T-TMC-5Y
- Carrier license:
  - L-FPR3K-FTD-CAR=
- Cisco Secure Client—See the [Cisco Secure Client Ordering Guide](#).

- Step 2** If you have not already done so, register the management center with the Smart Software Manager. Registering requires you to generate a registration token in the Smart Software Manager. See the [management center configuration guide](#) for detailed instructions.
- 

## Register the Threat Defense with the Management Center

Register the threat defense with the management center depending on which deployment method you are using.

### Add a Device to the Management Center Using Zero-Touch Provisioning

Zero-Touch Provisioning lets you register devices to the management center by serial number without having to perform any initial setup on the device. The management center integrates with Cisco Defense Orchestrator (CDO) for this functionality.

When you use zero-touch provisioning, the following interfaces are preconfigured. Note that other settings, such as the DHCP server on inside, access control policy, or security zones, are not configured.



- Ethernet 1/1—"outside", IP address from DHCP, IPv6 autoconfiguration
- Ethernet 1/2—"inside", 192.168.95.1/24
- Default route—Obtained through DHCP on the outside interface

Zero-Touch Provisioning is not supported with clustering or multi-instance mode.

High availability is only supported when you use the Management interface because zero-touch provisioning uses DHCP, which is not supported for data interfaces and high availability.

### Before you begin

- Make sure you have at least one access control policy configured on the management center so you can assign it to new devices. You cannot add a policy using CDO.
- If the device does not have a public IP address or FQDN, or you use the Management interface, set a public IP address/FQDN for the management center (if different from the management center management interface IP address; for example, it is behind NAT) so the device can initiate the management connection. See . You can also configure the public IP address/FQDN in CDO during this procedure.

### Procedure

#### Step 1

The first time you add a device using a serial number, you need to complete the following prerequisites. After the first time, you can skip to adding the devices directly in CDO.

- In the management center, choose **Devices > Device Management**.
- From the **Add** drop-down menu, choose **Device**.
- Click **Serial Number** for the provisioning method.

**Figure 44: Add Device by Serial Number**

Add Device ?

---

Select the Provisioning Method:

Registration Key     Serial Number

**1** **Step 1: Create Cisco Defense Orchestrator (CDO) and SecureX accounts**  
 CDO and SecureX are cloud services that are required for serial-number onboarding.  
 If you already have separate accounts, you need to link them. [Learn more](#)  
 If you don't already have accounts, perform the following:

- Request a CDO tenant. [Learn more](#)
- Create a SecureX user. [Learn more](#)

**2** **Step 2: Integrate the Management Center with SecureX**  
 SecureX integration is required to add an on-prem management center to CDO.  
[SecureX Integration](#)

**i** Complete above prerequisites before registering

- Create a CDO account.

**Note** If you already have preexisting but separate SecureX and CDO accounts, you need to link them. See <https://cisco.com/go/cdo-securex-link> for more information about linking accounts.

If you don't already have accounts, perform the following:

- Create a Cisco Security Cloud (formerly SecureX) account. See the [CDO documentation](#) for information about how to create one.
  - Request a CDO tenant. See the [CDO documentation](#) for information about requesting a new CDO tenant.
- e) Integrate the management center with Cisco Security Cloud (formerly SecureX). Click the link to open the **SecureX Integration** page in the management center.

Click the **Enable SecureX** to open a separate browser tab to log you into your Cisco Security Cloud account and confirm the displayed code. Make sure this page is not blocked by a pop-up blocker.

For detailed information, see .

CDO onboards the on-prem management center after you integrate the management center with Cisco Security Cloud. CDO needs the management center in its inventory for zero-touch provisioning to operate. CDO's management center support is limited to device onboarding, viewing its managed devices, viewing objects associated with the management center, and cross-launching the management center.

**Note** For a management center high-availability pair, you also need to integrate the secondary management center with Cisco Security Cloud.

- f) Click **Launch CDO** if you do not already have it open, or log in here: <https://www.defenseorchestrator.com/>

Make sure CDO is not blocked by a pop-up blocker.

## Step 2

On the CDO **Dashboard** (<https://www.defenseorchestrator.com/>), click **Onboard** ().

## Step 3

Click the **FTD** tile.

*Figure 45: FTD Tile*



## Step 4

On the **Onboard FTD Device** screen, click **Use Serial Number**.

Figure 46: Use Serial Number

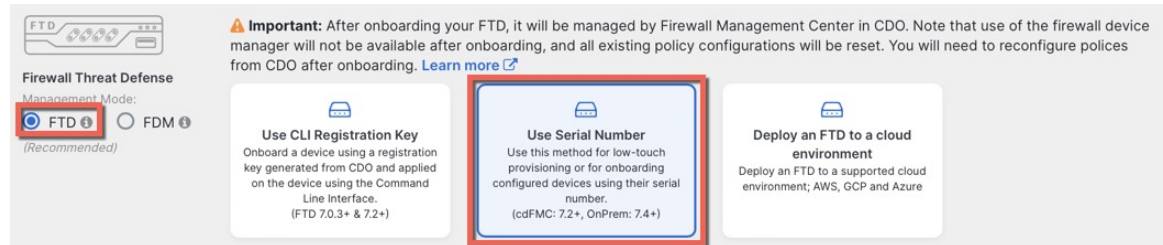
**Step 5**

In **Select FMC**, choose an **On-Prem FMC** from the list, and click **Next**.

Figure 47: Select FMC

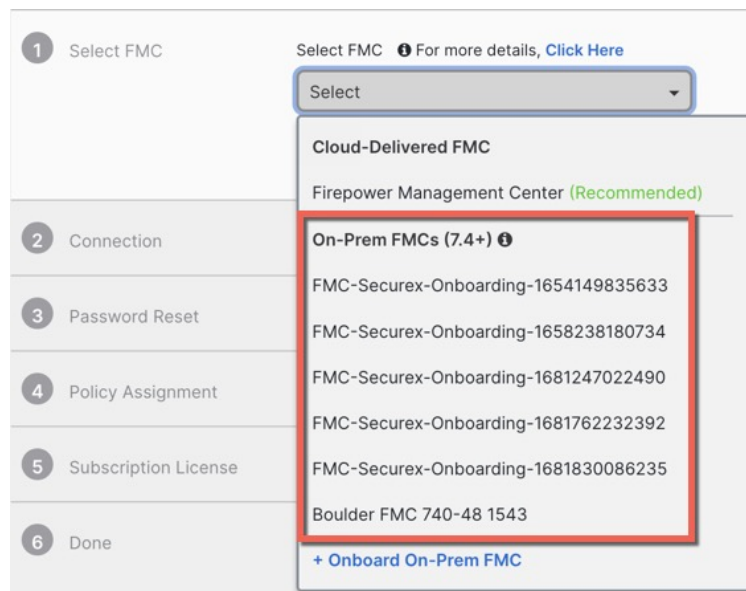

If the management center has a public IP address or FQDN set, it will show after you choose it.

Figure 48: Public IP Address/FQDN



The management center needs a public IP address/FQDN if the device does not have a public IP address/FQDN or if you use the Management interface for zero-touch provisioning. You can set the management center public IP address/FQDN by clicking the **FMC Public IP** link. You see the following dialog box.

Figure 49: Configure FMC Public IP/FQDN

Configure FMC Public IP/FQDN

Selected FMC: Boulder FMC 740-48 1543

Provide FMC Public IP address or FQDN

IP Address/FQDN

fmc-tech-pubs.cisco.com

FQDN preferred

Specify this value unless the FTD is publicly reachable, running a version older than 7.4, and connected with the data interface.

Save

**Note** For a management center high-availability pair, you also need to set the public IP address/FQDN on the secondary management center. You can't set value this using CDO; you need to set it in the secondary management center. See .

**Step 6** In **Connection**, enter the device's serial number and device name. Click **Next**.

Figure 50: Connection

2 Connection

Device Serial Number

JAD253802GB

Device Name

fp-1010-1

Next

Enter the serial number of the FTD device you want to onboard, then CDO will attempt to connect to the device.

Important: Only FTD 1000, 2100 or 3100 series devices (running on software version 7.4 or later) are supported.

**Step 7** In **Password Reset**, click **Yes...**. Enter a new password and confirm the new password for the device, then click **Next**.

For zero-touch provisioning, the device must be brand new or has been reimaged.

**Note** If you did log into the device and reset the password, and you did not change the configuration in a way that would disable zero-touch provisioning, then you should choose the **No...** option. There are a number of configurations that disable zero-touch provisioning, so we don't recommend logging into the device unless you need to, for example, to perform a reimage.

Figure 51: Password Reset

3 Password Reset

1 Please review all the prerequisites for onboarding with a serial number. [Learn more](#)

2 Is this a new device that has never been logged into or configured for a manager?

Yes, this new device has never been logged into or configured for a manager

Enter a new password for devices that have never been configured for a manager.

**Important:** If you select this option and the device's default password has already been changed, onboarding fails.

New Password

Confirm Password

No, this device has been logged into and configured for a manager

Use this option if you already changed the password in the device CLI.

**Important:** If you select this option and the device's default password has not been changed, onboarding fails.

**Password must:**

- Be 8-128 characters
- Have at least one lower and one upper case letter
- Have at least one digit
- Have at least one special character.
- Not contain consecutive repeated letters

Next

**Step 8** In **Policy Assignment**, use the drop-down menu to select an access control policy for the device. If you have not added a policy on the management center, you should go to the management center and add one now. Click **Next**.

Figure 52: Policy Assignment

4 Policy Assignment

Access Control Policy

Default Access Control Policy

Next

**Step 9** In **Subscription License**, select the licenses for the device. Click **Next**.

Figure 53: Subscription License

5 Subscription License

License Type	Includes
<input checked="" type="checkbox"/> Essentials	Base Firewall Capabilities
<input checked="" type="checkbox"/> Carrier (7.3+ FTDs only)	GTP/GPRS, Diameter, SCTP, M3UA
<input checked="" type="checkbox"/> IPS	Intrusion Policy
<input checked="" type="checkbox"/> Malware Defense	File Policy
<input checked="" type="checkbox"/> URL	URL Reputation
<input type="checkbox"/> RA VPN <input type="text" value="VPNOnly"/>	RA VPN

**Enable subscription licenses.** CDO will attempt to enable the selected licenses when the device is connected to CDO and registered with the supplied Smart License. [Learn more about Cisco Smart Accounts.](#)

Next

**Step 10** In **Done**, you can add labels to the device that show in CDO; they are not used on the management center.

Figure 54: Done

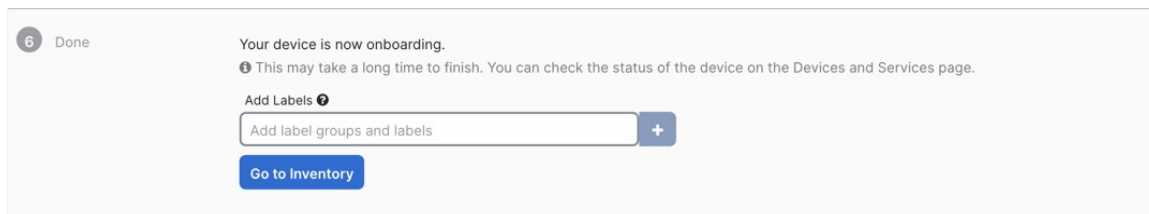

In the management center, the device is added to the **Device Management** page. You can also click **Go to Inventory** to see the devices in CDO. On-prem management center devices are viewable in CDO inventory for information purposes.

When using zero-touch provisioning on the outside interface, CDO acts as a DDNS provider and does the following:

- Enables DDNS on outside using the "fmcOnly" method. This method is only supported for zero-touch provisioning devices.
- Maps the outside IP address with the following hostname: *serial-number.local*.
- Provides the IP address/hostname mapping to the management center so it can resolve the hostname to the correct IP address.
- Informs the management center if the IP address ever changes, for example, if the DHCP lease renews.

If you use zero-touch provisioning on the Management interface, DDNS is not supported. The management center must be publicly reachable so the device can initiate the management connection.

You can continue to use CDO as the DDNS provider, or you can later change the DDNS configuration in the management center to a different method.

---

## Add a Device to the Management Center Manually

Register the threat defense to the management center.

### Procedure

---

- Step 1** In the management center, choose **Devices > Device Management**.
- Step 2** From the **Add** drop-down list, choose **Add Device**.

Figure 55: Add Device

Add Device
?

---

CDO Managed Device

Host:†

Display Name:

Registration Key:\*

Group:

Access Control Policy:\*

**Smart Licensing**  
 Note: All virtual Firewall Threat Defense devices require a performance tier license. Make sure your Smart Licensing account contains the available licenses you need. It's important to choose the tier that matches the license you have in your account. Click [here](#) for information about the Firewall Threat Defense performance-tiered licensing. Until you choose a tier, your Firewall Threat Defense virtual defaults to the FTDv50 selection.

Performance Tier (only for Firewall Threat Defense virtual 7.0 and above):

Malware  
 Threat  
 URL Filtering

Advanced

Unique NAT ID:†

Transfer Packets

Set the following parameters:

- **Host**—Enter the IP address or hostname of the threat defense you want to add. You can leave this field blank if you specified both the management center IP address and a NAT ID in the threat defense initial configuration.

**Note** In an HA environment, when both the management centers are behind a NAT, you can register the threat defense without a host IP or name in the primary management center. However, for registering the threat defense in a secondary management center, you must provide the IP address or hostname for the threat defense.

- **Display Name**—Enter the name for the threat defense as you want it to display in the management center.

- **Registration Key**—Enter the same registration key that you specified in the threat defense initial configuration.
- **Domain**—Assign the device to a leaf domain if you have a multidomain environment.
- **Group**—Assign it to a device group if you are using groups.
- **Access Control Policy**—Choose an initial policy. Unless you already have a customized policy you know you need to use, choose **Create new policy**, and choose **Block all traffic**. You can change this later to allow traffic; see [Allow Traffic from Inside to Outside](#), on page 39.

Figure 56: New Policy

New Policy ?

Name:

Description:

Select Base Policy:

Default Action:  
 Block all traffic  
 Intrusion Prevention  
 Network Discovery

- **Smart Licensing**—Assign the Smart Licenses you need for the features you want to deploy. **Note:** You can apply the Secure Client remote access VPN license after you add the device, from the **System > Licenses > Smart Licenses** page.
- **Unique NAT ID**—Specify the NAT ID that you specified in the threat defense initial configuration.
- **Transfer Packets**—Allow the device to transfer packets to the management center. When events like IPS or Snort are triggered with this option enabled, the device sends event metadata information and packet data to the management center for inspection. If you disable it, only event information will be sent to the management center, but packet data is not sent.

**Step 3** Click **Register**, and confirm a successful registration.

If the registration succeeds, the device is added to the list. If it fails, you will see an error message. If the threat defense fails to register, check the following items:

- **Ping**—Access the threat defense CLI, and ping the management center IP address using the following command:

```
ping system ip_address
```



If the ping is not successful, check your network settings using the **show network** command. If you need to change the threat defense Management IP address, use the **configure network management-data-interface** command.

- Registration key, NAT ID, and management center IP address—Make sure you are using the same registration key, and if used, NAT ID, on both devices. You can set the registration key and NAT ID on the threat defense using the **configure manager add** command.

For more troubleshooting information, see <https://cisco.com/go/fmc-reg-error>.

---

## Configure a Basic Security Policy

This section describes how to configure a basic security policy with the following settings:

- Inside and outside interfaces—Assign a static IP address to the inside interface. You configured basic settings for the outside interface as part of the manager access setup, but you still need to assign it to a security zone.
- DHCP server—Use a DHCP server on the inside interface for clients.
- NAT—Use interface PAT on the outside interface.
- Access control—Allow traffic from inside to outside.
- SSH—Enable SSH on the manager access interface.

## Configure Interfaces

When you use low-touch provisioning or the device manager for initial setup, the following interfaces are preconfigured:

- Ethernet 1/1—"outside", IP address from DHCP, IPv6 autoconfiguration
- Ethernet 1/2—"inside", 192.168.95.1/24
- Default route—Obtained through DHCP on the outside interface

If you performed additional interface-specific configuration within device manager before registering with the management center, then that configuration is preserved.

In any case, you need to perform additional interface configuration after you register the device. Enable the threat defense interfaces, assign them to security zones, and set the IP addresses. Also configure breakout interfaces.

The following example configures a routed mode inside interface with a static address and a routed mode outside interface using DHCP.

### Procedure

---

- Step 1** Choose **Devices > Device Management**, and click **Edit** (✎) for the firewall.
- Step 2** Click **Interfaces**.

Figure 57: Interfaces

Interface	Logical Name	Type	Security Zones	MAC Address (Active/Standby)	IP Address	Path Monitoring	Virtual Router	
● Management0/0	management	Physical				Disabled	Global	🔍 ↶
🔍 GigabitEthernet0/0		Physical				Disabled		✎
🔍 GigabitEthernet0/1		Physical				Disabled		✎
🔍 GigabitEthernet0/2		Physical				Disabled		✎
🔍 GigabitEthernet0/3		Physical				Disabled		✎
🔍 GigabitEthernet0/4		Physical				Disabled		✎
🔍 GigabitEthernet0/5		Physical				Disabled		✎
🔍 GigabitEthernet0/6		Physical				Disabled		✎
🔍 GigabitEthernet0/7		Physical				Disabled		✎

**Step 3** To create 4 x 10-Gb breakout interfaces from a 40-Gb interface (available on some models), click the breakout icon for the interface.

If you already used the 40-Gb interface in your configuration, you will have to remove the configuration before you can proceed with the breakout.

**Step 4** Click **Edit** (✎) for the interface that you want to use for *inside*.

The **General** tab appears.

Figure 58: General Tab

Edit Physical Interface

General IPv4 IPv6 Path Monitoring

Name:

Enabled  
 Management Only

Description:

Mode:

Security Zone:

Interface ID:

MTU:  
  
(64 - 9000)

Priority:  
 (0 - 65535)

Propagate Security Group Tag:

NVE Only:

- a) Enter a **Name** up to 48 characters in length.  
For example, name the interface **inside**.
- b) Check the **Enabled** check box.
- c) Leave the **Mode** set to **None**.
- d) From the **Security Zone** drop-down list, choose an existing inside security zone or add a new one by clicking **New**.

For example, add a zone called **inside\_zone**. Each interface must be assigned to a security zone and/or interface group. An interface can belong to only one security zone, but can also belong to multiple interface groups. You apply your security policy based on zones or groups. For example, you can assign the inside interface to the inside zone; and the outside interface to the outside zone. Then you can configure your access control policy to enable traffic to go from inside to outside, but not from outside to inside. Most policies only support security zones; you can use zones or interface groups in NAT policies, prefilter policies, and QoS policies.

- e) Click the **IPv4** and/or **IPv6** tab.
  - **IPv4**—Choose **Use Static IP** from the drop-down list, and enter an IP address and subnet mask in slash notation.  
For example, enter **192.168.1.1/24**

Figure 59: IPv4 Tab

The screenshot shows the 'Edit Physical Interface' window with the 'IPv4' tab selected. The 'IP Type' dropdown is set to 'Use Static IP'. The 'IP Address' field contains '192.168.1.1/24'. Below the field, there is a note: 'eg. 192.0.2.1/255.255.255.128 or 192.0.2.1/25'.

- **IPv6**—Check the **Autoconfiguration** check box for stateless autoconfiguration.

Figure 60: IPv6 Tab

The screenshot shows the 'Edit Physical Interface' window with the 'IPv6' tab selected. The 'Basic' sub-tab is active. The 'Enable IPV6' checkbox is unchecked. The 'Enforce EUI 64' checkbox is unchecked. The 'Link-Local address' field is empty. The 'Autoconfiguration' checkbox is checked. The 'Obtain Default Route' checkbox is unchecked.

f) Click **OK**.

- Step 5** Click **Edit** (✎) for the interface that you want to use for *outside*.  
The **General** tab appears.

Figure 61: General Tab

Edit Physical Interface

General IPv4 IPv6 Path Monitoring Hardware

Name:

Enabled  
 Management Only

Description:

Mode:

Security Zone:

Interface ID:

MTU:  
  
(64 - 9000)

Priority:  
 (0 - 65535)

Propagate Security Group Tag:

NVE Only:

You already pre-configured this interface for manager access, so the interface will already be named, enabled, and addressed. You should not alter any of these basic settings because doing so will disrupt the management center management connection. You must still configure the Security Zone on this screen for through traffic policies.

- a) From the **Security Zone** drop-down list, choose an existing outside security zone or add a new one by clicking **New**.

For example, add a zone called **outside\_zone**.

- b) Click **OK**.

**Step 6** Click **Save**.

## Configure the DHCP Server

Enable the DHCP server if you want clients to use DHCP to obtain IP addresses from the threat defense.

## Procedure

- Step 1** Choose **Devices > Device Management**, and click **Edit** (✎) for the device.
- Step 2** Choose **DHCP > DHCP Server**.

**Figure 62: DHCP Server**

The screenshot shows the DHCP Server configuration page. The left sidebar contains a navigation menu with 'DHCP Server' selected. The main content area has tabs for 'Device', 'Routing', 'Interfaces', 'Inline Sets', 'DHCP', and 'VTEP'. Under the 'DHCP' tab, there are several configuration fields: 'Ping Timeout' (50), 'Lease Length' (3600), 'Auto-Configuration' (unchecked), 'Interface' (dropdown), and 'Override Auto Configured Settings' (Domain Name, Primary/Secondary DNS Servers, Primary/Secondary WINS Servers). At the bottom right, there is a '+ Add' button highlighted with a red box. Below the configuration fields is a table with columns for 'Interface', 'Address Pool', and 'Enable DHCP Server', which is currently empty with the text 'No records to display'.

- Step 3** On the **Server** page, click **Add**, and configure the following options:

**Figure 63: Add Server**

The screenshot shows the 'Add Server' dialog box. It has a title bar with 'Add Server' and a help icon. The configuration options are: 'Interface\*' (dropdown menu with 'inside' selected), 'Address Pool\*' (text input with '10.9.7.9-10.9.7.25' and '(2.2.2.10-2.2.2.20)' below it), and a checked checkbox for 'Enable DHCP Server'. At the bottom, there are 'Cancel' and 'OK' buttons.

- **Interface**—Choose the interface from the drop-down list.
- **Address Pool**—Set the range of IP addresses from lowest to highest that are used by the DHCP server. The range of IP addresses must be on the same subnet as the selected interface and cannot include the IP address of the interface itself.
- **Enable DHCP Server**—Enable the DHCP server on the selected interface.

- Step 4** Click **OK**.

**Step 5** Click **Save**.

## Configure NAT

A typical NAT rule converts internal addresses to a port on the outside interface IP address. This type of NAT rule is called *interface Port Address Translation (PAT)*.

### Procedure

**Step 1** Choose **Devices > NAT**, and click **New Policy > Threat Defense NAT**.

**Step 2** Name the policy, select the device(s) that you want to use the policy, and click **Save**.

*Figure 64: New Policy*

The screenshot shows a 'New Policy' configuration window. The 'Name' field is filled with 'interface\_PAT'. The 'Description' field is empty. Under 'Targeted Devices', there is a checkbox and a search box. The 'Available Devices' list contains '10.10.0.6' and '10.10.0.7', with '10.10.0.6' selected. An 'Add to Policy' button is located between the 'Available Devices' and 'Selected Devices' lists. The 'Selected Devices' list contains '10.10.0.6' and '10.10.0.7'. At the bottom right, there are 'Cancel' and 'Save' buttons.

The policy is added the management center. You still have to add rules to the policy.

Figure 65: NAT Policy

interface\_PAT

Enter Description

Rules

Show Warnings Save Cancel

NAT Exemptions Policy Assignments (2)

Filter by Device Filter Rules Add Rule

	#	Direction	Type	Source Interface Objects	Destination Interface Objects	Original Packet			Translated Packet			Options	
						Original Sources	Original Destinations	Original Services	Translated Sources	Translated Destinations	Translated Services		
NAT Rules Before													
Auto NAT Rules													
NAT Rules After													

**Step 3** Click **Add Rule**.

The **Add NAT Rule** dialog box appears.

**Step 4** Configure the basic rule options:

Figure 66: Basic Rule Options

Add NAT Rule

NAT Rule:  
Auto NAT Rule

Type:  
Dynamic

Enable

Interface Objects Translation PAT Pool Advanced

- **NAT Rule**—Choose **Auto NAT Rule**.
- **Type**—Choose **Dynamic**.

**Step 5** On the **Interface Objects** page, add the outside zone from the **Available Interface Objects** area to the **Destination Interface Objects** area.



Figure 67: Interface Objects

**Add NAT Rule**

NAT Rule: Auto NAT Rule

Type: Dynamic

Enable

Interface Objects Translation PAT Pool Advanced

Available Interface Objects

Search by name

inside\_zone

**1** outside\_zone **2** Add to Destination

wfxAutomationZone

Add to Source

Source Interface Objects (0)

any

Destination Interface Objects (1)

**3** outside\_zone

**Step 6** On the **Translation** page, configure the following options:

Figure 68: Translation

**Add NAT Rule**

NAT Rule: Auto NAT Rule

Type: Dynamic

Enable

Interface Objects Translation PAT Pool Advanced

Original Packet

Original Source:\*

all-ipv4 +

Original Port:

TCP

Translated Packet

Translated Source:

Destination Interface IP

**1** The values selected for Destination Interface Objects in 'Interface Objects' tab will be used

Translated Port:

- **Original Source**—Click **Add (+)** to add a network object for all IPv4 traffic (0.0.0.0/0).

Figure 69: New Network Object

**Note** You cannot use the system-defined **any-ipv4** object, because Auto NAT rules add NAT as part of the object definition, and you cannot edit system-defined objects.

- **Translated Source**—Choose **Destination Interface IP**.

**Step 7** Click **Save** to add the rule.

The rule is saved to the **Rules** table.

**Step 8** Click **Save** on the **NAT** page to save your changes.

## Allow Traffic from Inside to Outside

If you created a basic **Block all traffic** access control policy when you registered the threat defense, then you need to add rules to the policy to allow traffic through the device. The following procedure adds a rule to allow traffic from the inside zone to the outside zone. If you have other zones, be sure to add rules allowing traffic to the appropriate networks.

### Procedure

**Step 1** Choose **Policy > Access Policy > Access Policy**, and click **Edit** (✎) for the access control policy assigned to the threat defense.

**Step 2** Click **Add Rule**, and set the following parameters:

Figure 70: Add Rule

- **Name**—Name this rule, for example, **inside-to-outside**.
- **Selected Sources**—Select the inside zone from **Zones**, and click **Add Source Zone**.
- **Selected Destinations and Applications**—Select the outside zone from **Zones**, and click **Add Destination Zone**.

Leave the other settings as is.

**Step 3** Click **Apply**.

The rule is added to the **Rules** table.

**Step 4** Click **Save**.

## Configure SSH on the Manager Access Data Interface

If you enabled management center access on a data interface, such as outside, you should enable SSH on that interface using this procedure. This section describes how to enable SSH connections to one or more *data* interfaces on the threat defense. SSH is not supported to the Diagnostic logical interface.



**Note** SSH is enabled by default on the Management interface; however, this screen does not affect Management SSH access.

The Management interface is separate from the other interfaces on the device. It is used to set up and register the device to the management center. SSH for data interfaces shares the internal and external user list with SSH for the Management interface. Other settings are configured separately: for data interfaces, enable SSH and access lists using this screen; SSH traffic for data interfaces uses the regular routing configuration, and not any static routes configured at setup or at the CLI.

For the Management interface, to configure an SSH access list, see the **configure ssh-access-list** command in the [Cisco Secure Firewall Threat Defense Command Reference](#). To configure a static route, see the **configure network static-routes** command. By default, you configure the default route through the Management interface at initial setup.

To use SSH, you do not also need an access rule allowing the host IP address. You only need to configure SSH access according to this section.

You can SSH only to a reachable interface ; if your SSH host is located on the outside interface, you can only initiate a management connection directly to the outside interface.

SSH supports the following ciphers and key exchange:

- Encryption—aes128-cbc, aes192-cbc, aes256-cbc, aes128-ctr, aes192-ctr, aes256-ctr
- Integrity—hmac-sha2-256
- Key exchange—dh-group14-sha256



---

**Note** After you make three consecutive failed attempts to log into the CLI using SSH, the device terminates the SSH connection.

---

### Before you begin

- You can configure SSH internal users at the CLI using the **configure user add** command. By default, there is an **admin** user for which you configured the password during initial setup. You can also configure external users on LDAP or RADIUS by configuring **External Authentication** in platform settings.
- You need network objects that define the hosts or networks you will allow to make SSH connections to the device. You can add objects as part of the procedure, but if you want to use object groups to identify a group of IP addresses, ensure that the groups needed in the rules already exist. Select **Objects > Object Management** to configure objects.



---

**Note** You cannot use the system-provided **any** network object. Instead, use **any-ipv4** or **any-ipv6**.

---

### Procedure

---

**Step 1** Choose **Devices > Platform Settings** and create or edit the threat defense policy.

**Step 2** Select **Secure Shell**.

**Step 3** Identify the interfaces and IP addresses that allow SSH connections.

Use this table to limit which interfaces will accept SSH connections, and the IP addresses of the clients who are allowed to make those connections. You can use network addresses rather than individual IP addresses.

- Click **Add** to add a new rule, or click **Edit** to edit an existing rule.
- Configure the rule properties:
  - **IP Address**—The network object or group that identifies the hosts or networks you are allowing to make SSH connections. Choose an object from the drop-down menu, or click + to add a new network object.
  - **Security Zones**—Add the zones that contain the interfaces to which you will allow SSH connections. For interfaces not in a zone, you can type the interface name into the field below the **Selected Security Zones** list and click **Add**. These rules will be applied to a device only if the device includes the selected interfaces or zones.
- Click **OK**.

**Step 4** Click **Save**.

You can now go to **Deploy > Deployment** and deploy the policy to assigned devices. The changes are not active until you deploy them.

## Deploy the Configuration

Deploy the configuration changes to the threat defense; none of your changes are active on the device until you deploy them.

### Procedure

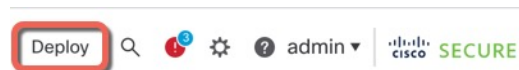
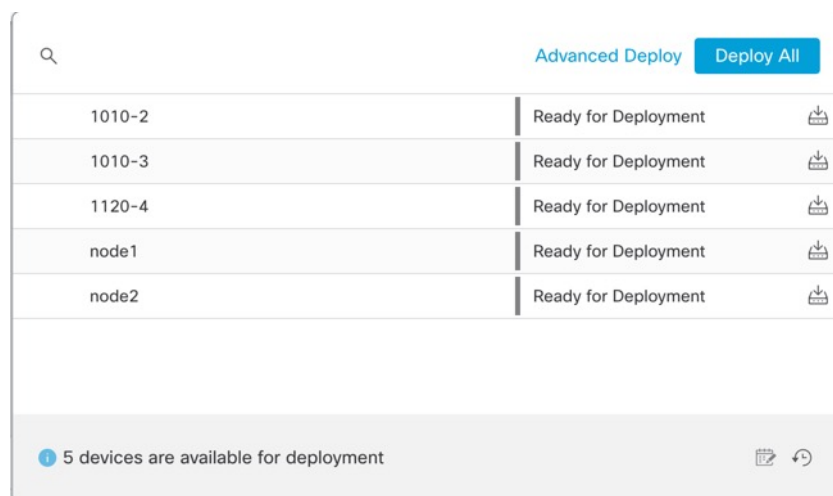
**Step 1** Click **Deploy** in the upper right.**Figure 71: Deploy****Step 2** For a quick deployment, check specific devices and then click **Deploy**, or click **Deploy All** to deploy to all devices. Otherwise, for additional deployment options, click **Advanced Deploy**.**Figure 72: Deploy All****Figure 73: Advanced Deploy**

Device	Modified by	Inspect Interruption	Type	Group	Last Deploy Time	Preview	Status
<input checked="" type="checkbox"/> node1	System		FTD		May 23, 2022 6:49 PM	[Icon]	Ready for Deployment
<input type="checkbox"/> 1010-2	admin, System		FTD		May 23, 2022 7:09 PM	[Icon]	Ready for Deployment
<input type="checkbox"/> node2	System		FTD		May 23, 2022 6:49 PM	[Icon]	Ready for Deployment
<input type="checkbox"/> 1010-3	System		FTD		May 23, 2022 6:49 PM	[Icon]	Ready for Deployment
<input type="checkbox"/> 1120-4	System		FTD		May 23, 2022 6:49 PM	[Icon]	Ready for Deployment

**Step 3** Ensure that the deployment succeeds. Click the icon to the right of the **Deploy** button in the menu bar to see status for deployments.

*Figure 74: Deployment Status*

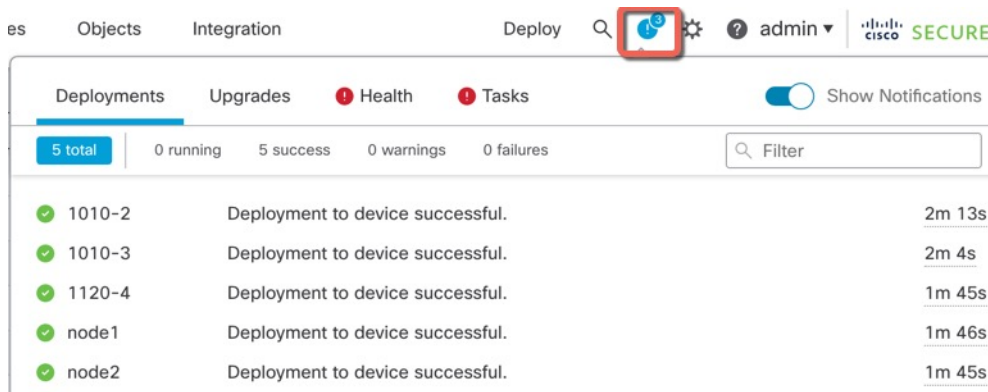

## Access the Threat Defense and FXOS CLI

Use the command-line interface (CLI) to set up the system and do basic system troubleshooting. You cannot configure policies through a CLI session. You can access the CLI by connecting to the console port.

You can also access the FXOS CLI for troubleshooting purposes.



**Note** You can alternatively SSH to the Management interface of the threat defense device. Unlike a console session, the SSH session defaults to the threat defense CLI, from which you can connect to the FXOS CLI using the **connect fxos** command. You can later connect to the address on a data interface if you open the interface for SSH connections. SSH access to data interfaces is disabled by default. This procedure describes console port access, which defaults to the FXOS CLI.

### Procedure

**Step 1** To log into the CLI, connect your management computer to the console port. The Secure Firewall 3100 ships with a DB-9 to RJ-45 serial cable, so you may need to buy a third party DB-9-to-USB serial cable to make the connection. Be sure to install any necessary USB serial drivers for your operating system. The console port defaults to the FXOS CLI. Use the following serial settings:

- 9600 baud
- 8 data bits
- No parity
- 1 stop bit

You connect to the FXOS CLI. Log in to the CLI using the **admin** username and the password you set at initial setup (the default is **Admin123**).

**Example:**

```
firepower login: admin
Password:
Last login: Thu May 16 14:01:03 UTC 2019 on ttyS0
Successful login attempts for user 'admin' : 1

firepower#
```

**Step 2** Access the threat defense CLI.

**connect ftd**

**Example:**

```
firepower# connect ftd
>
```

After logging in, for information on the commands available in the CLI, enter **help** or **?**. For usage information, see [Cisco Secure Firewall Threat Defense Command Reference](#).

**Step 3** To exit the threat defense CLI, enter the **exit** or **logout** command.

This command returns you to the FXOS CLI prompt. For information on the commands available in the FXOS CLI, enter **?**.

**Example:**

```
> exit
firepower#
```

---

## Power Off the Firewall

It's important that you shut down your system properly. Simply unplugging the power or pressing the power switch can cause serious file system damage. Remember that there are many processes running in the background all the time, and unplugging or shutting off the power does not allow the graceful shutdown of your firewall system.

You can power off the device using the management center device management page, or you can use the FXOS CLI.

### Power Off the Firewall Using the Management Center

It's important that you shut down your system properly. Simply unplugging the power or pressing the power switch can cause serious file system damage. Remember that there are many processes running in the background all the time, and unplugging or shutting off the power does not allow the graceful shutdown of your firewall.

You can shut down your system properly using the management center.

### Procedure

---

- Step 1** Choose **Devices > Device Management**.
- Step 2** Next to the device that you want to restart, click **Edit** (✎).
- Step 3** Click the **Device** tab.
- Step 4** Click **Shut Down Device** (⊗) in the **System** section.
- Step 5** When prompted, confirm that you want to shut down the device.
- Step 6** If you have a console connection to the firewall, monitor the system prompts as the firewall shuts down. You will see the following prompt:

```
System is stopped.
It is safe to power off now.
```

```
Do you want to reboot instead? [y/N]
```

If you do not have a console connection, wait approximately 3 minutes to ensure the system has shut down.

- Step 7** You can now turn off the power switch and unplug the power to physically remove power from the chassis if necessary.
- 

## Power Off the Firewall at the CLI

You can use the FXOS CLI to safely shut down the system and power off the device. You access the CLI by connecting to the console port; see [Access the Threat Defense and FXOS CLI, on page 92](#).

### Procedure

---

- Step 1** In the FXOS CLI, connect to local-mgmt:  
firepower # **connect local-mgmt**
  - Step 2** Issue the **shutdown** command:  
firepower(local-mgmt) # **shutdown**  
  
**Example:**  
firepower(local-mgmt)# shutdown  
This command will shutdown the system. Continue?  
Please enter 'YES' or 'NO': yes  
INIT: Stopping Cisco Threat Defense.....ok
  - Step 3** Monitor the system prompts as the firewall shuts down. You will see the following prompt:  
  
System is stopped.  
It is safe to power off now.  
Do you want to reboot instead? [y/N]
  - Step 4** You can now turn off the power switch and unplug the power to physically remove power from the chassis if necessary.
-



## What's Next?

To continue configuring your threat defense, see the documents available for your software version at [Navigating the Cisco Secure Firewall Threat Defense Documentation](#).

For information related to using the management center, see the [Cisco Secure Firewall Management Center Device Configuration Guide](#).





## CHAPTER 4

# Threat Defense Deployment with the Device Manager

---

### Is This Chapter for You?

To see all available applications and managers, see [Which Application and Manager is Right for You?](#), on page 1. This chapter applies to the threat defense with the device manager.

### About the Firewall

The hardware can run either threat defense software or ASA software. Switching between threat defense and ASA requires you to reimage the device. You should also reimage if you need a different software version than is currently installed. See [Cisco Secure Firewall ASA and Secure Firewall Threat Defense Reimage Guide](#).

The firewall runs an underlying operating system called the Secure Firewall eXtensible Operating System (FXOS). The firewall does not support the FXOS Secure Firewall chassis manager; only a limited CLI is supported for troubleshooting purposes. See the [Cisco FXOS Troubleshooting Guide for the Firepower 1000/2100 and Secure Firewall 3100/4200 with Firepower Threat Defense](#) for more information.

**Privacy Collection Statement**—The firewall does not require or actively collect personally identifiable information. However, you can use personally identifiable information in the configuration, for example for usernames. In this case, an administrator might be able to see this information when working with the configuration or when using SNMP.

- [End-to-End Tasks](#), on page 98
- [Review the Network Deployment and Default Configuration](#), on page 99
- [Cable the Firewall](#), on page 101
- [Power on the Firewall](#), on page 102
- [\(Optional\) Check the Software and Install a New Version](#), on page 103
- [\(Optional\) Change Management Network Settings at the CLI](#), on page 105
- [Log Into the Device Manager](#), on page 107
- [Complete the Initial Configuration](#), on page 107
- [Configure Licensing](#), on page 109
- [Configure the Firewall in the Device Manager](#), on page 116
- [Access the Threat Defense and the FXOS CLI](#), on page 119
- [Power Off the Firewall](#), on page 121
- [What's Next?](#), on page 122

# End-to-End Tasks

See the following tasks to deploy the threat defense with the device manager on your chassis.

Figure 75: End-to-End Procedure

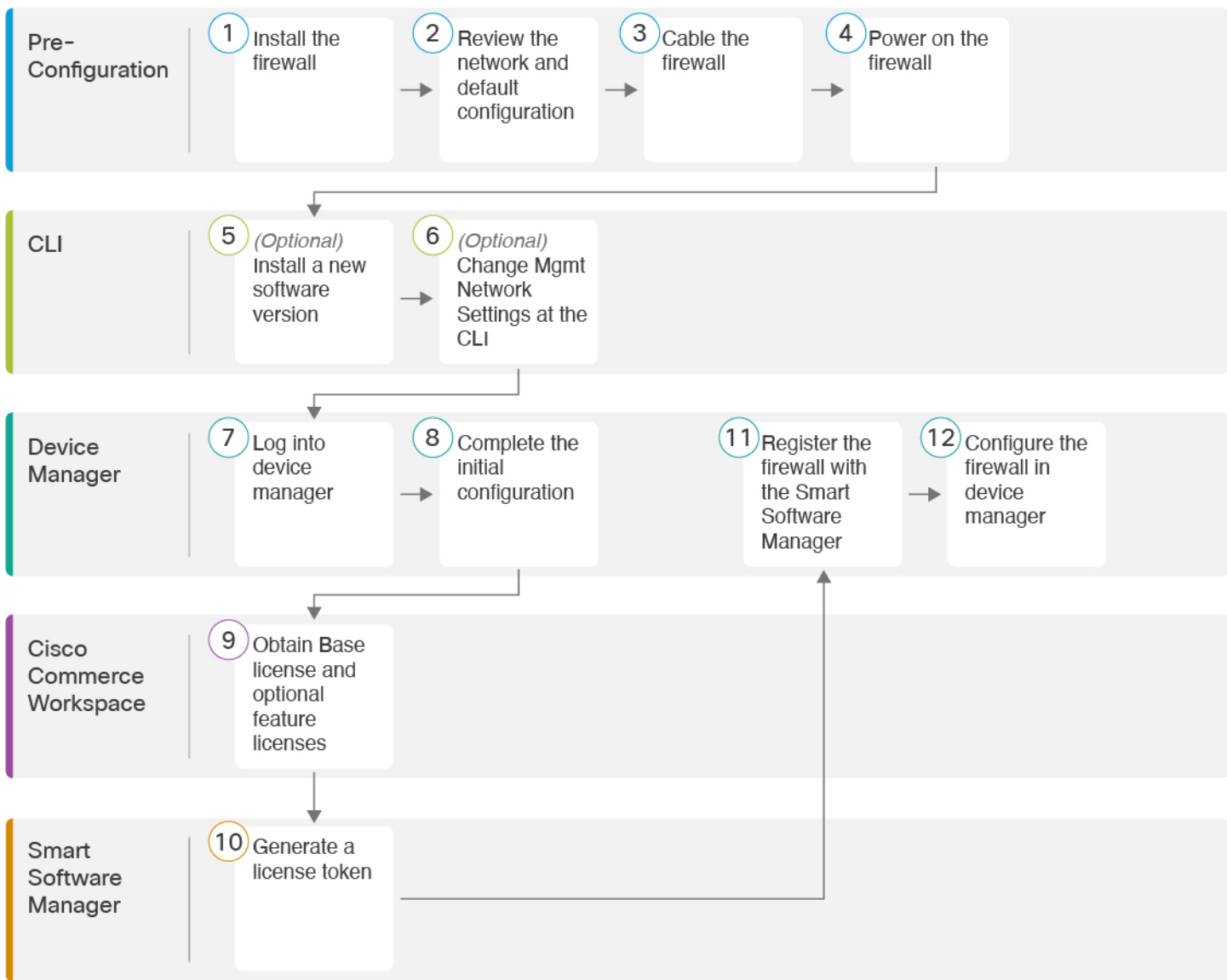

1	Pre-Configuration	Install the firewall. See the <a href="#">hardware installation guide</a> .
2	Pre-Configuration	<a href="#">Review the Network Deployment and Default Configuration, on page 99.</a>
3	Pre-Configuration	<a href="#">Cable the Firewall, on page 101.</a>

4	Pre-Configuration	<a href="#">Power on the Firewall, on page 102.</a>
5	CLI	<a href="#">(Optional) Check the Software and Install a New Version, on page 103.</a>
6	CLI	<a href="#">(Optional) Change Management Network Settings at the CLI, on page 105.</a>
7	Device Manager	<a href="#">Log Into the Device Manager, on page 107.</a>
8	Device Manager	<a href="#">Complete the Initial Configuration, on page 107.</a>
9	Cisco Commerce Workspace	Obtain the Base license and optional feature licenses ( <a href="#">Configure Licensing, on page 109</a> ).
10	Smart Software Manager	Generate a license token ( <a href="#">Configure Licensing, on page 109</a> ).
11	Device Manager	Register the firewall with the Smart Licensing Server ( <a href="#">Configure Licensing, on page 109</a> ).
12	Device Manager	<a href="#">Configure the Firewall in the Device Manager, on page 116.</a>

## Review the Network Deployment and Default Configuration

You can manage the threat defense using the device manager from either the Management 1/1 interface or the inside interface. The dedicated Management interface is a special interface with its own network settings.

The following figure shows the recommended network deployment. If you connect the outside interface directly to a cable modem or DSL modem, we recommend that you put the modem into bridge mode so the threat defense performs all routing and NAT for your inside networks. If you need to configure PPPoE for the outside interface to connect to your ISP, you can do so after you complete initial setup in device manager.



**Note** If you cannot use the default management IP address (for example, your management network does not include a DHCP server), then you can connect to the console port and perform initial setup at the CLI, including setting the Management IP address, gateway, and other basic networking settings.

If you need to change the inside IP address, you can do so after you complete initial setup in the device manager. For example, you may need to change the inside IP address in the following circumstances:

- The inside IP address is 192.168.95.1.
- If you add the threat defense to an existing inside network, you will need to change the inside IP address to be on the existing network.

The following figure shows the default network deployment for the threat defense using the device manager with the default configuration.

**Figure 76: Suggested Network Deployment**

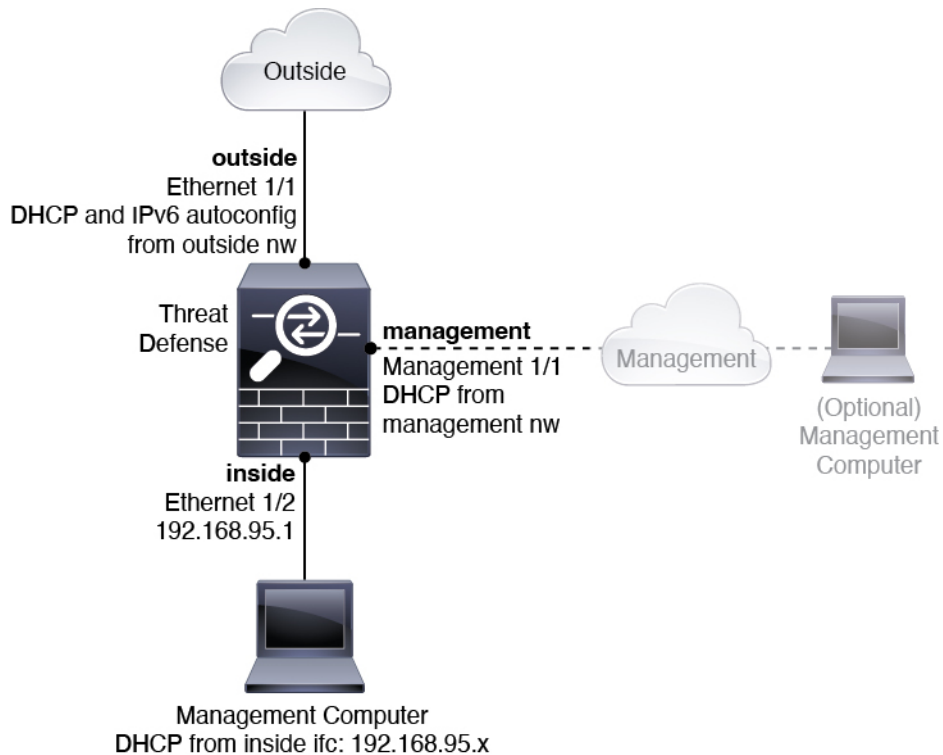

## Default Configuration

The configuration for the firewall after initial setup includes the following:

- **inside**—Ethernet 1/2, IP address 192.168.95.1.
- **outside**—Ethernet 1/1, IP address from IPv4 DHCP and IPv6 autoconfiguration
- **inside**→**outside** traffic flow
- **management**—Management 1/1 (management), IP address from DHCP



**Note** The Management 1/1 interface is a special interface separate from data interfaces that is used for management, Smart Licensing, and database updates. The physical interface is shared with a second logical interface, the Diagnostic interface. Diagnostic is a data interface, but is limited to other types of management traffic (to-the-device and from-the-device), such as syslog or SNMP. The Diagnostic interface is not typically used. See the [Cisco Secure Firewall Device Manager Configuration Guide](#) for more information.

- **DNS server for management**—OpenDNS: (IPv4) 208.67.222.222, 208.67.220.220; (IPv6) 2620:119:35::35, or servers you specify during setup. DNS servers obtained from DHCP are never used.
- **NTP**—Cisco NTP servers: 0.sourcefire.pool.ntp.org, 1.sourcefire.pool.ntp.org, 2.sourcefire.pool.ntp.org, or servers you specify during setup
- **Default routes**
  - **Data interfaces**—Obtained from outside DHCP, or a gateway IP address you specify during setup
  - **Management interface**—Obtained from management DHCP. If you do not receive a gateway, then the default route is over the backplane and through the data interfaces.

Note that the Management interface requires internet access for licensing and updates, either over the backplane or using a separate internet gateway. Note that only traffic originating on the Management interface can go over the backplane; otherwise, Management does not allow through traffic for traffic entering Management from the network.
- **DHCP server**—Enabled on the inside interface
- **Device Manager access**—All hosts allowed on Management and the inside interface.
- **NAT**—Interface PAT for all traffic from inside to outside

## Cable the Firewall

Figure 77: Cabling the Secure Firewall 3100

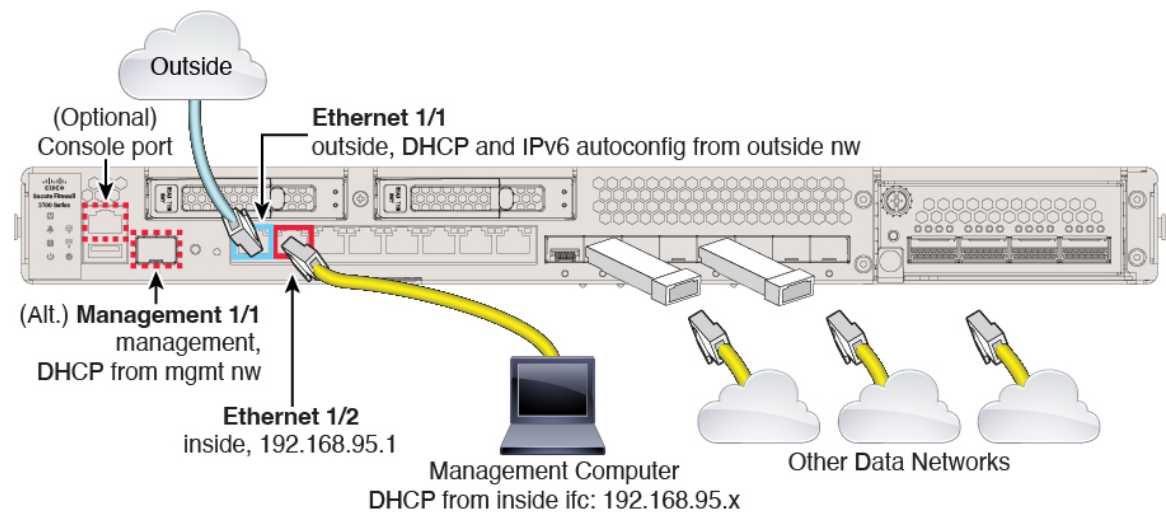

Manage the Secure Firewall 3100 on either Management 1/1 or Ethernet 1/2. The default configuration also configures Ethernet1/1 as outside.

### Before you begin

- (Optional) Install an SFP for the Management port—The Management port is a 1/10-Gb SFP port that requires an SFP module.

- (Optional) Obtain a console adapter—The Secure Firewall 3100 ships with a DB-9 to RJ-45 serial cable, so you may need to buy a third party DB-9-to-USB serial cable to make the connection.

### Procedure

---

**Step 1** Install the chassis. See the [hardware installation guide](#).

**Step 2** Connect your management computer to either of the following interfaces:

- Ethernet 1/2—Connect your management computer directly to Ethernet 1/2 for initial configuration, or connect Ethernet 1/2 to your inside network. Ethernet 1/2 has a default IP address (192.168.95.1) and also runs a DHCP server to provide IP addresses to clients (including the management computer), so make sure these settings do not conflict with any existing inside network settings (see [Default Configuration, on page 100](#)).
- Management 1/1—Connect Management 1/1 to your management network, and make sure your management computer is on—or has access to—the management network. Management 1/1 obtains an IP address from a DHCP server on your management network; if you use this interface, you must determine the IP address assigned to the firewall so that you can connect to the IP address from your management computer.

If you need to change the Management 1/1 IP address from the default to configure a static IP address, you must also cable your management computer to the console port. See [\(Optional\) Check the Software and Install a New Version, on page 103](#).

You can later configure device manager management access from other interfaces; see the [FDM configuration guide](#).

**Step 3** Connect the outside network to the Ethernet1/1 interface.

By default, the IP address is obtained using IPv4 DHCP and IPv6 autoconfiguration, but you can set a static address during initial configuration.

**Step 4** Connect other networks to the remaining interfaces.

---

## Power on the Firewall

System power is controlled by a rocker power switch located on the rear of the firewall. The power switch is implemented as a soft notification switch that supports graceful shutdown of the system to reduce the risk of system software and data corruption.



---

**Note** The first time you boot up the threat defense, initialization can take approximately 15 to 30 minutes.

---

### Before you begin

It's important that you provide reliable power for your firewall (for example, using an uninterruptible power supply (UPS)). Loss of power without first shutting down can cause serious file system damage. There are



many processes running in the background all the time, and losing power does not allow the graceful shutdown of your system.

### Procedure

- 
- Step 1** Attach the power cord to the firewall, and connect it to an electrical outlet.
  - Step 2** Turn the power on using the standard rocker-type power on/off switch located on the rear of the chassis, adjacent to the power cord.
  - Step 3** Check the Power LED on the back of the firewall; if it is solid green, the firewall is powered on.

**Figure 78: System and Power LEDs**

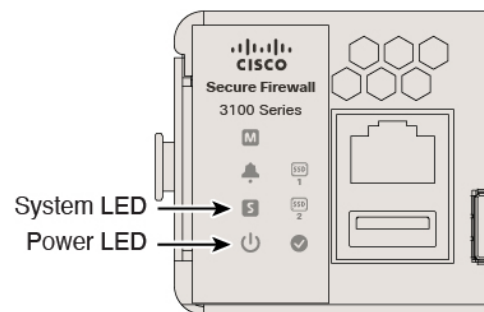

- Step 4** Check the System LED on the back of the firewall; after it is solid green, the system has passed power-on diagnostics.

**Note** When the switch is toggled from ON to OFF, it may take several seconds for the system to eventually power off. During this time, the Power LED on the front of the chassis blinks green. Do not remove the power until the Power LED is completely off.

---

## (Optional) Check the Software and Install a New Version

To check the software version and, if necessary, install a different version, perform these steps. We recommend that you install your target version before you configure the firewall. Alternatively, you can perform an upgrade after you are up and running, but upgrading, which preserves your configuration, may take longer than using this procedure.

### What Version Should I Run?

Cisco recommends running a Gold Star release indicated by a gold star next to the release number on the software download page. You can also refer to the release strategy described in <https://www.cisco.com/c/en/us/products/collateral/security/firewalls/bulletin-c25-743178.html>; for example, this bulletin describes short-term release numbering (with the latest features), long-term release numbering (maintenance releases and patches for a longer period of time), or extra long-term release numbering (maintenance releases and patches for the longest period of time, for government certification).

## Procedure

---

### Step 1

Connect to the console port. See [Access the Threat Defense and the FXOS CLI, on page 119](#) for more information.

Log in with the **admin** user and the default password, **Admin123**.

You connect to the FXOS CLI. The first time you log in, you are prompted to change the password. This password is also used for the threat defense login for SSH.

**Note** If the password was already changed, and you do not know it, you must perform a factory reset to reset the password to the default. See the [FXOS troubleshooting guide](#) for the [factory reset procedure](#).

#### Example:

```
firepower login: admin
Password: Admin123
Successful login attempts for user 'admin' : 1

[...]

Hello admin. You must change your password.
Enter new password: *****
Confirm new password: *****
Your password was updated successfully.

[...]

firepower#
```

### Step 2

At the FXOS CLI, show the running version.

**scope ssa**

**show app-instance**

#### Example:

```
Firepower# scope ssa
Firepower /ssa # show app-instance

Application Name      Slot ID   Admin State   Operational State   Running Version Startup
Version Cluster Oper State
-----
ftd                   1         Enabled       Online               7.6.0.65         7.6.0.65
                        Not Applicable
```

### Step 3

If you want to install a new version, perform these steps.

- a) If you need to set a static IP address for the Management interface, see [\(Optional\) Change Management Network Settings at the CLI, on page 105](#). By default, the Management interface uses DHCP.

You will need to download the new image from a server accessible from the Management interface.

- b) Perform the [reimage procedure](#) in the [FXOS troubleshooting guide](#).

After the firewall reboots, you connect to the FXOS CLI again.

- c) At the FXOS CLI, you are prompted to set the admin password again.

## (Optional) Change Management Network Settings at the CLI

If you cannot use the default management IP address, then you can connect to the console port and perform initial setup at the CLI, including setting the Management IP address, gateway, and other basic networking settings. You can only configure the Management interface settings; you cannot configure inside or outside interfaces, which you can later configure in the GUI.



**Note** You cannot repeat the CLI setup script unless you clear the configuration; for example, by reimaging. However, all of these settings can be changed later at the CLI using **configure network** commands. See [Cisco Secure Firewall Threat Defense Command Reference](#).

### Procedure

**Step 1** Connect to the threat defense console port. See [Access the Threat Defense and the FXOS CLI](#), on page 119 for more information.

Log in with the **admin** user and the default password, **Admin123**.

You connect to the FXOS CLI. The first time you log in, you are prompted to change the password. This password is also used for the threat defense login for SSH.

**Note** If the password was already changed, and you do not know it, you must perform a factory reset to reset the password to the default. See the [FXOS troubleshooting guide](#) for the [factory reset procedure](#).

#### Example:

```
firepower login: admin
Password: Admin123
Successful login attempts for user 'admin' : 1

[...]

Hello admin. You must change your password.
Enter new password: *****
Confirm new password: *****
Your password was updated successfully.

[...]

firepower#
```

**Step 2** Connect to the threat defense CLI.

**connect ftd**

**Example:**

```
firepower# connect ftd
>
```

**Step 3** The first time you log into the threat defense, you are prompted to accept the End User License Agreement (EULA). You are then presented with the CLI setup script.

Defaults or previously-entered values appear in brackets. To accept previously entered values, press **Enter**.

See the following guidelines:

- **Enter the IPv4 default gateway for the management interface**—If you set a manual IP address, enter either **data-interfaces** or the IP address of the gateway router. The **data-interfaces** setting sends outbound management traffic over the backplane to exit a data interface. This setting is useful if you do not have a separate Management network that can access the internet. Traffic originating on the Management interface includes license registration and database updates that require internet access. If you use **data-interfaces**, you can still use the device manager (or SSH) on the Management interface if you are directly-connected to the Management network, but for remote management for specific networks or hosts, you should add a static route using the **configure network static-routes** command. Note that the device manager management on data interfaces is not affected by this setting. If you use DHCP, the system uses the gateway provided by DHCP and uses the **data-interfaces** as a fallback method if DHCP doesn't provide a gateway.
- **If your networking information has changed, you will need to reconnect**—If you are connected with SSH to the default IP address but you change the IP address at initial setup, you will be disconnected. Reconnect with the new IP address and password. Console connections are not affected.
- **Manage the device locally?**—Enter **yes** to use the device manager. A **no** answer means you intend to use the on-premises or cloud-delivered management center to manage the device.

#### Example:

```
You must accept the EULA to continue.
Press <ENTER> to display the EULA:
End User License Agreement
[...]

Please enter 'YES' or press <ENTER> to AGREE to the EULA:

System initialization in progress. Please stand by.
You must configure the network to continue.
You must configure at least one of IPv4 or IPv6.
Do you want to configure IPv4? (y/n) [y]:
Do you want to configure IPv6? (y/n) [n]:
Configure IPv4 via DHCP or manually? (dhcp/manual) [manual]:
Enter an IPv4 address for the management interface [192.168.45.45]: 10.10.10.15
Enter an IPv4 netmask for the management interface [255.255.255.0]: 255.255.255.192
Enter the IPv4 default gateway for the management interface [data-interfaces]: 10.10.10.1
Enter a fully qualified hostname for this system [firepower]: ftd-1.cisco.com
Enter a comma-separated list of DNS servers or 'none' [208.67.222.222,208.67.220.220]:
Enter a comma-separated list of search domains or 'none' []:
If your networking information has changed, you will need to reconnect.
For HTTP Proxy configuration, run 'configure network http-proxy'

Manage the device locally? (yes/no) [yes]: yes

>
```

- Step 4** Log into the device manager on the new Management IP address.
- 

## Log Into the Device Manager

Log into the device manager to configure your threat defense.

### Procedure

---

- Step 1** Enter the following URL in your browser.
- Inside (Ethernet 1/2)—<https://192.168.95.1>.
  - Management—[https://management\\_ip](https://management_ip). The Management interface is a DHCP client, so the IP address depends on your DHCP server. If you changed the Management IP address at the CLI setup, then enter that address.
- Step 2** Log in with the username **admin**, and the default password **Admin123**.
- 

### What to do next

- Run through the device manager setup wizard; see [Complete the Initial Configuration, on page 107](#).

## Complete the Initial Configuration

Use the setup wizard when you first log into the device manager to complete the initial configuration. After you complete the setup wizard, you should have a functioning device with a few basic policies in place:

- An outside (Ethernet1/1) and an inside interface (Ethernet1/2).
- Security zones for the inside and outside interfaces.
- An access rule trusting all inside to outside traffic.
- An interface NAT rule that translates all inside to outside traffic to unique ports on the IP address of the outside interface.
- A DHCP server running on the inside interface.



---

**Note** If you performed any initial setup at the CLI, then some of these tasks, specifically changing the admin password and configuring the outside and management interfaces, should have already been completed.

---

## Procedure

---

**Step 1** You are prompted to read and accept the End User License Agreement and change the admin password. You must complete these steps to continue.

**Step 2** Configure the following options for the outside and management interfaces and click **Next**.

**Note** Your settings are deployed to the device when you click **Next**. The interface will be named “outside” and it will be added to the “outside\_zone” security zone. Ensure that your settings are correct.

a) **Outside Interface**—This is the data port that you connected to your gateway router. You cannot select an alternative outside interface during initial device setup. The first data interface is the default outside interface.

**Configure IPv4**—The IPv4 address for the outside interface. You can use DHCP or manually enter a static IP address, subnet mask, and gateway. You can also select **Off** to not configure an IPv4 address. You cannot configure PPPoE using the setup wizard. PPPoE may be required if the interface is connected to a DSL modem, cable modem, or other connection to your ISP, and your ISP uses PPPoE to provide your IP address. You can configure PPPoE after you complete the wizard.

**Configure IPv6**—The IPv6 address for the outside interface. You can use DHCP or manually enter a static IP address, prefix, and gateway. You can also select **Off** to not configure an IPv6 address.

b) **Management Interface**

**DNS Servers**—The DNS server for the system's management address. Enter one or more addresses of DNS servers for name resolution. The default is the OpenDNS public DNS servers. If you edit the fields and want to return to the default, click **Use OpenDNS** to reload the appropriate IP addresses into the fields.

**Firewall Hostname**—The hostname for the system's management address.

**Step 3** Configure the system time settings and click **Next**.

a) **Time Zone**—Select the time zone for the system.

b) **NTP Time Server**—Select whether to use the default NTP servers or to manually enter the addresses of your NTP servers. You can add multiple servers to provide backups.

**Step 4** (Optional) Configure the smart licenses for the system.

Your purchase of the threat defense device automatically includes a Base license. All additional licenses are optional.

You must have a smart license account to obtain and apply the licenses that the system requires. Initially, you can use the 90-day evaluation license and set up smart licensing later.

To register the device now, click the link to log into your Smart Software Manager account, and see [Configure Licensing, on page 109](#).

To use the evaluation license, select **Start 90 day evaluation period without registration**.

**Step 5** Click **Finish**.

---

### What to do next

- Although you can continue using the evaluation license, we recommend that you register and license your device; see [Configure Licensing, on page 109](#).
- You can also choose to configure the device using the device manager; see [Configure the Firewall in the Device Manager, on page 116](#).

## Configure Licensing

The threat defense uses Smart Software Licensing, which lets you purchase and manage a pool of licenses centrally.

When you register the chassis, the Smart Software Manager issues an ID certificate for communication between the chassis and the Smart Software Manager. It also assigns the chassis to the appropriate virtual account.

For a more detailed overview on Cisco Licensing, go to [cisco.com/go/licensingguide](https://cisco.com/go/licensingguide)

Smart Licensing does not prevent you from using product features that you have not yet purchased. You can start using a license immediately, as long as you are registered with the Smart Software Manager, and purchase the license later. This allows you to deploy and use a feature, and avoid delays due to purchase order approval. See the following licenses:

- **Essentials**—(Required) Essentials license.
- **IPS**—Security Intelligence and Next-Generation IPS
- **Malware Defense**—Malware defense
- **URL Filtering**—URL Filtering
- **Cisco Secure Client**—Secure Client Advantage, Secure Client Premier, or Secure Client VPN Only
- **Carrier**—Diameter, GTP/GPRS, M3UA, SCTP

### Before you begin

- Have an account on the [Smart Software Manager](#).

If you do not yet have an account, click the link to [set up a new account](#). The Smart Software Manager lets you create an account for your organization.

- Your Smart Software Licensing account must qualify for the Strong Encryption (3DES/AES) license to use some features (enabled using the export-compliance flag).

### Procedure

---

**Step 1** Make sure your Smart Licensing account contains the available licenses you need.

When you bought your device from Cisco or a reseller, your licenses should have been linked to your Smart Software License account. However, if you need to add licenses yourself, use the **Search All** field on the [Cisco Commerce Workspace](#).

Figure 79: License Search

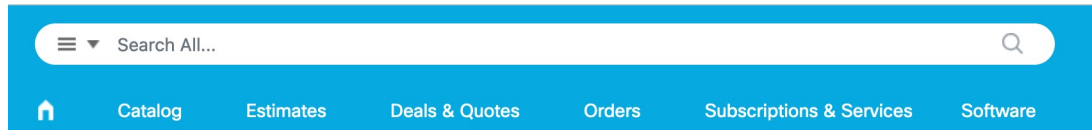

Choose **Products & Services** from the results.

Figure 80: Results

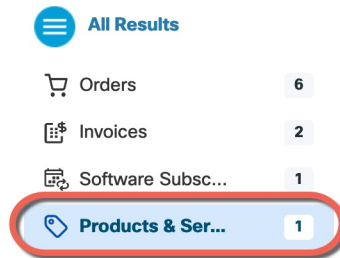

Search for the following license PIDs:

**Note** If a PID is not found, you can add the PID manually to your order.

- Essentials license:
  - L-FPR3110-BSE=
  - L-FPR3120-BSE=
  - L-FPR3130-BSE=
  - L-FPR3140-BSE=
- IPS, Malware Defense, and URL license combination:
  - L-FPR3110T-TMC=
  - L-FPR3120T-TMC=
  - L-FPR3130T-TMC=
  - L-FPR3140T-TMC=

When you add one of the above PIDs to your order, you can then choose a term-based subscription corresponding with one of the following PIDs:

- L-FPR3110T-TMC-1Y
- L-FPR3110T-TMC-3Y
- L-FPR3110T-TMC-5Y
- L-FPR3120T-TMC-1Y
- L-FPR3120T-TMC-3Y
- L-FPR3120T-TMC-5Y



- L-FPR3130T-TMC-1Y
  - L-FPR3130T-TMC-3Y
  - L-FPR3130T-TMC-5Y
  - L-FPR3140T-TMC-1Y
  - L-FPR3140T-TMC-3Y
  - L-FPR3140T-TMC-5Y
- Carrier license:
    - L-FPR3K-FTD-CAR=
  - Cisco Secure Client—See the [Cisco Secure Client Ordering Guide](#).

**Step 2** In the [Smart Software Manager](#), request and copy a registration token for the virtual account to which you want to add this device.

a) Click **Inventory**.



b) On the **General** tab, click **New Token**.

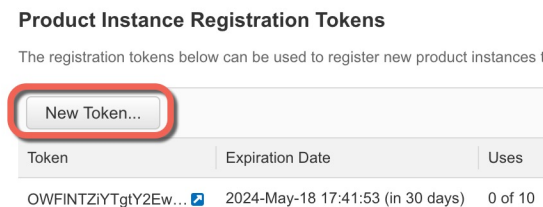

c) On the **Create Registration Token** dialog box enter the following settings, and then click **Create Token**:

### Create Registration Token ? x

This will create a token that is used to register product instances, so that they can use licenses from this virtual account. Once it's created, go to the Smart Licensing configuration for your products and enter the token, to register them with this virtual account.

Virtual Account: XXXXXXXXXX

Description:

\* Expire After:  Days

*Between 1 - 365, 30 days recommended*

Max. Number of Uses:

*The token will be expired when either the expiration or the maximum uses is reached*

Allow export-controlled functionality on the products registered with this token i

- **Description**
- **Expire After**—Cisco recommends 30 days.
- **Max. Number of Uses**
- **Allow export-controlled functionality on the products registered with this token**—Enables the export-compliance flag if you are in a country that allows for strong encryption. You must select this option now if you plan to use this functionality. If you enable this functionality later, you will need to re-register your device with a new product key and reload the device. If you do not see this option, your account does not support export-controlled functionality.

The token is added to your inventory.

- d) Click the arrow icon to the right of the token to open the **Token** dialog box so you can copy the token ID to your clipboard. Keep this token ready for later in the procedure when you need to register the threat defense.

**Figure 81: View Token**

General

Licenses

Product Instances

Event Log

#### Virtual Account

Description: XXXXXXXXXX

Default Virtual Account: No

---

#### Product Instance Registration Tokens

*The registration tokens below can be used to register new product instances to this virtual account.*

Token	Expiration Date	Uses	Export-Controlled
OWFINTZIYTgtY2Ew...	2024-May-18 17:41:53 (in 30 days)	0 of 10	Allowed

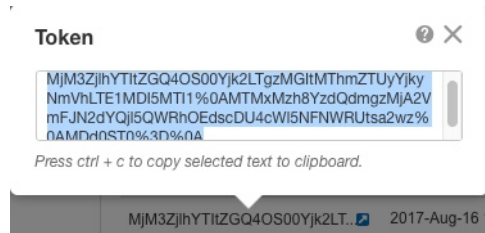
**Figure 82: Copy Token**

- Step 3** In the device manager, click **Device**, and then in the **Smart License** summary, click **View Configuration**. You see the **Smart License** page.
- Step 4** Click **Register Device**.

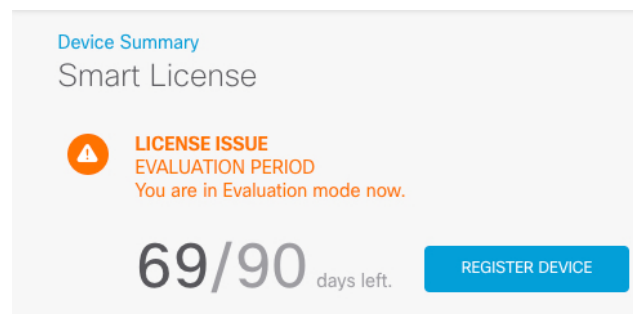

Then follow the instructions on the **Smart License Registration** dialog box to paste in your token:

Smart License Registration
✕

- 1 Create or log in into your [Cisco Smart Software Manager](#) account.
  - 2 On your assigned virtual account, under "General tab", click on "New Token" to create token.
  - 3 Copy the token and paste it here:
 

MGY2NzMwOGIiODJiZi00NzFjLWJiNjltYWwNzU0ODY2ZGVlTE1NlUzNzlv%0AODQ5Mzh8SUQ5Vm5XbzZiSmN5M3l6K3owZ3oyVmpmc3VtalJLQ2FFeGhFWmlW%0AWC9WTT0%3D%0A
  - 4 Select Region
 

When you register the device, you are also registered with Cisco Security Services Exchange (SSE). Please select the region in which your device is operating. You will be able to see your device in the device list of the regional SSE portal.

Region  

SSE US Region
▼
i
  - 5 Cisco Success Network
 

Cisco Success Network enablement provides usage information and statistics to Cisco which are essential for Cisco to provide technical support. This information also allows Cisco to improve the product and to make you aware of unused available features so that you can maximize the value of the product in your network.

Check out the [Sample Data](#) that will be sent to Cisco. [See more](#) ▼

Enable Cisco Success Network

CANCEL
REGISTER DEVICE

**Step 5** Click **Register Device**.

You return to the **Smart License** page. While the device registers, you see the following message:

**Registration request** sent on 10 Jul 2019. Please wait. Normally, it takes about one minute to complete the registration. You can check the task status in [Task List](#). Refresh this page to see the updated status.

After the device successfully registers and you refresh the page, you see the following:

Device Summary

### Smart License

✓

**CONNECTED**  
SUFFICIENT LICENSE

Last sync: 10 Jul 2019 11:39 AM

Next sync: 10 Jul 2019 11:49 AM

i

**Step 6** Click the **Enable/Disable** control for each optional license as desired.

SUBSCRIPTION LICENSES INCLUDED

**IPS** ENABLE

Disabled by user

This License allows you to perform intrusion detection and prevention and file control. You must have this license to apply intrusion policies in access rules. You also must have this license to apply file policies that control files based on file type.

Includes: Intrusion Policy

**Malware Defense** ENABLE

Disabled by user

This license lets you perform malware defense. You must have this license to apply file policies that detect and block malware in files transmitted over your network.

Includes: File Policy

**URL** ENABLE

Disabled by user

This license allows you to control web access based on URL categories and reputations, rather than by individual URL alone. You must have this license to deploy access rules that filter web traffic based on category and reputation.

Includes: URL Reputation

**Cisco Secure Client** Type: Advantage ▾ ENABLE

Disabled by user

Please select the license type that you purchased to enable remote access VPN. Note that Secure Firewall device manager does not support any of the advanced features covered by the Advantage license.

Includes: RA-VPN

- **Enable**—Registers the license with your Cisco Smart Software Manager account and enables the controlled features. You can now configure and deploy policies controlled by the license.
- **Disable**—Unregisters the license with your Cisco Smart Software Manager account and disables the controlled features. You cannot configure the features in new policies, nor can you deploy policies that use the feature.
- If you enabled the **Cisco Secure Client** license, select the type of license you want to use: **Advantage**, **Premier**, **VPN Only**, or **Premier and Advantage**.

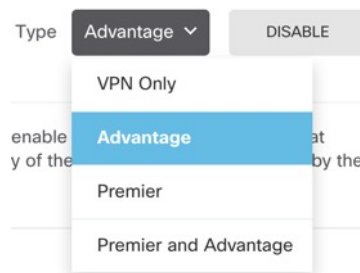

After you enable features, if you do not have the licenses in your account, you will see the following non-compliance message after you refresh the page:

Device Summary

Smart License

**LICENSE ISSUE** Last sync: 10 Jul 2019 11:47 AM

**OUT OF COMPLIANCE** Next sync: 10 Jul 2019 11:57 AM

There is no available license for the device. Licensed features continue to work. However, you must either purchase or free up additional licenses to be in compliance.

[GO TO LICENSE MANAGER](#) [Need help?](#)

- Step 7** Choose **Resync Connection** from the gear drop-down list to synchronize license information with Cisco Smart Software Manager.

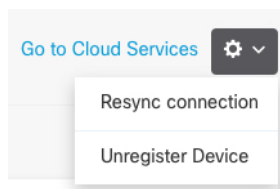

## Configure the Firewall in the Device Manager

The following steps provide an overview of additional features you might want to configure. Please click the help button (?) on a page to get detailed information about each step.

### Procedure

**Step 1** To create 4 x 10-Gb breakout interfaces from a 40-Gb interface (available on some models), choose **Device**, and then click the link in the **Interfaces** summary. Then click the breakout icon for the interface.

If you already used the 40-Gb interface in your configuration, you will have to remove the configuration before you can proceed with the breakout.

**Step 2** If you wired other interfaces, choose **Device**, and then click the link in the **Interfaces** summary.

Click the edit icon (🔧) for each interface to set the mode and define the IP address and other settings.

The following example configures an interface to be used as a “demilitarized zone” (DMZ), where you place publicly-accessible assets such as your web server. Click **Save** when you are finished.

*Figure 83: Edit Interface*

 A screenshot of the "Edit Physical Interface" configuration page. The page has a blue header with the title "Edit Physical Interface". Below the header, there are several fields:
 

- Interface Name:** A text input field containing "dmz".
- Status:** A toggle switch that is currently turned "On" (blue).
- Description:** A large empty text area.
- Navigation tabs:** Three tabs are visible: "IPv4 Address" (selected), "IPv6 Address", and "Advanced Options".
- Type:** A dropdown menu set to "Static".
- IP Address and Subnet Mask:** Two input fields. The first contains "192.168.6.1" and the second contains "24". Below these fields is a small example text: "e.g. 192.168.5.15/17 or 192.168.5.15/255.255.128.0".

**Step 3** If you configured new interfaces, choose **Objects**, then select **Security Zones** from the table of contents.

Edit or create new zones as appropriate. Each interface must belong to a zone, because you configure policies based on security zones, not interfaces. You cannot put the interfaces in zones when configuring them, so you must always edit the zone objects after creating new interfaces or changing the purpose of existing interfaces.

The following example shows how to create a new dmz-zone for the dmz interface.

**Figure 84: Security Zone Object**

The screenshot shows the 'Add Security Zone' configuration page. It features a blue header with the text 'Add Security Zone'. Below the header, there are three main sections: 'Name' with a text input field containing 'dmz-zone', 'Description' with an empty text area, and 'Interfaces' with a '+' button and a list containing the 'dmz' interface.

**Step 4** If you want internal clients to use DHCP to obtain an IP address from the device, choose **Device > System Settings > DHCP Server**, then select the **DHCP Servers** tab.

There is already a DHCP server configured for the inside interface, but you can edit the address pool or even delete it. If you configured other inside interfaces, it is very typical to set up a DHCP server on those interfaces. Click + to configure the server and address pool for each inside interface.

You can also fine-tune the WINS and DNS list supplied to clients on the **Configuration** tab. The following example shows how to set up a DHCP server on the inside2 interface with the address pool 192.168.4.50-192.168.4.240.

**Figure 85: DHCP Server**

The screenshot shows the 'Add Server' configuration page. It features a blue header with the text 'Add Server'. Below the header, there is a toggle switch for 'Enabled DHCP Server' which is turned on. Below that are three main sections: 'Interface' with a text input field containing 'inside2', 'Address Pool' with a text input field containing '192.168.4.50-192.168.4.240', and a smaller example 'e.g. 192.168.45.46-192.168.45.254'.

**Step 5** Choose **Device**, then click **View Configuration** (or **Create First Static Route**) in the **Routing** group and configure a default route.

The default route normally points to the upstream or ISP router that resides off the outside interface. A default IPv4 route is for any-ipv4 (0.0.0.0/0), whereas a default IPv6 route is for any-ipv6 (:::0/0). Create routes for each IP version you use. If you use DHCP to obtain an address for the outside interface, you might already have the default routes that you need.

**Note** The routes you define on this page are for the data interfaces only. They do not impact the management interface. Set the management gateway on **Device > System Settings > Management Interface**.

The following example shows a default route for IPv4. In this example, `isp-gateway` is a network object that identifies the IP address of the ISP gateway (you must obtain the address from your ISP). You can create this object by clicking **Create New Network** at the bottom of the **Gateway** drop-down list.

**Figure 86: Default Route**

The screenshot shows the 'Add Static Route' configuration page. It has a blue header with the text 'Add Static Route'. Below the header, there are several sections:

- Protocol:** Two radio buttons are present: 'IPv4' (which is selected) and 'IPv6'.
- Gateway:** A text input field containing the value 'isp-gateway'.
- Interface:** A text input field containing the value 'outside'.
- Metric:** A text input field containing the value '1'.
- Networks:** A section with a '+' icon and a list item 'any-ipv4'.

**Step 6** Choose **Policies** and configure the security policies for the network.

The device setup wizard enables traffic flow between the inside-zone and outside-zone, and interface NAT for all interfaces when going to the outside interface. Even if you configure new interfaces, if you add them to the inside-zone object, the access control rule automatically applies to them.

However, if you have multiple inside interfaces, you need an access control rule to allow traffic flow from inside-zone to inside-zone. If you add other security zones, you need rules to allow traffic to and from those zones. These would be your minimum changes.

In addition, you can configure other policies to provide additional services, and fine-tune NAT and access rules to get the results that your organization requires. You can configure the following policies:

- **SSL Decryption**—If you want to inspect encrypted connections (such as HTTPS) for intrusions, malware, and so forth, you must decrypt the connections. Use the SSL decryption policy to determine which connections need to be decrypted. The system re-encrypts the connection after inspecting it.
- **Identity**—If you want to correlate network activity to individual users, or control network access based on user or user group membership, use the identity policy to determine the user associated with a given source IP address.
- **Security Intelligence**—Use the Security Intelligence policy to quickly drop connections from or to blacklisted IP addresses or URLs. By blacklisting known bad sites, you do not need to account for them in your access control policy. Cisco provides regularly updated feeds of known bad addresses and URLs so that the Security Intelligence blacklist updates dynamically. Using feeds, you do not need to edit the policy to add or remove items in the blacklist.



- **NAT (Network Address Translation)**—Use the NAT policy to convert internal IP addresses to externally routeable addresses.
- **Access Control**—Use the access control policy to determine which connections are allowed on the network. You can filter by security zone, IP address, protocol, port, application, URL, user or user group. You also apply intrusion and file (malware) policies using access control rules. Use this policy to implement URL filtering.
- **Intrusion**—Use the intrusion policies to inspect for known threats. Although you apply intrusion policies using access control rules, you can edit the intrusion policies to selectively enable or disable specific intrusion rules.

The following example shows how to allow traffic between the inside-zone and dmz-zone in the access control policy. In this example, no options are set on any of the other tabs except for **Logging**, where **At End of Connection** is selected.

**Figure 87: Access Control Policy**

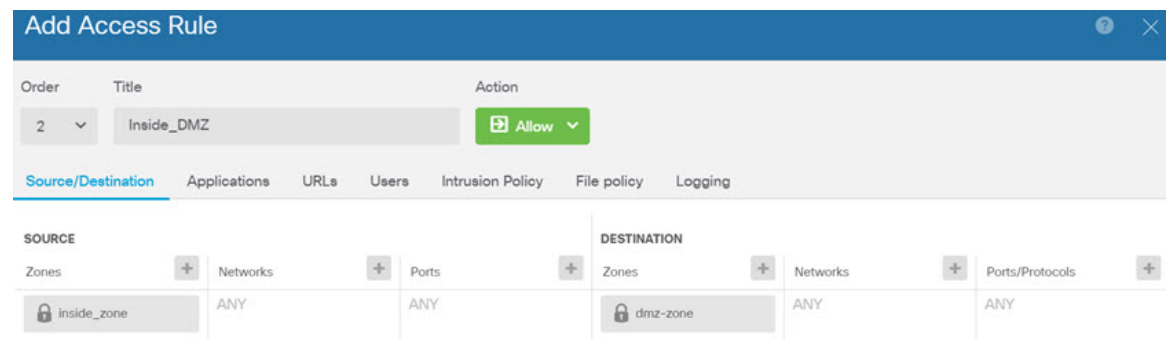

- Step 7** Choose **Device**, then click **View Configuration** in the **Updates** group and configure the update schedules for the system databases.

If you are using intrusion policies, set up regular updates for the Rules and VDB databases. If you use Security Intelligence feeds, set an update schedule for them. If you use geolocation in any security policies as matching criteria, set an update schedule for that database.

- Step 8** Click the **Deploy** button in the menu, then click the Deploy Now button (  ), to deploy your changes to the device.

Changes are not active on the device until you deploy them.

## Access the Threat Defense and the FXOS CLI

Use the command-line interface (CLI) to set up the system and do basic system troubleshooting. You cannot configure policies through a CLI session. You can access the CLI by connecting to the console port.

You can also access the FXOS CLI for troubleshooting purposes.



**Note** You can alternatively SSH to the Management interface of the threat defense device. Unlike a console session, the SSH session defaults to the threat defense CLI, from which you can connect to the FXOS CLI using the **connect fxos** command. You can later connect to the address on a data interface if you open the interface for SSH connections. SSH access to data interfaces is disabled by default. This procedure describes console port access, which defaults to the FXOS CLI.

## Procedure

**Step 1** To log into the CLI, connect your management computer to the console port. The Secure Firewall 3100 ships with a DB-9 to RJ-45 serial cable, so you may need to buy a third party DB-9-to-USB serial cable to make the connection. Be sure to install any necessary USB serial drivers for your operating system. The console port defaults to the FXOS CLI. Use the following serial settings:

- 9600 baud
- 8 data bits
- No parity
- 1 stop bit

You connect to the FXOS CLI. Log in to the CLI using the **admin** username and the password you set at initial setup (the default is **Admin123**).

### Example:

```
firepower login: admin
Password:
Last login: Thu May 16 14:01:03 UTC 2019 on ttyS0
Successful login attempts for user 'admin' : 1

firepower#
```

**Step 2** Access the threat defense CLI.

### connect ftd

### Example:

```
firepower# connect ftd
>
```

After logging in, for information on the commands available in the CLI, enter **help** or **?**. For usage information, see [Cisco Secure Firewall Threat Defense Command Reference](#).

**Step 3** To exit the threat defense CLI, enter the **exit** or **logout** command.

This command returns you to the FXOS CLI prompt. For information on the commands available in the FXOS CLI, enter **?**.

### Example:

```
> exit
firepower#
```

---

## Power Off the Firewall

It's important that you shut down your system properly. Simply unplugging the power or pressing the power switch can cause serious file system damage. Remember that there are many processes running in the background all the time, and unplugging or shutting off the power does not allow the graceful shutdown of your firewall system.

You can power off the firewall using device manager, or you can use the FXOS CLI.

## Power Off the Firewall Using the Device Manager

Shut down your system properly using the device manager.

### Procedure

---

- Step 1** Use the device manager to shut down the firewall.
- Click **Device**, then click the **System Settings > Reboot/Shutdown** link.
  - Click **Shut Down**.
- Step 2** If you have a console connection to the firewall, monitor the system prompts as the firewall shuts down. You will see the following prompt:
- ```
System is stopped.
It is safe to power off now.

Do you want to reboot instead? [y/N]
```
- If you do not have a console connection, wait approximately 3 minutes to ensure the system has shut down.
- Step 3** You can now turn off the power switch and unplug the power to physically remove power from the chassis if necessary.
- 

## Power Off the Firewall at the CLI

You can use the FXOS CLI to safely shut down the system and power off the firewall. You access the CLI by connecting to the console port; see [Access the Threat Defense and the FXOS CLI, on page 119](#).

### Procedure

---

- Step 1** In the FXOS CLI, connect to local-mgmt:

```
firepower # connect local-mgmt
```

**Step 2** Issue the **shutdown** command:

```
firepower(local-mgmt) # shutdown
```

**Example:**

```
firepower(local-mgmt) # shutdown
This command will shutdown the system. Continue?
Please enter 'YES' or 'NO': yes
INIT: Stopping Cisco Threat Defense.....ok
```

**Step 3** Monitor the system prompts as the firewall shuts down. You will see the following prompt:

```
System is stopped.
It is safe to power off now.
Do you want to reboot instead? [y/N]
```

**Step 4** You can now turn off the power switch and unplug the power to physically remove power from the chassis if necessary.

---

## What's Next?

To continue configuring your threat defense, see the documents available for your software version at [Navigating the Cisco Firepower Documentation](#).

For information related to using the device manager, see [Cisco Firepower Threat Defense Configuration Guide for Firepower Device Manager](#).



## CHAPTER 5

# Threat Defense Deployment with CDO

### Is This Chapter for You?

To see all available applications and managers, see [Which Application and Manager is Right for You?](#), on [page 1](#). This chapter applies to the threat defense using Cisco Defense Orchestrator (CDO)'s cloud-delivered Firewall Management Center.



---

**Note** CDO supports threat defense 7.2 and later.

---

### About the Firewall

The hardware can run either threat defense software or ASA software. Switching between threat defense and ASA requires you to reimage the device. You should also reimage if you need a different software version than is currently installed. See [Cisco Secure Firewall ASA and Secure Firewall Threat Defense Reimage Guide](#).

The firewall runs an underlying operating system called the Secure Firewall eXtensible Operating System (FXOS). The firewall does not support the FXOS Secure Firewall chassis manager; only a limited CLI is supported for troubleshooting purposes. See the [Cisco FXOS Troubleshooting Guide for the Firepower 1000/2100 and Secure Firewall 3100/4200 with Firepower Threat Defense](#) for more information.

**Privacy Collection Statement**—The firewall does not require or actively collect personally identifiable information. However, you can use personally identifiable information in the configuration, for example for usernames. In this case, an administrator might be able to see this information when working with the configuration or when using SNMP.

- [About Threat Defense Management by CDO](#), on page 124
- [End-to-End Tasks: Zero-Touch Provisioning](#), on page 125
- [End-to-End Tasks: Onboarding Wizard](#), on page 127
- [Central Administrator Pre-Configuration](#), on page 128
- [Deploy the Firewall With Low-Touch Provisioning](#), on page 132
- [Deploy the Firewall With the Onboarding Wizard](#), on page 138
- [Configure a Basic Security Policy](#), on page 152
- [Access the Threat Defense and FXOS CLI](#), on page 165
- [Power Off the Firewall](#), on page 166
- [What's Next](#), on page 168

# About Threat Defense Management by CDO

## About the Cloud-delivered Firewall Management Center

The cloud-delivered Firewall Management Center offers many of the same functions as an on-premises management center and has the same look and feel. When you use CDO as the primary manager, you can use an on-prem management center for analytics only. The on-prem management center does not support policy configuration or upgrading.

## CDO Onboarding Methods

Use one of the following methods to onboard a device.

### Zero-Touch Provisioning

- Send the threat defense to the remote branch office. Do not configure anything on the device, because zero-touch provisioning may not work with pre-configured devices.



---

**Note** You can preregister the threat defense on CDO using the threat defense serial number before sending the device to the branch office.

---

- At the branch office, cable and power on the threat defense.
- Finish onboarding the threat defense using CDO.

### Manual Provisioning

Use the manual onboarding wizard and CLI registration if you need to perform any pre-configuration or if you are using a manager interface that zero-touch provisioning does not support.

## Threat Defense Manager Access Interface

This guide covers **outside** interface access because it is the most likely scenario for remote branch offices. Although manager access occurs on the outside interface, the dedicated Management interface is still relevant. The Management interface is a special interface configured separately from the threat defense data interfaces, and it has its own network settings.

- The Management interface network settings are still used even though you are enabling manager access on a data interface.
- All management traffic continues to be sourced from or destined to the Management interface.
- When you enable manager access on a data interface, the threat defense forwards incoming management traffic over the backplane to the Management interface.
- For outgoing management traffic, the Management interface forwards the traffic over the backplane to the data interface.

Manager access from a data interface has the following limitations:

- You can only enable manager access on a physical, data interface. You cannot use a subinterface or EtherChannel. You can also use the management center to enable manager access on a single secondary interface for redundancy.
- This interface cannot be management-only.
- Routed firewall mode only, using a routed interface.
- PPPoE is not supported. If your ISP requires PPPoE, you will have to put a router with PPPoE support between the threat defense and the WAN modem.
- The interface must be in the global VRF only.
- SSH is not enabled by default for data interfaces, so you will have to enable SSH later using the management center. Because the Management interface gateway will be changed to be the data interfaces, you also cannot SSH to the Management interface from a remote network unless you add a static route for the Management interface using the **configure network static-routes** command.
- Clustering is not supported. You must use the Management interface in this case.
- High availability is not supported. You must use the Management interface in this case.

## End-to-End Tasks: Zero-Touch Provisioning

See the following tasks to deploy the threat defense with CDO using zero-touch provisioning.

Figure 88: End-to-End Procedure: Zero-Touch Provisioning

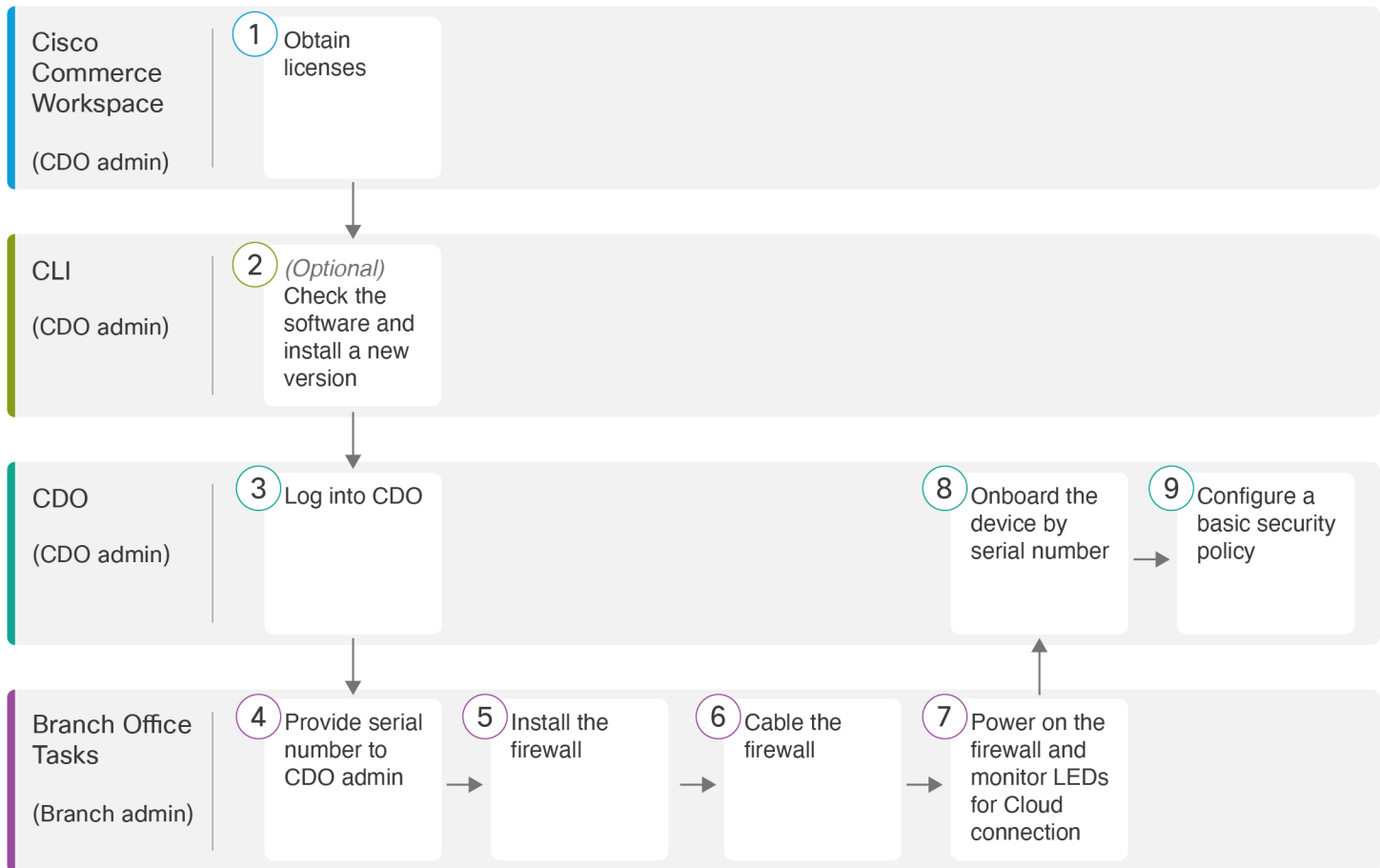

|   |                                         |                                                                                               |
|---|-----------------------------------------|-----------------------------------------------------------------------------------------------|
| 1 | Cisco Commerce Workspace<br>(CDO admin) | <a href="#">Obtain Licenses, on page 128.</a>                                                 |
| 2 | CLI<br>(CDO admin)                      | <a href="#">(Optional) Check the Software and Install a New Version, on page 130.</a>         |
| 3 | CDO<br>(CDO admin)                      | <a href="#">Log Into CDO, on page 132.</a>                                                    |
| 4 | Branch Office Tasks<br>(Branch admin)   | <a href="#">Provide the Firewall Serial Number to the Central Administrator, on page 132.</a> |
| 5 | Branch Office Tasks<br>(Branch admin)   | Install the firewall. See the <a href="#">hardware installation guide</a> .                   |
| 6 | Branch Office Tasks<br>(Branch admin)   | <a href="#">Cable the Firewall, on page 133.</a>                                              |



|   |                                       |                                                                             |
|---|---------------------------------------|-----------------------------------------------------------------------------|
| 7 | Branch Office Tasks<br>(Branch admin) | <a href="#">Power On the Firewall, on page 134.</a>                         |
| 8 | CDO<br>(CDO admin)                    | <a href="#">Onboard a Device with Zero-Touch Provisioning, on page 135.</a> |
| 9 | CDO<br>(CDO admin)                    | <a href="#">Configure a Basic Security Policy, on page 152.</a>             |

## End-to-End Tasks: Onboarding Wizard

See the following tasks to onboard the threat defense to CDO using the onboarding wizard.

Figure 89: End-to-End Procedure: Onboarding Wizard

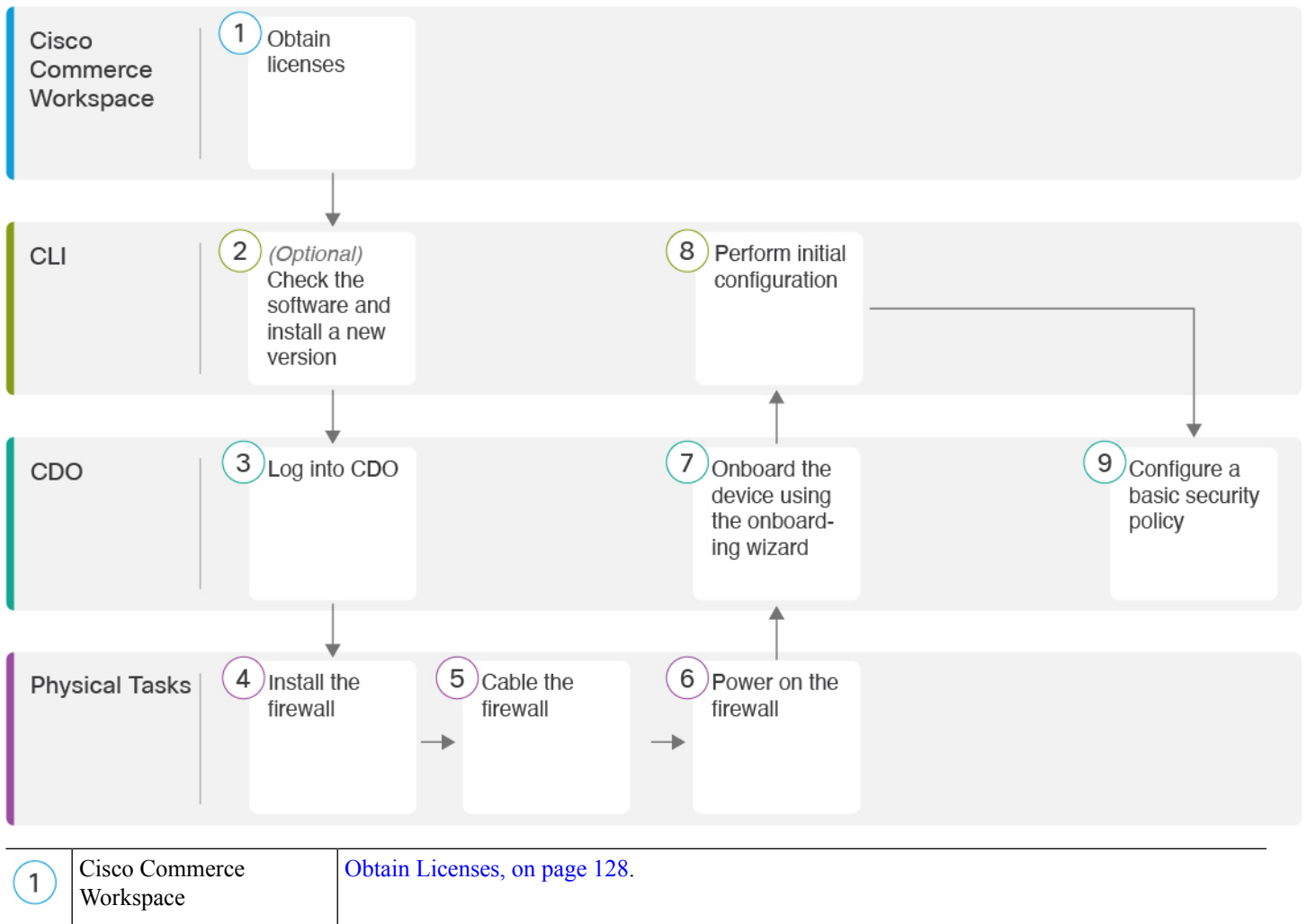

|   |                       |                                                                                                                                                                                                                               |
|---|-----------------------|-------------------------------------------------------------------------------------------------------------------------------------------------------------------------------------------------------------------------------|
| 2 | CLI                   | (Optional) <a href="#">Check the Software and Install a New Version</a> , on page 130.                                                                                                                                        |
| 3 | CDO                   | <a href="#">Log Into CDO</a> , on page 132.                                                                                                                                                                                   |
| 4 | Physical Tasks        | Install the firewall. See the <a href="#">hardware installation guide</a> .                                                                                                                                                   |
| 5 | Physical Tasks        | <a href="#">Cable the Firewall</a> , on page 138.                                                                                                                                                                             |
| 6 | Physical Tasks        | <a href="#">Power on the Firewall</a> , on page 139.                                                                                                                                                                          |
| 7 | CDO                   | <a href="#">Onboard a Device with the Onboarding Wizard</a> , on page 140.                                                                                                                                                    |
| 8 | CLI or Device Manager | <ul style="list-style-type: none"> <li>• <a href="#">Perform Initial Configuration Using the CLI</a>, on page 143.</li> <li>• <a href="#">Perform Initial Configuration Using the Device Manager</a>, on page 147.</li> </ul> |
| 9 | CDO                   | <a href="#">Configure a Basic Security Policy</a> , on page 152.                                                                                                                                                              |

## Central Administrator Pre-Configuration

This section describes how to obtain feature licenses for your firewall; how to install a new software version before you deploy; and how to log into CDO.

### Obtain Licenses

All licenses are supplied to the threat defense by CDO. You can optionally purchase the following feature licenses:

- **Essentials**—(Required) Essentials license.
- **IPS**—Security Intelligence and Next-Generation IPS
- **Malware Defense**—Malware defense
- **URL Filtering**—URL Filtering
- **Cisco Secure Client**—Secure Client Advantage, Secure Client Premier, or Secure Client VPN Only
- **Carrier**—Diameter, GTP/GPRS, M3UA, SCTP

For a more detailed overview on Cisco Licensing, go to [cisco.com/go/licensingguide](https://cisco.com/go/licensingguide)

#### Before you begin

- Have an account on the [Smart Software Manager](#).

If you do not yet have an account, click the link to [set up a new account](#). The Smart Software Manager lets you create an account for your organization.

- Your Smart Software Licensing account must qualify for the Strong Encryption (3DES/AES) license to use some features (enabled using the export-compliance flag).

## Procedure

**Step 1** Make sure your Smart Licensing account contains the available licenses you need.

When you bought your device from Cisco or a reseller, your licenses should have been linked to your Smart Software License account. However, if you need to add licenses yourself, use the **Search All** field on the [Cisco Commerce Workspace](#).

*Figure 90: License Search*

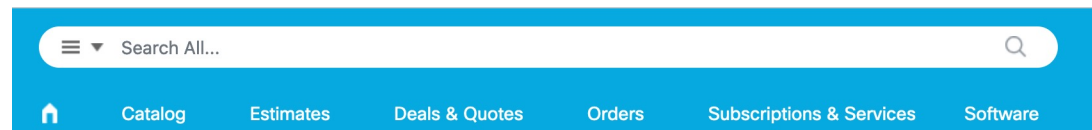

Choose **Products & Services** from the results.

*Figure 91: Results*

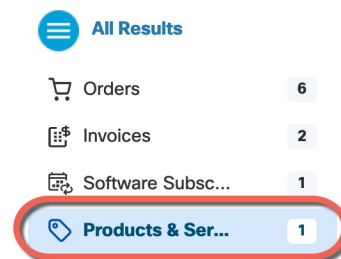

Search for the following license PIDs:

**Note** If a PID is not found, you can add the PID manually to your order.

- Essentials license:
  - L-FPR3110-BSE=
  - L-FPR3120-BSE=
  - L-FPR3130-BSE=
  - L-FPR3140-BSE=
- IPS, Malware Defense, and URL license combination:
  - L-FPR3110T-TMC=
  - L-FPR3120T-TMC=

- L-FPR3130T-TMC=
- L-FPR3140T-TMC=

When you add one of the above PIDs to your order, you can then choose a term-based subscription corresponding with one of the following PIDs:

- L-FPR3110T-TMC-1Y
- L-FPR3110T-TMC-3Y
- L-FPR3110T-TMC-5Y
- L-FPR3120T-TMC-1Y
- L-FPR3120T-TMC-3Y
- L-FPR3120T-TMC-5Y
- L-FPR3130T-TMC-1Y
- L-FPR3130T-TMC-3Y
- L-FPR3130T-TMC-5Y
- L-FPR3140T-TMC-1Y
- L-FPR3140T-TMC-3Y
- L-FPR3140T-TMC-5Y
- Carrier license:
  - L-FPR3K-FTD-CAR=
- Cisco Secure Client—See the [Cisco Secure Client Ordering Guide](#).

**Step 2** If you have not already done so, register CDO with the Smart Software Manager.

Registering requires you to generate a registration token in the Smart Software Manager. See the CDO documentation for detailed instructions.

---

## **(Optional) Check the Software and Install a New Version**

To check the software version and, if necessary, install a different version, perform these steps. We recommend that you install your target version before you configure the firewall. Alternatively, you can perform an upgrade after you are up and running, but upgrading, which preserves your configuration, may take longer than using this procedure.

### **What Version Should I Run?**

Cisco recommends running a Gold Star release indicated by a gold star next to the release number on the software download page. You can also refer to the release strategy described in <https://www.cisco.com/c/en/us/products/collateral/security/firewalls/bulletin-c25-743178.html>; for example, this bulletin describes short-term release numbering (with the latest features), long-term release numbering (maintenance releases and patches

for a longer period of time), or extra long-term release numbering (maintenance releases and patches for the longest period of time, for government certification).

## Procedure

**Step 1** Power on the firewall and connect to the console port. See [Power on the Firewall, on page 139](#) and [Access the Threat Defense and FXOS CLI, on page 165](#) for more information.

Log in with the **admin** user and the default password, **Admin123**.

You connect to the FXOS CLI. The first time you log in, you are prompted to change the password. This password is also used for the threat defense login for SSH.

**Note** If the password was already changed, and you do not know it, you must perform a factory reset to reset the password to the default. See the [FXOS troubleshooting guide](#) for the [factory reset procedure](#).

### Example:

```
firepower login: admin
Password: Admin123
Successful login attempts for user 'admin' : 1

[...]

Hello admin. You must change your password.
Enter new password: *****
Confirm new password: *****
Your password was updated successfully.

[...]

firepower#
```

**Step 2** At the FXOS CLI, show the running version.

```
scope ssa
```

```
show app-instance
```

### Example:

```
Firepower# scope ssa
Firepower /ssa # show app-instance

Application Name      Slot ID   Admin State   Operational State   Running Version Startup
  Version Cluster Oper State
-----
ftd                   1         Enabled       Online               7.6.0.65           7.6.0.65
                        Not Applicable
```

**Step 3** If you want to install a new version, perform these steps.

a) If you need to set a static IP address for the Management interface, see [Perform Initial Configuration Using the CLI, on page 143](#). By default, the Management interface uses DHCP.

You will need to download the new image from a server accessible from the Management interface.

- b) Perform the [reimage procedure](#) in the [FXOS troubleshooting guide](#).  
After the firewall reboots, you connect to the FXOS CLI again.
  - c) At the FXOS CLI, you are prompted to set the admin password again.  
For zero-touch provisioning, when you onboard the device, for the **Password Reset** area, be sure to choose **No...** because you already set the password.
  - d) Shut down the device. See [Power Off the Firewall at the CLI, on page 167](#).
- 

## Log Into CDO

For details on creating a CDO tenant and logging in, see the CDO documentation:  
<https://docs.defenseorchestrator.com>.

## Deploy the Firewall With Low-Touch Provisioning

After you receive the threat defense from central headquarters, you only need to cable and power on the firewall so that it has internet access from the outside interface. The central administrator can then complete the configuration.

## Provide the Firewall Serial Number to the Central Administrator

Before you rack the firewall or discard the shipping box, record the serial number so you can coordinate with the central administrator.

### Procedure

---

- Step 1** Unpack the chassis and chassis components.  
Take inventory of your firewall and packaging before you connect any cables or power on the firewall. You should also familiarize yourself with the chassis layout, components, and LEDs.
  - Step 2** Record the firewall's serial number.  
The serial number of the firewall can be found on the shipping box. It can also be found on a sticker on a pull-out tab on the front of the firewall.
  - Step 3** Send the firewall serial number to the CDO network administrator at your IT department/central headquarters.  
Your network administrator needs your firewall serial number to facilitate low-touch provisioning, connect to the firewall, and configure it remotely.  
Communicate with the CDO administrator to develop an onboarding timeline.
-

## Cable the Firewall

Connect the Secure Firewall 3100 so that it can be managed by CDO.

If you received a firewall at your branch office, and your job is to plug it in to your network, [watch this video](#). The video describes your firewall and the LED sequences on the firewall that indicate the firewall's status. If you need to, you'll be able to confirm the firewall's status with your IT department just by looking at the LEDs.

**Figure 92: Cabling the Secure Firewall 3100**

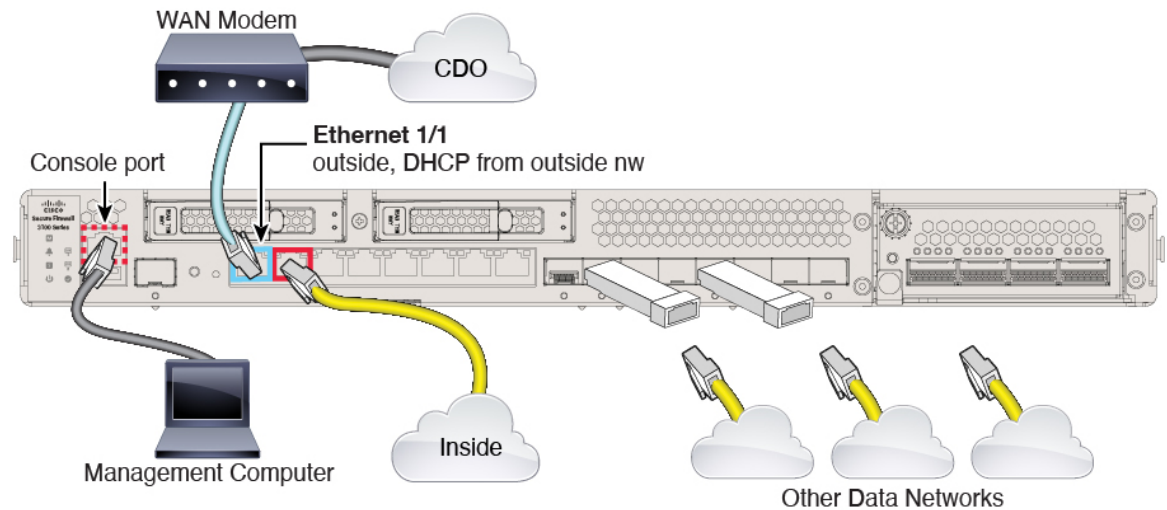

### Before you begin

(Optional) Obtain a console adapter—The Secure Firewall 3100 ships with a DB-9 to RJ-45 serial cable, so you may need to buy a third party DB-9-to-USB serial cable to make the connection.

### Procedure

- 
- Step 1** Install the chassis. See the [hardware installation guide](#).
  - Step 2** Connect the network cable from the Ethernet 1/1 interface to your wide area network (WAN) modem. Your WAN modem is your branch's connection to the internet and will be your firewall's route to the internet as well.
  - Step 3** Connect the inside interface (for example, Ethernet 1/2) to your inside switch or router.  
You can choose any interface for inside.
  - Step 4** Connect other networks to the remaining interfaces.
  - Step 5** (Optional) Connect the management computer to the console port.

At the branch office, the console connection is not required for everyday use; however, it may be required for troubleshooting purposes.

---

## Power On the Firewall

System power is controlled by a rocker power switch located on the rear of the firewall. The power switch is implemented as a soft notification switch that supports graceful shutdown of the system to reduce the risk of system software and data corruption.



**Note** The first time you boot up the threat defense, initialization can take approximately 15 to 30 minutes.

### Before you begin

It's important that you provide reliable power for your firewall (for example, using an uninterruptable power supply (UPS)). Loss of power without first shutting down can cause serious file system damage. There are many processes running in the background all the time, and losing power does not allow the graceful shutdown of your system.

### Procedure

- Step 1** Attach the power cord to the firewall, and connect it to an electrical outlet.
- Step 2** Turn the power on using the standard rocker-type power on/off switch located on the rear of the chassis, adjacent to the power cord.
- Step 3** Check the Power LED on the back of the firewall; if it is solid green, the firewall is powered on.

*Figure 93: Managed, Power, and System LEDs*

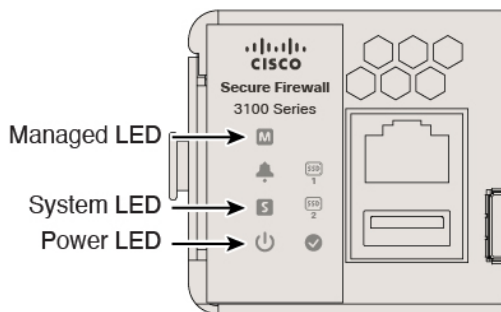

- Step 4** Check the System LED on the back of the firewall; after it is solid green, the system has passed power-on diagnostics.

**Note** When the switch is toggled from ON to OFF, it may take several seconds for the system to eventually power off. During this time, the Power LED on the front of the chassis blinks green. Do not remove the power until the Power LED is completely off.

- Step 5** Check the Managed LED on the back of the firewall; when the firewall connects to the Cisco cloud, the Managed LED slowly flashes green.

If there is a problem, the Managed LED flashes amber and green to indicate that the firewall did not reach the Cisco Cloud. If you see this pattern, make sure that your network cable is connected to the Ethernet 1/1



interface and to your WAN modem. If after adjusting the network cable, the firewall does not reach the Cisco cloud after approximately 10 more minutes, call your IT department.

### What to do next

- Communicate with your IT department to confirm your onboarding timeline and activities. You should have a communication plan in place with the CDO administrator at your central headquarters.
- After you complete this task, your CDO administrator will be able to configure and manage the firewall remotely. You're done.

## Onboard a Device with Zero-Touch Provisioning

Onboard the threat defense using zero-touch provisioning and the device serial number.

### Procedure

**Step 1** In the CDO navigation pane, click **Inventory**, then click the blue plus button (  ) to **Onboard** a device.

**Step 2** Select the **FTD** tile.

**Step 3** Under **Management Mode**, be sure **FTD** is selected.



At any point after selecting **FTD** as the management mode, you can click **Manage Smart License** to enroll in or modify the existing smart licenses available for your device. See [Obtain Licenses, on page 128](#) to see which licenses are available.

**Step 4** Select **Use Serial Number** as the onboarding method.

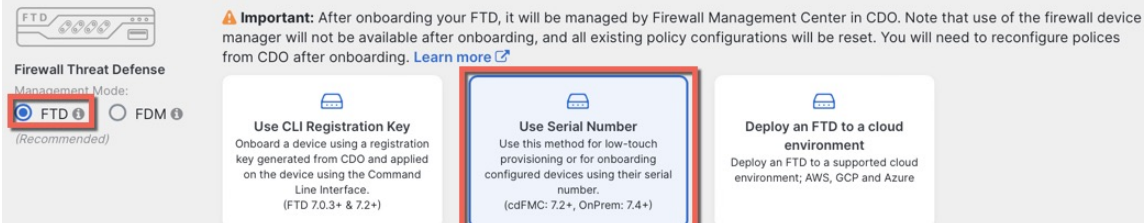
*Figure 94: Use Serial Number*



**Important:** After onboarding your FTD, it will be managed by Firewall Management Center in CDO. Note that use of the firewall device manager will not be available after onboarding, and all existing policy configurations will be reset. You will need to reconfigure policies from CDO after onboarding. [Learn more](#)

Firewall Threat Defense  
Management Mode:  
 **FTD**   FDM   
*(Recommended)*

**Use CLI Registration Key**  
Onboard a device using a registration key generated from CDO and applied on the device using the Command Line Interface.  
(FTD 7.0.3+ & 7.2+)

**Use Serial Number**  
Use this method for low-touch provisioning or for onboarding configured devices using their serial number.  
(cdFMC: 7.2+, OnPrem: 7.4+)

**Deploy an FTD to a cloud environment**  
Deploy an FTD to a supported cloud environment; AWS, GCP and Azure

**Step 5** In **Select FMC**, choose the **Cloud-Delivered FMC > Firewall Management Center** from the list, and click **Next**.

Figure 95: Select FMC

1 Select FMC For more details, [Click Here](#)

Select

**Cloud-Delivered FMC**

Firepower Management Center (Recommended)

**On-Prem FMCs (7.4+)**

FMC-Securex-Onboarding-1654149835633

FMC-Securex-Onboarding-1658238180734

FMC-Securex-Onboarding-1681247022490

FMC-Securex-Onboarding-1681762232392

FMC-Securex-Onboarding-1681830086235

Boulder FMC 740-48 1543

[+ Onboard On-Prem FMC](#)

2 Connection

3 Password Reset

4 Policy Assignment

5 Subscription License

6 Done

**Step 6** In the **Connection** area, enter the **Device Serial Number** and the **Device Name** and then click **Next**.

Figure 96: Connection

2 Connection

Device Serial Number

JAD253802GB

Device Name

fp-1010-1

**Next**

**i** Enter the serial number of the FTD device you want to onboard, then CDO will attempt to connect to the device.

**Important:** Only FTD 1000, 2100 or 3100 series devices (running on software version 7.4 or later) are supported.

**Step 7** In **Password Reset**, click **Yes...** Enter a new password and confirm the new password for the device, then click **Next**.

For low-touch provisioning, the device must be brand new or has been reimaged.

**Note** If you did log into the device and reset the password, and you did not change the configuration in a way that would disable low-touch provisioning, then you should choose the **No...** option. There are a number of configurations that disable low-touch provisioning, so we don't recommend logging into the device unless you need to, for example, to perform a reimage.

Figure 97: Password Reset

3 Password Reset

1 Please review all the prerequisites for onboarding with a serial number. [Learn more](#)

2 Is this a new device that has never been logged into or configured for a manager?

Yes, this new device has never been logged into or configured for a manager

Enter a new password for devices that have never been configured for a manager.

**Important:** If you select this option and the device's default password has already been changed, onboarding fails.

New Password

Confirm Password

No, this device has been logged into and configured for a manager

Use this option if you already changed the password in the device CLI.

**Important:** If you select this option and the device's default password has not been changed, onboarding fails.

**Next**

**1** Password must:

- Be 8-128 characters
- Have at least one lower and one upper case letter
- Have at least one digit
- Have at least one special character.
- Not contain consecutive repeated letters

**Step 8**

For the **Policy Assignment**, use the drop-down menu to choose an access control policy for the device. If you have no policies configured, choose the **Default Access Control Policy**.

Figure 98: Policy Assignment

4 Policy Assignment

Access Control Policy

Default Access Control Policy ▾

**Next**

**Step 9**

For the **Subscription License**, check each of the feature licenses you want to enable. Click **Next**.

Figure 99: Subscription License

5 Subscription License

| License Type                                                         | Includes                       |
|----------------------------------------------------------------------|--------------------------------|
| <input checked="" type="checkbox"/> Essentials                       | Base Firewall Capabilities     |
| <input checked="" type="checkbox"/> Carrier (7.3+ FTDs only)         | GTP/GPRS, Diameter, SCTP, M3UA |
| <input checked="" type="checkbox"/> IPS                              | Intrusion Policy               |
| <input checked="" type="checkbox"/> Malware Defense                  | File Policy                    |
| <input checked="" type="checkbox"/> URL                              | URL Reputation                 |
| <input type="checkbox"/> RA VPN <input type="text" value="VPNOnly"/> | RA VPN                         |

**Next**

**1** Enable subscription licenses. CDO will attempt to enable the selected licenses when the device is connected to CDO and registered with the supplied Smart License. Learn more about [Cisco Smart Accounts](#).

**Step 10** (Optional) Add labels to your device to help sort and filter the **Inventory** page. Enter a label and select the blue plus button (+). Labels are applied to the device after it's onboarded to CDO.

*Figure 100: Done*

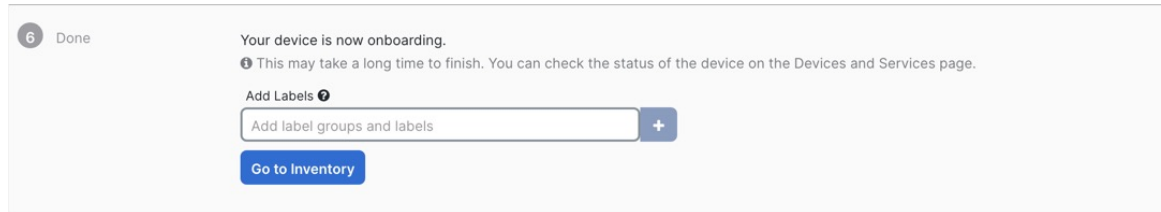

### What to do next

From the **Inventory** page, select the device you just onboarded and select any of the option listed under the **Management** pane located to the right.

## Deploy the Firewall With the Onboarding Wizard

This section describes how to configure the firewall for onboarding using the CDO onboarding wizard.

### Cable the Firewall

Connect the Secure Firewall 3100 so that it can be managed by CDO.

*Figure 101: Cabling the Secure Firewall 3100*

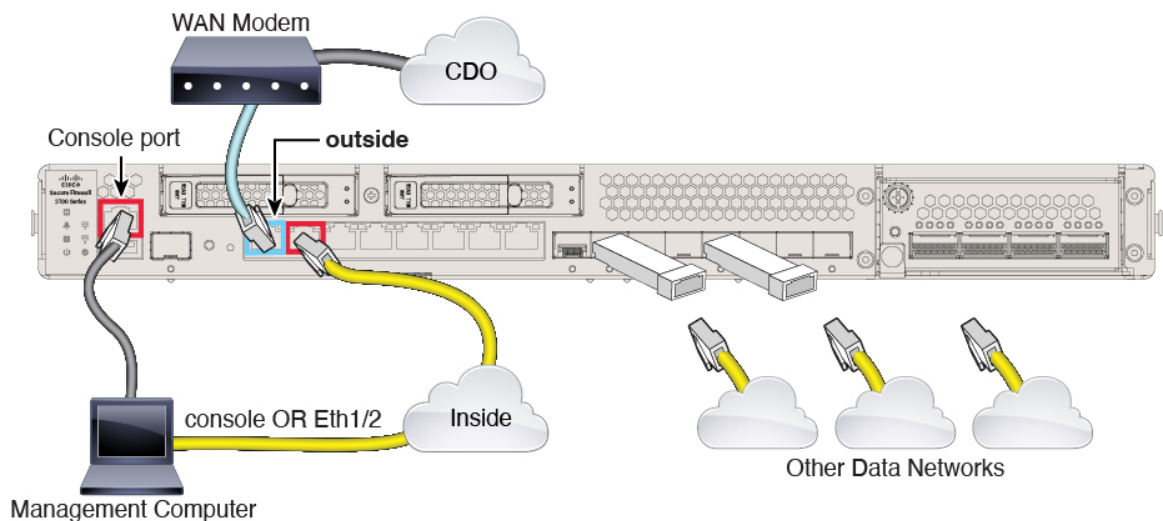

### Before you begin

Obtain a console adapter—The Secure Firewall 3100 ships with a DB-9 to RJ-45 serial cable, so you may need to buy a third party DB-9-to-USB serial cable to make the connection.

### Procedure

---

- Step 1** Install the chassis. See the [hardware installation guide](#).
- Step 2** Connect the outside interface (for example, Ethernet 1/1) to your outside router.
- Step 3** Connect the inside interface (for example, Ethernet 1/2) to your inside switch or router.
- Step 4** Connect other networks to the remaining interfaces.
- Step 5** Connect the management computer to the console port or the Ethernet 1/2 interface.

If you perform initial setup using the CLI, you will need to connect to the console port. The console port may also be required for troubleshooting purposes. If you perform initial setup using the device manager, connect to the Ethernet 1/2 interface.

---

## Power on the Firewall

System power is controlled by a rocker power switch located on the rear of the firewall. The power switch is implemented as a soft notification switch that supports graceful shutdown of the system to reduce the risk of system software and data corruption.



---

**Note** The first time you boot up the threat defense, initialization can take approximately 15 to 30 minutes.

---

### Before you begin

It's important that you provide reliable power for your firewall (for example, using an uninterruptible power supply (UPS)). Loss of power without first shutting down can cause serious file system damage. There are many processes running in the background all the time, and losing power does not allow the graceful shutdown of your system.

### Procedure

---

- Step 1** Attach the power cord to the firewall, and connect it to an electrical outlet.
- Step 2** Turn the power on using the standard rocker-type power on/off switch located on the rear of the chassis, adjacent to the power cord.
- Step 3** Check the Power LED on the back of the firewall; if it is solid green, the firewall is powered on.

Figure 102: System and Power LEDs

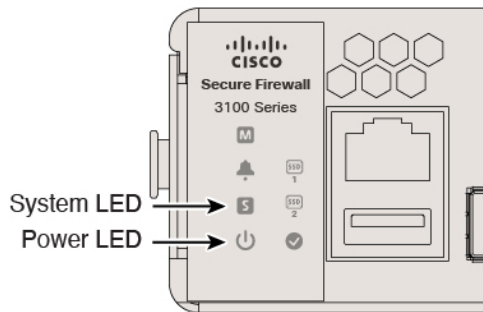

**Step 4** Check the System LED on the back of the firewall; after it is solid green, the system has passed power-on diagnostics.

**Note** When the switch is toggled from ON to OFF, it may take several seconds for the system to eventually power off. During this time, the Power LED on the front of the chassis blinks green. Do not remove the power until the Power LED is completely off.

## Onboard a Device with the Onboarding Wizard

Onboard the threat defense using CDO's onboarding wizard using a CLI registration key.

### Procedure

**Step 1** In the CDO navigation pane, click **Inventory**, then click the blue plus button (  ) to **Onboard** a device.

**Step 2** Click the **FTD** tile.

**Step 3** Under **Management Mode**, be sure **FTD** is selected.

At any point after selecting **FTD** as the management mode, you can click **Manage Smart License** to enroll in or modify the existing smart licenses available for your device. See [Obtain Licenses, on page 128](#) to see which licenses are available.

**Step 4** Select **Use CLI Registration Key** as the onboarding method.

Figure 103: Use CLI Registration Key

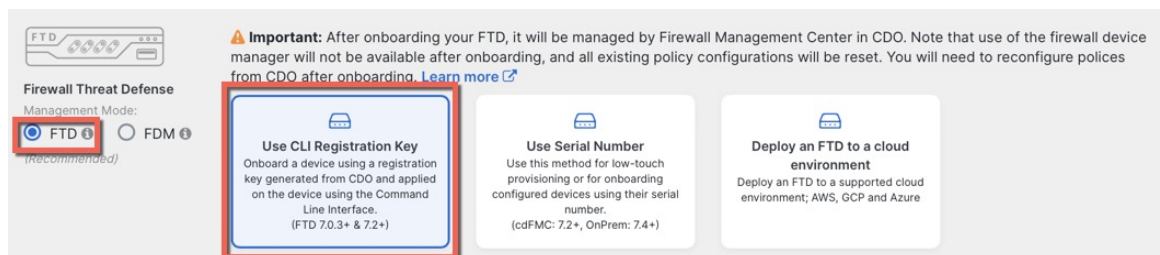

**Step 5** Enter the **Device Name** and click **Next**.

*Figure 104: Device Name*

1 Device Name

Device Name

ftd1

Next

**Step 6** For the **Policy Assignment**, use the drop-down menu to choose an access control policy for the device. If you have no policies configured, choose the **Default Access Control Policy**.

*Figure 105: Access Control Policy*

2 Policy Assignment

Access Control Policy

Default Access Control Policy ▾

Next

**Step 7** For the **Subscription License**, click the **Physical FTD Device** radio button, and then check each of the feature licenses you want to enable. Click **Next**.

*Figure 106: Subscription License*

3 Subscription License

Please indicate if this FTD is physical or virtual:

Physical FTD Device

Virtual FTD Device

| License Type                                                      | Includes                       |
|-------------------------------------------------------------------|--------------------------------|
| <input checked="" type="checkbox"/> Essentials                    | Base Firewall Capabilities     |
| <input checked="" type="checkbox"/> Carrier (7.3+ FTDs only)      | GTP/GPRS, Diameter, SCTP, M3UA |
| <input checked="" type="checkbox"/> IPS                           | Intrusion Policy               |
| <input checked="" type="checkbox"/> Malware Defense               | File Policy                    |
| <input checked="" type="checkbox"/> URL                           | URL Reputation                 |
| <input checked="" type="checkbox"/> RA VPN <span>Premier ▾</span> | RA VPN                         |

Next

**Step 8** For the **CLI Registration Key**, CDO generates a command with the registration key and other parameters. You must copy this command and use it in the initial configuration of the threat defense.

Figure 107: CLI Registration Key

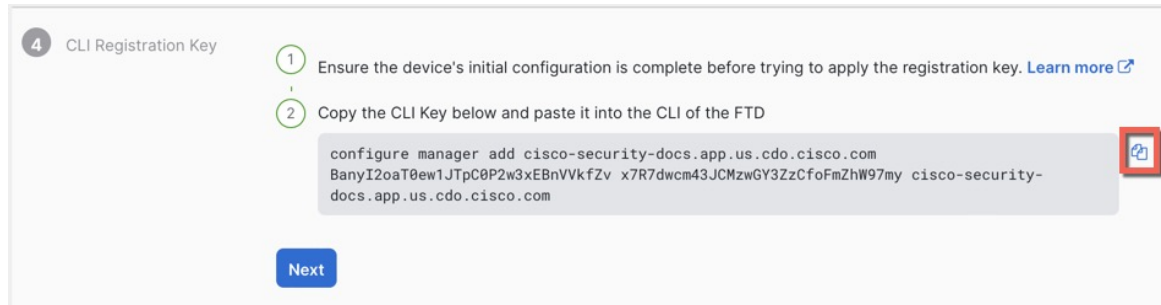

**configure manager add** *cdo\_hostname registration\_key nat\_id display\_name*

Complete initial configuration at the CLI or using the device manager:

- [Perform Initial Configuration Using the CLI, on page 143](#)—Copy this command at the threat defense CLI after you complete the startup script.
- [Perform Initial Configuration Using the Device Manager, on page 147](#)—Copy the *cdo\_hostname*, *registration\_key*, and *nat\_id* parts of the command into the **Management Center/CDO Hostname/IP Address**, **Management Center/CDO Registration Key**, and **NAT ID** fields.

#### Example:

Sample command for CLI setup:

```
configure manager add account1.app.us.cdo.cisco.com KPOOP0rgWzaHrnj1V5ha2q5Rf8pKFX9E
Lzm1HOynhVUWhXYWz2swmkj2ZWsn3Lb account1.app.us.cdo.cisco.com
```

Sample command components for GUI setup:

Figure 108: configure manager add command components

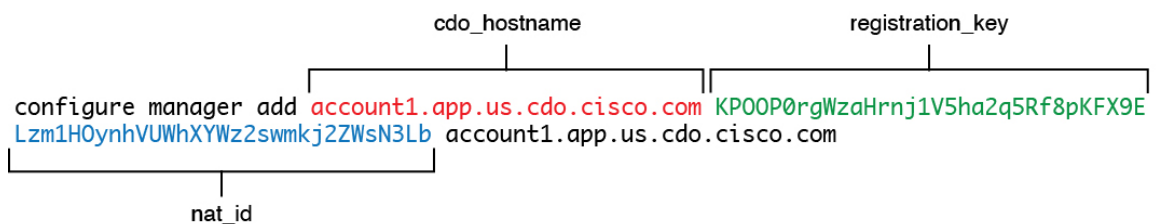

**Step 9** Click **Next** in the onboarding wizard to start registering the device.

**Step 10** (Optional) Add labels to your device to help sort and filter the **Inventory** page. Enter a label and select the blue plus button () . Labels are applied to the device after it's onboarded to CDO.



Figure 109: Done

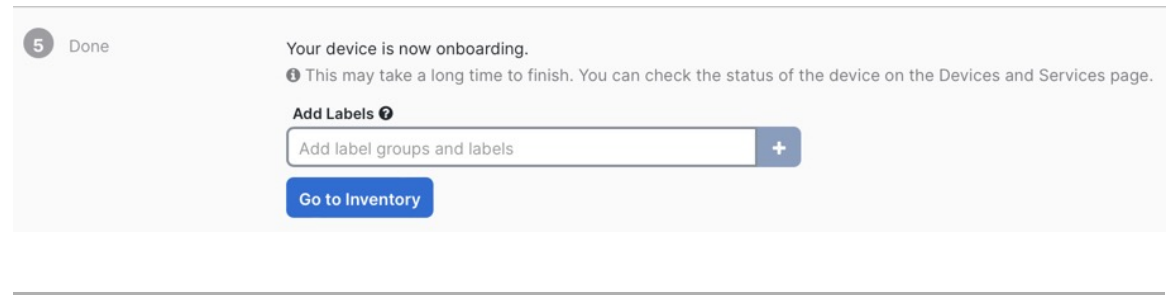

### What to do next

From the **Inventory** page, select the device you just onboarded and select any of the option listed under the **Management** pane located to the right.

## Perform Initial Configuration

Perform initial configuration of the threat defense using the CLI or using the device manager.

### Perform Initial Configuration Using the CLI

Connect to the threat defense CLI to perform initial setup. When you use the CLI for initial configuration, only the Management interface and manager access interface settings are retained. When you perform initial setup using the device manager, *all* interface configuration completed in the device manager is retained when you switch to CDO for management, in addition to the Management interface and manager access interface settings. Note that other default configuration settings, such as the access control policy, are not retained.

#### Procedure

**Step 1** Connect to the threat defense CLI on the console port.

The console port connects to the FXOS CLI.

**Step 2** Log in with the username **admin** and the password **Admin123**.

The first time you log in to FXOS, you are prompted to change the password. This password is also used for the threat defense login for SSH.

**Note** If the password was already changed, and you do not know it, then you must reimage the device to reset the password to the default. See the [FXOS troubleshooting guide](#) for the [reimage procedure](#).

#### Example:

```
firepower login: admin
Password: Admin123
Successful login attempts for user 'admin' : 1

[...]

Hello admin. You must change your password.
Enter new password: *****
```

```
Confirm new password: *****
Your password was updated successfully.
```

```
[...]
```

```
firepower#
```

**Step 3** Connect to the threat defense CLI.

**connect ftd**

**Example:**

```
firepower# connect ftd
>
```

**Step 4** The first time you log in to the threat defense, you are prompted to accept the End User License Agreement (EULA). You are then presented with the CLI setup script for the Management interface settings.

The Management interface settings are used even though you are enabling manager access on a data interface.

**Note** You cannot repeat the CLI setup wizard unless you clear the configuration; for example, by reimaging. However, all of these settings can be changed later at the CLI using **configure network** commands. See [Cisco Secure Firewall Threat Defense Command Reference](#).

Defaults or previously entered values appear in brackets. To accept previously entered values, press **Enter**.

See the following guidelines:

- **Do you want to configure IPv4?** and/or **Do you want to configure IPv6?**—Enter **y** for at least one of these types of addresses. Although you do not plan to use the Management interface, you must set an IP address, for example, a private address.
- **Configure IPv4 via DHCP or manually?** and/or **Configure IPv6 via DHCP, router, or manually?**—Choose **manual**. You cannot configure a data interface for management if the management interface is set to DHCP, because the default route, which must be **data-interfaces** (see the next bullet), might be overwritten with one received from the DHCP server.
- **Enter the IPv4 default gateway for the management interface** and/or **Enter the IPv6 gateway for the management interface**—Set the gateway to be **data-interfaces**. This setting forwards management traffic over the backplane so it can be routed through the manager access data interface.
- **Manage the device locally?**—Enter **no** to use CDO. A **yes** answer means you will use the device manager instead.
- **Configure firewall mode?**—Enter **routed**. Outside manager access is only supported in routed firewall mode.

**Example:**

```
You must accept the EULA to continue.
Press <ENTER> to display the EULA:
End User License Agreement
[...]
```

```
System initialization in progress. Please stand by.
You must configure the network to continue.
Configure at least one of IPv4 or IPv6 unless managing via data interfaces.
```

```

Do you want to configure IPv4? (y/n) [y]:
Do you want to configure IPv6? (y/n) [y]: n
Configure IPv4 via DHCP or manually? (dhcp/manual) [manual]:
Enter an IPv4 address for the management interface [192.168.45.61]: 10.89.5.17
Enter an IPv4 netmask for the management interface [255.255.255.0]: 255.255.255.192
Enter the IPv4 default gateway for the management interface [data-interfaces]:
Enter a fully qualified hostname for this system [firepower]: 1010-3
Enter a comma-separated list of DNS servers or 'none'
[208.67.222.222,208.67.220.220,2620:119:35::35]:
Enter a comma-separated list of search domains or 'none' []: cisco.com
If your networking information has changed, you will need to reconnect.
Disabling IPv6 configuration: management0
Setting DNS servers: 208.67.222.222,208.67.220.220,2620:119:35::35
Setting DNS domains:cisco.com
Setting hostname as 1010-3
Setting static IPv4: 10.89.5.17 netmask: 255.255.255.192 gateway: data on management0
Updating routing tables, please wait...
All configurations applied to the system. Took 3 Seconds.
Saving a copy of running network configuration to local disk.
For HTTP Proxy configuration, run 'configure network http-proxy'

Manage the device locally? (yes/no) [yes]: no
DHCP server is already disabled
DHCP Server Disabled
Configure firewall mode? (routed/transparent) [routed]:
Configuring firewall mode ...

Device is in OffBox mode - disabling/removing port 443 from iptables.
Update policy deployment information
  - add device configuration
  - add network discovery
  - add system policy

You can register the sensor to a Firepower Management Center and use the
Firepower Management Center to manage it. Note that registering the sensor
to a Firepower Management Center disables on-sensor Firepower Services
management capabilities.

When registering the sensor to a Firepower Management Center, a unique
alphanumeric registration key is always required. In most cases, to register
a sensor to a Firepower Management Center, you must provide the hostname or
the IP address along with the registration key.
'configure manager add [hostname | ip address ] [registration key ]'

However, if the sensor and the Firepower Management Center are separated by a
NAT device, you must enter a unique NAT ID, along with the unique registration
key.
'configure manager add DONTRESOLVE [registration key ] [ NAT ID ]'

Later, using the web interface on the Firepower Management Center, you must
use the same registration key and, if necessary, the same NAT ID when you add
this sensor to the Firepower Management Center.
>

```

## Step 5 Configure the outside interface for manager access.

### **configure network management-data-interface**

You are then prompted to configure basic network settings for the outside interface. See the following details for using this command:

- The Management interface cannot use DHCP if you want to use a data interface for management. If you did not set the IP address manually during initial setup, you can set it now using the **configure network**

**{ipv4 | ipv6} manual** command. If you did not already set the Management interface gateway to **data-interfaces**, this command will set it now.

- When you add the threat defense to CDO, CDO discovers and maintains the interface configuration, including the following settings: interface name and IP address, static route to the gateway, DNS servers, and DDNS server. For more information about the DNS server configuration, see below. In CDO, you can later make changes to the manager access interface configuration, but make sure you don't make changes that can prevent the threat defense or CDO from re-establishing the management connection. If the management connection is disrupted, the threat defense includes the **configure policy rollback** command to restore the previous deployment.
- If you configure a DDNS server update URL, the threat defense automatically adds certificates for all of the major CAs from the Cisco Trusted Root CA bundle so that the threat defense can validate the DDNS server certificate for the HTTPS connection. The threat defense supports any DDNS server that uses the DynDNS Remote API specification (<https://help.dyn.com/remote-access-api/>).
- This command sets the *data* interface DNS server. The Management DNS server that you set with the setup script (or using the **configure network dns servers** command) is used for management traffic. The data DNS server is used for DDNS (if configured) or for security policies applied to this interface.

On CDO, the data interface DNS servers are configured in the Platform Settings policy that you assign to this threat defense. When you add the threat defense to CDO, the local setting is maintained, and the DNS servers are *not* added to a Platform Settings policy. However, if you later assign a Platform Settings policy to the threat defense that includes a DNS configuration, then that configuration will overwrite the local setting. We suggest that you actively configure the DNS Platform Settings to match this setting to bring CDO and the threat defense into sync.

Also, local DNS servers are only retained by CDO if the DNS servers were discovered at initial registration. For example, if you registered the device using the Management interface, but then later configure a data interface using the **configure network management-data-interface** command, then you must manually configure all of these settings in CDO, including the DNS servers, to match the threat defense configuration.

- You can change the management interface after you register the threat defense to CDO, to either the Management interface or another data interface.
- The FQDN that you set in the setup wizard will be used for this interface.
- You can clear the entire device configuration as part of the command; you might use this option in a recovery scenario, but we do not suggest you use it for initial setup or normal operation.
- To disable data management, enter the **configure network management-data-interface disable** command.

### Example:

```
> configure network management-data-interface
Data interface to use for management: ethernet1/1
Specify a name for the interface [outside]:
IP address (manual / dhcp) [dhcp]:
DDNS server update URL [none]:
https://deanwinchester:pa$$w0rd17@domains.example.com/nic/update?hostname=<h>&myip=<a>
Do you wish to clear all the device configuration before applying ? (y/n) [n]:
```

Configuration done with option to allow manager access from any network, if you wish to change the manager access network use the 'client' option in the command 'configure network management-data-interface'.

```
Setting IPv4 network configuration.
Network settings changed.
```

```
>
```

### Example:

```
> configure network management-data-interface
Data interface to use for management: ethernet1/1
Specify a name for the interface [outside]: internet
IP address (manual / dhcp) [dhcp]: manual
IPv4/IPv6 address: 10.10.6.7
Netmask/IPv6 Prefix: 255.255.255.0
Default Gateway: 10.10.6.1
Comma-separated list of DNS servers [none]: 208.67.222.222,208.67.220.220
DDNS server update URL [none]:
Do you wish to clear all the device configuration before applying ? (y/n) [n]:
```

Configuration done with option to allow manager access from any network, if you wish to change the manager access network use the 'client' option in the command 'configure network management-data-interface'.

```
Setting IPv4 network configuration.
Network settings changed.
```

```
>
```

- Step 6** Identify the CDO that will manage this threat defense using the **configure manager add** command that CDO generated. See [Onboard a Device with the Onboarding Wizard, on page 140](#) to generate the command.

### Example:

```
> configure manager add account1.app.us.cdo.cisco.com KPOOP0rgWzaHrnj1V5ha2q5Rf8pKFX9E
Lzm1HOynhVUWhXYWz2swmkj2ZWsn3Lb account1.app.us.cdo.cisco.com
Manager successfully configured.
```

## Perform Initial Configuration Using the Device Manager

When you use the device manager for initial setup, the following interfaces are preconfigured in addition to the Management interface and manager access settings:

- Ethernet 1/1—"outside", IP address from DHCP, IPv6 autoconfiguration
- Ethernet 1/2—"inside", 192.168.95.1/24
- Default route—Obtained through DHCP on the outside interface

Note that other settings, such as the DHCP server on inside, access control policy, or security zones, are not configured.

If you perform additional interface-specific configuration within device manager before onboarding to CDO, then that configuration is preserved.

When you use the CLI, only the Management interface and manager access settings are retained (for example, the default inside interface configuration is not retained).

## Procedure

---

- Step 1** Connect your management computer to the Ethernet1/2 interface.
- Step 2** Log in to the device manager.
- a) Enter the following URL in your browser: **https://192.168.95.1**
  - b) Log in with the username **admin**, and the default password **Admin123**.
  - c) You are prompted to read and accept the End User License Agreement and change the admin password.
- Step 3** Use the setup wizard when you first log into the device manager to complete the initial configuration. You can optionally skip the setup wizard by clicking **Skip device setup** at the bottom of the page.
- After you complete the setup wizard, in addition to the default configuration for the inside interface (Ethernet1/2), you will have configuration for an outside (Ethernet1/1) interface that will be maintained when you switch to CDO management.
- a) Configure the following options for the outside and management interfaces and click **Next**.
    1. **Outside Interface Address**—This interface is typically the internet gateway, and might be used as your manager access interface. You cannot select an alternative outside interface during initial device setup. The first data interface is the default outside interface.
 

If you want to use a different interface from outside (or inside) for manager access, you will have to configure it manually after completing the setup wizard.

**Configure IPv4**—The IPv4 address for the outside interface. You can use DHCP or manually enter a static IP address, subnet mask, and gateway. You can also select **Off** to not configure an IPv4 address. You cannot configure PPPoE using the setup wizard. PPPoE may be required if the interface is connected to a DSL modem, cable modem, or other connection to your ISP, and your ISP uses PPPoE to provide your IP address. You can configure PPPoE after you complete the wizard.

**Configure IPv6**—The IPv6 address for the outside interface. You can use DHCP or manually enter a static IP address, prefix, and gateway. You can also select **Off** to not configure an IPv6 address.
    2. **Management Interface**

You will not see Management Interface settings if you performed initial setup at the CLI.

The Management interface settings are used even though you are enabling the manager access on a data interface. For example, the management traffic that is routed over the backplane through the data interface will resolve FQDNs using the Management interface DNS servers, and not the data interface DNS servers.

**DNS Servers**—The DNS server for the system's management address. Enter one or more addresses of DNS servers for name resolution. The default is the OpenDNS public DNS servers. If you edit the fields and want to return to the default, click **Use OpenDNS** to reload the appropriate IP addresses into the fields.

**Firewall Hostname**—The hostname for the system's management address.
  - b) Configure the **Time Setting (NTP)** and click **Next**.
    1. **Time Zone**—Select the time zone for the system.
    2. **NTP Time Server**—Select whether to use the default NTP servers or to manually enter the addresses of your NTP servers. You can add multiple servers to provide backups.

- c) Select **Start 90 day evaluation period without registration**.

Do not register the threat defense with the Smart Software Manager; all licensing is performed in CDO.

- d) Click **Finish**.

- e) You are prompted to choose **Cloud Management** or **Standalone**. For the CDO cloud-delivered management center, choose **Standalone**, and then **Got It**.

The **Cloud Management** option is for legacy CDO/FDM functionality.

- Step 4** (Might be required) Configure the Management interface. See the Management interface on **Device > Interfaces**.

The Management interface must have the gateway set to data interfaces. By default, the Management interface receives an IP address and gateway from DHCP. If you do not receive a gateway from DHCP (for example, you did not connect this interface to a network), then the gateway will default to data interfaces, and you do not need to configure anything. If you did receive a gateway from DHCP, then you need to instead configure this interface with a static IP address and set the gateway to data interfaces.

- Step 5** If you want to configure additional interfaces, including an interface other than outside or inside that you want to use for the manager access, choose **Device**, and then click the link in the **Interfaces** summary.

See [Configure the Firewall in the Device Manager, on page 116](#) for more information about configuring interfaces in the device manager. Other device manager configuration will not be retained when you register the device to CDO.

- Step 6** Choose **Device > System Settings > Central Management**, and click **Proceed** to set up the management center management.

- Step 7** Configure the **Management Center/CDO Details**.

Figure 110: Management Center/CDO Details

### Configure Connection to Management Center or CDO

Provide details to register to the management center/CDO.

**Management Center/CDO Details**

Do you know the Management Center/CDO hostname or IP address?

Yes    No

**Threat Defense**



10.89.5.16  
fe80::6a87:c6ff:fea6:4c00/64

→

**Management Center/CDO**



10.89.5.35

Management Center/CDO Hostname or IP Address

10.89.5.35

Management Center/CDO Registration Key

••••

NAT ID

*Required when the management center/CDO hostname or IP address is not provided. We recommend always setting the NAT ID even when you specify the management center/CDO hostname or IP address.*

11203

---

**Connectivity Configuration**

Threat Defense Hostname

1120-3

DNS Server Group

CustomDNSServerGroup

Management Center/CDO Access Interface

Data Interface

Please select an interface

Management Interface [View details](#)

- a) For **Do you know the Management Center/CDO hostname or IP address**, click **Yes**.

CDO generates the **configure manager add** command. See [Onboard a Device with the Onboarding Wizard, on page 140](#) to generate the command.

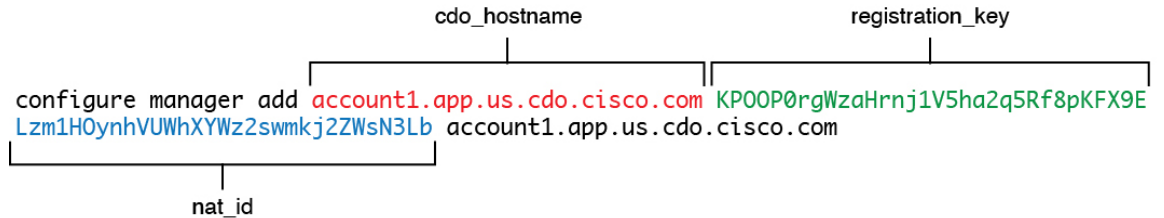

```
configure manager add cdo_hostname registration_key nat_id display_name
```

**Example:****Figure 111: configure manager add command components**

- b) Copy the *cdo\_hostname*, *registration\_key*, and *nat\_id* parts of the command into the **Management Center/CDO Hostname/IP Address**, **Management Center/CDO Registration Key**, and **NAT ID** fields.

**Step 8** Configure the **Connectivity Configuration**.

- a) Specify the **FTD Hostname**.

This FQDN will be used for the outside interface, or whichever interface you choose for the **Management Center/CDO Access Interface**.

- b) Specify the **DNS Server Group**.

Choose an existing group, or create a new one. The default DNS group is called **CiscoUmbrellaDNSServerGroup**, which includes the OpenDNS servers.

This setting sets the *data* interface DNS server. The Management DNS server that you set with the setup wizard is used for management traffic. The data DNS server is used for DDNS (if configured) or for security policies applied to this interface. You are likely to choose the same DNS server group that you used for Management, because both management and data traffic reach the DNS server through the outside interface.

On CDO, the data interface DNS servers are configured in the Platform Settings policy that you assign to this threat defense. When you add the threat defense to CDO, the local setting is maintained, and the DNS servers are *not* added to a Platform Settings policy. However, if you later assign a Platform Settings policy to the threat defense that includes a DNS configuration, then that configuration will overwrite the local setting. We suggest that you actively configure the DNS Platform Settings to match this setting to bring CDO and the threat defense into sync.

Also, local DNS servers are only retained by CDO if the DNS servers were discovered at initial registration.

- c) For the **Management Center/CDO Access Interface**, choose **outside**.

You can choose any configured interface, but this guide assumes you are using outside.

**Step 9** If you chose a different data interface from outside, then add a default route.

You will see a message telling you to check that you have a default route through the interface. If you chose outside, you already configured this route as part of the setup wizard. If you chose a different interface, then you need to manually configure a default route before you connect to CDO. See [Configure the Firewall in the Device Manager, on page 116](#) for more information about configuring static routes in the device manager.

**Step 10** Click **Add a Dynamic DNS (DDNS) method**.

DDNS ensures CDO can reach the threat defense at its Fully-Qualified Domain Name (FQDN) if the threat defense's IP address changes. See **Device > System Settings > DDNS Service** to configure DDNS.

If you configure DDNS before you add the threat defense to CDO, the threat defense automatically adds certificates for all of the major CAs from the Cisco Trusted Root CA bundle so that the threat defense can validate the DDNS server certificate for the HTTPS connection. The threat defense supports any DDNS server that uses the DynDNS Remote API specification (<https://help.dyn.com/remote-access-api/>).

**Step 11** Click **Connect**. The **Registration Status** dialog box shows the current status of the switch to CDO. After the **Saving Management Center/CDO Registration Settings** step, go to CDO, and add the firewall.

If you want to cancel the switch to CDO, click **Cancel Registration**. Otherwise, do not close the device manager browser window until after the **Saving Management Center/CDO Registration Settings** step. If you do, the process will be paused, and will only resume when you reconnect to the device manager.

If you remain connected to the device manager after the **Saving Management Center/CDO Registration Settings** step, you will eventually see the **Successful Connection with Management Center or CDO** dialog box, after which you will be disconnected from the device manager.

**Figure 112: Successful Connection**

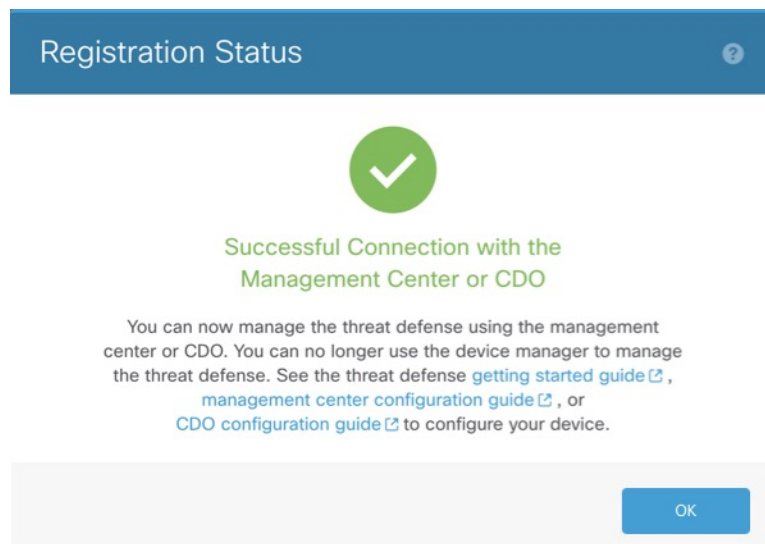

## Configure a Basic Security Policy

This section describes how to configure a basic security policy with the following settings:

- Inside and outside interfaces—Assign a static IP address to the inside interface. You configured basic settings for the outside interface as part of the manager access setup, but you still need to assign it to a security zone.
- DHCP server—Use a DHCP server on the inside interface for clients.
- NAT—Use interface PAT on the outside interface.
- Access control—Allow traffic from inside to outside.
- SSH—Enable SSH on the manager access interface.

## Configure Interfaces

When you use low-touch provisioning or the device manager for initial setup, the following interfaces are preconfigured:

- Ethernet 1/1—"outside", IP address from DHCP, IPv6 autoconfiguration
- Ethernet 1/2—"inside", 192.168.95.1/24
- Default route—Obtained through DHCP on the outside interface

If you performed additional interface-specific configuration within device manager before registering with the management center, then that configuration is preserved.

In any case, you need to perform additional interface configuration after you register the device. Enable the threat defense interfaces, assign them to security zones, and set the IP addresses. Also configure breakout interfaces.

The following example configures a routed mode inside interface with a static address and a routed mode outside interface using DHCP.

### Procedure

**Step 1** Choose **Devices > Device Management**, and click **Edit** (✎) for the firewall.

**Step 2** Click **Interfaces**.

**Figure 113: Interfaces**

| Interface          | Logical Name | Type     | Security Zones | MAC Address (Active/Standby) | IP Address | Path Monitoring | Virtual Router |
|--------------------|--------------|----------|----------------|------------------------------|------------|-----------------|----------------|
| Management0/0      | management   | Physical |                |                              |            | Disabled        | Global         |
| GigabitEthernet0/0 |              | Physical |                |                              |            | Disabled        |                |
| GigabitEthernet0/1 |              | Physical |                |                              |            | Disabled        |                |
| GigabitEthernet0/2 |              | Physical |                |                              |            | Disabled        |                |
| GigabitEthernet0/3 |              | Physical |                |                              |            | Disabled        |                |
| GigabitEthernet0/4 |              | Physical |                |                              |            | Disabled        |                |
| GigabitEthernet0/5 |              | Physical |                |                              |            | Disabled        |                |
| GigabitEthernet0/6 |              | Physical |                |                              |            | Disabled        |                |
| GigabitEthernet0/7 |              | Physical |                |                              |            | Disabled        |                |

**Step 3** To create 4 x 10-Gb breakout interfaces from a 40-Gb interface (available on some models), click the breakout icon for the interface.

If you already used the 40-Gb interface in your configuration, you will have to remove the configuration before you can proceed with the breakout.

**Step 4** Click **Edit** (✎) for the interface that you want to use for *inside*.

The **General** tab appears.

Figure 114: General Tab

Edit Physical Interface

General IPv4 IPv6 Path Monitoring

Name:

Enabled  
 Management Only

Description:

Mode:

Security Zone:

Interface ID:

MTU:  
  
(64 - 9000)

Priority:  
 (0 - 65535)

Propagate Security Group Tag:

NVE Only:

- Enter a **Name** up to 48 characters in length.  
For example, name the interface **inside**.
- Check the **Enabled** check box.
- Leave the **Mode** set to **None**.
- From the **Security Zone** drop-down list, choose an existing inside security zone or add a new one by clicking **New**.

For example, add a zone called **inside\_zone**. Each interface must be assigned to a security zone and/or interface group. An interface can belong to only one security zone, but can also belong to multiple interface groups. You apply your security policy based on zones or groups. For example, you can assign the inside interface to the inside zone; and the outside interface to the outside zone. Then you can configure your access control policy to enable traffic to go from inside to outside, but not from outside to inside. Most policies only support security zones; you can use zones or interface groups in NAT policies, prefilter policies, and QoS policies.

- Click the **IPv4** and/or **IPv6** tab.
  - IPv4**—Choose **Use Static IP** from the drop-down list, and enter an IP address and subnet mask in slash notation.  
For example, enter **192.168.1.1/24**

Figure 115: IPv4 Tab

The screenshot shows the 'Edit Physical Interface' window with the 'IPv4' tab selected. The 'IP Type' dropdown is set to 'Use Static IP'. The 'IP Address' field contains '192.168.1.1/24'. Below the field, a small text note reads 'eg. 192.0.2.1/255.255.255.128 or 192.0.2.1/25'.

- **IPv6**—Check the **Autoconfiguration** check box for stateless autoconfiguration.

Figure 116: IPv6 Tab

The screenshot shows the 'Edit Physical Interface' window with the 'IPv6' tab selected. The 'Basic' sub-tab is active. The 'Enable IPv6' checkbox is unchecked. The 'Enforce EUI 64' checkbox is unchecked. The 'Link-Local address' field is empty. The 'Autoconfiguration' checkbox is checked. The 'Obtain Default Route' checkbox is unchecked.

f) Click **OK**.

- Step 5** Click **Edit** (✎) for the interface that you want to use for *outside*.  
The **General** tab appears.

Figure 117: General Tab

Edit Physical Interface

General IPv4 IPv6 Path Monitoring Hardware

Name:

Enabled  
 Management Only

Description:

Mode:

Security Zone:

Interface ID:

MTU:  
  
(64 - 9000)

Priority:  
 (0 - 65535)

Propagate Security Group Tag:

NVE Only:

You already pre-configured this interface for manager access, so the interface will already be named, enabled, and addressed. You should not alter any of these basic settings because doing so will disrupt the management center management connection. You must still configure the Security Zone on this screen for through traffic policies.

- a) From the **Security Zone** drop-down list, choose an existing outside security zone or add a new one by clicking **New**.

For example, add a zone called **outside\_zone**.

- b) Click **OK**.

**Step 6** Click **Save**.

## Configure the DHCP Server

Enable the DHCP server if you want clients to use DHCP to obtain IP addresses from the threat defense.

## Procedure

**Step 1** Choose **Devices > Device Management**, and click **Edit** (✎) for the device.

**Step 2** Choose **DHCP > DHCP Server**.

**Figure 118: DHCP Server**

The screenshot shows the DHCP Server configuration page. The left sidebar lists 'DHCP Server', 'DHCP Relay', and 'DDNS'. The main area has tabs for 'Device', 'Routing', 'Interfaces', 'Inline Sets', 'DHCP', and 'VTEP'. Under the 'DHCP' tab, there are input fields for 'Ping Timeout' (50, range 10-10000 ms), 'Lease Length' (3600, range 300-10,48,575 sec), and an unchecked 'Auto-Configuration' checkbox. Below is an 'Interface' dropdown menu. The 'Override Auto Configured Settings' section includes 'Domain Name', 'Primary DNS Server', 'Secondary DNS Server', 'Primary WINS Server', and 'Secondary WINS Server'. At the bottom, there are 'Server' and 'Advanced' tabs, and a table with columns 'Interface', 'Address Pool', and 'Enable DHCP Server'. A red box highlights the '+ Add' button in the top right corner of the table area.

**Step 3** On the **Server** page, click **Add**, and configure the following options:

**Figure 119: Add Server**

The 'Add Server' dialog box is shown. It has a title bar with a question mark icon. Below the title, there are three main configuration sections: 'Interface\*' with a dropdown menu showing 'inside'; 'Address Pool\*' with a text input field containing '10.9.7.9-10.9.7.25' and a range '(2.2.2.10-2.2.2.20)' below it; and a checked checkbox for 'Enable DHCP Server'. At the bottom of the dialog, there are two buttons: 'Cancel' and 'OK'.

- **Interface**—Choose the interface from the drop-down list.
- **Address Pool**—Set the range of IP addresses from lowest to highest that are used by the DHCP server. The range of IP addresses must be on the same subnet as the selected interface and cannot include the IP address of the interface itself.
- **Enable DHCP Server**—Enable the DHCP server on the selected interface.

**Step 4** Click **OK**.

**Step 5** Click **Save**.

## Configure NAT

A typical NAT rule converts internal addresses to a port on the outside interface IP address. This type of NAT rule is called *interface Port Address Translation (PAT)*.

### Procedure

**Step 1** Choose **Devices > NAT**, and click **New Policy > Threat Defense NAT**.

**Step 2** Name the policy, select the device(s) that you want to use the policy, and click **Save**.

*Figure 120: New Policy*

The screenshot shows the 'New Policy' configuration interface. It includes the following elements:

- Name:** A text input field containing 'interface\_PAT'.
- Description:** An empty text input field.
- Targeted Devices:** A section with a checkbox and the instruction 'Select devices to which you want to apply this policy.'
- Available Devices:** A list with a search bar 'Search by name or value' and two items: '10.10.0.6' and '10.10.0.7', both highlighted in blue.
- Selected Devices:** A list with two items: '10.10.0.6' and '10.10.0.7', each with a trash icon to its right.
- Buttons:** An 'Add to Policy' button is positioned between the two device lists. At the bottom right, there are 'Cancel' and 'Save' buttons.

The policy is added the management center. You still have to add rules to the policy.



Figure 121: NAT Policy

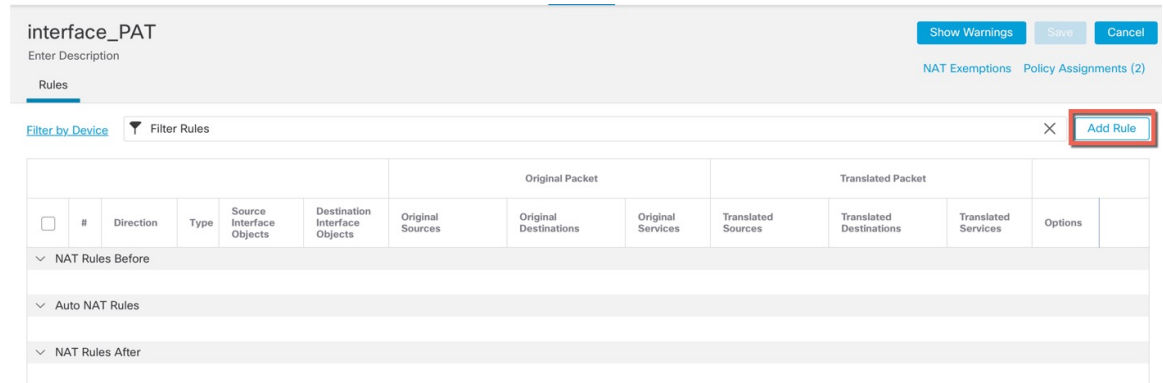

**Step 3** Click **Add Rule**.

The **Add NAT Rule** dialog box appears.

**Step 4** Configure the basic rule options:

Figure 122: Basic Rule Options

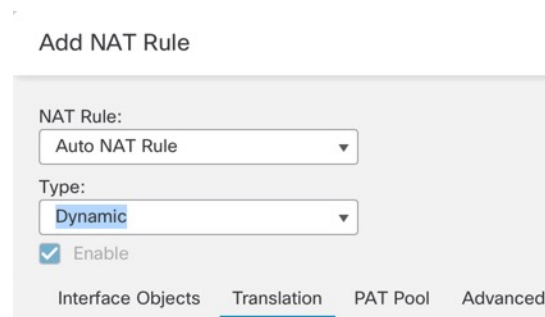

- **NAT Rule**—Choose **Auto NAT Rule**.
- **Type**—Choose **Dynamic**.

**Step 5** On the **Interface Objects** page, add the outside zone from the **Available Interface Objects** area to the **Destination Interface Objects** area.

Figure 123: Interface Objects

**Add NAT Rule**

NAT Rule: Auto NAT Rule

Type: Dynamic

Enable

Interface Objects Translation PAT Pool Advanced

Available Interface Objects

- inside\_zone
- 1 outside\_zone**
- wfxAutomationZone

**2 Add to Destination**

Source Interface Objects (0)

Destination Interface Objects (1)

- 3 outside\_zone**

**Step 6** On the **Translation** page, configure the following options:

Figure 124: Translation

**Add NAT Rule**

NAT Rule: Auto NAT Rule

Type: Dynamic

Enable

Interface Objects Translation PAT Pool Advanced

Original Packet

Original Source:\* all-ipv4 +

Original Port: TCP

Translated Packet

Translated Source: Destination Interface IP

**i** The values selected for Destination Interface Objects in 'Interface Objects' tab will be used

Translated Port:

- **Original Source**—Click **Add (+)** to add a network object for all IPv4 traffic (0.0.0.0/0).

Figure 125: New Network Object

**Note** You cannot use the system-defined **any-ipv4** object, because Auto NAT rules add NAT as part of the object definition, and you cannot edit system-defined objects.

- **Translated Source**—Choose **Destination Interface IP**.

**Step 7** Click **Save** to add the rule.  
The rule is saved to the **Rules** table.

**Step 8** Click **Save** on the **NAT** page to save your changes.

## Allow Traffic from Inside to Outside

If you created a basic **Block all traffic** access control policy when you registered the threat defense, then you need to add rules to the policy to allow traffic through the device. The following procedure adds a rule to allow traffic from the inside zone to the outside zone. If you have other zones, be sure to add rules allowing traffic to the appropriate networks.

### Procedure

- Step 1** Choose **Policy > Access Policy > Access Policy**, and click **Edit** (✎) for the access control policy assigned to the threat defense.
- Step 2** Click **Add Rule**, and set the following parameters:

Figure 126: Add Rule

The screenshot shows the 'Create Rule' configuration page. The rule name is 'inside-to-outside'. The action is set to 'Allow'. The rule is enabled. The rule is applied to the 'inside\_zone' source and 'outside\_zone' destination. The interface shows various configuration options like Logging, Time Range, and File Policy.

- **Name**—Name this rule, for example, **inside-to-outside**.
- **Selected Sources**—Select the inside zone from **Zones**, and click **Add Source Zone**.
- **Selected Destinations and Applications**—Select the outside zone from **Zones**, and click **Add Destination Zone**.

Leave the other settings as is.

**Step 3** Click **Apply**.

The rule is added to the **Rules** table.

**Step 4** Click **Save**.

## Configure SSH on the Manager Access Data Interface

If you enabled management center access on a data interface, such as outside, you should enable SSH on that interface using this procedure. This section describes how to enable SSH connections to one or more *data* interfaces on the threat defense. SSH is not supported to the Diagnostic logical interface.



**Note** SSH is enabled by default on the Management interface; however, this screen does not affect Management SSH access.

The Management interface is separate from the other interfaces on the device. It is used to set up and register the device to the management center. SSH for data interfaces shares the internal and external user list with SSH for the Management interface. Other settings are configured separately: for data interfaces, enable SSH and access lists using this screen; SSH traffic for data interfaces uses the regular routing configuration, and not any static routes configured at setup or at the CLI.

For the Management interface, to configure an SSH access list, see the **configure ssh-access-list** command in the [Cisco Secure Firewall Threat Defense Command Reference](#). To configure a static route, see the **configure network static-routes** command. By default, you configure the default route through the Management interface at initial setup.

To use SSH, you do not also need an access rule allowing the host IP address. You only need to configure SSH access according to this section.

You can SSH only to a reachable interface; if your SSH host is located on the outside interface, you can only initiate a management connection directly to the outside interface.

SSH supports the following ciphers and key exchange:

- Encryption—aes128-cbc, aes192-cbc, aes256-cbc, aes128-ctr, aes192-ctr, aes256-ctr
- Integrity—hmac-sha2-256
- Key exchange—dh-group14-sha256



---

**Note** After you make three consecutive failed attempts to log into the CLI using SSH, the device terminates the SSH connection.

---

### Before you begin

- You can configure SSH internal users at the CLI using the **configure user add** command. By default, there is an **admin** user for which you configured the password during initial setup. You can also configure external users on LDAP or RADIUS by configuring **External Authentication** in platform settings.
- You need network objects that define the hosts or networks you will allow to make SSH connections to the device. You can add objects as part of the procedure, but if you want to use object groups to identify a group of IP addresses, ensure that the groups needed in the rules already exist. Select **Objects > Object Management** to configure objects.



---

**Note** You cannot use the system-provided **any** network object. Instead, use **any-ipv4** or **any-ipv6**.

---

### Procedure

---

- Step 1** Choose **Devices > Platform Settings** and create or edit the threat defense policy.
- Step 2** Select **Secure Shell**.
- Step 3** Identify the interfaces and IP addresses that allow SSH connections.

Use this table to limit which interfaces will accept SSH connections, and the IP addresses of the clients who are allowed to make those connections. You can use network addresses rather than individual IP addresses.

- a) Click **Add** to add a new rule, or click **Edit** to edit an existing rule.
- b) Configure the rule properties:
  - **IP Address**—The network object or group that identifies the hosts or networks you are allowing to make SSH connections. Choose an object from the drop-down menu, or click + to add a new network object.
  - **Security Zones**—Add the zones that contain the interfaces to which you will allow SSH connections. For interfaces not in a zone, you can type the interface name into the field below the **Selected Security Zones** list and click **Add**. These rules will be applied to a device only if the device includes the selected interfaces or zones.
- c) Click **OK**.

**Step 4** Click **Save**.

You can now go to **Deploy > Deployment** and deploy the policy to assigned devices. The changes are not active until you deploy them.

## Deploy the Configuration

Deploy the configuration changes to the threat defense; none of your changes are active on the device until you deploy them.

### Procedure

**Step 1** Click **Deploy** in the upper right.

*Figure 127: Deploy*



**Step 2** For a quick deployment, check specific devices and then click **Deploy**, or click **Deploy All** to deploy to all devices. Otherwise, for additional deployment options, click **Advanced Deploy**.

*Figure 128: Deploy All*

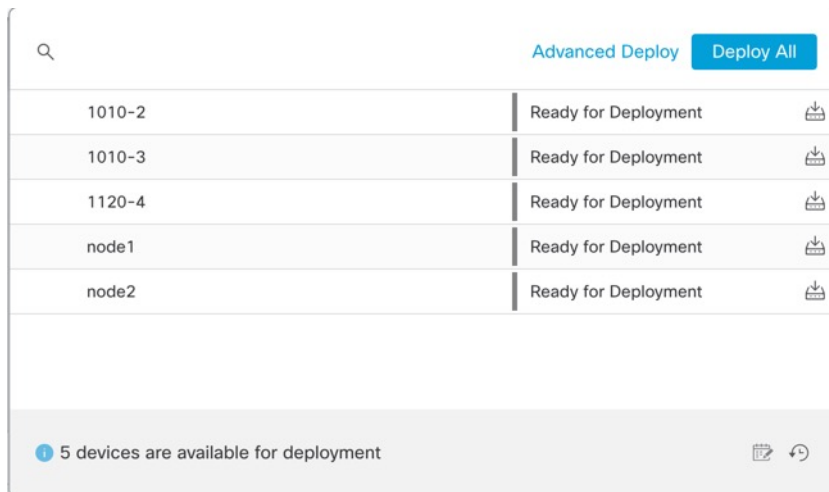

*Figure 129: Advanced Deploy*

| 1 device selected                         |               |                      |      |       |                      |           |                      | Deploy time: Estimate | Deploy |
|-------------------------------------------|---------------|----------------------|------|-------|----------------------|-----------|----------------------|-----------------------|--------|
| Device                                    | Modified by   | Inspect Interruption | Type | Group | Last Deploy Time     | Preview   | Status               |                       |        |
| <input checked="" type="checkbox"/> node1 | System        |                      | FTD  |       | May 23, 2022 6:49 PM | [Preview] | Ready for Deployment |                       |        |
| <input type="checkbox"/> 1010-2           | admin, System |                      | FTD  |       | May 23, 2022 7:09 PM | [Preview] | Ready for Deployment |                       |        |
| <input type="checkbox"/> node2            | System        |                      | FTD  |       | May 23, 2022 6:49 PM | [Preview] | Ready for Deployment |                       |        |
| <input type="checkbox"/> 1010-3           | System        |                      | FTD  |       | May 23, 2022 6:49 PM | [Preview] | Ready for Deployment |                       |        |
| <input type="checkbox"/> 1120-4           | System        |                      | FTD  |       | May 23, 2022 6:49 PM | [Preview] | Ready for Deployment |                       |        |

**Step 3** Ensure that the deployment succeeds. Click the icon to the right of the **Deploy** button in the menu bar to see status for deployments.

**Figure 130: Deployment Status**

| Deployment ID | Status  | Message                          | Time   |
|---------------|---------|----------------------------------|--------|
| 1010-2        | Success | Deployment to device successful. | 2m 13s |
| 1010-3        | Success | Deployment to device successful. | 2m 4s  |
| 1120-4        | Success | Deployment to device successful. | 1m 45s |
| node1         | Success | Deployment to device successful. | 1m 46s |
| node2         | Success | Deployment to device successful. | 1m 45s |

## Access the Threat Defense and FXOS CLI

Use the command-line interface (CLI) to set up the system and do basic system troubleshooting. You cannot configure policies through a CLI session. You can access the CLI by connecting to the console port.

You can also access the FXOS CLI for troubleshooting purposes.



**Note** You can alternatively SSH to the Management interface of the threat defense device. Unlike a console session, the SSH session defaults to the threat defense CLI, from which you can connect to the FXOS CLI using the **connect fxos** command. You can later connect to the address on a data interface if you open the interface for SSH connections. SSH access to data interfaces is disabled by default. This procedure describes console port access, which defaults to the FXOS CLI.

### Procedure

**Step 1** To log into the CLI, connect your management computer to the console port. The Secure Firewall 3100 ships with a DB-9 to RJ-45 serial cable, so you may need to buy a third party DB-9-to-USB serial cable to make the connection. Be sure to install any necessary USB serial drivers for your operating system. The console port defaults to the FXOS CLI. Use the following serial settings:

- 9600 baud
- 8 data bits
- No parity
- 1 stop bit

You connect to the FXOS CLI. Log in to the CLI using the **admin** username and the password you set at initial setup (the default is **Admin123**).

**Example:**

```
firepower login: admin
Password:
Last login: Thu May 16 14:01:03 UTC 2019 on ttyS0
Successful login attempts for user 'admin' : 1

firepower#
```

**Step 2** Access the threat defense CLI.

**connect ftd**

**Example:**

```
firepower# connect ftd
>
```

After logging in, for information on the commands available in the CLI, enter **help** or **?**. For usage information, see [Cisco Secure Firewall Threat Defense Command Reference](#).

**Step 3** To exit the threat defense CLI, enter the **exit** or **logout** command.

This command returns you to the FXOS CLI prompt. For information on the commands available in the FXOS CLI, enter **?**.

**Example:**

```
> exit
firepower#
```

## Power Off the Firewall

It's important that you shut down your system properly. Simply unplugging the power or pressing the power switch can cause serious file system damage. Remember that there are many processes running in the background all the time, and unplugging or shutting off the power does not allow the graceful shutdown of your firewall system.

You can power off the device using the management center device management page, or you can use the FXOS CLI.

## Power Off the Firewall Using CDO

It's important that you shut down your system properly. Simply unplugging the power or pressing the power switch can cause serious file system damage. Remember that there are many processes running in the background all the time, and unplugging or shutting off the power does not allow the graceful shutdown of your firewall.



You can shut down your system properly using the management center.

### Procedure

- 
- Step 1** Choose **Devices > Device Management**.
  - Step 2** Next to the device that you want to restart, click **Edit** (✎).
  - Step 3** Click the **Device** tab.
  - Step 4** Click **Shut Down Device** (⊗) in the **System** section.
  - Step 5** When prompted, confirm that you want to shut down the device.
  - Step 6** If you have a console connection to the firewall, monitor the system prompts as the firewall shuts down. You will see the following prompt:

```
System is stopped.
It is safe to power off now.
```

```
Do you want to reboot instead? [y/N]
```

If you do not have a console connection, wait approximately 3 minutes to ensure the system has shut down.

- Step 7** You can now turn off the power switch and unplug the power to physically remove power from the chassis if necessary.
- 

## Power Off the Firewall at the CLI

You can use the FXOS CLI to safely shut down the system and power off the device. You access the CLI by connecting to the console port; see [Access the Threat Defense and FXOS CLI, on page 165](#).

### Procedure

- 
- Step 1** In the FXOS CLI, connect to local-mgmt:  
firepower # **connect local-mgmt**

- Step 2** Issue the **shutdown** command:  
firepower(local-mgmt) # **shutdown**

#### Example:

```
firepower(local-mgmt)# shutdown
This command will shutdown the system. Continue?
Please enter 'YES' or 'NO': yes
INIT: Stopping Cisco Threat Defense.....ok
```

- Step 3** Monitor the system prompts as the firewall shuts down. You will see the following prompt:

```
System is stopped.
It is safe to power off now.
Do you want to reboot instead? [y/N]
```

- Step 4** You can now turn off the power switch and unplug the power to physically remove power from the chassis if necessary.
- 

## What's Next

To continue configuring your threat defense using CDO, see the [Cisco Defense Orchestrator](#) home page.



## CHAPTER 6

# ASA Deployment with ASDM

### Is This Chapter for You?

To see all available operating systems and managers, see [Which Application and Manager is Right for You?](#), on [page 1](#). This chapter applies to ASA using ASDM.

### About the Firewall

The hardware can run either threat defense software or ASA software. Switching between threat defense and ASA requires you to reimage the device. You should also reimage if you need a different software version than is currently installed. See [Cisco Secure Firewall ASA and Secure Firewall Threat Defense Reimage Guide](#).

The firewall runs an underlying operating system called the Secure Firewall eXtensible Operating System (FXOS). The firewall does not support the FXOS Secure Firewall chassis manager; only a limited CLI is supported for troubleshooting purposes. See the [Cisco FXOS Troubleshooting Guide for the Firepower 1000/2100 and Secure Firewall 3100/4200 with Firepower Threat Defense](#) for more information.

**Privacy Collection Statement**—The firewall does not require or actively collect personally identifiable information. However, you can use personally identifiable information in the configuration, for example for usernames. In this case, an administrator might be able to see this information when working with the configuration or when using SNMP.

- [About the ASA, on page 169](#)
- [End-to-End Tasks, on page 171](#)
- [Review the Network Deployment and Default Configuration, on page 173](#)
- [Cable the Firewall, on page 175](#)
- [Power on the Firewall, on page 176](#)
- [\(Optional\) Change the IP Address, on page 177](#)
- [Log Into ASDM, on page 178](#)
- [Configure Licensing, on page 179](#)
- [Configure the ASA, on page 185](#)
- [Access the ASA and FXOS CLI, on page 187](#)
- [What's Next?, on page 188](#)

## About the ASA

The ASA provides advanced stateful firewall and VPN concentrator functionality in one device.

## Migrating an ASA 5500-X Configuration

You can copy and paste an ASA 5500-X configuration into the Secure Firewall 3100. However, you will need to modify your configuration. Also note some behavioral differences between the platforms.

1. To copy the configuration, enter the **more system:running-config** command on the ASA 5500-X.
2. Edit the configuration as necessary (see below).
3. Connect to the console port of the Secure Firewall 3100, and enter global configuration mode:

```
ciscoasa> enable
Password:
The enable password is not set. Please set it now.
Enter Password: *****
Repeat Password: *****
ciscoasa# configure terminal
ciscoasa (config)#
```

4. Clear the current configuration using the **clear configure all** command.
5. Paste the modified configuration at the ASA CLI.

This guide assumes a factory default configuration, so if you paste in an existing configuration, some of the procedures in this guide will not apply to your ASA.

| ASA 5500-X Configuration | Secure Firewall 3100 Configuration                                                                                                                                                                                                                                                                                                                                                                                                                                                                                                                                                                                                                                         |
|--------------------------|----------------------------------------------------------------------------------------------------------------------------------------------------------------------------------------------------------------------------------------------------------------------------------------------------------------------------------------------------------------------------------------------------------------------------------------------------------------------------------------------------------------------------------------------------------------------------------------------------------------------------------------------------------------------------|
| PAK License              | Smart License<br><br>PAK licensing is not applied when you copy and paste your configuration. There are no licenses installed by default. Smart Licensing requires that you connect to the Smart Licensing server to obtain your licenses. Smart Licensing also affects ASDM or SSH access (see below).                                                                                                                                                                                                                                                                                                                                                                    |
| Initial ASDM access      | Remove any VPN or other strong encryption feature configuration—even if you only configured weak encryption—if you cannot connect to ASDM or register with the Smart Licensing server.<br><br>You can reenab these features after you obtain the Strong Encryption (3DES) license.<br><br>The reason for this issue is that the ASA includes 3DES capability by default for management access only. If you enable a strong encryption feature, then ASDM and HTTPS traffic (like that to and from the Smart Licensing server) are blocked. The exception to this rule is if you are connected to a management-only interface, such as Management 1/1. SSH is not affected. |
| Interface IDs            | Make sure you change the interface IDs to match the new hardware IDs. For example, the ASA 5525-X includes Management 0/0, and GigabitEthernet 0/0 through 0/5. The Firepower 1120 includes Management 1/1 and Ethernet 1/1 through 1/8.                                                                                                                                                                                                                                                                                                                                                                                                                                   |

| ASA 5500-X Configuration                                                                                                                    | Secure Firewall 3100 Configuration                                                                                                                                                                                                                                                                                                                                                                                                                                                                                                                                                                                                  |
|---------------------------------------------------------------------------------------------------------------------------------------------|-------------------------------------------------------------------------------------------------------------------------------------------------------------------------------------------------------------------------------------------------------------------------------------------------------------------------------------------------------------------------------------------------------------------------------------------------------------------------------------------------------------------------------------------------------------------------------------------------------------------------------------|
| <p><b>boot system</b> commands</p> <p>The ASA 5500-X allows up to four <b>boot system</b> commands to specify the booting image to use.</p> | <p>The Secure Firewall 3100 only allows a single <b>boot system</b> command, so you should remove all but one command before you paste. You actually do not need to have <i>any</i> <b>boot system</b> commands present in your configuration, as it is not read at startup to determine the booting image. The last-loaded boot image will always run upon reload.</p> <p>The <b>boot system</b> command performs an action when you enter it: the system validates and unpacks the image and copies it to the boot location (an internal location on disk0 managed by FXOS). The new image will load when you reload the ASA.</p> |

## End-to-End Tasks

See the following tasks to deploy and configure the ASA on your chassis.

Figure 131: End-to-End Procedure

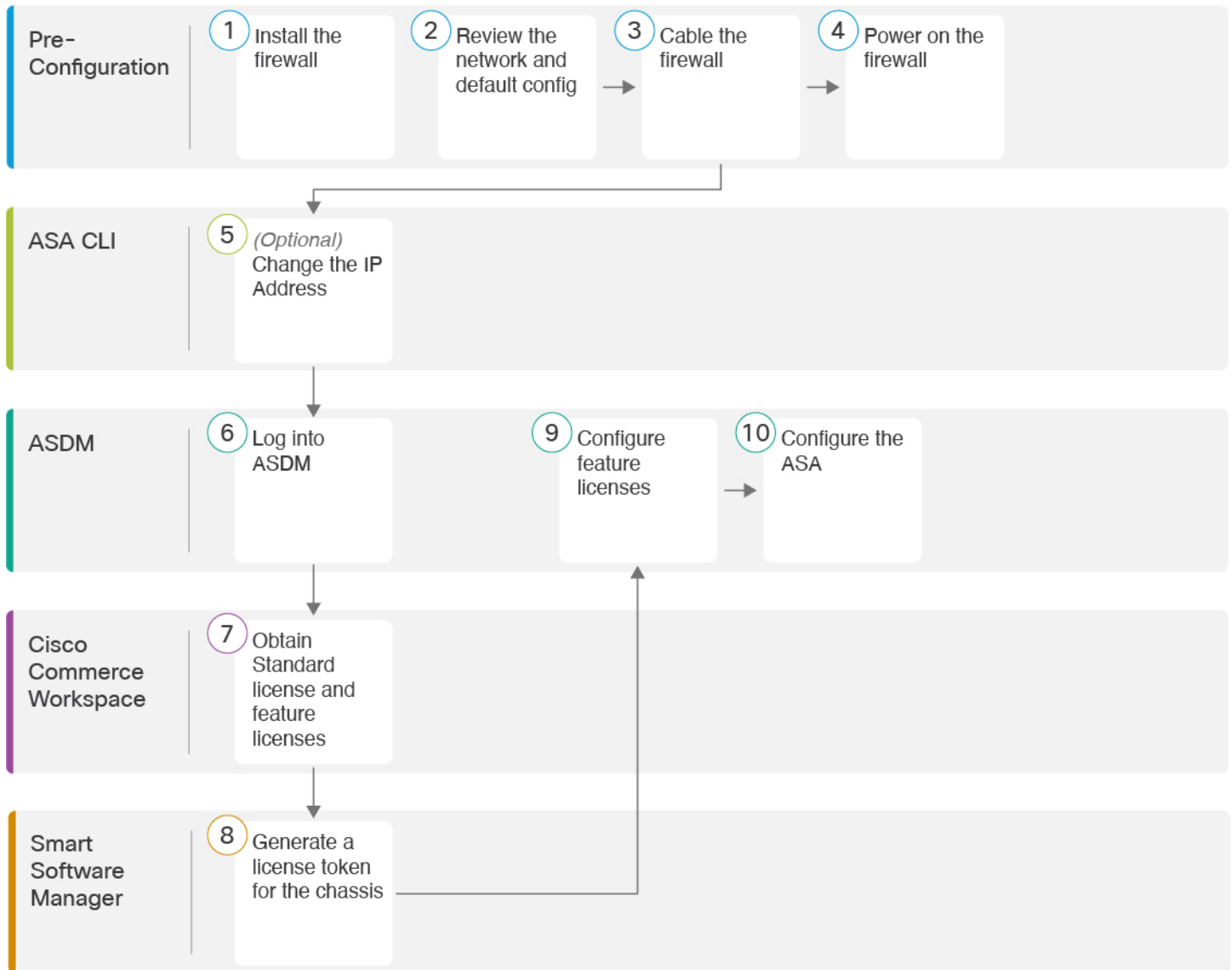

|   |                   |                                                                                        |
|---|-------------------|----------------------------------------------------------------------------------------|
| 1 | Pre-Configuration | Install the firewall. See the <a href="#">hardware installation guide</a> .            |
| 2 | Pre-Configuration | <a href="#">Review the Network Deployment and Default Configuration</a> , on page 173. |
| 3 | Pre-Configuration | <a href="#">Cable the Firewall</a> , on page 175.                                      |
| 4 | Pre-Configuration | <a href="#">Power on the Firewall</a> , on page 176.                                   |
| 5 | ASA CLI           | <a href="#">(Optional) Change the IP Address</a> , on page 177.                        |

|    |                          |                                                                                                             |
|----|--------------------------|-------------------------------------------------------------------------------------------------------------|
| 6  | ASDM                     | <a href="#">Log Into ASDM, on page 178.</a>                                                                 |
| 7  | Cisco Commerce Workspace | Obtain Standard license and optional feature licenses ( <a href="#">Configure Licensing, on page 179</a> ). |
| 8  | Smart Software Manager   | Generate a license token for the chassis ( <a href="#">Configure Licensing, on page 179</a> ).              |
| 9  | ASDM                     | Configure feature licenses ( <a href="#">Configure Licensing, on page 179</a> ).                            |
| 10 | ASDM                     | <a href="#">Configure the ASA, on page 185.</a>                                                             |

## Review the Network Deployment and Default Configuration

The following figure shows the default network deployment for the ASA using the default configuration.

If you connect the outside interface directly to a cable modem or DSL modem, we recommend that you put the modem into bridge mode so the ASA performs all routing and NAT for your inside networks. If you need to configure PPPoE for the outside interface to connect to your ISP, you can do so as part of the ASDM Startup Wizard.



**Note** If you cannot use the default Management IP address for ASDM access, you can set the Management IP address at the ASA CLI. See [\(Optional\) Change the IP Address, on page 177](#).

If you need to change the inside IP address, you can do so using the ASDM Startup Wizard. For example, you may need to change the inside IP address in the following circumstances:

- If the outside interface tries to obtain an IP address on the 192.168.1.0 network, which is a common default network, the DHCP lease will fail, and the outside interface will not obtain an IP address. This problem occurs because the ASA cannot have two interfaces on the same network. In this case you must change the inside IP address to be on a new network.
- If you add the ASA to an existing inside network, you will need to change the inside IP address to be on the existing network.

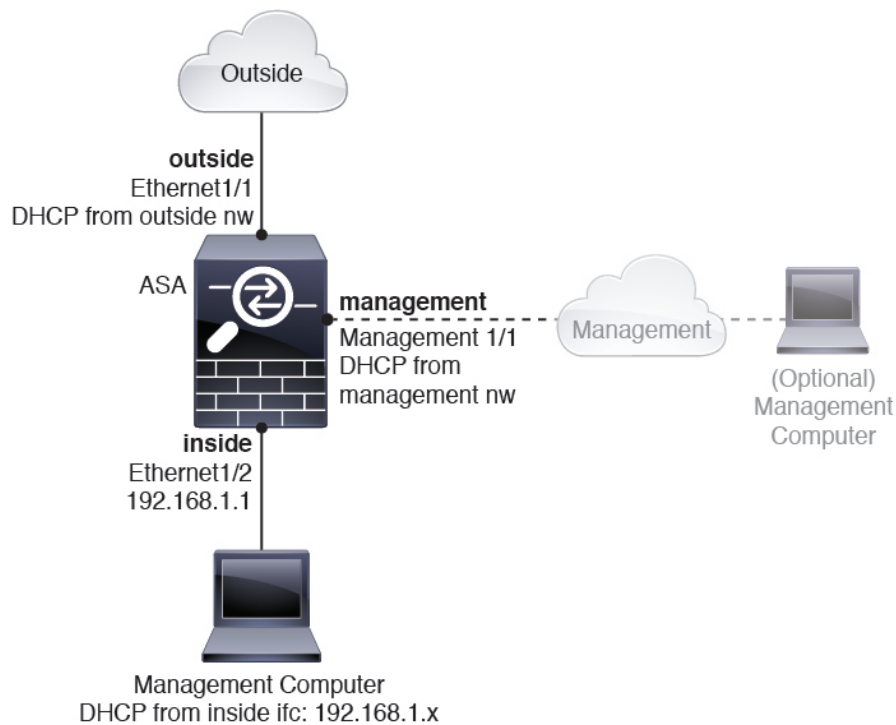

## Secure Firewall 3100 Default Configuration

The default factory configuration for the Secure Firewall 3100 configures the following:

- **inside→outside traffic flow**—Ethernet 1/1 (outside), Ethernet 1/2 (inside)
- **outside IP address** from DHCP, **inside IP address**—192.168.1.1
- **management**—Management 1/1 (management), IP address from DHCP
- **DHCP server** on inside interface
- **Default routes** from outside DHCP, management DHCP
- **ASDM access**—Management and inside hosts allowed. Inside hosts are limited to the 192.168.1.0/24 network.
- **NAT**—Interface PAT for all traffic from inside to outside.
- **DNS servers**—OpenDNS servers are pre-configured.

The configuration consists of the following commands:

```
interface Management1/1
  management-only
  nameif management
  security-level 100
  ip address dhcp setroute
  no shutdown
!
interface Ethernet1/1
```



```

nameif outside
security-level 0
ip address dhcp setroute
no shutdown
!
interface Ethernet1/2
nameif inside
security-level 100
ip address 192.168.1.1 255.255.255.0
no shutdown
!
object network obj_any
subnet 0.0.0.0 0.0.0.0
nat (any,outside) dynamic interface
!
http server enable
http 0.0.0.0 0.0.0.0 management
http 192.168.1.0 255.255.255.0 inside
!
dhcpd auto_config outside
dhcpd address 192.168.1.20-192.168.1.254 inside
dhcpd enable inside
!
dns domain-lookup outside
dns server-group DefaultDNS
name-server 208.67.222.222 outside
name-server 208.67.220.220 outside
!

```

## Cable the Firewall

**Figure 132: Cabling the Secure Firewall 3100**

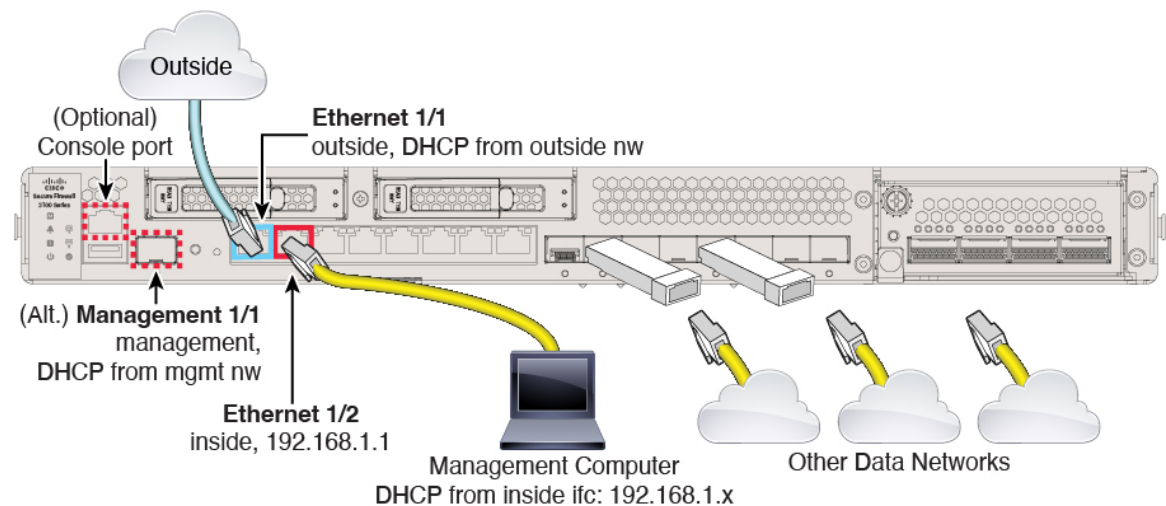

Manage the Secure Firewall 3100 on either Management 1/1 or Ethernet 1/2. The default configuration also configures Ethernet1/1 as outside.

**Before you begin**

- Install an SFP for the Management port—The Management port is a 1/10-Gb SFP port that requires an SFP module.
- Obtain a console adapter—The Secure Firewall 3100 ships with a DB-9 to RJ-45 serial cable, so you may need to buy a third party DB-9-to-USB serial cable to make the connection.

**Procedure**

- 
- Step 1** Install the chassis. See the [hardware installation guide](#).
- Step 2** Connect your management computer to either of the following interfaces:
- **Ethernet 1/2**—Ethernet 1/2 has a default IP address (192.168.1.1) and also runs a DHCP server to provide IP addresses to clients (including the management computer), so make sure these settings do not conflict with any existing inside network settings (see [Secure Firewall 3100 Default Configuration, on page 174](#)). Only clients on 192.168.1.0/24 can access the ASA.  
  
If you need to change the Ethernet 1/2 IP address from the default, you must also cable your management computer to the console port. See [\(Optional\) Change the IP Address, on page 177](#).
  - **Management 1/1**—Management 1/1 obtains an IP address from a DHCP server on your management network; if you use this interface, you must determine the IP address assigned to the ASA so that you can connect to the IP address from your management computer.
- You can later configure ASA management access from other interfaces; see the [ASA general operations configuration guide](#).
- Step 3** Connect the outside network to the Ethernet1/1 interface.  
For Smart Software Licensing, the ASA needs internet access.
- Step 4** Connect other networks to the remaining interfaces.
- 

## Power on the Firewall

System power is controlled by a rocker power switch located on the rear of the firewall. The power switch is implemented as a soft notification switch that supports graceful shutdown of the system to reduce the risk of system software and data corruption.

**Procedure**

- 
- Step 1** Attach the power cord to the firewall, and connect it to an electrical outlet.
- Step 2** Turn the power on using the standard rocker-type power on/off switch located on the rear of the chassis, adjacent to the power cord.
- Step 3** Check the Power LED on the back of the firewall; if it is solid green, the firewall is powered on.

Figure 133: System and Power LEDs

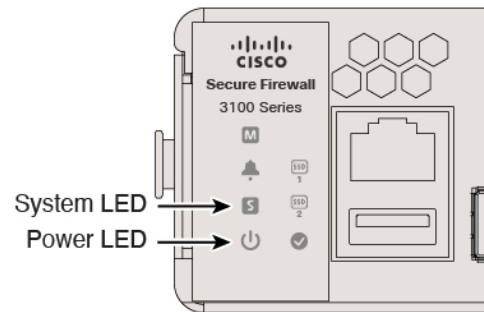

- Step 4** Check the System LED on the back of the firewall; after it is solid green, the system has passed power-on diagnostics.

**Note** When the switch is toggled from ON to OFF, it may take several seconds for the system to eventually power off. During this time, the Power LED on the front of the chassis blinks green. Do not remove the power until the Power LED is completely off.

## (Optional) Change the IP Address

If you cannot use the default IP address for ASDM access, you can set the IP address of the inside interface at the ASA CLI.



**Note** This procedure restores the default configuration and also sets your chosen IP address, so if you made any changes to the ASA configuration that you want to preserve, do not use this procedure.

### Procedure

- Step 1** Connect to the ASA console port, and enter global configuration mode. See [Access the ASA and FXOS CLI, on page 187](#) for more information.
- Step 2** Restore the default configuration with your chosen IP address.

**configure factory-default** [*ip\_address* [*mask*]]

#### Example:

```
ciscoasa(config)# configure factory-default 10.1.1.151 255.255.255.0
Based on the management IP address and mask, the DHCP address
pool size is reduced to 103 from the platform limit 256
```

```
WARNING: The boot system configuration will be cleared.
The first image found in disk0:/ will be used to boot the
system on the next reload.
Verify there is a valid image on disk0:/ or the system will
not boot.
```

```
Begin to apply factory-default configuration:
Clear all configuration
Executing command: interface ethernet1/2
Executing command: nameif inside
INFO: Security level for "inside" set to 100 by default.
Executing command: ip address 10.1.1.151 255.255.255.0
Executing command: security-level 100
Executing command: no shutdown
Executing command: exit
Executing command: http server enable
Executing command: http 10.1.1.0 255.255.255.0 management
Executing command: dhcpd address 10.1.1.152-10.1.1.254 management
Executing command: dhcpd enable management
Executing command: logging asdm informational
Factory-default configuration is completed
ciscoasa(config)#
```

**Step 3** Save the default configuration to flash memory.

**write memory**

---

## Log Into ASDM

Launch ASDM so you can configure the ASA.

The ASA includes 3DES capability by default for management access only, so you can connect to the Smart Software Manager and also use ASDM immediately. You can also use SSH and SCP if you later configure SSH access on the ASA. Other features that require strong encryption (such as VPN) must have Strong Encryption enabled, which requires you to first register to the Smart Software Manager.



**Note** If you attempt to configure any features that can use strong encryption before you register—even if you only configure weak encryption—then your HTTPS connection will be dropped on that interface, and you cannot reconnect. The exception to this rule is if you are connected to a management-only interface, such as Management 1/1. SSH is not affected. If you lose your HTTPS connection, you can connect to the console port to reconfigure the ASA, connect to a management-only interface, or connect to an interface not configured for a strong encryption feature.

---

### Before you begin

- See the [ASDM release notes](#) on Cisco.com for the requirements to run ASDM.

### Procedure

---

**Step 1** Enter the following URL in your browser.

- **https://192.168.1.1**—Inside (Ethernet 1/2) interface IP address.
- **https://management\_ip**—Management interface IP address assigned from DHCP.

**Note** Be sure to specify **https://**, and not **http://** or just the IP address (which defaults to HTTP); the ASA does not automatically forward an HTTP request to HTTPS.

The **Cisco ASDM** web page appears. You may see browser security warnings because the ASA does not have a certificate installed; you can safely ignore these warnings and visit the web page.

- Step 2** Click **Install ASDM Launcher**.
- Step 3** Follow the onscreen instructions to launch ASDM.  
The **Cisco ASDM-IDM Launcher** appears.
- Step 4** Leave the username and password fields empty, and click **OK**.  
The main ASDM window appears.

---

## Configure Licensing

The ASA uses Smart Licensing. You can use regular Smart Licensing, which requires internet access; or for offline management, you can configure Permanent License Reservation or a Smart Software Manager On-Prem (formerly known as a Satellite server). For more information about these offline licensing methods, see [Cisco ASA Series Feature Licenses](#); this guide applies to regular Smart Licensing.

For a more detailed overview on Cisco Licensing, go to [cisco.com/go/licensingguide](https://cisco.com/go/licensingguide)

When you register the chassis, the Smart Software Manager issues an ID certificate for communication between the firewall and the Smart Software Manager. It also assigns the firewall to the appropriate virtual account. Until you register with the Smart Software Manager, you will not be able to make configuration changes to features requiring special licenses, but operation is otherwise unaffected. Licensed features include:

- Essentials
- Security Contexts
- Carrier—Diameter, GTP/GPRS, M3UA, SCTP
- Strong Encryption (3DES/AES)—If your Smart Account is not authorized for strong encryption, but Cisco has determined that you are allowed to use strong encryption, you can manually add a strong encryption license to your account.
- Cisco Secure Client—Secure Client Advantage, Secure Client Premier, or Secure Client VPN Only.

The ASA includes 3DES capability by default for management access only, so you can connect to the Smart Software Manager and also use ASDM immediately. You can also use SSH and SCP if you later configure SSH access on the ASA. Other features that require strong encryption (such as VPN) must have Strong Encryption enabled, which requires you to first register to the Smart Software Manager.



**Note** If you attempt to configure any features that can use strong encryption before you register—even if you only configure weak encryption—then your HTTPS connection will be dropped on that interface, and you cannot reconnect. The exception to this rule is if you are connected to a management-only interface, such as Management 1/1. SSH is not affected. If you lose your HTTPS connection, you can connect to the console port to reconfigure the ASA, connect to a management-only interface, or connect to an interface not configured for a strong encryption feature.

When you request the registration token for the ASA from the Smart Software Manager, check the **Allow export-controlled functionality on the products registered with this token** check box so that the full Strong Encryption license is applied (your account must be qualified for its use). The Strong Encryption license is automatically enabled for qualified customers when you apply the registration token on the chassis, so no additional action is required. If your Smart Account is not authorized for strong encryption, but Cisco has determined that you are allowed to use strong encryption, you can manually add a strong encryption license to your account.

### Before you begin

- Have a master account on the [Smart Software Manager](#).

If you do not yet have an account, click the link to [set up a new account](#). The Smart Software Manager lets you create a master account for your organization.

- Your Smart Software Manager account must qualify for the Strong Encryption (3DES/AES) license to use some features (enabled using the export-compliance flag).

### Procedure

#### Step 1

Make sure your Smart Licensing account contains the available licenses you need, including at a minimum the Essentials license.

When you bought your device from Cisco or a reseller, your licenses should have been linked to your Smart Software License account. However, if you need to add licenses yourself, use the **Search All** field on the [Cisco Commerce Workspace](#).

*Figure 134: License Search*

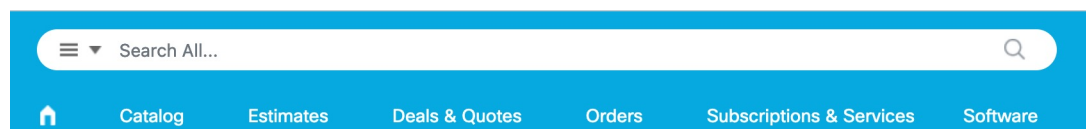

Choose **Products & Services** from the results.

Figure 135: Results

| All Results                  |          |
|------------------------------|----------|
| Orders                       | 6        |
| Invoices                     | 2        |
| Software Subsc...            | 1        |
| <b>Products &amp; Ser...</b> | <b>1</b> |

Search for the following license PIDs:

**Note** If a PID is not found, you can add the PID manually to your order.

- Essentials license—L-FPR3110-BSE=. The Essentials license is a required license.
- Essentials license—L-FPR3120-BSE=. The Essentials license is a required license.
- Essentials license—L-FPR3130-BSE=. The Essentials license is a required license.
- Essentials license—L-FPR3140-BSE=. The Essentials license is a required license.
- 5 context license—L-FPR3K-ASASC-5=. Context licenses are additive; buy multiple licenses to meet your needs.
- 10 context license—L-FPR3K-ASASC-10=. Context licenses are additive; buy multiple licenses to meet your needs.
- Carrier (Diameter, GTP/GPRS, M3UA, SCTP)—L-FPR3K-ASA-CAR=
- Strong Encryption (3DES/AES) license—L-FPR3K-ENC-K9=. Only required if your account is not authorized for strong encryption.
- Cisco Secure Client—See the [Cisco Secure Client Ordering Guide](#). You do not enable this license directly in the ASA.

## Step 2

In the [Cisco Smart Software Manager](#), request and copy a registration token for the virtual account to which you want to add this device.

- a) Click **Inventory**.

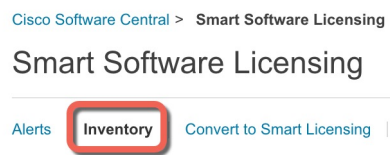

- b) On the **General** tab, click **New Token**.

### Product Instance Registration Tokens

The registration tokens below can be used to register new product instances t

| Token                                                                                                 | Expiration Date                   | Uses    |
|-------------------------------------------------------------------------------------------------------|-----------------------------------|---------|
| OWFINTZIYTgtY2Ew...  | 2024-May-18 17:41:53 (in 30 days) | 0 of 10 |

- c) On the **Create Registration Token** dialog box enter the following settings, and then click **Create Token**:

#### Create Registration Token ? x

This will create a token that is used to register product instances, so that they can use licenses from this virtual account. Once it's created, go to the Smart Licensing configuration for your products and enter the token, to register them with this virtual account.

Virtual Account: XXXXXXXXXX

Description:

\* Expire After:  Days  
*Between 1 - 365, 30 days recommended*

Max. Number of Uses:

*The token will be expired when either the expiration or the maximum uses is reached*

Allow export-controlled functionality on the products registered with this token 

- **Description**
- **Expire After**—Cisco recommends 30 days.
- **Max. Number of Uses**
- **Allow export-controlled functionality on the products registered with this token**—Enables the export-compliance flag.

The token is added to your inventory.

- d) Click the arrow icon to the right of the token to open the **Token** dialog box so you can copy the token ID to your clipboard. Keep this token ready for later in the procedure when you need to register the ASA.



Figure 136: View Token

**General** | Licenses | Product Instances | Event Log

**Virtual Account**

Description: [blurred]

Default Virtual Account: No

---

**Product Instance Registration Tokens**

The registration tokens below can be used to register new product instances to this virtual account.

[New Token...](#)

| Token                                                                                              | Expiration Date                   | Uses    | Export-Controlled |
|----------------------------------------------------------------------------------------------------|-----------------------------------|---------|-------------------|
| OWFINTZIYgtY2Ew.  | 2024-May-18 17:41:53 (in 30 days) | 0 of 10 | Allowed           |

Figure 137: Copy Token

**Token** ? X

MjM3ZjhhYThhZGQ4OS00Yjk2LTgzMGltMThmZTUyYjkyNmVhLTE1MDI5MTI1%0AMTMxMzh8YzdQdmgzMjA2VmFJN2dYQjI5QWRhOEpscDU4cWI5NFNWRUtsa2wz%0AMDd0ST0%3D%0A

Press **ctrl + c** to copy selected text to clipboard.

MjM3ZjhhYThhZGQ4OS00Yjk2LT... 2017-Aug-16 1

- Step 3** In ASDM, choose **Configuration** > **Device Management** > **Licensing** > **Smart Licensing**.
- Step 4** Click **Register**.

Configuration > Device Management > Licensing > Smart Licensing

To configure an HTTP proxy for smart licensing, see the [Smart Call-Home](#) page. Note that Smart Call Home is automatically enabled and is required for smart licensing.

Enable Smart license configuration

Feature Tier: -- None --

Throughput Level: -- None --

Privacy  Host Name  Version

Transport  Call Home  Smart Transport

Configure Transport URL

Default  URL

Registration

Utility

Proxy URL

Proxy Port

Configure Utility Mode

Enable Standard Utility Mode

Custom ID

Customer Company Identifier

Customer Company Name

Customer Street

Customer City

Customer State

Customer Country

Customer Postal Code

Registration Status: UNREGISTERED

Effective Running Licenses

| License Feature     | License Value |
|---------------------|---------------|
| Maximum VLANs       | 200           |
| Inside Hosts        | Unlimited     |
| Failover            | Active/Active |
| Encryption-DES      | Enabled       |
| Encryption-3DES-AES | Enabled       |
| Security Contexts   | 2             |
| Carrier             | Disabled      |

**Step 5** Enter the registration token in the **ID Token** field.

Smart License Registration

ID Token:

Force registration

You can optionally check the **Force registration** check box to register the ASA that is already registered, but that might be out of sync with the Smart Software Manager. For example, use **Force registration** if the ASA was accidentally removed from the Smart Software Manager.

**Step 6** Click **Register**.

The ASA registers with the Smart Software Manager using the pre-configured outside interface, and requests authorization for the configured license entitlements. The Smart Software Manager also applies the Strong Encryption (3DES/AES) license if your account allows. ASDM refreshes the page when the license status is updated. You can also choose **Monitoring > Properties > Smart License** to check the license status, particularly if the registration fails.

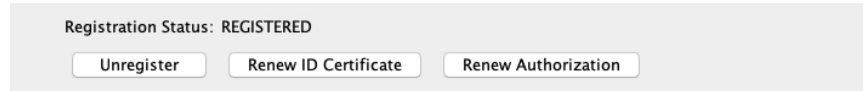
**Step 7**

Set the following parameters:

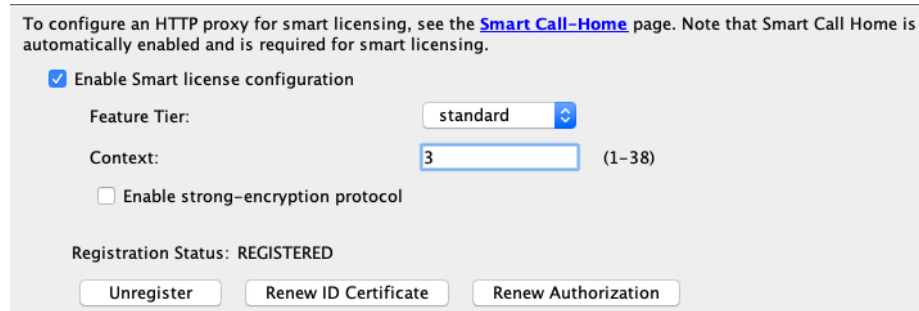

- a) Check **Enable Smart license configuration**.
- b) From the **Feature Tier** drop-down list, choose **Essentials**.

Only the Essentials tier is available.

- c) (Optional) For the **Context** license, enter the number of contexts.

You can use 2 contexts without a license. The maximum number of contexts depends on your model:

- Secure Firewall 3100—100 contexts

For example, to use the maximum of 100 contexts on the Secure Firewall 3110, enter 98 for the number of contexts; this value is added to the default of 2.

**Step 8**

Click **Apply**.

**Step 9**

Click the **Save** icon in the toolbar.

**Step 10**

Quit ASDM and relaunch it.

When you change licenses, you need to relaunch ASDM to show updated screens.

## Configure the ASA

Using ASDM, you can use wizards to configure basic and advanced features. You can also manually configure features not included in wizards.

## Procedure

**Step 1** Choose **Wizards > Startup Wizard**, and click the **Modify existing configuration** radio button.

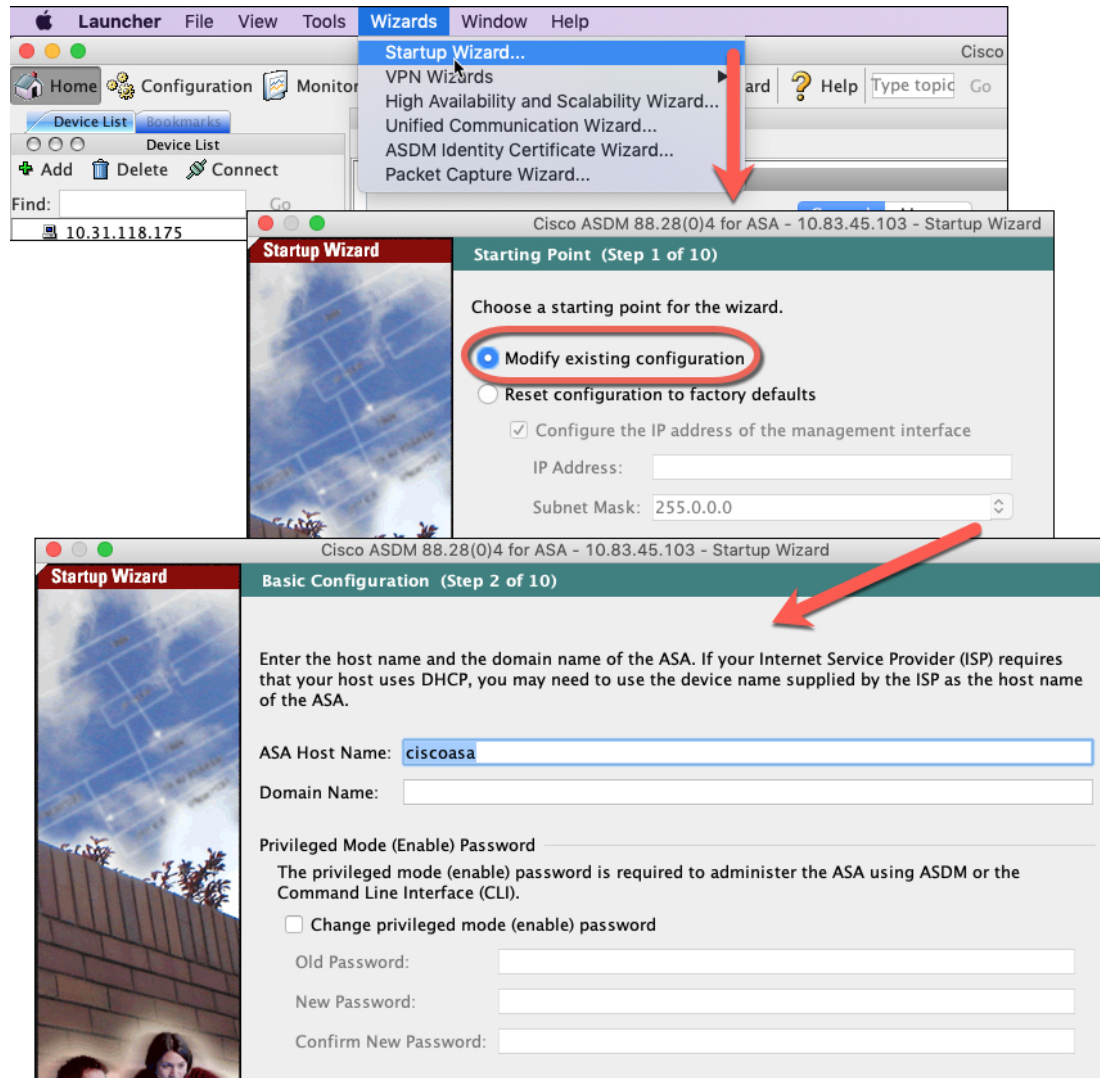

**Step 2** The **Startup Wizard** walks you through configuring:

- The enable password
- Interfaces, including setting the inside and outside interface IP addresses and enabling interfaces.
- Static routes
- The DHCP server
- And more...

**Step 3** (Optional) From the **Wizards** menu, run other wizards.

- Step 4** To continue configuring your ASA, see the documents available for your software version at [Navigating the Cisco ASA Series Documentation](#).
- 

## Access the ASA and FXOS CLI

You can use the ASA CLI to troubleshoot or configure the ASA instead of using ASDM. You can access the CLI by connecting to the console port. You can later configure SSH access to the ASA on any interface; SSH access is disabled by default. See the [ASA general operations configuration guide](#) for more information.

You can also access the FXOS CLI from the ASA CLI for troubleshooting purposes.

### Procedure

---

- Step 1** Connect your management computer to the console port. Be sure to install any necessary serial drivers for your operating system. Use the following serial settings:
- 9600 baud
  - 8 data bits
  - No parity
  - 1 stop bit

You connect to the ASA CLI. There are no user credentials required for console access by default.

- Step 2** Access privileged EXEC mode.

**enable**

You are prompted to change the password the first time you enter the **enable** command.

#### Example:

```
ciscoasa> enable
Password:
The enable password is not set. Please set it now.
Enter Password: *****
Repeat Password: *****
ciscoasa#
```

The enable password that you set on the ASA is also the FXOS **admin** user password if the ASA fails to boot up, and you enter FXOS failsafe mode.

All non-configuration commands are available in privileged EXEC mode. You can also enter configuration mode from privileged EXEC mode.

To exit privileged EXEC mode, enter the **disable**, **exit**, or **quit** command.

- Step 3** Access global configuration mode.

**configure terminal**

#### Example:

```
ciscoasa# configure terminal
ciscoasa(config)#
```

You can begin to configure the ASA from global configuration mode. To exit global configuration mode, enter the **exit**, **quit**, or **end** command.

**Step 4** (Optional) Connect to the FXOS CLI.

**connect fxos [admin]**

- **admin**—Provides admin-level access. Without this option, users have read-only access. Note that no configuration commands are available even in admin mode.

You are not prompted for user credentials. The current ASA username is passed through to FXOS, and no additional login is required. To return to the ASA CLI, enter **exit** or type **Ctrl-Shift-6, x**.

Within FXOS, you can view user activity using the **scope security/show audit-logs** command.

**Example:**

```
ciscoasa# connect fxos admin
Connecting to fxos.
Connected to fxos. Escape character sequence is 'CTRL-^X'.
firepower#
firepower# exit
Connection with FXOS terminated.
Type help or '?' for a list of available commands.
ciscoasa#
```

## What's Next?

- To continue configuring your ASA, see the documents available for your software version at [Navigating the Cisco ASA Series Documentation](#).
- For troubleshooting, see the [FXOS troubleshooting guide](#).



