



# Preferred Architecture for Cisco Collaboration 14 Enterprise On-Premises Deployments

Cisco Validated Design (CVD) Guide

Revised: May 21, 2021

**Cisco Systems, Inc.**  
[www.cisco.com](http://www.cisco.com)

Cisco has more than 200 offices worldwide.  
Addresses, phone numbers, and fax numbers  
are listed on the Cisco website at  
[www.cisco.com/go/offices](http://www.cisco.com/go/offices).

First Published: May 21, 2021



THE SPECIFICATIONS AND INFORMATION REGARDING THE PRODUCTS IN THIS MANUAL ARE SUBJECT TO CHANGE WITHOUT NOTICE. ALL STATEMENTS, INFORMATION, AND RECOMMENDATIONS IN THIS MANUAL ARE BELIEVED TO BE ACCURATE BUT ARE PRESENTED WITHOUT WARRANTY OF ANY KIND, EXPRESS OR IMPLIED. USERS MUST TAKE FULL RESPONSIBILITY FOR THEIR APPLICATION OF ANY PRODUCTS.

THE SOFTWARE LICENSE AND LIMITED WARRANTY FOR THE ACCOMPANYING PRODUCT ARE SET FORTH IN THE INFORMATION PACKET THAT SHIPPED WITH THE PRODUCT AND ARE INCORPORATED HEREIN BY THIS REFERENCE. IF YOU ARE UNABLE TO LOCATE THE SOFTWARE LICENSE OR LIMITED WARRANTY, CONTACT YOUR CISCO REPRESENTATIVE FOR A COPY.

The Cisco implementation of TCP header compression is an adaptation of a program developed by the University of California, Berkeley (UCB) as part of UCB's public domain version of the UNIX operating system. All rights reserved. Copyright © 1981, Regents of the University of California.

NOTWITHSTANDING ANY OTHER WARRANTY HEREIN, ALL DOCUMENT FILES AND SOFTWARE OF THESE SUPPLIERS ARE PROVIDED "AS IS" WITH ALL FAULTS. CISCO AND THE ABOVE-NAMED SUPPLIERS DISCLAIM ALL WARRANTIES, EXPRESSED OR IMPLIED, INCLUDING, WITHOUT LIMITATION, THOSE OF MERCHANTABILITY, FITNESS FOR A PARTICULAR PURPOSE AND NONINFRINGEMENT OR ARISING FROM A COURSE OF DEALING, USAGE, OR TRADE PRACTICE.

IN NO EVENT SHALL CISCO OR ITS SUPPLIERS BE LIABLE FOR ANY INDIRECT, SPECIAL, CONSEQUENTIAL, OR INCIDENTAL DAMAGES, INCLUDING, WITHOUT LIMITATION, LOST PROFITS OR LOSS OR DAMAGE TO DATA ARISING OUT OF THE USE OR INABILITY TO USE THIS MANUAL, EVEN IF CISCO OR ITS SUPPLIERS HAVE BEEN ADVISED OF THE POSSIBILITY OF SUCH DAMAGES.

Cisco and the Cisco logo are trademarks or registered trademarks of Cisco and/or its affiliates in the U.S. and other countries. To view a list of Cisco trademarks, go to this URL: [www.cisco.com/go/trademarks](http://www.cisco.com/go/trademarks). Third-party trademarks mentioned are the property of their respective owners. The use of the word partner does not imply a partnership relationship between Cisco and any other company. (1721R)

Any Internet Protocol (IP) addresses and phone numbers used in this document are not intended to be actual addresses and phone numbers. Any examples, command display output, network topology diagrams, and other figures included in the document are shown for illustrative purposes only. Any use of actual IP addresses or phone numbers in illustrative content is unintentional and coincidental.

© 2014-2021 Cisco Systems, Inc. All rights reserved.



## **Preface** xv

Documentation for Enterprise Collaboration	xv
About This Guide	xvi
Revision History	xvii
Obtaining Documentation and Submitting a Service Request	xvii
Conventions	xvii

---

## **CHAPTER 1**

### **Introduction** 1-1

What's New in This Chapter	1-1
Architectural Overview	1-2
Virtualization	1-5
Cisco Business Edition 7000 (BE7000)	1-5
Cisco Unified Communications on the Cisco Unified Computing System (UCS)	1-5
Core Applications	1-6
Collaboration Endpoints	1-6

---

## **CHAPTER 2**

### **Call Control** 2-1

What's New in This Chapter	2-1
Core Components	2-2
Key Benefits	2-3
Architecture	2-3
Unified CM Redundancy with Survivable Remote Site Telephony (SRST)	2-4
Unified CM and IM and Presence Service Clustering	2-4
High Availability	2-5
Computer Telephony Integration (CTI)	2-6
CTI Architecture	2-6
High Availability for CTI	2-7
Capacity Planning for CTI	2-7
IM and Presence Architecture	2-7
Deployment of the Unified CM and IM and Presence Service Cluster	2-8
Integration with Apple Push Notification Service (APNs)	2-9
Endpoints	2-11

Multi-Cluster Considerations	2-12
Topology Example	2-13
Certificate Considerations	2-13
DNS Considerations	2-13
Endpoint Addressing	2-14
+E.164 Routing and Dialing Normalization	2-14
Classes of Service and Calling Search Spaces (CSSs)	2-15
Outbound Gateway Selection Using Local Route Group	2-16
Outbound Calls: Called and Calling Number Localization	2-16
Inbound Calls: Called and Calling Number Globalization	2-16
User Provisioning with LDAP Synchronization	2-16
User Authentication with LDAP	2-17
Deployment Overview	2-18
DNS Requirements	2-18
Provision the Cisco Unified CM and IM and Presence Service Cluster	2-19
Cisco Unified CM and IM and Presence Service Certificate Management	2-20
Initial Cisco Unified CM Configuration	2-20
Node Name Configuration	2-20
Enterprise Parameter Settings	2-21
Service Activation	2-22
Service Parameter Settings	2-23
Onboarding for Push Notifications via Apple Push Notification Service (APNs)	2-25
Other IM and Presence Settings	2-26
Dial Plan Configuration	2-27
Example Topology	2-27
Endpoint Addressing	2-27
Addressing Enterprise Services for External Access	2-27
General Numbering Plan	2-28
Dialing Habits	2-29
Partitions	2-30
Dialing Normalization Translation Patterns	2-32
Classes of Service and Calling Search Spaces (CSSs)	2-34
Special CSSs	2-36
Local Route Groups for Call Type Specific Outbound Gateway Selection	2-38
Route Lists Using Local Route Groups	2-39
Route Patterns for PSTN Access and Emergency Calls	2-39
Emergency Call Considerations in Multi-National Environments	2-42
Route Patterns for Video PSTN (ISDN) Calls	2-43
Outbound Calls: Called and Calling Number Transformations on ISDN Gateways	2-44
Outbound Calls: Called and Calling Number Transformations on SIP Trunks	2-46

Inbound Calls: Called and Calling Number Transformations on ISDN Gateways	2-47
Inbound Calls: Called and Calling Number Transformations on SIP Trunks	2-48
Calling Party Information Display on Phones	2-48
Automated Alternate Routing	2-50
Alternate Routing for Unregistered Endpoints	2-51
LDAP System Configuration	2-52
LDAP Custom Filter	2-52
Feature Group Templates	2-53
LDAP Synchronization Agreements	2-54
User Authentication with LDAP	2-56
Cisco Unified CM Group Configuration	2-56
Phone NTP References	2-57
Date and Time Groups	2-57
Media Resources	2-58
Media Resource Manager	2-58
Media Resource Selection and Avoiding the Default MRG	2-58
Cisco IP Voice Media Streaming Application	2-58
MRG and MRGL Definitions	2-59
Device Pools	2-61
SIP Trunks	2-66
SIP Profiles	2-66
SIP Trunk Security Profiles	2-67
SIP Trunk Connections	2-68
Route Groups	2-71
Specific Non-LRG Route Lists	2-72
Endpoint Provisioning	2-72
Configure the Device	2-73
Configure the Line	2-74
Add the Device to Devices Controlled by the User	2-76
Configure the Line Association for Presence	2-76
Verify the User's Primary Extension	2-76
Jabber Provisioning	2-76
ILS Configuration for Multi-Cluster Deployments	2-77
Assign Unique Cluster IDs for Each Unified CM Cluster in the Network	2-78
Activate ILS on the First ILS Hub Cluster in the Network	2-78
Activate ILS on the Remaining ILS Clusters in the Network	2-79
Consider UDS Certificate Requirements	2-79
GDPR Configuration (Multi-Cluster Only)	2-80
Advertise URIs	2-80
Configure Advertised Patterns	2-80

Configure Partitions for Learned Numbers and Patterns	2-81
Configure Intercluster Trunks	2-82
Configure SIP Route Patterns	2-82
Example GDPR Call Flow	2-83
IM and Presence Intercluster	2-84
Survivable Remote Site Telephony (SRST) Deployment	2-84
Deployment	2-84
Provisioning	2-85
Extension Mobility	2-86
Deploying Extension Mobility	2-87
Busy Line Field (BLF) Presence	2-87
Deploying BLF Presence	2-87
Deploying Computer Telephony Integration (CTI)	2-88

**CHAPTER 3****Conferencing 3-1**

What's New in This Chapter	3-1
Core Components	3-2
Key Benefits	3-2
Conference Types	3-3
Architecture	3-3
Role of Cisco Meeting Server	3-6
Role of Cisco TMS	3-8
Role of Cisco TMS Extensions for Microsoft Exchange	3-8
Role of Cisco Meeting Management	3-8
Deployment Overview	3-9
Requirements and Recommendations	3-10
Conference Call Flows	3-10
Instant Conferences	3-10
Permanent Conferences with Cisco Meeting Server Spaces	3-11
Scheduled Conferences	3-11
Third-Party Endpoints	3-12
High Availability for Conferencing	3-12
Cisco Meeting Server High Availability	3-12
TMS High Availability	3-16
Cisco Meeting Management High Availability	3-16
Security for Conferencing	3-17
Scaling the Conferencing Solution	3-17
Considerations for Multiple Unified CM Clusters	3-17
Conferencing Deployment Process	3-20

1. Plan the Conferencing Deployment	3-20
Requirements	3-20
Licensing	3-21
Cisco TelePresence Management Suite	3-22
2. Deploy Cisco Meeting Servers	3-24
Overview	3-24
Deployment Considerations	3-24
Deployment Tasks for Cisco Meeting Servers	3-25
Summary	3-27
3. Enable Unified CM for Conferences	3-28
Overview	3-28
Deployment Considerations	3-29
Deployment Tasks to Enable Unified CM for Instant Conferences	3-29
Deployment Tasks to Enable Unified CM for Permanent and Scheduled Conferences	3-32
Summary	3-33
4. Deployment Tasks for Active Control	3-33
5. Deploy Cisco TelePresence Management Suite	3-35
Overview	3-35
Deployment Tasks for Cisco TMS High Availability	3-35
Deployment Tasks for Cisco TMS Basic Configuration	3-37
Deployment Tasks for Cisco TMS for Scheduled Conferences	3-40
Summary	3-46
6. Deploy Cisco Meeting Server Spaces	3-46
Overview	3-46
Deployment Considerations	3-46
Deployment Tasks for Unified CM for Cisco Meeting Server Permanent Conferences	3-47
Deployment Tasks for Cisco Meeting Server to Create Spaces	3-48
Summary	3-50
7. Deploy Cisco Meeting Management	3-51
Overview	3-51
Deployment Considerations	3-51
Deployment Tasks for Cisco Meeting Management	3-51
Summary	3-57
Related Documentation	3-57

**CHAPTER 4****Collaboration Edge 4-1**

What's New in This Chapter 4-1

Core Components 4-1

Key Benefits 4-2

Architecture	4-2
Role of Expressway-C and Expressway-E for Internet Access	4-4
Mobile and Remote Access	4-5
Business-to-Business Communications	4-6
Instant Messaging and Presence Federation	4-7
PSTN Access	4-7
Role of the Cisco Unified Border Element	4-7
Role of Voice Gateways	4-8
Deployment Overview	4-9
Deployment of Expressway for Internet Connectivity	4-9
Mobile and Remote Access	4-12
Business-to-Business Communications	4-16
IP-based Dialing for Business-to-Business Calls	4-18
Deployment of External XMPP Federation through Expressway	4-19
Deployment of Cisco Unified Border Element for PSTN Voice Connection Through a SIP Trunk	4-20
PSTN Gateways	4-22
High Availability for Collaboration Edge	4-23
High Availability for Expressway-C and Expressway-E	4-23
High Availability for Cisco Unified Border Element	4-25
High Availability for Voice Gateways	4-26
Security for Collaboration Edge	4-27
Security for Expressway-C and Expressway-E	4-27
Network Level Protection	4-27
Mobile and Remote Access	4-27
Business-to-Business Communications	4-28
Security for Cisco Unified Border Element	4-30
Security for Voice Gateways	4-31
Scaling the Collaboration Edge Solution	4-31
Scaling the Internet Edge Solution	4-31
Mobile and Remote Access	4-31
Business-to-Business Communications	4-35
Scaling the Cisco Unified Border Element	4-39
Scaling the PSTN Solution	4-43
Collaboration Edge Deployment Process	4-44
Deploy Expressway-C and Expressway-E	4-44
Deploy Mobile and Remote Access	4-44
Deploy Business-to-Business Communications	4-45
Deploy Cisco Unified Border Element	4-46
Deploy Cisco Voice Gateways	4-51



## CHAPTER 5

**Voice Messaging 5-1**

- What's New in This Chapter 5-1
- Prerequisites 5-1
- Unified Messaging with Cisco Unity Connection 5-2
  - Core Components 5-2
  - Key Benefits 5-2
- Architecture 5-3
  - Centralized Messaging and Centralized Call Processing 5-3
  - Role of Unified CM 5-4
  - Role of Unity Connection 5-4
  - Role of Microsoft Exchange 5-4
  - High Availability for Unified Messaging 5-5
  - Licensing Requirements 5-6
  - Unified Messaging Requirements 5-7
  - Scaling Unity Connection 5-7
- Cisco Unity Connection Deployment Process 5-7
  - Prerequisites 5-7
  - Deployment Overview 5-8
    1. Provision the Unity Connection Cluster 5-8
      - Publisher 5-8
      - Subscriber 5-8
      - Unity Connection Mailbox Stores 5-8
      - Prerequisite for Unity Connection Cluster Deployment When the Servers Are to Be Installed in the Same Building 5-9
      - Prerequisite for Unity Connection Cluster Deployment When the Servers Are to Be Installed in Separate Buildings 5-9
      - To Deploy Unity Connection Cluster 5-10
    2. Configure Unified CM for Unity Connection Integration 5-10
      - Unity Connection Application Username and Server for End User PIN Synchronization 5-10
      - SIP Trunk Security Profile 5-11
      - SIP Profile 5-12
      - SIP Trunk 5-13
      - Route Group 5-14
      - Route List 5-14
      - Route Pattern 5-14
      - Voice Mail Pilot 5-14
      - Voice Profile 5-15
    3. Unity Connection Base Configuration 5-16
      - Service Activation 5-16

Database Replication	5-16
Unified CM Integration	5-16
Voicemail Port Audio Codec Configuration	5-17
System Settings	5-18
Phone System Settings	5-18
Port Group Settings	5-19
Voice Messaging Port Sizing Considerations	5-20
Port Settings	5-21
Active Directory Integration	5-21
Unity Connection Partitions and CSS	5-22
Restriction Tables	5-22
Class of Service	5-23
User Provisioning	5-23
Unity Connection User Self Enrollment	5-24
4. Enable Single Inbox	5-25
Perquisites for Enabling Single Inbox with Unity Connection	5-25
Unity Connection Certificate Management	5-25
Confirm the Exchange Authentication and SSL Settings for Unity Connection	5-25
Configure SMTP Proxy Addresses in Unity Connection	5-25
Create Unified Messaging Services Account in Active Directory and Grant Permissions for Unity Connection	5-26
SMTP Smart Host	5-26
Unified Messaging Service	5-27
Unified Messaging Account	5-27
Voice Mail User COS	5-27
Install ViewMail for Outlook on User Workstations	5-28
5. Enable Visual Voicemail	5-28
Unity Connection Configuration	5-28
Unified CM Configuration	5-28
6. Voice Mail in SRST Mode	5-29
Unified CM Configuration	5-30
Branch SRST Router Configuration	5-30
7. HTTPS Internetworking of Two Unity Connection Clusters	5-30
Check the Display Name and SMTP Domain of Each Unity Connection Server	5-32
Create the HTTPS Network Between Unity Connection Clusters	5-32
Configure SMTP Access for Cluster Subscriber Servers	5-33
Replication Between the Locations	5-33
Add Remote Location Partition to Local Unity Connection CSS	5-34
Related Documentation	5-34

**CHAPTER 6****Collaboration Management Services 6-1**

- What's New in This Chapter 6-2
- Cisco Prime Collaboration Deployment 6-2
  - Core Components 6-2
  - Benefits 6-2
  - Architecture 6-3
    - High Availability for Cisco Prime Collaboration Deployment 6-4
    - Scaling Cisco Prime Collaboration Deployment 6-4
  - Cisco Prime Collaboration Deployment Process 6-4
    - Deploying the Cisco Prime Collaboration Deployment Application Server 6-4
    - Deploying Cisco Collaboration Application Server Clusters with Cisco Prime Collaboration Deployment 6-5
- Cisco Smart Software Manager 6-6
  - Core Components 6-6
  - Benefits 6-6
  - Architecture 6-6
    - High Availability for Cisco Smart Software Manager 6-8
    - Scaling Cisco Smart Software Manager 6-8
  - Cisco Smart Software Manager Deployment Process 6-9
    - Managing Licenses and Entitlement with the Cisco Smart Account and Smart Software Manager 6-9
    - Authorizing and Registering Collaboration Product Instances and Applying Licenses 6-9
- Webex Cloud-Connected UC 6-10
  - Core Components 6-10
  - Benefits 6-10
  - Architecture 6-10
    - High Availability for Webex Cloud-Connected UC 6-11
    - Scaling Webex Cloud-Connected UC 6-12
  - Webex Cloud-Connected UC Deployment Process 6-12
    - Managing Analytics, Reporting, and Monitoring with Webex Control Hub 6-12
    - Configuring Webex Cloud-Connected UC and Onboarding On-Premises Applications 6-12

**CHAPTER 7****Security 7-1**

- What's New in This Chapter 7-1
- Core Components 7-2
- Key Benefits 7-3
- Architecture 7-3
  - Security in Layers 7-3
    - Physical Security 7-4

Network Security	7-4
Preventing Unauthorized Access	7-8
Toll Fraud Mitigation	7-9
Certificate Management	7-11
Brief PKI Overview	7-11
General Guidance on Certificates	7-12
Cisco Unified CM and IM and Presence	7-17
Cisco Unity Connection	7-21
Cisco Expressway	7-21
Cisco Meeting Server	7-22
Cisco Meeting Management	7-22
Cisco Prime Collaboration Deployment	7-22
Encryption	7-23
TLS Overview	7-23
Cisco Unified CM with IM and Presence and Endpoints	7-25
Cipher Suite Support	7-26
Media and Signaling Encryption	7-28
TFTP Configuration File Confidentiality	7-29
Secure SRST	7-30
Cisco Meeting Server	7-30
Cisco Unity Connection	7-31
Cisco Expressway	7-31
Cisco IOS Gateway and Cisco Unified Border Element	7-32
Multi-Cluster Considerations	7-32
High Availability Considerations for Collaboration Security	7-33
Collaboration Security Capacity Planning	7-33
Deployment	7-33
Cisco Unified CM with IM and Presence and Endpoints	7-33
Cipher Suites Configuration	7-34
Server Certificate Generation and Management	7-34
Certificate Monitoring	7-37
LDAP over SSL Configuration	7-38
SIP Trunk Encryption	7-39
Media and Signaling Encryption on the Endpoints	7-40
Enable Secure Survivable Remote Site Telephony (SRST)	7-44
Cisco Unity Connection	7-44
Collaboration Edge	7-45
Cisco Expressway	7-45
Cisco IOS Gateways and Cisco Unified Border Element	7-50
Conferencing	7-52

Cisco Meeting Server	7-52
Cisco Meeting Management	7-54
Cisco TelePresence Management Suite	7-54
Collaboration Management Services	7-55
Multi-Cluster Considerations	7-55

**CHAPTER 8****Bandwidth Management 8-1**

What's New in This Chapter	8-1
Core Components	8-2
Recommended Deployment	8-3
Key Benefits	8-4
Architecture	8-4
Introduction	8-4
Collaboration Media	8-5
Audio versus Video	8-5
"Smart" Media Techniques (Media Resilience and Rate Adaptation)	8-7
The Self-Regulating Video Network, Prioritized Audio, and Opportunistic Video	8-9
QoS Architecture for Collaboration	8-9
Identification and Classification	8-10
WAN Queuing and Scheduling	8-20
Provisioning and Admission Control	8-23
Enhanced Locations Call Admission Control	8-24
Call Admission Control Architecture	8-24
Multi-Cluster Considerations	8-31
Design Considerations for Call Admission Control	8-38
Bandwidth Management Deployment	8-42
Deployment Overview	8-42
Identification and Classification	8-43
Access Layer Endpoint Identification and Classification	8-44
Application Server QoS	8-49
WAN Edge Identification and Classification	8-50
WAN Edge Queuing and Scheduling	8-56
Provisioning and Admission Control	8-58
Enhanced Locations CAC	8-59
Deploy Device Mobility for Mobile and Remote Access (MRA)	8-63
Bandwidth Allocation Guidelines	8-65

**CHAPTER 9****Sizing 9-1**

What's New in This Chapter	9-2
----------------------------	-----

Call Control	9-2
Unified CM Sizing	9-2
IM and Presence Sizing	9-4
SRST Sizing	9-6
Conferencing	9-6
Conference Port Usage Guidelines	9-6
Cisco Meeting Server Platform Sizing	9-7
Cisco TelePresence Management Suite (TMS)	9-8
Cisco Meeting Management	9-9
Collaboration Edge	9-9
Cisco Expressway Sizing	9-9
Cisco Unified Border Element Sizing	9-12
Voice Messaging	9-13
Collaboration Management Services	9-14
Cisco Prime Collaboration Deployment	9-14
Virtual Machine Placement and Platforms	9-15
Redundancy Consideration	9-16
Platforms	9-16

---

**APPENDIX A****Product List A-1**



## Preface

---

**Revised: May 21, 2021**

Cisco Validated Designs (CVDs) explain important design and deployment decisions based on common use cases and current system releases. They incorporate a broad set of technologies, features, and applications to address customer needs. Cisco engineers have comprehensively tested and documented the guidelines within the CVDs in order to provide faster, more reliable, and fully predictable deployment. CVDs provide a tested starting point for Cisco partners and customers to begin designing and deploying systems using their own setup and configuration.

## Documentation for Enterprise Collaboration

[Cisco Preferred Architecture \(PA\) Design Overview](#) guides help customers and sales teams select the appropriate architecture based on an organization's business requirements; understand the products that are used within the architecture; and obtain general design best practices. These guides support sales processes.

[Cisco Validated Design \(CVD\)](#) guides provide detailed steps for deploying the Cisco Preferred Architectures. These guides support planning, design, and implementation of the Preferred Architectures.

[Alternative Design Guides](#) — Are post-sales documents that describe optional designs that can be deployed as alternatives to the Preferred Architectures described in the PA overview guides and CVDs. The alternative design may start with the main PA as a foundation and build upon it; therefore, each alternative design guide may be used in conjunction with its corresponding PA overview guide and CVD. In some cases the Alternative Design Guides can be used as standalone guides.

[Cisco Collaboration System Solution Reference Network Design \(SRND\)](#) guide provides detailed design options for Cisco Collaboration. The SRND should be referenced when design requirements are outside the scope of Cisco Preferred Architectures.

## About This Guide

This Cisco Validated Design guide for the Cisco Enterprise Collaboration Preferred Architecture is for:

- Sales teams that sell, design, and deploy collaboration solutions
- Customers and sales teams who want detailed design best practices and ordered steps for deploying Cisco Collaboration

Readers of this guide should have a general knowledge of Cisco voice, video, and collaboration products and a basic understanding of how to deploy these products. We recommend that readers review the [Preferred Architecture for Cisco Collaboration System Release 14 On-Premises Deployments, Design Overview](#) before reading this CVD document.

The design decisions within this CVD are in line with the framework outlined in the latest version of the [Cisco Collaboration SRND](#). While the SRND offers many design and deployment options, in this document a single deployment recommendation is selected based on fundamental assumptions for the Preferred Architecture design. Different assumptions can certainly lead to different design decisions, which then should be validated against the SRND. For large deployments with unique needs and advanced customization, it is recommended to work with your Cisco Account Manager for guidance beyond that contained in this CVD or the SRND.

This guide simplifies the design and sales process by:

- Building upon the product and design recommendations of the [Preferred Architecture for Cisco Collaboration System Release 14 On-Premises Deployments, Design Overview](#)
- Detailing a collaboration architecture, identifying best practices, and explaining the reasoning behind those recommendations

This CVD guide is organized into the following discrete modules that integrate together to form the overall Collaboration solution:

- **Call Control** — Explains fundamental concepts of dial plan design, Computer Telephony Integration (CTI), Survivable Remote Site Telephony (SRST), IM and Presence, LDAP directory integration, SIP trunks, and other aspects of call control. This chapter also lists the best practices for deploying call control in the Enterprise Collaboration Preferred Architecture.
- **Conferencing** — Describes the types of conferences available in the Enterprise Collaboration Preferred Architecture and explains how to deploy conferencing capability.
- **Collaboration Edge** — Explains how to deploy Cisco Collaboration Edge components to provide remote registration services, external communications, and interoperability.
- **Voice Messaging** — Lists the various applications and deployment tools available in the Enterprise Collaboration Preferred Architecture, and focuses on two core applications for unified messaging and conference scheduling.
- **Collaboration Management Services** — Lists the core management applications that are considered to be a basic requirement and foundational to any collaboration solution such as Cisco Prime Collaboration Deployment to assist with installation of applications, Cisco Smart Software



Manager an Internet-based Cisco cloud service with web portal for managing collaboration user licenses and Cisco Webex Cloud-Connected UC (CCUC) providing centralized on-premises application analytics and operations from Webex Control Hub.

- **Security** — Provides simplified guidance on network access security, toll-fraud access protection, certificate management, and encryption for the Cisco Preferred Architecture (PA) for Enterprise Collaboration.
- **Bandwidth Management** — Provides a holistic approach to bandwidth management that incorporates an end-to-end Quality of Service (QoS) architecture, call admission control, and video rate adaptation and resiliency mechanisms to ensure the best possible user experience for deploying pervasive video over managed and unmanaged networks
- **Sizing** — Provides simplified sizing examples to size the components of the Enterprise Collaboration Preferred Architecture to fit the requirements of your deployment.

## Revision History

This CVD guide may be updated at any time without notice. You can obtain the latest version of this document online at:

<https://www.cisco.com/go/pa>

Visit the above website periodically and check for documentation updates by comparing the revision date of your copy with the revision date of the online document.

**Table 1** lists the revision history for this document.

**Table 1** *Revision History for This CVD Guide*

Revision Date	Comments
May 21, 2021	This document was created for Cisco Collaboration System Release (CSR) 14.

## Obtaining Documentation and Submitting a Service Request

For information on obtaining documentation, using the Cisco Bug Search Tool (BST), submitting a service request, and gathering additional information, see *What's New in Cisco Product Documentation* at: <https://www.cisco.com/c/en/us/td/docs/general/whatsnew/whatsnew.html>.

Subscribe to *What's New in Cisco Product Documentation*, which lists all new and revised Cisco technical documentation, as an RSS feed and deliver content directly to your desktop using a reader application. The RSS feeds are a free service.

## Conventions

This document uses the following conventions:

<b>bold font</b>	Commands and keywords and user-entered text appear in <b>bold font</b> .
------------------	--

<i>italic font</i>	Document titles, new or emphasized terms, and arguments for which you supply values are in <i>italic font</i> .
[ ]	Elements in square brackets are optional.
{ x   y   z }	Required alternative keywords are grouped in braces and separated by vertical bars.
[ x   y   z ]	Optional alternative keywords are grouped in brackets and separated by vertical bars.
string	A nonquoted set of characters. Do not use quotation marks around the string or the string will include the quotation marks.
<code>courier font</code>	Terminal sessions and information the system displays appear in <code>courier font</code> .
< >	Nonprinting characters such as passwords are in angle brackets.
[ ]	Default responses to system prompts are in square brackets.
!, #	An exclamation point (!) or a pound sign (#) at the beginning of a line of code indicates a comment line.

**Note**

Means *reader take note*. Notes contain helpful suggestions or references to material not covered in the manual.

**Tip**

Means *the following information will help you solve a problem*. The tips information might not be troubleshooting or even an action, but could be useful information, similar to a Timesaver.

**Caution**

Means *reader be careful*. In this situation, you might perform an action that could result in equipment damage or loss of data.

**Timesaver**

Means *the described action saves time*. You can save time by performing the action described in the paragraph.

**Warning****IMPORTANT SAFETY INSTRUCTIONS**

**This warning symbol means danger. You are in a situation that could cause bodily injury. Before you work on any equipment, be aware of the hazards involved with electrical circuitry and be familiar with standard practices for preventing accidents. Use the statement number provided at the end of each warning to locate its translation in the translated safety warnings that accompanied this device.**

**SAVE THESE INSTRUCTIONS****Warning**

**Statements using this symbol are provided for additional information and to comply with regulatory and customer requirements.**







# Introduction

**Revised: May 21, 2021**

In recent years, many new collaborative tools have been introduced to the market, enabling businesses to enhance communications and extend collaboration outside the walls of their businesses. Organizations realize the added value that collaboration applications bring to their businesses through increased employee productivity and enhanced customer relationships. Significant advances have been made in the collaboration space to simplify deployment, improve interoperability, and enhance the overall user experience.

Today's collaboration solutions offer organizations the ability to integrate video, audio, and web participants into a single, unified meeting experience. The guidelines within this Cisco Validated Design (CVD) guide are written with the overall collaboration architecture in mind. Subsystems are used for better organization of the content, and the recommendations within them are tested to ensure they align with recommendations in related subsystems.

## What's New in This Chapter

[Table 1-1](#) lists the topics that are new in this chapter or that have changed significantly from previous releases of this document.

**Table 1-1** *New or Changed Information Since the Previous Release of This Document*

New or Revised Topic	Described in:	Revision Date
Minor updates related to collaboration applications running on virtualized platform with ESXi 6.7 and 7.0	<a href="#">Virtualization</a>	May 21, 2021
Added Cisco Webex Desk Pro and removed end of sale DX, MX, and SX series endpoints	<a href="#">Table 1-3</a>	May 21, 2021
Added Cisco Webex Cloud-Connected Unified Communications (CCUC) component	<a href="#">Table 1-2</a>	May 21, 2021

# Architectural Overview

This CVD for the Enterprise Collaboration Preferred Architecture incorporates a subset of products from the total Cisco Collaboration portfolio that is best suited for the enterprise market segment. This Preferred Architecture deployment model is prescriptive, out-of-the-box, and built to scale with an organization as its business needs change. This prescriptive approach simplifies the integration of multiple system-level components while also enabling an organization to select the features, services, and capacities that best address its business needs.

This CVD for the Enterprise Collaboration Preferred Architecture provides end-to-end collaboration targeted for deployments larger than 1,000 users. For smaller deployments, consult the [Preferred Architecture Design Overview and CVDs for Midmarket Collaboration](#).

This CVD for the Enterprise Collaboration Preferred Architecture provides high availability for critical applications. The architecture supports an advanced set of collaboration services that extend to mobile workers, partners, and customers through the following key services:

- Voice communications
- Instant messaging and presence
- High-definition video and content sharing
- Rich media conferencing
- Enablement of mobile and remote workers
- Business-to-business voice and video communications
- Unified voice messaging

Because of the adaptable nature of Cisco endpoints and their support for IP networks, this architecture enables an organization to use its current data network to support both voice and video calls. The preferred architecture employs a holistic approach to bandwidth management that incorporates an end-to-end QoS architecture, call admission control, and video rate adaptation and resiliency mechanisms to provide the best possible user experience for deploying pervasive video over managed and unmanaged networks.

The Cisco Preferred Architecture for Enterprise Collaboration, shown in [Figure 1-1](#), provides highly available and secure centralized services. These services extend easily to remote offices and mobile workers, providing availability of critical services even if communication with headquarters is lost. This should be viewed as a fundamental architecture from which to design a new deployment or to evolve an existing one. As the Preferred Architecture progresses, this architecture will be expanded upon with additional products and solutions.

Figure 1-1 Cisco Preferred Architecture for Enterprise Collaboration

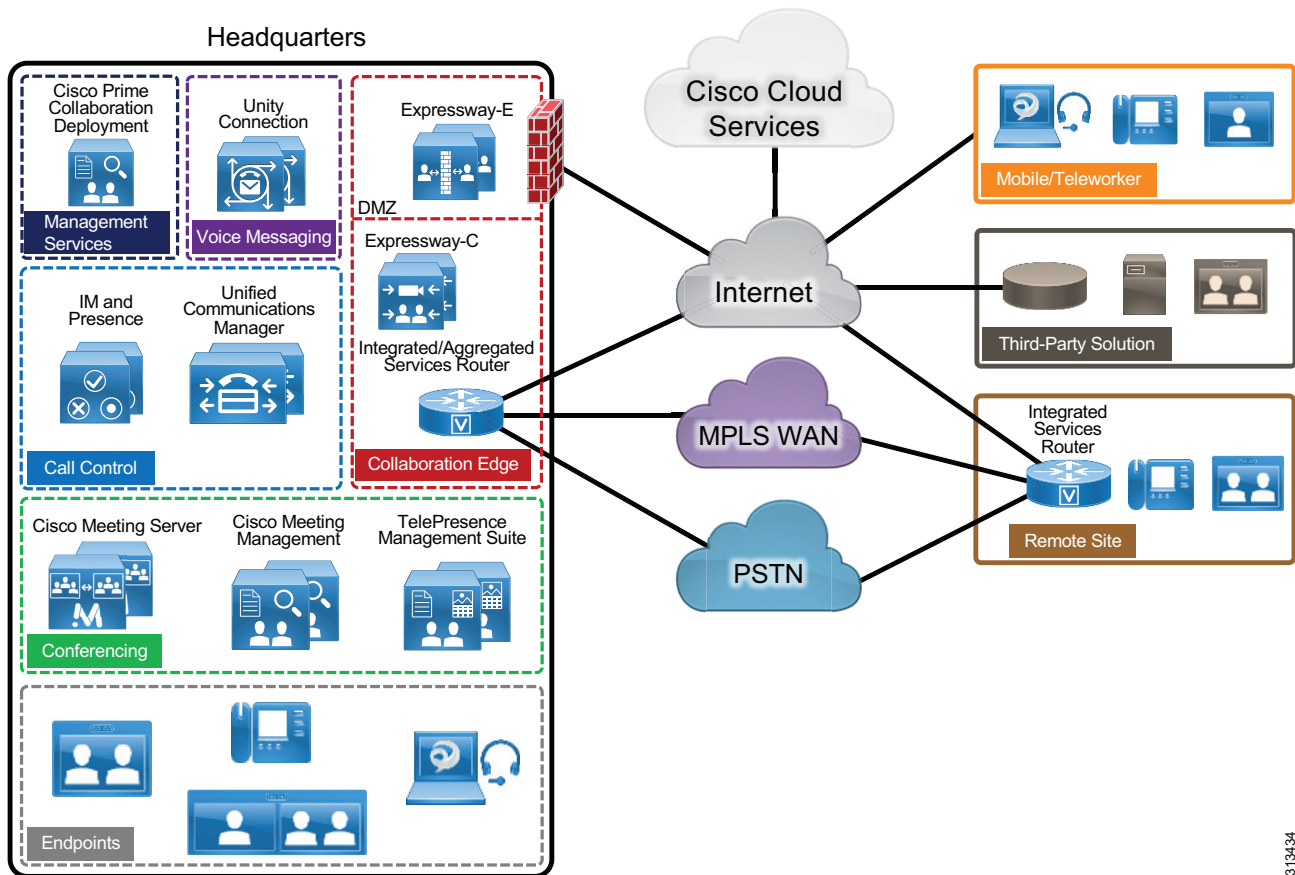

313434

Table 1-2 lists the products in this architecture. For simplicity, products are grouped into modules to help categorize and define their roles. The content of this CVD is organized into the same modules.

Table 1-2 Components of the Cisco Preferred Architecture for Enterprise Collaboration

Module	Component(s)	Purpose
Call Control	Cisco Unified Communications Manager (Unified CM) Cisco Unified Communications Manager IM and Presence Service Cisco Integrated Services Router (ISR)	Call control provides registration, call processing, resource management and instant messaging and presence for users and endpoints. It also encompasses remote site survivability for remote offices.
Conferencing	Cisco Meeting Server Cisco Meeting Management Cisco TelePresence Management Suite (TMS)	Conferencing allows three or more parties to communicate via voice, video, and content sharing in real time.

**Table 1-2** Components of the Cisco Preferred Architecture for Enterprise Collaboration (continued)

Module	Component(s)	Purpose
Collaboration Edge	Cisco Expressway-C Cisco Expressway-E Cisco Integrated Services Router (ISR) Cisco Aggregation Services Routers (ASR)	Collaboration Edge provides remote registration services, external communications, and interoperability.
Voice Messaging	Cisco Unity Connection	Cisco Unity Connection provides unified messaging and voicemail services.
Collaboration Management Services	Cisco Prime Collaboration Deployment	Cisco Prime Collaboration Deployment assists in the management of Unified Communications applications. It allows the user to perform tasks such as migration of older software versions of clusters to new virtual machines, fresh installs, and upgrades on existing clusters.
	Cisco Smart Software Manager	Internet-based web portal that provides simplified, enterprise-wide management of licensing. Cisco Smart Software Manager provides administrators with a single management point for the Cisco Unified CM, Cisco Unity Connection Cisco Meeting Server, and Expressway licenses within a deployment.
	Cisco Webex Cloud-Connected Unified Communications	Cisco Webex Cloud-Connected Unified Communications (CCUC) is a suite of cloud services providing centralized administrative services within Webex Control Hub for on-premises collaboration applications. Services enabled with CUC include system health checks and analytics.
Security	All components	Security incorporates a compilation of security features ranging from those enabled by default to those recommended for deployment. Some example features include unauthorized access protection, toll-fraud protection, certificate generation and management, and provisioning and enabling encryption for all the components in this solution.
Bandwidth Management	Network infrastructure and products from all chapters of this document	Bandwidth management incorporates an end-to-end QoS architecture, call admission control, and video rate adaptation and resiliency mechanisms to provide the best possible user experience for deploying pervasive video over managed and unmanaged networks.
Sizing	Products from all chapters of this document Quote Collab Tool	Sizing for all modules that are covered in this document, as well as a virtual machine placement example using the Quote Collab Tool.



### Network Services

The Preferred Architecture for Enterprise Collaboration requires a well-structured, highly available, and resilient network infrastructure as well as an integrated set of network services, including Domain Name System (DNS), Dynamic Host Configuration Protocol (DHCP), Trivial File Transfer Protocol (TFTP), and Network Time Protocol (NTP). A detailed description of how these basic network services are utilized by Cisco applications and endpoints can be found in the *Network Infrastructure* chapter of the [Cisco Collaboration SRND](#).

## Virtualization

Virtualizing multiple applications and consolidating them on physical servers lowers cost, minimizes rack space, lowers power requirements, and simplifies deployment and management. Virtualization also accommodates redeploying hardware and scaling software applications as organizational needs change.

### Cisco Business Edition 7000 (BE7000)

The Cisco BE7000 is built on a modified virtualized UCS that ships ready-for-use with a pre-installed virtualization hypervisor and application installation files. The specifications of the BE7000 appliance accommodates deployments of 1000 phones or more (multiple appliances usually required). The Cisco BE7000 solution offers premium voice, video, messaging, instant messaging, and presence, and contact center features on a single, integrated platform. For more information about the Cisco BE7000, see the [Cisco Business Edition 7000 Solutions Data Sheet](#).

## Cisco Unified Communications on the Cisco Unified Computing System (UCS)

Cisco Collaboration applications define requirements for compatibility, minimum hardware specifications and virtual machine (VM) placement, with example bills of materials provided for various deployment sizes. For more information, refer to the Cisco Collaboration Infrastructure Requirements collateral available at [https://www.cisco.com/c/dam/en/us/td/docs/voice\\_ip\\_comm/uc\\_system/virtualization/cisco-collaboration-infrastructure.html](https://www.cisco.com/c/dam/en/us/td/docs/voice_ip_comm/uc_system/virtualization/cisco-collaboration-infrastructure.html)



#### Note

The Cisco Collaboration Infrastructure Requirements collateral applies not only to CSR 14 on ESXi 6.7/7.0, but also to CSR 12.7 on ESXi 7.0.

The Cisco Technical Assistance Center (TAC) supports Cisco applications on Cisco or 3rd-party virtualized hardware environments satisfying application rules. Cisco TAC also supports Cisco OEMs of VMware software and Cisco hardware.

## Core Applications

In the Preferred Architecture for Enterprise Collaboration, the following virtualized applications are deployed on multiple Cisco UCS servers to provide hardware and software redundancy:

- Cisco Unified Communications Manager
- Cisco Unified Communications Manager IM and Presence Service
- Cisco Unity Connection
- Cisco Expressway, consisting of Expressway-C and Expressway-E
- Cisco Meeting Server and Cisco Meeting Management
- Cisco TelePresence Management Suite

We recommend always deploying redundant configurations to provide the highest availability for critical business applications.

## Collaboration Endpoints

The recommendations within this CVD guide assume a deployment of Cisco voice and video endpoints, including soft clients such as Cisco Jabber. These endpoints use SIP to register to Cisco Unified Communications Manager (Unified CM). [Table 1-3](#) lists the preferred endpoints for optimal features, functionality, and user experience.

**Table 1-3** *Cisco Collaboration Endpoints*

Product	Description
<b>Mobile:</b> <ul style="list-style-type: none"> <li>• Jabber for Android</li> <li>• Jabber for iPhone and iPad</li> </ul> <b>Desktop:</b> <ul style="list-style-type: none"> <li>• Jabber for Mac</li> <li>• Jabber for Windows</li> </ul>	Soft client with integrated voice, video, voicemail, instant messaging, and presence functionality as well as secure edge traversal for mobile devices and personal computers
Cisco IP Phone 8800 Series	Public space, general office use, single-line and multi-line audio and video phones
Cisco IP Phone Conference 8832	IP conference phone
Cisco Webex Deskpro	Personal Collaboration endpoint for the desktop
Cisco Webex Room Series	Collaboration integrator and multipurpose room endpoint



# Call Control

**Revised: May 21, 2021**

This chapter describes the call control function for the Cisco Preferred Architecture (PA) for Enterprise Collaboration.

Certain requirements might put your deployment outside the PA design guidelines and recommendations, in which case you might have to use other documentation such as the [Cisco Collaboration SRND](#) and related product documentation.

The first part of this chapter provides an architectural overview and introduces some fundamental design concepts, while the second part explains more detailed deployment considerations. The [Architecture](#) section discusses topics such as redundancy concepts, high availability, Computer Telephony Integration (CTI), and IM and presence architecture, and it introduces a hypothetical customer topology used in the examples throughout this document. The focus of this chapter is the [Deployment Overview](#) section. The deployment examples in that section will help you to understand the background of certain design decisions more clearly than an abstract discussion of concepts can. Topics covered in the [Deployment Overview](#) section include DNS requirements, cluster provisioning, certificate management, dial plan configuration, user provisioning using LDAP, media resources, SIP trunking considerations, endpoint provisioning, and multi-cluster considerations. The order of the topics in the [Deployment Overview](#) section follows the recommended configuration order.

## What's New in This Chapter

[Table 2-1](#) lists the topics that are new in this chapter or that have changed significantly from previous releases of this document.

**Table 2-1** *New or Changed Information Since the Previous Release of This Document*

New or Revised Topic	Described in:	Revision Date
Minor Edits		May 21, 2021

# Core Components

The core architecture contains these key elements (Figure 2-1):

- Cisco Unified Communications Manager
- Cisco Unified Communications Manager IM and Presence Service
- Cisco Integrated Services Router (ISR)

**Figure 2-1 Preferred Architecture Overview**

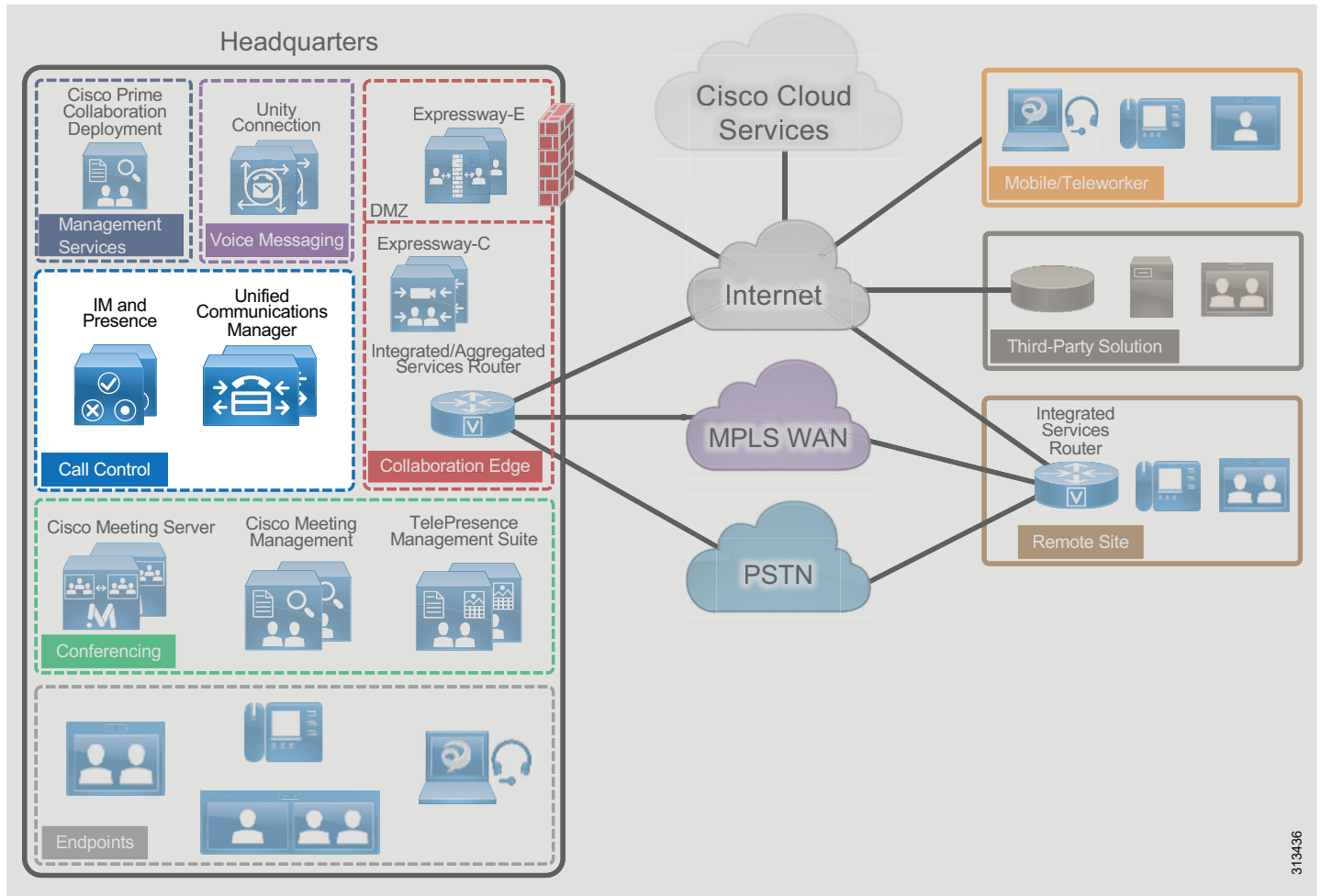

313436

## Key Benefits

- Call control is centralized at a single location that serves multiple remote sites.
- Management and administration are centralized.
- Common telephony features are available across voice and video endpoints.
- Single call control and a unified dial plan are provided for voice and video endpoints.
- Critical business applications are highly available and redundant.

## Architecture

The handling and processing of voice and video calls is a critical function provided by enterprise communications systems. This functionality is handled by some type of call processing entity or agent. Given the critical nature of call processing operations, it is important to design unified communications deployments to ensure that call processing systems are scalable enough to handle the required number of users and devices and are resilient enough to handle various network and application outages or failures.

This chapter provides guidance for designing scalable and resilient call processing systems with Cisco Unified Communications Manager (Unified CM) and Survivable Remote Site Telephony (SRST). A centralized Unified CM cluster implements call processing services for all customer sites. Unified CM IM and Presences Service as part of the centralized Unified CM cluster implements instant messaging and presence services for the enterprise. Cisco Survivable Remote Site Telephony (SRST) is used to implement backup services for remote sites when the corporate WAN reliability does not match the voice services availability requirements.

Cisco Unified CM provides call processing services for small to very large single-site deployments, multi-site centralized call processing deployments, and/or multi-site distributed call processing deployments. Unified CM is at the core of a Cisco Collaboration solution, and it serves as a foundation to deliver voice, video, IM and presence, messaging, mobility, web conferencing, and security.

Access to the enterprise collaboration network and to Unified CM from the Internet to enable remote access and business-to-business secure video communications, is also available through various collaboration edge solutions such as VPN and Cisco Expressway.

### Role of Unified CM

Cisco Unified CM is the central call control component in any Cisco collaboration deployment. Unified CM provides foundation services including call control, endpoint registration, endpoint configuration, call admission control, codec negotiation, trunk protocol translation, and CTI. Unified CM is the central point of administration and provisioning. All SIP trunks to other components – including conferencing media resources, gateways, and other components – are terminated on Unified CM so that Unified CM can orchestrate access to all of those components. Call routing is controlled by the dial plan configuration applied to Unified CM.

### Role of IM and Presence Service

The Cisco Unified CM IM and Presence Service provides on-premises instant messaging and presence. It uses standards-based XMPP and also supports SIP for interoperability with SIP IM providers. Cisco Unified CM IM and Presence Service is an on-premises solution. The other Cisco instant messaging and presence service, Cisco WebEx Messenger, is a cloud-based service and is not covered in this document.

### Role of SRST

When deploying Cisco desk phones in branch locations separated from a centralized call processing platform by a low-speed or unreliable WAN link, it is important to consider local call processing redundancy. By leveraging Survivable Remote Site Telephony (SRST) on a Cisco IOS router in each branch location, basic IP telephony services can be maintained for the desk phones if connectivity to the centralized call processing platform is lost. However, the set of available user-facing features is much smaller when a device is registered to SRST than when the phone is registered to Unified CM.

## Unified CM Redundancy with Survivable Remote Site Telephony (SRST)

Cisco IOS SRST provides highly available call processing services for endpoints in locations remote from the Unified CM cluster. Unified CM clustering redundancy schemes provide a high level of redundancy for call processing and other application services within a LAN or MAN environment. However, for remote locations separated from the central Unified CM cluster by a WAN or other low-speed links, SRST can be used as a redundancy method to provide basic call processing services to these remote locations in the event of loss of network connectivity between the remote and central sites. We recommend deploying SRST-capable Cisco IOS routers at each remote site where call processing services are considered critical and need to be maintained in the event that connectivity to the Unified CM cluster is lost. Endpoints at these remote locations must be configured with an appropriate SRST reference within Unified CM so that the endpoint knows what address to use to connect to the SRST router for call processing services when connectivity to Unified CM subscribers is unavailable.

## Unified CM and IM and Presence Service Clustering

Unified CM supports the concept of clustering. The Unified CM architecture enables a group of server nodes to work together as a single call processing entity. This grouping of server nodes is known as a cluster.

There are two types of Cisco Unified CM nodes: publisher and subscriber.

- Unified CM publisher

The publisher is a required server node in all clusters. There can be only one publisher per cluster. This server node contains the cluster configuration, and it provides the database services to all other subscribers in the cluster. In this design, the Unified CM publisher is a dedicated node; it does not handle TFTP requests, endpoint registration, or call processing.

- Unified CM subscriber

Subscriber nodes subscribe to the publisher to obtain a copy of the database information. Subscriber nodes include, for example, the Unified CM TFTP nodes and the Unified CM call processing subscriber nodes.

Cisco IM and Presence nodes have the same clustering concept. The first IM and Presence node is the IM and Presence publisher. The other IM and Presence nodes are the IM and Presence subscribers, and they obtain a copy of their database from the IM and Presence publisher. The IM and Presence publisher communicates with the Unified CM publisher and most of the IM and Presence configuration is actually done through the Unified CM publisher (for instance, the Unified CM users, the UC services available to presence users, and the service activation). Hence, all IM and Presence nodes, including the IM and Presence publisher, are considered subscribers of the larger Unified CM and IM and Presence Service cluster. [Figure 2-2](#) shows the relationship between the Unified CM publisher and a two-node IM and Presence cluster.

**Figure 2-2 Relationship Between Unified CM and a Two-Node IM and Presence Cluster**

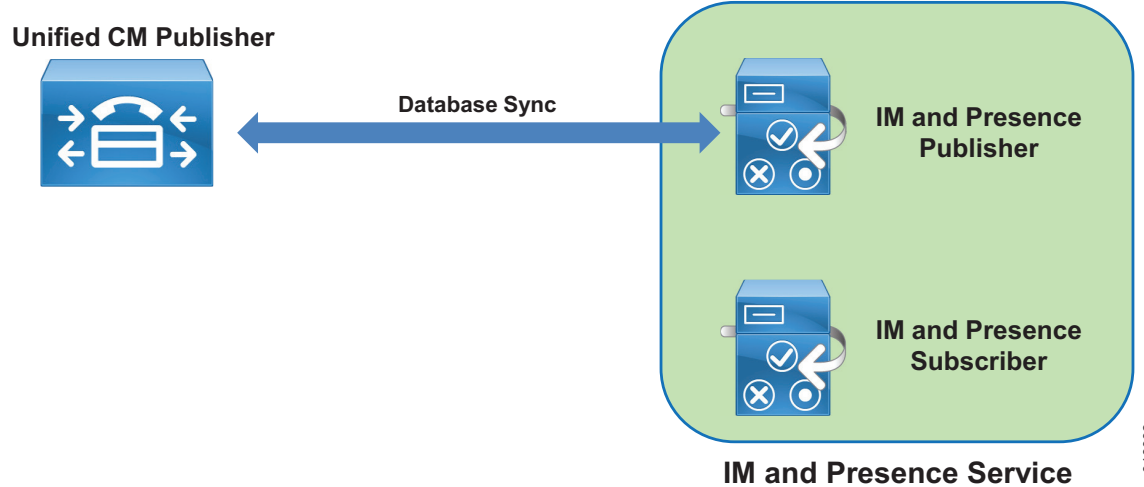

## High Availability

Unified CM and IM and Presence nodes should be deployed in a highly available infrastructure. For example, the use of dual power supplies combined with the use of uninterruptible power supply (UPS) sources will provide maximum power availability. From a network perspective, the platform servers should be connected to multiple upstream switches.

Unified CM and IM and Presence systems also handle high availability at the application level.

With Unified CM in this design, two TFTP servers should be deployed for redundancy. The call processing nodes should be deployed with one-to-one (1:1) redundancy, where for every primary call processing subscriber there is a backup call processing subscriber. This 100%:0% redundancy design compared to a 50%:50% redundancy design has a number of advantages, including the reduction of Unified CM groups and device pools and simplified configuration and distribution of devices with fewer redundancy options.

Cisco IOS Survivable Remote Site Telephony (SRST) provides highly available call processing services for endpoints in locations remote from the Unified CM cluster when the WAN links are down.

Individual Cisco IM and Presence nodes are grouped in subclusters. A subcluster can have one or two nodes. Adding the second node in a subcluster provides high availability. High availability is recommended, and therefore in this design each subcluster consists of two nodes. A two-node subcluster allows for users associated with one server of the subcluster to use the other server in the subcluster automatically if a failover event occurs. We recommend balancing the user assignment between the two nodes in each pair. The IM and Presence publisher handles IM and Presence information from presence clients just like any other IM and Presence subscriber does, and it is deployed as one of the two nodes in an IM and Presence subcluster.

## Computer Telephony Integration (CTI)

Cisco Computer Telephony Integration (CTI) extends the rich feature set available on Cisco Unified CM to third-party applications.

### CTI Architecture

Cisco CTI consists of the following components (Figure 2-3), which interact to enable applications to take advantage of the telephony feature set available in Cisco Unified CM:

- CTI application — Cisco or third-party application written to provide specific telephony features and/or functionality. It can use a JTAPI or TAPI interface. The protocol between the CTI application and Unified CM is Quick Buffer Encoding (QBE).
- Unified CM subscriber with the following services:
  - CCM — The Cisco CallManager Service, the telephony processing engine.
  - CTI Manager (CTIM) — A service that runs on one or more Unified CM subscribers operating in primary/secondary mode and that authenticates and authorizes telephony applications to control and/or monitor Cisco IP devices.

**Figure 2-3** CTI Architecture

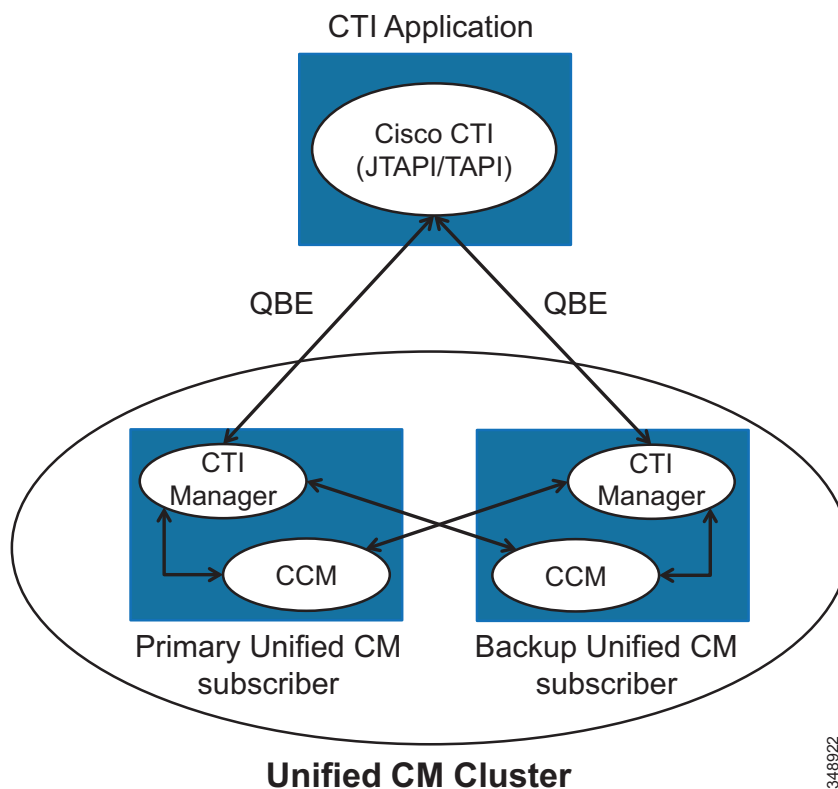

348922



## High Availability for CTI

High availability for CTI Manager relies on the CTI application being able to connect to the backup CTI Manager Service in case the primary CTI Manager fails. In case both the CTI Manager and CCM services on the primary Unified CM subscriber fail (for example, if the entire primary Unified CM subscriber fails), then both CCM and CTI Manager services running on the backup Unified CM subscriber will become active, and the CTI Manager service will monitor and control the devices that are registered to the CCM service located on the same backup Unified CM subscriber. If the primary CTI Manager Service fails but the primary CCM Service is still running (assuming you have 1:1 redundancy with a distribution of 100%/0% on the primary/backup Unified CM subscribers), then all the devices will stay registered to the CCM Service running on the primary Unified CM subscriber, and the CTI Manager running on the backup Unified CM subscriber will become active and will monitor and control the CTI devices even though they are registered to a CCM service running on a different node (the primary Unified CM subscriber in this case).

## Capacity Planning for CTI

Ensure the capacity limits are not exceeded for the three types of CTI resources:

- The maximum number of CTI applications connecting to a given CTI Manager instance (Unified CM node running the CTI Manager service). This number is typically low with CTI server-based application, but with CTI client-based applications such as Jabber clients in deskphone mode where each Jabber client is considered a CTI application, it is important to ensure the limit is not exceeded when deploying a large number of Jabber clients.
- The maximum number of CTI-enabled endpoints registered to a given Unified CM call processing subscriber.
- The maximum number of CTI-enabled endpoints monitored and controlled by a CTI Manager instance. Ideally, the CTI Manager service running on a Unified CM node monitors only the endpoints registered to that Unified CM node. But it is possible that a CTI Manager service also monitors endpoints registered to other Unified CM nodes.

The CTI limits are the same for all three CTI resources described above. The CTI capacity limits vary with the type of OVA template. If the CTI limit is reached, deploy another pair of Unified CM call processing nodes running the CTI Manager service.

## IM and Presence Architecture

The Cisco Unified CM IM and Presence Service provides on-premises instant messaging and presence. The main presence component of the solution is the IM and Presence Service, which incorporates the Extensible Communications Platform (XCP) and supports SIP/SIMPLE and Extensible Messaging and Presence Protocol (XMPP) for collecting information regarding a user's availability status and communications capabilities. The user's availability status indicates whether or not the user is actively using a particular communications device such as a phone.

Applications (either Cisco or third-party) can integrate presence and provide services that improve the end user experience and efficiency. In addition, Cisco Jabber is a supported client of the IM and Presence Service that also integrates instant messaging and presence status.

The IM and Presence Service uses the same underlying appliance model and hardware used by Unified CM on the Cisco Unified Computing System (UCS) platform.

The IM and Presence Service is deployed as an IM and Presence cluster. The IM and Presence cluster consists of up to six nodes, including one designated as a publisher and up to five subscriber nodes. As discussed in the sections on [Unified CM and IM and Presence Service Clustering](#) and [High Availability](#), the IM and Presence nodes are grouped in subclusters and each subcluster consists of two nodes for high availability. As discussed in the sizing section, a single subcluster can be deployed in order to support up to 15,000 users. The IM and Presence publisher handles IM and presence requests, just like the IM and Presence subscribers do, so the first subcluster consists of the IM and Presence publisher and one IM and Presence subscriber.

As discussed in the section on [Unified CM and IM and Presence Service Clustering](#), the IM and Presence nodes are considered part of the larger Unified CM and IM and Presence Service cluster.

## Deployment of the Unified CM and IM and Presence Service Cluster

The Cisco Unified CM and IM and Presence Service cluster consists of the following nodes:

- 1x Cisco Unified CM publisher
- 2x (1 pair) Cisco Unified CM TFTP server subscribers
- 2x (1 pair) Cisco Unified CM call processing subscribers (Add additional pairs to scale.)
- 2x (1 pair) Cisco Unified IM and Presence nodes (Add additional pairs, or subclusters, to scale.)

The number of Unified CM call processing pairs and of IM and Presence pairs to add in order to scale is discussed in the chapter on [Sizing](#).

[Figure 2-4](#) shows an example of a Unified CM and IM and Presence Service cluster deployment with up to 10,000 devices and 10,000 users. For more sizing information, refer to the [Sizing](#) chapter.

**Figure 2-4 Unified CM and IM and Presence Service Cluster Deployment**

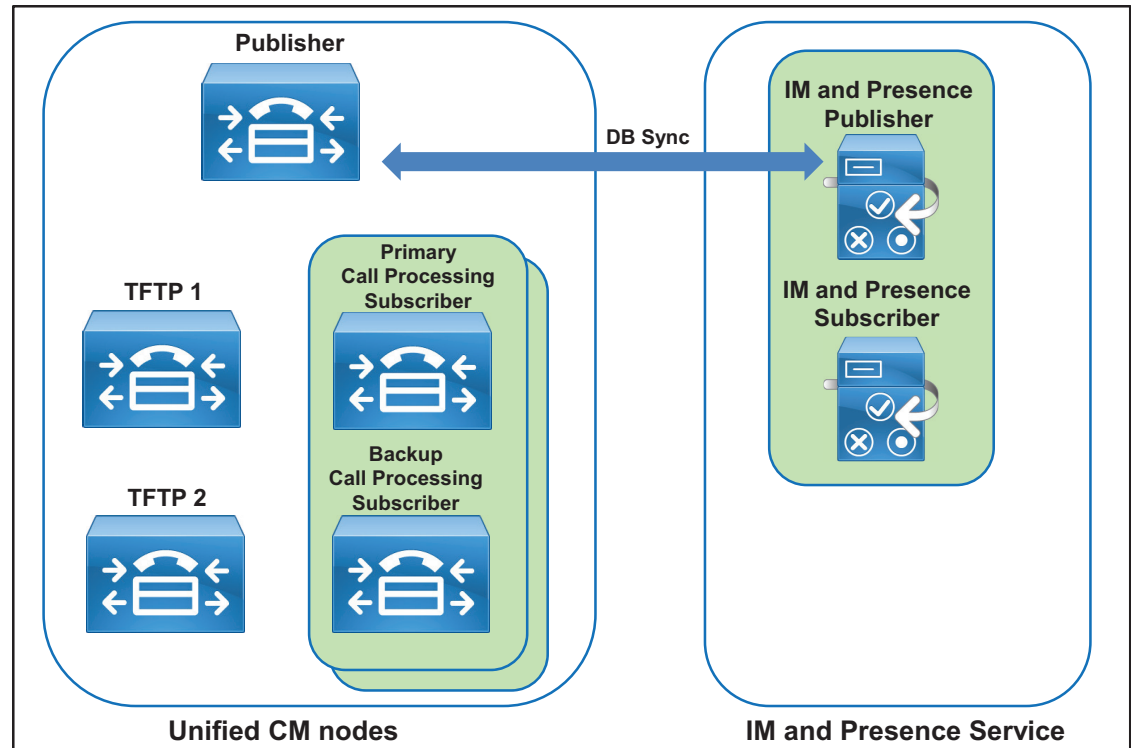

**Unified CM with IM and Presence Service**

348923

## Integration with Apple Push Notification Service (APNs)

When integrating a deployment of Unified CM and Unified CM IM and Presence Service with Apple Push Notification service (APNs), you can use Apple's cloud-based Push Notification service to push notifications for voice and video calls and instant messages to Cisco Jabber for iPad and iPhone clients that are running in the background. Cisco Jabber clients on start-up register with Unified CM either directly when on the corporate network or through Cisco Expressway using mobile and remote access (MRA) when connecting from outside the corporate network. As long as the Cisco Jabber client is running in foreground mode, call and IM notifications are received directly from Unified CM or Unified CM IM and Presence Service. As soon as the Cisco Jabber client transitions to suspended mode (background), this direct method of receiving notifications transitions to Apple Push Notifications. Cisco Jabber clients in the background are activated as soon as an Apple Push Notification is received by Apple iOS. Cisco Jabber then re-activates direct communication with Unified CM and Unified CM IM and Presence Service. With this mechanism Cisco Jabber does not need to constantly poll for events such as incoming IM messages or call events. This leads to better battery lifetime and improved user experience.

Figure 2-5 shows the overall architecture of the integration with APNs. Each application running on an Apple iOS platform registers with APNs to be able to receive notifications via APNs and receives a device and application specific device token. Notification providers intending to send notifications via APNs register with APNs; and when they send a notification to a device, they need to present the device token uniquely identifying the target device and application.

**Figure 2-5** Architecture for Integration with APNs

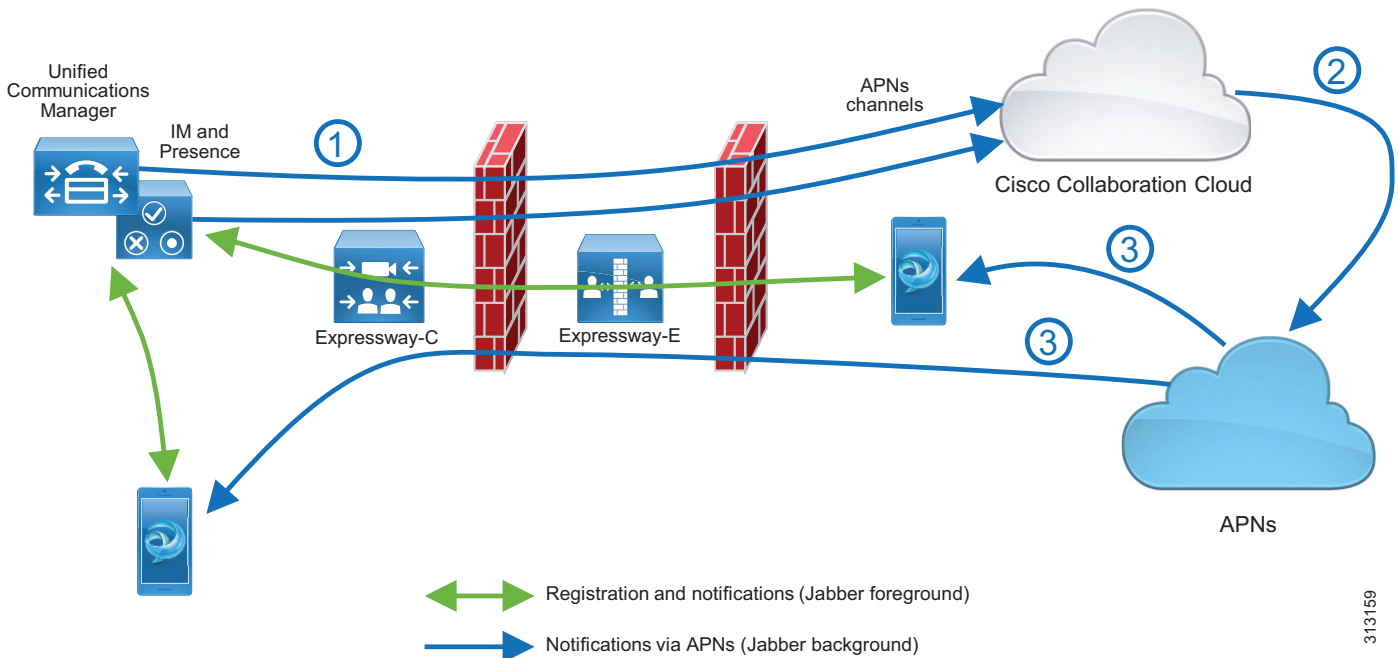

313159

In the architecture shown in [Figure 2-5](#), a single APNs provider is used for all integrations, and this APNs provider (Push REST service) is hosted in the Cisco Collaboration Cloud. To enable APNs integration for a given Unified CM and IM and Presence Service cluster, the cluster first needs to be onboarded into the cloud-based Push REST service. During this onboarding process a machine account is created for the specific cluster in the Cisco Collaboration Cloud, and an OAuth refresh token is issued for the cluster. With this information, all IM and Presence nodes and call processing nodes of the cluster can then create connections to the Push REST service to issue notification requests targeted for specific Jabber clients (step 1). These requests are authenticated using OAuth access tokens generated using the OAuth refresh token obtained during the onboarding process.

The Jabber clients obtain a device token from APNs during registration with APNs. This device token is reported back to the Unified CM cluster and is then used by the IM and Presence and call processing nodes in outbound notification requests to the Push REST service.

The Push REST service relays all notification requests coming in from the IM and Presence and call processing nodes to APNs (step 2), which then in turn forwards the notifications to the individual devices over the persistent connection between the Apple iOS devices and APNs (step 3).

When an Apple Push Notification is received, Apple iOS dispatches the notification to the target application. This wakes up Cisco Jabber, which transitions into foreground mode and resumes normal calling and IM interaction with Unified CM and with Unified CM IM and Presence Service.

Jabber clients running on Apple iOS need to be able to connect to APNs in the Apple cloud on port 443/TCP from within the enterprise to be able to create the connection with APNs and receive notifications from APNs.

## Endpoints

### Jabber

Cisco Jabber clients provides core collaboration capabilities for voice, video, and instant messaging to users. Cisco Jabber is available on a wide variety of platforms including Windows, Mac, and mobile devices such as smartphones and tablets.

Cisco Jabber can be deployed in either of two modes:

- Full UC and Cisco Jabber for Everyone (IM only) Mode

This is the default mode. The user's primary authentication is to an IM and Presence server. This is the mode used in this Preferred Architecture design and cover in this document.

- Phone Mode

In phone mode, the IM and Presence Service is not required.

Figure 2-6 illustrates the architecture of an on-premises deployment that includes Cisco Unified Communications Manager IM and Presence.

**Figure 2-6 Cisco Unified Communications with IM and Presence Architecture**

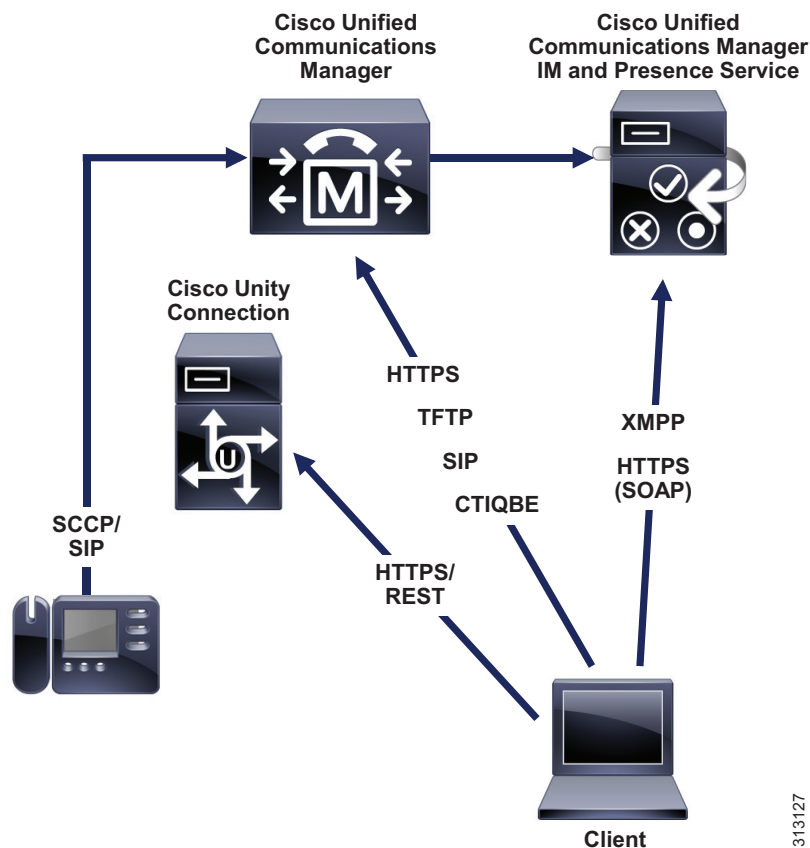

To connect to services, Cisco Jabber requires the following information:

- Source of authentication that enables users to sign in to the client

In full UC or IM-only modes, the source of authentication is the IM and Presence service. In phone-only mode, it is Unified CM.

- Location of services

The services include IM and Presence, directory, CTI, voicemail, and conferencing.

To provide this information to the client, we recommend using the Service Discovery method over the Manual Connection method. With the Service Discovery method, the client automatically locates and connects to services.

In this design, the client automatically discovers services and configuration with the SRV record `_cisco-uds` that is retrieved when the user first enters his or her email address in the Jabber client.

The Jabber Contact Sources can be an LDAP contact source with Cisco Directory Integration (CDI). Another source for the contacts can be the Unified CM User Data Service (UDS), but CDI is the recommended contact source for on-premises deployments.

## Multi-Cluster Considerations

In a multi-cluster deployment, interconnect all the individual Unified CM clusters through SIP trunks. To avoid session traversal through individual clusters, deploy a full mesh of SIP trunks. With four or more clusters, deploy Cisco Unified CM Session Management Edition (SME) to centralize the dial plan and trunking and to avoid the complexity of a full-mesh SIP trunk topology. Cisco Unified CM SME is not covered in this document. For more information about SME, refer to the [Cisco Collaboration SRND](#).

In multi-cluster deployments, use Global Dial Plan Replication (GDPR) to replicate dial plan information between clusters. GDPR can advertise a +E.164 number, one Enterprise Significant Number (ESN), and up to five alpha-numeric URIs per directory number. An ESN is the abbreviated inter-site dialing equivalent of a directory number. The information advertised and learned through GDPR enables deterministic intercluster routing for these dialing habits:

- +E.164 dialing based on the advertised +E.164 numbers
- Enterprise abbreviated inter-site dialing based on the advertised ESNs
- Alpha-numeric URI dialing based on the advertised URIs

GDPR uses Intercluster Lookup Service (ILS) as the transport medium, therefore setting up ILS between all Unified CM clusters is required for multi-cluster deployments. In addition to GDPR, UDS-based service discovery used by Jabber also relies on the ILS exchange to detect the existence of UDS nodes on remote clusters to which `/cucm-uds/homeCluster` requests of non-local users can be forwarded to determine the home cluster of a user trying to log in to Jabber.

IM and Presence functionality is limited by having communications within a single cluster. To extend presence and instant messaging capability and functionality, these standalone clusters can be configured for peer relationships for communication between clusters within the same domain. This functionality provides the ability for users in one cluster to communicate and subscribe to the presence of users in a different cluster within the same domain. To create a fully meshed presence topology, each Cisco IM and Presence cluster requires a separate peer relationship for each of the other Cisco IM and Presence clusters within the same domain. The intercluster peer is configured as the IP address of the remote Unified CM cluster IM and Presence publisher node.

## Topology Example

For the purpose of this document, we assume a centralized call processing deployment serving three sites in the US: SJC, RCD, and RTP. The Unified CM and IM and Presence Service servers are centrally located in RCD. Central PSTN access is in RCD as well. SJC and RTP are assumed to be small sites, with Survivable Remote Site Telephony (SRST) configured locally, with local PSTN access when the WAN connectivity to the RCD site is down. [Figure 2-7](#) illustrates this topology example.

**Figure 2-7 Example Topology**

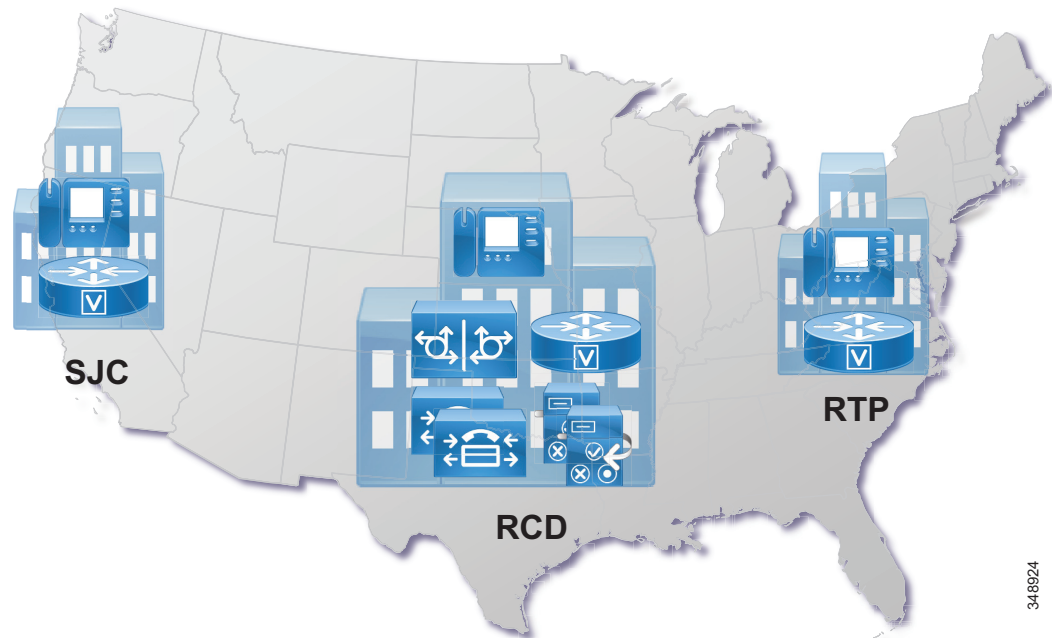

The topology example used in this document for multi-cluster considerations is a two-cluster deployment: the cluster in the United States as shown in [Figure 2-7](#), and a second cluster to cover Europe, the Middle East, and Africa (EMEA).

## Certificate Considerations

For certificate considerations – general concepts, deployment recommendations, and so forth – refer to the [Security](#) chapter.

## DNS Considerations

As explained in the previous section, the identity of server certificates presented during connection setup is validated. This implies that clients need to initiate connections based on fully qualified domain names (FQDNs) so that the subject in the presented certificate really can be checked against the identity to which the client intends to connect. The use of FQDNs for connection initiation implies that DNS is a fundamental requirement. The enterprise DNS needs to be set up so that name resolution is reliably

available for all clients and servers in the network. In addition to providing reliable FQDN-to-IP-address (and reverse) resolution, DNS also is required for the automatic service discovery process used by Jabber clients.

During startup, Jabber clients locate the UDS service required for UDS-based service discovery by trying to resolve the `_cisco-uds._tcp` SRV using DNS. For best redundancy and load balancing, we recommend provisioning DNS SRV records with equal priority and weight for the Unified CM publisher, TFTP nodes and call processing subscribers.

## Endpoint Addressing

All directory numbers on endpoints with DID address are provisioned as +E.164 numbers. The benefits of this approach include the following:

- +E.164 directory numbers are unique by definition.
- +E.164 directory numbers enable one dialing habit (+E.164) directly without requiring any further dial plan configuration.
- +E.164 directory numbers simplify the implementation of forced on-net routing.
- Configuration of Automated Alternate Routing (AAR) is greatly simplified. There is no need to provision multiple AAR groups and AAR PSTN prefixes because the target on-net destination can be used directly as an alternate PSTN address; it is a +E.164 number.
- Correct caller ID is automatically achieved for all call flows (direct, forwarded, on-net, and off-net).

Unique addresses are also required for endpoints without an associated DID (for example, lobby phones) and enterprise services (for example, call pickup, call park, and so forth). Since no +E.164 number exists for them, we recommend the use of an alternate enterprise specific numbering (ESN) schema to address them. The recommended format for the ESN schema is an access code chosen so that no overlap between ESN dialing and other dialing habits is created, followed by a site code and the intra-site extension. The length of the site code and extension is a trade-off between providing a large enough number space and keeping the ESN dialing as short as possible.

## +E.164 Routing and Dialing Normalization

To achieve the intended forced on-net routing (calls to any on-net destination dialed using any of the supported numeric dialing habits has to be routed on-net), the recommended dial plan design uses a two-step routing approach. In the first step, the dialed digit string is normalized to +E.164, if possible (calls to non-DIDs obviously cannot be normalized to +E.164), and then in the second step the resulting +E.164 digit string is matched against a +E.164 numeric plan that includes directory numbers and route patterns.

The dialing normalization is achieved by provisioning translation patterns matching on the non+E.164 dial strings, and then the dialed string is transformed to +E.164 through the called party transformations on the translation patterns.

Figure 2-8 shows an example of a dialing normalization translation pattern that can be used to normalize abbreviated intra-site dialing in SJC to the full +E.164 number of the dialed destination. If a user in site SJC dials 4001, this dialed string is matched by a translation pattern 4XXX; and the called party transformation mask configured on the translation pattern, when applied to 4001, creates the resulting digit string +14085554001, which then can be routed in a +E.164 routing schema.



**Figure 2-8 Example Dialing Normalization Translation Pattern**

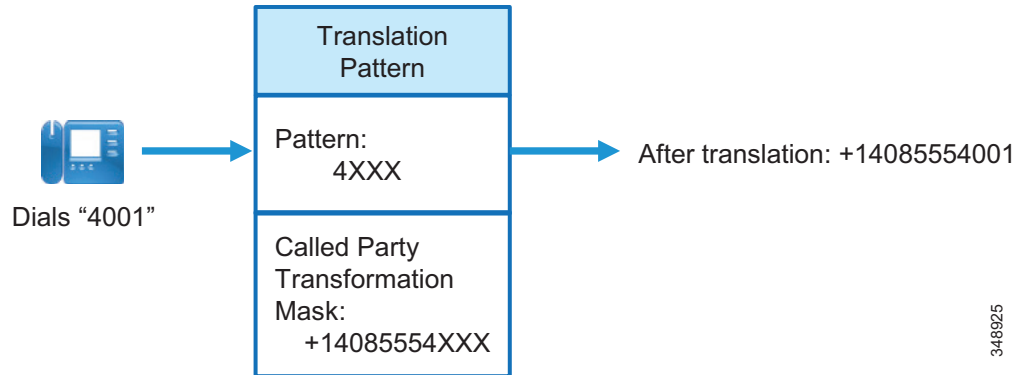

348925

After applying the called party transformations defined on a translation pattern, Unified CM then executes a secondary lookup of the resulting digit string using the calling search space (CSS) defined on the translation pattern. Unified CM enables definition of translation patterns that use the originator's CSS for this secondary lookup. This allows definition of dialing normalization translation patterns that can be reused in multiple context, because after applying the dialing normalization, the secondary lookup of the normalized digit string is executed, not based on a single fixed CSS, but based on the CSS in effect when the translation pattern was engaged.



**Tip**

On dialing normalization translation patterns, set the option **Use Originator's Calling Search Space** so that the CSS used for the secondary lookup is identical to the CSS used for the primary lookup.



**Tip**

On dialing normalization translation patterns that are fixed length (they do not end with a variable length wildcard), also set the option **Do Not Wait For Interdigit Timeout On Subsequent Hops** so that even if the secondary lookup matches on a variable length route pattern, the call is still routed without inter-digit timeout.

## Classes of Service and Calling Search Spaces (CSSs)

Partitions and CSSs are the fundamental components in Unified CM used to build classes of service. Dialable patterns are grouped into equivalence classes by putting patterns belonging to the same class into the same partition. Each CSS then is a list of partitions that defines which partitions and, thus, which patterns a calling entity using the CSS can access. A CSS effectively enforces class of service by determining which destinations can be reached from a device using this CSS.

The number of classes of service defined is the major factor driving dial plan complexity, and thus the number of required classes of service should be as small as possible. In a well designed enterprise dial plan, re-use of patterns and partitions for multiple classes of service helps to simplify the dial plan deployment.

## Outbound Gateway Selection Using Local Route Group

Following the maxim to avoid and eliminate redundancies in the dial plan as much as possible, the concept of Local Route Groups (LRGs) is used to define the egress gateway selection.

Route patterns using a local route group offer a unique characteristic: they allow for dynamic selection of the egress gateway based on the device originating the call. By contrast, calls routed by route patterns using static route groups will route the call to the same gateway, no matter which device originated the call. Route patterns configured to refer to a route list that makes use of LRGs will resolve to the actual route group configured as the LRG in the calling party's device pool.

This allows for re-use of route patterns that are not specific to each site, instead of requiring you to provision site-specific route patterns that are directly associated with the egress gateway of the respective site.

## Outbound Calls: Called and Calling Number Localization

The dial plan design presented in this document uses local route groups for egress gateway selection based on the calling device. Hence, calling and called party transformations required to adapt to service provider requirements cannot be done on the route pattern or route list level. These transformations would be shared among all gateways. Instead, these service provider specific transformations to localize calling and called party information are configured either on the gateway using Cisco IOS voice translation rules or on Unified CM using calling and called party transformation patterns addressed by calling and called party transformation CSSs configured on the gateway or on the gateway's device pool.

## Inbound Calls: Called and Calling Number Globalization

Because all call routing on Unified CM is based on +E.164 numbers for all incoming calls arriving at Unified CM, we need to make sure that called party information is globalized to +E.164 from the format received on the link from the provider. This is achieved through a combination of Cisco IOS translations on the SIP gateways (required to avoid loss of number type information received from the ISDN network when sending the request to Unified CM over SIP) and prefixes and possibly calling and called number transforms configured on Unified CM.

## User Provisioning with LDAP Synchronization

Synchronization of Unified CM with a corporate LDAP directory allows the administrator to provision users easily by mapping Unified CM data fields to directory attributes. Critical user data maintained in the LDAP store is copied into the appropriate corresponding fields in the Unified CM database on a scheduled basis. The corporate LDAP directory retains its status as the central repository. Unified CM has an integrated database for storing user data and a web interface within Unified CM Administration for creating and managing user accounts and data. When LDAP synchronization is enabled, the local Unified CM database is still used, and additional local end-user accounts can be created. Management of end-user accounts is then accomplished through the interface of the LDAP directory and Unified CM Administration.

## User Authentication with LDAP

The LDAP authentication feature enables Unified CM to authenticate LDAP synchronized users against the corporate LDAP directory. Locally configured users are always authenticated against the local database. Also, PINs of all end users are always checked against the local database only.

To enable authentication, a single authentication agreement is defined for the entire cluster.

The following statements describe Unified CM's behavior when authentication is enabled:

- End user passwords of users imported from LDAP are authenticated against the corporate directory by a simple bind operation.
- End user passwords for local users are authenticated against the Unified CM database.
- Application user passwords are authenticated against the Unified CM database.
- End user PINs are authenticated against the Unified CM database.

In environments that employ a distributed Active Directory topology with multiple domain controllers geographically distributed, authentication speed might be unacceptable. When the Domain Controller for the authentication agreement does not contain a user account, a search must occur for that user across other domain controllers. If this configuration applies to your deployment, and login speed is unacceptable, it is possible to set the authentication configuration to use a Global Catalog Server.

An important restriction exists, however. A Global Catalog does not carry the `employeeNumber` attribute by default. In that case either use Domain Controllers for authentication (beware of the limitations listed above) or update the Global Catalog to include the `employeeNumber` attribute. Refer to Microsoft Active Directory documentation for details.

To enable queries against the Global Catalog, configure the LDAP Server Information in the LDAP Authentication page to point to the IP address or host name of a Domain Controller that has the Global Catalog role enabled, and configure the LDAP port as 3268.

# Deployment Overview

Deployment begins with provisioning of the centralized Cisco Unified CM cluster followed by further configuration and provisioning tasks. The following sections describe how to set up and configure the call control according to the Preferred Architecture design in this document:

- [DNS Requirements](#)
- [Provision the Cisco Unified CM and IM and Presence Service Cluster](#)
- [Cisco Unified CM and IM and Presence Service Certificate Management](#)
- [Initial Cisco Unified CM Configuration](#)
- [Other IM and Presence Settings](#)
- [Dial Plan Configuration](#)
- [LDAP System Configuration](#)
- [Cisco Unified CM Group Configuration](#)
- [Phone NTP References](#)
- [Date and Time Groups](#)
- [Media Resources](#)
- [Device Pools](#)
- [SIP Trunks](#)
- [Endpoint Provisioning](#)
- [ILS Configuration for Multi-Cluster Deployments](#)
- [GDPR Configuration \(Multi-Cluster Only\)](#)
- [Survivable Remote Site Telephony \(SRST\) Deployment](#)
- [Extension Mobility](#)
- [Busy Line Field \(BLF\) Presence](#)
- [Deploying Computer Telephony Integration \(CTI\)](#)

## DNS Requirements

Before deploying the solution, make sure DNS resolution is available for all servers to be deployed. Both forward (from DNS name to IP address) and reverse (from IP address to DNS name) lookups have to be configured in the enterprise DNS.

Also, the DNS resolver configured in Unified CM IM and Presence Service and in Unified CM call processing nodes must allow resolution of externally routable addresses. This is required for Push notifications via APNs.

In addition to enabling UDS-based service discovery for Jabber clients, provision DNS SRV records for all Unified CM publisher, TFTP and call processing subscriber nodes, defining these as service locations for `_cisco-uds`. [Example 2-1](#) shows an example of DNS SRV records defining a number of Unified CM nodes as `_cisco-uds` service locations.

**Example 2-1 DNS SRV Records for UDS-Based Service Discovery**

```

_cisco-uds._tcp.ent-pa.com      SRV service location:
    priority      = 10
    weight        = 10
    port          = 8443
    srv hostname  = us-cm-pub.ent-pa.com
_cisco-uds._tcp.ent-pa.com      SRV service location:
    priority      = 10
    weight        = 10
    port          = 8443
    srv hostname  = us-cm-tftp1.ent-pa.com
_cisco-uds._tcp.ent-pa.com      SRV service location:
    priority      = 10
    weight        = 10
    port          = 8443
    srv hostname  = us-cm-tftp2.ent-pa.com
_cisco-uds._tcp.ent-pa.com      SRV service location:
    priority      = 10
    weight        = 10
    port          = 8443
    srv hostname  = us-cm-sub1.ent-pa.com
_cisco-uds._tcp.ent-pa.com      SRV service location:
    priority      = 10
    weight        = 10
    port          = 8443
    srv hostname  = us-cm-sub2.ent-pa.com

```

In [Example 2-1](#), five Unified CM nodes (publisher, two TFTP subscriber nodes and two call processing subscriber nodes) are defined as service locations for UDS service discovery to make sure that the load of the initial UDS requests from Jabber clients making use of UDS service discovery are evenly distributed among all active Unified CM nodes.

As part of the UDS service discovery process, after locating the home cluster using the /cucm uds/clusterUser resource, Jabber clients will use the /cucm-uds/servers resource to get a list of all UDS nodes in the user's home cluster, so that the actual UDS requests during the registration process are load balanced between all UDS nodes of the cluster independent of the SRV records.

## Provision the Cisco Unified CM and IM and Presence Service Cluster

To deploy the Unified CM and IM and Presence Service cluster, perform the following tasks:

1. Determine the number of required call processing subscriber pairs based on the target number of users and devices.
2. Determine the number of required IM and Presence nodes based on the target number of users.
3. Determine the network parameters (DNS names, IP addresses, and so forth) for all required cluster members. Make sure to consider the TFTP servers also.
4. Deploy the required number of virtual machines on your compute infrastructure using the appropriate Cisco provided OVA template files. For information on how to obtain these OVA files, refer to the documentation at [https://www.cisco.com/c/dam/en/us/td/docs/voice\\_ip\\_comm/uc\\_system/virtualization/collaboration-virtualization-sizing.html](https://www.cisco.com/c/dam/en/us/td/docs/voice_ip_comm/uc_system/virtualization/collaboration-virtualization-sizing.html)
5. In Cisco Prime Collaboration Deployment, define the Unified CM cluster with all its members, and map the nodes to the virtual machines created in task 4.
6. Deploy all nodes using Cisco Prime Collaboration Deployment.

For more information on how to provision a cluster using Cisco Prime Collaboration Deployment, refer to the latest version of the *Cisco Prime Collaboration Deployment Administration Guide*, available at

<https://www.cisco.com/c/en/us/support/unified-communications/unified-communications-manager-callmanager/products-maintenance-guides-list.html>

## Cisco Unified CM and IM and Presence Service Certificate Management

Follow the steps outlined in the section on [Server Certificate Generation and Management](#) in the [Security](#) chapter. Even if you are not planning to configure encryption on the endpoints, we recommend having an external CA sign the Tomcat certificates of Cisco Unified CM and IM and Presence Service and Cisco Unity Connection.

It is important to make sure that certificates issued by the CA have the required key usage and extended key usage. A typical problem is that the CA issuing the certificate based on the provided CSR does not simply issue a certificate with the key usage and extended key usage copied from the CSR, but instead sets the key usage and extended key usage of the issued certificate based on settings in a template selected for issuing the certificate. A certificate issued based on a typical Web Server template, for example, will not have the TLS Web Client Authentication extended key usage include. This creates problems with inter-server communications – for example, Intercluster Lookup Service (ILS) and User Data Store (UDS) – where the Tomcat certificate on the initiating side of the TLS connection is also used as a client certificate, and thus TLS connection setup fails due to the incorrect key usage (see the section [Consider UDS Certificate Requirements](#)).

## Initial Cisco Unified CM Configuration

Immediately after installing the Unified CM cluster, perform the following basic configuration tasks:

- [Node Name Configuration](#)
- [Enterprise Parameter Settings](#)
- [Service Activation](#)
- [Service Parameter Settings](#)

### Node Name Configuration

To allow for correct certificate validation and to ensure that references to Unified CM cluster members can always be resolved correctly, set the node names under System/Server in the Unified CM administration GUI to fully qualified domain names (FQDNs) for all cluster members. To achieve this, navigate to System/Server in the Cisco Unified CM administration GUI and verify that all servers show up in the first column as FQDNs. Change the entries of servers showing up as only a hostname without a DNS domain, to FQDNs.

## Enterprise Parameter Settings

Check and update the Enterprise Parameters listed in [Table 2-2](#).

**Table 2-2** Enterprise Parameters

Enterprise Parameter	Description	Value
Cluster ID	Used to uniquely identify the Unified CM cluster in a number of intercluster features, including Intercluster Lookup Service (ILS) and intercluster call admission control	Example: USCluster
Auto Registration Phone Protocol	Signaling protocol provisioned for auto-registering phones	SIP
BLF For Call Lists	Specifies whether call lists in phones supporting this feature should show presence	Enabled
URI Lookup Policy	According to RFC 3261, when determining SIP URI equivalence, the check on the left-hand side (user portion) of the URI has to be case-sensitive. The default behavior of Unified CM is to adhere to this standard, but to avoid potential issues with URIs using mixed capitalization, it is typically better to change the default.	Case Insensitive
Enable Dependency Records	Dependency records simplify the administration of Unified CM.	True
Auto select DN on any Partition	Simplifies administration. If enabled, the directory number configuration page automatically gets populated with the data of the first matching directory number.	True
CDR File Time Interval	Determines the time interval for call detail record (CDR) file updates	10
URL Authentication URL Directories URL Information URL Services Secured Authentication URL Secured Directory URL Secured Information URL Secured Services URL	URLs used by endpoints for various purposes	Make sure these URLs refer to the FQDN of the Unified CM publisher node
Organization Top Level Domain		Example: ent-pa.com

Table 2-2 Enterprise Parameters (continued)

Enterprise Parameter	Description	Value
Cluster Fully Qualified Domain Name	When routing numeric SIP URIs, Unified CM considers SIP URIs with the right-hand side (host portion) of the URI matching the configured Cluster Fully Qualified Domain Name (CFQDN) as destinations to be routed according to the configured local numeric dial plan. If no match is found for the numeric left-hand side of the URI in the configured numeric dial plan, then Unified CM rejects the call. For more details, refer to the section on <i>Routing of SIP Requests in Unified CM</i> in the <i>Dial Plan</i> chapter of the latest version of the <i>Cisco Collaboration System SRND</i> .	Space-separated list of all Unified CM call processing nodes in the cluster.  Example: us-cm-sub1.ent-pa.com us-cm-sub2.ent-pa.com
OAuth with Refresh Login Flow	This enables OAuth grant flow authentication. This is highly recommended for deployments using push notifications via APNs. OAuth grant flow authentication makes sure that a Jabber client receiving an incoming call APN can be brought to the foreground and re-authenticate quickly enough for the user to answer the incoming call in a timely manner. It is also required to enable encrypted media and signaling with Jabber, if no Locally Significant Certificate (LSC) is installed on Jabber.	Enabled

## Service Activation

Table 2-3 summarizes the services to be activated on the Unified CM publisher node, the dedicated Unified CM TFTP server subscriber nodes, and the Unified CM call processing subscriber nodes.

Table 2-3 Unified CM Node Service Activation

Service	Publisher	Dedicated TFTP Subscriber	Call Processing Subscriber
<b>CM Services</b>			
Cisco CallManager			Yes
Cisco IP Voice Media Streaming App			Yes
Cisco CTIManager			Yes
Cisco Intercluster Lookup Service	Yes		
Cisco Location Bandwidth Manager			Yes
Cisco Dialed Number Analyzer Server	Yes		
Cisco Dialed Number Analyzer	Yes		
Cisco Tftp		Yes	
<b>CTI Services</b>			



**Table 2-3 Unified CM Node Service Activation (continued)**

Service	Publisher	Dedicated TFTP Subscriber	Call Processing Subscriber
Cisco WebDialer Web Service			Yes
<b>Database and Admin Services</b>			
Cisco Bulk Provisioning Service	Yes		
Cisco AXL Web Service	Yes		
<b>Performance and Monitoring Services</b>			
Cisco Serviceability Reporter	Yes		
Cisco CallManager SNMP Service	Yes	Yes	Yes
<b>Security Services</b>			
Cisco CTL Provider	Yes	Yes	Yes
Cisco Certificate Authority Proxy Function	Yes		
<b>Directory Services</b>			
Cisco DirSync	Yes		

Table 2-4 lists the services to be activated on Cisco Unified CM IM and Presence publisher and subscriber nodes.

**Table 2-4 Unified CM IM and Presence Node Service Activation**

Service	Publisher	Subscriber
Cisco AXL Web Service	Yes	Yes
Cisco Bulk Provisioning Service	Yes	
Cisco Serviceability Reporter	Yes	
Cisco SIP Proxy	Yes	Yes
Cisco Presence Engine	Yes	Yes
Cisco XCP Connection Manager	Yes	Yes
Cisco XCP Authentication Service	Yes	Yes

## Service Parameter Settings

Some service parameters of the Cisco CallManager service are global in nature and need to be set only once in Unified CM Administration. The global service parameter settings for Cisco CallManager service are listed in Table 2-5.

**Note**

Only non-default Service Parameter and other configuration field values are specified in this document. If a field configuration value is not mentioned, then the default value should be assumed.

**Note**

Some of the service parameters listed are advanced service parameters.

**Table 2-5 Global Service Parameters**

Service Parameter	Value	Description
Call Diagnostics Enabled	Enable Only When CDR Enabled Flag is True	This parameter determines whether call management records (CMR), also called diagnostic records, are generated.
T302 Timer	5000	Whenever a destination is dialed digit-by-digit and based on the numeric dial plan provisioned in Unified CM, no immediate deterministic decision can be made about which provisioned pattern has to be considered for the dialed destination. Because a potential longer match (could be variable length) exists, the T302 inter-digit timeout has to expire before Unified CM selects the best route and routes the call. The default of 15,000 milliseconds (ms) typically is too long.
Apply Transformations On Remote Number	True	Makes sure that calling party transformations are also applied mid-call; for example, if a call is transferred from one party to another.
Max Forward UnRegistered Hops to DN	2	Limit CFUR loops from occurring, for example, if a phone is unregistered but the site's gateway still is registered with Unified CM.
Stop Routing on Q.931 Disconnect Cause Code	3 21 27 28 38 42 63	Allows Unified CM to stop hunting down the configured hunt list when receiving specific Q.850 cause codes.
G.722 Codec Enabled	Enabled for All Devices Except Recording-Enabled Devices	G.722 disabled on recording-enabled devices to avoid problems with G.722 not being supported by the recorder.
Automated Alternate Routing Enable	True	This service parameter globally enables automated alternate routing (AAR).

Other service parameters of the Cisco CallManager service must be set explicitly as shown in [Table 2-6](#) for each Unified CM call processing node.

**Table 2-6 Per-Node Service Parameters**

Service Parameter	Value	Description
CDR Enabled Flag	True	This parameter enables the generation of call detail records (CDR).
CDR Log Calls with Zero Duration Flag	True	This parameter enables or disables the logging of call detail records (CDRs) for calls that never connected or that lasted less than 1 second.
Digit Analysis Complexity	TranslationAndAlternatePatternAnalysis	This parameter specifies the amount of digit analysis information that CCM trace files will provide.

## Onboarding for Push Notifications via Apple Push Notification Service (APNs)

Follow the *Push Notifications Configuration Task Flow* described in the latest version of the document on *Push Notifications Deployment for Cisco Jabber on iPhone and iPad with Cisco Unified Communications Manager*, available at

<https://www.cisco.com/c/en/us/support/unified-communications/unified-communications-manager-callmanager/products-installation-and-configuration-guides-list.html>

In summary the following steps are required for the onboarding:

- Smart License Registration
  - Register the Unified CM cluster on the license management page
- Voucher generation
  - In **Advanced Features > Cisco Cloud Onboarding** click **Generate Voucher**
- Onboarding
  - In **Advanced Features > Cisco Cloud Onboarding**

Select **Enable Push Notifications**.

Select **Send Troubleshooting information to the Cisco Cloud**.

Select **I want Cisco to manage the Cisco Cloud Service CA Certificates required for this trust**.

Select **Enable HTTP Proxy** and enter Proxy details if the connectivity requirements in [Table 2-7](#) require the use of a forward proxy.

Click **Save**.
  - Restart the **XCP Router Service** on Unified CM IM and Presence nodes
    - After successfully onboarding the cluster, you must restart the XCP Router Service on all Unified CM IM and Presence nodes in the cluster. We recommend restarting the service during a maintenance window.

[Table 2-7](#) summarizes the connectivity requirements for the various Unified CM nodes. If direct access is not possible due to existing networking policies, then access to the destinations in [Table 2-7](#) must be enabled through a forward proxy.

**Table 2-7 Cloud Connectivity Requirements for Push Notifications via APNs**

From	To	Port	Usage
Unified CM Publisher	Cisco cloud	443/TCP	The Unified CM publisher during the onboarding process needs access to the onboarding service hosted at <b>fos-a.wbx2.com</b> .
Unified CM IM and Presence and call processing	Cisco cloud	443/TCP	All call processing subscribers and IM and Presence nodes need access to the Common Identity service at <b>idbroker.webex.com</b> to obtain OAuth access tokens. Also, they need to be able to access the Push REST service at <b>push.webexconnect.com</b> .

## Other IM and Presence Settings

Previous sections discussed the IM and Presence service activation, certificates management, and the IM and Presence SIP trunk configuration. In addition to that, configure settings on IM and Presence servers:

- Configure a Unified CM domain in the **IM&P Cisco SIP Proxy** Service Parameter.
- In **Cisco Unified CM IM and Presence Administration > Presence > Settings > Standard Configuration**:
  - Configure a Cluster ID value.
  - Enable availability sharing. If not enabled, users can view only their own availability status.
  - Check **Enable ad-hoc presence subscriptions** to turn on ad-hoc presence subscriptions for Cisco Jabber users.
- In **Cisco Unified CM IM and Presence Administration > Presence > Routing > Settings**:
  - Configure **Proxy Server Settings: Enable Method/Event Routing Status**
- In **Cisco Unified CM IM and Presence Administration > Messaging > Settings**:
  - Enable instant messaging.
- Enable OAuth grant flow authentication.
  - Set the Enterprise parameter **OAuth with Refresh Login Flow** to **Enabled**.
- Enable Multi Device Messaging.
  - In Cisco Unified CM IM and Presence Administration, choose **System > Service Parameters**.
  - From the **Server** drop-down list, choose the IM and Presence Service Publisher node.
  - From the **Service** drop-down list, choose **Cisco XCP Router (Active)**.
  - From the **Enable Multi-Device Messaging** drop-down list, choose **Enabled**.
  - Click **Save**.
- Enable Push Notifications High Availability.
  - In Cisco Unified CM IM and Presence Administration, choose **System > Service Parameters**.
  - From the **Server** drop-down list, choose the IM and Presence Service Publisher node.
  - From the **Service** drop-down list, choose **Cisco XCP Router (Active)**.
  - From the **Push Notifications High Availability** drop-down list, choose **Enabled**.
  - Click **Save**.
- Restart the XCP Router Service.
  - Changing the two service parameters to enable Multi Device Messaging and Push Notifications High Availability requires you to restart the **Cisco XCP Router** service on all Unified CM IM and Presence nodes during a maintenance window.

Also configure UC services for Jabber clients, as described in the section on [Jabber Provisioning](#).

## Dial Plan Configuration

A structured, well-designed dial plan is essential to successful deployment of any call control system. The design of an enterprise dial plan needs to cover these main areas:

- Endpoint addressing
- General numbering plan
- Dialing habits
- Routing
- Classes of service

The recommended dial plan design follows the design approach documented in the *Dial Plan* chapter of the latest version of the *Cisco Collaboration System SRND*.

### Example Topology

For the purpose of this document, we assume a centralized call processing deployment serving three sites in the US: SJC, RCD, and RTP. [Table 2-8](#) provides the DID (direct inward dial) ranges for these sites.

**Table 2-8** DID Ranges for Example Sites

Site	DID range
SJC	+1 408 555 4XXX
RCD	+1 972 555 5XXX
RTP	+1 919 555 1XXX

### Endpoint Addressing

For endpoints with DID addresses, directory numbers are provisioned as full +E.164 numbers, where +E.164 represents a leading "+" followed by the full global E.164 phone number. To provision a +E.164 directory number in Unified CM, the leading "+" has to be escaped; for example, extension 4001 in SJC would have to be provisioned as \+14085554001.

Some endpoints will not have DIDs because not enough DIDs are available from the provider or because the associated devices do not need to be reachable from the PSTN (for example, lobby phones). For these endpoints no DIDs (E.164 numbers) exist, and thus an address format other than +E.164 is required for these endpoints. This address format is discussed in the section on [General Numbering Plan](#).

### Addressing Enterprise Services for External Access

Some services have assigned PSTN numbers. An example of this might be a voicemail pilot number that has to be reachable from the outside to enable users to call into voicemail from the PSTN. PSTN E.164 numbers for these services have to be reserved from the DID ranges assigned by the PSTN providers.

## General Numbering Plan

In addition to endpoints with associated DIDs for which +E.164 addresses can be used, a number of additional destinations exist for which no DIDs exist:

- Lobby phones
- Regular endpoints for which no DIDs could be assigned by the provider
- Services (call pickup numbers, call park numbers, conferences, and so forth)

In this document we refer to these types of destinations as *non-DIDs*.

Addresses for these non-DIDs, similar to +E.164 addresses, must be unique system-wide to avoid site-specific partitions for non-DIDs. The recommended solution is to introduce an enterprise specific numbering (ESN) schema for all non-DIDs. This ESN schema follows the structure of typical abbreviated inter-site dialing:

- Access-code  
A single-digit access code for abbreviated inter-site dialing. In the design phase, choose the access code so that there is no overlap with any other enterprise dialing habit (see below).
- Site-code  
A digit sequence uniquely identifying a site in the network. In the design phase, choose the length of the site code so that it not only covers all existing sites, but also allows for growth.
- Extension  
A digit sequence uniquely identifying the respective entity within the site.

In this document we use 8 as the access-code for abbreviated inter-site dialing, and thus all ESNs start with 8 and use a three-digit site code and a four-digit extension. [Table 2-9](#) indicates an ESN range for the DID and non-DID numbers for each site in our example.

**Table 2-9 ESN Ranges for DIDs and Non-DIDs**

Site	+E.164 Range	Site Code	ESN Range for DIDs	ESN Range for Non-DIDs
SJC	+1 408 555 4XXX	140	8-140-4XXX	8-140-5XXX
RCD	+1 972 555 5XXX	197	8-197-5XXX	8-197-6XXX
RTP	+1 919 555 1XXX	191	8-191-1XXX	8-191-2XXX

The plan is to use the same site code for DIDs and non-DIDs, but the first digit of the extension for non-DIDs is different from the first digit of the DID extensions. This also allows for abbreviated four-digit intra-site dialing to non-DIDs and DIDs.

While the ESN ranges in [Table 2-9](#) leave room in the ESN plan for site-specific numbers, there is also a requirement to assign number ranges for non-site-specific services such as, for example, scheduled conferences. [Table 2-10](#) shows an example of how this requirement can be addressed by reserving a dedicated site code (in this case 099).

**Table 2-10 ESN Ranges for Conferences**

ESN Range	Usage
8099[12]XXX	Scheduled conferences

## Dialing Habits

Dialing habits describe what end users must dial to reach various types of destinations. Dialing habits can first be classified as numeric dialing (for example, 914085550123) or alphanumeric dialing (for example, bob@ent-pa.com).

In this design, in addition to alpha URI dialing, the numeric dialing habits shown in [Table 2-11](#) are supported.

**Table 2-11 Supported Numeric Dialing Habits**

Dialed Pattern	Example (site SJC)	Type of Destination
XXXX	4001 (DID) 5001 (non-DID)	Abbreviated intra-site dialing to reach a destination at the same site.  The called destination can be a DID, a non-DID, or a service number.
+E.164	+14085554001 (on-net, SJC) +19195551001 (on-net, RTP) +1212551001 (off-net)	Full +E.164 dialing for example from directories. The dialed destination can be on-net or off-net. The implemented dial plan makes sure that calls to on-net destinations dialed as +E.164 are routed on-net. Non-DIDs obviously cannot be called as +E.164.
Access code–site code–extension	8-140-4001 (DID, SJC) 8-140-5001 (non-DID, SJC) 8-191-1001 (DID, RTP) 8-191-2001 (non-DID, RTP)	Abbreviated inter-site dialing to reach a destination at the same site or a different site. The called destination can be a DID, a non-DID, or a service number. The access code (8 in the example) has to be selected so that it does not overlap with any other dialing habit; for example any abbreviated intra-site dialing: access code 8 for inter-site dialing prohibits four digit intra-site dialing starting with 8.
*E.164	*12125551567	Dialing of a video call through dedicated video ISDN gateways. The * is used to create a specific dialing habit with no overlap to any other numeric(!) dialing habit. To avoid the use of * also a number area starting with the abbreviated inter-site access code 8 can be used: for example 8000-<E.164>.
91-<10 digits>	914085554001 (on-net, SJC) 919195551001 (on-net, RTP) 912125551001 (off-net)	US specific habitual PSTN dialing of national destinations. The implemented dial plan ensures that if the dialed destination is on-net then the call is routed on-net. The leading 9 here is the PSTN access code typically used in the US.
9011-<E.164 number>	90114961007739764	US specific habitual PSTN dialing of international destinations. The implemented dial plan makes sure that if the dialed destination is on-net then the call is routed on-net.

In general, using fewer supported dialing habits simplifies the design. Starting the design process with an overview of all dialing habits makes sure that overlaps between any two dialing habits leading to inter-digit timeouts are detected and can be resolved before starting the dial plan deployment. Avoiding overlaps with any other (typically on-net) dialing habit is the key reason for using a PSTN access code (typically 9 in the US, as shown above).

## Partitions

When defining the partitions and CSSs provisioned to build an enterprise dial plan, one goal is to avoid replication of duplicate configuration as much as possible. Following this maxim, [Table 2-12](#) shows the global (that is, not site or country specific) partitions required.

**Table 2-12 Global Partitions**

Partition	Description
DN	Holds all +E.164 directory numbers and other local on-net +E.164 destinations (for example, pilot numbers reachable from the PSTN). All +E.164 patterns are provisioned as urgent patterns.
ESN	Holds all Enterprise Specific Numbers (ESNs). This includes ESN directory numbers (for example, for non-DID phones) as well as dialing normalization translation patterns transforming from abbreviated inter-site dialing of DIDs to +E.164.
PSTNInternational	Holds +E.164 route patterns required to provide PSTN access to international destinations.
URI	Holds manually provisioned URIs.
onNetRemote	Holds all patterns of remote on-net destinations. In environments with multiple Unified CM clusters, this includes all remote number ranges learned via Global Dial Plan Replication (GDPR).
B2B_URI	Holds SIP route patterns required for business-to-business (B2B) URI dialing through the Internet.
Directory URI	System Partition where all auto-generated URIs are put. This partition does not need to be created. It is listed here for reference to introduce the partition, which is used again later in this document.

All of the partitions [Table 2-12](#) except the Directory URI partition must be created. In addition to the pattern classes represented by these global partitions, several site, country, or class-of-service specific pattern classes are required, as show in [Table 2-13](#).



**Table 2-13 Country or Site Specific Partitions**

Partition	Description
USPSTNNational	<p>Holds +E.164 route patterns required to provide PSTN access to national destinations in the US. To support other countries, and thus other country-specific dialing habits, a country appropriate xxPSTNNational partition (where xx represents the country; for example, DEPSTNNational, UKPSTNNational, ITPSTNNational) also needs to be provisioned, which then holds the +E.164 route patterns required to provide PSTN access to national destinations of that country.</p> <p>The reason we differentiate between international PSTN access (see <a href="#">Table 2-12</a>) and national PSTN access is that we need to be able to build differentiated classes of service allowing calls to reach national only, or national and international destinations.</p>
USToE164	Holds dialing normalization translation patterns to transform US specific habitual PSTN dialing (for example, 91-<10 digits>) to +E.164. To support other countries, and thus other country-specific dialing habits, a country appropriate xxToE164 partition (where xx represents the country; for example, DEToE164, UKToE164, ITToE164) also needs to be provisioned, which then holds the dialing normalization translation patterns required to transform the country specific habitual PSTN dialing to +E.164.
USEmergency	Holds route patterns required to provide access to emergency calls using the US specific emergency dialing habits.
USPhLocalize	Holds calling party transformation patterns to localize +E.164 calling party numbers for abbreviated display on phones in the US.
<site>Intra	Site-specific intra-site dialing. For example: SJCIntra. Holds dialing normalization patterns to transform site-specific abbreviated intra-site dialing to DIDs, or non-DIDs to +E164 or ESN, respectively.
<site>PhLocalize	Site-specific. For example: SJCPHLocalize. Holds calling party transformation patterns to localize +E.164 calling party numbers for abbreviated display on phones in a given site.

As emergency calls are placed using country specific dialing habits, partition USEmergency with the route patterns enabling the US dialing habit for emergency calls also is country specific. To also support other dialing domains (countries), the equivalent partitions for these other dialing domains (for example, DEEmergency, ITEmergency, DEPhLocalize, ITPHLocalize, for Germany and Italy respectively) would need to be created.

## Dialing Normalization Translation Patterns

Table 2-14 summarizes which dialing normalization translation patterns need to be provisioned using the partitions from the previous section. All dialing normalization translation patterns are provisioned as urgent patterns and have **Use Originator's Calling Search Space** set as described in section on [Partitions](#) so that, after applying the called party transformation defined in the dialing normalization translation pattern, the original CSS is used to find the final match for the dialed destination.

**Table 2-14** Summary of Dialing Normalization Translation Patterns

Partition	Pattern	Called Party Transformation Mask	Note
ESN	81404XXX	+14085554XXX	Abbreviated inter-site dialing to site SJC
ESN	81975XXX	+19725555XXX	Abbreviated inter-site dialing to site RCD
ESN	81911XXX	+19195551XXX	Abbreviated inter-site dialing to site RTP
SJCItra	4XXX	+14085554XXX	Abbreviated intra-site dialing in site SJC to DID in SJC
SJCItra	5XXX	81405XXX	Abbreviated intra-site dialing in site SJC to non-DID in SJC
RCDItra	5XXX	+19725554XXX	Abbreviated intra-site dialing in site RCD to DID in RCD
RCDItra	6XXX	81976XXX	Abbreviated intra-site dialing in site RCD to non-DID in RCD
RTPItra	1XXX	+19195551XXX	Abbreviated intra-site dialing in site RTP to DID in RTP
RTPItra	2XXX	81912XXX	Abbreviated intra-site dialing in site RTP to non-DID in RTP
UStoE164	9.1[2-9]XX[2-9]XXXXXX	No Mask, strip pre-dot, prefix +	US specific habitual PSTN dialing to national destinations in the US
UStoE164	9011.!#	No Mask, strip pre-dot, prefix +	US specific habitual PSTN dialing to national destinations in the US.
UStoE164	9011.!	No Mask, strip pre-dot, prefix +	US specific habitual PSTN dialing to national destinations in the US  <b>Note</b> This is the only pattern for which <b>Do Not Wait For Interdigit Timeout On Subsequent Hops</b> is not set.

For dialing domains other than the US, other country specific dialing normalization translation patterns must be defined if the installation has to support those country specific dialing habits. Table 2-15 shows the required dialing normalization for Germany (DE) and Italy (IT) as examples.

**Table 2-15** *Dialing Normalization for Germany and Italy*

Partition	Pattern	Called Party Transformation	Note
DEtoE164	000.!	strip pre-dot, prefix +	Germany: international call (000-E.164). <b>Note</b> Do Not Wait For Interdigit Timeout On Subsequent Hops is not set.
DEtoE164	000.!#	strip pre-dot trailing #, prefix +	Germany: international call (000-E.164).
DEtoE164	00.[^0]!	strip pre-dot, prefix +49	Germany: national call (00-national significant number). <b>Note</b> The numbering plan in Germany is variable length and this pattern needs to cover this. <b>Note</b> Do Not Wait For Interdigit Timeout On Subsequent Hops is not set.
DEtoE164	00.[^0]!#	strip pre-dot trailing #, prefix +49	Germany: national call (00-national significant number).
ITtoE164	000.!	strip pre-dot, prefix +	Italy: international call (000-E.164). <b>Note</b> Do Not Wait For Interdigit Timeout On Subsequent Hops is not set.
ITtoE164	000.!#	strip pre-dot trailing #, prefix +	Italy: international call (000-E.164)
ITtoE164	0.0[^0]!	strip pre-dot, prefix +39	Italy: national call (0-national significant number (NSN) where NSN starts with 0). <b>Note</b> The numbering plan in Italy is variable length and this pattern needs to cover this. <b>Note</b> Do Not Wait For Interdigit Timeout On Subsequent Hops is not set.
ITtoE164	0.0[^0]!#	strip pre-dot trailing #, prefix +39	Italy: national call (0-NSN where NSN starts with 0).
ITtoE164	0.[^0]!	strip pre-dot, prefix +39	Italy: national call (0-NSN where NSN does not start with 0). <b>Note</b> The numbering plan in Italy is variable length and this pattern needs to cover this. <b>Note</b> Do Not Wait For Interdigit Timeout On Subsequent Hops is not set.
ITtoE164	0.[^0]!#	strip pre-dot trailing #, prefix +39	Italy: national call (0-NSN where NSN does not start with 0).

The example in [Table 2-15](#) shows that in Italy and Germany the ITU recommended 0 is used to access a trunk from inside the enterprise, and then 0 and 00 are used for national and international access. Since 1998, geographic numbers in Italy start with 0, and digits 1 to 9 as the first digit of a national significant number indicate different types of numbers. Hence, dial strings starting with exactly two 0s (00) need to be treated differently in Italy than in Germany. In Italy the second zero has to be considered part of the NSN and hence has to be kept in the resulting +E.164 digit string, while a second zero in Germany would need to be removed because geographic numbers in Germany do not start with a zero.

The example of the dialing normalization required for these two countries shows how country specific dialing habits can be modeled in the design approach presented.

For more information on international numbering plans, see the *International Numbering Resources* page of the ITU-T at <https://www.itu.int/en/ITU-T/inr/Pages/default.aspx>. There you can find links to various resources, including E.164 country codes and national numbering plans. An overview of dialing procedures used in various countries can be found in *Operational Bulletin No.994 (15.XII.2011) and Annexed List: Dialling procedures (international prefix, national (trunk) prefix and national (significant) number) (in accordance with ITU-T Recommendation E.164 (11/2010)) (Position on 15 December 2011)*, available at <https://www.itu.int/pub/T-SP-OB.994-2011>. The actual list of dialing procedures starts at page 25 of that document and is also available for download at [https://www.itu.int/dms\\_pub/itu-t/opb/sp/T-SP-E.164C-2011-PDF-E.pdf](https://www.itu.int/dms_pub/itu-t/opb/sp/T-SP-E.164C-2011-PDF-E.pdf).

## Classes of Service and Calling Search Spaces (CSSs)

As mentioned before, a CSS is a list of partitions that defines which partitions, and thus patterns, a calling entity using the CSS can access. In this document we use a dial plan approach that uses only the line CSS to define class of service.

Table 2-16 lists the classes of service considered in this design. The classes of service chosen for this design are only examples. If further classes of services are required, then these can be defined equivalently.



**Tip**

The number of classes of service is one of the key parameters driving the complexity of enterprise dial plan designs. Therefore, it is good practice to define as few classes of service as possible for the dial plan.

The recommended design makes use of only the CSS provisioned on the line and does not use the device CSS to define class of service. The device CSS can be used to implement general dialing habits that need to be available for everyone. An example for this is emergency calling; see the section on [Emergency Call Considerations in Multi-National Environments](#) for more details on when to use the device CSS to implement emergency calls.

**Table 2-16**      **Classes of Service**

Class of Service	Access to
International	All on-net destinations National PSTN destinations International PSTN destinations Business-to-business URI dialing Emergency calls
National	All on-net destinations National PSTN destinations Emergency calls
Internal	All on-net destinations Emergency calls

Adding business-to-business URI dialing to only the International class of service is an example based on the assumption that business-to-business (B2B) calls consume limited edge resources. Also we are trying to avoid increasing the number of classes of service by a factor of two by introducing classes of service International, InternationalB2B, National, NationalB2B, Internal, and InternalB2B.

Because only the line CSS is used to define both class of service and the set of dialing habits available to a given caller, a CSS needs to be provisioned per site and class of service.

Table 2-17 shows how class of service International for a user in site SJC would be defined based on the partition set previously defined (see Table 2-12 and Table 2-13).

**Table 2-17 Class of Service International for SJC User**

CSS Name	Partitions
SJCInternational	DN Directory URI URI ESN onNetRemote SJCIntra UStoE164 USPSTNNational PSTNInternational B2B_URI USEmergency

As depicted in Table 2-18, the remaining classes of service are created equivalently by selectively removing access to B2B URI dialing, international, and national PSTN destinations.

**Table 2-18 Classes of Service National and Internal for SJC User**

CSS Name	Partitions	CSS Name	Partitions
SJCNational	DN Directory URI URI ESN onNetRemote SJCIntra UStoE164 USPSTNNational USEmergency	SJCInternal	DN Directory URI URI ESN onNetRemote SJCIntra UStoE164 USEmergency

CSSs for classes of services for users in other sites are created equivalent to the above CSSs, with the only difference being a different partition used with the site-specific dialing normalization patterns.

Table 2-19 shows an example of the RTP site National and Internal classes of service.

**Table 2-19** *Classes of Service National and Internal for RTP User*

CSS Name	Partitions	CSS Name	Partitions
RTPNational	DN Directory URI URI ESN onNetRemote RTPIntra UStoE164 USPSTNNational USEmergency	RTPInternal	DN Directory URI URI ESN onNetRemote RTPIntra UStoE164 USEmergency

These examples clearly show that the chosen partition scheme allows for optimal reuse of patterns and partitions when creating CSSs to implement classes of service for multiple sites.

For sites in other dialing domains (countries), the same CSS and partition schema as shown above can be used, with the only difference being that the dialing normalization partition for the specific dialing domain and the partition with the country specific route to national PSTN destinations would be used instead of the US partitions used above. For example, [Table 2-20](#) shows the CSS for class of service International for a site FRA in Germany (DE).

**Table 2-20** *Class of Service International for Users in site FRA in Germany (DE)*

CSS Name	Partitions
FRAInternational	DN Directory URI URI ESN onNetRemote FRAIntra DEtoE164 DEPSTNNational PSTNInternational B2B_URI DEEmergency

## Special CSSs

In addition to classes of service for users, calling search spaces (CSSs) also are used to define classes of service for applications connected through trunks, such as Cisco Unity Connection, for example.

Assuming that Unity Connection should have access only to on-net destinations and that, in addition to ESN and +E.164 dialing, also US dialing habits should be supported from Unity Connection, [Table 2-21](#) shows the CSS to implement this class of service.

**Table 2-21** *Class of Service for Voicemail*

CSS Name	Partitions
VoiceMail	DN ESN URI onNetRemote Directory URI UStoE164

In scenarios where Cisco Unity Connection needs to serve multiple countries, then implementing the country specific dialing normalization as defined in partition UStoE164 in the above example is not an option. The only dialing habits that can be supported in that case are the globally significant dialing habits ESN and +E.164.

To use Unified CM presence, a subscribe CSS has to be provisioned, among other things, to allow access to all presentities that a presence user subscribes to. To allow for a very simple provisioning of Unified CM presence without further differentiation of presence access, a single CSS needs to be provisioned that allows access to all possible on-net destinations. [Table 2-22](#) shows the settings for this default subscribe CSS.

**Table 2-22** *Default Subscribe CSS*

CSS Name	Partitions
DefaultSubscribe	DN ESN URI onNetRemote Directory URI

This subscribe CSS ensures access to all types of on-net destinations.

[Table 2-23](#) shows the (trivial) CSS "DN" to be used as the incoming CSS on PSTN trunks. To avoid loops, a PSTN trunk can address only +E.164 directory numbers. A PSTN trunk would not need access to ESN patterns, dialing normalization patterns, or URIs because only a single number format is supported by the PSTN, and this is normalized to +E.164 on ingress.

**Table 2-23** *Inbound CSS for PSTN Gateways*

CSS Name	Partitions
DN	DN

[Table 2-24](#) shows the CSS ICTInbound to be used as an incoming CSS on trunks to other Unified CM clusters. To avoid loops, the incoming CSS on these intercluster trunks should not provide access to remote on-net destinations (partition onNetRemote), but the trunks (inbound CSS) need to support all valid on-net addressing modes (+E.164, ESN, and URIs). Dialing normalization is not part of this CSS because dialing habits other than +E.164 and ESN would already have been normalized to +E.164 or ESN on the remote Unified CM cluster prior to landing on the incoming intercluster trunk.

**Table 2-24 Inbound CSS for Trunks to Other Unified CM Clusters**

CSS Name	Partitions
ICTInbound	DN ESN URI Directory URI

## Local Route Groups for Call Type Specific Outbound Gateway Selection

To allow for flexible egress gateway selection based on the calling device, we recommend using local route groups (LRGs). Using LRGs for egress gateway selection avoids the need for site-specific route patterns.

To allow for differentiated LRG selection for different call types, set up multiple LRG names as shown in [Table 2-25](#).

**Table 2-25 Local Route Group Names**

Local Route Group Name	Description
LRG_PSTN_1	Local route group referring to primary PSTN resources to be used for PSTN calls
LRG_PSTN_2	Local route group referring to secondary PSTN resources to be used for PSTN calls
LRG_VIDEO_1	Local route group referring to primary PSTN resources to be used for video PSTN calls
LRG_VIDEO_2	Local route group referring to secondary PSTN resources to be used for video PSTN calls
LRG_Emergency_1	Local route group referring to primary PSTN resources to be used for emergency calls
LRG_Emergency_2	Local route group referring to secondary PSTN resources to be used for emergency calls

With these LRG definitions, dedicated route lists can be created for both "normal" PSTN calls and emergency calls so that different PSTN resources (gateways) are used for emergency calls than for normal PSTN calls. This makes sense in scenarios where centralized PSTN resources are provisioned for normal PSTN calls, but emergency calls should still use dedicated small gateways local to the site to allow for local emergency call routing to the correct Public Safety Answering Point (PSAP).

The video LRGs are provisioned for video-enabled ISDN gateways and treat them as separate resources.



## Route Lists Using Local Route Groups

Using the LRGs as defined in the previous section, route lists should be created as depicted in [Table 2-26](#).

**Table 2-26** *Route List Definitions*

Route List	Members	Description
RL_PSTN	LRG_PSTN_1 LRG_PSTN_1 Standard Local Route Group	Normal PSTN calls should make use of the primary and secondary site-specific PSTN resources defined for normal PSTN calls. The last member, Standard Local Route Group, allows for fallback to PSTN resources not specific to a call type.
RL_Emergency	LRG_Emergency_1 LRG_Emergency_2 LRG_PSTN_1 LRG_PSTN_1 Standard Local Route Group	For emergency calls, the first call-specific resources for emergency calls should be used, then the second, then the PSTN resources defined for normal PSTN calls, and lastly the non-specific PSTN resources.
RL_VIDEO	LRG_VIDEO_1 LRG_VIDEO_2 LRG_PSTN_1 LRG_PSTN_2 Standard Local Route Group	For video calls, first the video-specific gateway resources are used, then the regular PSTN resources are considered as a fallback (audio only), and lastly the Standard Local Route Group is used if the others fail.

With the above LRG and route list definition on each device pool, up to seven route groups can be selected for the defined LRGs to allow for very specific outbound gateway selection. The actual PSTN resources to be used for certain call types are defined during device pool provisioning. If selecting different outbound PSTN resources based on call type is not required for a given set of devices, and only a single PSTN resource is needed for all call types, then it is sufficient to define only an actual route group for the Standard Local Route Group on the respective device pool and leave all other LRGs in that device pool set to **<None>**. Having **Standard Local Route Group** as the last entry in all route lists is a good way to achieve this.

## Route Patterns for PSTN Access and Emergency Calls

PSTN access is achieved through PSTN route patterns. As described in the section about [Classes of Service and Calling Search Spaces \(CSSs\)](#), the route to international destinations needs to be provisioned in the PSTNInternational partition, while national PSTN routes are provisioned in the dialing domain specific partitions xxPSTNNational (where xx represents dialing domain USPSTNNational, for example). [Table 2-27](#) shows the configured PSTN route patterns.

**Table 2-27 PSTN Route Patterns**

Pattern	Partition	Gateway or Route List	Description
\+!	PSTNInternational	RL_PSTN	Variable length to allow for dialing of arbitrary international destinations.
\+!#	PSTNInternational	RL_PSTN	Alternative pattern for international destinations to allow terminating variable length dialing with #. Discard Digits set to <b>Trailing-#</b>
\+1[2-9]XX[2-9]XXXXXX	USPSTNNational	RL_PSTN	Explicit pattern for national destinations in the US. <b>Urgent Priority</b> checked to avoid overlap with variable length PSTN route pattern \+! defined for international destinations.
911	USEmergency	RL_Emergency	US emergency calling <b>Urgent Priority</b> checked
9911	USEmergency	RL_Emergency	US emergency calling <b>Urgent Priority</b> checked

Apart from the route pattern settings explicitly shown in [Table 2-27](#), all other settings are left with default values as shown in [Table 2-28](#). This especially includes the calling, connected, and called party transformations, which are left empty (apart from stripping a trailing # as mentioned above) because the calling and called party transformations required to match the PSTN requirements are configured as explicit calling and called party transformations. This is described in the sections on [Outbound Calls: Called and Calling Number Transformations on ISDN Gateways](#) and [Outbound Calls: Called and Calling Number Transformations on SIP Trunks](#).

**Table 2-28 Route Pattern Default Settings**

Setting	Value
<b>Pattern Definition</b>	
Numbering Plan	-- Not Selected --
Route Filter	<None>
MLPP Precedence	Default
Apply Call Blocking Percentage	Unchecked
Resource Priority Namespace Network Domain	<None>
Route Class	Default
Route Option	Route this pattern
Call Classification	OffNet
External Call Control Profile	<None>
Allow Device Override	Unchecked
Provide Outside Dial Tone	Checked
Allow Overlap Sending	Unchecked

**Table 2-28 Route Pattern Default Settings (continued)**

Setting	Value
Require Forced Authorization Code	Unchecked
Authorization Level	0
Require Client Matter Code	Unchecked
<b>Calling Party Transformations</b>	
Use Calling Party's External Phone Number Mask	Unchecked
Calling Party Transform Mask	Leave empty; do not enter any value
Prefix Digits (Outgoing Calls)	Leave empty; do not enter any value
Calling Line ID Presentation	Default
Calling Name Presentation	Default
Calling Party Number Type	Cisco CallManager
Calling Party Numbering Plan	Cisco CallManager
<b>Connected Party Transformations</b>	
Connected Line ID Presentation	Default
Connected Name Presentation	Default
<b>Called Party Transformations</b>	
Discard Digits	<None>
Called Party Transform Mask	Leave empty; do not enter any value
Prefix Digits (Outgoing Calls)	Leave empty; do not enter any value
Called Party Number Type	Cisco CallManager
Called Party Numbering Plan	Cisco CallManager
<b>ISDN Network-Specific Facilities Information Element</b>	
Network Service Protocol	-- Not Selected --
Carrier Identification Code	Leave empty; do not enter any value
Network Service	-- Not Selected --

While the international PSTN route patterns in partition PSTNInternational are not dialing domain (country) specific, the route patterns in partitions USPSTNNational and USEmergency are country specific. If the dial plan needs to support other countries, then the route patterns for these countries need to be created as shown in [Table 2-29](#).

**Table 2-29 Non-US Route Patterns for National Destinations**

Pattern	Partition	Gateway or Route List	Description
\+49!	DEPSTNNational	RL_PSTN	Variable length because the German numbering plan with country code 49 is variable length.
\+49!#	DEPSTNNational	RL_PSTN	Alternative pattern for national destinations to allow terminating variable length dialing with #. Discard Digits set to <b>Trailing-#</b>
\+33XXXXXXXXXX	FRPSTNNational	RL_PSTN	Explicit pattern for national destinations in France. <b>Urgent Priority</b> checked to avoid overlap with variable length PSTN route pattern \+! defined for international destinations.
112	DEEmergency	RL_Emergency	German emergency calling <b>Urgent Priority</b> checked
0112	DEEmergency	RL_Emergency	German emergency calling <b>Urgent Priority</b> checked
112	FREmergency	RL_Emergency	French emergency calling <b>Urgent Priority</b> checked
0112	FREmergency	RL_Emergency	French emergency calling <b>Urgent Priority</b> checked

Table 2-29 shows the difference between fixed and variable length numbering plans. The national numbering plan in Germany is variable length and thus the route pattern to match on national destinations in Germany has to match on variable length digit strings, and we also need to provision an alternate route pattern ending on # to enable users to explicitly terminate dial strings with # to avoid inter-digit timeouts when dialing national destinations. In contrast to this, the national numbering plan in France is fixed length (as in the US), and thus a single urgent fixed-length route pattern is enough to cover all national numbers in France.

Because Germany and France use the same emergency dialing habit, the emergency routing can be simplified by combining both emergency partitions DEEmergency and FREmergency into a single partition 112Emergency and by using that partition instead in the CSS definitions.

## Emergency Call Considerations in Multi-National Environments

Independent from individual classes of service, access to emergency numbers is required from all endpoints at all times. As shown previously, this is easily achieved by adding the partition with the emergency calling route patterns to all CSSs. This approach is problematic if multiple countries need to be supported, those countries require different emergency dialing habits, and mobility features such as extension mobility and device mobility are used.

In this case, if a user roams between countries with different emergency dialing habits, then the device this user is using inherits the emergency dialing habits specific to the visiting user. For example, if a user from Germany logs into a phone in the US, then the line CSS as defined on the German user's extension

mobility profile gets assigned to the visited phone in the US, so that on this phone emergency calls now need to be placed using the German emergency calling dialing 112, and the US emergency call dialing habit 911 is not supported any longer.

To make sure that phones in a given country always support the national emergency call dialing habit independent of whether a foreign user logged into the phone, a different approach for emergency calls can be implemented. Instead of adding the USEmergency to all CSSs, create a dedicated USEmergency CSS and assign that CSS as the device CSS on all devices in the US. Then if a foreign user logs into a phone in the US, the visiting user's "home" dialing habits as defined by the line CSS will be combined with the visited countries emergency dialing habit. In the above case of a German user logging into a US phone, that user's German PSTN dialing habits will be supported together with the US specific emergency dialing habit 911. Keep in mind that this combination of dialing habits between different countries might create overlaps between the visited sites' emergency dialing and the visiting user's regular dialing habits. For example, if a site in Germany has four-digit extensions starting with 9 (such as +E.164 range +49 6100 773 9XXX), then the abbreviated four-digit intra-site dialing defined for that site through a 9XXX dialing normalization translation pattern creates an overlap with the US emergency dialing 911 if a user from that German site logs into a phone in the US. As long as the emergency dialing habit is more specific, then creating the emergency calling route pattern as urgent pattern makes sure that no delay is experienced when placing an emergency call. On the other hand, the 911 US emergency pattern would "block" all four-digit dialing starting with 911, affecting four-digit intra-site dialing to directory numbers +49 6100 773 911X, for example.

Moving the emergency dialing from the line to the device CSS also avoids the problem that visiting users' emergency dialing habits (112 in case of a user from Germany) need to be transformed to the visited countries emergency dialing habit (911 in the US).

## Route Patterns for Video PSTN (ISDN) Calls

Video ISDN gateways require special treatment from the dial plan perspective because it is unfeasible from the cost perspective to use ISDN video gateways for regular voice calls. In this design the selection of video ISDN gateways is explicitly tied to a special video PSTN dialing habit (see [Table 2-11](#)).

[Table 2-30](#) shows the required route patterns to enable this dialing habit.

**Table 2-30** Route Patterns for Video PSTN (ISDN) Calls

Pattern	Partition	Gateway or Route List	Description
*!	PSTNInternational	RL_VIDEO	Variable length because we need to support E.164 behind the *
*!#	PSTNInternational	RL_VIDEO	Alternative pattern to allow termination of variable length dialing with #. Discard Digits set to <b>Trailing-#</b>
*1XXXXXXXXXX	PSTNInternational	RL_VIDEO	Supplementary route pattern to allow dialing to US destinations (fixed length) without inter-digit timeout. <b>Urgent Priority</b> checked.

Putting the video ISDN route patterns into partition PSTNInternational effectively adds video dialing capabilities to class of service International.

## Outbound Calls: Called and Calling Number Transformations on ISDN Gateways

On ISDN trunks, calling and called party number information is sent and received in calling and called party information elements. These information elements are a triplet consisting of numbering plan, number type, and number. How these fields need to be set depends on the trunk service definition of the provider. As an example, for a call to E.164 destination 4961007739764 on a trunk in Germany in the same area code 6100, the called party number in the outgoing ISDN SETUP message could be sent as (plan/type/number) ISDN/national/61007739764, ISDN/subscriber/7739764, or unknown/unknown/061007739764.

If gateways terminating ISDN trunks are connected to Unified CM using SIP, then number types cannot be sent from Unified CM to the gateway because SIP does not know the concept of number types. Whether different ISDN number types need to be supported for different call types depends on the provider's SIP trunk service definition. On ISDN trunks, some providers always allow called and calling party numbers independent of called destination to be sent using the same ISDN plan and type indication.

Table 2-31 shows an example of alternate called party number formats that an ISDN provider in the US might accept.

**Table 2-31** *Alternate ISDN Number Format for Calls on US ISDN Trunk*

Type of Call	Destination	Called Party Plan/Type/Number to Be Sent to PSTN	Digit String Sent to Gateway
National	+12125551234	unknown/unknown/12125551234	*12125551234
International	+4961007739764	unknown/unknown/0114961007739764	*0114961007739764

The digit string sent to the gateway is prefixed with a "\*" to simplify the dial peer definition on the gateway. Prefixing called party numbers sent to the gateway with a "\*" enables easy non-colliding destination-pattern based outbound dial-peer selection on the gateway for inbound and outbound calls because called party numbers received from the PSTN never start with a "\*". The leading "\*" prefixed by Unified CM needs to be removed on the gateway before sending the call to the PSTN. The leading "\*" on all called party numbers sent from Unified CM to the gateway allows the use of "destination-pattern \*" on the POTS dial peers on the gateway. The default digit stripping behavior of Cisco IOS will then automatically strip the leading "\*".

The transformation from the called +E.164 destination to the digit string to be sent to the PSTN can be achieved on Unified CM, and on the gateway the ISDN plan and type can be enforced easily using Cisco IOS voice translation rules as shown in Example 2-2.

### **Example 2-2** *Cisco IOS Voice Translations to Force Single ISDN Plan and Type*

```
voice translation-rule 1
  rule 1 /^*/ // type any unknown plan any unknown
  rule 2 // // type any unknown plan any unknown
voice translation-profile ISDNunknown
  translate called 1
  translate calling 1
dial-peer voice 1 pots
  translation-profile outgoing ISDNunknown
```

The Cisco IOS configuration piece shown in Example 2-2 demonstrates how to force a single ISDN plan and type for calling and called party information to be sent to the PSTN through a given POTS dial-peer. Rule 1 of voice-translation-rule 1 matches all numbers starting with "\*" and simply removes this leading "\*". Rule 2 of voice translation-rule 1 matches on all numbers with any plan and type, and it forces both

plan and type to unknown while not changing the actual digit string of the number. With this Cisco IOS voice translation-rule applied to the POTS dial peer pointing to the ISDN, all called and calling party numbers sent from Unified CM to the gateway will be forwarded to the PSTN unchanged, with plan and type forced to unknown.

With this translation logic in place on the gateway, the piece that still needs to be provisioned on Unified CM is the transformation of the +E.164 called party information to the digit string to be sent to the PSTN according to [Table 2-31](#). Table 24 depicts the required called party transformation patterns for localizing +E.164 for ISDN dialing.

**Table 2-32** *Called Party Transformation Patterns to Localize +E.164 for ISDN via SIP*

Pattern	Partition	Transformation	Description
\+.1!	USGWLocalizeCd	Strip pre-dot, prefix *	+12125551234 -> *12125551234
\+.!	USGWLocalizeCd	Strip pre-dot, prefix *011	+4961007739764 -> *0114961007739764

To apply the called party transformations defined by the called party transformation patterns shown in [Table 2-32](#) to a gateway, a CSS USGWLocalizeCd with only partition USGWLocalizeCd in it needs to be defined, and this CSS is then set as **Called Party Transformation CSS** in the **Device Mobility Related Information** section on the gateway's device pool. Configuring these transformations on the device pool enables sharing the same settings with multiple gateways in the same site sharing the same called party transformation requirements. To achieve this, the **Use Device Pool Called Party Transformation CSS** option needs to be checked in the **Outbound Calls** section on the gateway configuration page.

Also, we need to provision the transformation required to force the calling party number from +E.164 to whatever needs to be sent to the service provider. Here we need to consider how to treat calling party information for a call originating from a non-DID or a call originating from a DN that is not part of the DID range associated with the given gateway. The most common option is to set the caller ID to a site-specific main extension. This site specificity requires creation of site-specific calling party transformations as illustrated by [Table 2-33](#).

**Table 2-33** *Calling Party Transformation Patterns to Localize +E.164 for ISDN via SIP*

Pattern	Partition	Transformation	Description
\+.19195551XXX	RTPGWLocalizeCn	Strip pre-dot	+19195551001 -> 19195551001 Forward caller ID from the DID range associated with the gateway, but strip the leading plus (+), assuming that the calling party number can be sent to the provider as 1 plus 10 digits
\+!	RTPGWLocalizeCn	Mask 19195551888	Force everything to 19195551888
!	RTPGWLocalizeCn	Mask 19195551888	Force everything to 19195551888

The calling party transformation patterns in [Table 2-33](#) perform the required transformations that make sure any calling party number, whether in the form of a +E.164 number or an enterprise specific number not matching the trunks DN range, is forced to a main number (19195551888).

To enable these transformations equivalent to the above method to apply outbound called party transformations, a CSS RTPGWLocalizeCn needs to be created using only partition RTPGWLocalizeCn, and this CSS needs to be applied as the calling party transformation CSS in the **Outbound Calls** section on the gateway configuration page or in the **Device Mobility Related Information** section on the gateway's device pool.

If a specific called or calling party transformation is needed per gateway, then using the device pool level settings for the called party transformations is overly complicated. In that case uncheck the **Use Device Pool Called/Calling Party Transformation CSS** options in the **Outbound Calls** section on the gateway configuration page, and set the called or calling party transformation CSS there.

## Outbound Calls: Called and Calling Number Transformations on SIP Trunks

As mentioned earlier, SIP does not have the concept of "typed" numbers. Usually on SIP trunks all called and calling party numbers need to be sent in a single format independent of the type of called destination. The most common options are +E.164 or E.164. To enable easier dial-peer configuration with non-overlapping destination patterns for inbound and outbound calls, again we want to prefix all E.164 called party information with "\*" when sent to the Cisco Unified Border Element terminating the SIP trunk.

If E.164 needs to be sent (without the +), then the above approach using called party transformation patterns can be reused. The single called party transformation shown in [Table 2-34](#) is enough to make sure that the leading + of all +E.164 numbers gets stripped. Again we also need to create a CSS (for example, GWNoPlus) that addresses only partition GWNoPlus, and then apply this called party transformation pattern as **Called Party Transformation CSS** on either the gateway or the gateway's device pool.

**Table 2-34** Called Party Transformation Pattern to Localize +E.164 to \*E.164 for SIP

Pattern	Partition	Transformation	Description
\+.	GWNoPlus	Strip pre-dot, prefix *	+4961007739764 -> *4961007739764 +12125551234 -> *12125551234

Even if no format transformation is required for calling party information sent on a SIP trunk, some filtering still needs to be applied to the calling party information to make sure that only valid numbers are sent to the provider. The same calling party transformations as described before in section on [Outbound Calls: Called and Calling Number Transformations on ISDN Gateways](#) and summarized in [Table 2-33](#) can be used. Cisco IOS voice translations on Cisco Unified Border Element then make sure that the calling party information is sent to the provider according to the format requirements of the provider. [Example 2-3](#) shows Cisco IOS voice translations to be applied on the VoIP dial-peer on the Cisco Unified Border Element (CUBE) pointing to the provider. These translations transform called party information from \*E.164 to +E.164 and the calling party information from E.164 to +E.164.

### Example 2-3 Cisco IOS Voice Translations to Force +E.164 Calling and Called Party Number on CUBE

```
voice translation-rule 2
  rule 1 /\^*\// +/
  rule 2 // +/
voice translation-profile SIPtoE164
  translate called 2
  translate calling 2
dial-peer voice 2 voip
  translation-profile outgoing SIPtoE164
```



Rule 1 in [Example 2-3](#) replaces a leading "\*" with a leading "+" while rule 2 just prefixes a "+" to all numbers.

## Inbound Calls: Called and Calling Number Transformations on ISDN Gateways

Because all call routing on Unified CM is based on +E.164 for all incoming calls arriving at Unified CM, we need to make sure that called party information is transformed to +E.164 from the format received on the link from the provider. As mentioned earlier in the section on [Outbound Calls: Called and Calling Number Transformations on ISDN Gateways](#), calling and called party information sent and received on ISDN trunks is a triplet consisting of numbering plan, number type, and number. Because SIP does not support number types, the semantics of the number type as received from the provider is lost if only the actual number is forwarded by the gateway over the SIP trunk to Unified CM. To avoid this, Cisco IOS voice translation needs to be deployed on the gateway to create a +E.164 digit string to be sent to Unified CM based on the received number plan, type, and number. [Example 2-4](#) shows the Cisco IOS voice translation configuration to achieve this.

### Example 2-4 Cisco IOS Voice Translations to Map from ISDN to +E.164

```
voice translation-rule 3
  rule 1 /^\(.\+\)$ / +1\1/ type national unknown plan any unknown
  rule 2 /^\(.\+\)$ / +\1/ type international unknown plan any unknown
voice translation-profile ISDNtoE164
  translate called 3
  translate calling 3
dial-peer voice 1 pots
  translation-profile incoming ISDNtoE164
```

The Cisco IOS translation shown in [Example 2-4](#) assumes that we received called party information as type national and that the number in this case has only 10 digits. Rule 1 matches on any number (`/^\(.\+\)$ /`) with type international and simply prefixes +1 (`+/+1/`) while forcing plan and type to unknown because both are irrelevant when forwarded on the SIP trunk to Unified CM. The same translation rule is applied to both calling and called party information in translation profile ISDNtoE164, so that the calling party information as a 10-digit number with type national will be transformed correctly to +E.164 by rule 1. Rule 2 does not really apply to received called party information because the provider will typically send called party information using only a single format. Hence, rule 2 is relevant only for calls received from international destinations for which we expect to receive calling party information as type international with the number set to the full E.164 number of the calling party.

Different number formats might be used, depending on the provider, and this will require use of different transformations on the gateway or on Unified CM. For a detailed explanation of voice translation rules, see the document on *Number Translation using Voice Translation Profiles*, available at

<https://www.cisco.com/c/en/us/support/docs/voice/call-routing-dial-plans/64020-number-voice-translation-profiles.html>

If for some reason the same rules cannot be used for calling and called party information transformation, then separate voice translation rules need to be provisioned for calling and called party information and associated with translation of calling and called party information in one translation profile.

Using inbound Cisco IOS voice translation rules is required only if different number types are sent by the provider. If the number type for calling or called party information is always unknown, for example, then the digit transformation to globalized +E.164 can happen on Unified CM either by using the inbound prefixes for calling and called party information or by using calling and called party transformation CSSs. Both prefixes and calling and called party transformations can be defined either

on the trunk level or on the device pool level. Keep in mind that, because SIP does not support different number types, inbound calling and called prefixes or CSSs need to be set for number type **unknown** if set on the device pool level.

## Inbound Calls: Called and Calling Number Transformations on SIP Trunks

Inbound call number information treatment on PSTN SIP trunks is generally simpler than the number handling in the ISDN case described before. The main reason is that number information on SIP trunks is not typed, and thus transformations are less complex and need to consider only the received digit string. Typically both calling and called party information on a SIP trunk is already in +E.164 format, and thus no transformations are needed.

If calling and called parties are received in E.164 format, then the easiest way to transform to +E.164 is to simply configure a prefix "+" on the SIP trunk in Unified CM or on the trunk's device pool. This prefix can be configured in the Incoming Calling Party Settings or Incoming Called Party Settings on the trunk or the trunk's device pool. Remember that for SIP trunks the setting for number type **Unknown Number** is relevant on the device pool level.

## Calling Party Information Display on Phones

Because all directory numbers are provisioned as +E.164 numbers for calls originating from these +E.164 directory numbers, calling party information is in +E.164 format automatically. To simplify and provide consistent calling party presentation for all possible call flows, all calling party information received from outside networks such as the PSTN is normalized to +E.164 as discussed earlier. When a call is presented to a phone or to an outside network, the calling party information presented for that call sometimes needs to be transformed to the format expected by the network in case of the call being sent to a gateway or the format expected by the user in case of the call being sent to a phone.

Of special consideration are calls originating from phones with non-DIDs. In this case the only available calling party information is identical to the provisioned non-DID in the format of an enterprise specific number (ESN). [Table 2-9](#) summarizes the ESN ranges used in the example topology.

On phones, sometimes +E.164 is not the preferred calling party display information, although keeping this information as +E.164 simplifies the deployment and is preferred. In that case the desired format typically depends on both the calling and called entities. [Table 2-35](#) shows an example of the expected calling party display on a phone in site SJC for calls from various sources.

**Table 2-35** *Expected Calling Party Display on SJC Phone*

Calling Entity "Native" Calling Party Information	Expected Display	Comment
+12125551234	912125551234	Call from US; display follows PSTN dialing habit.
+14085554001	4001	Call from +E.164 DN in the SJC DID range; display follows abbreviated intra-site dialing habit.

**Table 2-35** Expected Calling Party Display on SJC Phone (continued)

Calling Entity "Native" Calling Party Information	Expected Display	Comment
81405001	5001	Call from non-DID in the SJC ESN range (see <a href="#">Table 2-9</a> ); display follows abbreviated four-digit intra-site dialing to non-DIDs in site SJC.
+4961007739764	90114961007739764	Call from international PSTN destination; display follows US PSTN dialing habit for international destinations.

To achieve the display format depicted in [Table 2-35](#), calling party transformation patterns need to be provisioned in adequate partitions, and calling party transformation CSSs based on these partitions have to be configured on the phones, to enable the transformations.

Table 28 summarizes all calling party transformation patterns that must be provisioned to achieve the abbreviated calling party number display shown in [Table 2-35](#) for all US sites based on the number ranges shown in [Table 2-9](#).

**Table 2-36** Phone Localization Calling Party Transformation Patterns

Pattern	Partition	Transformation	Description
\+.!	USPhLocalize	Strip pre-dot, prefix 9	Any US destination: +12125551234 -> 912125551234
\+.	USPhLocalize	Strip pre-dot, prefix 9011	Any international destination: +4961007739764 -> 90114961007739764
\+14085554XXX	SJCPhLocalize	Mask 4XXX	Call from local DN range: +14085554001 -> 4001
81405XXX	SJCPhLocalize	Mask 5XXX	Call from local non-DID range: 81405001 -> 5001
\+19725555XXX	RCDPhLocalize	Mask 5XXX	Call from local DN range: +19725555001 -> 5001
81976XXX	RCDPhLocalize	Mask 6XXX	Call from local non-DID range: 81976001 -> 6001
\+19195551XXX	RTPPhLocalize	Mask 1XXX	Call from local DN range: +19195551001 -> 1001
81912XXX	RTPPhLocalize	Mask 2XXX	Call from local non-DID range: 81912001 -> 2001

[Table 2-37](#) shows the calling party transformation CSSs to enable calling party localization for phones in all US sites. The schema allows the reuse of dialing domain (country) specific calling party localization transformation patterns for all sites in that dialing domain (country). The country specific calling party localization patterns basically map national and international numbers to the country specific national and international dialing habit.

**Table 2-37 Phone Localization Calling Party Transformation CSSs for US Sites**

CSS	Partitions
SJCPHLocalize	SJCPHLocalize
	USPHLocalize
RCDPHLocalize	RCDPHLocalize
	USPHLocalize
RTPPHLocalize	RTPPHLocalize
	USPHLocalize

Table 2-38 shows an example of the country specific phone localization calling party transformation patterns that would need to be provisioned for Italy and Germany.

**Table 2-38 Phone Localization Calling Party Transformation Patterns for Italy and Germany**

Pattern	Partition	Transformation	Description
\+49.!	DEPHLocalize	Strip pre-dot, prefix 00	Any German destination: +4941001234 -> 0041001234
\+.	DEPHLocalize	Strip pre-dot, prefix 000	Any international destination: +14085551234 -> 00014085551234
\+39.!	ITPHLocalize	Strip pre-dot, prefix 0	Any Italian destination: +390730123456 -> 00730123456 +393012345678 -> 03012345678
\+.	ITPHLocalize	Strip pre-dot, prefix 000	Any international destination: +14085551234 -> 00014085551234

## Automated Alternate Routing

Automated alternate routing (AAR) is a mechanism that reroutes calls to registered endpoints via an alternate route through the PSTN in case sufficient bandwidth is not available (call admission control does not allow the call) between the originating endpoint, gateway, or trunk and the called endpoint. AAR applies only to calls to endpoints. Insufficient bandwidth for calls to other destinations such as gateways and trunks does not trigger AAR. For those cases, the alternate routing mechanism is based on route lists and route groups. The following steps are required to activate AAR:

- Set the Automated Alternate Routing Enable service parameter (see the section on [Service Parameter Settings](#)).
- Configure a single AAR group **Default** without any Dial Prefix (default).
- Define a CSS PSTNReroute with access only to +E.164 PSTN route patterns. Based on the examples in this design, this CSS would need to include only partition PSTNInternational.
- On all endpoints, trunks, and other devices initiating calls that potentially might be subject to AAR:
  - Set the AAR Calling Search Space to PSTNReroute.
  - Set AAR Group to **Default**.
- On all device pools, set the AAR Calling Search Space to PSTNReroute.
- On all device pools, set AAR Group to **Default**

- On +E.164 directory numbers, configure the AAR masks so that the resulting number is the +E.164 number of the directory number. In a country with a fixed length numbering plan, the mask can be set to some identical value on all directory numbers (such as +1XXXXXXXXXX in the US). If variable length directory numbers need to be covered, more specific masks covering a single site or, as a worst case scenario, a fully qualified +E.164 AAR mask identical to the respective directory number have to be provisioned. For non-DIDs the AAR mask is left empty. This effectively disables AAR if a non-DID is called. This makes sense because a non-DID does not have an equivalent E.164 address and thus cannot be reached via the PSTN.

The above list shows one of the advantages of a dial plan using +E.164 directory numbers. In this case the called +E.164 address can be reused directly for alternate dialing over the PSTN without applying any other modifications.

## Alternate Routing for Unregistered Endpoints

In case of a WAN failure in a multi-site deployment with centralized call processing, endpoints in the affected lose connectivity with the centralized Unified CM and register with a local SRST gateway instead (see the section on [Survivable Remote Site Telephony \(SRST\) Deployment](#)). This allows the affected phones to still place and receive calls to and from phones in the same site and the PSTN. Calls from phones registered with the central Unified CM will fail, though, because from the central Unified CM's perspective the called device is unregistered and thus unreachable. To enable automatic rerouting of calls to unregistered endpoints over the PSTN, perform the following tasks on each directory number that requires automatic rerouting:

- Set the Forward Unregistered Internal and Forward Unregistered External destination to the same value as the phone's +E.164 directory number.
- Set the Forward Unregistered Internal and Forward Unregistered External CSS to PSTNReroute. This is the same CSS as defined in the section on [Automated Alternate Routing](#), and it allows access to PSTN route patterns.
- Set the **Max Forward UnRegistered Hops to DN** service parameter to a value other than zero to make sure to limit the impact of routing loops that can occur if a phone is unregistered (for example, because it is not plugged in) while the site's gateway still is connected to Unified CM.

Alternate routing over the PSTN for unregistered endpoints makes sense only for endpoints with +E.164 directory numbers. For endpoints without a DID (endpoints with an ESN as directory number), the only meaningful rerouting for unregistered endpoints is to forward incoming calls to voicemail. To forward calls to unregistered endpoints to voicemail, perform these tasks:

- Select the Voicemail options for Forward Unregistered Internal and Forward Unregistered External.
- Set the Forward Unregistered Internal and Forward Unregistered External CSS to a CSS implementing class of service Internal (for example, SJCInternal). Effectively this CSS has to provide access to only the voicemail pilot number.

## LDAP System Configuration

Before defining the actual synchronization agreements, the LDAP system has to be enabled. In the LDAP System Configuration menu, do the following:

- Select (check) the **Enable Synchronizing from LDAP Server** option
- Select the correct LDAP Server Type for your deployment.
- Select the correct LDAP Attribute for User ID for your deployment.

In an environment where users are synchronized from Microsoft Active Directory, use the settings shown in [Table 2-39](#).

**Table 2-39 LDAP System Settings for Microsoft Active Directory**

Setting	Value
LDAP Server Type	Microsoft Active Directory
LDAP Attribute for User ID	sAMAccountName

## LDAP Custom Filter

If a Unified CM based directory search is used on phones, then it does make sense to synchronize the full corporate LDAP directory to Unified CM. In that case we need to be able to differentiate between users who actually use UC services of the local cluster and users who are synchronized only to reflect the complete corporate LDAP directory on Unified CM.

To achieve this goal, custom LDAP filters can be used to define two groups of users: local and remote. Remote here means that these users do not use any UC services on the local Unified CM cluster.

[Table 2-40](#) shows two custom LDAP filters, assuming that our deployment has users in the US and Europe and that only the US users are considered as local users.

**Table 2-40 Custom LDAP Filter Settings**

LDAP Filter Name	Filter
Local	<pre>( &amp; (objectclass=user) (! (objectclass=Computer)) (! (UserAccountControl:1.2.840.113556.1.4.803:=2)) (telephoneNumber=+1*) )</pre>
Remote	<pre>( &amp; (objectclass=user) (! (objectclass=Computer)) (! (UserAccountControl:1.2.840.113556.1.4.803:=2)) (   (telephoneNumber=+3*) (telephoneNumber=+4*) ) )</pre>

For better readability, the LDAP filter strings in [Table 2-40](#) are separated into multiple lines, with the indentation levels reflecting the structure of the LDAP filter strings. To provision these LDAP filters in Unified CM, you have to concatenate all lines of a given filter into a single line.

Both LDAP filters are extensions of the default LDAP filter for Microsoft Active Directory. Default LDAP filters for other directory types can be found in the chapter on *Directory Integration and Identity Management* in the latest version of the *Cisco Collaboration System SRND* and in the Unified CM online help for the LDAP directory settings.

The LDAP filters in [Table 2-40](#) use the beginning of the phone numbers as criteria to determine whether the individual user is a local or a remote user.

When using multiple LDAP synchronization agreements, you have to make sure that the LDAP filters used by these synchronization agreements are disjunct so that no single user is matched by both filters.

## Feature Group Templates

Capabilities of users synchronized from LDAP are defined in a feature group template (FGT). [Table 2-41](#) summarizes the settings for the FGT defining the capabilities of users with active devices on the Unified CM cluster.

**Table 2-41** Feature Group Template for Local Users

Setting	Value	Comment
Name	FGTlocal	Name should indicate that this is an FGT used for local users.
Description	FGT for local users	
Home Cluster	Checked	Make sure that UDS-based service discovery for this user resolves to the local Unified CM cluster.
Enable User for Unified CM IM and Presence	Checked	Enable the user for IM and Presence
BLF Presence Group	Standard Presence Group	Single BLF presence group for all users, to simplify the deployment.
SUBSCRIBE Calling Search	DefaultSubscribe	Use the default subscribe CSS described in the section on <a href="#">Special CSSs</a> .

All other settings can be left as default values.

Because remote users are also synchronized from LDAP (see the section on [LDAP Custom Filter](#)), an FGT for remote users must also be provisioned. The key difference is that in that FGT the **Home Cluster** and **Enable User for Unified CM IM and Presence** options are not checked. [Table 2-42](#) summarizes these settings.

**Table 2-42** Feature Group Template for Remote Users

Setting	Value	Comment
Name	FGTremote	Name should indicate that this is an FGT used for remote users.
Description	FGT for remote users	

**Table 2-42 Feature Group Template for Remote Users (continued)**

Setting	Value	Comment
Home Cluster	Not checked	Make sure that UDS-based service discovery for this user does not resolve to the local Unified CM cluster.
Enable User for Unified CM IM and Presence	Not checked	Do not enable the user for IM and Presence.

All other settings can be left as default values.

## LDAP Synchronization Agreements

To synchronize all local users to Unified CM, an LDAP synchronization agreement needs to be configured. [Table 2-43](#) shows the required settings to be configured under **System/LDAP/LDAP Directory**.

**Table 2-43 LDAP Synchronization Agreement for Local Users**

Setting	Value	Comment
LDAP Configuration Name	Local	Indicates that this LDAP synchronization agreement synchronizes local users.
LDAP Manager Distinguished Name	Name of admin users	Can be in the form of ldapaccess@ent-pa.com or cn=ldapaccess,cn=users,dc=ent-pa,dc=com
LDAP Password	Password of the LDAP admin	
LDAP User Search Base	LDAP Search base	Example: dc=ent-pa,dc=com
LDAP Custom Filter	Local	Refers to the custom LDAP filter described in the section on <a href="#">LDAP Custom Filter</a> .
Perform Sync Just Once	Unchecked	LDAP synchronization is executed periodically.
Perform a Re-sync Every	Reasonable interval	Make sure to set the interval small enough to pick up corporate directory changes in a reasonable time, but keep in mind that executing the LDAP synchronization creates significant load on the Unified CM publisher. Synchronizing once every 24 hours probably is a good default.
Directory URI	mail	Typically directory URIs of users are identical to their email addresses.
Access Control Groups	Standard CCM End Users Standard CTI Enabled	Add or remove other access control groups as needed, but keep in mind that without Standard CCM End Users, the users will not be able to log into the self-service portal.
Feature Group Template	Local	Refers to the FGT described in the section on <a href="#">Feature Group Templates</a> .
LDAP Server Information	References to corporate LDAP servers to be uses as source	Make sure to provision redundant servers, if possible.



The LDAP synchronization agreement in [Table 2-43](#) ties together the FGT and custom LDAP filter defined before. This makes sure that, for all users in the corporate directory matching the custom LDAP filter, a user on Unified CM is created with the capabilities defined in the FGT.

A dedicated LDAP synchronization agreement is also required to synchronize the remote users who do not use UC services on the local Unified CM cluster. [Table 2-44](#) summarizes the settings for this LDAP synchronization agreement.

**Table 2-44** LDAP Sync Agreement for Remote Users

Setting	Value	Comment
LDAP Configuration Name	Remote	Indicates that this LDAP synchronization agreement synchronizes remote users.
LDAP Manager Distinguished Name	Name of admin users	Can be in the form of ldapaccess@ent-pa.com or cn=ldapaccess,cn=users,dc=ent-pa,dc=com
LDAP Password	Password of the LDAP admin	
LDAP User Search Base	LDAP Search base	Example: dc=ent-pa,dc=com
LDAP Custom Filter	Remote	Refers to the custom LDAP filter described in the section on <a href="#">LDAP Custom Filter</a> .
Perform Sync Just Once	Unchecked	LDAP synchronization is executed periodically.
Perform a Re-sync Every	Reasonable interval	Make sure to set the interval small enough to pick up corporate directory changes in a reasonable time, but keep in mind that executing the LDAP synchronization creates significant load on the Unified CM publisher. Synchronizing once every 24 hours probably is a good default.
Directory URI	mail	Typically directory URIs of users are identical to their email addresses.
Access Control Groups	No access control groups selected	Remote users are not members of any access control group.
Feature Group Template	Remote	Refers to the FGT described in the section on <a href="#">Feature Group Templates</a> .
LDAP Server Information	References to corporate LDAP servers to be uses as source	Make sure to provision redundant servers, if possible.

Using the above LDAP synchronization agreements, all users can be identified from the corporate directory, and the FGTs associated with the LDAP synchronization agreements make sure that capabilities are configured correctly for all users.

## User Authentication with LDAP

Table 2-45 shows an example of LDAP authentication settings.

**Table 2-45** LDAP Authentication Settings

Setting	Example	Comment
LDAP Authentication for End Users		
Use LDAP Authentication for End Users	Checked	Enables LDAP authentication for the Unified CM cluster.
LDAP Manager Distinguished Name	cn=ldapmanager,dc=ent pa,dc=com	Distinguished name of an AD account with read access rights to all user objects in the desired user search base.
LDAP Password	Some password	
Confirm Password	Same as above	
LDAP User Search Base	ou=enterprise,dc=ent-pa,dc=com	
LDAP Server Information		
Host Name or IP Address for Server	ent-dc1.ent-pa.com	Server with global catalog role
LDAP Port	3268	Port to access global catalog (recommended)

## Cisco Unified CM Group Configuration

Cisco Unified CM groups allow you to define groups of Unified CM instances in the cluster that determine which Unified CM instances should be used by devices to register to the Unified CM cluster. If only a single Unified CM call processing pair is deployed (see the section on [Provision the Cisco Unified CM and IM and Presence Service Cluster](#) for more information), then a single Unified CM group named Default also needs to be deployed, and both Unified CM instances running on the single pair of Unified CM call processing subscribers in the cluster have to be members of this single Unified CM group.

If more than one pair of Unified CM call processing subscribers exists, then additional Unified CM groups need to be provisioned (one for each pair of Unified CM call processing subscribers), and in each Unified CM group the two Unified CM instances running on that specific pair are added to the group.

For a Unified CM cluster with two pairs of Unified CM call processing subscribers named ucm1a.ent-pa.com and ucm1b.ent-pa.com in the first pair and ucm2a.ent-pa.com and ucm2b.ent-pa.com in the second pair, with ucm1a and ucm2a being the primary Unified CM call processing subscribers in each pair, [Table 2-46](#) lists the Unified CM groups to be provisioned.

**Table 2-46** Example Unified CM Group Definition

Unified CM Group	Unified CM Group Members
CM_1	CM_ucm1a.ent-pa.com CM_ucm1b.ent-pa.com
CM_2	CM_ucm2a.ent-pa.com CM_ucm2b.ent-pa.com

All registrations have to be equally balanced between Unified CM groups. This is achieved by assigning devices to Unified CM groups via device pool configuration as discussed in the section on [Device Pools](#).

## Phone NTP References

If you want to do so, you can configure phone Network Time Protocol (NTP) references in Cisco Unified Communications Manager Administration to ensure that a phone running SIP gets its date and time from the NTP server. If all NTP servers do not respond, the phone that is running SIP uses the date header in the 200 OK response to the REGISTER message for the date and time.

After you add the phone NTP reference to Cisco Unified CM Administration, you must add it to a date/time group.

To define phone NTP references, get the IP addresses of the NTP servers you plan to use, and configure the settings according to [Table 2-47](#).

**Table 2-47** Phone NTP Reference Settings

Setting	Example	Comment
IP Address	66.228.35.252	IP address of NTP server to be used
Description	0.pool.ntp.org	Should refer to the hostname of the IP address being entered
Mode	Unicast	Unicast limits devices to using only NTP response from listed servers

Make sure to provision multiple phone NTP references for redundancy.

## Date and Time Groups

Date and time groups allow you to define the time zone and the date and time format to be used for sets of devices registering with Unified CM. The date/time group configuration is specified in the device pool, and the device pool is specified on the phone page. For more information on device pools, see the section on [Device Pools](#).

If you want SIP phones to get their date and time from NTP servers, then in the date/time group you prioritize the phone NTP references, starting with the first server that you want the phone to contact.

Create one named Date/Time Group for each of the time zones in which you will deploy endpoints, as illustrated in [Table 2-48](#).

**Table 2-48** Example Date/Time Group Definitions

Date and Time Group	Time Zone
RCD_Time	America/North_Dakota/New_Salem
RTP_Time	America/New_York
SJC_Time	America/Los_Angeles

## Media Resources

A media resource is a software-based or hardware-based entity that performs media processing functions on the data streams to which it is connected. Media processing functions include mixing multiple streams to create one output stream (conferencing), passing the stream from one connection to another (media termination point), converting the data stream from one compression type to another (transcoding), streaming music to callers on hold (music on hold), echo cancellation, signaling, voice termination from a TDM circuit (coding/decoding), packetization of a stream, streaming audio (annunciation), and so forth. The software-based resources are provided by the Cisco Unified CM IP Voice Media Streaming Application.

### Media Resource Manager

The Media Resource Manager (MRM), a software component in the Unified CM, determines whether a media resource needs to be allocated and inserted in the media path. When the MRM decides and identifies the type of the media resource, it searches through the available resources according to the configuration settings of the media resource group list (MRGL) and media resource groups (MRGs) associated with the devices in question. MRGLs and MRGs are constructs that hold related groups of media resources together for allocation purposes

### Media Resource Selection and Avoiding the Default MRG

Media resource groups (MRGs) and media resource group lists (MRGLs) provide a method to control how resources are allocated, which could include rights to resources, location of resources, or resource type for specific applications. MRGs are used to group together media resources of similar characteristics, and MRGLs define a set of MRGs to be considered when selecting a required media resource for a session. If the Media Resource Manager does not find a required resource by searching through a configured MRGL, considering all media resources being members of MRGs of that list, then the Media Resource Manager checks a default media resource group for media resources. All media resources by default are members of this default MRG unless they are explicitly configured to be members of any specific MRG.

In this design we will not use the default MRG because it makes troubleshooting of media resource selection more complicated. To make sure that the default MRG is empty, you have to assign all media resources to at least one MRG.

### Cisco IP Voice Media Streaming Application

The Cisco IP Voice Media Streaming Application provides the following software-based media resources:

- Conference bridge
- Music on Hold (MoH)
- Annunciator
- Media termination point (MTP)

When the IP Voice Media Streaming Application is activated on a node in the Unified CM cluster, one of each of the above resources is automatically configured. For service activation recommendations, see [Table 2-3](#).

In this design only unicast MoH is used, with media being streamed from the Cisco IP Voice Media Streaming Application running on the Unified CM cluster subscriber nodes.

An annunciator is a software function of the Cisco IP Voice Media Streaming Application that provides the ability to stream spoken messages or various call progress tones from the system to a user.

All MOH and annunciator media resources created by the Cisco IP Voice Media Streaming Application running on Unified CM are combined in a single MRG by performing the following tasks:

- Create an MRG named Software.
- Assign all annunciator resources created by the Cisco IP Voice Media Streaming Application to MRG Software.
- Assign all MoH resources created by the Cisco IP Voice Media Streaming Application to MRG Software.

The software-based conferencing and media termination points created by the Cisco IP Voice Media Streaming Application are not used in this design. To disable them, perform the following tasks:

- Create an MRG named Unused.
- Assign all software-based conference bridges created by the Cisco IP Voice Media Streaming Application to MRG Unused.
- Assign all software-based media termination points created by the Cisco IP Voice Media Streaming Application to MRG Unused.

This makes sure that these resources are not part of the default MRG any longer and are never considered in the Media Resource Manager media resource selection process.

## MRG and MRGL Definitions

It's good practice to keep the number of provisioned MRGLs to a minimum. Factors contributing to the number of required MRGLs include:

- Site specificity  
If site-specific media resources exist, then site-specific MRGs for those resources need to be configured, and typically also site-specific MRGLs are required to allow for site-specific selection of (typically local) media resources.
- Different types of media resources of the same class  
Unified CM does not differentiate between audio-only and audio/video conferencing resources. If both audio and audio/video conferencing media resources are provisioned, then an MRG (and MRGL) is required per type of media resource to allow configuration of differential access policies to these resources. See the [Conferencing](#) chapter for more details on conferencing resources.

If no site-specific media resources and no differentiation of media resource types is required, then at least a single MRGL named Standard needs to be configured.

For each required MRGL based on site specificity and media resource type provision, create an MRGL by performing the following tasks:

- Set the MRGL name so that it reflects the site specificity and media resource type of the MRGL.
- Select the desired MRGs for the MRGL. Make sure to always include the Software MRG so that access to MoH and Annunciator is ensured.

[Table 2-49](#) shows example MRGL definitions that provide differentiated treatment of audio and video conferencing. MRGL Audio would need to be assigned to devices requiring access to audio conferencing media resources only, while MRGL Video would allow access to video conferencing resources.

**Table 2-49 Example MRGL Definition with Audio and Video Conferencing**

MRGL Name	MRGs	Comment
Audio	Audio Software	MRGL with access to audio conferencing media resources in MRG Audio.  MRG Software added to provide access to MoH and annunciator.
Video	Video Software	MRGL with access to video conferencing media resources in MRG Video.  MRG Software added to provide access to MoH and annunciator.

## Device Pools

Device pools define sets of common characteristics for devices. Characteristics defined on the device pool include the settings shown in [Table 2-50](#).

**Table 2-50**     **Device Pool Settings**

Setting	Description
Cisco Unified Communications Manager Group	Unified CM groups are needed to distribute registrations equally among Unified CM call processing subscriber pairs (see the section on <a href="#">Cisco Unified CM Group Configuration</a> ). The Unified CM Group provisioned on the device pool determines the Unified CM call processing subscribers to which devices associated with the given device pool will try to register.
Local Route Groups	As described in the section on <a href="#">Local Route Groups for Call Type Specific Outbound Gateway Selection</a> , multiple LRGs are defined to allow for call type specific egress gateway selection based on LRGs. For each defined LRG name, the route group selected for that LRG name defines which devices will be considered for a call of the selected type (defined by the route pattern matching on the called number and pointing to a route list referring to specific LRGs). It is important to set route groups for all defined LRG names to avoid call failures due to route lists not containing any valid PSTN resources.
<b>Roaming Sensitive Settings</b>	
Date/Time Group	Defines date and time format and phone NTP references. See the section on <a href="#">Phone NTP References</a> .
Media Resource Group List	MRGL defining the media resources available for a group of devices. See the section on <a href="#">MRG and MRGL Definitions</a> .
<b>Device Mobility Related Information</b>	
AAR Calling Search Space	The CSS used to route calls to an alternate PSTN destination. The dial plan design in this document allows use of the same AAR CSS (PSTNReroute) in all cases (see the section on <a href="#">Automated Alternate Routing</a> ).
AAR Group	To enable AAR, an AAR group has to be defined. Using +E.164 directory numbers allows you to deploy AAR using a single AAR group, Default (see the section on <a href="#">Automated Alternate Routing</a> ).
Calling Party Transformation CSS	This CSS defines the calling party transformations applied to calling party information sent in the direction of the affected device.  For gateways this CSS is tied to the calling party transformation CSS defined in the Outbound Calls section on the gateway configuration page.  For phones this CSS is tied to the calling party transformation CSS defined in the Remote Number section on the phone configuration page.
Called Party Transformation CSS	This CSS defines the called party transformations applied to called party information sent in the direction of the affected device.  For gateways this CSS is tied to the called party transformation CSS defined in the Outbound Calls section on the gateway configuration page.  For phones this CSS has no equivalent on the phone configuration page and does not have any effect when configured on a device pool used for phones.
Call Routing Information	This setting allows you to define incoming calling and called party transformations per numbering type to be applied to incoming calls on gateways. The same settings also can be configured in the gateway configuration page if individual gateway-specific settings are required.

All other device pool level settings are not used in this design.

Whenever the same settings for the configuration options listed in [Table 2-50](#) need to be applied to a group of devices, we recommend creating a device pool with these settings and then assigning all devices to this device pool. If one of the settings needs to be changed for all of the devices, the device pool level configuration allows you to change the setting for all devices at one point.

To minimize the number of device pools, create a device pool only if multiple devices share the same characteristics. An example of this is phones in the same site. [Table 2-51](#) shows an example of device pool settings for phones with video conferencing capabilities in site RTP.

**Table 2-51** Device Pool Settings for Phones with Video Conferencing Capabilities in Site RTP

Setting	Value	Comment
Device Pool Name	RTPPhoneVideo	Name should uniquely identify the devices (type and further classification) this device pool is used for. In this case we use this device pool for phones in site RTP with video conferencing capabilities
Cisco Unified Communications Manager Group	CM_1	
<b>Local Route Group Settings</b>		
Standard Local Route Group	RTP_PSTN	All route lists use Standard Local Route Group as last option. Always set Standard Local Route Group to the local PSTN gateways' route group.
LRG_PSTN_1	RTP_PSTN	First option for PSTN calls is to use local RTP gateways.
LRG_PSTN_2	SJC_PSTN	Use HQ gateways as fallback.
LRG_VIDEO_1	SJC_VIDEO	No site-specific video gateways exist. We use the video gateway in site SJC.
LRG_VIDEO_2	<None>	
LRG_EMERGENCY_1	<None>	No setting; fallback to Standard Local Route Group.
LRG_EMERGENCY_2	<None>	No setting; fallback to Standard Local Route Group.
<b>Roaming Sensitive Settings</b>		
Date/Time Group	RTP_Time	See the section on <a href="#">Date and Time Groups</a> .
Media Resource Group List	Video	Provide access to video conferencing media resources (see <a href="#">Table 2-49</a> ).
<b>Device Mobility Related Information</b>		
AAR Calling Search Space	PSTNReroute	Same for all devices and device pools.
AAR Group	Default	Same for all devices and device pools.
Calling Party Transformation CSS	RTPPhLocalize	Site-specific calling party transformations (see <a href="#">Table 2-36</a> and <a href="#">Table 2-37</a> ).
Called Party Transformation CSS	<None>	Does not apply to phones.

[Table 2-51](#) shows how the actual site-specific PSTN gateways are assigned to the LRG names to achieve the site-specific egress gateway selection for phones in different sites.



Figure 2-9 shows how different LRG selections for the same LRG name LRG\_PSTN\_1 on the device pools for phones in site RTP and SJC make sure that PSTN calls from phones in site RTP and SJC egress to the PSTN through different gateways although the same route pattern and route list are used for calls from both sites.

**Figure 2-9 Site-Specific Egress Gateway Selection**

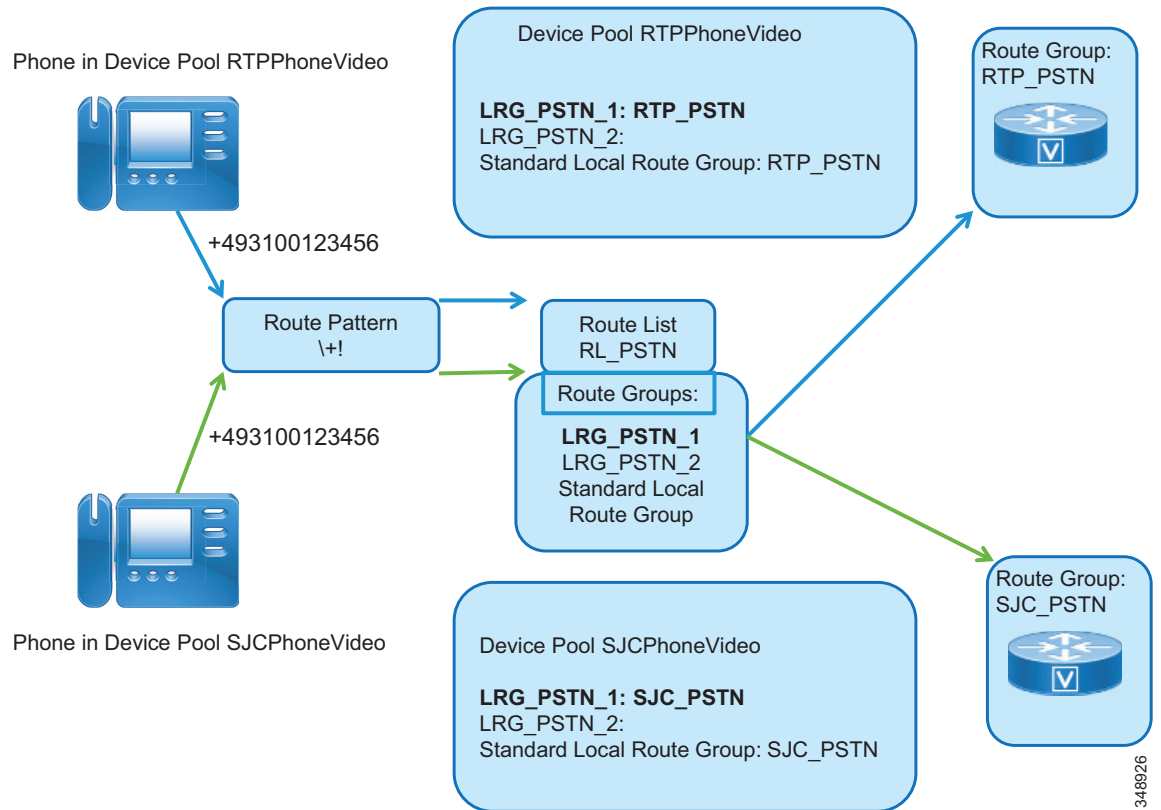

From the example in Table 2-51 we can see that, following the same schema, we would need to provision two device pools per site to be able to differentiate between devices with and without video conferencing capabilities. If video conferencing capabilities were the exception, we could decide to use only one device pool per site with MRGL set to Audio and then on the few video-enabled devices set the MRGL to Video in the device configuration.

Table 2-52 summarizes the device pool settings of the device pool used for gateways in a specific site. Site RTP is used as an example here.

**Table 2-52 Device Pool Settings for PSTN Gateways in Site RTP**

Setting	Value	Comment
Device Pool Name	RTP_PSTN	Name should uniquely identify the devices (type and further classification) this device pool is used for. In this case we use this device pool for PSTN gateways in site RTP.
Cisco Unified Communications Manager Group	CM_1	
<b>Local Route Group Settings</b>		
Standard Local Route Group	RTP_PSTN	There actually is no call flow for which a PSTN trunk would need a PSTN resource. Also see the note on configuration order in the section on <a href="#">Route Groups</a> . When you create the device pool, the required route group does not exist yet. Hence, initially you need to configure the device pool and leave the LRG mapping set to <None>. After configuring the SIP trunks and route groups, you can come back and set the LRG mapping.
LRG_PSTN_1	<None>	
LRG_PSTN_2	<None>	
LRG_VIDEO_1	<None>	
LRG_VIDEO_2	<None>	
LRG_EMERGENCY_1	<None>	
LRG_EMERGENCY_2	<None>	
<b>Roaming Sensitive Settings</b>		
Date/Time Group	RTP_Time	See the section on <a href="#">Date and Time Groups</a> .
Media Resource Group List	Audio	Calls coming in from the PSTN would not require access to video conferencing resources.
<b>Device Mobility Related Information</b>		
AAR Calling Search Space	PSTNReroute	Same for all devices and device pools, although not really required for a PSTN trunk.
AAR Group	Default	Same for all devices and device pools, although not really required for a PSTN trunk.
Calling Party Transformation CSS	RTPGWLocalizeCn	Site-specific calling party transformations to make sure that only valid calling party information is sent (all numbers not belonging to the RTP DID range are masked). Also, the digit string is set to a format suitable for the ISDN gateway (see <a href="#">Table 2-33</a> ).
Called Party Transformation CSS	USGWLocalizeCd	See <a href="#">Table 2-32</a> . This transformation makes sure that called party numbers are transformed from +E.164 to the format that can be sent as plan <b>unknown</b> and type <b>unknown</b> .
<b>Call Routing Information</b>		
Incoming Calling Party Settings	Nothing is configured here. We assume that the transformation from ISDN number format to +E.164 is achieved using Cisco IOS voice translation rules on the gateway (see the section on <a href="#">Inbound Calls: Called and Calling Number Transformations on ISDN Gateways</a> ).	
Incoming Called Party Settings		

Table 2-53 summarizes the device pool settings for a SIP trunks to other Unified CM clusters and application servers. SIP trunks to other Unified CM clusters do not require any transformations on calling and called part information because the called party number already is globalized to +E.164 by the dialing normalization translation patterns provisioned in the dial plan, and calling party information internal to Unified CM based on the provisioned dial plan is either +E.164 or an ESN and both formats make sense in the context of on-net intercluster calls.

**Table 2-53 Device Pool Settings for Central Trunks and Applications**

Setting	Value	Comment
Device Pool Name	Trunks_and_Apps	Name should uniquely identify the devices (type and further classification) this device pool is used for.
Cisco Unified Communications Manager Group	CM_1	
<b>Local Route Group Settings</b>		
Standard Local Route Group	RTP_PSTN	Trunks actually do not need PSTN access, but applications might require PSTN access. So PSTN resources of one site are selected via the Standard Local Route Group configuration. Other site's PSTN resources can be used as failover.
LRG_PSTN_1	RTP_PSTN	
LRG_PSTN_2	SJC_PSTN	
LRG_VIDEO_1	<None>	
LRG_VIDEO_2	<None>	
LRG_EMERGENCY_1	<None>	
LRG_EMERGENCY_2	<None>	
<b>Roaming Sensitive Settings</b>		
Date/Time Group	RTP_Time	See the section on <a href="#">Date and Time Groups</a> .
Media Resource Group List	Video	Intercluster calls could potentially require video media resources.
<b>Device Mobility Related Information</b>		
AAR Calling Search Space	PSTNReroute	Same for all devices and device pools.
AAR Group	Default	Same for all devices and device pools.
Calling Party Transformation CSS	<None>	No transformations on intercluster trunks and trunks to application servers.
Called Party Transformation CSS	USGWLocalizeCd	No transformations on intercluster trunks and trunks to application servers.
<b>Call Routing Information</b>		
Incoming Calling Party Settings	Nothing configured. We assume that inbound calling and called party numbers already are normalized.	
Incoming Called Party Settings		

## SIP Trunks

All connections to other entities, including call controls, applications, and conferencing resources, use SIP trunks.

## SIP Profiles

A SIP profile comprises the set of SIP attributes that are associated with SIP trunks and SIP endpoints. To keep the number of SIP profiles to a minimum, follow these rules:

- Consider the default profiles first.
- Then consider already defined non-default profiles.
- Create a new SIP profile only if none of the default profiles match.
- Avoid defining profiles per trunk.

[Table 2-54](#) shows the settings for a SIP profile to be used for all SIP IP phones and SIP trunks to other Unified CM clusters or SIP gateways.

**Table 2-54** SIP Profile for SIP Phones and Standard Trunks

Setting	Value	Comment
<b>Copy of Standard SIP Profile</b>		
Name	FQDN	
Use Fully Qualified Domain Name in SIP Requests	Checked	Prevents IP address of Unified CM server from showing up in SIP calling party information sent by Unified CM.
Early Offer support for voice and video calls	Best Effort (no MTP inserted)	This is the recommended configuration for all Unified CM trunks. Best Effort Early Offer trunks never use MTPs to create an Early Offer and, depending on the calling device, can initiate an outbound SIP trunk call using either Early Offer or Delayed Offer. In the context of this design, outbound calls always use Early Offer.
Enable OPTIONS Ping to monitor destination status for Trunks with Service Type "None (Default)"	Checked	Allows monitoring of the reachability of SIP trunk peers; applies to SIP trunks only.
Ping Interval for In-service and Partially In-service Trunks (seconds)	10	One ping every 10 seconds, combined with a retry count of 6, makes sure that SIP trunk unavailability is detected within a minute.
Ping Interval for Out-of-service Trunks (seconds)	60	If a trunk is out of service, then we do not have to try to reach the peer as often.
Ping Retry Timer (milliseconds)	500	
Ping Retry Count	6	

## SIP Trunk Security Profiles

Cisco CallManager Administration groups SIP trunk security-related settings – for example, device security mode, digest authentication, and incoming/outgoing transport type settings – so you can apply all configured settings to a SIP trunk when you choose the profile in the SIP Trunk Configuration window.

[Table 2-55](#) shows the default settings on the system generated SIP trunk security profile Non Secure SIP Trunk Profile. This SIP trunk security profile is used for the SIP trunks to ISDN PSTN gateways, for example.

**Table 2-55 Non Secure SIP Trunk Profile SIP Trunk Security Profile Settings**

Setting	Value
Name	Non Secure SIP Trunk Profile
Device Security Mode	Non Secure
Incoming Transport Type	TCP+UDP
Outgoing Transport Type	TCP
Enable Digest Authentication	Not Checked
Incoming Port	5060
Enable Application level authorization	Not Checked
Accept presence subscription	Not Checked
Accept out-of-dialog refer	Not Checked
Accept unsolicited notification	Not Checked
Accept replaces header	Not Checked
Transmit security status	Not Checked
Allow charging header	Not Checked
SIP V.150 Outbound SDP Offer Filtering	Use Default Filter

[Table 2-56](#) shows the settings for a SIP Trunk Security Profile used for a SIP trunk to the IM and Presence nodes, differing from the default settings in [Table 2-55](#).

**Table 2-56 SIP Trunk Security Profile for IM and Presence Trunk**

Setting	Value	Comment
Name	IM and Presence	Meaningful name describing the use of the SIP Trunk Security Profile.
Accept Presence Subscription	Checked	
Accept Out-of-Dialog REFER	Checked	
Accept Unsolicited Notification	Checked	
Accept Replaces Header	Checked	

[Table 2-57](#) shows the settings on the SIP trunk security profile to be used for intercluster trunks to other Unified CM clusters. On these trunks we want to accept presence subscriptions to enable intercluster Busy Lamp Field (BLF) presence.

**Table 2-57 SIP Trunk Security Profile for Intercluster Trunks**

Setting	Value	Comment
Name	ICT	Name describing the use of the SIP Trunk Security Profile.
Accept Presence Subscription	Checked	
Transmit Security Status	Checked	

## SIP Trunk Connections

SIP trunks are the preferred way to set up connectivity between Unified CM clusters and between Unified CM and other systems such as gateways, applications, and media resources. Depending on the type of connected system, the parameters configured on each SIP trunk differ slightly. [Table 2-58](#) summarizes the settings for a SIP trunk to a PSTN gateway in site RTP.

**Table 2-58 SIP Trunk Settings for Trunk to ISDN Gateway in Site RTP**

Setting	Value	Comment
Name	ST_RTP_PSTN_1	Prefix ST_ to avoid name collisions with other devices stored in the same table internally. The remainder of the name identifies the location of the gateway and allows numbers for multiple gateways.
Description		Some meaningful description
Device Pool	RTP_PSTN	Common device pool for all RTP PSTN gateways. Allows sharing of site-specific settings between all RTP gateways.
Media Resource Group List	<None>	Use the MRGL defined on the device pool.
AAR Group	Default	Same everywhere
PSTN Access	Checked	
Run On All Active Unified CM Nodes	Checked	This settings is recommended on all SIP trunks. This makes sure that outbound calls to SIP do not require intra-cluster control signaling between Unified CM call processing subscribers.
<b>Inbound Calls</b>		
Calling Search Space	DN	Inbound calls have +E.164 called party numbers, and only local destinations can be called from the PSTN. Hence, no access is required to ESN numbers and intercluster destinations.
AAR Calling Search Space	PSTNReroute	
<b>Outbound Calls</b>		
Use Device Pool Called Party Transformation CSS	Checked	

**Table 2-58 SIP Trunk Settings for Trunk to ISDN Gateway in Site RTP (continued)**

Setting	Value	Comment
Use Device Pool Calling Party Transformation CSS	Checked	
<b>SIP Information</b>		
Destination	X.X.X.X	IP address of ISDN gateway
SIP Trunk Security Profile	Non Secure SIP Trunk Profile	Default SIP trunk security profile
SIP Profile	FQDN	

The key here is that the inbound CSS provides access to local +E.164 destinations only. These include voicemail pilots or other services that need to be reachable from the PSTN, but no access is required to PSTN route patterns, dialing normalization translation patterns, ESNs, URIs, and intercluster destinations.

Settings for SIP trunks to other Unified CM clusters differ somewhat from the settings on SIP trunks to ISDN gateways. [Table 2-59](#) summarizes these settings.

**Table 2-59 SIP Trunk Settings for Intercluster Trunk to Other Unified CM Cluster**

Setting	Value	Comment
Name	ST_UCM_EMEA	Prefix ST_ to avoid name collisions with other devices stored in the same table internally. The remainder of the name identifies the trunk's purpose.
Description		Some meaningful description
Device Pool	Trunks_and_Apps	Common device pool for central trunks (see <a href="#">Table 2-53</a> )
Media Resource Group List	<None>	Use the MRGL defined on the device pool.
AAR Group	Default	Same everywhere
PSTN Access	Not checked	
Run On All Active Unified CM Nodes	Checked	This settings is recommended on all SIP trunks. This makes sure that outbound calls to SIP do not require intra-cluster control signaling between Unified CM call processing subscribers.
<b>Inbound Calls</b>		
Calling Search Space	ICTInbound	Incoming calls on trunks need to support +E.164, ESN, and URI dialing. This special CSS supports all three dialing habits but does not provide access to PSTN or remote on-net destinations (see <a href="#">Table 2-24</a> in the section on <a href="#">Special CSSs</a> ).  For applications requiring PSTN access, another special class of service (CSS) is required to also provide access to the partitions with PSTN access route patterns (see <a href="#">Table 2-27</a> in the section on <a href="#">Route Patterns for PSTN Access and Emergency Calls</a> ).
AAR Calling Search Space	PSTNReroute	Same CSS everywhere

**Table 2-59 SIP Trunk Settings for Intercluster Trunk to Other Unified CM Cluster (continued)**

Setting	Value	Comment
<b>Outbound Calls</b>		
Use Device Pool Called Party Transformation CSS	Checked	
Use Device Pool Calling Party Transformation CSS	Checked	
Calling and Connected Party Info Format	Deliver URI and DN in connected party, if available	On intercluster trunks to other Unified CM clusters, blended identity with both numeric and URI information should be delivered to the remote cluster. If both types of identity exist, then based on the capabilities of the called endpoint, the cluster terminating the call can decide which piece of the identity information can be displayed on the final called party.
<b>SIP Information</b>		
Destination	X.X.X.X	List IP addresses of all Unified CM call processing subscribers of remote Unified CM cluster. The order of the IP addresses is not relevant because outbound calls are randomly distributed among the defined destinations.
SIP Trunk Security Profile	ICT	See <a href="#">Table 2-57</a>
SUBSCRIBE Calling Search Space	ICTInbound	Subscriptions on +E.164, ESN, and URIs should be accepted. For the definition of the CSS, see the section on <a href="#">Special CSSs</a> .
SIP Profile	FQDN	See <a href="#">Table 2-54</a>

In contrast to the SIP trunk to a PSTN ISDN gateway, inbound calls from other Unified CM clusters in addition to +E.164 numbers also need access to ESNs and URIs. However, to avoid routing loops and transit-routing, intercluster trunks do not have access to intercluster destinations (partition onNetRemote, see [Table 2-12](#)).

For the SIP trunk to the IM and Presence nodes, configure a SIP trunk between Unified CM and IM and Presence. For this SIP trunk, configure the destination IP addresses of all IM and Presence nodes. Select the SIP Trunk Security Profile that you just created for the IM and Presence Service. Also select the Standard SIP Profile.



## Route Groups

All SIP trunks are assigned to route groups. Route groups combine trunks with common characteristics. [Table 2-60](#) shows the route group definition for the PSTN gateways in site RTP.

**Table 2-60** *Route Group for RTP PSTN Gateways*

Setting	Value	Comment
Route Group Name	RTP_PSTN	Meaningful name
Distribution Algorithm	Circular	We want to make sure to balance the load over all gateways.
Route Group Members	ST_RTP_PSTN_1 ST_RTP_PSTN_2 ST_RTP_PSTN_3	Add all SIP trunks to all SIP gateways in site RRP.



### Note

Route groups can be configured only after the SIP trunks have been created, and these can be added only after the respective device pool have been configured. This means that at the time of creating the device pool for PSTN gateways, route groups do not yet exist. Thus the configuration order is:

1. Configure the device pool for the PSTN gateway without defining the LRG mapping in the device pool.
2. Configure SIP trunks.
3. Create the route group.
4. Go back to the device pool and add LRG mapping (if required).

For intercluster trunks to other Unified CM clusters, a route group per trunks also needs to be defined. [Table 2-61](#) shows an example of a route group for an intercluster trunks to a remote Unified CM cluster.

**Table 2-61** *Route Group for Intercluster Trunk to Other Unified CM Cluster*

Setting	Value	Comment
Route Group Name	UCM_EMEA	Meaningful name; in this case, for the route group holding only the intercluster trunk to the EMEA Unified CM cluster.
Distribution Algorithm	Circular	Irrelevant as long as only one route group member exists.
Route Group Members	ST_UCM_EMEA	SIP trunk to remote Unified CM cluster.

Similar trivial route groups must be created for each non-PSTN SIP trunk provisioned on Unified CM.

## Specific Non-LRG Route Lists

The section on [Route Lists Using Local Route Groups](#) introduces route lists for PSTN access using local route groups only. For non-PSTN trunks, specific route lists need to be created using the route groups referring to these non-PSTN trunks. The reason for defining trivial route groups with only a single member and trivial route lists with only a single non-LRG route group as member, is that route patterns in Unified CM should never point to a trunk directly, because whenever a route pattern is changed in Unified CM, then the device the route pattern is pointing to is reset, and pointing route patterns to a route list instead of trunks makes sure that editing the route patterns will not reset the trunk itself but rather the route list. Examples for such trunks include trunks to other Unified CM clusters and applications.

[Table 2-62](#) shows the trivial route list for an intercluster trunk to another Unified CM cluster.

**Table 2-62** *Route List for Intercluster Trunk to Another Unified CM Cluster*

Route List	Members	Description
RL_UCM_EMEA	UCM_EMEA	Only a single member: the actual trunk to the remote Unified CM cluster. The leading RL makes sure to avoid naming collisions with trunks. Internally route lists are treated as devices, and the names of route lists cannot be identical to names of SIP trunks, for example.

Similar trivial route lists have to be created for each non-PSTN SIP trunk provisioned on Unified CM.

## Endpoint Provisioning

When provisioning a new endpoint, these minimum tasks are required:

- [Configure the Device](#)
- [Configure the Line](#)
- [Add the Device to Devices Controlled by the User](#)
- [Configure the Line Association for Presence](#)

## Configure the Device

When adding a new endpoint to Unified CM, the design described in this document requires the settings summarized in [Table 2-63](#). Settings not mentioned here are either left as default or have to be configured according to device-specific requirements:

**Table 2-63**      **Endpoint Device Settings**

Setting	Value	Description
<b>Device Information</b>		
Device Pool	RTPPhoneVideo	Site-specific device pool for endpoints (see <a href="#">Table 2-51</a> ). In this case this is the device pool for endpoints in site RTP with access to video conferencing media resources.
Calling Search Space	USEmergency	Access to emergency routing in multi-national environments is implemented on the device level (see the section on <a href="#">Emergency Call Considerations in Multi-National Environments</a> ). If only one country (dialing domain) such as the US needs to be supported, then this CSS can be left as <None>.
AAR Calling Search Space	PSTNReroute	Same everywhere (see the section on <a href="#">Automated Alternate Routing</a> ).
Media Resource Group List	<None>	Use device pool level settings.
AAR_Group	Default	Same everywhere (see the section on <a href="#">Automated Alternate Routing</a> ).
Owner	Select "User"	If the device is a phones without user association (for example a lobby phone), then select "Anonymous (Public/Shared Space)" and do not set the "Owner User ID"
Owner User ID	Select the user ID of the owner of this phone.	
Allow Control of Device from CTI	Checked	
<b>Number Presentation Transformation</b>		
Caller ID For Calls From This Phone	"Use Device Pool Calling Party Transformation CSS (Caller ID For Calls From This Phone)" checked	
Remote Number	"Use Device Pool Calling Party Transformation CSS (Device Mobility Related Information)" checked	
<b>Protocol Specific Information</b>		
SIP Profile	FQDN	See <a href="#">Table 2-54</a>

## Configure the Line

On each endpoint, at least the first line needs to be provisioned. [Table 2-64](#) summarizes the line settings specific to the design described in this document.

**Table 2-64** Line Settings

Setting	Value	Description
<b>Directory Number Information</b>		
Directory Number	\+14085554146	Full +E.164 directory number matching the phone number of the user this DN is provisioned for. The leading + has to be escaped with \. If a non-DID is provisioned, then the directory number is set to the ESN (for example, 81405001).
Route Partition	DN	If a non-DID is provisioned, then the partition is ESN.
Alerting Name	Aristotle Boyle	Full name of the user associated with the number. If the number is not associated with a user, then provision a meaningful name (for example, Bldg. 31 Lobby).
Allow Control of Device from CTI	Checked	
<b>Directory Number Settings</b>		
Calling Search Space	SJCInternational	CSS defining the effective class of service for calls from this line. The CSS is specific to site and class of service (see the section on <a href="#">Classes of Service and Calling Search Spaces (CSSs)</a> for other CSSs).
BLF Presence Group	Standard Presence Group	Same for all lines
<b>+E.164 Alternate Number</b>		
Number Mask	Leave mask empty	An empty mask creates the +E.164 alternate number identical to the directory number configured above. If a non-DID is provisioned, no +E.164 alternate number is added because no PSTN address exists for non-DIDs, by definition.
Add to Local Route Partition	Not checked	The +E.164 alternate number is not added to a local route partition because the directory number itself already is a +E.164 number
Advertise Globally via ILS	Not checked	The +E.164 alternate number is not advertised via ILS. Instead, summary routes for each DID range are advertised (see <a href="#">Table 2-68</a> ). The only reason to create the +E.164 alternate number is to be able to advertise this +E.164 alternate number as the GDPR PSTN failover number for URIs associated with this directory number.
<b>PSTN Failover for Enterprise Alternate Number, +E.164 Alternate Number, and URI Dialing</b>		
Advertised Failover Number	+E.164 Number	The +E.164 number is advertised as GDPR PSTN. If a non-DID is provisioned, then set to <None>.

Table 2-64 Line Settings (continued)

Setting	Value	Description
<b>AAR Settings</b>		
Voice Mail	Not checked	If a non-DID is provisioned, then check this option.
AAR Destination Mask	+14085554XXX	This DID range mask makes sure that the alternate PSTN destination for AAR is equal to the directory number. If a non-DID is provisioned, then leave this mask empty.
AAR Group	Default	Same everywhere
<b>Call Forward and Call Pickup Settings</b>		
Calling Search Space Activation Policy	Use System Default	
Forward All	"Voicemail" not checked Calling Search Space: SJCInternational	CSS might be set to a more restricted CSS
All other Forward settings other than "Forward Unregistered Internal" and "Forward Unregistered External"	"Voicemail" checked Calling Search Space: SJCInternational	CSS might be set to a more restricted CSS
"Forward Unregistered Internal" and "Forward Unregistered External"	Destination: +14085554146 Calling Search Space: PSTNReroute	Forward Unregistered implements an alternate route through the PSTN in case the endpoint is unregistered. This makes sense only for endpoints in remote sites with local PSTN access for which an alternate route through the PSTN can be established.  If a non-DID is provisioned or a DN for which PSTN reroute does not make sense, then check "Voicemail" and set the CSS to SJCInternational or some other CSS that can reach the voicemail pilot.
<b>Line 1 on Device</b>		
Display (Caller ID)	Aristotle Boyle	Full name of the user associated with the number. If the number is not associated with a user then, provision a meaningful name (for example, Bldg. 31 Lobby).
Line Text Label	4146	Makes sure that the last four digits of the directory number are displayed next to the line button on the phone. This setting exists only for lines on devices supporting line text labels.
External Phone Number Mask	+14085554XXX	The external phone number mask is not referenced anywhere in the provisioned dial plan and can be set to anything. For phones on which the external phone number mask determines the text in the first line on the phone display, the mask can be set to something that creates a meaningful label.

## Add the Device to Devices Controlled by the User

For devices associated with users, after provisioning the device in the End User Configuration of the respective user in the Device Information section in Unified CM Administration, make sure that the device is associated with the user. The recommended way to achieve this is to select **Device Association** and search for devices where the directory number matches the phone number of the user.

## Configure the Line Association for Presence

To determine the presence state of a user, only the line appearances (per DN and device) explicitly associated for presence are considered. To make sure that all line appearances of a user's directory numbers are considered for presence, in the End User Configuration of the respective user in the section on Device Information in Unified CM Administration, select **Line Appearance Association for Presence** and associate all line appearances.

## Verify the User's Primary Extension

To make sure that the user's directory URI synchronized from LDAP propagates to the directory number, select the Primary Extension in the Directory Number Associations section in the End User Configuration of the respective user in Unified CM Administration.

## Jabber Provisioning

Service Discovery enables Jabber to establish configuration automatically. The Jabber client gets its configuration through Unified CM User Discovery Service (UDS). It is the recommended configuration and is preferred over the older manual configuration.

The services are configured through UC services. A Service profile specifies which UC services to use. Each user is associated with a service profile.

[Table 2-65](#) shows the UC services that can be made available to Jabber clients. Those services are configured in **User Management > User Settings > UC service**.

**Table 2-65 UC Services**

UC Service Type	Comment
IM and Presence	Create an IM and Presence service for each IM and Presence node.
Directory	Create a Directory service for each active directory server. Do not select "Use UDS for Contact Resolution" when integrating with LDAP directly. The recommended contact source for on-premises deployments is CDI.
CTI	Create a CTI service for each Unified CM running the CTI Manager service. This is used for desk phone control mode. Load balance the CTI load across all Unified CM call processing nodes.
Voicemail	Create a Voicemail service for each Unity Connection node.

Associate the UC services to a Service Profile. A Service Profile is then associated to each user. For deployments with more than two Unified CM call processing subscribers, spread the CTI load equally across all Unified CM call processing subscribers and ensure that the CTI scalability limit is not

exceeded on any single Unified CM call processing subscriber running the CTI Manager service. To associate Jabber clients with another Unified CM call processing subscriber running the CTI Manager service, configure another Service Profile with the relevant CTI UC service settings.

For users connected to the internal enterprise network (not using Cisco Collaboration Edge), directory search Contact Sources can be provided through UDS or through LDAP. With LDAP, Cisco Directory Integration (CDI) is available. The Contact Source or directory can be configured through the jabber-config.xml file or through the directory UC service which takes precedence. The recommendation is to configure a jabber-config.xml file that is uploaded onto the Unified CM TFTP server. The jabber-config.xml file is also used to enable URI dialing for Jabber clients. [Example 2-5](#) shows a jabber-config.xml file to enable URI dialing for Jabber clients. This is the recommended minimum. Additional configuration options can be added.

**Example 2-5 jabber-config.xml File to Enable URI Dialing**

```
<?xml version="1.0" encoding="utf-8"?>
<config version="1.0">
  <Policies>
    <EnableSIPURIDialling>true</EnableSIPURIDialling>
  </Policies>
</config>
```

For more details, refer to the latest version of the following documents:

- *Configuration and Administration of IM and Presence on Cisco Unified Communications Manager*  
<https://www.cisco.com/c/en/us/support/unified-communications/unified-communications-manager-callmanager/products-installation-and-configuration-guides-list.html>
- Cisco Jabber Install and Upgrade Guides  
<https://www.cisco.com/c/en/us/support/unified-communications/jabber-windows/products-installation-guides-list.html>

## ILS Configuration for Multi-Cluster Deployments

When the Intercluster Lookup Service (ILS) is configured on multiple clusters, ILS updates Unified CM with the current status of remote clusters in the ILS network.

The ILS cluster discovery service allows Unified CM to learn about remote clusters without the need for an administrator to manually configure connections between each cluster.

The ILS cluster discovery service enables UDS-based service discovery for Jabber clients in multi-cluster environments. In addition, ILS is the foundation for global dial plan replication (GDPR), which allows the exchange of reachability information for both alphanumeric URIs and numeric destinations between Unified CM clusters to enable deterministic intercluster routing for those destinations.

To create an ILS network of multiple Unified CM clusters, perform the following tasks:

- [Assign Unique Cluster IDs for Each Unified CM Cluster in the Network](#)
- [Activate ILS on the First ILS Hub Cluster in the Network](#)
- [Activate ILS on the Remaining ILS Clusters in the Network](#)
- [Consider UDS Certificate Requirements](#)

## Assign Unique Cluster IDs for Each Unified CM Cluster in the Network

The cluster IDs defined in the Unified CM cluster enterprise parameters have to be unique. See [Table 2-2](#) for details.

## Activate ILS on the First ILS Hub Cluster in the Network

Forming an ILS network starts with activating ILS on the first Unified CM cluster. This done by changing the role from Standalone Cluster to Hub Cluster in the ILS Configuration menu in Unified CM Administration.

[Table 2-66](#) shows the settings to be applied when activating ILS on the first Unified CM cluster.

**Table 2-66** ILS Activation on First Unified CM Cluster

Setting	Value	Comment
Role	Hub Cluster	ILS is activated by changing the role from Standalone Cluster to Hub Cluster.
Exchange Global Dial Plan Replication Data with Remote Clusters	Checked	Makes sure that URI and numeric reachability information is exchanged with remote clusters.
Advertised Route String	us.route	The advertised route string is the location attribute tied to all URI and numeric reachability information advertised by this Unified CM cluster. Remote clusters trying to reach any of the destinations advertised by this cluster will establish the route to this destination by matching the learned SIP route string against SIP route patterns provisioned on the remote cluster.
Synchronize Clusters Every	2	Setting the synchronization interval to a reasonably small interval makes sure that changes are picked up by remote clusters after a short period of time. The overhead of a short synchronization interval is limited because GDPR uses an incremental update algorithm that exchanges only delta information if any changes occurred since the last update.
<b>ILS Authentication</b>		
Use TLS Certificates	Checked	Certificate-based authentication of ILS TLS connections.
Use Password	Checked	Password-based authorization.
Password	<some password>	Choose a secure password. This password is shared among all Unified CM clusters participating in the ILS network.

When you activate ILS by changing the role from Standalone Cluster to Hub Cluster in Unified CM Administration, an ILS Cluster Registration pop-up appears and asks you to input a Registration Server. When you activate ILS on the first Unified CM cluster, no registration server information is available, so the input in that pop-up should be left empty.

If you activate both **Use TLS Certificates** and **Use Password** at the same time, then at TLS connection setup the TLS certificate presented by the remote end has to pass only the regular TLS certificate validity checks (identity, validity, and trust), and the decision whether the remote peer is a trusted peer for ILS communication is based on checking the shared secret (password). Without using the shared secret



(password) authorization, all Tomcat certificates of all clusters involved in the ILS exchange would need to be exchanged between all clusters. Using shared secret (password) authorization greatly simplifies the deployment of ILS with CA-signed certificates.

## Activate ILS on the Remaining ILS Clusters in the Network

Adding more Unified CM clusters to the ILS network requires the same process as activating ILS on the first Unified CM cluster: changing the role from Standalone Cluster to Hub Cluster in the ILS Configuration menu in Unified CM Administration.

Table 2-67 shows the settings to apply when activating ILS on the remaining Unified CM clusters.

**Table 2-67** ILS Activation on Additional Unified CM Clusters

Setting	Value	Comment
Role	Hub Cluster	ILS is activated by changing the role from Standalone Cluster to Hub Cluster.
Exchange Global Dial Plan Replication Data with Remote Clusters	Checked	Makes sure that URI and numeric reachability information is exchanged with remote clusters.
Advertised Route String	emea.route	Make sure that the SIP route string for each cluster is unique to allow for deterministic routing based on these route strings.  The example here indicated that this is a Unified CM cluster serving EMEA destinations.
Synchronize Clusters Every	2	Make sure to use the same synchronization interval on all clusters for consistency.
<b>ILS Authentication</b>		
Use TLS Certificates	Checked	Certificate-based authentication of ILS TLS connections.
Use Password	Checked	Password-based authorization is selected.
Password	<some password>	Choose a secure password. This password is shared among all Unified CM clusters participating in the ILS network.

## Consider UDS Certificate Requirements

To enable UDS-based service discovery, the UDS process on each Unified CM cluster tries to establish connectivity with the UDS processes running on remote Unified CM clusters to learn about the remote clusters' UDS nodes. For this server-to-server communication, TLS connections between the Unified CM clusters' nodes are established and the remote peers' certificates are validated during TLS connection setup. To prevent this validation from failing, the Tomcat certificates of the Unified CM publisher and call processing subscriber nodes must be signed by a trusted CA.

Also, this server-to-server communication is one of the reasons why **TLS Web Client Authentication** has to be in the X.509 extended key usage when issuing Tomcat certificates on an external CA.

## GDPR Configuration (Multi-Cluster Only)

When Global Dial Plan Replication (GDPR) is enabled across an ILS network, remote clusters in an ILS network share global dial plan data, including the following:

- Directory URIs
- +E.164 and ESN patterns
- PSTN failover numbers

GDPR allows you to create a global dial plan, including intercluster dialing of directory URIs and alternate numbers, that spans across an ILS network. GDPR allows you to quickly configure the global dial plan across the ILS network without the need to configure each dial plan component on each cluster separately.

Configuring GDPR requires the following steps in addition to activating ILS as described in the previous section:

- [Advertise URIs](#)
- [Configure Advertised Patterns](#)
- [Configure Partitions for Learned Numbers and Patterns](#)
- [Configure Intercluster Trunks](#)
- [Configure SIP Route Patterns](#)

### Advertise URIs

In this document we assume that URIs for users are automatically provisioned based on the directory URI synchronized for each user from the email attribute of the corporate directory (see [Table 2-43](#)) and the primary extension configure for the user. By default the **Advertise Globally via ILS** option is set for these URIs automatically created in partition Directory URI. Also make sure to set the **Advertise Globally via ILS** option on all URIs you have provisioned in addition to the ones created automatically.

### Configure Advertised Patterns

To keep the route plan small on remote clusters, in this design only summary patterns are advertised for each +E.164 and ESN range hosted on each cluster. For the example cluster hosting the sites RTP, RCD, and SJC, the patterns shown in [Table 2-68](#) need to be configured as GDPR advertised patterns. For information on the DID ranges and ESN ranges used in the example, refer to [Table 2-9](#) and [Table 2-10](#).

**Table 2-68** Patterns Advertised via GDPR

Pattern	Pattern Type	PSTN Failover Setting	Comment
+14085554XXX	+E.164 Number	Use Pattern as PSTN Failover Number	Site SJC DID range
81404XXX	Enterprise Number	Apply Strip Digits and Prepend Digits to Pattern and Use for PSTN Failover PSTN Failover Strip Digits: 4 PSTN Failover Prepend Digits: +1408555	ESN range of SJC DIDs. Strip digits and prefix to transform from ESN to PSTN failover number.
81405XXX	Enterprise Number	Don't use PSTN Failover	ESN range of SJC non-DIDs. No PSTN failover possible.

**Table 2-68** Patterns Advertised via GDPR (continued)

Pattern	Pattern Type	PSTN Failover Setting	Comment
+19195551XXX	+E.164 Number	Use Pattern as PSTN Failover Number	Site RTP DID range
81911XXX	Enterprise Number	Apply Strip Digits and Prepend Digits to Pattern and Use for PSTN Failover PSTN Failover Strip Digits: 4 PSTN Failover Prepend Digits: +1919555	ESN range of RTP DIDs. Strip digits and prefix to transform from ESN to PSTN failover number.
81912XXX	Enterprise Number	Don't use PSTN Failover	ESN range of SJC non-DIDs. No PSTN failover possible.
+19725555XXX	+E.164 Number	Use Pattern as PSTN Failover Number	Site RCD DID range
81975XXX	Enterprise Number	Apply Strip Digits and Prepend Digits to Pattern and Use for PSTN Failover PSTN Failover Strip Digits: 4 PSTN Failover Prepend Digits: +1972555	ESN range of RCD DIDs. Strip digits and prefix to transform from ESN to PSTN failover number.
81976XXX	Enterprise Number	Don't use PSTN Failover	ESN range of RCD non-DIDs. No PSTN failover possible.
8099XXXX	Enterprise Number	Don't use PSTN Failover	ESN ranges for conferences on this cluster (see <a href="#">Table 2-10</a> ).

Advertising both the +E.164 range and the ESN range for each site makes sure that both formats can be used as the intercluster dialing habit on the remote clusters learning this information.

## Configure Partitions for Learned Numbers and Patterns

Numeric patterns (+E.164 and ESN) learned from remote clusters are added to the local route plan into predefined partitions. The **Partitions for Learned Numbers and Patterns** menu in Unified CM Administration allows you to define differentiated partitions for each type of learned information. In this design we do not need this differentiation and simply configure GDPR to learn all remote numeric patterns in a single partition, onNetRemote (see [Table 2-12](#)).

[Table 2-69](#) summarizes the settings for the GDPR partitions.

**Table 2-69** GDPR Partition Settings

Setting	Value	Comment
Partition for Enterprise Alternate Numbers	onNetRemote "Mark Learned Numbers as Urgent" checked	
Partition for +E.164 Alternate Numbers	onNetRemote "Mark Learned Numbers as Urgent" checked	Marked urgent to avoid inter-digit timeout on +E.164 on-net intercluster calls.

**Table 2-69** GDPR Partition Settings (continued)

Setting	Value	Comment
Partition for Enterprise Patterns	onNetRemote "Mark Fixed Length Patterns as Urgent" checked "Mark Variable Length Patterns as Urgent" unchecked	
Partition for +E.164 Patterns	onNetRemote "Mark Fixed Length Patterns as Urgent" checked "Mark Variable Length Patterns as Urgent" unchecked	Marked urgent to avoid inter-digit timeout on +E.164 on-net intercluster calls.

## Configure Intercluster Trunks

The GDPR exchange only makes sure that all URI and numeric reachability information is exchanged between Unified CM clusters and associated with a SIP route string as the location attribute. Sessions between clusters need SIP trunks to be established. In this design we assume full-mesh SIP trunks between all Unified CM clusters, with a maximum of three Unified CM clusters. The maximum of three Unified CM clusters makes sure that the topology of the full mesh of SIP trunks is manageable. If more than three Unified CM clusters are required, then adding Unified CM Session Management Edition (SME) is recommended to simplify the topology to a hub-and-spoke topology with SME as the hub and all other Unified CM clusters as spokes or leaf clusters.

Regular SIP intercluster trunks are used for GDPR routing. SIP trunk ST\_UCM\_EMEA, as with the settings shown in [Table 2-59](#), is an example of an intercluster trunk provisioned for GDPR routing.

## Configure SIP Route Patterns

SIP route patterns tie together the SIP route strings learned via GDPR and the SIP trunk topology. Think of it as if a GDPR route strings tells us "where" a learned URI or numeric pattern is located, and we need route patterns matching on these route strings to tell how to get to this destination.

To achieve full GDPR reachability, we need to make sure that each SIP route string advertised via GDPR can be routed according to the provisioned SIP route patterns. [Table 2-70](#) summarizes the trunks, route groups, route lists, and SIP route patterns that need to be provisioned to enable full intercluster GDPR routing between two Unified CM clusters.

**Table 2-70** GDPR Routing with Two Unified CM Clusters

Component	US Cluster	EMEA Cluster	Comment
SIP Trunk	ST_UCM_EMEA	ST_UCM_US	SIP trunk on each cluster to the other Unified CM cluster (see <a href="#">Table 2-59</a> )
Route Group with above SIP trunk as member	UCM_EMEA	UCM_US	Dedicated route group for the intercluster trunk (see <a href="#">Table 2-61</a> )
Route List with above route group as member	RL_UCM_EMEA	RL_UCM_US	Dedicated non-LRG route list for the intercluster trunk (see <a href="#">Table 2-62</a> )

**Table 2-70** GDPR Routing with Two Unified CM Clusters (continued)

Component	US Cluster	EMEA Cluster	Comment
SIP Route String	us.route	emea.route	SIP route string advertised by the Unified CM cluster
SIP Route Pattern pointing to above route list	emea.route in partition onNetRemote	us.route in partition onNetRemote	Provisioned SIP route pattern matches on the SIP route string advertised by the other Unified CM cluster

## Example GDPR Call Flow

With the above configuration, this section describes how a call would be routed if +14085554001 is dialed on an endpoint with class of service "international" registered to the EMEA cluster in the above example.

1. The dialed digits (+14085554001) are matched against the dial plan on the EMEA cluster, using the calling device's CSS XXXInternational, where XXX represents a site code of a site provisioned on the EMEA cluster. The actual site-specific dialing normalization is irrelevant here.

The important point is that CSS XXXInternational contains at least the following partitions (see [Table 2-17](#); again XXX represents a site code while XX represents some dialing domain identifier):

- DN
- Directory URI
- URI
- ESN
- onNetRemote
- XXXIntra
- XXtoE164
- XXPSTNNational
- PSTNInternational
- B2B\_URI
- USEmergency

The dialed digits (+14085554001) in these partitions have three matches:

- +14085554XXX in partition onNetRemote learned from the US cluster with SIP route string us.route (see [Table 2-68](#))
  - \+! in partition PSTNInternational (see [Table 2-27](#))
  - \+!# in partition PSTNInternational (see [Table 2-27](#))
2. Because +14085554XXX in partition onNetRemote is inserted into the route plan as urgent pattern (see [Table 2-69](#)) and this pattern at this point is the best match, digit collection is stopped immediately and the call is routed based on this best match.
  3. +14085554XXX in partition onNetRemote is a GDPR learned pattern and is associated with SIP route string us.route. Hence, us.route is matched against the configured SIP route patterns on the EMEA cluster, again using the calling device's CSS XXXInternational.

The only match is SIP route pattern us.route in partition onNetRemote.

4. The call on the EMEA cluster is extended to SIP trunk ST\_UCM\_EMEA, dereferencing the route list RL\_UCM\_EMEA the matched SIP route pattern us.route points to and route group RG\_UCM\_EMEA (see [Table 2-70](#))
5. On the US cluster, the inbound CSS ICTInbound of SIP trunk ST\_UCM\_EMEA (see [Table 2-59](#)) is used to route the inbound call to destination +14085554001.
6. CSS ICTInbound has these partitions:
  - DN
  - ESN
  - URI
  - Directory URI

In these partitions the only (potential) match is on a +E.164 directory number \+14085554001 (marked urgent) in partition DN. If this directory number exists, then the call is extended to all associated devices.

Routing of remotely dialed ESN destinations follows the exact same flow, with the only exception being that the final lookup on the US cluster using CSS ICTInbound in that case would find a match on an ESN in partition ESN.

## IM and Presence Intercluster

To create a fully meshed presence topology, each Cisco IM and Presence cluster requires a separate peer relationship for each of the other Cisco IM and Presence clusters within the same domain. The address configured in this intercluster peer is the IP address of the remote Unified CM cluster IM and Presence publisher node.

The interface between each Cisco IM and Presence cluster is two-fold: an AXL/SOAP interface and a signaling protocol interface (SIP or XMPP). The AXL/SOAP interface, between publisher-only servers of an IM and Presence cluster, handles the synchronization of user information for home cluster association, but it is not a full user synchronization. The signaling protocol interface (SIP or XMPP) is a full mesh encompassing all servers within the deployment. It handles the subscription and notification traffic, and it rewrites the host portion of the URI before forwarding if the user is detected to be on a remote Cisco IM and Presence cluster within the same domain.

When Cisco IM and Presence is deployed in an intercluster environment, a presence user profile should be determined. The presence user profile helps determine the scale and performance of an intercluster presence deployment and the number of users that can be supported. The presence user profile helps establish the number of contacts (or buddies) a typical user has, as well as whether those contacts are mostly local cluster users or users of remote clusters.

## Survivable Remote Site Telephony (SRST) Deployment

Configure SRST at each remote site in order to provide call processing survivability in case the WAN to the remote site fails. With SRST, if the WAN fails, phone calls can still be made within the remote site or out to the PSTN.

### Deployment

Deploy one Cisco Integrated Services Router (ISR) for each remote sites that you want to enable for SRST.

## Provisioning

To configure SRST, you must perform the configuration on both Unified CM and the SRST router.

On Unified CM:

- Configure an SRST Reference for each remote site, and associate this SRST Reference in the device pool of the remote phones.
- Configure Call Forwarding Unregistered (CFUR) on the DNs of the remote phones to use the phone's +E.164 number and the AAR CSS. In case the WAN fails and the phone unregisters, Unified CM uses this information to route incoming calls destined for the unregistered phone to the site's gateway via the PSTN.
- Set the **Max Forward UnRegistered Hops to DN** service parameter to a value other than zero to make sure to limit the impact of routing loops that can occur if a phone is unregistered (for example, because it is not plugged in) while the site's gateway still is connected to Unified CM.

On the SRST router:

- Configure SRST on each remote branch router. Since our recommendation is to use SIP phones, use the **voice register global** and **voice register pool** commands. Use the **voice service voip/sip** command to bind the IP addresses of the source interface and enable the registrar capability. Configure DHCP for the phones in the remote branch. The DHCP server may be configured on the SRST router or on other network service resources.
- If the WAN fails, the SIP phones will register with their +E.164 extensions. In order to allow users to call other local users by their four-digit extensions, configure a voice translation profile that is referenced as an incoming profile in the voice register pool configuration. This voice translation profile transforms the called number from four digits to the complete +E.164 number.
- Configure POTS dial-peers to allow local access to the PSTN in case the WAN is down. Configure translation voice profiles in order to comply with the service provider's PSTN dialing requirements. For more details on dial-peer configuration, refer to the section that describes how to [Deploy Cisco Unified Border Element](#).

The SRST configuration in [Example 2-6](#) is just a partial configuration to illustrate some of the concepts discussed in the previous paragraphs. It does not cover the full SRST configuration. For instance, configuration to reach the Cisco Unity Connection server in the main site is covered in the chapter on [Voice Messaging](#).

**Example 2-6 SRST Partial Configuration**

```

voice service voip
  allow-connections sip to sip
sip
  bind control source-interface GigabitEthernet0/0.241
  bind media source-interface GigabitEthernet0/0.241
  registrar server
!
voice register global
  mode srst
  max-dn 100
  max-pool 100
!
voice register pool 1
  translation-profile incoming 4-digit-rtp
  id network 10.0.94.0 mask 255.255.255.0
!
voice translation-rule 1
  rule 1 /\(^1...\)$/ /+1919555\1/
!
voice translation-profile 4-digit-rtp
  translate called 1
!

```

For more details on configuring SRST, refer to the *Cisco Unified SCCP and SIP SRST System Administrator Guide*, available at

[https://www.cisco.com/c/en/us/td/docs/voice\\_ip\\_comm/cusrst/admin/sccp\\_sip\\_srst/configuration/guide/SCCP\\_and\\_SIP\\_SRST\\_Admin\\_Guide.html](https://www.cisco.com/c/en/us/td/docs/voice_ip_comm/cusrst/admin/sccp_sip_srst/configuration/guide/SCCP_and_SIP_SRST_Admin_Guide.html)

## Extension Mobility

Cisco Extension Mobility allows users to temporarily access their Cisco Unified IP Phone configuration – such as line appearances, services, and speed dials – from other Cisco Unified IP Phones.

One or two Unified CM call processing nodes can actively handle Extension Mobility requests. The benefits of adding a second Unified CM call processing node for Extension Mobility are resiliency and increased capacity. In this scenario, a load balancer is required to send the requests to both Unified CM nodes. Cisco IOS Server Load Balancing can be used, for example.

Extension Mobility Cross Cluster (EMCC) provides the ability to perform Extension Mobility logins between clusters within an enterprise. This feature is not covered in this guide. For more details on EMCC, refer to the latest version of the *Cisco Collaboration System SRND* and the EMCC product documentation.



## Deploying Extension Mobility

To deploy Extension Mobility, perform the following tasks:

- Ensure that the Cisco Extension Mobility service is activated on one or two Unified CM call processing servers.
- Add an IP Phone Service for Extension Mobility. A secure IP Phone Services URL using HTTPS in addition to a non-secure URL can be configured. The non-secure URL is

```
http://<IPAddress>:8080/emapp/ EMAppServlet?device=#DEVICENAME#
```

You can either make this service available to all phones in the cluster by selecting Enterprise Subscription or make it available to selected phones by subscribing those phones to this service.

- For each user that will use Extension Mobility, create at least one Device Profile. Since a Device Profile is tied to a specific user, the Device Profile is usually referred to as a User Device Profile. If a Device Profile is not created for a user, that user will not be able to log in with extension mobility.
- Associate the device profile to a user for extension mobility. If CTI is needed, also associate the profile to be a CTI controlled device profile.
- For each phone that can be used for users to log in, enable Extension Mobility.
- On the DN configuration, configure the association of the appropriate user to the line. This allows the DN to send presence information for that user if the line of that phone is in use. For example:

User B is using Jabber and is monitoring user A. User A logs into a phone with Extension Mobility and has a User Device Profile with the DN associated to himself/herself. When user A goes off-hook, this presence information will be reported on the Jabber client of user B.

For more details on Extension Mobility, refer to the latest version of the *Feature Configuration Guide for Cisco Unified Communications Manager*, available at

<https://www.cisco.com/c/en/us/support/unified-communications/unified-communications-manager-callmanager/products-installation-and-configuration-guides-list.html>

## Busy Line Field (BLF) Presence

The BLF Presence feature allows a user (watcher) to monitor the real-time status of another user at a directory number or SIP URI from the device of the watcher. A watcher can monitor the status of the user by using the following options:

- BLF/SpeedDial buttons
- Missed call, placed call, or received call lists in the directories window
- Shared directories, such as the corporate directory

BLF Presence is not based in Cisco Unified IM and Presence.

## Deploying BLF Presence

- Enable the **BLF for Call List** enterprise parameter (see [Table 2-2](#)).
- Configure the cluster-wide service parameters for BLF presence.
- To use BLF presence group authorization, configure BLF presence groups and permissions.
- Apply a BLF presence group to the directory number, SIP trunk, phone that is running SIP, phone that is running SCCP, end user, and application user (for application users that are sending BLF presence requests over the SIP trunk) in Cisco Unified Communications Manager Administration.

- To allow BLF presence requests from a SIP trunk, select the **Accept Presence Subscription** option in the SIP Trunk Security Profile Configuration window (see [Table 2-57](#)).
- Configure the SUBSCRIBE calling search space and apply the calling search space to the phone, trunk, or end user, if required.
- For BLF/SpeedDial buttons on the phones, customize phone button templates for the BLF/SpeedDial buttons or add them directly to the phones.

## Deploying Computer Telephony Integration (CTI)

- Activate the CTI Manager service on the Unified CM call processing nodes that need the CTI Manager service.
- For redundancy, through the CTI application administration, select a primary and backup Unified CM node running the CTI Manager service,
- Download the TAPI client software for applications using TAPI.
- If possible, for a given CTI-enabled endpoint, configure the same Unified CM call processing node for CCM registration and for CTI Manager monitoring and control.
- Ensure the CTI load is spread across all Unified CM nodes running the CTI Manager and that the CTI capacity limits are not exceeded. For example, with Jabber clients, if two Unified CM call processing pairs are required, spread the registration across the two pairs; also, if the Jabber clients are configured with the ability to be in deskphone mode, spread the CTI Manager connectivity across the two pairs. This can be achieved with multiple Service Profiles with different CTI profiles associated. Ensure the number of Jabber clients in deskphone mode monitored and controlled by each Unified CM running the CTI Manager service does not exceed the CTI capacity limit.



# Conferencing

**Revised: May 21, 2021**

This chapter describes the components and deployment of video and audio conferencing in an enterprise deployment. The chapter describes the [Architecture](#) for conferencing and then outlines the major tasks involved in the [Conferencing Deployment Process](#).

Each major task of the [Conferencing Deployment Process](#) starts with an *Overview* section listing the steps required for that task, followed by a section on the important *Deployment Considerations* for that task, and then a section (or sections) detailing the deployment tasks listed in the *Overview* section.

## What's New in This Chapter

[Table 3-1](#) lists the topics that are new in this chapter or that have changed significantly from previous releases of this document.

**Table 3-1** *New or Changed Information Since the Previous Release of This Document*

New or Revised Topic	Described in:	Revision Date
Cisco Meeting Management	Various sections throughout this chapter	May 21, 2021
Web Bridge 3 and C2W Services	Various sections throughout this chapter	May 21, 2021
CMS Web App	Various sections throughout this chapter	May 21, 2021
Smart Licensing	<a href="#">Configure licensing mode</a>	May 21, 2021

## Core Components

The core architecture contains these key conferencing elements:

- Cisco Meeting Server for audio and video conferencing as well as conference resource management
- Cisco TelePresence Management Suite (TMS) for conference provisioning, monitoring, and scheduling
- Cisco TelePresence Management Suite Extension for Microsoft Exchange (TMSXE) for interfacing with Microsoft Exchange room and resource calendars
- Cisco Meeting Management for monitoring and managing meetings, as well as provisioning CMS web app users and managing conferencing licenses.

In addition, Cisco TMS architecture includes these non-Cisco components:

- Microsoft SQL database
- Microsoft Active Directory
- Microsoft Exchange or Microsoft Office 365
- Network load balancer

## Key Benefits

- Simplified and optimized conferencing user experiences with all device types
- Flexible, extendable architecture that supports deployment of one or more permanent, scheduled, and/or instant conference resources
- High availability of conference resources and processes
- Resilience in the video network
- A single tool for hosts to schedule participants and conference rooms for a meeting
- Multiparty licensing enables full access to all conference resources on the bridge
- White glove service to monitor and manage meetings on a single interface
- Browser based application where users can create and participate in meetings

# Conference Types

The conferencing solution supports the conference types and conferencing features listed in [Table 3-2](#).

**Table 3-2** *Types of Conferences*

Conference Type	Description
Instant conferences	Manually escalated from a point-to-point call hosted on Unified CM, to a three-party call hosted on a conference bridge. (Also referred to as ad hoc conference.) Instant conferences are not scheduled or arranged prior to the conference.
Permanent conferences	Predefined addresses that allow conferencing without previous scheduling. The conference host shares the address with other users, who can call in to that address at any time. (Also referred to as meet-me, static, or rendezvous conferences.) Permanent conferences covered in this chapter can also be referred to as CMS spaces. Spaces can be user based and are provisioned for items such as conference name, layouts, and PIN. Spaces can be created by importing users, API, or manually. Spaces can also be created by CMS web app users when provisioned by Cisco Meeting Management.
Scheduled conferences	Conferences booked via Cisco TMS and/or integration using Cisco TMS with a start and end time, optionally with a predefined set of participants.

## Architecture

The conferencing architecture consists of Cisco Meeting Server for bridge resources as well as resource management; Cisco TelePresence Management Suite (TMS) for resource provisioning and scheduling; Cisco Meeting Management for conference monitoring and meeting management, conferencing license management, CMS web app user space provisioning; and Cisco Unified Communications Manager (Unified CM) for call processing. SIP call control is used exclusively in this architecture. Use Cisco Meeting Server as the conference bridges for all conference types, and SIP trunks to connect the Cisco Meeting Server with Unified CM ([Figure 3-1](#)).

Unified CM communicates with Cisco Meeting Server using XML-RPC over HTTPS to control the conference bridges for instant conferences. Cisco TMS uses the REST API connections to link to the Cisco Meeting Server for provisioning and scheduling conference resources. Cisco Meeting Management and Cisco Meeting Server are connected via REST API, Event subscription, and Call Detail Record (CDR) interfaces to perform meeting management functions. Also, Cisco Meeting Management uses the TMS Booking API to connect with Cisco TMS to manage scheduled meetings. ([Figure 3-1](#))

Figure 3-1 Architecture Overview

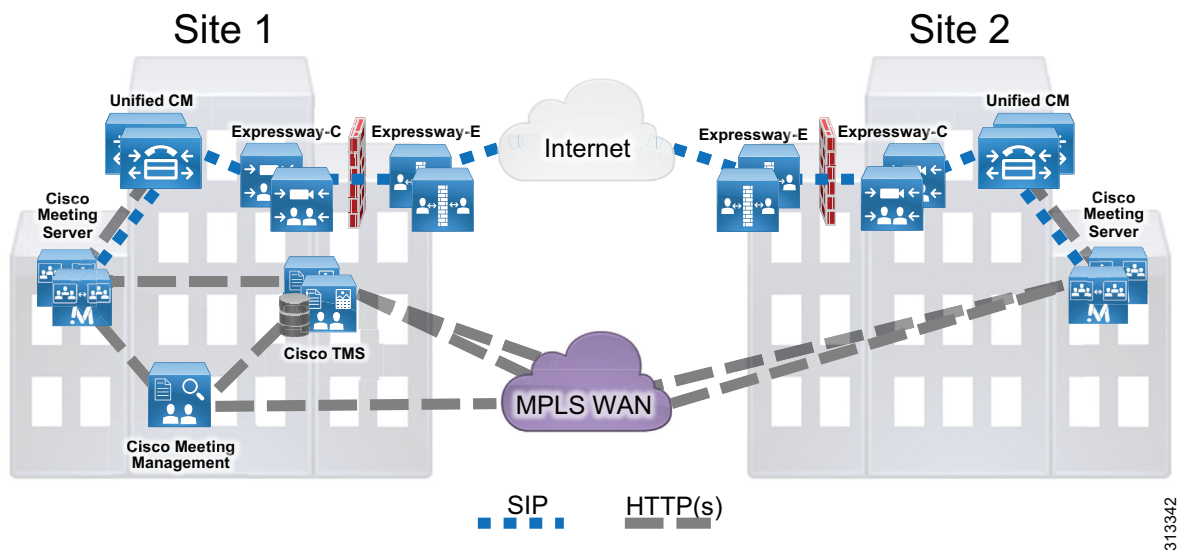

For licensing, use and install multiparty licenses along with other feature licenses onto each Cisco Meeting Server. By default, all users in the system use Shared Multiparty plus (SMP+); and if Personal Multiparty plus (PMP+) is desired, PMP+ should be assigned to users via the Cisco Meeting Server API or by provisioning assignment with Cisco Meeting Management. Additional licenses are required for custom layouts and recording and streaming features.

The scheduling architecture consists of an active and a passive node for both Cisco TMS and TMSXE, which are deployed behind a network load balancer. The active node processes the incoming requests, while the passive node runs in standby mode with its web pages and services locked down and refusing all incoming traffic. For large Cisco TMS deployments (see the [Sizing](#) chapter), Cisco TMS and TMSXE must be installed on separate virtual machines, as indicated in [Figure 3-2](#). TMS servers are installed in the customer data center that also hosts the organization's SQL deployment. All the server nodes function from an external Microsoft SQL database. Additionally, endpoints, Cisco Meeting Server, and Unified CM are involved in a successful scheduled conference. ([Figure 3-2](#))

**Figure 3-2 High-Level View of the Scheduling Architecture**

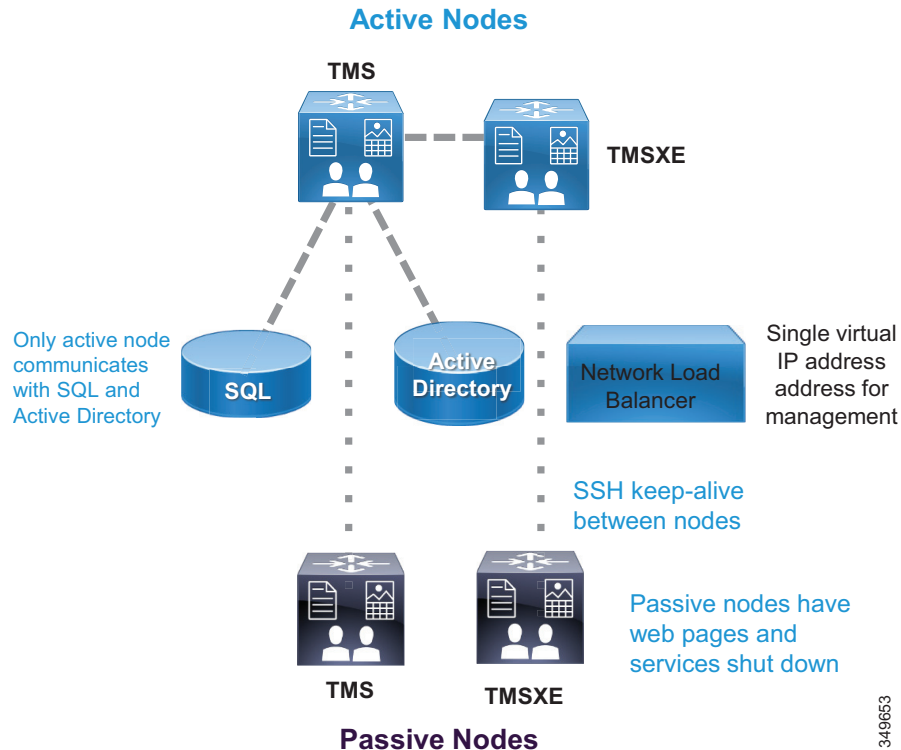

Cisco Meeting Management runs on a separate server outside of Cisco Meeting Server and is dedicated for Cisco Meeting Server deployment only. Cisco Meeting Management users reside in the LDAP directory that it utilizes for user authentication. The users can be assigned as either Cisco Meeting Management Administrators or Operators. LDAP is also leveraged by Cisco Meeting Management to provision Cisco Meeting Server web app users to be able to create their own Spaces using specific templates and permissions. Cisco Meeting Management uses the Event subscription interface and REST API to perform meeting management functions on Cisco Meeting Server. Cisco Meeting Management configures itself as the CDR receiver on Cisco Meeting Server to receive call related events so that it knows when a meeting has started or ended along with other call activities. Cisco Meeting Management uses the TMS Booking API to retrieve information on upcoming scheduled meetings from Cisco TMS. (Figure 3-3)

For compatible versions of Cisco Meeting Server and TMS, refer to the latest version of the *Cisco Meeting Management Installation and Configuration Guide*, available at

<https://www.cisco.com/c/en/us/support/conferencing/meeting-management/products-installation-guides-list.html>



**Note**

Cisco Meeting Management requires no extra license other than properly licensed Cisco Meeting Server instance(s).

Figure 3-3 Cisco Meeting Management Architecture

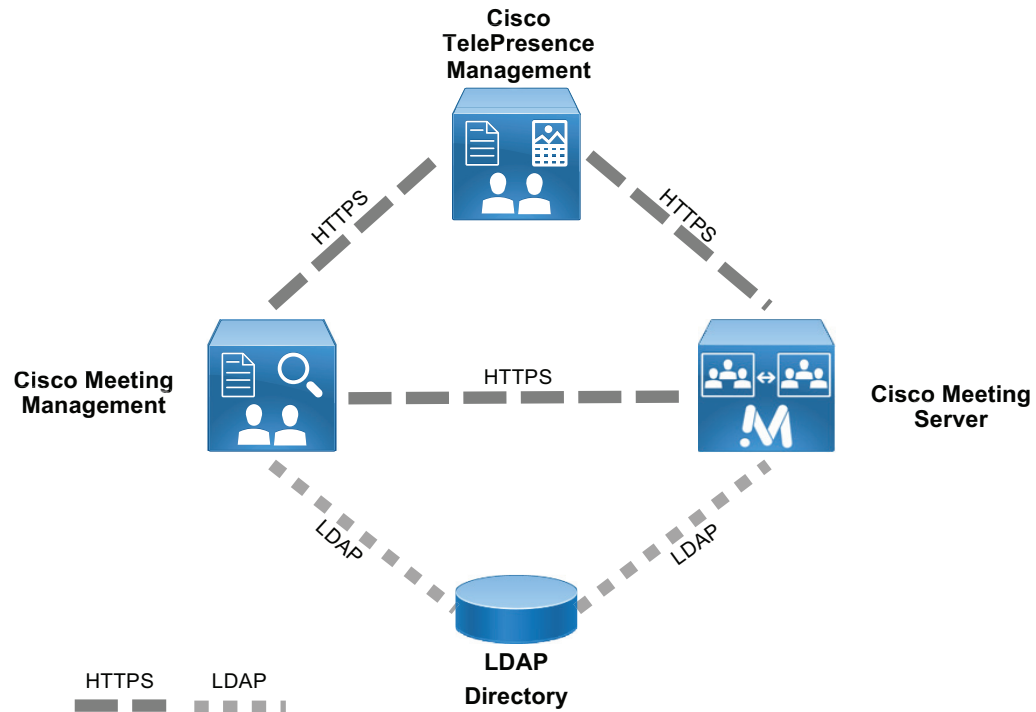

313343

## Role of Cisco Meeting Server

Cisco Meeting Server consists of multiple components that provide video conferencing capability (Figure 3-4) and can handle conferences of all types. The Call Bridge component integrates with Unified CM for call control and provides resources to perform conference functions. All Cisco Meeting Server conferences are hosted on CMS Spaces. Spaces are virtual meeting rooms that have audio, video, and content sharing capability and are accessible using the Space URI or directory number. Cisco Meeting Server must integrate with a directory server such as Microsoft Active Directory to import users into the system. During the import process, spaces will be created using the field mapping expressions configuration. All the information for users and Spaces is stored in the database. Participants can join conferences using Cisco or third-party standard video endpoints, Cisco Jabber client, or the browser-based client named CMS web app. The Web Bridge 3 service connects CMS web app users to the Call Bridge and introduces “Call Bridge to Web Bridge” protocol (C2W) to link Call Bridge and Web Bridge 3.



**Figure 3-4** Components Inside Cisco Meeting Server

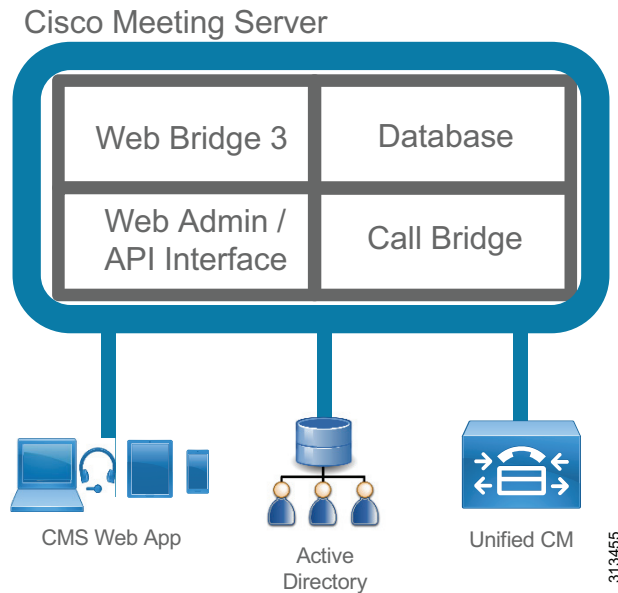

**Note**

Not all Cisco Meeting Server components are shown in [Figure 3-4](#), but only components relevant to the Enterprise Collaboration Preferred Architecture are shown.

CMS web app is a browser-based client that utilizes the WebRTC protocol. With CMS web app, users can log in and join the conference with audio and video along with content sharing. With the CMS web app client, users without an account in Cisco Meeting Server can join the conference as a guest. In addition, users can use CMS web app to run their meetings and perform actions such as view participants, mute and remove participants, start and stop recording, as well as create and edit their own Spaces.

**Note**

CMS web app can be deployed inside or outside of the enterprise network to join a conference, but only deployment inside the enterprise network is covered in this Enterprise Collaboration Preferred Architecture. For deployment outside of the enterprise network, refer to the latest version of the Cisco Meeting Server configuration guides available at <https://www.cisco.com/c/en/us/support/conferencing/meeting-server/products-installation-and-configuration-guides-list.html>.

Using Cisco Meeting Server for conferences has several benefits, including:

- Scaling easily for small or large deployments, allowing capacity to be added incrementally as needed
- Consistent, intuitive, and optimized conference experiences across all device types
- Unrestricted number of participants in a meeting up to the limit of available underlying hardware when using multiparty licensing
- Single deployment model for all conference types
- A secure collaboration platform using industry standard security architecture and protocols

## Role of Cisco TMS

Cisco TMS provides conference scheduling as well as conference room system reservation. Unified CM maintains the configuration control for endpoints, and TMS is then able to push the calendar information to those endpoints. Administrators are able to set the parameters for the default conference for their organization, and then individual conferences will be created according to this template.

Some of the TMS features are not used in the Preferred Architecture – for example, phone books, software management, and reporting functions.

## Role of Cisco TMS Extensions for Microsoft Exchange

When end users schedule a meeting in Microsoft Outlook with multiple conference room resources, the Exchange Web Services (EWS) feature of Exchange synchronizes that event into TMS as a scheduled conference. This synchronization is bidirectional, allowing an administrator or support staff to update meetings as well without the need to access the meeting organizer's Outlook event. All endpoint resources within the organization that are intended to be in the conference must be listed on a single Exchange meeting request.

## Role of Cisco Meeting Management

Cisco Meeting Management and Cisco TMS work together to provide management and scheduling functions for Cisco Meeting Server. Cisco Meeting Management provides white glove service for customers, and allows operators to see active meetings, meetings that have ended (up to 7 days), or upcoming scheduled meetings (within the next 24 hours). Operators can view detailed information about meetings, such as participants, meeting duration, and meeting start time. The view on screen for managing meetings can be filtered by activity or status for viewing the relevant display the operator requires.

For active meetings, operators can perform meeting management functions such as:

- Pane placement
- Move or add participants
- Set layout for meeting
- Mute/unmute participants
- Start or stop recording and streaming
- Mute participants

- End the meeting

For individual participants in a meeting operators can:

- View participants call statistics
- Change SIP participants' layout
- Mute participants audio or video
- Set importance for participant

Users in Cisco Meeting Management belong to one of the user groups, Administrator or Video Operator. Each user group maps to an LDAP group defined inside the directory with users assigned to it. When users log into the portal, Meeting Management authenticates them using the directory and determines their group membership. Administrators have full access to all functions in the Cisco Meeting Management portal. Video Operators only have access to the meeting monitoring and management as well as system status checking functions in the Cisco Meeting Management portal. Local users can also be created for Cisco Meeting Management. Local users can have password policies set as required for security.

## Deployment Overview

The standard deployment uses multiple Unified CM nodes for call control. Cisco Meeting Server connects to Unified CM with SIP trunks to manage conference resources and to bridge calls. (Figure 3-5) Cisco TMS and Cisco Meeting Management provide conference management facilities and scheduling. In addition to meeting management Cisco Meeting Management manages Cisco Meeting Server licensing and license enforcement. The same conferencing infrastructure is used for both non-scheduled and scheduled conferencing. Cisco Expressway provides the firewall traversal capability to enable business-to-business and mobile and remote access (MRA) calling into the local enterprise. These elements together provide voice and video conferencing for the local enterprise.

**Figure 3-5 Standard Deployment**

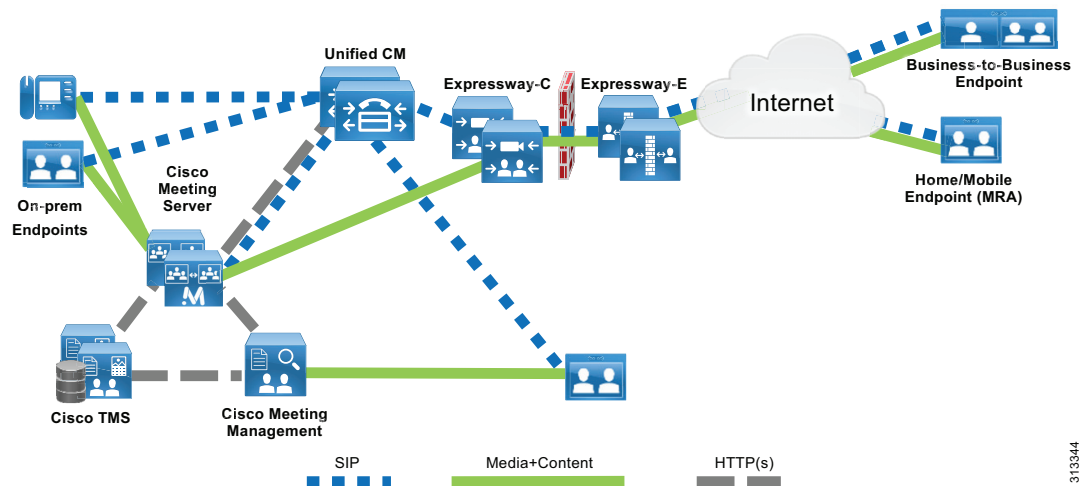

313344

## Requirements and Recommendations

- Early Offer messaging is recommended for all SIP trunks connected to Unified CM that carry TelePresence calls.
- Use a single SIP trunk for all conference types (instant, permanent, and scheduled) with a single Cisco Meeting Server.
- Configure Multiparty Licenses in Cisco Meeting Management to host conferences.
- Acquire required certificates for Cisco Meeting Manager as described in the security chapter of this document.

## Conference Call Flows

Unified CM provides device registration and routing of voice and video calls between the connected endpoints. Permanent, instant, and scheduled conference calls are all routed over a single SIP trunk to the Call Bridge on Cisco Meeting Server. Each Call Bridge requires a separate SIP trunk. An HTTPS connection is configured on the Unified CM node that carries the XML-RPC requests to the Cisco Meeting Server nodes for instant conferences (see [Figure 3-6](#)). When users press the conference softkey on the device to escalate a two-party to three-party call, Unified CM sends an API request to Cisco Meeting Server to create a temporary Space for hosting the conference via this HTTPS connection. Instant, permanent, and scheduled conferences are hosted on Spaces that are created by different components. For more information on Spaces, see [section 6. Deploy Cisco Meeting Server Spaces](#).

**Figure 3-6** Unified CM and Cisco Meeting Server SIP Trunk

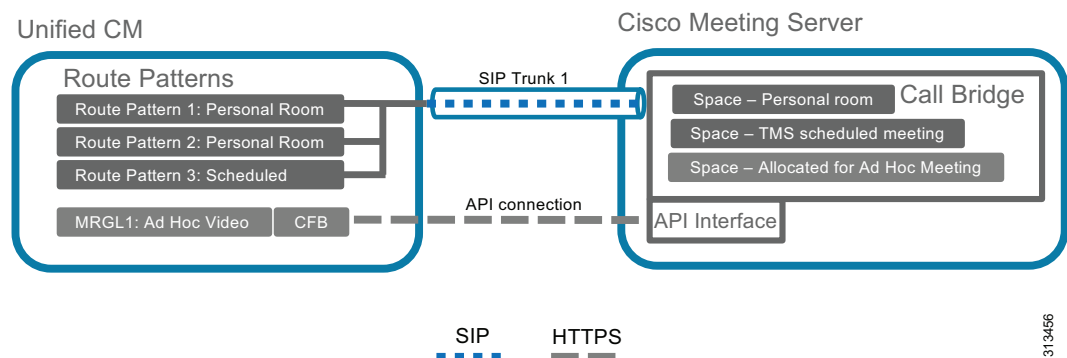

Instant call flows that are managed by Unified CM cannot be used to add participants to conferences created by any other method, such as scheduled conferences. Other call flows cannot be used to add participants to instant conferences. The instant call escalation method is supported only in an instant conference that was created by it, and conferences generated by other methods cannot be extended by the instant mechanism. This avoids any potential for chained conferences.

## Instant Conferences

Instant conferences use an HTTPS XML-RPC connection associated with the SIP trunk between Unified CM and the Call Bridge on Cisco Meeting Server. When a user presses the conference softkey to initiate an instant conference, Unified CM issues an API request through the HTTPS connection to

create a temporary Space on Cisco Meeting Server. Unified CM then routes all the participants to that Space through the SIP trunk. When the conference is done, Unified CM issues another API request to delete that Space from Cisco Meeting Server.

**Figure 3-7** Instant Conference Call Flow

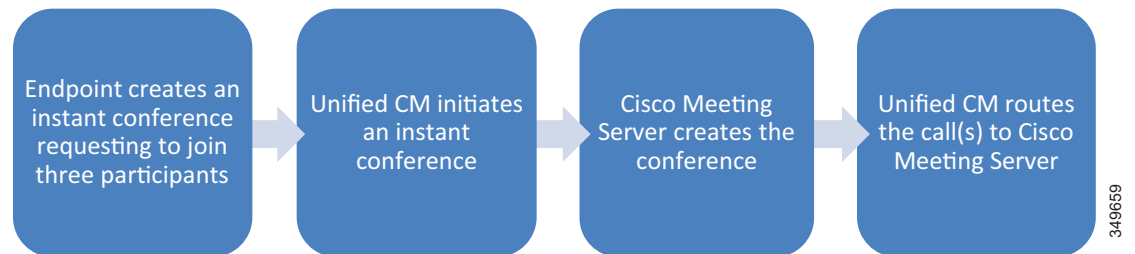

## Permanent Conferences with Cisco Meeting Server Spaces

Permanent conferences are deployed using Cisco Meeting Server spaces. Spaces provide a permanent-type conference and are created as part of the users import process from LDAP either using the Application Programming Interface (API) or Cisco Meeting Management provisioning feature. Users can dial the Space URI at any time to start a meeting. Administrators can specify the Space's attributes (for example: name, username, URIs, and so forth) through the field mappings so that the Spaces can be created using those mappings. Users can then log in using CMS web app client and manage their own Spaces. Connect a SIP trunk between Unified CM and the Call Bridge on Cisco Meeting Server for this conference type. The same SIP trunk is used for other conference types to route conference participants to the Space.

**Figure 3-8** Permanent or Scheduled Conference Call Flow

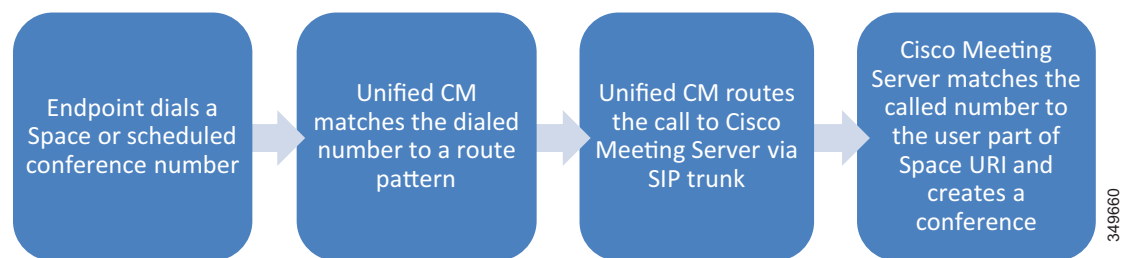

## Scheduled Conferences

This solution supports scheduling of conferences on Cisco Meeting Server, and scheduling is performed with Cisco TMS. Scheduled conferences require a SIP trunk between Unified CM and the Call Bridge on Cisco Meeting Server. Again the same SIP trunk is used as with other conference types, and Unified CM routes the scheduled conference participants to the destination of the SIP trunk. Add Cisco Meeting Server to Cisco TMS to allow for issuing REST API requests on Cisco Meeting Server through the HTTPS connection. After configuring a range of numeric IDs for scheduled conferences, Cisco TMS creates an inactive Space on Cisco Meeting Server for each numeric ID via the API link. Cisco TMS will

then randomly chooses a dial-in number from the range when an organizer schedules a meeting. When it is time to start the scheduled meeting, Cisco TMS activates the Space using the API, and participants can start calling in.

## Third-Party Endpoints

Endpoints from other equipment providers can participate in any conferences using standard SIP. Only endpoints registered to Unified CM that support the conference button can initiate an instant conference. Cisco Expressway or Cisco VCS can be used to interwork H.323 calls to SIP, allowing H.323 endpoints to join conferences.

## High Availability for Conferencing

High availability must be considered at several levels with the conferencing solution and is achieved in different ways depending on the service being considered.

For both scheduled and non-scheduled conferences, high availability involves Cisco Unified CM, Cisco Meeting Server, and Cisco TMS.

## Cisco Meeting Server High Availability

Deploying additional instances of services on one or more servers can provide resiliency for Cisco Meeting Server so that the component instances can share the load, and if one of them fails, the backup instance picks up the load. In addition, Call Bridges and databases can be clustered together to operate as a single instance and Web Bridge 3 instances can be deployed for redundancy. See [Figure 3-9](#).

**Figure 3-9** Minimum Components Required for Cisco Meeting Server Cluster with High Availability

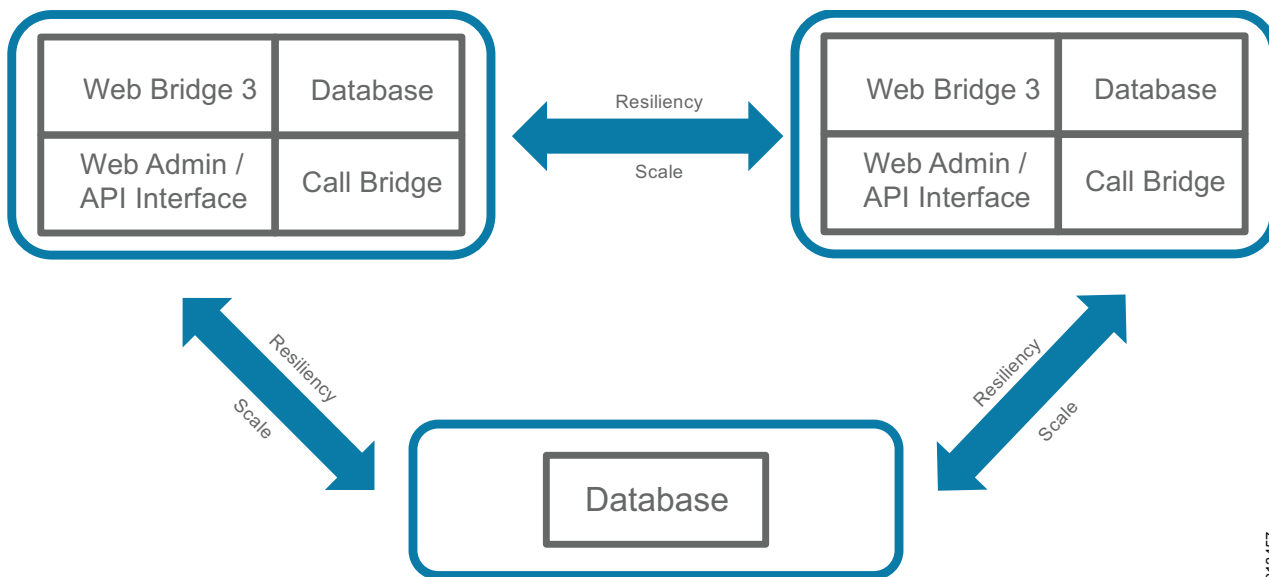

313457

Services like Call Bridges and databases can be clustered together to operate as a single instance. Services like a recorder, streamer or Web Bridge 3 have not notion of clustering however, increasing the number of these services across multiple servers will increase the overall capacity of these services. Services like a recorder, streamer or Web Bridge 3 must be configured to work with a specific Call Bridge or Call Bridge group. These services do not interact with non-configured Call Bridges or Call Bridge groups even if they are in the same cluster.

A standard Cisco Meeting Server cluster consists of two or more (up to 24) nodes with Call Bridge service enabled. The maximum round trip time (RTT) between Call Bridges is 300 ms. Call Bridge cluster peers are connected to each other in full mesh via the distribution link. This link is an HTTPS connection used for passing call signaling and control status messages between Call Bridges. Calls can be sent to any Call Bridges in the cluster. If one Call Bridge goes down, Unified CM can route calls to the remaining Call Bridges to join the conferences. In the event that a Call Bridge fails during a live conference, those calls will be dropped and participants will need to dial the same number to join the conference on a new Call Bridge. Using the Unified CM route group and route list construct, calls can be distributed through the SIP trunks to Cisco Meeting Server.

Call Bridges that are configured as a cluster can be put into one or more Call Bridge groups. For Call Bridges within the group, Cisco Meeting Server can intelligently load-balance calls across them and send calls for the same conference to the same Call Bridge whenever possible. When a call is sent to a Call Bridge, Cisco Meeting Server decides to reject or accept the call based on the current load in the Call Bridge. If the current load is less than the preset threshold, the call will be accepted. Otherwise, the call will be rejected and Unified CM will reroute the call to another Call Bridge in the Call Bridge group using the dial plan configuration. If Unified CM cannot find any Call Bridge that accepts the call, the whole call will be rejected. After a Cisco Meeting Server accepts the call, the call could be hosted on the Call Bridge of this Cisco Meeting Server or moved to another Call Bridge with highest priority according to an internal ordered list for the conference. When the call is moved, the target Cisco Meeting Server with the Call Bridge enabled sends an INVITE with Replaces to Unified CM to take over the call. By default, a Call Bridge in a Call Bridge group will reject all calls for new participants at 80% load, and only new distribution calls will be allowed. For network requirements between Call Bridges, RTT should be 100 ms or less between Call Bridges inside the group and 300 ms or less between any two Call Bridges in the same cluster. Call Bridge groups are supported with both Unified CM as well as Cisco Expressway using the same load balancing logic. [Table 3-3](#) shows the maximum RTT allowed between the service components.

**Table 3-3** Maximum RTT Allowed Between Cisco Meeting Server (CMS) Service Components

Maximum RTT Allowed Between CMS Components	CMS Components
300ms	Any 2 Call Bridge nodes in a cluster
200ms	Call Bridges and database instance
100ms	Call Bridges within the same Call Bridge group



**Note**

If Call Bridge groups and load balancing are not used, then calls will not be rejected, but the quality of all calls will be reduced when the load limit is reached. If this happens often, we recommend deploying additional hardware. A review by Cisco engineering is required in designs that require eight or more servers. To engage engineering email them at [personalmultiparty@cisco.com](mailto:personalmultiparty@cisco.com).

**Note**

For more information on load balancing calls across meeting servers see Cisco Meeting Server 3.2, White Paper on Load Balancing Calls Across Cisco Meeting Servers located here: <https://www.cisco.com/c/en/us/support/conferencing/meeting-server/products-installation-and-configuration-guides-list.html>

The database cluster consists of one master and multiple replicas, up to a maximum of 5 nodes with maximum RTT of 200 ms between databases. The database master can perform both read and write operations, while replicas can only have read access. Call Bridges always connect to the database master for read and write, and all changes made on the master are replicated to the replicas. Call Bridges with a local database automatically connect to the master of the local database cluster, while Call Bridges with no local database have to be connected manually to the database cluster. If the master fails, one of the replicas will become the new master, and other replicas will re-register with this new master. After correcting the failure, the old master will become the replica and register with the new master. In cases where a network partition occurs, only database nodes that can see more than half of the cluster members are considered for promotion to become a master. Likewise, any existing master that cannot see more than half of the cluster members will be demoted to a replica. This ensures that multiple masters are not created. So, if a database cluster consists of an even number (2 or 4) of nodes and the network is partitioned into 2 segments with an equal number of nodes are on each side, the master on one side will be demoted to a replica since it cannot see more than half of the cluster members. In that case, there will be no master in the cluster, and the Call Bridges can still take calls but no database write operations are possible. For this reason, we recommend having an odd number of nodes in the database cluster to ensure that a master is always elected. As a result, the minimum number of database nodes in a cluster is 3.

**Web Bridge 3**

Call Bridge clusters provide failover protection for a CMS web app client by having more than one Web Bridge 3 instance added. All nodes in a Call Bridge cluster should be able to reach out to a C2W instance for the web bridge3 service to be available for authenticated users and guests. If a Call Bridge cannot establish a TLS connection to the C2W the web bridge3 service shows up as unavailable.

Web bridge3 instances are not aware of the existence/location of the other Web bridge3 instances. The web bridge3 services can be reached by the CMS web app clients via a single DNS A record. To instruct Call Bridges on how to reach the Web Bridge 3, a Web Bridge 3 object is created and a `c2w://url` is specified. The `c2w://url` must have a unique hostname/A record to reach each Web Bridge 3 at the interface where the C2W is listening, in this way each Web Bridge 3 can identify the unique specific Call Bridge connection and peer id.

Every Call Bridge in the cluster will continuously communicate with every Web Bridge 3 via C2W interface, unless Call Bridge groups are configured. In Call Bridge groups every Call Bridge will communicate with the Web Bridge 3 instance assigned to the group.

When a guest or authenticated user joins the Web Bridge 3, one of the Call Bridges that are alive connecting via C2W interface will be selected. Call Bridge will reach `c2w://url` and it will validate that the A record of the URL is present in the as a Subject Alternative Name or Common Name in the certificate presented by the C2W instance. If the validation fails Call Bridge web user interface will show a TLS negotiation error towards the `c2w://url`. Web Bridge 3 also validates that the certificate presented by the Call Bridge is trusted by the C2W trust store.

Figure 3-10 illustrates the application flow of Web Bridge 3 at a high level.



**Figure 3-10 Web Bridge 3: High level application flow**

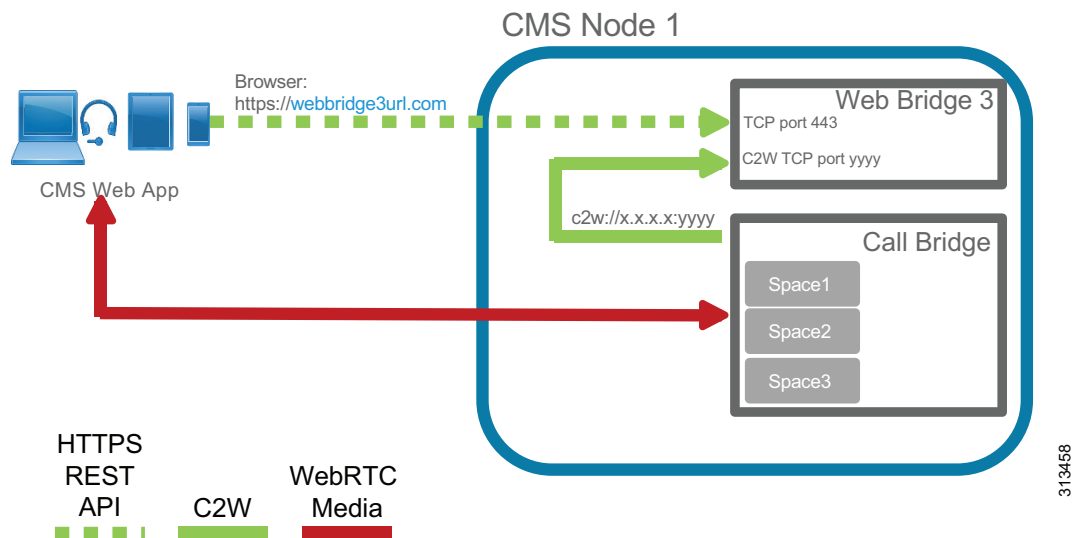

Referring back to [Figure 3-9](#) illustrating the minimum components required for CMS with high-availability. Enable at least 2 instances of each component service (Web Bridge 3 and Call Bridge) in separate servers, and put the Call Bridges into a group. There is no need to activate all services inside each server; activate only the ones that are required. If the deployment requires more capacity than the 2 Call Bridges can handle, additional Call Bridge can be set up in the third server (no need to acquire a fourth server for just the Call Bridge). [Table 3-4](#) lists the minimum Cisco Meeting Server cluster configuration required for various numbers of Call Bridges for a single Unified CM cluster.

**Table 3-4** Minimum Cisco Meeting Server Cluster Configuration for Various Numbers of Call Bridges for a Single Unified CM Cluster

Call Bridge Group	Number of Call Bridges	Cisco Meeting Server Cluster Configuration
A	2	Node A1: Web Bridge 3, Call Bridge, Database Node A2: Web Bridge3, Call Bridge, Database Node A3: XMPP, Database
	3	Node A1: Web Bridge 3, Call Bridge, Database Node A2: Web Bridge 3, Call Bridge, Database Node A3: Call Bridge, Database, XMPP
	4	Node A1: Web Bridge 3, Call Bridge, Database Node A2: Web Bridge 3, Call Bridge, Database Node A3: Call Bridge, Database Node A4: Call Bridge
	5	Node A1: Web Bridge 3, Call Bridge, Database Node A2: Web Bridge 3, Call Bridge, Database Node A3: Call Bridge, Database Node A4: Call Bridge Node A5: Call Bridge

## TMS High Availability

High availability of a large Cisco TMS deployment includes: Two TMS front-end servers, two servers running TMSXE, a network load balancer, and an external Microsoft SQL database (see [Figure 3-2](#)). TMS resiliency supports only two servers – one active node and one passive node – and this model does not increase or decrease the capacity of the TMS deployment. The network load balancer (NLB) is deployed in front of the TMS servers. Inbound traffic to TMS goes through the NLB, which forwards it to the active node. Outbound traffic from TMS is sent directly to the destination without going through the NLB. If the NLB detects a failure on the existing active node, it automatically switches to the new active node without any user intervention.

## Cisco Meeting Management High Availability

Cisco Meeting Management does not have the built-in cluster function for resiliency. For high availability, customers can configure two Cisco Meeting Management instances to manage the same Cisco Meeting Server deployment. Each Cisco Meeting Management instance is configured independently and gets data from the connected Cisco Meeting Servers and Cisco TMS. No information is exchanged between the Cisco Meeting Management instances, nor is there failover when a server fails, as such there is no benefit to deploying a load balancer. Cisco Meeting Management users are directed to the address of the appropriate Cisco Meeting Management instance to manage conferences. In the event of a failure with the Cisco Management in use, users are asked to sign in to the other Cisco Meeting Management server while corrective action is taken to resolve issue with original Cisco Meeting Management.

## Security for Conferencing

The Preferred Architecture fully supports media and signaling encryption; but for simplicity, the solution presented in this document implements non-secure SIP trunks between Unified CM and Cisco Meeting Server for all conferences. An exception to this is the solution requirement that API communications between unified CM and the Cisco Meeting Server must be encrypted.

Cisco Meeting Server uses secure connections to communicate with external components as well as between internal components, and certificates are required. Use certificate authority (CA) signed certificates to secure the connections between components. Refer to the [Security](#) chapter for further detail.

Another level of security can be added to restrict access to the conferences themselves with PINs or passwords. Any scheduled conference or permanent conference can have a PIN set so that all participants are challenged to enter the PIN before being allowed to connect.

## Scaling the Conferencing Solution

You can scale the conferencing solution primarily by adding more Call Bridges (up to 24) to a standard Cisco Meeting Server cluster.

In this deployment, based on the dial plan and route group and route list configuration with the SIP trunks in Unified CM, calls can be routed to any Call Bridge within the cluster. If calls for the same conference are routed to different Call Bridges, the audio and video of the last 4 active speakers are exchanged between Call Bridges for participants on one bridge to see the active speakers on the other bridge.

**Note**

Cisco Meeting Server supports clustering with more than 8 Call Bridges, but deployment requires prior approval by Cisco. Contact your local Cisco account team for details.

Each Call Bridge can support 450 participants. Thus, the maximum number of participants per conference is 450 with a single server, and up to 2,600 participants across multiple servers in a single cluster.

## Considerations for Multiple Unified CM Clusters

For large-scale deployments with multiple Unified CM clusters, use a single Cisco Meeting Server cluster configured with multiple Call Bridge groups, and dedicate one group to each Unified CM cluster.

For example, if your deployment has three Unified CM clusters, then you should deploy a single Cisco Meeting Server cluster with three Call Bridge groups, one in each Unified CM cluster. Each Unified CM cluster should have a SIP trunk to each Call Bridge in its local Call Bridge group. All incoming conference calls to a Unified CM cluster will be handled by the local Call Bridge group. Call Bridges should have their distribution links connected to their peers inside and outside of the groups in full mesh. For the same conference, users can dial in from their Unified CM cluster to reach the local Call Bridge group, and the Call Bridges in different groups will exchange the audio and video of the last 4 active speakers with their peers so that participants can see each other across the bridges. ([Figure 3-11](#))

Figure 3-11 Cisco Meeting Server Deployment with Multiple Unified CM Clusters

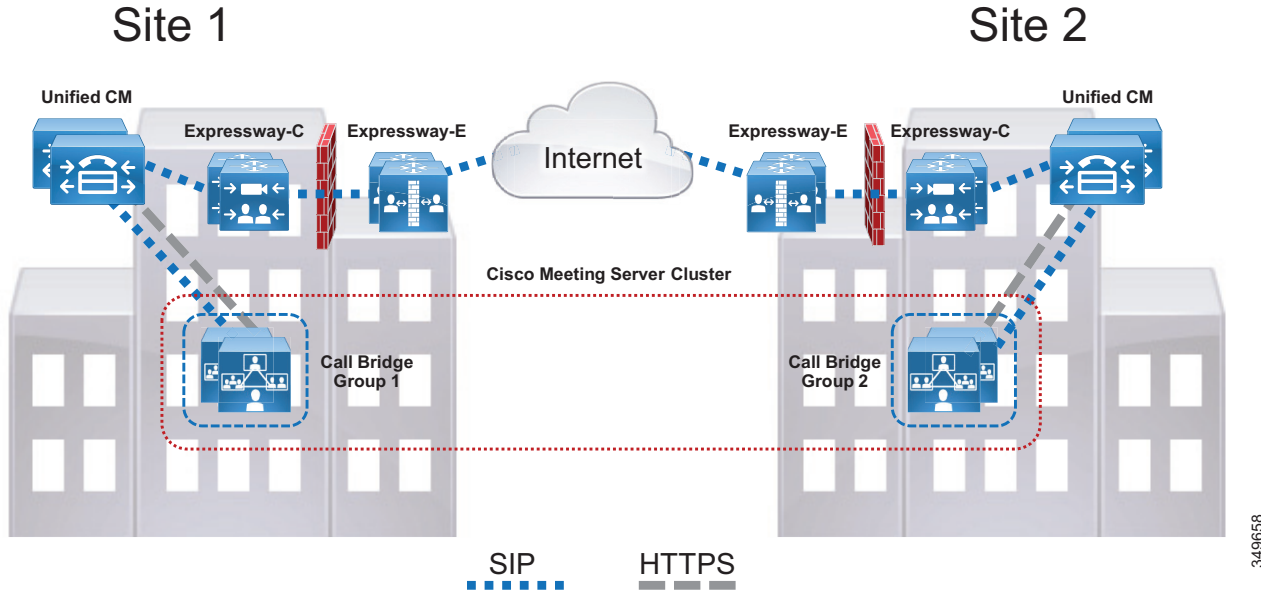

For the first Unified CM cluster, refer to the section on [Cisco Meeting Server High Availability](#) and [Table 3-4](#) for the design.

For the second Unified CM cluster, expand the Cisco Meeting Server cluster to add 2 extra servers. In each of the servers, enable the web bridge and Call Bridge. No extra database are required for this Unified CM cluster. Connect the Call Bridges to the existing database cluster. Put the Call Bridges into a new Call Bridge group that is used by this second Unified CM cluster, and associate the web bridges with this Call Bridge group. If additional capacity is desired, add an extra server to host a Call Bridge, and put that Call Bridge into the Call Bridge group for this second Unified CM cluster. [Table 3-5](#) illustrates the additional Cisco Meeting Server cluster configuration required for the second Unified CM cluster, based upon the number of additional Call Bridges required.

**Table 3-5** Additional Cisco Meeting Server Node Configuration for the Second Unified CM Cluster

Call Bridge Group	Number of Additional Call Bridges	Additional Cisco Meeting Server Node Configuration
B	2	Node B1: Web Bridge 3, Call Bridge Node B2: Web Bridge 3, Call Bridge
	3	Node B1: Web Bridge 3, Call Bridge Node B2: Web Bridge 3, Call Bridge Node B3: Call Bridge
	4	Node B1: Web Bridge 3, Call Bridge Node B2: Web Bridge 3, Call Bridge Node B3: Call Bridge Node B4: Call Bridge

For the third Unified CM cluster, expand the Cisco Meeting Server cluster to have 2 extra servers. In each of the servers, enable the Web Bridge 3 and Call Bridge. Connect the Call Bridges to the existing database cluster, and add all additional Call Bridges. Put the Call Bridges into a new Call Bridge group that is used by this third Unified CM cluster, and associate the web bridges with this Call Bridge group. If additional capacity is desired, add an extra server to host a Call Bridge, and put that Call Bridge into the Call Bridge group for this third Unified CM cluster. [Table 3-6](#) illustrates the additional Cisco Meeting Server node configuration required for the third Unified CM cluster, based upon the number of additional Call Bridges required.

**Table 3-6 Additional Cisco Meeting Server Node Configuration for the Third Unified CM Cluster**

Call Bridge Group	Number of Additional Call Bridges	Additional Cisco Meeting Server Node Configuration
C	2	Node C1: Web Bridge 3, Call Bridge Node C2: Web Bridge 3, Call Bridge
	3	Node C1: Web Bridge 3, Call Bridge Node C2: Web Bridge 3, Call Bridge Node C3: Call Bridge
	4	Node C1: Web Bridge 3, Call Bridge Node C2: Web Bridge 3, Call Bridge Node C3: Call Bridge Node C4: Call Bridge

With three Unified CM clusters and thus three separate Call Bridge groups, the database cluster nodes local to the first Call Bridge group can be distributed among the Call Bridge groups so that each Call Bridge group would have a local XMPP and database cluster node. By migrating two database cluster nodes local to the first Call Bridge group to the second and third Call Bridge groups, respectively, this creates redundancy for the database services across each Call Bridge group. [Table 3-7](#) illustrates this new Cisco Meeting Server cluster configuration.

**Table 3-7 Migrating XMPP and Database Services to Second and Third Call Bridge Group**

Call Bridge Group	Cisco Meeting Server Cluster Configuration
A (Unified CM Cluster 1)	Node A1: Web Bridge 3, Call Bridge, Database Node A2: Web Bridge 3, Call Bridge
B (Unified CM Cluster 2)	Node B1: Web Bridge 3, Call Bridge, Database Node B2: Web Bridge 3, Call Bridge
C (Unified CM Cluster 3)	Node C1: Web Bridge 3, Call Bridge, Database Node C2: Web Bridge 3, Call Bridge

If the deployment requires a fourth Unified CM cluster, we recommend moving to a Cisco Unified CM Session Management Edition design, which is out of the scope for this document.

The following guidelines apply when expanding the Cisco Meeting Server cluster into different regions for multiple Unified CM clusters:

- A single Cisco Meeting Server cluster should be used for deployment of one or more Unified CM clusters.
- You may deploy up to 8 Call Bridges for the standard Cisco Meeting Server cluster. If the cluster exceeds 8 Call Bridges, acquire Cisco account team approval before deployment.
- Deploy a maximum of 5 databases and an odd number of nodes in the Cisco Meeting Server cluster.
- Round-trip-time (RTT) network requirements:
  - Maximum of 300 ms between Call Bridges and 200 ms between databases in the Cisco Meeting Server cluster
  - Maximum of 100 ms between Call Bridges inside the group

## Conferencing Deployment Process

To deploy the conferencing solution, perform the following major tasks in the order listed here:

1. Plan the Conferencing Deployment
2. Deploy Cisco Meeting Servers
3. Enable Unified CM for Conferences
5. Deploy Cisco TelePresence Management Suite
6. Deploy Cisco Meeting Server Spaces
7. Deploy Cisco Meeting Management

### 1. Plan the Conferencing Deployment

Before deploying the conferencing solution, plan for the following aspects:

#### Requirements

- Configure DNS for Cisco Meeting Server, which needs a number of DNS SRV and A records. For example, Cisco Meeting App uses the `_xmpp-client` SRV record to look up the XMPP service for user authentication.
- Cisco Meeting Server requires the use of an API client to complete the deployment. Acquire a tool that can be used to issue REST API commands for an update; for example, Postman (<https://www.getpostman.com/>) or use the API navigator within CMS web user interface under Configuration > API.
- Refer to the [Security](#) chapter of this document for certificate requirements. Information for these requirements can also be found at <https://www.cisco.com/c/en/us/support/conferencing/meeting-server/products-installation-and-configuration-guides-list.html>

## Licensing

Licenses must be installed on various products:

- Cisco TMS must have enough device licenses installed for the deployment.
- Cisco Meeting Server must have enough Multiparty licenses installed on each node running the Call Bridge or enough Multiparty licenses available in the smart account if using Smart Licensing option with Cisco Meeting Management.
- Cisco Meeting Server optional features require an additional license. These features are:
  - Custom Layouts
  - Recording and streaming

Cisco Meeting Management is required with Cisco Meeting Server for license reporting and integration with Cisco Smart Licensing for license management.

Multiparty is a user-based licensing model recommended for Cisco Meeting Server deployment, and it should be applied to every node with Call Bridge service enabled. It comes with two variations: Personal and Shared. Personal Multiparty Plus (PMP+) is for specific named hosts while Shared Multiparty Plus (SMP+) is for conference room systems or for sharing between users. Each license entitles a user to host a conference with unlimited participants and up to 1080p video resolution. [Table 3-8](#) summarizes the features included in the Personal and Shared Multiparty licenses.

**Table 3-8** *Multiparty Plus License Options*

Personal Multiparty Plus	Shared Multiparty Plus	Enterprise License Agreement
Named Host license	Shared Host license	
Cluster wide licensing for meetings	Cluster wide licensing for meetings	Cluster wide licensing company-wide
		Conferencing portfolio company-wide
Jabber for CMS and CMS web app	Jabber for CMS and CMS web app	Jabber for CMS and CMS web app
Expressway RMS licenses	Expressway RMS licenses	Expressway RMS licenses
Add CMS recording/streaming	Add CMS recording/streaming	Add CMS recording/streaming
Add Calling Flex for UCM ad-hoc	Add Calling Flex for UCM ad-hoc	Add Calling Flex for UCM ad-hoc
MSFT Skype/Lync interoperability	MSFT Skype/Lync interoperability	MSFT Skype/Lync interoperability
		SMP included as needed
Subscription licensing		
Personal and scheduled meetings for all users, unrestricted meeting size, floating licenses		

Multiparty licensing is the license model used in the Preferred Architecture.

## Cisco TelePresence Management Suite

Before beginning the installation and configuration process, you must decide on several items to align with the specific structure and preferences of your organization. Some specific settings must be used during the configuration process and should be gathered prior to beginning the install process.

### Microsoft SQL

Cisco TMS utilizes an external Microsoft SQL database to store all data regarding meetings, users, and systems. During the installation process, TMS and associated software extensions create a number of specific databases. The TMS application does not allow users to log into the web page if communication is not currently active with the tmsng database. This dependency on constant communication with the SQL database requires the SQL database to utilize Microsoft's methods for making the database resilient as well. The databases will vary in size depending upon the deployment size and number of scheduling events; but as a general guideline, 1 GB of initial storage will suffice for most organizations.

Table 3-9 lists the Microsoft SQL specifics required to support Cisco TMS.

**Table 3-9** *Microsoft SQL Specifics Required to Support Cisco TMS*

Requirement	Parameter
SQL user account permissions for account used by TMS	<b>dbcreator</b> and <b>security admin</b> roles
Authentication	SQL Server and Windows authentication (mixed mode)
Default language	English
Time zone	Must match the time zone on TMS server
Databases created	tmsng (CiscoTMS)
Resiliency model	<b>AlwaysOn Failover Cluster</b> instances through Windows Server Failover Clusters (WSFC)



**Note**

While other modes of SQL resiliency are supported by TMS, any method besides **AlwaysOn Failover Cluster** requires manual adjustments by the TMS administrator during an SQL outage situation.

### Active Directory

Cisco TMS integrates with many aspects of Microsoft Active Directory, and the server must be added to the organization's domain,. All TMS users must be imported from and authenticated with Active Directory.

During the configuration process, you must enter an **AD Service account username and password** for TMS to import users. This is a read-only account, and TMS does not modify any information in Active Directory. This account should have access to the highest level of the AD structure that enables all subsequent end users to access its functionality. In organizations with multiple domains, the TMS user account must be associated with the top level domain. An additional service account is required for the TMSXE application for end-user booking of Exchange resources. This should also be a read-only service



account, and end user credentials are used for the actual event booking. TMSXE user account permits only the TMSXE application to authenticate and communicate with the Exchange Servers through Exchange Web Services.

Additionally, identify existing, or create new, Groups with AD that will serve to synchronize TMS administrators and end users with scheduling access to TMS.

**Note**

---

Local machine accounts on the TMS server should not be used because they are not duplicated between front-end servers, and the user credentials would not be available if the other node became active.

---

## Email Integration

TMS sends automated emails to users when they schedule meetings, with all connection information included for the participants. During the installation process, you must enter the "from" address that end users will see as the originating for these emails, so select an address such as collabconferencing@ent-pa.com or a similar address not currently used in your organization.

You will also need to enter the SMTP address of the outgoing mail server.

## Endpoint Naming Conventions

Endpoints are added to Cisco TMS for two reasons:

- Correlation with Exchange resources for conference resource allocation
- Enabling TMS to provide One Button to Push connection information on the endpoint user interface

As endpoints are added to TMS, use the same character string as the room or resource name in Exchange. This provides uniformity and consistency to end users when system names appear in the call history and fill the text of on-screen labels from conferencing resources.

An organized plan for how to use the folder structure of TMS Systems Navigator will also assist the administrator in having a simplified interface.

## Default Conference Parameters for Your Organization

These settings are customizable for each organization and should be used in accordance with your own network considerations, meeting flows, and corporate culture. The default conference settings are used for all meetings scheduled by end users through Outlook. For all possible settings of the default conference, refer to the latest version of the *Cisco TelePresence Management Suite Administrator Guide*, available at

<https://www.cisco.com/c/en/us/support/conferencing/telepresence-management-suite-tms/products-maintenance-guides-list.html>

## Cisco Meeting Server Space Provisioning

An understanding of how the organization plans to utilize Cisco Meeting Server Spaces requires an understanding of the workflow that end users expect for meetings. Some organizations may choose to leverage the Spaces instead of scheduled resources for certain meeting types, especially in cases where workers are in separate locations and not able to gather in a common conference room.

## Location of Servers

Both the active and passive nodes for a redundant TMS deployment must be configured with the same time zone within the server operating system. In addition, this must be the same time zone as the SQL server. Support of TMS redundancy is limited to the same local network for both the active and passive nodes, along with the SQL server.

## 2. Deploy Cisco Meeting Servers

This section describes the major tasks required to deploy Cisco Meeting Servers and prepare them for use with scheduled and non-scheduled conferences.

### Overview

#### Deployment Tasks for Cisco Meeting Servers:

1. Install the Cisco Meeting Server feature license keys.
2. Generate enterprise CA signed certificates.
3. Configure the Web Admin, Call Bridge, and Web Bridge 3 services.
4. Set up an additional node for redundancy and configure clustering for database, and Call Bridge.
5. Set up the outbound dial plan to send calls to the Call Bridge cluster peer for distributed conferences.
6. Set up the outbound dial plan rules to forward calls to the call control.
7. Set up the incoming rules to match and accept incoming calls to CMS spaces.
8. Create a Call Bridge group and add all Call Bridges to it for the Unified CM cluster.
9. Update the call settings parameters.

### Deployment Considerations

The physical location of a Cisco Meeting Server is important to consider because media traffic flows between it and each participant in the conference. To provide the best experience for participants, centralize the location of the Cisco Meeting Server with Call Bridges and put them into a group for each regional Unified CM cluster.

If the deployment includes CMS Web app or a Web Bridge 3 avoid using the parent domain (for example, ent-pa.com) as the user domain video domain because other components such as Cisco Unified CM IM and Presence Service might have already used it, which could complicate the overall design. We recommend using a sub-domain such as cms.ent-pa.com to create a concise dial plan.

Deploy a 3-node cluster for database; this should cover a majority of deployment scenarios to provide resiliency and high availability.

Create a DNS A record using the same name (for example, join.ent-pa.com) to point to each Web Bridge 3 so it is easy for participants to remember the web bridge URL (from example, https://join.ent-pa.com) used to join the conference and could load balance the CMS Web app connections using a load balancing method.

## Deployment Tasks for Cisco Meeting Servers

Cisco Meeting Server cannot take calls without a Call Bridge license. The Call Bridge, multiparty license along with other feature licenses are managed by Cisco Meeting Management and is described in the Cisco Meeting Management section of this chapter.

Go to the [Cisco Meeting Server](#) section of the [Security](#) chapter for details on how to generate the enterprise CA signed certificates. This will generate 2 certificates; one certificate that is shared for web admin, Call Bridge, Web Bridge 3, and database cluster and the database client certificate which is used for database cluster internal communication.

### Web Bridge 3 (skip if this is not a Call Bridge node):

For web admin, use the Mainboard Management Processor (MMP) commands to specify the listening interface and port, install the shared CA signed certificate, and enable the service. This allows the administrator to access the Web interface using the specified listening interface and port. By default, both web admin and web bridge use TCP port 443. If they both use TCP port 443, then they need to use different network interfaces. However, if the same interface is used, one of the services must have a different default port. In that case, we recommend changing the web admin default port to some other used port (for example, TCP port 444).

For the Call Bridge, use MMP commands to specify the listening interface, install the shared CA signed certificate, and restart the service.

### Steps to configure the Web Bridge 3 (skip if this is not a Call Bridge node):

1. For Web Bridge 3, use MMP commands to specify the listening interface, commands uses are found in the [Security](#) chapter.
2. Install the full chain certificate which is in the shared certificate and the complete trust chain. The entity must be on the top, then the intermediate chains if applicable and end with the root CA chain.
3. Specify the C2W port, it should be a TCP port different than the Web Bridge 3 listening port and web admin listening port if it is running on the same server.
4. Configure the shared certificate and the complete trust chain that C2W will send to the Call Bridge.
5. Configure the Root Certificate Authority chain in the C2W trust store to validate Call Bridge certificate.
6. Create a Web Bridge 3 object in Cisco Meeting Server to configure the c2w url.
7. Navigate to the web admin interface of the Cisco Meeting Server and navigate to Configuration > API. Use the filter field to find object “/api/v1/webBridges” and expand the list.
8. Click on “create new” and enter the c2w “url: c2w://us-cms-1.ent-pa.com:9999” and click on “create”.
9. The web bridge 3 connects to the call bridge after accepting the connection from the CMS Web app client, and therefore it needs to trust the certificate from call bridge.

### Repeat the steps above for every node in the cluster hosting a Web Bridge 3 instance

### Set up the database cluster

On each database node, use the MMP commands to specify the network interface used by the database, and install the shared CA signed certificate. Select one node as the master and run the MMP command to initialize the database. Go to each database replica node, and run the MMP command to join the database with the cluster. On all nodes that have the Call Bridge without a local database, install the

second certificate and run the MMP command to connect to the cluster. Ensure that the command execution status is successful before moving on to the next command. This completes the database cluster setup.



**Warning**

**Data in the replica database will be overwritten by the master after the replica joins the cluster.**

**Setup the Call Bridge cluster.**

On each Call Bridge node, go to the web interface (**Configuration -> Cluster**) and configure a Unique name (for example, callbridge1) under **Call Bridge identity** for the Call Bridge. After that, go back to the cluster configuration (**Configuration -> Cluster**) on one of the Call Bridge nodes, fill in the Clustered Call Bridges with the information for all Call Bridges, using the sample in [Table 3-10](#), and leave other fields blank or as default:

**Table 3-10 Clustered Call Bridges Configuration Example**

Unique Name	Address	Comment
callbridge1	https://10.x.x.60:444	Address column is the URL and port number used to access the web interface
callbridge2	https://10.x.x.61:444	
callbridge3	https://10.x.x.62:444	

The Clustered Call Bridges configuration will appear in all Call Bridge nodes from the web interface. These are the distribution links used by the Call Bridges to pass call signal and status messages between peers for distributed conferences.

Each Call Bridge should have an outbound dial plan rule configured for each of its peers so that it routes calls directly to its peer instead of through a call control. Configure an outbound rule to each of the peers based on the ip addresses of the peers as show in [Table 3-11](#).

**Table 3-11 OutboundDialPlanRules Parameters Example**

Domain	SIP Proxy to Use	Priority	Trunk Type	Call Bridge Scope
10.x.x.61	10.x.x.61	100	Standard Sip	all
10.x.x.62	10.x.x.62	100	Standard Sip	all
10.x.x.60	10.x.x.60	100	Standard Sip	all

For each Web Bridge 3 deployed, the Call Bridge needs to know the c2w://URL for accessing the Web Bridge 3. Run the POST method on the /webBridges node using the URL parameter from each row in [Table 3-12](#).

**Table 3-12 Web Bridge 3 Configuration Example**

Web Bridge 3 cw2 IP Address:Port	URL
10.x.x.60:9999	c2w://10.x.x.60:9999
10.x.x.61:9999	c2w://10.x.x.61:9999

Using the same name (for example, join.ent-pa.com) for each web bridge, create a DNS A record that resolves to the IP address of the interface used by the web bridge.

Use an API (POST /callBridgeGroups) with the parameter **loadBalancingEnabled** set to **true** to create a Call Bridge group with the load balancing option enabled, and write down the returned Call Bridge group GUID. For each Call Bridge, use an API (PUT /callBridges) to set the **callBridgeGroup** parameter to the *<callBridgeGroup GUID>* for adding the Call Bridge to the group. Use an API (PUT /system/configuration/cluster) to set the **loadLimit** parameter value for the maximum load on the server platform, using the platform dependent value as specified in the latest version of the white paper on *Load Balancing Calls Across Cisco Meeting Servers*, available at,

<https://www.cisco.com/c/en/us/support/conferencing/meeting-server/products-installation-and-configuration-guides-list.html>

For each web bridge, use an API (PUT /webBridges) to set the **callBridgeGroup** parameter to the *<callBridgeGroup GUID>* to associate the web bridge with the Call Bridge group so that only Call Bridges in the group will attempt to connect to the web bridge.

At this point, a complete Cisco Meeting Server cluster should be configured. Browse to one of the web admin pages and update the call settings parameters in the web interface (**Configuration -> General**) using the values in [Table 3-13](#).

**Table 3-13** Call Settings Configuration Example

Field Name	Value	Comment
SIP media encryption	allowed	Allow both RTP and SRTP
SIP call participant labels	enabled	Show display name if layout supports it
TIP calls	enabled	Allow use of TIP

## Summary

After completing the above tasks, the Cisco Meeting Servers will be ready to add to Unified CM.

## 3. Enable Unified CM for Conferences

This section describes the major tasks required to enable Unified CM for conferences with the Cisco Meeting Server cluster.

### Overview

#### Deployment Tasks to Enable Unified CM for Instant Conferences:

1. Create a new SIP profile named **Standard SIP Profile for CMS** and a SIP trunk security profile named **Security SIP Trunk Profile for CMS**.
2. Create a SIP trunk pointing to the Cisco Meeting Server Call Bridge node (SIP\_TRUNK\_CMS1). This step must be repeated for each Call Bridge in the Cisco Meeting Server cluster nodes. For example, if there are three Call Bridges in the cluster, there should be three SIP trunks configured.
3. Create a conference bridge and add a SIP trunk (configured in task 2) to it. Each conference bridge should contain the SIP trunk to one of the Call Bridge cluster peers.

Configure each conference bridge with the username and password created on Cisco Meeting Server with API privilege.

This step must be repeated for each Call Bridge enabled in the Cisco Meeting Server cluster. For example, if there are three Call Bridges in the cluster, there should be three conference bridges configured.

4. Create media resource group (MRG) named **Video**. Add all conference bridges to the MRG. If you have three Call Bridges in the cluster, then the MRG should have three conference bridges in it.
5. Create a media resource group list (MRGL) named **Video** and add the MRG (configured in task 4) to it. To allow an endpoint to use instant conferencing, assign the MRGL to the device pool or the device itself.

#### Deployment Tasks to Enable Unified CM for Permanent and Scheduled Conferences:

6. Create a route group for permanent and scheduled conferences (RG\_SPACE\_SCHED). Add all SIP trunks (configured in task 2) to the route group. If you have three Call Bridge nodes in the cluster, then the route group should have three SIP trunks in it, each pointing to one of Call Bridge nodes.
7. Create a route list (RL\_SPACE\_SCHED) and add the route group to it.
8. Create a route pattern (8099[12]XXX) that matches the numeric alias for scheduled conferences to be configured in section 5. [Deploy Cisco TelePresence Management Suite](#). Further route patterns are required to configure Spaces, and they are discussed in section 6. [Deploy Cisco Meeting Server Spaces](#).

## Deployment Considerations

Unified CM is the first point of logic that decides how to route a call to Cisco Meeting Server to start the conference. Unified CM has different configuration procedures for instant and permanent or scheduled conferences because the mechanism for joining each type of conference is different.



### Note

The endpoint used to initiate an instant conference must have a conference button. Endpoints that do not have a conference button can still be participants in an instant conference, but they must be added to the conference by an endpoint that has a conference button.

## Deployment Tasks to Enable Unified CM for Instant Conferences

It is important to understand that the SIP trunk in Unified CM should point to the call bridge in the Cisco Meeting Server, while the API connection should point to the web admin interface and port. The API connection must be secured using HTTPS hence Unified CM should trust the certificate presented by the Web admin, in this case the shared certificate. Upload the root certificate of the Certificate Authority that signed the shared certificate into the Tomcat Trust store before adding Cisco Meeting Server as Conference Bridge (CFB). The same SIP trunk can be used for all conference types. Each call bridge node within the Cisco Meeting Server cluster requires a unique set consisting of a SIP trunk and an API connection from the conference bridge in Unified CM.

SIP trunks to Cisco Meeting Server require a customized SIP profile and SIP trunk security profile in order to support calls in all scenarios. To create the SIP profile, copy the **Standard SIP Profile for TelePresence Conferencing** and name the copy **Standard SIP Profile for CMS**, then change the settings as indicated in [Table 3-14](#).

**Table 3-14** Settings for SIP Profile

Setting	Value	Comment
Early Offer support for voice and video calls	Best Effort (no MTP inserted)	This is the recommended configuration for all Unified CM trunks. Best Effort Early Offer trunks never use MTPs to create an Early Offer and, depending on the calling device, may initiate an outbound SIP trunk call using either Early Offer or Delayed Offer. In the context of this design, outbound calls always use Early Offer.

To create the SIP trunk security profile, copy the **Non Secure SIP Trunk Profile** and name the copy **Security SIP Trunk Profile for CMS**, then change the settings as indicated in [Table 3-15](#).

**Table 3-15** Settings for SIP Trunk Security Profile

Setting	Value	Comment
Accept replaces header	checked	Enable this option for Unified CM to accept INVITE with Replaces header to reroute calls to the appropriate Cisco Meeting Server in the Call Bridge group in order to allow load balancing to work as designed.

SIP trunks inform Unified CM where to route SIP traffic. In the case of instant conferences, Unified CM will use the destination ip of the trunk to send the direct API requests, and they are used in the conference bridge configuration (Figure 3-12). SIP trunks connected to the Call Bridge in Cisco Meeting Server can be configured to be secure; but for the purpose of this guide, they are assumed to be configured as non-secure.

Figure 3-12 Cisco Unified CM Instant Configuration

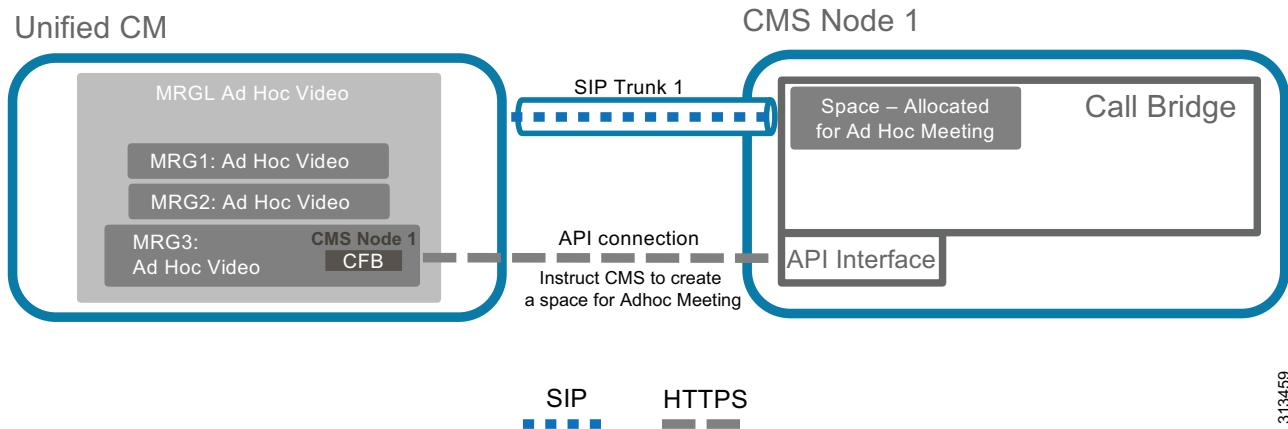

313459

Conference bridge configuration provides two key pieces of information to Unified CM: the API credentials to communicate with Cisco Meeting Server and the destination address for that communication (Figure 3-12). The username and password should match those for the API user configured in Cisco Meeting Server. Unified CM should trust the Certificate Authority that signed the shared certificate, make sure that the root CA certificate exists in the tomcat trust store of Unified CM. The SIP trunk configured in the conference bridge indicates to Unified CM where to send the HTTPS API traffic. Configure each SIP trunk with the settings indicated in Table 3-16. In addition, each Unified CM cluster should have a unique Conference Bridge Prefix configured in the conference bridges. The prefix does not affect operations in a single Unified CM cluster; but in multi-cluster Unified CM deployments, this prefix would prevent two Unified CM clusters from assigning the same meeting number to different instant conferences at the same time.

Table 3-16 SIP Trunk Settings for Instant Conferences

Setting	Value	Comment
Name	SIP_TRUNK_CMS1	Name of the SIP trunk pointing to Cisco Meeting Server node 1 with the Call Bridge enabled
Description		Some meaningful description
Device Pool	Trunks_and_Apps	Common device pool for central trunks
Media Resource Group List	<None>	Use the MRGL defined on the device pool
AAR Group	Default	Same everywhere



**Table 3-16** SIP Trunk Settings for Instant Conferences (continued)

Setting	Value	Comment
Transmit UTF-8 for Calling Party Name	Checked	This will allow the ASCII Alerting Name to be transmitted to devices that support UTF-8 characters
PSTN Access	Not checked	
Run On All Active Unified CM Nodes	Checked	This setting is recommended on all SIP trunks. It makes sure that outbound calls to SIP do not require intra-cluster control signaling between Unified CM call processing subscribers.
<b>Inbound Calls</b>		
Calling Search Space	TelePresenceConferencing	As defined in the <a href="#">Call Control</a> chapter
AAR Calling Search Space	PSTNReroute	
<b>Outbound Calls</b>		
Use Device Pool Called Party Transformation CSS	Checked	
Use Device Pool Calling Party Transformation CSS	Checked	
<b>SIP Information</b>		
Destination	us-cms1.ent-pa.com	FQDN of Cisco Meeting Server node 1
SIP Trunk Security Profile	Security SIP Trunk Profile for CMS	Use the SIP trunk security profile created above.
Rerouting Calling Search Space	TelePresenceConferencing	Use the same Calling Search Space as configured for Inbound Calls above.
SIP Profile	Standard SIP Profile for CMS	Use the SIP profile created above.

Once all conference bridges are configured, they can be added to media resource groups (MRG). Each media resource group should contain one conference bridge from each Call Bridge in the Cisco Meeting Server node, so that if communication with one Call Bridge node is not possible, then calls can be routed to another node.

Each media resource group can then be added to its own media resource group list (MRGL). The media resource group list can be assigned to devices or the device pool in Unified CM and used when those devices escalate a point-to-point call to a conference call using the conference button.

Inside Cisco Meeting Server, the Space used by the instant conference is created dynamically through the HTTPS API connection when a user presses the conference button on the device to initiate the escalation. That Space will be deleted through the API connection after the conference ends.

## Deployment Tasks to Enable Unified CM for Permanent and Scheduled Conferences

Permanent and scheduled conferences are configured on Unified CM in a similar way to instant conferences, but they require a dial plan to be configured rather than media resources (see Figure 3-13). Use the same SIP trunk and SIP profile for permanent and scheduled conferences that you created for instant conferences, with the settings indicated in Table 3-16.

**Figure 3-13** Scheduled and Permanent conferences dial plan for Cisco Unified CM and Cisco Meeting Server Spaces

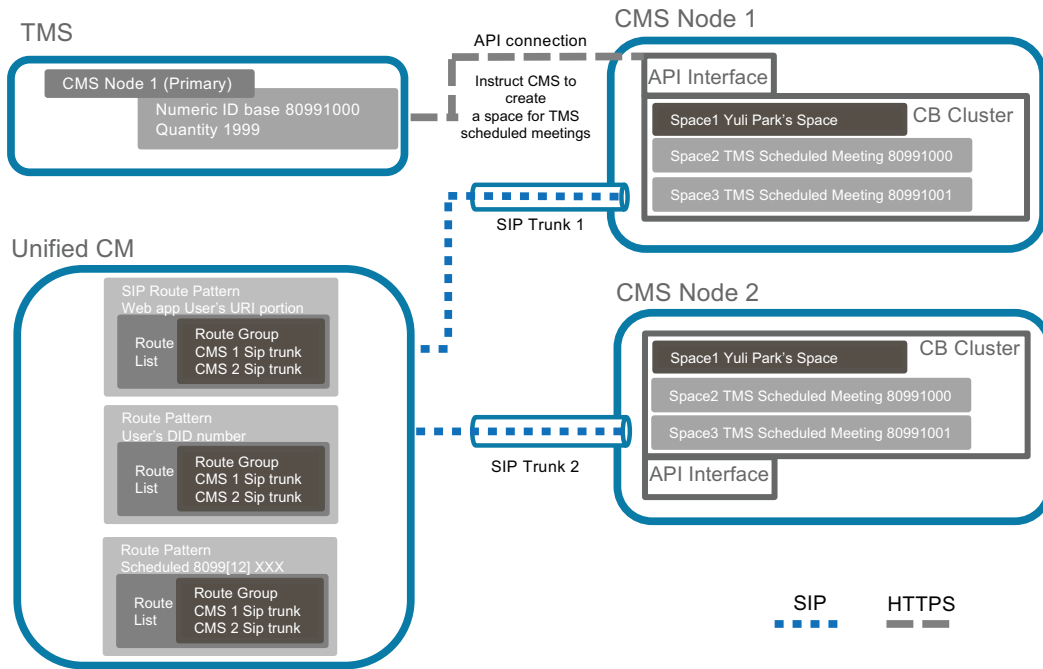

Create a route group for all the SIP trunks created for scheduled conferences. Add the route group into a route list. The route list is chosen when a call matches a route pattern that points to it.

To route calls through the SIP trunk to the Cisco Meeting Server, configure a route pattern for the route list. The route pattern should match with the alias range configured for the scheduled conferences, as indicated in Table 3-17. Spaces for scheduled conferences are created when the administrator creates the numeric ID ranges for scheduled conferences in Cisco TMS, and one Space will be created for each number ID. Refer to section 5. Deploy Cisco TelePresence Management Suite for details.

**Table 3-17** Route Pattern for Scheduled Conference Route List

Pattern	Partition	Gateway or Route List	Description
8099[12]XXX	ESN	RL_SPACE_SCHED	Pattern to match scheduled alias range

More details on deployment and route pattern configuration for Cisco Meeting Server permanent conferences are discussed in section 6. Deploy Cisco Meeting Server Spaces.

## Summary

After you complete the deployment tasks outlined above, Unified CM should be able to communicate with Cisco Meeting Server.

## 4. Deployment Tasks for Active Control

ActiveControl is negotiated using IX application media between the Call Bridge and Endpoints to enable users to control their meeting experience directly from the endpoint without external interventions such as a 3rd party application or an operator. Some features that become available with ActiveControl negotiation are meeting rosters, muting/unmuting participants, video layout control, unlocking/locking the meeting and raise hand, among others. It is worth mentioning that IX application media is also required when setting up Multistream support.

ActiveControl utilizes the IX media negotiation within the SDP in SIP signaling in Cisco devices running a software version that supports ActiveControl. ActiveControl is enabled by default in Meeting Server however it is necessary to grant permissions to participants to use the feature. The permissions are controlled by the callLegProfiles which are objects that exist within the API hierarchy.

Configure the callLegProfile at the system level so all participants will get the configured permissions and if a specific set of permissions is required you can apply a more specific callLegProfile to other hierarchies such as space level, accessMethod level or tenant level.

The list of supported features that ActiveControl enables vary depending on the version of the client. To take advantage of all the Active Control based features supported in Cisco Meeting Server check the supported versions in the compatibility matrix. The call path between the Endpoints and CMS should support IX media application negotiation end to end.

Tasks:

1. Enable ActiveControl in CE Endpoint
  - a. Navigate to **Configuration > Conference > ActiveControl Mode** and set it ON.
2. Enable ActiveControl in UC Manager:
  - a. Select the trunk that points to Meeting Server.
  - b. Confirm the name of SIP profile assigned.
  - c. Navigate to the **SIP profile**:
  - d. **Device > Device Settings > SIP Profile >**
  - e. Find and edit the **SIP Profile** assigned to the trunk pointing to Meeting Server.
  - f. Navigate down to SDP information section and select “**Allow IX application Media**” and save changes.
  - g. Restart the trunk or devices that has the **SIP Profile** assigned.



### Note

If security is required a secure SIP profile is needed on the Endpoint to negotiate encrypted IX. The call path must also use TLS end-to-end for encrypted IX to be successfully negotiated. Active control is not supported in h323 and interworked call flows.

3. Configure callLegProfile to enable permissions to use the ActiveControl features enabled.
  - a. Create a callLegProfile object in Cisco Meeting Server.

- b. Navigate to the web admin interface of the Cisco Meeting Server and navigate to **Configuration > API**. Use the filter field to find object “/api/v1/callLegProfiles” and expand the list.
- c. Click on “create new” and enter set as true the attributes you want to set up. For instance “addParticipantAllowed”, just keep in mind if you leave one attribute unset it’s going to inherit the permission from an object in the parent hierarchy. Once you are done click on “create” and a new callLegProfile id will be created.
- d. Apply the callLegProfile to an object in at the hierarchy.
- e. Set the desired level, for example, at the system level “ /api/v1/system/profiles”
- f. Navigate to **Configuration > API**. Use the filter to find object “/api/v1/system/profiles”
- g. Click on “View or Edit” and enter the callLegProfile id previously generated and click on modify.
- h. Now the permissions are applied to the system level.

## 5. Deploy Cisco TelePresence Management Suite

This section describes the deployment tasks for Cisco TMS for scheduled conferences using Cisco Meeting Server.

### Overview

#### Deployment Tasks for Cisco TMS High Availability:

1. Install and configure Cisco TMS on active and passive nodes.
2. Install and configure the network load balancer (NLB).
3. Configure file sharing between active and passive node servers.

#### Deployment Tasks for Cisco TMS Basic Configuration:

4. Configure Active Directory integration, group structure, and users.
5. Create the TMS System Navigator folder structure.
6. Configure default conference setting.

#### Deployment Tasks for Cisco TMS for Scheduled Conferences:

7. Integrate Cisco Meeting Server with TMS.
8. Integrate Unified CM with TMS.
9. Add conference room endpoints to TMS.
10. Install and configure TMS Extensions for Microsoft Exchange (TMSXE).

### Deployment Tasks for Cisco TMS High Availability

This section describes the tasks required to deploy Cisco TMS with high availability.

#### Install and Configure Cisco TMS on Active and Passive Nodes

Cisco TelePresence Management Suite (TMS) should be installed for redundant deployments according to the guidelines in the latest version of the *Cisco TelePresence Management Suite Installation and Upgrade Guide*, available at

<https://www.cisco.com/c/en/us/support/conferencing/telepresence-management-suite-tms/products-installation-guides-list.html>

- Install the application on the primary server.
- Point to the external SQL resource configured in the planning stage.
- Make note of the encryption key.
- Verify basic operation by logging into the web portal and enabling TMS redundancy.
- Install the application on the second server using the encryption key from the first server, and using the same SQL credentials as the first server.

Both servers will access the single SQL database that holds all conferencing and configuration data. In the active and passive node configuration, a single encryption key and certificate are used for both servers. Having this encryption key and certificate on each server allows for all communications from end users to TMS, and from TMS to managed devices, to be done using secure protocols.

### Install and Configure Network Load Balancer (NLB)

The specifics of the network load balancing configuration are left to the instructions of the load balancer chosen by the customer. The following are functional requirements that must be configured:

- Forward HTTP, HTTPS, and SNMP traffic to the active node.
- Configure the network load balancer probe to the Probe URL within Cisco TMS.
- Push all traffic to the active node.

The Cisco TMS server sends outbound communications directly to managed devices without routing that traffic through the NLB. However, all return communications from managed devices and all web portal requests must be routed through the NLB. The communication path permits end users and endpoints to use a single address, regardless of which TMS server node is in active mode.

Configure TMS Network Settings to the FQDN of the TMS address configured on the network load balancer. This setting within TMS will populate the address that the managed devices use to initiate communications to TMS. By using a FQDN of tms.ent-pa.com that resolves to the load balancer, all inbound traffic from endpoints or end user web clients will be directed through the NLB and resolve to the active node. (See Figure 3-14.)

**Figure 3-14** NLB Directs Communications from Managed Devices to the Active TMS Node

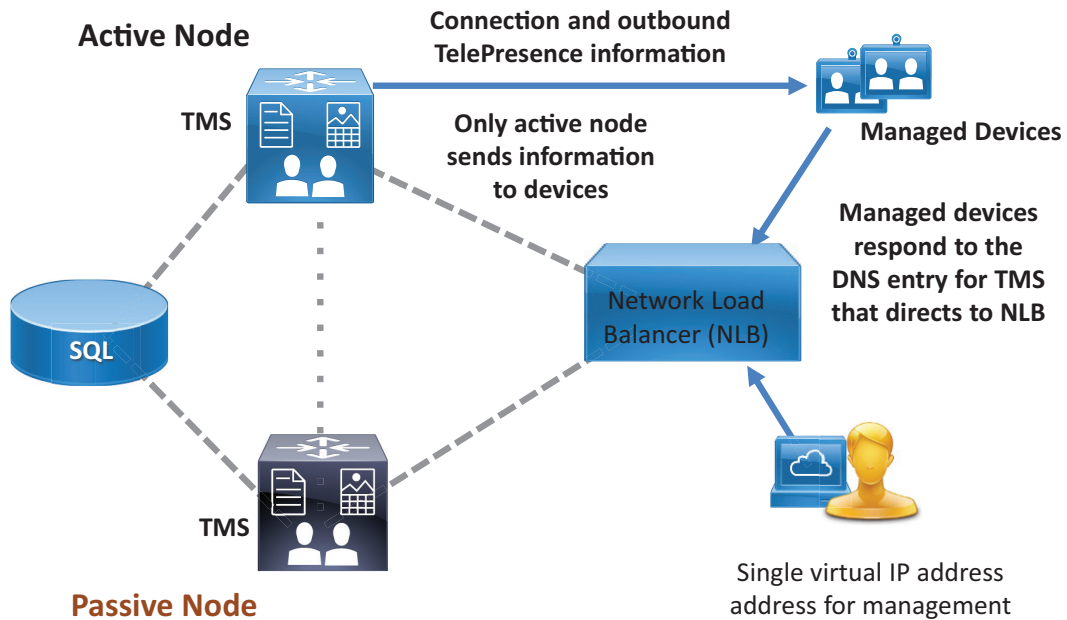

3-48936

## Configure File Sharing Between Active and Passive Node Servers

While the SQL database is used for all operational data, some application specific files are stored within the file structure of the host server. These customizable files are added by the TMS application and must be synchronized between the two servers when using a redundant deployment. The files include software and images that can be uploaded to Cisco TMS, and images created by Cisco TMS.

In a default installation, the files are located at:

```
C:\Program Files\TANDBERG\TMS\Config\System\  
C:\Program Files\TANDBERG\TMS\Data\GenericEndpoint\  
C:\Program Files\TANDBERG\TMS\Data\SystemTemplate\  
C:\Program Files\TANDBERG\TMS\wwwTMS\Data\CompanyLogo\  
C:\Program Files\TANDBERG\TMS\wwwTMS\Data\ExternalSourceFiles\  
C:\Program Files\TANDBERG\TMS\wwwTMS\Public\Data\SystemSoftware\
```

Use the Distributed File System (DFS) function within the Windows Server operating system to complete this replication process between the two servers. DFS will keep these folds in sync between the two servers when the "Full mesh" configuration is used.

## Deployment Tasks for Cisco TMS Basic Configuration

Perform the following additional configuration tasks during the installation of Cisco TMS to make the deployment function as intended in the Preferred Architecture:

- [Active Directory Integration, Group Structure, and Users](#)
- [System Navigator Folder Structure](#)
- [Default Conference Settings](#)
- [Default Conference Settings](#)
- [Modify Email Templates within TMS](#)

### Active Directory Integration, Group Structure, and Users

**Verify that all of the information is correctly entered for your Active Directory service account.**

**Note**

Make sure all of your settings for AD connectivity are correct, and test the connection. Other AD interfacing commands within TMS might not display errors, even if AD synchronization is not functioning.

**Build a group structure to match your organizational needs using Active Directory Groups.**

Three different groups are created by default during the TMS installation:

- Users
- Video Unit Administrator
- Site Administrator

These groups may be modified to meet customer needs, but they cannot be removed. By default, all groups have the same access permissions as Site Administrator.

These default groups are limited to manual entry of users; therefore, groups should be imported from Active Directory, and existing Active Directory Groups should be used to manage end user access to TMS functions. Be sure to consider groups for support desk personnel and technical administrators as well as end users who schedule conferences.

For additional information about groups, see the latest version of the *Cisco TelePresence Management Suite Administrator Guide*, available at

<https://www.cisco.com/c/en/us/support/conferencing/telepresence-management-suite-tms/products-maintenance-guides-list.html>

Using the **Import from AD** feature allows for a single point of end user job function management. When employees are added or removed, or job functions change and organizational Active Directory groups are modified, TMS permissions are automatically updated.

Once you have imported groups from Active Directory, assign appropriate permissions to each group. On the screen that appears, simply uncheck any permissions that you do not want that group to have. Failure to restrict these permissions can result in unintended configuration changes.

Also, be sure to select the appropriate default group for all users.

**Note**

---

Anyone accessing Cisco TMS will be added automatically to the Users group, and this cannot be unselected. De-select any permissions that the administrator does not want everyone within the organization to have.

---

**Import Users**

Once permissions are set for groups, import users using the **Synchronize All Users with AD** function. Depending upon organization size and number of groups involved, the synchronization can take many minutes to complete.

**Note**

---

Users will not appear in the list of users until they log into TMS for the first time.

---

## System Navigator Folder Structure

The TMS System Navigator utilizes a folder structure to group devices logically for the administrator. Build a folder structure to match your organization's physical deployment. These folders are visible only to the administrators, not to end users. Arrange the folders according to the logical flow for your organization. For example, create a folder for each geography, and then create a sub-folder for the infrastructure and another folder for conference room endpoints. Folders within the System Navigator may contain endpoints and/or infrastructure devices that receive connection instructions from TMS.



## Default Conference Settings

Before scheduling conferences, the administrator should understand the end user community usage model as well as any endpoint limitations. Important Cisco TMS settings to consider include:

- [One Button to Push](#)
- [Bandwidth](#)
- [Allow Participants to Join 5 minutes Early](#)

### One Button to Push

One Button to Push enables end users to see a calendar of the day's meetings for a particular room and to launch the connection to the conference. Cisco TMS gives users 72 hours worth of calendar information per request.

### Bandwidth

This setting is per endpoint. Adjust the bandwidth to the desired setting for your network. To allow for HD main channel and maximum resolution of content, the default bandwidth for non-room system video devices should be set to 2048 kbps. Any endpoint that has a lower setting for maximum bandwidth will join at its maximum bandwidth.

### Allow Participants to Join 5 minutes Early

This setting should be selected to allow for slight variations of end-user time interfaces. Allowing users to join prior to the exact time of the TMS server provides a more consistent end-user experience and prevents end users from receiving an "unable to connect" message if they attempt to connect to a meeting a few minutes before the meeting start time.

## Modify Email Templates within TMS

Cisco TMS contains the templates used to notify conference organizers. However, Cisco TMSXE can inject errors, warnings, and informational text into email messages sent by Cisco TMS. These messages can be modified by the administrator. Avoid removing or changing text in curly brackets – for example, {MEETING\_TITLE}, {CONTACT\_HOST}, and so forth – because these are variables that embed other specific content from the scheduled event.

Look at all email templates to ensure that communications automatically generated by TMS align with your intended procedures. Many of these templates might be rather simplistic and are intended to be enhanced by individual organizations. The templates may be modified using any standard HTML editor.

## Deployment Tasks for Cisco TMS for Scheduled Conferences

For Cisco TMS to build scheduled conferences, you must add the needed components into TMS as systems. Unified CM is added to TMS to allow the TMS scheduling mechanisms be aware of the call control entity for all devices. TMS does not control any settings on Unified CM, but it does communicate directly to conference room endpoints managed by Unified CM. (See [Figure 3-15](#).)

**Figure 3-15** Cisco TMS Communicates Directly with Unified CM Managed Endpoints

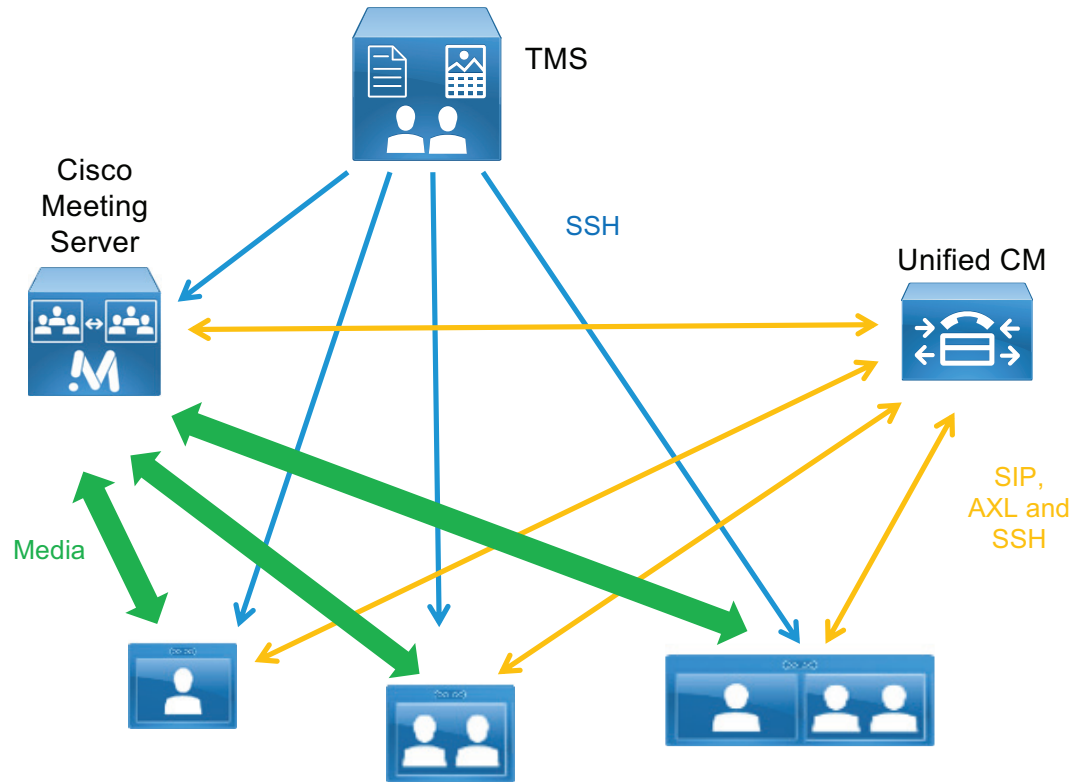

### Integrate Cisco Meeting Server with Cisco TMS

To allow Cisco TMS to perform scheduling and conference control for scheduled conferences, add one Cisco Meeting Server node from each Cisco Meeting Server cluster.

Cisco TMS must be configured with a range of numeric IDs, and these are used by Cisco TMS to determine where a scheduled call is placed.

Add one Cisco Meeting Server from each Cisco Meeting Server cluster to Cisco TMS. Add them to the appropriate folder using an administrator account configured on the Cisco Meeting Server. For each Cisco Meeting Server configured in Cisco TMS, set the parameters as listed in [Table 3-18](#).

**Table 3-18 Cisco TMS Parameter Settings for Cisco Meeting Server**

Setting	Value	Comment
IP Address	10.X.X.2:445	Cisco Meeting Server web admin interface IP address and port number
Username	TMSadmin	This setting should match the username configured on the Cisco Meeting Server
Password	<password>	
Usage Type	Other	

After adding Cisco Meeting Server, specify the alternate IP Network Settings in the Cisco Meeting Server settings as listed in [Table 3-19](#). The alternate IP Cisco Meeting Server takes over the operations in case the first Cisco Meeting Server fails.

**Table 3-19 Alternate IP Network Settings for Cisco Meeting Server**

Setting	Value	Comment
Alternate IP	<Select one in drop-down>	Cisco Meeting Server cluster nodes with Call Bridge enabled
Alternate IP Username	TMSadmin	User configured in the Cisco Meeting Server with the IP address specified in the alternate IP
Password	<password>	

Configure the conference alias and identify a numeric range for Cisco Meeting Server to use as part of the dial plan and as designated in the SIP trunks. [Table 3-20](#) lists the Extended settings for Cisco Meeting Server to specify the numeric ID range for scheduled calls.

**Table 3-20 Extended Settings for Cisco Meeting Server**

Parameter	Value
Domain	Domain associated with the Cisco Meeting Server.
Numeric ID Base	This is the first number in the scheduled conferencing range of the dial plan.
Numeric ID Quantity	Specify the number of numeric IDs required for scheduled conferences.

Save the configuration to add Cisco Meeting Server. For each numeric ID, Cisco TMS will create an inactive Space using the numeric ID as the URI user part on the Cisco Meeting Server. These Spaces are used to host scheduled conferences created by Cisco TMS. When it is time to start the scheduled conference, Cisco TMS will activate the Space on Cisco Meeting Server, and participants can begin calling in.

Cisco TMS will populate the dial plan numbers provided in the previous steps into both E.164 aliases and SIP URIs. However, the implementation of E.164 logic within TMS differs from its use elsewhere in the Preferred Architecture. TMS associates an E.164 alias with H.323 communication only. It is therefore necessary to adjust the integrated ticket system of TMS to ignore certain warnings for the Cisco Meeting Server.

Once the Cisco Meeting Server has been added to TMS, adjust the Ticket Filters for this entry by adding the filter for **Gatekeeper Mode Off**.

To use Cisco Meeting Server for scheduled calls, you must edit the Cisco Meeting Server settings within Cisco TMS. H.323 dialing should be disabled in both directions, Allow Booking should be enabled, and SIP dialing should be enabled in both directions.

The numeric ID range used must be configured so that the scheduled conference number range matches that configured on Unified CM. Edit the Extended Settings of the Cisco Meeting Server in Cisco TMS, as listed in [Table 3-21](#). The domain should match the domain configured in Cisco Meeting Server. The numeric ID should match the route pattern configured for the trunk to Cisco Meeting Server from Unified CM.

**Table 3-21** *Extended Settings for Cisco Meeting Server*

Setting	Value	Comment
Domain	cms.ent-pa.com	SIP URI domain for the scheduled meetings
Numeric ID Base	80991000	The first number that Cisco TMS uses to form the dial string used by participants dialing into the scheduled conference; for example, 80991000.
Numeric ID Quantity	1999	The number of times Cisco TMS will increase the number from the Numeric ID Base. This number should be set so that the highest number does not exceed the allocated range for scheduling: 80991000 to 80992999.

It is important to configure Cisco TMS to use Cisco Meeting Server for scheduling, otherwise scheduling will fail. In **Administrative Tools > Configuration > Conference Settings**, edit the settings as shown in [Table 3-22](#).

**Table 3-22** *Cisco TMS Conference Settings*

Setting	Value	Comment
Preferred MCU Type in Routing	Cisco Meeting Server	Prefers Cisco Meeting Server for scheduling over other devices

## Integrate Unified CM with TMS

While Unified CM administers the conference room endpoints for all other aspects of configuration and management, the Unified CM cluster must be added into TMS to allow for booking and connection initiation. To add Unified CM to TMS, perform the following tasks:

- [Create an Application User for Cisco TMS within Unified CM](#)
- [Add the Publisher for each Unified CM Cluster in Your Environment](#)

Adding multiple Unified CM clusters requires adherence to the dial plan configuration outlined in the [Call Control](#) chapter.

### Create an Application User for Cisco TMS within Unified CM

This application user allows TMS to communicate with endpoints controlled by Unified CM. This user must be assigned all of the conference room devices within Unified CM that will be scheduled. This user must also be added to a user group just for Cisco TMS, with the following roles:

- Standard AXL API Access
- Standard CTI Enabled
- Standard SERVICEABILITY
- Standard CCM Admin Users
- Standard RealtimeAndTraceCollection

For more information, refer to the latest version of the *Administration Guide for Cisco Unified Communications Manager and IM and Presence Service*, available at

<https://www.cisco.com/c/en/us/support/unified-communications/unified-communications-manager-callmanager/products-maintenance-guides-list.html>

### Add the Publisher for each Unified CM Cluster in Your Environment

Adding the Unified CM publisher to TMS makes TMS aware of the call control authority for its endpoints. Without knowledge of Unified CM, the TMS scheduling engine cannot properly utilize the full functionality of your deployment, and connection failures could occur.

Add the publisher by the same method used for other devices, by using the application user you created in the above step for the user name and password when prompted by TMS.

## Add Conference Room Endpoints to TMS

Rather than adding devices by IP address or DNS name, use the **From List** tab and then select Unified CM. Select all the conference room TelePresence devices that you wish to have available through the scheduling interfaces of TMS. Make sure the DN for each endpoint in Unified CM complies with the E.164 guidelines listed in the [Call Control](#) chapter.

## Install and Configure TMS Extensions for Microsoft Exchange

Cisco TelePresence Management Suite Extension for Microsoft Exchange (Cisco TMSXE) is an extension for Cisco TelePresence Management Suite that enables videoconference scheduling via Microsoft Outlook, and it replicates Cisco TMS conferences to Outlook room calendars.

This software extension to TMS requires a license key to activate the functionality within TMS. This key must be installed in TMS before installing the TMSXE software. For deployments with more than 50 scheduled endpoints, TMSXE must be installed on its own server or virtual machine instance.

### Prerequisites

Before installing Cisco TMSXE, make sure both Outlook and Exchange are already set up so that users are able to book meetings that include room mailboxes (see [Figure 3-16](#)). This integration is licensed either by groups of endpoints or as an Application Integration license key. The correct key must be procured and entered into TMS before proceeding with the installation. If both option keys are added, only the Application Integration Package option will be used by Cisco TMS

Cisco TMSXE may use Microsoft Exchange Resources that are either on-premises, Office 365 hosted deployments, or hybrid customer deployments. Consult the Microsoft Exchange administration and deployment guides for any guidelines or recommendations that might apply to specific customer environments.

**Figure 3-16 Sample Flow for Scheduling a Conference by an End User**

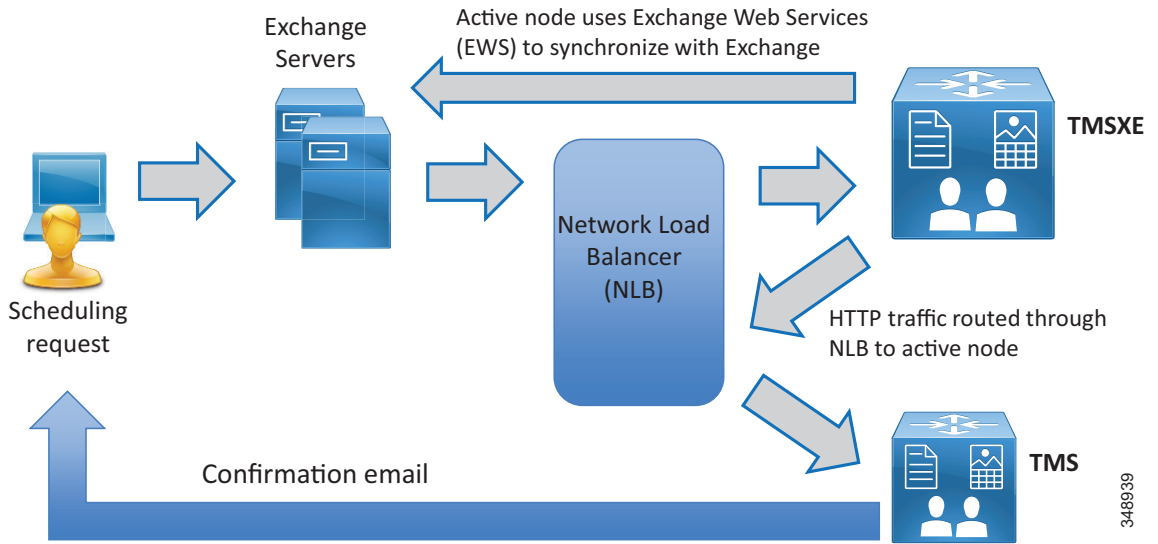

Once the per-system option key has been activated in Cisco TMS, the **Allow Remote Bookings** setting determines whether each system is using a license. This setting allows the administrator to select which endpoints are able to be booked by end users and consume one of the individual endpoint licenses. This setting is void and hidden if the Application Integration Package option is used.

Before endpoints can be added to Cisco TMSXE, they must be represented by a room mailbox in Exchange. To simplify TMSXE setup, we recommend using the endpoint's Cisco TMS display name as the mailbox name (with any spaces removed). This provides commonality across all methods by which end users would see the system name appear.

**Special Notes About Privacy Features of Exchange:**

All room mailboxes added to Cisco TMSXE must be configured to handle booking subjects and privacy settings in the same way. This means that the following settings must be applied to either all or none of the mailboxes:

- Delete the subject
 

We recommend not using this feature so that support staff is able to identify a particular meeting in the Conference Control Center. Also, this will allow the meeting title to appear on the One Button to Push interface of capable endpoints.
- Add the organizer's name to the subject
 

Use of this setting should be considered very carefully, and will depend upon organizational culture and practices. Keep in mind that if one person schedules meetings for multiple groups, those meetings will be listed by that scheduler's user name and not by the meeting subject, which might be more beneficial. On the other hand, if meetings are scheduled by their respective hosts, then it would be easy to identify "Bob's meeting" instead of remembering the specific meeting title. For most organizations, we recommend not using this setting.

- Remove the private flag on an accepted meeting

While the "private" flag is respected within the Outlook client, it is not supported by Cisco TMS, and meeting subjects will be freely viewable:

- In Cisco TMS
- On endpoints that support the Meetings calendar, if other individuals also have use of a room used for a meeting where the subject title should not be public within the organization. (For example, if a "Merger meeting" for the chief executive is scheduled in a room also used by lower-level employees who would not need to have knowledge of a pending merger, those lower-level employees would be able to see the meeting on a room system calendar.)
- If a booking that has a "private" flag in Exchange has its participants or recurrence pattern modified in Cisco TMS, the "private" flag will be removed when these changes are replicated to Exchange.

#### **Create TMSXE User**

- Create a TMSXE user in Active Directory and import that user into TMS.
- In TMS, the user needs to be in a new or existing group with the following permissions enabled under Booking:
  - Read
  - Update
  - Book on Behalf of
  - Approve Meeting

#### **Install Certificates**

Cisco TMSXE and TMS communicate using HTTPS. The certificate also allows for secure communications between the TMSXE server and the Exchange environment. As with the TMS application server, the same certificate is loaded on both the active and passive nodes of TMSXE, and the certificate DNS entry points to the entry of the Network Load Balance address used for TMSXE.

#### **Run Software Installer**

- Select the TMS Booking Service.
- Select the appropriate redundancy option for active or passive nodes.
- Complete the software installation on both active and passive nodes.

Once both the active and passive nodes have been installed, configure the Network Load Balancer with the probe URL for each node.

#### **Configure Cisco TMSXE**

- Cisco TMS Connection Information

Configure TMS connection information using the TMSXE account created in Active Directory to allow the TMSXE application to communicate with the TMS application.

- Configure Exchange Web Services

Configure Exchange Web Services (EWS) to allow TMSXE to communicate with the Exchange servers for user and resource mailboxes. The credentials used for this connection are also the same TMSXE credentials used elsewhere.

- Align Exchange and TMS Resources

Align Exchange resources to TMS System IDs. This may be done individually or by using a .csv file as outlined in the latest version of the *Cisco TelePresence Management Suite Extension for Microsoft Exchange Deployment Guide*, available at

<https://www.cisco.com/c/en/us/support/conferencing/telepresence-management-suite-extensions/products-installation-guides-list.html>

## Summary

After you complete the deployment tasks outlined above, Cisco TMS will be configured to communicate with Cisco Meeting Server for scheduled conferencing.

## 6. Deploy Cisco Meeting Server Spaces

This section describes the major tasks required to deploy Cisco Meeting Server Spaces.

### Overview

#### Deployment Tasks for Unified CM for Cisco Meeting Server Permanent Conferences:

1. Configure an Early Offer SIP trunk between Unified CM and Cisco Meeting Server. The SIP trunk SIP\_TRUNK\_CMS1 configured previously can be used here.
2. Set up new route pattern(s) for the Space numeric alias that points to the route list containing the relevant trunks. The route list RL\_SPACE\_SCHIED configured previously can be used here.
3. Create a SIP route pattern for the Space URI that points to the route list (RL\_SPACE\_SCHIED) used in task 2.

#### Deployment Tasks for Cisco Meeting Server to Create Spaces:

4. Create a User Profile and assign Multiparty licenses to users.
5. Import users from LDAP and create Spaces.
6. Create dial plan rules to handle incoming calls.

### Deployment Considerations

Cisco Meeting Server Spaces are similar to permanent conferences created in the TelePresence infrastructure that resides in the enterprise's data center. Each Space has a unique set of video addresses that a user can call into to start a meeting at any time, and the video addresses can be in the format of numeric aliases or SIP URIs. Each Space can be associated with an individual user and can be created through LDAP user synchronization.

Cisco Meeting Server Spaces provide an easy way for participants to join a conference regardless of where those participants are located. Everyone dials into the same virtual meeting room from their laptop, telepresence room, desktop endpoint, or mobile device.

Deploying Spaces involves the deployment of Unified CM and Cisco Meeting Server. The following sections describe the high-level process for deploying each component for Spaces.





Tip

Before deploying Spaces, decide on the format of the conference aliases (numeric or SIP URI).

## Deployment Tasks for Unified CM for Cisco Meeting Server Permanent Conferences

The main function of Unified CM is to handle call routing to and from Cisco Meeting Server. Connect Unified CM to Cisco Meeting Server with a SIP trunk enabled for Early Offer. (Use the same trunk as previously configured for scheduled conferences: SIP\_TRUNK\_CMS1.) When a user dials the Space alias, the call is sent to Call Bridge on Cisco Meeting Server via the SIP trunk. Similarly, Cisco Meeting Server can send calls to Unified CM through the SIP trunk for auto-dial participants. The conference alias has two formats: SIP URI or numeric. The dial plan design should include the call routing for both the numeric alias and SIP URI for Spaces. For dial plan design details, refer to the [Call Control](#) chapter.

A Cisco Meeting Server Space can be created for each individual user, and the Space numeric alias can be based upon the user's DID number. [Table 3-23](#) shows the Space numeric alias ranges for a deployment using the dial plan example from [Call Control](#) chapter.

**Table 3-23** Space Numeric Alias Ranges

Site	+E.164 DID Range	Space Numeric Alias Range
SJC	+1 408 555 4XXX	8-004-4XXX
RTP	+1 919-555 1XXX	8-005-1XXX
RCD	+1 972 555 5XXX	8-006-5XXX

For numeric aliases, configure a route pattern for each site that routes to the Cisco Meeting Server route list for permanent conferences, as shown in [Table 3-24](#).

**Table 3-24** Route Patterns Configuration for Space Numeric Alias

Pattern	Partition	Gateway or Route List	Description
80044XXX	ESN	RL_SPACE_SCHED	Pattern to match SJC DID range
80051XXX	ESN	RL_SPACE_SCHED	Pattern to match RTP DID range
80065XXX	ESN	RL_SPACE_SCHED	Pattern to match RCD DID range

For SIP URIs, use the specified domain as the domain part when provisioning users. The domain configured in this document is cms.ent-pa.com. For example, participants can dial `<username>.space@cms.ent-pa.com` to join the conference on Cisco Meeting Server. Web app users are also reachable by dialing `<username>@cms.ent-pa.com`, for example, from a Unified CM registered device. Configure a Domain Routing SIP Route Pattern with the Cisco Meeting Server domain that routes calls to the Cisco Meeting Server route list for permanent conferences, as shown in [Table 3-25](#).

**Table 3-25** SIP Route Pattern Configuration for Space URI

Pattern	Partition	Gateway or Route List
cms.ent-pa.com	URI	RL_SPACE_SCHED

## Deployment Tasks for Cisco Meeting Server to Create Spaces



**Note**

The tasks in this section are deployed using Cisco Meeting Server API Navigator available in the web user interface of the Cisco Meeting Server. For API details, refer to the latest version of the *Cisco Meeting Server API Reference Guide*, available at <https://www.cisco.com/c/en/us/support/conferencing/meeting-server/products-programming-reference-guides-list.html>.

Cisco Meeting Server must have the Multiparty licenses applied before it can host conferences. Each user should be given a license if Personal Multiparty Plus (PMP+) is desired. To assign PMP+, the user should be associated with a user profile object that has the hasLicense field set to **true**. If the hasLicense field is **false** or does not exist in the user profile object, the user has no license and Shared Multiparty Plus (SMP+) will be used. User profiles specify the capabilities for the users. This can also be accomplished by provisioning the user in Cisco Meeting Management. In Cisco Meeting Management provisioning, when adding a user import select User properties. Assign Personal Multiparty Plus (PMP+) to imported users. Administrators can also use the API to create a userProfile object (POST /userProfiles) using the parameters as listed in [Table 3-26](#), and set the hasLicense field to **true**.

**Table 3-26 userProfile Object Parameters**

Parameter	Value	Description
hasLicense	true	Use Personal Multiparty License
canReceiveCall	true	Allow Cisco Meeting App users to receive call

All users in Cisco Meeting Server reside in the LDAP directory. The user profile object (created previously) should be used as one of the parameters to synchronize the users from the directory to Cisco Meeting Server, and all imported users will be associated with that user profile. The ldapServers, ldapMappings, and ldapSources objects are required to create the user synchronization process.

ldapServers specifies the location, credentials, and other attributes to access the server. Use the parameters as listed in [Table 3-27](#) to create the ldapServers object (POST /ldapServers).

**Table 3-27 ldapServers Object Parameters**

Parameter	Example Value	Description
address	10.x.x.10	IP address or FQDN of the directory
portNumber	636	Port number used by the directory
username	ent-pa\tmlssvc	Username to access the directory
password	<password>	Password of the account associated with username
secure	true	Use a secure connection for directory access

ldapMappings allows you to specify the attributes related to the Space; for example, name, username, URI, and so forth. The attributes can be created based upon the attributes from Microsoft Active Directory (see [Table 3-28](#)). Use the parameters as listed in [Table 3-28](#) to create the ldapMappings object (POST /ldapMappings).

**Table 3-28** *ldapMappings Object Parameters*

Parameter	Example Value	Description
nameMapping	\$displayName\$	Display name
jidMapping	\$sAMAccountName\$@cms.ent-pa.com	User's JID
coSpaceNameMapping	\$displayName\$'s Meeting Space	Space name
coSpaceUriMapping	\$sAMAccount\$.space	Space primary URI
coSpaceSecondaryUriMapping	80044\$telephoneNumber!/.*([[:digit:]]{3})\$/1/\$	Space secondary URI

Note that the prefix for Space secondary URI varies depending on the site, and the last three digits are extracted from the user's DID number. Using the dial plan example from the [Call Control](#) chapter, the SJC site has prefix 80044, RTP site has prefix 80051, and RCD site has prefix 80065. Hence, the ldapMappings object will be created three times, one for each site.

After importing the user with the mappings in [Table 3-28](#), the user has the username `<username>@cms.ent-pa.com`, which can be used to sign in to the Cisco Meeting App. The user has an associated Space with primary URI `<username>.space@<domain>` and secondary URI `80044XXX@<domain>`. The domain is based on the domain name configured in the call matching table for incoming calls inside Cisco Meeting Server (see [Table 3-30](#)).

LDAP Sources are used to combine the LDAP Server, LDAP Mapping, user profile, and LDAP filter into a single source so that a specific group of users can be imported into Cisco Meeting Server. Use the parameters as listed in [Table 3-29](#) to create the ldapSources object (POST /ldapSources).

**Table 3-29** *ldapSources Object Parameters*

Parameter	Example Value	Description
server	<code>&lt;ldapServers id&gt;</code>	ldapServers object ID
mapping	<code>&lt;ldapMappings id&gt;</code>	ldapMappings object ID
userProfile	<code>&lt;userProfile id&gt;</code>	userProfile object ID
baseDn	ou=enterprise,dc=ent-pa,dc=com	Top level search base
filter	memberof=cn=sjcgroup,ou,ou=enterprise,dc=ent-pa,dc=com	LDAP filter

Note that the ID of the object can be retrieved using the GET operation. For example, to retrieve the ID of the ldapMapping object, use GET /ldapMappings. Also, each site will have different filter so that users at each site will be imported based on the Active Directory group to which the users belong. For example, SJC users should belong to **sjcgroup** Active Directory group, RTP users should belong to **rtpgroup** Active Directory group, and RCD users should belong to **rcdgroup** Active Directory group. Hence, three ldapSource objects will be created using the site-specific ldapMapping and filter.

After all LDAP Sources are created, use the ldapSyncs object (POST /ldapSyncs) to start the user synchronization immediately. When the synchronization is done, users from all sites and a Space for each imported user should be created in Cisco Meeting Server.

**Note**

Spaces can be created using an API or manually by users in the Cisco Meeting App.

Next, create dial plan rules in Cisco Meeting Server to handle incoming calls. Browse to one of the web admin interfaces and add the domains to the call matching table of incoming calls configured in the web interface (**Configuration -> Incoming Calls**) using the values in [Table 3-30](#). The domains are cms.ent-pa.com and top level domain ent-pa.com match incoming calls to sip URIs that are mapped according to the information in [table Table 3-30](#), and FQDN and IP address of all Call Bridges (us-cms-1.ent-pa.com, us-cms-2.ent-pa.com and us-cms-3.ent-pa.com).

**Table 3-30 Incoming Call Handling Configuration**

Domain Name	Priority	Targets Spaces	Targets Users	Targets IVRs	Targets Lync
cms.ent-pa.com	100	yes	yes	yes	no
ent-pa.com	100	yes	no	yes	no
us-cms-1.ent-pa.com	100	yes	no	no	no
us-cms-2.ent-pa.com	100	yes	no	no	no
us-cms-3.ent-pa.com	100	yes	no	no	no
10.x.x.60	100	yes	no	yes	no
10.x.x.61	100	yes	no	yes	no

All SIP URI calls that are dialed to cms.ent-pa.com are either for the Spaces or Cisco Meeting App users. Users calling into the Spaces using numeric dialing will hit the rules for the top level domain or the Call Bridge FQDNs or IP addresses.

## Summary

After you complete the deployment tasks outlined above, users can sign into their Space using Web app to specify PIN, add members, and customize other preferences. Users can then dial the SIP URI or numeric alias to start the meeting.

## 7. Deploy Cisco Meeting Management

This section describes the major deployment tasks for Cisco Meeting Management.

### Overview

#### Deployment Tasks for Cisco Meeting Management:

1. Deploy Cisco Meeting Management OVA and configure network settings
2. Connect Cisco Meeting Management to Cisco TMS
3. Add Cisco Meeting Server call bridges to be managed
4. Configure licensing mode
5. Configure LDAP settings and add LDAP user groups
6. Configure CMS web app user provisioning
7. Restart Cisco Meeting Management to save settings
8. Create a backup of Cisco Meeting Management

Cisco Meeting Management is the platform for managing the Cisco Meeting Server solution. Cisco Meeting Management displays active meeting information with controls for managing those meetings, manages Cisco Meeting Server licenses, as well as providing administrators the ability to provision users and space templates on managed Cisco Meeting Servers.

### Deployment Considerations

Cisco Meeting Management is mandatory with Cisco Meeting Server 3.0 or later and requires no additional licensing. Cisco Meeting Management can manage a single CMS call bridge to multiple clustered call bridges. Sizing Cisco Meeting Management depends on the call volume expected and the size of the Cisco Meeting Server deployment. Cisco Meeting Management reports on license utilization and manages the licensing with Cisco Smart Software Licensing.

Cisco Meeting Management uses LDAP directory for user authentication and LDAP groups to map the user group that determines the user's role. At least 2 LDAP directory groups are required for the deployment, create one group (e.g. CMMAdmin) for the administrators and another group (e.g. CMMOperator) for the video operators. Then decide on which user should belong to which group and assign users to the corresponding groups before proceeding with first-time setup.

### Deployment Tasks for Cisco Meeting Management

#### Deploy Cisco Meeting Management OVA

Meeting Management is available as an OVA file on [cisco.com](http://cisco.com) for all customers with a Cisco Meeting Server support contract. During the deployment of the Cisco Meeting Management OVA network settings are configured for the Cisco Meeting Management.

For details on first-time setup, refer to the latest version of the *Cisco Meeting Management Installation and Configuration Guide*, available at

<https://www.cisco.com/c/en/us/support/conferencing/meeting-management/products-installation-guides-list.html>

### Connect Cisco Meeting Management to Cisco TMS

Cisco Meeting Management uses the TMS Booking API connection to retrieve information about upcoming TMS scheduled meetings as well as for access to the TMS address books. In the Cisco Meeting Management web interface go to Settings -> TMS and use the values shown in [Table 3-31](#) for configuration information.

**Table 3-31 TMS Configuration**

Parameter	Example Value	Description
Use TMS with Meeting Management		Enable TMS integration
TMS Address	10.x.x.75	IP address or FQDN of TMS
Protocol	HTTPS	Protocol used to connect with TMS
Username	<username>	TMS site administrator user account
Password	<password>	Password of the user

Then go to **Settings** -> **NTP** and add the NTP server. The same NTP server should be used for Cisco Meeting Server and TMS in order to synchronize the time among the three components.

### Add Cisco Meeting Server call bridges to be managed

Add all call bridges within the cluster into Cisco Meeting Management for monitoring and management. Go to the Servers page and add a call bridge (any call bridge within the cluster) using the values in [Table 3-32](#) for the configuration.

**Table 3-32 Add Call Bridge Configuration**

Parameter	Example Value	Description
Server Address	10.x.x.60	IP address or FQDN of Call Bridge
Port	445	Port used by webadmin in Cisco Meeting Server
Display Name	US-CMS1	Meaningful name to represent the Call Bridge
Username	<user>	Local Cisco Meeting Server user with API access
Password	<password>	User password

Use the auto-discovered Call Bridge option to add the rest of Call Bridges within the cluster into Cisco Meeting Management. Cisco Meeting Management needs to know the Call Bridge that is added to TMS in order to show the scheduled meetings. To do so, the administrator needs to associate the Cisco Meeting Server cluster with TMS. Click on the **Associate cluster with TMS** link on top of the cluster table and use the values in [Table 3-33](#) for the configuration.

**Table 3-33 Associate Cluster with TMS Configuration**

Parameter	Example Value	Description
Connected Call Bridge	US-CMS1	Name of Call Bridge added to TMS
TMS System ID	<id>	TMS ID located in the Call Bridge settings page inside TMS

## Configure licensing mode

As of version 3.0 Cisco Meeting Management is required for licensing the Cisco Meeting Server. There are 3 modes for licensing the Cisco Meeting Server:

- Traditional licensing; which requires that valid license files are installed on all call bridges
- Smart licensing; which requires a Smart Account with the appropriate licensing in the Smart licensing Virtual account
- No licensing; used in resilient Cisco Meeting Management deployments

**Note**

All Cisco Meeting Servers must be configured to an instance of Cisco Meeting Management. In resilient deployments of Cisco Meeting Management only configure 1 Cisco Meeting Management for Smart Licensing. Having 2 Cisco Management server configured for Smart Licensing results in double counting of licenses available in the Smart account.

**To enable Traditional licensing for call bridges:**

Select Traditional from the Licensing tab in Cisco Meeting Management Licensing page

**To enable Smart licensing for call bridges:**

Sign in to your Cisco Smart Software Manager account and generate a token. Copy this token and enter it into the Cisco Meeting Management when prompted.

Go to the **Settings > Licensing** tab in Cisco Meeting Management and select Change

Select **Smart Licensing** and **Save**

Select **Register** and paste the token copied previously

Choose **Smart Licensing** and **Save**

Click on **Register**

Once registered go to the **Cisco Meeting Management Licensing** page and allocate Cisco Meeting Server licenses as required for the deployment

**Note**

Cisco Meeting Management has a Trial option that does not require licensing and is useful for testing CMS or optional features.

Cisco meeting management enforces license compliance at different time thresholds. See [Figure 3-17](#) for the enforcement work flow to maintain compliance.

**Figure 3-17 Licensing enforcement workflow**

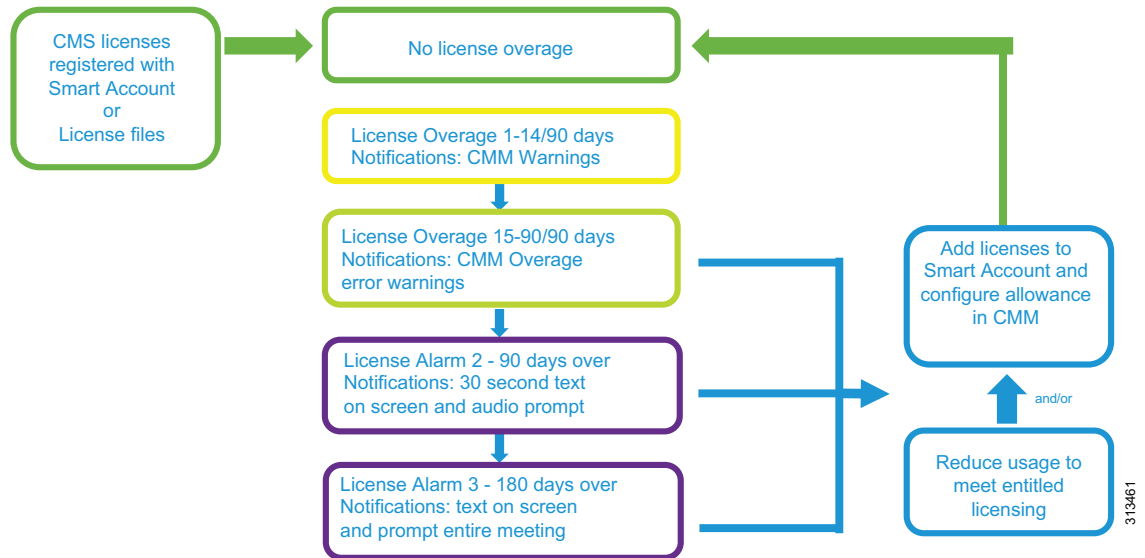

**Configure LDAP settings and LDAP user groups**

All users in Cisco Meeting Management reside in the LDAP directory that Meeting Management utilizes for user authentication. Therefore, after logging into the portal for the first-time, configure the LDAP server, user search base, and authentication information using the values in [Table 3-34](#).

**Table 3-34 First-Time Setup Server Configuration**

Parameter	Example Value	Description
<b>LDAP Server:</b>		
Protocol	LDAPS	Protocol used to access the directory
Server Address	10.x.x.10	IP address or FQDN of the directory
Port	636	Port number used by the directory
<b>Search Base:</b>		
Base DN	OU=Enterprise, DC=ent-pa, DC=com	Top-level user search base
Search Attribute	sAMAccountName	Attribute used to identify the user
<b>Authorization:</b>		
Bind DN	CN=tmssvc, OU=Enterprise, DC=ent-pa, DC=com	Service account used to access the directory
Password	<password>	Service account password

Cisco Meeting Management uses the LDAP group to map the user group and thus determine the user access privilege in the portal. At this point, map the LDAP group (CMMGroup) created previously for the administrator so that users can login to continue the setup. Use the example shown in [Table 3-35](#) to configure the group mapping.



**Table 3-35 Group Mapping Configuration**

Parameter	Example Value	Description
Group DN	CN=CMMAdmin, OU=Enterprise, DC=ent-pa, DC=com	LDAP group for administrator

After the first-time setup is complete, log into the Cisco Meeting Management portal using one of the administrator (user in CMMAdmin LDAP group) credentials. Once logged in, go to **Settings** -> **CDR** to set up the CDR receiver address using the IP address or FQDN of the Cisco Meeting Management server (for example, https://10.x.x.68). Cisco Meeting Management uses this address to construct the CDR receiver URI string in the Call Bridges to receive call related events.

Go to **Users** -> **User Groups** and use the values shown in [Table 3-36](#) for the configuration.

**Table 3-36 Video Operator Group Configuration**

Parameter	Example Value	Description
LDAP Path	CN=CMMOperator, OU=Enterprise, DC=ent-pa, DC=com	LDAP group for video operators
Role	Video Operators	Role for the user group

### Configure CMS web app user provisioning

This section describes the major tasks for configuring Cisco Meeting Management to enable user provisioning.

An administrator can use Cisco Meeting Management to provision users and spaces for Cisco Meeting Servers managed by the Cisco Meeting Management. Cisco Meeting Management leverages LDAP to enable provisioning.

Supported LDAP implementations are:

- Microsoft Active Directory
- Open LDAP
- Oracle Internet Directory (LDAP v3)



#### Note

If Cisco Meeting Server LDAP has been configured by using the Cisco Meeting Server web user interface the configuration must be removed from Cisco Meeting Server web user interface configuration page before configuring Cisco meeting Management for LDAP.

### Configuration Tasks for Cisco Meeting Management user/space provisioning

Refer to [Table 3-34](#) in Deployment Tasks for Cisco Meeting Management for the LDAP details needed to configure provisioning in Cisco Meeting Management.

The number of PMP+ licenses is also required.

Add LDAP server(s) for provisioning in Cisco Meeting Management by going to **Servers > Setup provisioning**

In the **Servers** page click **Set up provisioning** and enter details for the LDAP server(s)

Default port numbers for LDAP server

- LDAP: 389
- LDAPS: 636 (Recommended)

**Note**

Changes in configuration of Cisco Meeting Management must be committed, otherwise, changes are lost if Cisco Meeting Management is restarted.

**Provisioning**

Import users by going to the Provisioning page Import users and define which users will be imported for provisioning. The users are a subset of users in an LDAP server configured above. Multiple user imports can be configured as needed. However, it is recommended that users are only configured in one import as Cisco Meeting Management cannot differentiate between users to add to groups.

- Go to **Servers > Set up provisioning**
- On Import users tab select Add user import
- Add a name that distinguishes the import defined.
- From the drop down menu for LDAP servers select the LDAP server to apply the user import.
- Enter Base DN for the search starting point for users
- Enter LDAP search filters as desired.
- Enter Login user mapping as desired.
- Enter Display name as desired.
- For each group of users sign-in user name mapping ie: **\$sAMAccountName\$@example.com** and display name mapping ie: **\$cn\$**.
- If desired check the **Assign Personal Multiparty Plus (PMP+) license** to imported users check box.

Once provisioning for users is configured additional provisioning permissions can be defined.

**Automatically create spaces for users:**

This configuration automatically creates spaces for users using existing space templates or templates created for automatically created spaces. Rules are created to map subsets of users to templates. The spaces created automatically are not activated until the provisioned web app users logs and selects to enable the space.

**Allow users to create spaces:**

The ability for provisioned Cisco Meeting Server web app users to create spaces is done by assigning specific templates to specific user imports. On the **Provisioning page > Allow users to create spaces** tab templates are selected or created and assigned to specific groups of users.

In order for users to be imported and have the provisioning settings applied Cisco Meeting Management and the configured LDAP servers must be synchronized. Cisco meeting Management LDAP synch can also be used for synchronizing any changes to LDAP such as added or removed users.

On the Provisioning page under the LDAP sync tab LDAP sync can be initiated as well as scheduled. Syncs can be triggered manually as needed from this tab or can be scheduled at regular intervals.

**Restart Cisco Meeting Management to save configured settings**

Changes will not be applied before you have committed them. After you have committed the changes, template settings will take effect immediately. Changes to LDAP server details and any changes that affect users will take effect next time the Meeting Server is synchronized with the LDAP servers.

## Create a backup of Cisco Meeting Management

It is recommended that you always create a new backup before you make any changes to Meeting Management. The backup contains:

- Configuration
- Database

In the Cisco Meeting Management interface go to **Settings > Backup and Restore > Download backup file**. Save the file in a secure location.

## Summary

After you complete the deployment tasks outlined above, video operators can login to the Cisco Meeting Management portal to monitor and manage meetings for Cisco Meeting Server. CMS web app users are also provisioned as required for user spaces, templates and permissions for creating their own spaces.

## Related Documentation

For additional information about Cisco Meeting Server, refer to the latest version of the following documents, available at the links provided below:

- Cisco Meeting Server deployment guides and certificate guideline documents  
<https://www.cisco.com/c/en/us/support/conferencing/meeting-server/products-installation-and-configuration-guides-list.html>
- Cisco Meeting Server API Reference Guide  
<https://www.cisco.com/c/en/us/support/conferencing/meeting-server/products-programming-reference-guides-list.html>
- Cisco Meeting Server release notes  
<https://www.cisco.com/c/en/us/support/conferencing/meeting-server/products-release-notes-list.html>
- Cisco Meeting Management documentation  
<https://www.cisco.com/c/en/us/support/conferencing/meeting-management/series.html> - Configuration
- Cisco Meeting Server web app documentation  
<https://www.cisco.com/c/en/us/support/conferencing/cisco-meeting-app/series.html>





# Collaboration Edge

**Revised: May 21, 2021**

This chapter describes the Collaboration Edge preferred architecture, which includes a series of servers and gateways defining access to services at the perimeter of a collaboration network. The Collaboration Edge preferred architecture provides access to public networks, including the Internet and PSTN.

The chapter presents a detailed [Architecture](#) description of Collaboration Edge, followed by a [Deployment Overview](#) section that describes how to deploy Cisco Expressway for Internet access and Cisco Unified Border Element for PSTN access. The chapter also covers [High Availability for Collaboration Edge](#), [Security for Collaboration Edge](#), and [Scaling the Collaboration Edge Solution](#). Then the section on the [Collaboration Edge Deployment Process](#) presents more detailed information on deploying Cisco Expressway, Cisco Unified Border Element, and Cisco voice gateways.

## What's New in This Chapter

[Table 4-1](#) lists the topics that are new in this chapter or that have changed significantly from previous releases of this document.

**Table 4-1** *New or Changed Information Since the Previous Release of This Document*

New or Revised Topic	Described in:	Revision Date
Minor Edits		May 21, 2021

## Core Components

The core components of the Collaboration Edge architecture are:

- Cisco Expressway-C and Expressway-E, for Internet connectivity and firewall traversal for voice and video
- Cisco Unified Border Element, for audio PSTN connectivity via IP trunks
- PSTN voice gateway, for direct audio PSTN connectivity

## Key Benefits

- Connect to customers and partners, independent of the technology they are implementing and the public network they are using.
- Provide for a resilient, flexible and extendable architecture.
- Provide any hardware and software client with the ability to access any public network (Internet and PSTN).
- Provide secure VPN-less access to collaboration services for Cisco mobile and remote clients and endpoints.

## Architecture

The architecture for Collaboration Edge interfaces with two major networks: Internet and PSTN.

Internet connectivity enables VPN-less Mobile and Remote Access (MRA) and business-to-business communications. These services allow Jabber users and hardware endpoints to access corporate collaboration services securely outside the organization's network boundaries, and they provide business-to-business audio and video communications with external organizations.

Cisco Expressway-C and Expressway-E should be deployed as a pair and in almost all cases where a firewall boundary needs to be traversed. Expressway-C sits in the internal network and Expressway-E in the demilitarized zone (DMZ), one for each side of the firewall, in order to enable firewall traversal capabilities. In addition, each Expressway-C and Expressway-E can be clustered. (See [Figure 4-1](#).) In most cases the firewall boundary crossed is an Internet connection, but it could also be a separate corporate WiFi network for Bring Your Own Device (BYOD) connections.

Figure 4-1 High-Level View of the Architecture

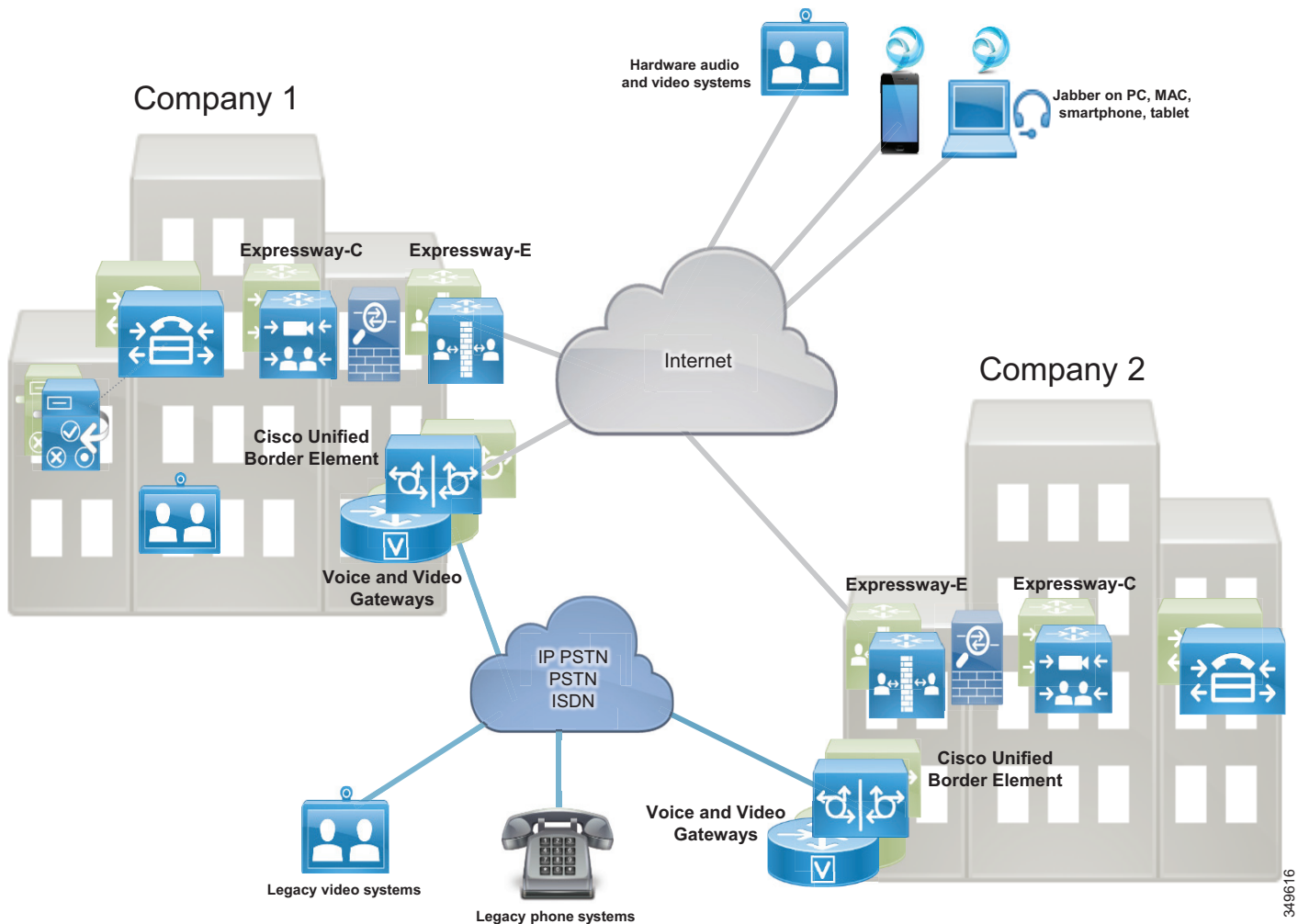

PSTN connectivity enables audio and video communications to Telecom carrier networks. The PSTN connection can be achieved in multiple ways:

- Through an IP trunk to a Telecom carrier, usually for voice-only services. This connectivity is provided by the Cisco Unified Border Element (CUBE) on a Cisco Integrated Services Router (ISR), a Cisco Aggregation Services Router (ASR) or a Catalyst Edge platform. Cisco Unified Border Element should be deployed in a central site where the Telecom carrier's network communicates with the enterprise network.
- Through voice gateways. Gateways include analog and ISDN interfaces on a variety of router platform, such as Cisco Integrated Services Routers (ISR). In this document only ISDN voice interfaces are considered. Voice gateways should be deployed locally in the sites where a PSTN connection is required

There are cost savings associated with deploying Internet communications for video calls (Expressway) and IP PSTN connections for audio-only calls (CUBE). However, it is worth noting that, although IP network reliability is increasing over time, network connectivity problems might prevent remote sites from accessing centralized IP PSTN services. If such sites are relying heavily on PSTN connectivity to run daily business, we recommend a local PSTN connection used as backup for the centralized access.

The recommendations for PSTN are:

- Centralize PSTN, which will help reducing operational costs and expenses.
- Local PSTN connections maintained only for those sites highly relying on PSTN to run daily business. In these cases, the number of ISDN channels should be reduced because they will be used only in those situations where central PSTN access is not available. This would help save money by reducing hardware costs and simplifying the management.

Based on the above considerations, IP trunk connections to the PSTN for voice, with local PSTN breakout used as backup and Internet for video, satisfy the vast majority of connectivity requirements.

Cisco Collaboration Edge includes scenarios where users have access to the following options:

- Mobile and Remote Access (MRA) for teleworkers and mobile connectivity
- Business-to-business video communications between organizations
- PSTN for cellphones and access to landlines

Under these scenarios any corporate user inside the company or on the Internet has access to PSTN voice calls and business-to-business communications as if they were inside the enterprise. Services such as hold, transfer, and conference are also available in most cases. Independently from who is calling whom, the Collaboration Edge solution enables interconnectivity between mobile and remote access, business-to-business, PSTN voice, and video services.

## Role of Expressway-C and Expressway-E for Internet Access

Use of the Internet for collaboration services continues to increase in popularity and is quickly replacing existing legacy ISDN video systems. The two primary protocols leveraged for Internet based collaboration services are SIP and H.323.

Moreover, the Internet is also used to connect remote and mobile users to voice, video, IM and presence, and content sharing services without the use of a virtual private network (VPN).

Mobile and remote access, as well as business-to-business services, can be enabled as part of the same Expressway-C and Expressway-E solution pair. Expressway-C is deployed inside the corporate network, while Expressway-E is deployed in the DMZ.

The Expressway-C and Expressway-E pair performs the following functions:

- Interworking — The capability to interconnect H.323-to-SIP calls for voice, video, and content sharing.
- Boundary communications services — While Expressway-C sits in the corporate network, Expressway-E is in the enterprise DMZ and provides a distinct connection point for communication services between the enterprise network and the Internet.
- Security — The capability to provide authentication and encryption for both mobile and remote access and business-to-business communications.

Mobile and remote access and business-to-business calls flow through Expressway-E and Expressway-C, which handle both call signaling and media as well as other collaboration data flows, including XMPP and HTTP.



## Mobile and Remote Access

The mobile and remote access feature of the Cisco Expressway solution provides secure reverse proxy firewall traversal connectivity, which enables remote users and their devices to access and consume enterprise collaboration applications and services.

As shown in [Figure 4-2](#), the Cisco Expressway solution encompasses two main components: the Expressway-E peer and the Expressway-C peer. These two components work in combination with Cisco Unified Communications Manager (Unified CM) to enable secure mobile and remote access. The Expressway-E peer provides the secure edge interface to mobile and remote devices.

Expressway-C creates a secure connection with the Expressway-E peer. The Expressway-C peer provides proxy registration to Unified CM for remote secure endpoint registration. The Expressway-C peer includes a back-to-back user agent (B2BUA), which provides media termination capabilities.

[Figure 4-2](#) shows that both signaling and media traverse Expressway-C and Expressway-E for all mobile and remote access calls.

**Figure 4-2** B2BUA and Call Legs on Expressway

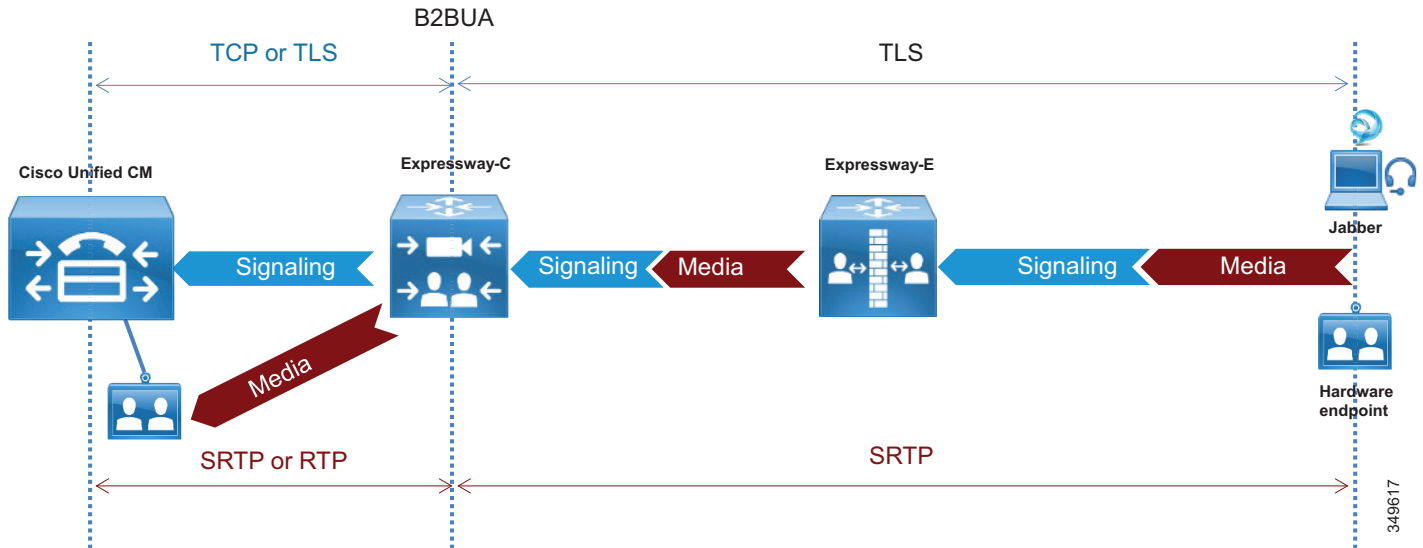

349617

## Business-to-Business Communications

Expressway-C and Expressway-E are designed to work together to form a firewall traversal solution that is the core component for business-to-business communications over the Internet.

Expressway-C sits on the inside (trusted side) of the enterprise network and serves the role of providing a secure, trusted, and standards-based way of connecting to Expressway-E. It acts as a traversal client to all devices behind it. This solves the problem for devices using a large number of media ports by multiplexing all of the media to a very small number of ports opened for outbound communications. It provides an authenticated and trusted connection from inside the enterprise to outside by sending keep-alives for the traversal zone from Expressway-C to Expressway-E. Additionally, it provides a single point of contact for all Internet communications, thus minimizing the security risk. (See [Figure 4-3](#).)

**Figure 4-3** Expressway-C Multiplexing and Keep-Alive

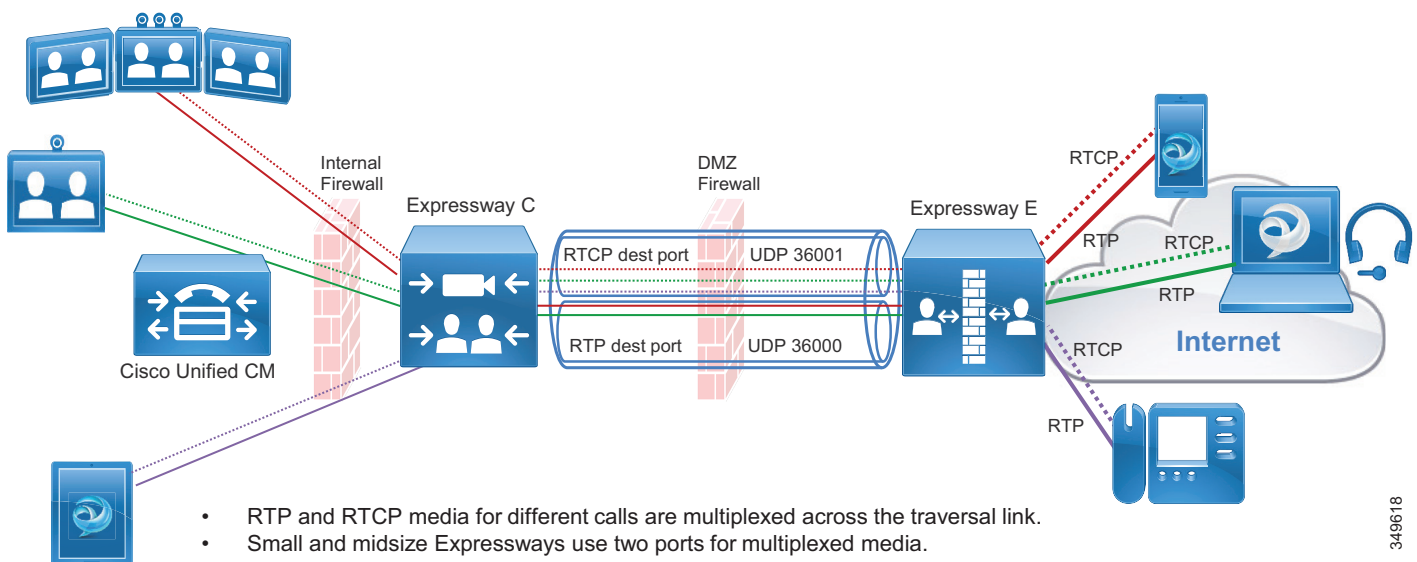

Real-time and near real-time communication protocols such as SIP, H.323, and XMPP do not address the need to communicate with devices that might be behind a firewall. Typical communications using these protocols include the device IP address in the signaling and media, which becomes the payload of the TCP and UDP packets, respectively. When these devices are on the same internally routable network, they can successfully communicate directly with each other. The signaling IP address carried in the payload of the TCP packet is routable back to the initiating device, and vice versa. However, when the initiating device is on a different network behind a public or network edge firewall, two problems are encountered. The first problem is that the receiving device, after decoding the packet, will respond to the internal IP address carried in the payload. This IP address is typically a non-routable RFC 1918 address and will never reach the return destination. The second problem encountered is that, even if the return IP address is routable, the media (which is RTP/UDP) is blocked by the external firewall. This applies to both business-to-business and mobile and remote access communications.

Expressway-E sits at the network edge in the DMZ. It serves the role of solving both the signaling and media routing problems for SIP, H323, and XMPP, while maintaining standards interoperability. It changes the appropriate headers and IP addresses to process the media and signaling on behalf of the endpoints, devices, and application servers that are inside the network.

## Instant Messaging and Presence Federation

Instant messaging and presence federation involves allowing users to send XMPP traffic through an organization's external firewall for chat and presence status information to and from users in another organization.

Prior Cisco architectures included using the Cisco Adaptive Security Appliance (ASA) firewall and allowing inbound ports to be opened through the external firewall to directly access the internal IM and Presence servers. This is still the recommended solution for SIP federation.

XMPP federation uses the same Expressway-C and Expressway-E paired architecture for a trusted secure firewall traversal solution for XMPP traffic to and from external destinations. Expressway-E provides a secure DMZ-based termination point for XMPP to the Internet. Expressway-C provides a TLS-based authenticated secure connection to Expressway-E for firewall traversal, and as such does not require any port to be opened on the firewall.

Expressway-C also provides an AXL API connection to the IM and Presence server. The AXL API sends XMPP server-to-server information collected from Expressway-E to the IM and Presence database. This provides the IM and Presence server with the necessary connection information to initiate a federated connection to the other organization through Expressway-E without opening any other ports on the firewall. XMPP federation allows voice and video escalation. The same organization might implement both XMPP and SIP federation at the same time.

## PSTN Access

This section describes the architecture for PSTN access using Cisco Unified Border Element as the session border controller (SBC).

### Role of the Cisco Unified Border Element

Voice connectivity using IP trunks to Telecom carriers, instead of traditional PSTN connections, is increasing in popularity and gradually replacing existing TDM-based PSTN access. SIP is commonly used as the access protocol for connectivity into provider networks, and today many Telecom carriers offer a voice-only service to the PSTN through a session border controller such as Cisco Unified Border Element. Session border controllers are SIP back-to-back user agents (B2BUAs) and are typically used in flow-through mode, where both the voice media and SIP signaling for each call flow through the Cisco Unified Border Element. (See [Figure 4-4](#).)

Cisco Unified Border Element is a licensed Cisco IOS application available on a wide range of Cisco router and gateway platforms, and it is the recommended platform to connect to the PSTN through a SIP trunk to the Telecom carrier's border element.

Cisco Unified Border Element enables enterprise voice networks based on Cisco Unified Communications Manager (Unified CM) to connect to and interoperate with Telecom carriers through SIP trunk services. Cisco Unified Border Element terminates and re-originates both signaling and media streams to provide secure border interconnection services between IP networks. Using Cisco Unified Border Element, customers can save on their current network services, simplify their network architectures, and position their networks for ongoing enhancements in collaboration services.

**Figure 4-4 Cisco Unified Border Element as B2BUA**

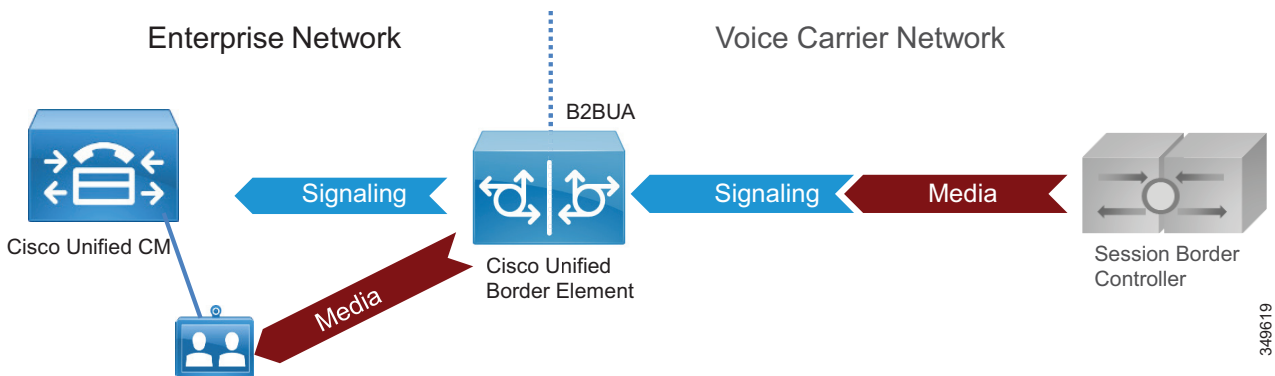

Cisco Unified Border Element performs the following functions between the enterprise and Telecom carrier networks:

- Session control — The capability to offer flexible trunk routing, call admission control, resiliency, and call accounting for the SIP sessions.
- Interworking — The capability to offer media transcoding services for voice, and interoperability between SIP Delayed Offer and Early Offer.
- Demarcation — The capability to act as a distinct demarcation point between two networks for address and port translation and to facilitate troubleshooting.
- Security — The capability to intelligently allow or disallow real-time traffic between networks, and to encrypt the real-time traffic as appropriate for the application.

## Role of Voice Gateways

We recommend using TDM gateways to connect to the PSTN if centralized PSTN access is not available. Cisco offers a full range of TDM gateways for analog and digital connections to the PSTN on Integrated Services Routers (ISR) with appropriate interface cards enabling: low-density digital (BRI), high-density digital (T1, E1, and T3), and analog (FXS, FXO, and E&M) interfaces.

For more information on voice gateways, refer to the documentation for Cisco Integrated Services Routers available at:

<https://www.cisco.com/c/en/us/products/routers/branch-routers/index.html>

# Deployment Overview

This section presents a general description of how to deploy Cisco Expressway for Internet connectivity and Cisco Unified Border Element for PSTN access.

## Deployment of Expressway for Internet Connectivity

The standard deployment of the Cisco Collaboration Edge architecture involves deploying at least one Expressway-C and Expressway-E pair for secure mobile device and remote VPN-less access back to enterprise collaboration services.

Both Expressway-C and Expressway-E should be deployed in a cluster to provide better resiliency. The number of servers for each cluster depends on the number of the concurrent proxied registrations to Unified CM and the number of concurrent calls. While the first takes into consideration mobile and remote users who register through Expressway to Unified CM, the second accounts for concurrent calls for business-to-business and for mobile and remote access (MRA). (See the [Sizing](#) chapter for details.)

This service is provided to Jabber clients, selected IP Phone models, and Cisco video devices running TC or CE Software. Frequently, multiple pairs of Expressway-C and Expressway-E are deployed for geographic coverage and scale, providing access to multiple instances of collaboration services. GeoDNS should be used to balance remote client and endpoint access based on a variety of metrics from the Internet service provider.

This same Expressway can be leveraged for business-to-business communications as well. When the volume of calls exceeds the capacity of the Expressway cluster, business-to-business and MRA services have to be split over different boxes (see the [Sizing](#) chapter for details).

When Expressway is used for both services, Unified CM is connected to Expressway-C through a SIP trunk for unified business communications access over the Internet. Expressway-C sits on the trusted side of the network, providing secure firewall traversal services to Expressway-E.

Based on the enterprise security policy, a number of different deployment models can be implemented. In this document we focus on a DMZ deployment with a dual interface because it is the most common and secure deployment model. For additional deployment models, refer to the latest version of the [Cisco Expressway Basic Configuration Deployment Guide](#).

Expressway-C and Expressway-E provide firewall traversal capabilities. Firewall traversal works as follows:

1. Expressway-E is the traversal server installed within the enterprise DMZ. Expressway-C is the traversal client installed inside the enterprise network.
2. Expressway-C initiates traversal connections outbound through the firewall to specific ports on Expressway-E, with secure login credentials. If the firewall allows outbound connections, as it does in the vast majority of cases, no additional ports are required to be opened in the enterprise firewall. For ports details, refer to the latest version of the document on [Cisco Expressway IP Port Usage Configuration Guide](#).

Mobile and remote access requires a separate traversal zones, called the Unified Communications traversal zone. The Unified Communications traversal zone works with SIP and requires TLS and media encryption, while the business-to-business traversal zone allows SIP and H.323 as voice and video signaling protocols. The Unified Communications traversal zone also allows XMPP and HTTPs, which are used to connect to IM and Presence servers and for provisioning purposes.

3. Once the connection has been established, Expressway-C sends periodic keep-alive packets to Expressway-E to maintain the connection.

4. When Expressway-E receives a call or other collaboration service request, it issues an incoming request to Expressway-C reusing the same connection that has been created by the Expressway-C outbound to Expressway-E.
5. Expressway-C then routes the request to Unified CM or other collaboration service applications.
6. The connection is established, and application traffic (including voice and video media) traverses the firewall securely over an existing traversal connection.

In order for firewall traversal to work, a traversal client zone has to be configured on Expressway-C and a traversal server zone has to be configured on Expressway-E. Figure 4-5 summarizes the firewall traversal process.

**Figure 4-5 Expressway-C and Expressway-E Firewall Traversal Process**

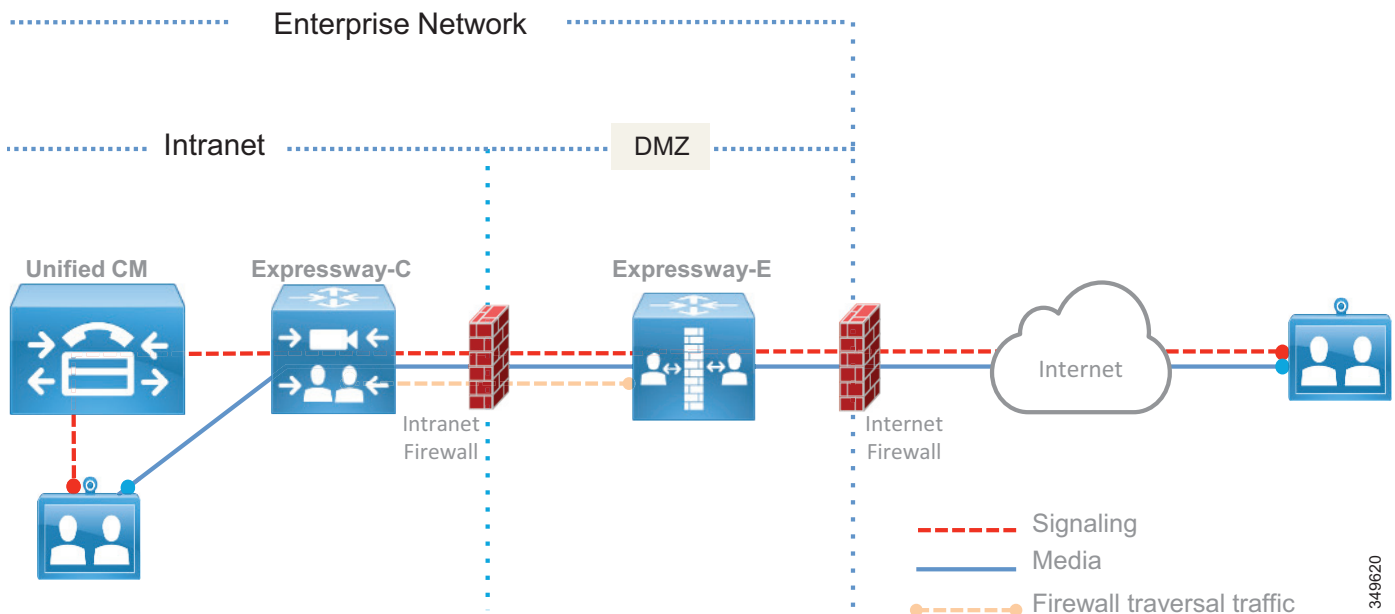

Although Expressway-E can be deployed with a single LAN interface or with dual LAN interfaces, we recommend using dual interfaces. In the dual-interface deployment scenario, Expressway-E sits in the DMZ between two firewalls: the Internet firewall provides for NAT services toward the Internet, and the intranet firewall provides access to the corporate trusted network.

Expressway-E has two LAN interfaces: one toward the Internet firewall (also called the *external interface*), and the other toward the intranet firewall (also called the *internal interface*).

There is no need for the external interface to be assigned a public IP address because the address can be translated statically by NAT. In this case, the public IP address that is used in NAT must be configured as the "Static NAT address" on Expressway-E.

Expressway-C has an embedded B2BUA to terminate mobile and remote access as well as business-to-business calls. Every mobile and remote access call requires an instance of B2BUA, and every business-to-business call might require an instance of B2BUA, depending on the encryption settings. Expressway-E has an embedded B2BUA used to terminate business-to-business calls. Expressway-C and Expressway-E have other B2BUAs dedicated to different services, such as H.323-to-SIP protocol interworking.

349620

The B2BUA terminates collaboration application traffic. A connection from the Internet to Expressway-C via Expressway-E is always encrypted for mobile and remote access, while the connection between Expressway-C and the Unified Communications Manager endpoint can be encrypted or not based on the configuration. A connection from the Internet for business-to-business communications may or may not be encrypted, based on the configuration and dictated by the corporate policies. This document focuses on the scenario where encryption is achieved on all of the different call legs involved in the same call. This requires Cisco Unified CM to Expressway configuration for authentication and encryption. Encryption capabilities are discussed further in the section on [Security for Collaboration Edge](#).

Expressway-C proxies the registration of mobile and remote access clients or devices to Unified CM, which lists them as registered devices with the IP address of Expressway-C.

Figure 4-6 shows the deployment described above. The relevant IP addresses are shown in the figure. Public IP addresses, which will vary based on location and Internet service provider, are shown with letters instead of digits.

Expressway-E has two interfaces; the internal interface has IP address 172.16.20.20, while the external interface has IP address 192.168.25.2. The external interface IP address is statically translated to X.Y.W.Z. This address is also configured on Expressway-E. When Expressway-E sends an INVITE, it creates the Session Description Protocol (SDP) message with the IP address set to the translated interface address instead of using its own address, so that the called party can use the public routable address instead of the private one.

**Figure 4-6 NAT Interfaces on the Internet Firewall**

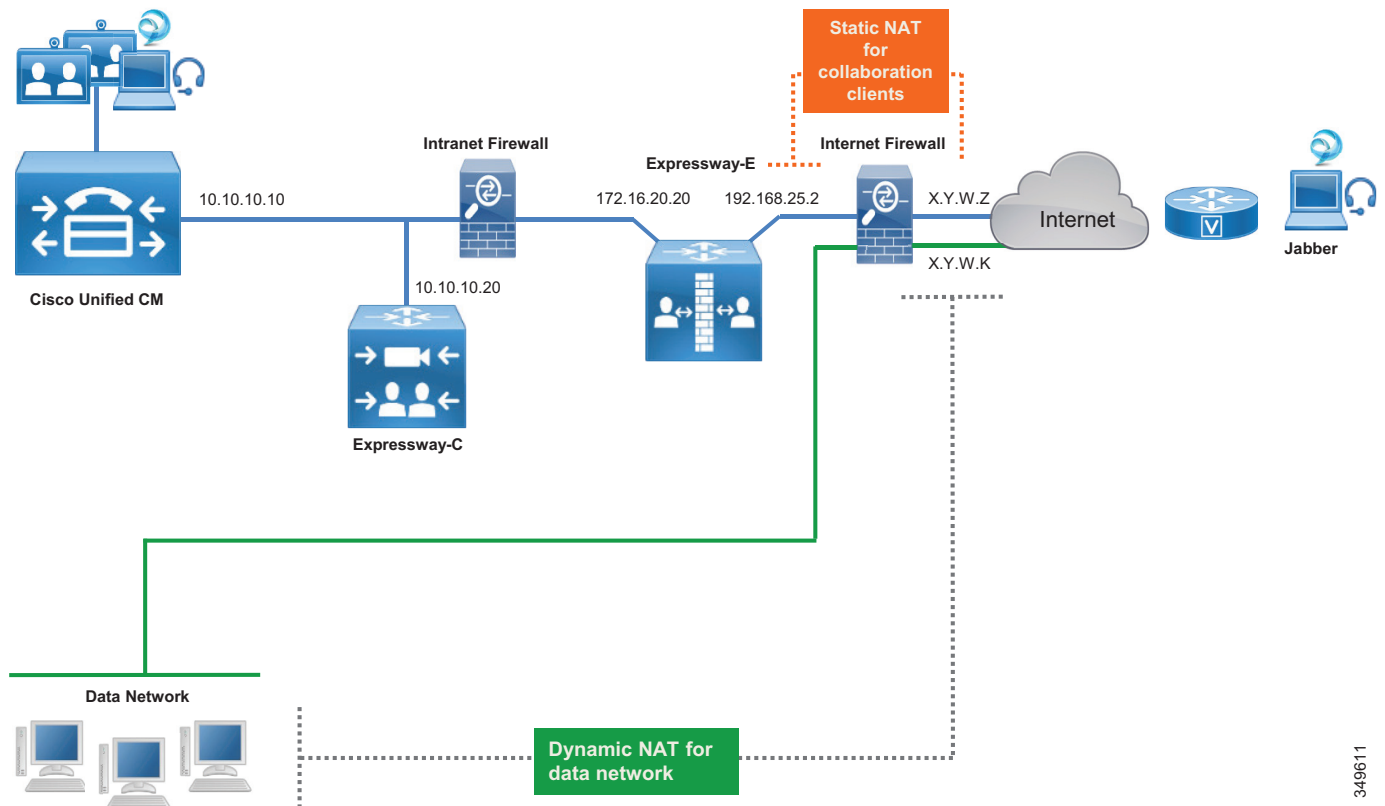

349611

When an endpoint on the Internet connects to Unified CM or other collaboration application through Expressway, its IP address is first translated to a public IP address by the local customer premises equipment (CPE). On Expressway-E, the endpoint source IP address is replaced by the address of the internal IP LAN interface of Expressway-E. When the packet enters Expressway-C, Expressway-C replaces the source IP address of the packet with its own IP address before forwarding the packet to the collaboration service applications.

In the other direction, when traffic from internal endpoints traverses the Expressway toward the Internet, their source IP addresses are replaced by the Expressway-E external LAN interface address, which is later statically translated by NAT on the Internet firewall. Source IP addresses of data devices are dynamically translated to X.Y.W.K by using another interface of the Internet firewall.

For a PC with data and a communication application, such as Jabber and a browser, the Jabber application address would be statically translated by NAT and the browser application address would be dynamically translated by NAT.

Even if the static NAT translation occurs in the firewall, the packet source IP address is transformed during its travel: it is translated to the IP address of Expressway-C when the packet goes from Expressway-C to Expressway-E, and it is translated to the IP address of Expressway-E when the packet goes from Expressway-E to the firewall. In the firewall, the packet is statically translated by NAT and sent to the Internet.

## Mobile and Remote Access

In the case of call control services, Expressway-C proxy registers the endpoint to Unified CM using its own IP address, as shown in [Figure 4-7](#).

**Figure 4-7** NAT in the Life of a Packet

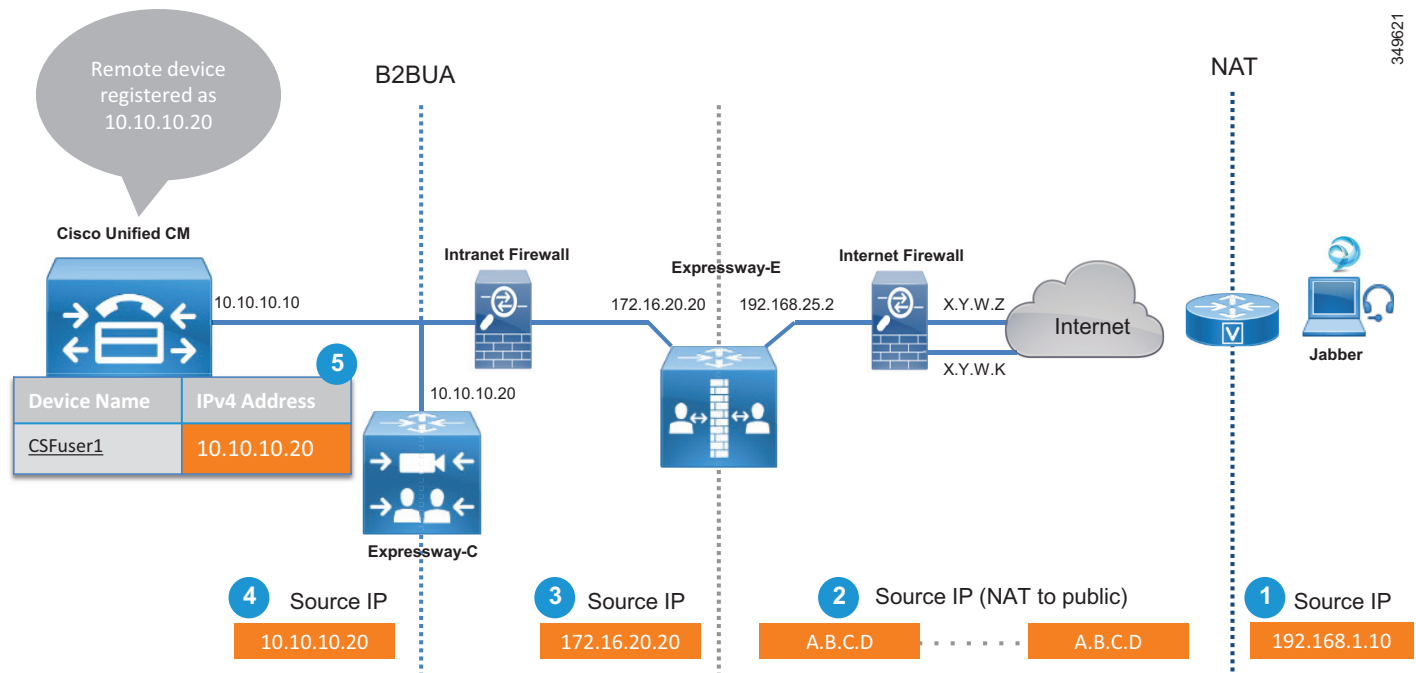



The address translation process shown in [Figure 4-7](#) involves the following steps:

1. The source IP address of the endpoint is translated by NAT at the router that gives access to the Internet (192.168.1.10 to A.B.C.D.) if the endpoint does not have a public IP address.
2. The packet arrives at Expressway-E.
3. Expressway-E sends the packet to Expressway-C by using its own internal LAN interface address (A.B.C.D to 172.16.20.20).
4. Expressway-C receives the packet and terminates the connection. It re-originates another connection toward Unified CM by using its own IP address (172.16.20.20 to 10.10.10.20).
5. The endpoint is registered on Unified CM with the IP address of Expressway-C (10.10.10.20).

Registering the device to Unified CM with the IP address of the Expressway-C has some inherent benefits. For example, it is possible to limit the video bandwidth of remote devices when they are not connected directly to the corporate network, and assign them a different value when they are on-premises. Although we do not discuss it here, this can easily be achieved through the use of mobility features on Unified CM, which allow for definition of specific policies based on the IP address range.

When an endpoint is registered through the Internet, it cannot be managed remotely by the Cisco Collaboration architecture. This is because the endpoint IP address is dynamically translated and is behind a firewall. If remote management is required, deploy the endpoint through a VPN. The exception to this is an endpoint upgrade, which can be done remotely even if the endpoint is behind a firewall.

VPN technologies are not part of this architecture, but can be added as required.

Mobile and remote access has to be enabled on Expressway-E and Expressway-C. Expressway-C can then be configured to discover Unified CM and IM and Presence clusters by specifying the DNS name of the Unified CM and IM and Presence publisher nodes.

Expressway-E, deployed in the DMZ, provides a trusted point of entry for Jabber clients and TelePresence endpoints that use the mobile and remote access service.

Expressway-C connects to Unified CM and IM and Presence clusters and Cisco Unity Connection using HTTPs, SIP, and XMPP. (See [Figure 4-8](#).)

Moreover, there are a number of cases where Jabber has to connect via HTTP to a specific server; for example, for Visual Voicemail, Jabber Update Server, custom HTML tabs and icons, and directory photo host. In these cases Jabber would connect directly to these servers without passing through Unified CM, and Expressway-C would need an HTTP allow list that specifies which servers the Jabber client is allowed to connect to.

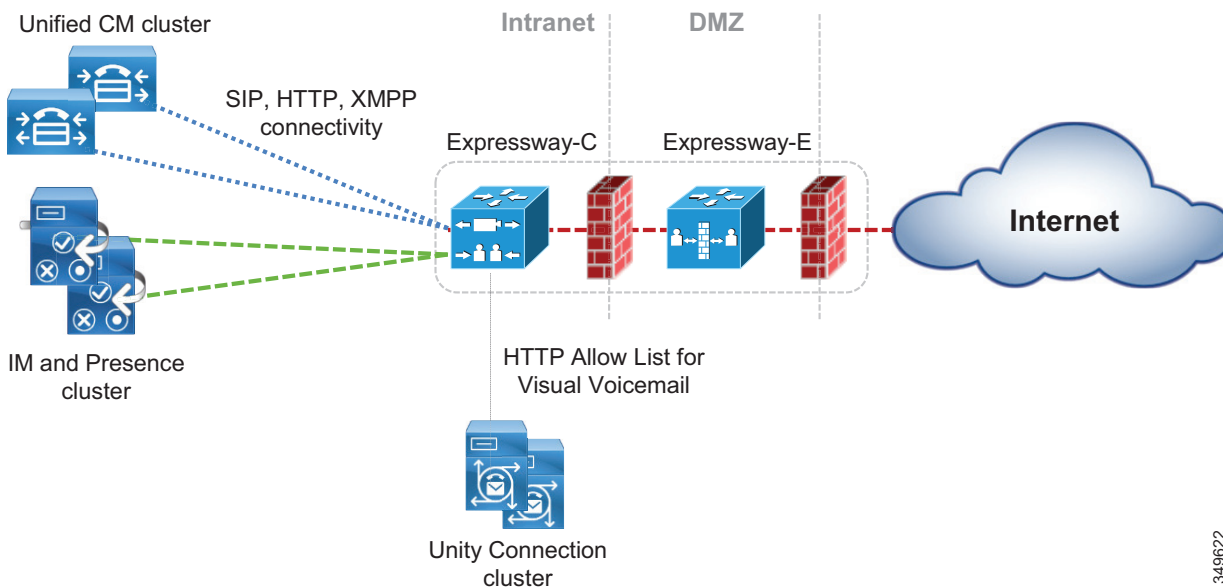
**Figure 4-8 Expressway Connection to Unified CM, IM and Presence Service, and Unity Connection**

349622

Table 4-2 summarizes the protocols used by Expressway for mobile and remote access.

**Table 4-2 Expressway Protocols for Mobile and Remote Access**

Protocol	Security	Service
SIP	TLS	Session establishment – register, invite, and so forth
HTTPS	TLS	Login, provisioning, configuration, contact search, visual voicemail
XMPP	TLS	Instant messaging, presence
RTP	SRTP	Audio, video, content sharing, advanced control

When a Jabber or hardware endpoint user logs in, they specify the discovery domain, user ID and password. Jabber concatenates the User ID and the discovery domain in a fully qualified name (for example, user1@ent-pa.com). The client queries the public DNS server for specific SRV records:

- `_cisco-uds._tcp.ent-pa.com`, which is configured only on the corporate DNS server.
- `_collab-edge._tls.ent-pa.com`, which is configured only on the public DNS server and resolves to the public interfaces of the Expressway-E cluster. Note that this record always specifies TLS.

If the client is connected over the Internet, no answer will be provided by the public DNS server for `_cisco-uds`, but the client will receive an answer for the `_collab-edge` SRV record.

The DNS server will then send the A-record for Expressway-E (or multiple records if Expressway-E is clustered) to the client. Once the client knows the DNS name of Expressway-E, it can start the provisioning and registration procedure.

While provisioning takes place by using HTTPs, registration uses SIP and XMPP.

Expressway-C has an HTTPs reverse proxy server feature to manage the provisioning process. A reverse proxy is the opposite of the most common forward proxy server, also referred to as the *proxy server*.

As shown in Figure 4-9, while a forward proxy server provides services information for on-premises clients by hiding client details when connecting to Internet servers, a reverse proxy server provides information for off-premises clients by hiding on-premises server information.

Expressway-C has a reverse proxy feature that provides provisioning, registration, and service details to the clients on the Internet, on behalf of collaboration application servers such as Cisco Unified CM, IM and Presence, and Unity Connection.

**Figure 4-9 Forward Proxy vs. Reverse Proxy Server**

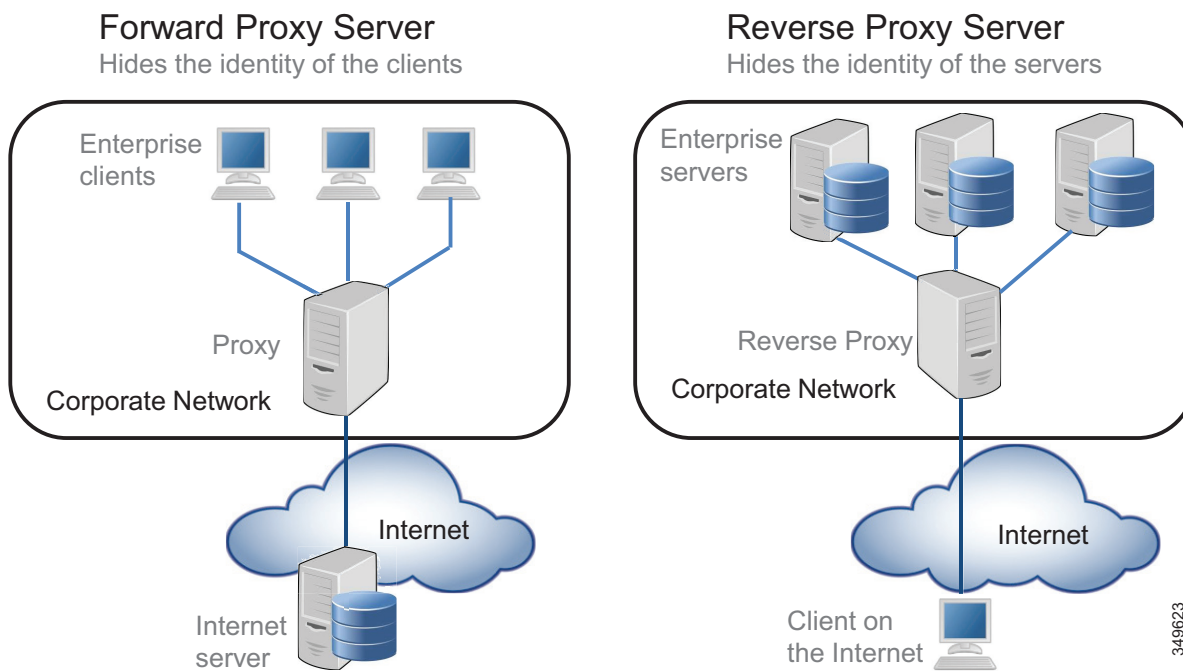

Also consider that for services like Visual Voicemail, Jabber Update Server, custom HTML tabs and icons, directory photo host, Expressway-C will allow these connections if these services are specified under the *HTTP allow list*, which is a type of access list for HTTP services.

Provisioning and registration are multi-step processes that involve the client, Expressway-C, Expressway-E, Unified CM, and IM and Presence server.

The following is an overview of the major steps involved when a client registers through the Collaboration Edge.

1. Provisioning starts with the `get_edge_config` request issued from the client. For example:
 

```
https://expressway_e.ent-pa.com:8443/ZeW50LXBhLmNvbQ/get_edge_config?service_name=_cisco-uds&service_name=_cuplogin
```

Along with the request, the client sends the credentials of the user (For example, username "user1", password "user1"). The query is sent to Expressway-E, which forwards it to Expressway-C.

2. Expressway-C performs a UDS query to Unified CM to determine the home cluster for user1. This is essential for multi-cluster scenarios:

```
GET cucm.ent-pa.com:8443/cucm-uds/clusterUser?username=user1
```

3. Once the home cluster is found, a response is sent to Expressway-C. This response includes all servers in the cluster.

4. Expressway-C asks the home cluster for provisioning information by making the following queries for user1 on behalf of the client:

**GET /cucm-uds/user/user1/devices** retrieves the devices association list.

**GET /cucm-uds/servers** retrieves the list of servers for the cluster.

**GET /cucm-uds/user/user1** retrieves the user and line configuration for user1.

In response to the queries, the TFTP servers are also returned.

Subsequent queries, such as **http://us\_cucm1.ent-pa.com:6972/SPDefault.cnf.xml**, are TFTP queries over HTTP. Thus, the provisioning process is done by queries to the UDS and to the TFTP server. As a result of these queries, provisioning information is forwarded to the client, and the client is able to start the registration process.

The registration process consists of two actions:

1. IM and Presence login, which is achieved via XCP router functionality on Expressway-C. The XCP router queries the IM and Presence clusters configured on Expressway-C in order to find the IM and Presence cluster where the user is configured, and the Jabber client is able to login for IM and Presence services.
2. Unified CM registration using SIP REGISTER messages, which are proxied by the Expressway SIP Proxy function.

## Business-to-Business Communications

Business-to-business communications require the ability to look up the domains of remote organizations for the purpose of URI routing. This is done by creating a DNS zone on Expressway-E. Though security best practice suggests that H.323 should be turned off, as it is an inherently insecure protocol, in some cases this might not be possible for business reasons. In the DNS zone both SIP and H.323 can independently be turned on. This allows Expressway-E to automatically re-initiate a DNS query using the other protocol not used by the initiating call, thereby giving the call the best chance of success. Expressway-C and Expressway-E use the protocol that was used to initiate the call, and they automatically try the other protocol when SIP-to-H.323 interworking is enabled on the Expressway.

If H.323 is enabled on the Expressway, SIP-to-H.323 interworking should be set to **On** for Expressway-E. If a call is received as an H.323 call, this allows Expressway-E to interwork the call to SIP and use native SIP for the rest of the call legs to Unified CM. Likewise, an outbound call to an H.323 system will remain a SIP call until it reaches Expressway-E, where it will be interworked to H.323.

In order to receive business-to-business communications over the Internet, External SIP and H.323 DNS records are required. These records allow other organization to resolve the domain of the URI to the Expressway-E that is offering that call service. Cisco's validated design included the SIP and SIPS SRV records and the H.323/H.225 SRV record for business-to-business communications. The SRV record used for RAS is not necessary for Expressway-E because this record is used by an endpoint to find its gatekeeper for registration.

[Figure 4-10](#) shows the DNS process for resolving the domain of the URI, [Example 4-1](#) shows an SRV lookup example, and [Table 4-3](#) shows the DNS SRV records used for business-to-business call scenarios.

Figure 4-10 URI Dialing with DNS

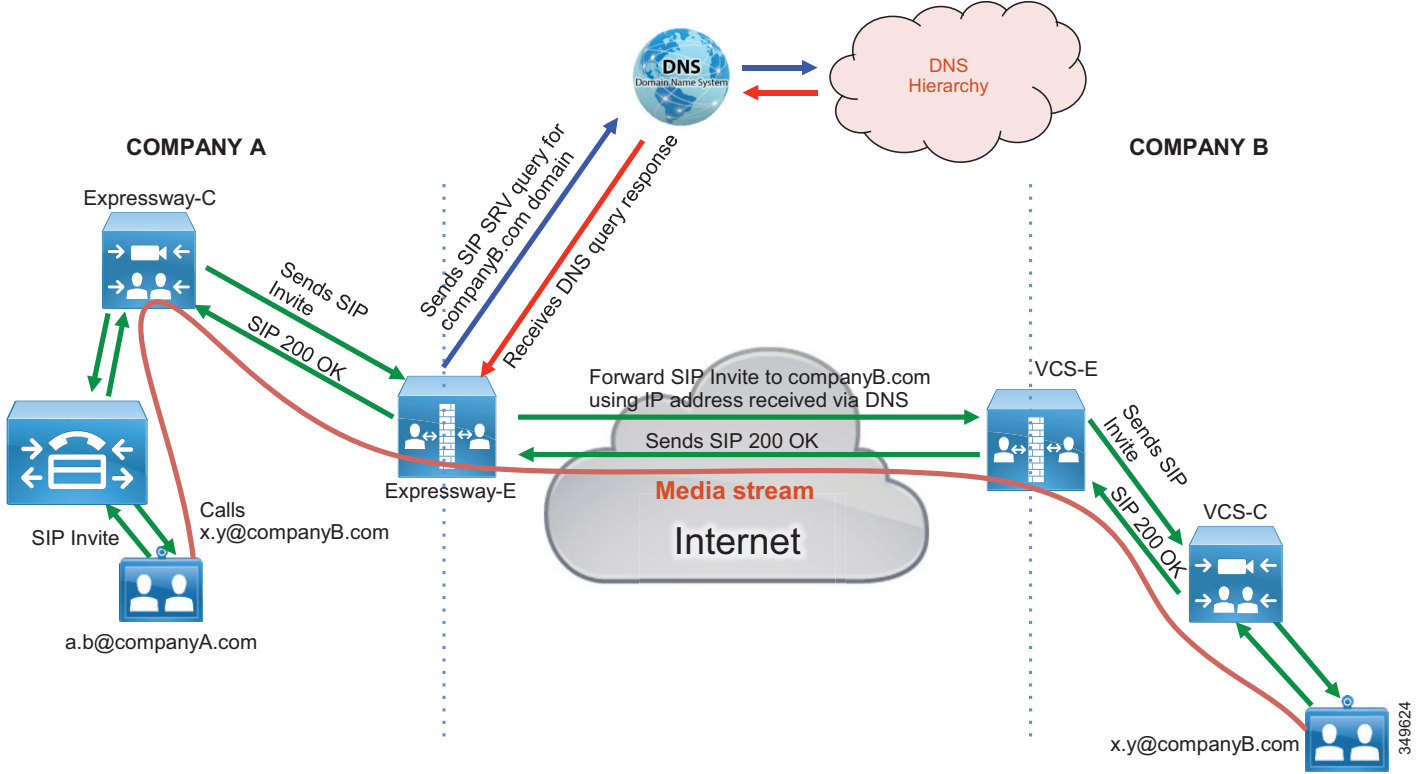

**Example 4-1 SRV Record Examples for the Domain ent-pa.com**

```
>nslookup
set type=srv
_sips._tcp.ent-pa.com

Non-authoritative answer:
_sips._tcp.ent-pa.com SRV service location
priority = 1
weight = 10
port = 5061
srv hostname = expe.ent-pa.com.
```

**Table 4-3 Business-to-Business DSN SRV Records**

Call Type	SRV Record	Port	Protocol
SIP business-to-business	_sips._tcp.ent-pa.com	5061	TLS
	_sip._tcp.ent-pa.com	5060	TCP
	_sip._udp.ent-pa.com	5060	UDP
H.323 business-to-business	_h323ls._udp.ent-pa.com	1719	RAS
	_h323cs._tcp.ent-pa.com	1720	H.225

For more information on configuring a DNS zone on Expressway-E, refer to the latest version of the *Cisco Expressway Basic Configuration Deployment Guide*.

## IP-based Dialing for Business-to-Business Calls

IP-based dialing is a feature well known and used in most scenarios, when dealing with H.323 endpoints. The Cisco Collaboration Architecture uses SIP URIs and does not need IP-based dialing. However, when interacting with endpoints in other organizations that are capable of making and receiving calls using IP addresses only, the Cisco Collaboration Architecture allows IP-based dialing for both inbound and outbound calls.

### Outbound Calls

Outbound IP dialing is supported on Expressway-E and Expressway-C, but it does not have full native support on Cisco Unified Communications Manager. However, it is possible to set up Unified CM to have IP-based dialing, as described below.

Instead of dialing the IP address alone, users on Cisco Unified CM can dial a SIP URI-based IP address as shown in this example: 10.10.10.10@ip, where "@ip" is literal and could be replaced with "external", "offsite" or other meaningful terms.

Unified CM will match a SIP route pattern configured to route the "ip" fictional domain to Expressway-C. Expressway-C strips off the domain "@ip" and sends the call to the Expressway-E, which is also configured for IP address dialing.

Calls to unknown IP addresses on Expressway -E should be set to **Direct**. Since IP-based address dialing is mostly configured in H.323 endpoints when no call control is deployed, this allows Expressway-E to send H.323 calls directly to an endpoint at a public IP address. The call will remain a SIP call until interworked on Expressway-E, as shown in [Figure 4-11](#).

There are other options to provide for IP address dialing. One option is to replace the "." used in the IP address field with the symbol "\*", as in the following example: "10\*10\*10\*10". Cisco Unified Communications Manager will match it against a route pattern, and Expressway will replace the "\*" with the "." using regular expression (regex) search rules.

**Figure 4-11** Example of Outbound IP-based Dialing

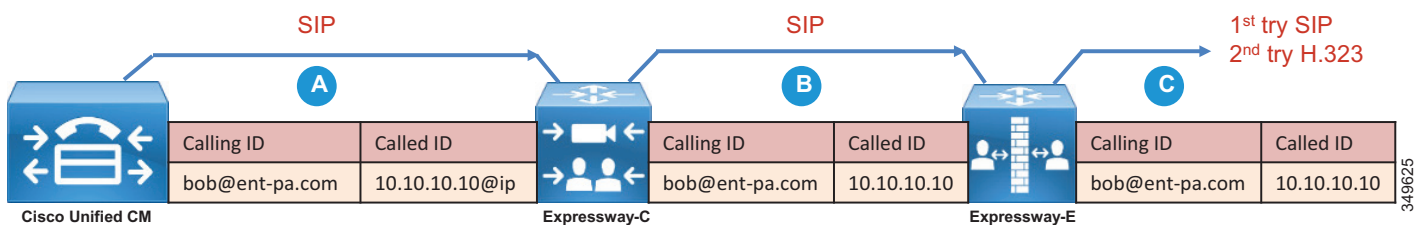

### Inbound Calls

IP-based inbound calls make use of a *fallback alias* configured in Expressway-E. When a user on the Internet dials the IP address of the Expressway-E external LAN interface, Expressway-E receives the call and sends the call to the alias configured in the fallback alias setting. As an example, if the fallback alias is configured to send the call to conference number 80044123 or to the conference alias meet@ent-pa.com, the inbound call will be sent to the Cisco Meeting Server in charge of such conferences.

If the static mapping between the IP address and the fallback alias is too limited, it is possible to set the fallback alias to the pilot number of Cisco Unity Connection. In this way it is possible to use the Unity Connection auto-attendant feature to specify the final destination through DTMF, or by speech recognition if Unity Connection is enabled to support this feature.

If Unity Connection is used as an auto-attendant feature for external endpoints dialing the IP address of the Expressway-E, remember to set the **Rerouting Calling Search Space** on the Unified CM trunk configuration for Unity Connection. Figure 4-12 shows the setup.

Figure 4-12 Example of Inbound IP-based Dialing

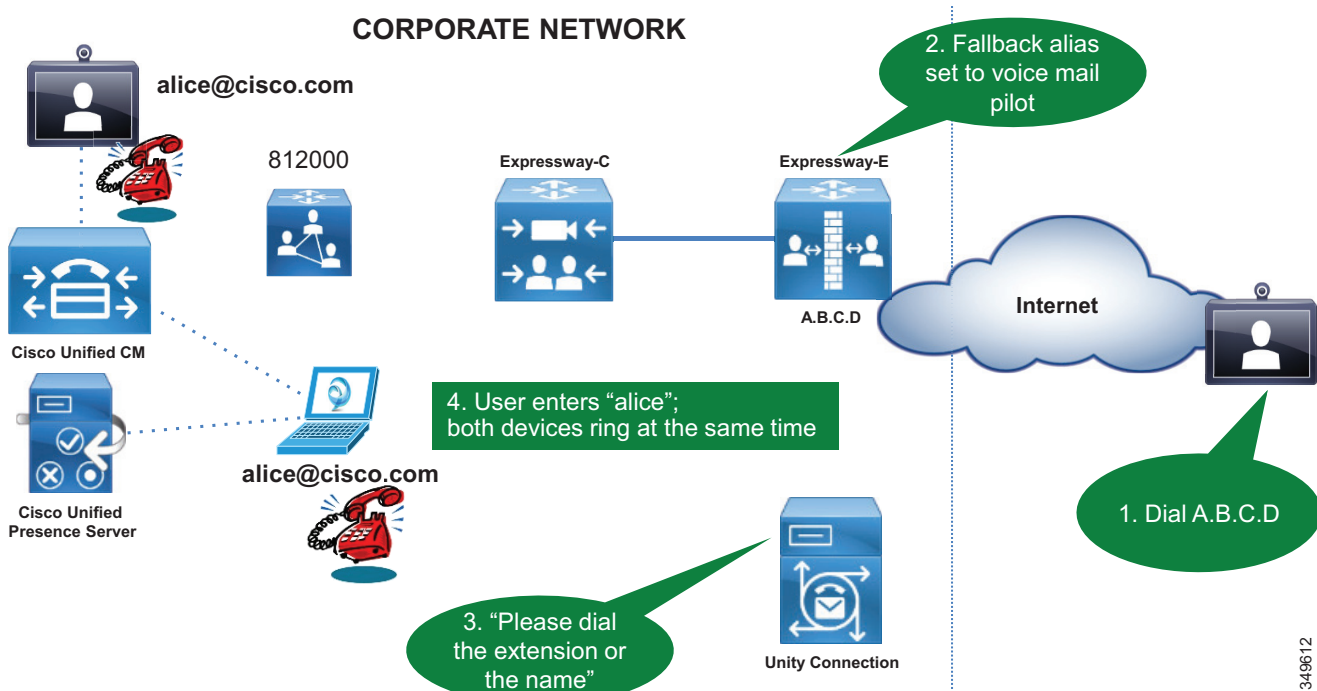

349612

## Deployment of External XMPP Federation through Expressway

XMPP federation utilizes the same type of traversal connection – Unified Communications traversal – as does mobile and remote access. XMPP federation can be deployed as a standalone service. It can also be deployed on the same Expressway-C and Expressway-E pair with mobile and remote access, utilizing the same Unified Communications traversal link.

Perform the following typical tasks to deploy instant messaging and presence federation:

1. Validated email addresses for federation.

XMPP federation through Expressway does not support translation of email addresses to XMPP addresses. Translation of email addresses to Jabber IDs is a feature of the IM and Presence server federation model. This feature is typically used to improve user experience and simplify communication for XMPP federation when the email URI convention and JID URI convention are different. When deploying XMPP federation through Expressway, the same goals of improved user experience and simplified communications apply. We recommend setting the IM and Presence domain to the same domain as the email domain. We also recommend using the LDAP sAMaccount

name for UserID, email address convention, and Jabber ID. In the overall collaboration architecture, we recommend having a comprehensive and consistent strategy for URI convention that is repeatable and scalable.

2. Ensure that the IM and Presence service is operational and has XMPP federation turned off.

XMPP federation on the IM and Presence server must be turned off so that it does not interfere with the federation configured on the Expressway.

3. Complete server certificate requirements.

Plan ahead when setting up certificates for Expressway-C and Expressway-E. If you plan to use chat node aliases as a part of XMPP federation, the chat nodes alias FQDN must be included in the subject alternate name (SAN) field of the certificate. Doing this ahead of time avoids having to generate new certificates and possibly incurring greater expense for the public certificates on your Expressway-Es. Refer to the [Security](#) chapter for more details on security and certificates for Expressway.

4. Configure the local domains for XMPP federation on Expressway-C.

5. Configure Expressway-E for XMPP federation and security.

This step enables federation and the level of security desired for external federation. Authentication is required and is set up via the dialback secret. Securing the communications via TLS is the recommended configuration. Authorization of which foreign domains and external chat node aliases are allowed or denied, is configured in this section as well.

6. Configure how XMPP servers for federated domains and chat node aliases are located using either DNS lookups or static routes.

The Expressway series supports federation via DNS SRV records and federation via static routes. Static routes define a path to reach external domains without having to do a DNS query. Public XMPP SRV records are used to resolve external domains that support federation. These records are required for other organizations to reach your organization when deploying an open federation model.

7. Ensure that the correct firewall ports are open.

8. Check the status of XMPP federation.

## Deployment of Cisco Unified Border Element for PSTN Voice Connection Through a SIP Trunk

Cisco Unified Border Element is the recommended session border controller for PSTN centralized access. It is deployed as a demarcation point between the enterprise network and the Telecom carrier network. It gives access to the IP PSTN through its external interface and to the enterprise network through its internal interface. It enables centralized PSTN service and therefore has to be deployed where the enterprise network connects to the Telecom carrier's network.

Because all remote sites leverage central PSTN connectivity, Cisco Unified Border Element has to be highly redundant. If the PSTN central service is not available, only those offices with local PSTN access would be able to make external calls. Therefore, we recommend deploying Cisco Unified Border Element in pairs to provide redundancy.



Unified Border Element is a Cisco IOS feature set supported on the Cisco IOS Integrated Services Router (ISR) and Aggregation Services Router (ASR) platforms. For information on how to choose the correct platform, see the [Sizing](#) chapter.

Cisco Unified Border Element is a session border control that terminates sessions from Unified CM and re-originates them toward the Telecom carrier network, and vice-versa. Note that in contrast to Expressway-E, which is exposed on the Internet, Cisco Unified Border Element is deployed between private networks: the corporate network and the carrier's network. From the carrier's perspective, the traffic to the centralized PSTN originates from the Cisco Unified Border Element external interface. From the enterprise's perspective, the traffic from the carrier originates from the internal Cisco Unified Border Element interface. In this sense, the Cisco Unified Border Element performs topology hiding.

Deployment of Cisco Unified Border Element is different from that of the Expressway. While the former gives access to the carrier network - a private, controlled and secured network - the latter gives access to the Internet. For this reason, deployment of Cisco Unified Border Element does not require a DMZ.

For this Preferred Architecture, as shown in [Figure 4-13](#), the Unified Border Element has a WAN interface on the Telecom carrier network and a LAN interface on the enterprise network.

**Figure 4-13 IP PSTN Architecture**

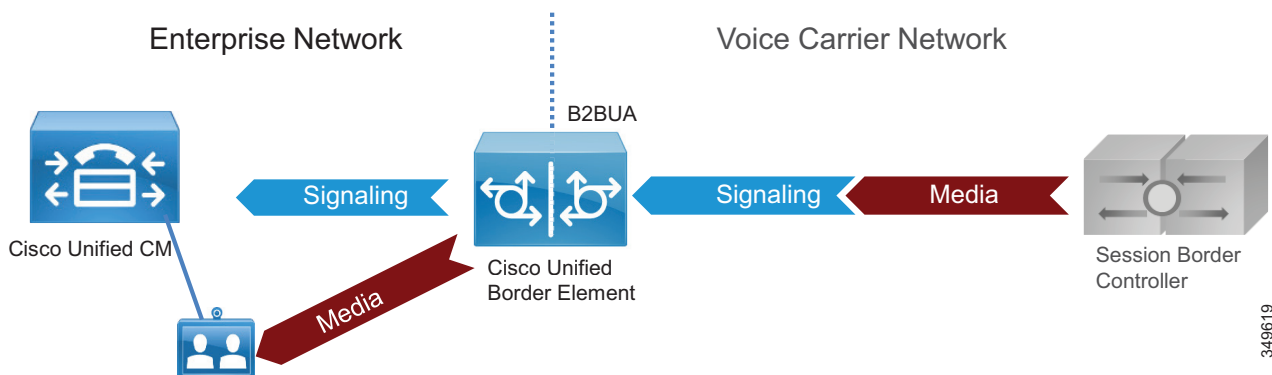

Cisco Unified Border Element performs the following functions:

- Topology hiding, as shown in [Figure 4-14](#), including address and port translations. All traffic from Unified CM is sent to the Unified Border Element internal interface, and all traffic from the Telecom carrier soft-switch is sent to the Unified Border Element external interface. There is no direct connection between them. [Figure 4-14](#) details the trunking configuration on Cisco Unified CM and the voice routes on the Unified Border Element.
- Delayed Offer to Early Offer conversion, and vice versa
- Media interworking — In-band and out-of-band DTMF support, DTMF conversion, fax passthrough and T.38 fax relay, volume and gain control
- Call admission control (CAC) — CAC can be performed by Unified Border Element based on resource consumption such as CPU, memory, and call arrival spike detection. CAC can be implemented at interface level or globally. While CAC configured on Unified CM is location-based, CAC configured on the Unified Border Element is resource-based. Resources-based CAC is recommended to avoid over-subscription of the Unified Border Element and for security reasons (see the section on [Security for Collaboration Edge](#)).

- Security capabilities, including RTP-to-SRTP interworking, SIP malformed packet detection, non-dialog RTP packet drops, SIP listening port configuration, digest authentication, simultaneous call limits, call rate limits, toll fraud protection, and a number of signaling and media encryption options
- Mid-call supplementary services, including hold, transfer, and conference
- PPI/PAI/Privacy and RPID — Identity Header Interworking with Telecom carriers
- Simultaneous connectivity to SIP trunks from multiple Telecom carriers
- Conversion of multicast music on hold (MoH) to unicast MoH
- Billing statistics and call detail record (CDR) collection

**Figure 4-14** *Trunking Considerations for Cisco Unified Border Element*

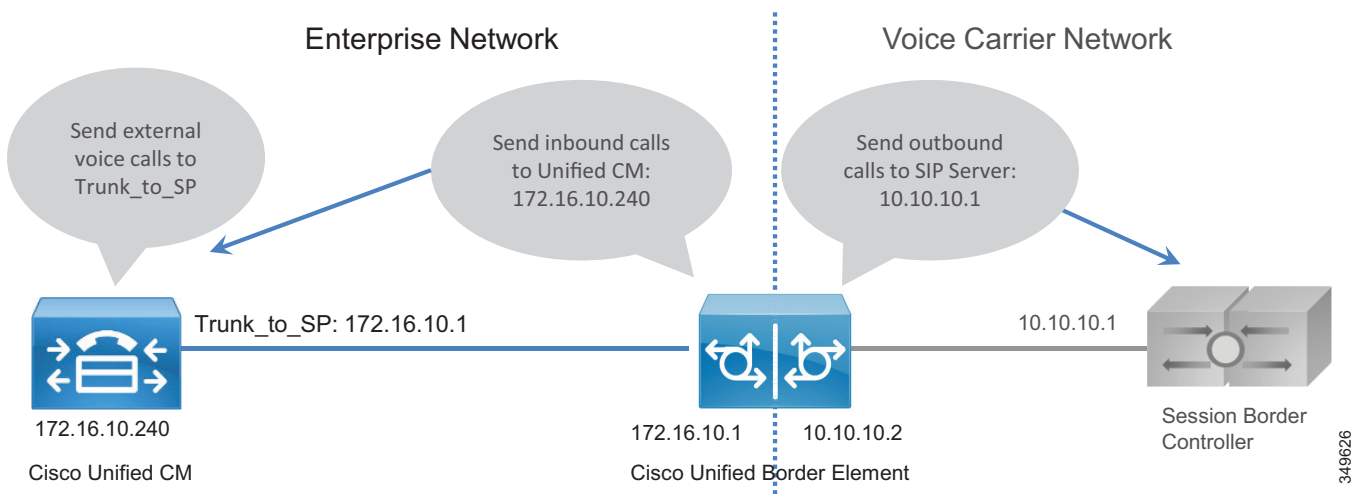

## PSTN Gateways

Legacy PSTN gateways are deployed in a distributed architecture, where each site has its own PSTN connection. We recommend using Cisco Unified Border Element for centralized PSTN access, but PSTN gateways can still be used as a backup for those sites heavily relying on external calls to run their daily business.

In this case the number of concurrent ISDN channels can be much lower than the number of concurrent calls to the centralized PSTN because they are used just in backup scenarios. As an example, if the normal situation allows for 30 concurrent calls to the centralized PSTN, it would be possible to size the backup ISDN gateway to support only two BRI channels, since they would be used in backup scenarios only.

Cisco voice gateways support:

- DTMF relay capabilities
- Supplementary services support — Supplementary services are basic telephony functions such as hold, transfer, and conferencing.
- Fax passthrough and T.38 fax relay

PSTN gateways support many protocols (SCCP, MGCP, H.323, SIP). SIP is the recommended protocol because it aligns with the overall Cisco collaboration solution and is the protocol of choice for new voice and video products.

Voice gateway functionality is enabled on any Cisco ISR with appropriate PVDMs and service modules or cards.

## High Availability for Collaboration Edge

High availability is a critical aspect of designing and deploying collaboration systems. Collaboration Edge allows for redundancy, load-sharing, and call license sharing.

### High Availability for Expressway-C and Expressway-E

We recommend deploying Expressway-C and Expressway-E in clusters. Each cluster can have up to six Expressway peers and a maximum of N+2 physical redundancy. All peers are active in the cluster. For details about cluster configuration, refer to the latest version of the [Cisco Expressway Cluster Creation and Maintenance Deployment Guide](#).

Expressway clusters provide configuration redundancy. The first peer configured in the cluster is the *publisher primary peer or publisher*, while all other peers are *peers or subscribers*. Configuration is done in the primary peer and automatically replicated to the other peers.

Expressway clusters provide call license sharing and resilience. All rich media sessions are shared equally across peers in the cluster. Call licenses are contributed by the licenses configured on each peer.

The following rules apply to Expressway clustering:

- Expressway-C and Expressway-E types cannot be mixed in the same cluster.
- All peers in a cluster must have identical configurations for zones, authentication, and call policy.
- Configuration changes should be made only on the primary peer, and this will overwrite the configuration on the other peers in the cluster when replication occurs.
- If a peer becomes unavailable, the licenses it contributed to the cluster will become unavailable after 2 weeks.
- Deploy an equal number of peers in Expressway-C and Expressway-E clusters.
- Deploy the same OVA template throughout the cluster.
- All peers in a cluster need to be within 80 ms maximum round-trip time to all other cluster peers. This means that each Expressway in the cluster must be within a 40ms hop of all other peers in the cluster.
- H.323 must be enabled on all peers in a cluster for database replication. At the same time, if you also want to block H.323 calls coming from the Internet, you can configure Expressway-E with firewall rules to drop H.323 traffic on the external LAN interface.
- If mobile and remote access and business-to-business communications are enabled on the same Expressway-C and Expressway-E pairs, the SIP port number used on the SIP trunk between Unified CM and Expressway-C used for B2B needs to be changed from the default 5060 or 5061.
- A DNS SRV record must be available for the cluster and must contain A records for each peer of the cluster.

Since Expressway-C is deployed in the internal network and Expressway-E in the DMZ, Expressway-C has to be connected to Expressway-E through a *Unified Communications traversal zone* for mobile and remote access. Business-to-business calls require a separate traversal zone, which retains the name of traversal client zone for Expressway-C and traversal server zone for Expressway-E. The traversal server, traversal client, and Unified Communications traversal zones include all the peers of Expressway-C and Expressway-E, so that if one of the peers is not reachable, another peer of the cluster will be reached instead.

As shown in [Figure 4-15](#), Expressway-C connects to all servers of the Cisco Unified CM, IM and Presence, and Unity Connection clusters, so high availability and redundancy are preserved across the entire connection path.

**Figure 4-15 Expressway Services Connection**

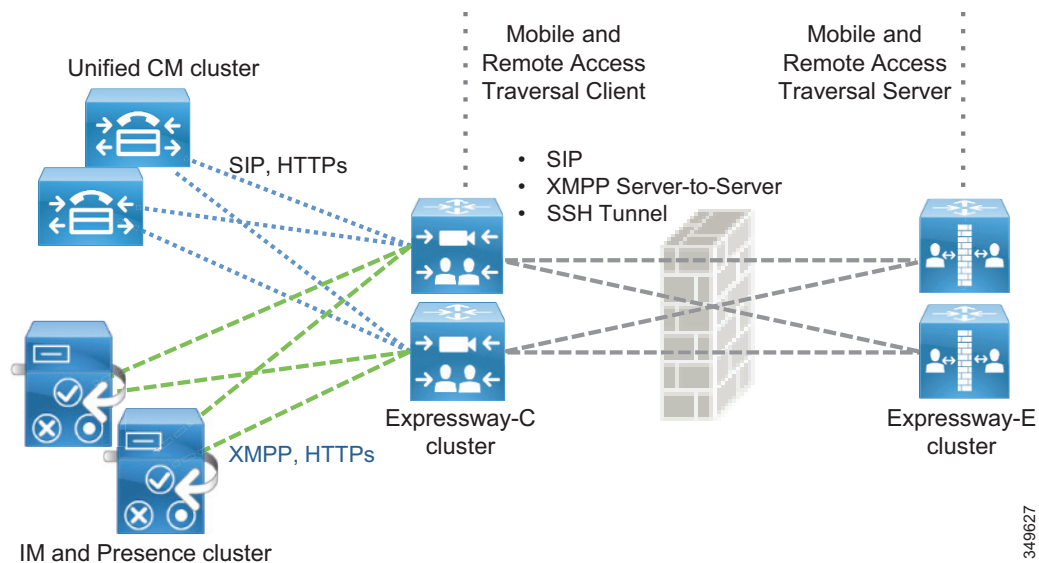

[Figure 4-15](#) shows the high availability built into the Unified Communications traversal zone and into mobile and remote access. However, the following description applies to both Unified Communications traversal zones and standard (client and server) traversal zones.

The traversal client zone configured on Expressway-C should contain the fully qualified domain names of all of the cluster peers of the corresponding Expressway-E cluster. Likewise, the traversal server zone on Expressway-E should connect to all Expressway-C cluster peers. This is achieved by including in the subject alternative names of the Expressway-C certificate the FQDNs of the Expressway-C cluster peers and by setting the **TLS verify subject name** on Expressway-E equal to the FQDN of the Expressway-C cluster. This creates a mesh configuration of cluster peers across the traversal zone and provides continuous and high availability of the traversal zone until the last cluster peer is unavailable.

Expressway-C connects to Unified CM via trunks for routing inbound and outbound business-to-business calls. Unified CM also trunks to Expressway-C. For high availability, the fully qualified domain names of each Expressway-C cluster peer should be listed in the trunk configuration on Unified CM. Conversely, the fully qualified domain name (FQDN) of each member of the Unified CM cluster should be listed in the neighbor zone profile of Expressway-C.

349627

A meshed trunk configuration is created here as well. Unified CM will check the status of the nodes in the trunk configuration via a SIP OPTIONS Ping. If a node is not available, Unified CM will take that node out of service and will not route calls to it. Expressway-C will also check the status of the trunk from Unified CM via a SIP OPTIONS Ping. Calls will be routed only to nodes that are shown as active and available. This provides high availability for both sides of the trunk configuration.

DNS SRV records can add to availability of Expressway-E for inbound business-to-business traffic. For high availability all peers in the cluster should be listed with the same priority and same weight in the SRV record. This allows all peers to be returned in the DNS query. A DNS SRV record helps to minimize the time spent by a client on lookups since a DNS response can contain all of the peers listed in the SRV record. The far-end server or far-end endpoint will typically cache the DNS response and will try all peers returned in the DNS query until a response is received. This provides the best chance for a successful call.

In addition, Expressway clusters support rich media license sharing across clusters. If a peer is lost from the cluster, its call licenses will continue to be shared for the next 2 weeks. Any one Expressway cannot process any more rich media licenses than its physical capacity, even though it can carry more licenses than its physical capacity.

## High Availability for Cisco Unified Border Element

High availability for Cisco Unified Border Element can be achieved in more than one way. For the Preferred Architecture, box-to-box redundancy with call preservation is recommended because it provides both signaling and media call preservation if the Unified Border Element fails.

Unified Border Element servers are deployed in pairs, following the active/standby model. If the active Unified Border Element goes down, the standby Unified Border Element is engaged and all active sessions are transferred. This provides high availability for both signaling and media. (See [Figure 4-16](#).)

Hot Standby Routing Protocol (HSRP) technology provides high network availability by routing IP traffic from hosts on networks without relying on the availability of any single router. HSRP is used in a group of routers for selecting an active router and a standby router. HSRP monitors both the inside and outside interfaces; if any interface goes down, the whole device is considered down, and the standby device becomes active and takes over the responsibilities of the active router.

Box-to-box redundancy uses the HSRP protocol to form an HSRP active/standby pair of routers. The active and standby servers share the same virtual IP address and continually exchange status messages. Unified Border Element session information is shared across the active/standby pair of routers, as seen in [Figure 4-16](#), where 172.16.0.1 and 10.10.10.10 are the virtual IP addresses of the Cisco Unified Border Element pairs. This enables the standby router to immediately take over all Unified Border Element call processing responsibilities if the active router goes out of service for planned or unplanned reasons.

**Figure 4-16 Cisco Unified Border Element Box-to-Box Redundancy**

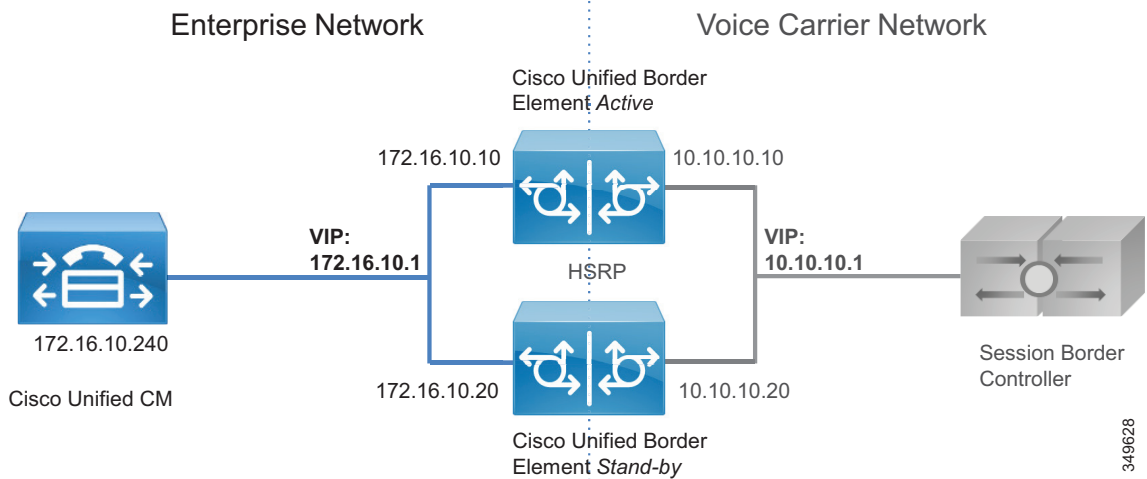

349628

## High Availability for Voice Gateways

PSTN gateways directly connect via physical interfaces to the PSTN network. If a gateway goes down, all communications with the PSTN are cleared. Mechanisms such as HSRP would not be of any benefit in this case, as they would in the case of PSTN access through IP trunks to a Telecom carrier. Unlike the Unified Border Element, a TDM-based PSTN gateway deployment is by nature distributed, although there are cases where a centralized PSTN with gateway interconnection is deployed. Also, a PSTN voice gateway manages a smaller amount of calls than a Unified Border Element does. Due to the nature of PSTN, media preservation is not possible in this scenario.

However, it is possible to provide signaling resilience by configuring multiple gateways in the same Unified CM route group, so that load balancing of calls will occur. If one of the gateways in the group goes down, all calls will be dropped, but new calls will be established using one of the remaining available gateways.

# Security for Collaboration Edge

This section explains how to implement security in the Collaboration Edge.

## Security for Expressway-C and Expressway-E

Security on Expressway-C and Expressway-E can be further partitioned into network level and application level. Network level security includes feature such as firewall rules and intrusion protection, while application level security includes authorization, authentication, and encryption.

### Network Level Protection

Network level protection on Expressway-C and Expressway-E consists of two main components: firewall rules and intrusion protection.

Firewall rules enable the ability to:

- Specify the source IP address subnet from which to allow or deny traffic.
- Choose whether to drop or reject denied traffic.
- Configure well known services such as SSH and HTTP/HTTPS, or specify customized rules based on transport protocols and port ranges.
- Configure different rules for the LAN 1 and LAN 2 interfaces on Expressway-E.

The Automated Intrusion Protection feature should be used to detect and block malicious traffic and to help protect the Expressway from dictionary-based attempts to breach login security.

Automated Intrusion Protection works by parsing the system log files to detect repeated failures to access specific service categories, such as SIP, SSH, and web/HTTPS. When the number of failures within a specified time reaches the configured threshold, the source host IP address (the intruder) and destination port are blocked for a specified period of time. The host address is automatically unblocked after that time period so as not to lock out any genuine hosts that might have been temporarily misconfigured.

### Mobile and Remote Access

TLS, SRTP, HTTPS, and XMPP are the only configuration options between the client on the Internet and Expressway-C for mobile and remote access. All traffic between the client and Expressway-C is always encrypted.

The connection between Unified CM and Expressway-C may be encrypted and authenticated, depending on the configuration. We recommend end-to-end encryption of media and signaling in all of the call signaling and media legs between the source and the destination. This might require mixed-mode on Unified CM if SIP OAuth is not an option. SIP OAuth is the recommended encryption and authentication method but it is endpoint-dependent. See the [Security](#) chapter for more information.

Security certificates are needed for secure communications between Cisco Unified CM and Expressway-C. Certificates provide the identity of servers and clients and must be deployed on Expressway-C, Expressway-E, Unified CM, and the Unified CM IM and Presence Service. The recommended configuration is to use a certificate authority (CA) to sign certificates.

CAs can be private or public. Private CA deployments have the benefit of being cost-effective, but these certificates are valid only inside the organization. Public CAs increase the security and are trusted by every organization; thus, they are commonly used for communications between different companies.

For cost reduction, Expressway-C certificates may be signed by an internal CA not recognized outside the company. In this case, it is important that the internal CA certificate be included in the Trusted CA certificate list of Expressway-E in order for Expressway-C and Expressway-E to establish a connection. Expressway-E certificates must be signed by a public CA.

[Table 4-4](#) summarizes the public and private approach for certificate deployment. For more details on certificates, refer to the [Security](#) chapter.

**Table 4-4** *Public and Private Certification Authority And Certificates*

	Unified CM	IM and Presence Service	Expressway-C	Expressway-E
<b>Certificate signed by</b>	Internal CA	Internal CA	Internal CA	Public CA
<b>Trust List includes</b>	Internal CA certificate	Internal CA certificate	Internal CA and public CA certificates	Internal CA and public CA certificates

## Business-to-Business Communications

Securing business-to-business communications include authentication, encryption, and authorization. Business-to-business communications use an authenticated traversal link by default. The traversal link can also benefit from the use of a Public Key Infrastructure (PKI) verified by a mutually authenticated transport layer security (MTLS) connection between Expressway-C and Expressway-E. If the business-to-business traversal link is deployed on the same Expressway-C and Expressway-E infrastructure as mobile and remote access, make sure that the traversal zone uses the FQDNs of the Expressway-C and Expressway-E cluster peers instead of their IP addresses. This makes it straightforward to use certificates for each server to validate the offered certificate against its certificate trust for the traversal connection.

Inbound calls can be differentiated by whether they are authenticated or unauthenticated. This differentiation can be used to authorize access to protected resources. Configuration of call authentication is performed at the zone configuration level. As an example, Expressway-E Default Zone authentication policy will be set to "do not check credentials." This will mark Unknown remote business-to-business calls as unauthenticated, as shown in [Figure 4-17](#).



Figure 4-17 Call Authentication

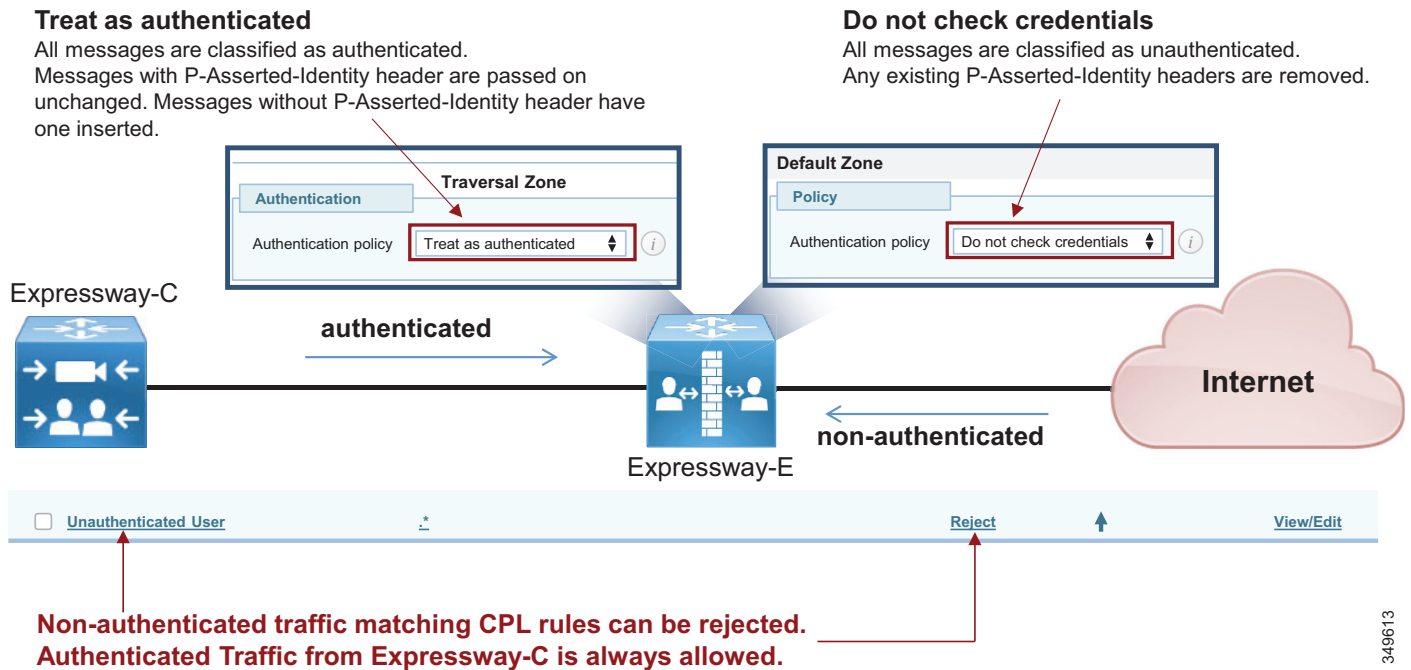

These calls should be restricted from access to protected resources such as the PSTN. This is accomplished by configuring Call Processing Language (CPL) rules with regular expressions to block access to prefixes used for gateway access.

CPL are very useful in blocking spam calls and toll fraud. For this reason, due to an increase of these types of fraudulent attempts, we recommend to carefully evaluate the CPL configuration. The rules should be set so that only specific destinations are allowed, while everything else is discarded.

CPL should be used in combination with the Calling Search Space on Unified CM, to prevent unauthenticated calls access from the PSTN by mistake. Check the [Call Control](#) chapter for further details.

As an example, consider a company where calls are allowed to a set of devices in the range of +1 408 555 44XX.

Clearly, the administrator has to give access to only those numbers and not to a wider range. Also, if any call enters the Expressway with the corporate domain or Expressway corporate IP in the calling ID, this might indicate that it is a spam call.

The administrator might allow alphanumeric URI dialing. In this case it is also advisable that the smallest range of SIP URIs are allowed, based on the corporate policy. For example a good regular expression to identify those SIP URIs where the right-hand-side might not contain more than 8 characters, cannot start with a digit, cannot contain digits but might end with a digit, could be the following:

```
^[a-z]{2,7}\w@ent-pa.com
```

This is very different from the more common rule: `.*@ent-pa.com`, because in the first case only a portion of possible patterns is allowed, where the latter allows all SIP URIs if they contain the corporate domain.

So the administrator allows access to the numeric range or the SIP URIs only if the calling ID does not include Expressway-E IP or the corporate domain, as in this example in [Table 4-5](#).

**Table 4-5** Example of a Deny-Based Policy

Source Type	Destination	Action
From Address: .*ent\-pa\.com.*	.*	Reject
From Address: .*@192\.\0\.\2\.\10	.*	Reject
Zone: Default Zone	\+14085554\d\d@ent-pa\.com	Allow
Zone: Default Zone	^[a-z]{2,7}\w@ent-pa\.com	Allow
Zone: Default Zone	.*	Reject

Any other destination that is not included in the exposed portion of the internal dial plan will be rejected by the last rule in [Table 4-5](#) ("deny all").

The CPL works together with the Intrusion Protection Rule called "SIP authentication failure". It is recommended that this rule is turned on, because by default after 10 minutes (detection window) and 5 wrong attempts (trigger level) identified by a rejected CPL the source IP originating the spam call will be automatically jailed by the Expressway firewall for 10 minutes (block duration). The administrator might decide to configure different values for the detection window, trigger level and block duration.

#### Requirements and Recommendations

- Turn off H.323 on the business-to-business traversal client and traversal server zone. This will ensure that all traffic between Expressway-C and Expressway-E is encrypted. H.323 interworking will be performed on Expressway-E before sending the call to the traversal server zone for inbound calls and to the Internet for outbound calls.
- Set media encryption on the traversal client side (Expressway-C) of the business-to-business traversal zone to **best effort**. Use the same media encryption settings (**best effort**) for Expressway-E business-to-business traversal server, Default Zone, and business-to-business DNS Zone. This means encryption for SIP calls will always be performed on Expressway-C. If the remote system does not support encryption, Expressway-C will set up a non-encrypted call. If strong encryption policy is required, set the media encryption to **force encrypted**. In this case the call will be encrypted as in the case of best effort; the difference being that if the remote system does not support encryption, the call will be terminated without any non-encryption fall-back.
- Use TLS for signaling encryption for the SIP trunk between Unified CM and Expressway-C.

Certificate settings for mobile and remote access and business-to-business call scenarios:

- General requirements for certificates are that the fully qualified DNS name (FQDN) of Expressway-C and Expressway-E must match the hostname in the certificate.
- While business-to-business communication does not have any other requirements for certificates, MRA has more. For a detailed explanation on how to set up certificates on Expressway for mobile and remote access, refer to the [Security](#) chapter.

## Security for Cisco Unified Border Element

Unlike Internet connections, PSTN connectivity over IP trunks is delivered through a private network offered by the Telecom carrier. As such, it is a controlled network. Security deployed for the Internet Edge is thus different from that deployed for IP PSTN access. Between the Cisco Unified Border Element and the carrier, there are no firewalls; however, in specific cases, companies and Telecom providers require the use of an enterprise DMZ.

Between the carrier and the enterprise network, the traffic typically is sent unencrypted. Depending on the corporate policies, internal enterprise traffic can be encrypted or not. In such cases, the Unified Border Element is able to perform TLS-to-TCP and SRTP-to-RTP conversion. Usage of the internal CA to sign Unified Border Element certificates is recommended when multiple gateways are deployed.

Because the Unified Border Element is deployed without a firewall, it is protected at various layers. As an example, it is possible to create an access control list to allow only the Telecom carrier's session border control to initiate calls from the PSTN side, and to allow only Unified CM to initiate calls from the internal network side.

The Unified Border Element is also protected against toll fraud and telephony denial of service (TDoS) attacks. Large packet arrival rates can also be mitigated through call admission control mechanisms based on CPU, memory, bandwidth utilization, and call arrival spike detection.

## Security for Voice Gateways

PSTN gateways have an interface on the customer network and a second interface on the PSTN. They are deployed inside the corporate network and they are not reachable from the Internet. The PSTN is inherently secure; thus, there are no specific tools to use to protect the gateway, unless the gateway is deployed on a router that also gives access to the Internet. In this case Cisco IOS features on the gateway can be used to perform firewall and intrusion protection. In all other cases, no specific tools are required to protect the gateway (for example, denial of service (DoS) prevention and so on).

However, we recommend always encrypting media from the endpoint to the gateway. In such cases the gateway will use TLS and SRTP. Use of CA-signed certificates is recommended in this case.

## Scaling the Collaboration Edge Solution

The number of Collaboration Edge clusters deployed does not depend on the number of call control clusters, but rather on the number of connection points to the Internet. A customer with multiple Unified CM and IM and Presence clusters, and multiple TelePresence Conductor clusters, will have a single Internet Edge if that customer has a single Internet breakout point. The same environment might have multiple PSTN hop-offs if the Telecom carrier offers more than one connection point to the PSTN network.

## Scaling the Internet Edge Solution

When multiple Internet Edges are deployed, it is important to set routing rules properly in order to send collaboration traffic to the nearest Internet Edge.

## Mobile and Remote Access

If multiple Unified CM and IM and Presence clusters are deployed, every Expressway-C must discover all Unified CM clusters. If Expressway-C discovers only some of the clusters, it will be able to proxy registration only for those users belonging to the clusters that have already been discovered.

If a registration request is made from a client belonging to a Unified CM and IM and Presence cluster that has not been discovered by Expressway-C, that client will not be able to log in. This is the reason why it is important for each Expressway-C to discover all Unified CM and IM and Presence clusters if users

are enabled for mobility, as shown in Figure 4-18. Very large networks might require user segregation in order to avoid every Expressway-C having to discover all internal Unified CM and IM&P servers. This exception is not covered in this document.

In addition, if some of the Unified CM and IM and Presence clusters are sharing the same SIP domain, it is important to enable ILS on the Unified CM clusters. ILS is a feature through which each Unified CM cluster learns of other clusters in the same network, and it can tell Expressway-C which cluster a specific user is homed to. This requires that the **home cluster** setting is enabled (checkbox is checked) in the Unified CM user page settings.

**Figure 4-18** Service Discovery of Multiple Unified CM and IM and Presence Clusters

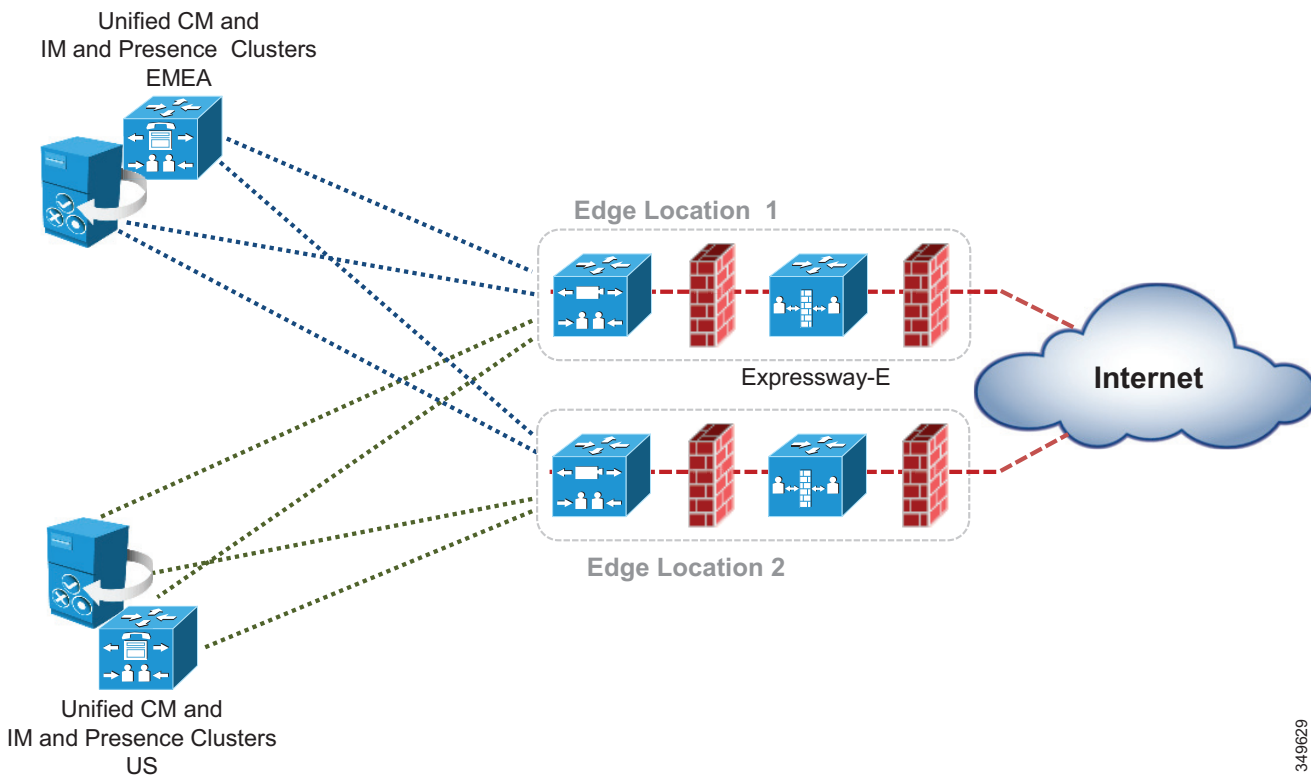

349629

When two or more Internet Edges are deployed, it is important to understand how to split the load between them for incoming requests. If the Internet Edges are deployed in the same datacenter or in the same area, load balancing can occur at the DNS SRV level. As an example, if the enterprise network includes three Internet Edges used for mobile and remote access, each one consisting of a cluster of two Expressway-E and Expressway-C peers, the `_collab-edge._tls.ent-pa.com` will include all six Expressway-E records at the same priority and weight. This distributes the registrations and calls equally across the various Expressway-E and Expressway-C clusters.

Once a mobile-and-remote-access connected endpoint is registered through a specific Expressway cluster pair, it will stay connected until the client is disconnected or it has been switched off.

However, if the Expressway clusters are deployed across geographical regions, some intelligent mechanisms on top of the DNS SRV priority and weight record are needed to ensure that the endpoint uses the nearest Expressway-E cluster.

As an example, if an enterprise has two Expressway clusters, one in the United States (US) and the other in Europe (EMEA), it is desirable for users located in the US to be directed to the Expressway-E cluster in the US while users in Europe are directed to the Expressway-E cluster in Europe. This is facilitated by implementing GeoDNS services. GeoDNS services are cost effective and easy to configure. With GeoDNS it is possible to route traffic based on different policies such as location (IP address routing), minimum latency, and others.

The following examples explain how to configure DNS for GeoDNS services:

- [GeoDNS Configuration for DNS SRV Records](#)
- [GeoDNS Configuration for CNAME Aliases](#)

#### GeoDNS Configuration for DNS SRV Records

In the first example scenario, two Internet edge Expressway clusters are deployed, one in the US and one in Europe, each composed of two Expressway-C and Expressway-E servers. If the measured latency between the calling endpoint and the European edge is less than the latency between the endpoint and the US edge, or if the endpoint IP address matches the range for Europe, the endpoint will be directed to the European edge for registration based on the configured policy (latency or IP address).

Although some GeoDNS providers support GeoDNS services on SRV records, many others allow GeoDNS for CNAME or A-records only. We recommend implementing GeoDNS services on SRV records because this allows for a simpler configuration and easy troubleshooting. A GeoDNS configuration for SRV records is shown in [Figure 4-19](#).

If the caller is in the US, the call will be sent to the US cluster; but if the US cluster is down, the call will be sent to the EMEA cluster. This configuration works for any DNS SRV records, and thus it can address business-to-business as well as mobile and remote access scenarios. It allows for geographic redundancy as well, as shown in [Figure 4-19](#).

**Figure 4-19** Example GeoDNS Configuration for DNS SRV Records

SRV Record	Priority	Weight	Expressway-E	
<i>_sips._tcp.ent-pa.com</i>	<b>10</b>	<b>10</b>	<b>us-expe1.ent-pa.com</b>	us-expe default for clients in US
<i>_collab-edge._tls.ent-pa.com</i>	<b>10</b>	<b>10</b>	<b>us-expe2.ent-pa.com</b>	
Location: US	20	10	<i>emea-expe1.ent-pa.com</i>	emea-expe as backup for clients in US
	20	10	<i>emea-expe2.ent-pa.com</i>	
Location: EMEA	<b>10</b>	<b>10</b>	<b>emea-expe1.ent-pa.com</b>	emea-expe default for clients in EMEA
	<b>10</b>	<b>10</b>	<b>emea-expe2.ent-pa.com</b>	
	20	10	<i>us-expe1.ent-pa.com</i>	us-expe as backup for clients in EMEA
	20	10	<i>us-expe2.ent-pa.com</i>	

349615

In this scenario, the SRV record for mobile and remote access (or for business-to-business calls) is given a tag corresponding to the specific location. That SRV record will resolve into Expressway-E peers for that location and, with a lower priority, into the Expressway-E peers for the backup location. In this way, if for some reason the US Expressway cluster is not available for the US endpoints, they will be redirected to the Expressway-E cluster in EMEA, and vice-versa.

While geographic redundancy works with both Jabber and hardware clients, it must be noted that Jabber users generally log on and off every day, while hardware clients are often connected to the same edge. If this configuration is also supplied to a hardware endpoint, it will not be able to re-home to the original Expressway-E cluster after geographic backup occurs unless it is switched off and on again. This is not a problem for Jabber since logout occurs more frequently.

### GeoDNS Configuration for CNAME Aliases

Some Geo DNS providers do not support GeoDNS services applied to the DNS SRV records, but in some cases they support it if applied to the CNAME or A-record instead. CNAME is an alias that resolves into the real A-records for that resource, and it is the most popular DNS record for DNS SRV implementation. While we cannot provide a universal configuration that works in all cases, we will give some recommendations on how to address this specific scenario.

If your GeoDNS provider allows you to specify GeoDNS services for CNAME records only and not for SRV records, the following example illustrates how to configure the GeoDNS if only CNAME is supported for GeoDNS services. In this scenario, a DNS SRV record resolves into a CNAME record which, in turn, resolves into an A-record. CNAME records can be assigned a geographic location. As an example, consider an Expressway-E cluster in the US and another Expressway-E cluster in EMEA. A SRV record `_sips._tcp.ent-pa.com` for SIP TLS and/or `_sip._tcp.ent-pa.com` is configured for business-to-business calls. This record resolves into `alias1.ent-pa.com`, a CNAME record.

Based on the GeoDNS configuration, a label is applied to the CNAME record to identify the region where the record is active. In this case, the CNAME resolution will be an A-record for the US and another A-record for EMEA, with highest priority (10 in this example). This will address the first peer of the cluster in both regions.

The second CNAME record will resolve into the second peer of US and EMEA clusters with highest priority. This needs to be repeated until all peers of the cluster are included.

In order to have geographic redundancy, backup CNAME aliases have to be created. In the example in [Figure 4-20](#), `backup-alias1.ent-pa.com` resolves into the first EMEA Expressway peer for US users and into the first US Expressway peer for EMEA users, thus providing geographic redundancy for both regions. This backup alias process has to be repeated until all peers of the cluster are included. Those backup records will be used only if the first ones are not answering, because the DSN SRV is set to a lower priority (20 in this example).

[Figure 4-20](#) shows the DNS record structure for GeoDNS services applied to CNAME records.

**Figure 4-20** DNS Record Structure for Geo DNS with CNAME and Geographic Redundancy

SRV Record	Priority	Weight	CNAME	Expressway-E
_sips_tcp.ent-pa.com _collab-edge_tls.ent-pa.com	10	10	alias1.ent-pa.com	Location: US → us-expe1.ent-pa.com
				Location: EMEA → emea-expe1.ent-pa.com
	10	10	alias2.ent-pa.com	Location: US → us-expe2.ent-pa.com
				Location: EMEA → emea-expe2.ent-pa.com
	20	10	backup.alias1.ent-pa.com	Location: US → emea-expe1.ent-pa.com
				Location: EMEA → us-expe1.ent-pa.com
	20	10	backup.alias2.ent-pa.com	Location: US → emea-expe2.ent-pa.com
				Location: EMEA → us-expe2.ent-pa.com

349614

## Business-to-Business Communications

Scalability for business-to-business communications can be addressed by adding multiple Expressway-C and Expressway-E clusters, either in the same physical location or geographically dispersed.

When multiple Expressway-C and Expressway-E pairs are deployed, Unified CM can direct an outbound call to the edge server that is nearest to the calling endpoint, thus minimizing internal WAN traffic. Additionally, when utilizing multiple edge clusters, the Expressway-Cs should form a meshed trunk configuration with the Unified CM clusters. This adds more scalability and resiliency by allowing additional outbound traversal paths if the geographically located traversal is full or not available.

For large deployments it might be preferable to host business-to-business communications on Expressway-C and Expressway-E pairs separate from mobile and remote access. This allows the server resources to be dedicated to external Internet communications.

### Considerations for Inbound Calls

DNS SRV records are used to determine which Expressway-E clusters are authorized for the SIP and H.323 ent-pa.com domain. SRV records with the same weight and priority are used to balance calls across Expressway-E cluster peers.

Much like with the mobile and remote access service, GeoDNS is used to direct different DNS responses to the same queries. Different metrics such as network latency and geographical location should be used to provide the correct Expressway-E cluster in the DNS response.

GeoDNS is a very good method of providing the best edge, Expressway-E, for the other server or endpoint to connect to, based on the metrics chosen by the customer. The response here is typically based on the edge physically closest to the server making the query. The mechanism is the same as described

in the previous section, except that the SRV records are different. As an example, a SRV record for SIP TLS would be: `_sips._tcp.ent-pa.com`. [Figure 4-20](#) can be used in order to set up GeoDNS service, where `_collab-edge._tls.ent-pa.com` is replaced by `_sips._tcp.ent-pa.com`

An alternative solution for B2B calls is designed to return the edge that is closest to the destination endpoint or device. This requires finding or knowing where the destination endpoint is located and then returning the appropriate edge. The benefit of this solution is to minimize the use of bandwidth on the customer network by delivering the shortest internal path to the endpoint.

This can be achieved by configuring Expressway-E to direct the call to the Expressway-E in another region if the called endpoint belongs to the other region.

As an example, consider two Expressway-C and Expressway-E clusters in EMEA, and another two Expressway-C and Expressway-E clusters in APJC. The Unified CM inbound calling search space on the Expressway-C trunk in EMEA will contain the partition of the EMEA phones but not the partition of the APJC phones. Analogously the inbound calling search space on the Expressway-C trunk in APJC will contain the partition of the APJC phones but not the partition of the EMEA phones. If a user on the Internet in EMEA calls a corporate endpoint in APJC, the call will be sent by DNS to the EMEA Expressway-E cluster, the default for business-to-business calls. The EMEA Expressway-E and Expressway-C will try to send the call to the destination, but the inbound calling search space of the Expressway-C trunk will block the call. The EMEA Expressway-E will then forward the call to the APJC Expressway-E. This time the call will be delivered to the destination because the inbound calling search space of APJC Expressway-C contains the APJC endpoints partition.

In order to allow the Expressway-E in EMEA to remove itself from the signaling and media path, it is important to make sure that there is no TCP-to-TLS or RTP-to-SRTP conversion on Expressway-E EMEA clusters, and to make sure that the call signaling optimization parameter is set to **on** in all Expressway-C and Expressway-E.

Because this is not a deterministic process, in the case of three or more Expressway edges the searching mechanism would require too much time. Therefore, this configuration is recommended for no more than two Expressway edges.

To scale to more than two edges, a different architecture called Directory Expressway can be deployed. Directory Expressway architecture is not part of the Preferred Architecture.

[Figure 4-21](#) shows the Expressway edge design that enables selection of the edge closest to the destination endpoint.



Figure 4-21 Selection of the Expressway Cluster Closest to the Destination

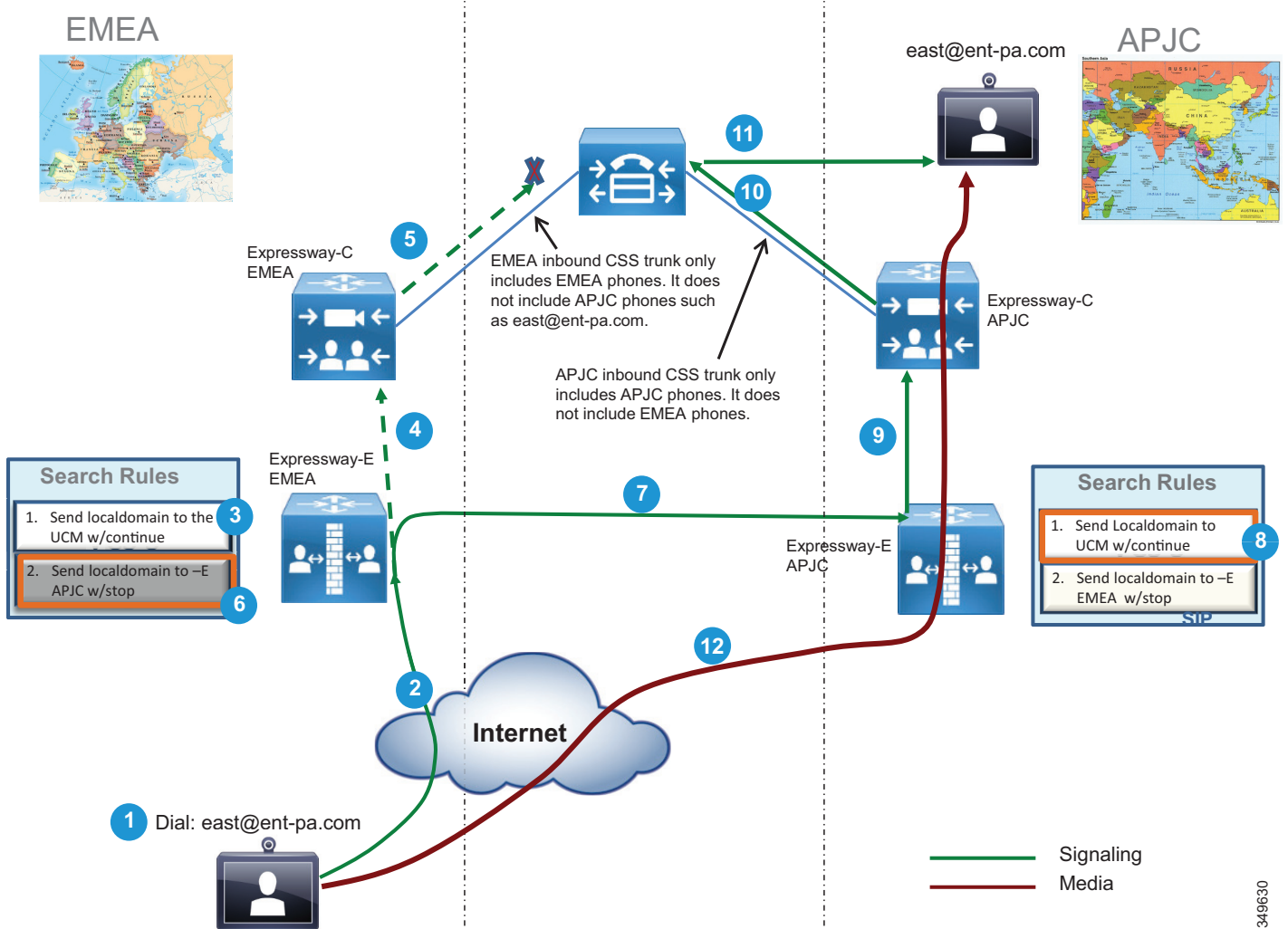

349630

## Considerations for Outbound Calls

Outbound calls should be directed to the Expressway-C that is nearest to the calling endpoint. This can be achieved by using Cisco Unified CM mechanisms such as calling search spaces and partitions.

Figure 4-22 shows the Unified CM configuration.

**Figure 4-22** Partitions and Calling Search Spaces Configured in Unified CM

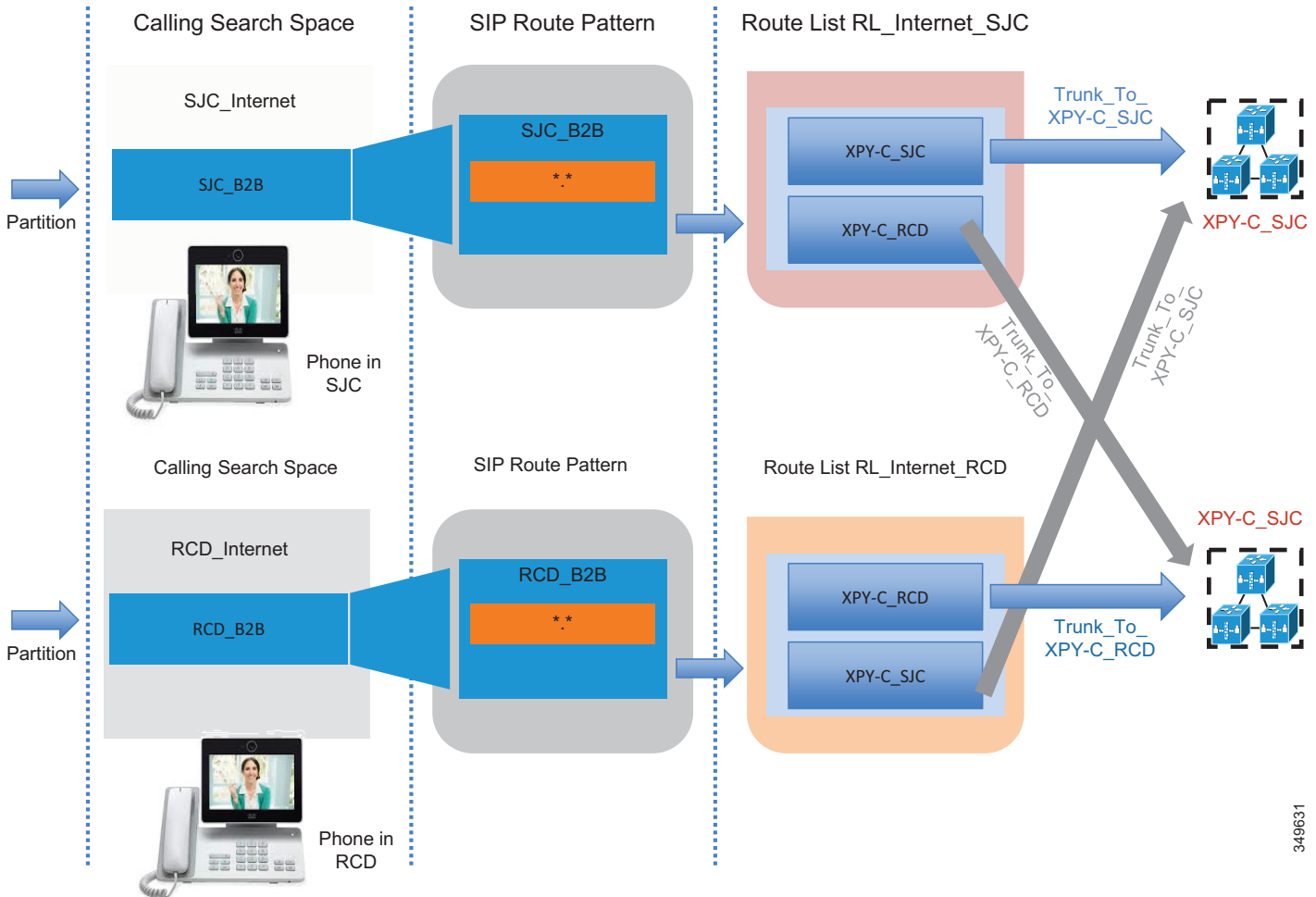

349631

The Unified CM Local Route Group feature helps scale this solution when multiple sites access two or more Expressway-C clusters. This mechanism is also applied on ISDN gateways and Cisco Unified Border Element, and it is further described in the next section. A full description of the configuration is documented in the next two sections, since it also applies to Cisco Unified Border Element and voice gateways.

## Scaling the Cisco Unified Border Element

For session capacities per platform, see the [Sizing](#) chapter.

If more than one datacenter is deployed, Cisco Unified Border Element can be deployed in each datacenter. This might happen for many reasons; for example, if it is required for a disaster recovery architecture, as shown in [Figure 4-23](#).

**Figure 4-23 Multiple Cisco Unified Border Elements**

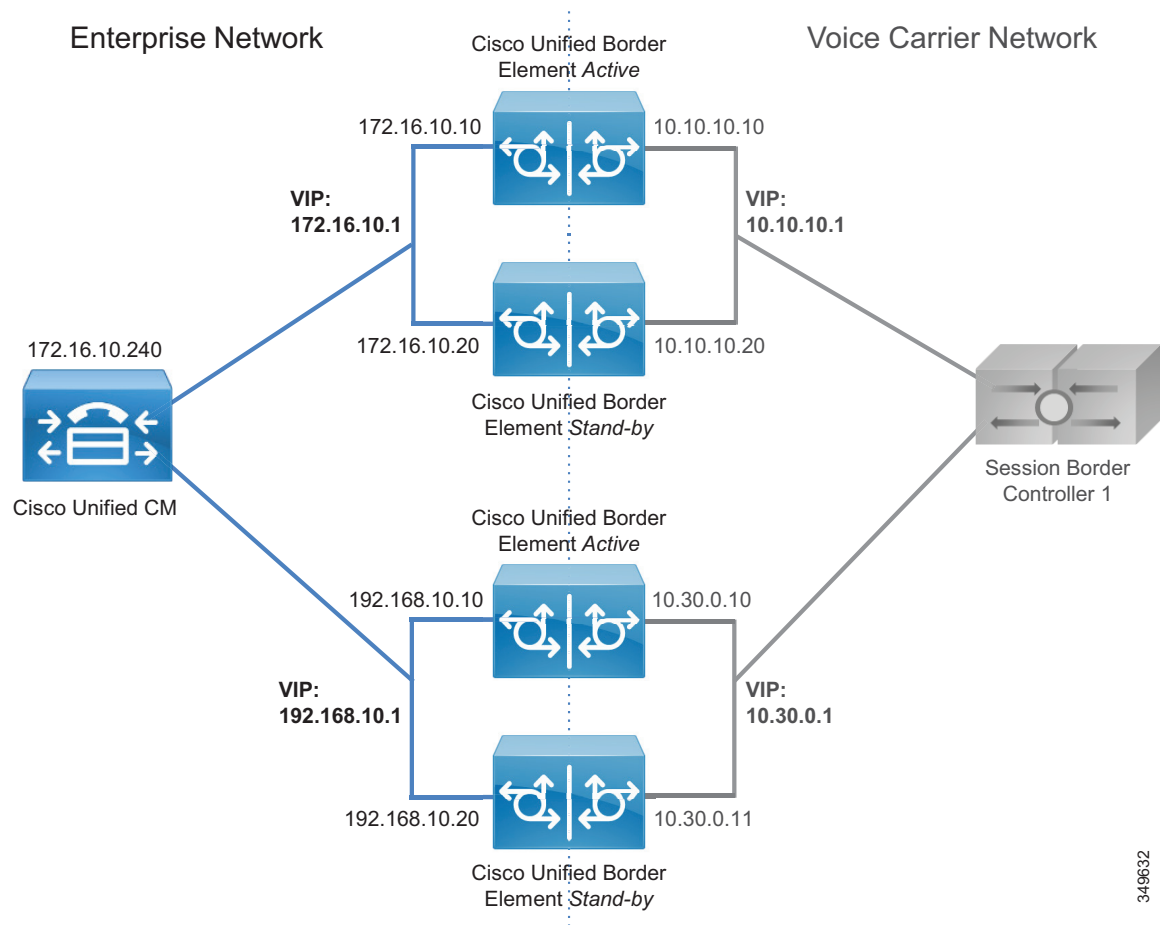

All trunks to the Unified Border Element can be inside the same route group. This would provide load balancing between datacenters. If the active router in the datacenter breaks, active calls will be preserved. If a datacenter becomes unreachable, call requests will be sent to the remaining datacenters. In this case, active calls would be dropped and users would have to reestablish them manually.

349632

As shown in [Figure 4-24](#), if the enterprise voice network is spread across a wide area, more than one session border controller (SBC) from the Telecom carrier is used. For each SBC, a Cisco Unified Border Element might be deployed, based on the carrier's recommendations.

**Figure 4-24** Multiple Cisco Unified Border Element Connected to Different SBCs

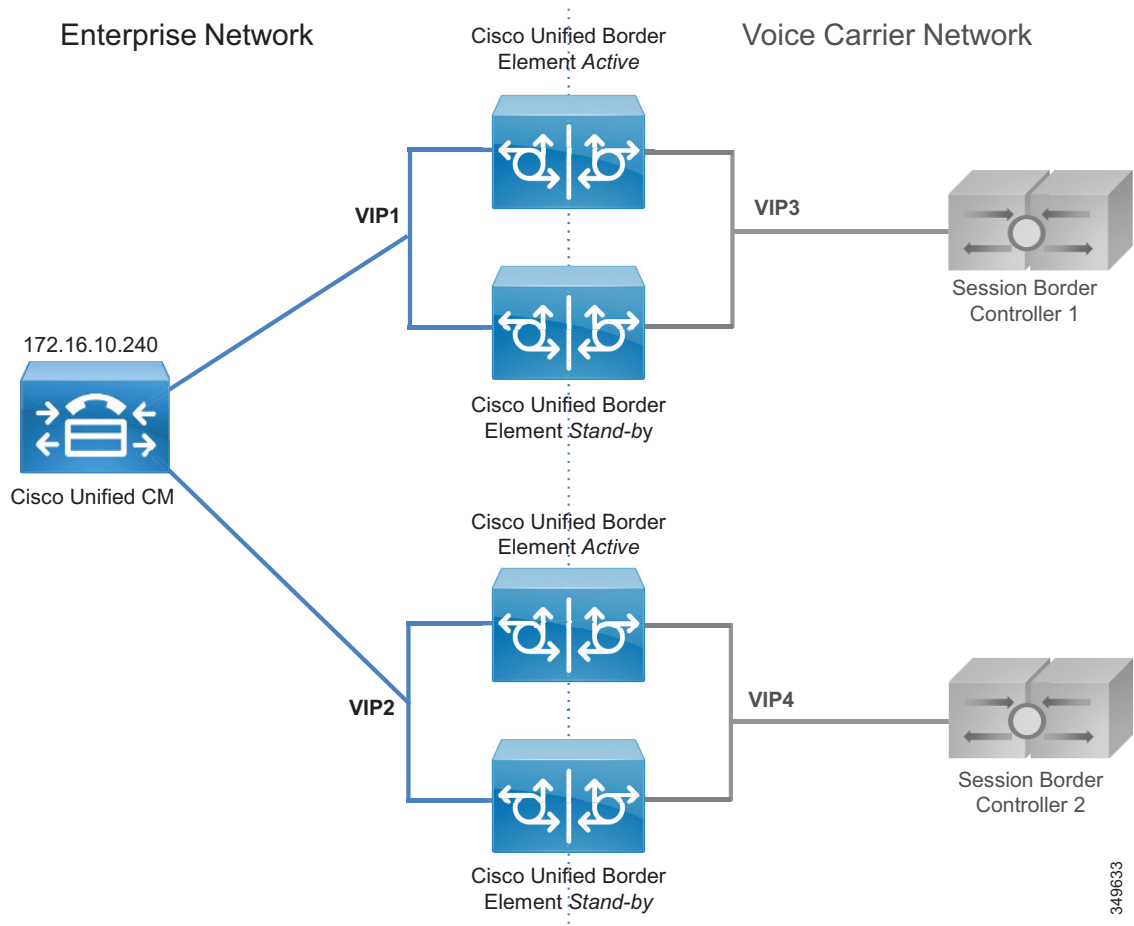

As an example, assume that another Unified Border Element is needed in the US besides the one already deployed. A new trunk called `Trunk_to_CUBE_US2` is added. [Figure 4-25](#) shows the configuration based on standard 1:1 mapping between calling search space and route pattern. This configuration has some limitations because, as the number of Unified Border Elements increases, it has a big impact on Unified CM resources. It is shown in [Figure 4-25](#) in order to contrast this approach with the Local Route Group approach shown in [Figure 4-26](#).

349633

**Figure 4-25 Unified CM Configuration for Cisco Unified Border Element Connection**

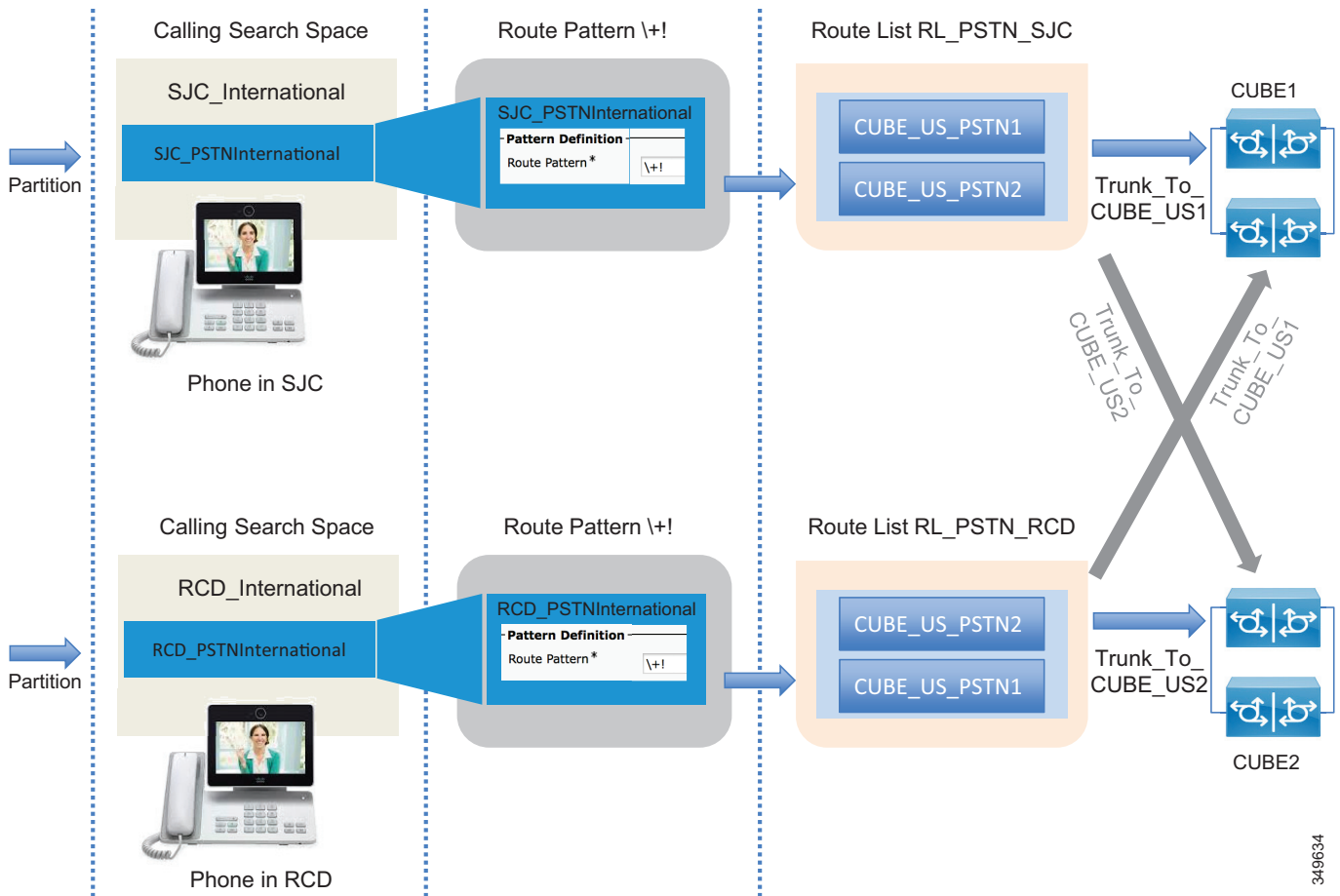

The same route pattern, \+!, is repeated for every physical destination, and it resides in different partitions. The original partition PSTNInternational needs to be split into two, SJC\_PSTNInternational and RCD\_PSTNInternational, and the route pattern \+! has to be deleted and moved into the two newly created partitions. This approach works if the number of sites is not high, no more than two or three. A much better approach is to use the Local Route Group concept, as shown in [Figure 4-26](#).

**Figure 4-26 Unified CM Configuration for Cisco Unified Border Element Connection by Using the Local Route Group Approach**

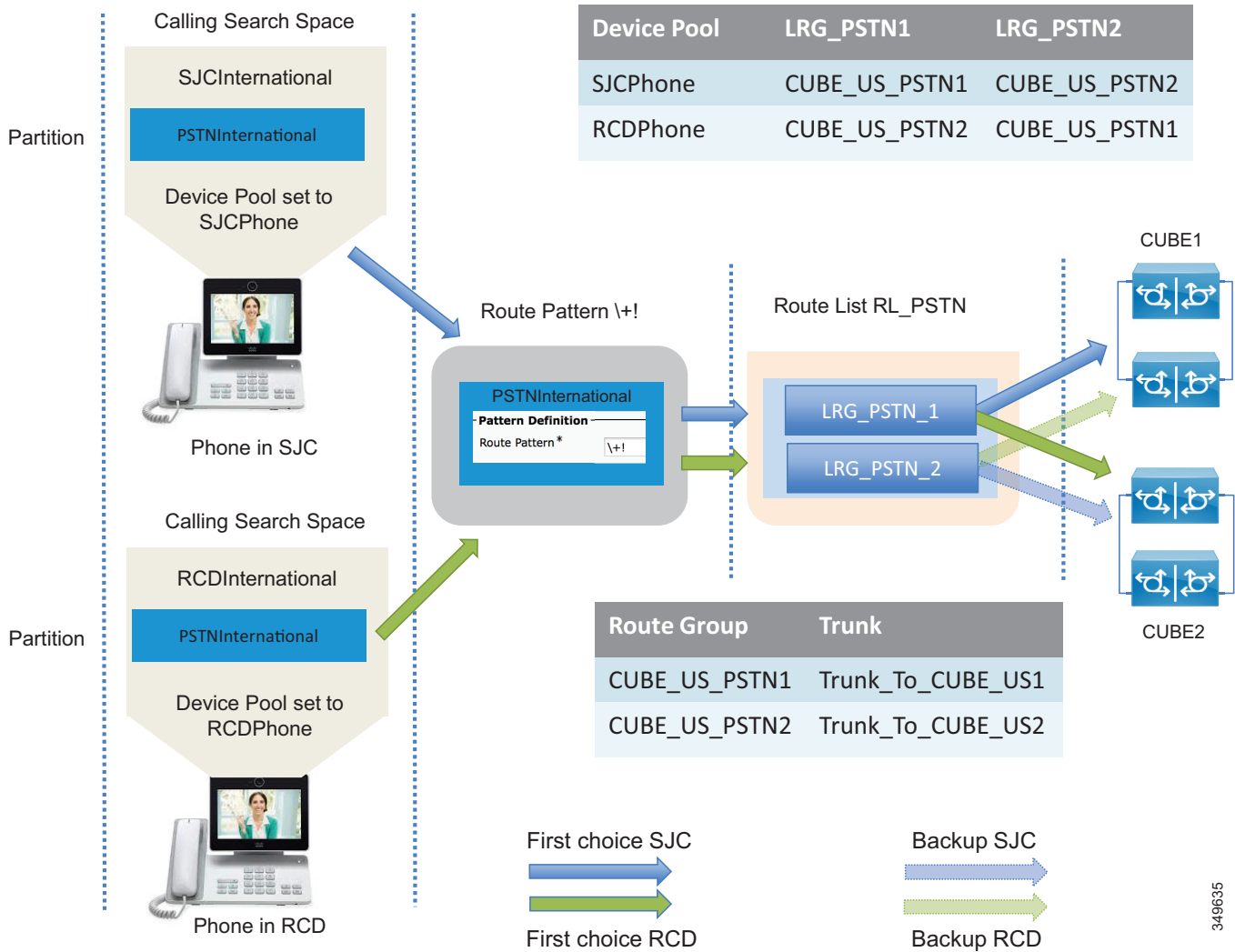

In this case, the device pool SCJPhone has LRG\_PSTN1 set equal to the route group CUBE\_US\_PSTN1, while device pool RCDPhone has LRG\_PSTN1 set equal to the route group CUBE\_US\_PSTN2. LRG\_PSTN2 is set equal to CUBE\_US\_PSTN2 for SJC phones and equal to CUBE\_US\_PSTN1 for RCD phones. This approach is recommended because new partitions and route patterns are not required, and this approach is much more scalable than the approach shown in [Figure 4-25](#).

349635

## Scaling the PSTN Solution

Distributed gateways providing local PSTN access are deployed in branch offices and used as backup services.

If the number of branches is high, the route group and route list configuration construct within Unified CM does not scale well. For this deployment we recommend using the Local Route Group feature, so that route patterns to the PSTN do not have to be replicated for each site.

The configuration presented in the previous section is easily adapted to cover this scenario. What is needed is to assign the device profile LRG\_PSTN1 to route group CUBE\_US\_PSTN, and to assign LRG\_PSTN2 to the route group corresponding to the local gateway for that device pool, as shown in Figure 4-27.

**Figure 4-27 Configuration for Centralized PSTN Access with Local Gateways**

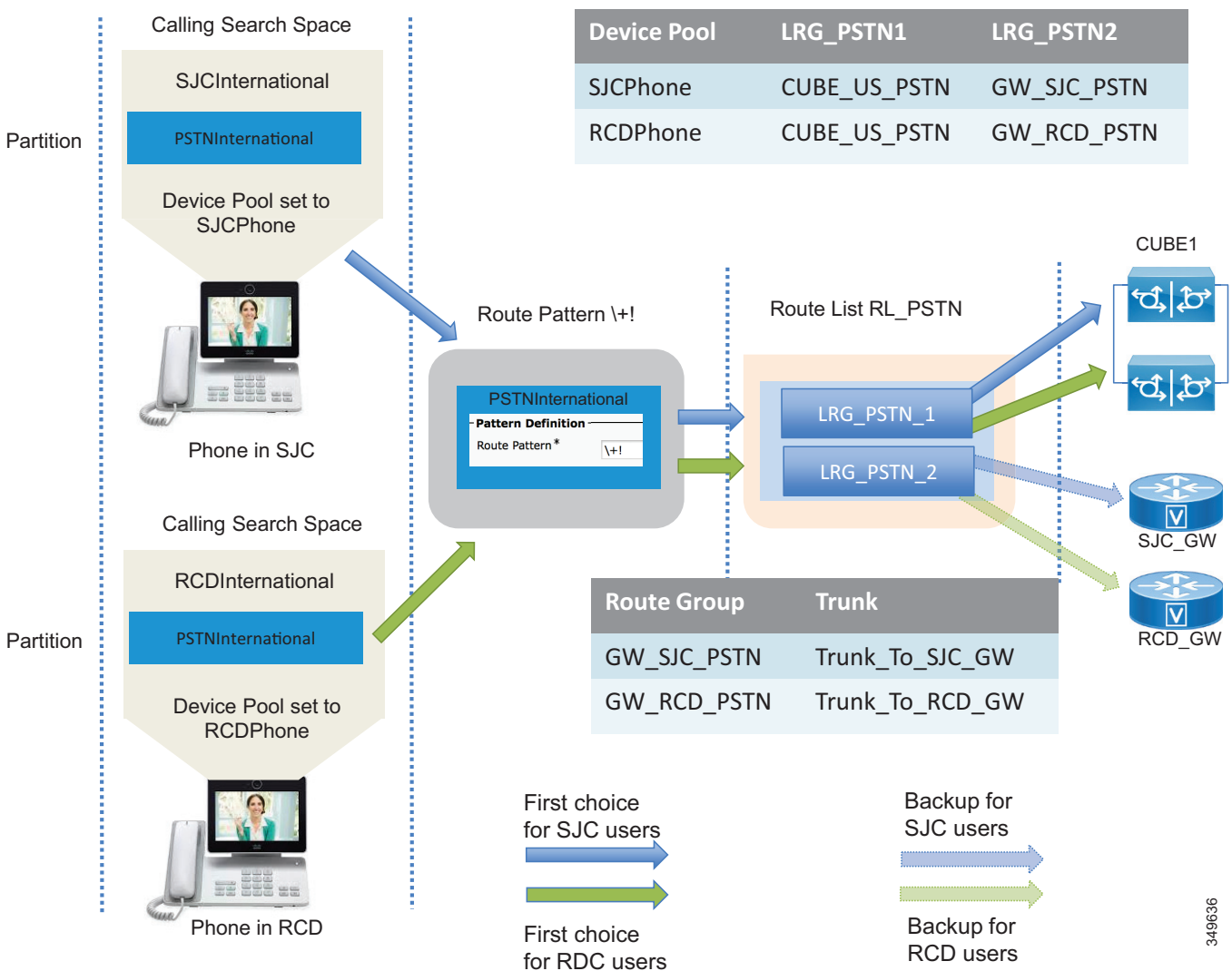

349636

# Collaboration Edge Deployment Process

This section summarizes the Collaboration Edge deployment process. Each component of Collaboration Edge is treated separately since each deployment may not require all access methods. As an example, a company might have only PSTN. Another company might use PSTN as a local backup for IP PSTN at specific local sites and have an Internet Edge deployment.

The Collaboration Edge components should be deployed in the following order:

- [Deploy Expressway-C and Expressway-E](#)
- [Deploy Cisco Unified Border Element](#)
- [Deploy Cisco Voice Gateways](#)

## Deploy Expressway-C and Expressway-E

This section provides an overview of the tasks required to install and deploy Expressway-C and Expressway-E. The task should be performed in the following order:

1. Download and deploy Expressway-C and Expressway-E OVA templates and install the Expressway software. If the appliance model is used, there is no need to download and install OVA templates and the Expressway software.
2. Configure network interfaces and settings, including DNS and NTP, and system host name and domain name. Expressway-E has two LAN interfaces. If the external interface IP address is to be translated statically, the IP address of the translated interface has to be configured. Expressway-E will use the public IP address in payload references. Configure static routing for Expressway-E with two LAN interfaces. Static routing is needed if the Expressway-C interface is on another network than Expressway-E and the Expressway-C interface is not translated by NAT. This would make Expressway-C appear as if it was in the same network as Expressway-E. A single Expressway-E interface is also supported but not covered in this Preferred Architecture document.
3. Configure clustering.

## Deploy Mobile and Remote Access

1. Enable mobile and remote access by setting the Unified Communications mode to **Mobile and remote access**.
2. After setting the Unified Communications mode to **Mobile and remote access**, on Expressway-C set the **MRA Access Control** settings as shown in [Table 4-6](#).

**Table 4-6 Expressway-C Mobile and Remote Access (MRA) Access Control Settings**

Parameter	Setting	Description
<b>Authentication path</b>	UCM/LDAP basic authentication	Determines the authentication path for MRA connected endpoints. If using SSO, choose one of the other settings.
<b>Authorize by OAuth token with refresh</b>	On	Enables OAuth 2 authentication flows for Jabber MRA connections.



**Table 4-6 Expressway-C Mobile and Remote Access (MRA) Access Control Settings (continued)**

Parameter	Setting	Description
<b>Authorize by user credential</b>	On	Enables authentication for hardware endpoint MRA connections.
<b>Check for internal authentication availability</b>	No	Sets system to not query the home cluster authentication mode. All clusters in this deployment use the same authentication method.

3. Select the domains for which mobile and remote access is enabled. Turn on **SIP registration and provisioning on Unified CM, IM and Presence service on Unified CM, and XMPP federation if inter-company federation**.
4. Upload the CA certificate to Expressway-C and Expressway-E. This is needed to discover Unified CM and IM and Presence clusters if **TLS verify mode** is **on** (recommended). This way Expressway-C will verify the identity of the cluster servers by checking the certificate.
5. Discover Unified CM and IM and Presence servers by configuring the publisher for each cluster.
6. Install certificates on both Expressway-C and Expressway-E. Both Expressway peer types are able to generate a Certificate Signing Request (CSR) which is then signed by a CA. If an internal CA is used, the CSRs have to be signed by it. An Expressway-C certificate can be signed by an internal CA, but Expressway-E requires a certificate signed by a public CA. The signed certificates then need to be uploaded on Expressway-C and Expressway-E.
7. Configure a Unified Communication traversal zone between Expressway-C and Expressway-E, and allow for proxy registration to Cisco Unified CM.
8. To ensure that everything has been set up properly, check the Unified Communications status.

**Note**

- This configuration enables mobile and remote access. Business-to-business requires an additional configuration.
- The configuration above is done entirely on Expressway-C and Expressway-E.
- These steps are required for TCP/RTP connection to Unified CM (TLS/SRTP is not shown).

## Deploy Business-to-Business Communications

This section provides an overview of the additional steps necessary to setup business-to-business communications.

1. Configure the basic Layer 3 configuration, including NTP, DNS, and system name, on both Expressway-C and Expressway-E.
2. Set up NAT configuration on Expressway-E, including IP routes necessary for routing traffic.
3. Ensure that the external firewall is set to block all traffic to Expressway-E before placing it in the DMZ.
4. Configure an administrative access policy, including local and/or remote authentication for both Expressway-C and Expressway-E.
5. Configure DNS A records in the appropriate DNS servers to be able to resolve the FQDN of each server.

6. Set up local authentication credentials in Expressway-E for the purpose of authenticating the traversal client connection coming from Expressway-C.
7. Set up the traversal server zone on Expressway-E for SIP only.
8. Set interworking on Expressway-E to **On**. This allows Expressway-E to send and receive H.323 calls and interwork them to SIP at the edge of the network, thus maintaining a single protocol inside the enterprise.
9. Set up the traversal client zone on Expressway-C for SIP only.
10. Use the FQDN of Expressway-E to enable the traversal link to allow for the possible use of PKI.
11. Configure the external DNS zone for outbound domain resolution for business-to-business communications.
12. Place basic CPL rules in place on Expressway-E to restrict access to protected resources such as video, voice, and IP PSTN gateways.
13. Set up domains for which Expressway-C and Expressway-E will have authorization.
14. Set up the dial plan on Expressway-C and Expressway-E with presearch transforms, search rules, DNS search rules, and external IP address routing.
15. Configure the SIP neighbor zone to Unified CM on Expressway-C.
16. Configure the SIP trunk on Unified CM to communicate with Expressway-C.

## Deploy Cisco Unified Border Element

This section provides an overview of the process for deploying Cisco Unified Border Elements with box-to-box redundancy. Box-to-box redundancy has to be configured on both Unified Border Element routers, and the configuration is the same on both. It is possible to copy and paste the configuration from the active to the standby Unified Border Element.

1. Configure the network settings: the two Ethernet interfaces (one toward the LAN and the other facing the WAN) on both active and standby Unified Border Elements, as well as IP routing.
2. Enable the Unified Border Element on both routers for SIP-to-SIP calls, fax relay or passthrough, calling ID treatments as privacy headers, and enforcement of Early Offer. We recommend enabling this feature on Unified Border Element because Unified CM is configured for Best Effort Early Offer only. Although in new deployments only Early Offer will be sent from endpoints, there might be some cases involving old Cisco devices where Delayed Offer is sent instead. Even though these cases are not covered in this document, it is good practice to enforce Early Offer on Cisco Unified Border Element.
3. Enable box-to-box redundancy, and configure HSRP globally and on both the LAN and WAN interfaces for the active and standby routers.
4. Configure the voice codecs preference (in case the voice codec can be negotiated and it is not enforced by Unified CM or the Telecom carrier soft switch).
5. Configure music on hold.
6. Configure the dial-peers. Dial-peers are associated with call legs and can be matched inbound or outbound. As an example, an inbound call from Unified CM will be matched by an inbound dial-peer (corresponding to the inbound call leg). Another call leg will be generated by Cisco Unified Border Element (CUBE) toward the session border controller (SBC) of the Telecom carrier, and thus will be matched against another dial-peer. although the same dial-peer can match inbound or outbound calls, we recommend having each dial-peer match a specific call leg. Following this recommendation, there will be 4 distinct dial-peers: inbound dial-peer from Unified CM to CUBE,

outbound dial-peer from CUBE to SBC, inbound dial-peer from SBC to CUBE, and outbound dial-peer from CUBE to Unified CM. Dial-peers can be matched against calling or called numbers or patterns. A dial-peer can force a single codec or can negotiate the list of codecs configured in step 4. The **incoming called-number** command makes a dial-peer inbound only.

Inbound dial-peers do not have an associated target, while outbound dial-peers have Unified CM or the carrier's SBC defined as targets.

Since calls to external destinations match generic patterns, dial-peer configuration on Unified Border Elements might lead to errors. As an example, in [Figure 4-28](#) an outbound call matches both dial-peer 201 and 101, and therefore the routing does not work properly.

**Figure 4-28** Inbound and Outbound Dial-Peer Configuration on Cisco Unified Border Element

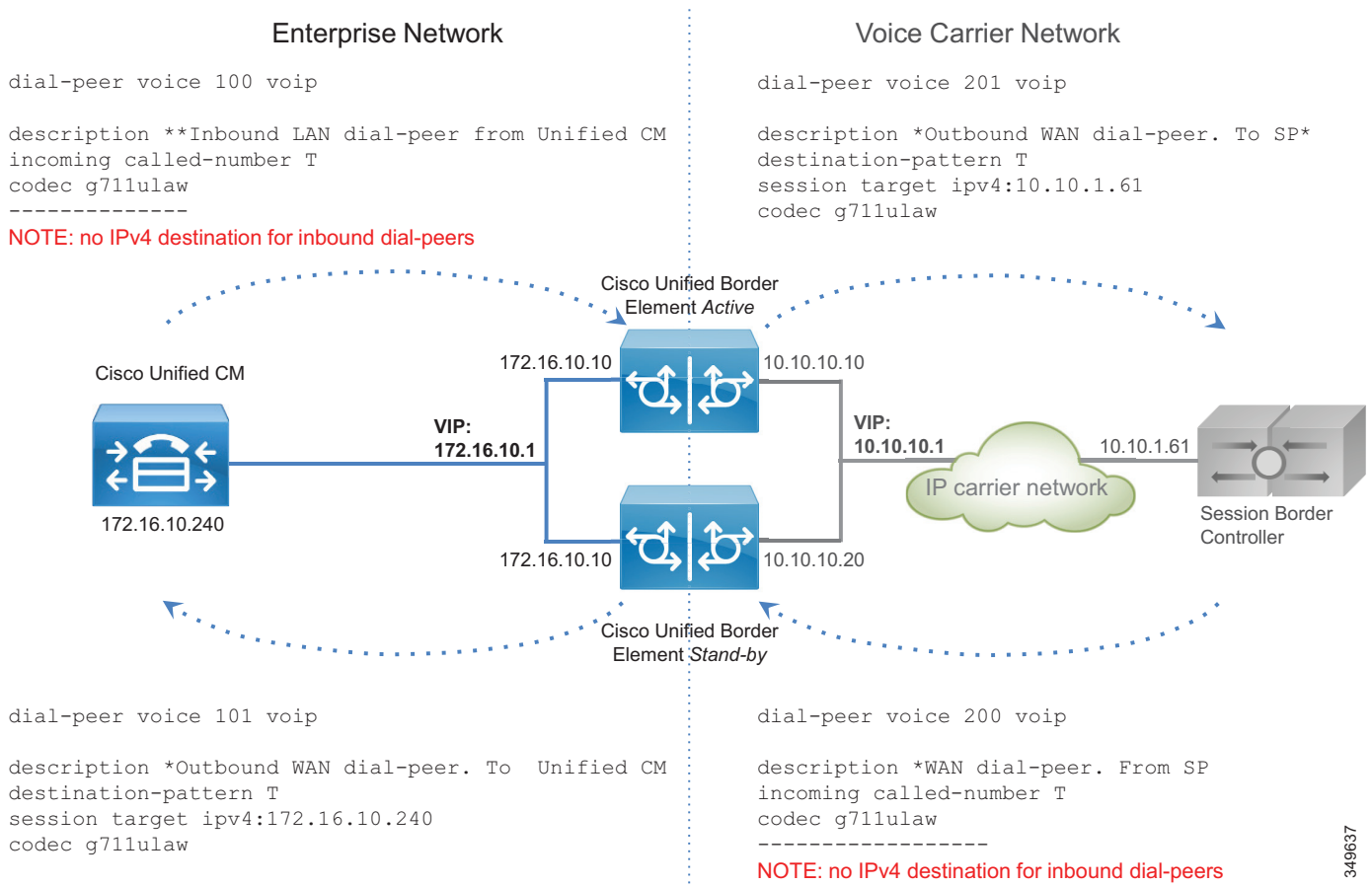

The variable T in [Figure 4-29](#) indicates any numeric string of any length, since calls from Unified CM might be sent to any destination in the world. A closest match might help, but when the Unified Border Element is centralized and provides the service for multiple locations, it might not

be practical to list all the possible destinations in the "destination pattern" configuration. To overcome this limitation, and in order to simplify the routing process and make it more responsive, the following additional configuration is implemented:

- a. Server groups in outbound dial-peers — If a server group is set as the destination in a dial-peer, and a round-robin algorithm is selected, the Unified Border Element will share the load between multiple servers:

```
voice class server-group 1
  ipv4 172.16.10.240
  ipv4 172.16.10.241
  ipv4 172.16.10.242
  ipv4 172.16.10.243
  ipv4 172.16.10.244
  hunt-scheme round-robin
```

- b. SIP Out-of-Dialog OPTIONS Ping — It is possible to configure many parameters, such as the ping interval when a server is up and running, and the interval when it is down (set to 30 and 60 seconds respectively in this example):

```
voice class sip-options-keepalive 171
  transport tcp
  sip-profile 100
  down-interval 30
  up-interval 60
  retry 5
  description Target Unified CM
```

This way, the outbound dial-peer to Unified CM will be as follows:

```
dial-peer voice 101 voip
  description *Outbound WAN dial-peer. ToUnified CM
  destination-pattern T
  session protocol sipv2
  session server-group 1
  voice-class sip options-keepalive profile 171
  codec g711ulaw
```

- c. The outbound call leg to the Telecom carrier will be matched by an outbound dial-peer:

```
dial-peer voice 201 voip
  description *Outbound WAN dial-peer. To SP*
  destination-pattern T
  session target ipv4:10.10.1.61
  codec g711ulaw
```

- d. A leading "\*" is sent by Unified CM on outbound calls (inbound calls from Unified Border Element's perspective), which enables the router to distinguish the direction of the call. This character must be eliminated before the call goes out to the IP PSTN. Further, according to the configured dial plan, the calling number has to be normalized with the "+". Rule 2 prefixes a "+" and is applied to the calling number, while rule 1 replaces the leading "\*" with "+". The rules are applied to the called number. Two rules might be created for this, one for the called number and one for the calling number. However, since the called number always matches the first rule, and the calling number always matches the second rule, it is possible to use a single voice translation rule. This is configured on the inbound dial-peer.

The outbound call leg (dial-peer) is bound to the inbound dial-peer via the **dpg** command, so that if any call is received with a leading "\*", it is sent to the dial-peer facing the SBC and not to the one going to Cisco Unified CM:

```
voice class dpg 201
  dial-peer 201

voice translation-rule 2
  rule 1 /^*/ /+/
  rule 2 // /+/
voice translation-profile SIPToE164
  translate called 2
  translate calling 2
dial-peer voice 100 voip
  translation-profile outgoing SIPToE164
  incoming called-number *T
  destination dpg 201
  codec g711
```

Dial-peer 200 needs also to be bound to dial-peer 101:

```
voice class dpg 101
  dial-peer 101

dial-peer voice 200 voip
  description *WAN dial-peer. From SP
  incoming called-number T
  destination dpg 101
  codec g711ulaw
```

Figure 4-29 shows this configuration.

**Figure 4-29 Dial-Peer Configuration for Cisco Unified Border Element**

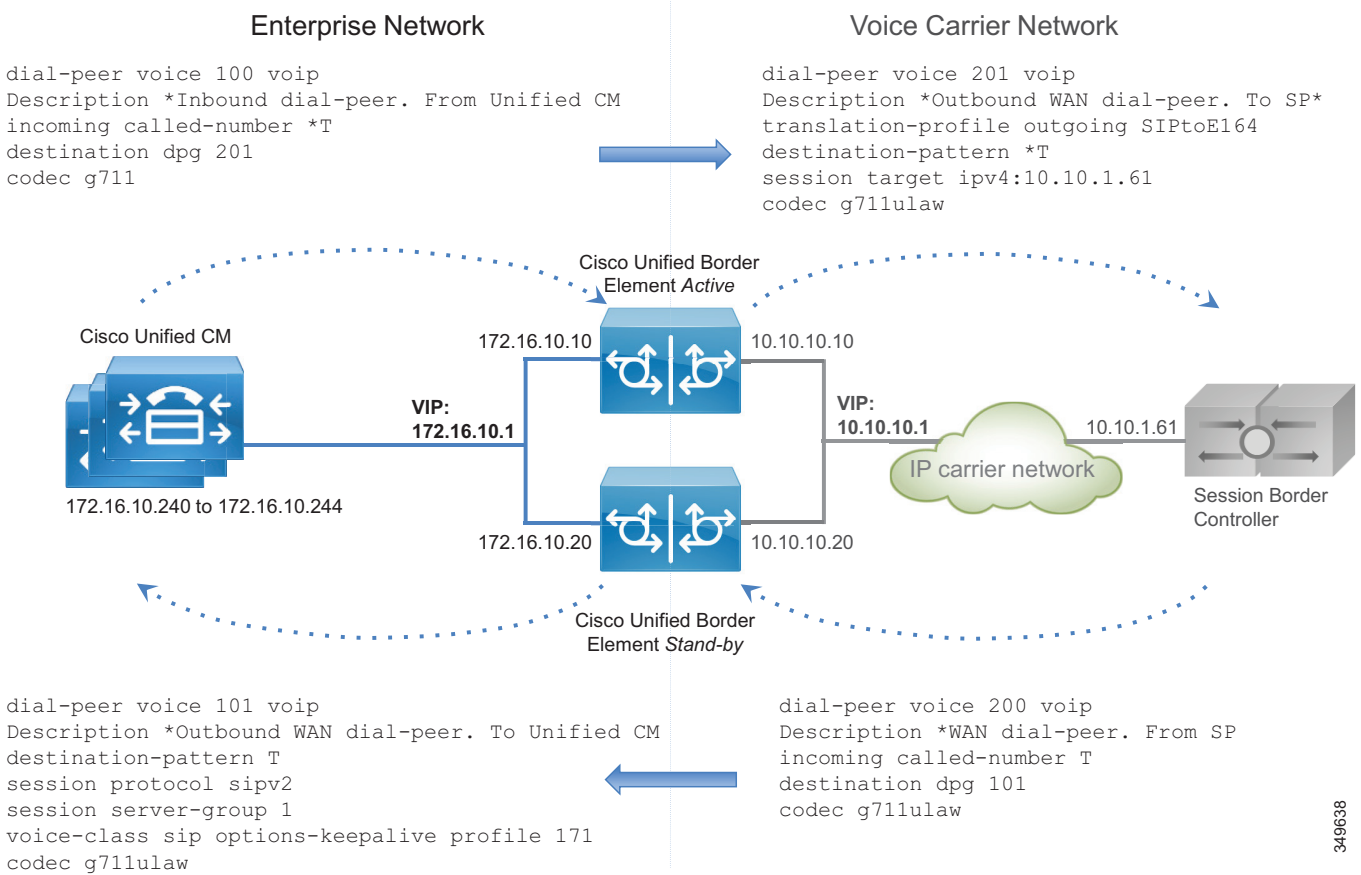

If the call leg comes from Unified CM, it will hit the Unified Border Element with a leading "\*", thus matching dial-peer 100. The call is then sent to dial-peer 200 by using the outbound dial-peer group as an inbound dial-peer destination. Dial-peer 200 removes the leading "\*" and sends the call to the PSTN. Note that without this feature, dial-peer 201 would also be matched, resulting in routing errors.

If the call leg comes from the SBC, it might match dial-peers 201, 101, and 200. But since the "incoming called-number" takes precedence over the "destination pattern," dial-peer 200 will be matched; and since dial-peer 200 is linked to the dial-peer 101, the call is correctly routed to the destination.

7. Configure transcoding if required. Remember that transcoding requires dedicated hardware resources (DSPs).

Perform the following configuration tasks on Unified CM:

1. Configure a Best Effort Early Offer trunk for each Unified Border Element, as specified in the [Call Control](#) chapter.
2. Configure route group CUBE\_US\_PSTN and add the Unified Border Element trunk as a member.
3. Configure local route group LRG\_PSTN1.
4. Configure a route list that includes the default local route group and the route group LRG\_PSTN1.
5. For each device pool set LRG\_PSTN1 to CUBE\_US\_PSTN.

349638

## Deploy Cisco Voice Gateways

PSTN interfaces are available across a wide range of routers, such as Cisco ISR and ASR routers. PSTN interfaces include analog, BRI, and PRI ISDN voice cards. Analog interfaces are used mostly to connect fax machines and analog telephones.

Perform the following tasks to configure a PSTN gateway with ISDN voice interfaces:

1. Configure network settings and routing on the router.
2. Activate the ISDN interface.
3. Set the ISDN parameters for user side, switch-type, framing, and linecode, based on the Telecom carrier's requirements.
4. Configure the dial-peers.

The dial-peer logic is the same as for the IP PSTN and Unified Border Element, but in this case besides the "voip" dial-peers, a voice gateway also has "pots" dial-peers toward the PSTN.

If there are analog devices such as fax machines, they can be connected to the router through an analog interface.

If the router is used only for analog fax interconnection and with the PSTN interfaces attached to another router, T.38 fax-relay can be configured since it provides for better resiliency, especially if the path to the PSTN gateway traverses the WAN.

The dial-peer configuration is different from IP PSTN and the Unified Border Element configuration. Since the gateway is deployed within a specific location and serves phones for that location, the pattern destination is well known, as for example +14085554XXX.

On the other side, an incoming PSTN call has an address that is composed of plan, type, and number. Plan and type are not supported in SIP, and based on the Telecom carrier, the call can reach the gateway with a different plan and type. As an example, for a call to E.164 destination 4961007739764 on a trunk in Germany in the same area code 6100, the called party number in the outgoing ISDN SETUP message could be sent as (plan/type/number) ISDN/national/61007739764, ISDN/subscriber/7739764, or unknown/unknown/061007739764.

Based on the plan/type, the number changes, and thus the dial-peers might not match. For this reason it is necessary to force the plan/type to unknown/unknown. This way the full E164 number will be released to the destination. Dial-peer structure is described in detail in the [Call Control](#) chapter and is referenced here for consistency.

For outbound dial-peers, this rule transforms any calling party number to plan "unknown" and type "unknown", and it transforms the called party number with the leading "\*" to the +E.164 number.

```
voice translation-rule 1
    rule 1 /^.* / // type any unknown plan any unknown
    rule 2 // // type any unknown plan any unknown
voice translation-profile ISDNunknown
    translate called 1
translate calling 1
dial-peer voice 1 pots
    translation-profile outgoing ISDNunknown
```

For inbound dial-peers, if the calling party information has a 10-digit number with type "national" (and does not include the country code "1" for US), the call will be transformed correctly to the +E.164 number, prepending "+1". If it is "unknown" the following rules will not be matched.

If the called number comes from an international destination, and thus it has the country code and is in the E.164 format, then rule 2 will add the leading "+".

However, since ISDN setup is hop-by-hop, we are not expecting to see many calls with type "national" since the latest switch might force it to "national". In any case, these rules normalize the calling and called party numbers correctly.

```
voice translation-rule 3
  rule 1 /^\(.\+\)$/ /+1\1/ type national unknown plan any unknown
  rule 2 /^\(.\+\)$/ /+\1/ type international unknown plan any unknown
voice translation-profile ISDNtoE164
  translate called 3
  translate calling 3

dial-peer voice 1 pots
  translation-profile incoming ISDNtoE164
```

Figure 4-30 shows a dial-peer configuration for G.711 and the E1 PRI interface.

**Figure 4-30 Dial-Peer Configuration for Voice Gateways**

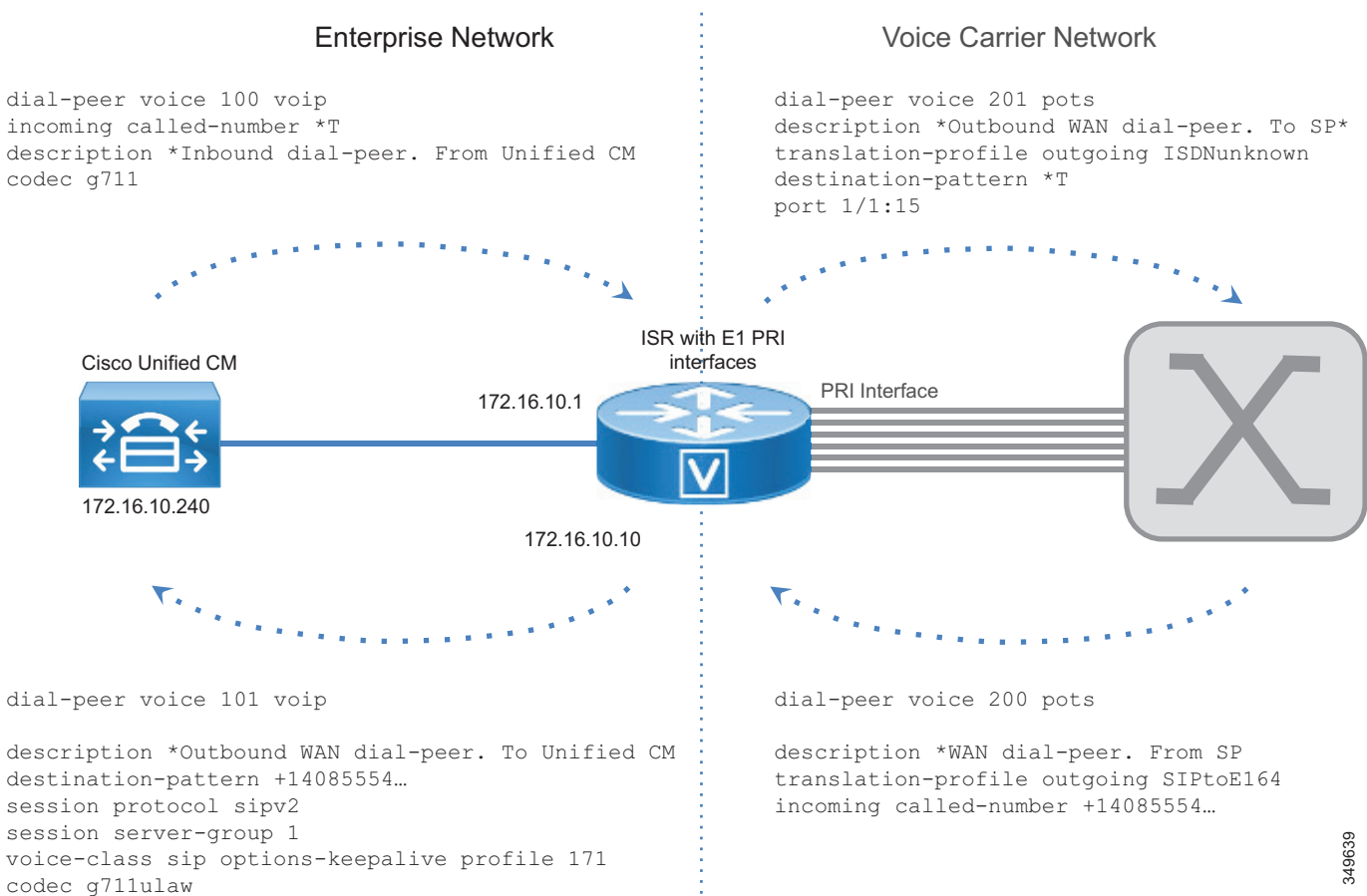

Perform the following configuration tasks on Unified CM:

1. Configure a Best Effort Early Offer trunk for each gateway (Trunk\_to\_SiteID\_GW, SiteID is a variable that identifies the location).
2. Configure route group LRG\_PSTN1 and include the gateway trunk as member.
3. Configure local route group LRG\_PSTN1.

349639



4. Configure a route list that includes the default local route group and LRG\_PSTN1.
5. For each device pool, set LRG\_PSTN1 to Trunk\_to\_SiteID\_GW. This configuration assumes, as recommended, that for each site there is a device pool SiteIDPhone.

By using the local route group configuration, it is easy to reconfigure PSTN access. As an example, it is possible to use the Unified Border Element for centralized access to the PSTN and to use the local PSTN connection as backup. In this case, the device pool would specify the Unified Border Element route group as LRG\_PSTN1, and LRG\_PSTN2 will include the trunk to the local gateway (Trunk\_to\_SiteID\_GW).





# Voice Messaging

Revised: May 21, 2021

This chapter describes the voice messaging services included in the Preferred Architecture for Enterprise Collaboration. This chapter explains how to implement [Unified Messaging with Cisco Unity Connection](#). It contains a description of the core architecture as well as details about the deployment process.

## What's New in This Chapter

[Table 5-1](#) lists the topics that are new in this chapter or that have changed significantly from previous releases of this document.

**Table 5-1** *New or Changed Information Since the Previous Release of This Document*

New or Revised Topic	Described in:	Revision Date
Minor Edits		May 21, 2021

## Prerequisites

Before deploying the core applications for the Preferred Architecture, ensure that:

- Cisco Unified Communications Manager (Unified CM) is deployed and functioning.
- Microsoft Active Directory is installed, and the integration for each application is understood.
- The [Call Control](#) chapter of this document is understood and implemented.

# Unified Messaging with Cisco Unity Connection

Cisco Unity Connection enables unified messaging for the Cisco Preferred Architecture for Enterprise Collaboration. This section provides the information and instructions for deploying Unity Connection for voice messaging and unified messaging along with features such as single inbox and visual voicemail. This section also covers networking between two Unity Connection clusters.

## Core Components

The core architecture contains these elements:

- Cisco Unified Communications Manager (Unified CM)
- Cisco Unity Connection
- Microsoft Exchange
- Microsoft Active Directory

## Key Benefits

- Users can access the voicemail system and retrieve their voice messages by using:
  - Cisco Unified IP Phones, TelePresence endpoints, Jabber, and mobile devices
  - Web interface with PCs or Mac
  - Email client applications such as Microsoft Outlook
- Visual voicemail provides secure access to a visual display of voice messages on a Jabber client, listed with sender name, date, and message duration.

# Architecture

The Preferred Architecture uses a centralized deployment model for voice messaging and call processing, as described in this section.

## Centralized Messaging and Centralized Call Processing

As shown in [Figure 5-1](#), with centralized messaging Unity Connection is located in the same site as the Unified Communications Manager (Unified CM) cluster. Remote branch sites located over the WAN from the central site rely on the centralized Unity Connection for unified messaging services. Unity Connection integrates with Unified CM using SIP for call control and RTP for the media path. Each Unity Connection cluster consists of two server nodes providing high availability and redundancy.

**Figure 5-1** Architecture Overview

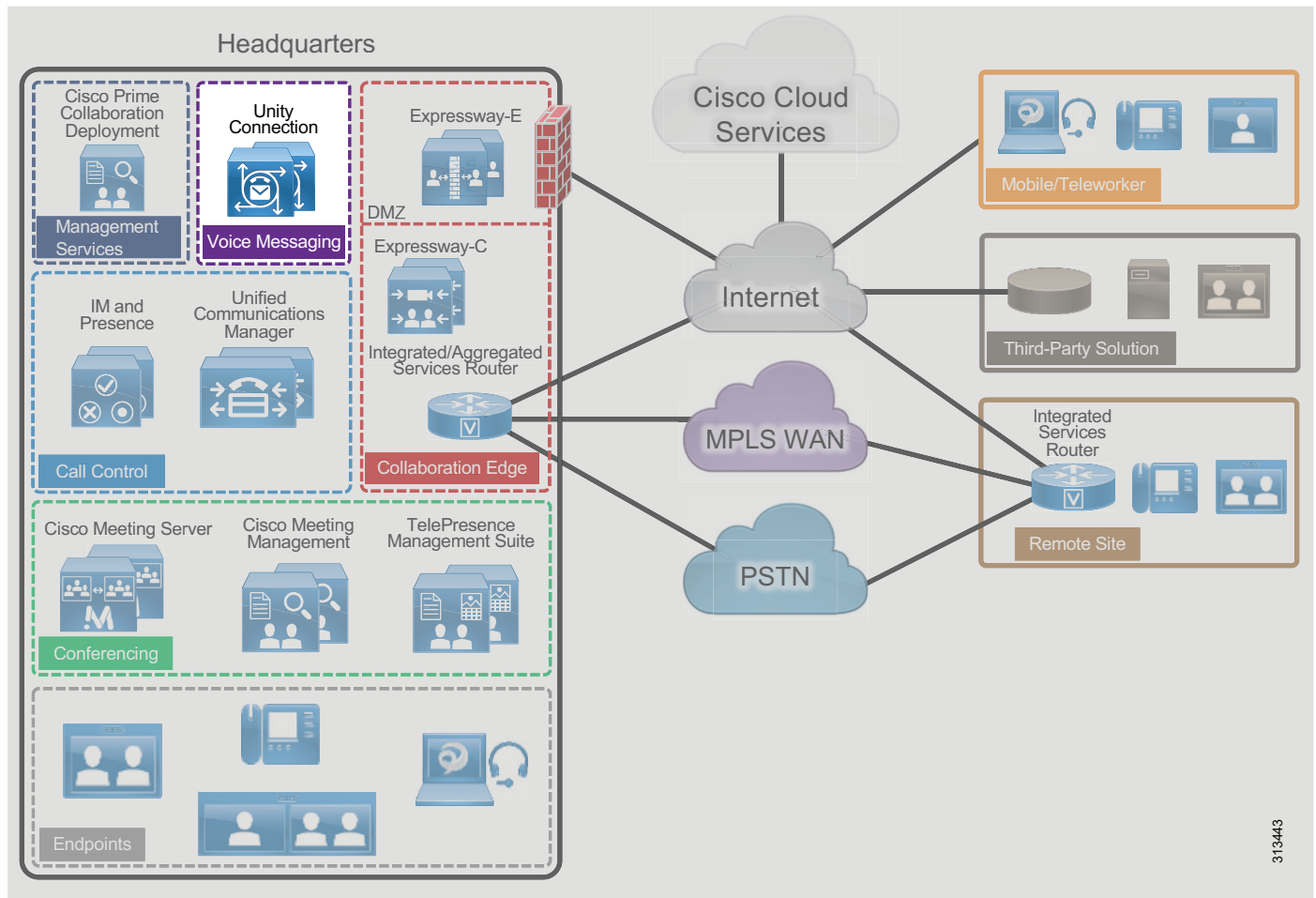

At the remote branch site, Cisco Unified Survivable Remote Site Telephony (SRST) is installed as a backup call agent, which is integrated with the central Unity Connection server. In the event of an IP WAN outage, all the phones at the remote branch register with SRST, which is preconfigured to send all the unanswered and busy calls to the central Unity Connection server via the PSTN.

313443

## Role of Unified CM

Unified CM provides call control capabilities and forwards calls to Unity Connection in the event that a called phone is either busy or unanswered. If a user presses the message button on the phone or dials the voicemail pilot number from an outside network, then Unified CM routes the call to Unity Connection.

## Role of Unity Connection

In a centralized messaging deployment, Unity Connection provides users with the ability to store and retrieve voicemails. Typically calls forwarded to Unity Connection are direct calls or are due to a called extension that is either busy or unanswered. Message Waiting Indicator (MWI) is displayed on the endpoint for any new messages stored for the user. With each call, the following call information is typically passed between the phone system and Unity Connection:

- The extension of the called party
- The extension of the calling party (for internal calls) or the phone number of the calling party (if it is an external call and the phone system supports caller ID)
- The reason for the forward (the extension is busy, does not answer, or is set to forward all calls)

If the call is forwarded because the called party did not answer the call, Unity Connection plays the called user's standard greeting. If the call was forwarded because the called phone was busy, Unity Connection plays the called user's busy greeting.

Unity Connection handles direct calls differently than forwarded calls. When Unity Connection receives a call, it first attempts to determine whether the caller is a user. It does this by identifying whether the caller ID matches a user's primary or alternate extension. If Unity Connection finds a match, it assumes that a user is calling and it asks for that user's voicemail PIN. If Unity Connection determines that the caller ID is not associated with a user, then the call is sent to the opening greeting. An opening greeting is the main greeting that outside callers hear when they reach the Unity Connection auto-attendant.

## Role of Microsoft Exchange

Unity Connection is integrated with Microsoft Exchange to enable the Single Inbox feature. Single Inbox in Unity Connection enables unified messaging and synchronizes voice messages between Unity Connection and Microsoft Exchange. This enables users to retrieve voicemail using their email client.

This chapter focuses on Unified Messaging with Microsoft Exchange. Unity Connection can also be integrated with IBM Lotus Sametime instant messaging application, allowing users to play their voice messages using Lotus Sametime. For more information on this topic, refer to the Unity Connection documentation available at

<https://www.cisco.com/en/US/products/ps6509/index.html>

## High Availability for Unified Messaging

Figure 5-2 shows Unity Connection in an active/active pair, allowing the Unity Connection servers to be installed in the same or separate buildings to provide high availability and redundancy. Both servers in the active/active pair are running Unity Connection, both accept calls and HTTPS requests, and both servers store user information and messages. In the event that only one server in the clustered pair is active, Unity Connection preserves the complete end-user functionality, including voice calls and HTTPS requests. However, Unity Connection port capacity for calls will be reduced by half, to that of a single server.

**Figure 5-2** Unity Connection Cluster

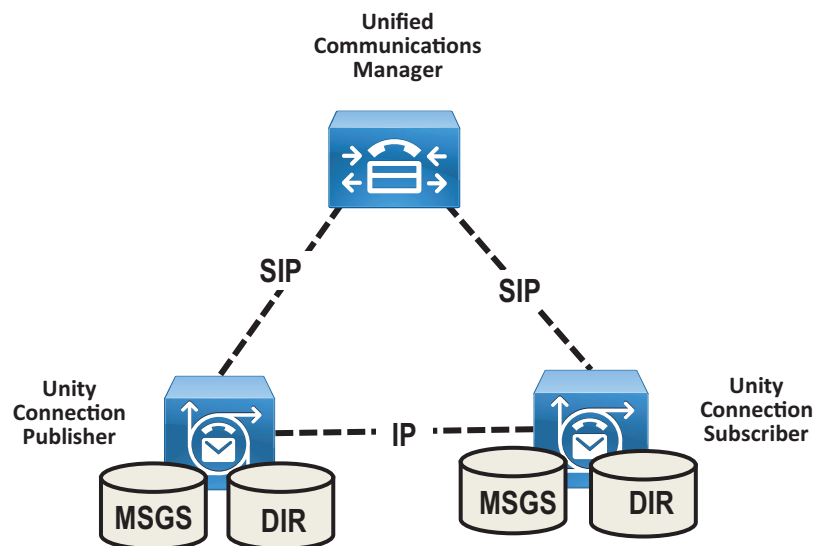

All user client and administrator sessions (for example, IMAP and Cisco Personal Communications Assistant) and administration traffic (for example, Cisco Unity Connection Administration, the Bulk Administration Tool, and backup operations) connect to the Unity Connection publisher server. If the publisher server stops functioning, the user client and administrator sessions can connect to the Unity Connection subscriber server.

This topology requires two separate Unified CM SIP trunks pointing to each Unity Connection server node in the cluster. This configuration provides both high availability and redundancy. Unified CM should be configured to route all calls to the Unity Connection subscriber node first. If the subscriber server is unavailable or all the ports of the subscriber are busy, then calls are routed to the publisher node. Given the SIP integration between Unified CM and Unity Connection, trunk selection is achieved via Unified CM route pattern, route list, and route group constructs (see Figure 5-3). Both trunks are part of the same route group and assigned to the same route list, and the trunks within the route group are ordered using a top-down trunk distribution algorithm. This approach allows Unified CM to control the preference of the Unity Connection server node selection during both normal and failover operation.

**Figure 5-3** Unity Connection SIP Trunk Selection

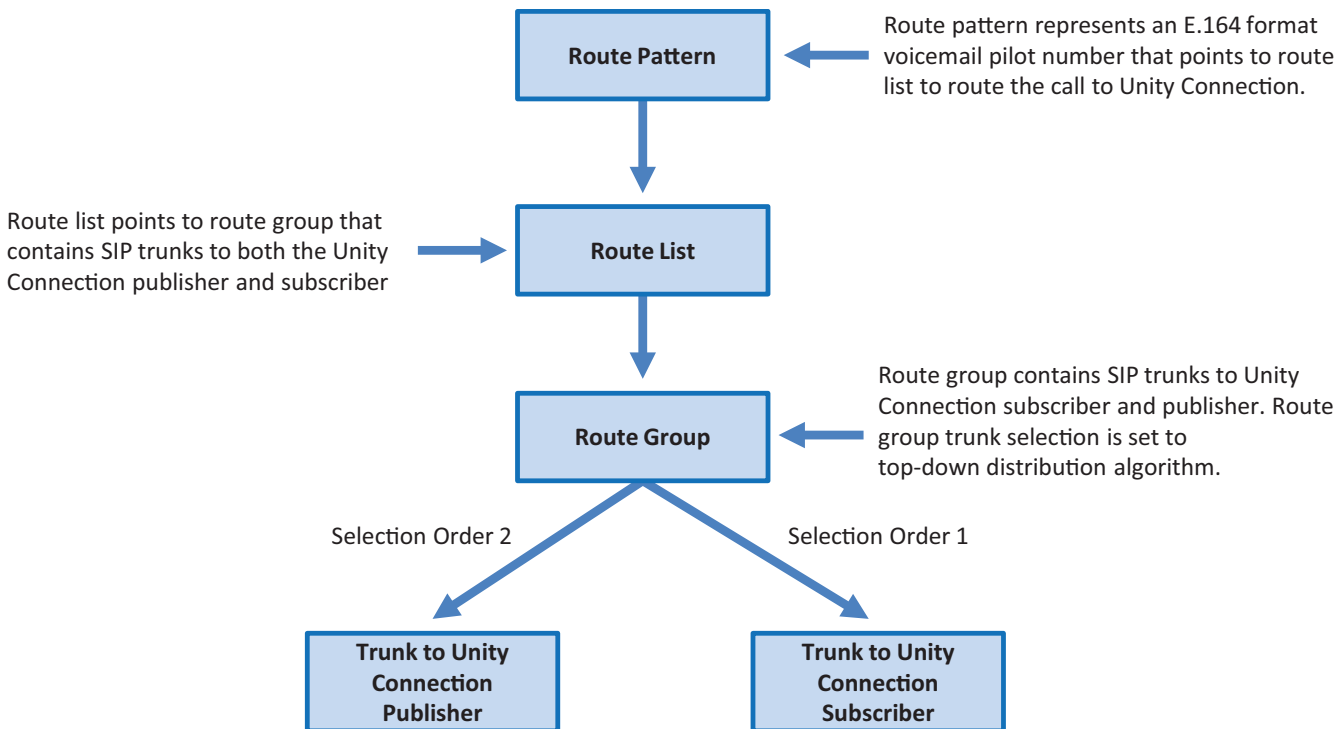

Unity Connection supports using Single Inbox with Microsoft Exchange Database Availability Groups (DAGs) for high availability. The DAGs are deployed according to Microsoft recommendations. Unity Connection also supports connecting to a client access server (CAS) array for high availability. This section does not cover Microsoft Exchange high availability deployment. For more information about Exchange high availability deployments, refer to the Microsoft Exchange product information available at <https://www.microsoft.com/>.

## Licensing Requirements

The licenses for Unity Connection are managed by Cisco Smart Software Manager. To use the licensed features on Unity Connection, valid licenses for the features must be available within the customer's Cisco Smart Software Manager licensing account, and Unity Connection must communicate with the Cisco Smart Software Manager service to access and use the licenses. Cisco Smart Software Manager provides web-based centralized, simplified, and enterprise-wide management of user-based licensing.



## Unified Messaging Requirements

- Unity Connection supports Microsoft Exchange, Microsoft Business Productivity Online Suite (BPOS) Dedicated Services, and Microsoft Office 365 cloud-based Exchange for Single Inbox.
- Exchange servers and Active Directory domain controllers/global catalog servers (DC/GCs) can be installed in any hardware virtualization environment supported by Microsoft. Refer to Microsoft Exchange product information available at <https://www.microsoft.com/> for more information about supported hardware platforms.
- The Microsoft Exchange message store can be stored in any storage area network configuration supported by Microsoft. Refer to Microsoft Exchange product information available at <https://www.microsoft.com/> for more information about supported storage area network.
- For every 50 voice messaging ports on each server, 7 Mbps of bandwidth is required between Unity Connection and Microsoft Exchange for message synchronization.
- The default Unity Connection configuration is sufficient for a maximum of 2,000 users and 80 milliseconds of round-trip latency between Unity Connection and the Exchange servers. For more than 2,000 users and/or more than 80 milliseconds of latency, you can change the default configuration. For more information, see the information on latency in the latest version of the *Design Guide for Cisco Unity Connection*, available at

<https://www.cisco.com/c/en/us/support/unified-communications/unity-connection/products-implementation-design-guides-list.html>

## Scaling Unity Connection

A Unity Connection cluster consists of a maximum of two nodes, one publisher and one subscriber in an active/active deployment. Under normal operation, call processing load balancing does not occur in an active/active deployment. Unified CM is configured to route all calls to the Unity Connection subscriber server first. If all ports are busy or if the subscriber server is unavailable, then calls are routed to the publisher. When sizing Unity Connection, consider the following aspects:

- Total number of current and future users
- Required voice messaging storage capacity
- Number of voicemail ports supported with each platform
- Whether encryption is enabled

For more information on Unity Connection scaling, see the [Sizing](#) chapter.

## Cisco Unity Connection Deployment Process

This section describes how to deploy Cisco Unity Connection in the Preferred Architecture.

### Prerequisites

Before deploying the unified messaging architecture, ensure that:

- Cisco Unified CM is installed and configured for call control (see the [Call Control](#) chapter).
- Microsoft Exchange is installed and configured as an email server.

## Deployment Overview

For the purposes of this Preferred Architecture, we assume a centralized messaging deployment model serving three sites in the US: SJC, RCD, and RTP. The deployment of centralized messaging starts with the Unity Connection cluster installation followed by further provisioning and configuration. To deploy centralized unified messaging with Cisco Unity Connection, perform the following tasks in the order listed here:

1. Provision the Unity Connection Cluster
2. Configure Unified CM for Unity Connection Integration
3. Unity Connection Base Configuration
4. Enable Single Inbox
5. Enable Visual Voicemail
6. Voice Mail in SRST Mode
7. HTTPS Internetworking of Two Unity Connection Clusters

**Note**

---

Only non-default and other configuration field values are specified in this document. If a field configuration value is not mentioned, then the default value should be assumed.

---

## 1. Provision the Unity Connection Cluster

When clustering Unity Connection server nodes, one server is designated as the publisher server in the server pair while the other server is designated as the subscriber server.

### Publisher

In Unity Connection only two servers are supported in a cluster for active/active high availability. The publisher server is the first to be installed, and it publishes the database and message store, replicating this information to the other subscriber server in the cluster.

### Subscriber

Once the software is installed, the subscriber server node subscribes to the publisher to obtain a copy of the database and message store.

### Unity Connection Mailbox Stores

During installation, Unity Connection automatically creates:

- A directory database for system configuration information (user data, templates, classes of service, and so forth).
- A mailbox store database for information on voice messages (who each message was sent to, when it was sent, the location of the WAV file on the hard disk, and so forth).
- An operating system directory for voice message WAV files.

## Prerequisite for Unity Connection Cluster Deployment When the Servers Are to Be Installed in the Same Building

- For inbound and outbound calls to Unity Connection, the TCP and UDP ports of the firewall must be open as listed in the chapter on *IP Communications Required by Cisco Unity Connection* in the latest version of the *Security Guide for Cisco Unity Connection*, available at <https://www.cisco.com/c/en/us/support/unified-communications/unity-connection/products-maintenance-guides-list.html>
- For a cluster with two virtual machines, both must have the same virtual platform overlay.
- The servers must not be separated by a firewall.
- Both Unity Connection servers must be in the same time zone.
- Both Unity Connection server nodes must integrate to the same phone system.
- Both Unity Connection servers must have the same enabled features and configurations.

## Prerequisite for Unity Connection Cluster Deployment When the Servers Are to Be Installed in Separate Buildings

- For inbound and outbound calls to Unity Connection, the TCP and UDP ports of the firewall must be open as listed in the chapter on *IP Communications Required by Cisco Unity Connection* in the latest version of the *Security Guide for Cisco Unity Connection*, available at <https://www.cisco.com/c/en/us/support/unified-communications/unity-connection/products-maintenance-guides-list.html>
- For a cluster with two virtual machines, both must have the same virtual platform overlay.
- Both Unity Connection server nodes must integrate to the same phone system.
- Both Unity Connection servers must have the same enabled features and configurations.
- Depending on the number of voice messaging ports on each Unity Connection server node, the connectivity between the server nodes must have the following guaranteed bandwidth with no steady-state congestion:
  - For every 50 voice messaging ports on each server, 7 Mbps of bandwidth is required.
  - Maximum round-trip latency must be no more than 150 milliseconds (ms).

## To Deploy Unity Connection Cluster

- Determine which VMware Open Virtual Archive (OVA) template you want to deploy for the Unity Connection node based on the maximum number of ports and the maximum number of users. Refer the section on [Scaling Unity Connection](#).
- Add both the Unity Connection nodes as host A records in the enterprise domain name service (DNS) server. For example, set the publisher Unity Connection hostname as US-CUC1.ent-pa.com and the subscriber hostname as US-CUC2.ent-pa.com.
- Determine the network parameters required for the installation:
  - Time zone for the server
  - Host name, IP address, network mask, and default gateway. Ensure that the hostname and IP address match the previous DNS configuration.
  - DNS IP addresses
  - Network Time Protocol (NTP) server IP addresses
- Download the appropriate OVA file from the Cisco website.
- Deploy the Unity Connection publisher and subscriber server nodes using the VMware vSphere Client.
- Install the Unity Connection publisher and subscriber nodes with Cisco Prime Collaboration Deployment.

For details, see the section on [Cisco Prime Collaboration Deployment](#) in the [Collaboration Management Services](#) chapter.



### Note

Optionally, the Unity Connection cluster can be deployed manually. In that case, first deploy the Unity Connection publisher node using the preferred OVA on the VMWare host, then install the Unity Connection package manually on this publisher node. Once the publisher node installation completes, repeat the process for the subscriber node (deploy the OVA on the VMWare host and manually installing the Unity Connection package).

## 2. Configure Unified CM for Unity Connection Integration

Before Unity Connection communicates with Unified CM, certain tasks must be performed on Unified CM. Unity Connection communicates to Unified CM over a SIP trunk. This section provides an overview of the tasks required to integrate Unified CM with Unity Connection.

### Unity Connection Application Username and Server for End User PIN Synchronization

To simplify end user PIN management, enable PIN synchronization between Unified CM and Unity Connection. With PIN synchronization an end user can use the same PIN for multiple purposes, including voice mail access, Extension Mobility, and Conference Now. The PIN is synchronized whether a user changes their PIN number using the Unified CM Self-Care Portal or the Cisco Unity Connection Personal Communications Assistant (PCA).

First, confirm that an application user is configured to match the Unity Connection system administrator account username and password. (For example, **administrator**.) Assuming the system administrator account names and passwords are the same for Unified CM and Unity Connection, this account is already configured.

Next, add new Unity Connection application servers for both publisher and subscriber nodes as shown in [Table 5-2](#).

**Table 5-2** *Defining the Unity Connection Application Server*

Parameter	Value	Comments
Name	<b>US-CUC1</b>	Enter the name of the Unity Connection server.
IP Address	<IP_Address_US-CUC1>	Enter the IP address of the Unity Connection server.
Selected Application Users	<b>administrator</b>	Select the application user that matches the Unity Connection system administrator account.
Enable End User PIN Synchronization	Checked	Check to enable synchronization of the end user PIN between Unified CM (for Extension Mobility and so forth) and Unity Connection (for voice message access).



**Note**

When enabling end-user PIN synchronization between Unified CM and Unity Connection, it is important make sure the assigned PIN authentication rule on Unified CM matches the assigned voicemail authentication rule on Unity Connection in terms of minimum credential length and expiration. Failure to align these authentication rules can result in PIN synchronization errors and login failures, and might require administrator intervention.



**Note**

Unity Connection and Unified CM must both contain the far-end server or root CA certificate loaded to **tomcat-trust** in order for PIN synchronization to work. For more details on certificate management, refer to the [Security](#) chapter.

## SIP Trunk Security Profile

As far as media and signaling encryption is concerned, this guide assumes they are not used and instead non-secure SIP trunks are implemented between Unified CM and Unity Connection server nodes. Create a new SIP Trunk Security Profile for Unity Connection with device security mode set to **Non Secure**. [Table 5-3](#) lists the SIP trunk security profile settings.

**Table 5-3** *SIP Trunk Security Profile Settings*

Parameter	Value	Comments
Name	Unity Connection SIP Trunk Security Profile	Enter the name of the security profile.
Description	Unity Connection SIP Trunk Security Profile	Enter the description for profile.
Device Security Mode	Non Secure	Security mode for SIP trunk.

**Table 5-3 SIP Trunk Security Profile Settings (continued)**

Parameter	Value	Comments
Accept out-of-dialog refer	Checked	Ensures that Unified CM accepts incoming non-INVITE, out-of-dialog refer messages that come via the SIP trunk.
Accept unsolicited notification	Checked	Ensures that Unified CM accepts incoming non-INVITE, unsolicited notification messages that come via the SIP trunk. This parameter must be checked to accept MWI messages from Unity Connection.
Accept replaces header	Checked	Ensures that Unified CM accepts new SIP dialogs, which replace existing SIP dialogs. This allows "REFER w/replaces" to be passed, which is used for Cisco Unity Connection initiated supervised transfers.

## SIP Profile

Configure a SIP profile for the SIP trunk to Unity Connection. Copy the standard SIP profile and rename it to **Unity Connection SIP Profile**. Select the checkbox **Use Fully Qualified Domain Name in SIP Requests** to prevent the IP address of the Unified CM server from showing up in SIP calling party information sent by Unified CM. Ensure that the checkbox **Enable OPTIONS Ping to monitor destination status for Trunks with Service Type "None (Default)"** is checked so that the system tracks the status of connectivity to the Unity Connection node.

When the OPTIONS Ping is enabled, each node running the trunk's SIP daemon will periodically send an OPTIONS Request to each of the trunk's destination IP addresses to determine its reachability and will send calls only to reachable nodes. A destination address is considered to be "out of service" if it fails to respond to an OPTIONS Request, if it sends a Service Unavailable (503) response or Request Timeout (408) response, or if a TCP connection cannot be established. The overall trunk state is considered to be "in service" when at least one node receives a response (other than a 408 or 503) from a least one destination address. SIP trunk nodes can send OPTIONS Requests to the trunk's configured destination IP addresses or to the resolved IP addresses of the trunk's DNS SRV entry. Enabling SIP OPTIONS Ping is recommended for all SIP trunks because it allows Unified CM to track the trunk state dynamically rather than determining trunk destination state on a per-node, per-call, and time-out basis.

## SIP Trunk

Create two separate SIP trunks, one for each Unity Connection server node in the cluster. [Table 5-4](#) lists the SIP trunk settings.

**Table 5-4 Parameter Settings for SIP Trunk to Unity Connection Server**

Parameter	Value	Description
Name	US_CUC1_SIP_Trunk	Enter the unique name for SIP trunk to Unity Connection.
Description	Unity Connection Publisher	Enter the description for the SIP trunk.
Device Pool	Trunks_and_Apps	Enter the device pool for Unity Connection. (See the <a href="#">Call Control</a> chapter.)
Run On All Active Unified CM Nodes	Checked	This ensures that outbound calls using the SIP trunk do not require intra-cluster control signaling between Unified CM call processing subscribers.
<b>Call Routing Information – Inbound Calls</b>		
Calling Search Space (CSS)	VoiceMail (Refer to the <a href="#">Call Control</a> chapter for more about CSS configuration.)	CSS assigned contains all the on-net destinations such as DIDs, non-DID numbers, and URI partitions. If the CSS does not include all these partitions, then the MWI Unsolicited Notify messages from Unity Connection will not reach user phones.
Redirecting Diversion Header Delivery - Inbound	Checked	This ensures that the redirecting Information Element, the first redirecting number, and the call forward reason are sent and accepted as a part of incoming messages. Unity Connection uses the first redirecting number to answer the call.
<b>Call Routing Information – Outbound Calls</b>		
Calling and Connected Party Info Format	Deliver URI and DN in connected party, if available	This option determines whether Unified CM inserts a directory number, a directory URI, or a blended address that includes both the directory number and directory URI, in the SIP identity headers for outgoing SIP messages.
Redirecting Diversion Header Delivery - Outbound	Checked	This ensures that the redirecting Information Element, the first redirecting number, and the call forward reason are sent and accepted as a part of outgoing messages. Unity Connection uses the first redirecting number to answer the call.
<b>SIP Destination Information</b>		
Destination Address	us-cuc1.ent-pa.com	Enter the fully qualified domain name (FQDN) of Unity Connection server.
SIP Trunk Security Profile	Unity Connection SIP Trunk Security Profile	See <a href="#">Table 5-3</a> .
SIP Profile	Unity Connection SIP Profile	See the <a href="#">SIP Profile</a> section.

## Route Group

Create a separate route group RG\_CUC for the Unity Connection cluster. The route group contains the SIP trunks to the Unity Connection subscriber and publisher nodes. Ensure that the SIP trunk that connects to the subscriber node (US\_CUC2\_SIP\_Trunk) appears first in the list, followed by the publisher node (US\_CUC1\_SIP\_Trunk). The route group distribution algorithm should be set to the **Top Down** trunk selection method. A route group configured with the **Top Down** distribution algorithm ensures that the calls are always sent to the Unity Connection subscriber server node (US-CUC2) first. If the Unity Connection subscriber server node is busy or unavailable, then the calls are sent to the publisher server node (US-CUC1).

## Route List

Create a separate route list RL\_CUC for the Unity Connection cluster. The route list should contain only the Unity Connection route group (RG\_CUC) created previously. Ensure that the options **Enable this Route List** and **Run on all Active Unified CM Nodes** are selected.

## Route Pattern

Create a separate route pattern for the voicemail pilot number pointing to the Unity Connection route list created above. This number must match the voicemail pilot number. [Table 5-5](#) shows the route pattern configuration example.

**Table 5-5** Unity Connection Pilot Number-Route Pattern Example

Parameter	Value
Route Pattern	+14085554999
Route Partition	DN
Gateway/Route List	RL_CUC
Call Classification	OnNet
Provide Outside Dial Tone	Unchecked

## Voice Mail Pilot

The voicemail pilot number designates the directory number that users dial to access voice messages. Unified CM automatically dials the voicemail pilot number when a user presses the Messages button on an IP endpoint. A single voicemail pilot number is created for all three sites. [Table 5-6](#) shows the voicemail pilot configuration example.

**Table 5-6** Voicemail Pilot Example

Parameter	Value
Voice Mail Pilot number	+14085554999
Calling Search Space	DN
Description	VM Pilot
Make this the default Voice Mail Pilot for the system	Checked



Voicemail users located at remote sites can check their messages from the PSTN by dialing the voicemail access number from their own DID range. A separate translation pattern is created to translate the voicemail PSTN access number to the voicemail pilot number. Table 6 shows the translation pattern configuration for the voicemail pilot.

**Table 5-7 Voicemail Pilot Translation Pattern Example**

Parameter	Value
Translation Pattern	+19195551999
Partition	DN
Use Originators Calling Search Space	Checked
Route Option	Route this pattern
<b>Called Party Transformations</b>	
Called Party Transform Mask	+14085554999

Additional translation patterns would be created for other remote sites.

## Voicemail Profile

A voicemail profile is assigned to each user's phone line on all endpoint devices and Extension Mobility profiles. The profile enables users to press the Messages button on an endpoint for one-touch access to the voicemail system. If Unity Connection is integrated with a single phone system, we recommend using the default voicemail profile. During the initial provisioning of a line on an endpoint device, the default voicemail profile (None) is assigned to the directory number. For the users who do not require voicemail access, no voicemail profile is assigned to their endpoint lines. Table 5-8 shows the settings for the voicemail profile configuration example.

**Table 5-8 Voicemail Profile Example**

Parameter	Value
Voice Mail Profile Name	Default
Description	VM Profile
Voice Mail Pilot	+14085554999/DN
Voice Mail Mask	Blank
Make this the default Voice Mail Profile for the System	Checked

## 3. Unity Connection Base Configuration

### Service Activation

- After Unity Connection installation is complete, login to Cisco Unified Serviceability and activate the **DirSync** service on the publisher server node.
- Under Unified Serviceability, **Navigate to Tools → Control Centre-Feature Services**. Verify that the Cisco DirSync service is started on publisher server node.
- Under Unity Connection Serviceability, **Navigate to Tools → Service Management**. Verify the status of services on the publisher and subscriber Unity Connection server nodes. [Table 5-9](#) shows the services status for this deployment.

**Table 5-9 Unity Connection Services Status**

Services	Unity Connection Publisher (Primary)	Unity Connection Subscriber (Secondary)
<b>Status Only Services (Can be deactivated from OS command line interface)</b>		
All the Services in this category	Yes	Yes
<b>Critical Services</b>		
Connection Conversation Manager	Yes	Yes
Connection Mailbox Sync	Yes	No
Connection Message Transfer Agent	Yes	No
Connection Mixer	Yes	Yes
Connection Notifier	Yes	No
<b>Base Services</b>		
All the Services in this category	Yes	Yes
<b>Optional Services</b>		
Connection Branch Sync Service	No	No
Connection Digital Networking Replication Agent	No	No
All other remaining services in this category (including Connection Jetty and Connection REST Service)	Yes	Yes

### Database Replication

After activating services on both publisher and subscriber Unity Connection server nodes, confirm that the subscriber node can connect to the publisher node. Also check the database replication status using the OS Command line interface (CLI) command **show perf query class "Number of Replicates Created and State of Replication"** on both the nodes

### Unified CM Integration

Each Unity Connection cluster is integrated with the co-located Unified CM cluster. This provides a simple integration model with each Unity Connection cluster dedicated to a Unified CM cluster. While SIP trunks are configured on the Unified CM for interconnectivity into the Unity Connection cluster,

voicemail ports are used for capacity and licensing purposes on the Unity Connection system. This section discusses design considerations, capacity planning, and configuration settings of the voicemail ports.

## Voicemail Port Audio Codec Configuration

In Unity Connection, a call in any audio codec format that is supported by Unity Connection SIP signaling will always be transcoded to PCM linear. From PCM linear, the recording is encoded in the system-level recording audio codec system-wide setting in Unity Connection Administration. G.711 mu-law is the default.

In this section, we refer to the audio codec that is negotiated between the calling device and Unity Connection as the *line codec*, and the audio codec that is set as the system-level recording audio codec as the *recording codec*.

Supported line codecs (advertised codecs):

- G.711 mu-law
- G.711 a-law
- G.722
- G.729
- iLBC

Supported recording codecs (system-level recording audio codecs):

- PCM linear
- G.711 mu-law (default)
- G.711 a-law
- G.729a
- G.726
- GSM 6.10

Because transcoding is inherent in every connection, there is little difference in system impact when the line codec differs from the recording codec. For example, using G.729a as the line codec and G.711 mu-law as the recording codec does not place a significant additional load on the Unity Connection server for transcoding. However, the iLBC or G.722 codecs require more computation to transcode, and therefore they place a significant additional load on the Unity Connection server. Consequently, a Unity Connection server can support only half as many G.722 or iLBC connections as it can G.711 mu-law connections.

For this example topology, the system recording codec is left at default (G.711 mu-law). The supported line codes are set to G.729 and G.711 mu-law. Using this default configuration, the users located at the same site of Unity Connection will use G.711 mu-law. For the users located over the WAN from the centralized Unity Connection servers, the selected line codec will be G.729.

Use of the G.722 or iLBC codec as line codecs or advertised codecs reduces the number of voice ports that can be provisioned on the Cisco Unity Connection server. For more information on the number of voice ports supported for each platform overlay when using G.722 or iLBC codecs, refer to the documentation on [Virtualization for Cisco Unity Connection](#).

## System Settings

Just as with the Unified CM call control system, OAuth with refresh token is needed for the Unity Connection voicemail system. You must enable OAuth with refresh tokens on the system and configure the Unified CM publisher node as the authorization (Authz) server.

Navigate to **Cisco Unity Connection Administration > System Settings > Enterprise Parameters** and under the SSO and OAuth Configuration section, set **OAuth with Refresh Login Flow** to **Enabled**.

Next navigate to **System Settings > Authz Servers** and click the **Add New** button to add an Authz server. [Table 5-10](#) lists the Authz Server settings for adding and configuring the Unified CM publisher as the AuthZ server.

**Table 5-10 Authz Server Settings**

Parameter	Value	Description
Display Name	Authz Server (us-cm-pub)	This setting defines the display name for the Authz server.
Authz Server	us-cm-pub.ent-pa.com	This setting specifies the FQDN of the Authz server, which is the Unified CM publisher node.
Port	8443 (default)	This setting determines the port used to communicate with the Authz server.
Username	administrator	This is the user name Unity Connection uses to sign in to the Authz server.
Password	<password>	This is the password Unity Connection uses to sign in to the Authz server.
Ignore Certificate Errors	unchecked (default)	This setting determines whether Unity Connection validates the certificate received from the Authz server.

Click **Save** to create the Authz server and synchronize keys.

## Phone System Settings

Phone system integration enables communication between Unity Connection and Unified CM. We recommend using default **PhoneSystem** if Unity Connection is integrated with single Unified CM cluster. [Table 5-11](#) shows the Phone System settings.

**Table 5-11 Phone System Settings**

Parameter	Value	Description
Phone System Name	PhoneSystem	PhoneSystem
Default TRAP Phone System	Checked	Phone system enables TRAP connections so that administrators and users without voicemail boxes can record and playback through the phone in Unity Connection web applications.

### Call Loop Detection by Using Extension

Table 5-11 Phone System Settings (continued)

Parameter	Value	Description
Enable for Forwarded Message Notification Calls (by Using Extension)	Checked	Unity Connection uses the extension to detect and reject new-message notifications that are sent to a device (such as a mobile phone) and that the device forwards back to Unity Connection because the device did not answer. If the call loop is not detected and rejected, the call creates a new voice message for the user and triggers Unity Connection to send a new-message notification call to the device.
<b>Outgoing Call Restrictions</b>		
Enable outgoing calls	Checked	Unity Connection places outgoing calls (for example, setting MWIs) as needed through the phone system.
<b>AXL Servers (under Edit &gt; Cisco Unified Communications Manager AXL Servers)</b>		
Order 0	<IP_Address_US-CM-PUB>.	Enter the IP address of the Unified CM AXL server node (publisher).
Port	8443	Enter the TCP port of the Unified CM server that Unity Connection uses for AXL communication.
Username/Password	administrator	Enter the username and password of the Unified CM application user with "Standard AXL API Access" role.
Cisco Unified Communications Manager Version	5.0 or Greater (SSL)	Specify SSL for Unified CM 5.0 and later versions.
Enable End User PIN Synchronization for Primary AXL Server	Checked	Check to enable synchronization of the end user PIN between Unity Connection (for voice message access) and Unified CM (for Extension Mobility and so forth).
Ignore Certificate Errors	Unchecked	Uncheck to ensure Unity Connection validates the Unified CM Tomcat certificate.

**Note**

When enabling end-user PIN synchronization between Unified CM and Unity Connection, it is important make sure the assigned PIN authentication rule on Unified CM matches the assigned voicemail authentication rule on Unity Connection in terms of minimum credential length and expiration. Failure to align these authentication rules can result in PIN synchronization errors and login failures, and might require administrator intervention.

## Port Group Settings

A port group is used to control the SIP communications between the Unified CM and Unity Connection clusters. The port group allows the system to restrict and specify which Unified CM servers the Unity Connection server will accept SIP messages from, and the order and preference that the Unity Connection servers will use to route outbound calls to the Unified CM servers. The Unity Connection servers are configured to mirror the Unified CM SIP routing design for Unity Connection, hence outbound routing should be configured on Unity Connection servers to prefer the first available Unified CM subscriber node. [Table 5-12](#) provides the port group settings.

**Table 5-12 Port Group Settings**

Parameter	Value	Description
Display Name	PhoneSystem-1	Descriptive name for the Phone System
Integration Method	SIP	The method of integration that is used to connect Unity Connection and Unified CM
<b>Session Initiation Protocol (SIP) Settings</b>		
Register with SIP Server	Checked	This ensures that Cisco Unity Connection is registered with the SIP server.
<b>SIP Servers (under Edit &gt; Servers)</b>		
Order 0	<IP_Address_US-CM-SUB1>	The SIP server configured for Order 0 will have higher preference. Enter the IP address of the primary Unified CM call processing node.
Order 1	<IP_Address_US-CM-SUB2>	The SIP server configured for Order 1 will have lower preference. Enter the IP address of the secondary Unified CM call processing node.
Port	5060	Enter the TCP port of the Unified CM server that Unity Connection uses for SIP communication.
TLS Port	5061	Enter the TCP TLS port of the Unified CM server that Unity Connection uses for secure SIP communication.
<b>TFTP Servers (under Edit &gt; Servers)</b>		
Order 0	<IP_Address_US-CM-TFTP1>	The TFTP server configured for Order 0 will have higher preference. Enter the IP address of the primary Unified CM TFTP node.
Order 1	<IP_Address_US-CM-TFTP2>	The TFTP server configured for Order 1 will have lower preference. Enter the IP address of the backup Unified CM TFTP node.

## Voice Messaging Port Sizing Considerations

Each Unity Connection server in a cluster must have voice messaging ports designated for the following dial-in function in case either server has an outage:

- Answer Calls

Further, each Unity Connection server must have voice messaging ports designated for the following dial-out functions:

- Sending message waiting indications (MWIs)
- Performing message notifications
- Allowing telephone record and playback (TRAP) connections

We recommend reserving 20% of the total number of voicemail ports on the system for message notification, dial out MWI, and TRAP to reduce the possibility of call blocking on the ports for answering calls versus ports dialing out.

## Port Settings

As discussed in the previous section, ports will be either incoming or outgoing ports. [Table 5-13](#) shows a voicemail port allocation configuration example, and [Table 5-14](#) provides the configuration template for answer port configuration.

**Table 5-13 Voicemail Port Allocation Configuration Example**

Cisco Unity Connection Server	Port Range	Function
US-CUC1	1-80	Answer
US-CUC2	1-80	Answer
US-CUC1	81-100	Dial-Out
US-CUC2	81-100	Dial-Out

**Table 5-14 Voicemail Answer Port Configuration Example**

Parameter	Value	Description
Enabled	Checked	Check the box to enable the phone system port.
<b>Phone System Port</b>		
Port Name	Auto Created	Unity Connection Automatically creates the port name.
Phone System	PhoneSystem	Choose the appropriate Phone System.
Port Group	PhoneSystem-1	Choose the appropriate Port Group.
Server	US-CUC2/US-CUC1	Choose the Cisco Unity Connection subscriber node first, and similarly add ports for the Unity Connection publisher node.
<b>Phone behavior</b>		
Answer Call	Checked	This setting designates the port for answering the call.
Perform Message Notification	Unchecked	This setting designates the port for notifying users of messages.
Send MWI Requests	Unchecked	This setting designates the port for sending MWI on and off requests.
Allow TRAP Connections	Unchecked	This setting designates the port for Telephony Recording and Playback (TRAP) connections.

The configuration shown in the [Table 5-14](#) should also be used to create voicemail dial out ports. However, in the case of dial out ports, uncheck the Answer Call parameter and check the Perform Message Notification, Send MWI Requests, and Allow TRAP Connection parameters instead.

## Active Directory Integration

Unity Connection supports Microsoft Active Directory synchronization and authentication for Unity Connection web applications such as Cisco Personal Communications Assistant (PCA) for end users, which rely on authentication against Active Directory. Likewise IMAP email applications that are used

to access Unity Connection voice messages are authenticated against the Active Directory. For telephone user interface or voice user interface access to Unity Connection voice messages, numeric passwords (PINs) are still authenticated against the Unity Connection database. These PINs are synced with the Unified CM system PINs when PIN synchronization is enabled between Unity Connection and Unified CM.

The administrator account must be created in the Active Directory that Unity Connection will use to access the sub-tree specified in the user search base. We recommend using an account dedicated to Unity Connection, with minimum permissions set to "read" all user objects in the search base and with a password set to never expire.

Ensure that the Unified CM Mail ID field is synchronized with the Active Directory mail field. During the integration process, this causes values in the LDAP mail field to appear in the Corporate Email Address field in Unity Connection. Unity Connection uses Corporate Email Address in the Unified Messaging account to enable Single Inbox.

Unity Connection integrates with Active Directory to enable importing of user information. Integrating Unity Connection with an Active Directory provides several benefits:

- User creation — Unity Connection users are created by importing data from the Active Directory.
- Data synchronization — Unity Connection is configured to automatically synchronize user data in the Unity Connection database with data in the Active Directory.
- Single set of credentials — Configure Unity Connection to authenticate user names and passwords for Unity Connection web applications against the Active Directory, so that users do not have to maintain multiple application passwords.

Refer the [Call Control](#) chapter for Active Directory settings.

## Unity Connection Partitions and CSS

All the users for this deployment are configured in the default calling search space (US-CUC1 Search Space), which contains the default partition (US-CUC1 partition).

## Restriction Tables

Unity Connection uses restriction tables to prevent the voicemail system from calling unauthorized telephone numbers. These rules are normally configured to explicitly match either allowed or blocked numbers. For this deployment, the Unity Connection system is not using restriction rules for call blocking from the voicemail system but instead is using the SIP trunk incoming calling search space (CSS) to prevent unauthorized calling from Unity Connection. The SIP trunk CSS is set to allow Unity Connection to dial only on-net destinations. [Table 5-15](#) lists the Default Transfer restriction table settings.

**Table 5-15** Restriction Table in Unity Connection

Order	Blocked	Pattern
0	Uncheck the check box	+*
1	Uncheck the check box	9+*
2	Uncheck the check box	91??????*?
3	Uncheck the check box	9011??????*?
4	Uncheck the check box	9??????????*?



**Table 5-15 Restriction Table in Unity Connection (continued)**

Order	Blocked	Pattern
5	Uncheck the check box	900
6	Uncheck the check box	*

Unity Connection contains four additional restriction tables for Default Fax, Default Outdial, Default System Transfer, and User-defined and Automatically-Added Alternate Extensions. These restriction tables can also be disabled using the settings mentioned in [Table 5-15](#).

## Class of Service

Class of service (CoS) defines limits and features for users of Unity Connection voice mail. Class of service is typically defined in a User Template, which is then applied to the user's account when it is created. For this deployment, the default Voice Mail User COS is associated with all users.

## User Provisioning

Import the users into Unity Connection by using the user template from the Active Directory server. The user template contains settings that are common to a group of users. Users inherit the common settings from the user template when their account is created. Separate user templates should be created for each site in the local time zone. [Table 5-16](#) provides the user template settings.

**Table 5-16 Voicemail User Template**

Section	Field	Value
<b>Basics</b>	Alias	SJC_User_Template
	Display Name	SJC_User_Template
	Display Name Generation	First name, then last name
	Phone System	PhoneSystem
	Class of Service	Voice Mail User COS
	Set for Self-enrollment at Next Login	Checked
	List in Directory	Checked
	Time Zone	(GMT-8:00) America/Los_Angeles
	Language	English(United States)
	Generate SMTP Proxy Address from the Corporate Email Address	Checked
<b>Password Settings - VM</b>	User Must Change at Next Sign-In	Checked
	Does Not Expire	Checked
	Authentication Rule	Recommended Voice Mail Authentication Rule
<b>Change Password-Voicemail</b>	PIN	<PIN>

Basing new user settings on a template minimizes the number of settings to be modified on individual user accounts, making the job of adding users quicker and less prone to error.

Note that any subsequent user template changes (after the creation of user accounts using the template) are not applied to existing user accounts; that is, the common settings are picked up from the template at user account creation time only. An individual user's settings can be changed after the template has been used to create a Unity Connection account without affecting the template or other users.

The web application password should not be changed here because Unity Connection is integrated with LDAP and user authenticates from Active Directory. You have to give these PINs and passwords to users so that they can sign in to the Unity Connection system telephone user interface (TUI) and to the Cisco Personal Communications Assistant (PCA).

Select the options **Allow Users to Use the Messaging Assistant** and **Allow Users to Use the Web Inbox and RSS Feeds** under **Voice Mail User COS class of Service** to allow users to access their web inbox using Cisco PCA.

Import the users from LDAP using the template created above.

## Unity Connection User Self Enrollment

End users must enroll as Unity Connection users. The Unity Connection administrator should provide an ID (usually the user's desk phone extension) and a temporary PIN (set during [User Provisioning](#)) for each user. The first-time enrollment conversation is a set of prerecorded prompts that guide users to do the following tasks:

- Record user name.
- Record a greeting that outside callers hear when the user does not answer the phone.
- Change user PIN. (User's new PIN will be propagated to Unified CM with PIN synchronization.)
- Choose whether to be listed in the directory. (When the user is listed in the directory, callers who do not know the user's extension can reach the user by spelling or saying user's name.)

Unity Connection users can dial the voicemail pilot number from an IP endpoint within the organization or from the outside network for the self-enrollment process. If the user is calling from an extension number that is unknown to Unity Connection, either from within your organization or from outside, the user must press \* (star key) when Unity Connection answers to continue the self-enrollment process. If the user hangs up before enrollment finishes, the first-time enrollment conversation plays again the next time the user signs in to Unity Connection.

## 4. Enable Single Inbox

Single Inbox, one of the unified messaging features in Unity Connection, synchronizes voice messages in Unity Connection and Microsoft Exchange mailboxes. When a user is enabled for a Single Inbox, all Unity Connection voice messages that are sent to the user, including those sent from Unity Connection ViewMail for Microsoft Outlook, are first stored in Unity Connection and immediately replicated to the user's Exchange mailbox. This section explains configuration tasks required for integrating Unity Connection with Microsoft Exchange to enable Single Inbox.

### Prerequisites for Enabling Single Inbox with Unity Connection

- Before enabling the Single Inbox feature, ensure that Microsoft Exchange is configured and users can send and receive emails.
- Microsoft Active Directory is required for Unified Messaging service account authentication.
- Unity Connection users are imported and configured for basic voice messaging. See the section on [User Provisioning](#).

### Unity Connection Certificate Management

When you install Cisco Unity Connection, local self-signed certificates are automatically created and installed to secure communication between Cisco PCA and Unity Connection, and between IMAP email clients and Unity Connection. This means that all the network traffic (including usernames, passwords, other text data, and voice messages) between Cisco PCA and Unity Connection is automatically encrypted, and the network traffic between IMAP email clients and Unity Connection is automatically encrypted, if you enable encryption in the IMAP clients.

We recommend using certificates issued by a certificate authority (CA). In this case the Unity Connection self-signed Tomcat certificates are replaced with a multi-server certificate issued and signed by the enterprise's CA. For more information on this process, refer to the [Security](#) chapter.

### Confirm the Exchange Authentication and SSL Settings for Unity Connection

Confirm that the Exchange server is configured for the desired web-based authentication mode (NT LAN Manager, or NTLM, is recommended) and web-based protocol (HTTPS is recommended). The authentication mode must match on both Exchange and Unity Connection for them to communicate.

Select the option to validate certificates signed by an external CA for Exchange servers and Active Directory domain controllers. Obtain and install the enterprise CA root certificate on both the Exchange and domain controller servers.

### Configure SMTP Proxy Addresses in Unity Connection

When Single Inbox is configured, Unity Connection uses SMTP proxy addresses to map the sender of a message that is sent from Unity Connection ViewMail for Microsoft Outlook to the appropriate Unity Connection user, and to map recipients to Unity Connection users.

For example, suppose an email client is configured to access Unity Connection with the email address aross@ent-pa.com. This user records a voice message in ViewMail for Outlook and sends it to user ahall@ent-pa.com. Unity Connection then searches the list of SMTP proxy addresses for

aross@ent-pa.com and ahall@ent-pa.com. If these addresses are defined as SMTP proxy addresses for the Unity Connection users ahall and aross respectively, Unity Connection delivers the message as a voice message from the Unity Connection user aross to the Unity Connection user ahall.

The SMTP proxy address for the user is automatically created when you import the users via the user template. In the user template, select the **Generate SMTP Proxy Address from the Corporate Email Address** option for creating the SMTP proxy address. Refer to the section on [User Provisioning](#) for more information.

## Create Unified Messaging Services Account in Active Directory and Grant Permissions for Unity Connection

Single Inbox requires an Active Directory account (called the Unified Messaging Services account), and the account must have the rights necessary for Unity Connection to perform operations on behalf of users. Unity Connection accesses Exchange mailboxes using the Unified Messaging Services account. When creating the Unified Messaging Services account, follow these guidelines:

- Do not create an Exchange mailbox for the account.
- Do not add the account to any administrator group.
- Do not disable the account, otherwise Unity Connection cannot use it to access Exchange mailboxes

Sign in to a server on which the Exchange Management Shell is installed and assign the **ApplicationImpersonation Management** role to the Unified Messaging Services account for Unity Connection using the following command:

```
new-ManagementRoleAssignment -Name: RoleName -Role:ApplicationImpersonation -User:'Account'
```

Where:

- *RoleName* is the name that you want to give the assignment; for example, Unity ConnectionUMServicesAcct. The name that you enter for RoleName appears when you run the command **get-ManagementRoleAssignment**.
- *Account* is the name of the Unified Messaging Services account in domain/alias format.

## SMTP Smart Host

Unity Connection relays the message to the user email address using SMTP Smart Host. When a Unity Connection user receives a new message, Unity Connection can send a text notification to an email address. With this type of notification, you can configure Unity Connection to include a link to Cisco PCA in the body of the email message. Under the user configuration, navigate to the **Edit Notification Device** page for the user and select the option to **Include a Link to the Cisco Unity Connection Web Inbox in Message Text**. [Table 5-17](#) lists the SMTP Smart Host configuration.

**Table 5-17** SMTP Smart Host Details (System Settings > SMTP Configuration > Smart Host)

Parameter	Value
SmartHost	US-EXCH1.ent-pa.com

## Unified Messaging Service

In Unity Connection Administration, expand **Unified Messaging**, then select **Unified Messaging Services**.

- Unified Messaging Services define the type of Microsoft Exchange and authentication method that Unity Connection will use to communicate with Microsoft Exchange.
- Configure Unified Messaging Services to communicate with a specific Exchange server using an FQDN.
- Configure the Unity Connection Unified Messaging Services for the same web-based authentication mode (NTLM recommended) and web-based protocol (HTTPS recommended) that is configured on Microsoft Exchange.
- Enter the Active Directory account credentials created in the section [Create Unified Messaging Services Account in Active Directory and Grant Permissions for Unity Connection](#).
- Select the options to **Access Exchange Calendar and Contacts** and **Synchronize Connection and Exchange Mailboxes (Single Inbox)** to enable Unified Messaging features.
- If the Exchange server certificate is signed by the enterprise CA, then Unity Connection will automatically validate the SSL certificate from Exchange because the enterprise CA root certificate is installed in the trust store.

## Unified Messaging Account

In Unity Connection Administration, expand **Users** then select **Users**. On the Edit User Basics page, in the Edit menu, select **Unified Messaging Accounts**.

- When you create a user account, Unity Connection does not automatically create a unified messaging account for that user. A unified messaging account can be created for one user or multiple users. Use the Bulk Administration Tool (BAT) to create the unified messaging account for large number of users.
- Unified messaging requires that you enter the Exchange email address for each Unity Connection user. On the Unified Messaging Account page, select **Use Corporate Email Address: None Specified** to cause Unity Connection to use the corporate email address specified on the Edit User Basics page as the Exchange email address.
- In the Active Directory integration, the Unified CM Mail ID field is synchronized with the Active Directory mail field. This causes values in the LDAP mail field to appear in the Corporate Email Address field in Unity Connection.

For more information on creating unified messaging accounts for multiple users with the Bulk Administration Tool, refer to the latest version of the *System Administration Guide for Unity Connection*, available at

<https://www.cisco.com/c/en/us/support/unified-communications/unity-connection/products-maintenance-guides-list.html>

## Voice Mail User COS

Edit the Voice Mail User Class of Service (**Class of Service** → **Voice Mail User COS**) to enable the user for Single Inbox. In the **Licensed Features** select the option to **Allow Users to Access Voicemail Using an IMAP Client and/or Single Inbox**. Also select the option to **Allow IMAP Users to Access Message Bodies**.

## Install ViewMail for Outlook on User Workstations

Cisco ViewMail for Microsoft Outlook provides a visual interface from which users can send, listen to, and manage their Unity Connection voice messages from within Outlook. Download [Unity Connection ViewMail for Microsoft Outlook](#) from the Cisco website and install it on each user workstation. After installing ViewMail, open the ViewMail settings or Options tab and associate an email account with a Unity Connection server. Enter the user information and Unity Connection server details.

When using another email client to access Unity Connection voice messages in Exchange, or in cases when ViewMail for Outlook is not installed, note the following:

- The email client treats Unity Connection voice messages like emails with .wav file attachments.
- When a user replies to or forwards a Unity Connection voice message, the reply or forward is treated like an email, even if the user attaches a .wav file. Message routing is handled by Exchange, not by Unity Connection, so the message is never sent to the Unity Connection mailbox for the recipient.

## 5. Enable Visual Voicemail

Visual Voicemail provides access to Unity Connection directly from the voicemail tab on Jabber clients. Users can view a list of voice messages and play messages from Jabber. Users can also delete voice messages.

### Unity Connection Configuration

- Ensure that the Unity Connection users are imported and configured for basic voice messaging. Refer to the section on [User Provisioning](#).
- Ensure that the Unity Connection **Connection Jetty** service and **Connection REST Service** are up and running. Both services are activated during [Service Activation](#) under the **Optional Services** category.
- Ensure that **Class of Service** is enabled for voicemail access from the IMAP client. Refer the section on [Voice Mail User COS](#).
- Edit the Unity Connection Voice Mail Class of Service (CoS) to allow users to use web inboxes. Under the **Features** tab, select the option to **Allow Users to Use Unified Client to Access Voicemail**.
- Select the following options under the API settings (**System Settings > Advanced**):
  - Allow Access to Secure Message Recordings through Cisco Unity Connection Messaging Interface (CUMI)
  - Display Message Header Information of Secure Messages through CUMI
  - Allow Message Attachments through CUMI

### Unified CM Configuration

Add a **Voicemail** UC service for each Unity Connection server node. [Table 5-18](#) shows the voicemail UC service configuration.

**Table 5-18 Voicemail Service Settings (User Management > User Settings > UC Service)**

Parameter	Value	Comments
Product Type	Unity Connection	Enter the product name of the voicemail system.
Name	us-cuc1	Enter the name of the voicemail service. Choose the display name that will help to distinguish between publisher and subscriber voicemail services.
Description	us-cuc1	Enter the display name that will help to distinguish between publisher and subscriber voicemail services.
Host Name/IP address	us-cuc1.ent.pa.com	Enter the FQDN of the voicemail service.
Port	443	Enter the port to connect with the voicemail service.
Protocol	HTTPS	Select the protocol to route voice messages securely.

Apply the **Voicemail UC** service created previously to the **Standard Service Profile (User Management → User Settings → Service Profile)**. Ensure that the Voicemail UC service created for Unity Connection publisher (us-cuc1.ent.pa.com) is set to the primary profile and the Unity Connection subscriber (us-cuc2.ent.pa.com) is set to the secondary profile. To synchronize credentials for the voicemail service, select **Unified CM - IM and Presence** from the **Credentials source for voicemail service** drop-down list.

## 6. Voice Mail in SRST Mode

With the centralized messaging deployment model, during a WAN outage the branch site's Survivable Remote Site Telephony (SRST) routes the unanswered and busy calls to the central Unity Connection. Incoming calls that reach a busy signal, calls that are unanswered, and calls made by pressing the message button are forwarded to Unity Connection. This configuration allows phone message buttons to remain active. To enable this functionality, configure POTS dial peer access to Unity Connection through PRI.

When calls are routed over the PSTN to Unity Connection, Redirected Dialed Number Information Service (RDNIS) is critical. Incorrect RDNIS information can affect calls to voicemail that are rerouted over the PSTN. If the RDNIS information is not correct, the call will not reach the voicemail box of the dialed user but will instead receive the automated attendant prompt, and the caller might be asked to reenter the extension number of the party they wish to reach. This behavior is primarily an issue when the telephone carrier is unable to ensure RDNIS across the network. There are numerous reasons why the carrier might not be able to ensure that RDNIS is properly sent. Check with your carrier to determine whether it provides guaranteed RDNIS delivery end-to-end for your circuits.

## Unified CM Configuration

Ensure that the settings mentioned in [Table 5-19](#) are enabled in Unified CM configuration for the SIP trunk to the central site PSTN gateway.

**Table 5-19 Settings for the SIP Trunk to the PSTN gateway for Voicemail in SRST Mode**

Parameter	Value	Comments
<b>Call Routing Information – Inbound Calls</b>		
Redirecting Diversion Header Delivery - Inbound	Checked	This ensures that the redirecting Information Element, the first redirecting number, and the call forward reason are sent and accepted as a part of incoming messages. Unity Connection uses the first redirecting number to answer the call.
<b>Call Routing Information – Outbound Calls</b>		
Redirecting Diversion Header Delivery - Outbound	Checked	This ensures that the redirecting Information Element, the first redirecting number, and the call forward reason are sent and accepted as a part of outgoing messages. Unity Connection uses the first redirecting number to answer the call.

## Branch SRST Router Configuration

Configure the following command on the branch site SRST router to enable voicemail access over PRI.

```
!
!
dial-peer voice 10 pots
destination-pattern +14085554999
direct-inward-dial
port 1/0:15
!
!
voice register pool 1
call-forward b2bua busy +14085554999
call-forward b2bua noan +14085554999 timeout 12
!
!
```

## 7. HTTPS Internetworking of Two Unity Connection Clusters

[Figure 5-4](#) shows HTTPS internetworking of two Unity Connection clusters. HTTPS networking connects multiple Unity Connection clusters so that they can share directory information and exchange of voice messages. You can join two or more Unity Connection servers or clusters to form a well-connected network, referred to as a Unity Connection site. The servers that are joined to the sites are referred to as *locations*. Within a site, each location uses HTTPS protocol to exchange directory information and SMTP protocol to exchange voice messages with each other.

Within a site, Unity Connection locations automatically exchange directory information, so that a user in one location can dial out to or address messages to a user in any other system by name or extension, provided that the target user is reachable in the search scope of the originating user. The networked systems function as though they share a single directory.



**Figure 5-4 HTTPS Internetworking of Two Unity Connection Clusters**

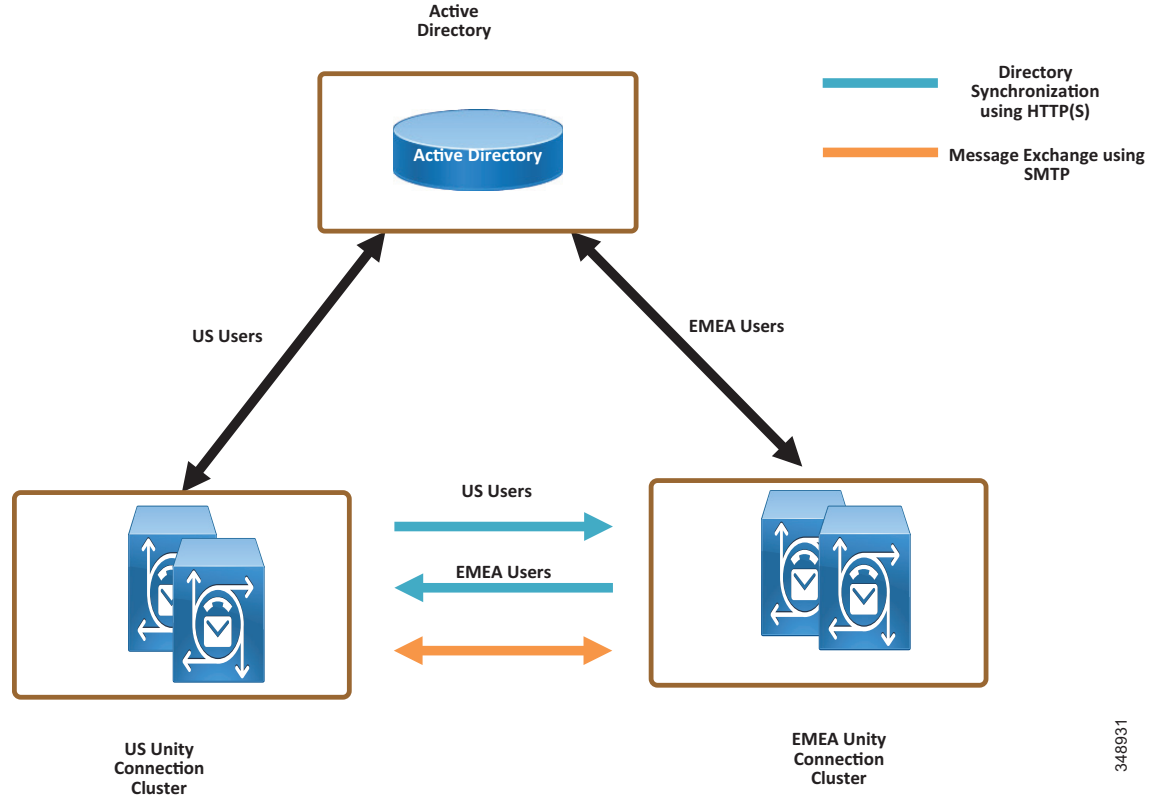

348931

In HTTPS networking, Unity Connection clusters are joined together using a hub-and-spoke topology. In this topology, all the directory information among the spokes is shared through the hub that connects the spokes. The number of Unity Connection locations that can be connected in an HTTPS network and the maximum number of users in HTTPS networking depend on the deployed OVA template. For more information on the maximum number of supported locations and maximum directory size, refer to the information on *directory object limits* in the latest version of the *System Requirements for Cisco Unity Connection*, available at

<https://www.cisco.com/c/en/us/support/unified-communications/unity-connection/products-installation-guides-list.html>

In HTTPS networking, the directory replication is accomplished by means of a Feeder service and a Reader service running on each location in the network. The Reader service periodically polls the remote location for any directory changes since the last poll interval. The Feeder service checks the change tracking database for directory changes and responds to poll requests with the necessary information.

In the HTTPS networking, when the publisher server of a cluster location is up and running, it is responsible for the synchronization of directory information. However, if the publisher server is down, the subscriber server takes the role of synchronizing directory information.

Depending upon the server of a cluster (publisher or subscriber) with which the directory synchronization is being performed, the directory synchronization can be either of the following types:

- Standard — Specifies that the directory synchronization is done by the publisher server with the connected locations.
- Alert — Specifies that the publisher server is unreachable and the subscriber server is responsible for providing directory information to the connected locations. However, the subscriber server has the directory information stored that was last synchronized with the publisher server when it was running.

In the event of a publisher failure, directory synchronization occurs in the Alert mode. During the Alert mode, the connected nodes in the HTTPS network have limited access to directory synchronization with the subscriber. The limited access means that the connected nodes can fetch only the directory information that was last synchronized with the publisher when it was running. When the publisher comes up, the nodes that are directly connected to the publisher synchronize the updated directory information through the publisher. Therefore, the key benefit of the Alert mode is that the connected nodes remain synchronized with the subscriber server even when the publisher is down.

The clusters that are networked together are directly accessible through TCP/IP port 25 (SMTP). In addition, both locations must be able to route to each other via HTTPS on port 8444.

For the purposes of this deployment documentation, HTTPS internetworking is configured between the US and EMEA Unity Connection clusters. [Table 5-20](#) shows the server node information of both clusters that are joined using HTTPS networking.

**Table 5-20** Unity Connection Cluster Details for HTTPS Networking

Server	US Unity Connection Cluster		EMEA Unity Connection Cluster	
	Hostname	IP address	Hostname	IP address
Publisher	US-CUC1	<IP_Address_US_CUC1>	EMEA-CUC1	<IP_Address_EMEA_CUC1>
Subscriber	US-CUC2	<IP_Address_US_CUC2>	EMEA-CUC2	<IP_Address_EMEA_CUC2>

To set up HTTPS networking between two Unity Connection clusters, perform the following tasks.

## Check the Display Name and SMTP Domain of Each Unity Connection Server

- The Unity Connection server that you join to an HTTPS network must have a unique display name and SMTP domain.
- Before enabling HTTPS networking, verify the display name and SMTP domain of the Unity Connection publisher server in the **Networking** → **Locations** settings.

## Create the HTTPS Network Between Unity Connection Clusters

- To create an HTTPS network of Unity Connection servers, start by linking two clusters together by creating an HTTPS link and then ensuring that the subscribers of each cluster are added for the SMTP Access.
- On each Unity Connection publisher, add a new HTTPS link. [Table 5-21](#) shows the HTTPS Link settings.

**Table 5-21** *HTTPS Link Settings (Networking > HTTP(s) Links)*

Parameter	Value	Comments
<b>Link to Cisco Unity Connection Remote Location</b>		
Publisher (IP address/FQDN/Hostname)	emea-cuc1.ent-pa.com	Enter the FQDN of the remote Unity Connection publisher node.
Username	Name of admin user	Enter the Username of an administrator at the location specified in the above publisher field. The administrator user account must be assigned the System Administrator role.
Password	Password of the admin user	Enter the password for the administrator specified in the Username field.
<b>Transfer Protocol</b>		
Use Secure Socket Layer (SSL)	Checked	This option enables SSL to encrypt directory synchronization traffic between the various HTTPS locations.

## Configure SMTP Access for Cluster Subscriber Servers

In an HTTPS network that includes a Unity Connection cluster server pair, you can join only the publisher server of the pair to the network. In order for all locations in the network to communicate directly with the cluster subscriber server node when the subscriber is the primary server, all network locations should be configured to allow SMTP connections from the subscriber server.

In this example we are adding the EMEA subscriber to the SMTP configuration of the US publisher, as well as adding the US subscriber to the EMEA publisher SMTP configuration.

- In the US cluster on the US publisher, add the EMEA subscriber to the SMTP configuration (System Settings). In the **Edit** menu, select **Search IP Address Access List**. On the New IP Address page, enter the IP address of an EMEA subscriber server (<IP\_Address\_EMEA\_CUC2>). Ensure that the **Allow Connection** option is selected.
- Repeat the above steps on the EMEA cluster publisher, emea-cuc1.ent-pa.com, to add the US cluster subscriber IP address.

## Replication Between the Locations

After creating the HTTPS network, verify that the complete database is replicated between the two locations added to network. When initial replication begins, it can take a few minutes to a few hours for the data to be fully replicated between all locations, depending on the size of your directory.

Open the **HTTP(S) Link** created in the above step, and check the following values:

- Time of Last Synchronization

Indicates the time stamp of the last time the local reader service attempted to poll the remote location feeder service for directory changes on the remote locations, regardless of whether a response was received.

- **Time of Last Failure**  
Indicates the time stamp of the last time the local reader service encountered an error while attempting to poll the remote location feeder service. If the value of this field is 0, or if the Time of Last Synchronization value is later than the Time of Last Error value, replication is likely to be progressing without problems.
- **Object Count**  
Indicates the number of users that the local Unity Connection location has synchronized from the remote location.

## Add Remote Location Partition to Local Unity Connection CSS

When you initially set up a network between locations, users that are provisioned on the US cluster will not be able to send voice messages to users on the EMEA cluster because the users in each location are in separate partitions and separate user search spaces that do not contain the partitions of users in the other locations.

- Edit the us-cuc1 calling search space (CSS) configured for the US Unity Connection server to include the EMEA location Unity Connection server partition emea-cuc1.
- Edit the emea-cuc1 CSS configured for the EMEA Unity Connection server to include the US location Unity Connection server partition us-cuc1.

## Related Documentation

For additional information about voice messaging and Cisco Unity Connection, refer to the latest version of the following documents, available at the links provided below:

- *Design Guide for Cisco Unity Connection*  
<https://www.cisco.com/c/en/us/support/unified-communications/unity-connection/products-implementation-design-guides-list.html>
- *HTTPS Networking Guide for Cisco Unity Connection*  
<https://www.cisco.com/c/en/us/support/unified-communications/unity-connection/products-maintenance-guides-list.html>
- *Unified Messaging Guide for Cisco Unity Connection*  
<https://www.cisco.com/c/en/us/support/unified-communications/unity-connection/products-maintenance-guides-list.html>



# Collaboration Management Services

**Revised: May 21, 2021**

This chapter describes the collaboration management services included in the Enterprise Collaboration Preferred Architecture. This chapter focuses on a subset of core applications that are necessary for most collaboration environments. This Preferred Architecture is built with all of the available applications in mind, to simplify the deployment of these applications and to avoid unnecessary configuration changes.

The first two sections of this chapter describe the tools for deployment of Cisco Unified Communications Manager (Unified CM), Cisco Unified CM IM and Presence Service, and Cisco Unity Connection. Those tools are: Cisco Prime Collaboration Deployment and the web-based Cisco Smart Software Manager portal. The third section of this chapter explains the optional implementation of Webex Cloud-Connected UC for Webex cloud-based monitoring and management of on-premise collaboration applications.

The collaboration management services include:

- [Cisco Prime Collaboration Deployment](#)
- [Cisco Smart Software Manager](#)
- [Webex Cloud-Connected UC](#)

### Key Benefits of Collaboration Management Services

- Eases deployment of new infrastructure components.
- Provides a single, centralized web-based tool to manage licenses, software, and entitlement for various products.
- Simplifies and consolidates product deployment and management with automated provisioning, monitoring, and trend reporting.
- Single pane of glass for both cloud and on-premises UC management, simplifies and augments monitoring and reporting features across a deployment.

# What's New in This Chapter

Table 6-1 lists the topics that are new in this chapter or that have changed significantly from previous releases of this document.

**Table 6-1** *New or Changed Information Since the Previous Release of This Document*

New or Revised Topic	Described in:	Revision Date
Webex Cloud-Connected UC	Webex Cloud-Connected UC	May 21, 2021
Cisco Meeting Server and Cisco Expressway applications add support for Cisco Smart Licensing with Cisco Smart Software Manager (SSM)	Cisco Smart Software Manager	May 21, 2021
Removed Cisco Prime Collaboration Provisioning		May 21, 2021

## Cisco Prime Collaboration Deployment

Cisco Prime Collaboration Deployment provides a simplified solution for deploying collaboration application nodes, including Cisco Unified Communications Manager (Unified CM), Cisco Unified CM IM and Presence Service, and Cisco Unity Connection. Cisco Prime Collaboration Deployment assists the administrator by automating many of the steps necessary to install Unified CM, Unified CM IM and Presence Service, and Unity Connection clusters.

### Core Components

The core components of the Cisco Prime Collaboration Deployment architecture are:

- Cisco Prime Collaboration Deployment for deploying collaboration application nodes on the VMware ESXi server using Cisco ISO installation files
- VMware ESXi server for hosting collaboration application node virtual machines (VMs), including Unified CM and Unity Connection

### Benefits

Using Cisco Prime Collaboration Deployment to deploy the Enterprise Collaboration Preferred Architecture call control and voice messaging application nodes provides the following benefits:

- Centralizes storage for collaboration application Cisco ISO files.
- Automates the installation of Unified CM, Unified CM IM and Presence Service, and Unity Connection collaboration applications.
- Applies an array of common settings across collaboration application server node VMs, including network components (NTP, DNS), administration accounts and passwords, and base certificate information.

## Architecture

The Cisco Prime Collaboration Deployment architecture consists of the Cisco Prime Collaboration Deployment server node, where collaboration application Cisco ISO files are stored for installation. These files are placed on Cisco Prime Collaboration Deployment using secure FTP (SFTP). A network file system (NFS) mount is created to the ESXi host once the ESXi host is configured in Cisco Prime Collaboration Deployment. This NFS mount enables the appropriate collaboration application Cisco ISO files to be installed on the ESXi host server node VMs (Figure 6-1).

**Figure 6-1** Cisco Prime Collaboration Deployment Architecture

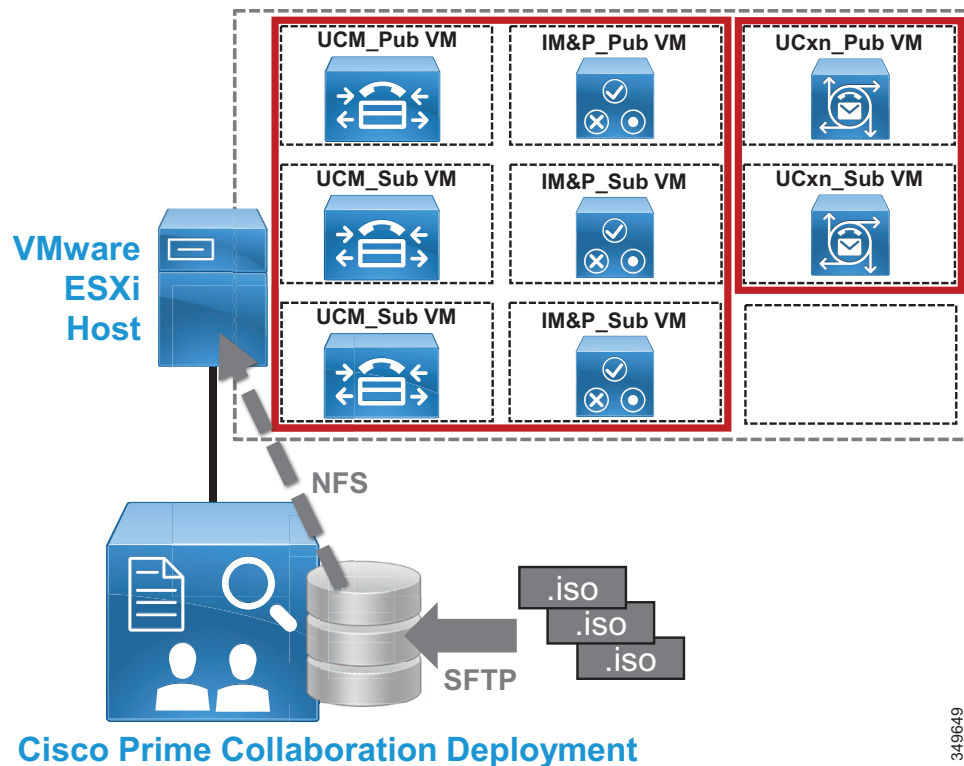

Cisco Prime Collaboration Deployment may be deployed with multiple ESXi hosts as required for larger deployments that span multiple ESXi host servers.

### Role of Cisco Prime Collaboration Deployment

Cisco Prime Collaboration Deployment serves as the collaboration application Cisco ISO store as well as the administrative interface for deploying and configuring collaboration application nodes on the VMware ESXi host or hosts.

### Role of ESXi Host

The ESXi host server or servers contain the application node VMs for Unified CM, Unified CM IM and Presence Service, and Unity Connection clusters installed by Cisco Prime Collaboration Deployment.

## High Availability for Cisco Prime Collaboration Deployment

The Cisco Prime Collaboration Deployment application does not support high availability; however, because Cisco Prime Collaboration Deployment is used for initial deployment and base configuration, redundancy is not a requirement. In order to deploy and perform base configuration for collaboration application nodes, the Cisco Prime Collaboration Deployment application node must be in service and able to reach the ESXi server host or hosts where collaboration application server nodes will be deployed. In cases where Cisco Prime Collaboration Deployment is not operational, it must be returned to service so that the network connectivity is available and the NFS mount to the ESXi server is up.

As with other collaboration and management applications, the Cisco Prime Collaboration Deployment application server should be backed up regularly using the Disaster Recovery System (DRS). DRS device configuration, backup scheduling, and backup and restore operations are managed through the Cisco Prime Collaboration Deployment application server command line interface (CLI).

## Scaling Cisco Prime Collaboration Deployment

Given that there is only a single Cisco Prime Collaboration Deployment OVA template file for each release, capacity considerations for Cisco Prime Collaboration Deployment are limited to the amount of disc storage capacity of the Cisco Prime Collaboration Deployment VM. Because the Cisco ISO files for the various deployed collaboration applications are stored on Cisco Prime Collaboration Deployment, disc capacity is important. For this reason, management of Cisco ISO files is critical. Cisco ISO files that are no longer needed should be removed to make room for newer Cisco ISO files.

## Cisco Prime Collaboration Deployment Process

There are two deployment aspects to consider with Cisco Prime Collaboration Deployment:

- [Deploying the Cisco Prime Collaboration Deployment Application Server](#)
- [Deploying Cisco Collaboration Application Server Clusters with Cisco Prime Collaboration Deployment](#)

## Deploying the Cisco Prime Collaboration Deployment Application Server

The Cisco Prime Collaboration Deployment application is deployed as a single standalone node. Deploy the Cisco-provided Cisco Prime Collaboration Deployment OVA template file on your compute infrastructure.

Once the OVA has been deployed, mount the Cisco Prime Collaboration Deployment Cisco ISO file and power on the Cisco Prime Collaboration Deployment VM to install Cisco Prime Collaboration Deployment. After you enter the appropriate information, including account information (administrator account name and password), network information (IP address, hostname, DNS, NTP, and so forth), and web security information (self-signed certificate information including location, organization, and so forth), the installation will complete.

For information on how to obtain the OVA template and Cisco ISO files, refer to the documentation at

[https://www.cisco.com/c/dam/en/us/td/docs/voice\\_ip\\_comm/uc\\_system/virtualization/virtualization-cisco-prime-collaboration-deployment.html](https://www.cisco.com/c/dam/en/us/td/docs/voice_ip_comm/uc_system/virtualization/virtualization-cisco-prime-collaboration-deployment.html)

Once the OVA template is deployed and the Cisco Prime Collaboration Deployment Cisco ISO file is installed, you manage Cisco Prime Collaboration Deployment and deploy collaboration application server nodes and clusters using the web-based graphical user interface (GUI). Upgrades and backups of the Cisco Prime Collaboration Deployment system are performed using the CLI.



## Deploying Cisco Collaboration Application Server Clusters with Cisco Prime Collaboration Deployment

To deploy collaboration application nodes and clusters with Cisco Prime Collaboration Deployment, perform these required steps:

1. Prepare for Collaboration application deployment.

Download the necessary OVA templates and bootable Cisco ISO images for the target collaboration application(s): Unified CM, Unified CM IM and Presence Service, and Unity Connection. Next, SFTP the Collaboration application install .iso images to the '/fresh\_install' directory on Cisco Prime Collaboration Deployment.



**Note** Cisco Prime Collaboration Deployment does not support the deployment of other PA collaboration applications such as Cisco Expressway, Cisco Meeting Server, and Cisco TelePresence Management Suite.

2. Deploy OVA templates and virtual machines (VMs) on the compute infrastructure ESXi host(s).  
Create one VM for each required collaboration application node using the appropriate application OVA template based on the deployment size. For example, create VMs for the Unified CM publisher, dedicated Unified CM TFTP subscribers, and Unified CM call processing subscriber nodes. Repeat this process for Unified CM IM and Presence Service nodes and Unity Connection nodes. Leave all VMs powered off.
3. Add compute infrastructure ESXi host(s) to Cisco Prime Collaboration Deployment inventory.  
Use the Cisco Prime Collaboration Deployment administrative GUI to add the ESXi host (or hosts) where your collaboration application VMs are deployed. Enter the appropriate ESXi hostname, username, and password for each host.
4. Define new Unified Communications clusters in the Cisco Prime Collaboration Deployment inventory.  
Use the Cisco Prime Collaboration Deployment administrative GUI to define Unified Communications clusters for each Unified CM, IM and Presence Service, and Unity Connection cluster. Each cluster must have a unique name. Next, add the appropriate collaboration application node VMs (previously created in step 1) to the respective clusters. Finally, configure cluster-wide settings, including credentials and passwords, certificate information, DNS, NTP, and time zones for each cluster.
5. Add an installation task for each cluster.  
From the Cisco Prime Collaboration Deployment administrative GUI, select one of the Unified Communications clusters for installation and select the appropriate installation file (Cisco ISO file) for the cluster nodes. Next, specify a start time (immediately or sometime in the future). Repeat these steps for each cluster. If manual start is selected, manually start each installation task. Finally, monitor the installation tasks and confirm that each installation completes successfully.
6. Configure the installed clusters using the application server GUI.  
Once the Cisco Prime Collaboration Deployment installation tasks have completed successfully, the base configuration of all cluster nodes will be in place. Next configure the clusters manually using information contained in the [Call Control](#) chapter (for Unified CM and IM and Presence Service clusters) and the [Voice Messaging](#) chapter (for Unity Connection clusters). Once you have configured the clusters, use Cisco Prime Collaboration Provisioning for subsequent moves, adds, changes, and deletions (MACDs) as described in the section on [Webex Cloud-Connected UC](#).

# Cisco Smart Software Manager

Cisco Smart Software Manager provides a centralized method for applying, tracking, and managing licenses on Cisco Unified CM, Cisco Unity Connection, Cisco Meeting Server (CMS), and Cisco Expressway as well as other Cisco products. Cisco Smart Software Manager assists the administrator by automating many of the steps necessary to license users on the application servers.

## Core Components

The core component of the Smart Software Manager architecture is the web-hosted Cisco Smart Software Manager portal. This portal is used to acquire, apply, and track user licenses across Unified CM, Unity Connection, CMS, and Expressway clusters within the enterprise deployment.

## Benefits

You must use Cisco Smart Software Manager to license the Enterprise Collaboration Preferred Architecture call control, voice messaging, conferencing and edge clusters. Cisco Smart Software licensing provides the following benefits:

- Centralizes user and feature license management, allocation, entitlement, and reconciliation for Unified CM, Unity Connection, CMS, and Expressway.
- Provides shared license pooling across all enterprise clusters.
- Provides enterprise-level reporting of usage and entitlement.
- Simplifies future license planning and procurement of additional licenses as the number of users within a deployment grows.

## Architecture

The Cisco Smart Software Manager architecture consists of the Cisco hosted Cisco Smart Software Manager web portal, where an organization's collaboration application entitlements and licenses are tracked and synchronized to call control and voice messaging, conferencing, and edge components. Cisco Smart Software Manager manages and monitors user and/or feature licensing for Cisco Unified CM, Unity Connection, CMS, and Expressway.

As shown in [Figure 6-2](#), appropriate licenses must first be acquired and applied to the Cisco Smart Account for managing software and entitlement using the Cisco Smart Software Manager portal (step 1). Next, the administrator generates a product instance registration token on the Cisco Smart Software Manager portal at <https://software.cisco.com> (step 2). The administrator then registers the collaboration application product instances (Unified CM, Unity Connection, CMS, and Expressway) using the registration token copied from the Cisco Smart Software Manager portal (step 3). Once registered, the publishers will synchronize with Cisco Smart Software Manager and receive user and/or feature licensing entitlement information (step 4).

Figure 6-2 Cisco Smart Software Manager Architecture

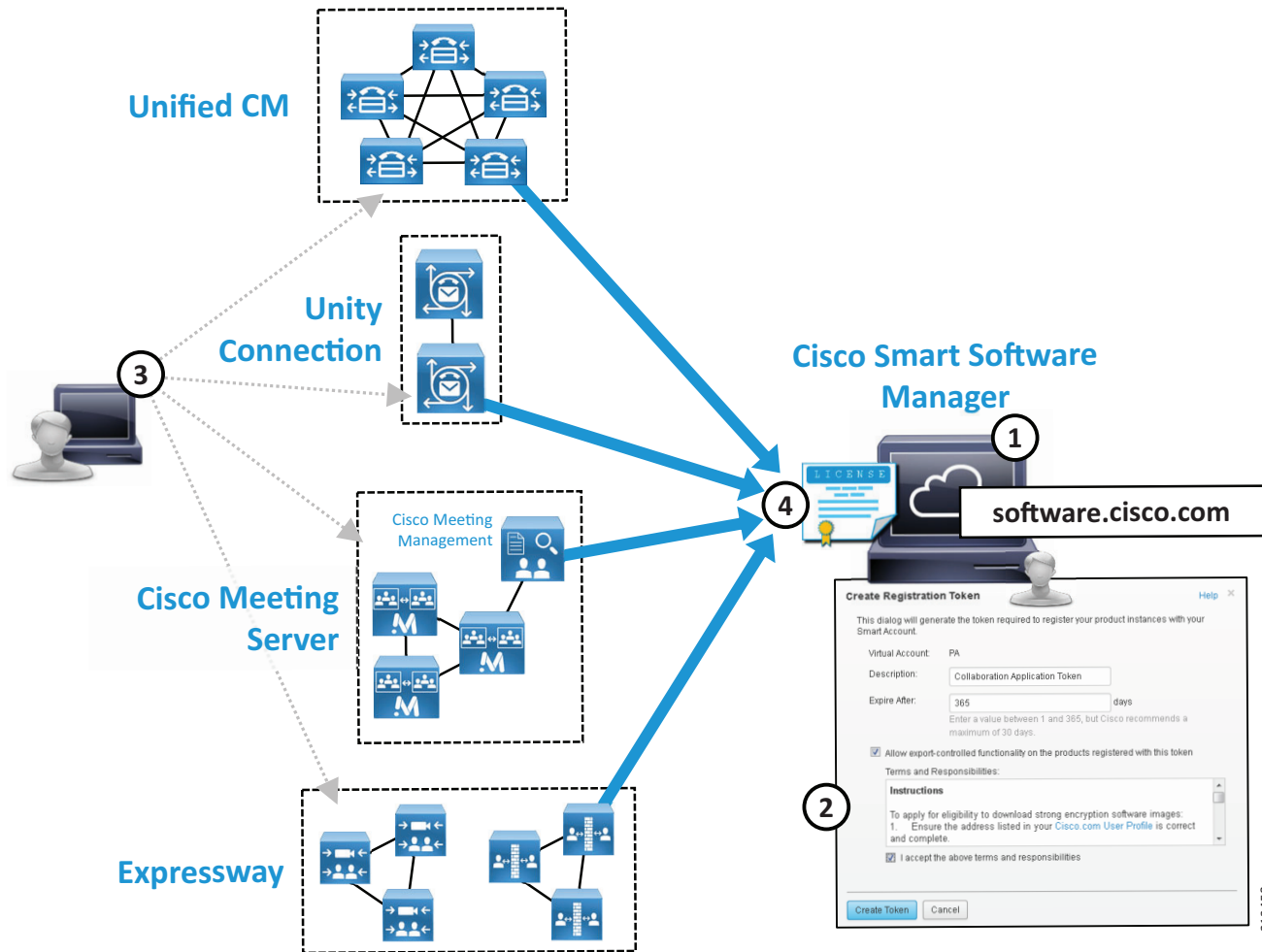
**Note**

CMS licensing is managed by Cisco Meeting Management (CMM) which handles communication with Cisco Smart Software Manager.

The Cisco Smart Licensing Manager service is enabled on appropriate application cluster nodes during initial installation or configuration. Registration and synchronization between collaboration applications and Cisco Smart Software Manager happens directly using an outbound HTTPS connection from the node(s) to the Internet hosted Cisco Smart Software Manager service.

For more information about Cisco Smart Software Manager, see

<https://www.cisco.com/c/en/us/buy/smart-accounts/software-manager.html>

**Role of Cisco Smart Software Manager**

Cisco Smart Software Manager centralizes management of user-based call control and voice messaging licenses and entitlement across enterprise collaboration application deployments. Cisco Smart Software Manager enables license planning, license entitlement and distribution, and usage tracking. Because the Cisco Smart Software Manager is hosted on the Internet, administration and management of licenses and software entitlement is done using a web browser.

### Alternative Architectures for Cisco Smart Software Manager

If your organization has network availability considerations or security policies in place that prevent direct Internet access from the collaboration application clusters, there are some additional options:

- HTTPS proxy

If an HTTPS proxy has already been deployed within the organization, it can be used for communication with the Cisco Smart Software Manager.

- Cisco Smart Software Manager On-Prem (formerly Smart Software Manager satellite).

Application cluster nodes register with and report license consumption to the Cisco Smart Software Manager On-Prem server instead of the online Cisco Smart Software Manager service. The satellite system must periodically connect to the online Cisco Smart Software Manager to synchronize (connected), or a report file from the system must be manually uploaded to the online service (disconnected).

For more information on Cisco Smart Software Manager On-Prem, refer to

<https://www.cisco.com/c/en/us/buy/smart-accounts/software-manager.html>

- Specific License Reservation

Applications are licensed by an initial manual exchange of information (cut and paste) with the Cisco Smart Software Manager service. Once the product configuration and authorization process is complete, no further interaction with Cisco Smart Software Manager service is required. With this configuration, the license reservations are permanently allocated to the systems within Cisco Smart Software Manager unless or until the reservation is updated or removed. Any update to the reservation requires another manual exchange of information between the Cisco Smart Software Manager service and the collaboration systems. Specific License Reservation is not supported with CMS/CMM or Expressway.

## High Availability for Cisco Smart Software Manager

The online Cisco Smart Software Manager application is highly available; however, in the case of an Internet connection issue, the collaboration application systems will continue to operate without impacting administrator or user experience for 90 days. Limitations to configuration and provisioning as well as intrusive warning notifications occur once the systems reach full non-compliance. In order to maintain system operation, the online Cisco Smart Software Manager must be reachable consistently.

## Scaling Cisco Smart Software Manager

Because Cisco Smart Software Manager is an Internet-hosted online service, there are few or no scalability considerations. The primary sizing considerations from an enterprise perspective are Internet connection bandwidth and network availability.

## Cisco Smart Software Manager Deployment Process

There are two deployment aspects to consider with Cisco Smart Software Manager:

- [Managing Licenses and Entitlement with the Cisco Smart Account and Smart Software Manager](#)
- [Authorizing and Registering Collaboration Product Instances and Applying Licenses](#)

### Managing Licenses and Entitlement with the Cisco Smart Account and Smart Software Manager

In order to license the collaboration applications, you first need to procure appropriate collaboration user and feature licensing before you can authorize the collaboration application systems. Once you have purchased the appropriate licenses, you can apply those licenses to your Cisco Smart Account.

Next, access the Cisco Smart Software Manager (<https://software.cisco.com>) using your Cisco Smart Account. Once logged into the Cisco Smart Software Manager, select (or create) the relevant virtual account (organization dependent). Under the virtual account you can manage collaboration licenses, view licenses and license usage, and register product instances.

For information on Cisco Smart Accounts, see:

<https://www.cisco.com/c/en/us/buy/smart-accounts.html>

### Authorizing and Registering Collaboration Product Instances and Applying Licenses

Smart Licensing is available by default on the appropriate application nodes. However, until your products are registered to the Cisco Smart Software Manager and licenses have been applied to the system, your system will be out of compliance and after the grace period will have severely reduced capabilities and functionality, capacity, and user experience.

In order to manage user licensing for collaboration applications with Cisco Smart Software Manager, perform the following required steps:

1. Create a product instance registration token

To set up Smart Licensing, go to the Smart Software Manager and under your virtual account create a new product instance registration token by clicking the **New Token...** button. In the subsequent dialog box specify a small number of days that the registration token will be valid (**Expires After:**), check the **Allow export-controlled functionality...** check box along with the **I accept the above terms and responsibilities** check box, and then click **Create Token**.



**Note** The **Allow export-controlled functionality** option is not shown for Smart Accounts that are not authorized to use export-controlled functionality.

2. Register product instances

Next register the collaboration applications by copying the product instance registration token from the Smart Software Manager portal and entering it in the device/product license window. On the application server license page, click the **Register** button. In the resulting pop-up window, enter the product instance registration token in the Smart Software Licensing Product Registration window and click the **Register** button to complete registration.

Once the collaboration applications are registered, they synchronize with Cisco Smart Software Manager to receive licensing and authorization for current users and features.

The above registration and authorization operations require a valid Smart Account for managing your Cisco software and licensing and appropriate product licensing entitlement.

# Webex Cloud-Connected UC

Webex Cloud-Connected UC is a set of cloud services delivered by Webex and managed through Webex Control Hub that provides centralized and simplified on-premises collaboration application management and visibility.

Webex Cloud-Connected UC (CCUC) is designed for customers with on-premises collaboration deployments with Unified CM that want to move some of administrative workloads to the Webex cloud while still maintaining their on-premises calling workload.

## Core Components

The core component of the Webex Cloud-Connected UC architecture is the web-hosted Webex Control Hub portal. This portal is used to access CCUC services for on-premises collaboration applications within the enterprise deployment.

## Benefits

You should use Webex Cloud-Connected UC for analytics with the Enterprise Collaboration Preferred Architecture call control and other application clusters. Webex CCUC provides the following benefits:

- Webex Control Hub provides a single pane of glass for both cloud and on-premises UC management.
- Solution enabled by cloud connectors running on infrastructure collaboration application nodes.
- Lower total cost of ownership (TCO) as customer gains cost optimized insights and increased administrative productivity through automated workflows.
- Delivers analytics for broad business and operations actionable insights for collaboration products.
- Enables customer to maintain business-critical calling and media on-premises.
- Simplifies and augments monitoring and reporting features and workflows for Cisco on-premises UC collaboration deployments.
- Industry leading Webex security and privacy with disaster recovery and redundancy.
  - All data is encrypted at rest and in transit.
  - Cisco Webex Identity Services infrastructure is used to authenticate and authorize cloud connectors to a specific Webex Control Hub organization.
  - All the data sent by CCUC is outlined in the privacy data sheet maintained at the Trust Portal (<https://trustportal.cisco.com>).

## Architecture

The Webex Cloud-Connected UC architecture includes on-premises collaboration applications like Unified CM and the Webex Control Hub web portal, where an organization's collaboration application analytics are collected, and other management and monitoring tasks are conducted.

As shown in [Figure 6-3](#), a Webex organization with Webex Control Hub access and UC Management enablement is required in order to enable Webex CCUC and access analytics (step 1). Next, the on-premises network firewalls must be configured to allow outbound communication to Webex (step 2). The administrator then onboards on-premises application nodes to activate CCUC (step 3). Once

on-premises application cluster nodes are onboarded, the administrator must verify application nodes with Webex Control Hub to complete onboarding and begin collecting information about on-premises systems (step 4).

**Figure 6-3** Webex Cloud-Connected UC Deployment Architecture

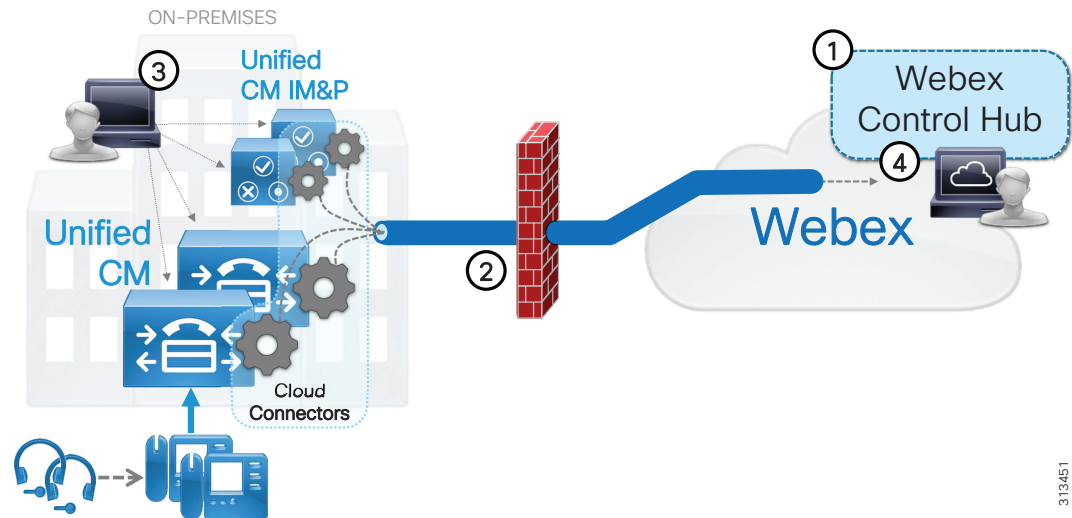

A cloud connector is enabled on appropriate application cluster nodes during initial configuration and onboarding. The connector manages the synchronization between collaboration applications and Webex Control Hub which happens directly using outbound HTTPS connections from the node(s) to the Internet-hosted Webex cloud services on TLS port 443.

For more information about Webex Cloud-Connected UC, see

<https://help.webex.com/en-us/jv0u1db/Cisco-Webex-Cloud-Connected-UC-Overview>

#### Role of Webex Control Hub

Webex Control Hub centralizes monitoring and analytics across enterprise collaboration deployments by extending cloud management services to on-premises applications. Webex Control Hub enables single pane of glass management and monitoring providing administrators a central location to view and analyze applications and services operations and utilization. Because the Webex Control Hub is hosted on the Internet, administration of management and analytics is done using a web browser.

## High Availability for Webex Cloud-Connected UC

The online Webex Control Hub is highly available; however, in the case of an Internet connection issue, the collaboration application systems will continue to collect analytics and other information to send to Webex. However, without a network connection to Webex this information cannot be sent and as such cloud-based monitoring and analytics capabilities will not be available until access to Webex Control Hub has been restored. In the meantime, traditional on-premises collaboration application management and monitoring tools may be used. In order to maintain Webex Control Hub analytics and monitoring of on-premises systems, access to Webex over the Internet must be maintained consistently.

## Scaling Webex Cloud-Connected UC

Because Webex Control Hub is an Internet-hosted online service, there are few or no scalability considerations. The primary sizing considerations from an enterprise perspective are Internet connection bandwidth and network availability.

## Webex Cloud-Connected UC Deployment Process

There are two deployment aspects to consider with Webex Cloud-Connected UC:

- [Managing Analytics, Reporting, and Monitoring with Webex Control Hub](#)
- [Configuring Webex Cloud-Connected UC and Onboarding On-Premises Applications](#)

## Managing Analytics, Reporting, and Monitoring with Webex Control Hub

In order to manage collaboration applications analytics, reporting, and monitoring with Webex Cloud-Connected UC (CCUC), you must first procure a Webex organization with CCUC entitlement in order to access the Webex Control Hub and Connected UC services.

Next, access the Webex Control Hub (<https://admin.webex.com>) using your Webex administrator account. Once logged into Webex Control Hub, to configure and manage CCUC, select **Connected UC** under the *Services* section of the left-hand navigation pane. You will see on-premises application node and cluster inventory information here as you onboard application server nodes.

Within Webex Control Hub, analytics for CCUC-enabled on-premises applications is available via the Connected UC Analytics page (select Analytics under the Monitoring section of the navigation pane).

For more information on Webex Control Hub, see:

<https://help.webex.com/ld-nwespu1-CiscoWebexControlHub/Control-Hub>

## Configuring Webex Cloud-Connected UC and Onboarding On-Premises Applications



### Note

The following deployment steps rely on the use of CLI commands at the collaboration application nodes to onboard the server and activate CCUC. Although not discussed, an alternate method for onboarding the nodes and activating CCUC is available which relies on the installation of an agent install or COP (.cop) file. This file is downloaded from Webex Control Hub (**Connected UC > UC Management > Install Files**) and installed on each collaboration application node.

1. Prepare Webex Control Hub for on-premises node onboarding.

To begin, login to Webex Control Hub with organization administrator account. Once logged in add a collaboration application cluster group by navigating to the UC Management Inventory page (under *Services: Connected UC > UC Management > Inventory*) and clicking the **Add Cluster Group** button. Enter the cluster group name (for example, 'PA Unified CM Cluster') and cluster group description (for example, 'Primary Unified CM cluster') and then click **Save**.



### Note

The above Webex Control Hub operations require a valid Webex organization with Connected UC entitlement.

2. Update on-premises firewalls and networks to allow communication with Webex cloud.



Next, prepare the on-premises firewall and any network access control lists to allow outbound communication from collaboration application server nodes to Internet-based Webex cloud services. Outbound HTTPS traffic on TLS port 443 should be allowed to the following URLs:

- \*.ucmgt.cisco.com
- \*.webex.com

If your organization utilizes an HTTP proxy for connections to the Internet, you should configure the cloud connector to utilize this proxy for all external communications. On each collaboration application node use the CLI **utils ucmgt proxy** set of commands to configure and manage proxy information.

For more information on preparing the enterprise network for CCUC, see:

<https://help.webex.com/en-us/fg3qim/Network-Requirements-for-Cisco-Webex-Cloud-Connected-UC>

For more information on configuring the on-premises proxy for CCUC, see:

<https://help.webex.com/en-us/ty4jte/Add-a-Proxy>

### 3. Onboard on-premises application nodes.

Once a cluster group has been configured on Webex Control Hub and the on-premises network and firewall allow outbound communication to Webex, you are ready to onboard your collaboration application server nodes.

To onboard an application node, first use the CLI **utils ucmgt organization** command to associate the application node with your organization. You can find your organization ID in Webex Control Hub by navigating to the Account page (under *Management: Account*).

Once the organization ID is configured, use the **utils ucmgt agent** CLI command set to enable and manage the cloud connector UC management agent.

Repeat these CLI commands at each collaboration application node you wish to onboard.



#### Note

You must set the following global and per node CDR related service parameters values to enable call quality metrics for CCUC: **Call Diagnostics Enabled** set to 'Enabled Only When CDR Enabled Flag is True' (global), and **CDR Enabled Flag** and **CDR Log Calls with Zero Duration Flag** are set to 'True' (per node). These parameters were covered earlier in the [Call Control](#) chapter and should already be configured as above.

### 4. Complete node onboarding by verifying and assigning nodes to a cluster group.

To complete application node onboarding, return to Webex Control Hub and again navigate to the UC Management Inventory page (under Services: **Connected UC > UC Management > Inventory**). Once there, you should see a cluster and set of nodes requiring assignment to a cluster group. Begin by clicking **Resolve** next to the cluster and nodes requiring assignment.

On the next screen, click **Verify** next to each cluster node requiring verification. On the subsequent screen, compare the displayed verification code for each node with the verification code displayed at the node when using the CLI command **utils ucmgt agent verification**. Ensure that the verification code displayed on Webex Control Hub matches the verification code displayed at the application CLI.

Finally, assign the node to a cluster group by selecting the cluster group that you created earlier from the dropdown menu (for example, 'PA Unified CM Cluster') and then clicking the checkmark next to each node to verify and assign to the cluster group.

As indicated previously, analytics information can be found on the Connected UC Analytics page (select **Analytics** under the *Monitoring* section of the navigation pane). It will be the next day before Connected UC analytics information begins to display.

For more information on deploying Webex Cloud-Connected UC, see:

<https://help.webex.com/en-us/nzt6c0b/Set-Up-Cisco-Webex-Cloud-Connected-UC-for-On-Premises-Devices>



# Security

**Revised: May 21, 2021**

This chapter describes network access security, toll-fraud access protection, certificate management, and encryption for the Cisco Preferred Architecture (PA) for Enterprise Collaboration.

The first part of this chapter provides an architectural overview while the second part covers deployment procedures. The [Architecture](#) section discusses various aspects of security. It starts with a high level discussion of the layered security approach, unauthorized access protection, and toll-fraud protection. Then it focuses on certificate management and encryption. The next portion of this chapter is the [Deployment](#) section. It covers the procedures on how to generate and manage certificates and how to enable and provision encryption for all the components in this solution.



**Note**

The information in this chapter assumes that the products are running software version 12.5 or later.

## What's New in This Chapter

[Table 7-1](#) lists the topics that are new in this chapter or that have changed significantly from previous releases of this document.

**Table 7-1** *New or Changed Information Since the Previous Release of This Document*

New or Revised Topic	Described in:	Revision Date
Webex Cloud-Connected Certificate Management option to monitor certificates	Certificate Monitoring	May 21, 2021
Support of multi-server certificates with self-signed certificates in Unified CM and IM & Presence	Various sections of this chapter	May 21, 2021
SIP OAuth support and recommendation on the 7800/8800 phones	Various sections of this chapter	May 21, 2021
Additional information related to SIP OAuth support on the 7800/8800 Series phones	Various sections of this chapter	May 21, 2021
TFTP configuration file confidentiality and encryption	Various sections of this chapter	May 21, 2021

**Table 7-1** New or Changed Information Since the Previous Release of This Document (continued)

New or Revised Topic	Described in:	Revision Date
Certificate deployment procedure updated with CMS, refer to the CMS chapter for example	Cisco Meeting Server	May 21, 2021
Remove Prime Collaboration Provisioning information	Cisco Prime Collaboration Provisioning	May 21, 2021

## Core Components

Security applies to all the components in the Cisco Collaboration solution (see [Figure 7-1](#)). It is important to implement security across the solution. In fact, it is important to implement security with a layered approach. Do not rely on a single component to provide security, but instead plan for multiple layers of defense.

**Figure 7-1** Secure All Components of the Enterprise Collaboration Preferred Architecture

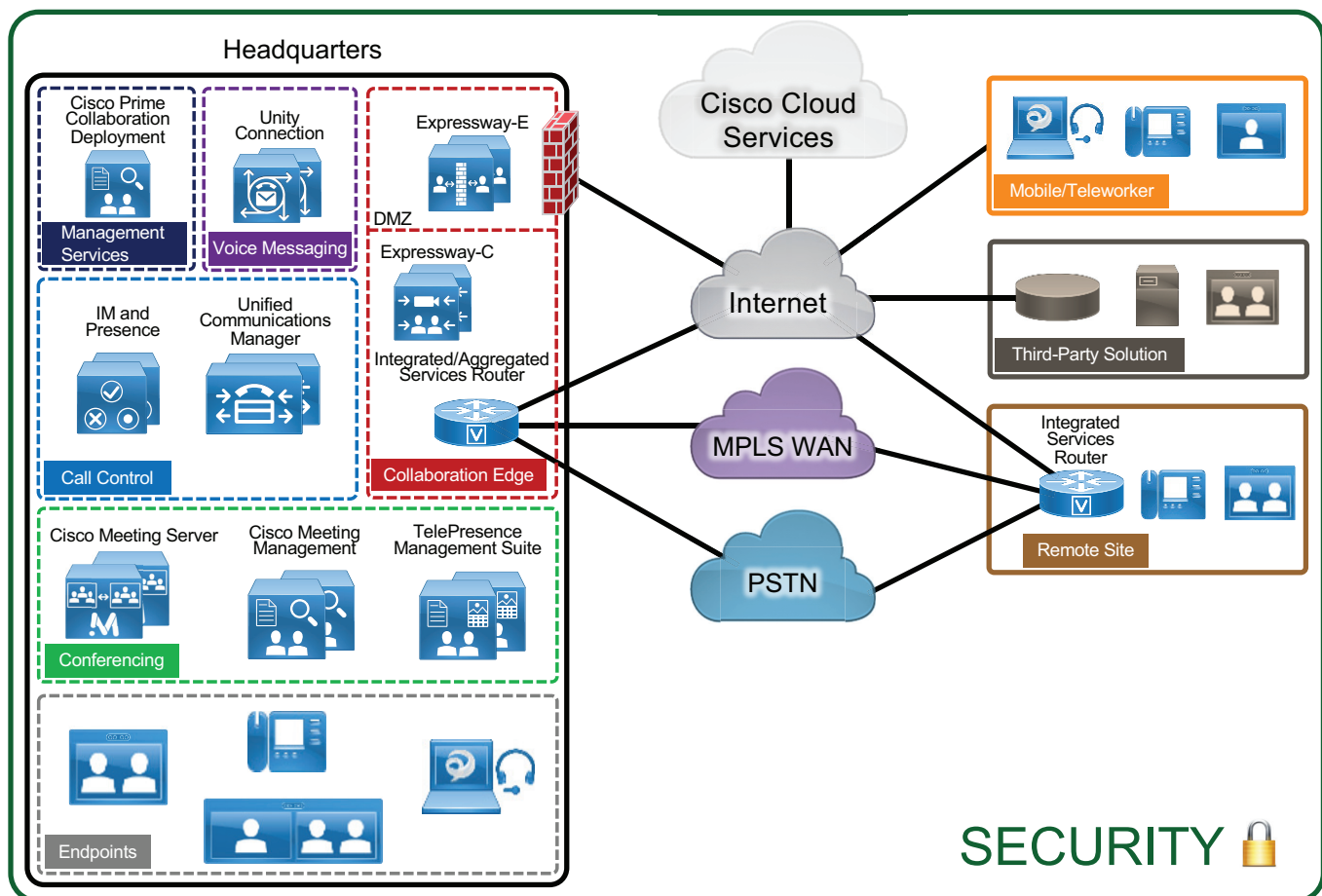

313446

## Key Benefits

This deployment provides the following benefits:

- Implementing a layered approach provides multiple layers of defense.
- Protecting access to your network and your systems makes it more difficult to compromise your servers, your Collaboration solution, and the rest of the organization.
- Implementing toll fraud protection mechanisms can prevent unauthorized access to your telephony system, data network, and PSTN lines that would lead to unauthorized financial charges.
- Using encryption and certificates for your various communications can protect against eavesdropping, tampering, and session replay.
- Implementing a good certificate management plan provides a good level of protection while reducing complexity.

## Architecture

This section starts with an overview on the security mechanisms for Cisco Collaboration. It then discusses toll-fraud mitigation, and then focuses on certificate management and encryption.

## Security in Layers

There are a wide variety of threats that can be addressed by different mechanism. As a general best practice, a layered security approach to secure your collaboration deployment should be used. Physical access to your premises as well as access to your network, servers, endpoints, and systems should be protected and secure. Communications should be encrypted, and a good certificate management system should be deployed. Securing as many components and layers as possible augments the security, and if a layer or component is compromised, your system would still be protected by other security layers and security mechanisms.

[Table 7-2](#) provides examples of collaboration threats and countermeasures. For each threat, multiple countermeasures should be deployed.

**Table 7-2** *Examples of Collaboration Threats and Countermeasures*

Threats	Countermeasures
Denial of Service (DoS)	Physical security; network security; firewall and intrusion prevention system (IPS); QoS
Scan and spam over Internet telephony	Firewall and advanced malware protection (AMP); Cisco Collaboration Edge security; Cisco Unified Communications Manager (Unified CM) dial-plan
Virus	Host-based firewall; IPS; anti-virus software
Toll-fraud	Cisco Unified CM calling search space (CSS) and partitions; toll-fraud prevention and access protection; Cisco Collaboration Edge Policy Rules and security
Learning private information	Encryption with certificate management; physical security; network security

**Table 7-2 Examples of Collaboration Threats and Countermeasures (continued)**

Threats	Countermeasures
Man-in-the-middle attacks	Encryption with certificate management; physical security; network security
Eavesdropping	Encryption with certificate management; physical security; network security
Impersonating others	Encryption with certificate management; physical security; network security
Media tampering	Encryption with certificate management; physical security; network security
Data modification	Encryption with certificate management; physical security; network security
Session replay	Encryption with certificate management; physical security; network security

## Physical Security

The first line of defense is physical security. It is important to provide physical security to your premises, network access, and very importantly to your core network infrastructure and servers. When physical security is compromised, simple attacks such as service disruption by shutting down power to your premises and/or servers can be initiated. With physical access, attackers could get access to server devices, reset passwords, and gain access to servers. Physical access also facilitates more sophisticated attacks such as man-in-the-middle attacks, which is why the second security layer, the network security, is critical.

For more information on general security practices, refer to the documentation at the following locations:

<https://www.cisco.com/c/en/us/solutions/enterprise/design-zone-security/index.html>

[https://www.cisco.com/en/US/products/svcs/ps2961/ps2952/serv\\_group\\_home.html](https://www.cisco.com/en/US/products/svcs/ps2961/ps2952/serv_group_home.html)

## Network Security

Network security is the next line of defense. The following section provides examples of some of the network security mechanisms. This section provides only brief coverage of network security and the [Deployment](#) section of this guide does not cover it. For more information on network security, refer to network security design guides available at

<https://www.cisco.com/c/en/us/solutions/enterprise/design-zone-security/index.html>

## Voice and Video VLAN

Separate voice/video and data VLANs are recommended for the following reasons:

- Protection from malicious network attacks

VLAN access control, 802.1Q, and 802.1p tagging can provide protection for voice devices from malicious internal and external network attacks such as worms, denial of service (DoS) attacks, and attempts by data devices to gain access to priority queues through packet tagging.

- Ease of management and configuration

Separate VLANs for voice and data devices at the access layer provide ease of management and simplified QoS configuration.

The voice/video VLAN includes the hardware desk phones and video systems. The data VLAN includes end-user desktops and laptops, and software clients such as Jabber. Access lists (ACL), VLAN access lists (VACL), or firewalls can be used to limit traffic between the VLANs.

With wireless access, there are additional considerations. For details, refer to the *Real-Time Traffic over Wireless LAN Solution Reference Network Design Guide* and the *Cisco Collaboration System Solution Reference Network Design (SRND)* guide, both available at <https://www.cisco.com/go/ucsrnd>.

## Layer 2 and Layer 3 Security

Use the standard security features available at Layer 2 and Layer 3.

### Port Security

A classic attack on a switched network is a MAC content-addressable memory (CAM) flooding attack. This type of attack floods the switch with so many MAC addresses that the switch does not know which port an end station or device is attached to. Consequently, it broadcasts the traffic destined for that device to the entire VLAN. In this way, the attacker is able to see all traffic that is coming to all the users in a VLAN. Either port security or dynamic port security can be used to inhibit a MAC flooding attack. A customer with no requirement to use port security as an authorization mechanism would want to use dynamic port security with the number of MAC addresses appropriate to the function attached to a particular port. For example, a port with only a workstation attached to it would want to limit the number of learned MAC addresses to one. A port with a Cisco Unified IP Phone and a workstation behind it would want to set the number of learned MAC addresses to two (one for the IP phone itself and one for the workstation behind the phone) if a workstation is going to plug into the PC port on the phone. Port security also provides a form of device-level security authorization by checking the MAC address of the endpoint.

### DHCP Snooping

Dynamic Host Configuration Protocol (DHCP) snooping prevents a non-approved DHCP or rogue DHCP server from handing out IP addresses on a network by blocking all replies to a DHCP request from untrusted ports. Because most phone deployments use DHCP to provide IP addresses to the phones, you should use the DHCP snooping feature in the switches to secure DHCP messaging. DHCP snooping can also help to protect against DHCP address scope starvation attacks which are used to create a DHCP denial-of-service (DoS) attack. With DHCP snooping enabled, untrusted ports will make a comparison of the source MAC address to the DHCP payload information and fail the request if they do not match. DHCP snooping prevents any single device from capturing all the IP addresses in any given scope, but incorrect configurations of this feature can deny IP addresses to approved users.

### Dynamic ARP Inspection

Dynamic Address Resolution Protocol (ARP) Inspection (DAI) is a feature used on the switch to prevent Gratuitous ARP attacks on the devices plugged into the switch and on the router.

Gratuitous ARP (GARP) is an unsolicited ARP reply. In its normal usage, it is sent as a MAC broadcast. All stations on a LAN segment that receive a GARP message will cache this unsolicited ARP reply, which acknowledges the sender as the owner of the IP address contained in the GARP message. Gratuitous ARP has a legitimate use for a station that needs to take over an address for another station on failure. However, Gratuitous ARP can also be exploited by malicious programs that want to illegitimately take on the identity of another station. When a malicious station redirects traffic to itself from two other stations that were talking to each other, the hacker who sent the GARP messages becomes the man in the middle.

Dynamic ARP Inspection (DAI) is used to inspect all ARP requests and replies (gratuitous or non-gratuitous) coming from untrusted (or user-facing) ports to ensure that they belong to the ARP owner. The ARP owner is the port that has a DHCP binding that matches the IP address contained in the ARP reply. ARP packets from a DAI trusted port are not inspected and are bridged to their respective VLANs.

Dynamic ARP Inspection (DAI) requires that a DHCP binding be present to legitimize ARP responses or Gratuitous ARP messages. If a host does not use DHCP to obtain its address, it must either be trusted or an ARP inspection access control list (ACL) must be created to map the host's IP and MAC address. (See [Figure 7-2](#).) Like DHCP snooping, DAI is enabled per VLAN, with all ports defined as untrusted by default. To leverage the binding information from DHCP snooping, DAI requires that DHCP snooping be enabled on the VLAN prior to enabling DAI.

**Figure 7-2** Using DHCP Snooping and DAI to Block ARP Attacks

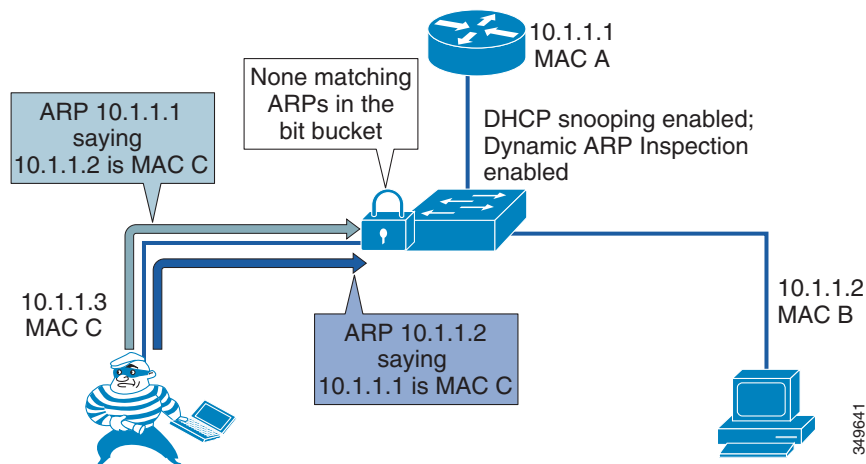

### IP Source Guard

IP Source Guard provides source IP address filtering on a Layer 2 port to prevent a malicious host from impersonating a legitimate host by assuming the legitimate host's IP address. The feature uses dynamic DHCP snooping and static IP source binding to match IP addresses to hosts on untrusted Layer 2 access ports.

Initially, all IP traffic on the protected port is blocked except for DHCP packets. After a client receives an IP address from the DHCP server, or after static IP source binding is configured by the administrator, all traffic with that IP source address is permitted from that client. Traffic from other hosts is denied.



This filtering limits a host's ability to attack the network by claiming a neighbor host's IP address. IP Source Guard is a port-based feature that automatically creates an implicit port access control list (PACL).

### 802.1X

802.1X is an IEEE standard that permits or denies network connectivity based on the identity of the end user or device. The 802.1X authentication feature can be used to identify and validate the device credentials of a Cisco endpoint before granting it access to the network. 802.1X is a MAC-layer protocol that interacts between an end device and a RADIUS server such as the Cisco Identity Service Engine (ISE). It encapsulates the Extensible Authentication Protocol (EAP) over LAN, or EAPOL, to transport the authentication messages between the end devices and the switch. In the 802.1X authentication process, the Cisco endpoint acts as an 802.1X supplicant, initiates the request to access the network, and provides its certificate (Locally Significant Certificate recommended). The Cisco Catalyst Switch, acting as the authenticator, passes the request to the authentication server and then either allows or restricts the phone from accessing the network.

802.1X can also be used to authenticate the data devices attached to the Cisco Unified IP Phones. An EAPOL pass-through mechanism is used by the Cisco Unified IP Phones, allowing the locally attached PC to pass EAPOL messages to the 802.1X authenticator. The Cisco Catalyst Switch port must be configured in multiple-authentication mode to permit one device on the voice VLAN and multiple authenticated devices on the data VLAN.

### Firewalls, IPS, and AMP

Firewalls can be used in conjunction with access control lists (ACLs) to protect the collaboration servers and gateways from devices that are not allowed to communicate with them. You can deploy the Cisco Adaptive Security Appliance (ASA) with FirePOWER services. It combines the ASA firewall functionality and the Next Generation Intrusion Prevention System (NGIPS) as well as Anti-Malware Protection (AMP).

Some UDP and TCP ports used by the Cisco Collaboration systems might have to be opened in firewalls. Refer to the following guides to determine which ports are used:

- For Cisco Unified CM and IM and Presence, refer to the latest version of the *System Configuration Guide for Cisco Unified Communications Manager*, available at <https://www.cisco.com/c/en/us/support/unified-communications/unified-presence/products-installation-and-configuration-guides-list.html>.
- For Cisco Unity Connection, refer to the latest version of the *Security Guide for Cisco Unity Connection*, available at <https://www.cisco.com/c/en/us/support/unified-communications/unity-connection/products-maintenance-guides-list.html>.
- For Cisco Expressway, refer to the latest version of the *Cisco Expressway IP Port Usage for Firewall Traversal Deployment Guide*, available at <https://www.cisco.com/c/en/us/support/unified-communications/expressway-series/products-installation-and-configuration-guides-list.html>.
- For Cisco Jabber, refer to the latest version of the *Planning Guide for Cisco Jabber*, available at <https://www.cisco.com/c/en/us/support/unified-communications/jabber-windows/products-installation-guides-list.html>.

### QoS

Quality of Service (QoS) can be used to ensure collaboration traffic receives appropriate priority over other traffic in the network, and it can safeguard against network flood attacks (a type of Denial of Service attack). While QoS is not a security feature in and of itself, when properly implemented it does ensure that packets with the appropriate QoS levels are given priority. This can prove effective against

some packet flood attacks that attempt to bombard the network with packets to overwhelm interface buffers. With QoS those buffers are protected when the unmarked packets are dropped and the properly marked packets are allowed.

Refer to the [Bandwidth Management](#) chapter for more information on Collaboration QoS policies.

## Preventing Unauthorized Access

Most of the Cisco Collaboration products have a hardened platform. For example, the platforms used by Cisco Unified CM, IM and Presence Service, and Unity Connection are locked down; the root account is disabled; third-party software installation is not allowed; a host-based intrusion protection (SELinux) and host-based firewall (iptables) are installed and enabled by default; a complex password policy is applied to administrative accounts; and secure management interfaces (HTTPS, SSH, SFTP) are enforced. Further – with the ability to assign users to access control groups and therefore to specific roles – administrators, end users, and application users can be given only the permissions they need. All installation packages are signed and include both the OS and application. System audit logging is available, which is critical for determining what might have happened when issues arise.

Servers deployed at the edge should be well secured because they are more exposed to the Internet. On the Cisco IOS gateway or Cisco Unified Border Element, there are many security features available, such as access control lists (ACLs), IP trust list, call threshold, call spike protection, bandwidth-based call admission control (CAC), media policing, NBAR policing, and voice policies. On Cisco Expressway, Call Processing Language (CPL) rules, host-based firewall (with dynamic system rules, non-configurable application rules, and user-configurable rules), and automated intrusion protection can be configured to protect the system.

Even though securing endpoints might not seem as critical as securing servers, endpoints should also be secured. Firstly, it is typically easier to access endpoints because they can be accessed by end users and are not locked down in a data center. Secondly, compromising endpoints can also be damaging. Critical information about the endpoint and the system it is registered to can be discovered on the phone screen and on the phone's web interface. Logs can be downloaded. Some endpoints such as Cisco video endpoints provide the endpoint administrator user many advanced capabilities, including call control of the endpoint and even capturing packets. On those endpoints, do not leave the default empty password but instead configure strong passwords. In general, when the settings Web Access, Web Admin, Console Access, Telnet Access, and SSH Access are available on an endpoint, we recommend disabling them. Those features should be enabled only when needed; for example, when troubleshooting an endpoint. An access control list should be configured to limit access to these interfaces to a management station or stations accessible by the administrator. If you decide to enable Web Access on an endpoint, allow only HTTPS (and not HTTP).

The Settings Access parameter on the Unified CM administration phone pages allows users to access the device settings when they press the Settings button. We recommend disabling this parameter or setting it to Restricted when available (this disables the access to administrative tasks). If you are performing an operation where endpoints could possibly lose the trust relationship with Unified CM (for example, when migrating endpoints from one Unified CM cluster to another Unified CM cluster and not distributing one ITLRecovery certificate and private key across all Unified CM clusters), you may temporarily enable Setting Access. You could also enable it temporarily for Unified CM upgrades as a precaution, even though Unified CM certificates should not be modified during upgrades. In case endpoints lose the trust with Unified CM, temporarily enabling Setting Access would allow the users to recover trust by going to the menu on their phone and resetting the security settings, which deletes the Initial Trust List (ITL) or Certificate Trust List (CTL). Alternatively, if trust is lost, it could also be recovered by using the ITL recovery key (refer to the [CTL and ITL](#) section for more information).

If not already enforced by default, ensure that complex password and PIN policies (for example, number of allowed failed logins, failed login account lockout duration, minimum credential length) are configured for administrators and users across all Cisco Collaboration products.

## Toll Fraud Mitigation

### Cisco Unified CM

On Cisco Unified CM, several mechanisms can be used to prevent toll fraud. Partitions and calling search spaces (CSS) provide segmentation and access control to the directory numbers, route patterns, directory URIs, and SIP route patterns that can be called on the device or line that is placing the call. As a best practice, apply the most restrictive class of service possible based on partitions and calling search spaces. For example, for SIP trunks connecting to PSTN gateways and Expressways, create an inbound calling search space that does not allow access to any of the PSTN gateway partitions. To prevent all offnet-to-offnet transfers, classify the SIP trunks to PSTN gateways as **Offnet** with the **Call Classification** enterprise parameter and set the **Block OffNet to OffNet Transfer** CallManager service parameter to **True**. Other mechanisms can also be used, such as time-of-day routing, forced authentication code (FAC), and using the **Drop Ad hoc Conferences** CallManager service parameter (set to **When No OnNet Parties Remain in the Conference**). If auto-registration is enabled, create a device pool with a restricted calling search space. We also recommend proactively monitoring system call detail records (CDRs).

### Cisco Unity Connection

Unauthorized users could use the transfer feature in Cisco Unity Connection to place unauthorized calls. There are two main ways to prevent toll fraud with Unity Connection:

- On Unity Connection — Restriction tables control the phone numbers that can be used for transferring calls, for message notification, and for other Unity Connection functions. Each class of service has several restriction tables associated with it, and you can add more as needed. Refer to the [Voice Messaging](#) chapter for more details and for an example.
- On Unified CM — For the calling search space and rerouting calling search space, include only the required partitions. Refer to [Table 2-21, Class of Service for Voicemail](#).

For more details, refer to the latest version of the *Security Guide for Cisco Unity Connection*, available at <https://www.cisco.com/c/en/us/support/unified-communications/unity-connection/products-maintenance-guides-list.html>

Also refer to *Troubleshoot Toll Fraud via Unity Connection*, available at

<https://www.cisco.com/c/en/us/support/docs/unified-communications/unity-connection/119337-technote-cuc-00.html>

### Cisco Expressway

With Expressway business-to-business deployments, use Call Processing Language (CPL) rules to allow or reject calls from the Default Zone. For example, if you want to reject any business-to-business calls inbound to Expressway to unknown destinations with 9 as a prefix (to avoid unauthorized calls to the PSTN), you can create a CPL rule with the settings in [Table 7-3](#).

**Table 7-3 CPL Settings for Business-to-Business Calls**

Source Type	Zone
Originating zone	DefaultZone
Destination pattern	9.*
Action	Reject

Also use the automated detection feature where IP addresses can be automatically rejected by Expressway-E internal firewall for a configurable period of time, after a configurable number of rejections from an IP address. With this automated detection feature, calls from those IP addresses are not processed by Expressway-E and they don't appear in the call logs for example.

You can also use the SIP rate limiting feature where a limit is configured for the maximum number of connections per second and maximum burst size.

#### **Cisco IOS Gateway and Cisco Unified Border Element**

The telephony denial-of-service (TDoS) attack mitigation feature prevents Cisco IOS Gateways and Cisco Unified Border Element from responding to Session Initiation Protocol (SIP) requests arriving from untrusted IP addresses, which helps prevent toll fraud and leads to an improvement in performance. The SIP stack authenticates the source IP address of an incoming SIP request and blocks the response if the source IP address does not match any IP address in the trusted IP address list. The IP addresses configured in the dial-peer session target or in the voice class server-group are automatically part of the trusted IP address list. Additional trusted IP addresses can be added with the command **ip address trusted list**.

This TDoS feature is configured with the command:

```
voice service voip
  ip address trusted authenticate
```

If Cisco Unified Border Element is not deployed as a registrar server, disable the registrar service to avoid consuming unnecessary resources.

## Certificate Management

Certificates are critical in a Cisco Collaboration deployment. They allow individuals, computers, and other services on the network to be authenticated and are required when establishing secure connections. Implementing good certificate management provides a good level of protection while reducing complexity.

This section starts with a brief overview of the public key infrastructure (PKI). Then general guidance is provided. Finally, architecture details for the various Cisco Collaboration products are provided.

### Brief PKI Overview

The public key infrastructure (PKI) provides a mechanism to secure communications and validate identities of communicating parties. Communications are made secure through encryption, and identities are validated through the use of public/private key pairs and digital identity certificates.

#### Public/Private Key Pair

A public and private key pair comprises two uniquely related cryptographic keys mathematically related. Whatever is encrypted with a public key may be decrypted only by its corresponding private key (which must be kept secret), and vice versa.

#### Certificates

A digital certificate is an electronic credential that is used to certify the identity of individuals, computers, and other services on a network. It is a wrapper around the public key. It provides information about the owner of the public key. It is used, for example, in a TLS handshake to authenticate the other party or used to digitally sign a file. Certificates deployed with Cisco Collaboration products are based on the X.509 standards. The certificates include the following information, among others:

- Public Key
- Common Name (CN)
- Organization Name (O)
- Issuer Name
- Validity period (Not before, not after)
- Extensions (optional) — For example, Subject Alternate Name (SAN)

A certificate can be self-signed or signed by a certificate authority (CA).

#### Certificate Validation During TLS Handshake

When a client initiates a TLS connection to a server, the server sends its certificate during the TLS handshake so that the client can authenticate the server. This happens, for example, when an administrator or end-user connects to the Unified CM pages or when the Jabber client starts and connects to the Unified CM UDS server, IM and Presence server, and Unity Connection server.

In some cases, the server also authenticates the client and requests the client to send its certificate. This is mutual authentication (mutual TLS, or MTLS) and it is used, for example, between Unified CM and Cisco endpoints in encrypted mode (configured with media and signaling encryption), with SIP trunks connecting two Unified CM clusters, or with SIP trunks connecting Unified CM to Unity Connection, a Cisco IOS Gateway, or Expressway (if TLS verify is configured on Expressway).

When a certificate is received, the verification consists of checking the following items:

- Identity — The subject or identity for which the certificate is issued must match the identity that the initiator of the session intended to reach. The hostname (FQDN) is checked against the common name (CN) or Subject Alternate Name (SAN) extension.
- Validity period — The current time and date must be within the certificate's validity range.
- Revocation status of the certificate
- Trust — The certificate must be trusted. A certificate is considered trusted if the signing (issuing) party is trusted. Trust with signing parties typically is established by importing the certificate of the signing party into a store of trusted certificates (trust store). Refer to the section on [CA-Signed Certificates Instead of Self-Signed Certificates](#) for more details.
- Additionally, there could be other verification checks on the certificate. For example, in order to mitigate DNS poisoning, mobile and remote access clients require that the Unified CM registration domains are added in the Subject Alternate Name of the certificate, see **Table 7-16** for more details.”

## General Guidance on Certificates

Some servers such as Cisco Unified CM and IM and Presence Service can have different certificates for the various system services. Some servers such as Cisco Expressway have only one certificate for the service they provide. [Table 7-4](#) lists the server certificates for this Preferred Architecture. As discussed in the next section, ECDSA certificates are not covered in this document.

**Table 7-4** Server Certificates in the Cisco Collaboration Preferred Architecture

Service	Certificate	Description
Cisco Unified CM	tomcat	Used for secure web connections. Also used for example with services such as LDAP, ILS and LBM, Disaster Recovery System, Jabber, and secure signaling for endpoints configured with SIP OAuth.
Cisco Unified CM	CallManager	Used for secure signaling when not using SIP OAuth and for TFTP files signature. In order to reduce the number of certificates in your Unified CM cluster, it is recommended to re-use the tomcat certificate for the CallManager service.
Cisco Unified CM	CAPF	Required by endpoints when connecting to the Certificate Authority Proxy Function (CAPF) service.
Cisco Unified CM	TVS	Required when connecting to the Trust Verification Service (TVS).
Cisco Unified CM	ITLRecovery	Used for the ITL and CTL files signature.
Cisco Unified CM	ipsec	For IPsec connections. IPsec can be enabled, but it is not covered in this document.
Cisco Unified CM	authz	Used for OAuth.
IM and Presence Service	tomcat	For SIP clients (Unified CM), Web services, SOAP, LDAP.
IM and Presence Service	cup	For SIP Proxy, Presence Engine, SIP federation.
IM and Presence Service	cup-xmpp	For secure XMPP (IM)
IM and Presence Service	cup-xmpp-s2s	For secure XMPP federation

**Table 7-4** Server Certificates in the Cisco Collaboration Preferred Architecture (continued)

Service	Certificate	Description
IM and Presence Service	ipsec	For IPsec
Cisco Unity Connection	tomcat	Unity Connection web services certificate. Used for media and signaling encryption to the voice mail ports.
Cisco Unity Connection	ipsec	For IPsec
Cisco Expressway-C	Server	For all secure connections from/to Expressway-C.
Cisco Expressway-E	Server	For all secure connections from/to Expressway-E.
Cisco Meeting Server	Database client	For Cisco Meeting Servers with the Call Bridge service without a database, to connect securely to Cisco Meeting Server nodes with a database
Cisco Meeting Server	Shared certificate used for Web Admin, Call Bridge, Web Bridge, and database server	For simplicity, except for the database client, we use the same certificate for all Cisco Meeting Server nodes and services.
Cisco Meeting Management	Server	For web connections and call bridge connections
Survivable Remote Site Telephony (SRST), Cisco IOS Gateway, Cisco Unified Border Element	Cisco IOS certificate	With SRST, the SRST certificate is included in the configuration file of each endpoint.
Cisco Prime Collaboration Deployment	tomcat	For Web services

There are also other ECDSA certificates, but as discussed in the section on [RSA and ECDSA](#), they are not used for the deployment guidance in this chapter, so they are not listed in [Table 7-4](#).

In general, the Cisco Collaboration servers are installed by default with a self-signed certificate. The exception is Cisco Meeting Server, which has no certificate installed by default.

Cisco Unified CM self-signed certificates are valid for 5 years. The ITLRecovery certificate validity period is also 5 years with Unified CM release 14.

## RSA and ECDSA

Certificates for the Cisco Collaboration products are typically based on RSA (Rivest, Shamir, and Adelman) for public/private keys and digital signatures. Some products also support Elliptical Curve Digital Signature Algorithm (ECDSA) certificates, but for simplicity the general recommendation is to use RSA-based certificates, and that is what is covered in this document.

For endpoints, we recommend using RSA-based Locally Significant Certificates (LSCs). For Unified CM SIP TLS, ECDSA and RSA are always enabled, but by default RSA is preferred over ECDSA, so RSA certificates are negotiated. This is the recommended configuration. For HTTPS, with Unified CM, IM and Presence Service, and Unity Connection, ECDSA is not enabled by default. It may be enabled by changing the HTTPS Ciphers enterprise parameter, but the recommendation is to use the default settings (ECDSA disabled).



### Note

Encryption cipher suites based on ECDHE do not require certificates based on ECDSA; they can be negotiated with certificates based on RSA.

## CA-Signed Certificates Instead of Self-Signed Certificates

By default, when installing servers for the Cisco products discussed here, self-signed certificates are installed (except with Cisco Meeting Server, where no certificate is installed by default). To establish trust with a service based on a self-signed certificate, the server self-signed certificates must be imported into the trusted certificates store (or trust store) of all entities requiring secure connections to the service (clients). If not, with servers initiating the connections (for example, with Unified CM SIP trunks), the connection will fail. With Jabber and web browsers, users are prompted with warning messages and can accept the certificates, which then are in general added to the trusted certificate store. This should be avoided because being prompted multiple times to accept a number of certificates during startup of the client is not a good user experience. Even more important is the fact that most users will not actually verify whether the presented certificate is correct by checking the certificate's fingerprint, and instead will just accept any certificate. This breaks the security concept of certificate-based authentication for secure session establishment.

Importing self-signed certificates can be handled if the set of communicating parties is small, but it becomes less practical for large numbers of communication peers. This is the main reason why we recommend replacing most default self-signed certificates with certificates that are signed by a CA. It simplifies certificate management. With CA-signed certificates, it is not necessary to import each server certificate in the client trust store; but instead, importing the root CA certificate to the client trust store is sufficient. On the server side, in general, the root CA certificate must also be imported to the server trust store; and if using intermediate CA(s), all the certificates in the certificate chain must also be imported to the server trust store. Using CA-signed certificates also allows for issuing new service certificates without having to update all client or server trusted certificate stores, as long as the signing CA's root certificate has already been added to the trusted certificate stores of all clients.

As an example of the benefit of using a CA-signed certificate: If self-signed certificates are used with Jabber clients, the Unified CM Tomcat certificate (for UDS and for downloading TFTP configuration file), the IM and Presence tomcat and cup-xmpp certificates (for login and secure chat), and the Unity Connection Tomcat certificate (for visual voice mail) would have to be imported into the trust store of each client running Jabber. With CA-signed certificate, only the signing CA's root certificate needs to be imported.

In general, using a CA-signed certificate for the Tomcat certificates is the most beneficial approach because they are widely used and are user-facing certificates. This is also required when using SIP OAuth on the 7800/8800 Series phones. Using CA-signed certificates for the CallManager certificates avoids importing the CallManager certificates for all of the entities that connect to Unified CM subscribers via a SIP trunk.

However, it is not necessary to sign all of the certificates with an enterprise CA. Some certificates are used only for internal operations and are provided to the entity that needs them without any user intervention. For example, the Trust Verification Service (TVS) certificate is included in the Initial Trust List (ITL) file, and that ITL file is automatically downloaded by the endpoints when they boot, restart, or reset. Similarly, the ITLRecovery certificate is included in the Certificate Trust List (CTL) and Initial Trust List (ITL). Thus there are no benefits to signing those certificates with an external CA. There are also no real benefits to signing the CAPF certificate by an external CA. It does not provide support for Certificate Authority Proxy Function (CAPF) certificate or endpoint Locally Significant Certificate (LSC) revocation. Also, when configuring phone VPN or 802.1x, importing the root CA certificate into the ASA trust store is not sufficient. The CAPF certificate would still have to be imported because the endpoints do not send the certificate chain (and therefore do not send the CAPF certificate) during a TLS handshake.

[Table 7-5](#) list the certificates that Cisco recommends to be signed by a CA.



**Table 7-5** Certificates to be Signed by a CA

Product	Certificate	Notes
Cisco Unified CM and IM and Presence Service	tomcat	Used for various applications, including administrators and users accessing the web interface and Jabber accessing UDS and logging in. The tomcat certificate is required to be CA-signed when configuring SIP OAuth with the 7800/8800 Series phones.
Cisco Unified CM	CallManager	Used for various applications, including SIP trunks.
Cisco Unified CM	ipsec	Only if IPsec is used. The IPsec certificates are required to be CA-signed in this case.
IM and Presence Service	xmpp	
IM and Presence Service	xmpp-s2s	
Cisco Unity Connection	tomcat	Used for various applications, including administrators and users accessing the web interface and Jabber accessing visual voice mail.
Cisco Expressway-C	Server	
Cisco Expressway-E	Server	Use a public CA.
Survivable Remote Site Telephony (SRST) and Cisco IOS Gateway	SRST and Cisco IOS Gateway	
Cisco Unified Border Element	Cisco IOS	In general, use an enterprise CA. If the SIP service provider supports encryption, use a public CA.
Cisco Meeting Server	Server	Shared certificate for all Cisco Meeting Server services
Cisco Meeting Server	Database client	
Cisco Meeting Management	Server	
Cisco TelePresence Management Suite (TMS)	Server	
Cisco Prime Collaboration Deployment	tomcat	
Cisco Prime Collaboration Provisioning	Provisioning	

## Multi-Server Certificates

To further simplify certificate management, a multi-server certificate can be used. Instead of having a certificate for each node, a single certificate can be used across all the nodes in a cluster. A single corresponding private key is also used across all the nodes and is automatically propagated across the nodes. We recommend using multi-server certificates wherever available, as described in [Table 7-6](#). Starting with Unified CM release 14, self-signed certificates can also be multi-server certificates.

**Table 7-6 Multi-Server Certificate Support**

Product	Certificate	Notes
Unified CM and IM and Presence Service	tomcat	Single Tomcat certificate across all the Unified CM and IM and Presence nodes in a cluster. Generate the Certificate Signing Request (CSR) and upload the CA-issued certificate on the Unified CM publisher node.
Unified CM and IM and Presence Service	Tomcat-ECDSA	Tomcat-ECDSA certificate is not used in this guide*. Use a multi-server self-signed certificate.
Unified CM	CallManager	
Unified CM	CallManager-ECDSA	CallManager-ECDSA certificate is not used in this guide <sup>1</sup> . Use a multi-server self-signed certificate.
Unified CM	TVS	TVS certificates can remain self-signed, but use multi-server certificates to reduce the number of certificates.
IM and Presence Service	cup-xmpp	
IM and Presence Service	cup-xmpp-s2s	
IM and Presence Service	cup-xmpp-s2s-ECDSA	cup-xmpp-s2s ECDSA certificate is not used in this guide*. Use a multi-server self-signed certificate.
Unity Connection	tomcat	

1. In this guide, we are not using ECDSA with tomcat, CallManager, cup-xmpp-ECDSA, and cup-xmpp-s2s-ECDSA certificates. However, these ECDSA certificates are still present in the servers and have to be renewed before they expire in order to avoid certificate expiration alerts. In order to simplify the management of those certificates, generate self-signed multi-server certificates for these ECDSA certificates.

With Cisco Meeting Server, you can also issue a single certificate and single private key shared across all the nodes in the Cisco Meeting Server cluster (in addition to a separate certificate for the database client). However, the private key is not propagated automatically; it has to be imported manually to each Cisco Meeting Server node.



### Note

Wildcard certificates are not supported for the Cisco Collaboration products discussed in this chapter, except for Cisco Meeting Server. For Cisco Meeting Server, we recommend issuing a standard (non-wildcard) certificate and using that certificate for all Cisco Meeting Server services and nodes. (A second certificate for the database client would have to be generated.)

## Public versus Private CA

Besides the requirement to use a public CA for the Expressway-E certificates, you could use either a public or enterprise CA (private or internal CA) to sign the various certificates of the Cisco Collaboration products in this document. The benefits of using a public CA include the fact that some clients and servers by default already trust major public CAs, and it is not required to establish trust between those devices and the public CA (import CA certificate in the client trust store). With a public CA, your IT organization also does not have to install and maintain internal CA servers. But the major drawbacks are the cost to issue certificates and restrictions that some public CAs might have.

What we recommend and describe in this document is the use of an enterprise CA for the certificates that we recommend to be CA-signed, except for the Expressway-E certificates which must be signed by a public CA and except for the Cisco Unified Border Element certificate if the SIP service provider supports encryption.

## Cisco Unified CM and IM and Presence

This section describes certificate management for Cisco Unified CM and IM and Presence.

### Unified CM Mixed Mode

As discussed later in the section on [Media and Signaling Encryption](#), Unified CM mixed mode is enabled in this guide in order to allow media and signaling encryption on endpoints that do not support SIP OAuth, e.g. video endpoints. Unified CM SIP OAuth mode is also enabled to allow media and signaling encryption on the 7800 and 8800 Series phones and Jabber clients.

### CTL and ITL

The Certificate Trust List (CTL) and Initial Trust List (ITL) are files that include Unified CM certificates. Those files are downloaded by Cisco endpoints. These trust lists allow the endpoints to get the minimum set of Unified CM certificates to build the trust to Unified CM services. The ITL files are always present in a Unified CM cluster, whether the Unified CM cluster is in non-secure mode or mixed mode. The CTL file is present and relevant only when Unified CM is in mixed mode.

The CTL and ITL files are signed by using the System Administrator Security Token (SAST, see [Table 7-7](#)) and contain a list of records. Each record contains a certificate, a certificate role or function, and pre-extracted certificate fields for easy look-up by the endpoint. [Table 7-7](#) lists the certificate roles.

**Table 7-7** Certificate Roles in CTL and ITL Files

Certificate Role	Certificates	Description
TFTP	CallManager	To authenticate Unified CM TFTP server. For example, used to verify TFTP configuration file signatures. Records with this certificate role are included in the ITL file when Unified CM is not in mixed mode.
CCM+TFTP	CallManager	To authenticate CallManager Service with encrypted signaling; and to authenticate the Unified CM TFTP server when verifying TFTP configuration file signatures. Records with this certificate role are included in the ITL and CTL files when Unified CM is in mixed mode.

Table 7-7 Certificate Roles in CTL and ITL Files (continued)

Certificate Role	Certificates	Description
System Administrator Security Token (SAST)	With CTL: ITLRecovery and CallManager certificate on publisher  With ITL: ITLRecovery and CallManager certificates on TFTP servers	To authenticate the SAST, which is the entity that signs the CTL, ITL, or TFTP configuration files.  This type of record is included in the ITL and CTL files.  The ITL and CTL files are signed by using the ITL recovery key. The TFTP configuration files are signed by using the TFTP servers' CallManager private keys.
Certificate Authority Proxy Function (CAPF)	CAPF	To authenticate CAPF service during secure communications with CAPF. A record with this certificate role is included in the ITL and CTL files if the CAPF service is activated on the Unified CM publisher.
Trust Verification Service (TVS)	TVS	To authenticate TVS service when connecting to TVS. Present in the ITL file only.

The ITL is signed by using the ITLRecovery private key. Each Unified CM node running the TFTP service has its own ITL file that it provides to the endpoints.

The CTL file is signed by using the private key of a System Administrator Security Token (SAST). With CTL, the SAST is the ITLRecovery private key. There is only one CTL file shared across the entire Unified CM cluster.

When endpoints boot or reset, before downloading their configuration file, they download the Certificate Trust List (CTL) from their TFTP server if Unified CM is in mixed mode. Then they download their TFTP server's Initial Trust List (ITL), if ITL is supported by the endpoint. Jabber does not support ITL, but the rest of the endpoints in this Preferred Architecture do support it. If the endpoint is newly deployed and it is the first time the endpoint connects to Unified CM, it does not have an existing CTL or ITL file and therefore does not have a list of certificates it can use to validate the CTL or ITL signature. In that case, the endpoint simply accepts the CTL/ITL file in a one-time leap of faith and stores the certificates that are part of those files. Once the endpoint has a trusted list of certificates, it can use them to validate the signatures of subsequent CTL and ITL files.

If an endpoint supports ITL or if Unified CM is in mixed mode (in which case a CTL file is downloaded by the endpoints), the endpoint possesses the ITLRecovery certificate from the ITL/CTL file(s) and therefore requests a configuration file that is signed by using the CallManager private key on the Unified CM TFTP server. If not (for example, as is the case with Jabber and when Unified CM is not in mixed mode), it requests a non-signed configuration file. After downloading its configuration file, the endpoint then verifies that it has the correct firmware. If not, it downloads the relevant firmware and validates the signature of the firmware to ensure it was not tampered with. [Figure 7-3](#) summarizes the files downloaded by the endpoints when they start up. These are the high-level steps during the startup of the endpoints. For simplicity reasons, we are not including all of the steps during the endpoint startup.

**Figure 7-3** Files Downloaded by Endpoints During Startup

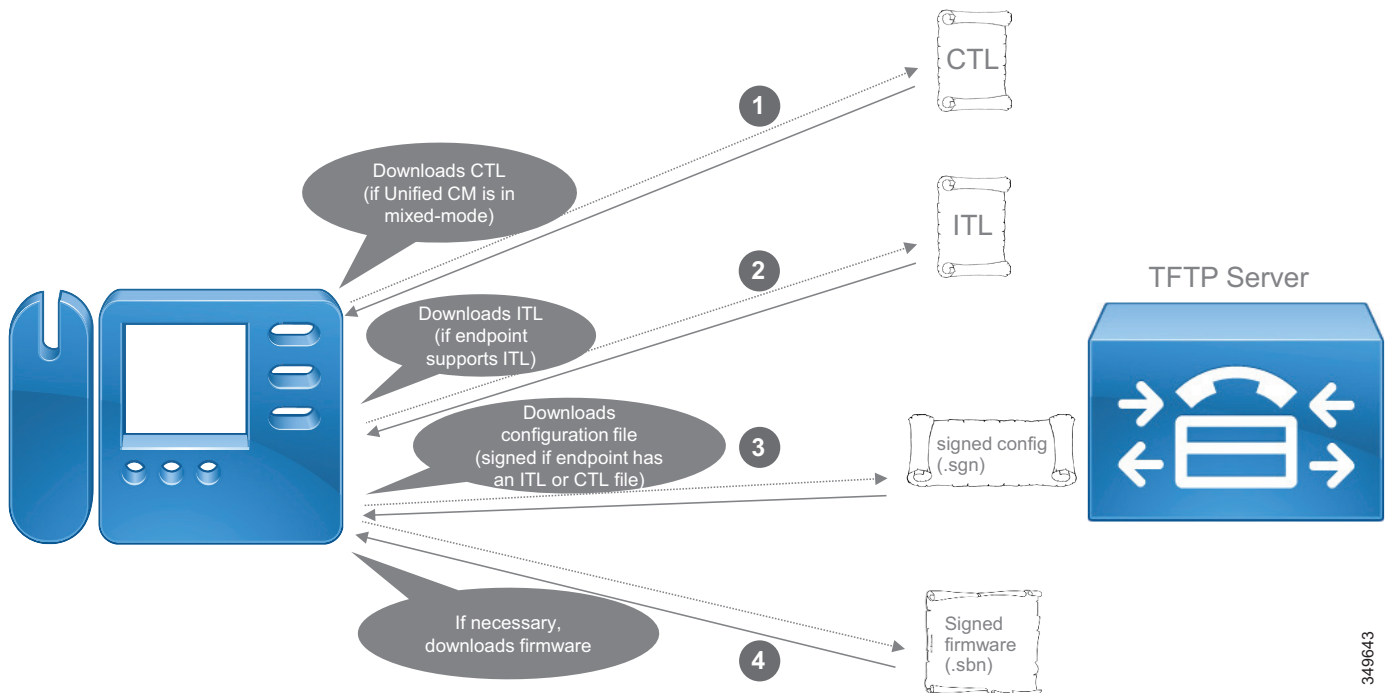

349643

## Endpoint Certificates

Endpoint certificates are mainly used in the following scenarios:

- Media and signaling encryption when using mixed mode with endpoint certificates. In this guide, this only applies to video endpoints. Media and signaling encryption for Jabber clients and the 7800/8800 Series phones are enabled through SIP OAuth which does not rely on endpoint certificates.
- 802.1x authentication.
- Phone VPN authentication with certificate.
- Encrypted TFTP configuration files. In this guide, this only applies to video endpoints. The 7800/8800 Series phones are configured with SIP OAuth and the TFTP configuration file confidentiality is obtained in a different fashion, without relying on endpoint certificates. Refer to the TFTP configuration file confidentiality section for more details.
- Access to the endpoint's web server via HTTPS.
- Wireless LAN authentication.
- Access to the endpoint's web server via HTTPS.

There are two types of certificates on Cisco endpoints:

- Manufacturing Installed Certificate (MIC)
- Locally Significant Certificate (LSC)

MICs are pre-installed on the endpoints during the manufacturing process and are signed by Cisco Manufacturing CA. They are valid for 10 years or more and there is no certificate revocation support. An MIC could be used for media and signaling encryption, but as explained later, we recommend generating an LSC instead. The Cisco IP Phone 7800 Series and 8800 Series and CE-based video endpoints (Webex Desk Pro, Webex Room Series and Cisco MX, SX, Webex DX) all have MICs. Jabber does not have a MIC.

LSCs are certificates that you install in your own deployment. They can be signed by the Certificate Authority Proxy Function (CAPF) service running on the Unified CM publisher node or they can be signed by an external CA. All Cisco endpoints considered in this Preferred Architecture document support LSCs. LSCs are valid for up to 5 years, and the validity of the LSC can be tracked easily from the Unified CM Administration page or by receiving email notification as the expiration date approaches. With all endpoints listed in this guide, LSCs are based on SHA2 and can be based on a key length of 2048 bits or even up to 4096 bits with Jabber and the Cisco IP Phone 7800 Series and 8800 Series endpoints. Once a LSC is installed, the MIC is not used any longer by the endpoint except for activation code onboarding.

The goal of an MIC is to prove that the phone is a genuine Cisco phone and has been signed by Cisco Manufacturing CA. One of the benefits of using an MIC is to prevent a non-legitimate client spoofing a legitimate MAC address that is configured on your Unified CM cluster. However, the MIC does not prove the endpoint is part of your own Unified CM cluster. One of the drawbacks of using an MIC is that the Cisco Manufacturing CA certificate would have to be trusted in the ISE servers or in some Unified CM trust stores, which means that any Cisco endpoint, even the ones that are not part of your organization, would get their MIC trusted. The general recommendation is to use the MIC, only during the first CAPF enrollment to generate the first LSC on the endpoint. Once the endpoint has an LSC, then the recommendation is always to use the LSC rather than the MIC for authentication when renewing the LSCs.

There are three ways to issue LSCs on the phones:

- The first method is to have the CAPF service in Cisco Unified CM sign the LSCs. This is the easiest method.
- The second method is to use an online external CA (Microsoft CA) that issues LSCs to phones through the CAPF service when initiating the CAPF enrollment. The main benefit of this method is that the LSCs are signed by your own CA.
- The third method is to use an offline external CA. This is similar to the second method. The LSCs are issued by an external CA, but in an off-line manner where the endpoint Certificate Signing Request (CSR) files have to be exported manually from Unified CM, signed by the external CA, and then imported back into Unified CM. The benefit of this method compared to the online external CA is that it is not limited to Microsoft CA. However, it requires manual steps. This approach does not scale for large organizations and therefore is not covered in the current Preferred Architecture document.

**Note**

---

With endpoints using a wireless LAN connection, the LSC issued by CAPF cannot be extended to 802.1X or EAP. Instead, use the MIC or a user installed certificate (installed via SCEP or manually installed through the phone web interface).

---

## Survivable Remote Site Telephony (SRST)

Secure SRST is supported. When the Unified CM servers become unreachable, endpoints register to the local SRST router, and endpoints configured in encrypted mode in Unified CM still have their media and signaling encrypted when registering to the SRST router.

At a high level, this is how secure SRST is provisioned:

1. First, generate a certificate for the SRST router. As with most certificates, using a CA-signed certificate simplifies certificate management.
2. When Unified CM is configured with the **Is SRST Secure** setting enabled (check-box selected), Unified CM requests the SRST certificate from the credential server running on the SRST router and inserts the SRST certificate in the configuration file of the endpoints that are configured with SRST.
3. Manually import into the SRST router the trust certificates corresponding to the entity that signed the endpoint LSCs. If you used CAPF to issue the LSCs, this is the CAPF certificate. If you use an external CA to issue the LSCs, this the CA certificate (or trust chain certificates).
4. When the WAN goes down and/or the Unified CM servers become unreachable, the endpoints communicate securely with SRST for endpoints using encryption based on mixed mode. The endpoints authenticate SRST with the SRST certificate in their TFTP configuration file, and SRST authenticates the endpoints with the certificate corresponding to the entity that issued the LSCs (CAPF or external CA certificate) that you imported in the previous step.

## Cisco Unity Connection

This document covers Cisco Unity Connection media and signaling encryption using Next Generation Encryption (NGE). With this configuration, Unity Connection Tomcat certificates are used instead of the Unity Connection Root and SIP certificates. A SIP trunk is configured between Unified CM and Unity Connection. This SIP trunk is secure, and Unified CM and Unity Connection are mutually authenticated. Unified CM is authenticated with its CallManager certificate (or Tomcat certificate if Unified CM was configured to reuse the Tomcat certificate for the CallManager certificate) while Unity Connection is authenticated with its Tomcat certificate. As mentioned earlier, the recommendation is to sign those certificates with an enterprise CA so that no certificate exchange between Unified CM and Unity Connection is required. The root CA certificate just needs to be imported to the Unified CM CallManager trust store and to the Unity Connection Tomcat trust store. Note that Unity Connection also automatically downloads the Unified CM CallManager certificates from the Unified CM TFTP servers to its Tomcat trust store.

## Cisco Expressway

New installations of Cisco Expressway software ship with a temporary trusted CA and a server certificate issued by that temporary CA. We recommend replacing the server certificate with a CA-signed certificate and installing root CA certificates or certificate chains for the authorities that you trust.

Expressway-C certificates can be signed by either an enterprise CA or a public CA, and as mentioned earlier, this document assumes an enterprise CA is used. As for Expressway-E, the requirement is to sign the server certificate with a public CA. There are two reasons for this requirement:

- Hardware endpoints capable of mobile and remote access (MRA) have a list of over 100 public root CA certificates that they trust and that are included in the endpoint firmware. There is no mechanism for adding additional root CA certificates, and thus the Expressway-E certificate must be signed by one of those public CAs. The list of supported public CAs is available on <https://www.cisco.com> in

the endpoint documentation; for example, <https://www.cisco.com/c/en/us/support/collaboration-endpoints/unified-ip-phone-8800-series/products-technical-reference-list.html>.

- Cisco Expressway-E is an Internet-facing component that communicates with endpoints, other organizations, and even the Cisco Collaboration Cloud. For this reason the public key infrastructure (PKI) underlying public CA trust is required to provide maximum security and trust with minimal effort.

CAPF enrollment is not supported while endpoints are connected to the enterprise over mobile and remote access (MRA). That means LSCs cannot be installed nor updated when endpoints are connecting over MRA. But this should not matter in general since MRA endpoints connecting via MRA do not use their endpoint certificate whether they are configured with encryption or not.

**Note**

If a video endpoint is configured with encryption using mixed mode (with a phone security profile configured with the **Device Security Mode** set to **Encrypted**) and does not have an LSC, it is still able to connect successfully over MRA. However, if or when the encrypted video endpoint connects directly to the enterprise (on-premises), it must have an LSC, otherwise it will not register. This does not apply to Jabber and the 7800/8800 series phones configured in encrypted mode because they would be configured with SIP OAuth in this guide and endpoint certificates are not used with SIP OAuth.

The [Collaboration Edge](#) chapter also has some security considerations for Cisco Expressway. Refer that chapter for more details.

## Cisco Meeting Server

By default, Cisco Meeting Server does not have any certificates. Cisco Meeting Server supports multiple options for the certificates, but the recommendation in this document is to issue a CA-signed certificate for the database client and another CA-signed certificate for the rest of the services, and then copy those certificates and corresponding private keys across the nodes in the Cisco Meeting Server cluster.

## Cisco Meeting Management

Cisco Meeting Management uses a certificate to identify itself to browsers and to call bridges. During setup, Meeting Management generates a self-signed certificate. It should be replaced by a CA-signed certificate.

## Cisco Prime Collaboration Deployment

Cisco Prime Collaboration Deployment uses the same platform as Unified CM, but it does not have a graphical user interface for certificate management. For HTTPS, ECDSA is disabled, so it is necessary to sign only the Tomcat certificate with a CA. Use the platform's command line interface (CLI) to generate a Certificate Signing Request (CSR) and upload a CA-signed Tomcat certificate.

Cisco Prime Collaboration Deployment uses SOAP services, based on HTTPS, to connect to the Cisco Collaboration products to export and/or import data during Cisco Prime Collaboration Deployment tasks.



## Encryption

With more services extending beyond the internal network, and with internal networks potentially subject to internal attacks, encryption and authentication are becoming increasingly critical.

Encryption protects against attacks such as eavesdropping, tampering, and session replay. If an unauthorized user was able to capture the traffic, he/she would not be able to decrypt the contents of the communication or modify it without knowing the encryption keys. Encryption also provides authentication through digital certificates when the encrypted communication is set up.

In general, we recommend enabling encryption on the various server connections, as discussed in the [TLS Overview](#) section. For Jabber we recommend enabling encrypted media and signaling, which is simple to provision and manage since Jabber can use the OAuth token to perform encrypted media and signaling and does not need an LSC. For phones and video endpoints, we recommend enabling encrypted media and signaling if possible, but it would require more configuration because mixed-mode would have to be enabled and LSCs would have to be installed (the recommendation is to use LSCs instead of MICs).

The authentication can be one-way or two-way; for example, it is one-way between an administrator or end user using a web browser to access web services, where the client (browser) authenticates the web server but where the server does not authenticate the client (browser). Alternatively, the authentication can be two-way with Mutual TLS (MTLS), where the server also authenticates the client. MTLS is used, for example, with the signaling between endpoints and the Unified CM server they are registered to or with Unified CM SIP trunks.

## TLS Overview

Transport Layer Security (TLS) is a method for encrypting TCP traffic and is commonly used for web services traffic as well as SIP signaling. The following steps present an overview on how a TLS session is established:

1. A TLS connection is initiated by a TLS client, which connects to a TLS server. The client establishes a TCP connection with the server, sending first a Client Hello that contains a random number and its capabilities. These capabilities include the list of cipher suites the client supports.
2. The TLS server selects one of the cipher suites, typically taking into account the cipher suite preference of the client, and replies with a Server Hello. This message also includes another random number and the server certificate so that the client can authenticate it.

[Figure 7-4](#) illustrates these two steps for establishing a TLS session. For simplicity, it does not include all the messages and possible variations in the TLS handshake. The server certificate could be sent in the Server Hello message or could be sent separately.

**Figure 7-4** TLS Handshake

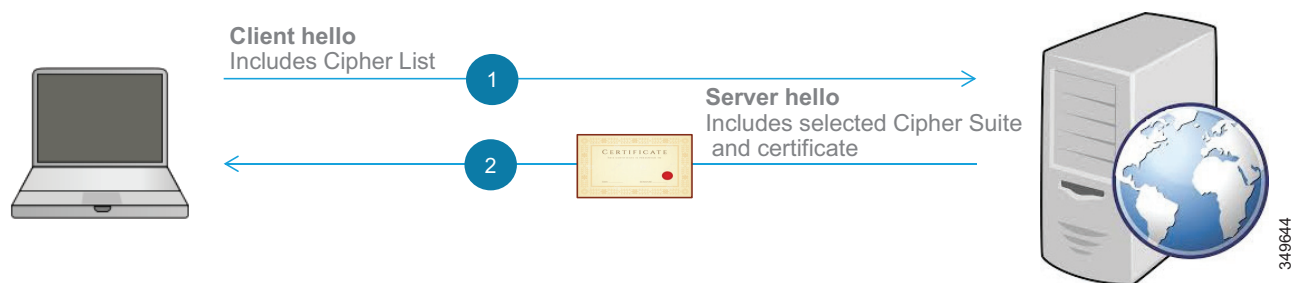

The authentication can be one-way authentication; for example, when an administrator or end user uses a web browser to access web services, where the TLS client (browser) authenticates the web server (TLS Server) but where the server does not authenticate the client (browser). Alternatively, the authentication can be two-way with Mutual TLS (MTLS), where the server also authenticates the client. MTLS is used, for example, with the signaling between endpoints and the Unified CM server they are registered to or with Unified CM SIP trunks. With Mutual TLS (MTLS), the server also authenticates the client. The server sends a client Certificate\_Request to the client, which in turn sends back its certificate. Figure 7-5 illustrates this flow at a high level.

Figure 7-5 MTLS Handshake

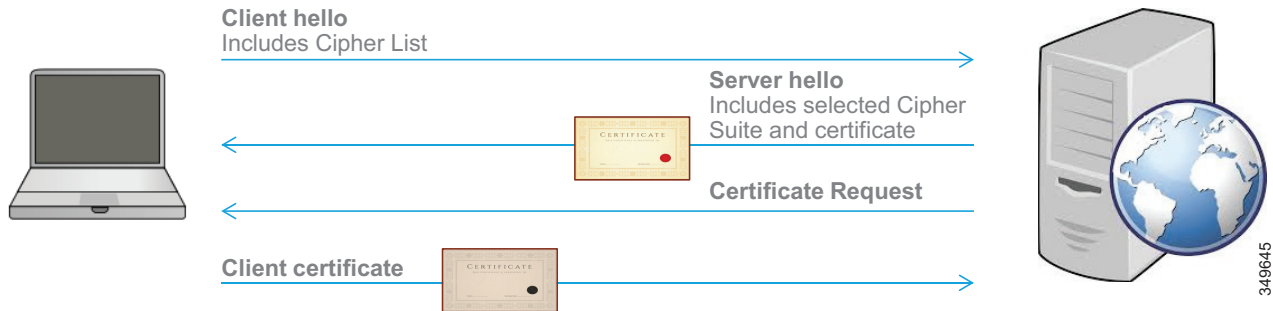

With RSA, the client encrypts the pre-master secret with the server's public key and sends it to the server. With Diffie-Hellman (DH) key agreement algorithms, the pre-master secret is not sent over the network; instead, the client and server exchange data (computed from random numbers and signed by the private key for authentication purposes) so that the client and the server can derive the pre-master secret on their own. DH combined with changing random numbers (Diffie-Hellman Ephemeral) allows for Perfect Forward Secrecy (PFS).

Then, the master secret is derived and session keys are computed from the master secret. From this point, the client and server stop using the public-private key pair (asymmetric encryption) and start using the shared session keys for encryption (symmetric encryption).

In general, Cisco Collaboration products support TLS version 1.2. However, some products might not support it yet and some older products will not support it at all. In order to maximize interoperability, we recommend using the default configuration and not explicitly disabling TLS 1.0 or TLS 1.1 unless you have specific requirements for doing so. With the default configuration, when both client and server interfaces support TLS 1.2 as is typically the case, TLS 1.2 is negotiated. For more information on TLS 1.2 support with Cisco Collaboration products and the ability to disable lower versions of TLS, refer to the latest version of the *TLS Compatibility Matrix for Cisco Collaboration Products*, available at

[https://www.cisco.com/c/en/us/td/docs/voice\\_ip\\_comm/uc\\_system/unified/communications/system/Compatibility/TLS/TLS1-2-Compatibility-Matrix.html](https://www.cisco.com/c/en/us/td/docs/voice_ip_comm/uc_system/unified/communications/system/Compatibility/TLS/TLS1-2-Compatibility-Matrix.html)

## Cisco Unified CM with IM and Presence and Endpoints

There are three main types of connections to encrypt:

- HTTPS and administrative or user interfaces

Most of those interfaces use encryption by default. For example, the Unified CM administrative web interface and the Unified CM end-user portal use HTTPS. If passwords or other sensitive information is sent in a connection, encrypt that connection; for example, for Unified CM integrated with LDAP, use LDAP over SSL. Or on the endpoints, for example, configure HTTPS for web services such as Extension Mobility.

- Signaling

TLS is mainly used to encrypt call control signaling; for example, with SIP signaling between endpoints and Unified CM servers or in SIP trunks. TLS is also used for other TCP communications such as XMPP.

- Media

The media traffic can be encrypted using Secure RTP (SRTP). The signaling must also be encrypted because the media encryption keys are exchanged between the endpoints through the signaling to Unified CM (using SDES).

Figure 7-6 shows a high-level view of the encrypted signaling and media on the endpoints. TLS is first set up for the SIP signaling between the endpoints and Unified CM (endpoint registration), as shown by step 1 in the figure. When an endpoint is placing a call, media encryption keys are generated and are sent through the SIP TLS channel, and the media is encrypted with SRTP, as shown by step 2 in the figure. As shown in Figure 7-6, with phones and video endpoints, the TLS handshake authentication for signaling is based on certificates on Unified CM and on the endpoints. During the call, the endpoints will also show a lock icon to indicate that the media is encrypted.

**Figure 7-6** Signaling and Media Encryption with Unified CM Registered Endpoints

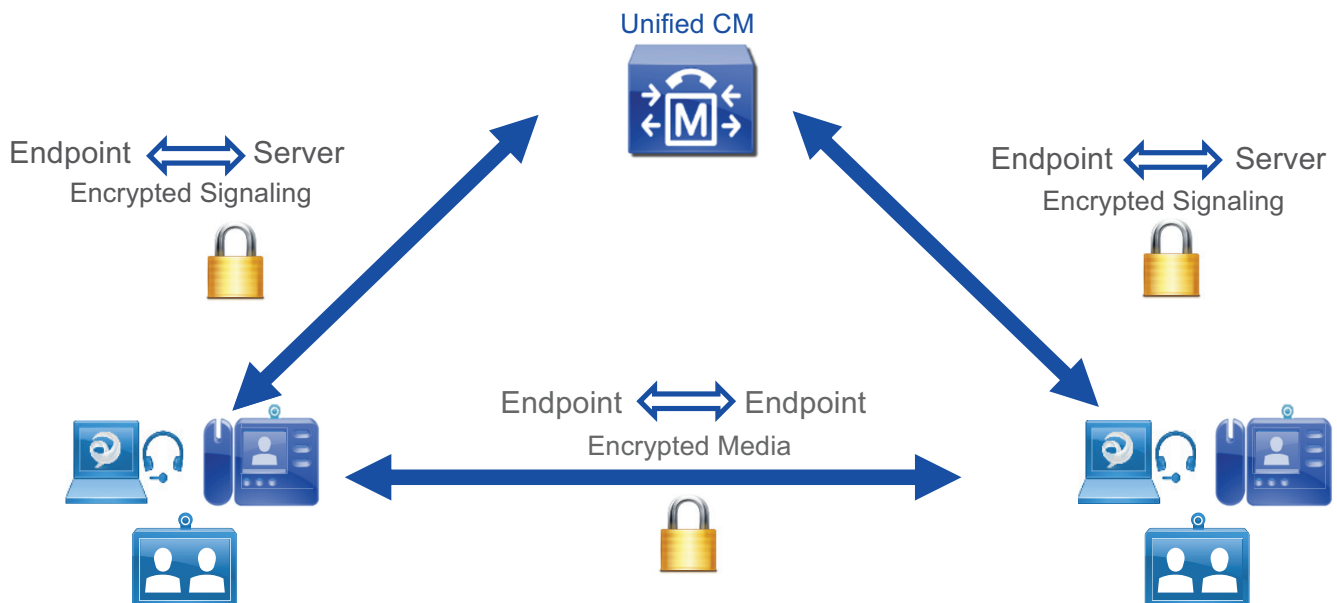

313452

Some endpoints can be configured with signaling and media encryption and some can be configured without it in the same deployment. If an endpoint configured with signaling and media encryption places a call to an endpoint configured without signaling and media encryption, the call will be successful, the signaling between the encrypted endpoint and Unified CM will be encrypted, the signaling between the unencrypted endpoint and Unified CM will be unencrypted, and the media between the two endpoints will be unencrypted, as shown in **Figure 7-7**. During the call, the endpoints will not show the lock icon since the media is not encrypted.

**Figure 7-7** Interoperability between encrypted and unencrypted endpoints

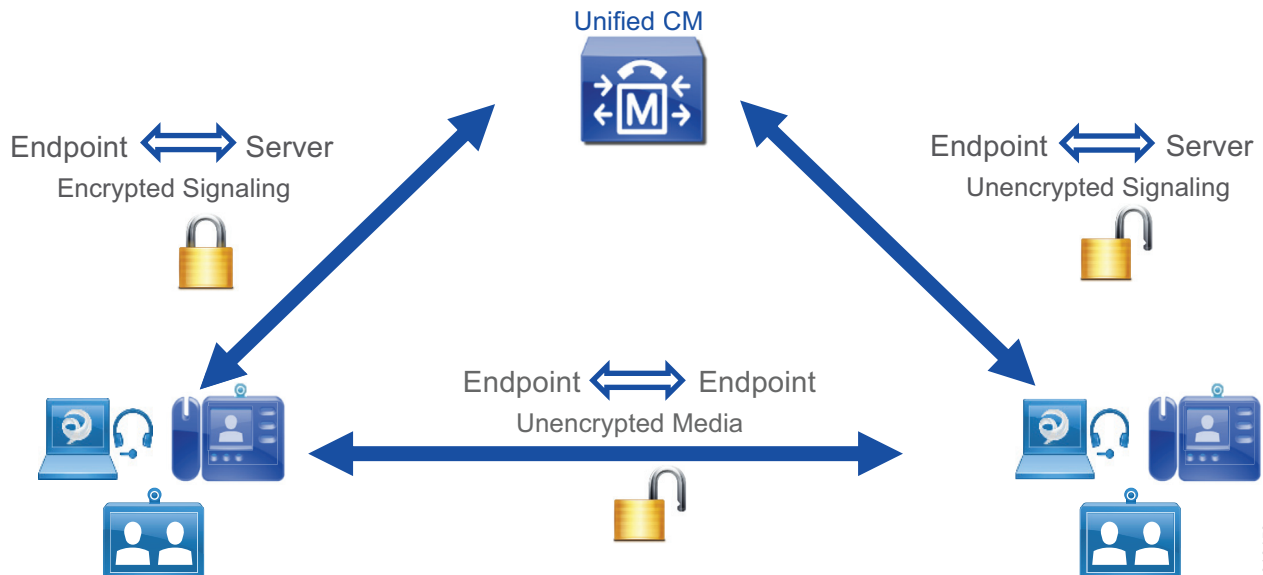

**Note**

To encrypt the communications between the nodes within a Unified CM cluster with IM and Presence (for example, Intra-Cluster Communication Signaling (ICCS)), IPsec must be deployed. However, because configuring and operating IPsec adds considerable complexity and affects the scalability of the system, and because Unified CM and IM and Presence nodes are typically located in protected and trusted data centers, deploying IPsec typically is not necessary for most deployments and is not covered in this document.

## Cipher Suite Support

A cipher suite is a combination of cryptographic algorithms used to establish a TLS session. The list of supported cipher suites to encrypt communication links depends on the Cisco Collaboration products. The standard cipher suites are supported across the Cisco Collaboration solution. Some products such as Cisco Unified CM, IM and Presence, Unity Connection, and most endpoints listed in this document (for example, Cisco Jabber, Cisco IP Phone 7800 Series and 8800 Series, and Cisco Webex DX Series) support newer and stronger cipher suites that we refer to as Next Generation Encryption (NGE). These stronger cipher suites are based on newer algorithms and/or have longer cryptographic keys, and they are more difficult to compromise. In general, the strongest cipher suite that is supported by both client and server is negotiated. If a client supports only weaker cipher suites, then a weaker cipher might be negotiated. If you want to avoid negotiating down to cipher suites that are too weak, it is in general possible to restrict the cipher suites that can be negotiated. For example, on Unified CM there is a setting to limit TLS cipher suite negotiation to the strongest cipher suite (only AES 256 with SHA 384), another

setting to allow strong and medium-strength cipher suites (adds AES 128 with SHA 256), and a setting to allow all supported cipher suites. For more granularity, it is possible to configure the list of cipher suites that can be allowed. For the digital signature algorithm used to set up a TLS connection, RSA is supported across the Cisco Collaboration solution. The other digital signature algorithm that can be used is Elliptic Curve Digital Signature Algorithm (ECDSA), which provides the same level of security as RSA but with smaller keys. However, it is not supported across all Unified CM services, across all Cisco Collaboration products, or on the endpoints, and it requires the server and sometimes the client to have an ECDSA-based certificate. Refer to the [Certificate Management](#) section for more details on RSA and ECDSA.

**Note**

Encryption cipher suites based on ECDHE do not require certificates based on ECDSA; they can be negotiated with certificates based on RSA.

The following list discusses cipher suites for the various type of connections and provides our recommendation:

- HTTPS connection

For Unified CM with IM and Presence, there is one Enterprise Parameter setting for the HTTPS cipher suites. This parameter determines whether RSA-only cipher suites are allowed or all cipher suites (RSA and ECDSA) are allowed. We recommend using the default value, which is to allow RSA-only cipher suites (refer to the [RSA and ECDSA](#) section for more details).

The typical cipher suites that are negotiated are

TLS\_ECDHE\_RSA\_WITH\_AES\_256\_GCM\_SHA384 or

TLS\_ECDHE\_RSA\_WITH\_AES\_128\_GCM\_SHA256. For those cipher suites, ECDHE (Elliptical Curve Diffie Hellman Ephemeral) and RSA represent the ciphers used for the digital signature algorithm and key agreement. AES (Advanced Encryption Standard), GCM (Galois Counter Mode) and SHA (Secure Hash Algorithm) represent the ciphers used for the actual encryption and authentication of the encrypted packets.

- SIP TLS (signaling)

With Unified CM, by default, cipher suites based on RSA are preferred over the ones based on ECDSA. This is the recommended configuration because ECDSA is not supported by all endpoints and is not supported across all Cisco Collaboration servers.

By default, all supported cipher suites are enabled. As described earlier, stronger cipher suites will be negotiated first, and typically TLS\_ECDHE\_RSA with AES256\_GCM\_SHA384 is negotiated. However, there could be some cases where both parties do not support this cipher suite and a lower strength cipher would need to be negotiated. To maximize cipher suite compatibility across the various components in the solution, we recommend using the default setting (allow all cipher suites, with RSA preferred).

- SRTP (media)

With Unified CM, by default all ciphers are enabled. As described earlier, stronger cipher suites will be attempted first, and typically the strongest one, AEAD AES-256 GCM (Authenticated Encryption with Associated Data, Advanced Encryption Standard, 256 key size, Galois Counter Mode), is negotiated. However, Cisco IOS Gateways, some endpoints, and some servers might not support this cipher suite. For this reason, we recommend using the default setting and allowing fallback to weaker cipher suites. To verify which cipher suites are supported for any Cisco endpoint, go to Cisco Unified Reporting page of Unified CM (**System Reports > Unified CM Phone Feature List**).

## Media and Signaling Encryption

In order to enable encryption for media and signaling, two options are available.

- Unified CM Mixed mode. This is the traditional method. The endpoints authenticate to Unified CM through mutual TLS using their endpoint certificate.
- SIP OAuth (or encrypted mode based on OAuth token). This is the new method supported with Jabber since the collaboration system release 12.5 and supported with the 7800/8800 Series phones starting with the collaboration system release 14. The endpoints use their OAuth token in order to authenticate to Unified CM.

In general, SIP OAuth is recommended over Unified CM mixed mode because it is easier to configure and maintain. Indeed, with Unified CM mixed mode, endpoints certificates are required. Jabber client doesn't have a MIC so an LSC would need to be installed on each Jabber client. The 7800/8800 Series phones have a MIC by default, but we recommend using Locally Significant Certificates (LSC) over Manufacturer Installed Certificates (MIC), so an LSC would also need to be installed on each 7800/8800 Series phone. Since SIP OAuth is supported with Jabber and the 7800/8800 Series phones, we recommend using SIP OAuth to enable media and signaling encryption on those endpoints. SIP OAuth is not supported with the video endpoints, therefore Unified mixed mode would need to be configured and an LSC would need to be installed on each video endpoint in order to enable media and signaling encryption with those endpoints. The administrator also has to monitor the validity of the LSCs and renew them before they expire. This is summarized in [Table 7-8](#).

**Table 7-8**      **Method to enable media and signaling encryption**

Endpoint Type	Method to enable media and signaling encryption	
	Unified CM mixed mode with endpoint certificates	SIP OAuth
Jabber clients	Supported, but use SIP OAuth instead	Recommended method in this guide
7800 / 8800 <sup>1</sup> series phones	Supported, but use SIP OAuth instead	Recommended method in this guide
Video endpoints and phones that do not support SIP OAuth	Only option available. LSCs must be installed on the video endpoints.	Not supported

1. Cisco IP Phones 8821 does not support SIP OAuth. See the Cisco phone data sheet for the latest information. Use encryption based on mixed mode for the phones that do not support SIP OAuth.

With both methods, Unified CM mixed mode and SIP OAuth, the Export-Controlled functionality has to be allowed in Smart Licensing, and the Restricted version of Unified CM software is required. (Media and signaling encryption is not available with the Unrestricted version of Unified CM.)

Those two different methods can be used in the same deployment, for example if video endpoints, 7800/8800 Series phones, and Jabber clients are all present in the same deployment. It does not matter which encryption method is used, for example, endpoints configured with one encryption method can place calls to endpoints configured with the other encryption method or with the same encryption method, the calls will be encrypted. Figure 7-8 shows an example where calls between video endpoints configured with encryption using mixed mode and Jabber clients or 7800/8800 Series phones configured with encryption using SIP OAuth are still encrypted.

**Figure 7-8 Interoperability between endpoints configured with encryption based on mixed mode and based on SIP OAuth**

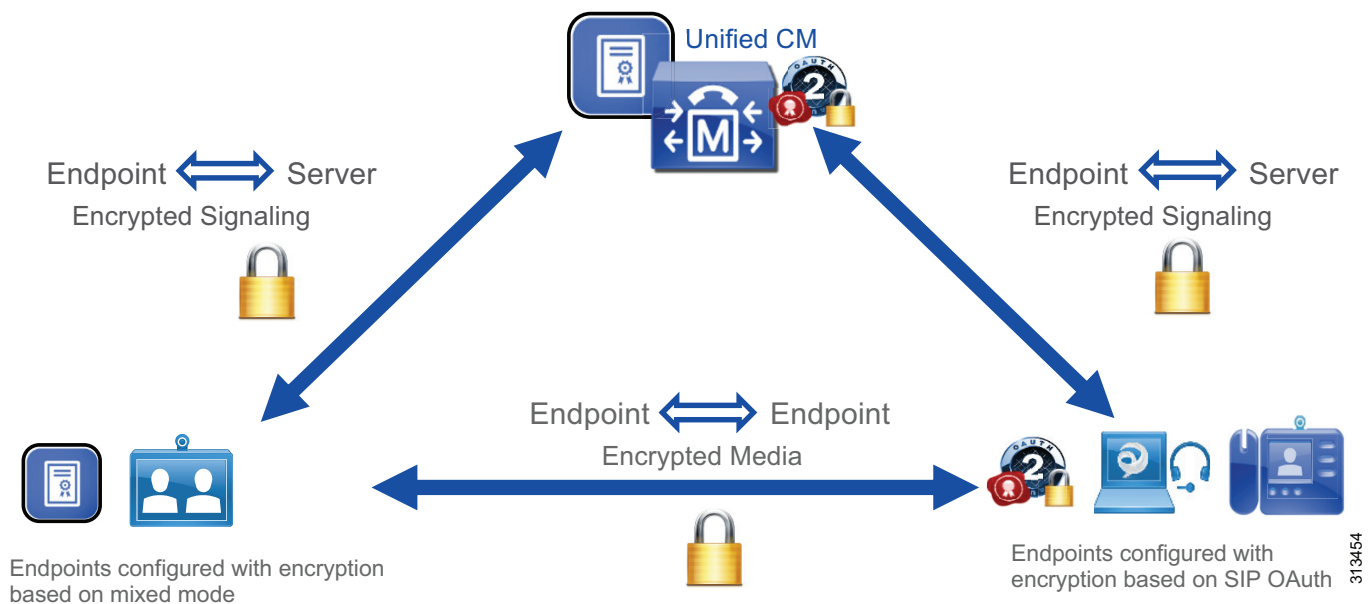

In order to deploy SIP OAuth for on-premises 7800/8800 Series phones, you can simply configure SIP OAuth for phones that are already registered to Unified CM and they will automatically securely get an OAuth token (zero touch onboarding.) Alternatively, you could use activation code onboarding for new phones and they will get an OAuth token during onboarding.

In order to deploy SIP OAuth for 7800/8800 Series phones connecting via MRA, you can either use activation code onboarding over MRA. Or you can first onboard your phones while they are inside the corporate network and then change the MRA mode (by configuring “Allow activation code via MRA” on the Unified CM phone page). At this point, the phones can simply be taken outside of the corporate network, connect automatically via MRA using SIP OAuth without end-users having to enter username/password on their phones or perform activation code onboarding over MRA.

## TFTP Configuration File Confidentiality

Without TFTP configuration file confidentiality, TFTP configuration files are available in plain text from any of the Unified CM TFTP servers through an unencrypted connection to anyone who has access network connectivity to the TFTP servers. The type of information available in a TFTP configuration file includes, for example, phone firmware information and information on the Unified CM cluster. More importantly, if usernames and passwords are provisioned in the Unified CM administration phone page, they could also be saved in plain text in the TFTP configuration files. Therefore, the general recommendation is to protect the TFTP configuration file confidentiality especially if usernames, passwords, or sensitive information are configured in the Unified CM administration phone page.

TFTP configuration file confidentiality is obtained by one of the following two methods.

- Encrypting the TFTP configuration file itself and use a non-encrypted network connection (HTTP) to the TFTP server.
- Using a mutually authenticated encrypted network connection (HTTPS) between the endpoint and the Unified CM TFTP server without encrypting the TFTP configuration files itself.

The support of those 2 methods depends on the endpoint type and whether the endpoint is configured with SIP OAuth. This is described in [Table 7-9](#).

**Table 7-9** *Methods to perform TFTP configuration file confidentiality*

Endpoint Type	TFTP configuration file confidentiality method	
	File encryption of the TFTP configuration file (with MIC/LSC endpoint certificates)	Mutually authenticated and encrypted connection between endpoints and TFTP servers
Jabber clients	Can be used if Jabber is not configured in encrypted mode based on SIP OAuth (so Jabber clients could be configured in non-encrypted mode or in encrypted mode based on mixed mode). This would require installing an LSC on Jabber.	Not available with Jabber clients.
7800/8800 Series phones (support SIP OAuth)	Can be used if the phones are not configured in encrypted mode based on SIP OAuth.	Automatically performed if media/signaling encryption is configured through SIP OAuth.

When endpoints are connecting via MRA, CAPF operations such as installing an LSC or updating an LSC are not supported. For this reason, it is simpler not to enable TFTP configuration file encryption for endpoints connecting through MRA. In this case, ensure that sensitive information (passwords for example) is not configured for those endpoints. In the case of the 7800/8800 phones configured with SIP OAuth and connecting via MRA, TFTP configuration file confidentiality will be performed automatically.

## Secure SRST

Survivable Remote Site Telephony (SRST) routers based on the Cisco 4000 Series Integrated Services Routers can also be configured with secure SRST. When endpoints cannot establish communications with the Unified CM call processing servers, they fail-over to SRST, and media and signaling are still encrypted with secure SRST. The endpoints and the SRST routers are able to establish a secure and authenticated session because the endpoints have the SRST certificate in their TFTP configuration file and the SRST routers have the certificate of the CA that signed the LSC in their trust store (CAPF certificate or external CA certificate, manually imported by the administrator).

## Cisco Meeting Server

Internal communications between Cisco Meeting Server nodes use encryption (TLS). For external communications between Cisco Meeting Server and other servers or devices, encryption could be forced or optional, depending on the type of communications. For example, the RESTful API communication between Unified CM and Cisco Meeting Server is always encrypted. But the SIP signaling and media between Cisco Meeting Server and Unified CM or endpoints can be configured with or without encryption (encryption is recommended). In a conference, if all participating endpoints are encrypted (encrypted media and signaling), a lock icon is displayed on all endpoints that support the conference lock. If one of the participating endpoints is not secure, an unlocked icon is displayed on all endpoints that support the conference lock.



## Cisco Unity Connection

This document covers Cisco Unity Connection media and signaling encryption using Next Generation Encryption (NGE). With encryption, the signaling to/from Unity Connection and the media between the endpoints and the Unity Connection voicemail ports are encrypted. By default, the TLS\_ECDHE\_RSA\_WITH\_AES\_256\_GCM\_SHA384 cipher suite is negotiated for the signaling between Unified CM and Unity Connection.

## Cisco Expressway

This section discusses mobile and remote access (MRA) and business-to-business communications with Cisco Expressway.

### Mobile and Remote Access (MRA)

The media and signaling between an MRA endpoint and Expressway-C are always encrypted. If an MRA endpoint calls an endpoint inside the corporate network, then the call leg inside the corporate network (that is, the signaling between Expressway-C and Unified CM, and the media between Expressway-C and the internal endpoint) may be encrypted depending on the configuration. If the MRA endpoint is configured with a phone security profile in non-encrypted mode, then this internal call leg is not encrypted. If Unified CM is in mixed mode and if the MRA endpoint is configured with a phone security profile in encrypted mode, then the SIP signaling between Expressway-C and Unified CM is encrypted. In addition to that, if the internal endpoint is also configured in encrypted mode, then the media between Expressway-C and the internal endpoint is encrypted (SRTP), and therefore the media and signaling are encrypted end-to-end (or more precisely, all the call legs are encrypted). See [Figure 7-9](#).

**Figure 7-9** Media and Signaling Encryption for MRA Endpoints

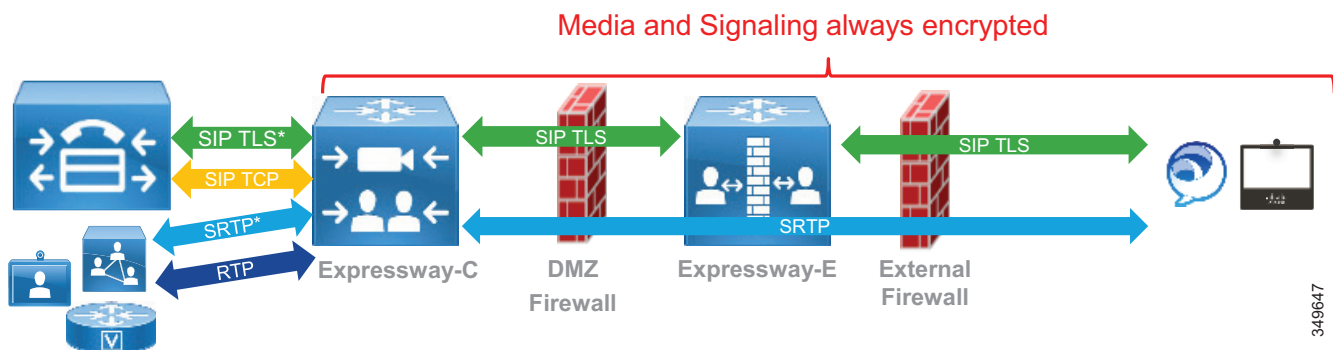

The certificates used for SIP TLS authentication with MRA differs somewhat from on-premises calls. When an endpoint connects to the enterprise through MRA, the endpoint verifies the Expressway-E server certificate but the server does not check the endpoint certificate. This TLS connection does not use mutual authentication. The MIC or LSC on the MRA client, whether it is present or not, is not verified. The user on the MRA client is then authenticated via the username and password against the Cisco Unified CM user database or integrated LDAP server (or IdP if Jabber is deployed with Single Sign-On). For the call leg between Expressway-C and Unified CM, if the MRA endpoint is configured with the encrypted mode, Expressway-C establishes a SIP TLS connection with Unified CM and sends its own certificate on behalf of the MRA endpoint. When Unified CM receives this certificate, it verifies that the phone security profile's name configured for that MRA endpoint is part of the SAN extension of the Expressway-C certificate.

## Business-to-Business Communications

With business-to-business communications, the connection between Expressway and the other party does not have to be encrypted. This depends on the **Transport** parameter in the Expressway zone configuration. If **Transport** is set to **TLS**, certificate verification is not required. The administrator can disable certificate verification by setting the **TLS verify** parameter in the Expressway zone configuration to **Off**.

## Cisco IOS Gateway and Cisco Unified Border Element

Cisco IOS Gateways and Cisco Unified Border Element support TLS and SRTP. For SRTP, the cipher suite AES\_CM\_128\_HMAC\_SHA1\_32 is negotiated by default. The cipher suite AES\_CM\_128\_HMAC\_SHA1\_80 can also be configured. In order to support the NGE cipher suites, SRTP pass-through must be configured. The main downside with SRTP pass-through is that media interworking between RTP and SRTP (handling RTP in one call leg and SRTP in the other call leg) is not supported.

By default, if the Cisco IOS Gateway or Cisco Unified Border Element initiates a call and request SRTP but the called endpoint does not support SRTP, the call is dropped. To maximize interoperability, configure **srtp fallback** and **srtp negotiate**. When they are configured, the Cisco IOS Gateway or Cisco Unified Border Element does not drop the call but instead falls back from SRTP to RTP.

For more information on the SRTP commands, refer to the *Cisco IOS Voice Command Reference*, available at <https://www.cisco.com/c/en/us/td/docs/ios-xml/ios/voice/vcr4/vcr4-cr-book/vcr-s11.html>.

## Multi-Cluster Considerations

In a multi-cluster deployment, if clusters are located in the same data center, encryption between the clusters is not critical. However, if the clusters are located in different data centers and are connected over service provider links, we recommend enabling encryption on the following intercluster links:

- SIP trunks

Encrypt the SIP trunks between the clusters. With the CallManager certificates signed by a CA and the CA certificate (or root CA certificate) already in the CallManager-trust store, no additional operations related to certificates are required for intercluster SIP trunk encryption.
- Intercluster Lookup Service (ILS) connections

Encrypt Intercluster Lookup Service (ILS) connections. To enable ILS encryption, we recommend using TLS certificates (Tomcat certificates) for authentication and a shared password across the clusters for authorization. With the Tomcat certificates signed by a CA and the CA certificate (or root CA certificate) already in the Tomcat trust store, no additional operations related to certificates are required to enable ILS encryption.
- Location Bandwidth Manager (LBM) links

If call admission control (CAC) is configured, intercluster LBM links should also be encrypted. LBM encryption is also based on Tomcat certificates, and with the Tomcat certificate signed by a CA and the CA certificate already in the Tomcat trust store, there are no additional operations related to certificates required to enable LBM encryption.

## High Availability Considerations for Collaboration Security

There is high availability for the Unified CM Trust Verification Service (TVS). The TVS runs as a network service on all Unified CM nodes. Endpoints use the same TVS nodes as the Unified CM call processing nodes they are configured with in the Cisco Unified CM group. Their primary TVS server is their primary call processing subscriber, and their backup TVS server is their backup call processing subscriber.

The Unified CM publisher has a critical role with security components. The publisher runs the CAPF service to which the phones connect. Therefore, if the publisher is down, CAPF operations are not possible. For example, Locally Significant Certificate (LSC) installation is not possible. Generating a multi-server certificate and enabling/disabling mixed mode are also operations that are performed on the publisher and require it to be running.

## Collaboration Security Capacity Planning

Enabling encryption can slightly increase the CPU and memory utilization on the servers. However, except for Cisco Unified Border Element, the simplified sizing deployments described in the [Sizing](#) chapter are not affected by enabling encryption.

## Deployment

This section provides information on the deployment of certificate management and encryption. It starts with certificate management since that needs to be done first. Once all the certificates are in place, you can enable and configure encryption.

This section provides deployment information for the following components of the Enterprise Collaboration Preferred Architecture:

- [Cisco Unified CM with IM and Presence and Endpoints](#)
- [Cisco Unity Connection](#)
- [Collaboration Edge](#) (Cisco Expressway, Cisco IOS Gateways, and Cisco Unified Border Element)
- [Conferencing](#)
- [Collaboration Management Services](#)

## Cisco Unified CM with IM and Presence and Endpoints

For Cisco Unified CM with IM and Presence and for endpoints, at a high level, perform the following configurations:

- [Cipher Suites Configuration](#)
- [Server Certificate Generation and Management](#)
- [Certificate Monitoring](#)
- [LDAP over SSL Configuration](#)
- [SIP Trunk Encryption](#)

For media and signaling encryption on the endpoints, also perform the following configurations:

- Mixed mode configuration
- CAPF enrollment and configuration of media and signaling encryption on the endpoints
- Secure SRST configuration

## Cipher Suites Configuration

There are three main types of secure connections, and there is a cipher enterprise parameter for each of them:

- HTTPS

As discussed in the [Cipher Suite Support](#) section, we recommend using the default value for the **HTTPS Ciphers** enterprise parameter, **RSA Ciphers only**. If you want to enable ECDSA ciphers, change the setting to **All Supported EC and RSA Ciphers**.

- TLS (signaling)

As discussed in the [Cipher Suite Support](#) section, we recommend using the default value for the **TLS Ciphers** enterprise parameter, **All Ciphers RSA Preferred**. However, if you have specific requirements and, for example, need to disable the negotiation of weaker cipher suites or wish to negotiate ECDSA over RSA cipher suites, the **TLS Ciphers** enterprise parameter can be modified.

- SRTP (media)

As discussed in the [Cipher Suite Support](#) section, we recommend using the default value for the **SRTP Ciphers** enterprise parameter, **All Supported Ciphers**. However, if you have specific requirements and, for example, need to disable the negotiation of weaker cipher suites, the **SRTP Ciphers** enterprise parameter can be modified and can be set to **Strongest - AEAD AES-256 GCM cipher only** or to **Medium - AEAD AES-256 GCM, AEAD AES-128 GCM ciphers only**, but note that some endpoints and servers do not support these cipher suites. See the [Cipher Suite Support](#) section for more details.

## Server Certificate Generation and Management

As mentioned in the section on [CA-Signed Certificates Instead of Self-Signed Certificates](#), we recommend using CA-signed certificates for most certificates. We are also recommending using multi-server certificates whenever it is possible. For a list of certificates to be signed by a CA and certificates to be multi-server certificates, refer to [Table 7-5](#) and [Table 7-6](#). Certificates that do not need to be CA-signed and do not need to be multi-server certificates do not need to be modified or regenerated.

At a high level, the procedure to issue CA-signed certificates is as follows:

1. [Upload the root CA certificate](#) or certificate chain into the corresponding server trust store.
2. [Generate the certificate signing requests \(CSR\)](#) for the desired certificate.
3. [Download the CSRs](#).
4. [Submit the CSRs to the signing CA](#).
5. [Upload the new CA-signed certificate using the appropriate type](#).

With Unified CM, IM and Presence Service, and Unity Connection, these operations are performed from the OS Administration web interface of your system.

For more detailed steps, refer to the latest version of the *Security Guide for Cisco Unified Communications Manager*, available at <https://www.cisco.com/c/en/us/support/unified-communications/unified-communications-manager-call-manager/products-maintenance-guides-list.html>.

## 1. Upload the root CA certificate

The first step is to import the root CA certificate (or certificate chain if there are intermediate CAs). With Unified CM and IM and Presence Service, this operation needs to be done only on the publisher, and the certificate will then automatically be distributed to the trust stores of the other nodes in the cluster.

Go to the OS Administration page and select **Security > Certificate Management > Upload Certificate/Certificate chain**, and then upload the root CA certificate (or certificate chain) into the trust store of the service for which you are issuing a CA-signed certificate. Note that the RSA and ECDSA certificates share the same trust store. [Table 7-10](#) lists the trust stores where the CA certificate needs to be imported.

**Table 7-10** Trust Stores Where the CA Certificate is Imported for Unified CM with IM and Presence Service

Product	Node Where the CA Certificate Should be Uploaded
Unified CM	tomcat-trust
Unified CM	callManager-trust
IM and Presence Service	tomcat-trust
IM and Presence Service	cup-xmpp-trust

## 2. Generate the certificate signing requests (CSR)

To generate a certificate signing request (CSR), go to the OS Administration page and select **Security > Certificate Management > Generate CSR**.

Some certificates support the multi-server feature; see [Table 7-6](#) for the list. For those certificates, generate the CSR on the publisher and select **Multi-Server (SAN)** in the **Distribution** field of the CSR page. See [Table 7-11](#) for where to generate the CSR for multi-server certificates. For the other certificates, issue a CSR on each node and use the default value for the **Distribution** field.

**Table 7-11** CSRs for Multi-Server Certificates

Product	Certificate	Where to Generate the CSR
Unified CM and IM and Presence Service	tomcat	Unified CM publisher
Unified CM	callManager	Unified CM publisher
IM and Presence Service	xmpp	IM and Presence Service publisher
IM and Presence Service	xmpp-s2s	IM and Presence Service publisher

In general, you do not have to change the default value for the **Common Name** field. This field is by default set to the FQDN of the node where you are generating the CSR. With a multi-server certificate, a "-ms" is appended after the hostname portion of the FQDN.

In general, we recommend using a **Key Length** of 2048 bits or larger and a **Hash Algorithm** set to **SHA256**. Therefore, you can use the default value for those fields.

### 3. Download the CSRs

### 4. Submit the CSRs to the signing CA

The CA generates corresponding certificates.

Key usage and extended key usage extensions restrict the purposes for which a key may be used. Ensure that the X.509 key usage and X.509 extended key usage in the issued certificate match the request in the CSR. A common problem is that the enterprise CA issuing and signing the certificate is not configured with the appropriate certificate template and does not issue a certificate with the appropriate key usage extension. For example, the Unified CM Tomcat certificate must include the TLS Web Client Authentication extended key usage (EKU). Failure to use a template that includes the TLS Web Client EKU will result in TLS connection setup failures for inter-server communications – for example, Intercluster Lookup Service (ILS) and User Data Store (UDS) – due to the incorrect key usage.

Table 7-12 shows an example of the Key Usage Requirements. As a general rule, generate a CSR, note the Key Usage and Extended Key Usage specified in the CSR, ensure the enterprise CA has a certificate template that contains the correct Key Usage and Extended Key and, if not, create a new certificate template. After submitting the CSR to the CA and getting back the certificate, ensure that the Key Usage and Extended Key Usage are still there.

**Table 7-12 Key Usage and Extended Key Usage Requirements**

Product	Certificate	X509v3 Key Usage	X509v3 Extended Key Usage
Unified CM and IM and Presence Service	tomcat	Digital Signature, Key Encipherment, Data Encipherment	TLS Web Server Authentication, TLS Web Client Authentication
Unified CM	CallManager	Digital Signature, Key Encipherment, Data Encipherment	TLS Web Server Authentication, TLS Web Client Authentication
Unified CM	CAPF	Digital Signature, Certificate Sign	TLS Web Server Authentication
IM and Presence Service	cup-xmpp	Digital Signature, Key Encipherment, Data Encipherment	TLS Web Server Authentication, TLS Web Client Authentication
IM and Presence Service	cup-xmpp-s2s	Digital Signature, Key Encipherment, Data Encipherment	TLS Web Server Authentication, TLS Web Client Authentication

### 5. Upload the new CA-signed certificate using the appropriate type

Upload the certificate and select the corresponding value for the **Certificate Purpose** field. For example, if uploading the Tomcat certificate, select **tomcat** for the **Certificate Purpose** field.

For multi-server certificates, perform the upload operation on the publisher node and not on the subscriber nodes.

Once certificates are uploaded, services must be restarted. The GUI indicates which service to restart. For example, with the CallManager certificate, the Cisco Tftp, Cisco CallManager, and Cisco CTIManager services must be restarted.

The procedure to issue multi-server self-signed is simple. Go to the OS Administration page and select **Security > Certificate Management > Generate Self-signed** and select **Multi-Server (SAN)** in the **Distribution** field of the certificate page. And again, restart the relevant services indicated by the GUI.

If activation code onboarding is configured with the 7800/8800 Series phones, ensure that Unified CM has been configured in the “Cisco Cloud Onboarding” menu as specified in the Call Control chapter for example with the recommendation to select the checkbox “I want Cisco to manage the Cisco Cloud Service CA Certificates required for this trust”. Also configure the following items:

- In Cisco Unified CM Administration > Advanced Features > MRA Service Domain, create MRA Service Domain(s).
- In Cisco Unified CM Administration > Advanced Features > Cisco Cloud Onboarding, enable activation code onboarding by selecting the “Enable Activation Code Onboarding with Cisco Cloud” checkbox and enter the MRA activation domain to use.

If SIP OAuth and/or activation code onboarding is configured with the 7800/8800 Series phones, also import the following root CA certificates described in [Table 7-13](#) into the Phone-Edge-trust of Unified CM.

**Table 7-13** Certificates to import into Unified CM Phone-Edge-Trust for 7800 / 8800 Series phones configured with SIP OAuth

Certificate(s)	Purpose
Certificate of the root CA that signs the Unified CM tomcat certificate	This is for the 7800/8800 Series phones to verify the Unified CM tomcat certificate when they connect to Unified CM SSO Service Provider (SSOSP) or CallManager service on port 5090. This is required if configuring SIP OAuth on those phones.
Certificate of the root CA that signs the Expressway-E certificate	This is for the 7800/8800 Series phones to verify the Expressway-E certificate when they connect via MRA and are configured with SIP OAuth. This is also required for activation code onboarding via MRA.



**Note**

Once you import a certificate to the Phone-Edge-trust and the 7800/8800 Series phones receive the certificates from that trust store, the 7800/8800 Series phones configured with SIP OAuth will not trust the built-in list of public CA certificates anymore. Therefore, once you upload for example your enterprise root CA certificate into the Phone-Edge-trust for the on-premises SIP OAuth configuration, you would need to upload the certificate of the root CA that signed the Expressway-E certificate even if that CA certificate is part of the built-in list of public CA certificates that the phone used to trust.

## Certificate Monitoring

### Monitor Certificate Validity

Enable certificate validity monitoring on Unified CM for server certificates and LSCs.

Go to **Cisco Unified CM OS Administration > Security > Certificate Monitor** and enter the number of days before expiration to begin notification as well as the frequency of the notifications. Enable email notification. Select **Enable LSC monitoring** so that both server certificates and LSCs are monitored.

Alternatively, if Webex Cloud-Connected UC is deployed, you can configure certificate monitoring for all your Unified CM and IM & Presence servers (and for more UC applications in the future) conveniently from a single place, use the certificate monitoring functionality in Webex Control Hub. Configure the Notification Start Time, Notification Frequency, and the email of the notification recipients.

### Certificate Validity Check for Long-Lived Sessions

Unified CM can periodically check the revocation and expiry status of the certificates for long-lived connections. This is done for CTI connections with JTAPI/TAPI applications and LDAP connections (and IPsec, which is not covered in this document).

To enable certificate validity check (expiry and revocation status check) for long-lived connections, enable the Unified CM Enterprise Parameter **Certificate Validity Check**.

For certificate revocation status validation, also configure Online Certificate Status Protocol (OCSP) in **Cisco Unified CM OS Administration > Security > Revocation**.

### LDAP over SSL Configuration

Configure LDAP over SSL for the connections to Microsoft Active Directory.

On Unified CM, perform the following steps:

- If the LDAP certificate is self-signed, import it into the Unified CM tomcat-trust store.  
If the LDAP certificate is signed by a CA, import the root CA certificate into the Unified CM tomcat-trust store. If you configured Online Certificate Status Protocol (OCSP) to monitor the revocation status of the LDAP certificate, also import the LDAP certificate itself.
- In **Cisco Unified CM Administration > System > LDAP > LDAP directory** and in **Cisco Unified CM Administration > System > LDAP > Authentication**, change the **LDAP port** to a secure port and enable the **Use TLS** option (check the box). Typically, the LDAP secure port is 3268 if synchronizing against a global catalog (GC) or 636 if synchronizing against the Windows Microsoft Active Directory domain controller (DC). For more information about DC and GC behavior and port numbers, refer to the Microsoft documentation at <https://technet.microsoft.com/en-us/library/cc978012.aspx>.



## SIP Trunk Encryption

This section explains how to configure encryption for Unified CM SIP trunks.

For each type of SIP trunk, create a secure SIP Trunk security profile in the Unified CM Administration interface (under **System > Security**) for all the existing SIP trunk security profiles. Use the same parameter as the existing SIP trunk security profile (see the [Call Control](#) chapter), except for the parameters listed in [Table 7-14](#).

**Table 7-14 SIP Trunk Security Profile Parameters for Secure SIP Trunks**

Parameter	Value
Device Security Mode	Encrypted
Incoming Transport Type	TLS
Outgoing Transport Type	TLS
X.509 Subject Name	The common name (CN) of the remote party. For example: <ul style="list-style-type: none"> <li>• Unity Connection: us-cuc-ms.ent-pa.com (multi-server certificate)</li> <li>• Cisco Meeting Server: cms.ent-pa.com (Cisco Meeting Server domain name)</li> <li>• Expressway-C (business-to-business): CN of the Expressway-C cluster</li> <li>• Cisco IOS Gateway and Cisco Unified Border Element: List of CNs used by Cisco IOS Gateway and Cisco Unified Border Element</li> <li>• Other Unified CM cluster: emea-cm-pub-ms.ent-pa.com (CallManager multi-server certificate)</li> </ul>
Incoming Port	Typically, enter 5061. For SIP trunks to Expressway, since mobile and remote access (MRA) and business-to-business are enabled on the same Expressway cluster in this Preferred Architecture, use a different port for business-to-business (for example, port 5561).

In the configuration for each SIP trunk, use the settings described in [Table 7-15](#).

**Table 7-15 SIP Trunk Configuration for Secure SIP Trunks**

Parameter	Value
SRTP Allowed	Selected (check the box)
When this option is enabled, Encrypted TLS must configured in the network to provide end-to-end security. Failure to do so will expose keys and other information.	
SIP Information > Destination - > Destination port	5061
SIP Trunk security profile	Select the SIP trunk security profile you created in the previous step
Outgoing Transport Type	TLS

**Note**

Do not encrypt the Presence SIP trunk between Unified CM nodes and IM and Presence nodes because not all messages are encrypted.

## Media and Signaling Encryption on the Endpoints

To configure media and signaling encryption on the endpoints, perform the following high-level steps:

- Enable the OAuth token for SIP (for Jabber and the 7800/8800 Series phone).
- Enable mixed mode (for the video endpoints).
- Create phone security profiles with encrypted mode to enable media and signaling encryption.
- Associate the phone security profiles to the endpoints and install a Locally Significant Certificate (LSC) on the phones and on-premises video endpoints, except for the endpoints connecting only through MRA.
- Configure the MRA mode on the 7800/8800 Series phones configured with SIP OAuth.

The following sections provide more details on these steps.

### Enable SIP OAuth Mode

With the OAuth token enabled for SIP, Jabber and the 7800/8800 Series phones can perform media and signaling encryption, without the need to install an LSC or enable mixed mode.

To enable the SIP OAuth mode, enter the following CLI command:

```
utils sipOAuth-mode enable
```

Restart the CallManager services on all Unified CM nodes running this service. If you plan to enable mixed mode, you can wait to restart the CallManager service until after you enable mixed mode.

### Enable Mixed Mode

Before enabling mixed mode, activate the CAPF service on the Unified CM publisher first. If you activate the CAPF service after enabling mixed mode, the Certificate Trust List (CTL) file will need to be updated.

To enable mixed mode, perform the following steps:

- SSH into the Unified CM publisher.
- Enter the **utils ctl set-cluster mixed-mode** CLI command.
- Restart the TFTP, CallManager, and CTIManager services on all Unified CM nodes running those services.

For more details, refer to the latest version of the *Security Guide for Cisco Unified Communications Manager*, available at

<https://www.cisco.com/c/en/us/support/unified-communications/unified-communications-manager-call-manager/products-maintenance-guides-list.html>.

### CAPF Online CA Mode

If you chose the CAPF online CA mode where the LSC endpoint certificates are signed by an external CA, perform the following steps:

1. Import the CA certificate (or trust chain) to the Unified CM CAPF-trust.

2. Import the CA server IIS certificate or its CA certificate (or trust chain) to the Unified CM tomcat-trust, if not already done.
3. If some phones or video endpoints are configured in encrypted mode, import the CA certificate (or trust chain) to the Unified CM CallManager-trust, if not already done.
4. Configure the CAPF service parameters on the Unified CM publisher. Use the following settings:

Field	Setting
Certificate Issuer to Endpoint	Online CA
Online CA Hostname	Common Name (CN) in the certificate used by Microsoft IIS service. Typically, this is an FQDN.
Online CA Port	Typically 443
Online CA Template	Name of the certificate template defined in the Microsoft CA
Online CA Type	<b>Microsoft CA</b>
Online CA Username	Username of a user that has the right permissions to issue a certificate using the certificate template specified above
Online CA Password	Password of a user that has the right permissions to issue a certificate using the certificate template specified above

5. Activate the Cisco Certificate Enrollment Service on the Unified CM publisher, if not already done.
6. Restart the CAPF service.

### Phone Security Profiles and LSC Installation

At this point in the configuration process, the server certificates are generated, and mixed mode and SIP OAuth are enabled on Unified CM.

The next step is to create a phone security profile with Device Security Mode set to **Encrypted** to enable media and signaling encryption on the endpoints. The following considerations apply to the phone security profiles:

- When creating phone security profiles, use the Phone Security Profile Type **Universal Device Template**. This type of phone security profile is not specific to a particular phone model, so it can be applied to any phone model. This simplifies the configuration and the certificate management. With a phone security profile that is specific to a phone model, when a new type of endpoint is added, a new phone security profile has to be created. If the endpoint is configured for encryption using mixed mode instead of SIP OAuth then the Expressway-C certificate needs to be regenerated with the new phone security device profile name added as a SAN if MRA endpoints are using this phone security profile. With a universal phone security profile, there is no need to create a new phone security profile or to regenerate a new Expressway-C certificate each time you add a new device type.
- A phone security profile can be associated to both MRA and non-MRA endpoints. But ensure that the phone security profile name is in FQDN format if it is associated to MRA endpoints.
- Since our recommendation is to use media and signaling encryption, set the Device Security Mode setting to **Encrypted**.
- To enable TFTP configuration file encryption, select the **TFTP Encrypted Config** option (check the box). As discussed in the [Architecture](#) section, the recommendation is to enable TFTP encrypted configuration only for on-premises video endpoints and to disable it for endpoints connecting over

MRA (and ensure that no sensitive information is entered in the phone page). **TFTP Encrypted Config** also requires the endpoint to have a certificate installed (MIC or LSC). Refer to the [Architecture](#) section for more information on TFTP configuration file confidentiality.

- Select the **Enable OAuth Authentication** checkbox for the phone security profiles that will be used by Jabber endpoints and the 7800/8800 Series phones (see [Table 7-16](#)). This is to configure encryption based on SIP OAuth. If the Device Security Mode is selected but this checkbox is not selected, then encryption is configured based on mixed mode and not based on SIP OAuth. With SIP OAuth, the TFTP configuration file confidentiality cannot be modified, refer to the TFTP configuration file confidentiality section for more information.
- The recommendation in this guide is to enable SIP OAuth for the Jabber endpoints. However, that means that the Jabber TFTP configuration file is not encrypted and not confidential. If TFTP configuration file for Jabber is an absolute requirement for you, then do not configure SIP OAuth for Jabber and install an LSC on the Jabber clients instead. Since installing and managing LSC certificates on Jabber require sizeable additional administrative overhead, we usually do not recommend installing LSC certificates and deploying TFTP configuration file encryption for Jabber endpoints. Instead, we recommend configuring encryption based on SIP OAuth and this is what we cover in this guide.
- The phone security profile also specifies the authentication mode used when an endpoint connects to CAPF. In general, we recommend using the authentication mode **By Existing Certificate (precedence to LSC)**. With this setting, if an endpoint has only an MIC, the existing MIC is used for authentication to CAPF. If the endpoint has an LSC (with or without an MIC), then the LSC is used instead. So this works well for endpoints that have either an MIC or an LSC.
- For the Key Order setting in the phone security profile, select **RSA Only**; and for the RSA Key Size setting select **2048** or larger.

With these considerations, you would create different phone security profiles. [Table 7-16](#) shows how they differ. Use the values discussed above for the rest of the settings.

**Table 7-16** Phone Security Profiles to Configure

Phone Security Profile Name Examples	Authentication Mode (for CAPF Enrollment)	TFTP Encrypted Configuration File	OAuth Authentication	Type of endpoint using this profile
UDT-SIPOAuth	By Existing Certificate (precedence to LSC)	N/A	Enabled	For Jabber and 7800/8800 Series phones configured with SIP OAuth, on-premises and connecting via MRA.

Table 7-16 Phone Security Profiles to Configure (continued)

Phone Security Profile Name Examples	Authentication Mode (for CAPF Enrollment)	TFTP Encrypted Configuration File	OAuth Authentication	Type of endpoint using this profile
UDT-Encrypted-LSC.ent-pa.com	By Existing Certificate (precedence to LSC)	Enabled	Disabled	Optional. For on-premises video endpoints configured with TFTP configuration file encryption.
UDT-Encrypted-NullString.ent-pa.com	By Null String or By Authentication String	Disabled	Disabled	For on-premises video endpoints configured with no TFTP configuration file encryption and for MRA video endpoints.

Associate the phone security profiles to endpoints and install a Locally Significant Certificate (LSC) on the on-premises video endpoints

#### Associate the phone security profiles to all endpoints.

To associate a phone security profile to an endpoint, go to the phone configuration page and select the desired security profile in the **Device security profile** setting.

Install and LSC on the video endpoints. To configure LSC installation, select **Install/Upgrade** for the **Certificate Operation** field on the phone configuration page. In the Certification Authority Proxy Function (CAPF) Information section in the phone configuration page, the CAPF information from the phone security profile should be populated automatically. You need to update only the **Operation Completes By** field to a future date, if it is not already set.

Then, after associating the phone security profile and optionally configuring LSC installation, save the configuration. Apply the configuration or reset the endpoint. At this point, the phone security profile should be applied. If the LSC installation was configured, the endpoint gets an LSC. (With an authentication string, in some cases, the user has to press the **Update** button for the LSC installation to proceed.) The endpoint should also be configured with media and signaling encryption.



#### Tip

The Cisco Unified Communications Manager Bulk Administration Tool (BAT) or Cisco Prime Collaboration Provisioning can be used to assign the phone security profile and/or to perform the CAPF enrollment.

#### Configure the MRA mode on the 7800/8800 Series phones configured with SIP OAuth

When provisioning the 7800/8800 Series phones with SIP OAuth, if the endpoints will be connecting via MRA, select the checkbox **Allow Activation Code via MRA** in the Unified CM phone page in order to allow activation code onboarding over MRA or when taking an endpoint already configured with SIP OAuth and successfully registered and moving it from on-premises to MRA. If the 7800/8800 Series phones configured as encrypted with SIP OAuth are inside the corporate network, unselect the checkbox **Allow Activation Code via MRA**, otherwise the endpoints might not be able to register.

## Enable Secure Survivable Remote Site Telephony (SRST)

With Survivable Remote Site Telephony (SRST), use the following procedure:

- Use the enterprise CA to sign the certificate of the SRST router. For details on certificate management on a Cisco IOS router, refer to the section on [Cisco IOS Gateway and Cisco Unified Border Element](#).
- Import, into the SRST router, the trust certificate corresponding to the entity that signed the endpoint LSCs, so that SRST is able to authenticate the LSCs. If you used CAPF to issue the LSCs, this is the CAPF certificate. If you use an external CA to issue the LSCs, this is the CA certificate (or trust chain certificates).
- Enable secure SRST by enabling (checking the box) **Is SRST Secure?** in the SRST reference configuration in **Cisco Unified CM Administration > System > SRST**.

For more details, refer to the latest version of the *Security Guide for Cisco Unified Communications Manager*, available at

<https://www.cisco.com/c/en/us/support/unified-communications/unified-communications-manager-call-manager/products-maintenance-guides-list.html>.

## Cisco Unity Connection

This section covers Cisco Unity Connection media and signaling encryption using Next Generation Encryption (NGE), which uses the Unity Connection Tomcat certificate instead of the Unity Connection Root and SIP certificates.

At a high-level the steps for enabling NGE for media and signaling on Unity Connection are as follows:

- On Unity Connection, manage certificates.
- On Unity Connection, configure encryption for the telephony integration.
- On the Unified CM, enable encryption on the SIP trunk to Unity Connection.

First, manage the certificates on Unity Connection. On Unity Connection, perform the following steps:

- On the Unity Connection publisher node, upload the root CA certificate (or certificate chain) into the Unity Connection tomcat-trust store. Similarly, upload the root CA certificate into the CallManager-trust store (required with CA-signed CallManager certificates). Those certificates are automatically propagated to the trust stores on the Unity Connection subscriber node.
- On the Unity Connection publisher node, issue a CSR to get a multi-server Tomcat certificate and get it signed by the enterprise CA. As an example, the common name is us-cuc-ms.ent-pa.com. The X509v3 key usage extensions are Digital Signature, Key Encipherment, and Data Encipherment. The X509v3 extended key usage extensions are TLS Web Server Authentication and TLS Web Client Authentication. Since this is a multi-server certificate, the certificate is automatically installed on the Unity Connection subscriber when you install it on the Unity Connection publisher. After installing this new Tomcat certificate, restart the Tomcat service on both Unity Connection nodes.

For details on uploading the CA certificate or issuing a CA-signed Tomcat certificate, refer to the [Cisco Unified CM and IM and Presence](#) section. The procedure is the same for Unity Connection.

Since we are assuming the same CA is used with Cisco Unified CM and Unity Connection, there is no need to import the CA certificate into the Unified CM tomcat-trust store; it should already be there.

Next, configure encryption on Unity Connection:

- In **Cisco Unity Connection Administration > Telephony Integrations > Security > SIP Security Profile**, create a new SIP security profile with the following settings:

Field	Setting
Port	5061
Do TLS	Select this check box

This SIP security profile is automatically assigned the display name **5061/TLS**.

- Under **Telephony Integrations > Port Group**, select the port group **PhoneSystem-1** and modify the port group with the following settings:

Field	Setting
SIP Security Profile	Select the SIP Security Profile you created in the previous step ( <b>5061/TLS</b> )
Enable Next Generation Encryption	Select this check box
Secure RTP	Select this check box

- On the **Port Group** page, go to **Edit > Servers**. In the SIP Servers configuration, ensure that 5061 is configured for the TLS port. In the TFTP Servers configuration, ensure that the Unified CM TFTP servers are configured. This is how Unity Connection automatically downloads the CallManager certificates in its CallManager-trust store when the Port Group has been reset.

Next, enable encryption on the Unified CM SIP trunk to Unity Connection:

- A SIP trunk security profile with encryption and the appropriate X.509 Subject Name should already have been created (see [Table 7-14](#)). Select this SIP trunk security profile for the SIP trunk to Unity Connection.

At this point, on Unified CM the encrypted SIP trunk should be in full service. When a phone connects to a voicemail port, the media and signaling should also be encrypted. LDAP over SSL should also be configured. Go to **Cisco Unity Connection Administration > System Settings > LDAP**; and in the **LDAP Directory Configuration** and **LDAP Authentication** pages, select **Use TLS** and configure the port 636, similarly to the LDAP over SSL configuration on Unified CM.

## Collaboration Edge

This section provides high-level information for deploying certificate management and encryption on Cisco Expressway, Cisco IOS Gateways, and Cisco Unified Border Element.

### Cisco Expressway

This section discusses certificate management first, then it explains the settings to use for encryption.

#### Cisco Expressway Certificate Management

As mentioned in the [Architecture](#) section, new installations of Cisco Expressway software ship with a temporary trusted CA and a server certificate issued by that temporary CA. Replace the temporary CA certificates with the CA certificates that you trust, and generate CA-signed certificates for Expressway. Use the enterprise CA to sign the Expressway-C certificates and a public CA to sign the Expressway-E

certificates. The list of the supported public CAs for Expressway-E is available in the endpoint documentation on cisco.com; for example, see the *Certificate Authority Trust List* available at <https://www.cisco.com/c/en/us/support/collaboration-endpoints/unified-ip-phone-8800-series/products-technical-reference-list.html>.

To implement certificate management for Cisco Expressway, use the steps outlined in the following sections.

#### Upload the CA Root Certificate.

Go to the **Trusted CA certificate** page (**Maintenance > Security certificates > Trusted CA certificate**). On this page, replace the existing certificates with a new root CA certificate or certificate chain. Subsequent CA certificates are appended to the existing list of CA certificates. Upload the CA certificate listed in [Table 7-17](#). This operation has to be done on each Expressway node of both Expressway-C and Expressway-E clusters.

**Table 7-17 Cisco Expressway Trust Store**

Expressway-C Trust Store	Expressway-E Trust Store
<ul style="list-style-type: none"> <li>• Root CA certificate from the public CA that signed the Expressway-E certificate</li> <li>• Root CA certificate (or certificate chain) from the enterprise CA that signs the Unified CM CallManager and Expressway-C certificates</li> </ul>	<ul style="list-style-type: none"> <li>• Root CA certificate (or certificate chain) from the public CA that signed the Expressway-E certificate</li> <li>• Root CA certificate from the enterprise CA that signs the Unified CM CallManager and Expressway-C certificates</li> <li>• With business-to-business or cloud communications, root CA certificates of other businesses</li> </ul>

If configuring encryption with SIP OAuth and/or activation code onboarding, ensure OAuth with refresh token is configured. On Expressway C, in **Configuration > Unified Communications > Configuration**, enable **Authorize by OAuth token with refresh**.

If using activation code onboarding via MRA with the 7800/8800 Series phones, also enable “Allow activation code onboarding” on that page. With activation code onboarding over MRA, the phones send their MIC certificate to Expressway-E as part of the mutual TLS connection setup. By default, the root certificates of the Cisco Manufacturing CAs that sign the MICs are already in Expressway, but you can verify that by going to the **Trusted CA certificate** page (**Maintenance > Security certificates > Trusted CA certificate**) and clicking on **Activation code onboarding trusted CA certificates**.

#### Generate a Certificate Signing Request (CSR) for each Expressway node.

1. Go to **Maintenance > Security > Server certificate**.
2. Generate a CSR.

Subject Alternate Name (SAN) extensions for IM and Presence chat node aliases should be added automatically. Additional SAN extensions might have to be added, depending on whether your Expressway node is an Expressway-C or an Expressway-E node and depending on the features that are deployed. For more details, refer to [Table 7-18](#).



**Table 7-18 Subject Alternate Names (SAN) to be Added to the CSR**

Add the items below as Subject Alternate Name (SAN)	When Generating a CSR for the Following Purposes:		
	Mobile and Remote Access	XMPP Federation	Business-to-business calls
Expressway-C cluster name	On Expressway-C only	On Expressway-C only	On Expressway-C only
Unified CM registrations domains <sup>1</sup>	Required on Expressway-E only	–	–
XMPP federation domains	–	Required on Expressway-E only	–
IM and Presence chat node aliases (federated group chat)	–	Required on both Expressway-C and Expressway-E	–
Unified CM phone security profile names (FQDN format) <sup>2</sup>	Required on Expressway-C only	–	–

1. The Unified CM registration domains used in the Expressway configuration and Expressway-E certificate are the domains that MRA clients will use to look up the \_collab-edge DNS SRV record in the process of service discovery. The Unified CM registration domains enable MRA registrations on Unified CM, and in our case these domains will match the domain used on Unified CM for SIP URIs. However, these domains are primarily for service discovery, and the SIP domains used on Unified CM do not have to match.
2. There is no need to add the phone security profile name that is used for SIP OAuth in the SAN in the Expressway-C certificated (see [Table 7-16](#) for the list of phone security profiles). Only add the name of the phone security profile for endpoints that are configured with encryption based on mixed mode, which would correspond to the video endpoints in our guide.

For more information, refer to the latest version of the *Cisco Expressway Certificate Creation and Use Deployment Guide*, available at <https://www.cisco.com/c/en/us/support/unified-communications/expressway-series/products-installation-and-configuration-guides-list.html>.

3. Download the CSR and submit it to the CA so that a CA-signed certificate can be issued. Use the Base 64 format. Verify that the X509v3 Key Usage and X509v3 Extended Key Usage in the CSR are present in the certificate issued by the CA, as shown in [Table 7-19](#).

**Table 7-19 Cisco Expressway Key Usage and Extended Key Usage**

Certificate	X509v3 Key Usage	X509v3 Extended Key Usage
Expressway-C and Expressway-E	Digital Signature, Key Encipherment	TLS Web Server Authentication, TLS Web Client Authentication

4. Upload the new certificate

## Cisco Expressway Encryption Configuration

### MRA and XMPP Federation

TLS is used for the Unified Communications zone on Expressway-C. Ensure that **TLS verify** is set to **On** for all Unified Communications services: Unified CM servers, IM and Presence Service nodes, and Unity Connection. You configure this when performing Unified Communications service node discovery (**Configuration > Unified Communications**). This ensures that Expressway-C nodes verify the certificates of the Unified Communications nodes.

The Unified Communications traversal zone between Expressway-C and Expressway-E is implicitly configured with TLS certification verification enabled and with media encryption. On the Expressway-C MRA traversal zone, set the **Authentication policy** to **Do not check credentials**. On the Expressway-E MRA traversal zone, set the **Authentication policy** to **Do not check credentials** and enter a **TLS verify subject name** that matches the cluster name of the Expressway-C certificate (added as a SAN in the Expressway-C certificate).

The media and signaling traffic between an MRA endpoint and Expressway-E are always encrypted. In order to encrypt the call leg inside the corporate network (that is, the signaling between Expressway-C and Unified CM, and the media between Expressway-C and the internal endpoint), configure the MRA endpoint and the endpoints inside the network with a phone security profile in encrypted mode. When you do so, the media and signaling are encrypted end-to-end (all the call legs are encrypted).

With XMPP federation, we recommend setting the **Security mode** to **TLS Required**. However, there are cases where it should be set to **TLS optional**. For example, **TLS Required** is not supported with Cisco WebEx Messenger; so if you have XMPP federation with an enterprise using Cisco WebEx Messenger, you should use **TLS Optional**. In this scenario, you should also set **Require Client-side security certificates** to **Off**.

### Business-to-Business Communications

As mentioned in the [Architecture](#) section, configure Call Processing Language (CPL) rules.

Also, for the Unified CM neighbor zone on Expressway-C, use the recommended settings in [Table 7-20](#).

**Table 7-20 Expressway-C Business-to-Business Unified CM Neighbor Zone Configuration**

Field	Setting
Port	If MRA and business-to-business are enabled on the same Expressway cluster, use a port other than 5061 (for example, port 5561).
Transport	TLS
TLS Verify	On
Media Encryption	Best Effort

For the traversal zone on Expressway-C, use the recommended settings in [Table 7-21](#).

**Table 7-21 Expressway-C Business-to-Business Traversal Zone Configuration**

Field	Setting
Port	The port has to be different than 5060, 5061, and ports used with other traversal zones. For example, use a port in the range 7xxx.
Transport	TLS

**Table 7-21 Expressway-C Business-to-Business Traversal Zone Configuration (continued)**

Field	Setting
TLS Verify	On
Media Encryption	Auto

For the traversal zone on Expressway-E, use the recommended settings in [Table 7-22](#).

**Table 7-22 Expressway-E Business-to-Business Traversal Zone Configuration**

Field	Setting
Port	Same port as the one on Expressway-C for the traversal zone
Transport	TLS
TLS Verify	On
TLS Verify subject name	SAN of the Expressway-C cluster name
Media Encryption	Best effort

For the default zone (incoming calls), on Expressway-E, use the recommended settings in [Table 7-23](#).

**Table 7-23 Expressway-E Default Zone Configuration**

Field	Setting
Enable Mutual TLS on Default Zone	Off
Authentication Policy	Do not check credentials
Media Encryption	Best effort

For the DNS zone (outgoing calls) on Expressway E, use the recommended settings in [Table 7-24](#).

**Table 7-24 Expressway-E DNZ Zone Configuration**

Field	Setting
TLS Verify	Off
Media Encryption	Best effort

On Unified CM at this point, the SIP trunk security profile should already have been created. Refer to [Table 7-14](#) for details.

## Cisco IOS Gateways and Cisco Unified Border Element

This section discusses certificate management first, then it discusses encryption configuration.

### Certificate Management

With Cisco IOS Gateways and Cisco Unified Border Element (CUBE), we also recommend using CA-signed certificates.

There are various ways to upload the certificates. The following procedure is based on the manual certificate enrollment using the terminal. Certificates are in PEM (base 64) format.

1. Create an RSA keypair.

For example: **crypto key generate rsa general-keys label CUBE modulus 2048**

2. Create a PKI trustpoint for Cisco Unified Border Element (CUBE).

For example, with a manual enrollment using the terminal:

```
crypto pki trustpoint CUBE-Certificate
  enrollment terminal pem
  subject-name CN=US-CUBE1.ent-pa.com
  revocation-check none
  rsakeypair CUBE
  hash sha256
```

3. Authenticate the trustpoint with the CA and accept the CA certificate.

Basically, this uploads the CA certificate for that trustpoint.

For example: **crypto pki authenticate CUBE-Certificate**

And then paste the CA certificate in PEM format.

4. Enroll the trustpoint with the CA server. Basically, this creates the Certificate Signing Request (CSR).

For example: **crypto pki enroll CUBE-Certificate**

In this step, you do not have to include the router serial number or the IP address in the subject name.

5. Sign this CSR with the CA.

Use a CA template that is for Client and Server Web Authentication (TLS Web Client Authentication and TLS Web Server Authentication in the X509v3 Extended Key Usage).

6. Import the certificate that was just generated into the Cisco gateway.

For example, if you are manually importing the certificate in PEM format using the terminal:  
**crypto pki import CUBE-Certificate certificate**

If the Unified CM certificate was not signed by a CA, then the Unified CM CallManager certificate of all the Unified CM call processing subscriber nodes would need to be imported in the Cisco IOS Gateways and Cisco Unified Border Element (CUBE) using a new trustpoint.

Once the certificate management is done, proceed with the encryption configuration.

## Encryption Configuration

Follow these steps:

1. Associate the trustpoint with the Cisco IOS voice process.

For example:

```
sip-ua
crypto signaling remote-addr [UnifiedCMIPaddress1] [mask] trustpoint CUBE-Certificate
crypto signaling remote-addr [UnifiedCMIPaddress2] [mask] trustpoint CUBE-Certificate
```

2. Enable TLS transport for the dial-peers.

For example:

```
dial-peer voice 300 voip
session protocol sipv2
session transport tcp tls
```

3. Enable secure signaling.

For example, to enable secure signaling to/from specific devices, configure the following:

```
sip-ua
crypto signaling remote-addr [UnifiedCMIPaddress1] [mask] trustpoint CUBE-Certificate
crypto signaling remote-addr [UnifiedCMIPaddress2] [mask] trustpoint CUBE-Certificate
```

4. Enable SRTP.

Cisco IOS Gateways and Cisco Unified Border Element (CUBE) support AES\_CM\_128\_HMAC\_SHA1\_80 and AES\_CM\_128\_HMAC\_SHA1\_32 (default). To enable AES\_CM\_128\_HMAC\_SHA1\_80, configure:

```
voice service voip
sip
srtp-auth sha1-80
```

With SRTP pass-thru, stronger ciphers can be used between the source and destination devices, and Cisco Unified Border Element would just forward the packet without processing it. To configure **srtp passthru**, configure:

```
voice service voip
srtp pass-thru
```

## Conferencing

This section describes how to deploy Cisco Meeting Server and Cisco TelePresence Management Suite (TMS) for conferencing services.

### Cisco Meeting Server

Cisco Meeting Server does not provide a web interface to manage certificates. Certificate management is done via the mainboard management processor (MMP) commands.

Use the following high-level steps to generate and install the Cisco Meeting Server certificates:

- Generate a single CSR (and private key) for all services. In this CSR, specify the organization domain in the CN field and in the SAN extension. Also specify the FQDN of all the Cisco Meeting Server nodes in the SAN extension. Download the private key via SFTP. Sign the CSR by your enterprise CA. Ensure that the Extended Key Usage **Server Authentication** and **Client Authentication** are present. In this guide we refer to this certificate as the *shared certificate*.
- Upload via SFTP the new shared CA-signed certificate (and associated private key) and CA certificate to all Cisco Meeting Server nodes. Also upload the new database client CA-signed certificate (and associated private key) to the Cisco Meeting Server nodes running the Call Bridge service with no local database.
- Install the certificates.
  - Web Admin: On each node running this service, disable the service, install the shared certificate and associated private key, and then enable the service.
  - Call Bridge: On each node running this service, install the shared certificate and associated private key, and restart the service.
  - Web Bridge: On each node running this service, install the shared certificate and associated private key and the CA certificate, and restart the service.
  - Database server: On each node with a local database, ensure that database clustering is not activated, then install the shared certificate and associated private key. Once this is done, clustering configuration between the nodes can be enabled.
  - Database client: On each node running the Call Bridge service with no local database, ensure that database clustering is not activated, then install the database client certificate and associated private key. Once this is done, clustering configuration between the nodes can be enabled.

The following sections provide examples of the above steps. In those examples, the shared Cisco Meeting Server certificate signed by the enterprise CA is `CAsignedCluster.cer`, the corresponding private key is `CAsignedCluster.key`, and the root CA certificate is `rootCAcert.cer`.

Generate CSRs.

For the database client certificate:

```
pki csr dbclusterclient CN:postgres
```

For the shared certificate:

```
pki csr uscmscluster CN:us-cms.ent-pa.com
subjectAltName:us-cms-1.ent-pa.com,us-cms-2.ent-pa.com,us-cms-3.ent-pa.com
```

Issue certificates based on those CSRs

Install certificates for the various services and Cisco Meeting Server nodes.

On each node running the Web Admin service:

```
webadmin disable (if already running)
webadmin certs uscmscluster.key uscmscluster.cer cabundle.cer
CAsignedCluster.key CAsignedCluster.cer
webadmin listen a 444
webadmin enable
```

On each node running the Call Bridge service:

```
callbridge certs uscmscluster.key uscmscluster.cer cabundle.cer
callbridge listen a
callbridge restart
```

Create a file containing the CMS certificate and the CA certificate chain. We name this file `uscmsclusterfullchain.cer` in this example.

On each node running the Web Bridge service:

```
webbridge3 disable (if already running)
webbridge3 https uscmscluster.key uscmsclusterfullchain.cer
webbridge3 https listen a:443
webbridge3 c2w listen a:9999
webbridge3 c2w certs uscmscluster.key uscmsclusterfullchain.cer
webbridge3 c2w trust cabundle.cer
webbridge3 enable
```

On the node that will host the database master (usually first node that is configured with a database):

```
database cluster certs uscmscluster.key uscmscluster.cer dbclusterclient.key
dbclusterclient.cer cabundle.cer
database cluster localnode a
database cluster initialize
database cluster status
```

On the other nodes that will also run the local database:

```
database cluster certs uscmscluster.key uscmscluster.cer dbclusterclient.key
dbclusterclient.cer cabundle.cer
database cluster localnode a
database cluster join us-cms-1 (enter the A-record or IP address of the node running
the master database)
database cluster status
```

If you have a node running the Call Bridge service but with no local database:

```
database cluster connect <IP_address_NodeWithDatabase>
```

For more information, refer to the latest version of the *Cisco Meeting Server, Certificate Guidelines for Scalable and Resilient Server Deployments*, available at

<https://www.cisco.com/c/en/us/support/conferencing/meeting-server/products-installation-and-configuration-guides-list.html>.

On Unified CM, ensure that a SIP trunk security profile is configured with encryption, TLS, and the Cisco Meeting Server XMPP domain name in the X.509 Subject Name, as described in the section on [SIP Trunk Encryption](#). Associate this SIP trunk security profile with all the SIP trunks to CMS nodes running the Call Bridge service.

## Cisco Meeting Management

Cisco Meeting Management (CMM) is installed by default with a self-signed certificate.

Generate a CA-signed certificate with the **CDRreceiveraddress** as well as any addresses your users will use for the browser interface.

The private key and certificate are created outside of Cisco Meeting Management by performing the following steps:

1. Generate a private key using the following command:  

```
openssl genrsa -out us-cmm-privatekey.pem 2048
```
2. Generate a certificate signing request (CSR) using the private key from step 1:  

```
openssl req -new -key us-cmm-privatekey.pem -out us-cmm-certcsr.pem
```
3. Enter the data requested, including Country, State or province, Organization name, and so forth.
4. Send the Cisco Meeting Management certificate signing request file, **us-cmm-certcsr.pem**, to be signed by your enterprise certificate authority (CA). You should get a certificate chain back from the CA, **us-cmm.cer**.
5. Upload the private key and certificate chain through the CMM administration pages.
6. Restart Cisco Meeting Management as prompted by the administration pages.

## Cisco TelePresence Management Suite

The private key and certificate are created outside of Cisco TelePresence Management Suite (TMS). You can do this with OpenSSL, for example, by following these high-level steps:

1. Generate a private key using the following command:  

```
openssl genrsa -out us-tms1-privatekey.pem 2048
```
2. Generate a certificate signing request (CSR) using the private key above:  

```
openssl req -new -key us-tms1-privatekey.pem -out us-tms1-certcsr.pem
```
3. Enter the data requested, including Country, State or province, Organization name, and so forth.
4. Send the TMS certificate signing request file, **us-tms1-certcsr.pem**, to be signed by your enterprise certificate authority (CA). You should receive the signed certificate, **us-tms1.cer**, back from the CA.
5. Combine the signed certificate with the private key:  

```
openssl pkcs12 -export -inkey us-tms1-privatekey.pem -in us-tms1.cer -out us-tms1-cert-key.p12 -name us-tms1-cert-key
```
6. On TMS, import the root CA certificate into the Certification Authority Trust store. Also import the new TMS certificate and associated private key to the Personal trust store.
7. With Microsoft Management Console (MMC) and the certificate Snap-in, select the certificate you just imported, right-click, and select **All Tasks > Manage Private Keys**. Provide read and full control permissions to the users that are used by TMS (in most cases they will be the SERVICE and NETWORK SERVICE users).
8. Go to the TMS tool and in **Security Settings > TLS Certificates**, select the new certificate.
9. Go to IIS and configure binding to the new certificate.
10. Restart the IIS and TMS services.



For more information, refer to the latest version of the *Cisco TelePresence Management Suite Administrator Guide*, available at <https://www.cisco.com/c/en/us/support/conferencing/telepresence-management-suite-tms/products-maintenance-guides-list.html>.

Also refer to the *TMS Certificates with TMS Tools for TLS Communication Configuration Example*, available at <https://www.cisco.com/c/en/us/support/docs/conferencing/telepresence-management-suite-tms/118723-configure-tms-00.html>.

## Collaboration Management Services

### Cisco Prime Collaboration Deployment

Cisco Prime Collaboration Deployment does not have a graphical user interface (GUI) for the platform administration. To issue a CA-signed certificate, go to the command line interface (CLI) and issue a CSR. Use the CLI commands **set csr gen tomcat** to generate a CSR, **show csr own tomcat /tomcat.csr** to display the CSR in PEM format, **set cert import trust tomcat** to import CA and/or subordinate CA certificates, and **set cert import own tomcat tomcat-trust/<tomcat-certificate-name>** to import the Tomcat certificate.

Restart the Tomcat service with the command **utils service restart Cisco Tomcat**.

## Multi-Cluster Considerations

In a multi-cluster deployment, if clusters are not part of the same data center, enable encryption for the intercluster links.

For the SIP trunks, since our recommendation is to use CA-signed certificates for CallManager, and assuming the same CA is used for the different clusters, there is no need to exchange CallManager or CA certificates between the clusters.

To enable ILS encryption, we recommend using TLS certificates for authentication and using a password for authorization. In the Unified CM ILS configuration page, select the **Use TLS Certificates** option (check the box), select the **Use Password** option (check the box), and enter a password that will be shared between the Unified CM clusters. With the Tomcat certificate signed by the enterprise CA, and with the enterprise root CA certificate (or certificate chain) already in the Tomcat trust store, there are no additional operations required to enable ILS encryption for the certificates.

To enable LBM encryption, simply set the Unified CM Enterprise Parameter **LBM Security Mode** to **Secure**. Again, with the Tomcat certificate signed by the enterprise CA, and with the enterprise root CA certificate already in the Tomcat trust store, there are no additional operations required to enable LBM encryption for the certificates.





# Bandwidth Management

**Revised: May 21, 2021**

This chapter describes the bandwidth management strategy for the Cisco Preferred Architecture (PA) for Enterprise Collaboration.

Certain requirements might put your deployment outside the PA design guidelines and recommendations, in which case you might have to use other documentation such as the [Cisco Collaboration SRND](#) and related product documentation for a more customized architecture.

The first part of this chapter provides an architectural overview and introduces some fundamental design concepts, while the second part covers deployment procedures. The [Architecture](#) section discusses topics such as identification and classification, queuing and scheduling, provisioning and admission control, using the hypothetical customer topology presented in the examples throughout this document. The next portion of this chapter is the [Bandwidth Management Deployment](#) section. The deployment examples in that section help you to understand the implementation of certain design decisions more clearly than an abstract discussion of concepts can. The order of the topics in the [Bandwidth Management Deployment](#) section follows the recommended order of configuration.

## What's New in This Chapter

[Table 8-1](#) lists the topics that are new in this chapter or that have changed significantly from previous releases of this document.

**Table 8-1** *New or Changed Information Since the Previous Release of This Document*

New or Revised Topic	Described in:	Revision Date
Minor edits		May 3, 2021

## Core Components

The Quality of Service (QoS) architecture contains these key components:

- Cisco Unified Communications Manager
- Cisco endpoints
- Cisco Expressway
- Cisco Unity Connection
- Cisco Meeting Server
- Network infrastructure:
  - Cisco routers
  - Cisco switches

Figure 8-1 illustrates the design approach to QoS used in the Cisco PA for Enterprise Collaboration. This approach consists of the following phases:

- **Identification and classification** — Refers to concepts of trust and techniques for identifying media and call signaling for endpoints and applications. It also includes the process of mapping the identified traffic to the correct DSCP to provide the media and signaling with the correct per-hop behavior end-to-end across the network.
- **Queuing and scheduling** — Consists of general WAN queuing and scheduling, the various types of queues, and recommendations for ensuring that collaboration media and signaling are correctly queued on egress to the WAN.
- **Provisioning and admission control** — Refers to provisioning the bandwidth in the network and determining the maximum bit rate that groups of endpoints will utilize. This is also where call admission control can be implemented in areas of the network where it is required.
- **Monitoring, troubleshooting, and optimization** — Ensures the proper operation and management of voice and video across the network. Cisco Prime Collaboration offers a suite of tools to perform these functions. Monitoring, troubleshooting and optimization are not covered in the Preferred Architectures but are part of the overall approach.

Figure 8-1 Architecture for Bandwidth Management

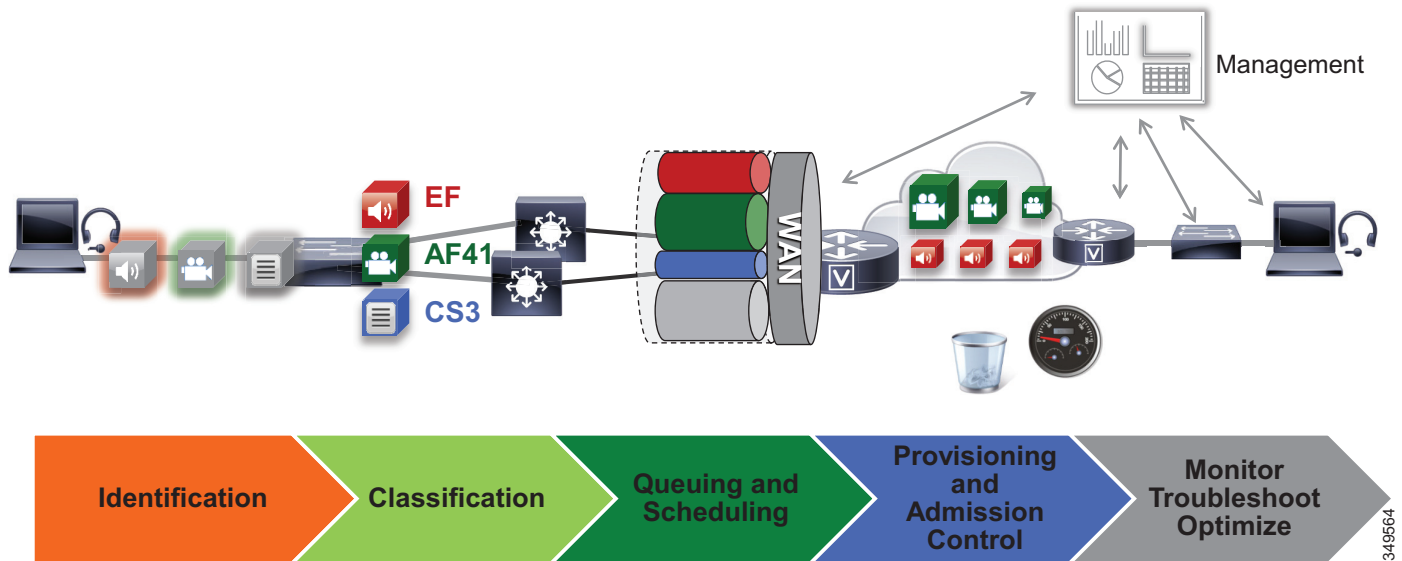

## Recommended Deployment

- Identify media and SIP signaling traffic from the endpoints.
- Classify and mark traffic at the access switch edge.
  - Mark all audio with Expedited Forwarding class EF (includes all audio of voice-only and video calls).
  - Mark all critical desktop and room system video with an Assured Forwarding class of AF41 for prioritized video.
  - Mark all Jabber, mobile and remote access (MRA), and edge video with an Assured Forwarding class of AF42 for opportunistic video. Or mark as AF41 if opportunistic video is not an option for the enterprise.
  - Mark all call signaling with CS3.
  - Configure QoS on all media originating and terminating applications and MCUs across the solution.
- Apply simplified WAN edge policies for identifying, classifying, marking, and queuing collaboration traffic:
  - WAN edge ingress re-marking policy
  - WAN edge egress queuing and scheduling policy
- Group video endpoints into classes according to maximum video bit rate, to limit bandwidth consumption based on endpoint type and usage within the solution.
- Deploy Enhanced Locations Call Admission Control and limit video calling only in areas of the network where bandwidth resources are restricted.

## Key Benefits

This deployment of bandwidth management provides the following benefits:

- Provides prescriptive recommendations to simplify deployment with a simplified QoS architecture
- Makes more efficient use of network resources
- Supports mobile and multi-media Collaboration devices
- Takes into account "unmanaged" network segments (Internet)
- Is "future-proof" because it facilitates introduction of new services, features, and endpoints

## Architecture

Bandwidth management is about ensuring the best possible user experience end-to-end for all voice and video endpoints, clients, and applications in the Collaboration solution. This chapter provides a holistic approach to bandwidth management, incorporating an end-to-end Quality of Service (QoS) architecture with call admission control and video rate adaptation and resiliency mechanisms to ensure the best possible user experience for deploying pervasive video over managed and unmanaged networks.

This section starts with a discussion of collaboration media, the differences between audio and video, and the impact this has on the network. Next this section outlines an end-to-end QoS architecture for collaboration that includes: identification and classification of collaboration media and SIP signaling for endpoints, clients, and applications; WAN queuing and scheduling; and bandwidth provisioning and admission control. The next section on [Bandwidth Management Deployment](#) explains the steps involved in implementing this architecture in both the collaboration and network architecture.

**Note**

---

The *Network Infrastructure* chapter in the latest version of the [Cisco Collaboration SRND](#) lays the foundation for QoS in the LAN and WAN. If you are unfamiliar with the concepts of QoS, it is important to read that chapter to fully understand the concepts discussed therein. This chapter assumes an understanding of QoS.

---

## Introduction

In this Preferred Architecture, usage of the Internet and cloud-based services such as WebEx are an important aspect of the solution, which means that some of the Collaboration infrastructure is located outside of the managed enterprise network and located in the cloud. The enterprise office connectivity options also range from remote sites and mobile users connected over managed leased lines directly connected to MPLS or other technologies, to being connected over the Internet through technologies such as Dynamic Multipoint VPN (DMVPN), for example. [Figure 8-2](#) illustrates the convergence of a traditional on-premises Collaboration solution in a managed (capable of QoS) network with cloud services and sites located over an unmanaged (not capable of QoS) network such as the Internet. On-premises remote sites are connected over this managed network, where administrators can prioritize collaboration media and signaling with QoS, while other remote sites and branches connect into the enterprise over the Internet, where collaboration media and signaling cannot be prioritized or prioritized only outbound from the site. Many different types of mobile users and teleworkers also connect over the Internet into the on-premises solution. So the incorporation of the Internet as a source for connecting the enterprise with remote sites, home and mobile users, as well as other businesses and consumers, has an important impact on bandwidth management and user experience.

Figure 8-2 Managed versus Unmanaged Network

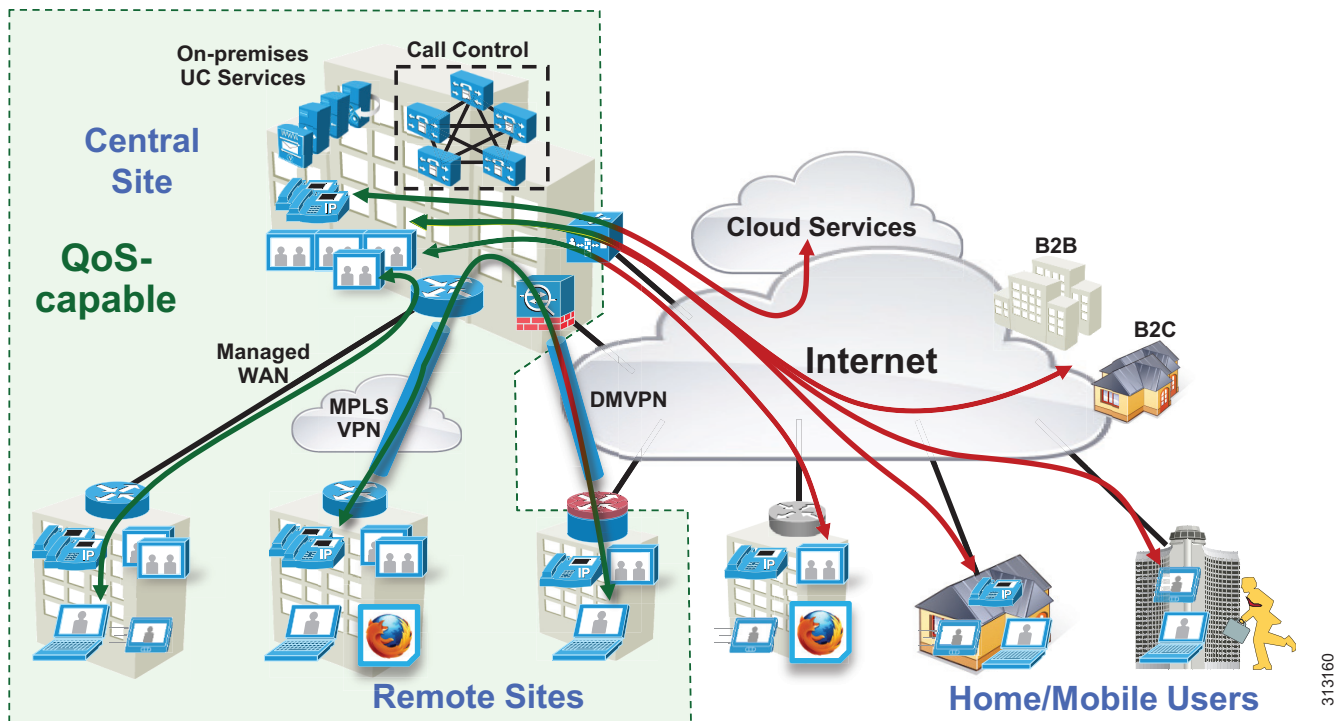

This section presents a strategy for leveraging smart media techniques in Cisco video endpoints, building an end-to-end QoS architecture, and using the latest design and deployment recommendations and best practices for managing bandwidth to achieve the best user experience possible based on the network resources available and the various types of networks that collaboration media traverse.

## Collaboration Media

This section covers the characteristics of audio and video streams in real-time media as well as the smart media techniques that Cisco video endpoints employ to ensure high fidelity video in the event of packet loss, delay, and jitter.

### Audio versus Video

Voice and video are often thought of as quite similar, and although they are both real-time protocol (RTP) applications, the similarities stop there. Voice is generally considered well behaved because each packet is a fixed size and fixed rate. Video frames are spread over multiple packets that travel as a group. Because one lost packet can ruin a P-frame, and one bad P-frame can cause a persistent artifact, video generally has a tighter loss requirement than audio. Video is asymmetrical. Voice can also be asymmetrical but typically is not. Even on mute, an IP phone will send and receive the same size flow. Video increases the average real-time packet size and has the capacity to quickly alter the traffic profile of networks. Without planning, this could be detrimental to network performance. Figure 8-3 shows the difference between a series of audio packets and video packets sent during a specific time interval.

Figure 8-3 Audio versus Video

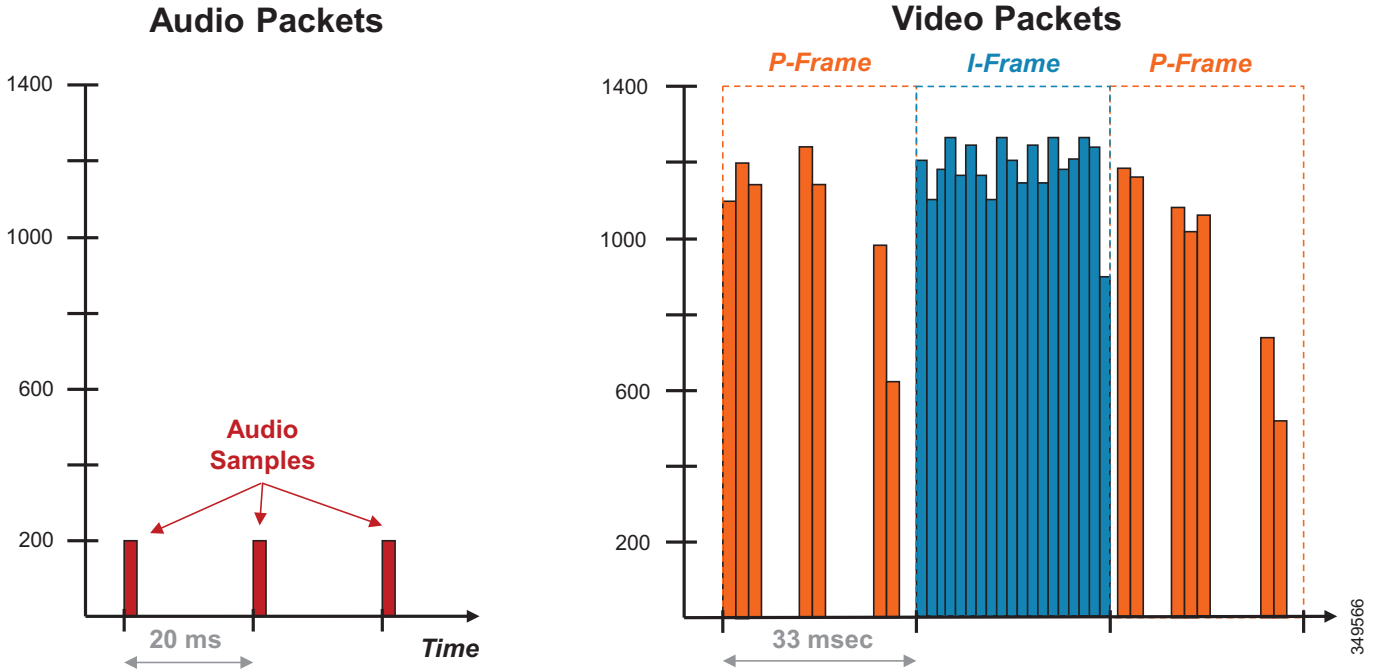

As illustrated in Figure 8-3, the audio packets are the same size, sent at exactly the same time intervals, and represent a very smooth stream. Video, on the other hand, sends a larger group of packets over fixed intervals and can vary greatly from frame to frame. Figure 8-3 shows the difference in the number of packets and packet sizes for an I-Frame compared to P-frames. This translates to a stream of media that is very bursty in nature when compared to audio. This burstiness is illustrated in Figure 8-4, which shows the bandwidth profile over time of an HD video stream. Note the large bursts when I-Frames are sent.

Figure 8-4 Bandwidth Usage: High-Definition Video Call

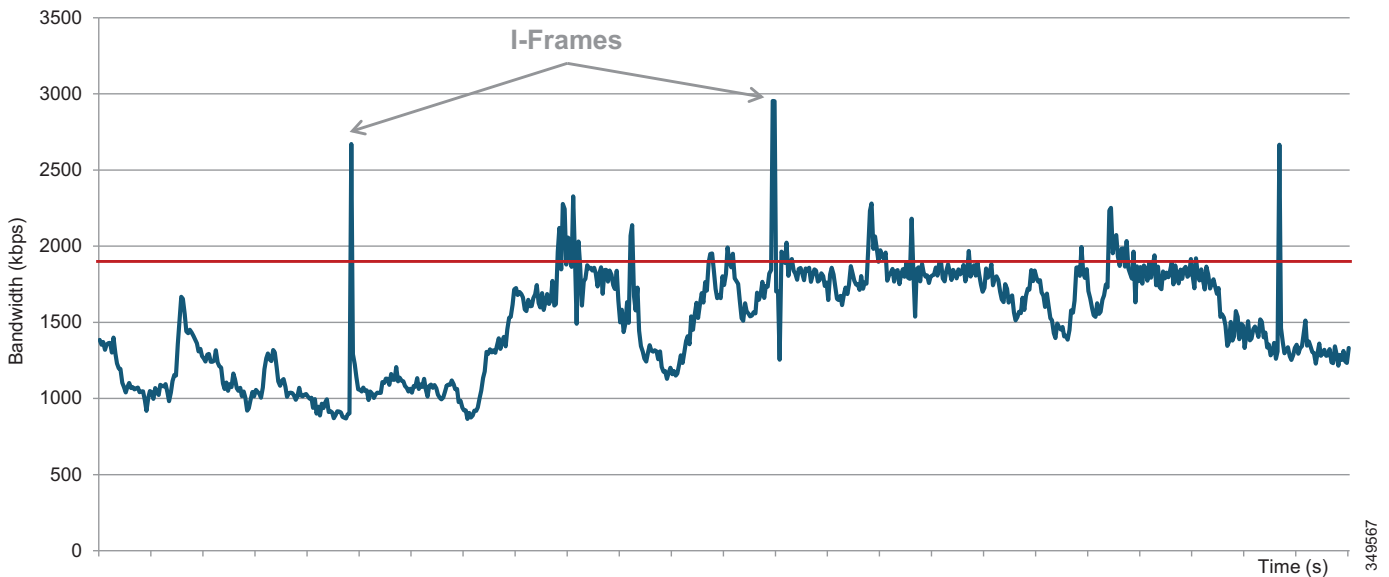
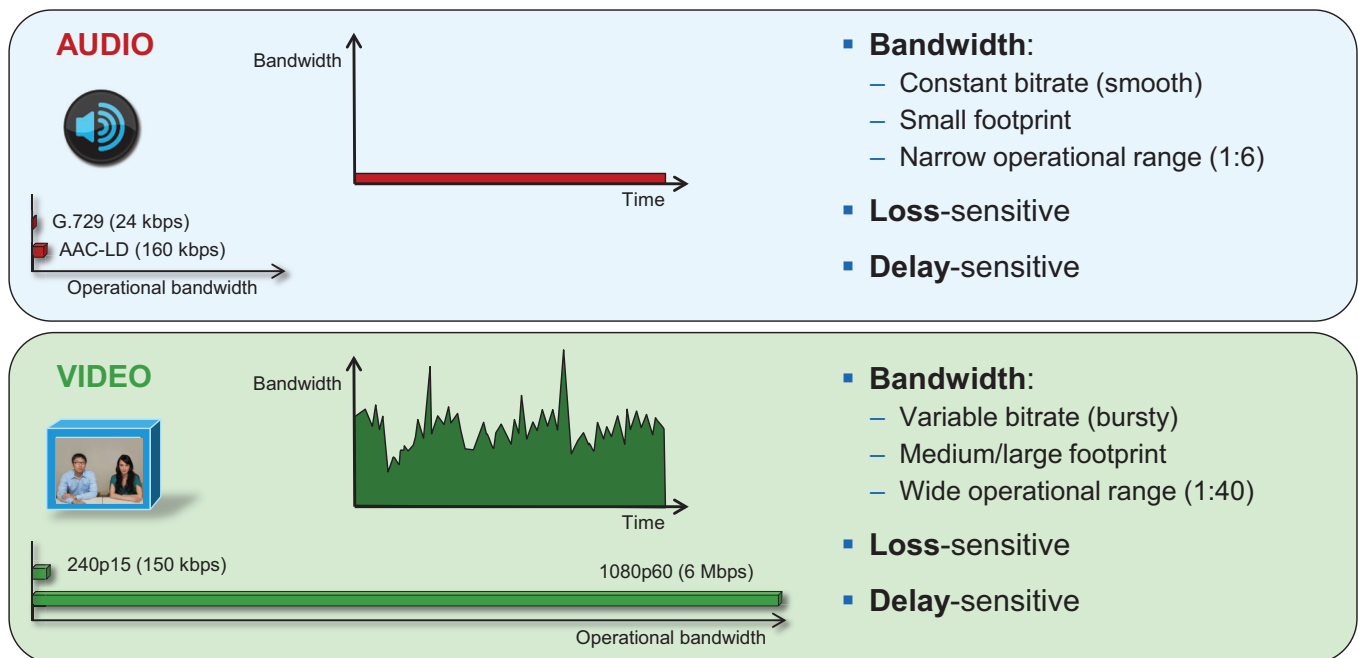



Figure 8-4 shows an HD video call at 720p at 30 fps and 1920 kbps (1792 kbps video + 128 kbps audio). The red line indicates the average bit rate for the duration of the call.

While audio and video are both transported over UDP and are sensitive to loss and delay, they are quite different in their network requirements and profile. As shown in Figure 8-5, audio is a constant bit rate, has a smaller footprint compared to video, and has a narrower operational range of 1:6 ratio when comparing the lowest bit rate audio codec to one of the highest bit rate codecs. Video, on the other hand, has a variable bit rate (is bursty), has a medium to large footprint when compared to audio, and has a wide operational range of 1:40 (250p at 15 fps up to 1080p at 60 fps).

Figure 8-5 Video Traffic Requirements and Profiles



The main point here is that audio and video, while similar in transport and sensitivity to loss and delay, are quite different in the methods employed to manage their bandwidth requirements in the network. Also, while video is pertinent to a full collaboration experience, audio is critical. For example, during a video call, if video is lost or distorted due to a network outage or some other network related event, communication can continue provided that audio is not lost during that outage. This is a critical concept in bandwidth management in the PA.

## "Smart" Media Techniques (Media Resilience and Rate Adaptation)

When deploying video pervasively across an organization, administrators will inevitably encounter insufficient bandwidth to handle the load of video required during the busy hour in some bottleneck areas of the Wide Area Network (WAN). In light of this it is important to prioritize video correctly, to ensure that audio is not affected by any video packet loss that may occur, and to ensure that certain types of video can leverage video rate adaptation to manage the amount of bandwidth used during times of congestion. The media resilience and rate adaptation techniques allow for an optimized video experience in the face of congestion and packet loss over managed and unmanaged networks, but that is not all. These techniques, when used as a strategy coupled with QoS, can offer the ability for an organization to

deploy video pervasively by allowing the endpoints to reduce their bit rate and thus their bandwidth utilization during congestion and packet loss, while also allowing the endpoints to increase their bit rate and thus bandwidth utilization during more idle times of the day outside of the busy hour, thereby maximizing video quality.

Every Cisco video endpoint employs a number of smart media techniques to avoid network congestion, recover from packet loss, and optimize network resources. The following smart media techniques are some of the techniques employed by Cisco video endpoints:

- Media resilience techniques
  - Encoder pacing
  - Gradual Decoder Refresh (GDR)
  - Long-Term Reference Frame (LTRF) with Repair
  - Forward Error Correction (FEC)
- Rate adaptation

### Media Resilience Techniques

This Preferred Architecture supports the following media resilience techniques for Cisco video endpoints:

- Encoder Pacing

Encoder pacing is a simple technique used to spread the packets as evenly as possible in order to smooth out the peaks of the bursts of bandwidth.
- Gradual Decoder Refresh (GDR)

GDR is a method of gradually refreshing the picture over a number of frames, giving a smoother, less bursty bit stream.
- Long Term Reference Frame (LTRF)

A Long Term Reference Frame (LTRF) is a reference frame stored in the encoder and decoder, which allows the video endpoints to recover more efficiently from packet loss with less bandwidth utilization over the network path in order to resend lost frames.
- Forward Error Correction (FEC)

Forward error correction (FEC) provides redundancy to the transmitted information by using a predetermined algorithm. The redundancy allows the receiver to detect and correct a limited number of errors occurring anywhere in the message, without the need to ask the sender for additional data. FEC gives the receiver an ability to correct errors without needing a reverse channel (such as RTCP) to request retransmission of data, but this advantage is at the cost of a fixed higher forward channel bandwidth (more packets sent). FEC protects the most important data (typically the repair P-frames) to make sure the receiver is receiving those frames. The endpoints do not use FEC on bandwidths lower than 768 kbps, and there must also be at least 1.5% packet loss before FEC is introduced. Endpoints typically monitor the effectiveness of FEC; and if FEC is not efficient, they make a decision not to do FEC.

## Rate Adaptation

Rate adaptation or dynamic bit rate adjustments adapt the call rate to the variable bandwidth available, down-speeding or up-speeding the video bit rate based on the packet loss condition. An endpoint will reduce bit rate when it receives messages from the receiver indicating there is packet loss; and once the packet loss has decreased, up-speeding of the bit rate will occur.

## The Self-Regulating Video Network, Prioritized Audio, and Opportunistic Video

The self-regulating video network, prioritized audio, and opportunistic video are all QoS concepts as well as a QoS strategy. A self-regulating video network consists of leveraging the smart media techniques and rate adaptation discussed previously, along with proper provisioning and QoS to allow the video endpoints to maximize their video resolution during times when video bandwidth is not fully utilized in the network, and rate adapting or throttling down their bit rate to accommodate more video flows during the busy hour of the day.

Prioritized audio for both audio-only and audio of video calls ensures that all audio is prioritized in the network and is thus not impacted by any loss that can occur in the video queues. Prioritizing voice from all types of collaboration media ensures that even during times of extreme congestion when video is experiencing packet loss and adjusting to that loss, the audio streams are not experiencing packet loss and are allowing the user to carry on an uninterrupted audio experience. Prioritizing audio from both voice-only and video calls is a paradigm shift from the previous historic model where audio and video of video calls were always marked with the same QoS.

Opportunistic video allows for a group of video endpoints to be strategically marked with a lower class of video, thus allowing them to opportunistically use available bandwidth for optimal video resolution during times when the network is more idle and more bandwidth is available or, conversely, to down-speed their video more aggressively than the more prioritized class of video during times of congestion when the network is in its busy hour. This concept of opportunistic video coupled with prioritized audio maintains an acceptable video experience while simultaneously ensuring that voice media for these opportunistic video calls is not compromised. This of course applies to the managed network, since an unmanaged network such as the Internet is not QoS-enabled and thus provides no guarantees with regard to packet loss. Nevertheless, the media resiliency and rate adaptation mechanisms also attempt to ensure that media over unmanaged networks has the best possible quality in the face of packet loss, delay, and jitter.

Opportunistic video is an optional deployment choice that adds value to a self-regulating video network with prioritized audio; however, it is not mandatory for a self-regulating video network to function.

## QoS Architecture for Collaboration

Quality of Service (QoS) ensures reliable, high-quality voice and video by reducing delay, packet loss, and jitter for media endpoints and applications. QoS provides a foundational network infrastructure technology, which is required to support the transparent convergence of voice, video, and data networks. With the increasing amount of interactive applications (particularly voice and video applications), real-time services are often required from the network. Because these resources are finite, they must be managed efficiently and effectively. If the number of flows contending for such priority resources were not limited, then as these resources become oversubscribed, the quality of all real-time traffic flows would degrade, eventually to the point of futility. "Smart" media techniques, QoS, and admission control ensure that real-time applications and their related media do not oversubscribe the network and the bandwidth provisioned for those applications. These smart media techniques coupled with QoS and,

where needed, admission control, are a powerful set of tools used to protect real-time media from non-real-time network traffic and to protect the network from over-subscription and the potential loss of quality of experience for end users of voice and video applications.

## Identification and Classification

### QoS Trust and Enforcement

The enforcement of QoS is crucial to any real-time audio or video experience. Without the proper QoS treatment (classification, prioritization, and queuing) through the network, real-time media can potentially incur excessive delay or packet loss, which compromises the quality of the real-time media flow. In the QoS enforcement paradigm, the issue of trust and the trust boundary is equally important. Trust is the permitting or the "trusting" of QoS marking (Layer 2 CoS or Layer 3 IP DSCP) of the traffic by the endpoint or device, to allow the traffic to continue through the network. The trust boundary is the place in the network where the trust occurs. It can occur at any place in the network; however, we recommend enforcing trust at the network edge such as the LAN access ingress or the WAN edge, or both, as is feasible and applicable.

There are three main categories of trust:

- **Untrusted** — These devices include unsecure PCs, Macs, or hand-held mobile devices running Jabber clients, IP phones, and desktop endpoints.
- **Trusted** — These devices can include secure PCs and servers, video conferencing endpoints, analog and video conferencing gateways, PSTN gateways, Cisco Unified Border Element, trusted application servers, and other similar devices.
- **Conditionally trusted** — These devices typically include endpoints that support Cisco Discovery Protocol (CDP). Although Cisco Room Systems, IP phones, and desktop phones support CDP, they are not conditionally trusted in the PA.

In the PA, trusted and untrusted switch ports are used but conditionally trusted ports are not used. Conditional trust is not recommended in the PA for the following reasons:

- Complexity across a variety of switches — Enabling conditional trust across a variety of switch types can become complex. Some of the older switch types do not trust by default, while newer switches do trust by default. Furthermore, the commands for enabling trust and the process of trust enforcement are different across platforms.
- Even more important is the lack of Layer 3 DSCP re-marking on PC ports of IP phones and desktop endpoints. The endpoints re-mark only Layer 2 CoS. Because of this and the inability to correctly re-mark PC traffic at the DSCP level, using access lists to re-mark IP phones and desktop endpoints is a preferred method in the PA.
- A single ACL that maps directly to all switch ports is easier to manage than specifying only a limited number of ports for trust.

Figure 8-6 illustrates the types of trust used in the PA, and which devices are trusted and untrusted.

Figure 8-6 Trust Boundaries in the Preferred Architecture

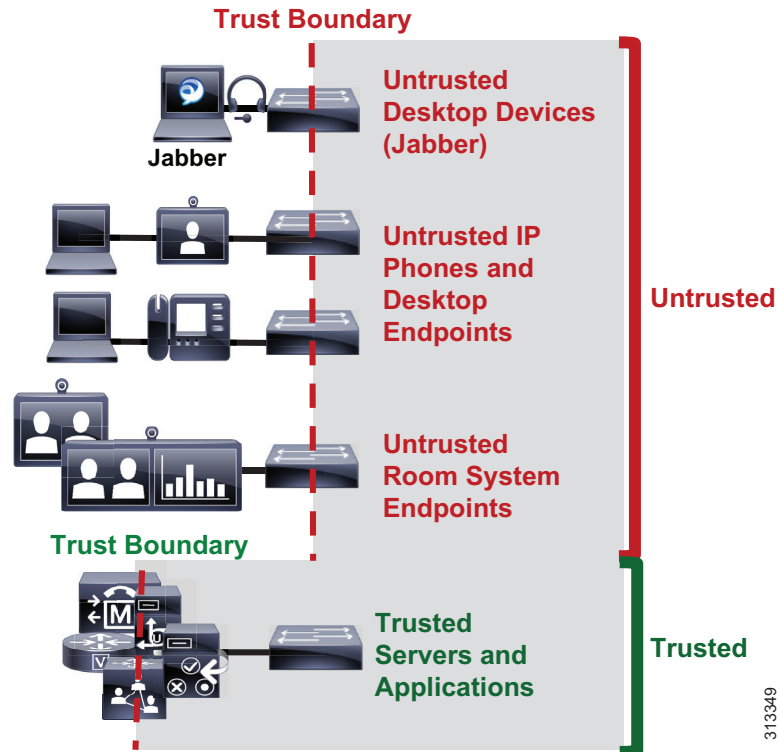

## Classification and Marking

This section discusses classification and marking for endpoints.

All Cisco endpoints derive their DSCP marking from Unified CM. Unified CM houses the QoS configuration for endpoints in two places, in the Service Parameters for the CallManager service (**Clusterwide Parameters (System - QoS)**) and in the SIP Profile (applicable only to SIP devices). The SIP Profile configuration of QoS settings overrides the Service Parameter configuration. This allows Unified CM administrators to set different QoS policies for groups of endpoints. Unified CM passes this QoS configuration to the endpoints in a configuration file over TFTP during endpoint registration. This configuration file contains the QoS parameters as well as a number of other endpoint specific parameters. For QoS purposes there are two categories of video endpoints: *room system endpoints* (any endpoint with TelePresence in the phone name, typically room systems or Webex Room Series, and some large desktop video endpoints such as the Webex DX80) and all other non-room-system video endpoints (referred to as *desktop endpoints*).

Table 8-2 shows the Preferred Architecture endpoints and their classification.

**Table 8-2 PA Video Endpoints**

Endpoint	Room System Endpoint	Desktop Endpoint
Cisco IP Phone 8800 Series		X
Cisco Jabber		X
Webex DX80	X	
Cisco MX Series	X	
Cisco SX Series	X	
Webex Room Series	X	
Webex Deskpro	X	

Figure 8-7 illustrates how the two categories of Cisco video endpoints derive DSCP. These categories apply only to QoS and call admission control (CAC).

**Figure 8-7 How Cisco Endpoints Derive DSCP**

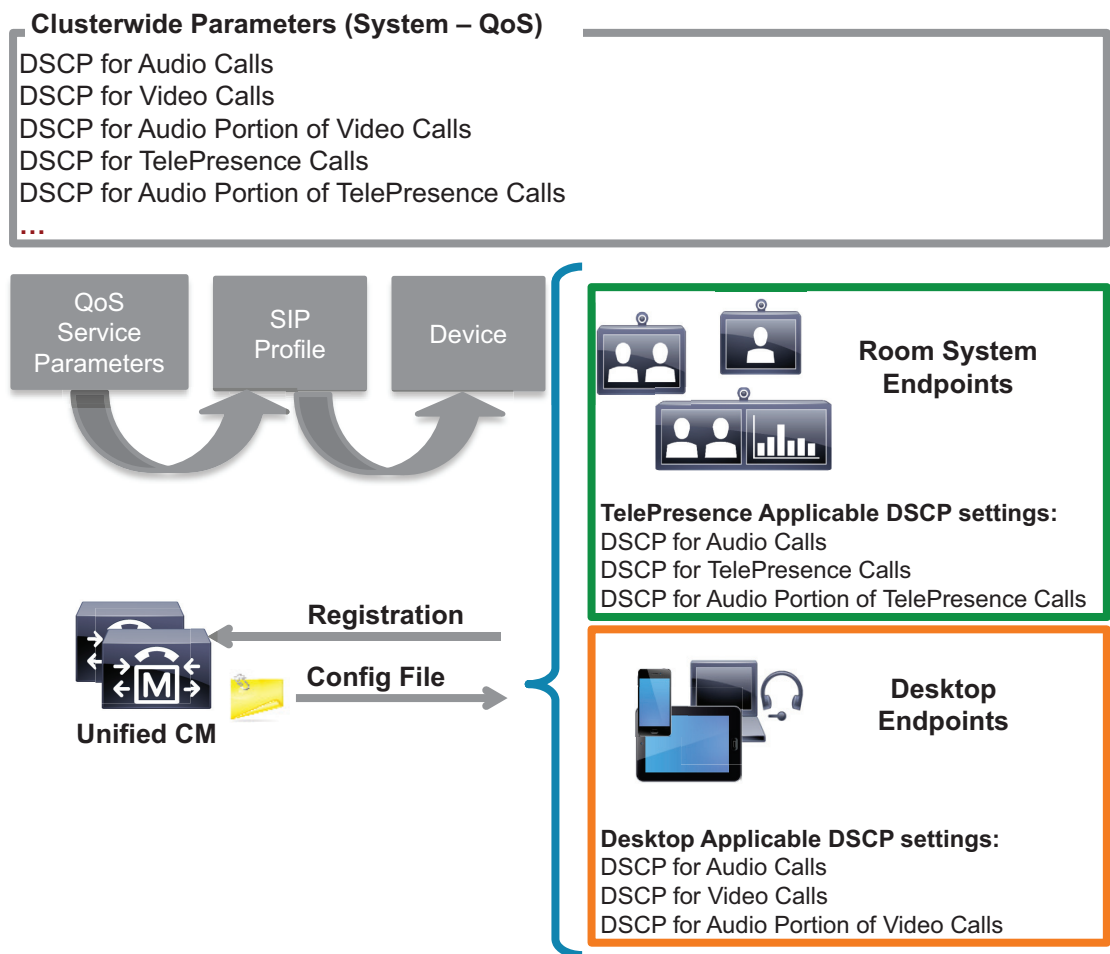

The configuration file is populated with the QoS parameters from the CallManager service parameters or the SIP Profile, when configured, and sent to the endpoint upon registration. The endpoint then uses the correct DSCP parameters for each type of media stream, depending on which category of endpoint it is. [Table 8-3](#) lists the DSCP parameters, the type of endpoint, and the type of call flow determining the DSCP marking of the stream.

**Table 8-3 DSCP for Basic Call Flows**

DSCP Parameter	Room System Endpoint	Desktop Endpoint	Call Flow
DSCP for Audio Calls	X	X	Voice-only
DSCP for Video Calls		X	Video – Audio and video stream of a video call, unless the endpoint supports the <b>DSCP for Audio Portion of Video Calls</b> parameter (see <a href="#">Table 8-4</a> )
DSCP for Audio Portion of Video Calls		X	Audio stream of a video call – Applicable only to endpoints that support the parameter
DSCP for TelePresence Calls	X		Video – Audio and video stream of a video call, unless the endpoint supports the <b>DSCP for Audio Portion of TelePresence Calls</b> parameter (see <a href="#">Table 8-4</a> )
DSCP for Audio Portion of TelePresence Calls	X		Audio stream of a video call – Applicable only to endpoints that support the parameter

**Table 8-4 Endpoint Support for DSCP for Audio Portion of Video and TelePresence Calls**

Video Endpoint	DSCP for Audio Portion of Video Call	DSCP for Audio Portion of TelePresence Call
IP Phone 8845 and 8865 Series	Yes	No
Webex DX80 <sup>1</sup>	No	Yes
SX and MX Series <sup>1</sup>	No	Yes
Webex Room Series <sup>1</sup>	No	Yes
Webex Deskpro <sup>1</sup>	No	Yes

1. CE Software

## Trusted Core Devices and Applications

Like endpoints, devices and applications in the collaboration portfolio source and terminate media and signaling streams. These trusted applications require the appropriate configuration on the application itself as well as the switch to which the application is connected in order to transparently pass the QoS marking of the media and signaling.

Core trusted devices and applications:

- Cisco Unified Communications Manager and IM and Presence Service
- Cisco Expressway
- Cisco Unity Connection
- Cisco Meeting Server
- Cisco IOS SIP Gateway and Cisco Unified Border Element

It is important to ensure that DSCP Trust is enabled on the switch ports to which these endpoints and application servers are connected. QoS DSCP trust is typically enabled by default on all newer Cisco switches; however, it is important to verify each switch platform to determine if this QoS trust is enabled, since some platforms do not trust DSCP by default.

## Endpoints and Clients

For the endpoints, the DSCP marking of packets on ingress into the switch needs to be re-marked using network access control lists (ACLs) to ensure that collaboration media and SIP signaling are marked appropriately and that other PC data traffic is marked to DSCP of Best Effort (DSCP 0) or as is appropriate based on the QoS data policies set forth by the enterprise.

The method used here consists of mapping identifiable media and signaling streams based on specific protocol ports, such as UDP and TCP ports, then making use of network access lists to remark QoS of the signaling and media streams based on those protocol port ranges. This method applies to all Cisco Jabber clients (Cisco Jabber for Windows, Cisco Jabber for Mac OS, Cisco Jabber for iPhone, Cisco Jabber for iPad, and Cisco Jabber for Android) because they all behave similarly when allocating media and signaling port ranges. Unlike Cisco Jabber clients, endpoints such as IP phones, 8800 Series IP and video phones, and DX Series with PC ports require an additional measure of matching on DSCP as well as UDP ports. The reason for this is that the IP phones and video endpoints use the same UDP port range for both audio and video, and thus in order to differentiate audio and video, matching on both UDP port range and DSCP allow for the proper identification of media traffic.

The concept is simple. An access list is used in the network access layer equipment (switch) to identify the media and signaling streams based on UDP port ranges and DSCP matching, and then it is set to re-mark them to the appropriate DSCP values. Although this technique is easy to implement and can be widely deployed, it is however not a 100% secure method and this point should be noted. This PA assumes that other security measures will be implemented to ensure the correct access to the network as well as any securing of the operating systems (OS) on the PCs and Macs used for Jabber to impede user tampering of OS related QoS settings.

[Figure 8-8](#) illustrates the use of network access control lists (ACLs) to map identifiable media and signaling streams to DSCP for Jabber clients.



Figure 8-8 Endpoint Marking

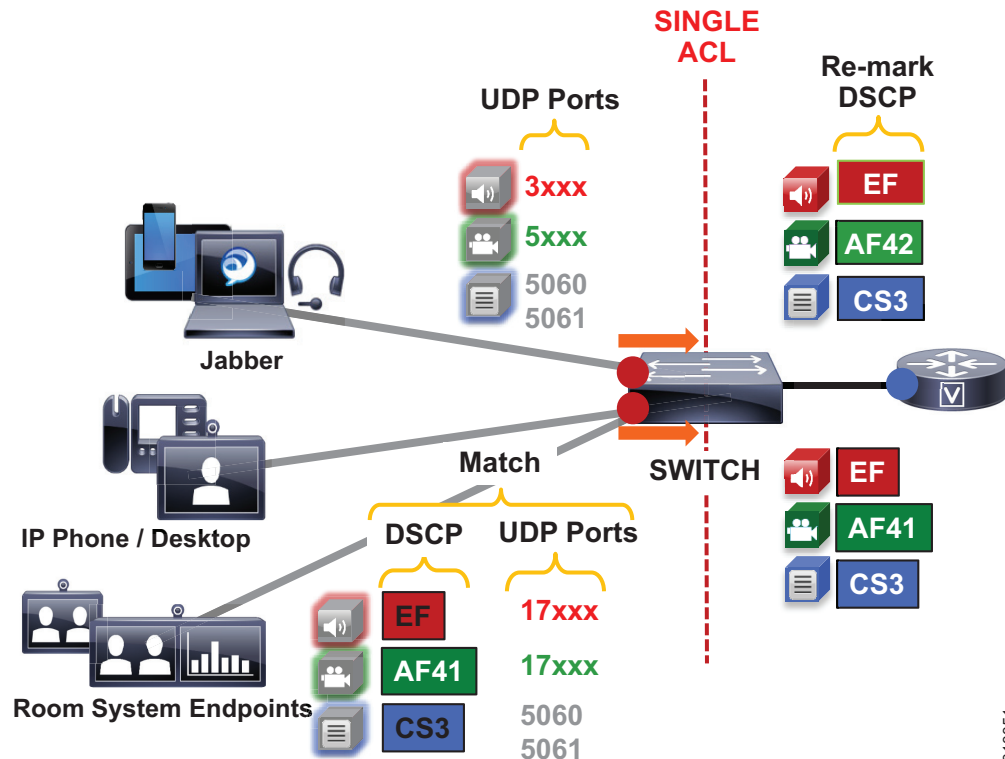

313351

**Example 8-1 Switch ACL-Based QoS Policy for Untrusted Endpoints in Figure 8-8:**

- Jabber clients
  - Match UDP Port Range 3xxx → Re-mark to DSCP EF
  - Match UDP Port Range 5xxx → Re-mark to DSCP AF42
  - Match TCP Port 5060 or 5061 → Re-mark to DSCP CS3
- IP phones and video endpoints
  - Match UDP Port Range 17xxx with DSCP EF → Re-mark to DSCP EF
  - Match UDP Port Range 17xxx with DSCP AF41 → Re-mark to DSCP AF41
  - Match TCP Port 5060 or 5061 → Re-mark to DSCP CS3
- Generic matching
  - Matches the rest of the traffic and sets DSCP to 0 (Best Effort or BE) using a default class-map

Endpoints send and receive other data and signaling such as ICMP, DHCP, TFTP, BFCP, LDAP, XMPP, FECC, CTI, and so forth. The QoS values for this traffic should follow the enterprise best practices for each type of traffic. Without doing this step, all other traffic apart from media and SIP signaling will be set to a DSCP of BE (DSCP 0) by the class-default in this configuration. We recommend either passing through the traffic marking by matching on DSCP and then re-marking the DSCP to the same value, or else using the TCP and UDP ports for each protocol that the endpoints use for communications.

## QoS for Cisco Jabber Clients

As discussed, this method involves classifying media and signaling by identifying the various streams from the Jabber client based on IP address, protocol, and/or protocol port range. Once identified, the signaling and media streams can be classified and re-marked with a corresponding DSCP. The protocol port ranges are configured in Unified CM and are passed to the endpoint to use during device registration. The network can then be configured via access control lists (ACLs) to classify traffic based on IP address, protocol, and protocol port range, and then to re-mark the classified traffic with the appropriate DSCP as discussed in the preceding section.

Cisco Jabber provides identifiable media streams based on UDP protocol port ranges and identifiable signaling streams based on TCP protocol port ranges. In Unified CM, the signaling port for endpoints is configured in the SIP Security Profile, while the media port range is configured in the SIP Profile of the Unified CM administration pages.

For the media port range, all endpoints and clients use the SIP profile parameter **Media Port Ranges** to derive the UDP ports used for media. By default, media port ranges are configured with **Common Port Range for Audio and Video**. When Jabber clients receive this port range in their configuration file, they split the port range in half and use the lower half for the audio streams of both voice and video calls and the upper half for the video streams of video calls. This is illustrated in [Figure 8-9](#).

**Figure 8-9 Media and Signaling Port Range – Common**

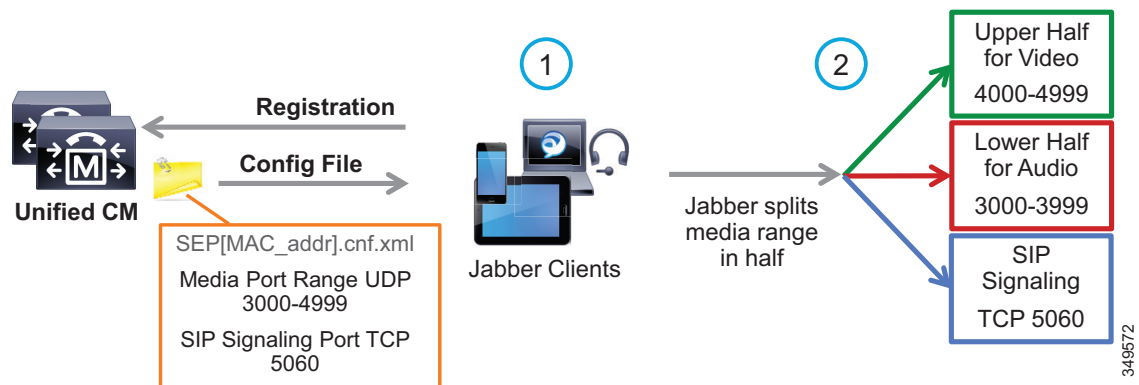

Jabber can also use the **Media Port Ranges > Separate Port Range for Audio and Video** configuration. In this configuration the Unified CM administrator can specify a non-contiguous audio and video port range, as illustrated in [Figure 8-10](#).

**Figure 8-10 Media and Signaling Port Range – Separate**

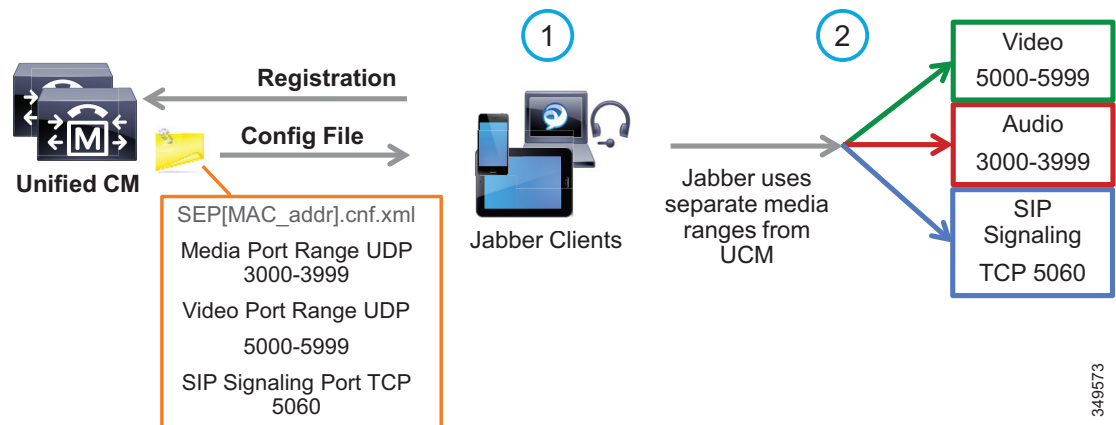

**Caution**

**Security Alert:** If you use identifiable media streams for QoS classification at the network level, the trust model does *not* extend to the application itself. Apart from prioritizing streams from the intended application, other applications *could* potentially be configured to use the same identification criteria (media port range) and marking, and therefore achieve network prioritization. Because this unintended traffic would not be accounted for in call admission control or in the provisioning of the network, severe overall impact to real-time conversations could occur. It is for this reason that it is a good practice to define restricted port ranges whenever possible to identify the media streams.

When utilizing this technique, it is important to ensure that the audio portion of these video calls that will be re-marked to the audio traffic class (EF), and the video portions that will be re-marked to the video traffic class (AF4), are provisioned in the network accordingly. [Figure 8-11](#) is an example of placing audio traffic into a Priority Queue (PQ) and video traffic into a Class Based Weighted Fair Queue (CBWFQ). The combination of PQ and CBWFQ is often referred to as low latency queuing (LLQ). Note that, because it is not possible to use port ranges in Cisco Jabber endpoints to differentiate the audio portion of voice-only calls from the audio portion of video calls, all audio using this technique will be re-marked to EF. It is important to provision the PQ adequately to support voice-only calls and the audio portion of video calls. An example of such provisioning is illustrated in [Figure 8-11](#). For more information on the design and deployment recommendations for provisioning queuing and scheduling in the network, see the [WAN Queuing and Scheduling](#) section.

**Figure 8-11 Provisioning Jabber QoS in the Network**

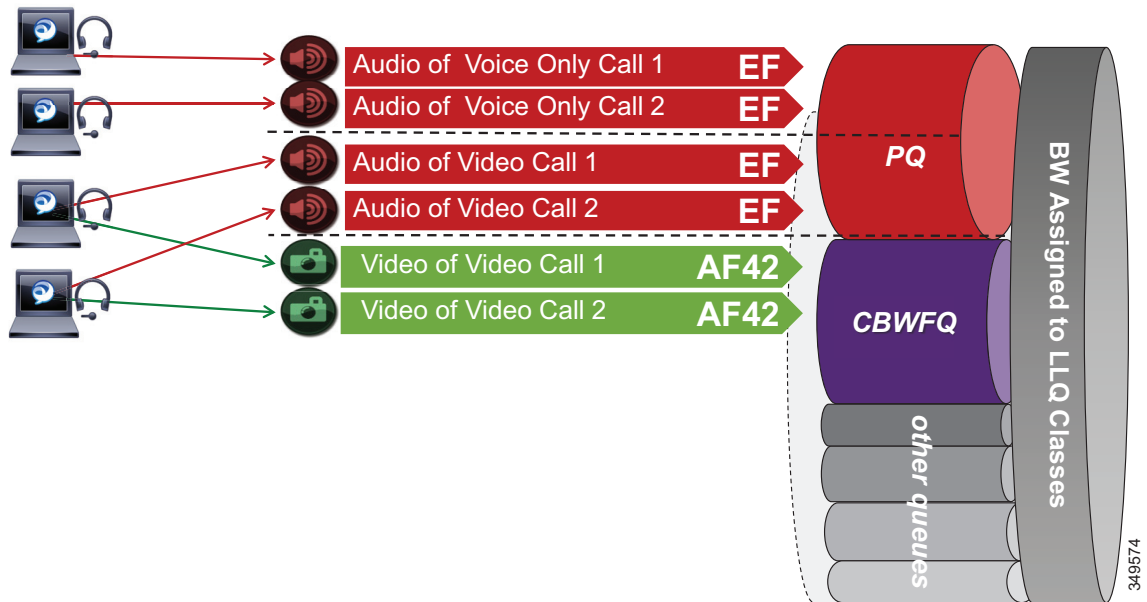

According to RFC 3551, when RTCP is enabled on the endpoints, it uses the next higher odd port. For example, a device that establishes an RTP stream on port 3500 would send RTCP for that same stream on port 3501. This function of RTCP is also true with all Jabber clients. RTCP is common in most call flows and is typically used for statistical information about the streams and to synchronize audio and video in video calls to ensure proper lip-sync. In most cases, video and RTCP can be enabled or disabled on the endpoint itself or in the common phone profile settings.

### Utilizing the Network for Classification and Marking

Based on the identifiable media and signaling streams created by the endpoints, common network QoS tools can be used to create traffic classes and to re-mark packets according to those classes.

These QoS mechanisms can be applied at different layers, such as the access layer (access switch), which is closest to the endpoint and the router level in the distribution, core, or services WAN edge. Regardless of where classification and re-marking occurs, we recommend using DSCP to ensure end-to-end per-hop behaviors.

As previously mentioned, Cisco Unified CM allows the port range utilized by SIP endpoints to be configured in the SIP Profile. As a general rule, a port range of a minimum of 100 ports (for example, 3000 to 3099) is sufficient for most scenarios. A smaller range could be configured as long as there are enough ports for the various audio, video, and associated RTCP ports (RTCP runs over the odd ports in the range), as well as ensuring against port conflict with other applications on the operating system of the device that may be using these ports since this could cause port collisions.

### Access Layer (Layer 2 Definitions)

When utilizing the access layer to classify traffic, the classification occurs at the ingress of traffic into the network, thus allowing the flows to be identified as they enter. In environments where QoS policies are applied not only in the WAN but also within the LAN, all upstream components can rely on traffic markings when processing. Classification at the ingress allows different methods to be utilized based on different types of endpoints.

Configuring QoS policies in the access layer of the network could result in a significant amount of devices that require configuration, which can create additional operational overhead. The QoS policy configurations should be standardized across the various switches of the access layer through templates. You can use configuration deployment tools to relieve the burden of manual configuration. The PA simplifies this process by using a single group of ACLs that can be used across the various switching platforms.

### Distribution/Core/Services WAN Edge (Layer 3 Definitions)

Another location where QoS marking can take place is at the Layer 3 routed boundary. In a campus network Layer 3 could be in the access, distribution, core, or services WAN edge layers. The recommendation is to classify and re-mark at the access layer, then trust through the distribution and core of the network, and finally re-classify and re-mark at the WAN edge if and when needed. For smaller networks such as branch offices where there are no Layer 3 switching components deployed, QoS marking can be applied at the WAN edge router. At Layer 3, QoS policies are applied to the Layer 3 routing interfaces. In most campus networks these would be VLAN interfaces, but they could also be Fast Ethernet or Gigabit Ethernet interfaces. Figure 8-12 illustrates the areas of the network where the various types of trust are applied in relation to the places in the network – access, distribution, core, or WAN edge.

Figure 8-12 Trust and Enforcement – Places in the Network

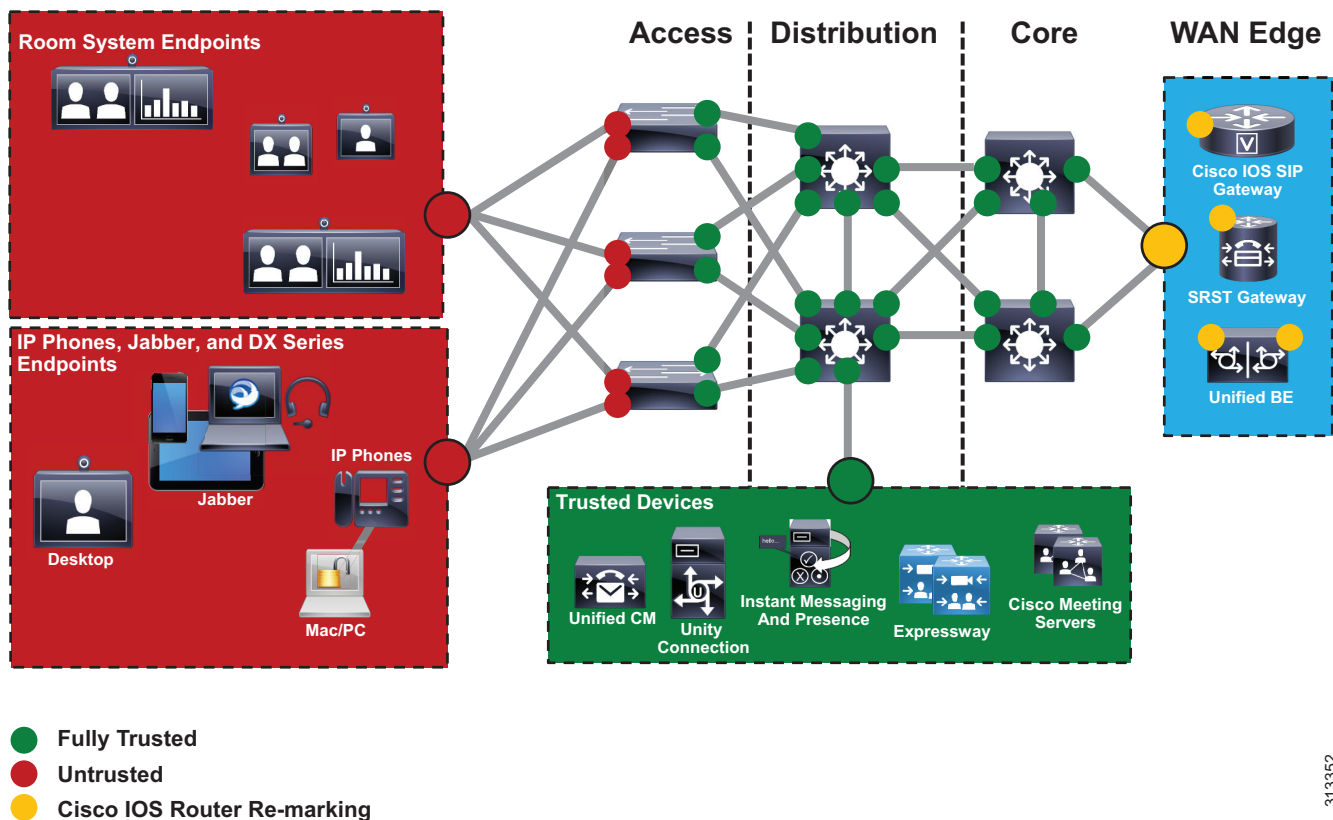

313352

## Endpoint Identification and Classification Considerations and Recommendations

Summary of design and deployment considerations and recommendations:

- Use DSCP markings whenever possible because these are IP layer end-to-end, more granular, and more extensible than Layer 2 markings.
- Mark as close to the endpoint as possible, preferably at the LAN switch level.
- When trying to minimize the number of media ports used by the Cisco Jabber client, a minimum range of 100 ports is recommended. This is to ensure that there are enough ports for all of the streams, such as RTCP, RTP for audio and video, BFCP, and RTP for secondary video for desktop sharing sessions, as well as to avoid any overlap with other applications on the same computer.
- Ensure a QoS policy includes other pertinent collaboration traffic to be re-marked, otherwise a value of 0 (Best Effort, or BE) will be placed on all remaining traffic.

## WAN Queuing and Scheduling

As discussed in the [Identification and Classification](#) section, Unified CM has the ability to differentiate the video endpoint types as well as their media streams. This provides the network administrator the ability to treat the video from different endpoints differently in the network. The recommended approach in the PA is to use AF42 DSCP markings for Jabber clients and AF41 for all desktop and room system video endpoints. These values are in line with RFC 4594. Alternatively, all video endpoints can use AF41. This will, however, negate the benefits of an opportunistic class of video endpoints, and all video endpoints will compete equally for video bandwidth with a single class.

### PA Queuing and Scheduling Approach (Single Video Queue)

A single rate-based queue with multiple DSCPs with differing drop probabilities is used in the PA for managing multiple types of video across an integrated collaboration media and data network. In this approach to scheduling video traffic in the WAN, the single video queue is configured with two AF4 drop probabilities using AF41 and AF42, where AF42 has a higher drop precedence or probability than AF41. The premise behind a single video queue with this service class with hierarchical drop precedence is that, when one class of video is not using the bandwidth within the queue, the rest of the queue bandwidth is available for the other class of video. This approach dedicates bandwidth reserved for video to be available only to the video queue during times of congestion. Other approaches such as dual rate-based video queues sub-optimally allocate excess video bandwidth from one queue to all queues on the interface equally.

Although different strategies for optimized video bandwidth utilization can be designed based on this single video queue with hierarchical DSCP drop probabilities, the PA approach is illustrated in [Figure 8-13](#).

Figure 8-13 Single Video Queue Approach

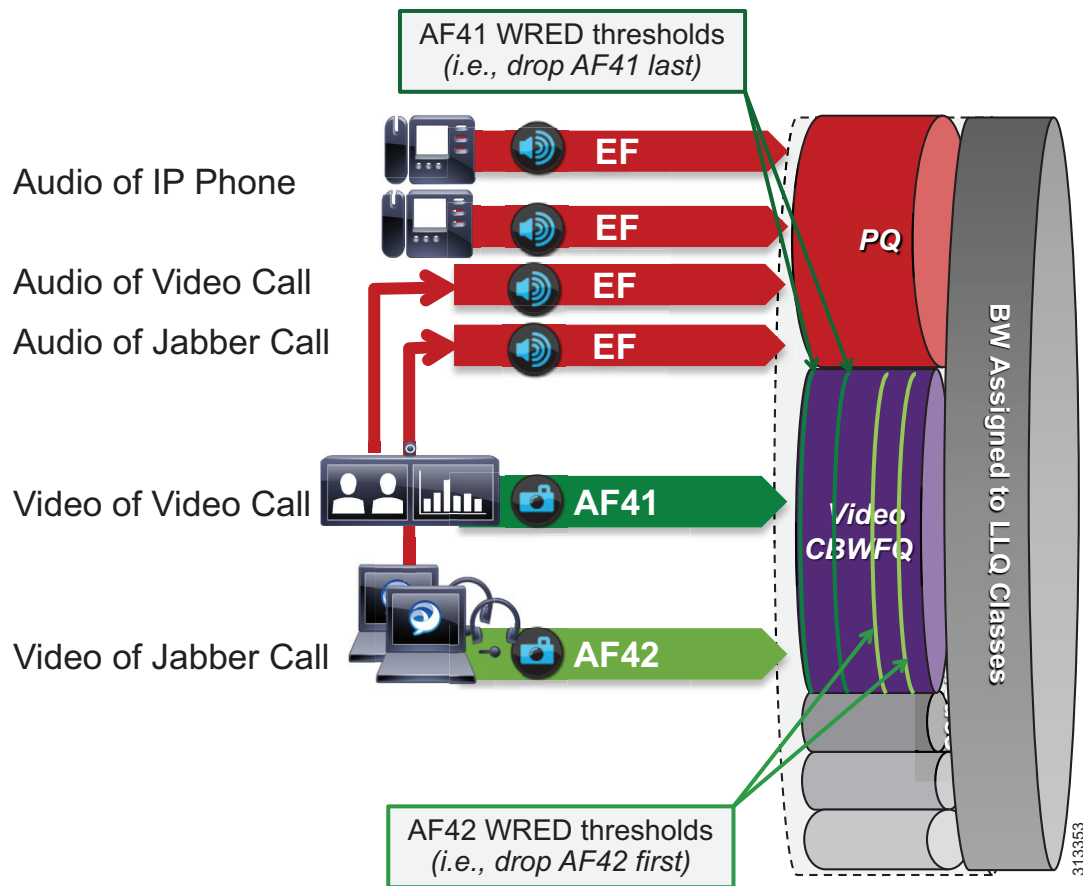

In [Figure 8-13](#) the audio of a voice call is marked as EF and placed into a Priority Queue (PQ) with a strict policer on how much bandwidth the PQ can allocate to this traffic. Video calls are separated into two classes, AF41 for prioritized video and AF42 for opportunistic or Jabber video. Using a CBWFQ with Weighted Random Early Detection (WRED), the administrator can adjust the drop precedence of AF42 over AF41, thus ensuring that during times of congestion when the queue is filling up, AF42 packets are dropped from the queue at a higher probability than AF41. See the *WAN Quality of Service* section of the *Network Infrastructure* chapter in the latest version of the [Cisco Collaboration SRND](#) for more details on the function of WRED.

The above example illustrates how an administrator using a single CBWFQ with DSCP-based WRED for all video can protect one type of video (prioritized video) from packet loss during periods of congestion over another type of video (see [Opportunistic Video, page 8-22](#)). With this *single video queue approach*, unlike the *dual video queue approach*, when one type of video is not using bandwidth in the queue, the other type of video gains full access to the entire queue bandwidth if and when needed. This is a significant improvement when deploying pervasive video.

Achieving this holistically across the entire solution depends on a number of conditions. Below is a list of conditions required to achieve marking all audio to a DSCP of EF:

- The customer equipment (CE) or service provider (SP) owned WAN equipment must support AF4 QoS containing both AF41 and AF42 QoS markings as well as Weighted Random Early Detection (WRED).
- Enhanced Locations Call Admission Control (ELCAC) can be implemented in conjunction with marking all audio as EF. ELCAC relies on the correct DSCP setting in order to ensure the protection of the queues that voice and video CAC pools represent. Changing the DSCP of audio streams of the video calls requires updating how ELCAC deducts bandwidth for video calls. This can be done by setting the service parameter **Deduct Audio Bandwidth from Audio Pool for Video Call**, under the Call Admission Control section of the CallManager service, to **True**. This parameter can be set to true or false:
  - **True** (recommended) — Cisco Unified CM splits the audio and video bandwidth allocations for video calls into separate pools. The bandwidth allocation for the audio portion of a video call is deducted from the audio pool, while the video portion of a video call is deducted from the video pool.
  - **False** (default)— Cisco Unified CM applies the legacy behavior, which is to deduct the audio and video bandwidth allocations of video call from the video pool. This is the default setting.

## Opportunistic Video

When video is deployed pervasively across the organization, bandwidth constraints typically determine the video resolution that can be achieved during the busiest hour of the day based on the bandwidth available and the number of video calls during that busy hour. To address this challenge, the PA has targeted a group of endpoints whose video is treated opportunistically by the network by using a single video queue with DSCP-based WRED coupled with a strategy for identification and classification of the Jabber clients' collaboration media.

Opportunistic video is achieving the best video quality based on the WAN bandwidth resources available at any given time. To achieve this, a number of requirements must be met:

- Select a group of video endpoints to be opportunistic. In the case of the PA, Jabber clients are used as the opportunistic video endpoints.
- Ensure the WAN is configured with a single video queue using DSCP-based WRED with AF4 DSCP class servicing with drop precedence of AF41 and AF42. (While AF43 could be used, only two DSCP values are necessary in the PA.)
- Identify and classify the video of opportunistic endpoints with AF42.
- Identify and classify all other video endpoints with AF41.



### Note

If AF42 marking and scheduling is not possible for the enterprise WAN edge, then AF41 can be used for *all* video. If that is the case, then all values set to AF42 in this document should be changed to AF41, and the benefits of opportunistic video will be minimized. With only AF41 marking, *all* video will compete for resources and will rate-adapt based on utilization in the self-regulating video network. This also simplifies the configuration. This document will, however, cover the necessary deployment procedures for marking Jabber as the opportunistic video endpoints with AF42.



## Provisioning and Admission Control

Provisioning bandwidth and ensuring the correct bit rate is negotiated between various groups of endpoints are important aspects of bandwidth management. In a Unified CM environment, bit rate is negotiated through Unified CM, which uses a concept of regions to set maximum audio and maximum video bit rates for any given call flow. This section focuses on the maximum bit rate for video calls.

Unified CM locations (see [Enhanced Locations Call Admission Control](#)) work in conjunction with regions to define the characteristics of a call flow. Regions define the type of compression or bit rate (8 kbps or G.729, 64 kbps or G.722/G.711, and so forth) that is used between any two devices. Location links define the amount of available bandwidth for the path between devices. Each device and trunk in the system is assigned to both a region (by means of a device pool) and a location (by means of a device pool or by direct configuration on the device itself):

- Regions allow the bandwidth of video calls to be set. The audio limit on the region can result in filtering out codecs with higher bit rates. However, for video calls, the video limit constrains the quality (resolution and transmission rate) of the video.
- Locations define the amount of total bandwidth available for all calls on that link. When a call is made on a link, the regional value for that call must be subtracted from the total bandwidth allowed for that link.

Building a region matrix to manage maximum video bit rate (video resolution) for groups of devices can assist in ensuring that certain groups of devices do not over-saturate the network bandwidth. The following guidelines apply to creating a region matrix:

- Group devices into maximum video bit rate categories.
- The smaller the number of groups, the easier it is to calculate bandwidth requirements.
- Consider the default region settings to simplify the matrix and provide intra-region and inter-region defaults.
- Use a single audio codec across the entire organization, both LAN and WAN, to simplify the region matrices.

For more information about region settings, see the section on [Enhanced Locations Call Admission Control](#).

[Table 8-5](#) lists an example of a maximum video session bit rate region matrix for three groups of devices.



### Note

[Table 8-5](#) is only an example of how to group devices and what maximum bit rate might be suggested for a general resolution between the groups of devices.

**Table 8-5 Example Group Region Matrix for Three Groups of Devices**

Endpoint Groupings	Video_1.5MB	Video_2.5MB	Video_20MB
Video_1.5MB	1,500 kbps	1,500 kbps	1,500 kbps
Video_2.5MB	1,500 kbps	2,500 kbps	2,500 kbps
Video_20MB	1,500 kbps	2,500 kbps	20,000 kbps

For the example in [Table 8-5](#), the three groups are:

- Video\_1.5MB

These clients would typically be the largest group of deployed video capable endpoints and thus would benefit from the opportunistic video approach. Classified as opportunistic video, they can go up to a maximum of 1,500 kbps (720p @ 30 fps) and will rate-adapt downward based on packet loss.

- Video\_2.5MB

These devices would be room systems such as the Cisco TelePresence MX or SX Series as well as desktop endpoints such as the Cisco DX Series. At 2,500 kbps maximum video bit rate, these endpoints would typically be capable of 720p @ 30 fps.

- Video\_20MB

This class is for larger room system endpoints such as the Webex Room Series and Cisco Meeting Servers and MCUs set to a maximum of 20 Mbps to allow for endpoints capable of it to run at their highest resolution and frames per second (FPS). Multi-screen systems use much more bandwidth, while single-screen systems use much less bandwidth; nonetheless, this group would be for devices utilizing their maximum bit rate capacity.

To simplify the configuration of the regions, it is important to standardize on one audio codec to be used throughout the entire organization. The first consideration is to decide whether to have a lower bit rate codec for audio calls between sites. Historically as part of managing bandwidth, enterprises have used a lower bit rate codec such as G.729 over the WAN while using a higher bit rate, wider band codec such as G.722 for calls within the LAN or MAN. Typically when deploying video at 1 to 2.5 MB per call, audio (even at 80 kbps per call) consumes so much less bandwidth that many enterprises have moved to using a higher bit rate, better quality codec such as G.722 across the entire organization (LAN and WAN). This decision has an impact on the region matrix and whether per-site regions are required or not. The concept here is that if inter-region audio or video bit rates are to be different, then per-site regions will be required. This augments the configuration of regions to the number of sites (N) multiplied by the number of video groups (X):

$$\text{Number of regions required on average} = N * X$$

If audio bit rates will be the same across the WAN and LAN, then only the regions for the video groups are required (X).

## Enhanced Locations Call Admission Control

The call admission control function is an important component of a Collaboration system, especially when multiple sites are connected through an IP WAN and limited bandwidth resources are available for audio and video calls.

### Call Admission Control Architecture

#### Unified CM Enhanced Locations Call Admission Control

Cisco Unified CM provides Enhanced Locations Call Admission Control (ELCAC) to support complex WAN topologies as well as distributed deployments of Unified CM for call admission control where multiple clusters manage devices in the same physical sites using the same WAN up-links.

To support more complex WAN topologies, Unified CM implements a location-based network modeling functionality. This provides Unified CM with the ability to support multi-hop WAN connections between calling and called parties. This network modeling functionality has also been incrementally enhanced to

support multi-cluster distributed Unified CM deployments. This allows each cluster to "share" locations by enabling the clusters to communicate with one another to reserve, release, and adjust allocated bandwidth for the same locations across clusters.

## Network Modeling with Locations, Links, and Weights

Enhanced Locations CAC is a model-based static CAC mechanism. ELCAC involves using the administration interface in Unified CM to configure locations and links to model the "routed WAN network" in an attempt to represent how the WAN network topology routes media between groups of endpoints for end-to-end audio and video calls. Although Unified CM provides configuration and serviceability interfaces in order to model the network, it is still a "static" CAC mechanism that does not take into account network failures and network protocol rerouting. Therefore, the model needs to be updated when the WAN network topology changes or bandwidth allocations across the WAN are increased or decreased. Enhanced Locations CAC is also call oriented, and bandwidth deductions are per-call not per-stream, so asymmetric media flows where the bit-rate is higher in one direction than in the other will always deduct for the highest bit rate bi-directionally. In addition, unidirectional media flows will be deducted as if they were bidirectional media flows.

Enhanced Locations CAC incorporates the following configuration components to allow the administrator to build the network model using locations and links:

- **Locations** — A location represents a LAN. It could contain endpoints or simply serve as a transit location between links for WAN network modeling. For example, an MPLS provider could be represented by a location.
- **Links** — Links interconnect locations and are used to define bandwidth available between locations. Links logically represent the WAN link and are configured in the Location user interface (UI).
- **Weights** — A weight provides the relative priority of a link in forming the effective path between any pair of locations. The effective path is the path used by Unified CM for the bandwidth calculations, and it has the least cumulative weight of all possible paths. Weights are used on links to provide a "cost" for the "effective path" and are pertinent only when there is more than one path between any two locations.
- **Path** — A path is a sequence of links and intermediate locations connecting a pair of locations. Unified CM calculates least-cost paths (lowest cumulative weight) from each location to all other locations and builds a map of the various paths. Only one "effective path" is used between any pair of locations.
- **Effective Path** — The effective path is the path with the least cumulative weight and is the bandwidth accounting path that is always used between any two locations.
- **Bandwidth Allocation** — Is the amount of bandwidth allocated in the model for each type of traffic: audio and video.
- **Location Bandwidth Manager (LBM)** — Is the active service in Unified CM that assembles a network model from configured location and link data in one or more clusters. It determines the effective paths between pairs of locations, determines whether to admit calls between a pair of locations based on the availability of bandwidth for each type of call, and deducts (reserves) bandwidth for the duration of each call that is admitted.
- **Location Bandwidth Manager Hub** — Is a Location Bandwidth Manager (LBM) service that has been designated to participate directly in intercluster replication of fixed locations, links data, and dynamic bandwidth allocation data. LBMs assigned to an LBM hub group discover each other through their common connections and form a fully-meshed intercluster replication network. Other LBM services in a cluster with an LBM hub participate indirectly in intercluster replication through the LBM hubs in their cluster.

## Locations, Links, and Weight

Unified CM uses the concept of locations to represent a physical site and to create an association with media devices such as endpoints, voice messaging ports, trunks, gateways, and so forth, through direct configuration on the device itself, through a device pool, or even through device mobility. Locations logically represent the Local Area Network (LAN). Unified CM also uses a configuration parameter called links to interconnect locations and to define bandwidth available between locations. Links logically represent the Wide Area Network (WAN). This section describes locations and links and how they are used (see [Figure 8-14](#)).

The location configuration itself consists of three main parts: links, intra-location bandwidth parameters, and RSVP locations settings. The intra-location bandwidth parameters are set to unlimited by default and should remain that way because there is little or no reason to limit bandwidth within a location (LAN). The RSVP locations settings are not considered here for Enhanced Location CAC because they apply only to RSVP implementations.

The link bandwidth parameters allow the administrator to characterize the provisioned bandwidth for audio and video calls between "adjacent locations" (that is, locations that have a link configured between them). This feature offers the administrator the ability to create a string of location pairings in order to model a multi-hop WAN network.

**Figure 8-14** Locations and Links

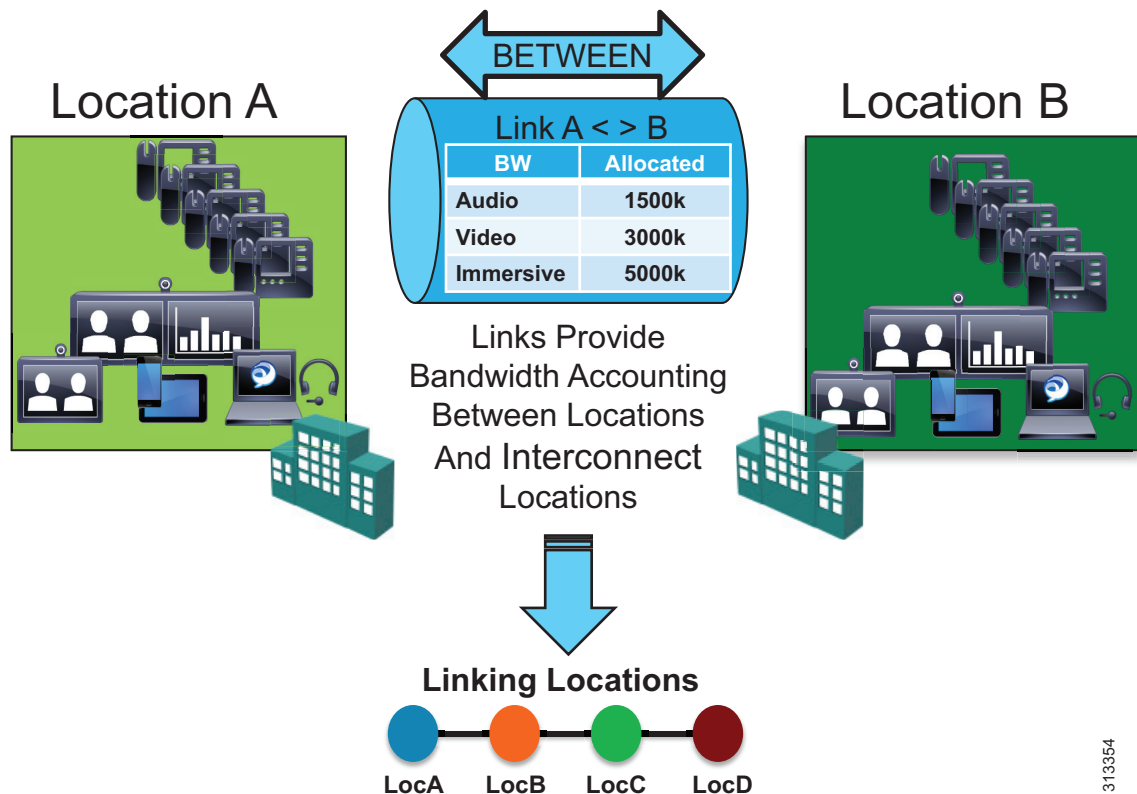

313354

Weight is configurable on the link and provides the ability to force a specific path choice when multiple paths between two locations are available. When multiple paths are configured, only one will be selected based on the cumulative weight, and this path is referred to as the *effective path*. This weight is static and the effective path does not change dynamically. When two paths have equal weight, one path is

randomly chosen; therefore it is important to ensure that only one path exists or has the least cumulative weight to ensure that it is the effective path for the Location Bandwidth Manager (LBM). This is especially important in multi-cluster environments. In most cases you will not need to modify the default weight unless there are multiple paths between two locations that have the same value, in which case you will have to modify the weight on one of the two paths to ensure that it is chosen as the effective path.

When you configure a device in Unified CM, the device can be assigned to a location. A location can be configured with links to other locations in order to build a topology. The locations configured in Unified CM are virtual locations and not real, physical locations. As mentioned, Unified CM has no knowledge of the actual physical topology of the network. Therefore, any changes to the physical network must be made manually in Unified CM to map the real underlying network topology with the Unified CM locations model. If a device is moved from one physical location to another, the system administrator must either perform a manual update on its location configuration or implement the device mobility feature so that Unified CM can correctly calculate bandwidth allocations for calls to and from that device. Each device is in location **Hub\_None** by default. Location **Hub\_None** is an example location that typically serves as a hub linking two or more locations, and it is configured by default with unlimited intra-location bandwidth allocations for audio and video bandwidth.

Unified CM allows the administrator to define separate voice and video bandwidth pools for each link between locations. In the PA, only voice and video bandwidth pools are used. Typically the link between locations is set to a finite number of kilobits per second (kbps) to match the provisioned amount of bandwidth available for audio and video in the WAN links between physical sites. Some WANs do not require any limitations because they are over-provisioned for the expected amount of traffic. If the bandwidth values are set to a finite number of kilobits per second (kbps), Unified CM will track all calls within the location and all calls that use the location as a transit location (a location that is in the calculation path but is not the originating or terminating location in the path).

The following devices must be configured in a location:

- Endpoints
- Conference bridges
- Gateways
- SIP trunks
- Music on hold (MoH) servers
- Annunciator (via device pool)

[Table 8-6](#) lists the amount of bandwidth requested for various call speeds. For all audio (both audio-only calls as well as audio of a video call), Unified CM counts the media bit rates plus the IP and UDP overhead. For example, a G.711 or G.722 audio call consumes 80 kbps (64 kbps bit rate + 16 kbps for IP/UDP headers) deducted from the audio bandwidth allocation of the location and link. For a video call, Unified CM counts only the payload (no IP/UDP header overhead) for video streams, but the audio portion is calculated with IP and UDP overhead. For example, for a video call at a bit rate of 384 kbps where audio is set to use a 64 kbps bit rate, Unified CM will allocate 320 kbps from the video bandwidth allocation and take 64 kbps for the audio and add the 16 kbps for IP/UDP headers to derive 80 kbps for the audio pool deduction. For the same call where the audio is set to use a 8 kbps bit rate, Unified CM will allocate 376 kbps from the video bandwidth allocation and take 8 kbps for the audio and add the 16 kbps for IP/UDP headers to derive 24 kbps for the audio pool deduction.

**Table 8-6** Amount of Bandwidth Requested by the Locations and Links Bandwidth Deduction Algorithm in the PA Configuration<sup>1</sup>

Call Speed (Session Bit Rate)	Audio Pool Bandwidth	Video Pool Bandwidth
G.711 or G.722 audio call (64 kbps)	80 kbps	N/A
G.729 audio call (8 kbps)	24 kbps	N/A
512 kbps video call with G.729 audio (8 kbps)	24 kbps	504 kbps
512 kbps video call with G.711 or G.722 audio (64 kbps)	80 kbps	448 kbps
768 kbps video call with G.729 audio (8 kbps)	24 kbps	760 kbps
768 kbps video call with G.711 or G.722 audio (64 kbps)	80 kbps	704 kbps
1,024 kbps video call with G.729 audio (8 kbps)	24 kbps	1,016 kbps
1,024 kbps video call with G.711 or G.722 audio (64 kbps)	80 kbps	960 kbps

1. Only 8 kbps and 64 kbps are used in these examples, but the same principle also applies to other audio bit rate codecs. The audio bit rate (payload only) is subtracted the video bit rate to get the adjusted video bit rate value.

For example, assume that the link configuration for the location Branch 1 to Hub\_None allocates 256 kbps of available audio bandwidth and 1,024 kbps of available video bandwidth. In this case the path from Branch 1 to Hub\_None can support up to three G.711 audio calls (at 80 kbps per call) or ten G.729 audio calls (at 24 kbps per call), or any combination of both that does not exceed 256 kbps. The link between locations can also support different numbers of video calls, depending on the video and audio codecs being used (for example, one video call requesting 1,024 kbps of bandwidth or two video calls with each requesting 512 kbps of bandwidth).

When a call is placed from one location to the other, Unified CM deducts the appropriate amount of bandwidth from the effective path of locations and links from one location to another. When the call has completed, Unified CM returns the bandwidth to those same links over the effective path. If there is not enough bandwidth at any one of the links over the path, the call is denied by Unified CM and the caller receives the network busy tone. If the calling device is an IP phone with a display, that device also displays the message "Not Enough Bandwidth."

When an inter-location call is denied by call admission control, Unified CM can automatically reroute the call to the destination through the PSTN connection by means of the Automated Alternate Routing (AAR) feature (see [Automated Alternate Routing](#), page 2-49).



**Note**

AAR is invoked only when Enhanced Locations Call Admission Control denies the call due to a lack of network bandwidth along the effective path. In such cases, the calls are redirected to the target specified in the Call Forward No Answer field of the called device. AAR is not invoked when the IP WAN is unavailable or other connectivity issues cause the called device to become unregistered with Unified CM.

Also, AAR is applicable only to intra-cluster endpoint-to-endpoint calls. For all inter-cluster calls that fail CAC, the route groups are used to try different SIP routing paths.

Video devices can be enabled to **Retry Video Call as Audio** if a video call between devices fails CAC. This option is configured on the video endpoint or SIP trunk configuration page in Unified CM and is applicable to video endpoints or trunks placing calls. For some video endpoints, **Retry Video Call as Audio** is enabled by default and not configurable on the endpoint.

## Locations, Links, and Region Settings

Location links work in conjunction with regions to define the characteristics of a call over the effective path of locations and links. Regions define the type of compression or bit rate (8 kbps or G.729, 64 kbps for G.722 or G.711, and so forth) that is used between devices, and location links define the amount of available bandwidth for the effective path between devices. You assign each device in the system to both a region (by means of a device pool) and a location (by means of a device pool or by direct configuration on the device itself).

You can configure locations in Unified CM to define:

- Physical sites (for example, a branch office) or transit sites (for example, an MPLS cloud) — A location represents a LAN. It could contain endpoints or simply serve as a transit location between links for WAN network modeling.
- Link bandwidth between adjacent locations — Links interconnect locations and are used to define bandwidth available between locations. Links logically represent the WAN link between physical sites.
  - Audio Bandwidth — The amount of bandwidth that is available in the WAN link for voice and fax calls being made from devices in the location to the configured adjacent location. Unified CM uses this bandwidth value for Enhanced Locations Call Admission Control.
  - Video Bandwidth — The amount of video bandwidth that is available in the WAN link for video calls being made from devices in the location to the configured adjacent location. Unified CM uses this bandwidth value for Enhanced Locations Call Admission Control.
  - Immersive Video Bandwidth — Not used in the PA configuration.

You can configure regions in Unified CM to define:

- The maximum audio bit rate
- The maximum session bit rate for video calls (includes audio)
- The maximum session bit rate for immersive video calls (includes audio) — Not used in the PA configuration.
- Audio codec preference lists

## Location Bandwidth Manager

The Location Bandwidth Manager (LBM) is a Unified CM Feature Service managed from the serviceability web pages and is responsible for all of the Enhanced Locations CAC bandwidth functions. The LBM should be configured to run on each subscriber node in the cluster that is also running the Cisco CallManager service.

The LBM performs the following functions:

- Assembles topology of locations and links
- Calculates the effective paths across the topology
- Services bandwidth requests from the Cisco CallManager service (Unified CM call control)
- Replicates the bandwidth information to other LBMs (see [Figure 8-15](#))
- Provides configured and dynamic information to serviceability
- Updates Location Real-Time Monitoring Tool (RTMT) counters

Figure 8-15 LBM Local Replication Network

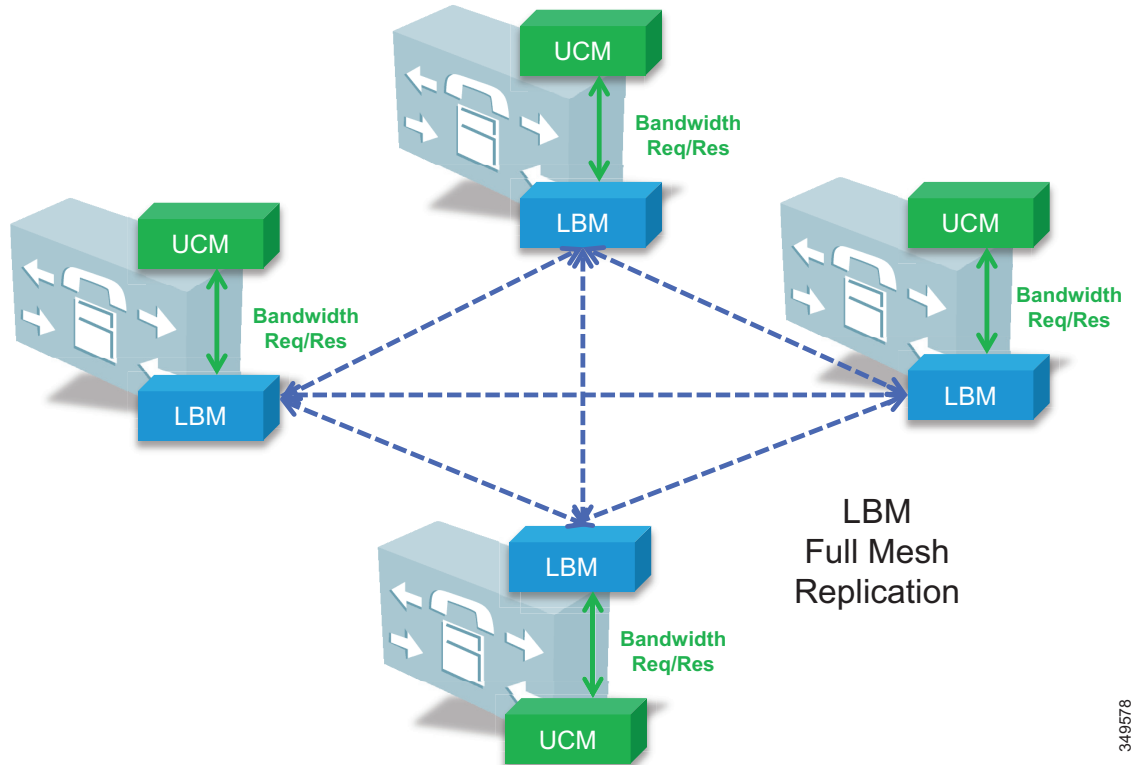

By default the CallManager service communicates with the local LBM service.

### Deducting All Audio from the Voice Pool

This PA utilizes a new Unified CM 11.x feature that allows the administrator to deduct the audio bandwidth of video calls from the voice pool. Because ELCAC relies on the correct DSCP setting in order to ensure the protection of the queues that voice and video CAC pools represent, changing how Unified CM deducts bandwidth from the video pool requires the DSCP of audio streams of the video calls to be marked the same as the audio streams of audio-only calls.

In Unified CM this feature is enabled by setting the service parameter **Deduct Audio Bandwidth from Audio Pool for Video Call** to **True** under the Call Admission Control section of the CallManager service. False is the default setting, and by default Unified CM deducts both audio and video streams of video calls from the video pool.



## Multi-Cluster Considerations

This section covers the following topics:

- [Intercluster ELCAC](#)
- [LBM Hub Replication Network](#)
- [Common Locations \(Shared Locations\) and Links](#)
- [Shadow Location](#)
- [Location and Link Management Cluster](#)

### Intercluster ELCAC

Intercluster Enhanced Locations CAC extends the concept of network modeling across multiple clusters. In intercluster Enhanced Locations CAC, each cluster manages its locally configured topology of locations and links and then propagates this local topology to other remote clusters that are part of the LBM intercluster replication network. Upon receiving a remote cluster's topology, the LBM assembles this into its own local topology and creates a global topology. Through this process the global topology is then identical across all clusters, providing each cluster a global view of enterprise network topology for end-to-end CAC. [Figure 8-16](#) illustrates the concept of a global topology with a simplistic hub-and-spoke network topology as an example.

**Figure 8-16** Example of a Global Topology for a Simple Hub-and-Spoke Network

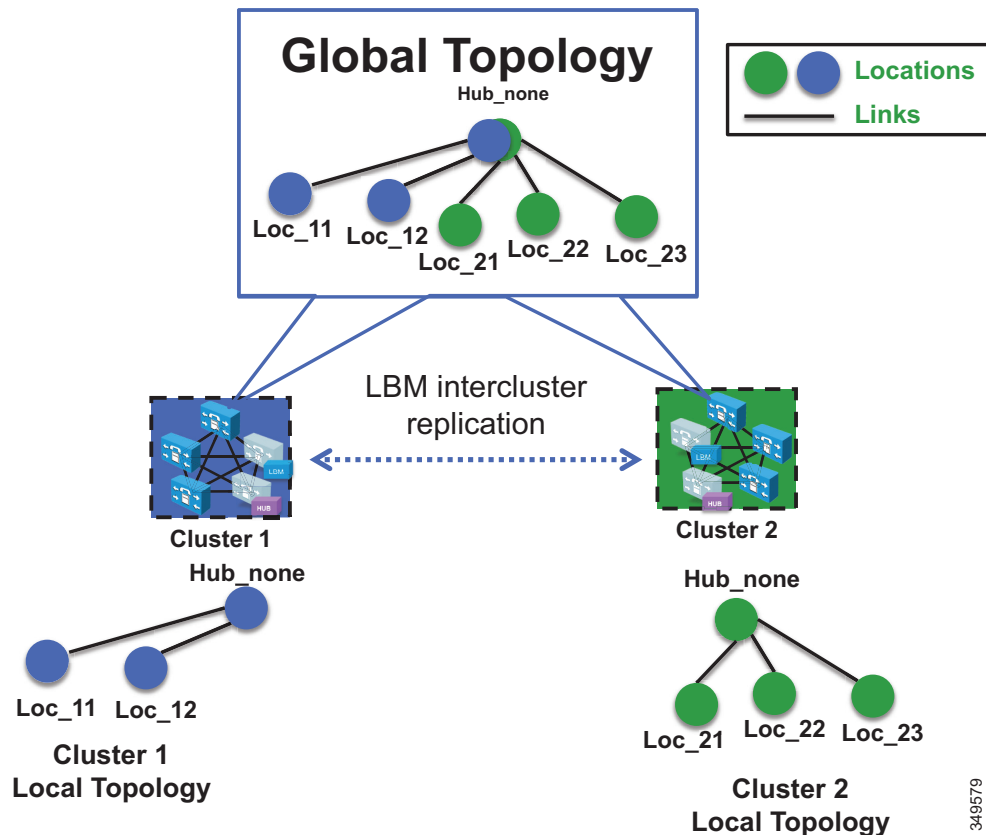

Figure 8-16 shows two clusters, Cluster 1 and Cluster 2, each with a locally configured hub-and-spoke network topology. Cluster 1 has configured Hub\_None with links to Loc\_11 and Loc\_12, while Cluster 2 has configured Hub\_None with links to Loc\_21, Loc\_22, and Loc\_23. When intercluster Enhanced Locations CAC is enabled, Cluster 1 sends its local topology to Cluster 2, as does Cluster 2 to Cluster 1. After each cluster obtains a copy of the remote cluster's topology, each cluster overlays the remote cluster's topology over its own. The overlay is accomplished through common locations, which are locations that are configured with the same name. Because both Cluster 1 and Cluster 2 have the common location Hub\_None with the same name, each cluster will overlay the other's network topology with Hub\_None as a common location, thus creating a global topology where Hub\_None is the hub and Loc\_11, Loc\_12, Loc\_21, Loc\_22 and Loc\_23 are all spoke locations. This is an example of a simple network topology, but more complex topologies would be processed in the same way.

## LBM Hub Replication Network

The intercluster LBM replication network is a separate replication network of designated LBMs called LBM hubs. LBM hubs create a separate full mesh with one another and replicate their local cluster's topology to other remote clusters. Each cluster effectively receives the topologies from every other remote cluster in order to create a global topology. The designated LBMs for the intercluster replication network are called *LBM hubs*. The LBMs that replicate only within a cluster are called *LBM spokes*. The LBM hubs are designated in configuration through the LBM **intercluster replication group**. The LBM role assignment for any LBM in a cluster can also be changed to a hub or spoke role in the intercluster replication group configuration. (For further information on the LBM hub group configuration, refer to the Cisco Unified Communications Manager product documentation available at [https://www.cisco.com/en/US/products/sw/voicew/ps556/tsd\\_products\\_support\\_series\\_home.html](https://www.cisco.com/en/US/products/sw/voicew/ps556/tsd_products_support_series_home.html).)

In the LBM intercluster replication group, there is also a concept of bootstrap LBM. Bootstrap LBMs are LBM hubs that provide all other LBM hubs with the connectivity details required to create the full-mesh hub replication network. Bootstrap LBM is a role that any LBM hub can have. If all LBM hubs point to a single LBM hub, that single LBM hub will tell all other LBM hubs how to connect to one another. Each replication group can reference up to three bootstrap LBMs.

Once the LBM hub group is configured on each cluster, the designated LBM hubs will create the full-mesh intercluster replication network. Figure 8-17 illustrates an intercluster replication network configuration with LBM hub groups set up between three clusters (Cluster 1, Cluster 2, and Cluster 3) to form the intercluster replication network.

Figure 8-17 Example Intercluster Replication Network for Three Clusters

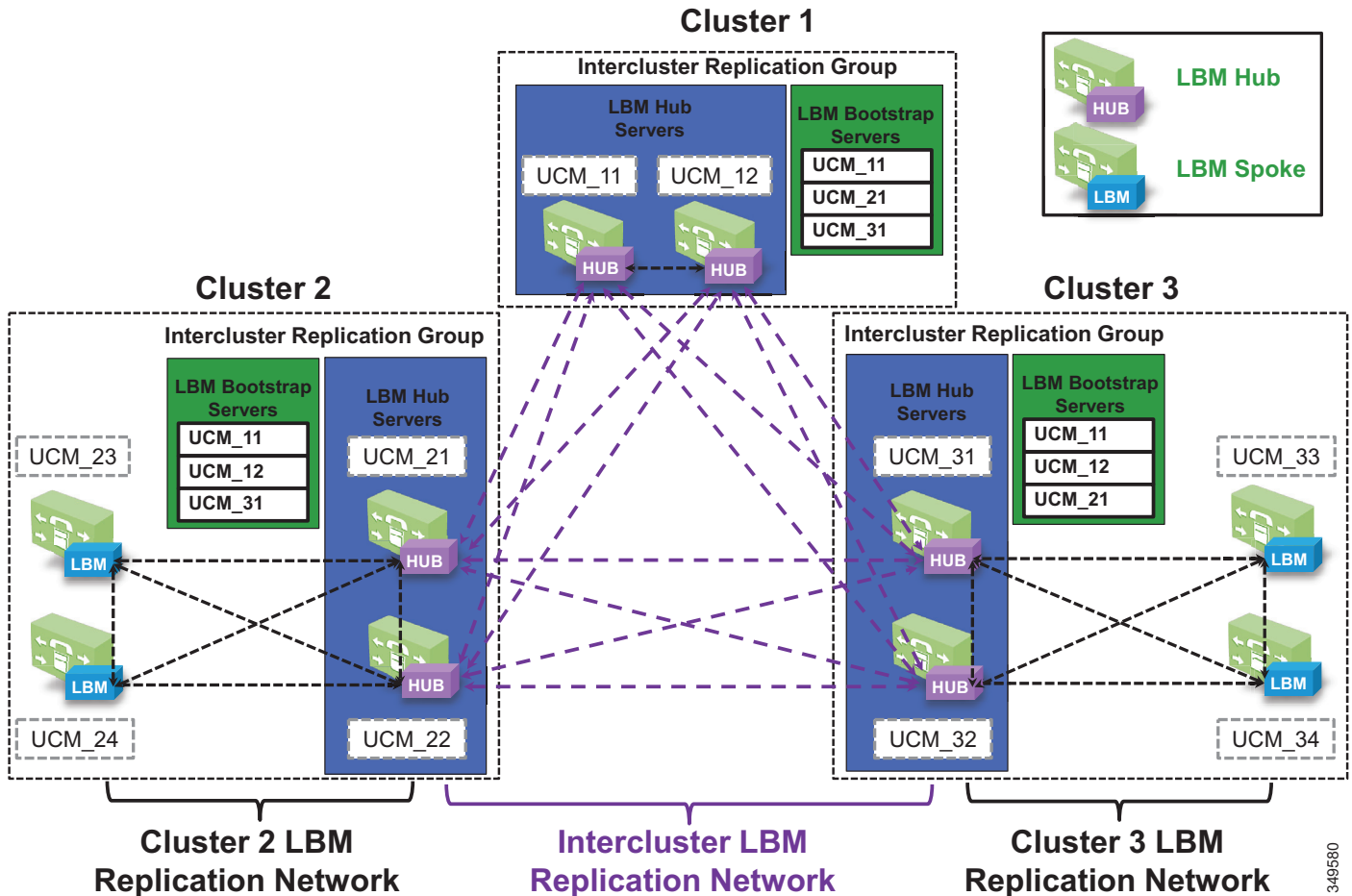

In Figure 8-17, two LBMs from each cluster have been designated as the LBM hubs for their cluster. This provides redundancy for the LBM hub role. These LBM hubs form the intercluster LBM replication network. The bootstrap LBMs configured in each LBM intercluster replication group are designated as UCM\_11 and UCM\_12. These two LBM hubs from Cluster 1 serve as points of contact or bootstrap LBMs for the entire intercluster LBM replication network. UCM\_21 and UCM\_31 in Cluster 2 and Cluster 3, respectively, serve as backup bootstrap LBM hubs when the primaries are not available (that is, when Cluster 1 is not available). Establishing the intercluster LBM replication network means that each LBM hub in each cluster connects to UCM\_11, replicates its local topology, and gets the remote topology. They also get the connectivity information for the other clusters from UCM\_11, connect to the other remote clusters, and replicate their topologies. This creates the full-mesh replication network. If UCM\_11 is unavailable, the LBM hubs will connect to UCM\_12. If Cluster 2 LBM hubs are unavailable, Cluster 2 and Cluster 3 LBM hubs will connect to UCM\_31, and Cluster 3 LBM hubs will connect to UCM\_21.

349580

The LBM has the following roles with respect to the LBM intercluster replication network:

- LBM hubs (local LBMs)
  - Communicate directly to other remote hubs as part of the intercluster LBM replication network
- LBM spokes (local LBMs)
  - Communicate directly to local LBM hubs in the cluster and indirectly to the remote LBM hubs through the local LBM hubs
- Bootstrap LBMs
  - LBM hubs responsible for interconnecting all clusters' LBM hubs in the replication network
  - Can be any LBM hub(s) in the network
  - Can indicate up to three bootstrap LBM hubs per LBM intercluster replication group
- LBM hub replication network — Bandwidth deduction and adjustment messages
  - LBM optimizes the LBM messages by choosing a sender and receiver from each cluster

LBM hubs can also be configured to encrypt their communications. This allows intercluster ELCAC to be deployed in environments where it is critical to encrypt traffic between clusters because the links between clusters might reside over unprotected networks. For further information on configuring encrypted signaling between LBM hubs, refer to the Cisco Unified Communications Manager product documentation available at

[https://www.cisco.com/en/US/products/sw/voicesw/ps556/tsd\\_products\\_support\\_series\\_home.html](https://www.cisco.com/en/US/products/sw/voicesw/ps556/tsd_products_support_series_home.html)

### Common Locations (Shared Locations) and Links

Common locations are locations that are named the same across clusters. Common locations play a key role in how the LBM creates the global topology and how it associates a single location across multiple clusters. A location with the same name between two or more clusters is considered the same location and thus is a shared location across those clusters. If a location is meant to be shared between multiple clusters, it must have exactly the same name. After replication, the LBM will check for configuration discrepancies across locations and links. Any discrepancy in bandwidth value or weight between common locations and links can be seen in serviceability, and the LBM calculates the locations and link paths with the most restrictive values for bandwidth and the lowest value (least cost) for weight.

Common locations and links can be configured across clusters for a number of different reasons. You might have a number of clusters that manage devices in the same physical site and use the same WAN up-links, and therefore the same location needs to be configured on each cluster in order to associate that location to the local devices on each cluster. You might also have clusters that manage their own topology, yet those topologies interconnect at specific locations and you will have to configure those locations as common locations across each cluster so that, when the global topology is being created, the clusters have the common interconnecting locations and links on each cluster to link each remote topology together effectively. [Figure 8-18](#) illustrates linking topologies together and shows the common topology that each cluster shares.

Figure 8-18 Using Common Locations and Links to Create a Global Topology

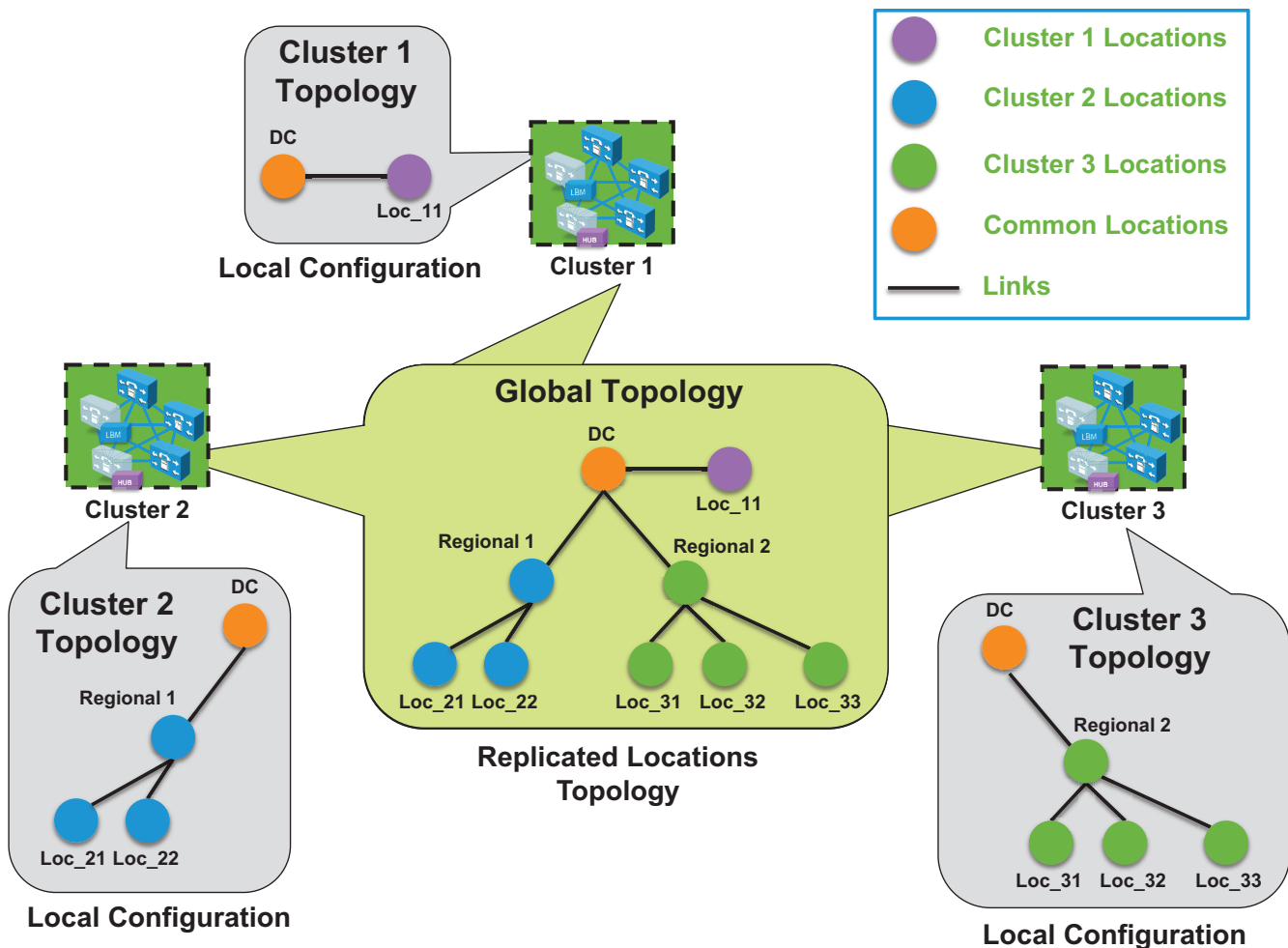

In Figure 8-18, Cluster 2 has devices in locations Regional 1, Loc\_21, and Loc\_22, but it requires configuring DC and a link from Regional 1 to DC in order to link to the rest of the global topology. Cluster 3 is similar, with devices in Regional 2 and Loc\_31, Loc\_32, and Loc\_33, and it requires configuring DC and a link from DC to Regional 2 to map into the global topology. Cluster 1 has devices in Loc\_11 only, and it requires configuring DC and a link to DC from Loc\_11 to map into Cluster 2 and Cluster 3 topologies.

The key to topology mapping from cluster to cluster is to ensure that at least one cluster has a common location with another cluster so that the topologies interconnect accordingly.

### Shadow Location

The shadow location is used to enable a SIP trunk to pass Enhanced Locations CAC information such as location name, among other things, required for Enhanced Locations CAC to function between clusters. In order to pass this location information across clusters, the SIP intercluster trunk (ICT) must be assigned to the shadow location. The shadow location cannot have a link to other locations, and therefore no bandwidth can be reserved between the shadow location and other locations. Any device other than a SIP ICT that is assigned to the shadow location will be treated as if it was associated to Hub\_None.

## Location and Link Management Cluster

In order to avoid configuration overhead and duplicated configuration across clusters that share a large number of locations, a Location and Link Management Cluster can be configured to manage all locations and links in the global topology. All other clusters uniquely configure the locations that they require for location-to-device association and do not configure links or any bandwidth values other than unlimited. The Location and Link Management Cluster is a design concept and is simply any cluster that is configured with the entire global topology of locations and links, while all other clusters in the LBM replication network are configured only with locations set to unlimited bandwidth values and without configured links. When intercluster Enhanced Locations CAC is enabled and the LBM replication network is configured, all clusters replicate their view of the network. The designated Location and Link Management Cluster has the entire global topology with locations, links, and bandwidth values; and once those values are replicated, all clusters use those values because they are the most restrictive. This design alleviates configuration overhead in deployments where a large number of common locations are required across multiple clusters.

### Recommendations

Location and Link Management Cluster:

- One cluster should be chosen as the management cluster (the cluster chosen to manage administratively locations and links).
- The management cluster should be configured with the following:
  - All locations within the enterprise will be configured in this cluster.
  - All bandwidth values and weights for all locations and links will be managed in this cluster.

All other clusters in the enterprise:

- All other clusters in the enterprise should configure only the locations required for association to devices but should not configure the links between locations. This link information will come from the management cluster when intercluster Enhanced Locations CAC is enabled. By default there is always a link configured between a newly added location and `hub_none`. This link should be removed if `hub_none` is either not used or is not correct in the topology being built.
- When intercluster Enhanced Locations CAC is enabled, all of the locations and links will be replicated from the management cluster.

LBM will always use the lowest, most restrictive bandwidth and lowest weight value after replication.

### Benefits

- Manages enterprise CAC topology from a single cluster.
- Alleviates location and link configuration overhead when clusters share a large number of common locations.
- Alleviates configuration mistakes in locations and links across clusters.
- Other clusters in the enterprise require the configuration only of locations needed for location-to-device and endpoint association.
- Provides a single cluster for monitoring of the global locations topology.

Figure 8-19 illustrates a Location and Link Management Cluster for three clusters.



#### Note

As mentioned, any cluster can act as the Location and Link Management Cluster. In Figure 8-19, Cluster 1 is the Location and Link Management Cluster.

Figure 8-19 Example of Cluster 1 as a Location and Link Management Cluster

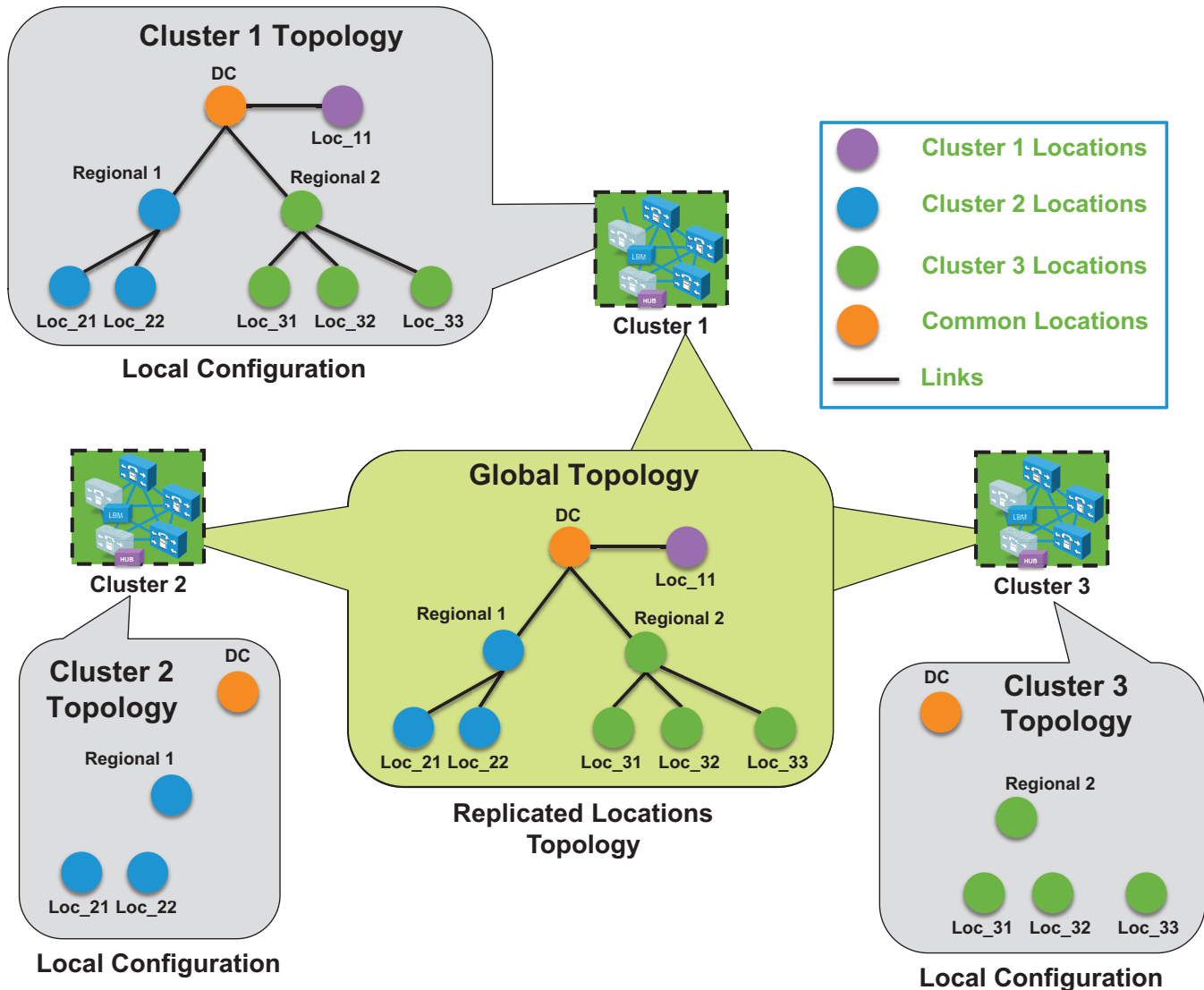

In Figure 8-19 there are three clusters, each with devices in only a regional and remote locations. Cluster 1 has the entire global topology configured with locations and links, and intercluster LBM replication is enabled among all three clusters. None of the clusters in this example share locations, although all of the locations are common locations because Cluster 1 has configured the entire location and link topology. Note that Cluster 2 and Cluster 3 configure only the locations that they require to associate to devices and endpoints, while Cluster 1 has the entire global topology configured. After intercluster replication, all clusters will have the global topology with locations and links.

349582

## Design Considerations for Call Admission Control

This section describes how to apply the call admission control mechanisms to various IP WAN topologies. Unified CM Enhanced Locations CAC network modeling support, together with intercluster enhanced locations, can support most of the network topologies in any Unified CM deployment model. Enhanced Locations CAC is still a statically defined mechanism that does not query the network, and therefore the administrator still has to provision Unified CM accordingly whenever network changes affect admission control. This is where a network-aware mechanism such as RSVP can fill that gap and provide support for dynamic changes in the network, such as when network failures occur and media streams take different paths in the network. This is often the case in designs with load-balanced dual or multi-homed WAN up-links or unequally sized primary and backup WAN up-links.

To learn how Enhanced Locations CAC functions, and for more design and deployment details of Enhanced Locations CAC, see the Enhanced Locations Call Admission Control information in the *Bandwidth Management* chapter in the latest version of the [Cisco Collaboration SRND](#).

This section explores a few typical topologies and explains how Enhanced Locations CAC can be designed to manage them.

### Dual Data Center Design

Figure 8-20 illustrates a simple dual data center WAN network design where each remote site has a single WAN up-link to each data center. The data centers are interconnected by a high-speed WAN connection that is over-provisioned for data traffic.

**Figure 8-20** Dual Data Center WAN Network

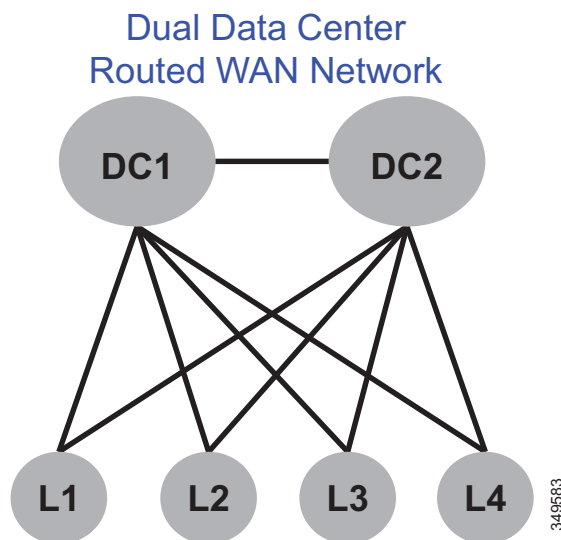

Typically these WAN up-links from the remote sites to the data centers are load-balanced or in a primary/backup configuration, and there are limited ways for a static CAC mechanism to handle these scenarios. Although you could configure this multi-path topology in Enhanced Locations CAC, only one path would be calculated as the effective path and would remain statically so until the weight metric was changed. A better way to support this type of network topology is to configure the two data centers as one data center or hub location in Enhanced Locations CAC and configure a single link to each remote site location. Figure 8-21 illustrates an Enhanced Locations CAC locations and links overlay.



**Figure 8-21** Enhanced Locations CAC Topology Model for Dual Data Centers

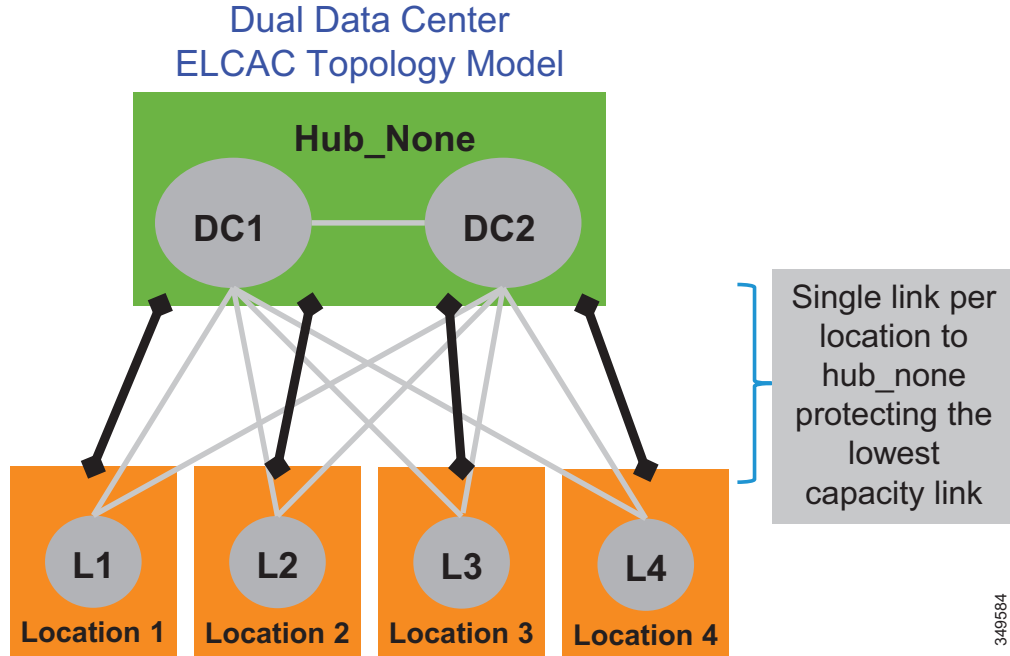

### Design Recommendations

The following design recommendations for dual data centers with remote dual or more links to remote locations, apply to both load-balanced and primary/backup WAN designs:

- A single location (Hub\_None) represents both data centers.
- A single link between the remote locations and Hub\_None protects the remote site up-links from over-subscription during normal conditions or failure of the highest bandwidth capacity links.
- The capacity of link bandwidth allocation between the remote site and Hub\_None should be equal to the lowest bandwidth capacity for the applicable Unified Communications media for a single link. For example, if each WAN up-link can support 2 Mbps of audio traffic marked EF, then the link audio bandwidth value should be no more than 2 Mbps to support a failure condition or equal-cost path routing.

### MPLS Clouds

When designing for Multiprotocol Label Switching (MPLS) any-to-any connectivity type clouds in the Enhanced Locations CAC network model, a single location can serve as the MPLS cloud. This location will not have any devices associated to it, but all of the locations that have up-links to this cloud will have links configured to the location representing the cloud. In this way the MPLS cloud serves as a transit location for interconnecting multiple variable-sized bandwidth WAN up-links to other remote locations.

### Design Recommendations

- The MPLS cloud should be configured as a location that does not contain any endpoints but is used as a hub to interconnect locations.
- The MPLS cloud serves as a transit location for interconnecting multiple variable-sized bandwidth WAN up-links to other remote locations.
- Remote sites with connectivity to dual MPLS clouds should treat those connections as a single link and size to the lowest capacity of the links in order to avoid over-subscription during network failure conditions.

### Call Admission Control Design Recommendations for Video Deployments

Admission control and QoS are complementary and in most cases co-dependent. Current Cisco product offerings such as audio and video endpoints, voice and video gateways, voice messaging, and conferencing all support native QoS packet marking based on IP Differentiated Services Code Point (IP DSCP). Note, however, that Jabber for Windows clients specifically do not follow the same native marking ability that other clients do, because the Windows operating system requires the use of Group Policy Objects (GPO) using application, IP addresses, and UDP/TCP port ranges to mark traffic with DSCP from the operating system itself. Group Policy Objects are very similar in function to network access lists in their ability to mark traffic.

QoS is critical to admission control because without it the network has no way of prioritizing the media to ensure that admitted traffic gets the network resources it requires above that of non-admitted or other traffic classifications. Unified CM's CallManager service parameters for QoS as well as the SIP Profile settings provide five main QoS settings that are applicable to endpoint media classification. [Table 8-7](#) shows the five main DSCP parameters along with their default and recommended values and Per Hop Behavior (PHB) equivalents.

**Table 8-7** QoS Settings for Endpoint Media Classification

Cisco CallManager Service Parameters Clusterwide Parameters (System - QoS)	Default Values		Recommended Values	
	DSCP	PHB	DSCP	PHB
DSCP for Audio Calls	46	EF	46	EF
DSCP for Video Calls	34	AF41	34	AF41
DSCP for Audio Portion of Video Calls	34	AF41	46	EF
DSCP for TelePresence Calls	32	CS4	34	AF41
DSCP for Audio Portion of TelePresence Calls	32	CS4	46	EF

The **DSCP for Audio Calls** setting is used for any device that makes an audio-only call. The **DSCP for Video Calls** setting is used for the audio and video traffic of any device that is classified as "desktop." **DSCP for TelePresence Calls** is used for the audio and video traffic of any device that is classified as "room system." The **DSCP for Audio Portion of Video Calls** and **DSCP for Audio Portion of TelePresence Calls** differentiate only the audio portion of video calls, dependent on the classified video call.

### Enhanced Locations CAC Design Considerations and Recommendations

The following design recommendation applies to video solutions that employ Enhanced Locations CAC:

- Intercluster SIP trunks should be associated with the shadow location.

## Design Recommendations for Cisco Expressway Deployments with Enhanced Locations CAC

In the Cisco Expressway mobile and remote access (MRA) solution, endpoints supporting the feature can register to Unified CM through a Cisco Expressway deployment without the use of a VPN. Cisco Expressway-C and Expressway-E servers are deployed, each with redundancy for high availability. Expressway-E is placed in the DMZ between the firewall to the Internet (outside) and the firewall to the enterprise (inside), while Expressway-C is placed inside the enterprise. Figure 8-22 illustrates this deployment. It also illustrates the following media flows:

- For Internet-based endpoints calling one another, the media is routed through Cisco Expressway E and Expressway C back out to the Internet, as is illustrated between endpoints B and C in Figure 8-22.
- For Internet-based endpoints calling internal endpoints, the media flows through Expressway-E and Expressway-C, as is illustrated between endpoints A and C in Figure 8-22.

**Figure 8-22** Deployment of Cisco Expressway Mobile and Remote Access (MRA)

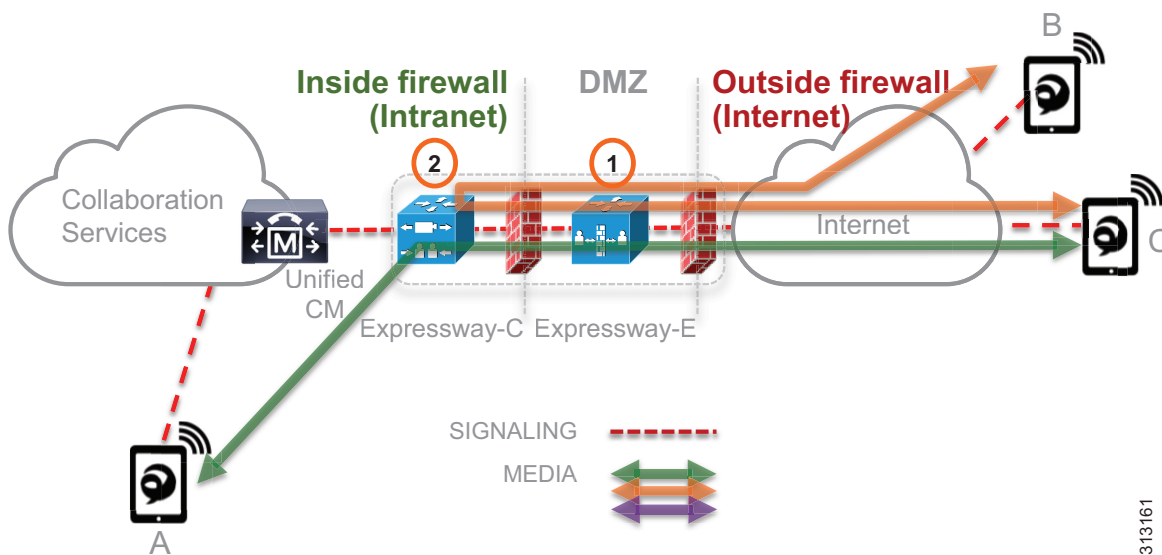

Enhanced Locations CAC for Cisco Expressway deployments requires the use of a feature in Unified CM called Device Mobility. Enabling Device Mobility on the endpoints allows Unified CM to know when the device is registered through Cisco Expressway or when it is registered from within the enterprise. Device Mobility also enables Unified CM to provide admission control for the device as it roams between the enterprise and the Internet. Device Mobility is able to do this by knowing that, when the endpoints register to Unified CM with the IP address of Expressway-C, Unified CM will associate the applicable Internet location. However, when the endpoint is registered with any other IP address, Unified CM will use the enterprise location that is configured directly on the device (or from the device pool directly configured on the device). It is important to note that Device Mobility does not have to be deployed across the entire enterprise for this function to work. Configuration of Device Mobility in Unified CM is required only for the Expressway IP addresses, and the feature is enabled only on the devices that require the function (that is to say, those devices registering through the Internet).

# Bandwidth Management Deployment

This section describes how to deploy bandwidth management for the PA. It explores all aspects discussed previously in this chapter, including identification and classification, WAN queuing and scheduling, provisioning, resource control, and bandwidth allocation guidelines for each site type.

## Deployment Overview

The Preferred Architecture example in this section is a large enterprise with users across a large geographic area and with a central headquarters site where the data center sits as well as multiple large, small, and micro sized branches with roughly 500, 50, 15, and 5 users in each branch type, respectively. To simplify the illustration of the network, these categories of sites (headquarters, large, small, and micro) are used as a template to size bandwidth considerations for each site that has a similar size user base and endpoint density. [Figure 8-23](#) illustrates this with numbers of users and endpoints at each type of site. The enterprise in this example has deployed Jabber with video to ensure that users have access to a video terminal for conferencing. The video conferencing resources are located in the data center at the Central Site (headquarters). IP phones are for voice-only communications. Video endpoints are Jabber clients, collaboration desktop endpoints (DX Series), and room-based endpoints (MX Series and SX Series). The Central Site and Large Branch also have Webex Room 70 G2s deployed.

The IT department is tasked with determining the bandwidth requirements for the WAN edge for each type of site. Each section below lists the requirements and illustrates a methodology for applying QoS, determining bandwidth and queuing requirements, and determining admission control requirements.

**Figure 8-23 Preferred Architecture for Enterprise Collaboration**

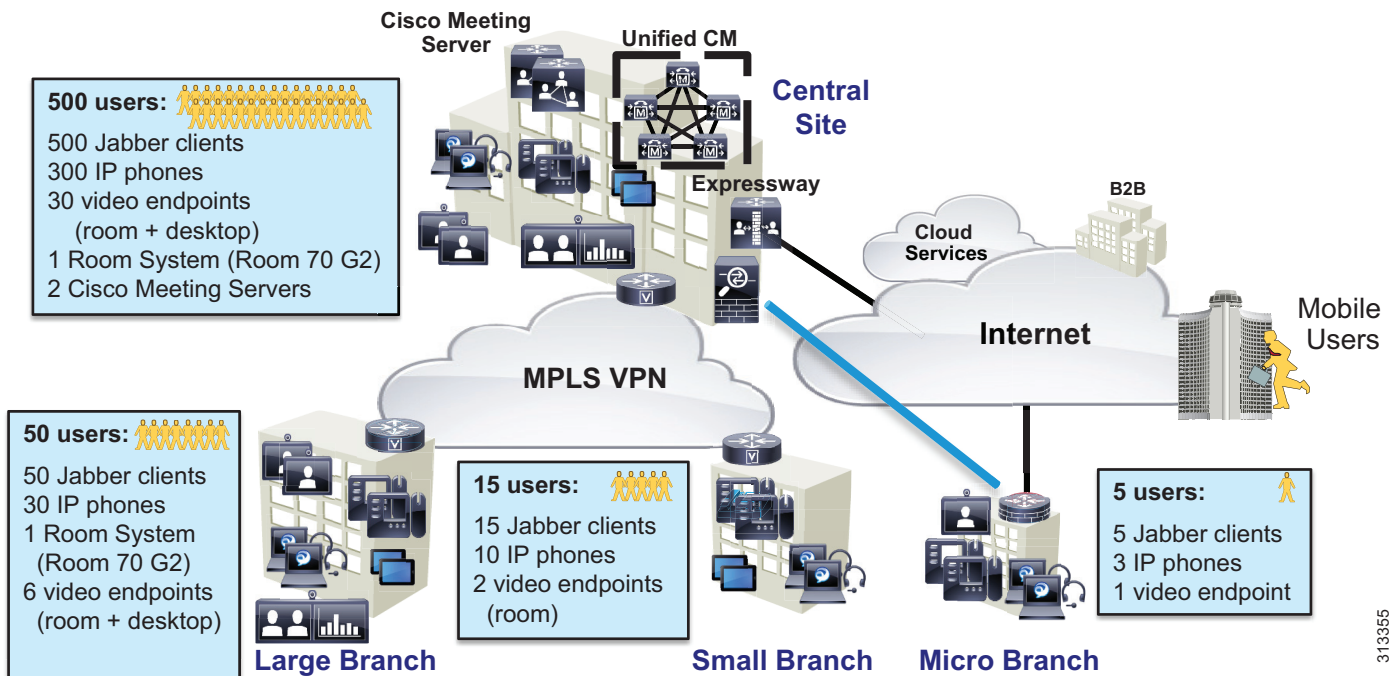

313355

Deployment of bandwidth management for the Enterprise Collaboration Preferred Architecture involves the following major tasks:

- Identification and Classification
  - Access Layer Endpoint Identification and Classification
  - Application Server QoS
  - WAN Edge Identification and Classification
  - WAN Edge Queuing and Scheduling
- Provisioning and Admission Control
  - Enhanced Locations CAC
  - Deploy Device Mobility for Mobile and Remote Access (MRA)
  - Bandwidth Allocation Guidelines

## Identification and Classification

In this phase the QoS requirements are established across the enterprise. The topics covered in this section include:

- Access Layer Endpoint Identification and Classification
  - Endpoints: Jabber
  - Endpoints: Desktop and Room System
- Application Server QoS
- WAN Edge Identification and Classification
- WAN Edge Queuing and Scheduling

This phase of the deployment involves the following high-level steps:

1. Configure endpoints in Unified CM with QoS for Jabber clients and desktop and room system endpoints.
2. Deploy an access layer policy for endpoint identification and classification for untrusted endpoints.
3. Configure application server QoS for media and SIP signaling.
4. Deploy a WAN Edge ingress marking policy for collaboration media and SIP signaling.
5. Deploy a WAN Edge egress queuing policy for collaboration media and SIP signaling.

## Access Layer Endpoint Identification and Classification

In this section endpoint QoS and media port ranges are configured in the network and in Unified CM.

### Endpoints: Jabber

Jabber endpoints are untrusted and typically sit in the data VLAN. Specific UDP port ranges are used to re-mark signaling and media at the access layer switch. In this case Unified CM is configured with a SIP Profile specifically for all Jabber clients to use the **Separate Media and Signaling Port Range** value of 3000 to 3999 for audio and 5000 to 5999 for video. The SIP signaling port of 5060 is used for SIP signaling and 5061 for secure SIP signaling. The SIP signaling port is configured in the SIP Security Profile in Unified CM. This is illustrated in [Figure 8-24](#).

**Figure 8-24 Jabber Endpoint QoS**

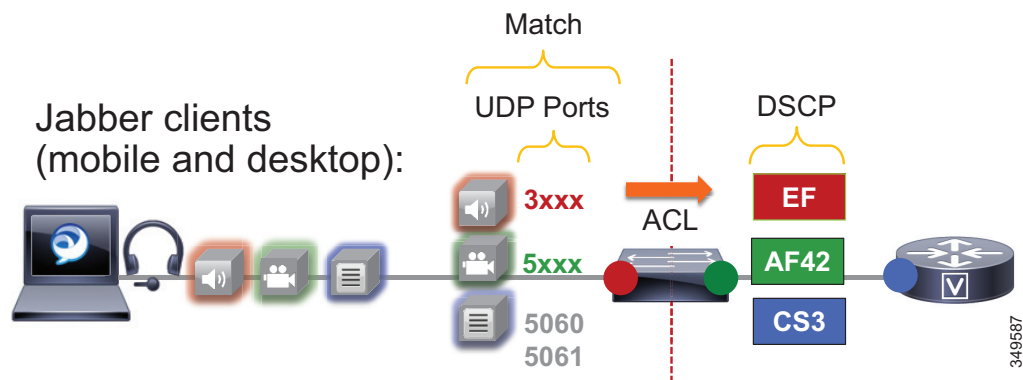

The administrator creates an ACL for the access switches for the data VLAN to re-mark UDP ports to the following DSCP values:

- Audio: UDP ports 3000 to 3999 marked as EF
- Video: UDP ports 5000 to 5999 marked as AF42
- Signaling: TCP ports 5060 to 5061 marked as CS3

Jabber classification summary:

- Audio streams of all Jabber calls (voice-only and video) are marked as EF
- Video streams of Jabber video calls are marked as AF42

For the Jabber endpoints, we also recommend changing the default QoS values in the Jabber SIP Profile. This is to ensure that, if for any reason the QoS is "trusted" via a wireless router or any other network component, then the correct "trusted" values are the same as they would be for the re-marked value. Therefore, the QoS parameters in the SIP Profile should be set as listed in [Table 8-8](#), and the UDP port ranges should be set as listed in [Table 8-9](#).

**Table 8-8 QoS Parameter Settings in SIP Profile for Jabber Endpoints**

QoS Service Parameter Name (SIP Profile)	Default Value	Changed Value
DSCP for Audio Calls	EF	No change
DSCP for Video Calls	AF41	AF42
DSCP for Audio Portion of Video Calls	AF41	EF
DSCP for TelePresence Calls	CS4	AF41
DSCP for Audio Portion of TelePresence Calls	CS4	EF

**Table 8-9 UDP Port Settings for Jabber Endpoints**

Media Port Ranges > Separate Port Range for Audio and Video	Value
Audio start port	3000
Audio stop port	3999
Video start port	5000
Video stop port	5999

The settings in [Table 8-8](#) ensure that audio of Jabber clients is set to EF, and the video will be set to AF42 if for any reason the traffic goes through a trusted path and is not re-marked via UDP port range at the access switch. This is simply to ensure a consistent configuration across Jabber endpoints.

**Note**

If you are not using AF42 for Jabber video, then the default system parameters for QoS can be used, and thus the SIP profile QoS parameters can be set to "use system default."

For Jabber on mobile devices, we recommend copying the **Standard SIP Profile for Mobile Device** when building a new SIP profile for these devices, because the default standard SIP profile for mobile devices includes recommended timer values for maintaining Jabber registration on Android and Apple iOS devices. These timers are required for any SIP profile assigned to dual-mode and tablet Jabber client devices.

**Note**

Jabber for Mac, iPad, iPhone, and Android all natively mark DSCP by the OS. Jabber for Windows, however, requires Group Policy Objects to re-mark DSCP by the OS. Without Group Policy Objects, Jabber for Windows will mark all traffic with a DSCP of 0. This is why specific port ranges are used for Jabber and without matching on DSCP.

## Endpoints: Desktop and Room System

IP phones, desktop, and room system endpoints also rely on an access layer switch ACL to re-mark traffic. Specific UDP port ranges and DSCP are used to re-mark signaling and media at the access layer switch. In this case Unified CM is configured with a SIP Profile specifically for all IP phones, desktop, and room system endpoints to use the common Media and Signaling Port Range value of 17000 to 17999 for audio and video. The SIP signaling port of 5060 is used for SIP signaling and 5061 for secure SIP signaling. The SIP signaling port is configured in the SIP Security Profile in Unified CM. This is illustrated in [Figure 8-25](#).

Figure 8-25 Desktop and Room System Endpoint QoS

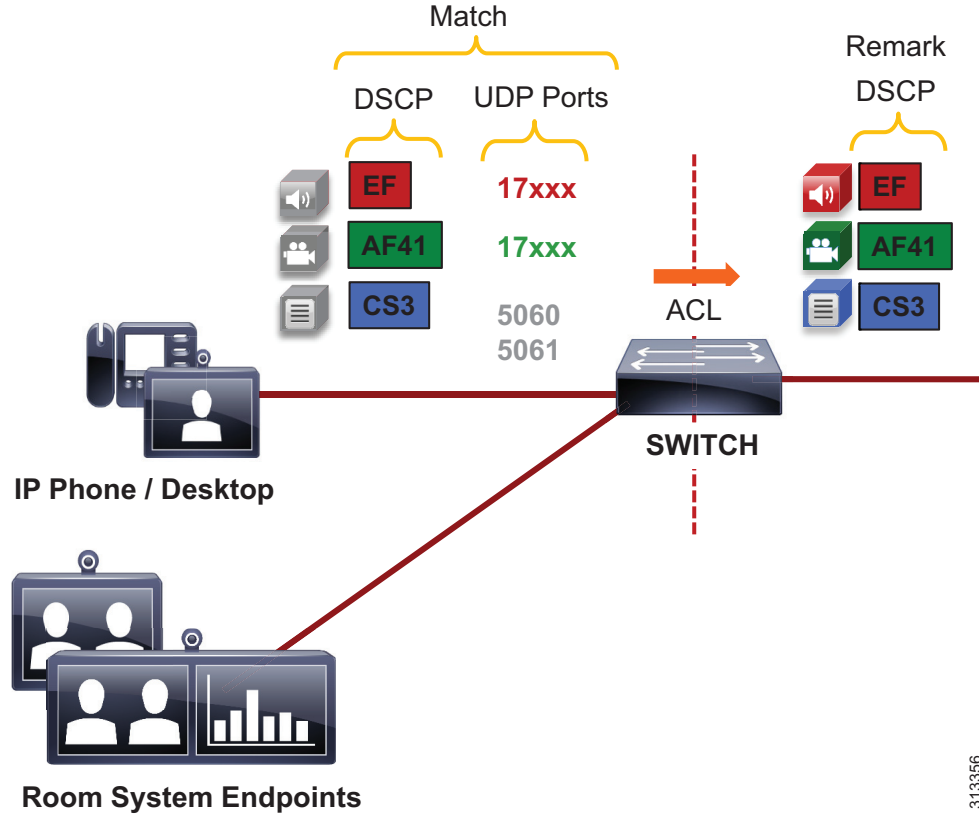

313356

The administrator creates an ACL for the access switch ports to re-mark UDP ports to the following DSCP values:

- Audio: UDP ports 17000 to 17999 with DSCP of EF to be re-marked as EF
- Video: UDP ports 17000 to 17999 with DSCP of AF41 to be re-marked as AF41
- Signaling: TCP ports 5060 to 5061 marked as CS3

Desktop and room system endpoint classification summary:

- Audio streams of all desktop and room system endpoint calls (voice-only and video) are marked EF.
- Video streams of desktop and room system endpoint video calls are marked AF41.

For the desktop and room system endpoints, the default QoS values must be changed in the SIP Profile and set as shown in [Table 8-10](#), and the UDP port ranges should be set as listed in [Table 8-11](#).



**Table 8-10 QoS Parameters in SIP Profile for Desktop and Room System Endpoints**

QoS Service Parameter Name (SIP Profile)	Default Value	Changed Value
DSCP for Audio Calls	EF	No change
DSCP for Video Calls	AF41	No change
DSCP for Audio Portion of Video Calls	AF41	EF
DSCP for TelePresence Calls	CS4	AF41
DSCP for Audio Portion of TelePresence Calls	CS4	EF

**Table 8-11 UDP Port Settings for Desktop and Room System Endpoints**

Media Port Ranges > Common Port Range for Audio and Video	Value
Media start port	17000
Media stop port	17999

### Example Switch ACL-Based QoS Policy for Endpoint Switch Ports

Desktop and room system endpoints:

- Match UDP port range 17xxx with DSCP EF → Re-mark to DSCP EF
- Match UDP port range 17xxx with DSCP AF41 → Re-mark to DSCP AF41
- Match TCP ports 5060 to 5061 → Re-mark to DSCP CS3

Jabber clients

- Match UDP port range 3xxx → Re-mark to DSCP EF
- Match UDP port range 5xxx → Re-mark to DSCP AF42
- Match TCP ports 5060 to 5061 → Re-mark to DSCP CS3

Generic matching

- Matches the rest of the traffic and sets DSCP to 0 (Best Effort or BE) using a default class-map



#### Note

The following is an example access control list based on the Cisco Common Classification Policy Language (C3PL).

```
! This section configures the ACLs to match the UDP port ranges and DSCP.
ip access-list extended QOS_VOICE
  permit udp any range 17000 17999 any dscp ef
  permit udp any range 3000 3999 any
ip access-list extended QOS_PRIORITIZED_VIDEO
  permit udp any range 17000 17999 any dscp af41
ip access-list extended QOS_JABBER_VIDEO
  permit udp any range 5000 5999 any
ip access-list extended QOS_SIGNALING
  permit tcp any any range 5060 5061
  permit tcp any any range 5060 5061 any
```

```

! This section configures the classes that match on the ACLs above.
class-map match-any VOICE
  match access-group name QOS_VOICE
class-map match-any PRIORITIZED_VIDEO
  match access-group name QOS_PRIORITIZED_VIDEO
class-map match-any JABBER_VIDEO
  match access-group name QOS_JABBER_VIDEO
class-map match-any SIGNALING
  match access-group name QOS_SIGNALING

! This section configures the policy-map matching the classes configured above and sets
DSCP for voice, video, and SIP signaling on ingress. Note that the class-default sets
everything that does not match the above to a DSCP of 0 (BE).
policy-map INGRESS_MARKING
  class VOICE
    set dscp ef
  class PRIORITIZED_VIDEO
    set dscp af41
  class JABBER_VIDEO
    set dscp af42
  class SIGNALING
    set dscp cs3
  class class-default
    set dscp 0

! This section applies the policy-map to the interface.
Switch (config-if)# service-policy input INGRESS-MARKING

```

As mentioned, endpoints send and receive other data and signaling such as ICMP, DHCP, TFTP, BFCP, LDAP, XMPP, FECC, CTI, and so forth. The QoS values for this traffic should follow the enterprise's best practices for each type of traffic. Without doing this step, all other traffic apart from media and SIP signaling will be set to a DSCP of BE (DSCP 0) by the class-default in this configuration. We recommend either passing through the traffic marking by matching on DSCP and then re-marking the DSCP to the same value, or else using the TCP and UDP ports for each protocol that the endpoints use for communications.

The following example illustrates this. A class-map is created to match on a DSCP of AF21 which is transactional data, and the policy sets that data to AF21, effectively re-marking the DSCP to the same value. This is simply an example of matching on a DSCP to re-mark to the same DSCP:

```

class-map match-any TRANSACTIONAL-DATA
  match dscp af21

policy-map INGRESS_MARKING
...
  class TRANSACTIONAL-DATA
    set dscp af21

```

TCP and UDP port ranges can also be used. For more information on the TCP and UDP ports used for communication between the endpoints and Unified CM, see the *Cisco Unified Communications Manager TCP and UDP Port Usage* information in latest version of the *System Configuration Guide for Cisco Unified Communications Manager*, available at

<https://www.cisco.com/c/en/us/support/unified-communications/unified-communications-manager-callmanager/products-installation-and-configuration-guides-list.html>

Also see the endpoints administration guides or the Jabber planning guide to determine the various protocols and ports used for other endpoint traffic. Some examples of these documents include:

- *Cisco DX Series Administration Guide*, available at <https://www.cisco.com/c/en/us/support/collaboration-endpoints/desktop-collaboration-experience-dx600-series/products-maintenance-guides-list.html>
- *Planning Guide for Cisco Jabber*, available at <https://www.cisco.com/c/en/us/support/unified-communications/jabber-android/products-installation-guides-list.html>

## Application Server QoS

Configure QoS on all media originating and terminating applications and MCUs across the solution. This section covers non-default configuration on all application servers in the PA. It is also equally important to ensure that the switch ports to which the application servers are connected trust the QoS set by the servers. Some switches such as the Cisco Catalyst 3850 Series trust the QoS by default, so verify the switch configuration to ensure that the switch port is trusted by default or enable QoS trust.

QoS settings for the various application servers:

- Cisco Unified CM (endpoint)
  - System > Service Parameters > Select Publisher > Select Cisco CallManager Service > Clusterwide Parameters (System - QOS) >** Change the QoS values from their defaults and set them as indicated in [Table 8-12](#).

**Table 8-12 QoS Parameter Settings for Unified CM Endpoints**

QoS Service Parameter Name (SIP Profile)	Default Value	Changed Value
DSCP for Audio Calls	EF	No change
DSCP for Video Calls	AF41	No change
DSCP for Audio Portion of Video Calls	AF41	EF
DSCP for TelePresence Calls	CS4	AF41
DSCP for Audio Portion of TelePresence Calls	CS4	EF

- Cisco Unity Connection
  - System settings > Advanced > Telephony**
    - Default = Audio (46 / EF), Video (46 / EF), Signaling (24 / CS3)
    - Change Video to 34 / AF41
- Cisco Meeting Server
  - Cisco Meeting Server DSCP settings are configured through the command line interface (CLI). The DSCP settings should be configured after Cisco Meeting Server has been configured as indicated in the chapter on [Conferencing, page 3-1](#). The default for all values is DSCP 0, therefore all DSCP values need to be configured. *These changes require a server restart.*
  - Command line values:
 

```
dscp 4 signaling 24
dscp 4 voice 46
dscp 4 multimedia 34
dscp 4 oa&m 24
```

- Cisco Expressway

The Expressway DSCP value for video is set to opportunistic video using a value of AF42 (DSCP 36). Alternatively, AF41 can be used if opportunistic video, and thus AF42, is not being used in the solution. All other values (Audio, Signaling, and XMPP) are set to default values.

**System > Quality of Service**

- DSCP Signaling value 24 (default)
- DSCP Audio value 46 (default)
- DSCP Video value 36 or DSCP Video value 34 (default)
- DSCP XMPP value 24 (default)

## WAN Edge Identification and Classification

At the WAN edge on ingress from the enterprise to the service provider, it is expected that the packets that arrive with a specific DSCP value because the collaboration traffic have been re-marked at the access layer switch. On ingress it is important to re-mark any traffic at the WAN edge that could not be re-marked at the access layer, as a failsafe in case any traffic from the access switches was trusted through the LAN. While QoS is important in the LAN, it is paramount in the WAN; and as routers assume a trust on ingress traffic, it is important to configure the correct QoS policy that aligns with the business requirements and user experience. The WAN edge re-marking is always done on the ingress interface into the router, while the queuing and scheduling is done on the egress interface. The following example walks through the WAN ingress QoS policy as well as the egress queuing policy. Figure 8-26 through Figure 8-31 illustrate the configuration and the re-marking process.

In Figure 8-26 the packets from endpoints are identified and classified with the appropriate DSCP marking via a trusted port or via an ACL. Because there are typically areas of the switched access network that either cannot be configured with the correct QoS policies or re-mark collaboration traffic to Best Effort DSCP (BE), the WAN ingress policy is a good place for a catch-all policy to readdress what the access layer might have missed before the traffic heads into the WAN.

**Figure 8-26 Example Router Ingress QoS Policy Process – Step 1**

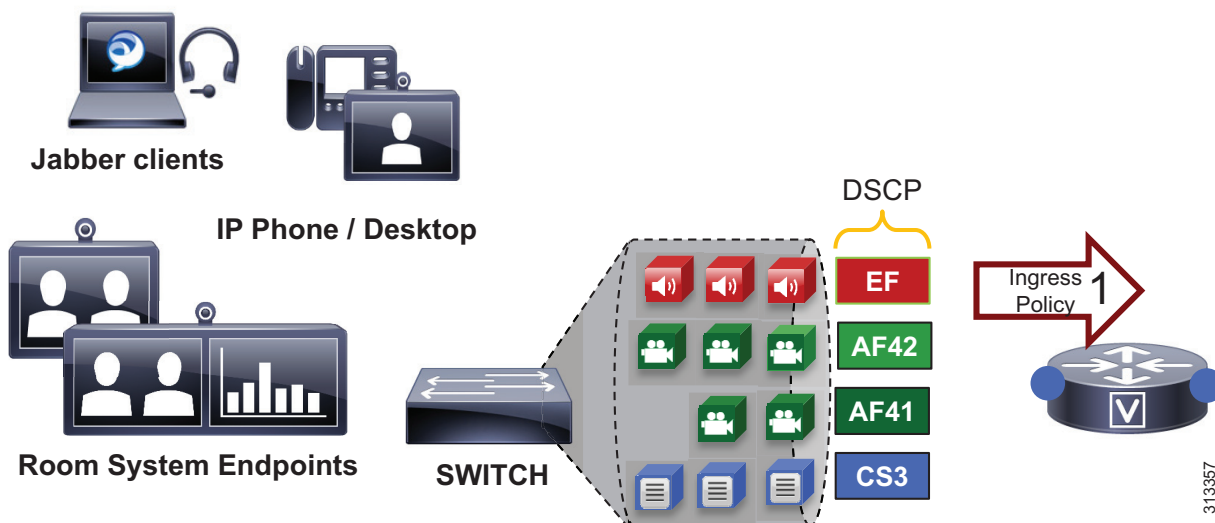

313357

Figure 8-26 through Figure 8-31 illustrate the policy matching criteria and DSCP re-marking. The illustrations show the following steps:

1. In step 1, packets arrive at the router ingress interface, which is configured with an input service policy.
2. In step 2, the policy-map is configured with four classes of traffic to set the appropriate DSCP (voice = EF; prioritized-video = AF41; Jabber-video = AF42; signaling = CS3).
3. In step 3, each one of these classes matches a class-map of the same name configured with match-any criterion. This match-any criterion means that the process will start top-down, and the first matching criterion will be executed according to each class in the policy-map statements.

Figure 8-27 Example Router Ingress QoS Policy Process – Steps 1 to 3

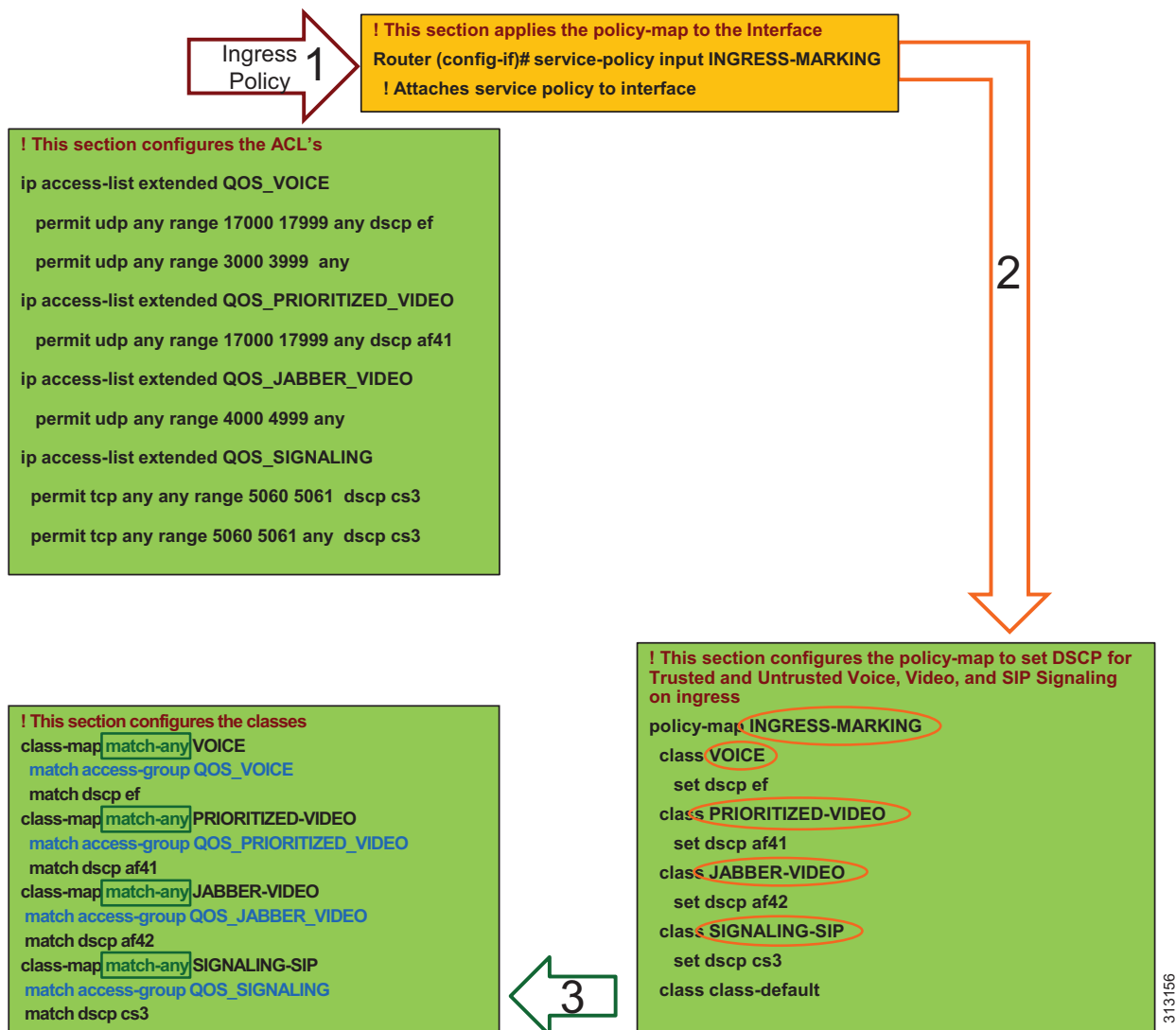

- In step 4, the first line in the class-map statement is parsed, which is the ACL that matches the UDP ports (and in some cases the DSCP value as well) set in Unified CM in the Identification and Classification section. When the ACL criteria are met (protocol, port range, and/or DSCP), then the traffic is marked as is configured in the corresponding policy-map statements.

Figure 8-28 Example Router Ingress QoS Policy Process – Step 4

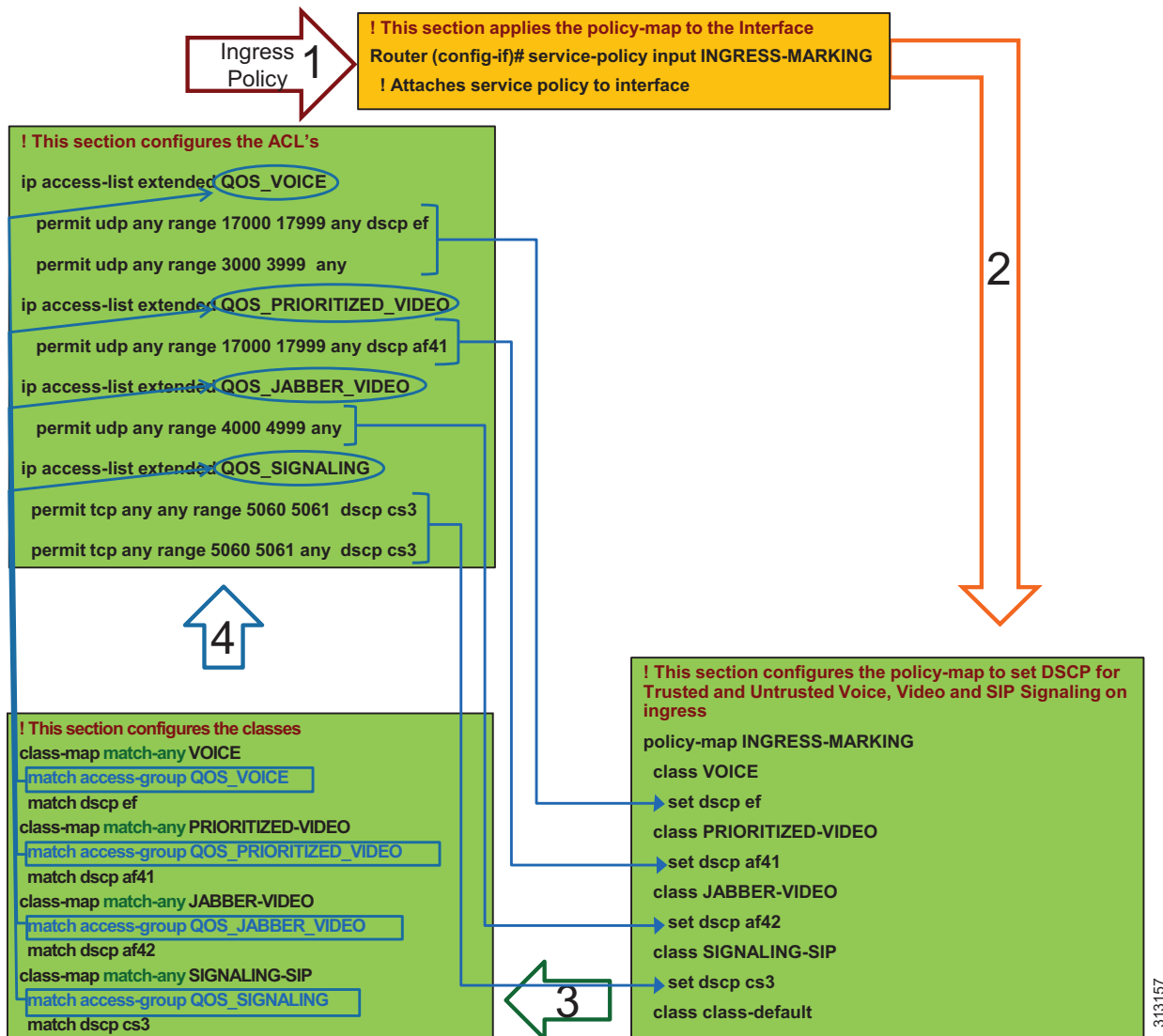

- In step 5, the traffic that did not match the first statement goes to the next match statement in the class-map, which is **match dscp**. If the traffic simply matches the DSCP, then DSCP is set again to the same value that was matched and as is configured in the policy-map statements. In this case the router is simply matching on DSCP and resetting the DSCP to the same value. This is a catch-all setting for the trusted DSCP from servers and applications coming into the WAN router.

Figure 8-29 Example Router Ingress QoS Policy Process – Step 5

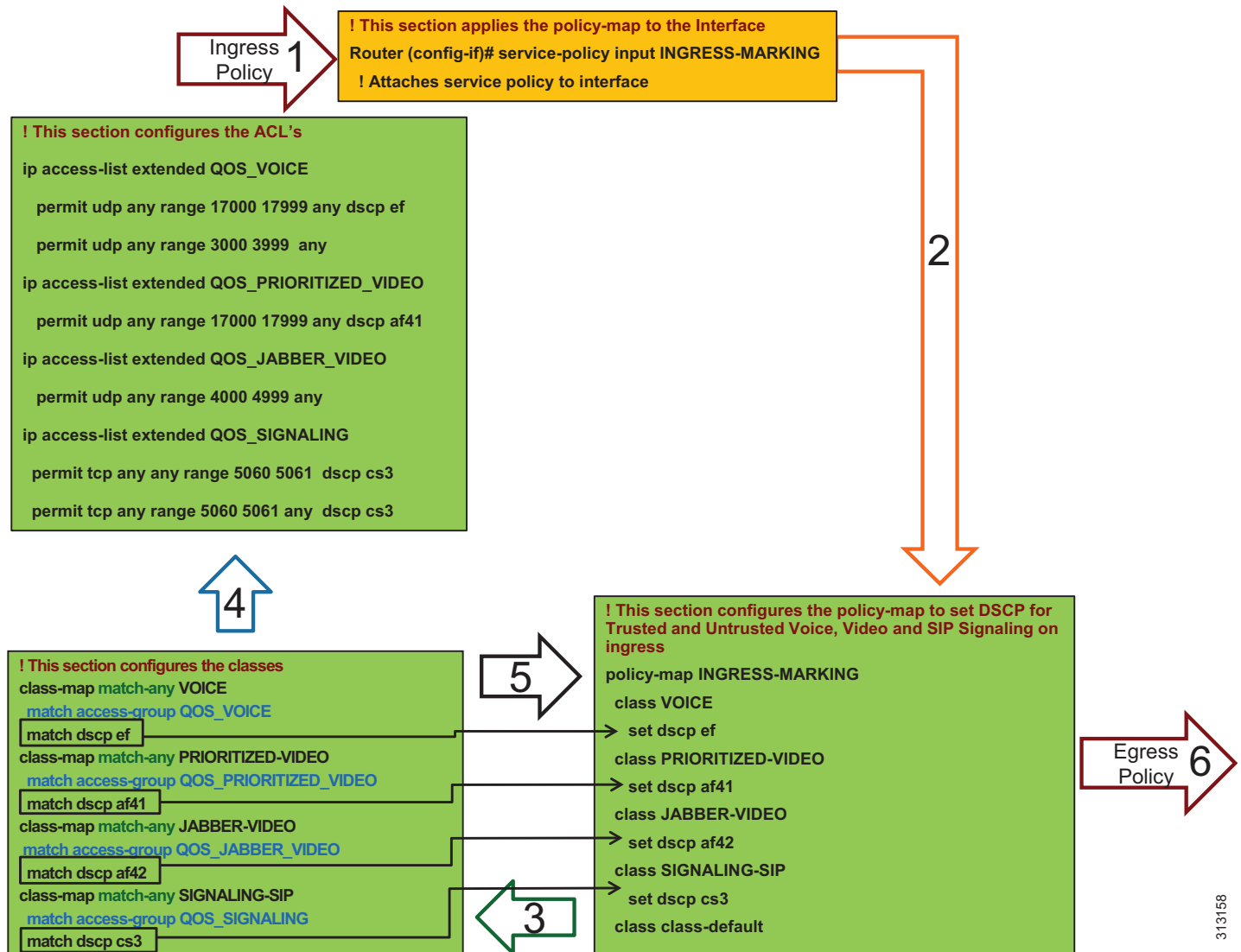

**Note**

This is an example QoS ingress marking policy based on the Cisco Common Classification Policy Language (C3PL). Refer to your specific router configuration guide for any updated C3PL commands and for information on how to configure a similar policy on a Cisco router supporting C3PL.

313158

- In step 6, the traffic goes to an outbound interface to be queued and scheduled by an output service policy that has three queues created: a Priority Queue called VOICE, a CBWFQ called VIDEO, and another CBWFQ called SIGNALING. This is illustrated in Figure 8-30 through Figure 8-31. This highlights the fact that the egress queuing policy is based only on DSCP as network marking occurring at the access switch and/or on ingress into the WAN router ingress interface. This is an example simply to illustrate the matching criteria and queues, and it does not contain the WRED functionality. For information on WRED, see the WAN Edge Queuing and Scheduling section.

Figure 8-30 Example Router Egress Queuing Policy Process – Step 6

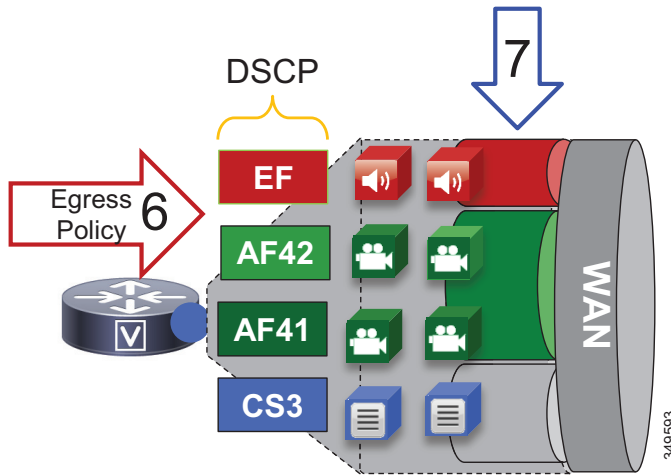

- In step 7, the traffic is matched against the class-map match statements. All traffic marked EF goes to the VOICE PQ, AF41 and AF42 traffic goes to the VIDEO CBWFQ, and CS3 traffic goes to the SIGNALING CBWFQ.

Figure 8-31 Example Router Egress Queuing Policy Process – Step 7

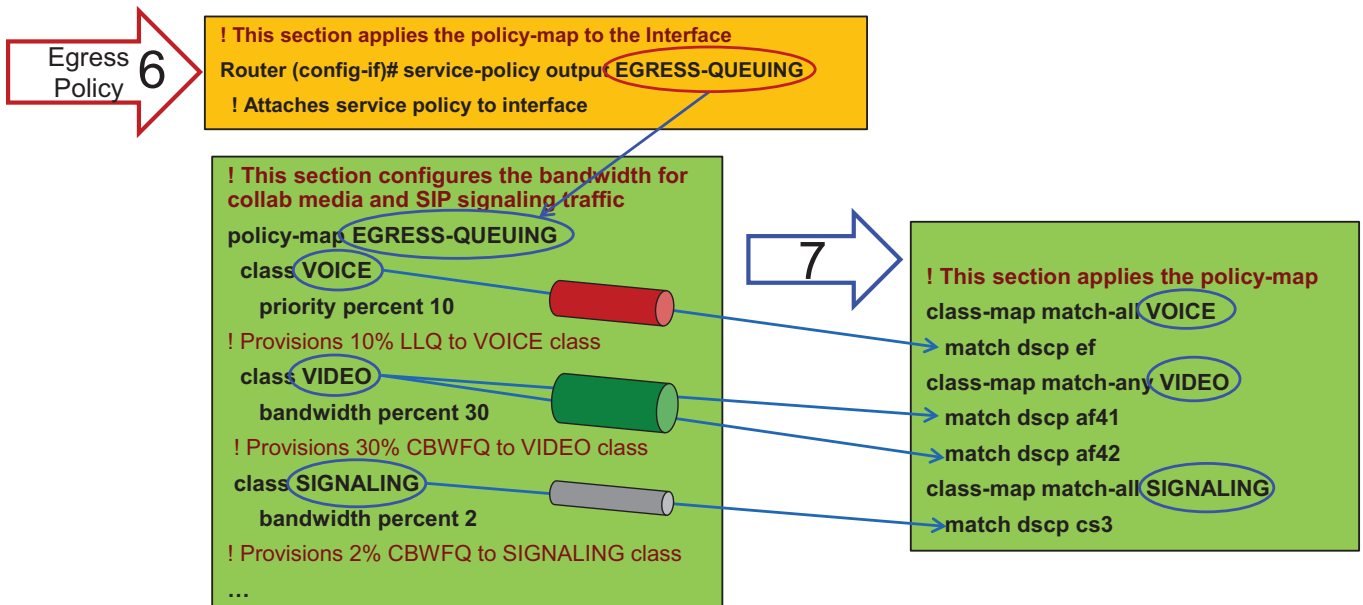



**Note**

This is an example egress queuing policy based on the Cisco Common Classification Policy Language (C3PL). Refer to your specific router configuration guide for any updated C3PL commands and for information on how to configure a similar policy on a Cisco router supporting C3PL.

**Example Configuration of Egress Queuing**

```
! This section applies the policy-map classes to match media and signaling QoS.
class-map match-any VIDEO
  match dscp af41
  match dscp af42
class-map match-any VOICE
  match dscp ef
class-map match-any SIGNALING
  match dscp cs3

! This section configures the bandwidth for Collaboration media and SIP signaling traffic.
policy-map EGRESS-QUEUING
  class VOICE
    priority percent 10
  class VIDEO
    bandwidth percent 30
    fair-queue
  class SIGNALING
    bandwidth percent 2
...

! This section applies the policy-map to the interface.
Router (config-if)# service-policy output EGRESS-QUEUING
! Attaches service policy to interface
```

## WAN Edge Queuing and Scheduling

This section covers the interface queuing. Figure 8-32 illustrates the voice PQ, video CBWFQ, and WRED thresholds used for the CBWFQ.

**Figure 8-32** Queuing and Scheduling Collaboration Media

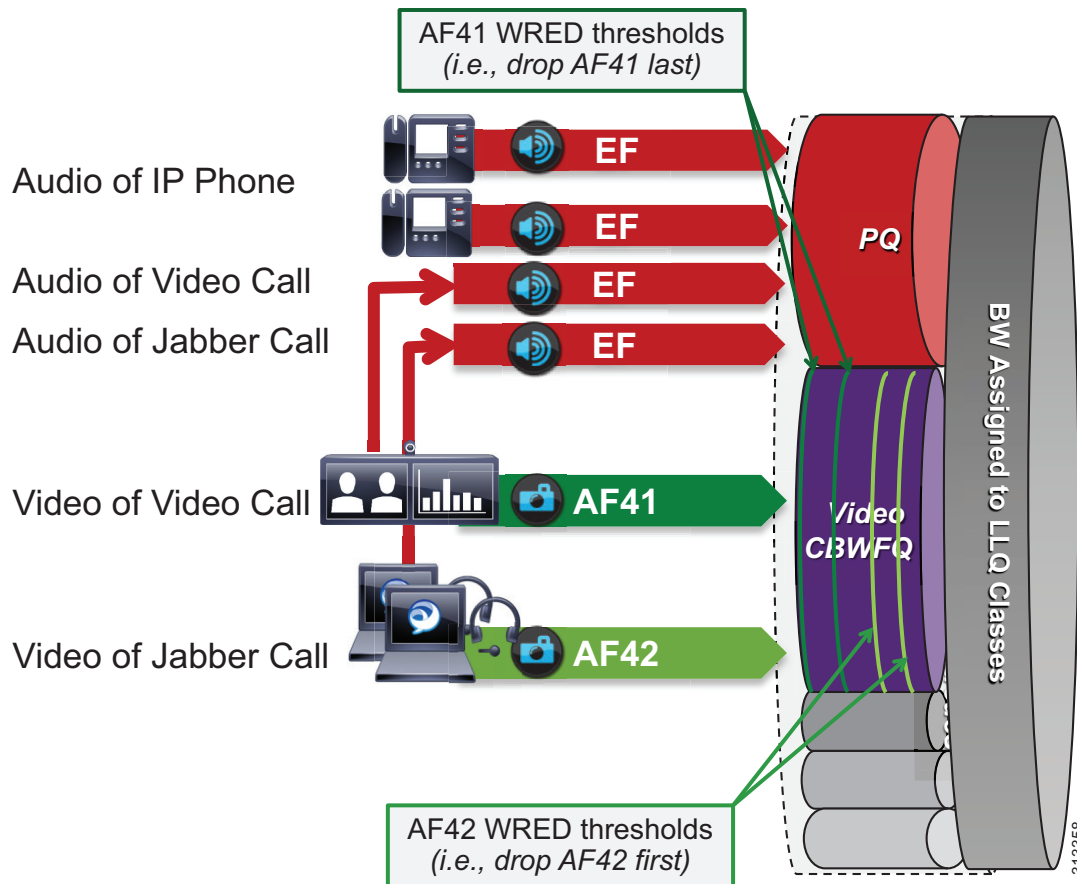

- All audio from all endpoints marked EF is mapped to the PQ.
- Video calls and Jabber share the same CBWFQ.
  - EF for audio streams of video calls from endpoints
  - AF41 for video streams of video calls from endpoints
  - EF for audio streams of all calls from Jabber clients
  - AF42 for video streams of video calls from Jabber clients
- WRED is configured on the video queue.
  - Minimum to maximum thresholds for AF42: approximately 10% to 30% of queue limit
  - Minimum to maximum thresholds for AF41: approximately 45% to 100% of queue limit

Weighted Random Early Detection (WRED) threshold minimum and maximum values are configured in the Video CBWFQ. To illustrate how the WRED thresholds are configured, assume that the interface had been configured with a queue depth of 256 packets. Then following the guidelines above, the WRED minimum and maximum thresholds for AF42 and AF41 would be configured as illustrated in Figure 8-33.

Figure 8-33 Threshold Example for Video CBWFQ with WRED

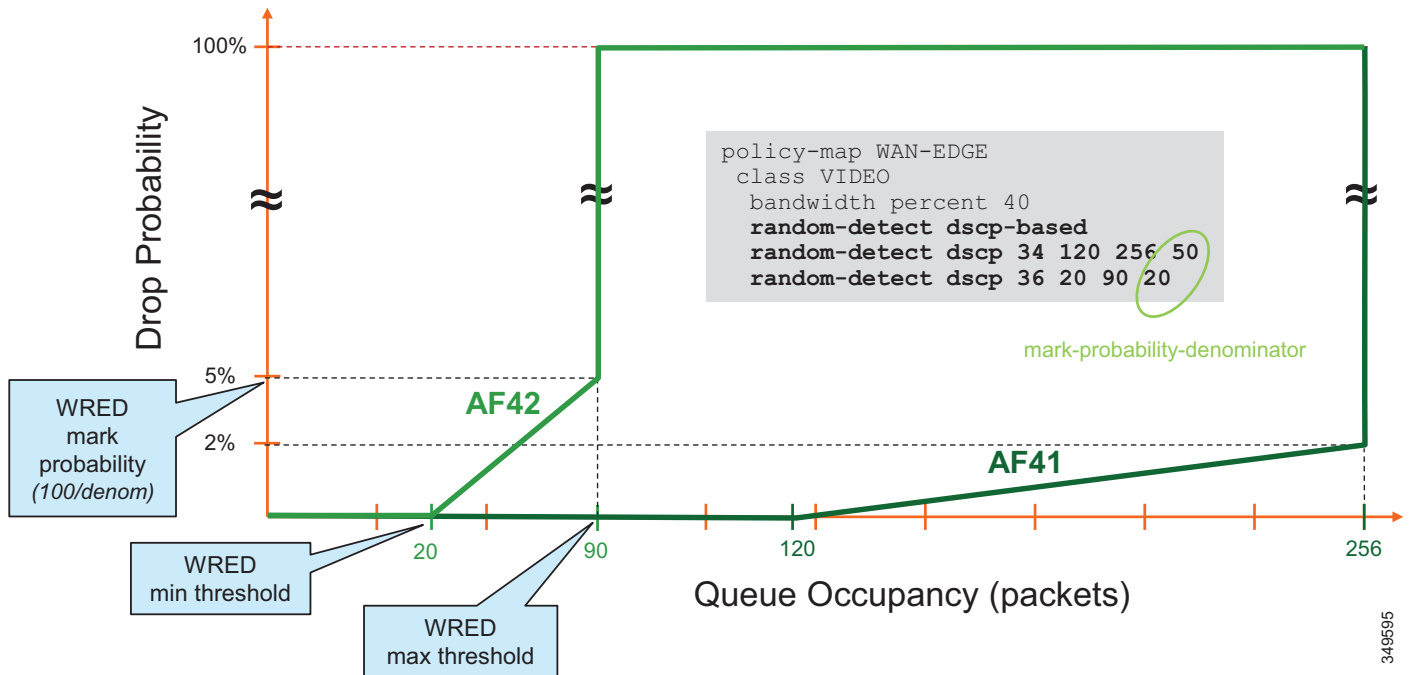

#### Recommended WRED Thresholds

Figure 8-34 lists the WRED thresholds for each traffic class (AF41 and AF42) and the recommended mark probability denominators that have been tested for various link speeds. These are just examples, and testing and customization are expected based on the amount of traffic in each traffic class and the aggressiveness required in the WRED drop probability during the busy hour.



#### Note

If only AF41 is used in the solution, the same WRED values are still recommended. AF41 would thus still start to engage WRED at about half of the queue depth and then tail drop if the queue is filled.

Figure 8-34 Recommended WRED Thresholds by Link Speed

WAN Link Speed		622 Mbps (OC12)	155 Mbps (OC3)	34-44 Mbps (E3/DS3)	10 Mbps	5 Mbps
WRED Values						
AF41	min-threshold	240	180	120	60	60
	max-threshold	512	384	256	128	128
	mark-probability-denominator	50	50	50	50	50
AF42	min-threshold	40	30	20	15	15
	max-threshold	180	135	90	40	40
	mark-probability-denominator	20	20	20	20	20
Video queue bandwidth %		43	53	55	40	30

349596

The following example configuration is for WRED in the video Class-Based Weighted Fair Queue (CBWFQ) of a DS3 link (44 Mbps).

```

policy-map EGRESS-QUEUING
  class VOICE
    priority percent 10
  class VIDEO
    bandwidth percent 30
    random-detect dscp-based
    random-detect dscp 34 120 256 50
    random-detect dscp 36 20 90 20
  fair-queue
    class SIGNALING
      bandwidth percent 2

```

**Note**

The WRED values might have to be customized for the specific environment. For example, if there is a much larger amount of AF42 traffic than AF41 traffic, then it makes sense to adjust the WRED threshold variables to suit those cases. Tweaking the variables and monitoring levels of drop is always the best way to achieve the desired results.

## Provisioning and Admission Control

This section addresses admission control and provisioning bandwidth to the queues for each site type. It covers the following topics:

- [Enhanced Locations CAC](#)
  - [Region Configuration](#)
  - [Deploy Enhanced Locations Call Admission Control](#)

- [Deploy Device Mobility for Mobile and Remote Access \(MRA\)](#)
- [Bandwidth Allocation Guidelines](#)

This phase of the deployment involves the following high-level steps:

1. Configure Enhanced Locations CAC.
2. Configure a region matrix for maximum video bit rate groups.
3. Deploy Device Mobility for mobile and remote access (MRA) endpoints.
4. Follow bandwidth allocation guidelines.

## Enhanced Locations CAC

Admission control is not used in this case to manage the video bandwidth but instead to manage the audio traffic to ensure that the Priority Queue (PQ) is not over-subscribed. In this specific example the Voice pool in Enhanced Locations CAC admits the audio for both the voice-only calls and the video calls.

In Unified CM this feature is enabled by setting the service parameter **Deduct Audio Bandwidth from Audio Pool for Video Call** to **True** under the Call Admission Control section of the CallManager service. **False** is the default setting, and by default Unified CM deducts both audio and video streams of video calls from the video pool. This parameter changes that behavior and is key to the QoS alterations in the Preferred Architecture.

[Figure 8-35](#) illustrates the various call flows, their corresponding audio and video streams, and queues to which queue they are directed.

Figure 8-35 Provisioning and Admission Control

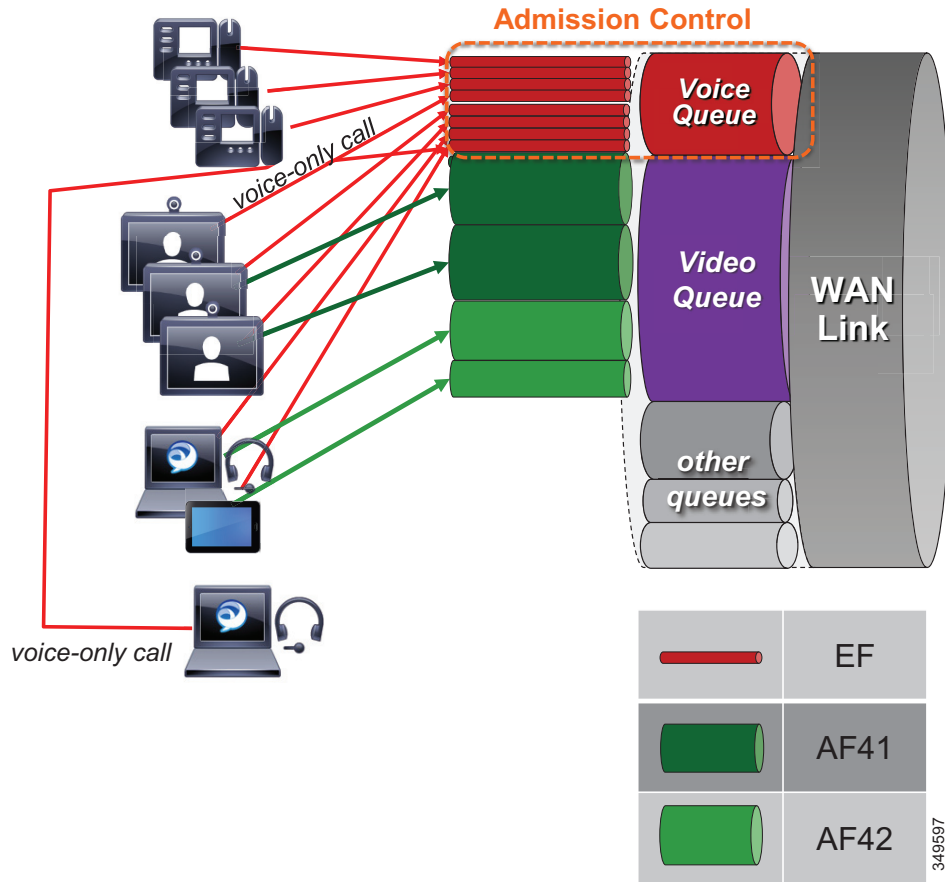

The following conditions apply to the example in [Figure 8-35](#):

- The Priority Queue is provisioned for all calls from endpoints and is protected by admission control (*E-LCAC voice BW pool*).
- The Video queue is over-provisioned for room-based video systems:
  - Ratios are applied to desktop video endpoint usage.
  - Jabber video calls can use any bandwidth unused by video room systems.
  - During congestion, video streams of Jabber calls are subject to WRED drops and dynamically reduce video bit rate.

## Region Configuration

Group video endpoints into classes of maximum video bit rate to limit bandwidth consumption based on endpoint type and usage within the solution. Three regions are required in total (see [Table 8-13](#)), and three device pools are required per site. This applies to a configuration where a single audio codec of G.722 is used across the entire organization, both LAN and WAN. Otherwise three regions per site are also required. See the considerations for regions in the [Architecture](#) section.

**Table 8-13 Example Region Matrix for Three Groups**

Endpoint Groupings	Video_1.5MB	Video_2.5MB	Video_20MB
Video_1.5MB	1,500 kbps	1,500 kbps	1,500 kbps
Video_2.5MB	1,500 kbps	2,500 kbps	2,500 kbps
Video_20MB	1,500 kbps	2,500 kbps	20,000 kbps

## Deploy Enhanced Locations Call Admission Control

Limit video calling based only in areas of the network where bandwidth resources are restricted beyond AF41 marked traffic; otherwise, video bandwidth in the Location links should be unlimited.

- Enable LBM services on every node where the Cisco CallManager service is enabled.
- Configure locations.
  - On the locations and links management cluster, configure all locations and links in the organization.
  - On all other clusters (subordinate to a locations and links management cluster), configure only locations and remove any links to/from the locations.
- Add locations to each device pool. The devices that must be configured in a location either directly or via a device pool include:
  - IP phones (via device pool)
  - Conference bridges (via device pool)
  - Gateways (via device pool)
  - SIP trunks (via device pool)
  - Music on hold (MoH) servers (directly)
  - Annunciator (via device pool)

### Intercluster Configuration

- Configure the LBM hub group
  - Used to assign LBMs to the hub role
  - Used to define three remote hub members that replicate hub contact information for all of the hubs in the LBM hub replication network

An LBM is a hub when it is assigned to an LBM hub group.

An LBM is a spoke when it is not assigned to an LBM hub group.

  - Name: Cluster1\_LBM\_Hub\_1
  - Bootstrap Servers: <names or IP addresses of bootstrap servers> (see the [LBM Hub Replication Network](#) section)
  - Select up to two LBMs in the cluster to serve as hubs.
- Recommendations for location configuration when intercluster ELCAC is implemented:
  - A cluster requires the location to be configured locally for location-to-device pool association.
  - Each cluster should have locations configured with the immediately neighboring locations of other clusters, so that each cluster's topology can inter-connect and create a single global topology. This does not apply to Location and Link Management Cluster deployments.
  - Discrepancies of bandwidth limits and weights on common locations and links are resolved by using the lowest bandwidth and weight values.
  - Naming locations consistently across clusters is critical. Follow the practice: "Same location, same name; different location, different name."
  - The Hub\_none location should be renamed to be unique in each cluster. If Hub\_none is left as default on all clusters, then it will be treated as the same location, which may or may not be desired, depending on the locations design being configured (see the [Enhanced Locations Call Admission Control](#) section).
  - Cluster-ID should be configured and must be unique on each cluster for serviceability reports to be usable.



## Deploy Device Mobility for Mobile and Remote Access (MRA)

### Configure Device Mobility

Figure 8-36 illustrates an overview of the device mobility configuration. Although this is a minimum configuration requirement for Device Mobility for ELCAC to function for Internet-based devices, Device Mobility can be configured to support mobility for these same endpoints within the enterprise. See the latest version of the [Cisco Collaboration SRND](#) for more information on Device Mobility for devices within the enterprise.

**Figure 8-36** Device Mobility Configuration and Location Association

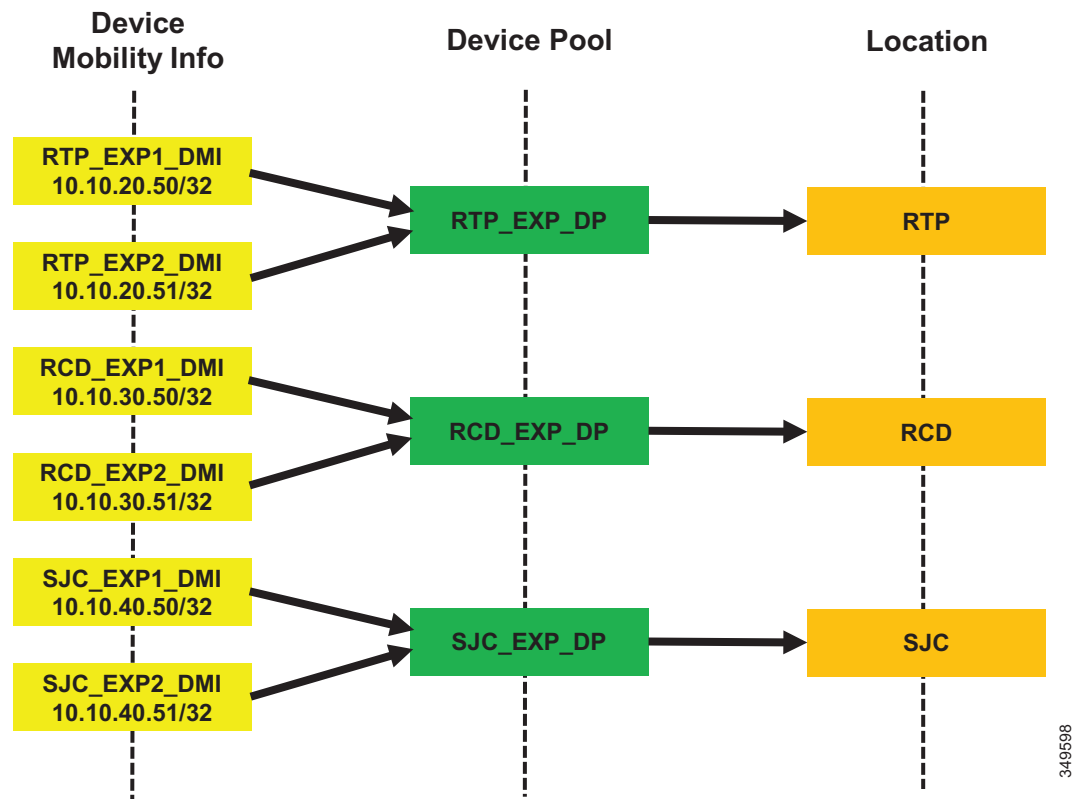

349598

Figure 8-36 shows a simplified version of device mobility for the example deployment of ELCAC. The IP addresses of the Expressway-C servers are configured in the device mobility information. In this example there is a redundant pair of Expressway-C servers for each of the three sites: RTP, BLD, and SJC. RTP\_EXP1\_DMI and RTP\_EXP2\_DMI are configured respectively with the server IP addresses of the RTP Expressway-C servers. These two are associated to a new device pool called RTP\_EXP\_DP, which has the location RTP configured on it. Each site is configured similarly. With this configuration, when any device enabled for device mobility registers to Unified CM with the IP address that corresponds to the device mobility information in RTP\_EXP1\_DMI or RTP\_EXP2\_DMI, it will be associated with the RTP\_EXP\_DP device pool and thus with the RTP location.

With the above configuration, when an Internet-based device registers through the Expressway to Unified CM, it will register with the IP address of Expressway-C. Unified CM then uses the IP address configured in the device mobility information and associates the device pool and thus the Internet location associated to this device pool. This process is illustrated in Figure 8-37.

Figure 8-37 Association of Device Pool and Location Based on Expressway IP Address

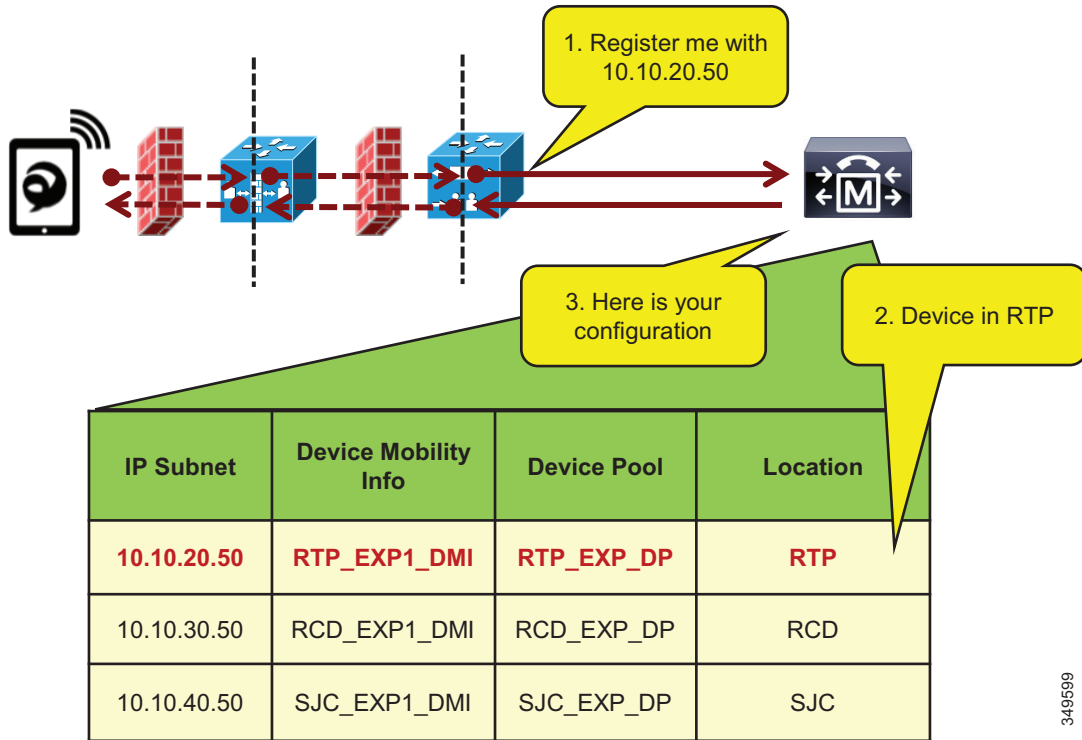

349599

In Figure 8-37, the client registers with Unified CM through the Expressway in RTP. Because the signaling is translated at the Expressway-C in RTP, the device registers with the IP address of that Expressway-C. The device pool RTP\_EXP\_DP is associated to the device based on this IP address. The RTP\_EXP\_DP pool is configured with the RTP location, and therefore that location is associated to the device. Thus, when devices register to the Expressway, they get the correct location association through device mobility. When the endpoint relocates to the enterprise, it will return to its static location configuration. Also, if the endpoint relocates to another Expressway in SJC, for example, it will get the correct location association through device mobility.

Configure Device Mobility Information (DMI) for Expressway-Cs:

- Create two DMIs per Expressway-C group (two Expressway-C nodes in a pair).
- Add the IP address of the Expressway-C node in a subnet with a mask of 32 bits (this matches the IP address exactly).
- Add the site device pool to respective DMIs. This is the device pool of the site where the Expressway pairs are located, which should contain the correct region and location.

Example for one DMI:

Name: SJC\_EXP1\_DMI

Subnet: 10.10.40.50

Mask: 32

Selected Device Pool: SJC\_Video\_1.5MB

Enable devices for device mobility. The bulk administration tool (BAT) can and should be used to facilitate this step.

## Bandwidth Allocation Guidelines

The bandwidth allocations in [Figure 8-38](#) are unique guidelines based on this example enterprise. They provide some guidance on percentages of available bandwidth for different common classes of Collaboration traffic.

**Figure 8-38** Bandwidth Allocation Guidelines

WAN Link Speed	622 Mbps (OC12)	155 Mbps (OC3)	34-44 Mbps (E3/DS3)	10 Mbps	5 Mbps	<2 Mbps (T1/E1)
Class						
Control (%)	1	1	1	1	2	10
Voice (%)	10	10	10	20	25	30
Video (%)	43	53	55	40	30	--
Signalling (%)	2	2	2	2	2	5
Scavenger (%)	1	1	1	1	1	1
Default (%)	43	33	31	36	40	54

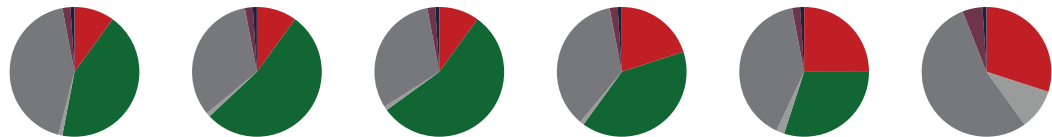

349600

[Figure 8-39](#) through [Figure 8-42](#) illustrate each site (Central, Large Branch, Small Branch, Micro Branch) and the link bandwidth provisioned for each class based on the number of users and available bandwidth for each class. Keep in mind that these values are based on bandwidth calculated for Layer 3 and above. Therefore, the values do not include the Layer 2 overhead, which is dependent on the link type (Ethernet, Frame-relay, MPLS, and so forth). See the *Network Infrastructure* chapter in the latest version of the [Cisco Collaboration SRND](#) for more information on L2 overhead. Also note that the audio portion of bandwidth for the video calls is deducted from the voice pool, so the voice queue is provisioned to include the audio bandwidth of both voice-only and video calls.



### Note

The calculations in the following examples use the maximum bandwidth for the number of endpoints and then multiply that value by a percentage to account for active calls. For example, for 30 video endpoints (30 calls possible) at 20% active video call rate, the calculation would be:  
 $1.2 \text{ Mbps} * 30 \text{ calls} * 0.2 = 7.2 \text{ Mbps}$ .

Figure 8-39 Central Site

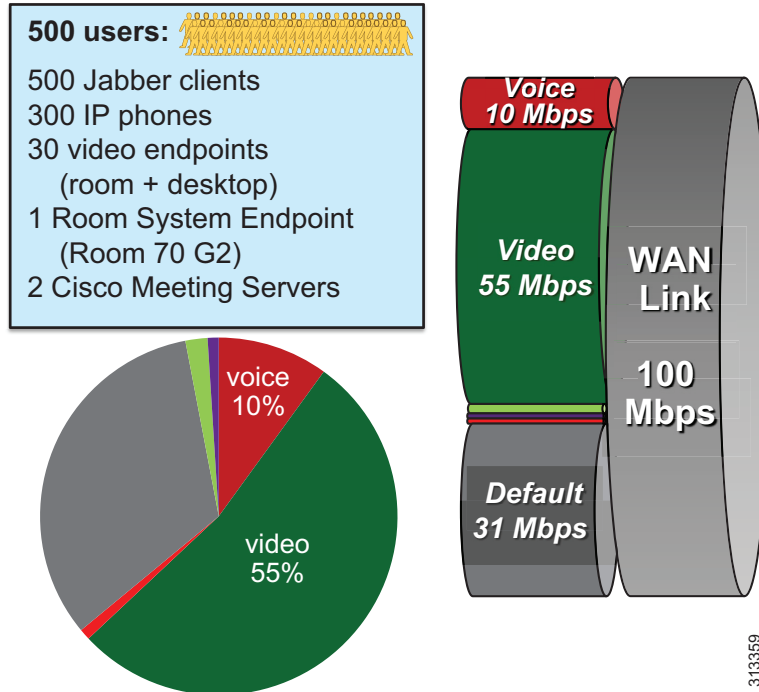

#### Central Site Link (100 Mbps) Bandwidth Calculation

As illustrated in Figure 8-39, the Central Site has the following bandwidth requirements:

- Voice queue (PQ): 10 Mbps (L3 bandwidth)
  - 125 calls @ G.711 or G.722
- Unified CM Location link bandwidth for the voice pool:
  - $125 * 80 \text{ kbps} = 10 \text{ Mbps}$
- Video queue: 55 Mbps (L3 bandwidth)
  - Room system video endpoint (Webex Room 70 G2):  $6 \text{ Mbps} * 1 \text{ call} = 6 \text{ Mbps}$
  - Video endpoints:  $1.2 \text{ Mbps} * 30 \text{ calls} * 0.2 = 7.2 \text{ Mbps}$
  - Cisco Meeting Servers:  $1.5 \text{ Mbps} * 40 \text{ calls} * 0.5 = 30 \text{ Mbps}$
  - $55 \text{ Mbps} - (6 \text{ Mbps} + 7.2 \text{ Mbps} + 30 \text{ Mbps}) = 11.8 \text{ Mbps}$  for Jabber media
    - 9 Jabber video calls @ 720p, or 13 @ 576p, or 36 @ 288p
    - (Plus any leftover bandwidth)

Figure 8-40 Large Branch

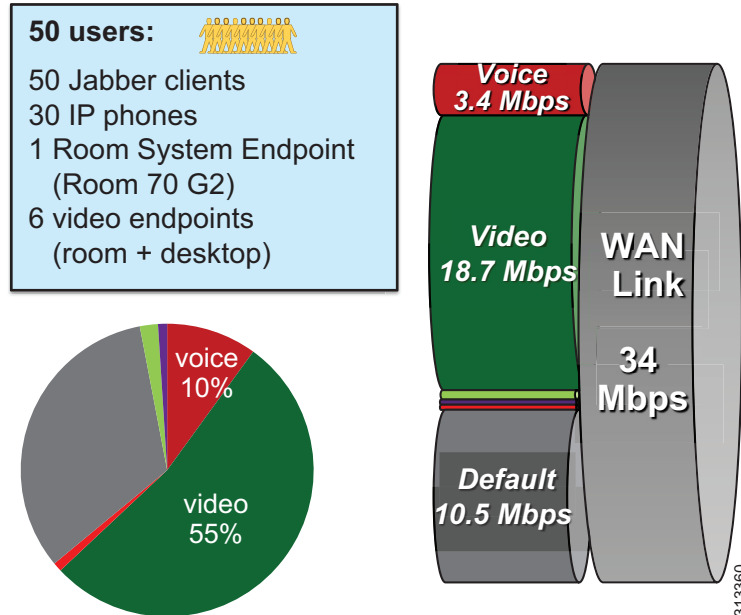

#### Large Branch Link (34 Mbps) Bandwidth Calculation

As illustrated in Figure 8-40, the Large Branch site has the following bandwidth requirements:

- Voice queue (PQ): 3.4 Mbps (L3 bandwidth)
  - 42 calls @ G.711 or G.722
- Unified CM Location link bandwidth for the voice pool:
  - $42 * 80 \text{ kbps} = 3.360 \text{ Mbps}$
- Video queue: 18.7 Mbps (L3 bandwidth)
  - Room system video endpoint (Webex Room 70 G2):  $6 \text{ Mbps} * 1 \text{ call} = 6 \text{ Mbps}$
  - Video endpoints:  $1.2 \text{ Mbps} * 6 \text{ calls} = 7.2 \text{ Mbps}$
  - $18.7 \text{ Mbps} - (6 \text{ Mbps} + 7.2 \text{ Mbps}) = 5.5 \text{ Mbps}$  for Jabber media
    - 4 Jabber video calls @ 720p, or 6 @ 576p, or 17 @ 288p
    - (Plus any leftover bandwidth)

Figure 8-41 Small Branch

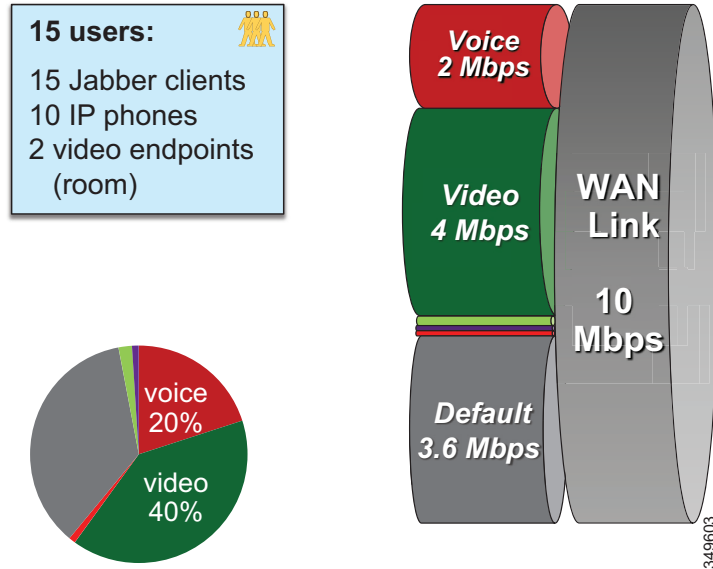

#### Small Branch Link (10 Mbps) Bandwidth Calculation

As illustrated in [Figure 8-41](#), the Small Branch site has the following bandwidth requirements:

- Voice queue (PQ): 2 Mbps (L3 bandwidth)  
 25 calls @ G.711 or G.722
- Unified CM Location link bandwidth for the voice pool:  
 $25 * 80 \text{ kbps} = 2 \text{ Mbps}$
- Video queue: 4 Mbps (L3 bandwidth)
  - Video endpoints:  $1.2 \text{ Mbps} * 2 \text{ calls} = 2.4 \text{ Mbps}$
  - $4 \text{ Mbps} - 2.4 \text{ Mbps} = 1.6 \text{ Mbps}$  for Jabber media  
 1 Jabber video call @ 720p, or 2 @ 576p, or 5 @ 288p  
 (Plus any leftover bandwidth)

Figure 8-42 Micro Branch

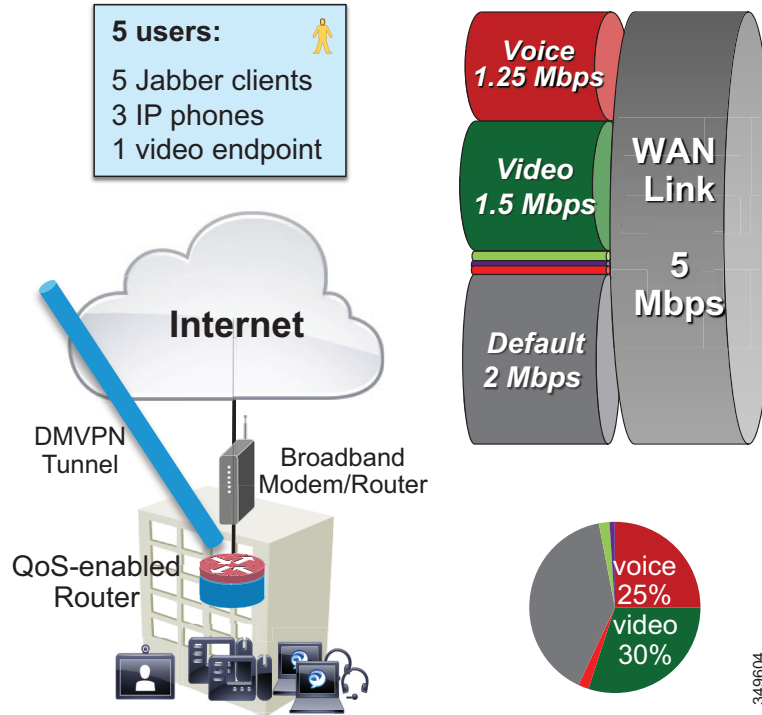

### Micro Branch Broadband Internet Connectivity (5 Mbps) Bandwidth Calculation

As illustrated in Figure 8-42, the Micro Branch site has the following bandwidth requirements:

- Broadband Internet connectivity + DMVPN to central site
- Configure interface of VPN router to match broadband up-link speed
- Enable QoS on VPN router to prevent **bufferbloat** from TCP flows
- Asymmetric download/upload broadband: consider limiting transmit bit rate on video endpoint
- Bandwidth calculation will ultimately depend on the broadband bandwidth available and should follow the same recommendations as in the Small Branch site link for provisioning.

### Large Branch with Constrained WAN Link (Enhanced Locations CAC Enabled for Video)

In specific branch sites with lower-speed WAN links, over-provisioning the video queue is not feasible. ELCAC can be applied to these location links for video to ensure that video calls do not over-subscribe the link bandwidth. This template requires using site-specific region configuration to limit maximum bandwidth used by video endpoints and Jabber clients. Also keep in mind that device mobility is required if Jabber users roam across sites.

**Figure 8-43** Large Branch with Constrained WAN Link (Enhanced Locations CAC Enabled for Video)

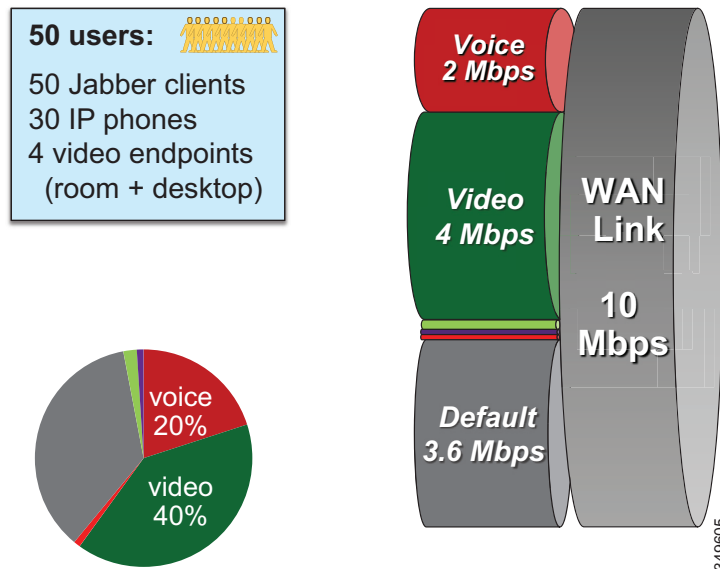

As illustrated in [Figure 8-43](#), a Large Branch site with a constrained WAN link (10 Mbps) has the following bandwidth requirements:

- Voice queue (PQ): 2 Mbps (L3 bandwidth)  
25 calls @ G.711 or G.722
- Unified CM Location link bandwidth for the voice pool:  
25 \* 80 kbps = 2 Mbps
- Video queue: 4 Mbps (L3 bandwidth)
  - Possible usage:  
1 call @ 720p (1,220 kbps) + 3 calls @ 576p (810 kbps) = 3,650 kbps  
Or 2 calls @ 576p (768 kbps) + 5 calls @ 288p (320 kbps) = 3136 kbps
  - Unified CM Location link bandwidth for video calls: 3.7 Mbps (L3 bandwidth)
  - Leaves room for L2 overhead





## Sizing

---

**Revised: May 21, 2021**

Sizing the components of the Preferred Architecture for Enterprise Collaboration solution is an important part of the overall solution design.

For a given deployment, the goal of the sizing process is to determine:

- The type of platform to be used.
- The specifications and number of instances to be deployed for each Cisco Collaboration product.

For the products that are deployed with virtualization, this corresponds to the selection of the virtual machine hardware specification defined in the Open Virtual Archive (OVA) template and the number of virtual machines. For the products that are not deployed with virtualization, this corresponds to the type and number of appliances or blades.

Sizing can be a complex exercise because of numerous parameters to take into consideration. In order to simplify the sizing exercise, this chapter provides some sizing examples with corresponding assumptions. We will refer to these sizing examples as *simplified sizing deployments*. If the requirements of your particular deployment are within those assumptions, then you can use the simplified sizing deployments in this document as a reference. If not, then the normal sizing calculations have to be performed as described in the latest version of the *Cisco Collaboration Sizing Guide* available at <https://www.cisco.com/go/srnd>.

Once the sizing is done for the products that are deployed with virtualization, determine how to place the virtual machines on Cisco Unified Computing System (UCS) servers, and consider the co-residency rules. Ultimately, this virtual machine placement process determines how many UCS servers are required for the solution.

This chapter explains sizing for all modules that are covered in this document, namely: [Call Control](#), [Conferencing](#), [Collaboration Edge](#), and [Voice Messaging](#). This chapter also covers [Virtual Machine Placement and Platforms](#).

For products that are deployed as virtual machines, this document does not provide details on the virtual machine OVA template specification. For that information, refer to the documentation on *Cisco Collaboration Virtualization*, available at <https://www.cisco.com/go/virtualized-collaboration>.

# What's New in This Chapter

**Table 9-1** lists the topics that are new in this chapter or that have changed significantly from previous releases of this document.

**Table 9-1** *New or Changed Information Since the Previous Release of This Document*

New or Revised Topic	Described in:	Revision Date
New Unified CM OVA templates and increased capacity numbers.	<a href="#">Unified CM Sizing</a>	May 21, 2021
SRST maximum number of phones sizing increase for 4451-X platform.	<a href="#">SRST Sizing</a>	May 21, 2021
Updated increased Cisco Meeting Server platform capacity numbers and added capacity numbers for Cisco Meeting Management.	<a href="#">Conferencing</a>	May 21, 2021
Updated increased Expressway capacity for MRA Fast Registration.	<a href="#">Collaboration Edge</a>	May 21, 2021
Removed Prime Collaboration Provisioning capacity coverage.	<a href="#">Cisco Meeting Management</a>	May 21, 2021
Removed references to the Virtual Machine Placement Tool (VMPT) and updated VM placement figures to reflect server diagram feature of Quote Collab tool.	<a href="#">Virtual Machine Placement and Platforms</a>	May 21, 2021

## Call Control

As discussed in the [Call Control](#) chapter, the Cisco Unified Communications Manager (Unified CM) and IM and Presence Service are provided through a Unified CM cluster and an IM and Presence cluster.

A Cisco Unified CM cluster consists of one publisher node, two dedicated TFTP servers, and one or multiple call processing node pairs. The number of call processing pairs depends on the size of the deployment and is discussed later in this section. The call processing nodes are deployed in pairs for 1:1 redundancy.

IM and Presence nodes are also deployed in pairs. The number of IM and Presence pairs also depends on the size of the deployment, and this will be discussed later in this section. The IM and Presence nodes are deployed in pairs for 1:1 redundancy.

## Unified CM Sizing

For Unified CM, the simplified sizing guidance covers deployments with up to 10,000 users and 10,000 devices. Unified CM supports more users and more devices under different assumptions or by adding more call processing pairs, but this is outside the scope of the simplified sizing guidance provided in this chapter. [Table 9-2](#) describes the simplified sizing deployments. The assumptions made for those deployments are documented below this table. If the number of users or endpoints in your deployment is outside of the values in [Table 9-2](#), or if the requirements of your specific deployment fall outside of the assumptions, do not use these simplified sizing deployments, but rather perform the normal sizing procedure documented in the Cisco Collaboration Sizing Guide for Collaboration Systems Release

(CSR) 14 available at [https://www.cisco.com/c/en/us/td/docs/solutions/PA/size/SRND\\_sizing14.html](https://www.cisco.com/c/en/us/td/docs/solutions/PA/size/SRND_sizing14.html) and in the Unified CM product documentation available at <https://www.cisco.com/c/en/us/support/unified-communications/unified-communications-manager-call-manager/tsd-products-support-series-home.html>

**Table 9-2 Unified CM Simplified Sizing Deployments**

Deployment Size	Unified CM Nodes to be Deployed (Medium OVA Template Used for Each Unified CM Node)
Up to 5,000 users or devices	<b>5 nodes:</b> 1 Publisher, 2 TFTP, 1 call processing pair (2 call processing subscribers)
Between 5,000 and 10,000 users or devices	<b>7 nodes:</b> 1 Publisher, 2 TFTP, 2 call processing pairs (4 call processing subscribers)

Table 9-2 sizes deployments based on the maximum number of users and devices, whichever number is greater. For example, in a deployment with 5,000 users and an average of two devices per user (for example, each user has a desk phone and a Jabber client in softphone mode), the 7-node deployment is required because there are 10,000 devices in total.

The Medium virtual machine configuration (OVA template) is used in these simplified sizing deployments in order to optimize the overall resources consumed on the UCS server. This OVA template requires a full UC performance CPU platform such as the Cisco Business Edition 7000; and it is not supported on the Business Edition 6000, for example. For more information on those OVA virtual machine configuration templates and on the platform requirements, refer to the documentation at <https://www.cisco.com/go/virtualized-collaboration>.

A Unified CM call processing pair deployed with the Medium OVA template could support up to 10,000 users under some conditions. But in this design, we use some assumptions that put an additional load on Unified CM; for instance, we assume that each user can be configured with a Remote Destination Profile for Single Number Reach, each user can use Extension Mobility, each endpoint can be CTI controlled, some shared lines are configured, mobile and remote access is enabled, and so forth. Therefore the capacity per Unified CM call processing pair is reduced, as shown in Table 9-2. The following description provides more information on the assumptions used in this simplified sizing model.

#### Unified CM Assumptions

The following assumptions apply to the two simplified sizing deployments listed in Table 9-2:

- Average of up to 4 busy hour call attempts (BHCA, the number of call attempts during the busy hour) per user.
- Average of up to 2 DNs per device.
- Media and SIP signaling encryption can be enabled without changing this Unified CM simplified sizing.
- Up to 500 shared lines per call processing subscriber pair, each line being shared with an average of up to 3 devices.
- Jabber clients registering to Unified CM (softphone mode) must be counted against the device limit.
- Up to 3,000 partitions; 6,000 calling search spaces (CSSs); and 12,000 translation patterns per cluster.

- Per Unified CM cluster, up to 1,000 route patterns; 1,000 route lists; and 2,100 route groups. Per Unified CM call processing pair, up to 100 hunt pilots, 100 hunt lists, 50 circular/sequential line groups with an average of 5 members per line group, and 50 broadcast line groups with an average of 10 members per line group.
- Up to 500 CTI ports and 100 CTI route points per Unified CM call processing pair.
- GDPR/ILS is enabled when multiple Unified CM clusters are deployed.
- Extension Mobility (EM) — All users can use EM, but no Extension Mobility Cross Cluster (EMCC) users. Up to 500 EM logins/logouts per minute are supported. (This simplified sizing assumes the EM service is activated on one Unified CM node.)
- Unified CM media resources — Unified CM software conference bridges (software CFBs) and Unified CM media termination points (MTPs) should not be used in this design. Instead, use Cisco Meeting Server and Cisco IOS-based MTP, respectively.
- Average of up to one remote destination or mobility identity per mobility user. For example, in a deployment with 5,000 users, there can be up to 5,000 remote destinations or mobility identities.
- Up to 50,000 users synchronized with active directory (but only up to 5,000 or 10,000 active users would place or receive calls, depending on the simplified sizing deployment selected in [Table 9-2](#)).
- Up to 1,500 concurrent active calls (conferencing and non-conferencing sessions) per Unified CM call processing pair. For example, if all calls are conference calls and if the average number of participants in a conference is 10, then this design assumes up to 150 conference calls per Unified CM call processing pair.
- Up to 15 calls per second (cps) per Unified CM call processing pair.

Other capacity limits that are applicable to the Cisco Collaboration solution and that are documented in the latest version of the *Cisco Collaboration Sizing Guide* and product documentation, also apply. For example:

- Computer Telephony Integration (CTI) — All devices can be enabled for CTI, with up to 5 lines per device and 5 J/TAPI applications monitoring the same CTI device.
- Annunciator – 48 per Unified CM call processing pair. Music on hold (MoH) – 250 concurrent MoH sessions per call processing pair. For a larger number of annunciators or concurrent MoH sessions, deploy standalone Unified CM subscribers as MoH servers.
- Gateway – Up to 2,100 per cluster.
- Locations and regions — When adding regions, select **Use System Default** for the Audio Codec Preference List and Audio and Session Bit Rate values. Changing these values for individual regions from the default has an impact on server initialization and publisher upgrade times. Hence, with a total of 2,000 regions you can modify up to 200 regions to use non-default values. With a total of 1,000 or fewer regions, you can modify up to 500 of them to use non-default values. A maximum of 2,000 locations is supported, and they do not have usage limitations like regions do.

## IM and Presence Sizing

For IM and Presence, simplified sizing guidance covers deployments of a single Unified CM cluster and IM and Presence subcluster with up to 15,000 devices. [Table 9-3](#) describes the simplified sizing deployments. If the number of users or logged-in Jabber endpoints in your deployment is outside of the values in [Table 9-3](#), do not use these simplified sizing deployments, but rather perform the normal sizing procedure documented in the *Sizing* chapter in the latest version of the *Cisco Collaboration SRND* and product documentation.

**Table 9-3 IM and Presence Simplified Sizing Deployments**

Deployment Size	IM and Presence Nodes to be Deployed
Less than 5,000 users or logged-in Jabber endpoints <sup>1</sup>	One IM and Presence pair using the 5k-user OVA template
Between 5,000 and 15,000 users or logged-in Jabber endpoints	One IM and Presence pair using the 15k-user OVA template

1. For deployments without advanced features. If advanced features like persistent chat, message archiving, 3rd party compliance, multiple device messaging, and managed file transfer are used in a 5,000 user deployment, then the 15k-user OVA template is recommended.

For example, if a deployment has 5,000 users and each user on average is logged on to two Jabber endpoints concurrently, then the capacity is limited by the 10,000 logged-in Jabber endpoints, and therefore this deployment requires one IM and Presence pair using the 15k-user OVA template. The two OVA virtual machine configuration templates in [Table 9-3](#) require a full Unified Communications performance CPU platform such as the Cisco Business Edition 7000. For more information on those OVA virtual machine configuration templates and on the platform requirements, refer to the documentation available at <https://www.cisco.com/go/virtualized-collaboration>.

The two IM and Presence nodes are deployed as a pair in order to provide redundancy if one of the nodes fails.

In some cases IM and Presence nodes may require additional resources and thus larger OVA templates to operate effectively. IM and presence features have significant impact on system performance above and beyond the number of users assigned to IM and Presence and the number of devices per user.

**Note**

OVA size refers to the total number of devices and does not reflect the impact the above features have on IM and Presence.

The following IM and Presence deployment types and features will require 15k-user OVA or higher OVA template:

- Centralized IM and Presence deployments (25k-user OVA recommended) - deployments with one (or more) IM and Presence cluster and multiple Unified CM clusters.
- Multi-cluster IM and Presence deployments - deployments with two (or more) Unified CM clusters each with IM and Presence sub-clusters or with two (or more) IM and Presence clusters.
- Persistent chat
- Message archiving
- 3rd party compliance
- Multiple device messaging (MDM)
- Managed file transfer (MFT)
- Outlook integration (Jabber client)

Failure to provide additional resources by using a larger OVA template for IM and Presence deployment types and features above will result in higher system CPU, IM and Presence service core dumps, persistent chat and other performance related issues.

## SRST Sizing

The number of phones and DNs supported on a Cisco Integrated Services Router (ISR) in Survivable Remote Site Telephony (SRST) mode depends on the platform. [Table 9-4](#) provides a capacity example. For information on other SRST platforms, including information on the required amount of DRAM and flash memory, refer to the Cisco Unified SRST documentation available at

<https://www.cisco.com/c/en/us/support/unified-communications/unified-survivable-remote-site-telephony/products-device-support-tables-list.html>

**Table 9-4 SRST Sizing Example**

Platform	Maximum Number of Phones	Maximum Number of DNs
Cisco 4451-X Integrated Service Routers	2000	3,500

## Conferencing

Sizing a deployment for conferencing is primarily an exercise in deciding how many concurrent connections are required to Cisco Meeting Server. Considerations include:

- Geographical location — Each region served by Unified CM should have dedicated conferencing resources. For example, there could be one central location for the US where Unified CM, Cisco Meeting Server, and other servers are installed, and one central location for EMEA.
- Cisco Meeting Server platform capacities
- Type of conferencing — Audio and/or video; scheduled and/or non-scheduled
- Conference video resolution — Higher quality conferences use more resources.
- Large conference requirements — For example, all-hands meetings

Conference resources are generally dedicated to a region in order to keep as much of the conference media on the regional network; therefore, sizing can be considered on a region-by-region basis.

## Conference Port Usage Guidelines

Audio and video conference sizing depends heavily on specific details about the customer, their user base, and their conferencing habits. The guidelines in this section can be used as a basis for sizing a conferencing deployment, but user-to-port ratios will vary greatly depending on the deployment environment and the requirements of the organization.

[Table 9-5](#) shows suggested ratios to start planning conference resource requirements. These numbers vary depending on the capabilities of deployed endpoints, availability of alternative audio conferencing such as Cisco WebEx, and users' comfort level in creating and joining conferences. As a starting point, the following formulas can be used to calculate port requirements:

- Audio ports = 50 + (<number of users> / 9)
- Video ports = 8 + (<number of users> / 15)

**Table 9-5** Recommended Number of Conference Ports

Number of Users	Number of Audio Ports	Number of Video Ports
1,000	161	75
1,750	244	125
3,000	383	208
5,000	605	342
10,000	1,161	675

The numbers in [Table 9-5](#) can be used for either scheduled or non-scheduled conferencing. It is expected that, for scheduled meetings, customers can use existing usage data to draw more definite conclusions about concurrent meeting usage.

Understanding what type of meetings a customer expects to take place will help further refine the number of ports required. The total number of ports can be calculated with the formula:

$$\text{Total ports} = \text{Average number of participants in a meeting} * \text{Concurrent meetings}$$

For example, with 3,000 users, [Table 9-5](#) suggests 208 ports. This can, for instance, correspond to an average of 3 participants per meeting and 69 concurrent meetings, or an average of 6 participants per meeting and 34 concurrent meetings. By assessing the suggested port numbers in this manner, it is easier to determine whether the total number of ports is likely to be sufficient for the deployment.

Another important point to consider is what the maximum meeting size is likely to be. In most cases the largest meeting is an all-hands meeting type. For instance, if a customer has 1,000 users but has a requirement to join 96 systems in an all-hands TelePresence conference, this would override the 75 port suggestion.

## Cisco Meeting Server Platform Sizing

Cisco Meeting Server is available in several different models and platforms with differing conference support and scalability. [Table 9-6](#) lists the recommended Cisco Meeting Server platforms for enterprise deployments, along with their associated per-node port capacities. These numbers are valid with non-encrypted and encrypted media and signaling. For more information on Cisco Meeting Server clustering, for information on other Cisco Meeting Server platforms, or for information on other video and data channel resolutions, refer to the *Cisco Meeting Server, Web App, and Meeting Management Data Sheet*, available at

<https://www.cisco.com/c/en/us/products/conferencing/meeting-server/datasheet-listing.html>

**Table 9-6** Cisco Meeting Server Platforms and Capacities

Cisco Meeting Server M5v2 Platform	Full HD 1080p30 Port Capacity <sup>1</sup>	HD 720p30 Port Capacity <sup>2</sup>	SD 480p30 Port Capacity <sup>2</sup>
Cisco Meeting Server 1000	60	120	240
Cisco Meeting Server 2000	437	875	1,250

1. Assumes content sharing at 720p resolution and 30 frames per second (fps).
2. Assumes content sharing at 720p resolution and 5 frames per second (fps)

There are other considerations to keep in mind too. For example, a single Cisco Meeting Server supports a maximum of 450 participants in each conference per node, and this capacity can be increased by adding Cisco Meeting Server nodes.

## Cisco TelePresence Management Suite (TMS)

We recommend two simplified sizing deployments for Cisco TMS, illustrated in Table 9-7. The two deployments in Table 9-7 provide high availability. The redundant node is deployed for resiliency, not for scalability. A load balancer providing a single virtual IP address for the primary and backup nodes is also required.

**Table 9-7 Cisco TMS Simplified Deployments and Capacities**

Deployment Model	Deployment	Cisco TMS	Cisco TMSXE
Regular Deployment	2 nodes total: both TMS/TMESPE/ TMSXE and Microsoft SQL running on each node	< 200 controlled systems (endpoints added to TMS for scheduling) < 100 concurrent participants < 50 concurrent ongoing scheduled conferences	< 50 endpoints bookable in Microsoft Exchange
Large Deployment	4 nodes total: 2 nodes with TMS and 2 nodes with TMSXE Additional servers for Microsoft SQL	< 5,000 controlled systems (endpoints added to TMS for scheduling) < 1,800 concurrent participants < 250 concurrent ongoing scheduled conferences	< 1,800 endpoints bookable in Microsoft Exchange or < 1,000 endpoints bookable in Office 365 or a combination of on-premises Exchange and Office 365

Other factors that influence Cisco TMS performance and scaling include:

- The number of users accessing the Cisco TMS web interface.
- Concurrency of scheduled or monitored conferences.
- Simultaneous usage of the Cisco TMS Booking API (TMSBA) by multiple extensions or custom clients. Booking throughput is shared by all scheduling interfaces, including the Cisco TMS New Conference page.

For more information on sizing Cisco TMS, refer to the *Cisco TelePresence Management Suite Installation and Upgrade Guide*, available at

<https://www.cisco.com/c/en/us/support/conferencing/telepresence-management-suite-tms/products-installation-guides-list.html>



## Cisco Meeting Management

There are two VM configurations for Cisco Meeting Management, depending on the number of Cisco Meeting Server call bridges, the number of call legs started at peak time across all call bridges, and the number of users signed into Meeting Management at the same time. Table 9-8 lists the Cisco Meeting Management platforms and capacities for an enterprise deployment.

**Table 9-8** Cisco Meeting Management Capacities

Cisco Meeting Management Server Platform	Concurrently Logged-in Meeting Management Users	Call Bridges Supported with CMS 1000	Call Bridges Supported with CMS 2000
Small <sup>1</sup>	15	1-8	1
Large	25	9-24	2-3

1. This platform size applies to both small and medium-sized deployments with 15 or fewer concurrent users.

For more information, refer to the latest version of the *Cisco Meeting Management Installation and Configuration Guide*, available at

<https://www.cisco.com/c/en/us/support/conferencing/meeting-management/products-installation-guides-list.html>

## Collaboration Edge

This section covers sizing of Cisco Expressway and Cisco Unified Border Element, two key components of the Collaboration Edge.

### Cisco Expressway Sizing

Table 9-9 shows the maximum capacity that a single Expressway node can handle at any point of time when using the medium OVA template.

The Expressway nodes are clustered together to provide redundancy and larger scalability. The cluster configurations that are recommended and that are covered in this document consist of clusters of 2, 3, or 6 nodes. Table 9-10 shows the cluster capacity for those recommended deployments. It is important to note that all of the deployment models account for redundancy. With a cluster of 2 or 3 nodes, one node can fail without impacting the cluster capacity (N+1 redundancy). With a full cluster of 6 nodes, two nodes can fail without impacting the cluster capacity (N+2 redundancy).

In order to better understand the relationship between the cluster capacity and the level of redundancy, the following example analyses the video capacity during normal operations and after a failover, using the medium OVA template:

The maximum video call capacity per node is 150 sessions. In a 3-node cluster in a non-resilient deployment, the video call cluster capacity is 450, but it would be reduced by one-third if one node fails. In order to provide resiliency and maintain the cluster capacity if one of the three nodes fails, the recommended high-available 3-node cluster capacity is limited to 300 video sessions. During normal operations, video calls are load-balanced across the cluster, with each node handling approximately 100 video calls. If one node fails, the remaining nodes can then handle all 300 video sessions because each node can handle 150 video sessions, and therefore the cluster capacity is maintained.

**Table 9-9 Expressway Node Capacity**

OVA Template	Mobile and Remote Access Proxy Registrations per Node <sup>1</sup>	Video Calls Capacity per Node	Audio-Only Calls Capacity per Node
Virtual machine with medium OVA template	3,000	150	300

1. Proxy registration considerations apply only to mobile and remote access, not to business-to-business communications. These numbers assume Fast Path Registration for MRA is enabled on Expressway-E.

**Table 9-10 Cisco Expressway Simplified Sizing Deployments and Associated Cluster Capacity**

Deployment Model	Expressway Cluster Deployment	Redundancy Model	Mobile and Remote Access Proxy Registrations per Cluster <sup>1</sup>	Video Calls Capacity per Cluster	Audio-Only Calls Capacity per Cluster
<b>Virtual machine with medium OVA template</b>					
Deployment 1	2 nodes	N+1	3,000	150	300
Deployment 2	3 nodes	N+1	6,000	300	600
Deployment 3	6 nodes	N+2	12,000	600	1,200

1. Proxy registration considerations apply only to mobile and remote access, not to business-to-business communications. These numbers assume Fast Path Registration for MRA is enabled on Expressway-E.



**Note**

There are two other OVA templates available, the small and the large OVA templates. The small OVA template is designed to run on the Cisco Business Edition 6000M or 6000H. The large OVA template is not supported with the Cisco Business Edition 7000, and it is supported only with limited hardware. There is also an option to use a hardware appliance, the Cisco Expressway CE1200. Refer to the documentation at <https://www.cisco.com/go/virtualized-collaboration> for more information.

The following assumptions are used for the Expressway simplified sizing deployments in [Table 9-10](#):

- All video calls are encrypted. The average call rate across all the video calls is 768 kbps. For example, half of the video calls could be at 384 kbps and the other half at 1152 kbps.
- All audio calls are encrypted, and the average bandwidth across all audio calls is 64 kbps.
- For virtual machines using the medium OVA template, the call rate is up to 5 calls per second (cps) per node.

The following guidelines apply when clustering Cisco Expressway:

- Expressway clusters support up to 6 nodes (cluster capacity up to 4 times the node capacity).
- Expressway-E and Expressway-C nodes cluster separately; an Expressway-E cluster consists of Expressway-E nodes only, and an Expressway-C cluster consists of Expressway-C nodes only.
- Expressway peers should be deployed in equal numbers across Expressway-E and Expressway-C clusters. For example, a three-node Expressway-E cluster should be deployed with a three-node Expressway-C cluster.

- The capacity of all nodes across and within each Expressway-E and Expressway-C cluster pair must be the same. For example, an Expressway-E node using the small OVA template must not be deployed if the other nodes in the Expressway-E cluster or in the corresponding Expressway-C cluster are using the medium OVA template.
- An Expressway-E and Expressway-C cluster pair can be formed by a combination of nodes running on an appliance or running as a virtual machine, as long as the node capacity is the same across all nodes.
- Multiple Expressway-E and Expressway-C clusters may be deployed to increase capacity.

For more information on Expressway, refer to the *Cisco Expressway Administrator Guide*, available at <https://www.cisco.com/c/en/us/support/unified-communications/expressway-series/products-maintenance-guides-list.html>

### Cisco Expressway Sizing Example

A company has 6,000 users, and on average 1,000 users are traveling at any given time. 80% of the mobile users require mobile and remote access at any given time. In this case, Expressway has to be sized to allow for 800 concurrent registrations (80% of 1,000).

Moreover, 10% of the mobile users are in a call at the same time. 5% of these users are calling through Expressway, while the remaining 5% are calling through the cellular network, so that the number of concurrent calls to the Expressway is 80 (10% of 800).

In the corporate network, 1% of the users are on a business-to-business calls at the same time. This accounts for an additional 50 calls (1% of (6,000 – 1,000)).

In this case we need to size the cluster to support 800 concurrent registrations and 130 concurrent calls (80+50).

Table 9-9 shows that a medium OVA template supports up to 150 concurrent calls and 3,000 concurrent registrations. We can therefore deploy an Expressway-C cluster consisting of two nodes using the medium OVA template, and an Expressway-E cluster also consisting of two nodes using the medium OVA template. Each Expressway server node can manage the whole amount of 800 registrations and 130 calls at the same time, as shown by Deployment 1 in Table 9-10. Clustering is needed because, if one of the two Expressway nodes goes down, the other node can handle the whole amount of traffic. Under normal conditions, calls and registrations are load-balanced between the two nodes of the Expressway-C and Expressway-E clusters.

After some time, the business-to-business calls in this example increase from 1% to 3%. We now need to account for 280 concurrent calls (130+150) instead of 130. The maximum that a medium OVA template can handle is 150 calls, so we need to deploy a larger cluster in this case. Table 9-10 shows that Deployment 2 can account for 300 concurrent calls even in case of a server failure. Therefore, the administrator in this example decides to add another medium OVA node to the Expressway-C and Expressway-E clusters, for a total of 3 nodes per cluster.

## Cisco Unified Border Element Sizing

Cisco Unified Border Element is supported on a wide range of Cisco routing platforms, including platforms such as the Cisco 4400 Series Integrated Services Routers (ISR) and the Cisco 1000 Series Aggregation Service Routers (ASR). Cisco Unified Border Element also provides redundancy on the following platforms:

- The Cisco ISR platforms, which can provide box-to-box redundancy with both signaling and media preservation for active calls.
- The Cisco ASR platforms, which can provide box-to-box or in-box redundancy with media and signaling preservation (stateful failover) for active calls.

**Table 9-11** provides capacity examples for a few platforms. This table shows the maximum number of SIP trunk sessions, which corresponds to the maximum number of end-to-end PSTN SIP-SIP calls. It provides limits without media and signaling encryption and limits with RTP/SRTP interworking, where traffic is encrypted inside the corporate network and not encrypted for the connection to the SIP service provider. For information on other platforms and for more detailed, information including required amount of DRAM and flash memory, refer to the *Cisco Unified Border Element Data Sheet* available at

<https://www.cisco.com/c/en/us/products/unified-communications/unified-border-element/datasheet-listing.html>

For additional information, refer to the Cisco Unified Border Element Ordering Guide available at

<https://www.cisco.com/c/en/us/products/unified-communications/unified-border-element/sales-resources-listing.html>

**Table 9-11** Cisco Unified Border Element Capacity Examples

Platform	Maximum SIP Trunk Sessions with Non-Encrypted Media and Signaling	Maximum SIP Trunk Sessions with Encrypted Media and Signaling
Cisco 4451-X Integrated Service Router	6,000	1,400
Cisco 1004 and 1006 Aggregation Services Routers	16,000	5,000

### Cisco Unified Border Element Sizing Example

A company has 10,000 users and has media and signaling encryption enabled in the corporate network. During the busiest hour, 10% of them are in a call at the same time. 8% of these users are calling external destinations, while the remaining users are engaged in internal calls. The Telecom carrier and the enterprise have agreed that G.711 can be used on all calls, therefore no transcoding is needed. For this deployment, 800 SIP sessions (8% of 10,000) are needed. **Table 9-11** shows that a Cisco 4451-X ISR can support up to 1,400 sessions with encryption. Thus, for this example two Cisco 4451-X ISRs can be deployed, one active and one standby to provide redundancy.

# Voice Messaging

This section covers sizing for Cisco Unity Connection.

As discussed in the section on the [Cisco Unity Connection Deployment Process](#), the recommended Unity Connection deployment in this design consists of one publisher and one subscriber in active/active mode.

This guide covers three simplified sizing deployments for Unity Connection, depending on the number of users and the number of Jabber endpoints. These deployments are shown in [Table 9-12](#). For example, if a deployment has 10,000 users and 1,000 Jabber endpoints total, then at a minimum the 10k-user OVA template has to be deployed. Or for example, if a deployment has 6,000 users and 2,000 Jabber endpoints, then at a minimum the 10k-user OVA template has to be deployed. There are other possible deployments with Unity Connection, but they are not covered in this guide. Refer to the latest version of the [Unity Connection SRND](#) and product documentation for information on the other possible deployments.

**Table 9-12 Cisco Unity Connection Simplified Sizing Deployments**

Deployment Size	Unity Connection Nodes to be Deployed for Active/Active
Up to 5,000 users or up to 1,000 Jabber endpoints	One Unity Connection pair using 5k-user OVA template
5,000 to 10,000 users or up to 2,000 Jabber endpoints	One Unity Connection pair using 10k-user OVA template
10,000 to 20,000 users or up to 5,000 Jabber endpoints	One Unity Connection pair using 20k-user OVA template

### Cisco Unity Connection Assumptions

- High availability is implemented for all Cisco endpoints, including Jabber endpoints.
- Media and SIP signaling encryption can be enabled without changing this Unity Connection simplified sizing.
- There is a single inbox for all users (Unified Messaging).
- Notifications of voice messages (new message, message update, and message deleted) use HTTP (not HTTPS).

The OVA template limits should not be exceeded. For example, with the 5k-user OVA template, there is a limit of 200 ports with G.711 or 50 ports with G.722. For more information on the OVA template limits, refer to:

- Cisco Unity Connection virtualization information at [https://www.cisco.com/c/dam/en/us/td/docs/voice\\_ip\\_comm/uc\\_system/virtualization/virtualization-cisco-unity-connection.html](https://www.cisco.com/c/dam/en/us/td/docs/voice_ip_comm/uc_system/virtualization/virtualization-cisco-unity-connection.html)
- *Cisco Unity Connection Supported Platforms List* at <https://www.cisco.com/c/en/us/support/unified-communications/unity-connection/products-installation-guides-list.html>

It is also important to consider the amount of storage required to store voice mail. The message storage depends on the size of the virtual disk. For example, the approximate message storage using the G.711 codec is 137k minutes with the 5k-user OVA template, which is defined with one vDisk of 200 GB. Note that with the 10k-user OVA template, different vDisk sizes are available to address different message storage requirements. For more information, refer to the latest version of the [Cisco Unity Connection Supported Platforms List](#).

# Collaboration Management Services

This section covers sizing for [Cisco Prime Collaboration Deployment](#) used in the Enterprise Collaboration Preferred Architecture:

## Cisco Prime Collaboration Deployment

Cisco Prime Collaboration Deployment is deployed as one node. There is no redundant node in this deployment. Back up your Cisco Prime Collaboration Deployment virtual machine instead. The single Cisco Prime Collaboration Deployment node can support a deployment of any size.

# Virtual Machine Placement and Platforms

With Cisco Collaboration products that are deployed with virtualization, after sizing the deployment, the next step is to determine how to place the virtual machines together on the Cisco Unified Computing System (UCS) servers, which will ultimately determine how many UCS servers are required for the solution. This process is performed manually or can be done using the Quote Collab Tool, which requires a cisco.com login and which is available at <https://cqc.cloudapps.cisco.com/>.

Figure 9-1 shows an example servers diagram from Quote Collab for a deployment with 5,000 users and 5,000 total endpoints (including 1,000 Jabber endpoints). This example assumes that Cisco Business Edition 7000M is deployed. It does not include the Cisco Meeting Servers; we assume they are deployed on the Cisco Meeting Server 1000 platform.

**Figure 9-1** Virtual Machine Placement Example Using Quote Collab

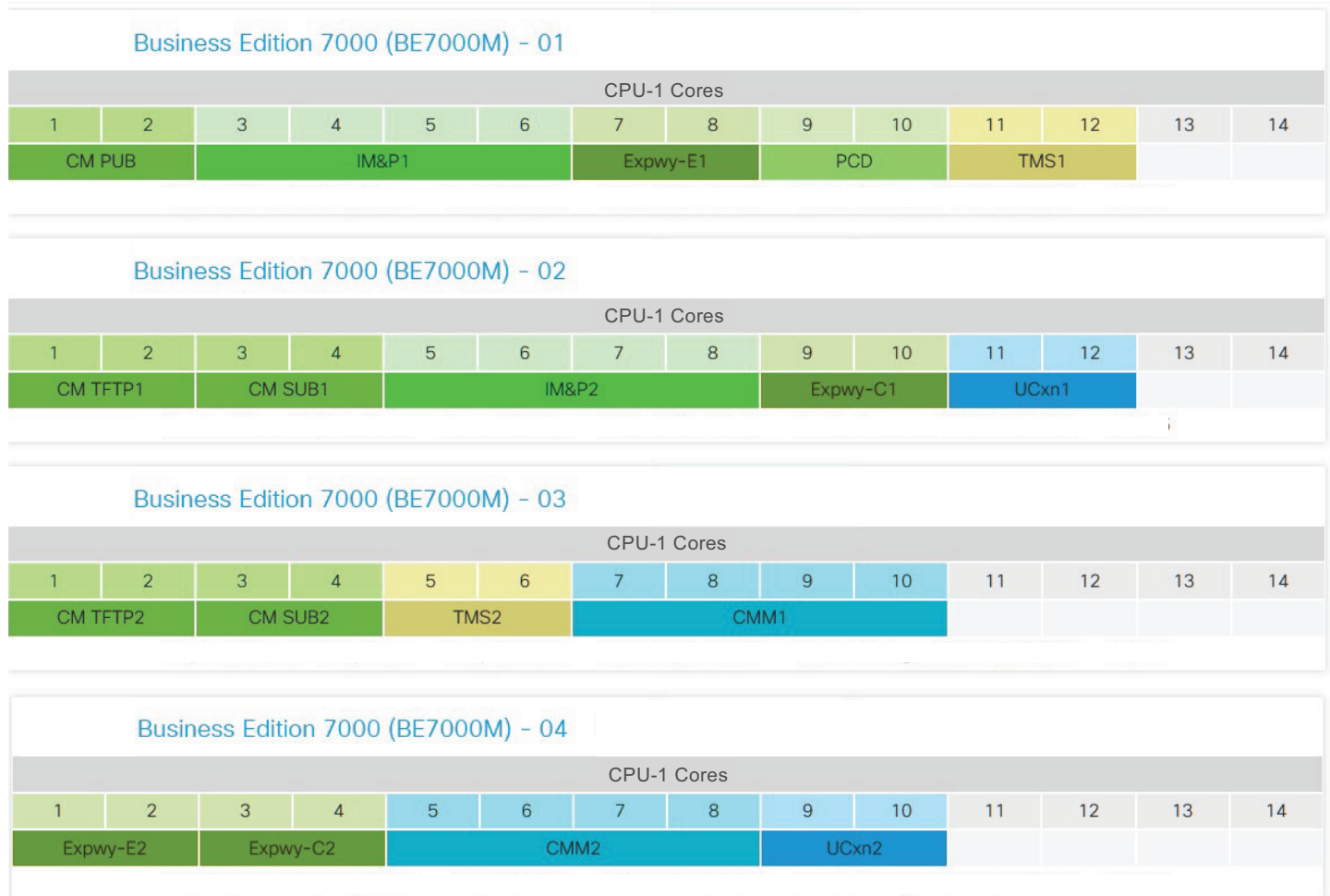

**Note**

To better summarize the overall VM requirements and placement for this simplified sizing example, in Figure 9-1 the Expressway-E VMs have been included on the same set of BE7000 servers as all the other VMs. In a production deployment the Expressway-E VMs would instead reside on separate host servers in the DMZ (BE7000 or other hardware).

In general, in addition to using Quote Collab, it is a good practice to validate the virtual machine placement by ensuring that the deployment meets all the co-residency requirements documented at

[https://www.cisco.com/c/dam/en/us/td/docs/voice\\_ip\\_comm/uc\\_system/virtualization/collaboration-virtualization-sizing.html](https://www.cisco.com/c/dam/en/us/td/docs/voice_ip_comm/uc_system/virtualization/collaboration-virtualization-sizing.html)

The main placement and co-residency rules are:

- No over-subscription — All virtual machines require a one-to-one mapping between virtual hardware and physical hardware. For example, with the CPU there must be a one-to-one mapping between virtual hardware and physical hardware, even when hyper-threading is enabled.
- VMware latency sensitivity, available with vSphere 5.5 and later versions, should be set to **High** for the Unity Connection virtual machines. If not, one spare physical core must be reserved for the ESXi scheduler on each ESXi host where Unity Connection is installed.
- Most of the applications discussed in this guide support co-residency with third-party applications, which means they can be installed on the same UCS server. However, it is important to understand that, with co-residency of third-party applications, the third-party applications must follow the same rules as Cisco collaboration applications. For example, once a third-party application is installed on the same host as a Cisco collaboration application, CPU over-subscription is not supported with that third-party application, a physical core needs to be reserved for the ESXi scheduler when deploying Unity Connection, and so forth. With Cisco Business Edition platforms, the ESXi license also dictates some of the co-residency options. For example, with the Cisco UC Virtualization Hypervisor/Foundation, there is a limit on the number of third-party applications that can be co-resident.

## Redundancy Consideration

Even though the hardware platforms can be highly redundant, it is good practice to plan for hardware redundancy. For example, do not deploy the primary and backup application virtual machines on the same UCS server, as shown in the example in Figure 9-1. Instead, deploy primary and backup virtual machines on different servers to provide redundancy in case a host fails.

## Platforms

For the products that are deployed with virtualization, Cisco Business Edition 7000 can be an excellent solution. It is easy to order and easy to deploy. VMware vSphere Hypervisor (ESXi) is pre-installed. Business Edition 7000 is also pre-loaded with the Cisco Collaboration software set and some of the Cisco Collaboration applications are also pre-installed.





## Product List

**Revised: May 21, 2021**

This product list identifies the Cisco products in the Preferred Architecture for Enterprise Collaboration, along with their recommended software versions.

**Table A-1** *Products and Software Versions for Enterprise Collaboration 14 Preferred Architecture*

Product	Product Description	Recommended Software Version
Cisco Unified Communications Manager and IM and Presence Service	Call control, instant messaging, and presence services	14
Cisco Unity Connection	Voicemail services	14
Cisco Expressway-C and Expressway-E	Mobile and remote access and business-to-business communications	X14
Cisco Prime Collaboration Deployment	Installs Unified CM cluster with IM and Presence Service and Unity Connection cluster	14
Cisco Meeting Server and Cisco Meeting Management	Audio and video conferencing and resource management	3.2
Cisco TelePresence Management Suite (TMS)	Scheduling, web conferencing integration, and other advanced video features	15.3
Cisco ISR and ASR	PSTN gateway, SRST, and external connectivity to the Internet	IOS XE 17.3(3)
Cisco IP Phone 8800 Series	General office use and IP conference phones	14
Cisco Unified IP Conference Phone 8832	IP conference phone	14
Cisco Jabber	Soft client with integrated voice, video, voicemail, and instant messaging and presence functionality for mobile devices and personal computers	Jabber 14
Webex Desk Pro	Personal endpoint for the desktop	CE 9.15 or later
Webex Room Series	Collaboration integrator and multipurpose room endpoint	CE 9.15 or later

