



Cisco Nexus 5500 Series NX-OS Layer 2 Switching Configuration Guide, Release 7.x

First Published: 2014-01-15

Last Modified: 2020-03-19

Americas Headquarters

Cisco Systems, Inc.
170 West Tasman Drive
San Jose, CA 95134-1706
USA
<http://www.cisco.com>
Tel: 408 526-4000
800 553-NETS (6387)
Fax: 408 527-0883

THE SPECIFICATIONS AND INFORMATION REGARDING THE PRODUCTS IN THIS MANUAL ARE SUBJECT TO CHANGE WITHOUT NOTICE. ALL STATEMENTS, INFORMATION, AND RECOMMENDATIONS IN THIS MANUAL ARE BELIEVED TO BE ACCURATE BUT ARE PRESENTED WITHOUT WARRANTY OF ANY KIND, EXPRESS OR IMPLIED. USERS MUST TAKE FULL RESPONSIBILITY FOR THEIR APPLICATION OF ANY PRODUCTS.

THE SOFTWARE LICENSE AND LIMITED WARRANTY FOR THE ACCOMPANYING PRODUCT ARE SET FORTH IN THE INFORMATION PACKET THAT SHIPPED WITH THE PRODUCT AND ARE INCORPORATED HEREIN BY THIS REFERENCE. IF YOU ARE UNABLE TO LOCATE THE SOFTWARE LICENSE OR LIMITED WARRANTY, CONTACT YOUR CISCO REPRESENTATIVE FOR A COPY.

The Cisco implementation of TCP header compression is an adaptation of a program developed by the University of California, Berkeley (UCB) as part of UCB's public domain version of the UNIX operating system. All rights reserved. Copyright © 1981, Regents of the University of California.

NOTWITHSTANDING ANY OTHER WARRANTY HEREIN, ALL DOCUMENT FILES AND SOFTWARE OF THESE SUPPLIERS ARE PROVIDED "AS IS" WITH ALL FAULTS. CISCO AND THE ABOVE-NAMED SUPPLIERS DISCLAIM ALL WARRANTIES, EXPRESSED OR IMPLIED, INCLUDING, WITHOUT LIMITATION, THOSE OF MERCHANTABILITY, FITNESS FOR A PARTICULAR PURPOSE AND NON-INFRINGEMENT OR ARISING FROM A COURSE OF DEALING, USAGE, OR TRADE PRACTICE.

IN NO EVENT SHALL CISCO OR ITS SUPPLIERS BE LIABLE FOR ANY INDIRECT, SPECIAL, CONSEQUENTIAL, OR INCIDENTAL DAMAGES, INCLUDING, WITHOUT LIMITATION, LOST PROFITS OR LOSS OR DAMAGE TO DATA ARISING OUT OF THE USE OR INABILITY TO USE THIS MANUAL, EVEN IF CISCO OR ITS SUPPLIERS HAVE BEEN ADVISED OF THE POSSIBILITY OF SUCH DAMAGES.

Any Internet Protocol (IP) addresses and phone numbers used in this document are not intended to be actual addresses and phone numbers. Any examples, command display output, network topology diagrams, and other figures included in the document are shown for illustrative purposes only. Any use of actual IP addresses or phone numbers in illustrative content is unintentional and coincidental.

All printed copies and duplicate soft copies of this document are considered uncontrolled. See the current online version for the latest version.

Cisco has more than 200 offices worldwide. Addresses and phone numbers are listed on the Cisco website at www.cisco.com/go/offices.

Cisco and the Cisco logo are trademarks or registered trademarks of Cisco and/or its affiliates in the U.S. and other countries. To view a list of Cisco trademarks, go to this URL: <https://www.cisco.com/go/trademarks>. Third-party trademarks mentioned are the property of their respective owners. The use of the word partner does not imply a partnership relationship between Cisco and any other company. (1721R)

© 2016–2020 Cisco Systems, Inc. All rights reserved.



CONTENTS

PREFACE

Preface xiii

Preface xiii

Audience xiii

Document Conventions xiii

Related Documentation xiv

Documentation Feedback xv

Communications, Services, and Additional Information xv

New and Changed Information xvii

CHAPTER 1

Overview 1

Layer 2 Ethernet Switching Overview 1

VLANs 1

Private VLANs 2

Spanning Tree 2

STP Overview 2

Rapid PVST+ 3

MST 3

STP Extensions 3

CHAPTER 2

Configuring VLANs 5

Finding Feature Information 5

Information About VLANs 5

Understanding VLANs 5

Understanding VLAN Ranges 6

Creating, Deleting, and Modifying VLANs 7

About the VLAN Trunking Protocol	8
Guidelines and Limitations for VTP	8
Configuring a VLAN	9
Creating and Deleting a VLAN	9
Configuring VLAN Long-Name	10
Changing the Range of Reserved VLANs	12
Configuring a VLAN	13
Adding Ports to a VLAN	15
Configuring VTP	15
Verifying the VLAN Configuration	17
Feature History for Configuring VLANs	17
<hr/>	
CHAPTER 3	Configuring Private VLANs 19
Information About Private VLANs	19
Primary and Secondary VLANs in Private VLANs	20
Private VLAN Ports	21
Primary, Isolated, and Community Private VLANs	22
Associating Primary and Secondary VLANs	23
Private VLAN Promiscuous Trunks	23
Private VLAN Isolated Trunks	24
Broadcast Traffic in Private VLANs	24
Private VLAN Port Isolation	24
Guidelines and Limitations for Private VLANs	24
Configuring a Private VLAN	25
Enabling Private VLANs	25
Configuring a VLAN as a Private VLAN	26
Associating Secondary VLANs with a Primary Private VLAN	27
Configuring an Interface as a Private VLAN Host Port	28
Configuring an Interface as a Private VLAN Promiscuous Port	29
Configuring a Promiscuous Trunk Port	30
Configuring an Isolated Trunk Port	32
Configuring Private VLANs on FEX Trunk Ports	33
Configuring the Allowed VLANs for PVLAN Trunking Ports	34
Configuring Native 802.1Q VLANs on Private VLANs	35

Verifying the Private VLAN Configuration 36

CHAPTER 4

Configuring Rapid PVST+ 37

Information About Rapid PVST+ 37

Understanding STP 37

STP Overview 37

Understanding How a Topology is Created 38

Understanding the Bridge ID 38

Understanding BPDUs 40

Election of the Root Bridge 41

Creating the Spanning Tree Topology 41

Understanding Rapid PVST+ 41

Rapid PVST+ Overview 41

Rapid PVST+ BPDUs 43

Proposal and Agreement Handshake 43

Protocol Timers 44

Port Roles 45

Port States 46

Synchronization of Port Roles 48

Spanning-Tree Dispute Mechanism 49

Port Cost 50

Port Priority 51

Rapid PVST+ and IEEE 802.1Q Trunks 51

Rapid PVST+ Interoperation with Legacy 802.1D STP 51

Rapid PVST+ Interoperation with 802.1s MST 52

Configuring Rapid PVST+ 52

Enabling Rapid PVST+ 52

Enabling Rapid PVST+ per VLAN 53

Configuring the Root Bridge ID 54

Configuring a Secondary Root Bridge 55

Configuring the Rapid PVST+ Port Priority 56

Configuring the Rapid PVST+ Path-Cost Method and Port Cost 57

Configuring the Rapid PVST+ Bridge Priority of a VLAN 58

Configuring the Rapid PVST+ Hello Time for a VLAN 59

Configuring the Rapid PVST+ Forward Delay Time for a VLAN	59
Configuring the Rapid PVST+ Maximum Age Time for a VLAN	60
Specifying the Link Type	60
Restarting the Protocol	61
Verifying the Rapid PVST+ Configuration	61

CHAPTER 5
Configuring Multiple Spanning Tree 63

Information About MST	63
MST Overview	63
MST Regions	64
MST BPDUs	64
MST Configuration Information	65
IST, CIST, and CST	65
IST, CIST, and CST Overview	65
Spanning Tree Operation Within an MST Region	66
Spanning Tree Operations Between MST Regions	66
MST Terminology	67
Hop Count	68
Boundary Ports	68
Spanning-Tree Dispute Mechanism	69
Port Cost and Port Priority	69
Interoperability with IEEE 802.1D	70
Interoperability with Rapid PVST+: Understanding PVST Simulation	70
Configuring MST	71
MST Configuration Guidelines	71
Enabling MST	71
Entering MST Configuration Mode	72
Specifying the MST Name	73
Specifying the MST Configuration Revision Number	73
Specifying the Configuration on an MST Region	74
Mapping and Unmapping VLANs to MST Instances	76
Mapping Secondary VLANs to Same MSTI as Primary VLANs for Private VLANs	77
Configuring the Root Bridge	77
Configuring a Secondary Root Bridge	78

Configuring the Port Priority	79
Configuring the Port Cost	80
Configuring the Switch Priority	81
Configuring the Hello Time	82
Configuring the Forwarding-Delay Time	83
Configuring the Maximum-Aging Time	83
Configuring the Maximum-Hop Count	84
Configuring PVST Simulation Globally	84
Configuring PVST Simulation Per Port	85
Specifying the Link Type	86
Restarting the Protocol	87
Verifying the MST Configuration	87
<hr/>	
CHAPTER 6	Configuring STP Extensions 89
Overview	89
Information About STP Extensions	89
Understanding STP Port Types	89
Understanding Bridge Assurance	90
Understanding BPDU Guard	90
Understanding BPDU Filtering	91
Understanding Loop Guard	92
Understanding Root Guard	92
Configuring STP Extensions	93
STP Extensions Configuration Guidelines	93
Configuring Spanning Tree Port Types Globally	93
Configuring Spanning Tree Edge Ports on Specified Interfaces	94
Configuring Spanning Tree Network Ports on Specified Interfaces	96
Enabling BPDU Guard Globally	97
Enabling BPDU Guard on Specified Interfaces	97
Enabling BPDU Filtering Globally	98
Enabling BPDU Filtering on Specified Interfaces	99
Enabling Loop Guard Globally	100
Enabling Loop Guard or Root Guard on Specified Interfaces	101
Configuring FEX Port Spanning Tree BPDU Transmit Interval	102

Verifying the STP Extension Configuration 103

CHAPTER 7**Configuring Flex Links 105**

- Information About Flex Links 105
- Guidelines and Limitations for Flex Link 106
- Default Settings for Flex Link 107
- Configuring Flex Links 107
- Configuring Flex Link Preemption 109
- Verifying Flex Link Configuration 111
- Flex Link Configuration Examples 111

CHAPTER 8**Configuring LLDP 115**

- Configuring LLDP 115
- Configuring Interface LLDP 116

CHAPTER 9**Configuring MAC Address Tables 121**

- Information About MAC Addresses 121
- Configuring MAC Addresses 121
 - Configuring Static MAC Addresses 121
 - Configuring the Aging Time for the MAC Table 122
 - Configuring MAC Move Loop Detection 123
 - Clearing Dynamic Addresses from the MAC Table 124
- Verifying the MAC Address Configuration 124

CHAPTER 10**Configuring IGMP Snooping 127**

- Information About IGMP Snooping 127
 - IGMPv1 and IGMPv2 128
 - IGMPv3 128
 - IGMP Snooping Querier 129
 - IGMP Forwarding 129
- Guidelines and Limitations for IGMP Snooping 129
- Configuring IGMP Snooping Parameters 130
- Verifying the IGMP Snooping Configuration 133

CHAPTER 11	Configuring MVR	135
	Information About MVR	135
	MVR Overview	135
	MVR Interoperation with Other Features	136
	Licensing Requirements for MVR	136
	Guidelines and Limitations for MVR	136
	Default MVR Settings	137
	Configuring MVR	137
	Configuring MVR Global Parameters	137
	Configuring MVR Interfaces	139
	Verifying the MVR Configuration	140

CHAPTER 12	Configuring VTP V3	145
	Configuring VTP V3	145
	VTP V3 Overview	145
	VTP V3 Modes	145
	VTP V3 Pruning	146
	VTP V3 Per Interface	146
	VTP V3 Pruning and Spanning Tree Protocol	147
	Configuring VTP V3	147
	Configuring VTP V3 Pruning	150

CHAPTER 13	Configuring Traffic Storm Control	151
	Information About Traffic Storm Control	151
	Guidelines and Limitations for Traffic Storm Control	152
	Configuring Traffic Storm Control	153
	Verifying the Traffic Storm Control Configuration	154
	Traffic Storm Control Example Configuration	154
	Default Settings for Traffic Storm Control	154

CHAPTER 14	Configuring the Fabric Extender	157
	Information About the Cisco Nexus 2000 Series Fabric Extender	157
	Fabric Extender Terminology	158

Fabric Extender Features	159
Layer 2 Host Interfaces	159
Host Port Channel	160
VLANs and Private VLANs	160
Virtual Port Channels	161
Fibre Channel over Ethernet Support	162
Protocol Offload	162
Quality of Service	162
Access Control Lists	163
IGMP Snooping	163
Switched Port Analyzer	163
Fabric Interface Features	164
Oversubscription	164
Management Model	166
Forwarding Model	166
Connection Model	167
Static Pinning Fabric Interface Connection	167
Port Channel Fabric Interface Connection	169
Port Numbering Convention	169
Fabric Extender Image Management	170
Fabric Extender Hardware	170
Chassis	170
Ethernet Interfaces	170
Speed and Duplex Mode	172
Example: Configuring the Interface Speed Parameters	174
Disabling Autonegotiation	175
Associating a Fabric Extender to a Fabric Interface	175
Associating a Fabric Extender to an Ethernet Interface	176
Associating a Fabric Extender to a Port Channel	177
Disassociating a Fabric Extender from an Interface	179
Configuring Fabric Extender Global Features	179
Enabling the Fabric Extender Locator LED	182
Redistributing the Links	182
Changing the Number of Links	183

Maintaining the Pinning Order	183
Redistributing Host Interfaces	184
Verifying the Fabric Extender Configuration	184
Verifying the Chassis Management Information	187
Configuring the Cisco Nexus N2248TP-E Fabric Extender	192
Configuring the Shared Buffer	193
Configuring the Queue Limit at the Global Level	194
Configuring the Queue Limit at the Port Level	195
Configuring the Uplink Distance	196
Configuring the Cisco Nexus N2248PQ Fabric Extender	196
Configuring the Shared Buffer	197
Configuring the Uplink Distance	198
Configuring Slow Drain	198
Load-balancing queues at the FEX global level	199

CHAPTER 15**Configuring VM-FEX 201**

Information About VM-FEX	201
VM-FEX Overview	201
VM-FEX Components	201
VM-FEX Terminology	202
Licensing Requirements for VM-FEX	203
Default Settings for VM-FEX	203
Configuring VM-FEX	204
Overview of the VM-FEX Configuration Steps	204
Enabling Features Required for VM-FEX	205
Configuring the Fixed Static Interfaces	206
Configuring a Port Profile for the Dynamic Interfaces	209
Configuring an SVS Connection to the vCenter Server	210
Activating an SVS Connection to the vCenter Server	212
Verifying the VM-FEX Configuration	213
Verifying the Status of the Virtual Interfaces	213
Verifying the Connection to the vCenter Server	215



Preface

The preface contains the following sections:

- [Preface, on page xiii](#)

Preface

This preface describes the audience, organization, and conventions of the Book Title. It also provides information on how to obtain related documentation.

This chapter includes the following topics:

Audience

This publication is for experienced network administrators who configure and maintain Cisco NX-OS on Cisco Nexus 5000 Series Platform switches.

Document Conventions



Note

- As part of our constant endeavor to remodel our documents to meet our customers' requirements, we have modified the manner in which we document configuration tasks. As a result of this, you may find a deviation in the style used to describe these tasks, with the newly included sections of the document following the new format.
- The Guidelines and Limitations section contains general guidelines and limitations that are applicable to all the features, and the feature-specific guidelines and limitations that are applicable only to the corresponding feature.

Command descriptions use the following conventions:

Convention	Description
bold	Bold text indicates the commands and keywords that you enter literally as shown.
<i>Italic</i>	Italic text indicates arguments for which the user supplies the values.

Convention	Description
[x]	Square brackets enclose an optional element (keyword or argument).
[x y]	Square brackets enclosing keywords or arguments separated by a vertical bar indicate an optional choice.
{x y}	Braces enclosing keywords or arguments separated by a vertical bar indicate a required choice.
[x {y z}]	Nested set of square brackets or braces indicate optional or required choices within optional or required elements. Braces and a vertical bar within square brackets indicate a required choice within an optional element.
<i>variable</i>	Indicates a variable for which you supply values, in context where italics cannot be used.
string	A nonquoted set of characters. Do not use quotation marks around the string or the string will include the quotation marks.

Examples use the following conventions:

Convention	Description
<code>screen font</code>	Terminal sessions and information the switch displays are in screen font.
boldface screen font	Information you must enter is in boldface screen font.
<i>italic screen font</i>	Arguments for which you supply values are in italic screen font.
<>	Nonprinting characters, such as passwords, are in angle brackets.
[]	Default responses to system prompts are in square brackets.
!, #	An exclamation point (!) or a pound sign (#) at the beginning of a line of code indicates a comment line.

This document uses the following conventions:



Note Means *reader take note*. Notes contain helpful suggestions or references to material not covered in the manual.



Caution Means *reader be careful*. In this situation, you might do something that could result in equipment damage or loss of data.

Related Documentation

Documentation for Cisco Nexus 5000 Series Switches is available at:

- Configuration Guides

<http://www.cisco.com/c/en/us/support/switches/nexus-5000-series-switches/products-installation-and-configuration-guides-list.html>

- Command Reference Guides

<http://www.cisco.com/c/en/us/support/switches/nexus-5000-series-switches/products-command-reference-list.html>

- Release Notes

<http://www.cisco.com/c/en/us/support/switches/nexus-5000-series-switches/products-release-notes-list.html>

- Install and Upgrade Guides

<http://www.cisco.com/c/en/us/support/switches/nexus-5000-series-switches/products-installation-guides-list.html>

- Licensing Guide

<http://www.cisco.com/c/en/us/support/switches/nexus-5000-series-switches/products-licensing-information-listing.html>

Documentation for Cisco Nexus 5000 Series Switches and Cisco Nexus 2000 Series Fabric Extenders is available at:

<http://www.cisco.com/c/en/us/support/switches/nexus-2000-series-fabric-extenders/products-installation-and-configuration-guides-list.html>

Documentation Feedback

To provide technical feedback on this document, or to report an error or omission, please send your comments to nexus5k-docfeedback@cisco.com. We appreciate your feedback.

Communications, Services, and Additional Information

- To receive timely, relevant information from Cisco, sign up at [Cisco Profile Manager](#).
- To get the business impact you're looking for with the technologies that matter, visit [Cisco Services](#).
- To submit a service request, visit [Cisco Support](#).
- To discover and browse secure, validated enterprise-class apps, products, solutions and services, visit [Cisco Marketplace](#).
- To obtain general networking, training, and certification titles, visit [Cisco Press](#).
- To find warranty information for a specific product or product family, access [Cisco Warranty Finder](#).

Cisco Bug Search Tool

[Cisco Bug Search Tool](#) (BST) is a web-based tool that acts as a gateway to the Cisco bug tracking system that maintains a comprehensive list of defects and vulnerabilities in Cisco products and software. BST provides you with detailed defect information about your products and software.

New and Changed Information

The table below summarizes the new and changed features for this document and shows the releases in which each feature is supported. Your software release might not support all the features in this document. For the latest caveats and feature information, see the Bug Search Tool at <https://tools.cisco.com/bugsearch/> and the release notes for your software release.



Note The new and changed information topic is added in the configuration guide from the Cisco Nexus Release 7.3(0)N1(1) onwards.

Cisco NX-OS Release Number	Platform Supported	New/Enhanced Features	Chapter/Topic Where Documented
7.3(0)N1(1)	Cisco Nexus 5500, 5600, and 6000 Series Switches	VLAN Long Name support	Configuring VLANs, on page 5



CHAPTER 1

Overview

This chapter contains the following sections:

- [Layer 2 Ethernet Switching Overview, on page 1](#)
- [VLANs, on page 1](#)
- [Private VLANs, on page 2](#)
- [Spanning Tree , on page 2](#)

Layer 2 Ethernet Switching Overview

The device supports simultaneous, parallel connections between Layer 2 Ethernet segments. Switched connections between Ethernet segments last only for the duration of the packet. New connections can be made between different segments for the next packet.

The device assigns a domain (for example, a server) to each device to solve traffic congestion caused by high-bandwidth devices and large number of users.

Because collisions cause significant congestion in Ethernet networks, an effective solution is full-duplex communication. Typically, 10/100-Mbps Ethernet operates in half-duplex mode, which means that stations can either receive or transmit. In full-duplex mode, which is configurable on these interfaces, two stations can transmit and receive at the same time. When packets can flow in both directions simultaneously, the effective Ethernet bandwidth doubles. 1/10-Gigabit Ethernet operates in full-duplex only.

VLANs

A VLAN is a switched network that is logically segmented by function, project team, or application, without regard to the physical locations of the users. VLANs have the same attributes as physical LANs, but you can group end stations even if they are not physically located on the same LAN segment.

Any switch port can belong to a VLAN, and unicast, broadcast, and multicast packets are forwarded and flooded only to end stations in that VLAN. Each VLAN is considered as a logical network, and packets destined for stations that do not belong to the VLAN must be forwarded through a bridge or a router.

All ports are assigned to the default VLAN (VLAN1) when the device comes up.

The devices support 4094 VLANs in accordance with the IEEE 802.1Q standard. These VLANs are organized into several ranges, and you use each range slightly differently. Some of these VLANs are reserved for internal use by the device and are not available for configuration.



Note Inter-Switch Link (ISL) trunking is not supported.

Private VLANs

Private VLANs provide traffic separation and security at the Layer 2 level.

A private VLAN is one or more pairs of a primary VLAN and a secondary VLAN, all with the same primary VLAN. The two types of secondary VLANs are isolated and community VLANs. Hosts on isolated VLANs communicate only with hosts in the primary VLAN. Hosts in a community VLAN can communicate only among themselves and with hosts in the primary VLAN but not with hosts in isolated VLANs or in other community VLANs.

Regardless of the combination of isolated and community secondary VLANs, all interfaces within the primary VLAN comprise one Layer 2 domain, and therefore, require only one IP subnet.

Spanning Tree

This section discusses the implementation of the Spanning Tree Protocol (STP). Spanning tree is used to refer to IEEE 802.1w and IEEE 802.1s. When the IEEE 802.1D Spanning Tree Protocol is referred to in the publication, 802.1D is stated specifically.

STP Overview

STP provides a loop-free network at the Layer 2 level. Layer 2 LAN ports send and receive STP frames, which are called Bridge Protocol Data Units (BPDUs), at regular intervals. Network devices do not forward these frames but use the frames to construct a loop-free path.

802.1D is the original standard for STP, and many improvements have enhanced the basic loop-free STP. You can create a separate loop-free path for each VLAN, which is named Per VLAN Spanning Tree (PVST+). Additionally, the entire standard was reworked to make the loop-free convergence process faster to keep up with the faster equipment. This STP standard with faster convergence is the 802.1w standard, which is known as Rapid Spanning Tree (RSTP).

Finally, the 802.1s standard, Multiple Spanning Trees (MST), allows you to map multiple VLANs into a single spanning tree instance. Each instance runs an independent spanning tree topology.

Although the software can interoperate with legacy 802.1D systems, the device runs Rapid PVST+ and MST. You can use either Rapid PVST+ or MST in a given VDC; you cannot mix both in one VDC. Rapid PVST+ is the default STP protocol.

STP L2 loop occurs when a Cisco Nexus 5000 switch in a vPC receives a frame with MACSEC Ethertype. The switch in the vPC blocks one of its ports and the packet is forwarded even though there is an STP block and thus creating a loop. This is a known limitation. To resolve this, troubleshoot the STP topology; identify the STP port on the blocking switch; and perform a shut/no shut on the port. This helps to break the loop.



Note Cisco NX-OS uses the extended system ID and MAC address reduction; you cannot disable these features.

In addition, Cisco has created some proprietary features to enhance the spanning tree activities.

Rapid PVST+

Rapid PVST+ is the default spanning tree mode for the software and is enabled by default on the default VLAN and all newly created VLANs.

A single instance, or topology, of RSTP runs on each configured VLAN, and each Rapid PVST+ instance on a VLAN has a single root device. You can enable and disable STP on a per-VLAN basis when you are running Rapid PVST+.

MST

The software also supports MST. The multiple independent spanning tree topologies enabled by MST provide multiple forwarding paths for data traffic, enable load balancing, and reduce the number of STP instances required to support a large number of VLANs.

MST incorporates RSTP, so it also allows rapid convergence. MST improves the fault tolerance of the network because a failure in one instance (forwarding path) does not affect other instances (forwarding paths).



Note Changing the spanning tree mode disrupts the traffic because all spanning tree instances are stopped for the previous mode and started for the new mode.

You can force specified interfaces to send prestandard, rather than standard, MST messages using the command-line interface.

STP Extensions

The software supports the following Cisco proprietary features:

- Spanning tree port types—The default spanning tree port type is normal. You can configure interfaces connected to Layer 2 hosts as edge ports and interfaces connected to Layer 2 switches or bridges as network ports.
- Bridge Assurance—Once you configure a port as a network port, Bridge Assurance sends BPDUs on all ports and moves a port into the blocking state if it no longer receives BPDUs. This enhancement is available only when you are running Rapid PVST+ or MST.
- BPDU Guard—BPDU Guard shuts down the port if that port receives a BPDU.
- BPDU Filter—BPDU Filter suppresses sending and receiving BPDUs on the port.
- Loop Guard—Loop guard prevents the occurrence of loop bridging because of unidirectional link failure in a point-to-point link.
- Root Guard—Root guard prevents a port from becoming a root port or a blocked port. If you configure a port with root guard then the port receives a superior BPDU and it immediately goes to root-inconsistent (blocked) state.



CHAPTER 2

Configuring VLANs

This chapter contains the following sections:

- [Finding Feature Information, on page 5](#)
- [Information About VLANs, on page 5](#)
- [Configuring a VLAN, on page 9](#)
- [Feature History for Configuring VLANs, on page 17](#)

Finding Feature Information

Your software release may not support all the features documented in this module. For the latest caveats and feature information, see [Bug Search Tool](#) and the release notes for your platform and software release. To find information about the features documented in this module, and to see a list of the releases in which each feature is supported, see the feature information table.

Use Cisco Feature Navigator to find information about platform support and Cisco software image support. To access Cisco Feature Navigator, go to www.cisco.com/go/cfn. An account on Cisco.com is not required.

Information About VLANs

Understanding VLANs

A VLAN is a group of end stations in a switched network that is logically segmented by function, project team, or application, without the limitation to the physical locations of the users. VLANs have the same attributes as physical LANs, but you can group end stations even if they are not physically located on the same LAN segment.

Any port can belong to a VLAN; all unicast, broadcast, and multicast packets are forwarded and flooded only to end stations in that VLAN. Each VLAN is considered a logical network. If a packet destination address does not belong to the VLAN, it must be forwarded through a router.

The following figure shows VLANs as logical networks. In this diagram, the stations in the engineering department are assigned to one VLAN, the stations in the marketing department are assigned to another VLAN, and the stations in the accounting department are assigned to yet another VLAN.

Figure 1: VLANs as Logically Defined Networks

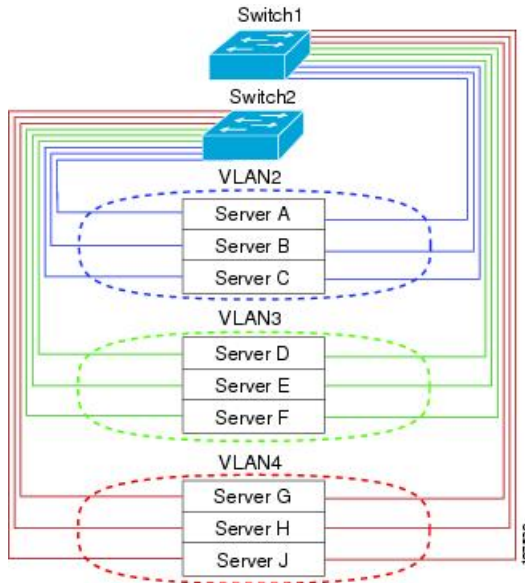

VLANs are usually associated with IP subnetworks. For example, all the end stations in a particular IP subnet belong to the same VLAN. To communicate between VLANs, you must route the traffic.

By default, a newly created VLAN is operational. To disable the VLAN use the **shutdown** command. Additionally, you can configure VLANs to be in the active state (passing traffic), or the suspended state (in which the VLANs are not passing packets). By default, the VLANs are in the active state and pass traffic.



Note The VLAN Trunking Protocol (VTP) mode is OFF. VTP BPDUs are dropped on all interfaces of the switch. This process has the effect of partitioning VTP domains if other switches have VTP turned on.

A VLAN can also be configured as a switched virtual interface (SVI). In this case, the switch ports in the VLAN are represented by a virtual interface to a routing or bridging system. The SVI can be configured for routing, in which case it supports Layer 3 protocols for processing packets from all switch ports associated with the VLAN, or for in-band management of the switch.

Understanding VLAN Ranges

The Cisco Nexus device supports VLAN numbers 1 to 4094 in accordance with the IEEE 802.1Q standard. These VLANs are organized into ranges. The switch is physically limited in the number of VLANs it can support. The hardware also shares this available range with its VSANs. For information about VLAN and VSAN configuration limits, see the configuration limits documentation for your device.

The following table describes the details of the VLAN ranges.

Table 1: VLAN Ranges

VLANs Numbers	Range	Usage
1	Normal	Cisco default. You can use this VLAN, but you cannot modify or delete it.

VLANs Numbers	Range	Usage
2—1005	Normal	You can create, use, modify, and delete these VLANs.
1006—4094	Extended	You can create, name, and use these VLANs. You cannot change the following parameters: <ul style="list-style-type: none"> • State is always active. • VLAN is always enabled. You cannot shut down these VLANs.
3968—4049 and 4094	Internally allocated	These 82 VLANs, plus VLAN 4094, are allocated for internal use. You cannot create, delete, or modify any VLANs within the block reserved for internal use.



Note You cannot configure the internally allocated VLANs (reserved VLANs).



Note VLANs 3968 to 4049 and 4094 are reserved for internal use; these VLANs cannot be changed or used.

Cisco NX-OS allocates a group of 82 VLAN numbers for those features, such as multicast and diagnostics, that need to use internal VLANs for their operation. By default, the system allocates VLANs numbered 3968 to 4049 for internal use. VLAN 4094 is also reserved for internal use by the switch.

You cannot use, modify, or delete any of the VLANs in the reserved group. You can display the VLANs that are allocated internally and their associated use.

Creating, Deleting, and Modifying VLANs

VLANs are numbered from 1 to 4094. All configured ports belong to the default VLAN when you first bring up the switch. The default VLAN (VLAN1) uses only default values. You cannot create, delete, or suspend activity in the default VLAN.

You create a VLAN by assigning a number to it. You can delete VLANs as well as move them from the active operational state to the suspended operational state. If you attempt to create a VLAN with an existing VLAN ID, the switch goes into the VLAN submode but does not create the same VLAN again.

Newly created VLANs remain unused until ports are assigned to the specific VLAN. All the ports are assigned to VLAN1 by default.

Depending on the range of the VLAN, you can configure the following parameters for VLANs (except the default VLAN):

- VLAN name
- Shutdown or not shutdown

When you delete a specified VLAN, the ports associated to that VLAN are shut down and no traffic flows. However, the system retains all the VLAN-to-port mapping for that VLAN, and when you reenables, or recreates, the specified VLAN, the system automatically reinstates all the original ports to that VLAN.



Note Commands entered in the VLAN configuration submode are immediately executed. VLANs 3968 to 4049 and 4094 are reserved for internal use; these VLANs cannot be changed or used.

About the VLAN Trunking Protocol

VLAN Trunking Protocol (VTP) is a distributed VLAN database management protocol that synchronizes the VTP VLAN database across domains. A VTP domain includes one or more network switches that share the same VTP domain name and are connected with trunk interfaces. Each switch can be in only one VTP domain. Layer 2 trunk interfaces, Layer 2 port channels, and virtual port channels (vPCs) support VTP functionality. You can configure VTP in client or server mode. In previous releases, VTP worked only in transparent mode.

The following are the different VTP modes:

- Server mode—Allows users to perform configurations, manage the VLAN database version, and store the VLAN database.
- Client mode—Does not allow users to perform configurations and relies on other switches in the domain to provide configuration information.
- Off mode—Allows users to access the VLAN database (VTP is enabled) but does not participate in VTP.
- Transparent mode—Does not participate in VTP, uses local configuration, and relays VTP packets to other forward ports. VLAN changes affect only the local switch. A VTP transparent network switch does not advertise its VLAN configuration and does not synchronize its VLAN configuration based on received advertisements.

Guidelines and Limitations for VTP

VTP has the following configuration guidelines and limitations:

- When a switch is configured as a VTP client, you cannot create VLANs on the switch in the range of 1 to 1005.
- VLAN 1 is required on all trunk ports used for switch interconnects if VTP is supported in the network. Disabling VLAN 1 from any of these ports prevents VTP from functioning properly.
- If you enable VTP, you must configure either version 1 or version 2. On the Cisco Nexus device, 512 VLANs are supported. If these switches are in a distribution network with other switches, the limit remains the same.

On the Cisco Nexus device, 512 VLANs are supported. If these switches are in a distribution network with other switches, the VLAN limit for the VTP domain is 512. If a Cisco Nexus device client/server receives additional VLANs from a VTP server, they transition to transparent mode.

- If **system vlan long-name** knob is enabled, then VTP configurations will come up in OFF mode and users can change the mode to Transparent. However, changing the mode to Server or Client is not allowed.
- The **show running-configuration** command does not show VLAN or VTP configuration information for VLANs 1 to 1000.
- When deployed with vPC, both vPC switches must be configured identically. vPC performs a Type 2 consistency check for VTP configuration parameters.

- VTP advertisements are not sent out on Cisco Nexus Fabric Extender ports.
- Private VLANs (PVLANS) are supported only when the switch is in transparent mode.
- If you are using VTP in a Token Ring environment, you must use version 2.
- When a switch is configured in VTP client or server mode, VLANs 1002 to 1005 are reserved VLANs.
- VTPv3 pruning is supported from Cisco NX-OS Release 7.2(0)N1(1) onwards.
- You must enter the **copy running-config startup-config** command followed by a reload after changing a reserved VLAN range. For example:

```
switch(config)# system vlan 2000 reserve
This will delete all configs on vlans 2000-2081. Continue anyway? (y/n) [no] y
```

After the switch reload, VLANs 2000 to 2081 are reserved for internal use, which requires that you enter the **copy running-config startup-config** command before the switch reload. Creating VLANs within this range is not allowed.

- In SNMP, the `vlanTrunkPortVtpEnabled` object indicates whether the VTP feature is enabled or not.

Configuring a VLAN

Creating and Deleting a VLAN

You can create or delete all VLANs except the default VLAN and those VLANs that are internally allocated for use by the switch. Once a VLAN is created, it is automatically in the active state.



Note When you delete a VLAN, ports associated to that VLAN shut down. The traffic does not flow and the packets are dropped.

Procedure

	Command or Action	Purpose
Step 1	switch# configure terminal	Enters global configuration mode.
Step 2	switch(config)# vlan {vlan-id vlan-range}	Creates a VLAN or a range of VLANs. If you enter a number that is already assigned to a VLAN, the switch moves into the VLAN configuration submode for that VLAN. If you enter a number that is assigned to an internally allocated VLAN, the system returns an error message. However, if you enter a range of VLANs and one or more of the specified VLANs is outside the range of internally allocated VLANs, the command takes effect on <i>only</i> those VLANs outside the range. The range

	Command or Action	Purpose
		is from 2 to 4094; VLAN1 is the default VLAN and cannot be created or deleted. You cannot create or delete those VLANs that are reserved for internal use.
Step 3	switch(config-vlan)# no vlan { <i>vlan-id</i> <i>vlan-range</i> }	Deletes the specified VLAN or range of VLANs and removes you from the VLAN configuration submode. You cannot delete VLAN1 or the internally allocated VLANs.

Example

This example shows how to create a range of VLANs from 15 to 20:

```
switch# configure terminal
switch(config)# vlan 15-20
```



Note You can create and delete VLANs in the VLAN configuration submode.

Configuring VLAN Long-Name



Note If VTP is enabled, it must be in transparent or in off mode. VTP cannot be in client or server mode. For more details about VTP, see the Configuring VTP chapter.

Beginning with Cisco NX-OS Release 7.3(0)N1(1), the length of VLAN name that you can configure is increased from 32 to 128 characters. In the earlier release version, you could configure the length of VLAN name up to 32 characters.

Procedure

Step 1 **configure terminal**

Example:

```
switch# configure terminal
```

Enters global configuration mode.

Step 2 **system vlan long-name**

Example:

```
switch(config)# system vlan long-name
```

Allows you to configure the length of VLAN names up to 128 characters.

Note Enabling or disabling the **system vlan long-name** command will trigger a system log message that will let you know if the VLAN long name is enabled or disabled.

If you try to enable or disable the **system vlan long-name** command, when it is already enabled or disabled, the system will throw error message. We recommend you view the status of the VLAN long-name knob before enabling or disabling this command.

Use the **no** form of this command to disable this feature.

Step 3 (Optional) copy running-config startup-config

Example:

```
switch(config)# copy running-config startup-config
```

Saves the change persistently through reboots and restarts by copying the running configuration to the startup configuration.

Step 4 show running-config | sec long-name

Example:

```
switch(config)# show running-config | sec long-name
```

Displays the VLAN long-name status information.

Note When you configure a VLAN name of more than 32 characters, the **show vlan** commands will show the output in multiple lines with each line containing a maximum of 32 characters.

Example

This example shows how to configure VLAN long-names of up to 128 characters.

```
switch# configure terminal
switch(config)# system vlan long-name
!2001 Sep 29 02:24:11 N72-3 %$ VDC-1 %$ %VLAN_MGR-2-CRITICAL_MSG: VLAN long name is Enabled!
switch(config)# copy running config startup config
switch(config)# show running-config | sec long-name
switch# configure terminal
switch(config)# vlan 2
switch(config-vlan)# name
VLAN128Char000000000000000400000000000000000000000000000000000000000000000000000000000000000000002

switch(config-vlan)# exit
switch# show vlan id 2

VLAN Name Status Ports
-----
2 VLAN128Char00000000000000040000 active
00000000000000000000000000000000
00000000000000000000000000000000
00000000000000000000000000000002
.
.
.
```

The following example displays the error output if you try to configure a VLAN long name of more than 128 characters.

	Command or Action	Purpose
	<code>switch(config)# copy running-config startup-config</code>	Note You must enter this command if you change the reserved block.
Step 4	reload Example: <code>switch(config)# reload</code>	Reloads the software, and modifications to VLAN ranges become effective. For more details about this command, see the <i>Cisco Nexus 7000 Series NX-OS Fundamentals Configuration Guide, Release 6.x</i> .
Step 5	(Optional) show system vlan reserved Example: <code>switch(config)# show system vlan reserved</code>	Displays the configured changes to the VLAN range.

Example

This example shows how to change the range of reserved VLANs:

```
switch# configuration terminal
switch(config)# system vlan 1006 reserve
This will delete all configs on vlans 1006-1087. Continue anyway? (y/n) [no] yes
Note: After switch reload, VLANs 1006-1087 will be reserved for internal use.
      This requires copy running-config to startup-config before
      switch reload. Creating VLANs within this range is not allowed.
switch(config)# copy running-config startup-config
switch(config)# reload
switch(config)# show system vlan reserved
```



Note You must reload the device for this change to take effect.

Configuring a VLAN

To configure or modify the VLAN for the following parameters, you must be in the VLAN configuration submode:

- Name



Note VLAN name can be either a short name (up to 32 characters) or long name (up to 128 characters). To configure VLAN long-name of up to 128 characters, you must enable **system vlan long-name** command.

- Shut down



Note You cannot create, delete, or modify the default VLAN or the internally allocated VLANs. Additionally, some of these parameters cannot be modified on some VLANs.

Procedure

	Command or Action	Purpose
Step 1	switch# configure terminal	Enters global configuration mode.
Step 2	switch(config)# vlan { <i>vlan-id</i> <i>vlan-range</i> }	Enters VLAN configuration submenu. If the VLAN does not exist, the system first creates the specified VLAN.
Step 3	switch(config-vlan)# name <i>vlan-name</i>	Names the VLAN. You can enter up to 32 alphanumeric characters to name the VLAN. You cannot change the name of VLAN1 or the internally allocated VLANs. The default value is VLANxxxx where xxxx represents four numeric digits (including leading zeroes) equal to the VLAN ID number.
Step 4	switch(config-vlan)# state { active suspend }	Sets the state of the VLAN to active or suspend. While the VLAN state is suspended, the ports associated with this VLAN are shut down, and that VLAN does not pass any traffic. The default state is active. You cannot suspend the state for the default VLAN or VLANs 1006 to 4094.
Step 5	(Optional) switch(config-vlan)# no shutdown	Enables the VLAN. The default value is no shutdown (or enabled). You cannot shut down the default VLAN, VLAN1, or VLANs 1006 to 4094.

Example

This example shows how to configure optional parameters for VLAN 5:

```
switch# configure terminal
switch(config)# vlan 5
switch(config-vlan)# name accounting
switch(config-vlan)# state active
switch(config-vlan)# no shutdown
```

Adding Ports to a VLAN

After you have completed the configuration of a VLAN, assign ports to it.

Procedure

	Command or Action	Purpose
Step 1	switch# configure terminal	Enters global configuration mode.
Step 2	switch(config)# interface { <i>ethernet slot/port</i> port-channel <i>number</i> }	Specifies the interface to configure, and enters the interface configuration mode. The interface can be a physical Ethernet port or an EtherChannel. Note If this is a QSFP+ GEM or a breakout port, the <i>port</i> syntax is <i>QSFP-module/port</i> .
Step 3	switch(config-if)# switchport access vlan <i>vlan-id</i>	Sets the access mode of the interface to the specified VLAN.

Example

This example shows how to configure an Ethernet interface to join VLAN 5:

```
switch# configure terminal
switch(config)# interface ethernet 1/13
switch(config-if)# switchport access vlan 5
```

Configuring VTP

You can configure VTP in the client or server mode on Cisco Nexus devices.

You can enable VTP and then configure the VTP mode (server [default], client, transparent, or off). If you enable VTP, you must configure either version 1 or version 2. If you are using VTP in a Token Ring environment, you must use version 2.

Procedure

	Command or Action	Purpose
Step 1	switch# configure terminal	Enters global configuration mode.
Step 2	switch(config)# feature vtp	Enables VTP on the device. The default is disabled.
Step 3	switch(config)# vtp domain <i>domain-name</i>	Specifies the name of the VTP domain that you want this device to join. The default is blank.

	Command or Action	Purpose
Step 4	switch(config)# vtp version {1 2}	Sets the VTP version that you want to use. The default is version 1.
Step 5	Required: switch(config)# vtp mode {client server transparent off}	Sets the VTP mode to client, server, transparent, or off. You can configure VTP in client or server mode.
Step 6	switch(config)# vtp file <i>file-name</i>	Specifies the ASCII filename of the IFS file system file where the VTP configuration is stored.
Step 7	switch(config)# vtp password <i>password-value</i>	Specifies the password for the VTP administrative domain.
Step 8	switch(config)# exit	Exits the configuration submenu.
Step 9	(Optional) switch# show vtp status	Displays information about the VTP configuration on the device, such as the version, mode, and revision number.
Step 10	(Optional) switch# show vtp counters	Displays information about VTP advertisement statistics on the device.
Step 11	(Optional) switch# show vtp interface	Displays the list of VTP-enabled interfaces.
Step 12	(Optional) switch# show vtp password	Displays the password for the management VTP domain.
Step 13	(Optional) switch# copy running-config startup-config	Copies the running configuration to the startup configuration.

Example

This example shows how to configure VTP in transparent mode for the device:

```
switch# config t
switch(config)# feature vtp
switch(config)# vtp domain accounting
switch(config)# vtp version 2
switch(config)# vtp mode transparent
switch(config)# exit
switch#
```

This example shows the VTP status and that the switch is capable of supporting Version 2 and that the switch is running Version 1:

```
switch(config)# show vtp status
VTP Status Information
-----
VTP Version : 2 (capable)
Configuration Revision : 0
Maximum VLANs supported locally : 1005
```

```

Number of existing VLANs      : 502
VTP Operating Mode           : Transparent
VTP Domain Name              :
VTP Pruning Mode             : Disabled (Operationally Disabled)
VTP V2 Mode                  : Disabled
VTP Traps Generation         : Disabled
MD5 Digest                   : 0xF5 0xF1 0xEC 0xE7 0x29 0x0C 0x2D 0x01
Configuration last modified by 60.10.10.1 at 0-0-00 00:00:00
VTP version running          : 1

```

Verifying the VLAN Configuration

Use one of the following commands to verify the configuration:

Command	Purpose
switch# show running-config vlan [vlan_id vlan_range]	Displays VLAN information.
switch# show vlan [brief id [vlan_id vlan_range] name name summary]	Displays selected configuration information for the defined VLAN(s).
switch# show system vlan reserved	Displays the system reserved VLAN range.

Feature History for Configuring VLANs

This table lists the release history for this feature.

Note The feature history table is added/updated in this guide from Cisco Nexus Release 7.3(0)N1(1) onwards.

Table 2: Feature History for Configuring VLANs

Feature Name	Releases	Feature Information
Configure VLAN long-name.	7.3(0)N1(1)	You can configure VLAN long-names of up to 128 characters. The following command was introduced: <ul style="list-style-type: none"> • system vlan long-name



CHAPTER 3

Configuring Private VLANs

This chapter contains the following sections:

- [Information About Private VLANs, on page 19](#)
- [Guidelines and Limitations for Private VLANs, on page 24](#)
- [Configuring a Private VLAN, on page 25](#)
- [Verifying the Private VLAN Configuration, on page 36](#)

Information About Private VLANs

A private VLAN (PVLAN) partitions the Ethernet broadcast domain of a VLAN into subdomains, allowing you to isolate the ports on the switch from each other. A subdomain consists of a primary VLAN and one or more secondary VLANs (see the following figure). All VLANs in a PVLAN domain share the same primary VLAN. The secondary VLAN ID differentiates one subdomain from another. The secondary VLAN can either be isolated VLAN or community VLAN. A host on an isolated VLAN can communicate only with the associated promiscuous port in its primary VLAN. Hosts on community VLAN can communicate among themselves and with their associated promiscuous port but not with ports in other community VLANs.

Figure 2: Private VLAN Domain

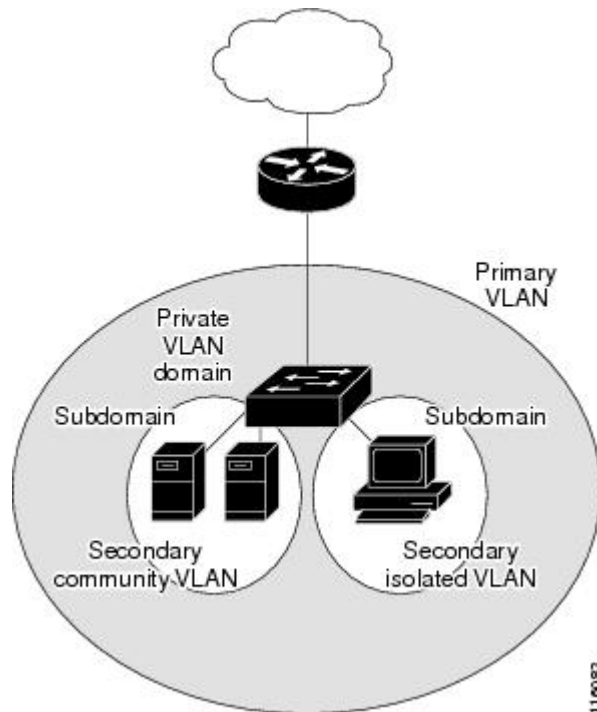

Note You must first create the VLAN before converting it to a PVLAN, either a primary VLAN or secondary VLAN.

Primary and Secondary VLANs in Private VLANs

A private VLAN domain has only one primary VLAN. Each port in a private VLAN domain is a member of the primary VLAN; the primary VLAN is the entire private VLAN domain.

Secondary VLAN provide isolation between the ports within the same private VLAN domain. The following two types are secondary VLANs within a primary VLAN:

- Isolated VLANs—Ports within an isolated VLAN cannot communicate directly with each other at the Layer 2 level.
- Community VLANs—Ports within a community VLAN can communicate with each other but cannot communicate with ports in other community VLANs or in any isolated VLANs at the Layer 2 level.

Baseboard Ports and HIF Ports

The following figure shows the baseboard and host interface (HIF) ports on a Cisco Nexus switch.

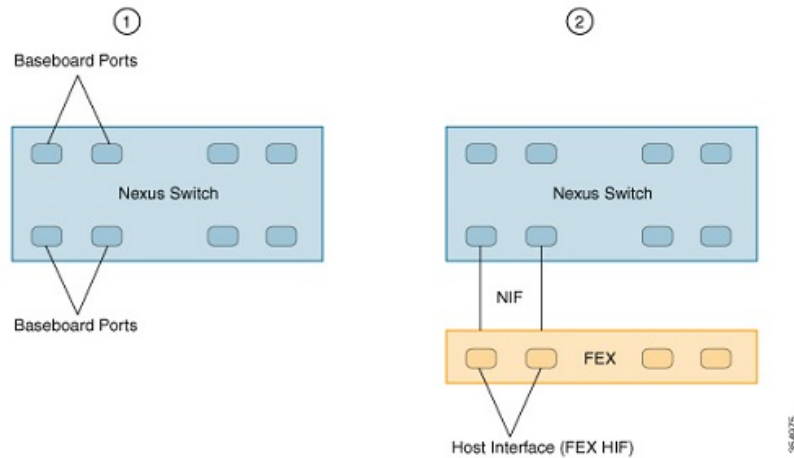

1	Baseboard ports are ports on a baseboard module in a Cisco Nexus switch.
2	FEX HIF ports are ports on the FEX module.

Private VLAN Ports

The following are three types of PVLAN ports:

- Promiscuous port—A promiscuous port belongs to a primary VLAN. The promiscuous port can communicate with all interfaces, including the community and isolated host ports, that belong to those secondary VLANs associated to the promiscuous port and associated with the primary VLAN. You can have several promiscuous ports in a primary VLAN. Each promiscuous port can have several secondary VLANs or no secondary VLANs that are associated to that port. You can associate a secondary VLAN to more than one promiscuous port, as long as the promiscuous port and secondary VLANs are within the same primary VLAN. You may want to do this for load-balancing or redundancy purposes. You can also have secondary VLANs that are not associated to any promiscuous port.

A promiscuous port can be configured either as an access port or as a trunk port.

- Isolated port—An isolated port is a host port that belongs to an isolated secondary VLAN. This port has complete isolation from other ports within the same PVLAN domain, except that it can communicate with associated promiscuous ports. PVLANS block all the traffic to isolated ports except traffic from promiscuous ports. Traffic received from an isolated port is forwarded only to promiscuous ports. You can have more than one isolated port in a specified isolated VLAN. Each port is completely isolated from all other ports in the isolated VLAN.

An isolated port can be configured as either an access port or a trunk port.

- Community port—A community port is a host port that belongs to a community secondary VLAN. Community ports communicate with other ports in the same community VLAN and with associated promiscuous ports. These interfaces are isolated from all other interfaces in other communities and from all isolated ports within the PVLAN domain.

A community port must be configured as an access port. A community VLAN must not be enabled on an isolated trunk port.



Note Because trunks can support VLANs that carry traffic between promiscuous, isolated, and community ports, the isolated and community port traffic might enter or leave the switch through a trunk interface.

Primary, Isolated, and Community Private VLANs

Primary VLANs and the two types of secondary VLANs (isolated and community) have the following characteristics:

- **Primary VLAN**—The primary VLAN carries traffic from the promiscuous ports to the host ports, both isolated and community, and to other promiscuous ports.
- **Isolated VLAN**—An isolated VLAN is a secondary VLAN that carries unidirectional traffic upstream from the hosts toward the promiscuous ports. You can configure only one isolated VLAN in a PVLAN domain. An isolated VLAN can have several isolated ports. The traffic from each isolated port also remains completely separate.
- **Community VLAN**—A community VLAN is a secondary VLAN that carries upstream traffic from the community ports to the promiscuous port and to other host ports in the same community. You can configure multiple community VLANs in a PVLAN domain. The ports within one community can communicate, but these ports cannot communicate with ports in any other community or isolated VLAN in the private VLAN.

The following figure shows the traffic flow within a PVLAN, along with the types of VLANs and types of ports.

Figure 3: Private VLAN Traffic Flows

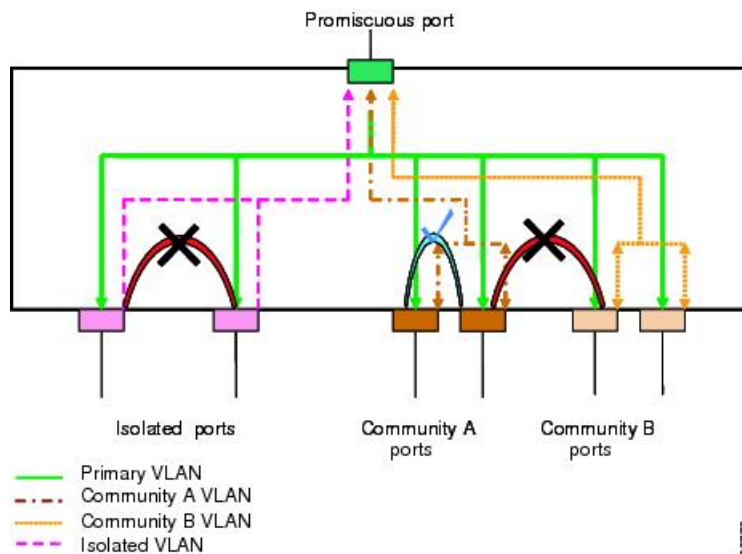

Note The PVLAN traffic flows are unidirectional from the host ports to the promiscuous ports. Traffic received on primary VLAN enforces no separation and forwarding is done as in a normal VLAN.

A promiscuous access port can serve only one primary VLAN and multiple secondary VLANs (community and isolated VLANs). A promiscuous trunk port can carry traffic for several primary VLANs. Multiple secondary VLANs under a given primary VLAN can be mapped to promiscuous trunk ports. With a promiscuous port, you can connect a wide range of devices as access points to a PVLAN. For example, you can use a promiscuous port to monitor or back up all the PVLAN servers from an administration workstation.

In a switched environment, you can assign an individual PVLAN and associated IP subnet to each individual or common group of end stations. The end stations need to communicate only with a default gateway to communicate outside the private VLAN.

Associating Primary and Secondary VLANs

To allow host ports in secondary VLANs to communicate outside the PVLAN, you associate secondary VLANs to the primary VLAN. If the association is not operational, the host ports (community and isolated ports) in the secondary VLAN are brought down.



Note You can associate a secondary VLAN with only one primary VLAN.

For an association to be operational, the following conditions must be met:

- The primary VLAN must exist and be configured as a primary VLAN.
- The secondary VLAN must exist and be configured as either an isolated or community VLAN.



Note Use the **show vlan private-vlan** command to verify that the association is operational. The switch does not display an error message when the association is nonoperational.

If you delete either the primary or secondary VLAN, the ports that are associated with the VLAN become inactive. Use the **no private-vlan** command to return the VLAN to the normal mode. All primary and secondary associations on that VLAN are suspended, but the interfaces remain in PVLAN mode. When you convert the VLAN back to PVLAN mode, the original associations are reinstated.

If you enter the **no vlan** command for the primary VLAN, all PVLAN associations with that VLAN are deleted. However, if you enter the **no vlan** command for a secondary VLAN, the PVLAN associations with that VLAN are suspended and are restored when you recreate the specified VLAN and configure it as the previous secondary VLAN.

In order to change the association between a secondary and primary VLAN, you must first remove the current association and then add the desired association.

Private VLAN Promiscuous Trunks

A promiscuous trunk port can carry traffic for several primary VLANs. Multiple secondary VLANs under a given primary VLAN can be mapped to a promiscuous trunk port. Traffic on the promiscuous port is received and transmitted with a primary VLAN tag.

Private VLAN Isolated Trunks

An isolated trunk port can carry traffic for multiple isolated PVLANS. Traffic for a community VLAN is not carried by isolated trunk ports. Traffic on isolated trunk ports is received and transmitted with an isolated VLAN tag. Isolated trunk ports are intended to be connected to host servers.

To support isolated PVLAN ports on a Cisco Nexus Fabric Extender, the Cisco Nexus device must prevent communication between the isolated ports on the FEX; all forwarding occurs through the switch.

**Caution**

You must disable all the FEX isolated trunk ports before configuring PVLANS on the FEX trunk ports. If the FEX isolated trunk ports and the FEX trunk ports are both enabled, unwanted network traffic might occur.

For unicast traffic, you can prevent such a communication without any side effects.

For multicast traffic, the FEX provides replication of the frames. To prevent communication between isolated PVLAN ports on the FEX, the switch prevents multicast frames from being sent back through the fabric ports. This restriction prevents communication between an isolated VLAN and a promiscuous port on the FEX. However, as host interfaces are not intended to be connected to another switch or router, you cannot enable a promiscuous port on a FEX.

Broadcast Traffic in Private VLANs

Broadcast traffic from ports in a private VLAN flows in the following ways:

- The broadcast traffic flows from a promiscuous port to all ports in the primary VLAN (which includes all the ports in the community and isolated VLANs). This broadcast traffic is distributed to all ports within the primary VLAN, including those ports that are not configured with private VLAN parameters.
- The broadcast traffic from an isolated port is distributed only to those promiscuous ports in the primary VLAN that are associated to that isolated port.
- The broadcast traffic from community ports is distributed to all ports within the port's community and to all promiscuous ports that are associated to the community port. The broadcast packets are not distributed to any other communities within the primary VLAN or to any isolated ports.

Private VLAN Port Isolation

You can use PVLANS to control access to end stations as follows:

- Configure selected interfaces connected to end stations as isolated ports to prevent any communication. For example, if the end stations are servers, this configuration prevents communication between the servers.
- Configure interfaces connected to default gateways and selected end stations (for example, backup servers) as promiscuous ports to allow all end stations access to a default gateway.

Guidelines and Limitations for Private VLANs

When configuring PVLANS, follow these guidelines:

- You must create a VLAN before you can assign the specified VLAN as a private VLAN.
- You must enable PVLANS before the switch can apply the PVLAN functionality.
- You cannot disable PVLANS if the switch has any operational ports in a PVLAN mode.
- Enter the **private-vlan synchronize** command from within the Multiple Spanning Tree (MST) region definition to map the secondary VLANs to the same MST instance as the primary VLAN.
- You must disable all the FEX isolated trunk ports before configuring FEX trunk ports.
- The number of mappings on a PVLAN trunk port is limited to 128.
- You cannot connect a second switch to a promiscuous or isolated PVLAN trunk. The promiscuous or isolated PVLAN trunk is supported only on host-switch.
- You cannot configure promiscuous ports and promiscuous trunk ports on the FEX interfaces (HIF) ports.
- If you configure a **private-vlan association** under a VLAN, but do not configure the **private-vlan type** as primary, this association will reappear in the running configuration under the same VLAN when the VLAN is deleted and re-created. Note that this earlier association cannot be removed by using the **no private-vlan association** command. It can be removed only by performing either of the following tasks:
 - Disable the PVLAN feature.Or
 - Configure the **private-vlan type** as primary, configure the same **private-vlan association** under that VLAN, and then remove the association using the **no private-vlan association** command.

Limitations with Other Features

Consider the following configuration limitations with other features when configuring private VLANs:

- IGMP snooping runs only on the primary VLAN and uses the configuration of the primary VLAN for all secondary VLANs.

Any IGMP snooping join request in the secondary VLAN is treated as if it is received in the primary VLAN.

Configuring a Private VLAN

Enabling Private VLANs

You must enable PVLANS on the switch to use the PVLAN functionality.



Note The PVLAN commands do not appear until you enable the PVLAN feature.

Procedure

	Command or Action	Purpose
Step 1	switch# configure terminal	Enters global configuration mode.
Step 2	switch(config)# feature private-vlan	Enables the PVLAN feature on the switch.
Step 3	(Optional) switch(config)# no feature private-vlan	Disables the PVLAN feature on the switch. Note You cannot disable PVLANS if there are operational ports on the switch that are in PVLAN mode.

Example

This example shows how to enable the PVLAN feature on the switch:

```
switch# configure terminal
switch(config)# feature private-vlan
```

Configuring a VLAN as a Private VLAN

To create a PVLAN, you must first create a VLAN, and then configure that VLAN to be a PVLAN.

Before you begin

Ensure that the PVLAN feature is enabled.

Procedure

	Command or Action	Purpose
Step 1	switch# configure terminal	Enters global configuration mode.
Step 2	switch(config)# vlan {vlan-id vlan-range}	Enters VLAN configuration submenu.
Step 3	switch(config-vlan)# private-vlan {community isolated primary}	Configures the VLAN as either a community, isolated, or primary PVLAN. In a PVLAN, you must have one primary VLAN. You can have multiple community and isolated VLANs.
Step 4	(Optional) switch(config-vlan)# no private-vlan {community isolated primary}	Removes the PVLAN configuration from the specified VLAN(s) and returns it to normal VLAN mode. If you delete either the primary or secondary VLAN, the ports that are associated with the VLAN become inactive.

Example

The following example shows how to assign VLAN 5 to a PVLAN as the primary VLAN:

```
switch# configure terminal
switch(config)# vlan 5
switch(config-vlan)# private-vlan primary
```

The following example shows how to assign VLAN 100 to a PVLAN as a community VLAN:

```
switch# configure terminal
switch(config)# vlan 100
switch(config-vlan)# private-vlan community
```

The following example shows how to assign VLAN 200 to a PVLAN as an isolated VLAN:

```
switch# configure terminal
switch(config)# vlan 200
switch(config-vlan)# private-vlan isolated
```

Associating Secondary VLANs with a Primary Private VLAN

When you associate secondary VLANs with a primary VLAN, follow these guidelines:

- The *secondary-vlan-list* parameter cannot contain spaces. It can contain multiple comma-separated items. Each item can be a single secondary VLAN ID or a hyphenated range of secondary VLAN IDs.
- The *secondary-vlan-list* parameter can contain multiple community VLAN IDs and one isolated VLAN ID.
- Enter a *secondary-vlan-list* or use the **add** keyword with a *secondary-vlan-list* to associate secondary VLANs with a primary VLAN.
- Use the **remove** keyword with a *secondary-vlan-list* to clear the association between secondary VLANs and a primary VLAN.
- You can change the association between a secondary and primary VLAN by removing the existing association, and then adding the desired association.

If you delete either the primary or secondary VLAN, the VLAN becomes inactive on the port where the association is configured. When you enter the **no private-vlan** command, the VLAN returns to the normal VLAN mode. All primary and secondary associations on that VLAN are suspended, but the interfaces remain in PVLAN mode. If you convert the specified VLAN to PVLAN mode again, the original associations are reinstated.

If you enter the **no vlan** command for the primary VLAN, all the PVLAN associations with that VLAN are lost. However, if you enter the **no vlan** command for a secondary VLAN, the PVLAN associations with that VLAN are suspended and are reinstated when you recreate the specified VLAN and configure it as the previous secondary VLAN.

Before you begin

Ensure that the PVLAN feature is enabled.

Procedure

	Command or Action	Purpose
Step 1	switch# configure terminal	Enters global configuration mode.

	Command or Action	Purpose
Step 2	switch(config)# vlan <i>primary-vlan-id</i>	Enters the number of the primary VLAN that you are working in for the PVLAN configuration.
Step 3	switch(config-vlan)# private-vlan association {[add] <i>secondary-vlan-list</i> remove <i>secondary-vlan-list</i> }	Associates the secondary VLANs with the primary VLAN. Use the remove keyword with a <i>secondary-vlan-list</i> to clear the association between secondary VLANs and a primary VLAN.
Step 4	(Optional) switch(config-vlan)# no private-vlan association	Removes all associations from the primary VLAN and returns it to normal VLAN mode.

Example

The following example shows how to associate community VLANs 100 through 110 and isolated VLAN 200 with primary VLAN 5:

```
switch# configure terminal
switch(config)# vlan 5
switch(config-vlan)# private-vlan association 100-110, 200
```

Configuring an Interface as a Private VLAN Host Port

In PVLANS, host ports are part of the secondary VLANs, which are either community VLANs or isolated VLANs. Configuring a PVLAN host port involves two steps. First, you define the port as a PVLAN host port and then you configure a host association between the primary and secondary VLANs.



Note We recommend that you enable BPDU Guard on all interfaces configured as a host ports.

Before you begin

Ensure that the PVLAN feature is enabled.

Procedure

	Command or Action	Purpose
Step 1	switch# configure terminal	Enters global configuration mode.
Step 2	switch(config)# interface <i>type</i> [<i>chassis/</i>] <i>slot/port</i>	Selects the port to configure as a PVLAN host port. This port can be on a FEX (identified by the chassis option). Note If this is a QSFP+ GEM or a breakout port, the <i>port</i> syntax is <i>QSFP-module/port</i> .

	Command or Action	Purpose
Step 3	switch(config-if)# switchport	Configures the interface as a Layer 2 interface and deletes any configuration specific to Layer 3 on this interface.
Step 4	switch(config-if)# switchport mode private-vlan host	Configures the port as a host port for a PVLAN.
Step 5	switch(config-if)# switchport private-vlan host-association {primary-vlan-id} {secondary-vlan-id}	Associates the port with the primary and secondary VLANs of a PVLAN. The secondary VLAN can be either an isolated or community VLAN.
Step 6	(Optional) switch(config-if)# no switchport private-vlan host-association	Removes the PVLAN association from the port.

Example

This example shows how to configure Ethernet port 1/12 as a host port for a PVLAN and associate it to primary VLAN 5 and secondary VLAN 101:

```
switch# configure terminal
switch(config)# interface ethernet 1/12
switch(config-if)# switchport
switch(config-if)# switchport mode private-vlan host
switch(config-if)# switchport private-vlan host-association 5 101
```

Configuring an Interface as a Private VLAN Promiscuous Port

In a PVLAN domain, promiscuous ports are part of the primary VLAN. Configuring a promiscuous port involves two steps. First, you define the port as a promiscuous port and then you configure the mapping between a secondary VLAN and the primary VLAN.

Before you begin

Ensure that the PVLAN feature is enabled.

Procedure

	Command or Action	Purpose
Step 1	switch# configure terminal	Enters global configuration mode.
Step 2	switch(config)# interface <i>type slot/port</i>	Selects the port to configure as a PVLAN promiscuous port. A base-board interface is required. This port cannot be on a FEX interface (HIF interface). Note If this is a QSFP+ GEM or a breakout port, the <i>port</i> syntax is <i>QSFP-module/port</i> .

	Command or Action	Purpose
Step 3	switch(config-if)# switchport	Configures the interface as a Layer 2 interface and deletes any configuration specific to Layer 3 on this interface.
Step 4	switch(config-if)# switchport mode private-vlan promiscuous	Configures the port as a promiscuous port for a PVLAN. You can enable promiscuous ports and promiscuous trunk ports only on base-board ports (base-board ports are the ports on the switch). You cannot configure promiscuous ports on FEX (HIF) ports. Note If you try to configure promiscuous ports on FEX (HIF) ports, the device will display an error.
Step 5	switch(config-if)# switchport private-vlan mapping <i>{primary-vlan-id}</i> <i>{secondary-vlan-list add secondary-vlan-list remove secondary-vlan-list}</i>	Configures the port as a promiscuous port and associates the specified port with a primary VLAN and a selected list of secondary VLANs. The secondary VLAN can be either an isolated or community VLAN.
Step 6	(Optional) switch(config-if)# no switchport private-vlan mapping	Clears the mapping from the PVLAN.

Example

The following example shows how to configure Ethernet interface 1/4 as a promiscuous port associated with primary VLAN 5 and secondary VLAN 200:

```
switch# configure terminal
switch(config)# interface ethernet 1/4
switch(config-if)# switchport
switch(config-if)# switchport mode private-vlan promiscuous
switch(config-if)# switchport private-vlan mapping 5 200
```

Configuring a Promiscuous Trunk Port

In a PVLAN domain, promiscuous trunks are part of the primary VLAN. Promiscuous trunk ports can carry multiple primary VLANs. Multiple secondary VLANs under a given primary VLAN can be mapped to a promiscuous trunk port.

Configuring a promiscuous port involves two steps. First, you define the port as a promiscuous port and then you configure the mapping between a secondary VLAN and the primary VLAN. Multiple primary VLANs can be enabled by configuring multiple mappings.



Note The number of mappings on a PVLAN trunk port is limited to 128.

Before you begin

Ensure that the PVLAN feature is enabled.

Procedure

	Command or Action	Purpose
Step 1	switch# configure terminal	Enters global configuration mode.
Step 2	switch(config)# interface <i>type slot/port</i>	Selects the port to configure as a PVLAN promiscuous trunk port. A base-board interface is required. This port cannot be on a FEX interface (HIF interface). Note If this is a QSFP+ GEM or a breakout port, the <i>port</i> syntax is <i>QSFP-module/port</i> .
Step 3	switch(config-if)# switchport	Configures the interface as a Layer 2 interface and deletes any configuration specific to Layer 3 on this interface.
Step 4	switch(config-if)# switchport mode private-vlan trunk promiscuous	Configures the port as a promiscuous trunk port for a PVLAN. You can enable promiscuous trunk ports only on base-board ports (base-board ports are the ports on the switch). You cannot configure promiscuous trunk ports on FEX (HIF) ports. Note If you try to configure promiscuous trunk ports on FEX (HIF) ports, the device will display an error.
Step 5	switch(config-if)# switchport private-vlan mapping trunk { <i>primary-vlan-id</i> } { <i>secondary-vlan-id</i> }	Maps the trunk port with the primary and secondary VLANs of a PVLAN. The secondary VLAN can be either an isolated or community VLAN.
Step 6	(Optional) switch(config-if)# no switchport private-vlan mapping trunk [<i>primary-vlan-id</i>]	Removes the PVLAN mapping from the port. If the <i>primary-vlan-id</i> is not supplied, all PVLAN mappings are removed from the port.

Example

The following example shows how to configure Ethernet interface 1/1 as a promiscuous trunk port for a PVLAN and then map the secondary VLANs to the primary VLAN:

```
switch# configure terminal
switch(config)# interface ethernet 1/1
switch(config-if)# switchport
switch(config-if)# switchport mode private-vlan trunk promiscuous
switch(config-if)# switchport private-vlan mapping trunk 5 100
```

```
switch(config-if)# switchport private-vlan mapping trunk 5 200
switch(config-if)# switchport private-vlan mapping trunk 6 300
```

Configuring an Isolated Trunk Port

In a PVLAN domain, isolated trunks are part of a secondary VLAN. Isolated trunk ports can carry multiple isolated VLANs. Configuring an isolated trunk port involves two steps. First, you define the port as an isolated trunk port and then you configure the association between the isolated and primary VLANs. Multiple isolated VLANs can be enabled by configuring multiple associations.

Before you begin

Ensure that the PVLAN feature is enabled.

Procedure

	Command or Action	Purpose
Step 1	switch# configure terminal	Enters global configuration mode.
Step 2	switch(config)# interface type [<i>chassis/</i>] <i>slot/port</i>	Selects the port to configure as a PVLAN isolated trunk port. This port can be on a FEX (identified by the chassis option). The PVLAN isolated trunk port can be configured on a Ethernet port and on a FEX port. Note If this is a QSFP+ GEM or a breakout port, the <i>port</i> syntax is <i>QSFP-module/port</i> . Note If this is a QSFP+ GEM or a breakout port, the <i>port</i> syntax is <i>QSFP-module/port</i> .
Step 3	switch(config-if)# switchport	Configures the interface as a Layer 2 interface and deletes any configuration specific to Layer 3 on this interface.
Step 4	switch(config-if)# switchport mode private-vlan trunk [secondary]	Configures the port as a secondary trunk port for a PVLAN. Note The secondary keyword is assumed if it is not present.
Step 5	switch(config-if)# switchport private-vlan association trunk { <i>primary-vlan-id</i> } { <i>secondary-vlan-id</i> }	Associates the isolated trunk port with the primary and secondary VLANs of a PVLAN. The secondary VLAN should be an isolated VLAN. Only one isolated VLAN can be mapped under a given primary VLAN.

	Command or Action	Purpose
Step 6	(Optional) switch(config-if)# no switchport private-vlan association trunk [<i>primary-vlan-id</i>]	Removes the PVLAN association from the port. If the <i>primary-vlan-id</i> is not supplied, all PVLAN associations are removed from the port.

Example

The following example shows how to configure Ethernet interface 1/1 as an isolated trunk port for a PVLAN and then associate the secondary VLANs to the primary VLAN:

```
switch# configure terminal
switch(config)# interface ethernet 1/1
switch(config-if)# switchport
switch(config-if)# switchport mode private-vlan trunk secondary
switch(config-if)# switchport private-vlan association trunk 5 100
switch(config-if)# switchport private-vlan association trunk 6 200
```

Configuring Private VLANs on FEX Trunk Ports

To enable a FEX HIF configured as a normal dot1q trunk port, the **system private-vlan fex trunk** command must be enabled to allow this interface to forward both primary and secondary VLAN traffic. FEX trunk ports extend the PVLAN domain to all the hosts connected to it and when configured, globally affects all FEX ports connected to the Cisco Nexus device.



Note The FEX interface does not support configurations that include promiscuous ports. Also, the FEX interface does not support connections to devices that have promiscuous ports. When promiscuous functionality is required, the device, such as a Cisco Nexus 1000V, must connect to the base ports of the Cisco Nexus device.



Caution You must disable all the FEX isolated trunk ports and isolated host ports before configuring PVLANS on the FEX trunk ports. If the FEX isolated trunk ports and the FEX trunk ports are both enabled, unwanted network traffic might occur. If the **system private-vlan fex trunk** command and the FEX isolated trunk ports are both enabled, then traffic coming on primary VLAN is not translated to secondary VLAN, when the traffic goes out of the FEX isolated trunk port.

Before you begin

Ensure that the PVLAN feature is enabled.

Procedure

	Command or Action	Purpose
Step 1	switch# configure terminal	Enters global configuration mode.
Step 2	switch(config)# system private-vlan fex trunk	Enables PVLANS on FEX trunk ports.

	Command or Action	Purpose
Step 3	(Optional) switch(config)# copy running-config startup-config	Saves the change persistently through reboots and restarts by copying the running configuration to the startup configuration.

Example

The following example shows how to configure a PVLAN over a FEX trunk port:

```
switch# configure terminal
switch(config)# system private-vlan fex trunk
switch(config)# copy running-config startup-config
```

Configuring the Allowed VLANs for PVLAN Trunking Ports

Isolated trunk and promiscuous trunk ports can carry traffic from regular VLANs along with PVLANS.

Before you begin

Ensure that the PVLAN feature is enabled.

Procedure

	Command or Action	Purpose
Step 1	switch# configure terminal	Enters global configuration mode.
Step 2	switch(config)# interface type [chassis/]slot/port	Selects the port to configure as a PVLAN host port. This port can be on a FEX (identified by the chassis option). Note If this is a QSFP+ GEM or a breakout port, the <i>port</i> syntax is <i>QSFP-module/port</i> .
Step 3	switch(config-if)# switchport	Configures the interface as a Layer 2 interface and deletes any configuration specific to Layer 3 on this interface.
Step 4	switch(config-if)# switchport private-vlan trunk allowed vlan {vlan-list all none [add except none remove {vlan-list}]}	Sets the allowed VLANs for the private trunk interface. The default is to allow only mapped/associated VLANs on the PVLAN trunk interface. Note The primary VLANs do not need to be explicitly added to the allowed VLAN list. They are added automatically once there is a mapping between primary and secondary VLANs.

Example

The following example shows how to add VLANs to the list of allowed VLANs on an Ethernet PVLAN trunk port:

```
switch# configure terminal
switch(config)# interface ethernet 1/3
switch(config-if)# switchport
switch(config-if)# switchport private-vlan trunk allowed vlan 15-20
```

Configuring Native 802.1Q VLANs on Private VLANs

Typically, you configure 802.1Q trunks with a native VLAN ID, which strips tagging from all packets on that VLAN. This configuration allows untagged traffic and control traffic to transit the Cisco Nexus device. Secondary VLANs cannot be configured with a native VLAN ID on promiscuous trunk ports. Primary VLANs cannot be configured with a native VLAN ID on isolated trunk ports.

**Note**

A trunk can carry the traffic of multiple VLANs. Traffic that belongs to the native VLAN is not encapsulated to transit the trunk. Traffic for other VLANs is encapsulated with tags that identify the VLAN that the traffic belongs to.

Before you begin

Ensure that the PVLAN feature is enabled.

Procedure

	Command or Action	Purpose
Step 1	switch# configure terminal	Enters global configuration mode.
Step 2	switch(config)# interface type [chassis/]slot/port	Selects the port to configure as a PVLAN host port. This port can be on a FEX (identified by the chassis option). Note If this is a QSFP+ GEM or a breakout port, the <i>port</i> syntax is <i>QSFP-module/port</i> .
Step 3	switch(config-if)# switchport	Configures the interface as a Layer 2 interface and deletes any configuration specific to Layer 3 on this interface.
Step 4	switch(config-if)# switchport private-vlan trunk native {vlan vlan-id}	Sets the native VLAN ID for the PVLAN trunk. The default is VLAN 1.
Step 5	(Optional) switch(config-if)# no switchport private-vlan trunk native {vlan vlan-id}	Removes the native VLAN ID from the PVLAN trunk.

Verifying the Private VLAN Configuration

Use the following commands to display PVLAN configuration information.

Command	Purpose
switch# show feature	Displays the features enabled on the switch.
switch# show interface switchport	Displays information on all interfaces configured as switch ports.
switch# show vlan private-vlan [type]	Displays the status of the PVLAN.

This example shows how to display the PVLAN configuration:

```
switch# show vlan private-vlan
Primary  Secondary  Type          Ports
-----  -
5        100        community
5        101        community     Eth1/12, Eth100/1/1
5        102        community
5        110        community
5        200        isolated      Eth1/2

switch# show vlan private-vlan type
Vlan Type
---- -
5    primary
100  community
101  community
102  community
110  community
200  isolated
```

This example shows how to display enabled features (some of the output has been removed for brevity):

```
switch# show feature
Feature Name          Instance  State
-----
fcsp                  1        enabled
...
interface-vlan       1        enabled
private-vlan         1        enabled
udld                  1        disabled
...
```



CHAPTER 4

Configuring Rapid PVST+

This chapter contains the following sections:

- [Information About Rapid PVST+, on page 37](#)
- [Configuring Rapid PVST+, on page 52](#)
- [Verifying the Rapid PVST+ Configuration, on page 61](#)

Information About Rapid PVST+

The Rapid PVST+ protocol is the IEEE 802.1w standard, Rapid Spanning Tree Protocol (RSTP), implemented on a per VLAN basis. Rapid PVST+ interoperates with the IEEE 802.1D standard, which mandates a single STP instance for all VLANs, rather than per VLAN.

Rapid PVST+ is enabled by default on the default VLAN (VLAN1) and on all newly created VLANs in the software. Rapid PVST+ interoperates with switches that run legacy IEEE 802.1D STP.

RSTP is an improvement on the original STP standard, 802.1D, which allows faster convergence.



Note Spanning tree is used to refer to IEEE 802.1w and IEEE 802.1s. If the text is discussing the IEEE 802.1D Spanning Tree Protocol, 802.1D is stated specifically.

Understanding STP

STP Overview

For an Ethernet network to function properly, only one active path can exist between any two stations.

When you create fault-tolerant internetworks, you must have a loop-free path between all nodes in a network. The STP algorithm calculates the best loop-free path throughout a switched network. LAN ports send and receive STP frames, which are called Bridge Protocol Data Units (BPDUs), at regular intervals. Switches do not forward these frames but use the frames to construct a loop-free path.

Multiple active paths between end stations cause loops in the network. If a loop exists in the network, end stations might receive duplicate messages and switches might learn end station MAC addresses on multiple LAN ports. These conditions result in a broadcast storm, which creates an unstable network.

STP defines a tree with a root bridge and a loop-free path from the root to all switches in the network. STP forces redundant data paths into a blocked state. If a network segment in the spanning tree fails and a redundant path exists, the STP algorithm recalculates the spanning tree topology and activates the blocked path.

When two LAN ports on a switch are part of a loop, the STP port priority and port path cost setting determine which port on the switch is put in the forwarding state and which port is put in the blocking state.

Understanding How a Topology is Created

All switches in an extended LAN that participate in a spanning tree gather information about other switches in the network by exchanging of BPDUs. This exchange of BPDUs results in the following actions:

- The system elects a unique root switch for the spanning tree network topology.
- The system elects a designated switch for each LAN segment.
- The system eliminates any loops in the switched network by placing redundant interfaces in a backup state; all paths that are not needed to reach the root switch from anywhere in the switched network are placed in an STP-blocked state.

The topology on an active switched network is determined by the following:

- The unique switch identifier Media Access Control (MAC) address of the switch that is associated with each switch
- The path cost to the root that is associated with each interface
- The port identifier that is associated with each interface

In a switched network, the root switch is the logical center of the spanning tree topology. STP uses BPDUs to elect the root switch and root port for the switched network, as well as the root port and designated port for each switched segment.

Understanding the Bridge ID

Each VLAN on each switch has a unique 64-bit bridge ID that consists of a bridge priority value, an extended system ID (IEEE 802.1t), and an STP MAC address allocation.

Bridge Priority Value

The bridge priority is a 4-bit value when the extended system ID is enabled.



Note

In Cisco NX-OS, the extended system ID is always enabled; you cannot disable the extended system ID.

Extended System ID

A 12-bit extended system ID field is part of the bridge ID.

Figure 4: Bridge ID with Extended System ID



The switches always use the 12-bit extended system ID.

Combined with the bridge ID, the system ID extension functions as the unique identifier for a VLAN.

Table 3: Bridge Priority Value and Extended System ID with the Extended System ID Enabled

Bridge Priority Value				Extended System ID (Set Equal to the VLAN ID)											
Bit 16	Bit 15	Bit 14	Bit 13	Bit 12	Bit 11	Bit 10	Bit 9	Bit 8	Bit 7	Bit 6	Bit 5	Bit 4	Bit 3	Bit 2	Bit 1
32768	16384	8192	4096	2048	1024	512	256	128	64	32	16	8	4	2	1

STP MAC Address Allocation



Note Extended system ID and MAC address reduction is always enabled on the software.

With MAC address reduction enabled on any switch, you should also enable MAC address reduction on all other connected switches to avoid undesirable root bridge election and spanning tree topology issues.

When MAC address reduction is enabled, the root bridge priority becomes a multiple of 4096 plus the VLAN ID. You can only specify a switch bridge ID (used by the spanning tree algorithm to determine the identity of the root bridge, the lowest being preferred) as a multiple of 4096. Only the following values are possible:

- 0
- 4096
- 8192
- 12288
- 16384
- 20480
- 24576
- 28672
- 32768
- 36864
- 40960
- 45056

- 49152
- 53248
- 57344
- 61440

STP uses the extended system ID plus a MAC address to make the bridge ID unique for each VLAN.



Note If another bridge in the same spanning tree domain does not run the MAC address reduction feature, it could achieve root bridge ownership because its bridge ID may fall between the values specified by the MAC address reduction feature.

Understanding BPDUs

Switches transmit bridge protocol data units (BPDUs) throughout the STP instance. Each switch sends configuration BPDUs to communicate and compute the spanning tree topology. Each configuration BPDU contains the following minimal information:

- The unique bridge ID of the switch that the transmitting switch determines is the root bridge
- The STP path cost to the root
- The bridge ID of the transmitting bridge
- Message age
- The identifier of the transmitting port
- Values for the hello, forward delay, and max-age protocol timer
- Additional information for STP extension protocols

When a switch transmits a Rapid PVST+ BPDU frame, all switches connected to the VLAN on which the frame is transmitted receive the BPDU. When a switch receives a BPDU, it does not forward the frame but instead uses the information in the frame to calculate a BPDU, and, if the topology changes, initiate a BPDU transmission.

A BPDU exchange results in the following:

- One switch is elected as the root bridge.
- The shortest distance to the root bridge is calculated for each switch based on the path cost.
- A designated bridge for each LAN segment is selected. This is the switch closest to the root bridge through which frames are forwarded to the root.
- A root port is selected. This is the port providing the best path from the bridge to the root bridge.
- Ports included in the spanning tree are selected.

Election of the Root Bridge

For each VLAN, the switch with the lowest numerical value of the bridge ID is elected as the root bridge. If all switches are configured with the default priority (32768), the switch with the lowest MAC address in the VLAN becomes the root bridge. The bridge priority value occupies the most significant bits of the bridge ID.

When you change the bridge priority value, you change the probability that the switch will be elected as the root bridge. Configuring a lower value increases the probability; a higher value decreases the probability.

The STP root bridge is the logical center of each spanning tree topology in a network. All paths that are not needed to reach the root bridge from anywhere in the network are placed in STP blocking mode.

BPDUs contain information about the transmitting bridge and its ports, including bridge and MAC addresses, bridge priority, port priority, and path cost. STP uses this information to elect the root bridge for the STP instance, to elect the root port leading to the root bridge, and to determine the designated port for each segment.

Creating the Spanning Tree Topology

In the following figure, Switch A is elected as the root bridge because the bridge priority of all the switches is set to the default (32768) and Switch A has the lowest MAC address. However, due to traffic patterns, the number of forwarding ports, or link types, Switch A might not be the ideal root bridge. By increasing the priority (lowering the numerical value) of the ideal switch so that it becomes the root bridge, you force an STP recalculation to form a new spanning tree topology with the ideal switch as the root.

Figure 5: Spanning Tree Topology

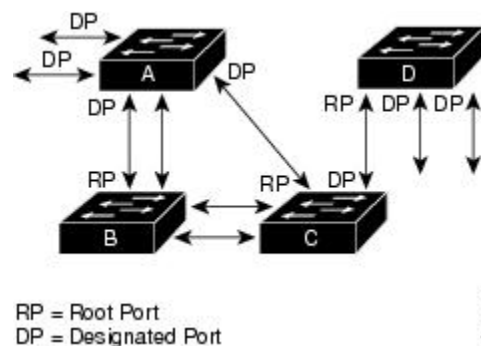

When the spanning tree topology is calculated based on default parameters, the path between source and destination end stations in a switched network might not be ideal. For instance, connecting higher-speed links to a port that has a higher number than the current root port can cause a root-port change. The goal is to make the fastest link the root port.

For example, assume that one port on Switch B is a fiber-optic link, and another port on Switch B (an unshielded twisted-pair [UTP] link) is the root port. Network traffic might be more efficient over the high-speed fiber-optic link. By changing the STP port priority on the fiber-optic port to a higher priority (lower numerical value) than the root port, the fiber-optic port becomes the new root port.

Understanding Rapid PVST+

Rapid PVST+ Overview

Rapid PVST+ is the IEEE 802.1w (RSTP) standard implemented per VLAN. A single instance of STP runs on each configured VLAN (if you do not manually disable STP). Each Rapid PVST+ instance on a VLAN

has a single root switch. You can enable and disable STP on a per-VLAN basis when you are running Rapid PVST+.



Note Rapid PVST+ is the default STP mode for the switch.

Rapid PVST+ uses point-to-point wiring to provide rapid convergence of the spanning tree. The spanning tree reconfiguration can occur in less than 1 second with Rapid PVST+ (in contrast to 50 seconds with the default settings in the 802.1D STP).



Note Rapid PVST+ supports one STP instance for each VLAN.

Using Rapid PVST+, STP convergence occurs rapidly. Each designated or root port in the STP sends out a BPDU every 2 seconds by default. On a designated or root port in the topology, if hello messages are missed three consecutive times, or if the maximum age expires, the port immediately flushes all protocol information in the table. A port considers that it loses connectivity to its direct neighbor root or designated port if it misses three BPDUs or if the maximum age expires. This rapid aging of the protocol information allows quick failure detection. The switch automatically checks the PVID.

Rapid PVST+ provides for rapid recovery of connectivity following the failure of a network device, a switch port, or a LAN. It provides rapid convergence for edge ports, new root ports, and ports connected through point-to-point links as follows:

- **Edge ports**—When you configure a port as an edge port on an RSTP switch, the edge port immediately transitions to the forwarding state. (This immediate transition was previously a Cisco-proprietary feature named PortFast.) You should only configure on ports that connect to a single end station as edge ports. Edge ports do not generate topology changes when the link changes.

Enter the **spanning-tree port type** interface configuration command to configure a port as an STP edge port.



Note We recommend that you configure all ports connected to a host as edge ports.

- **Root ports**—If Rapid PVST+ selects a new root port, it blocks the old root port and immediately transitions the new root port to the forwarding state.
- **Point-to-point links**—If you connect a port to another port through a point-to-point link and the local port becomes a designated port, it negotiates a rapid transition with the other port by using the proposal-agreement handshake to ensure a loop-free topology.

Rapid PVST+ achieves rapid transition to the forwarding state only on edge ports and point-to-point links. Although the link type is configurable, the system automatically derives the link type information from the duplex setting of the port. Full-duplex ports are assumed to be point-to-point ports, while half-duplex ports are assumed to be shared ports.

Edge ports do not generate topology changes, but all other designated and root ports generate a topology change (TC) BPDU when they either fail to receive three consecutive BPDUs from the directly connected neighbor or the maximum age times out. At this point, the designated or root port sends out a BPDU with the TC flag set. The BPDUs continue to set the TC flag as long as the TC While timer runs on that port. The value

of the TC While timer is the value set for the hello time plus 1 second. The initial detector of the topology change immediately floods this information throughout the entire topology.

When Rapid PVST+ detects a topology change, the protocol does the following:

- Starts the TC While timer with a value equal to twice the hello time for all the non-edge root and designated ports, if necessary.
- Flushes the MAC addresses associated with all these ports.

The topology change notification floods quickly across the entire topology. The system flushes dynamic entries immediately on a per-port basis when it receives a topology change.



Note The TCA flag is used only when the switch is interacting with switches that are running legacy 802.1D STP.

The proposal and agreement sequence then quickly propagates toward the edge of the network and quickly restores connectivity after a topology change.

Rapid PVST+ BPDUs

Rapid PVST+ and 802.1w use all six bits of the flag byte to add the role and state of the port that originates the BPDU and the proposal and agreement handshake. The following figure shows the use of the BPDU flags in Rapid PVST+.

Figure 6: Rapid PVST+ Flag Byte in BPDU

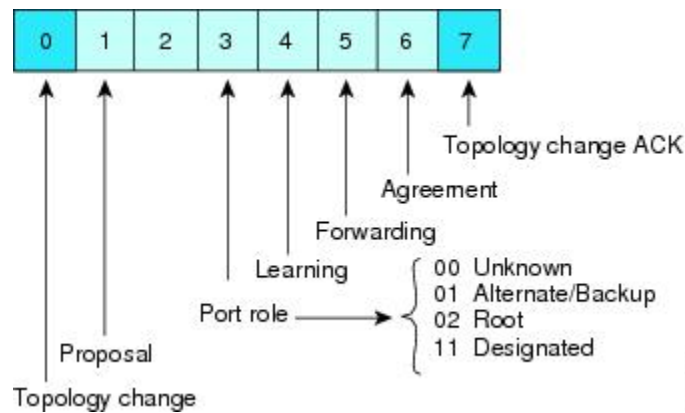

Another important change is that the Rapid PVST+ BPDU is type 2, version 2, which makes it possible for the switch to detect connected legacy (802.1D) bridges. The BPDU for 802.1D is version 0.

Proposal and Agreement Handshake

As shown in the following figure, Switch A is connected to Switch B through a point-to-point link, and all of the ports are in the blocking state. Assume that the priority of Switch A is a smaller numerical value than the priority of Switch B.

Figure 7: Proposal and Agreement Handshaking for Rapid Convergence

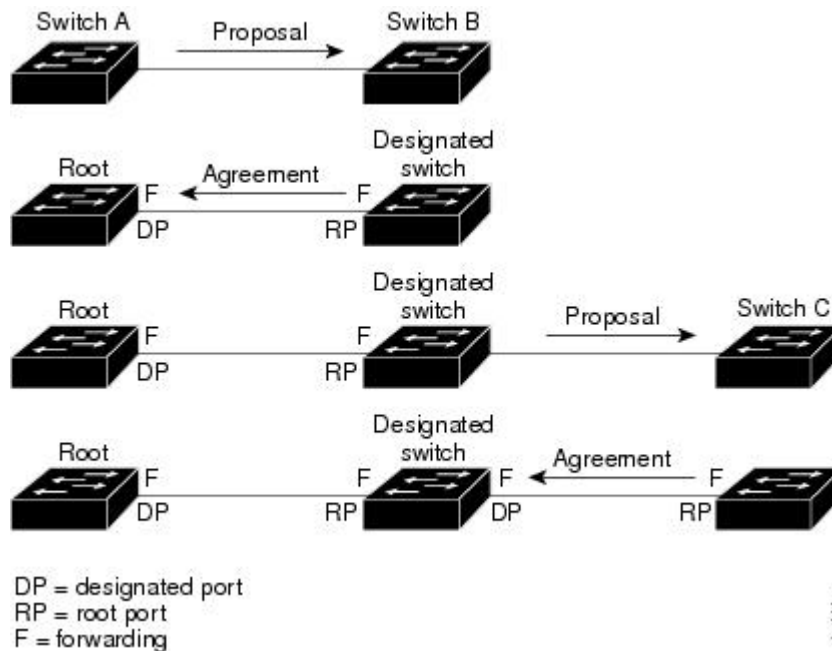

Switch A sends a proposal message (a configuration BPDU with the proposal flag set) to Switch B, proposing itself as the designated switch.

After receiving the proposal message, Switch B selects as its new root port the port from which the proposal message was received, forces all non-edge ports to the blocking state, and sends an agreement message (a BPDU with the agreement flag set) through its new root port.

After receiving the agreement message from Switch B, Switch A also immediately transitions its designated port to the forwarding state. No loops in the network can form because Switch B blocked all of its non-edge ports and because there is a point-to-point link between Switches A and B.

When Switch C connects to Switch B, a similar set of handshaking messages are exchanged. Switch C selects the port connected to Switch B as its root port, and both ends of the link immediately transition to the forwarding state. With each iteration of this handshaking process, one more network device joins the active topology. As the network converges, this proposal-agreement handshaking progresses from the root toward the leaves of the spanning tree.

The switch learns the link type from the port duplex mode: a full-duplex port is considered to have a point-to-point connection and a half-duplex port is considered to have a shared connection. You can override the default setting that is controlled by the duplex setting by entering the **spanning-tree link-type** interface configuration command.

This proposal/agreement handshake is initiated only when a non-edge port moves from the blocking to the forwarding state. The handshaking process then proliferates step-by-step throughout the topology.

Protocol Timers

The following table describes the protocol timers that affect the Rapid PVST+ performance.

Table 4: Rapid PVST+ Protocol Timers

Variable	Description
Hello timer	Determines how often each switch broadcasts BPDUs to other switches. The default is 2 seconds, and the range is from 1 to 10.
Forward delay timer	Determines how long each of the listening and learning states last before the port begins forwarding. This timer is generally not used by the protocol but is used as a backup. The default is 15 seconds, and the range is from 4 to 30 seconds.
Maximum age timer	Determines the amount of time protocol information received on an port is stored by the switch. This timer is generally not used by the protocol, but it is used when interoperating with 802.1D spanning tree. The default is 20 seconds; the range is from 6 to 40 seconds.

Port Roles

Rapid PVST+ provides rapid convergence of the spanning tree by assigning port roles and learning the active topology. Rapid PVST+ builds upon the 802.1D STP to select the switch with the highest priority (lowest numerical priority value) as the root bridge. Rapid PVST+ then assigns one of these port roles to individual ports:

- Root port—Provides the best path (lowest cost) when the switch forwards packets to the root bridge.
- Designated port—Connects to the designated switch, which incurs the lowest path cost when forwarding packets from that LAN to the root bridge. The port through which the designated switch is attached to the LAN is called the designated port.
- Alternate port—Offers an alternate path toward the root bridge to the path provided by the current root port. An alternate port provides a path to another switch in the topology.
- Backup port—Acts as a backup for the path provided by a designated port toward the leaves of the spanning tree. A backup port can exist only when two ports are connected in a loopback by a point-to-point link or when a switch has two or more connections to a shared LAN segment. A backup port provides another path in the topology to the switch.
- Disabled port—Has no role within the operation of the spanning tree.

In a stable topology with consistent port roles throughout the network, Rapid PVST+ ensures that every root port and designated port immediately transition to the forwarding state while all alternate and backup ports are always in the blocking state. Designated ports start in the blocking state. The port state controls the operation of the forwarding and learning processes.

A port with the root or a designated port role is included in the active topology. A port with the alternate or backup port role is excluded from the active topology (see the following figure).

Figure 8: Sample Topology Demonstrating Port Roles

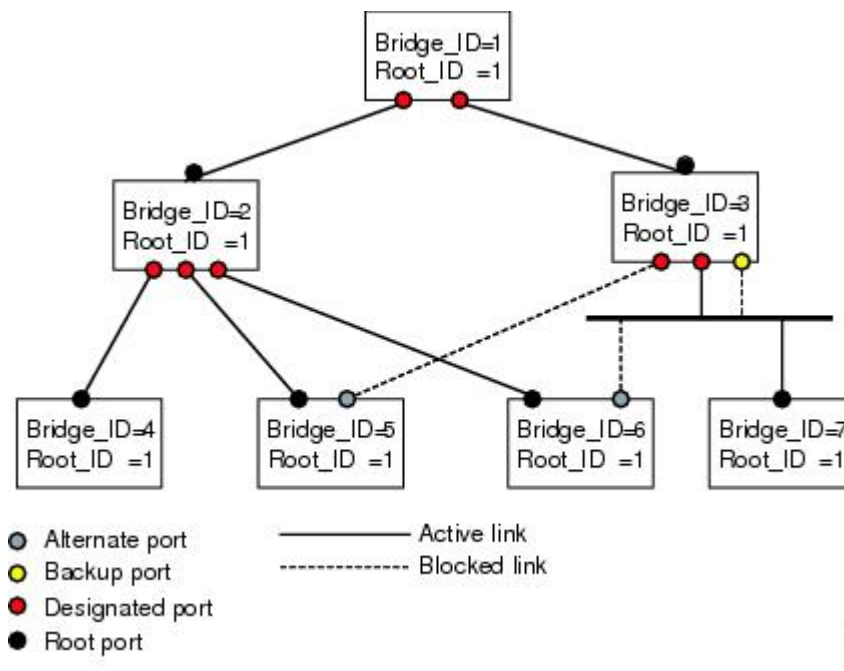

Port States

Rapid PVST+ Port State Overview

Propagation delays can occur when protocol information passes through a switched LAN. As a result, topology changes can take place at different times and at different places in a switched network. When a LAN port transitions directly from nonparticipation in the spanning tree topology to the forwarding state, it can create temporary data loops. Ports must wait for new topology information to propagate through the switched LAN before starting to forward frames.

Each LAN port on a software using Rapid PVST+ or MST exists in one of the following four states:

- Blocking—The LAN port does not participate in frame forwarding.
- Learning—The LAN port prepares to participate in frame forwarding.
- Forwarding—The LAN port forwards frames.
- Disabled—The LAN port does not participate in STP and is not forwarding frames.

When you enable Rapid PVST+, every port in the software, VLAN, and network goes through the blocking state and the transitory states of learning at power up. If properly configured, each LAN port stabilizes to the forwarding or blocking state.

When the STP algorithm places a LAN port in the forwarding state, the following process occurs:

- The LAN port is put into the blocking state while it waits for protocol information that suggests it should go to the learning state.
- The LAN port waits for the forward delay timer to expire, moves the LAN port to the learning state, and restarts the forward delay timer.

- In the learning state, the LAN port continues to block frame forwarding as it learns the end station location information for the forwarding database.
- The LAN port waits for the forward delay timer to expire and then moves the LAN port to the forwarding state, where both learning and frame forwarding are enabled.

Blocking State

A LAN port in the blocking state does not participate in frame forwarding.

A LAN port in the blocking state performs as follows:

- Discards frames received from the attached segment.
- Discards frames switched from another port for forwarding.
- Does not incorporate the end station location into its address database. (There is no learning on a blocking LAN port, so there is no address database update.)
- Receives BPDUs and directs them to the system module.
- Receives, processes, and transmits BPDUs received from the system module.
- Receives and responds to network management messages.

Learning State

A LAN port in the learning state prepares to participate in frame forwarding by learning the MAC addresses for the frames. The LAN port enters the learning state from the blocking state.

A LAN port in the learning state performs as follows:

- Discards frames received from the attached segment.
- Discards frames switched from another port for forwarding.
- Incorporates the end station location into its address database.
- Receives BPDUs and directs them to the system module.
- Receives, processes, and transmits BPDUs received from the system module.
- Receives and responds to network management messages.

Forwarding State

A LAN port in the forwarding state forwards frames. The LAN port enters the forwarding state from the learning state.

A LAN port in the forwarding state performs as follows:

- Forwards frames received from the attached segment.
- Forwards frames switched from another port for forwarding.
- Incorporates the end station location information into its address database.
- Receives BPDUs and directs them to the system module.
- Processes BPDUs received from the system module.

- Receives and responds to network management messages.

Disabled State

A LAN port in the disabled state does not participate in frame forwarding or STP. A LAN port in the disabled state is virtually nonoperational.

A disabled LAN port performs as follows:

- Discards frames received from the attached segment.
- Discards frames switched from another port for forwarding.
- Does not incorporate the end station location into its address database. (There is no learning, so there is no address database update.)
- Does not receive BPDUs from neighbors.
- Does not receive BPDUs for transmission from the system module.

Summary of Port States

The following table lists the possible operational and Rapid PVST+ states for ports and the corresponding inclusion in the active topology.

Table 5: Port State Active Topology

Operational Status	Port State	Is Port Included in the Active Topology?
Enabled	Blocking	No
Enabled	Learning	Yes
Enabled	Forwarding	Yes
Disabled	Disabled	No

Synchronization of Port Roles

When the switch receives a proposal message on one of its ports and that port is selected as the new root port, Rapid PVST+ forces all other ports to synchronize with the new root information.

The switch is synchronized with superior root information received on the root port if all other ports are synchronized. An individual port on the switch is synchronized if either of the following applies:

- That port is in the blocking state.
- It is an edge port (a port configured to be at the edge of the network).

If a designated port is in the forwarding state and is not configured as an edge port, it transitions to the blocking state when the Rapid PVST+ forces it to synchronize with new root information. In general, when the Rapid PVST+ forces a port to synchronize with root information and the port does not satisfy any of the above conditions, its port state is set to blocking.

After ensuring that all of the ports are synchronized, the switch sends an agreement message to the designated switch that corresponds to its root port. When the switches connected by a point-to-point link are in agreement about their port roles, Rapid PVST+ immediately transitions the port states to the forwarding state. The sequence of events is shown in the following figure.

Figure 9: Sequence of Events During Rapid Convergence

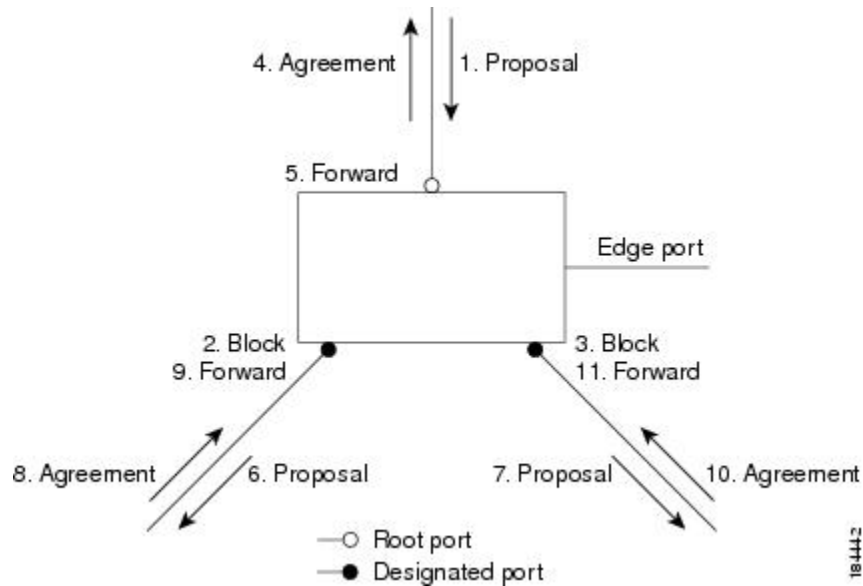

Processing Superior BPDUs

A superior BDU is a BDU with root information (such as a lower switch ID or lower path cost) that is superior to what is currently stored for the port.

If a port receives a superior BDU, Rapid PVST+ triggers a reconfiguration. If the port is proposed and is selected as the new root port, Rapid PVST+ forces all the other ports to synchronize.

If the received BDU is a Rapid PVST+ BDU with the proposal flag set, the switch sends an agreement message after all of the other ports are synchronized. The new root port transitions to the forwarding state as soon as the previous port reaches the blocking state.

If the superior information received on the port causes the port to become a backup port or an alternate port, Rapid PVST+ sets the port to the blocking state and sends an agreement message. The designated port continues sending BDUs with the proposal flag set until the forward-delay timer expires. At that time, the port transitions to the forwarding state.

Processing Inferior BDU Information

An inferior BDU is a BDU with root information (such as a higher switch ID or higher path cost) that is inferior to what is currently stored for the port.

If a designated port receives an inferior BDU, it immediately replies with its own information.

Spanning-Tree Dispute Mechanism

The software checks the consistency of the port role and state in the received BDUs to detect unidirectional link failures that could cause bridging loops.

When a designated port detects a conflict, it keeps its role, but reverts to a discarding state because disrupting connectivity in case of inconsistency is preferable to opening a bridging loop.

The following figure illustrates a unidirectional link failure that typically creates a bridging loop. Switch A is the root bridge, and its BPDUs are lost on the link leading to Switch B. The 802.1w-standard BPDUs include the role and state of the sending port. With this information, Switch A can detect that Switch B does not react to the superior BPDUs it sends and that Switch B is the designated, not root port. As a result, Switch A blocks (or keeps blocking) its port, which prevents the bridging loop. The block is shown as an STP dispute.

Figure 10: Detecting Unidirectional Link Failure

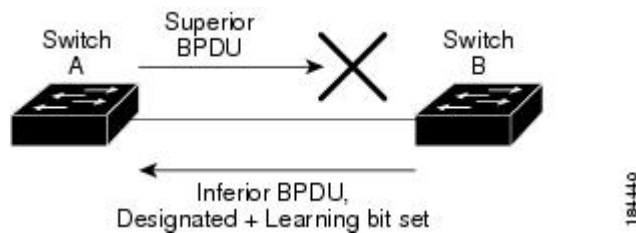

Port Cost



Note Rapid PVST+ uses the short (16-bit) path-cost method to calculate the cost by default. With the short path-cost method, you can assign any value in the range of 1 to 65535. However, you can configure the switch to use the long (32-bit) path-cost method, which allows you to assign any value in the range of 1 to 200,000,000. You configure the path-cost calculation method globally.

The STP port path-cost default value is determined from the media speed and path-cost calculation method of a LAN interface. If a loop occurs, STP considers the port cost when selecting a LAN interface to put into the forwarding state.

Table 6: Default Port Cost

Bandwidth	Short Path-Cost Method of Port Cost	Long Path-Cost Method of Port Cost
10 Mbps	100	2,000,000
100 Mbps	19	200,000
1 Gigabit Ethernet	4	20,000
10 Gigabit Ethernet	2	2,000

You can assign lower cost values to LAN interfaces that you want STP to select first and higher cost values to LAN interfaces that you want STP to select last. If all LAN interfaces have the same cost value, STP puts the LAN interface with the lowest LAN interface number in the forwarding state and blocks other LAN interfaces.

On access ports, you assign the port cost by the port. On trunk ports, you assign the port cost by the VLAN; you can configure the same port cost to all the VLANs on a trunk port.

Port Priority

If a loop occurs and multiple ports have the same path cost, Rapid PVST+ considers the port priority when selecting which LAN port to put into the forwarding state. You can assign lower priority values to LAN ports that you want Rapid PVST+ to select first and higher priority values to LAN ports that you want Rapid PVST+ to select last.

If all LAN ports have the same priority value, Rapid PVST+ puts the LAN port with the lowest LAN port number in the forwarding state and blocks other LAN ports. The possible priority range is from 0 through 224 (the default is 128), configurable in increments of 32. The software uses the port priority value when the LAN port is configured as an access port and uses the VLAN port priority values when the LAN port is configured as a trunk port.

Rapid PVST+ and IEEE 802.1Q Trunks

In a network of Cisco switches connected through 802.1Q trunks, the switches maintain one instance of STP for each VLAN allowed on the trunks. However, non-Cisco 802.1Q switches maintain only one instance of STP for all VLANs allowed on the trunks.

When you connect a Cisco switch to a non-Cisco switch through an 802.1Q trunk, the Cisco switch combines the STP instance of the 802.1Q VLAN of the trunk with the STP instance of the non-Cisco 802.1Q switch. However, all per-VLAN STP information that is maintained by Cisco switches is separated by a cloud of non-Cisco 802.1Q switches. The non-Cisco 802.1Q cloud that separates the Cisco switches is treated as a single trunk link between the switches.

Rapid PVST+ Interoperation with Legacy 802.1D STP

Rapid PVST+ can interoperate with switches that are running the legacy 802.1D protocol. The switch knows that it is interoperating with equipment running 802.1D when it receives a BPDU version 0. The BPDUs for Rapid PVST+ are version 2. If the BPDU received is an 802.1w BPDU version 2 with the proposal flag set, the switch sends an agreement message after all of the other ports are synchronized. If the BPDU is an 802.1D BPDU version 0, the switch does not set the proposal flag and starts the forward-delay timer for the port. The new root port requires twice the forward-delay time to transition to the forwarding state.

The switch interoperates with legacy 802.1D switches as follows:

- **Notification**—Unlike 802.1D BPDUs, 802.1w does not use TCN BPDUs. However, for interoperability with 802.1D switches, Cisco NX-OS processes and generates TCN BPDUs.
- **Acknowledgement**—When an 802.1w switch receives a TCN message on a designated port from an 802.1D switch, it replies with an 802.1D configuration BPDU with the TCA bit set. However, if the TC-while timer (the same as the TC timer in 802.1D) is active on a root port connected to an 802.1D switch and a configuration BPDU with the TCA set is received, the TC-while timer is reset.

This method of operation is required only for 802.1D switches. The 802.1w BPDUs do not have the TCA bit set.

- **Protocol migration**—For backward compatibility with 802.1D switches, 802.1w selectively sends 802.1D configuration BPDUs and TCN BPDUs on a per-port basis.

When a port is initialized, the migrate-delay timer is started (specifies the minimum time during which 802.1w BPDUs are sent), and 802.1w BPDUs are sent. While this timer is active, the switch processes all BPDUs received on that port and ignores the protocol type.

If the switch receives an 802.1D BPDU after the port migration-delay timer has expired, it assumes that it is connected to an 802.1D switch and starts using only 802.1D BPDUs. However, if the 802.1w switch is using 802.1D BPDUs on a port and receives an 802.1w BPDU after the timer has expired, it restarts the timer and starts using 802.1w BPDUs on that port.



Note If you want all switches to renegotiate the protocol, you must restart Rapid PVST+.

Rapid PVST+ Interoperation with 802.1s MST

Rapid PVST+ interoperates seamlessly with the IEEE 802.1s Multiple Spanning Tree (MST) standard. No user configuration is needed.

Configuring Rapid PVST+

Rapid PVST+, which has the 802.1w standard applied to the Rapid PVST+ protocol, is the default STP setting in the software.

You enable Rapid PVST+ on a per-VLAN basis. The software maintains a separate instance of STP for each VLAN (except on those VLANs on which you disable STP). By default, Rapid PVST+ is enabled on the default VLAN and on each VLAN that you create.

Enabling Rapid PVST+

Once you enable Rapid PVST+ on the switch, you must enable Rapid PVST+ on the specified VLANs.

Rapid PVST+ is the default STP mode. You cannot simultaneously run MST and Rapid PVST+.



Note Changing the spanning tree mode disrupts traffic because all spanning tree instances are stopped for the previous mode and started for the new mode.

Procedure

	Command or Action	Purpose
Step 1	switch# configure terminal	Enters global configuration mode.
Step 2	switch(config)# spanning-tree mode rapid-pvst	Enables Rapid PVST+ on the switch. Rapid PVST+ is the default spanning tree mode. Note Changing the spanning tree mode disrupts traffic because all spanning tree instances are stopped for the previous mode and started for the new mode.

Example

This example shows how to enable Rapid PVST+ on the switch:

```
switch# configure terminal
switch(config)# spanning-tree mode rapid-pvst
```



Note Because STP is enabled by default, entering the **show running-config** command to view the resulting configuration does not display the command that you entered to enable Rapid PVST+.

Enabling Rapid PVST+ per VLAN

You can enable or disable Rapid PVST+ on each VLAN.



Note Rapid PVST+ is enabled by default on the default VLAN and on all VLANs that you create.

Procedure

	Command or Action	Purpose
Step 1	switch# configure terminal	Enters global configuration mode.
Step 2	switch(config)# spanning-tree <i>vlan-range</i>	Enables Rapid PVST+ (default STP) on a per VLAN basis. The <i>vlan-range</i> value can be 2 through 4094 (except reserved VLAN values).
Step 3	(Optional) switch(config)# no spanning-tree <i>vlan-range</i>	Disables Rapid PVST+ on the specified VLAN.

	Command or Action	Purpose
		<p>Caution Do not disable spanning tree on a VLAN unless all switches and bridges in the VLAN have spanning tree disabled. You cannot disable spanning tree on some of the switches and bridges in a VLAN and leave it enabled on other switches and bridges. This action can have unexpected results because switches and bridges with spanning tree enabled will have incomplete information regarding the physical topology of the network.</p> <p>Do not disable spanning tree in a VLAN without ensuring that there are no physical loops present in the VLAN. Spanning tree serves as a safeguard against misconfigurations and cabling errors.</p>

Example

This example shows how to enable STP on a VLAN:

```
switch# configure terminal
switch(config)# spanning-tree vlan 5
```

Configuring the Root Bridge ID

The software maintains a separate instance of STP for each active VLAN in Rapid PVST+. For each VLAN, the switch with the lowest bridge ID becomes the root bridge for that VLAN.

To configure a VLAN instance to become the root bridge, modify the bridge priority from the default value (32768) to a significantly lower value.

When you enter the **spanning-tree vlan *vlan_ID* root** command, the switch checks the bridge priority of the current root bridges for each VLAN. The switch sets the bridge priority for the specified VLANs to 24576 if this value will cause the switch to become the root for the specified VLANs. If any root bridge for the specified VLANs has a bridge priority lower than 24576, the switch sets the bridge priority for the specified VLANs to 4096 less than the lowest bridge priority.



Note The **spanning-tree vlan *vlan_ID* root** command fails if the value required to be the root bridge is less than 1.



Caution The root bridge for each instance of STP should be a backbone or distribution switch. Do not configure an access switch as the STP primary root.

Enter the **diameter** keyword to specify the network diameter (that is, the maximum number of bridge hops between any two end stations in the network). When you specify the network diameter, the software automatically selects an optimal hello time, forward delay time, and maximum age time for a network of that diameter, which can significantly reduce the STP convergence time. You can enter the **hello-time** keyword to override the automatically calculated hello time.



Note With the switch configured as the root bridge, do not manually configure the hello time, forward-delay time, and maximum-age time using the **spanning-tree mst hello-time**, **spanning-tree mst forward-time**, and **spanning-tree mst max-age** configuration commands.

Procedure

	Command or Action	Purpose
Step 1	switch# configure terminal	Enters global configuration mode.
Step 2	switch(config)# spanning-tree vlan <i>vlan-range</i> root primary [diameter <i>dia</i> [hello-time <i>hello-time</i>]]	Configures a software switch as the primary root bridge. The <i>vlan-range</i> value can be 2 through 4094 (except reserved VLAN values.) The <i>dia</i> default is 7. The <i>hello-time</i> can be from 1 to 10 seconds, and the default value is 2 seconds.

Example

This example shows how to configure the switch as the root bridge for a VLAN:

```
switch# configure terminal
switch(config)# spanning-tree vlan 5 root primary diameter 4
```

Configuring a Secondary Root Bridge

When you configure a software switch as the secondary root, the STP bridge priority is modified from the default value (32768) so that the switch is likely to become the root bridge for the specified VLANs if the primary root bridge fails (assuming the other switches in the network use the default bridge priority of 32768). STP sets the bridge priority to 28672.

Enter the **diameter** keyword to specify the network diameter (that is, the maximum number of bridge hops between any two end stations in the network). When you specify the network diameter, the software automatically selects an optimal hello time, forward delay time, and maximum age time for a network of that diameter, which can significantly reduce the STP convergence time. You can enter the **hello-time** keyword to override the automatically calculated hello time.

You configure more than one switch in this manner to have multiple backup root bridges. Enter the same network diameter and hello time values that you used when configuring the primary root bridge.



Note With the switch configured as the root bridge, do not manually configure the hello time, forward-delay time, and maximum-age time using the **spanning-tree mst hello-time**, **spanning-tree mst forward-time**, and **spanning-tree mst max-age** global configuration commands.

Procedure

	Command or Action	Purpose
Step 1	switch# configure terminal	Enters global configuration mode.
Step 2	switch(config)# spanning-tree vlan <i>vlan-range</i> root secondary [diameter <i>dia</i> [hello-time <i>hello-time</i>]]	Configures a software switch as the secondary root bridge. The <i>vlan-range</i> value can be 2 through 4094 (except reserved VLAN values). The <i>dia</i> default is 7. The <i>hello-time</i> can be from 1 to 10 seconds, and the default value is 2 seconds.

Example

This example shows how to configure the switch as the secondary root bridge for a VLAN:

```
switch# configure terminal
switch(config)# spanning-tree vlan 5 root secondary diameter 4
```

Configuring the Rapid PVST+ Port Priority

You can assign lower priority values to LAN ports that you want Rapid PVST+ to select first and higher priority values to LAN ports that you want Rapid PVST+ to select last. If all LAN ports have the same priority value, Rapid PVST+ puts the LAN port with the lowest LAN port number in the forwarding state and blocks other LAN ports.

The software uses the port priority value when the LAN port is configured as an access port and uses VLAN port priority values when the LAN port is configured as a trunk port.

Procedure

	Command or Action	Purpose
Step 1	switch# configure terminal	Enters global configuration mode.
Step 2	switch(config)# interface <i>type slot/port</i>	Specifies the interface to configure, and enters interface configuration mode.

	Command or Action	Purpose
		Note If this is a QSFP+ GEM or a breakout port, the <i>port</i> syntax is <i>QSFP-module/port</i> .
Step 3	switch(config-if)# spanning-tree [vlan <i>vlan-list</i>] port-priority <i>priority</i>	Configures the port priority for the LAN interface. The <i>priority</i> value can be from 0 to 224. The lower the value indicates the higher the priority. The priority values are 0, 32, 64, 96, 128, 160, 192, and 224. All other values are rejected. The default value is 128.

Example

This example shows how to configure the access port priority of an Ethernet interface:

```
switch# configure terminal
switch(config)# interface ethernet 1/4
switch(config-if)# spanning-tree port-priority 160
```

You can only apply this command to a physical Ethernet interface.

Configuring the Rapid PVST+ Path-Cost Method and Port Cost

On access ports, you assign port cost by the port. On trunk ports, you assign the port cost by VLAN; you can configure the same port cost on all the VLANs on a trunk.



Note In Rapid PVST+ mode, you can use either the short or long path-cost method, and you can configure the method in either the interface or configuration submenu. The default path-cost method is short.

Procedure

	Command or Action	Purpose
Step 1	switch# configure terminal	Enters global configuration mode.
Step 2	switch(config)# spanning-tree pathcost method {long short}	Selects the method used for Rapid PVST+ path-cost calculations. The default method is the short method.
Step 3	switch(config)# interface <i>type slot/port</i>	Specifies the interface to configure, and enters interface configuration mode. Note If this is a QSFP+ GEM or a breakout port, the <i>port</i> syntax is <i>QSFP-module/port</i> .

	Command or Action	Purpose
Step 4	switch(config-if)# spanning-tree [vlan <i>vlan-id</i>] cost [<i>value</i> auto]	Configures the port cost for the LAN interface. The cost value, depending on the path-cost calculation method, can be as follows: <ul style="list-style-type: none"> • short—1 to 65535 • long—1 to 200000000 <p>Note You configure this parameter per interface on access ports and per VLAN on trunk ports.</p> <p>The default is auto, which sets the port cost on both the path-cost calculation method and the media speed.</p>

Example

This example shows how to configure the access port cost of an Ethernet interface:

```
switch# configure terminal
switch (config)# spanning-tree pathcost method long
switch (config)# interface ethernet 1/4
switch(config-if)# spanning-tree cost 1000
```

You can only apply this command to a physical Ethernet interface.

Configuring the Rapid PVST+ Bridge Priority of a VLAN

You can configure the Rapid PVST+ bridge priority of a VLAN.



Note Be careful when using this configuration. For most situations, we recommend that you configure the primary root and secondary root to modify the bridge priority.

Procedure

	Command or Action	Purpose
Step 1	switch# configure terminal	Enters global configuration mode.
Step 2	switch(config)# spanning-tree vlan <i>vlan-range</i> priority <i>value</i>	Configures the bridge priority of a VLAN. Valid values are 0, 4096, 8192, 12288, 16384, 20480, 24576, 28672, 32768, 36864, 40960, 45056, 49152, 53248, 57344, and 61440. All other values are rejected. The default value is 32768.

Example

This example shows how to configure the bridge priority of a VLAN:

```
switch# configure terminal
switch(config)# spanning-tree vlan 5 priority 8192
```

Configuring the Rapid PVST+ Hello Time for a VLAN

You can configure the Rapid PVST+ hello time for a VLAN.



Note Be careful when using this configuration. For most situations, we recommend that you configure the primary root and secondary root to modify the hello time.

Procedure

	Command or Action	Purpose
Step 1	switch# configure terminal	Enters global configuration mode.
Step 2	switch(config)# spanning-tree vlan <i>vlan-range</i> hello-time <i>hello-time</i>	Configures the hello time of a VLAN. The hello time value can be from 1 to 10 seconds. The default is 2 seconds.

Example

This example shows how to configure the hello time for a VLAN:

```
switch# configure terminal
switch(config)# spanning-tree vlan 5 hello-time 7
```

Configuring the Rapid PVST+ Forward Delay Time for a VLAN

You can configure the forward delay time per VLAN when using Rapid PVST+.

Procedure

	Command or Action	Purpose
Step 1	switch# configure terminal	Enters global configuration mode.
Step 2	switch(config)# spanning-tree vlan <i>vlan-range</i> forward-time <i>forward-time</i>	Configures the forward delay time of a VLAN. The forward delay time value can be from 4 to 30 seconds, and the default is 15 seconds.

Example

This example shows how to configure the forward delay time for a VLAN:

```
switch# configure terminal
switch(config)# spanning-tree vlan 5 forward-time 21
```

Configuring the Rapid PVST+ Maximum Age Time for a VLAN

You can configure the maximum age time per VLAN when using Rapid PVST+.

Procedure

	Command or Action	Purpose
Step 1	switch# configure terminal	Enters configuration mode.
Step 2	switch(config)# spanning-tree vlan <i>vlan-range</i> max-age <i>max-age</i>	Configures the maximum aging time of a VLAN. The maximum aging time value can be from 6 to 40 seconds, and the default is 20 seconds.

Example

This example shows how to configure the maximum aging time for a VLAN:

```
switch# configure terminal
switch(config)# spanning-tree vlan 5 max-age 36
```

Specifying the Link Type

Rapid connectivity (802.1w standard) is established only on point-to-point links. By default, the link type is controlled from the duplex mode of the interface. A full-duplex port is considered to have a point-to-point connection; a half-duplex port is considered to have a shared connection.

If you have a half-duplex link physically connected point-to-point to a single port on a remote switch, you can override the default setting on the link type and enable rapid transitions.

If you set the link to shared, STP moves back to 802.1D.

Procedure

	Command or Action	Purpose
Step 1	switch# configure terminal	Enters global configuration mode.
Step 2	switch(config)# interface <i>type slot/port</i>	Specifies the interface to configure, and enters the interface configuration mode.

	Command or Action	Purpose
		Note If this is a QSFP+ GEM or a breakout port, the <i>port</i> syntax is <i>QSFP-module/port</i> .
Step 3	switch(config-if)# spanning-tree link-type { auto point-to-point shared }	Configures the link type to be either a point-to-point link or shared link. The system reads the default value from the switch connection, as follows: half duplex links are shared and full-duplex links are point-to-point. If the link type is shared, the STP reverts to 802.1D. The default is auto, which sets the link type based on the duplex setting of the interface.

Example

This example shows how to configure the link type as a point-to-point link:

```
switch# configure terminal
switch (config)# interface ethernet 1/4
switch(config-if)# spanning-tree link-type point-to-point
```

You can only apply this command to a physical Ethernet interface.

Restarting the Protocol

A bridge running Rapid PVST+ can send 802.1D BPDUs on one of its ports when it is connected to a legacy bridge. However, the STP protocol migration cannot determine whether the legacy switch has been removed from the link unless the legacy switch is the designated switch. You can restart the protocol negotiation (force the renegotiation with neighboring switches) on the entire switch or on specified interfaces.

Command	Purpose
switch# clear spanning-tree detected-protocol [interface interface [<i>interface-num</i> <i>port-channel</i>]]	Restarts Rapid PVST+ on all interfaces on the switch or specified interfaces.

This example shows how to restart Rapid PVST+ on an Ethernet interface:

```
switch# clear spanning-tree detected-protocol interface ethernet 1/8
```

Verifying the Rapid PVST+ Configuration

Use the following commands to display Rapid PVST+ configuration information.

Command	Purpose
show running-config spanning-tree [all]	Displays the current spanning tree configuration.

Command	Purpose
show spanning-tree [<i>options</i>]	Displays selected detailed information for the current spanning tree configuration.

This example shows how to display spanning tree status:

```
switch# show spanning-tree brief

VLAN0001
  Spanning tree enabled protocol rstp
  Root ID    Priority    32768
             Address    001c.b05a.5447
             Cost      2
             Port      131 (Ethernet1/3)
             Hello Time 2 sec  Max Age 20 sec  Forward Delay 15 sec
  Bridge ID  Priority    32769 (priority 32768 sys-id-ext 1)
             Address    000d.ec6d.7841
             Hello Time 2 sec  Max Age 20 sec  Forward Delay 15 sec
Interface    Role Sts Cost      Prio.Nbr Type
-----
Eth1/3      Root FWD 2         128.131 P2p Peer (STP)
veth1/1     Desg FWD 2         128.129 Edge P2p
```



CHAPTER 5

Configuring Multiple Spanning Tree

This chapter contains the following sections:

- [Information About MST, on page 63](#)
- [Configuring MST, on page 71](#)
- [Verifying the MST Configuration, on page 87](#)

Information About MST

MST Overview



Note Spanning tree is used to refer to IEEE 802.1w and IEEE 802.1s. If the text is discussing the IEEE 802.1D Spanning Tree Protocol, 802.1D is stated specifically.

MST maps multiple VLANs into a spanning tree instance with each instance having a spanning tree topology independent of other spanning tree instances. This architecture provides multiple forwarding paths for data traffic, enables load balancing, and reduces the number of STP instances required to support a large number of VLANs.

MST provides rapid convergence through explicit handshaking as each MST instance uses the IEEE 802.1w standard, which eliminates the 802.1D forwarding delay and quickly transitions root bridge ports and designated ports to the forwarding state.

MAC address reduction is always enabled while you are using MST. You cannot disable this feature.

MST improves spanning tree operation and maintains backward compatibility with these STP versions:

- Original 802.1D spanning tree
- Rapid per-VLAN spanning tree (Rapid PVST+)
 - IEEE 802.1w defined the Rapid Spanning Tree Protocol (RSTP) and was incorporated into IEEE 802.1D.
- IEEE 802.1s defined MST and was incorporated into IEEE 802.1Q.



Note You must enable MST; Rapid PVST+ is the default spanning tree mode.

MST Regions

To allow switches to participate in MST instances, you must consistently configure the switches with the same MST configuration information.

A collection of interconnected switches that have the same MST configuration is an MST region. An MST region is a linked group of MST bridges with the same MST configuration.

The MST configuration controls the MST region to which each switch belongs. The configuration includes the name of the region, the revision number, and the MST VLAN-to-instance assignment map.

A region can have one or multiple members with the same MST configuration. Each member must be capable of processing 802.1w bridge protocol data units (BPDUs). There is no limit to the number of MST regions in a network.

Each region can support up to 65 MST instances (MSTIs). Instances are identified by any number in the range from 1 to 4094. The system reserves Instance 0 for a special instance, which is the IST. You can assign a VLAN to only one MST instance at a time.

The MST region appears as a single bridge to adjacent MST regions and to other Rapid PVST+ regions and 802.1D spanning tree protocols.



Note We recommend that you do not partition the network into a large number of regions.

MST BPDUs

Each region has only one MST BPDU, and that BPDU carries an M-record for each MSTI within the region (see the following figure). Only the IST sends BPDUs for the MST region; all M-records are encapsulated in that one BPDU that the IST sends. Because the MST BPDU carries information for all instances, the number of BPDUs that need to be processed to support MSTIs is significantly reduced.

Figure 11: MST BPDU with M-Records for MSTIs

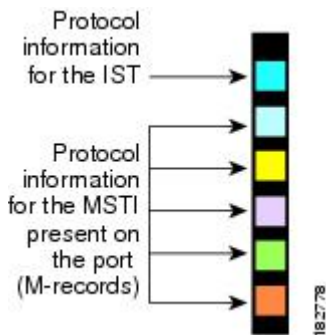

MST Configuration Information

The MST configuration that must be identical on all switches within a single MST region is configured by the user.

You can configure the following three parameters of the MST configuration:

- Name—32-character string, null padded and null terminated, identifying the MST region
- Revision number—Unsigned 16-bit number that identifies the revision of the current MST configuration



Note You must set the revision number when required as part of the MST configuration. The revision number is *not* incremented automatically each time that the MST configuration is committed.

- MST configuration table—4096-element table that associates each of the potential 4094 VLANs supported to a given instance with the first (0) and last element (4095) set to 0. The value of element number X represents the instance to which VLAN X is mapped.



Caution When you change the VLAN-to-MSTI mapping, the system restarts MST.

MST BPDUs contain these three configuration parameters. An MST bridge accepts an MST BPDU into its own region only if these three configuration parameters match exactly. If one configuration attribute differs, the MST bridge considers the BPDU to be from another MST region.

IST, CIST, and CST

IST, CIST, and CST Overview

Unlike Rapid PVST+, in which all the STP instances are independent, MST establishes and maintains IST, CIST, and CST spanning trees, as follows:

- An IST is the spanning tree that runs in an MST region.

MST establishes and maintains additional spanning trees within each MST region; these spanning trees are called multiple spanning tree instances (MSTIs).

Instance 0 is a special instance for a region, known as the IST. The IST always exists on all ports; you cannot delete the IST, or instance 0. By default, all VLANs are assigned to the IST. All other MST instances are numbered from 1 to 4094.

The IST is the only STP instance that sends and receives BPDUs. All of the other MSTI information is contained in MST records (M-records), which are encapsulated within MST BPDUs.

All MSTIs within the same region share the same protocol timers, but each MSTI has its own topology parameters, such as the root bridge ID, the root path cost, and so forth.

An MSTI is local to the region; for example, MSTI 9 in region A is independent of MSTI 9 in region B, even if regions A and B are interconnected.

- The CST interconnects the MST regions and any instance of 802.1D and 802.1w STP that may be running on the network. The CST is the one STP instance for the entire bridged network and encompasses all MST regions and 802.1w and 802.1D instances.
- A CIST is a collection of the ISTs in each MST region. The CIST is the same as an IST inside an MST region, and the same as a CST outside an MST region.

The spanning tree computed in an MST region appears as a subtree in the CST that encompasses the entire switched domain. The CIST is formed by the spanning tree algorithm running among switches that support the 802.1w, 802.1s, and 802.1D standards. The CIST inside an MST region is the same as the CST outside a region.

Spanning Tree Operation Within an MST Region

The IST connects all the MST switches in a region. When the IST converges, the root of the IST becomes the CIST regional root. The CIST regional root is also the CIST root if there is only one region in the network. If the CIST root is outside the region, the protocol selects one of the MST switches at the boundary of the region as the CIST regional root.

When an MST switch initializes, it sends BPDUs that identify itself as the root of the CIST and the CIST regional root, with both the path costs to the CIST root and to the CIST regional root set to zero. The switch also initializes all of its MSTIs and claims to be the root for all of them. If the switch receives superior MST root information (lower switch ID, lower path cost, and so forth) than the information that is currently stored for the port, it relinquishes its claim as the CIST regional root.

During initialization, an MST region might have many subregions, each with its own CIST regional root. As switches receive superior IST information from a neighbor in the same region, they leave their old subregions and join the new subregion that contains the true CIST regional root. This action causes all subregions to shrink except for the subregion that contains the true CIST regional root.

All switches in the MST region must agree on the same CIST regional root. Any two switches in the region will only synchronize their port roles for an MSTI if they converge to a common CIST regional root.

Spanning Tree Operations Between MST Regions

If you have multiple regions or 802.1w or 802.1D STP instances within a network, MST establishes and maintains the CST, which includes all MST regions and all 802.1w and 802.1D STP switches in the network. The MSTIs combine with the IST at the boundary of the region to become the CST.

The IST connects all the MST switches in the region and appears as a subtree in the CIST that encompasses the entire switched domain. The root of the subtree is the CIST regional root. The MST region appears as a virtual switch to adjacent STP switches and MST regions.

The following figure shows a network with three MST regions and an 802.1D switch (D). The CIST regional root for region 1 (A) is also the CIST root. The CIST regional root for region 2 (B) and the CIST regional root for region 3 (C) are the roots for their respective subtrees within the CIST.

Figure 12: MST Regions, CIST Regional Roots, and CST Root

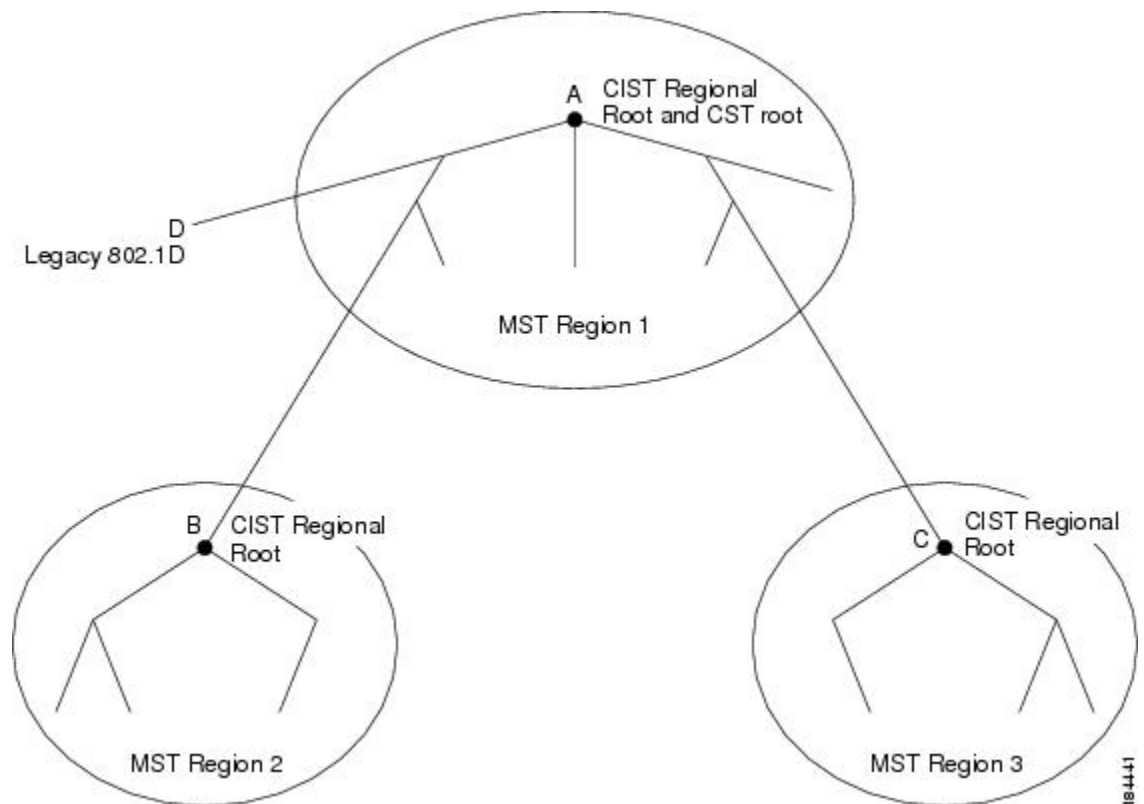

Only the CST instance sends and receives BPDUs. MSTIs add their spanning tree information into the BPDUs (as M-records) to interact with neighboring switches and compute the final spanning tree topology. Because of this process, the spanning tree parameters related to the BPDU transmission (for example, hello time, forward time, max-age, and max-hops) are configured only on the CST instance but affect all MSTIs. You can configure the parameters related to the spanning tree topology (for example, the switch priority, the port VLAN cost, and the port VLAN priority) on both the CST instance and the MSTI.

MST switches use Version 3 BPDUs or 802.1D STP BPDUs to communicate with 802.1D-only switches. MST switches use MST BPDUs to communicate with MST switches.

MST Terminology

MST naming conventions include identification of some internal or regional parameters. These parameters are used only within an MST region, compared to external parameters that are used throughout the whole network. Because the CIST is the only spanning tree instance that spans the whole network, only the CIST parameters require the external qualifiers and not the internal or regional qualifiers. The MST terminology is as follows:

- The CIST root is the root bridge for the CIST, which is the unique instance that spans the whole network.
- The CIST external root path cost is the cost to the CIST root. This cost is left unchanged within an MST region. An MST region looks like a single switch to the CIST. The CIST external root path cost is the root path cost calculated between these virtual switches and switches that do not belong to any region.

- If the CIST root is in the region, the CIST regional root is the CIST root. Otherwise, the CIST regional root is the closest switch to the CIST root in the region. The CIST regional root acts as a root bridge for the IST.
- The CIST internal root path cost is the cost to the CIST regional root in a region. This cost is only relevant to the IST, instance 0.

Hop Count

MST does not use the message-age and maximum-age information in the configuration BPDU to compute the STP topology inside the MST region. Instead, the protocol uses the path cost to the root and a hop-count mechanism similar to the IP time-to-live (TTL) mechanism.

By using the **spanning-tree mst max-hops** global configuration command, you can configure the maximum hops inside the region and apply it to the IST and all MST instances in that region.

The hop count achieves the same result as the message-age information (triggers a reconfiguration). The root bridge of the instance always sends a BPDU (or M-record) with a cost of 0 and the hop count set to the maximum value. When a switch receives this BPDU, it decrements the received remaining hop count by one and propagates this value as the remaining hop count in the BPDUs that it generates. When the count reaches zero, the switch discards the BPDU and ages the information held for the port.

The message-age and maximum-age information in the 802.1w portion of the BPDU remain the same throughout the region (only on the IST), and the same values are propagated by the region-designated ports at the boundary.

You configure a maximum aging time as the number of seconds that a switch waits without receiving spanning tree configuration messages before attempting a reconfiguration.

Boundary Ports

A boundary port is a port that connects one region to another. A designated port knows that it is on the boundary if it detects an STP bridge or receives an agreement proposal from an MST bridge with a different configuration or a Rapid PVST+ bridge. This definition allows two ports that are internal to a region to share a segment with a port that belongs to a different region, creating the possibility of receiving both internal and external messages on a port (see the following figure).

Figure 13: MST Boundary Ports

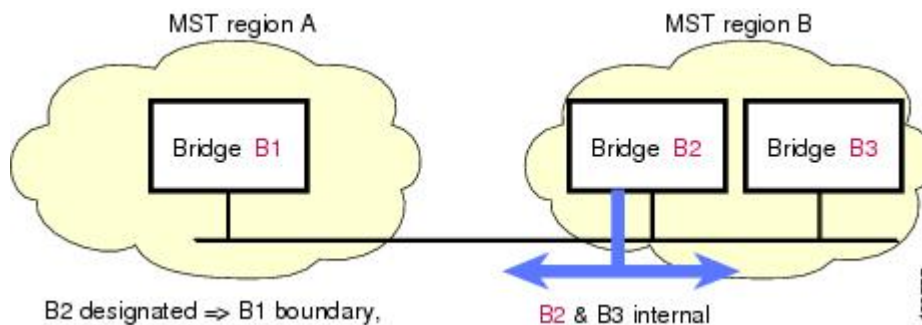

At the boundary, the roles of MST ports do not matter; the system forces their state to be the same as the IST port state. If the boundary flag is set for the port, the MST port-role selection process assigns a port role to the boundary and assigns the same state as the state of the IST port. The IST port at the boundary can take up any port role except a backup port role.

Spanning-Tree Dispute Mechanism

Currently, this feature is not present in the IEEE MST standard, but it is included in the standard-compliant implementation. The software checks the consistency of the port role and state in the received BPDUs to detect unidirectional link failures that could cause bridging loops.

When a designated port detects a conflict, it keeps its role but reverts to a discarding state because disrupting connectivity in case of inconsistency is preferable to opening a bridging loop.

The following figure shows a unidirectional link failure that typically creates a bridging loop. Switch A is the root bridge, and its BPDUs are lost on the link leading to Switch B. Rapid PVST+ (802.1w) and MST BPDUs include the role and state of the sending port. With this information, Switch A can detect that Switch B does not react to the superior BPDUs that it sends and that Switch B is the designated, not root port. As a result, Switch A blocks (or keeps blocking) its port, which prevents the bridging loop. The block is shown as an STP dispute.

Figure 14: Detecting a Unidirectional Link Failure

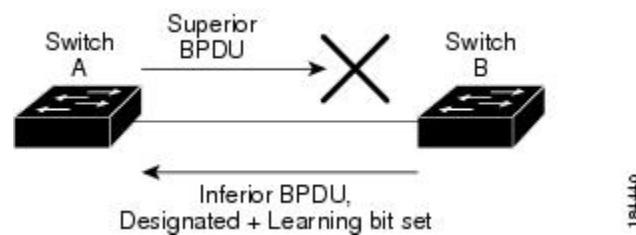

Port Cost and Port Priority

Spanning tree uses port costs to break a tie for the designated port. Lower values indicate lower port costs, and spanning tree chooses the least costly path. Default port costs are taken from the bandwidth of the interface, as follows:

- 10 Mbps—2,000,000
- 100 Mbps—200,000
- 1 Gigabit Ethernet—20,000
- 10 Gigabit Ethernet—2,000

You can configure the port costs in order to influence which port is chosen.



Note MST always uses the long path-cost calculation method, so the range of valid values is between 1 and 200,000,000.

The system uses port priorities to break ties among ports with the same cost. A lower number indicates a higher priority. The default port priority is 128. You can configure the priority to values between 0 and 224, in increments of 32.

Interoperability with IEEE 802.1D

A switch that runs MST supports a built-in protocol migration feature that enables it to interoperate with 802.1D STP switches. If this switch receives an 802.1D configuration BPDU (a BPDU with the protocol version set to 0), it sends only 802.1D BPDUs on that port. In addition, an MST switch can detect that a port is at the boundary of a region when it receives an 802.1D BPDU, an MST BPDU (Version 3) associated with a different region, or an 802.1w BPDU (Version 2).

However, the switch does not automatically revert to the MST mode if it no longer receives 802.1D BPDUs because it cannot detect whether the 802.1D switch has been removed from the link unless the 802.1D switch is the designated switch. A switch might also continue to assign a boundary role to a port when the switch to which this switch is connected has joined the region.

To restart the protocol migration process (force the renegotiation with neighboring switches), enter the **clear spanning-tree detected-protocols** command.

All Rapid PVST+ switches (and all 802.1D STP switches) on the link can process MST BPDUs as if they are 802.1w BPDUs. MST switches can send either Version 0 configuration and topology change notification (TCN) BPDUs or Version 3 MST BPDUs on a boundary port. A boundary port connects to a LAN, the designated switch of which is either a single spanning tree switch or a switch with a different MST configuration.



Note MST interoperates with the Cisco prestandard Multiple Spanning Tree Protocol (MSTP) whenever it receives prestandard MSTP on an MST port; no explicit configuration is necessary.

Interoperability with Rapid PVST+: Understanding PVST Simulation

MST interoperates with Rapid PVST+ with no need for user configuration. The PVST simulation feature enables this seamless interoperability.



Note PVST simulation is enabled by default. That is, by default, all interfaces on the switch interoperate between MST and Rapid PVST+.

However, you may want to control the connection between MST and Rapid PVST+ to protect against accidentally connecting an MST-enabled port to a Rapid PVST+-enabled port. Because Rapid PVST+ is the default STP mode, you may encounter many Rapid PVST+-enabled connections.

Disabling Rapid PVST+ simulation, which can be done per port or globally for the entire switch, moves the MST-enabled port to the blocking state once it detects it is connected to a Rapid PVST+-enabled port. This port remains in the inconsistent state until the port stops receiving Rapid PVST+/SSTP BPDUs, and then the port resumes the normal STP transition process.

Configuring MST

MST Configuration Guidelines

When configuring MST, follow these guidelines:

- When you work with private VLANs, enter the **private-vlan synchronize** command to map the secondary VLANs to the same MST instance as the primary VLAN.
- When you are in the MST configuration mode, the following guidelines apply:
 - Each command reference line creates its pending regional configuration.
 - The pending region configuration starts with the current region configuration.
 - To leave the MST configuration mode without committing any changes, enter the **abort** command.
 - To leave the MST configuration mode and commit all the changes that you made before you left the mode, enter the **exit** command.

Enabling MST

You must enable MST; Rapid PVST+ is the default.



Caution

Changing the spanning tree mode disrupts traffic because all spanning tree instances are stopped for the previous mode and started for the new mode. Also, having two different spanning-tree modes on Virtual Port Channel (vPC) peer switches is an inconsistency, so this operation is disruptive.

Procedure

	Command or Action	Purpose
Step 1	switch# configure terminal	Enters global configuration mode.
Step 2	switch# configure terminal	Enters configuration mode.
Step 3	switch(config)# spanning-tree mode mst	Enables MST on the switch.
Step 4	(Optional) switch(config)# no spanning-tree mode mst	Disables MST on the switch and returns you to Rapid PVST+.

Example

This example shows how to enable MST on the switch:

```
switch# configure terminal
switch(config)# spanning-tree mode mst
```



Note Because STP is enabled by default, entering a **show running-config** command to view the resulting configuration does not display the command that you entered to enable STP.

Entering MST Configuration Mode

You enter MST configuration mode to configure the MST name, VLAN-to-instance mapping, and MST revision number on the switch.

For two or more switches to be in the same MST region, they must have the identical MST name, VLAN-to-instance mapping, and MST revision number.



Note Each command reference line creates its pending regional configuration in MST configuration mode. In addition, the pending region configuration starts with the current region configuration.

When you are working in MST configuration mode, note the difference between the **exit** and **abort** commands.

Procedure

	Command or Action	Purpose
Step 1	switch# configure terminal	Enters global configuration mode.
Step 2	switch(config)# spanning-tree mst configuration	Enters MST configuration mode on the system. You must be in the MST configuration mode to assign the MST configuration parameters, as follows: <ul style="list-style-type: none"> • MST name • Instance-to-VLAN mapping • MST revision number • Synchronize primary and secondary VLANs in private VLANs
Step 3	switch(config-mst)# exit or switch(config-mst)# abort	Exits or aborts. <ul style="list-style-type: none"> • The exit command commits all the changes and exits MST configuration mode. • The abort command exits the MST configuration mode without committing any of the changes.

	Command or Action	Purpose
Step 4	(Optional) switch(config)# no spanning-tree mst configuration	Returns the MST region configuration to the following default values: <ul style="list-style-type: none"> • The region name is an empty string. • No VLANs are mapped to any MST instance (all VLANs are mapped to the CIST instance). • The revision number is 0.

Specifying the MST Name

You configure a region name on the bridge. For two or more bridges to be in the same MST region, they must have the identical MST name, VLAN-to-instance mapping, and MST revision number.

Procedure

	Command or Action	Purpose
Step 1	switch# configure terminal	Enters global configuration mode.
Step 2	switch(config)# spanning-tree mst configuration	Enters MST configuration submenu.
Step 3	switch(config-mst)# name name	Specifies the name for MST region. The <i>name</i> string has a maximum length of 32 case-sensitive characters. The default is an empty string.

Example

This example shows how to set the name of the MST region:

```
switch# configure terminal
switch(config)# spanning-tree mst configuration
switch(config-mst)# name accounting
```

Specifying the MST Configuration Revision Number

You configure the revision number on the bridge. For two or more bridges to be in the same MST region, they must have the identical MST name, VLAN-to-instance mapping, and MST revision number.

Procedure

	Command or Action	Purpose
Step 1	switch# configure terminal	Enters global configuration mode.
Step 2	switch(config)# spanning-tree mst configuration	Enters MST configuration submode.
Step 3	switch(config-mst)# revision version	Specifies the revision number for the MST region. The range is from 0 to 65535, and the default value is 0.

Example

This example shows how to configure the revision number of the MSTI region for 5:

```
switch# configure terminal
switch(config)# spanning-tree mst configuration
switch(config-mst)# revision 5
```

Specifying the Configuration on an MST Region

For two or more switches to be in the same MST region, they must have the same VLAN-to-instance mapping, the same configuration revision number, and the same MST name.

A region can have one member or multiple members with the same MST configuration; each member must be capable of processing IEEE 802.1w RSTP BPDUs. There is no limit to the number of MST regions in a network, but each region can support only up to 65 MST instances. You can assign a VLAN to only one MST instance at a time.

Procedure

	Command or Action	Purpose
Step 1	switch# configure terminal	Enters global configuration mode.
Step 2	switch(config)# spanning-tree mst configuration	Enters MST configuration submode.
Step 3	switch(config-mst)# instance instance-id vlan vlan-range	<p>Maps VLANs to an MST instance as follows:</p> <ul style="list-style-type: none"> • For <i>instance-id</i> , the range is from 1 to 4094. • For vlan vlan-range , the range is from 1 to 4094. <p>When you map VLANs to an MST instance, the mapping is incremental, and the VLANs specified in the command are added to or</p>

	Command or Action	Purpose
		<p>removed from the VLANs that were previously mapped.</p> <p>To specify a VLAN range, enter a hyphen; for example, enter the instance 1 vlan 1-63 command to map VLANs 1 through 63 to MST instance 1.</p> <p>To specify a VLAN series, enter a comma; for example, enter the instance 1 vlan 10, 20, 30 command to map VLANs 10, 20, and 30 to MST instance 1.</p>
Step 4	switch(config-mst)# name <i>name</i>	Specifies the instance name. The <i>name</i> string has a maximum length of 32 case-sensitive characters.
Step 5	switch(config-mst)# revision <i>version</i>	Specifies the configuration revision number. The range is from 0 to 65535.

Example

To return to defaults, do the following:

- To return to the default MST region configuration settings, enter the **no spanning-tree mst configuration** configuration command.
- To return to the default VLAN-to-instance map, enter the **no instance *instance-id* vlan *vlan-range*** MST configuration command.
- To return to the default name, enter the **no name** MST configuration command.
- To return to the default revision number, enter the **no revision** MST configuration command.
- To reenable Rapid PVST+, enter the **no spanning-tree mode** or the **spanning-tree mode rapid-pvst** global configuration command.

This example shows how to enter MST configuration mode, map VLANs 10 to 20 to MST instance 1, name the region region1, set the configuration revision to 1, display the pending configuration, apply the changes, and return to global configuration mode:

```
switch(config)# spanning-tree mst configuration
switch(config-mst)# instance 1 vlan 10-20
switch(config-mst)# name region1
switch(config-mst)# revision 1
switch(config-mst)# show pending
Pending MST configuration
Name      [region1]
Revision  1
Instances configured 2
```

```

Instance  Vlans Mapped
-----  -
0         1-9,21-4094
1         10-20
-----  -

```

Mapping and Unmapping VLANs to MST Instances



Caution

When you change the VLAN-to-MSTI mapping, the system restarts MST.



Note

You cannot disable an MSTI.

For two or more bridges to be in the same MST region, they must have the identical MST name, VLAN-to-instance mapping, and MST revision number.

Procedure

	Command or Action	Purpose
Step 1	switch# configure terminal	Enters global configuration mode.
Step 2	switch(config)# spanning-tree mst configuration	Enters MST configuration submode.
Step 3	switch(config-mst)# instance <i>instance-id</i> vlan <i>vlan-range</i>	Maps VLANs to an MST instance, as follows: <ul style="list-style-type: none"> For <i>instance-id</i> the range is from 1 to 4094. Instance 0 is reserved for the IST for each MST region. For <i>vlan-range</i> the range is from 1 to 4094. <p>When you map VLANs to an MSTI, the mapping is incremental, and the VLANs specified in the command are added to or removed from the VLANs that were previously mapped.</p>
Step 4	switch(config-mst)# no instance <i>instance-id</i> vlan <i>vlan-range</i>	Deletes the specified instance and returns the VLANs to the default MSTI, which is the CIST.

Example

This example shows how to map VLAN 200 to MSTI 3:

```
switch# configure terminal
switch(config)# spanning-tree mst configuration
switch(config-mst)# instance 3 vlan 200
```

Mapping Secondary VLANs to Same MSTI as Primary VLANs for Private VLANs

When you are working with private VLANs on the system, all secondary VLANs must be in the same MSTI and their associated primary VLAN.

Procedure

	Command or Action	Purpose
Step 1	switch# configure terminal	Enters global configuration mode.
Step 2	switch(config)# spanning-tree mst configuration	Enters MST configuration submode.
Step 3	switch(config-mst)# private-vlan synchronize	Automatically maps all secondary VLANs to the same MSTI as their associated primary VLAN in all private VLANs.

Example

This example shows how to automatically map all the secondary VLANs to the same MSTI as their associated primary VLANs in all private VLANs:

```
switch# configure terminal
switch(config)# spanning-tree mst configuration
switch(config-mst)# private-vlan synchronize
```

Configuring the Root Bridge

You can configure the switch to become the root bridge.



Note The root bridge for each MSTI should be a backbone or distribution switch. Do not configure an access switch as the spanning tree primary root bridge.

Enter the **diameter** keyword, which is available only for MSTI 0 (or the IST), to specify the network diameter (that is, the maximum number of hops between any two end stations in the network). When you specify the network diameter, the switch automatically sets an optimal hello time, forward-delay time, and maximum-age

time for a network of that diameter, which can significantly reduce the convergence time. You can enter the **hello** keyword to override the automatically calculated hello time.



Note With the switch configured as the root bridge, do not manually configure the hello time, forward-delay time, and maximum-age time using the **spanning-tree mst hello-time**, **spanning-tree mst forward-time**, and **spanning-tree mst max-age** global configuration commands.

Procedure

	Command or Action	Purpose
Step 1	switch# configure terminal	Enters global configuration mode.
Step 2	switch(config)# spanning-tree mst <i>instance-id</i> root { primary secondary } [diameter <i>dia</i> [hello-time <i>hello-time</i>]]	Configures a switch as the root bridge as follows: <ul style="list-style-type: none"> • For <i>instance-id</i>, you can specify a single instance, a range of instances separated by a hyphen, or a series of instances separated by a comma. The range is from 1 to 4094. • For diameter <i>net-diameter</i>, specify the maximum number of hops between any two end stations. The default is 7. This keyword is available only for MST instance 0. • For hello-time <i>seconds</i>, specify the interval in seconds between the generation of configuration messages by the root bridge. The range is from 1 to 10 seconds; the default is 2 seconds.
Step 3	(Optional) switch(config)# no spanning-tree mst <i>instance-id</i> root	Returns the switch priority, diameter, and hello time to default values.

Example

This example shows how to configure the switch as the root switch for MSTI 5:

```
switch# configure terminal
switch(config)# spanning-tree mst 5 root primary
```

Configuring a Secondary Root Bridge

You can execute this command on more than one switch to configure multiple backup root bridges. Enter the same network diameter and hello-time values that you used when you configured the primary root bridge with the **spanning-tree mst root primary** configuration command.

Procedure

	Command or Action	Purpose
Step 1	<code>switch# configure terminal</code>	Enters global configuration mode.
Step 2	<code>switch(config)# spanning-tree mst <i>instance-id</i> root {primary secondary} [diameter <i>dia</i> [hello-time <i>hello-time</i>]]</code>	Configures a switch as the secondary root bridge as follows: <ul style="list-style-type: none"> • For <i>instance-id</i>, you can specify a single instance, a range of instances separated by a hyphen, or a series of instances separated by a comma. The range is from 1 to 4094. • For diameter <i>net-diameter</i>, specify the maximum number of hops between any two end stations. The default is 7. This keyword is available only for MST instance 0. • For hello-time <i>seconds</i>, specify the interval in seconds between the generation of configuration messages by the root bridge. The range is from 1 to 10 seconds; the default is 2 seconds.
Step 3	(Optional) <code>switch(config)# no spanning-tree mst <i>instance-id</i> root</code>	Returns the switch priority, diameter, and hello-time to default values.

Example

This example shows how to configure the switch as the secondary root switch for MSTI 5:

```
switch# configure terminal
switch(config)# spanning-tree mst 5 root secondary
```

Configuring the Port Priority

If a loop occurs, MST uses the port priority when selecting an interface to put into the forwarding state. You can assign lower priority values to interfaces that you want selected first and higher priority values to the interface that you want selected last. If all interfaces have the same priority value, MST puts the interface with the lowest interface number in the forwarding state and blocks the other interfaces.

Procedure

	Command or Action	Purpose
Step 1	<code>switch# configure terminal</code>	Enters global configuration mode.
Step 2	<code>switch(config)# interface {{type slot/port} {port-channel number}}</code>	Specifies an interface to configure, and enters interface configuration mode.

	Command or Action	Purpose
		Note If this is a QSFP+ GEM or a breakout port, the <i>port</i> syntax is <i>QSFP-module/port</i> .
Step 3	switch(config-if)# spanning-tree mst instance-id port-priority priority	Configures the port priority as follows: <ul style="list-style-type: none"> • For <i>instance-id</i>, you can specify a single MSTI, a range of MSTIs separated by a hyphen, or a series of MSTIs separated by a comma. The range is from 1 to 4094. • For <i>priority</i>, the range is 0 to 224 in increments of 32. The default is 128. A lower number indicates a higher priority. <p>The priority values are 0, 32, 64, 96, 128, 160, 192, and 224. The system rejects all other values.</p>

Example

This example shows how to set the MST interface port priority for MSTI 3 on Ethernet port 3/1 to 64:

```
switch# configure terminal
switch(config)# interface ethernet 3/1
switch(config-if)# spanning-tree mst 3 port-priority 64
```

You can only apply this command to a physical Ethernet interface.

Configuring the Port Cost

The MST path-cost default value is derived from the media speed of an interface. If a loop occurs, MST uses the cost when selecting an interface to put in the forwarding state. You can assign lower cost values to interfaces that you want selected first and higher cost to interfaces values that you want selected last. If all interfaces have the same cost value, MST puts the interface with the lowest interface number in the forwarding state and blocks the other interfaces.



Note MST uses the long path-cost calculation method.

Procedure

	Command or Action	Purpose
Step 1	switch# configure terminal	Enters global configuration mode.

	Command or Action	Purpose
Step 2	switch(config)# interface <i>{{type slot/port}}</i> port-channel <i>number</i> }	Specifies an interface to configure, and enters interface configuration mode. Note If this is a QSFP+ GEM or a breakout port, the <i>port</i> syntax is <i>QSFP-module/port</i> .
Step 3	switch(config-if)# spanning-tree mst <i>instance-id</i> cost [<i>cost</i> auto]	Configures the cost. If a loop occurs, MST uses the path cost when selecting an interface to place into the forwarding state. A lower path cost represents higher-speed transmission as follows: <ul style="list-style-type: none"> • For <i>instance-id</i>, you can specify a single instance, a range of instances separated by a hyphen, or a series of instances separated by a comma. The range is from 1 to 4094. • For <i>cost</i>, the range is from 1 to 200000000. The default value is auto, which is derived from the media speed of the interface.

Example

This example shows how to set the MST interface port cost on Ethernet 3/1 for MSTI 4:

```
switch# configure terminal
switch(config)# interface ethernet 3/1
switch(config-if)# spanning-tree mst 4 cost 17031970
```

Configuring the Switch Priority

You can configure the switch priority for an MST instance so that it is more likely that the specified switch is chosen as the root bridge.



Note Exercise care when using this command. For most situations, we recommend that you enter the **spanning-tree mst root primary** and the **spanning-tree mst root secondary** global configuration commands to modify the switch priority.

Procedure

	Command or Action	Purpose
Step 1	switch# configure terminal	Enters global configuration mode.

	Command or Action	Purpose
Step 2	switch(config)# spanning-tree mst <i>instance-id</i> priority <i>priority-value</i>	<p>Configures a switch priority as follows:</p> <ul style="list-style-type: none"> • For <i>instance-id</i>, you can specify a single instance, a range of instances separated by a hyphen, or a series of instances separated by a comma. The range is from 1 to 4094. • For <i>priority</i>, the range is from 0 to 61440 in increments of 4096; the default is 32768. A lower number indicates that the switch will most likely be chosen as the root bridge. <p>Priority values are 0, 4096, 8192, 12288, 16384, 20480, 24576, 28672, 32768, 36864, 40960, 45056, 49152, 53248, 57344, and 61440. The system rejects all other values.</p>

Example

This example shows how to configure the priority of the bridge to 4096 for MSTI 5:

```
switch# configure terminal
switch(config)# spanning-tree mst 5 priority 4096
```

Configuring the Hello Time

You can configure the interval between the generation of configuration messages by the root bridge for all instances on the switch by changing the hello time.



Note Exercise care when using this command. For most situations, we recommend that you enter the **spanning-tree mst *instance-id* root primary** and the **spanning-tree mst *instance-id* root secondary** configuration commands to modify the hello time.

Procedure

	Command or Action	Purpose
Step 1	switch# configure terminal	Enters global configuration mode.
Step 2	switch(config)# spanning-tree mst hello-time <i>seconds</i>	Configures the hello time for all MST instances. The hello time is the interval between the generation of configuration messages by the root bridge. These messages mean that the switch is alive. For <i>seconds</i> , the range is from 1 to 10, and the default is 2 seconds.

Example

This example shows how to configure the hello time of the switch to 1 second:

```
switch# configure terminal
switch(config)# spanning-tree mst hello-time 1
```

Configuring the Forwarding-Delay Time

You can set the forward delay timer for all MST instances on the switch with one command.

Procedure

	Command or Action	Purpose
Step 1	switch# configure terminal	Enters global configuration mode.
Step 2	switch(config)# spanning-tree mst forward-time <i>seconds</i>	Configures the forward time for all MST instances. The forward delay is the number of seconds that a port waits before changing from its spanning tree blocking and learning states to the forwarding state. For <i>seconds</i> , the range is from 4 to 30, and the default is 15 seconds.

Example

This example shows how to configure the forward-delay time of the switch to 10 seconds:

```
switch# configure terminal
switch(config)# spanning-tree mst forward-time 10
```

Configuring the Maximum-Aging Time

The maximum-aging timer is the number of seconds that a switch waits without receiving spanning tree configuration messages before attempting a reconfiguration.

You set the maximum-aging timer for all MST instances on the switch with one command (the maximum age time only applies to the IST).

Procedure

	Command or Action	Purpose
Step 1	switch# configure terminal	Enters global configuration mode.
Step 2	switch(config)# spanning-tree mst max-age <i>seconds</i>	Configures the maximum-aging time for all MST instances. The maximum-aging time is the number of seconds that a switch waits

	Command or Action	Purpose
		without receiving spanning tree configuration messages before attempting a reconfiguration. For <i>seconds</i> , the range is from 6 to 40, and the default is 20 seconds.

Example

This example shows how to configure the maximum-aging timer of the switch to 40 seconds:

```
switch# configure terminal
switch(config)# spanning-tree mst max-age 40
```

Configuring the Maximum-Hop Count

MST uses the path cost to the IST regional root and a hop-count mechanism similar to the IP time-to-live (TTL) mechanism. You configure the maximum hops inside the region and apply it to the IST and all MST instances in that region. The hop count achieves the same result as the message-age information (triggers a reconfiguration).

Procedure

	Command or Action	Purpose
Step 1	switch# configure terminal	Enters global configuration mode.
Step 2	switch(config)# spanning-tree mst max-hops <i>hop-count</i>	Specifies the number of hops in a region before the BPDU is discarded, and the information held for a port is aged. For <i>hop-count</i> , the range is from 1 to 255, and the default value is 20 hops.

Example

This example shows how to set the maximum hops to 40:

```
switch# configure terminal
switch(config)# spanning-tree mst max-hops 40
```

Configuring PVST Simulation Globally

You can block this automatic feature either globally or per port. You can enter the global command and change the PVST simulation setting for the entire switch while you are in interface command mode.

Procedure

	Command or Action	Purpose
Step 1	switch# configure terminal	Enters global configuration mode.
Step 2	switch(config)# no spanning-tree mst simulate pvst global	Disables all interfaces on the switch from automatically interoperating with connected switch that is running in Rapid PVST+ mode. By default, all interfaces on the switch operate seamlessly between Rapid PVST+ and MST.

Example

This example shows how to prevent the switch from automatically interoperating with a connecting switch that is running Rapid PVST+:

```
switch# configure terminal
switch(config)# no spanning-tree mst simulate pvst global
```

Configuring PVST Simulation Per Port

MST interoperates seamlessly with Rapid PVST+. However, to prevent an accidental connection to a switch that does not run MST as the default STP mode, you may want to disable this automatic feature. If you disable PVST simulation, the MST-enabled port moves to the blocking state once it detects it is connected to a Rapid PVST+-enabled port. This port remains in the inconsistent state until the port stops receiving BPDUs, and then the port resumes the normal STP transition process.

You can block this automatic feature either globally or per port.

Procedure

	Command or Action	Purpose
Step 1	switch# configure terminal	Enters global configuration mode.
Step 2	switch(config)# interface <i>{{type slot/port} {port-channel number}}</i>	Specifies an interface to configure, and enters interface configuration mode. Note If this is a QSFP+ GEM or a breakout port, the <i>port</i> syntax is <i>QSFP-module/port</i> .
Step 3	switch(config-if)# spanning-tree mst simulate pvst disable	Disables specified interfaces from automatically interoperating with a connected switch that is running in Rapid PVST+ mode. By default, all interfaces on the switch operate seamlessly between Rapid PVST+ and MST.

	Command or Action	Purpose
Step 4	switch(config-if)# spanning-tree mst simulate pvst	Reenables the seamless operation between MST and Rapid PVST+ on specified interfaces.
Step 5	switch(config-if)# no spanning-tree mst simulate pvst	Sets the interface to the switch-wide MST and Rapid PVST+ interoperation that you configured using the spanning-tree mst simulate pvst global command.

Example

This example shows how to prevent the specified interfaces from automatically interoperating with a connecting switch that is not running MST:

```
switch# configure terminal
switch(config)# interface ethernet 1/4
switch(config-if)# spanning-tree mst simulate pvst disable
```

Specifying the Link Type

Rapid connectivity (802.1w standard) is established only on point-to-point links. By default, the link type is controlled from the duplex mode of the interface. A full-duplex port is considered to have a point-to-point connection; a half-duplex port is considered to have a shared connection.

If you have a half-duplex link physically connected point-to-point to a single port on a remote switch, you can override the default setting on the link type and enable rapid transitions.

If you set the link to shared, STP reverts to 802.1D.

Procedure

	Command or Action	Purpose
Step 1	switch# configure terminal	Enters configuration mode.
Step 2	switch(config)# interface type slot/port	Specifies the interface to configure, and enters interface configuration mode. Note If this is a QSFP+ GEM or a breakout port, the <i>port</i> syntax is <i>QSFP-module/port</i> .
Step 3	switch(config-if)# spanning-tree link-type {auto point-to-point shared}	Configures the link type to be either point to point or shared. The system reads the default value from the switch connection. Half-duplex links are shared and full-duplex links are point to point. If the link type is shared, the STP reverts to 802.1D. The default is auto, which

	Command or Action	Purpose
		sets the link type based on the duplex setting of the interface.

Example

This example shows how to configure the link type as point to point:

```
switch# configure terminal
switch (config)# interface ethernet 1/4
switch(config-if)# spanning-tree link-type point-to-point
```

Restarting the Protocol

An MST bridge can detect that a port is at the boundary of a region when it receives a legacy BPDU or an MST BPDU that is associated with a different region. However, the STP protocol migration cannot determine whether the legacy switch, which is a switch that runs only IEEE 802.1D, has been removed from the link unless the legacy switch is the designated switch. Enter this command to restart the protocol negotiation (force the renegotiation with neighboring switches) on the entire switch or on specified interfaces.

Procedure

	Command or Action	Purpose
Step 1	switch# clear spanning-tree detected-protocol [interface <i>interface</i> [<i>interface-num</i> <i>port-channel</i>]]	Restarts MST on the entire switch or specified interfaces.

Example

This example shows how to restart MST on the Ethernet interface on slot 2, port 8:

```
switch# clear spanning-tree detected-protocol interface ethernet 2/8
```

Verifying the MST Configuration

Use the following commands to display MST configuration information.

Command	Purpose
show running-config spanning-tree [all]	Displays the current spanning tree configuration.
show spanning-tree mst [<i>options</i>]	Displays detailed information for the current MST configuration.

This example shows how to display the current MST configuration:

```
switch# show spanning-tree mst configuration
```

```
% Switch is not in mst mode
```

```
Name      [mist-attempt]
```

```
Revision  1      Instances configured 2
```

```
Instance  Vlans mapped
```

```
-----
```

```
0          1-12,14-41,43-4094
```

```
1          13,42
```



CHAPTER 6

Configuring STP Extensions

This chapter contains the following sections:

- [Overview, on page 89](#)

Overview

Cisco has added extensions to Spanning Tree Protocol (STP) that make convergence more efficient. In some cases, even though similar functionality may be incorporated into the IEEE 802.1w Rapid Spanning Tree Protocol (RSTP) standard, we recommend using these extensions. All of these extensions can be used with both RPVST+ and Multiple Spanning Tree Protocol (MST).

The available extensions are spanning tree port types, Bridge Assurance, BPDU Guard, BPDU Filtering, Loop Guard, and Root Guard. Many of these features can be applied either globally or on specified interfaces.



Note Spanning tree is used to refer to IEEE 802.1w and IEEE 802.1s. If the text is discussing the IEEE 802.1D Spanning Tree Protocol, 802.1D is stated specifically.

Information About STP Extensions

Understanding STP Port Types

You can configure a spanning tree port as an edge port, a network port, or a normal port. A port can be in only one of these states at a given time. The default spanning tree port type is normal. Depending on the type of device to which the interface is connected, you can configure a spanning tree port as one of these port types.

Spanning Tree Edge Ports

Edge ports, which are connected to hosts, can be either an access port or a trunk port. The edge port interface immediately transitions to the forwarding state, without moving through the blocking or learning states. (This immediate transition was previously configured as the Cisco-proprietary feature PortFast.)

Interfaces that are connected to hosts should not receive STP bridge protocol data units (BPDUs).



Note If you configure a port connected to another switch as an edge port, you might create a bridging loop.

Spanning Tree Network Ports

Network ports are connected only to switches or bridges. Configuring a port as a network port while Bridge Assurance is enabled globally, enables Bridge Assurance on that port.



Note If you mistakenly configure ports that are connected to hosts or other edge devices as spanning tree network ports, those ports automatically move into the blocking state.

Spanning Tree Normal Ports

Normal ports can be connected to either hosts, switches, or bridges. These ports function as normal spanning tree ports.

The default spanning tree interface is a normal port.

Understanding Bridge Assurance

You can use Bridge Assurance to protect against certain problems that can cause bridging loops in the network. Specifically, you use Bridge Assurance to protect against a unidirectional link failure and a device that continues to forward data traffic when it is no longer running the spanning tree algorithm.



Note Bridge Assurance is supported only by Rapid PVST+ and MST. Legacy 802.1D spanning tree does not support Bridge Assurance.

Bridge Assurance is enabled by default and can only be disabled globally. Also, Bridge Assurance can be enabled only on spanning tree network ports that are point-to-point links. Finally, both ends of the link must have Bridge Assurance enabled.

With Bridge Assurance enabled, BPDUs are sent out on all operational network ports, including alternate and backup ports, for each hello time period. If the port does not receive a BPDU for a specified period, the port moves into the blocking state and is not used in the root port calculation. Once that port receives a BPDU, it resumes the normal spanning tree transitions.

Understanding BPDU Guard

Enabling BPDU Guard shuts down that interface if a BPDU is received.

You can configure BPDU Guard at the interface level. When configured at the interface level, BPDU Guard shuts the port down as soon as the port receives a BPDU, regardless of the port type configuration.

When you configure BPDU Guard globally, it is effective only on operational spanning tree edge ports. In a valid configuration, LAN edge interfaces do not receive BPDUs. A BPDU that is received by an edge LAN interface signals an invalid configuration, such as the connection of an unauthorized host or switch. BPDU Guard, when enabled globally, shuts down all spanning tree edge ports when they receive a BPDU.



Note On the edge trunk interface level, if the remote side of the disabled VLAN is configured as an access port then the BPDUs will be ignored.

BPDU Guard provides a secure response to invalid configurations, because you must manually put the LAN interface back in service after an invalid configuration.



Note When enabled globally, BPDU Guard applies to all operational spanning tree edge interfaces.

Understanding BPDU Filtering

You can use BPDU Filtering to prevent the switch from sending or even receiving BPDUs on specified ports.

When configured globally, BPDU Filtering applies to all operational spanning tree edge ports. You should connect edge ports only to hosts, which typically drop BPDUs. If an operational spanning tree edge port receives a BPDU, it immediately returns to a normal spanning tree port type and moves through the regular transitions. In that case, BPDU Filtering is disabled on this port, and spanning tree resumes sending BPDUs on this port.

In addition, you can configure BPDU Filtering by the individual interface. When you explicitly configure BPDU Filtering on a port, that port does not send any BPDUs and drops all BPDUs that it receives. You can effectively override the global BPDU Filtering setting on individual ports by configuring the specific interface. This BPDU Filtering command on the interface applies to the entire interface, whether the interface is trunking or not.



Caution Use care when configuring BPDU Filtering per interface. If you explicitly configuring BPDU Filtering on a port that is not connected to a host, it can result in bridging loops because the port ignores any BPDU that it receives and goes to forwarding.

If the port configuration is not set to default BPDU Filtering, the edge configuration does not affect BPDU Filtering. The following table lists all the BPDU Filtering combinations.

Table 7: BPDU Filtering Configurations

BPDU Filtering Per Port Configuration	BPDU Filtering Global Configuration	STP Edge Port Configuration	BPDU Filtering State
Default	Enabled	Enabled	Enabled The port transmits at least 10 BPDUs. If this port receives any BPDUs, the port returns to the spanning tree normal port state and BPDU Filtering is disabled.
Default	Enabled	Disabled	Disabled
Default	Disabled	Enabled/Disabled	Disabled
Disable	Enabled/Disabled	Enabled/Disabled	Disabled

BPDU Filtering Per Port Configuration	BPDU Filtering Global Configuration	STP Edge Port Configuration	BPDU Filtering State
Enabled	Enabled/Disabled	Enabled/Disabled	Enabled Caution BPDUs are never sent and if received, they do not trigger the regular STP behavior - use with caution.

Understanding Loop Guard

Loop Guard protects networks from loops that are caused by the following:

- Network interfaces that malfunction
- Busy CPUs
- Anything that prevents the normal forwarding of BPDUs

An STP loop occurs when a blocking port in a redundant topology erroneously transitions to the forwarding state. This transition usually happens because one of the ports in a physically redundant topology (not necessarily the blocking port) stops receiving BPDUs.

Loop Guard is useful only in switched networks where devices are connected by point-to-point links. On a point-to-point link, a designated bridge cannot disappear unless it sends an inferior BPDU or brings the link down.



Note Loop Guard can be enabled only on network and normal spanning tree port types.

You can use Loop Guard to determine if a root port or an alternate/backup root port receives BPDUs. If the port does not receive BPDUs, Loop Guard puts the port into an inconsistent state (blocking) until the port starts to receive BPDUs again. A port in the inconsistent state does not transmit BPDUs. If the port receives BPDUs again, the protocol removes its loop-inconsistent condition, and the STP determines the port state because such recovery is automatic.

Loop Guard isolates the failure and allows STP to converge to a stable topology without the failed link or bridge. Disabling Loop Guard moves all loop-inconsistent ports to the listening state.

You can enable Loop Guard on a per-port basis. When you enable Loop Guard on a port, it is automatically applied to all of the active instances or VLANs to which that port belongs. When you disable Loop Guard, it is disabled for the specified ports.

Understanding Root Guard

When you enable Root Guard on a port, Root Guard does not allow that port to become a root port. If a received BPDU triggers an STP convergence that makes that designated port become a root port, that port is put into a root-inconsistent (blocked) state. After the port stops sending superior BPDUs, the port is unblocked again. Through STP, the port moves to the forwarding state. Recovery is automatic.

Root Guard enabled on an interface applies this functionality to all VLANs to which that interface belongs.

You can use Root Guard to enforce the root bridge placement in the network. Root Guard ensures that the port on which Root Guard is enabled is the designated port. Normally, root bridge ports are all designated ports, unless two or more of the ports of the root bridge are connected. If the bridge receives superior BPDUs on a Root Guard-enabled port, the bridge moves this port to a root-inconsistent STP state. In this way, Root Guard enforces the position of the root bridge.

You cannot configure Root Guard globally.



Note You can enable Root Guard on all spanning tree port types: normal, edge, and network ports.

Configuring STP Extensions

STP Extensions Configuration Guidelines

When configuring STP extensions, follow these guidelines:

- Configure all access and trunk ports connected to hosts as edge ports.
- Bridge Assurance runs only on point-to-point spanning tree network ports. You must configure each side of the link for this feature.
- Loop Guard does not run on spanning tree edge ports.
- Enabling Loop Guard on ports that are not connected to a point-to-point link will not work.
- You cannot enable Loop Guard if Root Guard is enabled.

Configuring Spanning Tree Port Types Globally

The spanning tree port type designation depends on the type of device the port is connected to, as follows:

- Edge—Edge ports are connected to hosts and can be either an access port or a trunk port.
- Network—Network ports are connected only to switches or bridges.
- Normal—Normal ports are neither edge ports nor network ports; they are normal spanning tree ports. These ports can be connected to any type of device.

You can configure the port type either globally or per interface. By default, the spanning tree port type is normal.

Before you begin

Ensure that STP is configured.

Ensure that you are configuring the ports correctly for the type of device to which the interface is connected.

Procedure

	Command or Action	Purpose
Step 1	switch# configure terminal	Enters global configuration mode.

	Command or Action	Purpose
Step 2	switch(config)# spanning-tree port type edge default	Configures all interfaces as edge ports. Using this command assumes all ports are connected to hosts/servers. Edge ports immediately transition to the forwarding state without passing through the blocking or learning state at linkup. By default, spanning tree ports are normal port types.
Step 3	switch(config)# spanning-tree port type network default	Configures all interfaces as spanning tree network ports. Using this command assumes all ports are connected to switches and bridges. If you enable Bridge Assurance, it automatically runs on network ports. By default, spanning tree ports are normal port types. Note If you configure interfaces connected to hosts as network ports, those ports automatically move into the blocking state.

Example

This example shows how to configure all access and trunk ports connected to hosts as spanning tree edge ports:

```
switch# configure terminal
switch(config)# spanning-tree port type edge default
```

This example shows how to configure all ports connected to switches or bridges as spanning tree network ports:

```
switch# configure terminal
switch(config)# spanning-tree port type network default
```

Configuring Spanning Tree Edge Ports on Specified Interfaces

You can configure spanning tree edge ports on specified interfaces. Interfaces configured as spanning tree edge ports immediately transition to the forwarding state without passing through the blocking or learning states on linkup.

This command has four states:

- **spanning-tree port type edge**—This command explicitly enables edge behavior on the access port.
- **spanning-tree port type edge trunk**—This command explicitly enables edge behavior on the trunk port.



Note If you enter the **spanning-tree port type edge trunk** command, the port is configured as an edge port even in the access mode.

- **spanning-tree port type normal**—This command explicitly configures the port as a normal spanning tree port and the immediate transition to the forwarding state is not enabled.
- **no spanning-tree port type**—This command implicitly enables edge behavior if you define the **spanning-tree port type edge default** command in global configuration mode. If you do not configure the edge ports globally, the **no spanning-tree port type** command is equivalent to the **spanning-tree port type disable** command.

Before you begin

Ensure that STP is configured.

Ensure that the interface is connected to hosts.

Procedure

	Command or Action	Purpose
Step 1	switch# configure terminal	Enters global configuration mode.
Step 2	switch(config)# interface <i>type slot/port</i>	Specifies the interface to configure, and enters the interface configuration mode. Note If this is a QSFP+ GEM or a breakout port, the <i>port</i> syntax is <i>QSFP-module/port</i> .
Step 3	switch(config-if)# spanning-tree port type edge	Configures the specified access interfaces to be spanning edge ports. Edge ports immediately transition to the forwarding state without passing through the blocking or learning state at linkup. By default, spanning tree ports are normal port types.

Example

This example shows how to configure the Ethernet access interface 1/4 to be a spanning tree edge port:

```
switch# configure terminal
switch(config)# interface ethernet 1/4
switch(config-if)# spanning-tree port type edge
```

Configuring Spanning Tree Network Ports on Specified Interfaces

You can configure spanning tree network ports on specified interfaces.

Bridge Assurance runs only on spanning tree network ports.

This command has three states:

- **spanning-tree port type network**—This command explicitly configures the port as a network port. If you enable Bridge Assurance globally, it automatically runs on a spanning tree network port.
- **spanning-tree port type normal**—This command explicitly configures the port as a normal spanning tree port and Bridge Assurance cannot run on this interface.
- **no spanning-tree port type**—This command implicitly enables the port as a spanning tree network port if you define the **spanning-tree port type network default** command in global configuration mode. If you enable Bridge Assurance globally, it automatically runs on this port.



Note A port connected to a host that is configured as a network port automatically moves into the blocking state.

Before you begin

Ensure that STP is configured.

Ensure that the interface is connected to switches or routers.

Procedure

	Command or Action	Purpose
Step 1	switch# configure terminal	Enters global configuration mode.
Step 2	switch(config)# interface type slot/port	Specifies the interface to configure, and enters the interface configuration mode. The interface can be a physical Ethernet port.
Step 3	switch(config-if)# spanning-tree port type network	Configures the specified interfaces to be spanning network ports. If you enable Bridge Assurance, it automatically runs on network ports. By default, spanning tree ports are normal port types.

Example

This example shows how to configure the Ethernet interface 1/4 to be a spanning tree network port:

```
switch# configure terminal
switch(config)# interface ethernet 1/4
switch(config-if)# spanning-tree port type network
```

Enabling BPDU Guard Globally

You can enable BPDU Guard globally by default. In this condition, the system shuts down an edge port that receives a BPDU.



Note We recommend that you enable BPDU Guard on all edge ports.

Before you begin

Ensure that STP is configured.

Ensure that you have configured some spanning tree edge ports.

Procedure

	Command or Action	Purpose
Step 1	switch# configure terminal	Enters global configuration mode.
Step 2	switch(config)# spanning-tree port type edge bpduguard default	Enables BPDU Guard by default on all spanning tree edge ports. By default, global BPDU Guard is disabled.

Example

This example shows how to enable BPDU Guard on all spanning tree edge ports:

```
switch# configure terminal
switch(config)# spanning-tree port type edge bpduguard default
```

Enabling BPDU Guard on Specified Interfaces

You can enable BPDU Guard on specified interfaces. Enabling BPDU Guard shuts down the port if it receives a BPDU.

You can configure BPDU Guard on specified interfaces as follows:

- **spanning-tree bpduguard enable**—Unconditionally enables BPDU Guard on the interface.
- **spanning-tree bpduguard disable**—Unconditionally disables BPDU Guard on the interface.
- **no spanning-tree bpduguard**—Enables BPDU Guard on the interface if it is an operational edge port and if the **spanning-tree port type edge bpduguard default** command is configured.

Before you begin

Ensure that STP is configured.

Procedure

	Command or Action	Purpose
Step 1	switch# configure terminal	Enters global configuration mode.
Step 2	switch(config)# interface <i>type slot/port</i>	Specifies the interface to configure, and enters the interface configuration mode.
Step 3	switch(config-if)# spanning-tree bpduguard { enable disable }	Enables or disables BPDU Guard for the specified spanning tree edge interface. By default, BPDU Guard is disabled on physical Ethernet interfaces.
Step 4	(Optional) switch(config-if)# no spanning-tree bpduguard	Disables BPDU Guard on the interface. Note Enables BPDU Guard on the interface if it is an operational edge port and if you enter the spanning-tree port type edge bpduguard default command.

Example

This example shows how to explicitly enable BPDU Guard on the Ethernet edge port 1/4:

```
switch# configure terminal
switch (config)# interface ethernet 1/4
switch(config-if)# spanning-tree bpduguard enable
switch(config-if)# no spanning-tree bpduguard
```

Enabling BPDU Filtering Globally

You can enable BPDU Filtering globally by default on spanning tree edge ports.

If an edge port with BPDU Filtering enabled receives a BPDU, it loses its operation status and as edge port and resumes the regular STP transitions. However, this port maintains its configuration as an edge port.

**Caution**

Be careful when using this command: using it incorrectly can cause bridging loops.

**Note**

When enabled globally, BPDU Filtering is applied *only* on ports that are operational edge ports. Ports send a few BPDUs at linkup before they effectively filter outbound BPDUs. If a BPDU is received on an edge port, it immediately loses its operational edge port status and BPDU Filtering is disabled.

Before you begin

Ensure that STP is configured.

Ensure that you have configured some spanning tree edge ports.

Procedure

	Command or Action	Purpose
Step 1	switch# configure terminal	Enters global configuration mode.
Step 2	switch(config)# spanning-tree port type edge bpdudfilter default	Enables BPDU Filtering by default on all operational spanning tree edge ports. Global BPDU Filtering is disabled by default.

Example

This example shows how to enable BPDU Filtering on all operational spanning tree edge ports:

```
switch# configure terminal
switch(config)# spanning-tree port type edge bpdudfilter default
```

Enabling BPDU Filtering on Specified Interfaces

You can apply BPDU Filtering to specified interfaces. When enabled on an interface, that interface does not send any BPDUs and drops all BPDUs that it receives. This BPDU Filtering functionality applies to the entire interface, whether trunking or not.

**Caution**

Be careful when you enter the **spanning-tree bpdudfilter enable** command on specified interfaces. Explicitly configuring BPDU Filtering on a port that is not connected to a host can result in bridging loops because the port ignores any BPDU it receives and goes to forwarding.

You can enter this command to override the port configuration on specified interfaces.

This command has three states:

- **spanning-tree bpdudfilter enable**—Unconditionally enables BPDU Filtering on the interface.
- **spanning-tree bpdudfilter disable**—Unconditionally disables BPDU Filtering on the interface.
- **no spanning-tree bpdudfilter**—Enables BPDU Filtering on the interface if the interface is an operational edge port and if you configure the **spanning-tree port type edge bpdudfilter default** command.

**Note**

When you enable BPDU Filtering locally on a port, this feature prevents the device from receiving or sending BPDUs on this port.

Before you begin

Ensure that STP is configured.

Procedure

	Command or Action	Purpose
Step 1	switch# configure terminal	Enters global configuration mode.
Step 2	switch(config)# interface <i>type slot/port</i>	Specifies the interface to configure, and enters the interface configuration mode. Note If this is a QSFP+ GEM or a breakout port, the <i>port</i> syntax is <i>QSFP-module/port</i> .
Step 3	switch(config-if)# spanning-tree bpdudfilter { enable disable }	Enables or disables BPDU Filtering for the specified spanning tree edge interface. By default, BPDU Filtering is disabled.
Step 4	(Optional) switch(config-if)# no spanning-tree bpdudfilter	Disables BPDU Filtering on the interface. Note Enables BPDU Filtering on the interface if the interface is an operational spanning tree edge port and if you enter the spanning-tree port type edge bpdudfilter default command.

Example

This example shows how to explicitly enable BPDU Filtering on the Ethernet spanning tree edge port 1/4:

```
switch# configure terminal
switch (config)# interface ethernet 1/4
switch(config-if)# spanning-tree bpdudfilter enable
```

Enabling Loop Guard Globally

You can enable Loop Guard globally by default on all point-to-point spanning tree normal and network ports. Loop Guard does not run on edge ports.

Loop Guard provides additional security in the bridge network. Loop Guard prevents alternate or root ports from becoming the designated port because of a failure that could lead to a unidirectional link.



Note Entering the Loop Guard command for the specified interface overrides the global Loop Guard command.

Before you begin

Ensure that STP is configured.

Ensure that you have spanning tree normal ports or have configured some network ports.

Procedure

	Command or Action	Purpose
Step 1	switch# configure terminal	Enters global configuration mode.
Step 2	switch(config)# spanning-tree loopguard default	Enables Loop Guard by default on all spanning tree normal and network ports. By default, global Loop Guard is disabled.

Example

This example shows how to enable Loop Guard on all spanning tree normal or network ports:

```
switch# configure terminal
switch(config)# spanning-tree loopguard default
```

Enabling Loop Guard or Root Guard on Specified Interfaces

You can enable either Loop Guard or Root Guard on specified interfaces.

Enabling Root Guard on a port means that port cannot become a root port, and LoopGuard prevents alternate or root ports from becoming the designated port because of a failure that could lead to a unidirectional link.

Both Loop Guard and Root Guard enabled on an interface apply to all VLANs to which that interface belongs.



Note Entering the Loop Guard command for the specified interface overrides the global Loop Guard command.

Before you begin

Ensure that STP is configured.

Ensure that you are configuring Loop Guard on spanning tree normal or network ports.

Procedure

	Command or Action	Purpose
Step 1	switch# configure terminal	Enters global configuration mode.
Step 2	switch(config)# interface type slot/port	Specifies the interface to configure, and enters the interface configuration mode.

	Command or Action	Purpose
		Note If this is a QSFP+ GEM or a breakout port, the <i>port</i> syntax is <i>QSFP-module/port</i> .
Step 3	switch(config-if)# spanning-tree guard {loop root none}	Enables or disables either Loop Guard or Root Guard for the specified interface. By default, Root Guard is disabled by default, and Loop Guard on specified ports is also disabled. Note Loop Guard runs only on spanning tree normal and network interfaces.

Example

This example shows how to enable Root Guard on Ethernet port 1/4:

```
switch# configure terminal
switch (config)# interface ethernet 1/4
switch(config-if)# spanning-tree guard root
```

Configuring FEX Port Spanning Tree BPDU Transmit Interval

You can configure the number of seconds between generation of the config Bridge Protocol Data Units (BPDUs) for FEX ports when they are connected to Cisco Nexus devices.

Before you begin

Enter the **spanning-tree bpdudfilter disable** command if the FEX ports are connected to a Cisco Nexus device.

Procedure

	Command or Action	Purpose
Step 1	switch# configure terminal	Enters global configuration mode.
Step 2	switch(config)# spanning-tree vlan <i>vlan-id</i> fex-hello-time <i>fex-hello-time-value</i>	Configures the number of seconds between generation of config BPDUs for FEX ports. The <i>fex-hello-time-value</i> range is from 2 to 12. Note If the global hello-time is two seconds (default) and the fex-hello-time is two seconds, FEX port BPDU is not sent.

Example

The following examples show how to configure the number of seconds between generation of config BPDUs to 5 for VLAN 10..

```
switch# configure terminal  
switch(config)# spanning-tree vlan 10 fex-hello-time 5
```

Verifying the STP Extension Configuration

Use the following commands to display the configuration information for the STP extensions.

Command	Purpose
show running-config spanning-tree [all]	Displays the current status of spanning tree on the switch.
show spanning-tree [options]	Displays selected detailed information for the current spanning tree configuration.



CHAPTER 7

Configuring Flex Links

This chapter contains the following sections:

- [Information About Flex Links, on page 105](#)
- [Guidelines and Limitations for Flex Link, on page 106](#)
- [Default Settings for Flex Link, on page 107](#)
- [Configuring Flex Links, on page 107](#)
- [Configuring Flex Link Preemption, on page 109](#)
- [Verifying Flex Link Configuration, on page 111](#)
- [Flex Link Configuration Examples, on page 111](#)

Information About Flex Links

Flex links are a pair of a Layer 2 interfaces (switch ports or port channels) where one interface is configured to act as a backup to the other. The feature provides an alternative solution to the Spanning Tree Protocol (STP). You can disable STP and still retain basic link redundancy. Flex links are typically configured in service provider or enterprise networks where customers do not want to run STP on the switch. If the switch is running STP, Flex Links are not necessary because STP already provides link-level redundancy or backup.

You configure Flex Links on one Layer 2 interface (the active link) by assigning another Layer 2 interface as the Flex Links or backup link. The Flex Links interface can be on the same switch. When one of the links is up and forwarding traffic, the other link is in standby mode, ready to begin forwarding traffic if the other link shuts down. At any given time only one of the interfaces is in the linkup state and forwarding traffic. If the primary link shuts down, the standby link starts forwarding traffic. When the active link comes back up, it goes into standby mode and does not forward traffic. Flex Links are not configured by default and there are no backup interfaces defined. STP is disabled on Flex Link interfaces.

In the Flex Links Configuration Example, ports 1 and 2 on switch A are connected to uplink switches B and C. Because they are configured as Flex Links, only one of the interfaces is forwarding traffic; the other is in standby mode. If port 1 is the active link, it begins forwarding traffic between port 1 and switch B; the link between port 2 (the backup link) and switch C is not forwarding traffic. If port 1 goes down, port 2 comes up and starts forwarding traffic to switch C. When port 1 comes back up, it goes into standby mode and does not forward traffic; port 2 continues forwarding traffic.

Flex Links are supported only on Layer 2 ports and port channels, not on VLANs or on Layer 3 ports.

Figure 15: Flex Links Configuration Example

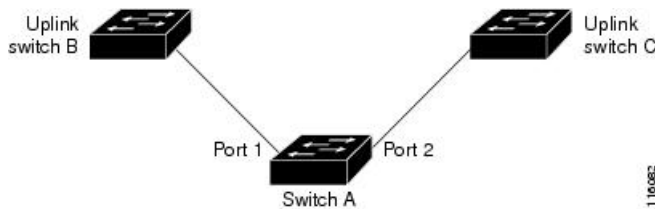

Preemption

You can optionally configure a preemption mechanism to specify the preferred port for forwarding traffic. For example, you can configure a Flex Link pair with preemption mode so that when a port comes back up, if it has greater bandwidth than the peer port, then it will begin forwarding after 35 seconds (default preemption delay) and the peer port will be on standby. This is done by entering the preemption mode bandwidth and delay commands.

If a primary (forwarding) link goes down, a trap notifies the network management stations. If the standby link goes down, a trap notifies the users.

You can configure preemption in the following three modes:

- Forced—The active interface always preempts the backup.
- Bandwidth—The interface with the higher bandwidth always acts as the active interface.
- Off—There is no preemption; the first interface that is up is put in forwarding mode.

You can also configure the preemption delay as a specified amount of time (in seconds) before preempting a working interface for another. This ensures that the counterpart in the upstream switch has transitioned to an STP forwarding state before the switch over.

Multicast Fast-Convergence

When a Flex Link interface is learned as an mrouter port, the standby (non-forwarding) interface is also co-learned as an mrouter port if the link is up. This co-learning is for internal software state maintenance and has no relevance with respect to IGMP operations or hardware forwarding unless multicast fast-convergence is enabled. With multicast fast-convergence configured, the co-learned mrouter port is immediately added to the hardware. Flex Link supports multicast fast convergence for IPv4 IGMP.

Guidelines and Limitations for Flex Link

Consider the following guidelines and limitations when configuring Flex Links:

- You can configure only one Flex Link backup link for any active link and it must be a different interface from the active interface.
- An interface can belong to only one Flex Link pair; it can be a backup link for only one active link.
- Neither of the links can be a port that belongs to an EtherChannel. However, you can configure two port channels (EtherChannel logical interfaces) as Flex Links, and you can configure a port channel and a physical interface as Flex Links, with either the port channel or the physical interface as the active link.

- STP is disabled on Flex Link ports. A Flex Link port does not participate in STP, even if the VLANs present on the port are configured for STP. When STP is not enabled, be sure that there are no loops in the configured topology.
- Do not configure any STP features (for example, PortFast, BPDU Guard, and so forth) on Flex Links ports or the ports to which the links connect.
- vPC is not supported. Flex Link is used in place of vPC where configuration simplicity is desired and there is no need for active-active redundancy.
- MVR configuration on Flex Link ports is not supported.

Flex links cannot be configured on the following interface types:

- FEX fabric ports and FEX host ports
- FCoE (vFC) interfaces
- VNTAG (vETH) interfaces
- Interfaces with port security enabled
- Layer 3 interfaces
- SPAN destinations
- Port channel members
- Interfaces configured with Private VLANs
- Interfaces in end node mode
- Fabric path core interfaces (Layer 2 multipath)

Default Settings for Flex Link

Table 8: Flex Link Default Parameter Settings

Parameter	Definition
Multicast Fast-Convergence	Disabled
Preemption mode	Off
Preemption delay	35 seconds

Configuring Flex Links

You can configure a pair of layer 2 interfaces (switch ports or port channels) as Flex Link interfaces, where one interface is configured to act as a backup to the other.

Procedure

	Command or Action	Purpose
Step 1	switch# configure terminal	Enters global configuration mode.
Step 2	switch(config) # feature flexlink	Enables Flex Link.

	Command or Action	Purpose
Step 3	switch(config) # interface { ethernet <i>slot/port</i> port-channel <i>channel-no</i> }	Specifies the Ethernet or port channel interface and enters interface configuration mode. The port channel range is 1 to 48. Note If this is a QSFP+ GEM or a breakout port, the <i>port</i> syntax is <i>QSFP-module/port</i> .
Step 4	switch(config-if) # switchport backup interface { ethernet <i>slot/port</i> port-channel <i>channel-no</i> } [multicast fast-convergence preemption { delay <i>delay-time</i> mode [bandwidth forced off] }]	Specifies a physical layer 2 interface (Ethernet or port channel) as the backup interface in a Flex Link pair. When one link is forwarding traffic the other interface is in standby mode. <ul style="list-style-type: none"> • ethernet <i>slot/port</i>—Specifies the backup Ethernet interface. The <i>slot</i> number is from 1 to 255 and the <i>port</i> number is from 1 to 128. • port-channel <i>port-channel-no</i>—Specifies the backup port channel interface. The <i>port-channel-no</i> number is from 1 to 4096. • multicast—Specifies the multicast parameters. • fast-convergence—Configures fast convergence on the backup interface. • preemption—Configures a preemption scheme for a backup interface pair. • delay <i>delay-time</i>—Specifies the preemption delay. The <i>delay-time</i> range is from 1 to 300 seconds. The default is 35 seconds. • mode—Specifies the preemption mode. • bandwidth—Specifies that the interface with the higher available bandwidth always preempts the backup. • forced—Specifies the interface that always preempts the backup. • off—Specifies that no preemption occurs from backup to active.
Step 5	(Optional) switch(config-if) # end	Return to privileged EXEC mode.
Step 6	(Optional) switch# show interface <i>interface-id</i> switchport backup	Verifies the configuration.

	Command or Action	Purpose
Step 7	(Optional) switch# copy running-config startup-config	Saves the change persistently through reboots and restarts by copying the running configuration to the startup configuration.

Example

This example shows how to configure an Ethernet switchport backup pair: Ethernet 1/1 is active interface, Ethernet 1/2 is the backup interface:

```
switch(config)# feature flexlink
switch(config)# interface ethernet1/1
switch(config-if)# switchport backup interface ethernet2/1
switch(config-if) # exit
switch(config)# interface po300
Switch(config-if)# switchport backup interface po301
switch# show ip igmp snooping mrouter
Type: S - Static, D - Dynamic, V - vPC Peer Link, I - Internal, C - Co-learned
Vlan Router-port Type Uptime Expires
4 Po300 D 00:00:12 00:04:50
4 Po301 DC 00:00:12 00:04:50
```

Configuring Flex Link Preemption

You can configure a preemption scheme for a pair of Flex Links.

Before you begin

Enable the Flex Link feature.

Procedure

	Command or Action	Purpose
Step 1	switch# configure terminal	Enters global configuration mode.
Step 2	switch(config) # interface ethernet 1/48 slot/port	Specifies the Ethernet interface and enters interface configuration mode. The interface is a physical Layer 2 interface or a port channel (logical interface). The <i>slot/port</i> range is from 1 to 48. Note If this is a QSFP+ GEM or a breakout port, the <i>port</i> syntax is <i>QSFP-module/port</i> .
Step 3	switch(config-if) # switchport backup interface ethernet slot/port	Configures a physical Layer 2 interface (or port channel) as part of a Flex Link pair with the interface. When one link is forwarding traffic, the other interface is in standby mode.

	Command or Action	Purpose
Step 4	switch(config-if) # switchport backup interface ethernet slot/port preempt mode [bandwidth forced off]	<p>Configures a physical Layer 2 interface (Ethernet or port channel) as part of a flex link pair. When one link is forwarding traffic the other interface is in standby mode.</p> <p>Configure a preemption mechanism and delay for a Flex link interface pair. You can configure the preemption as:</p> <ul style="list-style-type: none"> • bandwidth—Interface with higher bandwidth always acts as the active interface • forced—Active interface always preempts the backup • off—No preemption happens from active to backup <p>Note If this is a QSFP+ GEM or a breakout port, the <i>port</i> syntax is <i>QSFP-module/port</i>.</p>
Step 5	switch(config-if) # switchport backup interface ethernet slot/port preempt delay delay-time	<p>Configure the delay time until a port preempts another port. The default preemption delay is 35 seconds.</p> <p>Note Setting a delay time only works with forced and bandwidth modes.</p> <p>Note If this is a QSFP+ GEM or a breakout port, the <i>port</i> syntax is <i>QSFP-module/port</i>.</p>
Step 6	(Optional) switch(config-if) # end	Return to privileged EXEC mode.
Step 7	(Optional) switch# show interface interface-id switchport backup	Verifies the configuration.
Step 8	(Optional) switch# copy running-config startup-config	Saves the change persistently through reboots and restarts by copying the running configuration to the startup configuration.

Example

This example shows how to sets the preemption mode to forced, sets the delay time to 50, and verifies the configuration:

```
Switch# configure terminal
switch(conf) # interface ethernet0/1
switch(conf-if) #switchport backup interface ethernet0/2 preempt mode forced
switch(conf-if) #switchport backup interface ethernet0/2 preempt delay 50
```



```

switch(conf-if)# end

switch# show interface switchport backup detail
Active Interface Backup Interface State
-----
Ethernet0/21 Ethernet0/2 Active Up/Backup Standby
Interface Pair : Gi0/1, Gi0/2
Preemption Mode : forced
Preemption Delay : 50 seconds
Bandwidth : 100000 Kbit (Gi0/1), 100000 Kbit (Gi0/2)
Mac Address Move Update Vlan : auto

```

Verifying Flex Link Configuration

Use the following commands to display flex link configuration information:

Command	Purpose
show interface switchport backup	Displays information about all switch ort Flex Link interfaces.
show interface switchport backup detail	Displays detailed information about all switch ort Flex Link interfaces.
show running-config backup show startup-config backup	Displays the running or startup configuration for backup interfaces.
show running-config flexlink show startup-config flexlink	Displays the running or startup configuration for flex link interfaces.

Flex Link Configuration Examples

This example shows how to configure a port-channel switchport backup pair with forced preemption. The active interface port-channel10 is the preferred forwarding interface:

```

switch(config)# interface port-channel10
switch(config-if)# switchport backup interface port-channel20 preemption mode forced
switch(config-if)# switchport backup interface port-channel20 preemption delay 35

```

This example shows how to configure the port channel switchport backup pair with multicast fast convergence:

```

switch(config)# interface port-channel10
switch(config-if)# switchport backup interface port-channel20 multicast fast-convergence

```

This example shows an example of multicast convergence with a pair of Flex Link interfaces: po300 and po301. A general query received on po300 makes it an mrouter port and po301 as co-learned.

```

switch(config)# interface po300
Switch(config-if)# switchport backup interface po301
switch# show ip igmp snooping mrouter
Type: S - Static, D - Dynamic, V - vPC Peer Link, I - Internal, C - Co-learned
Vlan Router-port Type Uptime Expires
4 Po300 D 00:00:12 00:04:50
4 Po301 DC 00:00:12 00:04:50

```

This example shows po300 and po301 as mrouter ports (po301 is co-learned); it is not added to the hardware table when multicast fast-convergence is disabled.

```
switch# show ip igmp snooping groups vlan 4
Type: S - Static, D - Dynamic, R - Router port

Vlan Group Address      Ver  Type  Port list
4     */*
      224.1.1.1          v2   D     Eth1/31

switch# show platform fwm info hw-stm | grep 0100.5e01.0101
1.4   0100.5e01.0101   midx 36  1:2849:0 0:0:1:0 1.0.0.0.0.24 (e:0)

switch# show platform fwm info oifl 36
oifl 36 vdc 1 oifl 36: vdc 1 gpinif 0, mcast idx 36(alt:0), oifl_type 2
oifl 36 vdc 1 oifl 36: oifl iods 8,44
oifl 36 vdc 1 oifl 36: max_iod 8192, ref count 1000 num_oifs 2, seq_num 33
oifl 36 vdc 1 oifl 36: hw pgmd: 1 msg present: 0
oifl 36 vdc 1 oifl 36: l2_bum_ref_cnt 0, l3_macg_ref_cnt 1000
oifl 36 vdc 1 oifl 36: if_indexs - Po300 Eth1/31
```

This example shows co-learned po301 is added to hardware when multicast fast-convergence is enabled:

```
switch(config)# interface po300
Switch(config-if)# switchport backup interface po301 multicast fast-convergence

switch# show platform fwm info hw-stm | grep 0100.5e01.0101
1.4   0100.5e01.0101   midx 38  1:2849:0 0:0:1:0 1.0.0.0.0.26 (e:0)

switch# show platform fwm info oifl 38
oifl 38 vdc 1 oifl 38: vdc 1 gpinif 0, mcast idx 38(alt:0), oifl_type 2
oifl 38 vdc 1 oifl 38: oifl iods 8-9,44
oifl 38 vdc 1 oifl 38: max_iod 8192, ref count 1000 num_oifs 3, seq_num 35
oifl 38 vdc 1 oifl 38: hw pgmd: 1 msg present: 0
oifl 38 vdc 1 oifl 38: l2_bum_ref_cnt 0, l3_macg_ref_cnt 1000
oifl 38 vdc 1 oifl 38: if_indexs - Po300 Po301 Eth1/31
```

This example shows the running configuration of Flex Link:

```
switch# show running-config flexlink

!Command: show running-config flexlink
!Time: Thu Jan  1 03:21:12 2011

version 5.0(3)N2(1)
feature flexlink

logging level Flexlink 5

interface port-channel500
 switchport backup interface port-channel501 preemption delay 36
 switchport backup interface port-channel501 multicast fast-convergence

interface Ethernet2/2
 switchport backup interface port-channel507 preemption mode forced
```

This example shows details about the Flex Link interface. Forced preemption is about to take place because (scheduled) is displayed.

```
switch# show interface switchport backup detail

Switch Backup Interface Pairs:
```

```
Active Interface      Backup Interface      State
-----
port-channel300      port-channel301      Active Down/Backup Up
Preemption Mode      : forced
Preemption Delay     : 35 seconds (default) (scheduled)
Multicast Fast Convergence : Off
Bandwidth            : 20000000 Kbit (port-channel300), 10000000 Kbit (port-channel301)
```



CHAPTER 8

Configuring LLDP

This chapter contains the following sections:

- [Configuring LLDP, on page 115](#)
- [Configuring Interface LLDP, on page 116](#)

Configuring LLDP

Before you begin

Ensure that the Link Layer Discovery Protocol (LLDP) feature is enabled on the switch.

Procedure

	Command or Action	Purpose
Step 1	switch# configure terminal	Enters global configuration mode.
Step 2	switch(config)# lldp { holdtime <i>seconds</i> reinit <i>seconds</i> timer <i>seconds</i> tlv-select { dcbxp management-address port-description port-vlan system-capabilities system-description system-name }}	<p>Configures LLDP options.</p> <p>Use the holdtime option to set the length of time (10 to 255 seconds) that a device should save LLDP information received before discarding it. The default value is 120 seconds.</p> <p>Use the reinit option to set the length of time (1 to 10 seconds) to wait before performing LLDP initialization on any interface. The default value is 2 seconds.</p> <p>Use the timer option to set the rate (5 to 254 seconds) at which LLDP packets are sent. The default value is 30 seconds.</p> <p>Use the tlv-select option to specify the type length value (TLV). The default is enabled to send and receive all TLVs.</p>

	Command or Action	Purpose
		<p>Use the dcbxp option to specify the Data Center Ethernet Parameter Exchange (DCBXP) TLV messages.</p> <p>Use the management-address option to specify the management address TLV messages.</p> <p>Use the port-description option to specify the port description TLV messages.</p> <p>Use the port-vlan option to specify the port VLAN ID TLV messages.</p> <p>Use the system-capabilities option to specify the system capabilities TLV messages.</p> <p>Use the system-description option to specify the system description TLV messages.</p> <p>Use the system-name option to specify the system name TLV messages.</p>
Step 3	switch(config)# no lldp {holdtime reinit timer}	Resets the LLDP values to their defaults.
Step 4	(Optional)switch# show lldp	Displays LLDP configurations.

Example

This example shows how to configure the global LLDP hold time to 200 seconds:

```
switch# configure terminal
switch(config)# lldp holdtime 200
switch(config)#
```

This example shows how to enable LLDP to send or receive the management address TLVs:

```
switch# configure terminal
switch(config)# lldp tlv-select management-address
switch(config)#
```

Configuring Interface LLDP

Procedure

	Command or Action	Purpose
Step 1	switch# configure terminal	Enters global configuration mode.
Step 2	switch(config)# interface <i>type slot/port</i>	Selects the interface to change.

	Command or Action	Purpose
		Note If this is a QSFP+ GEM or a breakout port, the <i>port</i> syntax is <i>QSFP-module/port</i> .
Step 3	switch(config-if)# [no] lldp {receive transmit}	Sets the selected interface to either receive or transmit. The no form of the command disables the LLDP transmit or receive.
Step 4	(Optional) switch# show lldp {interface neighbors [detail interface system-detail] timers traffic}	Displays LLDP configurations.

Example

This example shows how to set an interface to transmit LLDP packets:

```
switch# configure terminal
switch(config)# interface ethernet 1/2
switch(config-if)# lldp transmit
```

This example shows how to configure an interface to disable LLDP:

```
switch# configure terminal
switch(config)# interface ethernet 1/2
switch(config-if)# no lldp transmit
switch(config-if)# no lldp receive
```

This example shows how to display LLDP interface information:

```
switch# show lldp interface ethernet 1/2
tx_enabled: TRUE
rx_enabled: TRUE
dcbx_enabled: TRUE
Port MAC address: 00:0d:ec:a3:5f:48
Remote Peers Information
No remote peers exist
```

This example shows how to display LLDP neighbor information:

```
switch# show lldp neighbors
LLDP Neighbors
Remote Peers Information on interface Eth1/40
Remote peer's MSAP: length 12 Bytes:
00 c0 dd 0e 5f 3a 00 c0 dd 0e 5f 3a
LLDP TLV's
LLDP TLV type:Chassis ID LLDP TLV Length: 7
LLDP TLV type:Port ID LLDP TLV Length: 7
```

```

LLDP TLV type:Time to Live LLDP TLV Length: 2
LLDP TLV type:LLDP Organizationally Specific LLDP TLV Length: 55
LLDP TLV type:LLDP Organizationally Specific LLDP TLV Length: 5
LLDP TLV type:END of LLDPDU LLDP TLV Length: 0
Remote Peers Information on interface Eth1/34
Remote peer's MSAP: length 12 Bytes:
00 0d ec a3 27 40 00 0d ec a3 27 69
LLDP TLV's
LLDP TLV type:Chassis ID LLDP TLV Length: 7
LLDP TLV type:Port ID LLDP TLV Length: 7
LLDP TLV type:Time to Live LLDP TLV Length: 2
LLDP TLV type:LLDP Organizationally Specific LLDP TLV Length: 55
LLDP TLV type:LLDP Organizationally Specific LLDP TLV Length: 5
LLDP TLV type:END of LLDPDU LLDP TLV Length: 0
Remote Peers Information on interface Eth1/33
Remote peer's MSAP: length 12 Bytes:
00 0d ec a3 27 40 00 0d ec a3 27 68
LLDP TLV's
LLDP TLV type:Chassis ID LLDP TLV Length: 7
LLDP TLV type:Port ID LLDP TLV Length: 7
LLDP TLV type:Time to Live LLDP TLV Length: 2
LLDP TLV type:LLDP Organizationally Specific LLDP TLV Length: 55
LLDP TLV type:LLDP Organizationally Specific LLDP TLV Length: 5
LLDP TLV type:END of LLDPDU LLDP TLV Length: 0

```

This example shows how to display the system details about LLDP neighbors:

```

switch# sh lldp neighbors system-detail
Capability codes:
  (R) Router, (B) Bridge, (T) Telephone, (C) DOCSIS Cable Device
  (W) WLAN Access Point, (P) Repeater, (S) Station, (O) Other
Device ID Local Intf Chassis ID PortID Hold-time Capability

switch-2 Eth1/7 0005.73b7.37ce Eth1/7 120 B
switch-3 Eth/9 0005.73b7.37d0 Eth1/9 120 B
switch-4 Eth1/10 0005.73b7.37d1 Eth1/10 120 B
Total entries displayed: 3

```

This example shows how to display LLDP timer information:

```

switch# show lldp timers

LLDP Timers

holdtime 120 seconds

reinit 2 seconds

msg_tx_interval 30 seconds

```

This example shows how to display information about LLDP counters:

```

switch# show lldp traffic

LLDP traffic statistics:

Total frames out: 8464
Total Entries aged: 6
Total frames in: 6342
Total frames received in error: 2
Total frames discarded: 2
Total TLVs unrecognized: 0

```



CHAPTER 9

Configuring MAC Address Tables

This chapter contains the following sections:

- [Information About MAC Addresses, on page 121](#)
- [Configuring MAC Addresses, on page 121](#)
- [Verifying the MAC Address Configuration, on page 124](#)

Information About MAC Addresses

To switch frames between LAN ports, the switch maintains an address table. When the switch receives a frame, it associates the media access control (MAC) address of the sending network device with the LAN port on which it was received.

The switch dynamically builds the address table by using the MAC source address of the frames received. When the switch receives a frame for a MAC destination address not listed in its address table, it floods the frame to all LAN ports of the same VLAN except the port that received the frame. When the destination station replies, the switch adds its relevant MAC source address and port ID to the address table. The switch then forwards subsequent frames to a single LAN port without flooding all LAN ports.

You can also enter a MAC address, which is termed a static MAC address, into the table. These static MAC entries are retained across a reboot of the switch.

Configuring MAC Addresses

Configuring Static MAC Addresses

You can configure static MAC addresses for the switch. These addresses can be configured in interface configuration mode or in VLAN configuration mode.

Procedure

	Command or Action	Purpose
Step 1	switch# configure terminal	Enters global configuration mode.

	Command or Action	Purpose
Step 2	switch(config) # mac address-table static <i>mac_address</i> vlan <i>vlan-id</i> { drop interface { <i>type slot/port</i> } port-channel <i>number</i> } [auto-learn]	Specifies a static address to add to the MAC address table. If you enable the auto-learn option, the switch will update the entry if the same MAC address is seen on a different port. Note If this is a QSFP+ GEM or a breakout port, the <i>port</i> syntax is <i>QSFP-module/port</i> .
Step 3	(Optional) switch(config)# no mac address-table static <i>mac_address</i> vlan <i>vlan-id</i>	Deletes the static entry from the MAC address table. Use the mac address-table static command to assign a static MAC address to a virtual interface.

Example

This example shows how to put a static entry in the MAC address table:

```
switch# configure terminal
switch(config) # mac address-table static 12ab.47dd.ff89 vlan 3 interface ethernet 1/4
switch(config) #
```

Configuring the Aging Time for the MAC Table

You can configure the amount of time that an entry (the packet source MAC address and port that packet ingresses) remains in the MAC table. MAC aging time can be configured in either interface configuration mode or in VLAN configuration mode.

Procedure

	Command or Action	Purpose
Step 1	switch# configure terminal	Enters global configuration mode.
Step 2	switch(config)# mac address-table aging-time <i>seconds</i> [vlan <i>vlan_id</i>]	Specifies the time before an entry ages out and is discarded from the MAC address table. The <i>seconds</i> range is from 0 to 1000000. The default is 300 seconds for Cisco NX-OS 5500 and 1800 for Cisco NX-OS 5600 and 6000 series. Entering the value 0 disables the MAC aging. If a VLAN is not specified, the aging specification applies to all VLANs.

Example

This example shows how to set the aging time for entries in the MAC address table to 300 seconds:

```
switch# configure terminal
switch(config) # mac address-table aging-time 300
switch(config) #
```

Configuring MAC Move Loop Detection

When the number of MAC address moves between two ports exceeds a threshold, it forms a loop. From Cisco NX-OS release 6.0(2)N2(1), you can configure the action of bringing down the port with the lower interface index when such a loop is detected by using the **mac address-table loop-detect port-down** command. To revert to the default action of disabling MAC learning, use the **no** form of this command.



Note If only the loop-detect port-down configuration is enabled, the last port on which MAC loop is detected is err-disabled.

Procedure

	Command or Action	Purpose
Step 1	switch# configure terminal	Enters global configuration mode.
Step 2	switch(config)# [no] mac address-table loop-detect port-down	Specifies the port-down action for MAC move loop detection. The no form of this command reverts to the default action of disabling MAC learning for 180 seconds.
Step 3	switch(config)# mac address-table loop-detect port-down edge-port	Enables the err-disabled detection for the edge-port on the MAC move loop detection.

Example

This example shows how to configure port-down as the action for MAC move loop detection.

```
switch# configure terminal
switch(config) # mac address-table loop-detect port-down
```

This example shows how to enable the err-disabled detection for the edge-port on the MAC move loop detection.

```
switch# configure terminal
switch(config) # mac address-table loop-detect port-down edge-port
```

Clearing Dynamic Addresses from the MAC Table

Procedure

	Command or Action	Purpose
Step 1	switch# configure terminal	Enters global configuration mode.
Step 2	switch(config)# clear mac address-table dynamic {address <i>mac-addr</i> } {interface [<i>type slot/port</i> <i>port-channel number</i>]} {vlan <i>vlan-id</i> }	Clears the dynamic address entries from the MAC address table. Note If this is a QSFP+ GEM or a breakout port, the <i>port</i> syntax is <i>QSFP-module/port</i> .

Verifying the MAC Address Configuration

Use one of the following commands to verify the configuration:

Table 9: MAC Address Configuration Verification Commands

Command	Purpose
show mac address-table aging-time	Displays the MAC address aging time for all VLANs defined in the switch.
show mac address-table	Displays the contents of the MAC address table. Note IGMP snooping learned MAC addresses are not displayed.
show mac address-table loop-detect	Displays the currently configured action.

This example shows how to display the MAC address table:

```
switch# show mac address-table
VLAN      MAC Address      Type      Age      Port
-----+-----+-----+-----+-----
1         0018.b967.3cd0   dynamic   10       Eth1/3
1         001c.b05a.5380   dynamic   200      Eth1/3
Total MAC Addresses: 2
```

This example shows how to display the current aging time:

```
switch# show mac address-table aging-time
Vlan      Aging Time
-----+-----
1         300
13        300
42        300
```

This example shows how to display the currently configured action:

```
switch# configure terminal
switch(config)# show mac address-table loop-detect
Port Down Action Mac Loop Detect : enabled
```

```
switch# configure terminal
switch(config)# no mac address-table loop-detect port-down
switch(config)# show mac address-table loop-detect
Port Down Action Mac Loop Detect : disabled
```



CHAPTER 10

Configuring IGMP Snooping

This chapter contains the following sections:

- [Information About IGMP Snooping, on page 127](#)
- [Guidelines and Limitations for IGMP Snooping, on page 129](#)
- [Configuring IGMP Snooping Parameters, on page 130](#)
- [Verifying the IGMP Snooping Configuration, on page 133](#)

Information About IGMP Snooping

The IGMP snooping software examines IGMP protocol messages within a VLAN to discover which interfaces are connected to hosts or other devices interested in receiving this traffic. Using the interface information, IGMP snooping can reduce bandwidth consumption in a multiaccess LAN environment to avoid flooding the entire VLAN. The IGMP snooping feature tracks which ports are attached to multicast-capable routers to help it manage the forwarding of IGMP membership reports. The IGMP snooping software responds to topology change notifications.



Note IGMP snooping is supported on all Ethernet interfaces. The term *snooping* is used because Layer 3 control plane packets are intercepted and influence Layer 2 forwarding decisions.



Note On Cisco Nexus 5548 switch, multicast traffic to groups in the range [225-239].0.0.x should not be used as there will be no S, G, or multicast MAC addresses learned for these groups. For example, use group 225.0.1.10 instead of group 225.0.0.10.

Cisco NX-OS supports IGMPv2 and IGMPv3. IGMPv2 supports IGMPv1, and IGMPv3 supports IGMPv2. Although not all features of an earlier version of IGMP are supported, the features related to membership query and membership report messages are supported for all IGMP versions.

The following figure shows an IGMP snooping switch that is located between the host and the IGMP router. The IGMP snooping switch snoops the IGMP membership reports and leave messages and forwards them only when necessary to the connected IGMP routers.

Figure 16: IGMP Snooping Switch

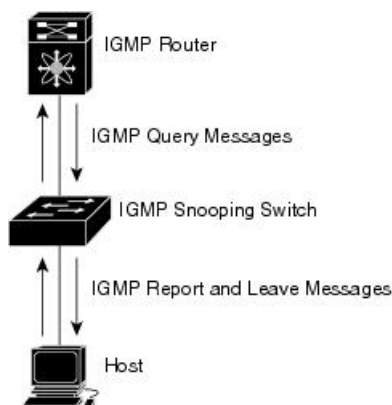

Note The switch supports IGMPv3 snooping based only on the destination multicast MAC address. It does not support snooping based on the source MAC address or on proxy reports.

The Cisco NX-OS IGMP snooping software supports optimized multicast flooding (OMF) that forwards unknown traffic to routers only and performs no data driven state creation. For more information about IGMP snooping, see <http://tools.ietf.org/wg/magma/draft-ietf-magma-snoop/rfc4541.txt>.

IGMPv1 and IGMPv2

Both IGMPv1 and IGMPv2 support membership report suppression, which means that if two hosts on the same subnet want to receive multicast data for the same group, the host that receives a member report from the other host suppresses sending its report. Membership report suppression occurs for hosts that share a port.

If no more than one host is attached to each VLAN switch port, you can configure the fast leave feature in IGMPv2. The fast leave feature does not send last member query messages to hosts. As soon as the software receives an IGMP leave message, the software stops forwarding multicast data to that port.

IGMPv1 does not provide an explicit IGMP leave message, so the software must rely on the membership message timeout to indicate that no hosts remain that want to receive multicast data for a particular group.



Note Cisco NX-OS ignores the configuration of the last member query interval when you enable the fast leave feature because it does not check for remaining hosts.

IGMPv3

The IGMPv3 snooping implementation on the switch forwards IGMPv3 reports to allow the upstream multicast router to do source-based filtering.

By default, the software tracks hosts on each VLAN port. The explicit tracking feature provides a fast leave mechanism. Because every IGMPv3 host sends membership reports, a report suppression feature limits the amount of traffic the switch sends to other multicast-capable routers. When report suppression is enabled, and no IGMPv1 or IGMPv2 hosts request the same group, the software provides proxy reporting. The proxy

feature builds the group state from membership reports from the downstream hosts and generates membership reports in response to queries from upstream queriers.

Even though the IGMPv3 membership reports provide a full accounting of group members on a LAN segment, when the last host leaves, the software sends a membership query. You can configure the parameter last member query interval. If no host responds before the timeout, the software removes the group state.

IGMP Snooping Querier

When there is no multicast router in the VLAN to originate the queries, you must configure an IGMP snooping querier to send membership queries.

When an IGMP snooping querier is enabled, it sends out periodic IGMP queries that trigger IGMP report messages from hosts that want to receive IP multicast traffic. IGMP snooping listens to these IGMP reports to establish appropriate forwarding.

Currently, you can configure the same SVI IP address for the switch querier and the IGMP snooping querier. Both queriers will then be active at the same time, and both queriers will send general queries to the VLAN periodically. To prevent this from happening, ensure that you use different IP addresses for the IGMP snooping querier and the switch querier.

IGMP Forwarding

The control plane of the Cisco Nexus device is able to detect IP addresses but forwarding occurs using the MAC address only.

When a host connected to the switch wants to join an IP multicast group, it sends an unsolicited IGMP join message, specifying the IP multicast group to join. Alternatively, when the switch receives a general query from a connected router, it forwards the query to all interfaces, physical and virtual, in the VLAN. Hosts wanting to join the multicast group respond by sending a join message to the switch. The switch CPU creates a multicast forwarding table entry for the group if it is not already present. The CPU also adds the interface where the join message was received to the forwarding table entry. The host associated with that interface receives multicast traffic for that multicast group.

The router sends periodic multicast general queries and the switch forwards these queries through all ports in the VLAN. Interested hosts respond to the queries. If at least one host in the VLAN wants to receive multicast traffic, the router continues forwarding the multicast traffic to the VLAN. The switch forwards multicast group traffic to only those hosts listed in the forwarding table for that multicast group.

When hosts want to leave a multicast group, they can either silently leave, or they can send a leave message. When the switch receives a leave message from a host, it sends a group-specific query to determine if any other devices connected to that interface are interested in traffic for the specific multicast group. The switch then updates the forwarding table for that MAC group so that only those hosts interested in receiving multicast traffic for the group are listed in the forwarding table. If the router receives no reports from a VLAN, it removes the group for the VLAN from its IGMP cache.

Guidelines and Limitations for IGMP Snooping

Consider the following configuration limitations with other features when configuring IGMP Snooping:

- IGMP snooping runs only on the primary VLAN and uses the configuration of the primary VLAN for all secondary VLANs.

Any IGMP snooping join request in the secondary VLAN is treated as if it is received in the primary VLAN.

Configuring IGMP Snooping Parameters

To manage the operation of the IGMP snooping process, you can configure the optional IGMP snooping parameters described in the following table.

Table 10: IGMP Snooping Parameters

Parameter	Description
IGMP snooping	Enables IGMP snooping on a per-VLAN basis. The default is enabled. Note If the global setting is disabled, all VLANs are treated as disabled, whether they are enabled or not.
Explicit tracking	Tracks IGMPv2 and IPMPv3 membership reports from individual hosts for each port on a per-VLAN basis. The default is enabled.
Fast leave	Enables the software to remove the group state when it receives an IGMP Leave report without sending an IGMP query message. This parameter is used for IGMPv2 hosts when no more than one host is present on each VLAN port. The default is disabled.
Last member query interval	Sets the interval that the software waits after sending an IGMP query to verify that no hosts that want to receive a particular multicast group remain on a network segment. If no hosts respond before the last member query interval expires, the software removes the group from the associated VLAN port. Values range from 1 to 25 seconds. The default is 1 second.
Snooping querier	Configures a snooping querier on an interface when there is no multicast router in the VLAN to generate queries. The default is disabled.
Report suppression	Limits the membership report traffic sent to multicast-capable routers. When you disable report suppression, all IGMP reports are sent as is to multicast-capable routers. The default is enabled.
Multicast router	Configures a static connection to a multicast router. The interface to the router must be in the selected VLAN.
Multicast router vpc-peer-link	Configures a static connection to a virtual port channel (vPC) peer link. By default, the vPC peer link is considered a multicast router port and the multicast packet is sent to the peer link for each receiver VLAN. To send the multicast traffic over a vPC peer link to each receiver VLAN that has orphan ports, use the no ip igmp snooping mrouter vpc-peer-link command. If you use the no ip igmp snooping mrouter vpc-peer-link command, the multicast traffic is not sent over to a peer link for the source VLAN and receiver VLAN unless there is an orphan port in the VLAN. The IGMP snooping mrouter VPC peer link should also be globally disabled on the peer VPC switch.

Parameter	Description
Static group	Configures an interface that belongs to a VLAN as a static member of a multicast group.

You can disable IGMP snooping either globally or for a specific VLAN.

Procedure

	Command or Action	Purpose
Step 1	switch# configure terminal	Enters global configuration mode.
Step 2	switch(config)# ip igmp snooping	Globally enables IGMP snooping. The default is enabled. Note If the global setting is disabled, all VLANs are treated as disabled, whether they are enabled or not.
Step 3	switch(config)# vlan configuration <i>vlan-id</i>	Enters VLAN configuration mode.
Step 4	switch(config-vlan)# ip igmp snooping	Enables IGMP snooping for the current VLAN. The default is enabled. Note If IGMP snooping is enabled globally, this command is not required.
Step 5	switch(config-vlan)# ip igmp snooping explicit-tracking	Tracks IGMPv2 and IGMPv3 membership reports from individual hosts for each port on a per-VLAN basis. The default is enabled on all VLANs.
Step 6	switch(config-vlan)# ip igmp snooping fast-leave	Supports IGMPv2 hosts that cannot be explicitly tracked because of the host report suppression mechanism of the IGMPv2 protocol. When you enable fast leave, the IGMP software assumes that no more than one host is present on each VLAN port. The default is disabled for all VLANs.
Step 7	switch(config-vlan)# ip igmp snooping last-member-query-interval <i>seconds</i>	Removes the group from the associated VLAN port if no hosts respond to an IGMP query message before the last member query interval expires. Values range from 1 to 25 seconds. The default is 1 second.
Step 8	switch(config-vlan)# ip igmp snooping querier <i>IP-address</i>	Configures a snooping querier when you do not enable PIM because multicast traffic does not need to be routed. The IP address is used as the source in messages. The default is disabled.

	Command or Action	Purpose
Step 9	switch(config-vlan)# ip igmp snooping report-suppression	Limits the membership report traffic sent to multicast-capable routers. When you disable report suppression, all IGMP reports are sent as is to multicast-capable routers. The default is enabled.
Step 10	switch(config-vlan)# ip igmp snooping mrouter interface <i>interface</i>	Configures a static connection to a multicast router. The interface to the router must be in the selected VLAN. You can specify the interface by type and number.
Step 11	switch(config-vlan)# ip igmp snooping mrouter vpc-peer-link	Configures a static connection to a virtual port channel (vPC) peer link. By default, the vPC peer link is considered as a multicast router port and the multicast packet is sent to the peer link for each receiver VLAN. To send the multicast traffic over a vPC peer link to each receiver VLAN that has orphan ports, use the no ip igmp snooping mrouter vpc-peer-link command. The IGMP snooping mrouter VPC peer link should also be globally disabled on the peer VPC switch.
Step 12	switch(config-vlan)# ip igmp snooping static-group <i>group-ip-addr</i> [<i>source source-ip-addr</i>] interface <i>interface</i>	Configures an interface belonging to a VLAN as a static member of a multicast group. You can specify the interface by type and number.

Example

This example shows how to configure IGMP snooping parameters for a VLAN:

```
switch# configure terminal
switch(config)# vlan configuration 5
switch(config-vlan)# ip igmp snooping last-member-query-interval 3
switch(config-vlan)# ip igmp snooping querier 172.20.52.106
switch(config-vlan)# ip igmp snooping explicit-tracking
switch(config-vlan)# ip igmp snooping fast-leave
switch(config-vlan)# ip igmp snooping report-suppression
switch(config-vlan)# ip igmp snooping mrouter interface ethernet 1/10
switch(config-vlan)# ip igmp snooping mrouter vpc-peer-link
switch(config-vlan)# ip igmp snooping static-group 230.0.0.1 interface ethernet 1/10
switch(config-vlan)# end
```

This example shows how to configure a static connection to a vPC peer link and how to remove the static connection to a vPC peer link:

```
switch(config)# ip igmp snooping mrouter vpc-peer-link
switch(config)# no ip igmp snooping mrouter vpc-peer-link
Warning: IGMP Snooping mrouter vpc-peer-link should be globally disabled on peer VPC switch
as well.
switch(config)#
```

Verifying the IGMP Snooping Configuration

Use the following commands to verify the IGMP snooping configuration.

Command	Description
<code>show ip igmp snooping [[vlan] vlan-id]</code>	Displays IGMP snooping configuration by VLAN.
<code>show ip igmp snooping groups [[vlan] vlan-id] [detail]</code>	Displays IGMP snooping information about groups by VLAN.
<code>show ip igmp snooping querier [[vlan] vlan-id]</code>	Displays IGMP snooping queriers by VLAN.
<code>show ip igmp snooping mrouter [[vlan] vlan-id]</code>	Displays multicast router ports by VLAN.
<code>show ip igmp snooping explicit-tracking vlan vlan-id</code>	Displays IGMP snooping explicit tracking information by VLAN.



Note **VPC behavior for v2 EHT:** In a VPC scenario, the explicit host tracking is not synced to the VPC peer. However in a VPC peer, the EHT is also learned by cfs sync and is displayed by using the detail option.

This example shows how to verify the IGMP snooping parameters:

```
switch# show ip igmp snooping
Global IGMP Snooping Information:
  IGMP Snooping enabled
IGMP Snooping information for vlan 1
  IGMP snooping enabled
  IGMP querier none
  Switch-querier disabled
  Explicit tracking enabled
  Fast leave disabled
  Report suppression enabled
  Router port detection using PIM Hellos, IGMP Queries
  Number of router-ports: 0
  Number of groups: 0
IGMP Snooping information for vlan 5
IGMP snooping enabled
  IGMP querier present, address: 192.0.2.1, version: 3
  Querier interval: 125 secs
  Querier last member query interval: 10 secs
  Querier robustness: 2
  Switch-querier enabled, address 192.0.2.1, currently running
  Explicit tracking enabled
  Fast leave enabled
  Report suppression enabled
  Router port detection using PIM Hellos, IGMP Queries
  Number of router-ports: 1
  Number of groups: 1
```

This example shows how to display the IGMP snooping configuration for explicit tracking on an IGMPv2 host:

```
switch# show ip igmp snooping explicit tracking
IGMP Snooping Explicit-tracking information
Vlan Source/Group
```

	Intf	Reporter	Uptime	Last-Join	Expires	Ver	Reports
100	*/225.1.1.69 Eth1/43	10.1.1.2	00:00:02	00:00:02	00:04:17	v2	1
100	*/225.1.1.70 Eth1/43	10.1.1.2	00:00:02	00:00:02	00:04:17	v2	1
100	*/225.1.1.71 Eth1/43	10.1.1.2	00:00:02	00:00:02	00:04:17	v2	1
100	*/225.1.1.72 Eth1/43	10.1.1.2	00:00:02	00:00:02	00:04:17	v2	1
100	*/225.1.1.73 Eth1/43	10.1.1.2	00:00:02	00:00:02	00:04:17	v2	1
100	*/225.1.1.74 Eth1/43	10.1.1.2	00:00:02	00:00:02	00:04:17	v2	1
100	*/225.1.1.75 Eth1/43	10.1.1.2	00:00:02	00:00:02	00:04:17	v2	1
100	*/225.1.1.76 Eth1/43	10.1.1.2	00:00:02	00:00:02	00:04:17	v2	1
100	*/225.1.1.77 Eth1/43	10.1.1.2	00:00:02	00:00:02	00:04:17	v2	1
100	*/225.1.1.78 Eth1/43	10.1.1.2	00:00:02	00:00:02	00:04:17	v2	1

switch#:



CHAPTER 11

Configuring MVR

This chapter contains the following sections:

- [Information About MVR, on page 135](#)
- [Licensing Requirements for MVR, on page 136](#)
- [Guidelines and Limitations for MVR, on page 136](#)
- [Default MVR Settings, on page 137](#)
- [Configuring MVR, on page 137](#)
- [Verifying the MVR Configuration, on page 140](#)

Information About MVR

MVR Overview

In a typical Layer 2 multi-VLAN network, subscribers to a multicast group can be on multiple VLANs. To maintain data isolation between these VLANs, the multicast stream on the source VLAN must be passed to a router, which replicates the stream on all subscriber VLANs, wasting upstream bandwidth.

Multicast VLAN Registration (MVR) allows a Layer 2 switch to forward the multicast data from a source on a common assigned VLAN to the subscriber VLANs, conserving upstream bandwidth by bypassing the router. The switch forwards multicast data for MVR IP multicast streams only to MVR ports on which hosts have joined, either by IGMP reports or by MVR static configuration. The switch forwards IGMP reports received from MVR hosts only to the source port. For other traffic, VLAN isolation is preserved.

MVR requires at least one VLAN to be designated as the common VLAN to carry the multicast stream from the source. More than one such multicast VLAN (MVR VLAN) can be configured in the system, and you can configure a global default MVR VLAN as well as interface-specific default MVR VLANs. Each multicast group using MVR is assigned to an MVR VLAN.

MVR allows a subscriber on a port to subscribe and unsubscribe to a multicast stream on the MVR VLAN by sending IGMP join and leave messages. IGMP leave messages from an MVR group are handled according to the IGMP configuration of the VLAN on which the leave message is received. If IGMP fast leave is enabled on the VLAN, the port is removed immediately; otherwise, an IGMP query is sent to the group to determine whether other hosts are present on the port.

MVR Interoperation with Other Features

MVR and IGMP Snooping

Although MVR operates on the underlying mechanism of IGMP snooping, the two features operate independently of each other. One feature can be enabled or disabled without affecting the operation of the other feature. If IGMP snooping is disabled globally or on a VLAN, and if MVR is enabled on the VLAN, IGMP snooping is internally enabled on the VLAN. Joins received for MVR groups on non-MVR receiver ports, or joins received for non-MVR groups on MVR receiver ports, are processed by IGMP snooping.

MVR and vPC

- As with IGMP snooping, IGMP control messages received by virtual port channel (vPC) peer switches are exchanged between the peers, allowing synchronization of MVR group information.
- MVR configuration must be consistent between the peers.
- The **no ip igmp snooping mrouter vpc-peer-link** command applies to MVR. With this command, multicast traffic is not sent over to a peer link for the source VLAN and receiver VLAN unless there is an orphan port in the VLAN.
- The **show mvr member** command shows the multicast group on the vPC peer switch. However, the vPC peer switch does not show the multicast groups if it does not receive the IGMP membership report of the groups.

Licensing Requirements for MVR

The following table shows the licensing requirements for this feature:

Product	License Requirement
Cisco NX-OS	This feature does not require a license. Any feature not included in a license package is bundled with the Cisco NX-OS system images and is provided at no extra charge to you. For a complete explanation of the Cisco NX-OS licensing scheme, see the <i>Cisco NX-OS Licensing Guide</i> .

Guidelines and Limitations for MVR

When configuring MVR, follow these guidelines:

- MVR is supported only on Layer 2 Ethernet ports, such as individual ports, port channels, and virtual Ethernet (vEth) ports.
- MVR receiver ports can only be access ports; they cannot be trunk ports. MVR source ports can be either access or trunk ports.
- MVR configuration on Flex Link ports is not supported.
- Priority tagging is not supported on MVR receiver ports.
- When using private VLANs (PVLANS), you cannot configure a secondary VLAN as the MVR VLAN.

- The total number of MVR VLANs cannot exceed 250.



Note During and in-service software upgrade (ISSU), MVR IGMP membership for the MVR receiver ports may timeout because the joins are not forwarded to the upstream router. In order to avoid a timeout, the querier timer on the upstream router or the network querier should be increased to accommodate an ISSU.

Default MVR Settings

Parameter	Default
MVR	Disabled globally and per interface
Global MVR VLAN	None configured
Interface (per port) default	Neither a receiver nor a source port

Configuring MVR

Configuring MVR Global Parameters

Procedure

	Command or Action	Purpose
Step 1	switch# configure terminal	Enters global configuration mode.
Step 2	switch(config)# [no] mvr	Globally enables MVR. The default is disabled. Use the no form of the command to disable MVR.
Step 3	switch(config)# [no] mvr-vlan <i>vlan-id</i>	Specifies the global default MVR VLAN. The MVR VLAN is the source of the multicast message that subsequent receivers subscribe to. The range is 1 to 4094. Use the no form of the command to clear the MVR VLAN.
Step 4	switch(config)# [no] mvr-group <i>addr[/mask]</i> [count <i>groups</i>] [vlan <i>vlan-id</i>]	Adds a multicast group at the specified IPv4 address and (optional) netmask length to the global default MVR VLAN. You can repeat this command to add additional groups to the MVR VLAN.

	Command or Action	Purpose
		<p>The IP address is entered in the format <i>a.b.c.d/m</i>, where <i>m</i> is the number of bits in the netmask, from 1 to 31.</p> <p>(Optional) You can specify a number of MVR groups using contiguous multicast IP addresses starting with the specified IP address. Use the count keyword followed by a number from 1 to 64.</p> <p>(Optional) You can explicitly specify an MVR VLAN for the group by using the vlan keyword; otherwise, the group is assigned to the default MVR VLAN.</p> <p>Use the no form of the command to clear the group configuration.</p>
Step 5	(Optional) switch(config)# end	Returns to privileged EXEC mode.
Step 6	(Optional) switch# clear mvr counters [source-ports receiver-ports]	Clears MVR IGMP packet counters.
Step 7	(Optional) switch# show mvr	Displays the global MVR configuration.
Step 8	(Optional) switch# copy running-config startup-config	Saves the change persistently through reboots and restarts by copying the running configuration to the startup configuration.

Example

This example shows how to globally enable MVR and configure the global parameters:

```

switch# configure terminal
switch(config)# mvr
switch(config-mvr)# mvr-vlan 100
switch(config-mvr)# mvr-group 230.1.1.1 count 4
switch(config-mvr)# mvr-group 228.1.2.240/28 vlan 101
switch(config-mvr)# mvr-group 235.1.1.6 vlan 340
switch(config-mvr)# end
switch# show mvr
MVR Status           : enabled
Global MVR VLAN      : 100
Number of MVR VLANs  : 3
switch# copy running-config startup-config

```

Configuring MVR Interfaces

Procedure

	Command or Action	Purpose
Step 1	switch# configure terminal	Enters global configuration mode.
Step 2	mvr	Globally enables MVR. The default is disabled. Note If MVR is enabled globally, then this command is not required.
Step 3	interface { ethernet <i>type slot/port</i> port-channel <i>channel-number</i> vethernet <i>number</i> }	Specifies the Layer 2 port to configure, and enters interface configuration mode. Note If this is a QSFP+ GEM or a breakout port, the <i>port</i> syntax is <i>QSFP-module/port</i> .
Step 4	[no] mvr-type { source receiver }	Configures an MVR port as one of these types of ports: <ul style="list-style-type: none"> • source—An uplink port that sends and receives multicast data is configured as an MVR source. The port automatically becomes a static receiver of MVR multicast groups. A source port should be a member of the MVR VLAN. • receiver— An access port that is connected to a host that wants to subscribe to an MVR multicast group is configured as an MVR receiver. A receiver port receives data only when it becomes a member of the multicast group by using IGMP leave and join messages. <p>If you attempt to configure a non-MVR port with MVR characteristics, the configuration is cached and does not take effect until the port becomes an MVR port. The default port mode is non-MVR.</p>
Step 5	(Optional) [no] mvr-vlan <i>vlan-id</i>	Specifies an interface default MVR VLAN that overrides the global default MVR VLAN for joins received on the interface. The MVR VLAN is the source of the multicast message that subsequent receivers subscribe to. The range is 1 to 4094.

	Command or Action	Purpose
Step 6	(Optional) [no] mvr-group <i>addr[/mask]</i> [vlan <i>vlan-id</i>]	<p>Adds a multicast group at the specified IPv4 address and (optional) netmask length to the interface MVR VLAN, overriding the global MVR group configuration. You can repeat this command to add additional groups to the MVR VLAN</p> <p>The IP address is entered in the format <i>a.b.c.d/m</i>, where <i>m</i> is the number of bits in the netmask, from 1 to 31.</p> <p>(Optional) You can explicitly specify an MVR VLAN for the group by using the vlan keyword; otherwise, the group is assigned to the interface default (if specified) or global default MVR VLAN.</p> <p>Use the no form of the command to clear the IPv4 address and netmask.</p>
Step 7	(Optional) end	Return to privileged EXEC mode.
Step 8	(Optional) switch# copy running-config startup-config	Saves the change persistently through reboots and restarts by copying the running configuration to the startup configuration.

Example

This example shows how to configure an Ethernet port as an MVR receiver port:

```
switch# configure terminal
switch(config)# mvr
switch(config-mvr)# interface ethernet 1/10
switch(config-if)# mvr-group 225.1.3.1 vlan 100
switch(config-if)# mvr-type receiver
switch(config-if)# end
switch# copy running-config startup-config
switch#
```

Verifying the MVR Configuration

Use the following commands to verify the MVR configuration:

Command	Description
show mvr	Displays the MVR subsystem configuration and status.
show mvr groups	Displays the MVR group configuration.

Command	Description
show ip igmp snooping [vlan <i>vlan-id</i>]	Displays information about IGMP snooping on the specified VLAN.
show mvr interface { ethernet <i>type slot/port</i> port-channel <i>number</i> }	Displays the MVR configuration on the specified interface. Note If this is a QSFP+ GEM or a breakout port, the <i>port</i> syntax is <i>QSFP-module/port</i> .
show mvr members [count]	Displays the number and details of all MVR receiver members.
show mvr members interface { ethernet <i>type slot/port</i> port-channel <i>number</i> }	Displays details of MVR members on the specified interface. Note If this is a QSFP+ GEM or a breakout port, the <i>port</i> syntax is <i>QSFP-module/port</i> .
show mvr members vlan <i>vlan-id</i>	Displays details of MVR members on the specified VLAN.
show mvr receiver-ports [ethernet <i>type slot/port</i> port-channel <i>number</i>]	Displays all MVR receiver ports on all interfaces or on the specified interface. Note If this is a QSFP+ GEM or a breakout port, the <i>port</i> syntax is <i>QSFP-module/port</i> .
show mvr source-ports [ethernet <i>type slot/port</i> port-channel <i>number</i>]	Displays all MVR source ports on all interfaces or on the specified interface. Note If this is a QSFP+ GEM or a breakout port, the <i>port</i> syntax is <i>QSFP-module/port</i> .

This example shows how to verify the MVR parameters:

```
switch# show mvr
MVR Status           : enabled
Global MVR VLAN      : 100
Number of MVR VLANs : 4
```

This example shows how to verify the MVR group configuration:

```
switch# show mvr groups
* - Global default MVR VLAN.

Group start   Group end       Count  MVR-VLAN  Interface
              Mask
-----
228.1.2.240   228.1.2.255     /28    101
230.1.1.1     230.1.1.4       4      *100
235.1.1.6     235.1.1.6       1      340
225.1.3.1     225.1.3.1       1      *100     Eth1/10
```

This example shows how to verify the MVR interface configuration and status:

```

switch# show mvr interface
Port      VLAN Type      Status      MVR-VLAN
-----
Po10      100 SOURCE    ACTIVE      100-101
Po201     201 RECEIVER ACTIVE      100-101,340
Po202     202 RECEIVER ACTIVE      100-101,340
Po203     203 RECEIVER ACTIVE      100-101,340
Po204     204 RECEIVER INACTIVE   100-101,340
Po205     205 RECEIVER ACTIVE      100-101,340
Po206     206 RECEIVER ACTIVE      100-101,340
Po207     207 RECEIVER ACTIVE      100-101,340
Po208     208 RECEIVER ACTIVE      2000-2001
Eth1/9    340 SOURCE    ACTIVE      340
Eth1/10   20 RECEIVER  ACTIVE      100-101,340
Eth2/2    20 RECEIVER  ACTIVE      100-101,340
Eth102/1/1 102 RECEIVER  ACTIVE      100-101,340
Eth102/1/2 102 RECEIVER  INACTIVE    100-101,340
Eth103/1/1 103 RECEIVER  ACTIVE      100-101,340
Eth103/1/2 103 RECEIVER  ACTIVE      100-101,340

```

Status INVALID indicates one of the following misconfiguration:

- Interface is not a switchport.
- MVR receiver is not in access, pvlan host or pvlan promiscuous mode.
- MVR source is in fex-fabric mode.

This example shows how to display all MVR members:

```

switch# show mvr members
MVR-VLAN  Group Address  Status  Members
-----
100        230.1.1.1    ACTIVE  Po201 Po202 Po203 Po205 Po206
100        230.1.1.2    ACTIVE  Po205 Po206 Po207 Po208
340        235.1.1.6    ACTIVE  Eth102/1/1
101        225.1.3.1    ACTIVE  Eth1/10 Eth2/2
101        228.1.2.241  ACTIVE  Eth103/1/1 Eth103/1/2

```

This example shows how to display all MVR receiver ports on all interfaces:

```

switch# show mvr receiver-ports
Port      MVR-VLAN  Status  Joins      Leaves
-----
          (v1,v2,v3)
-----
Po201     100        ACTIVE  8           2
Po202     100        ACTIVE  8           2
Po203     100        ACTIVE  8           2
Po204     100        INACTIVE 0           0
Po205     100        ACTIVE  10          6
Po206     100        ACTIVE  10          6
Po207     100        ACTIVE  5           0
Po208     100        ACTIVE  6           0
Eth1/10   101        ACTIVE  12          2
Eth2/2    101        ACTIVE  12          2
Eth102/1/1 340        ACTIVE  16          15
Eth102/1/2 340        INACTIVE 16          16
Eth103/1/1 101        ACTIVE  33          0
Eth103/1/2 101        ACTIVE  33          0

```

This example shows how to display all MVR source ports on all interfaces:

```

switch# show mvr source-ports
Port      MVR-VLAN  Status
-----
Po10      100        ACTIVE

```

Eth1/9	340	ACTIVE
--------	-----	--------



CHAPTER 12

Configuring VTP V3

This chapter contains the following sections:

- [Configuring VTP V3, on page 145](#)

Configuring VTP V3

From Cisco NX-OS Release 7.2(0)N1(1), VLAN Trunk Protocol (VTP) V3 supports PVLAN integration, 4K VLAN integration, generic database transport mechanism, and VTP authentication mechanism.

VTP V3 Overview

VTP V3 allows each router or LAN device to transmit advertisements in frames on its trunk ports. These frames are sent to a multicast address where they can be received by all neighboring devices. They are not forwarded by normal bridging procedures. An advertisement lists the sending device's VTP management domain, its configuration revision number, the VLANs which it knows about, and certain parameters for each known VLAN. By hearing these advertisements, all devices in the same management domain learn about any new VLANs that are configured in the transmitting device. This process allows you to create and configure a new VLAN only on one device in the management domain, and then that information is automatically learned by all the other devices in the same management domain.

Once a device learns about a VLAN, the device receives all frames on that VLAN from any trunk port by default, and if appropriate, forwards them to each of its other trunk ports, if any. This process prevents unnecessary VLAN traffic from being sent to a device. An extension of VTP called VTP pruning has been defined to limit the scope of broadcast traffic and save bandwidth. Beginning with Release 5.1(1), the Cisco NX-OS software supports VTP pruning.

VTP also publishes information about the domain and the mode in a shared local database that can be read by other processes such as Cisco Discovery Protocol (CDP).

VTP V3 Modes

From Cisco NX-OS Release 7.2(0)N1(1), VTP V3 supports the following modes:

- **Transparent**—Allows you to relay all VTP protocol packets that it receives on a trunk port to all other trunk ports. When you create or modify a VLAN that is in VTP transparent mode, those VLAN changes affect only the local device. A VTP transparent network device does not advertise its VLAN configuration

and does not synchronize its VLAN configuration based on received advertisements. You cannot configure VLANs 1002 to 1005 in VTP client/server mode because these VLANs are reserved for Token Ring.

- **Server**— Allows you to create, remove, and modify VLANs over the entire network. You can set other configuration options like the VTP version and also turn on or off VTP pruning for the entire VTP domain. VTP servers advertise their VLAN configuration to other switches in the same VTP domain and synchronize their VLAN configuration with other switches based on messages received over trunk links. Beginning with Release 5.1(1), the server mode is the default mode. The VLAN information is stored on the bootflash and is not erased after a reboot.
- **Client**— Allows you to create, change, and delete VLANs on the local device. In VTP client mode, a switch stores the last known VTP information including the configuration revision number, on the bootflash. A VTP client might or might not start with a new configuration when it powers up.
- **Off**— Behaves similarly to the transparent mode but does not forward any VTP packets. The off mode allows you to monitor VLANs by using the CISCO-VTP-MIB without having to run VTP. On Cisco Nexus 7000 Series devices, because VTP is a conditional service, its MIB is loaded only when the corresponding feature is enabled. The CISCO-VTP-MIB does not follow this convention. It is loaded by the VLAN manager and will always return the correct values whether the VTP process is enabled or disabled.



Note VTP client will move to transparent mode if there is any failure during updating VLAN database received from server. Following syslog message is displayed on console. "VTP-2-VTP_MODE_TRANSPARENT_CREATE_SEQ_FAILED: VTP Mode changed to transparent since VTP vlan create/update failed". User need to change back the VTP mode to client to get latest database from server.

VTP V3 Pruning

The VLAN architecture requires all flooded traffic for a VLAN to be sent across a trunk port even if it leads to switches that have no devices that are active in the VLAN. This method leads to wasted network bandwidth.

VTP V3 Pruning optimizes the usage of network bandwidth by restricting the flooded traffic to only those trunk ports that can reach all the active network devices. When this protocol is in use, a trunk port does not receive the flooded traffic that is meant for a certain VLAN unless an appropriate join message is received.

A join message is defined as a new message type in addition to the ones already supported by version 1 of the VTP V3 protocol. A VTP V3 implementation indicates that it supports this extension by appending a special TLV at the end of the summary advertisement messages that it generates. In VTP V3 transparent mode, VTP relays all VTP packets, and pruning requires that the switch processes TLVs in the VTP V3 summary packets.

VTP V3 Per Interface

VTP allows you to enable or disable the VTP protocol on a per-port basis to control the VTP traffic. When a trunk is connected to a switch or end device, it drops incoming VTP packets and prevents VTP advertisements on this particular trunk. By default, VTP is enabled on all the switch ports.

VTP V3 Pruning and Spanning Tree Protocol

VTP maintains a list of trunk ports in the Spanning Tree Protocol (STP) forwarding state by querying STP at bootup and listening to the notifications that are generated by STP.

VTP sets a trunk port into the pruned or joined state by interacting with STP. STP notifies VTP V3 when a trunk port goes to the blocking or forwarding state. VTP V3 notifies STP when a trunk port becomes pruned or joined.

Configuring VTP V3



Note

- VLAN 1 is required on all trunk ports used for switch interconnects if VTP V3 is used in transparent mode in the network. Disabling VLAN 1 from any of these ports prevents VTP from functioning properly in transparent mode.
- The overlapping of system reserved VLANs between Cisco Nexus 6000 Series Switches and Cisco Nexus 5000 Series Switches causes interoperability issues. When a Cisco Catalyst 6000 Switch sends a VLAN reserved in the Cisco Nexus switch, it causes the Cisco Nexus 5000 and 6000 Series Switches to move to VTP Transparent Mode.

Check the generated syslog messages in the Cisco Nexus Switches for information on the VLAN that caused the interoperability issue.

Before you begin

Ensure that you are in the correct virtual device context (VDC) (or enter the **switchto vdc** command). VLAN names and IDs can be repeated in different VDCs, so you must confirm which VDC that you are working in.

Procedure

	Command or Action	Purpose
Step 1	switch# configure terminal	Enters global configuration mode.
Step 2	switch(config)# feature vtp	Enables VTP on the device. The default is disabled.
Step 3	switch(config)# vtp domain <i>domain-name</i>	Specifies the name of the VTP domain that you want this device to join. The default is blank.
Step 4	switch(config)# vtp version {1 2 3}	Sets the VTP version that you want to use. The default is version 1.
Step 5	Required: switch(config)# vtp mode {client server transparent off} [vlan mst unknown]	Sets the VTP mode to client, server, transparent, or off. The default server mode is for vlan instance and transparent is for mst instance.

	Command or Action	Purpose
Step 6	switch(config)# vtp interface <i>interface-name</i> [only]	Configures the interface name used by the VTP updater for this device.
Step 7	switch(config)# vtp file <i>file-name</i>	Specifies the ASCII filename of the IFS file system file where the VTP configuration is stored.
Step 8	<p>switch(config)# vtp password <i>password-value</i> [hidden secret]</p> <p>Example:</p> <p>For Hidden:</p> <pre>Device (config) # vtp password helping hidden</pre> <p>Generating the secret associated to the password. Device# exit Device# show vtp password VTP Password: 89914640C8D90868B6A0D8103847A733 <p>Example:</p> <p>For Secret:</p> <pre>Device (config) # vtp password 89914640C8D90868B6A0D8103847A733 secret Device# exit Device# show vtp password VTP Password: 89914640C8D90868B6A0D8103847A733</pre> </p>	<p>Specifies the password for the VTP administrative domain. Default value is taken from vlan.dat.</p> <p>The following options are applicable only on VTP V3:</p> <ul style="list-style-type: none"> • Hidden—Password is not saved as clear text in vlan.data file. Instead, a hexadecimal secret key generated from the password is saved. This is displayed as the output of the show vtp password. • Secret—Use this keyword to directly configure the 32-character hexadecimal secret key. System administrators can distribute this secret key instead of the clear text password. <p>Note This command is applicable for VTP version 3 only.</p>
Step 9	switch(config)# exit	Exits the configuration submode.
Step 10	<p>switch# vtp primary [<i>feature</i>] [force]</p> <p>Example:</p> <pre>Device# vtp primary vlan</pre> <p>Enter VTP password: This switch is becoming Primary server for vlan feature in the VTP domain</p> <pre>VTP Database Conf Switch ID Primary Server Revision System Name ----- ----- VLANDB Yes 00d0.00b8.1400=00d0.00b8.1400 1 stp7</pre> <p>Do you want to continue (y/n) [n]? y</p>	<p>This command changes the operational state of a secondary server to primary and advertises the information to the entire VTP domain. If the password is configured as hidden, the user is prompted to re-enter the password after this command.</p> <p>Before the device takes over the role of primary, it attempts to discover servers that conflict this information and follows another primary server. If conflicting servers are discovered, the user must reconfirm the takeover of operational state and the subsequent overwriting of configuration.</p> <ul style="list-style-type: none"> • feature—Configures the device as primary server for a specific feature database. For example, the MST database. Possible values are MST and VLAN. By default, the VLAN database is chosen.

	Command or Action	Purpose
		Note This command is applicable for VTPv3 only.
Step 11	(Optional) switch# show vtp status	Displays information about the VTP configuration on the device, such as the version, mode, and revision number.
Step 12	(Optional) switch# show vtp counters	Displays information about VTP advertisement statistics on the device.
Step 13	(Optional) switch# show vtp interface	Displays the list of VTP-enabled interfaces.
Step 14	(Optional) switch# show vtp password	Displays the password for the management VTP domain.
Step 15	(Optional) switch# show vtp devices [conflict] Example: Device# show vtp devices Gathering information from the domain, please wait. VTP Database Conf switch ID Primary Server Revision System Name lict ----- ----- ----- VLAN Yes 00b0.8e50.d000 000c.0412.6300 12354 main.cisco.com MST No 00b0.8e50.d000 0004.AB45.6000 24 main.cisco.com VLAN Yes 000c.0412.6300=000c.0412.6300 67 qwerty.cisco.com	This is a VTP version 3 command that displays information about neighbor switches. The information is not learned from the summary packet used for regular VTP packets. This command sends out a separate packet to collect information regarding neighbor switches running VTP version 3.
Step 16	(Optional) switch# copy running-config startup-config	Copies the running configuration to the startup configuration.

Example

This example shows how to configure VTP in transparent mode for the device:

```
switch# configure terminal
switch(config)# feature vtp
switch(config)# vtp domain accounting
switch(config)# vtp version 2
switch(config)# vtp mode transparent
switch(config)# exit
switch#
```

Configuring VTP V3 Pruning

Follow the steps given below to configure VTP V3 Pruning.

Procedure

	Command or Action	Purpose
Step 1	switch# configure terminal	Enters global configuration mode.
Step 2	switch(config)# vtp pruning	Enables VTP pruning on the device. The default is disabled.
Step 3	(Optional) switch(config)# no vtp pruning	Disables VTP pruning on the device. The default is disabled.
Step 4	(Optional) switch(config)# show interface interface-identifier switchport	Displays the VTP pruning eligibility of the trunk port. The default is that all the VLANs from 2 to 1001 are pruning eligible.
Step 5	switch(config)# interface port-channel channel-number	Creates a port-channel interface and enter interface configuration mode.
Step 6	Required: switch(config-if)# switchport trunk pruning vlan [add remove except none all] VLAN-IDs	Sets the specified VLANs to be VTP pruning eligible.
Step 7	switch(config-if)# end	Returns to privileged EXEC mode.
Step 8	(Optional) switch# show vtp counters	Displays VTP pruning information and counters.
Step 9	(Optional) switch# clear vtp counters	Resets all the VTP pruning counter values.



CHAPTER 13

Configuring Traffic Storm Control

This chapter contains the following sections:

- [Information About Traffic Storm Control, on page 151](#)
- [Guidelines and Limitations for Traffic Storm Control, on page 152](#)
- [Configuring Traffic Storm Control, on page 153](#)
- [Traffic Storm Control Example Configuration, on page 154](#)
- [Default Settings for Traffic Storm Control, on page 154](#)

Information About Traffic Storm Control

A traffic storm occurs when packets flood the LAN, creating excessive traffic and degrading network performance. You can use the traffic storm control feature to prevent disruptions on Ethernet interfaces by a broadcast, multicast, or unknown unicast traffic storm.

Traffic storm control (also called traffic suppression) allows you to monitor the levels of the incoming broadcast, multicast, or unknown unicast traffic over a 10-microsecond interval. During this interval, the traffic level, which is a percentage of the total available bandwidth of the port, is compared with the traffic storm control level that you configured. When the ingress traffic reaches the traffic storm control level that is configured on the port, traffic storm control drops the traffic until the interval ends.

The following figure shows the broadcast traffic patterns on an Ethernet interface during a specified time interval. In this example, traffic storm control occurs between times T1 and T2 and between T4 and T5. During those intervals, the amount of broadcast traffic exceeded the configured threshold.

Figure 17: Broadcast Suppression

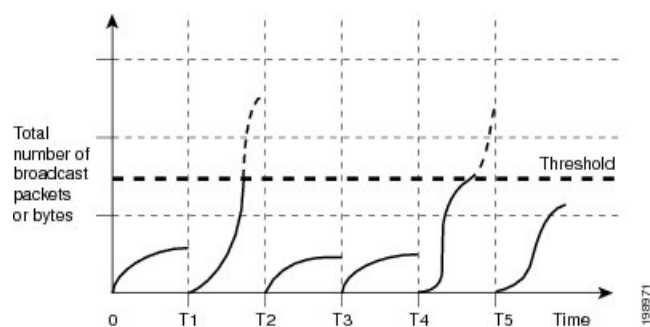

The traffic storm control threshold numbers and the time interval allow the traffic storm control algorithm to work with different levels of packet granularity. For example, a higher threshold allows more packets to pass through.

Traffic storm control is implemented in the hardware. The traffic storm control circuitry monitors packets that pass from an Ethernet interface to the switching bus. Using the Individual/Group bit in the packet destination address, the circuitry determines if the packet is unicast or broadcast, tracks the current count of packets within the 10-microsecond interval, and filters out subsequent packets when a threshold is reached.

Traffic storm control uses a bandwidth-based method to measure traffic. You set the percentage of total available bandwidth that the controlled traffic can use. Because packets do not arrive at uniform intervals, the 10-microsecond interval can affect the operation of traffic storm control.

The following are examples of how traffic storm control operation is affected:

- If you enable broadcast traffic storm control, and broadcast traffic exceeds the level within the 10-microsecond interval, traffic storm control drops all exceeding broadcast traffic until the end of the interval.
- If you enable multicast traffic storm control, and the multicast traffic exceeds the level within the 10-microsecond interval, traffic storm control drops all exceeding multicast traffic until the end of the interval.
- If you enable broadcast and multicast traffic storm control, and broadcast traffic exceeds the level within the 10-microsecond interval, traffic storm control drops all exceeding broadcast traffic until the end of the interval.
- If you enable broadcast and multicast traffic storm control, and multicast traffic exceeds the level within the 10-microsecond interval, traffic storm control drops all exceeding multicast traffic until the end of the interval.

By default, Cisco NX-OS takes no corrective action when traffic exceeds the configured level.

Guidelines and Limitations for Traffic Storm Control

When configuring the traffic storm control level, follow these guidelines and limitations:

- You can configure traffic storm control on a port-channel interface or on any physical interface.
- You can configure traffic storm control on a fabric port or a fabric port channel that connects the switch to a Fabric Extender (FEX). Storm control configured on a FEX applies to the aggregate traffic coming in on all the ports on that FEX.



Note The NIF storm control feature applies on all traffic coming in on a FEX fabric port. Traffic that comes on the FEX fabric port with the VNTAG header has an additional 6 bytes added to the original traffic. Due to these additional 6 bytes of overhead, the rate at which the traffic is policed by the storm control policer is skewed depending on the packet size of the original traffic that is ingressing on the HIF ports. The skew is larger for the smaller packet sizes compared to the larger packet sizes.

- Specify the level as a percentage of the total interface bandwidth:

- The level can be from 0 to 100.
 - The optional fraction of a level can be from 0 to 99.
 - 100 percent means no traffic storm control.
 - 0.0 percent suppresses all traffic.
- There are local link and hardware limitations that prevent storm-control drops from being counted separately. Instead, storm-control drops are counted with other drops in the discards counter.
 - Because of hardware limitations and the method by which packets of different sizes are counted, the level percentage is an approximation. Depending on the sizes of the frames that make up the incoming traffic, the actual enforced level might differ from the configured level by several percentage points.
 - Applying storm control over a HIF range is not recommended. The configuration might fail for one or more interfaces in the range depending on the hardware resource availability. The result of the command is partial success in some cases.
 - In the Cisco Nexus 5000 switch, storm-control does not distinguish between IP, non-IP, registered, or unregistered multicast traffic. All multicast traffic is subject to a single-multicast storm control policer when configured.
 - In the Cisco Nexus 5500 switch, storm-control is applied only to unregistered or unknown multicast MAC address.
 - The link-level control protocols (LACP, LLDP and so on) are not affected in case of a traffic storm. The storm control is applied to data plane traffic only.
 - The burst size values are:
 - For a 10G port, 48.68 Mbytes/390Mbits
 - For a 1G port, 25 Mbytes/200Mbits

Configuring Traffic Storm Control

You can set the percentage of total available bandwidth that the controlled traffic can use.



Note Traffic storm control uses a 10-microsecond interval that can affect the operation of traffic storm control.

Procedure

	Command or Action	Purpose
Step 1	switch# configure terminal	Enters global configuration mode.
Step 2	switch(config)# interface { <i>ethernet slot/port</i> <i>port-channel number</i> }	Enters interface configuration mode. Note If this is a QSFP+ GEM or a breakout port, the <i>port</i> syntax is <i>QSFP-module/port</i> .

	Command or Action	Purpose
Step 3	switch(config-if)# storm-control [broadcast multicast] level <i>percentage</i> [<i>.fraction</i>]	Configures traffic storm control for traffic on the interface. The default state is disabled.

Example

This example shows how to configure traffic storm control for port channels 122 and 123:

```
switch# configure terminal
switch(config)# interface port-channel 122, port-channel 123
switch(config-if-range)# storm-control multicast level 66.75
switch(config-if-range)# storm-control broadcast level 66.75
switch(config-if-range)#
```

Verifying the Traffic Storm Control Configuration

Use the following commands to display traffic storm control configuration information:

Command	Purpose
show interface [<i>ethernet slot/port</i> <i>port-channel number</i>] counters storm-control	Displays the traffic storm control configuration for the interfaces. Note Traffic storm control uses a 10-microsecond interval that can affect the operation of traffic storm control. Note If this is a QSFP+ GEM or a breakout port, the <i>port</i> syntax is <i>QSFP-module/port</i> .
show running-config interface	Displays the traffic storm control configuration.



Note When a storm event occurs on a port and the packets are dropped due to storm control configuration, a syslog message is generated to indicate that the storm event has started. An additional syslog message is generated when the storm event ends and the packet are no longer dropped.

Traffic Storm Control Example Configuration

This example shows how to configure traffic storm control:

Default Settings for Traffic Storm Control

The following table lists the default settings for traffic storm control parameters.

Table 11: Default Traffic Storm Control Parameters

Parameters	Default
Traffic storm control	Disabled
Threshold percentage	100



CHAPTER 14

Configuring the Fabric Extender

This chapter contains the following sections:

- [Information About the Cisco Nexus 2000 Series Fabric Extender, on page 157](#)
- [Fabric Extender Terminology, on page 158](#)
- [Fabric Extender Features, on page 159](#)
- [Oversubscription, on page 164](#)
- [Management Model, on page 166](#)
- [Forwarding Model, on page 166](#)
- [Connection Model, on page 167](#)
- [Port Numbering Convention, on page 169](#)
- [Fabric Extender Image Management, on page 170](#)
- [Fabric Extender Hardware, on page 170](#)
- [Speed and Duplex Mode, on page 172](#)
- [Disabling Autonegotiation, on page 175](#)
- [Associating a Fabric Extender to a Fabric Interface, on page 175](#)
- [Configuring Fabric Extender Global Features, on page 179](#)
- [Enabling the Fabric Extender Locator LED, on page 182](#)
- [Redistributing the Links, on page 182](#)
- [Verifying the Fabric Extender Configuration, on page 184](#)
- [Verifying the Chassis Management Information, on page 187](#)
- [Configuring the Cisco Nexus N2248TP-E Fabric Extender, on page 192](#)
- [Configuring the Cisco Nexus N2248PQ Fabric Extender, on page 196](#)

Information About the Cisco Nexus 2000 Series Fabric Extender

The Cisco Nexus 2000 Series Fabric Extender, also known as FEX, is a highly scalable and flexible server networking solution that works with Cisco Nexus Series devices to provide high-density, low-cost connectivity for server aggregation. Scaling across 1-Gigabit Ethernet, 10-Gigabit Ethernet, unified fabric, rack, and blade server environments, the Fabric Extender is designed to simplify data center architecture and operations.

The Fabric Extender integrates with its parent switch, which is a Cisco Nexus Series device, to allow automatic provisioning and configuration taken from the settings on the parent device. This integration allows large numbers of servers and hosts to be supported by using the same feature set as the parent device with a single management domain. The Fabric Extender and its parent switch enable a large multipath, loop-free, active-active data center topology without the use of the Spanning Tree Protocol (STP).

Figure 18: Single Management Domain

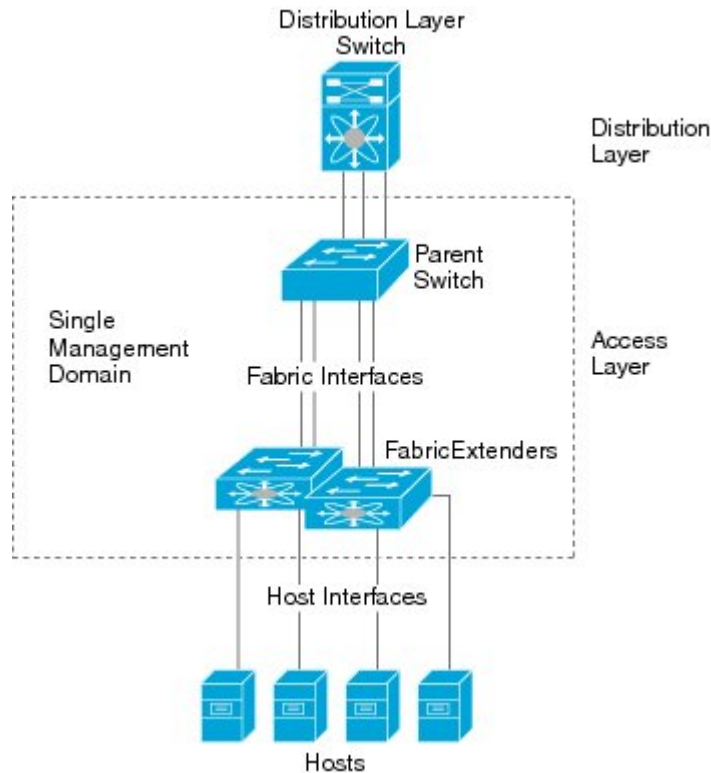

The Cisco Nexus 2000 Series Fabric Extender forwards all traffic to its parent Cisco Nexus Series device over 10-Gigabit Ethernet fabric uplinks, which allows all traffic to be inspected by policies established on the Cisco Nexus Series device.

No software is included with the Fabric Extender. The software is automatically downloaded and upgraded from its parent device.

**Note**

When you configure a Cisco Nexus 2248 port to 100mbps speed (instead of auto-negotiation), FEX does not auto negotiate with the peer. You must manually set the peer not to auto negotiate and set the peer to 100mbps speed.

Fabric Extender Terminology

Some terms used in this document are as follows:

- Fabric interface—A 10-Gigabit Ethernet uplink port that is designated for connection from the Fabric Extender to its parent switch. A fabric interface cannot be used for any other purpose. It must be directly connected to the parent switch.



Note A fabric interface includes the corresponding interface on the parent switch. This interface is enabled when you enter the **switchport mode fex-fabric** command.

- Port channel fabric interface—A port channel uplink connection from the Fabric Extender to its parent switch. This connection consists of fabric interfaces that are bundled into a single logical channel.
- Host interface—An Ethernet host interface for connection to a server or host system.



Note Do not connect a bridge or switch to a host interface. These interfaces are designed to provide end host or server connectivity.



Note On Cisco Nexus 2348TQ and Nexus 2348UPQ FEX, if a port channel is used to connect a parent switch with a Fabric Extender device, the port channels can have maximum of 8 ports.

The Nexus 2348 FEX devices have a total of 6 * 40 Gigabit Ethernet uplink ports towards the parent switch. If these are used with native 40G uplinks port on a parent switch, then there is no limitation. All 6 ports can be used in either single homed or dual homed configuration. You can also use 40 Gigabit Ethernet uplink ports on the N2348 Fabric Extender device with 10 Gigabit Ethernet ports on the parent switch when used with the appropriate cabling. A maximum of 8 ports can be added to the port channel between the parent switch and Fabric Extender device. If it is a dual homed setup, VPC to the Fabric Extender device, only 4 ports per switch are allowed in the port channel.

- Port channel host interface—A port channel host interface for connection to a server or host system.

Fabric Extender Features

The Cisco Nexus 2000 Series Fabric Extender allows a single switch—and a single consistent set of switch features—to be supported across a large number of hosts and servers. By supporting a large server-domain under a single management entity, policies can be enforced more efficiently.

Some of the features of the parent switch cannot be extended onto the Fabric Extender.

Layer 2 Host Interfaces

The Fabric Extender provides connectivity for computer hosts and other edge devices in the network fabric.

Follow these guidelines when connecting devices to Fabric Extender host interfaces:

- All Fabric Extender host interfaces run as spanning tree edge ports with BPDU Guard enabled and you cannot configure them as spanning tree network ports.

- You can connect servers that use active/standby teaming, 802.3ad port channels, or other host-based link redundancy mechanisms to Fabric Extender host interfaces.
- Any device that is running spanning tree connected to a Fabric Extender host interface results in that host interface being placed in an error-disabled state when a BPDU is received.
- You can connect only virtual switches that leverages a link redundancy mechanism not dependent on spanning tree such as Cisco FlexLink or vPC (with the BPDU Filter enabled) to a Fabric Extender host interface. Because spanning tree is not used to eliminate loops, you should ensure a loop-free topology below the Fabric Extender host interfaces.

You can enable host interfaces to accept Cisco Discovery Protocol (CDP) packets. This protocol only works when it is enabled for both ends of a link.



Note CDP is not supported on fabric interfaces when the Fabric Extender is configured in a virtual port channel (vPC) topology.

Ingress and egress packet counters are provided on each host interface.

For more information about BPDU Guard, see [Understanding BPDU Guard, on page 90](#).

Host Port Channel

The following fabric extenders support port channel host interface configurations. Up to eight interfaces can be combined in a port channel. The port channel can be configured with or without Link Aggregation Control Protocol (LACP).

- Cisco Nexus 2248TP
- Cisco Nexus 2348UPQ
- Cisco Nexus 2348TQ
- Cisco Nexus 2232PP
- Cisco Nexus 2332TQ
- Cisco Nexus 2224TP
- Cisco Nexus 2248PQ
- Cisco Nexus B22 Fabric Extender for Fujitsu (N2K-B22FTS-P)
- Cisco Nexus B22 Fabric Extender for Dell (N2K-B22DELL-P)
- Cisco Nexus B22 Fabric Extender for HP (N2K-B22HP-P)
- Cisco Nexus B22 Fabric Extender for IBM (N2K-B22IBM-P)

VLANs and Private VLANs

The Fabric Extender supports Layer 2 VLAN trunks and IEEE 802.1Q VLAN encapsulation. Host interfaces can be members of private VLANs with the following restrictions:

- You can configure a host interface as an isolated or community access port only.
- You cannot configure a host interface as a promiscuous port.
- You cannot configure a host interface as a private VLAN trunk port.

For more information about VLANs, see the chapter in this guide on Configuring VLANs.

Virtual Port Channels

With a virtual port channel (vPC), you can configure topologies where a Cisco Nexus Fabric Extender is connected to a pair of parent switches or a pair of Fabric Extenders are connected to a single parent switch. The vPC can provide multipath connections, which allow you to create redundancy between the nodes on your network.



Note A port channel between two FEXs that are connected to the same Cisco Nexus device is not supported. Virtual port channels (vPCs) cannot span two different FEXs when connected to the same Cisco Nexus device.

The following vPC topologies are possible with the Fabric Extender:

- The parent switches are connected single homed to Fabric Extenders that are subsequently connected to servers with dual interfaces (see the following figure).

Figure 19: Single Homed Fabric Extender vPC Topology

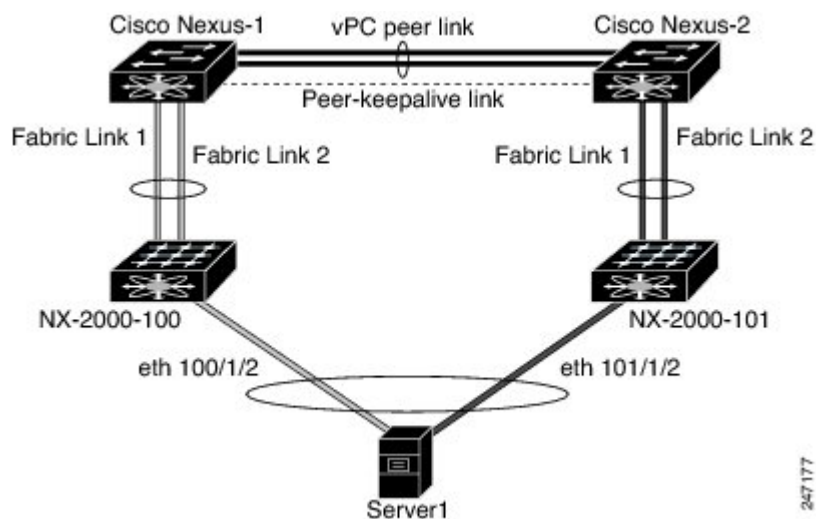

- The Fabric Extender is connected dual homed to two upstream parent switches and connected downstream to single homed servers (see the following figure).

Figure 20: Dual Homed Fabric Extender vPC Topology

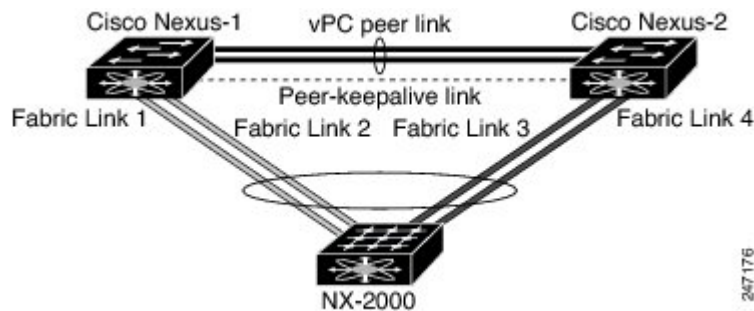

This configuration is also called an Active-Active topology.

**Note**

Port channels between two Fabric Extenders connected to the same Cisco Nexus device is not supported vPCs cannot span two different Fabric Extenders that are connected to the same physical Cisco Nexus device.

Fibre Channel over Ethernet Support

The Cisco Nexus 2232PP and Cisco Nexus 2248PQ support Fibre Channel over Ethernet (FCoE) with the following restrictions:

- Only FCoE Initialization Protocol (FIP) enabled converged network adapters (CNAs) are supported on the Fabric Extender.
- Binding to a port channel is limited to only one member in the port channel.

For configuration details, see the Fibre Channel over Ethernet Configuration Guide for the Nexus software release that you are using. The available versions of this document can be found at the following URL: http://www.cisco.com/en/US/products/ps9670/products_installation_and_configuration_guides_list.html.

Protocol Offload

To reduce the load on the control plane of the Cisco Nexus Series device, Cisco NX-OS allows you to offload link-level protocol processing to the Fabric Extender CPU. The following protocols are supported:

- Link Layer Discovery Protocol (LLDP)
- Cisco Discovery Protocol (CDP)
- Link Aggregation Control Protocol (LACP)

Quality of Service

The Fabric Extender provides two user queues for its quality-of-service (QoS) support, one for all no-drop classes and one for all drop classes. The classes configured on its parent switch are mapped to one of these two queues; traffic for no-drop classes is mapped to one queue and traffic for all drop classes is mapped to the other. Egress policies are also restricted to these two classes.

The Cisco Nexus Series device provides two predefined type qos class maps for matching broadcast or multicast traffic; class-all-flood and class-ip-multicast. These classes are ignored on the Fabric Extender.

The Fabric Extender uses IEEE 802.1p class of service (CoS) values to associate traffic with the appropriate class. Per-port quality of service (QoS) configuration and CoS-based egress queuing are also supported.

Host interfaces support pause frames, which are implemented using IEEE 802.3x link-level flow control (LLC). By default, flow control send is on and flow control receive is off on all host interfaces. Autonegotiation is enabled on the host interfaces. Per-class flow control is set according to the QoS classes.

Host interfaces support jumbo frames (up to 9216 bytes); however, a per-host interface maximum transmission unit (MTU) is not supported. Instead, MTU is set according to the QoS classes. You modify MTU by setting policy and class maps on the parent switch. Because the Fabric Extender has only two user queues, the MTU for the drop-queue is set to the maximum MTU of all drop classes and the MTU on the no-drop queue is set to the maximum MTU of all no-drop classes.

For more information about LLC and quality-of-service, see the Quality of Service Configuration Guide for your device.

Access Control Lists

The Fabric Extender supports the full range of ingress access control lists (ACLs) that are available on its parent Cisco Nexus Series device.

For more information about ACLs, see the Security Configuration Guide for your device.

IGMP Snooping

IGMP snooping is supported on all host interfaces of the Fabric Extender.

The Fabric Extender and its parent switch support IGMPv3 snooping based only on the destination multicast MAC address. It does not support snooping that is based on the source MAC address or on proxy reports.



Note For more information about IGMP snooping, see <http://tools.ietf.org/wg/magma/draft-ietf-magma-snoop/rfc4541.txt>. Also, see the Multicast Routing Configuration Guide for the Nexus software release that you are using. The available versions of this document can be found at the following URL:
http://www.cisco.com/en/US/products/ps9670/products_installation_and_configuration_guides_list.html.

Switched Port Analyzer

You can configure the host interfaces on the Fabric Extender as Switched Port Analyzer (SPAN) source ports. You cannot configure Fabric Extender ports as a SPAN destination. Only one SPAN session is supported for all the host interfaces on the same Fabric Extender. Ingress source (Rx), egress source (Tx), or both ingress and egress monitoring are supported.



Note All IP multicast traffic on the VLANs that a Fabric Extender host interface belongs to is captured in the SPAN session. You cannot separate the traffic by IP multicast group membership.

If you configure ingress monitoring and egress monitoring for host interfaces on the same Fabric Extender, you might see a packet twice: once as the packet ingresses on an interface with Rx configured, and again as the packet egresses on an interface with Tx configured.

For more information about SPAN, see the System Management Configuration Guide for your device.

Fabric Interface Features

The FEX fabric interfaces support static port channels and priority flow control (PFC). PFC allows you to apply pause functionality to specific classes of traffic on an interface (instead of all the traffic on the interface). During the initial discovery and association process, SFP+ validation and digital optical monitoring (DOM) are performed as follows:

- The FEX performs a local check on the uplink SFP+ transceiver. If it fails the security check, the LED flashes but the link is still allowed to come up.
- The FEX local check is bypassed if it is running its backup image.
- The parent switch performs SFP validation again when the fabric interface is brought up. It keeps the fabric interface down if SFP validation fails.

After an interface on the parent switch is configured in fex-fabric mode, all other features that were configured on that port and are not relevant to this mode are deactivated. If the interface is reconfigured to remove fex-fabric mode, the previous configurations are reactivated.



Note Per class flow control mode is enabled by default on the fabric interfaces. When a fabric interface is configured on the parent switch, PFC mode is enabled by default and cannot be changed.



Note For a 2248PQ, all fabric interfaces need to be bundled into a single fabric port channel. They cannot be used to connect the parent switch as individual ports.

For more information about PFC, see the Quality of Service Configuration Guide for your device.



Note Flow control is not supported on Cisco Nexus 2348TQ fabric extender.

Oversubscription

In a switching environment, oversubscription is the practice of connecting multiple devices to the same interface to optimize port usage. An interface can support a connection that runs at its maximum speed. Because

most interfaces do not run at their maximum speeds, you can take advantage of unused bandwidth by sharing ports. Oversubscription, which is a function of the available fabric interfaces to active host interfaces, provides cost-effective scalability and flexibility for Ethernet environments.

The Cisco Nexus 2148T Fabric Extender has 4 10-Gigabit Ethernet fabric interfaces and 48 1000BASE-T (1-Gigabit) Ethernet host interfaces. With this system, you can have any number of configurations. For example, you can configure the following:

- No oversubscription (40 host interfaces for four fabric interfaces)
- 1.2 to 1 oversubscription (48 host interfaces for four fabric interfaces)
- 4.8 to 1 oversubscription (48 host interfaces for one fabric interface)

The Cisco Nexus 2248TP Fabric Extender has 4 10-Gigabit Ethernet fabric interfaces and 48 100/1000BASE-T (100-Mb/1-Gigabit) Ethernet host interfaces. When its host interfaces are running in Gigabit Ethernet mode, it offers similar configurations to the Cisco Nexus 2148T.

The Cisco Nexus 2248TP can be run with no oversubscription when its host interfaces are running in 100-Mb mode.

The Cisco Nexus 2248PQ Fabric Extender has 16 10-Gigabit Ethernet fabric interfaces and 48 10-Gigabit Ethernet host interfaces. All host interfaces use all of the available fabric interfaces. (Static pinning is not supported. Port-channel mode is only supported on fabric interfaces.) When all host interfaces are sending traffic to all fabric interfaces, the maximum oversubscription ratio for the Cisco Nexus 2248PQ is 3:1.

The Cisco Nexus 2232PP Fabric Extender has 8 10-Gigabit Ethernet fabric interfaces and 32 10-Gigabit Ethernet host interfaces. All host interfaces use all of the available fabric interfaces. When all host interfaces are sending traffic to all fabric interfaces, the maximum oversubscription ratio for the Cisco Nexus 2232PP is 4:1.

The Cisco Nexus 2232TM Fabric Extender has 8 10-Gigabit Ethernet fabric interfaces and 32 10G-BASE-T (10-Gigabit) Ethernet host interfaces. With this system, you can configure a 4 to 1 oversubscription (4 host interfaces for one fabric interface) or higher.

The Cisco Nexus 2224TP Fabric Extender has 2 10-Gigabit Ethernet fabric interfaces and 24 100/1000BASE-T (100-Mb/1-Gigabit) Ethernet host interfaces. With this system, you can configure a 1.2 to 1 oversubscription (24 host interfaces for two fabric interfaces) or higher.

The Cisco Nexus B22 Fabric Extender for HP (NB22HP) has 8 10-Gigabit Ethernet fabric interfaces and 16 1G/10-Gigabit Ethernet host interfaces. All host interfaces use all of the available fabric interfaces. Static pinning and port-channel mode are supported. When all host interfaces are sending traffic to all fabric interfaces, the maximum oversubscription ratio for the Cisco Nexus B22 Fabric Extender for HP (N2K-B22HP-P) is 2:1.

The Cisco Nexus B22 Fabric Extender for Fujitsu (NB22FTS) has 8 10-Gigabit Ethernet fabric interfaces and 16 10-Gigabit Ethernet host interfaces. All host interfaces use all of the available fabric interfaces. Static pinning and port-channel mode are supported. When all host interfaces are sending traffic to all fabric interfaces, the maximum oversubscription ratio for the Cisco Nexus B22 Fabric Extender for Fujitsu (N2K-B22FTS-P) is 2:1.

The Cisco Nexus B22 Fabric Extender for Dell (NB22DELL) has 8 10-Gigabit Ethernet fabric interfaces and 16 1G/10-Gigabit Ethernet host interfaces. All host interfaces use all of the available fabric interfaces. Static pinning and port-channel mode are supported. When all host interfaces are sending traffic to all fabric interfaces, the maximum oversubscription ratio for the Cisco Nexus B22 Fabric Extender for Dell (N2K-B22DELL-P) is 2:1.

The Cisco Nexus B22 Fabric Extender for IBM (NB22IBM) has 8 10-Gigabit Ethernet fabric interfaces and 14 1G/10-Gigabit Ethernet host interfaces. All host interfaces use all of the available fabric interfaces. Static pinning and port-channel mode are supported. When all host interfaces are sending traffic to all fabric interfaces, the maximum oversubscription ratio for the Cisco Nexus B22 Fabric Extender for IBM (N2K-B22IBM-P) is 2:1.

Management Model

The Cisco Nexus 2000 Series Fabric Extender is managed by its parent switch over the fabric interfaces through a zero-touch configuration model. The switch discovers the Fabric Extender by detecting the fabric interfaces of the Fabric Extender.

After discovery, if the Fabric Extender has been correctly associated with the parent switch, the following operations are performed:

1. The switch checks the software image compatibility and upgrades the Fabric Extender if necessary.
2. The switch and Fabric Extender establish in-band IP connectivity with each other.

The switch assigns an IP address in the range of loopback addresses (127.15.1.0/24) to the Fabric Extender to avoid conflicts with IP addresses that might be in use on the network.

3. The switch pushes the configuration data to the Fabric Extender. The Fabric Extender does not store any configuration locally.
4. The Fabric Extender updates the switch with its operational status. All Fabric Extender information is displayed using the switch commands for monitoring and troubleshooting.

Forwarding Model

The Cisco Nexus 2000 Series Fabric Extender does not perform any local switching. All traffic is sent to the parent switch that provides central forwarding and policy enforcement, including host-to-host communications between two systems that are connected to the same Fabric Extender as shown in the following figure.

Figure 21: Forwarding Model

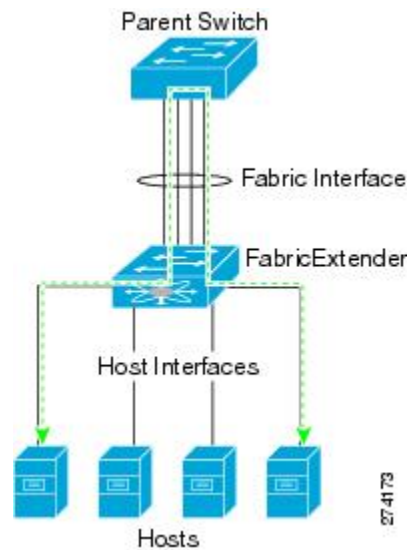

The forwarding model facilitates feature consistency between the Fabric Extender and its parent Cisco Nexus Series device.



Note The Fabric Extender provides end-host connectivity into the network fabric. As a result, BPDU Guard is enabled on all its host interfaces. If you connect a bridge or switch to a host interface, that interface is placed in an error-disabled state when a BPDU is received.

You cannot disable BPDU Guard on the host interfaces of the Fabric Extender.

The Fabric Extender supports egress multicast replication from the network to the host. Packets that are sent from the parent switch for multicast addresses attached to the Fabric Extender are replicated by the Fabric Extender ASICs and are then sent to corresponding hosts.

Connection Model

Two methods (the static pinning fabric interface connection and the Port Channel fabric interface connection) allow the traffic from an end host to the parent switch to be distributed when going through the Cisco Nexus 2000 Series Fabric Extender.



Note The Cisco Nexus 2248PQ Fabric Extender does not support the static pinning fabric interface connection.

Static Pinning Fabric Interface Connection

To provide a deterministic relationship between the host interfaces and the parent switch, you can configure the Fabric Extender to use individual fabric interface connections. This configuration connects the 10-Gigabit

Ethernet fabric interfaces as shown in the following figure. You can use any number of fabric interfaces up to the maximum available on the model of the Fabric Extender.

Figure 22: Static Pinning Fabric Interface Connections

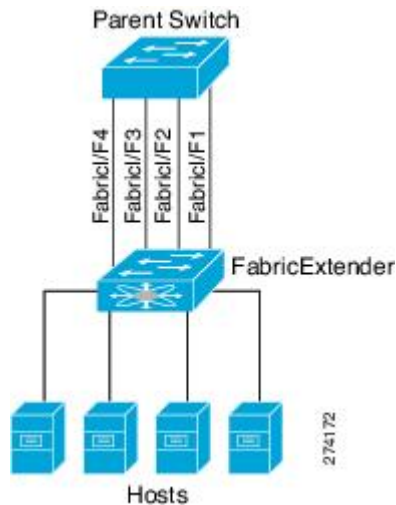

When the Fabric Extender is brought up, its host interfaces are distributed equally among the available fabric interfaces. As a result, the bandwidth that is dedicated to each end host toward the parent switch is never changed by the switch but instead is always specified by you.



Note If a fabric interface fails, all its associated host interfaces are brought down and remain down until the fabric interface is restored.

You must use the **pinning max-links** command to create a number of pinned fabric interface connections so that the parent switch can determine a distribution of host interfaces. The host interfaces are divided by the number of the max-links and distributed accordingly. The default value is max-links 1.



Caution Changing the value of the **max-links** is disruptive; all the host interfaces on the Fabric Extender are brought down and back up as the parent switch reassigns its static pinning.

The pinning order of the host interfaces is initially determined by the order in which the fabric interfaces were configured. When the parent switch is restarted, the configured fabric interfaces are pinned to the host interfaces in an ascending order by the port number of the fabric interface.

To guarantee a deterministic and sticky association across a reboot, you can manually redistribute the pinning.



Note The redistribution of the host interfaces will always be in an ascending order by the port number of the fabric interface.

Port Channel Fabric Interface Connection

To provide load balancing between the host interfaces and the parent switch, you can configure the Fabric Extender to use a port channel fabric interface connection. This connection bundles 10-Gigabit Ethernet fabric interfaces into a single logical channel as shown in the following figure.

Figure 23: Port Channel Fabric Interface Connection

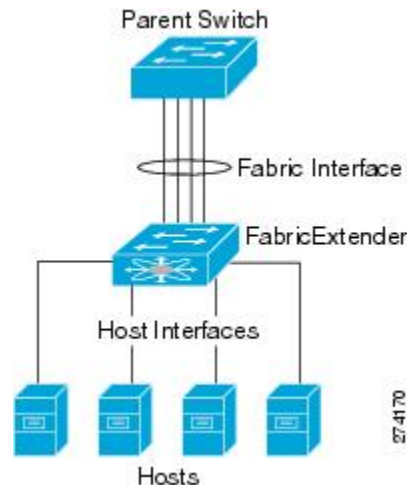

When you configure the Fabric Extender to use a port channel fabric interface connection to its parent switch, the switch load balances the traffic from the hosts that are connected to the host interface ports by using the following load-balancing criteria to select the link:

- For a Layer 2 frame, the switch uses the source and destination MAC addresses.
- For a Layer 3 frame, the switch uses the source and destination MAC addresses and the source and destination IP addresses.



Note A fabric interface that fails in the port channel does not trigger a change to the host interfaces. Traffic is automatically redistributed across the remaining links in the port channel fabric interface. If all links in the fabric port channel go down, all host interfaces on the FEX are set to the down state.

Port Numbering Convention

The following port numbering convention is used for the Fabric Extender:

interface ethernet *chassis/slot/port*

where

- *chassis* is configured by the administrator. A Fabric Extender must be directly connected to its parent Cisco Nexus Series device via individual fabric interfaces or a port channel fabric interface. You configure a chassis ID on a physical Ethernet interface or port channel on the switch to identify the Fabric Extender that is discovered through those interfaces.

The chassis ID ranges from 100 to 199.



Note The chassis ID is required only to access a host interface on the Fabric Extender. A value of less than 100 indicates a slot on the parent switch. The following port numbering convention is used for the interfaces on the switch:

interface ethernet *slot/port*

- *slot* identifies the slot number on the Fabric Extender.
- *port* identifies the port number on a specific slot and chassis ID.

Fabric Extender Image Management

No software ships with the Cisco Nexus 2000 Series Fabric Extender. The Fabric Extender image is bundled into the system image of the parent switch. The image is automatically verified and updated (if required) during the association process between the parent switch and the Fabric Extender.

When you enter the **install all** command, it upgrades the software on the parent Cisco Nexus Series switch and also upgrades the software on any attached Fabric Extender. To minimize downtime as much as possible, the Fabric Extender remains online while the installation process loads its new software image. Once the software image has successfully loaded, the parent switch and the Fabric Extender both automatically reboot.

This process is required to maintain version compatibility between the parent switch and the Fabric Extender.

Fabric Extender Hardware

The Cisco Nexus 2000 Series Fabric Extender architecture allows hardware configurations with various host interface counts and speeds.

Chassis

The Cisco Nexus 2000 Series Fabric Extender is a 1 RU chassis that is designed for rack mounting. The chassis supports redundant hot-swappable fans and power supplies.

Ethernet Interfaces

There are 8 models of the Cisco Nexus 2000 Series Fabric Extender:

- The Cisco Nexus 2148T has 48 1000BASE-T Ethernet host interfaces for its downlink connection to servers or hosts and 4 10-Gigabit Ethernet fabric interfaces with SFP+ interface adapters for its uplink connection to the parent switch.
- The Cisco Nexus 2224TP has 24 100BASE-T/1000Base-T Ethernet host interfaces for its downlink connection to servers or hosts and 2 10-Gigabit Ethernet fabric interfaces with SFP+ interface adapters for its uplink connection to the parent switch.

- The Cisco Nexus 2248PQ has 48 10-Gigabit Ethernet host interfaces with SFP+ interface adapters and 16 10-Gigabit Ethernet fabric interfaces corresponding to 4 QSFP interface adapters for its uplink connection to the parent switch.
- The Cisco Nexus 2232PP has 32 10-Gigabit Ethernet host interfaces with SFP+ interface adapters and 8 10-Gigabit Ethernet fabric interfaces with SFP+ interface adapters for its uplink connection to the parent switch.
- Cisco Nexus 2348UPQ—FEX for QSA (FET-10G, SFP-10G-SR, SFP-10G-ER). From Cisco NX-OS Release 7.3(2)N1(1), Cisco Nexus 2348UPQ 10GE Fabric Extender for ports using 1G Cu SFP GLC-T supports the **speed 100** command.



Note From Cisco NX-OS Release 7.3(2)N1(1), Cisco Nexus 2248PQ 10GE Fabric Extender, Cisco Nexus 2232PP 10GE Fabric Extender, and Cisco Nexus 2348UPQ 10GE Fabric Extender with 1G-based SFP support the **no negotiate auto** command.

- Cisco Nexus N2332TQ—FEX supporting 32 10GBaseT host ports and 4 QSFP+ network ports.
 - Cisco Nexus 2348TQ FEX (N2K-C2348TQ-10GE)
 - The Cisco Nexus 2248TP has 48 100BASE-T/1000Base-T Ethernet host interfaces for its downlink connection to servers or hosts and 4 10-Gigabit Ethernet fabric interfaces with SFP+ interface adapters for its uplink connection to the parent switch.
- The Cisco Nexus 2248TP-E has all the features of the Cisco Nexus 2248TP with these additional features:
- A larger buffer to absorb large bursts.
 - Support for an ingress and egress queue-limit per port.
 - Support for debug counters.
 - Support for pause no-drop behavior over a cable distance of 3000 meters between the Fabric Extender and switch.
 - Support for a user configurable shared-buffer.
 - Support for the **speed auto 100** command from Cisco NX-OS Release 7.3(2)N1(1).
- The Cisco Nexus B22 Fabric Extender for HP (NB22HP) has 16 1G/10-Gigabit Ethernet host interfaces. All host interfaces use all of the available fabric interfaces.
 - The Cisco Nexus B22 Fabric Extender for Fujitsu (NB22FTS) has 16 10-Gigabit Ethernet host interfaces. All host interfaces use all of the available fabric interfaces.
 - The Cisco Nexus B22 Fabric Extender for Dell (NB22DELL) has 16 1G/10-Gigabit Ethernet host interfaces. All host interfaces use all of the available fabric interfaces.
 - The Cisco Nexus B22 Fabric Extender for IBM (NB22IBM) has 14 1G/10-Gigabit Ethernet host interfaces. All host interfaces use all of the available fabric interfaces.

Speed and Duplex Mode

The table listed below shows the autonegotiation matrix for N2K-C2348TQ-10GE and N2K-C2332TQ-10GE fabric extenders.

Configuration N2K-C2348TQ-10GE and N2K-C2332TQ-10GE HIF (Speed/Duplex)	Configuration NIC (Speed/Duplex)	Resulting HIF status (Speed/Duplex)	Resulting NIC status (Speed/Duplex)	Comments
Table for 100 Mbps				
AUTO	AUTO	UP, 100 Mbps, Full duplex	UP, 100 Mbps, Full duplex	Assuming maximum capability of NIC is 100 Mbps, Full duplex
100 Mbps, Full duplex (force mode)	100 Mbps, Full duplex	UP, 100 Mbps, Full duplex	UP, 100 Mbps, Full duplex	Link DOWN in some scenarios. 1
100 Mbps, Full duplex (force mode)	100 Mbps, Half duplex	UP, 100 Mbps, Full duplex	UP, 100 Mbps, Half duplex	Duplex mismatch as per standard; results in collision errors. Hence, not a functional scenario.
100 Mbps, Full duplex (force mode)	AUTO	UP, 100 Mbps, Full duplex	UP, 100 Mbps, Half Duplex	Duplex mismatch as per standard; results in collision errors. Hence, not a functional scenario. (Link will be DOWN if NIC is not 100 Mbps, Half Duplex capable)
AUTO	100 Mbps, Full duplex	DOWN	DOWN	—
AUTO	100 Mbps, Half duplex	DOWN	DOWN	—
Table for 1G (1000 Mbps)				
AUTO	AUTO	UP, 1000 Mbps, Full duplex	UP, 1000 Mbps, Full duplex	Assuming maximum capability of NIC is 1000 Mbps, Full duplex

Configuration N2K-C2348TQ-10GE and N2K-C2332TQ-10GE HIF (Speed/Duplex)	Configuration NIC (Speed/Duplex)	Resulting HIF status (Speed/Duplex)	Resulting NIC status (Speed/Duplex)	Comments
1000 Mbps, Full duplex	AUTO	UP, 1000 Mbps, Full duplex	UP, 1000 Mbps, Full duplex	Assuming maximum capability of NIC is 1000 Mbps, Full duplex
AUTO	1000 Mbps, Full duplex	UP, 1000 Mbps, Full duplex	UP, 1000 Mbps, Full duplex	—
1000 Mbps, Full duplex	1000 Mbps, Full duplex	UP, 1000 Mbps, Full duplex	UP, 1000 Mbps, Full duplex	—
100 Mbps, Full duplex	1000 Mbps, Full duplex	DOWN	DOWN	Speed Mismatch
1000 Mbps, Full duplex	100 Mbps, Full duplex	DOWN	DOWN	Speed Mismatch
1000 Mbps, Full duplex	100 Mbps, Half duplex	DOWN	DOWN	Speed Mismatch
10000 Mbps, Full duplex	1000 Mbps, Full duplex	DOWN	DOWN	Speed Mismatch
10000 Mbps, Full duplex	100 Mbps, Full duplex	DOWN	DOWN	Speed Mismatch
10000 Mbps, Full duplex	100 Mbps, Half duplex	DOWN	DOWN	Speed Mismatch
Table for 10G (10000 Mbps)				
AUTO	AUTO	UP, 10000 Mbps, Full duplex	UP, 10000 Mbps, Full duplex	Assuming maximum capability of NIC is 10000 Mbps, Full duplex
10000 Mbps, Full duplex	AUTO	UP, 10000 Mbps, Full duplex	UP, 10000 Mbps, Full duplex	Assuming maximum capability of NIC is 10000 Mbps, Full duplex
AUTO	10000 Mbps, Full duplex	UP, 10000 Mbps, Full duplex	UP, 10000 Mbps, Full duplex	—
10000 Mbps, Full duplex	10000 Mbps, Full duplex	UP, 10000 Mbps, Full duplex	UP, 10000 Mbps, Full duplex	—
100 Mbps, Full duplex	10000 Mbps, Full duplex	DOWN	DOWN	Speed Mismatch

Configuration N2K-C2348TQ-10GE and N2K-C2332TQ-10GE HIF (Speed/Duplex)	Configuration NIC (Speed/Duplex)	Resulting HIF status (Speed/Duplex)	Resulting NIC status (Speed/Duplex)	Comments
1000 Mbps, Full duplex	10000 Mbps, Full duplex	DOWN	DOWN	Speed Mismatch

¹ Refer to [CSCut35369](#) for more details.

Example: Configuring the Interface Speed Parameters

Configuration: AUTO

Configuring speed as AUTO (advertises all speeds and Full Duplex only)

```
switch(config)# interface ethernet 101/1/1
switch(config-if)# speed auto
```

Configuration: AUTO 100

Configuring speed as AUTO 100 Mbps (autonegotiates the advertised speed to 100 Mbps)

```
switch(config)# interface ethernet 101/1/1
switch(config-if)# speed auto 100
```

Configuration: 100 (Force Mode)

Configuring speed as 100 Mbps

```
switch(config)# interface ethernet 101/1/1
switch(config-if)# speed 100
```

Configuration: 1G

Configuring speed as 1000 Mbps (This has autoneg enabled with 1000 Mbps)

```
switch(config)# interface ethernet 101/1/1
switch(config-if)# speed 1000
```

Configuration: 10G

Configuring speed as 10000 Mbps (This has autoneg enabled with 10000 Mbps)

```
switch(config)# interface ethernet 101/1/1
switch(config-if)# speed 10000
```

Disabling Autonegotiation

The **negotiate auto** command enables the autonegotiation protocol to configure the speed, duplex, and automatic flow-control of the Gigabit Ethernet interface. Use the **no negotiate auto** command to disable autonegotiation. The **no negotiate auto** command is supported only in Cisco Nexus 2248PQ 10GE Fabric Extender, Cisco Nexus 2232PP 10GE Fabric Extender, and Cisco Nexus 2348UPQ 10GE Fabric Extender with 1G-based SFP.

Procedure

-
- Step 1** Enter global configuration mode:
- ```
switch# configure terminal
```
- Step 2** Specify an Ethernet interface to configure:
- ```
switch(config)# interface ethernet slot/port
```
- Step 3** Disable the autonegotiation:
- ```
switch(config-if)# no negotiate auto
```
- Step 4** Exit interface and global configuration modes:
- ```
switch(config-if)# exit  
switch(config)# exit
```
-

Disabling Autonegotiation

This example shows a running configuration to disable autonegotiation. Replace the *placeholders* with relevant values for your setup.

```
configure terminal  
interface ethernet <1>/<40>  
  no negotiate auto  
  exit  
exit
```

Associating a Fabric Extender to a Fabric Interface

A FEX is connected to its parent device through physical Ethernet interfaces or a port channel. By default, the parent device does not allow the attached Fabric Extender to connect until it has been assigned a FEX number and is associated with the connected interface.



Note The Fabric Extender may connect to the switch through a number of separate physical Ethernet interfaces or one port channel interface.



Note You must enable the Fabric Extender features with the **feature fex** command before you can configure and use a Fabric Extender that is connected to the parent switch.

Associating a Fabric Extender to an Ethernet Interface

Before you begin

Ensure that you have enabled the Fabric Extender feature.

Procedure

	Command or Action	Purpose
Step 1	configure terminal Example: switch# configure terminal switch(config)#	Enters global configuration mode.
Step 2	interface ethernet <i>slot/port</i> Example: switch(config)# interface ethernet 1/40 switch(config)#	Specifies an Ethernet interface to configure.
Step 3	switchport mode fex-fabric Example: switch(config-if)# switchport mode fex-fabric switch(config-if)#	Sets the interface to support an external Fabric Extender.
Step 4	fex associate <i>FEX-number</i> Example: switch(config-if)# fex associate 101 switch#	Associates the FEX number to the Fabric Extender unit attached to the interface. The range of the FEX number is from 100 to 199.
Step 5	(Optional) show interface ethernet <i>port/slot</i> fex-intf Example: switch# show interface ethernet 1/40 fex-intf switch#	Displays the association of a Fabric Extender to an Ethernet interface.

Example

This example shows how to associate the Fabric Extender to an Ethernet interface on the parent device:

```
switch# configure terminal
switch(config)# interface ethernet 1/40
switch(config-if)# switchport mode fex-fabric
switch(config-if)# fex associate 101
switch(config)#
```

This example shows how to display the association of the Fabric Extender and the parent device:

```
switch# show interface ethernet 1/40 fex-intf
Fabric          FEX
Interface       Interfaces
-----
Eth1/40         Eth101/1/48  Eth101/1/47  Eth101/1/46  Eth101/1/45
                Eth101/1/44  Eth101/1/43  Eth101/1/42  Eth101/1/41
                Eth101/1/40  Eth101/1/39  Eth101/1/38  Eth101/1/37
                Eth101/1/36  Eth101/1/35  Eth101/1/34  Eth101/1/33
                Eth101/1/32  Eth101/1/31  Eth101/1/30  Eth101/1/29
                Eth101/1/28  Eth101/1/27  Eth101/1/26  Eth101/1/25
                Eth101/1/24  Eth101/1/23  Eth101/1/22  Eth101/1/21
                Eth101/1/20  Eth101/1/19  Eth101/1/18  Eth101/1/17
                Eth101/1/16  Eth101/1/15  Eth101/1/14  Eth101/1/13
                Eth101/1/12  Eth101/1/11  Eth101/1/10  Eth101/1/9
                Eth101/1/8   Eth101/1/7   Eth101/1/6   Eth101/1/5
                Eth101/1/4   Eth101/1/3   Eth101/1/2   Eth101/1/1
```

Associating a Fabric Extender to a Port Channel

Before you begin

Ensure that you have enabled the Fabric Extender feature.

Procedure

	Command or Action	Purpose
Step 1	configure terminal Example: switch# configure terminal switch(config)#	Enters global configuration mode.
Step 2	interface port-channel <i>channel</i> Example: switch(config)# interface port-channel 4 switch(config-if)#	Specifies a port channel to configure.
Step 3	switchport mode fex-fabric Example:	Sets the port channel to support an external Fabric Extender.

	Command or Action	Purpose
	<code>switch(config-if)# switchport mode fex-fabric</code>	
Step 4	fex associate <i>FEX-number</i> Example: <code>switch(config-if)# fex associate 101</code>	Associates a FEX number to the Fabric Extender unit attached to the interface. The range is from 100 to 199.
Step 5	(Optional) show interface port-channel channel fex-intf Example: <code>switch# show interface port-channel 4 fex-intf</code>	Displays the association of a Fabric Extender to a port channel interface.

Example

This example shows how to associate the Fabric Extender to a port channel interface on the parent device:

```
switch# configure terminal
switch(config)# interface ethernet 1/28
switch(config-if)# channel-group 4
switch(config-if)# no shutdown
switch(config-if)# exit
switch(config)# interface ethernet 1/29
switch(config-if)# channel-group 4
switch(config-if)# no shutdown
switch(config-if)# exit
switch(config)# interface ethernet 1/30
switch(config-if)# channel-group 4
switch(config-if)# no shutdown
switch(config-if)# exit
switch(config)# interface ethernet 1/31
switch(config-if)# channel-group 4
switch(config-if)# no shutdown
switch(config-if)# exit
switch(config)# interface port-channel 4
switch(config-if)# switchport
switch(config-if)# switchport mode fex-fabric
switch(config-if)# fex associate 101
```



Tip As a best practice, only enter the **fex associate** command from the port channel interface, not from the physical interface.



Note When adding physical interfaces to port channels, all configurations on the port channel and physical interface must match.

This example shows how to display the association of the Fabric Extender and the parent device:

```

switch# show interface port-channel 4 fex-intf
Fabric          FEX
Interface       Interfaces
-----
Po4             Eth101/1/48   Eth101/1/47   Eth101/1/46   Eth101/1/45
                Eth101/1/44   Eth101/1/43   Eth101/1/42   Eth101/1/41
                Eth101/1/40   Eth101/1/39   Eth101/1/38   Eth101/1/37
                Eth101/1/36   Eth101/1/35   Eth101/1/34   Eth101/1/33
                Eth101/1/32   Eth101/1/31   Eth101/1/30   Eth101/1/29
                Eth101/1/28   Eth101/1/27   Eth101/1/26   Eth101/1/25
                Eth101/1/24   Eth101/1/23   Eth101/1/22   Eth101/1/21
                Eth101/1/20   Eth101/1/19   Eth101/1/18   Eth101/1/17
                Eth101/1/16   Eth101/1/15   Eth101/1/14   Eth101/1/13
                Eth101/1/12   Eth101/1/11   Eth101/1/10   Eth101/1/9
                Eth101/1/8    Eth101/1/7    Eth101/1/6    Eth101/1/5
                Eth101/1/4    Eth101/1/3    Eth101/1/2    Eth101/1/1

```

Disassociating a Fabric Extender from an Interface

Before you begin

Ensure that you have enabled the Fabric Extender feature.

Procedure

	Command or Action	Purpose
Step 1	configure terminal Example: <pre>switch# configure terminal switch(config)#</pre>	Enters global configuration mode.
Step 2	interface { ethernet slot/port port-channel channel } Example: <pre>switch(config)# interface port-channel 4 switch(config-if)#</pre>	Specifies the interface to configure. The interface can be an Ethernet interface or a port channel. Note If this is a 10G breakout port, the <i>slot/port</i> syntax is <i>QSFP-module/port</i> .
Step 3	no fex associate Example: <pre>switch(config-if)# no fex associate</pre>	Disassociates the Fabric Extender unit attached to the interface.

Configuring Fabric Extender Global Features

You can configure global features on the Fabric Extender.

Before you begin

Ensure that you have enabled the Fabric Extender feature set.

Procedure

	Command or Action	Purpose
Step 1	configure terminal Example: <pre>switch# configure terminal switch(config)#</pre>	Enters global configuration mode.
Step 2	fex FEX-number Example: <pre>switch(config)# fex 101 switch(config-fex)#</pre>	Enters FEX configuration mode for the specified Fabric Extender. The range of the <i>FEX-number</i> is from 100 to 199.
Step 3	(Optional) description desc Example: <pre>switch(config-fex)# description Rack7A-N2K</pre>	Specifies the description. The default is the string FEXxxxx where xxxx is the FEX number. If the FEX number is 123, the description is FEX0123.
Step 4	(Optional) no description Example: <pre>switch(config-fex)# no description</pre>	Deletes the description.
Step 5	(Optional) type FEX-type Example: <pre>switch(config-fex)# type N2248T</pre>	Specifies the type of Fabric Extender. The <i>FEX-type</i> is one of the following: <ul style="list-style-type: none"> • N2148T—48 1000 BASE-T Ethernet host interfaces and 4 10-Gigabit SFP+ Ethernet fabric interfaces module • N2224TP—24 100 BASE-T/1000 BASE-T Ethernet host interfaces and 2 10-Gigabit SFP+ Ethernet fabric interfaces module • N2232P and N2232TM—32 10-Gigabit SFP+ Ethernet host interfaces and 8 10-Gigabit SFP+ Ethernet fabric interfaces module • N2248T and N2248TP-E—48 100 BASE-T/1000 BASE-T Ethernet host interfaces and 4 10-Gigabit SFP+ Ethernet fabric interfaces module. • N2248PQ—48 10-Gigabit SFP+ Ethernet host interfaces and 16 10-Gigabit SFP+ Ethernet fabric interfaces module.

	Command or Action	Purpose
		<ul style="list-style-type: none"> • NB22HP—16 1G/10-Gigabit SFP+ Ethernet host interfaces and 8 10-Gigabit SFP+ Ethernet fabric interfaces module • NB22FJ—16 10-Gigabit SFP+ Ethernet host interfaces and 8 10-Gigabit SFP+ Ethernet fabric interfaces module • NB22DELL—16 1G/10-Gigabit SFP+ Ethernet host interfaces and 8 10-Gigabit SFP+ Ethernet fabric interfaces module • NB22IBM—14 1G/10-Gigabit SFP+ Ethernet host interfaces and 8 10-Gigabit SFP+ Ethernet fabric interfaces module <p>The parent Cisco Nexus Series device remembers the type of the Fabric Extender in its binary configuration. When this feature is configured, the Fabric Extender is allowed to come online only if its type matches the configured FEX type.</p>
Step 6	(Optional) no type Example: <pre>switch(config-fex)# no type</pre>	Deletes the FEX type. When a Fabric Extender is connected to the fabric interfaces and does not match the configured type that is saved in the binary configuration on the parent switch, all configurations for all interfaces on the Fabric Extender are deleted.
Step 7	(Optional) pinning max-links uplinks Example: <pre>switch(config-fex)# pinning max-links 2</pre>	Defines the number of uplinks. The default is 1. The range is from 1 to 4. This command is only applicable if the Fabric Extender is connected to its parent switch using one or more statically pinned fabric interfaces. There can only be one port channel connection. Caution Changing the number of uplinks with the pinning max-links command disrupts all the host interface ports of the Fabric Extender.
Step 8	(Optional) no pinning max-links Example: <pre>switch(config-fex)# no pinning max-links</pre>	Resets the number of uplinks to the default. Caution Changing the number of uplinks with the no pinning max-links command disrupts all the host interface ports of the Fabric Extender.

	Command or Action	Purpose
Step 9	(Optional) <code>serial serial</code> Example: <code>switch(config-fex)# serial JAF1339BDSK</code>	Defines a serial number string. If this command is configured, a switch allows the corresponding chassis ID to associate (using the fex associate command) only if the Fabric Extender reports a matching serial number string. Caution Configuring a serial number that does not match the specified Fabric Extender forces the Fabric Extender offline.
Step 10	(Optional) <code>no serial</code> Example: <code>switch(config-fex)# no serial</code>	Deletes the serial number string.

Enabling the Fabric Extender Locator LED

The locator beacon LED on the Fabric Extender allows you to locate a specific Fabric Extender in a rack.

Procedure

	Command or Action	Purpose
Step 1	<code>locator-led fex FEX-number</code> Example: <code>switch# locator-led fex 101</code>	Turns on the locator beacon LED for a specific Fabric Extender.
Step 2	(Optional) <code>no locator-led fex FEX-number</code> Example: <code>switch# no locator-led fex 101</code>	Turns off the locator beacon LED for a specific Fabric Extender.

Redistributing the Links

When you provision the Fabric Extender with statically pinned interfaces, the downlink host interfaces on the Fabric Extender are pinned to the fabric interfaces in the order that they were initially configured. If you want to maintain a specific relationship of host interfaces to fabric interface across reboots, you should repin the links.

You may want to perform this function in these two situations:

- A change in the max-links configuration.
- If you need to maintain the pinning order of host interfaces to fabric interfaces.



Note The Cisco Nexus 2248PQ Fabric Extender does not support the static pinning fabric interface connection.

Changing the Number of Links

If you initially configured a specific port on the parent switch, for example port 33, as your only fabric interface, all 48 host interfaces are pinned to this port. If you provision another port, for example 35, you must enter the **pinning max-links 2** command to redistribute the host interfaces. All host interfaces are brought down and host interfaces 1 to 24 are pinned to fabric interface 33 and host interfaces 25 to 48 are pinned to fabric interface 35.

Maintaining the Pinning Order

The pinning order of the host interfaces is initially determined by the order in which the fabric interfaces were configured. In this example, four fabric interfaces were configured in the following order:

```
switch# show interface ethernet 1/35 fex-intf
Fabric          FEX
Interface       Interfaces
-----
Eth1/35         Eth101/1/12  Eth101/1/11  Eth101/1/10  Eth101/1/9
                Eth101/1/8   Eth101/1/7   Eth101/1/6   Eth101/1/5
                Eth101/1/4   Eth101/1/3   Eth101/1/2   Eth101/1/1

switch# show interface ethernet 1/33 fex-intf
Fabric          FEX
Interface       Interfaces
-----
Eth1/33         Eth101/1/24  Eth101/1/23  Eth101/1/22  Eth101/1/21
                Eth101/1/20  Eth101/1/19  Eth101/1/18  Eth101/1/17
                Eth101/1/16  Eth101/1/15  Eth101/1/14  Eth101/1/13

switch# show interface ethernet 1/38 fex-intf
Fabric          FEX
Interface       Interfaces
-----
Eth1/38         Eth101/1/36  Eth101/1/35  Eth101/1/34  Eth101/1/33
                Eth101/1/32  Eth101/1/31  Eth101/1/30  Eth101/1/29
                Eth101/1/28  Eth101/1/27  Eth101/1/26  Eth101/1/25

switch# show interface ethernet 1/40 fex-intf
Fabric          FEX
Interface       Interfaces
-----
Eth1/40         Eth101/1/48  Eth101/1/47  Eth101/1/46  Eth101/1/45
                Eth101/1/44  Eth101/1/43  Eth101/1/42  Eth101/1/41
                Eth101/1/40  Eth101/1/39  Eth101/1/38  Eth101/1/37
```

The next time that you reboot the Fabric Extender, the configured fabric interfaces are pinned to the host interfaces in an ascending order by port number of the fabric interface. If you want to configure the same fixed distribution of host interfaces without restarting the Fabric Extender, enter the **fex pinning redistribute** command.



Note It is a misconfiguration to have more fabric ports than pinning number even if the extra port is in DOWN state.

Redistributing Host Interfaces



Caution This command disrupts all the host interface ports of the Fabric Extender.

Procedure

	Command or Action	Purpose
Step 1	configure terminal Example: <pre>switch# configure terminal switch(config)#</pre>	Enters global configuration mode.
Step 2	fex pinning redistribute <i>FEX-number</i> Example: <pre>switch(config) # fex pinning redistribute 101 switch(config) #</pre>	Redistributes the host connections. The range of the <i>FEX-number</i> is from 100 to 199.

Verifying the Fabric Extender Configuration

Use the following commands to display configuration information about the defined interfaces on a Fabric Extender:

Command or Action	Purpose
show fex [<i>FEX-number</i>] [detail]	Displays information about a specific Fabric Extender or all attached units.
show interface <i>type number</i> fex-intf	Displays the Fabric Extender ports that are pinned to a specific switch interface.
show interface fex-fabric	Displays the switch interfaces that have detected a Fabric Extender uplink.
show interface ethernet <i>number</i> transceiver [fex-fabric]	Displays the SFP+ transceiver and diagnostic optical monitoring (DOM) information for the Fabric Extender uplinks.
show feature-set	Displays the status of the feature sets on the device.

Configuration Examples for the Fabric Extender

This example shows how to display all the attached Fabric Extender units:

```
switch# show fex
```

FEX Number	FEX Description	FEX State	FEX Model	FEX Serial
100	FEX0100	Online	N2K-C2248TP-1GE	JAF1339BDSK
101	FEX0101	Online	N2K-C2232P-10GE	JAF1333ADDD
102	FEX0102	Online	N2K-C2232P-10GE	JAS12334ABC

This example shows how to display the detailed status of a specific Fabric Extender:

```
switch# show fex 100 detail
FEX: 100 Description: FEX0100 state: Online
FEX version: 5.0(2)N1(1) [Switch version: 5.0(2)N1(1)]
FEX Interim version: 5.0(2)N1(0.205)
Switch Interim version: 5.0(2)N1(0.205)
Extender Model: N2K-C2224TP-1GE, Extender Serial: JAF1427BQLG
Part No: 73-13373-01
Card Id: 132, Mac Addr: 68:ef:bd:62:2a:42, Num Macs: 64
Module Sw Gen: 21 [Switch Sw Gen: 21]
post level: complete
pinning-mode: static Max-links: 1
Fabric port for control traffic: Eth1/29
Fabric interface state:
  Po100 - Interface Up. State: Active
  Eth1/29 - Interface Up. State: Active
  Eth1/30 - Interface Up. State: Active
Fex Port State Fabric Port Primary Fabric
Eth100/1/1 Up Po100 Po100
Eth100/1/2 Up Po100 Po100
Eth100/1/3 Up Po100 Po100
Eth100/1/4 Up Po100 Po100
Eth100/1/5 Up Po100 Po100
Eth100/1/6 Up Po100 Po100
Eth100/1/7 Up Po100 Po100
Eth100/1/8 Up Po100 Po100
Eth100/1/9 Up Po100 Po100
Eth100/1/10 Up Po100 Po100
Eth100/1/11 Up Po100 Po100
Eth100/1/12 Up Po100 Po100
Eth100/1/13 Up Po100 Po100
Eth100/1/14 Up Po100 Po100
Eth100/1/15 Up Po100 Po100
Eth100/1/16 Up Po100 Po100
Eth100/1/17 Up Po100 Po100
Eth100/1/18 Up Po100 Po100
Eth100/1/19 Up Po100 Po100
Eth100/1/20 Up Po100 Po100
Eth100/1/21 Up Po100 Po100
Eth100/1/22 Up Po100 Po100
Eth100/1/23 Up Po100 Po100
Eth100/1/24 Up Po100 Po100
Eth100/1/25 Up Po100 Po100
Eth100/1/26 Up Po100 Po100
Eth100/1/27 Up Po100 Po100
Eth100/1/28 Up Po100 Po100
Eth100/1/29 Up Po100 Po100
Eth100/1/30 Up Po100 Po100
Eth100/1/31 Up Po100 Po100
```

```

Eth100/1/32    Up      Po100    Po100
Eth100/1/33    Up      Po100    Po100
Eth100/1/34    Up      Po100    Po100
Eth100/1/35    Up      Po100    Po100
Eth100/1/36    Up      Po100    Po100
Eth100/1/37    Up      Po100    Po100
Eth100/1/38    Up      Po100    Po100
Eth100/1/39    Up      Po100    Po100
Eth100/1/40    Down    Po100    Po100
Eth100/1/41    Up      Po100    Po100
Eth100/1/42    Up      Po100    Po100
Eth100/1/43    Up      Po100    Po100
Eth100/1/44    Up      Po100    Po100
Eth100/1/45    Up      Po100    Po100
Eth100/1/46    Up      Po100    Po100
Eth100/1/47    Up      Po100    Po100
Eth100/1/48    Up      Po100    Po100

```

Logs:

```

02/05/2010 20:12:17.764153: Module register received
02/05/2010 20:12:17.765408: Registration response sent
02/05/2010 20:12:17.845853: Module Online Sequence
02/05/2010 20:12:23.447218: Module Online

```

This example shows how to display the Fabric Extender interfaces pinned to a specific switch interface:

```

switch# show interface port-channel 100 fex-intf
Fabric          FEX
Interface       Interfaces
-----
Po100           Eth100/1/48  Eth100/1/47  Eth100/1/46  Eth100/1/45
                Eth100/1/44  Eth100/1/43  Eth100/1/42  Eth100/1/41
                Eth100/1/40  Eth100/1/39  Eth100/1/38  Eth100/1/37
                Eth100/1/36  Eth100/1/35  Eth100/1/34  Eth100/1/33
                Eth100/1/32  Eth100/1/31  Eth100/1/30  Eth100/1/29
                Eth100/1/28  Eth100/1/27  Eth100/1/26  Eth100/1/25
                Eth100/1/24  Eth100/1/22  Eth100/1/20  Eth100/1/19
                Eth100/1/18  Eth100/1/17  Eth100/1/16  Eth100/1/15
                Eth100/1/14  Eth100/1/13  Eth100/1/12  Eth100/1/11
                Eth100/1/10  Eth100/1/9   Eth100/1/8   Eth100/1/7
                Eth100/1/6   Eth100/1/5   Eth100/1/4   Eth100/1/3
                Eth100/1/2   Eth100/1/1

```

This example shows how to display the switch interfaces that are connected to a Fabric Extender uplink:

```

switch# show interface fex-fabric
Fabric          Fabric          Fex          FEX
Fex  Port        Port State    Uplink      Model        Serial
-----
100  Eth1/29      Active       3           N2K-C2248TP-1GE  JAF1339BDSK
100  Eth1/30      Active       4           N2K-C2248TP-1GE  JAF1339BDSK
102  Eth1/33      Active       1           N2K-C2232P-10GE  JAS12334ABC
102  Eth1/34      Active       2           N2K-C2232P-10GE  JAS12334ABC
102  Eth1/35      Active       3           N2K-C2232P-10GE  JAS12334ABC
102  Eth1/36      Active       4           N2K-C2232P-10GE  JAS12334ABC
101  Eth1/37      Active       5           N2K-C2232P-10GE  JAF1333ADDD
101  Eth1/38      Active       6           N2K-C2232P-10GE  JAF1333ADDD
101  Eth1/39      Active       7           N2K-C2232P-10GE  JAF1333ADDD
101  Eth1/40      Active       8           N2K-C2232P-10GE  JAF1333ADDD

```

This example shows how to display the SFP+ transceiver and diagnostic optical monitoring (DOM) information for Fabric Extender uplinks for an SFP+ transceiver that is plugged into the parent switch interface:

```
switch# show interface ethernet 1/40 transceiver
Ethernet1/40
  sfp is present
  name is CISCO-MOLEX INC
  part number is 74752-9026
  revision is A0
  serial number is MOC13321057
  nominal bitrate is 12000 Mbits/sec
  Link length supported for copper is 3 m(s)
  cisco id is --
  cisco extended id number is 4
```

This example shows how to display the SFP+ transceiver and DOM information for Fabric Extender uplinks for an SFP+ transceiver that is plugged into the uplink port on the Fabric Extender:

```
switch# show interface ethernet 1/40 transceiver fex-fabric
Ethernet1/40
  sfp is present
  name is CISCO-MOLEX INC
  part number is 74752-9026
  revision is A0
  serial number is MOC13321057
  nominal bitrate is 12000 Mbits/sec
  Link length supported for 50/125mm fiber is 0 m(s)
  Link length supported for 62.5/125mm fiber is 0 m(s)
  cisco id is --
  cisco extended id number is 4
```

Verifying the Chassis Management Information

Use the following to display configuration information used on the switch supervisor to manage the Fabric Extender.

Command or Action	Purpose
show diagnostic result fex <i>FEX-number</i>	Displays results from the diagnostic test for a Fabric Extender.
show environment fex {all <i>FEX-number</i> } [temperature power fan]	Displays the environmental sensor status.
show inventory fex <i>FEX-number</i>	Displays inventory information for a Fabric Extender.
show module fex [<i>FEX-number</i>]	Displays module information about a Fabric Extender.
show sprom fex <i>FEX-number</i> {all backplane powersupply <i>ps-num</i> } all	Displays the contents of the serial PROM (SPROM) on the Fabric Extender. The unit of the power for the show sprom command is displayed in centi-amperes.

Configuration Examples for Chassis Management

This example shows how to display the module information about all connected Fabric Extender units:

```
switch# show module fex
FEX Mod Ports Card Type Model Status.
-----
100 1 48 Fabric Extender 48x1GE + 4x10G Mod N2K-C2248TP-1GE present
101 1 32 Fabric Extender 32x10GE + 8x10G Mo N2K-C2232P-10GE present
102 1 32 Fabric Extender 32x10GE + 8x10G Mo N2K-C2232P-10GE present

FEX Mod Sw Hw World-Wide-Name(s) (WWN)
-----
100 1 4.2(1)N1(1) 0.103 --
101 1 4.2(1)N1(1) 1.0 --
102 1 4.2(1)N1(1) 1.0 --

FEX Mod MAC-Address(es) Serial-Num
-----
100 1 000d.ece3.2800 to 000d.ece3.282f JAF1339BDSK
101 1 000d.ecca.73c0 to 000d.ecca.73df JAF1333ADDD
102 1 000d.ecd6.bec0 to 000d.ecd6.bedf JAS12334ABC
```

This example shows how to display the module information about a specific Fabric Extender:

```
switch# show module fex 100
FEX Mod Ports Card Type Model Status.
-----
100 1 48 Fabric Extender 48x1GE + 4x10G Mod N2K-C2248TP-1GE present

FEX Mod Sw Hw World-Wide-Name(s) (WWN)
-----
100 1 4.2(1)N1(1) 0.103 --

FEX Mod MAC-Address(es) Serial-Num
-----
100 1 000d.ece3.2800 to 000d.ece3.282f JAF1339BDSK
```

This example shows how to display the inventory information about a specific Fabric Extender:

```
switch# show inventory fex 101
NAME: "FEX 101 CHASSIS", DESCR: "N2K-C2248TP-1GE CHASSIS"
PID: N2K-C2248TP-1GE , VID: V00 , SN: SSI13380FSM

NAME: "FEX 101 Module 1", DESCR: "Fabric Extender Module: 48x1GE, 4x10GE Supervisor"
PID: N2K-C2248TP-1GE , VID: V00 , SN: JAF1339BDSK

NAME: "FEX 101 Fan 1", DESCR: "Fabric Extender Fan module"
PID: N2K-C2248-FAN , VID: N/A , SN: N/A

NAME: "FEX 101 Power Supply 2", DESCR: "Fabric Extender AC power supply"
PID: NXK-PAC-400W , VID: 000 , SN: LIT13370QD6
```

This example shows how to display diagnostic test results for a specific Fabric Extender:

```
switch# show diagnostic result fex 101
FEX-101: 48x1GE/Supervisor SerialNo : JAF1339BDSK
Overall Diagnostic Result for FEX-101 : OK

Test results: (. = Pass, F = Fail, U = Untested)
```

```

TestPlatform:
0)          SPROM: -----> .
1)  Inband interface: -----> .
2)          Fan: -----> .
3)    Power Supply: -----> .
4) Temperature Sensor: -----> .

TestForwardingPorts:
Eth   1  2  3  4  5  6  7  8  9 10 11 12 13 14 15 16 17 18 19 20 21 22 23 24
Port -----
. . . . .

Eth   25 26 27 28 29 30 31 32 33 34 35 36 37 38 39 40 41 42 43 44 45 46 47 48
Port -----
. . . . .

TestFabricPorts:
Fabric 1  2  3  4
Port -----
. . . .
    
```

This example shows how to display the environment status for a specific Fabric Extender:

```
switch# show environment fex 101
```

```

Temperature Fex 101:
-----
Module  Sensor      MajorThresh  MinorThres  CurTemp  Status
      (Celsius)      (Celsius)      (Celsius)
-----
1      Outlet-1      60           50          33       ok
1      Outlet-2      60           50          38       ok
1      Inlet-1       50           40          35       ok
1      Die-1        100          90          44       ok

Fan Fex: 101:
-----
Fan      Model              Hw      Status
-----
Chassis  N2K-C2148-FAN      --      ok
PS-1     --                 --      absent
PS-2     NXK-PAC-400W       --      ok

Power Supply Fex 101:
-----
Voltage: 12 Volts
-----
PS  Model              Power      Power      Status
      (Watts)      (Amp)
-----
1  --                 --         --         --
2  NXK-PAC-400W       4.32      0.36      ok

Mod Model              Power      Power      Power      Power      Status
      Requested Requested  Allocated  Allocated
      (Watts)      (Amp)      (Watts)      (Amp)
-----
1  N2K-C2248TP-1GE    0.00      0.00      0.00      0.00      powered-up
    
```

```

Power Usage Summary:
-----
Power Supply redundancy mode:          redundant

Total Power Capacity                   4.32 W

Power reserved for Supervisor(s)      0.00 W
Power currently used by Modules       0.00 W

-----
Total Power Available                  4.32 W
-----

```

This example shows how to display the SPROM for a specific Fabric Extender:

```

switch# show sprom fex 101 all
DISPLAY FEX 101 SUP sprom contents
Common block:
Block Signature : 0xabab
Block Version   : 3
Block Length    : 160
Block Checksum  : 0x1a1e
EEPROM Size     : 65535
Block Count     : 3
FRU Major Type  : 0x6002
FRU Minor Type  : 0x0
OEM String      : Cisco Systems, Inc.
Product Number  : N2K-C2248TP-1GE
Serial Number   : JAF1339BDSK
Part Number     : 73-12748-01
Part Revision   : 11
Mfg Deviation   : 0
H/W Version     : 0.103
Mfg Bits        : 0
Engineer Use    : 0
snmpOID         : 9.12.3.1.9.78.3.0
Power Consump   : 1666
RMA Code        : 0-0-0-0
CLEI Code       : XXXXXXXXXBTBDV00
VID             : V00
Supervisor Module specific block:
Block Signature : 0x6002
Block Version   : 2
Block Length    : 103
Block Checksum  : 0x2686
Feature Bits    : 0x0
HW Changes Bits : 0x0
Card Index      : 11016
MAC Addresses   : 00-00-00-00-00-00
Number of MACs  : 0
Number of EPLD  : 0
Port Type-Num   : 1-48;2-4
Sensor #1       : 60,50
Sensor #2       : 60,50
Sensor #3       : -128,-128
Sensor #4       : -128,-128
Sensor #5       : 50,40
Sensor #6       : -128,-128
Sensor #7       : -128,-128
Sensor #8       : -128,-128
Max Connector Power: 4000
Cooling Requirement: 65
Ambient Temperature: 40

```



```

00 00 00 00 00 00 00 00
00 00 00 00 00 00 00 00
00 00 00 00 00 00 00 00
00 00 00 00 00 00 00 00
00 00 00 00 00 00 00 00
00 00 00 00 00 00 00 00
00 00 00 00 00 00 00 00
00 00 00 00 00 00 00 00
00 00 00 00 00 00 00 00
00 00 00 00 00 00 00 00
00 00 00 00 00 00 00 00
00 00
License software-module specific block:
Block Signature : 0x6006
Block Version   : 1
Block Length    : 16
Block Checksum  : 0x86f
lic usage bits:
ff ff ff ff ff ff ff ff

DISPLAY FEX 101 power-supply 2 srom contents:
Common block:
Block Signature : 0xabab
Block Version   : 3
Block Length    : 160
Block Checksum  : 0x1673
EEPROM Size    : 65535
Block Count     : 2
FRU Major Type  : 0xab01
FRU Minor Type  : 0x0
OEM String      : Cisco Systems Inc   NXK-PAC-400W
Product Number  : NXK-PAC-400W
Serial Number   :      LIT13370QD6
Part Number     :      341
Part Revision   : -037
CLEI Code       : 5-01      01  000
VID             : 000
snmpOID         : 12336.12336.12336.12336.12336.12336.12374.12336
H/W Version     : 43777.2
Current         : 36
RMA Code        : 200-32-32-32
Power supply specific block:
Block Signature : 0x0
Block Version   : 0
Block Length    : 0
Block Checksum  : 0x0
Feature Bits    : 0x0
Current 110v    : 36
Current 220v    : 36
Stackmib OID    : 0

```

Configuring the Cisco Nexus N2248TP-E Fabric Extender

The Cisco Nexus 2248TP-E Fabric Extender supports all of the CLI commands of the Cisco Nexus 2248TP Fabric Extender with additional commands to configure the following:

- Shared buffer (FEX global level)
- Queue limit in ingress direction (FEX global level and interface level)

- Queue limit in egress direction (FEX global level and interface level)
- No drop class over a distance of 3000 meters between the FEX and switch (FEX global level)

Configuring the Shared Buffer

The following are guidelines for the configuration of the shared buffer:

- Configuring the shared buffer is done at the FEX global level.
- The total available buffer is 32 MB which is shared in both the ingress and egress directions.
- The default size of the shared buffer is 25392KB.

However, when configuring an Ethernet-based pause no-drop class, the shared buffer size changes to 10800 KB. This change is required to increase the dedicated buffer that supports the pause no-drop class. The pause no-drop class does not use buffer space from the shared-pool.



Note Performing these commands might result in traffic disruption on all ports.

Procedure

	Command or Action	Purpose
Step 1	configure terminal Example: switch# configure terminal switch(config)#	Enters global configuration mode.
Step 2	fex chassis_id Example: switch(config)# fex 100 switch(config-fex)#	Enters configuration mode for the specified FEX. The range of the <i>chassis_id</i> value is 100 to 199.
Step 3	hardware N2248TP-E shared-buffer-size buffer-size Example: switch(config-fex)# hardware N2248TP-E shared-buffer-size 25000	Specifies the shared buffer size (KB). The range of the <i>buffer-size</i> value is 10800 KB to 25392 KB. Note The hardware N2248TP-E shared-buffer-size command specifies the default shared buffer size of 25392 KB.

Example

This example shows how to configure the shared buffer.

```
switch# configure terminal
switch(config)# fex 100
```

```
switch(config-fex) # hardware N2248TP-E shared-buffer-size 25000
switch(config-fex) #
```

Configuring the Queue Limit at the Global Level

The following are guidelines for the configuration of the queue limit:

- The tx queue limit specifies the buffer size used for each queue in the egress (n2h) direction.
- The rx queue limit specifies the buffer size used for each port in the ingress (h2n) direction.
- You can adjust the ingress queue limit when the FEX uplink experiences temporary congestion.
- You can adjust the egress queue limit for improved burst absorption or in a situation where there is a many to one traffic pattern.
- When you disable the tx queue limit, any output port is able to use the entire shared buffer.

Procedure

	Command or Action	Purpose
Step 1	configure terminal Example: <pre>switch# configure terminal switch(config)#</pre>	Enters global configuration mode.
Step 2	fex chassis_id Example: <pre>switch(config)# fex 100 switch(config)#</pre>	Enters configuration mode for the specified FEX. The range of the <i>chassis_id</i> value is 100 to 199.
Step 3	hardware N2248TP-E queue-limit queue-limit tx rx Example: <pre>switch(config-fex) # hardware N2248TP-E queue-limit 83000 tx</pre>	Controls the egress (tx) or ingress (rx) queue tail drop threshold level on a FEX. <ul style="list-style-type: none"> • The default queue limit for tx (egress) is 4 MB. <p>Note The hardware N2248TP-E queue-limit command specifies the default tx queue limit.</p> <ul style="list-style-type: none"> • The default queue-limit for rx (ingress) is 1 MB. <p>Note The hardware N2248TP-E queue-limit rx command specifies the default rx queue limit.</p>

Example

This example shows how to configure the queue limit.

```
switch# configure terminal
switch(config)# fex 100
switch(config-fex)# hardware N2248TP-E queue-limit 83000 tx
switch(config-fex)#
```

Configuring the Queue Limit at the Port Level

You can overwrite the global level configuration by configuring the queue limit at the port level.

You can also disable the queue limit at the port level.

Procedure

	Command or Action	Purpose
Step 1	configure terminal Example: switch# configure terminal switch(config)#	Enters global configuration mode.
Step 2	interface ethernet <i>chassis_id / slot/port</i> Example: switch(config)# interface ethernet 100/1/1	Enters interface configuration mode.
Step 3	hardware N2248TP-E queue-limit <i>queue-limit</i> tx rx Example: switch(config-if)# hardware N2248TP-E queue-limit 83000 tx	Controls the egress (tx) or ingress (rx) queue tail drop threshold level on a FEX. <ul style="list-style-type: none"> • The default queue limit for tx (egress) is 4 MB. • The default queue limit for rx (ingress) is 1 MB.

Example

This example shows how to configure the queue limit.

```
switch# configure terminal
switch(config)# interface ethernet 100/1/1
switch(config-if)# hardware N2248TP-E queue-limit 83000 tx
switch(config-if)#
```

Configuring the Uplink Distance

The Cisco Nexus N2248TP-E FEX supports a pause no-drop class up to a distance of 3000 meters between the FEX and the switch.

The default cable length between the FEX and the switch is 300 meters.



Note When the pause no-drop class is not configured, the uplink distance configuration has no effect.

Procedure

	Command or Action	Purpose
Step 1	configure terminal Example: switch# configure terminal switch(config)#	Enters global configuration mode.
Step 2	fex chassis_id Example: switch(config)# fex 100 switch(config-fex)#	Enters configuration mode for the specified FEX. The range of the <i>chassis_id</i> value is 100 to 199.
Step 3	hardware N2248TP-E uplink-pause-no-drop distance distance-value Example: switch(config-fex)# hardware N2248TP-E uplink-pause-no-drop distance 3000	Specifies the no-drop distance between the FEX and the switch. The maximum distance is 3000 meters. Note The hardware N2248TP-E uplink-pause-no-drop distance command specifies the default 300 meter cable length.

Example

This example shows how to configure the uplink distance.

```
switch# configure terminal
switch(config)# fex 100
switch(config-fex)# hardware N2248TP-E uplink-pause-no-drop distance 3000
switch(config-fex)#
```

Configuring the Cisco Nexus N2248PQ Fabric Extender

The Cisco Nexus 2248PQ Fabric Extender supports all of the CLI commands of the Cisco Nexus 2248TP Fabric Extender with additional commands to configure the following:

- Shared buffer (FEX global level)

- Load-balancing queues (FEX global level)
- No drop class over a distance of 3000 meters between the FEX and switch (FEX global level)

Configuring the Shared Buffer

The following are guidelines for the configuration of the shared buffer:

- Configuring the shared buffer is done at the FEX global level.
- The total available buffer is 16 MB which is shared in both the ingress and egress directions.
- The default size of the shared buffer is 10240KB.



Note Performing these commands might result in traffic disruption on all ports.

Procedure

	Command or Action	Purpose
Step 1	configure terminal Example: switch# configure terminal switch(config)#	Enters global configuration mode.
Step 2	fex chassis_id Example: switch(config)# fex 100 switch(config-fex)#	Enters configuration mode for the specified FEX. The range of the <i>chassis_id</i> value is 100 to 199.
Step 3	hardware N2248PQ shared-buffer-size buffer-size Example: switch(config-fex)# hardware N2248PQ shared-buffer-size 8096	Specifies the shared buffer size (KB). The range of the <i>buffer-size</i> value is 3072 KB to 10240 KB. Note The hardware N2248PQ shared-buffer-size command specifies the default shared buffer size of 10240 KB.

Example

This example shows how to configure the shared buffer.

```
switch# configure terminal
switch(config)# fex 100
switch(config-fex)# hardware N2248PQ shared-buffer-size 8096
switch(config-fex)#
```

Configuring the Uplink Distance

The Cisco Nexus N2248PQ FEX supports a pause no-drop class up to a distance of 3000 meters between the FEX and the switch.

The default cable length between the FEX and the switch is 300 meters.



Note When the pause no-drop class is not configured, the uplink distance configuration has no effect.

Procedure

	Command or Action	Purpose
Step 1	configure terminal Example: <pre>switch# configure terminal switch(config)#</pre>	Enters global configuration mode.
Step 2	fex chassis_id Example: <pre>switch(config)# fex 100 switch(config-fex)#</pre>	Enters configuration mode for the specified FEX. The range of the <i>chassis_id</i> value is 100 to 199.
Step 3	hardware N2248PQ uplink-pause-no-drop distance distance-value Example: <pre>switch(config-fex)# hardware N2248PQ uplink-pause-no-drop distance 3000</pre>	Specifies the no-drop distance between the FEX and the switch. The maximum distance is 3000 meters. Note The hardware N2248PQ uplink-pause-no-drop distance command specifies the default 300 meter cable length.

Example

This example shows how to configure the uplink distance.

```
switch# configure terminal
switch(config)# fex 100
switch(config-fex)# hardware N2248PQ uplink-pause-no-drop distance 3000
switch(config-fex)#
```

Configuring Slow Drain

During slow drain detection, the driver checks for the pause condition for each No-Drop class per port at an interval of 200 ms. The following steps describe how to configure slow drain on a FEX.

Procedure

	Command or Action	Purpose
Step 1	<code>switch# configure terminal</code>	Enters global configuration mode.
Step 2	<code>switch(config)# fex chassis_id</code>	Enters configuration mode for the specified FEX. The range of the <i>chassis_id</i> value is 100 to 199.
Step 3	<code>switch(config-fex)# hardware fex slow-port-error-disable-time val</code>	Specifies the FEX and the time threshold. The value of <i>fex</i> is the PID of the configured FEX. The range of <i>val</i> is from 200ms to 1000ms. The default value is 1000 ms. Note The supported FEX PIDs are N2348UPQ, N2348TQ, N2332TQ, and N2348TQ-E. These fabric extenders are Tiburon supported FEX.

Example

This example shows how to configure the slow drain feature on the N2348TQ FEX:

```
switch# configure terminal
switch(config)# fex 100
switch(config-fex)# hardware N2348TQ slow-port-error-disable-time 500
```

Load-balancing queues at the FEX global level

The Cisco Nexus 2248PQ provides 8 load balancing queues. These load balancing queues are designed to resolve port congestion.

Procedure

	Command or Action	Purpose
Step 1	configure terminal Example: <code>switch# configure terminal</code> <code>switch(config)#</code>	Enters global configuration mode.
Step 2	fex chassis_id Example: <code>switch(config)# fex 100</code> <code>switch(config)#</code>	Enters configuration mode for the specified FEX. The range of the <i>chassis_id</i> value is 100 to 199.

	Command or Action	Purpose
Step 3	hardware N2248PQ uplink-load-balance-mode Example: <pre>switch(config-fex)# hardware N2248PQ uplink-load-balance-mode</pre>	Enables and disables load balancing queues at the FEX global level.

Example

This example shows how to configure the load balance queues.

```
switch# configure terminal
switch(config)# fex 100
switch(config-fex)# hardware N2248PQ uplink-load-balance-mode
switch(config-fex)#
```



CHAPTER 15

Configuring VM-FEX

This chapter contains the following sections:

- [Information About VM-FEX, on page 201](#)
- [Licensing Requirements for VM-FEX, on page 203](#)
- [Default Settings for VM-FEX, on page 203](#)
- [Configuring VM-FEX, on page 204](#)
- [Verifying the VM-FEX Configuration, on page 213](#)

Information About VM-FEX

VM-FEX Overview

Based on the (prestandard) IEEE 802.1Qbh port extender technology, Cisco Virtual Machine Fabric Extender (VM-FEX) extends the fabric from the switch chassis to the Virtual Machine (VM). Each VM is associated with a network adapter vNIC, which is associated with a virtual Ethernet (vEthernet or vEth) port on the parent switch. This dedicated virtual interface can be managed, monitored, and spanned in the same way as a physical interface. Local switching in the hypervisor is eliminated, with all switching being performed by the physical switch.

VM-FEX Components

Server

VM-FEX is supported by Cisco UCS C-Series rack-mount servers with the VMware virtualization environment as the hypervisor.

The configuration of the server is performed using the Cisco Integrated Management Controller (CIMC) interface, which provides both a GUI and a CLI interface. The configuration of the hypervisor and virtualization services is performed using the VMware vSphere client.

For information about CIMC and VM-FEX configuration, see the following documents:

- *Cisco UCS C-Series Servers Integrated Management Controller GUI Configuration Guide*
- *Cisco UCS Manager VM-FEX for VMware GUI Configuration Guide*

Supported OS

The supported OS for VM-FEX are:

- VMware ESXi 5.5
- VMware ESXi 5.5u1
- VMware ESXi 5.1u2

Virtual Interface Card Adapter

VM-FEX is supported by the Cisco UCS VIC 1225, 1227, a dual-port 10 Gigabit Ethernet PCIe adapter that supports static or dynamic virtualized interfaces, including up to 128 virtual network interface cards (vNICs).

The configuration of the VIC and its vNICs is performed using the CIMC interface on the Cisco UCS C-Series servers.

FEX

The physical ports of the server can be connected directly to the switch or to a fabric extender (FEX) connected to the switch. VM-FEX is supported by the Cisco Nexus Fabric Extender.

VM-FEX and AFEX require that the FEX is connected with a fabric PO and not individual links.

Switch

VM-FEX is supported by the Cisco Nexus device. Although a single switch chassis can be connected with VM-FEX, a typical application uses a pair of switches deployed as a virtual port channel (vPC) domain.

On the switch, a vEthernet interface represents the vNIC. All operations performed by the network administrator are performed on the vEthernet interface.

VM-FEX Terminology

The following terms are used in describing VM-FEX components and interfaces:

virtual Ethernet interface

A virtual Ethernet interface (vEthernet or vEth) represents the switch port that is connected to the vNIC of a virtual machine. Unlike a traditional switch interface, a vEth interface's name does not indicate the module with which the port is associated. Where a traditional physical switch port is specified as GigX/Y, where X is the module number and Y is the port number on the module, a vEth interface is specified as vEthY. This notation allows the interface to keep the same name when the VM migrates to another physical server.

dynamic interface

A dynamic interface is a vEthernet interface that is configured automatically as a result of adapter and switch communications. The provisioning model of a dynamic interface consists of the configuration on the switch of a vEthernet port profile, which is propagated to the network adapter as a port group, followed by the association of the port group with the vNIC. The port profile is created in the switch by the network administrator, while the association with the vNIC is performed on the adapter by the server administrator.

static interface

A static interface is configured manually on the switch and the adapter. A static virtual adapter can be a vNIC or a virtual host adapter bus (vHBA). A static interface can be a vEthernet or a virtual Fibre Channel (vFC) interface bound to a static vEthernet interface.

In one method of creating a static vEthernet, the network administrator assigns a channel number (equivalent to a VN-Tag or prestandard IEEE 802.1BR tag number) to the vEthernet. The server administrator must be sure to define a vNIC on the adapter with the same channel number.

In another method, the network administrator can create a static floating vEthernet by configuring the vEthernet with a virtual switching instance (VSI) MAC address and DVPort ID.

floating vEthernet interface

In a hypervisor environment, each vNIC on the network adapter is associated with one virtual machine (VM). VMs can migrate from one physical server to another. A virtual interface that migrates with a VM and virtual network link is called a floating vEthernet interface.

fixed vEthernet interface

A fixed vEthernet interface is a virtual interface that does not support migration across physical interfaces. For fixed vEthernet (static or dynamic), an administrator can change configurations at any time. The binding of the vEthernet interface number to a channel number is persistent unless the administrator changes it.

Licensing Requirements for VM-FEX

The following table shows the licensing requirements for this feature:

Product	License Requirement
Cisco NX-OS	<p>A VM-FEX license is required for each Cisco Nexus device. The license package name is VMFEX_FEATURE_PKG. A grace period of 120 days starts when you first configure the licensed feature.</p> <p>For a complete explanation of the Cisco NX-OS licensing scheme and how to obtain and apply licenses, see the <i>Cisco NX-OS Licensing Guide</i>.</p>

Default Settings for VM-FEX

The following table lists the default settings for parameters that are relevant to VM-FEX:

Parameters	Default
Virtualization feature set	Disabled
FEX	Disabled
VM-FEX	Disabled
LLDP	Enabled
vPC	Disabled

Parameters	Default
svs vethernet auto-setup	Enabled
FCoE	Disabled

Configuring VM-FEX

Overview of the VM-FEX Configuration Steps

The following steps outline the necessary sequence of procedures for configuring VM-FEX between the switch and the server hosting the VMs. Procedures to be performed on the switch are described in this document. For procedures to be performed on the server or the VMware vCenter, refer to the server and vCenter documentation.

Procedure

-
- Step 1** Server: Create vNICs on VIC adapter.
- Create two static vNICs to be used as uplinks from the host.
 - Create up to 112 VM-FEX interfaces.
 - Reboot the server.
- Step 2** Switch: Enable VM-FEX and other required services.
- See [Enabling Features Required for VM-FEX, on page 205](#).
- Step 3** Switch: Configure two static vEthernet interfaces and bind them to the physical port and channel.
- See [Configuring the Fixed Static Interfaces, on page 206](#).
- Step 4** Switch: Define port profiles to be associated with the VMs.
- See [Configuring a Port Profile for the Dynamic Interfaces, on page 209](#).
- Step 5** Switch: Verify that the two static vEthernet interfaces are active and associated with the vEthernet interfaces of the switch.
- See [Verifying the Status of the Virtual Interfaces, on page 213](#).
- Step 6** Switch and vCenter: Install XML certificate from switch to vCenter.
- Switch: Enable HTTP using the **feature http** command in global configuration mode.
 - From a web browser, access the IP address of the switch and download the displayed XML certificate.
 - Switch: Disable HTTP using the **no feature http** command in global configuration mode.
 - vCenter: Install the XML certificate plugin.
- Step 7** Switch: Enable vPC and register the vPC system to the vCenter as a distributed virtual switch (DVS).
- See [Configuring an SVS Connection to the vCenter Server, on page 210](#).
- Step 8** vCenter: Create a datacenter on the vCenter.

- Step 9** Switch: Activate and verify the SVS connection to the vCenter.
See [Activating an SVS Connection to the vCenter Server, on page 212](#) and [Verifying the Connection to the vCenter Server, on page 215](#).
- Step 10** vCenter: Verify that the port profiles (port groups) are propagated to the vCenter.
- Step 11** Server: Add resources to the DVS.
a) Add the ESX host to the DVS.
b) Add the static vNICs as uplinks to the DVS.
c) Associate VMs to the port groups defined by the switch.
d) Activate the VMs.
- Step 12** Switch: Verify that the dynamic vNICs are active, assigned to VMs, and connected to the vEthernet interfaces of the switch.
See [Verifying the Status of the Virtual Interfaces, on page 213](#).
- Step 13** Server: Verify that the interfaces are active and assigned to the VMs.
- Step 14** vCenter: Verify that the dynamic vNICs are active.

Enabling Features Required for VM-FEX

Procedure

	Command or Action	Purpose
Step 1	<code>switch# configure terminal</code>	Enters global configuration mode.
Step 2	<code>install feature-set virtualization</code>	Installs the virtualization feature set on the switch.
Step 3	<code>feature-set virtualization</code>	Enables the virtualization feature set on the switch. This feature set enables the use of static vEthernet interfaces.
Step 4	<code>feature fex</code>	Enables FEX features on the switch.
Step 5	<code>feature vmfex</code>	Enables VM-FEX features on the switch. This feature set enables the use of dynamic vEthernet interfaces.
Step 6	<code>feature vpc</code>	Enables a virtual port channel (vPC) on the switch.
Step 7	(Optional) <code>vethernet auto-create</code>	Globally enables the automatic creation of virtual Ethernet interfaces. This feature is not required if the fixed vEthernet interfaces are statically configured.
Step 8	(Optional) <code>feature fcoe</code>	Enables Fibre Channel over Ethernet (FCoE) on the switch.

	Command or Action	Purpose
Step 9	(Optional) <code>end</code>	Return to privileged EXEC mode.
Step 10	(Optional) <code>copy running-config startup-config</code>	Copies the running configuration to the startup configuration.
Step 11	(Optional) <code>reload</code>	Reloads the switch.

Example

This example shows how to enable the features required for VM-FEX:

```
switch# configure terminal
switch(config)# install feature-set virtualization
switch(config)# feature-set virtualization
switch(config)# feature fex
switch(config)# feature vmfex
switch(config)# feature vpc
switch(config)# vethernet auto-create
switch(config)# feature fcoe
switch(config)# end
switch# copy running-config startup-config
switch# reload
```

Configuring the Fixed Static Interfaces

You can configure two physical interfaces and binds two virtual interfaces to each physical interface, creating fixed static vEthernet interfaces. For more information on configuring fixed static interfaces, see the Adapter-FEX Configuration Guide for your device.

With redundant switches, you can perform the following procedure with identical settings on both the primary and secondary switches.

Before you begin

- VM-FEX and other required services must be enabled on the switches.
- Two static vNICs must be configured on the VIC adapter installed in the host server.

Procedure

	Command or Action	Purpose
Step 1	<code>switch# configure terminal</code>	Enters global configuration mode.
Step 2	<code>interface ethernet slot/port</code>	Enters interface configuration mode for the first Ethernet port. Note If this is a QSFP+ GEM or a breakout port, the <i>port</i> syntax is <i>QSFP-module/port</i> .

	Command or Action	Purpose
Step 3	shutdown	Disables local traffic on the interface. Note Shutting down the interface before enabling VN-Tag mode prevents the dynamic creation of a fixed vEthernet interface.
Step 4	switchport mode vntag	Enables port extender support on the interface.
Step 5	interface ethernet <i>slot/port</i>	Enters interface configuration mode for the second Ethernet port. Note If this is a QSFP+ GEM or a breakout port, the <i>port</i> syntax is <i>QSFP-module/port</i> .
Step 6	shutdown	Disables local traffic on the interface.
Step 7	switchport mode vntag	Enables port extender support on the interface.
Step 8	interface vethernet <i>interface-number</i>	Enters configuration mode for the first virtual interface for the first Ethernet port.
Step 9	bind interface ethernet <i>slot/port channel channel-number</i>	Binds the virtual interface to the physical interface and the specified port channel. Note The port channel numbers of the virtual interfaces must match those configured on the vNICs. Note If this is a QSFP+ GEM or a breakout port, the <i>port</i> syntax is <i>QSFP-module/port</i> .
Step 10	no shutdown	Enables local traffic on the interface.
Step 11	interface vethernet <i>interface-number</i>	Enters configuration mode for the second virtual interface for the first Ethernet port.
Step 12	bind interface ethernet <i>slot/port channel channel-number</i>	Binds the virtual interface to the physical interface and the specified port channel. Note If this is a QSFP+ GEM or a breakout port, the <i>port</i> syntax is <i>QSFP-module/port</i> .
Step 13	no shutdown	Enables local traffic on the interface.
Step 14	interface vethernet <i>interface-number</i>	Enters configuration mode for the first virtual interface for the second Ethernet port.

	Command or Action	Purpose
Step 15	bind interface ethernet <i>slot/port channel channel-number</i>	Binds the virtual interface to the physical interface and the specified port channel. Note If this is a QSFP+ GEM or a breakout port, the <i>port</i> syntax is <i>QSFP-module/port</i> .
Step 16	no shutdown	Enables local traffic on the interface.
Step 17	interface vethernet <i>interface-number</i>	Enters configuration mode for the second virtual interface for the second Ethernet port.
Step 18	bind interface ethernet <i>slot/port channel channel-number</i>	Binds the virtual interface to the physical interface and the specified port channel. Note If this is a QSFP+ GEM or a breakout port, the <i>port</i> syntax is <i>QSFP-module/port</i> .
Step 19	no shutdown	Enables local traffic on the interface.
Step 20	interface ethernet <i>slot/port</i>	Enters configuration mode for the first Ethernet port. Note If this is a QSFP+ GEM or a breakout port, the <i>port</i> syntax is <i>QSFP-module/port</i> .
Step 21	no shutdown	Enables local traffic on the interface.
Step 22	interface ethernet <i>slot/port</i>	Enters configuration mode for the second Ethernet port. Note If this is a QSFP+ GEM or a breakout port, the <i>port</i> syntax is <i>QSFP-module/port</i> .
Step 23	no shutdown	Enables local traffic on the interface.
Step 24	With redundant switches, repeat this procedure with identical settings on the secondary switch.	

Example

This example shows how to configure two physical interfaces, binds two virtual interfaces to each physical interface, and enables the interfaces:

```
switch-1# configure terminal
switch-1(config)# interface ethernet 1/17
switch-1(config-if)# shutdown
switch-1(config-if)# switchport mode vntag
switch-1(config-if)# interface ethernet 1/18
```

```

switch-1(config-if) # shutdown
switch-1(config-if) # switchport mode vntag

switch-1(config-if) # interface vethernet 1
switch-1(config-if) # bind interface ethernet 1/17 channel 10
switch-1(config-if) # no shutdown
switch-1(config-if) # interface vethernet 3
switch-1(config-if) # bind interface ethernet 1/17 channel 11
switch-1(config-if) # no shutdown

switch-1(config-if) # interface vethernet 2
switch-1(config-if) # bind interface ethernet 1/18 channel 10
switch-1(config-if) # no shutdown
switch-1(config-if) # interface vethernet 4
switch-1(config-if) # bind interface ethernet 1/18 channel 11
switch-1(config-if) # no shutdown

switch-1(config-if) # interface ethernet 1/17
switch-1(config-if) # no shutdown
switch-1(config-if) # interface ethernet 1/18
switch-1(config-if) # no shutdown

switch-1(config-if) #

```

What to do next

Verify the status of the connection between the static interfaces and the static vNICs on the host server.

Configuring a Port Profile for the Dynamic Interfaces

You can configure a port profile for dynamic virtual interfaces. This port profile is exported to the VMware vCenter distributed virtual switch (DVS) as a port-group.

With redundant switches, you can perform the following procedure with identical settings on both the primary and secondary switches.

Before you begin

- Dynamic vNICs must be configured on the VIC adapter installed in the host server.
- The VLAN specified in the port profile must be created.

Procedure

	Command or Action	Purpose
Step 1	switch# configure terminal	Enters global configuration mode.
Step 2	port-profile type vethernet <i>profilename</i>	Enters configuration mode for the specified port profile, creating it if necessary.
Step 3	(Optional) switchport mode access	Configures the interface to be in access mode.
Step 4	(Optional) switchport access vlan <i>vlan-id</i>	Specifies the VLAN when the interface is in access mode.

	Command or Action	Purpose
Step 5	<code>dvs-name {all name}</code>	Specifies the vCenter DVS to which the port profile is exported as a port-group. With the keyword all , the port profile is exported to all DVSs in the vCenter.
Step 6	(Optional) <code>port-binding dynamic</code>	Specifies dynamic port binding. The port is connected when the VM is powered on and disconnected when the VM is powered off. Max-port limits are enforced. The default is static port binding.
Step 7	<code>state enabled</code>	Enables the port profile.

Example

This example configures a port profile for dynamic virtual interfaces:

```
switch-1# configure terminal
switch-1(config)# port-profile type vethernet vm-fex-vlan-60
switch-1(config-port-prof)# switchport mode access
switch-1(config-port-prof)# switchport access vlan 60
switch-1(config-port-prof)# dvs-name all
switch-1(config-port-prof)# port-binding dynamic
switch-1(config-port-prof)# state enabled
switch-1(config-port-prof)#
```

Configuring an SVS Connection to the vCenter Server

You can configure a secure connection from the switch to the vCenter Server.

With redundant switches, perform this procedure on both the primary and the secondary switches. In normal operation, only the primary switch connects to the vCenter, with the secondary switch connecting only upon a failure of the primary.

Procedure

	Command or Action	Purpose
Step 1	<code>switch# configure terminal</code>	Enters global configuration mode.
Step 2	<code>svs connection svs-name</code>	Enables and enters configuration mode for an SVS connection from the switch to the vCenter Server.
Step 3	<code>protocol vmware-vim</code>	Enables the VMware Infrastructure Software Development Kit (VI SDK), which allows clients to communicate with the vCenter.
Step 4	<code>vmware dvs datacenter-name dc-name</code>	Creates a VMware distributed virtual switch (DVS) in the specified datacenter.

	Command or Action	Purpose
Step 5	<code>dvs-name dvs-name</code>	Configures a name for the DVS in the vCenter Server.
Step 6	Choose one: <ul style="list-style-type: none"> • remote ip address <i>ipv4-addr</i> [port <i>port-num</i>] [vrf {<i>vrf-name</i> default management}] • remote hostname <i>host-name</i> [port <i>port-num</i>] [vrf {<i>vrf-name</i> default management}] 	Specifies the hostname or IP address for the vCenter Server. Optionally, specifies the port number and VRF.
Step 7	<code>install certificate {bootflash:[//server/] default}</code>	Installs a certificate that is used to connect to the vCenter Server. The <i>server</i> argument specifies the boot flash memory location to install the certificate. The argument value can be module-1 , sup-1 , sup-active , or sup-local .
Step 8	<code>extension-key: extn-ID</code>	Configures the extension key to be used to connect to the vCenter Server. Note With redundant switches, perform this step only on the primary switch. The key is automatically synchronized with the secondary switch.

Example

This example shows how to configure the SVS connection on the primary switch and the secondary switch:

```
switch-1# configure terminal
switch-1(config)# svcs connection 2VC
switch-1(config-svs-conn)# protocol vmware-vim
switch-1(config-svs-conn)# vmware dvs datacenter-name DC1
switch-1(config-svs-conn)# dvs-name Pod1
switch-1(config-svs-conn)# remote ip address 192.0.20.125 port 80 vrf management
switch-1(config-svs-conn)# install certificate default
switch-1(config-svs-conn)# extension-key: Cisco_Nexus_6004_1543569268
switch-1(config-svs-conn)#

switch-2# configure terminal
switch-2(config)# svcs connection 2VC
switch-2(config-svs-conn)# protocol vmware-vim
switch-2(config-svs-conn)# vmware dvs datacenter-name DC1
switch-2(config-svs-conn)# dvs-name Pod1
switch-2(config-svs-conn)# remote ip address 192.0.20.125 port 80 vrf management
switch-2(config-svs-conn)# install certificate default
switch-2(config-svs-conn)#
```

What to do next

Activate the connection on the primary switch only.

Activating an SVS Connection to the vCenter Server

You can activate a connection from the switch to the vCenter Server.

Before you begin

- The vCenter Server must be running and reachable.
- You must have already registered an extension with the vCenter Server.
- The SVS connection must be configured on the switch.

Procedure

	Command or Action	Purpose
Step 1	switch# configure terminal	Enters global configuration mode.
Step 2	svs connection <i>svs-name</i>	Enables and enters configuration mode for an SVS connection from the switch to the vCenter Server.
Step 3	[no] connect	<p>Initiates a connection with the vCenter Server.</p> <p>Note With redundant switches, perform this step on both the primary and secondary switches. Only the primary will connect.</p> <p>The switch connects to the vCenter and becomes a DVS.</p>

Example

This example shows how to connect to a vCenter Server:

```
switch-1# configure terminal
switch-1(config)# svs connection 2VC
switch-1(config-svs-conn)# connect
Note: Command execution in progress..please wait
switch-1(config-svs-conn)#
```

Verifying the VM-FEX Configuration

Verifying the Status of the Virtual Interfaces

Use the following commands to display status information for virtual interfaces.

Command	Purpose
show interface vethernet <i>interface-number</i> [detail]	Displays the status of the virtual interface. Perform this procedure on each static virtual interface to verify that the interface is active and bound to the physical interface.
show interface virtual status vm-fex	Displays information about all floating virtual interfaces.
show interface virtual summary vm-fex	Displays summary information about virtual Ethernet interfaces.
show interface virtual status bound interface ethernet <i>port/slot</i>	Displays information about virtual interfaces on a bound Ethernet interface.
show interface virtual summary bound interface ethernet <i>port/slot</i>	Displays summary information about virtual interfaces on a bound Ethernet interface.

This example shows how to display status and configuration information about a static interface:

```
switch-1# show interface vethernet 1

Vethernet1 is up
Bound Interface is Ethernet1/17
Hardware is Virtual, address is 0005.73fc.24a0
Port mode is access
Speed is auto-speed
Duplex mode is auto
300 seconds input rate 0 bits/sec, 0 packets/sec
300 seconds output rate 0 bits/sec, 0 packets/sec
Rx
0 unicast packets 0 multicast packets 0 broadcast packets
0 input packets 0 bytes
0 input packet drops
Tx
0 unicast packets 0 multicast packets 0 broadcast packets
0 output packets 0 bytes
0 flood packets
0 output packet drops

switch-1# show interface vethernet 1 detail

vif_index: 20
-----
veth is bound to interface Ethernet1/17 (0x1a010000)
priority: 0
vntag: 16
status: active
channel id: 10
```

```

registered mac info:
  vlan 0 - mac 00:00:00:00:00:00
  vlan 0 - mac 58:8d:09:0f:0b:3c
  vlan 0 - mac ff:ff:ff:ff:ff:ff

```

```
switch-1#
```

This example shows how to display status and summary information about all virtual interfaces:

```
switch-1# show interface virtual status vm-fex
```

Interface	VIF-index	Bound If	Chan	Vlan	Status	Mode	Vntag
Veth32769	VIF-37	Eth1/20	----	101	Up	Active	7
Veth32770	VIF-39	Eth1/20	----	1	Up	Active	8
Veth32771	VIF-41	Eth1/20	----	1	Up	Standby	9
Veth32772	VIF-43	Eth1/20	----	1	Up	Active	10
Veth32773	VIF-47	Eth1/20	----	1	Up	Active	12
Veth32774	VIF-48	Eth1/20	----	1	Up	Standby	13
Veth32775	VIF-49	Eth1/20	----	1	Up	Active	14

```
switch-1# show interface virtual summary vm-fex
```

Veth Interface	Bound Interface	Channel/DV-Port	Port Profile	Mac Address	VM Name
Veth32769	Eth1/20	7415	Unused_Or_Quarantine_Veth	00:50:56:9b:33:a7	ESX145_1_RH55.
Veth32770	Eth1/20	7575	Unused_Or_Quarantine_Veth	00:50:56:9b:33:a8	ESX145_1_RH55.
Veth32771	Eth1/20	7576	Unused_Or_Quarantine_Veth	00:50:56:9b:33:a9	ESX145_1_RH55.
Veth32772	Eth1/20	7577	Unused_Or_Quarantine_Veth	00:50:56:9b:33:aa	ESX145_1_RH55.
Veth32773	Eth1/20	7578	Unused_Or_Quarantine_Veth	00:50:56:9b:33:ac	ESX145_1_RH55.
Veth32774	Eth1/20	7579	Unused_Or_Quarantine_Veth	00:50:56:9b:33:ad	ESX145_1_RH55.
Veth32775	Eth1/20	7580	Unused_Or_Quarantine_Veth	00:50:56:9b:33:ae	ESX145_1_RH55.
Veth32776	Eth1/20	7607	Unused_Or_Quarantine_Veth	00:50:56:9b:33:ab	ESX145_1_RH55.

```
switch-1#
```

This example shows how to display status and summary information about fixed vEthernet interfaces:

```
switch-1# show interface virtual status bound interface ethernet 1/20
```

Interface	VIF-index	Bound If	Chan	Vlan	Status	Mode	Vntag
Veth32769	VIF-16	Eth1/20	1	1	Up	Active	2
Veth32770	VIF-17	Eth1/20	5	1	Up	Active	46
Veth32771	VIF-18	Eth1/20	8	1	Up	Active	49
Veth32772	VIF-19	Eth1/20	9	1	Up	Active	50
Veth32773	VIF-20	Eth1/20	11	1	Up	Active	52
Veth32774	VIF-21	Eth1/20	12	1	Up	Active	53
Veth32775	VIF-22	Eth1/20	13	1	Up	Active	54
Veth32776	VIF-23	Eth1/20	14	1	Up	Active	55
Veth32777	VIF-24	Eth1/20	15	1	Up	Active	56

Total 9 Veth interfaces

```
switch-1# show interface virtual summary bound interface ethernet 1/20
```

Veth Interface	Bound Interface	Channel/DV-Port	Port Profile	Mac Address	VM Name
Veth32769	Eth1/20	1	sample		

```

Veth32770 Eth1/20      5   sample
Veth32771 Eth1/20      8   sample
Veth32772 Eth1/20      9   sample
Veth32773 Eth1/20     11   sample
Veth32774 Eth1/20     12   sample
Veth32775 Eth1/20     13   sample
Veth32776 Eth1/20     14   sample
Veth32777 Eth1/20     15   sample
Total 9 Veth interfaces

```

```
switch-1#
```

Verifying the Connection to the vCenter Server

Procedure

	Command or Action	Purpose
Step 1	switch# configure terminal	Enters global configuration mode.
Step 2	show svcs connections [<i>svs-name</i>]	Displays the current SVS connections.

Example

This example shows how to display the details of the SVS connection:

```

switch-1# configure terminal
switch-1(config)# show svcs connections

Local Info:
-----
connection 2VC:
  ip address: 192.0.20.125
  remote port: 80
  vrf: management
  protocol: vmware-vim https
  certificate: default
  datacenter name: DC1
  extension key: Cisco_Nexus_6004_1945593678
  dvs name: Pod1
  DVS uuid: cd 05 25 50 6d a9 a5 c4-eb 9c 8f 6b fa 51 b1 aa
  config status: Enabled
  operational status: Connected
  sync status: in progress
  version: VMware vCenter Server 6.0.2 build-388657

Peer Info:
-----
  hostname: -
  ip address: -
  vrf:
  protocol: -
  extension key: Cisco_Nexus_6004_1945593678
  certificate: default
    certificate match: TRUE
  datacenter name: DC1
  dvs name: Pod1
  DVS uuid: cd 05 25 50 6d a9 a5 c4-eb 9c 8f 6b fa 51 b1 aa

```

```
config status: Disabled
operational status: Connected

switch-1(config)#
```



INDEX

- <singlepage>Link Failure [49](#)
 - detecting unidirectional [49](#)
- 10-Gigabit Ethernet interface [170](#)
- 1000BASE-T Ethernet interface [170](#)
- 100BASE-T Ethernet interface [170](#)
- 802.1Q VLANs [35](#)
 - private VLANs [35](#)
- A**
- ACL support [163](#)
- active-active vPC topology [161](#)
- aging time, configuring [122](#)
 - MAC table [122](#)
- associating fabric extender [175](#)
- B**
- blocking state, STP [47](#)
- BPDU guard [90](#)
- BPDU Guard [159, 166](#)
- bridge ID [38](#)
- broadcast storms [151](#)
- C**
- CDP [159, 162](#)
- chassis configuration mode [179](#)
- chassis ID [169](#)
- Cisco Discovery Protocol, *See* CDP
- Cisco Nexus 2148T [170](#)
- Cisco Nexus 2224PP [170](#)
- Cisco Nexus 2232PP [170](#)
- Cisco Nexus 2248TP [170](#)
- Cisco Nexus B22 Fabric Extender for DELL (NB22DELL) [170](#)
- Cisco Nexus B22 Fabric Extender for Fujitsu (NB22FTS) [170](#)
- Cisco Nexus B22 Fabric Extender for HP (NB22HP) [170](#)
- Cisco Nexus B22 Fabric Extender for IBM (NB22IBM) [170](#)
- CIST regional root [66](#)
- CIST root [67](#)
- class of service, *See* CoS
- clearing dynamic addresses [124](#)
 - MAC table [124](#)
- community ports [21](#)
- community VLANs [20, 22](#)
- configuration data [166](#)
- configuration examples [111](#)
 - Flex Link [111](#)
- configuring [13, 30, 32, 102, 198](#)
 - FEX port spanning tree BPDU transmit interval [102](#)
 - isolated trunk port [32](#)
 - promiscuous trunk port [30](#)
 - slow drain [198](#)
 - VLANs [13](#)
- CoS [162](#)
- D**
- Data Center Bridging Exchange, *See* DCBX
- DCBX [162](#)
- default settings [107](#)
 - Flex Link [107](#)
- description [179](#)
- digital optical monitoring, *See* DOM
- DOM [164](#)
- drop queue [162](#)
- dual homed fabric extender vPC topology [161](#)
- E**
- edge port (PortFast) [159](#)
- enabling [10](#)
 - VLAN long-name [10](#)
- enabling long-name [10](#)
 - VLAN [10](#)
- Ethernet fabric interface [158](#)
- Ethernet interface [170](#)
- extended range VLANs [6](#)
- F**
- fabric interface [158](#)
- fabric interface Port Channel [169](#)
- fail-over load balancing [169](#)
- FEX trunk port [33](#)
 - pvlan [33](#)
- FEX-number [169](#)

- Flex Link [107, 109, 111](#)
 - configuration examples [111](#)
 - default settings [107](#)
 - preemption, configuring [109](#)
- Flex Links [105, 106, 107](#)
 - configuring [107](#)
 - guidelines and limitations [106](#)
 - information about [105](#)

G

- guidelines and limitations [106](#)
 - Flex Links [106](#)

H

- host interface [158](#)
- host interface autonegotiation [162](#)
- host interface flow control defaults [162](#)
- host interface link-level flow control [162](#)
- host ports [21](#)
 - kinds of [21](#)

I

- ICMPv2 [128](#)
- IEEE 802.1p [162](#)
- IEEE 802.1w [63](#)
- IEEE 802.3x [162](#)
- IGMP [130](#)
 - snooping parameters, configuring [130](#)
- IGMP forwarding [129](#)
- IGMP snooping [129, 136, 163](#)
 - interoperation with MVR [136](#)
 - queries [129](#)
- IGMPv1 [128](#)
- IGMPv3 [128](#)
- image management [170](#)
- information about [105](#)
 - Flex Links [105](#)
- isolated port [21](#)
- isolated VLANs [20, 22](#)

J

- jumbo frame [162](#)

L

- LACP [162](#)
- Layer 2 switching [1](#)
 - Ethernet switching [1](#)
- LED beacon [182](#)
- licensing [136, 203](#)
 - MVR [136](#)

- licensing (*continued*)
 - VM-FEX [203](#)
- Link Aggregation Control Protocol, *See* LACP
- Link Failure [68](#)
 - detecting unidirectional [68](#)
- Link Layer Discovery Protocol, *See* LLDP
- LLDP [162](#)
- load-balancing queues [199](#)
 - global level [199](#)
- local switching [166](#)
- locator LED [182](#)
- loopback address assignment [166](#)
- loopback address range [166](#)

M

- MAC address configuration [124](#)
 - verifying [124](#)
- MAC address tables [175](#)
 - static addresses [175](#)
- MAC addresses [121](#)
 - static, configuring [121](#)
- MAC table [122, 124](#)
 - aging time, configuring [122](#)
 - clearing dynamic addresses [124](#)
- manual redistribution [167](#)
- max-links disruption [167](#)
- maximum transmission unit, *See* MTU
- MST [66, 74](#)
 - CIST regional root [66](#)
 - setting to default values [74](#)
- MSTP [63, 64, 65, 66, 67, 68, 74](#)
 - boundary ports [68](#)
 - described [68](#)
 - CIST regional root [66](#)
 - CIST root [67](#)
 - CIST, described [65](#)
 - CST [65, 66](#)
 - defined [65](#)
 - operations between regions [66](#)
 - IEEE 802.1s [66](#)
 - terminology [66](#)
 - IST [65, 66](#)
 - operations within a region [65](#)
 - mapping VLANs to MST instance [74](#)
 - MST region [63, 64, 65, 67](#)
 - CIST [65](#)
 - described [63](#)
 - hop-count mechanism [67](#)
 - supported spanning-tree instances [64](#)
- MTU [162](#)
- multicast replication [166](#)
- multicast storms [151](#)
- MVR [135, 136, 137, 139, 140](#)
 - configuring global parameters [137](#)
 - configuring interfaces [139](#)

MVR (*continued*)

- default settings [137](#)
- guidelines and limitations [136](#)
- interoperation with IGMP snooping [136](#)
- interoperation with vPC snooping [136](#)
- licensing [136](#)
- overview [135](#)
- verifying the configuration [140](#)

N

- no-drop queue [162](#)

O

- oversubscription [164](#)
- oversubscription ratio [164](#)

P

- packet counter [159](#)
- per class flow control [162](#)
- PFC [164](#)
- pinning max-links [179](#)
- port channel [169](#)
- port channel fabric interface [158, 164](#)
- port channel host interface [158, 160](#)
- port numbering [169](#)
- PortFast BPDU filtering [91](#)
- ports [15](#)
 - adding to VLANs [15](#)
- preemption, configuring [109](#)
 - Flex Link [109](#)
- primary VLANs [20](#)
- priority flow control, *See* PFC
- private VLAN [160](#)
- private VLANs [20, 21, 22, 23, 24, 35](#)
 - 802.1Q VLANs [35](#)
 - community VLANs [20, 22](#)
 - end station access to [24](#)
 - isolated trunk [24](#)
 - isolated VLANs [20, 22](#)
 - ports [21](#)
 - community [21](#)
 - isolated [21](#)
 - promiscuous [21](#)
 - primary VLANs [20](#)
 - promiscuous trunk [23](#)
 - secondary VLANs [20](#)
- promiscuous ports [21](#)
- pvlan [33](#)
 - FEX trunk port [33](#)

Q

- QoS [162](#)
- QoS broadcast class [162](#)
- QoS egress policies [162](#)
- QoS multicast class [162](#)
- quality-of-service, *See* QoS
- queue-limit [194, 195](#)
 - global level [194](#)
 - port level [195](#)

R

- rapid PVST priority [58](#)
- Rapid PVST+ [52](#)
 - configuring [52](#)
- rapid PVST+ configurations [61](#)
 - verifying [61](#)
- Rapid Spanning Tree Protocol [63](#)
- redistributing host interfaces [184](#)
- reduced MAC address [38](#)
- reserved-range VLANs [6](#)
- root guard [92](#)
- RSTP [41, 45, 49, 63](#)
 - active topology [45](#)
 - BPDU [49](#)
 - processing [49](#)
 - designated port, defined [45](#)
 - designated switch, defined [45](#)
 - proposal-agreement handshake process [41](#)
 - rapid convergence [41](#)
 - point-to-point links [41](#)
 - root ports [41](#)
 - root port, defined [45](#)

S

- secondary VLANs [20](#)
- serial number [179](#)
- SFP+ [170](#)
- SFP+ interface adapter [170](#)
- SFP+ validation [164](#)
- shared buffer [193, 197](#)
 - configuring [193, 197](#)
- show diagnostics [187](#)
- show environment [187](#)
- show fabric interface [183](#)
- show fex [184](#)
- show inventory [187](#)
- show modules [187](#)
- show SPROM [187](#)
- show transceiver status [184](#)
- single homed fabric extender vPC topology [161](#)
- small form-factor pluggable transceiver [170](#)

- snooping parameters, configuring **130**
 - IGMP **130**
- SPAN restrictions **163**
- SPAN source ports **163**
- static MAC addresses **175**
 - adding **175**
- static MAC addresses, configuring **121**
- static pinning **167**
- STP **41, 47, 48, 89, 90**
 - edge ports **41, 89**
 - network ports **90**
 - normal ports **90**
 - port types **89**
 - PortFast **41, 89**
 - understanding **47, 48**
 - Blocking State **47**
 - disabled state **48**
 - forwarding state **47**
 - learning state **47**
- STP bridge ID **38**
- STP overview **37**
- STP root guard **92**
- switchport fex-fabric mode **164**
- switchport saved configuration **164**

T

- traffic storms **152**
 - control **152**
- type **179**

U

- unicast storms **151**

- uplink distance **196, 198**
 - configuring **196, 198**

V

- verifying **17, 61**
 - rapid PVST+ configurations **61**
 - VLAN configurations **17**
- version compatibility **170**
- VLAN configurations **17**
 - verifying **17**
- VLAN reserved ranges **12**
 - changing **12**
- VLANs **6, 12, 13, 15, 35**
 - adding ports to **15**
 - changing **12**
 - configuring **13**
 - extended range **6**
 - private **35**
 - reserved range **6**
- VM-FEX **201, 202, 203, 204, 205, 206, 209, 210, 213, 215**
 - components **201**
 - configuration steps **204**
 - configuring fixed static interfaces **206**
 - configuring port profile **209**
 - connection to vCenter **210**
 - default settings **203**
 - enabling features **205**
 - licensing **203**
 - overview **201**
 - terminology **202**
 - verifying interface status **213**
 - verifying vCenter connection **215**
- vPC **136**
 - interoperation with MVR **136**
- vPC topology **161**