



IP Multicast Routing Configuration Guide, Cisco IOS XE Release 3.7E and Later(Catalyst 3850 Switches)

First Published: 2014-12-10

Last Modified: 2015-04-12

Americas Headquarters

Cisco Systems, Inc.
170 West Tasman Drive
San Jose, CA 95134-1706
USA
<http://www.cisco.com>
Tel: 408 526-4000
800 553-NETS (6387)
Fax: 408 527-0883

THE SPECIFICATIONS AND INFORMATION REGARDING THE PRODUCTS IN THIS MANUAL ARE SUBJECT TO CHANGE WITHOUT NOTICE. ALL STATEMENTS, INFORMATION, AND RECOMMENDATIONS IN THIS MANUAL ARE BELIEVED TO BE ACCURATE BUT ARE PRESENTED WITHOUT WARRANTY OF ANY KIND, EXPRESS OR IMPLIED. USERS MUST TAKE FULL RESPONSIBILITY FOR THEIR APPLICATION OF ANY PRODUCTS.

THE SOFTWARE LICENSE AND LIMITED WARRANTY FOR THE ACCOMPANYING PRODUCT ARE SET FORTH IN THE INFORMATION PACKET THAT SHIPPED WITH THE PRODUCT AND ARE INCORPORATED HEREIN BY THIS REFERENCE. IF YOU ARE UNABLE TO LOCATE THE SOFTWARE LICENSE OR LIMITED WARRANTY, CONTACT YOUR CISCO REPRESENTATIVE FOR A COPY.

The Cisco implementation of TCP header compression is an adaptation of a program developed by the University of California, Berkeley (UCB) as part of UCB's public domain version of the UNIX operating system. All rights reserved. Copyright © 1981, Regents of the University of California.

NOTWITHSTANDING ANY OTHER WARRANTY HEREIN, ALL DOCUMENT FILES AND SOFTWARE OF THESE SUPPLIERS ARE PROVIDED "AS IS" WITH ALL FAULTS. CISCO AND THE ABOVE-NAMED SUPPLIERS DISCLAIM ALL WARRANTIES, EXPRESSED OR IMPLIED, INCLUDING, WITHOUT LIMITATION, THOSE OF MERCHANTABILITY, FITNESS FOR A PARTICULAR PURPOSE AND NON-INFRINGEMENT OR ARISING FROM A COURSE OF DEALING, USAGE, OR TRADE PRACTICE.

IN NO EVENT SHALL CISCO OR ITS SUPPLIERS BE LIABLE FOR ANY INDIRECT, SPECIAL, CONSEQUENTIAL, OR INCIDENTAL DAMAGES, INCLUDING, WITHOUT LIMITATION, LOST PROFITS OR LOSS OR DAMAGE TO DATA ARISING OUT OF THE USE OR INABILITY TO USE THIS MANUAL, EVEN IF CISCO OR ITS SUPPLIERS HAVE BEEN ADVISED OF THE POSSIBILITY OF SUCH DAMAGES.

Any Internet Protocol (IP) addresses and phone numbers used in this document are not intended to be actual addresses and phone numbers. Any examples, command display output, network topology diagrams, and other figures included in the document are shown for illustrative purposes only. Any use of actual IP addresses or phone numbers in illustrative content is unintentional and coincidental.

Cisco and the Cisco logo are trademarks or registered trademarks of Cisco and/or its affiliates in the U.S. and other countries. To view a list of Cisco trademarks, go to this URL: <http://www.cisco.com/go/trademarks>. Third-party trademarks mentioned are the property of their respective owners. The use of the word partner does not imply a partnership relationship between Cisco and any other company. (1110R)

© 2015 Cisco Systems, Inc. All rights reserved.



CONTENTS

PREFACE

| | |
|--|------------|
| Preface | xxi |
| Document Conventions | xxi |
| Related Documentation | xxiii |
| Obtaining Documentation and Submitting a Service Request | xxiii |

CHAPTER 1

| | |
|--|----------|
| Using the Command-Line Interface | 1 |
| Information About Using the Command-Line Interface | 1 |
| Command Modes | 1 |
| Understanding Abbreviated Commands | 3 |
| No and Default Forms of Commands | 3 |
| CLI Error Messages | 3 |
| Configuration Logging | 4 |
| Using the Help System | 4 |
| How to Use the CLI to Configure Features | 5 |
| Configuring the Command History | 5 |
| Changing the Command History Buffer Size | 5 |
| Recalling Commands | 6 |
| Disabling the Command History Feature | 6 |
| Enabling and Disabling Editing Features | 7 |
| Editing Commands Through Keystrokes | 7 |
| Editing Command Lines That Wrap | 8 |
| Searching and Filtering Output of show and more Commands | 9 |
| Accessing the CLI on a Switch Stack | 10 |
| Accessing the CLI Through a Console Connection or Through Telnet | 10 |

CHAPTER 2

| | |
|---|-----------|
| Using the Web Graphical User Interface | 13 |
|---|-----------|

| | |
|---|----|
| Prerequisites for Using the Web GUI | 13 |
| Information About Using The Web GUI | 14 |
| Web GUI Features | 14 |
| Connecting the Console Port of the Switch | 15 |
| Logging On to the GUI | 15 |
| Enabling Web and Secure Web Modes | 16 |
| Configuring the Switch Web GUI | 16 |

| | | |
|------------------|---|-----------|
| CHAPTER 3 | IP Multicast Routing Technology Overview | 21 |
| | Finding Feature Information | 21 |
| | Information About IP Multicast Technology | 21 |
| | Role of IP Multicast in Information Delivery | 21 |
| | IP Multicast Routing Protocols | 21 |
| | Multicast Group Transmission Scheme | 22 |
| | IP Multicast Boundary | 24 |
| | IP Multicast Group Addressing | 25 |
| | IP Class D Addresses | 25 |
| | IP Multicast Address Scoping | 25 |
| | Layer 2 Multicast Addresses | 27 |
| | IP Multicast Delivery Modes | 27 |
| | Source Specific Multicast | 27 |
| | Additional References | 28 |

| | | |
|------------------|--|-----------|
| CHAPTER 4 | Configuring IGMP | 29 |
| | Finding Feature Information | 29 |
| | Prerequisites for IGMP and IGMP Snooping | 29 |
| | Prerequisites for IGMP | 29 |
| | Prerequisites for IGMP Snooping | 30 |
| | Restrictions for IGMP and IGMP Snooping | 30 |
| | Restrictions for Configuring IGMP | 30 |
| | Restrictions for IGMP Snooping | 31 |
| | Information About IGMP | 31 |
| | Role of the Internet Group Management Protocol | 31 |
| | IGMP Multicast Addresses | 32 |

| | |
|---|----|
| IGMP Versions | 32 |
| IGMP Version 1 | 32 |
| IGMP Version 2 | 32 |
| IGMP Version 3 | 33 |
| IGMPv3 Host Signaling | 33 |
| IGMP Versions Differences | 33 |
| IGMP Join and Leave Process | 35 |
| IGMP Join Process | 35 |
| IGMP Leave Process | 36 |
| IGMP Snooping | 36 |
| Joining a Multicast Group | 37 |
| Leaving a Multicast Group | 38 |
| Immediate Leave | 39 |
| IGMP Configurable-Leave Timer | 39 |
| IGMP Report Suppression | 39 |
| IGMP Snooping and Switch Stacks | 40 |
| IGMP Filtering and Throttling | 40 |
| Default IGMP Configuration | 40 |
| Default IGMP Snooping Configuration | 41 |
| Default IGMP Filtering and Throttling Configuration | 41 |
| How to Configure IGMP | 42 |
| Configuring the Switch as a Member of a Group (CLI) | 42 |
| Controlling Access to IP Multicast Group (CLI) | 44 |
| Changing the IGMP Version(CLI) | 46 |
| Modifying the IGMP Host-Query Message Interval (CLI) | 47 |
| Changing the IGMP Query Timeout for IGMPv2 (CLI) | 49 |
| Changing the Maximum Query Response Time for IGMPv2 (CLI) | 51 |
| Configuring the Switch as a Statically Connected Member (CLI) | 53 |
| Configuring IGMP Profiles (CLI) | 54 |
| Applying IGMP Profiles (CLI) | 56 |
| Setting the Maximum Number of IGMP Groups (CLI) | 58 |
| Configuring the IGMP Throttling Action (CLI) | 59 |
| Configuring the Device to Forward Multicast Traffic in the Absence of Directly Connected IGMP Hosts | 61 |

| | |
|--|----|
| Controlling Access to an SSM Network Using IGMP Extended Access Lists | 63 |
| How to Configure IGMP Snooping | 65 |
| Enabling IGMP Snooping | 65 |
| Enabling or Disabling IGMP Snooping on a VLAN Interface (CLI) | 66 |
| Setting the Snooping Method (CLI) | 67 |
| Configuring a Multicast Router Port (CLI) | 68 |
| Configuring a Host Statically to Join a Group (CLI) | 70 |
| Enabling IGMP Immediate Leave (CLI) | 71 |
| Configuring the IGMP Leave Timer (CLI) | 72 |
| Configuring the IGMP Robustness-Variable (CLI) | 74 |
| Configuring the IGMP Last Member Query Count (CLI) | 75 |
| Configuring TCN-Related Commands | 77 |
| Configuring the IGMP Snooping Querier (CLI) | 80 |
| Disabling IGMP Report Suppression (CLI) | 82 |
| Monitoring IGMP | 84 |
| Monitoring IGMP Snooping Information | 84 |
| Monitoring IGMP Filtering and Throttling Configuration | 86 |
| Configuration Examples for IGMP | 86 |
| Example: Configuring the Switch as a Member of a Multicast Group | 86 |
| Example: Controlling Access to Multicast Groups | 86 |
| Examples: Configuring IGMP Snooping | 87 |
| Example: Configuring IGMP Profiles | 88 |
| Example: Applying IGMP Profile | 88 |
| Example: Setting the Maximum Number of IGMP Groups | 88 |
| Example: Interface Configuration as a Routed Port | 88 |
| Example: Interface Configuration as an SVI | 89 |
| Example: Configuring the Device to Forward Multicast Traffic in the Absence of Directly Connected IGMP Hosts | 89 |
| Controlling Access to an SSM Network Using IGMP Extended Access Lists | 90 |
| Example: Denying All States for a Group G | 90 |
| Example: Denying All States for a Source S | 90 |
| Example: Permitting All States for a Group G | 90 |
| Example: Permitting All States for a Source S | 91 |
| Example: Filtering a Source S for a Group G | 91 |

| | |
|--|----|
| Additional References | 91 |
| Feature History and Information for IGMP | 92 |

CHAPTER 5**Configuring IGMP Proxy 93**

| | |
|---|-----|
| Finding Feature Information | 93 |
| Prerequisites for IGMP Proxy | 93 |
| Information about IGMP Proxy | 94 |
| IGMP Proxy | 94 |
| How to Configure IGMP Proxy | 96 |
| Configuring the Upstream UDL Device for IGMP UDLR | 96 |
| Configuring the Downstream UDL Device for IGMP UDLR with IGMP Proxy Support | 97 |
| Configuration Examples for IGMP Proxy | 100 |
| Example: IGMP Proxy Configuration | 100 |
| Additional References | 101 |
| Feature History and Information for IGMP Proxy | 102 |

CHAPTER 6**Constraining IP Multicast in Switched Ethernet 103**

| | |
|--|-----|
| Finding Feature Information | 103 |
| Prerequisites for Constraining IP Multicast in a Switched Ethernet Network | 103 |
| Information About IP Multicast in a Switched Ethernet Network | 104 |
| IP Multicast Traffic and Layer 2 Switches | 104 |
| CGMP on Catalyst Switches for IP Multicast | 104 |
| IGMP Snooping | 105 |
| Router-Port Group Management Protocol (RGMP) | 105 |
| How to Constrain Multicast in a Switched Ethernet Network | 105 |
| Configuring Switches for IP Multicast | 105 |
| Configuring IGMP Snooping | 106 |
| Enabling CGMP | 106 |
| Configuring IP Multicast in a Layer 2 Switched Ethernet Network | 107 |
| Configuration Examples for Constraining IP Multicast in a Switched Ethernet Network | 108 |
| Example: CGMP Configuration | 108 |
| RGMP Configuration Example | 109 |
| Additional References | 109 |
| Feature History and Information for Constraining IP Multicast in a Switched Ethernet Network | 110 |

CHAPTER 7**Configuring PIM 111**

- Finding Feature Information 111
- Prerequisites for PIM 111
- Restrictions for PIM 112
 - PIMv1 and PIMv2 Interoperability 112
 - Restrictions for Configuring PIM Stub Routing 113
 - Restrictions for Configuring Auto-RP and BSR 113
 - Restrictions for Auto-RP Enhancement 114
- Information About PIM 115
 - Protocol Independent Multicast Overview 115
 - PIM Dense Mode 115
 - PIM Sparse Mode 116
 - Multicast Source Discovery Protocol (MSDP) 116
 - Sparse-Dense Mode 117
 - PIM Versions 117
 - PIM Stub Routing 118
 - IGMP Helper 119
 - Rendezvous Points 119
 - Auto-RP 120
 - The Role of Auto-RP in a PIM Network 121
 - Multicast Boundaries 121
 - Sparse-Dense Mode for Auto-RP 122
 - Auto-RP Benefits 122
 - PIMv2 Bootstrap Router 123
 - PIM Domain Border 123
 - Multicast Forwarding 124
 - Multicast Distribution Source Tree 124
 - Multicast Distribution Shared Tree 125
 - Source Tree Advantage 125
 - Shared Tree Advantage 126
 - PIM Shared Tree and Source Tree 126
 - Reverse Path Forwarding 127
 - RPF Check 128

| | |
|---|-----|
| Default PIM Routing Configuration | 129 |
| How to Configure PIM | 130 |
| Enabling PIM Stub Routing (CLI) | 130 |
| Configuring a Rendezvous Point | 132 |
| Manually Assigning an RP to Multicast Groups (CLI) | 133 |
| Setting Up Auto-RP in a New Internetwork (CLI) | 135 |
| Adding Auto-RP to an Existing Sparse-Mode Cloud (CLI) | 138 |
| Preventing Join Messages to False RPs (CLI) | 141 |
| Filtering Incoming RP Announcement Messages (CLI) | 141 |
| Configuring PIMv2 BSR | 143 |
| Defining the PIM Domain Border (CLI) | 143 |
| Defining the IP Multicast Boundary (CLI) | 145 |
| Configuring Candidate BSRs (CLI) | 147 |
| Configuring the Candidate RPs (CLI) | 149 |
| Configuring Sparse Mode with Auto-RP(CLI) | 151 |
| Delaying the Use of PIM Shortest-Path Tree (CLI) | 155 |
| Modifying the PIM Router-Query Message Interval (CLI) | 157 |
| Verifying PIM Operations | 159 |
| Verifying IP Multicast Operation in a PIM-SM or a PIM-SSM Network | 159 |
| Verifying IP Multicast on the First Hop Router | 159 |
| Verifying IP Multicast on Routers Along the SPT | 160 |
| Verifying IP Multicast Operation on the Last Hop Router | 161 |
| Using PIM-Enabled Routers to Test IP Multicast Reachability | 165 |
| Configuring Routers to Respond to Multicast Pings | 165 |
| Pinging Routers Configured to Respond to Multicast Pings | 166 |
| Monitoring and Troubleshooting PIM | 167 |
| Monitoring PIM Information | 167 |
| Monitoring the RP Mapping and BSR Information | 168 |
| Troubleshooting PIMv1 and PIMv2 Interoperability Problems | 168 |
| Configuration Examples for PIM | 169 |
| Example: Enabling PIM Stub Routing | 169 |
| Example: Verifying PIM Stub Routing | 169 |
| Example: Manually Assigning an RP to Multicast Groups | 170 |
| Example: Configuring Auto-RP | 170 |

Example: Sparse Mode with Auto-RP 170

Example: Defining the IP Multicast Boundary to Deny Auto-RP Information 170

Example: Filtering Incoming RP Announcement Messages 171

Example: Preventing Join Messages to False RPs 171

Example: Configuring Candidate BSRs 171

Example: Configuring Candidate RPs 172

Additional References 172

Feature History and Information for PIM 174

CHAPTER 8

Configuring PIM MIB Extension for IP Multicast 175

Finding Feature Information 175

Information About PIM MIB Extension for IP Multicast 175

 PIM MIB Extensions for SNMP Traps for IP Multicast 175

 Benefits of PIM MIB Extensions 176

How to Configure PIM MIB Extension for IP Multicast 176

 Enabling PIM MIB Extensions for IP Multicast 176

Configuration Examples for PIM MIB Extensions 178

 Example Enabling PIM MIB Extensions for IP Multicast 178

Additional References 178

CHAPTER 9

Configuring MSDP 181

Finding Feature Information 181

 181

Information About Using MSDP to Interconnect Multiple PIM-SM Domains 181

 Benefits of Using MSDP to Interconnect Multiple PIM-SM Domains 181

 182

MSDP Message Types 184

 SA Messages 184

 SA Request Messages 184

 SA Response Messages 185

 Keepalive Messages 185

SA Message Origination Receipt and Processing 185

 SA Message Origination 185

 SA Message Receipt 185

| | |
|--|-----|
| SA Message Processing | 188 |
| MSDP Peers | 188 |
| MSDP MD5 Password Authentication | 188 |
| How MSDP MD5 Password Authentication Works | 188 |
| Benefits of MSDP MD5 Password Authentication | 189 |
| SA Message Limits | 189 |
| MSDP Keepalive and Hold-Time Intervals | 189 |
| MSDP Connection-Retry Interval | 190 |
| Default MSDP Peers | 190 |
| MSDP Mesh Groups | 191 |
| Benefits of MSDP Mesh Groups | 191 |
| SA Origination Filters | 192 |
| Use of Outgoing Filter Lists in MSDP | 192 |
| Use of Incoming Filter Lists in MSDP | 193 |
| TTL Thresholds in MSDP | 194 |
| SA Request Messages | 194 |
| SA Request Filters | 194 |
| How to Use MSDP to Interconnect Multiple PIM-SM Domains | 195 |
| Configuring an MSDP Peer | 195 |
| Shutting Down an MSDP Peer | 196 |
| Configuring MSDP MD5 Password Authentication Between MSDP Peers | 197 |
| Troubleshooting Tips | 199 |
| Preventing DoS Attacks by Limiting the Number of SA Messages Allowed in the SA Cache from Specified MSDP Peers | 199 |
| Adjusting the MSDP Keepalive and Hold-Time Intervals | 200 |
| Adjusting the MSDP Connection-Retry Interval | 201 |
| Configuring a Default MSDP Peer | 202 |
| Configuring an MSDP Mesh Group | 203 |
| Controlling SA Messages Originated by an RP for Local Sources | 204 |
| Controlling the Forwarding of SA Messages to MSDP Peers Using Outgoing Filter Lists | 205 |
| Controlling the Receipt of SA Messages from MSDP Peers Using Incoming Filter Lists | 206 |
| Using TTL Thresholds to Limit the Multicast Data Sent in SA Messages | 207 |
| Controlling the Response to Outgoing SA Request Messages from MSDP Peers Using SA Request Filters | 208 |

| | |
|---|-----|
| Including a Bordering PIM Dense Mode Region in MSDP | 209 |
| Configuring an Originating Address Other Than the RP Address | 210 |
| Monitoring MSDP | 211 |
| Clearing MSDP Connections Statistics and SA Cache Entries | 214 |
| Enabling SNMP Monitoring of MSDP | 214 |
| Troubleshooting Tips | 215 |
| Configuration Examples for Using MSDP to Interconnect Multiple PIM-SM Domains | 216 |
| Example: Configuring an MSDP Peer | 216 |
| Example: Configuring MSDP MD5 Password Authentication | 216 |
| Example: Configuring a Default MSDP Peer | 217 |
| Example: Configuring MSDP Mesh Groups | 219 |
| Additional References | 219 |
| Feature History and Information for Multicast Source Discovery Protocol | 220 |

CHAPTER 10

| | |
|---|------------|
| Configuring Wireless Multicast | 221 |
| Finding Feature Information | 221 |
| Prerequisites for Configuring Wireless Multicast | 221 |
| Restrictions for Configuring Wireless Multicast | 221 |
| Restrictions for IPv6 Snooping | 222 |
| Restrictions for IPv6 RA Guard | 222 |
| Information About Wireless Multicast | 222 |
| Information About Multicast Optimization | 223 |
| IPv6 Global Policies | 223 |
| IPv6 RA Guard | 224 |
| Information About IPv6 Snooping | 224 |
| IPv6 Neighbor Discovery Inspection | 224 |
| How to Configure Wireless Multicast | 226 |
| Configuring Wireless Multicast-MCMC Mode (CLI) | 226 |
| Configuring Wireless Multicast-MCUC Mode (CLI) | 227 |
| Configuring IPv6 Snooping (CLI) | 228 |
| Configuring IPv6 Snooping Policy (CLI) | 229 |
| Configuring Layer 2 Port as Multicast Router Port (CLI) | 230 |
| Configuring IPv6 RA Guard (CLI) | 230 |
| Configuring Non-IP Wireless Multicast (CLI) | 231 |

| | |
|--|-----|
| Configuring Wireless Broadcast (CLI) | 232 |
| Configuring IP Multicast VLAN for WLAN (CLI) | 233 |
| Monitoring Wireless Multicast | 234 |
| Where to Go Next for Wireless Multicast | 235 |

CHAPTER 11
Configuring SSM 237

| | |
|--|-----|
| Finding Feature Information | 237 |
| Prerequisites for Configuring SSM | 237 |
| Restrictions for Configuring SSM | 238 |
| Information About SSM and SSM Mapping | 239 |
| SSM Components Overview | 239 |
| How SSM Differs from Internet Standard Multicast | 239 |
| SSM Operations | 240 |
| IGMPv3 Host Signaling | 241 |
| Benefits of SSM | 241 |
| SSM Mapping Overview | 242 |
| Static SSM Mapping | 243 |
| DNS-Based SSM Mapping | 243 |
| SSM Mapping Benefits | 244 |
| How to Configure SSM and SSM Mapping | 245 |
| Configuring Source Specific Multicast | 245 |
| Configuring SSM Mapping | 247 |
| Configuring Static SSM Mapping(CLI) | 247 |
| Configuring DNS-Based SSM Mapping(CLI) | 248 |
| Configuring Static Traffic Forwarding with SSM Mapping | 250 |
| Configuring Static Traffic Forwarding with SSM Mapping (CLI) | 251 |
| Verifying SSM Mapping Configuration and Operation | 253 |
| Monitoring SSM and SSM Mapping | 256 |
| Monitoring SSM | 256 |
| Monitoring SSM Mapping | 256 |
| Configuration Examples for SSM and SSM Mapping | 256 |
| SSM with IGMPv3 Example | 256 |
| SSM Filtering Example | 257 |
| SSM Mapping Example | 257 |

| | |
|---|-----|
| DNS Server Configuration Example | 260 |
| Additional References | 261 |
| Feature History and Information for SSM | 262 |

CHAPTER 12**Configuring Basic IP Multicast Routing 263**

| | |
|---|-----|
| Finding Feature Information | 263 |
| Prerequisites for Basic IP Multicast Routing | 263 |
| Restrictions for Basic IP Multicast Routing | 264 |
| Information About Basic IP Multicast Routing | 264 |
| Multicast Forwarding Information Base Overview | 264 |
| Multicast Routing and Switch Stacks | 265 |
| Default IP Multicast Routing Configuration | 265 |
| How to Configure Basic IP Multicast Routing | 266 |
| Configuring Basic IP Multicast Routing | 266 |
| Configuring IP Multicast Forwarding (CLI) | 268 |
| Configuring a Static Multicast Route (mroute) (CLI) | 270 |
| Configuring Optional IP Multicast Routing Features | 272 |
| Defining the IP Multicast Boundary (CLI) | 272 |
| Configuring sdr Listener Support | 274 |
| Monitoring and Maintaining Basic IP Multicast Routing | 277 |
| Clearing Caches, Tables, and Databases | 277 |
| Displaying System and Network Statistics | 278 |
| Displaying Multicast Peers, Packet Rates and Loss Information, and Path Tracing | 280 |
| Configuration Examples for IP Multicast Routing | 280 |
| Example: Configuring an IP Multicast Boundary | 280 |
| Example: Responding to mroute Requests | 281 |
| Additional References | 281 |
| Feature History and Information for IP Multicast | 282 |

CHAPTER 13**Configuring the Service Discovery Gateway 283**

| | |
|--|-----|
| Finding Feature Information | 283 |
| Restrictions for Configuring the Service Discovery Gateway | 283 |
| Information about the Service Discovery Gateway and mDNS | 284 |
| mDNS | 284 |

| | |
|--|-----|
| mDNS-SD | 284 |
| Service Discovery Gateway | 285 |
| mDNS Gateway and Subnets | 285 |
| Filtering | 286 |
| How to Configure the Service Discovery Gateway | 287 |
| Configuring the Service List (CLI) | 287 |
| Configuring the Service List (GUI) | 289 |
| Enabling mDNS Gateway and Redistributing Services (CLI) | 290 |
| Configuring Interface Service Rules (GUI) | 293 |
| Configuring mDNS Global Rules (GUI) | 293 |
| Monitoring Service Discovery Gateway | 294 |
| Configuration Examples | 294 |
| Example: Specify Alternative Source Interface for Outgoing mDNS Packets | 294 |
| Example: Redistribute Service Announcements | 295 |
| Example: Disable Bridging of mDNS Packets to Wireless Clients | 295 |
| Example: Creating a Service-List, Applying a Filter and Configuring Parameters | 295 |
| Example: Enabling mDNS Gateway and Redistributing Services | 296 |
| Example: Global mDNS Configuration | 296 |
| Example: Interface mDNS Configuration | 296 |
| Monitoring Service Cache (GUI) | 297 |
| Monitoring Static Service Cache (GUI) | 297 |
| Where to Go Next for Configuring Services Discovery Gateway | 298 |
| Additional References | 299 |
| Feature History and Information for Services Discovery Gateway | 300 |

CHAPTER 14
IP Multicast Optimization: Optimizing PIM Sparse Mode in a Large IP Multicast Deployment 301

| | |
|---|-----|
| Finding Feature Information | 301 |
| Prerequisites for Optimizing PIM Sparse Mode in a Large IP Multicast Deployment | 301 |
| Information About Optimizing PIM Sparse Mode in a Large IP Multicast Deployment | 302 |
| PIM Registering Process | 302 |
| PIM Version 1 Compatibility | 302 |
| PIM Designated Router | 303 |
| PIM Sparse-Mode Register Messages | 303 |
| Preventing Use of Shortest-Path Tree to Reduce Memory Requirement | 303 |

| | |
|---|-----|
| PIM Shared Tree and Source Tree - Shortest-Path Tree | 303 |
| Benefit of Preventing or Delaying the Use of the Shortest-Path Tree | 305 |
| How to Optimize PIM Sparse Mode in a Large IP Multicast Deployment | 305 |
| Optimizing PIM Sparse Mode in a Large Deployment | 305 |
| Configuration Examples for Optimizing PIM Sparse Mode in a Large Multicast Deployment | 307 |
| Optimizing PIM Sparse Mode in a Large IP Multicast Deployment Example | 307 |
| Additional References | 307 |
| Feature History and Information for Optimizing PIM Sparse Mode in a Large IP Multicast Deployment | 308 |

CHAPTER 15**IP Multicast Optimization: Multicast Subsecond Convergence 309**

| | |
|---|-----|
| Finding Feature Information | 309 |
| Prerequisites for Multicast Subsecond Convergence | 309 |
| Restrictions for Multicast Subsecond Convergence | 309 |
| Information About Multicast Subsecond Convergence | 310 |
| Benefits of Multicast Subsecond Convergence | 310 |
| Multicast Subsecond Convergence Scalability Enhancements | 310 |
| PIM Router Query Messages | 310 |
| Reverse Path Forwarding | 310 |
| RPF Checks | 311 |
| Triggered RPF Checks | 311 |
| RPF Failover | 311 |
| Topology Changes and Multicast Routing Recovery | 312 |
| How to Configure Multicast Subsecond Convergence | 312 |
| Modifying the Periodic RPF Check Interval | 312 |
| Configuring PIM RPF Failover Intervals | 313 |
| Modifying the PIM Router Query Message Interval | 313 |
| Verifying Multicast Subsecond Convergence Configurations | 314 |
| Configuration Examples for Multicast Subsecond Convergence | 315 |
| Example Modifying the Periodic RPF Check Interval | 315 |
| Example Configuring PIM RPF Failover Intervals | 316 |
| Modifying the PIM Router Query Message Interval Example | 316 |
| Additional References | 317 |
| Feature History and Information for Multicast Subsecond Convergence | 317 |

IP Multicast Optimization: IP Multicast Load Splitting across Equal-Cost Paths 319

| | |
|---|-----|
| Finding Feature Information | 319 |
| Prerequisites for IP Multicast Load Splitting across Equal-Cost Paths | 319 |
| Information About IP Multicast Load Splitting across Equal-Cost Paths | 320 |
| Load Splitting Versus Load Balancing | 320 |
| Default Behavior for IP Multicast When Multiple Equal-Cost Paths Exist | 320 |
| Methods to Load Split IP Multicast Traffic | 322 |
| Overview of ECMP Multicast Load Splitting | 322 |
| ECMP Multicast Load Splitting Based on Source Address Using the S-Hash Algorithm | 322 |
| ECMP Multicast Load Splitting Based on Source and Group Address Using the Basic S-G-Hash Algorithm | 323 |
| Predictability As a By-Product of Using the S-Hash and Basic S-G-Hash Algorithms | 323 |
| Polarization As a By-Product of Using the S-Hash and Basic S-G-Hash Algorithms | 323 |
| ECMP Multicast Load Splitting Based on Source Group and Next-Hop Address | 324 |
| Effect of ECMP Multicast Load Splitting on PIM Neighbor Query and Hello Messages for RPF Path Selection | 325 |
| Effect of ECMP Multicast Loading Splitting on Assert Processing in PIM-DM and DF Election in Bidir-PIM | 326 |
| Effect of ECMP Multicast Load Splitting on the PIM Assert Process in PIM-SM and PIM-SSM | 327 |
| ECMP Multicast Load Splitting and Reconvergence When Unicast Routing Changes | 328 |
| Use of BGP with ECMP Multicast Load Splitting | 328 |
| Use of ECMP Multicast Load Splitting with Static Mroutes | 328 |
| Alternative Methods of Load Splitting IP Multicast Traffic | 329 |
| How to Load Split IP Multicast Traffic over ECMP | 329 |
| Enabling ECMP Multicast Load Splitting | 329 |
| Prerequisites for IP Multicast Load Splitting - ECMP | 329 |
| Restrictions | 330 |
| Enabling ECMP Multicast Load Splitting Based on Source Address | 330 |
| Enabling ECMP Multicast Load Splitting Based on Source and Group Address | 332 |
| Enabling ECMP Multicast Load Splitting Based on Source Group and Next-Hop Address | 334 |
| Configuration Examples for Load Splitting IP Multicast Traffic over ECMP | 336 |
| Example Enabling ECMP Multicast Load Splitting Based on Source Address | 336 |
| Example Enabling ECMP Multicast Load Splitting Based on Source and Group Address | 336 |

Example Enabling ECMP Multicast Load Splitting Based on Source Group and Next-Hop Address 336

Additional References 337

Feature History and Information for Load Splitting IP Multicast Traffic over ECMP 338

CHAPTER 17

IP Multicast Optimization: SSM Channel Based Filtering for Multicast 339

Finding Feature Information 339

Finding Feature Information 339

Prerequisites for SSM Channel Based Filtering for Multicast Boundaries 340

Information About the SSM Channel Based Filtering for Multicast Boundaries Feature 340

Rules for Multicast Boundaries 340

Benefits of SSM Channel Based Filtering for Multicast Boundaries 340

How to Configure SSM Channel Based Filtering for Multicast Boundaries 341

Configuring Multicast Boundaries 341

Configuration Examples for SSM Channel Based Filtering for Multicast Boundaries 342

Configuring the Multicast Boundaries Permitting and Denying Traffic Example 342

Configuring the Multicast Boundaries Permitting Traffic Example 342

Configuring the Multicast Boundaries Denying Traffic Example 343

Additional References 343

Feature History and Information for SSM Channel Based Filtering for Multicast Boundaries 344

CHAPTER 18

IP Multicast Optimization: PIM Dense Mode State Refresh 345

Finding Feature Information 345

Prerequisite for PIM Dense Mode State Refresh 345

Restrictions on PIM Dense Mode State Refresh 345

Information About PIM Dense Mode State Refresh 346

PIM Dense Mode State Refresh Overview 346

Benefits of PIM Dense Mode State Refresh 346

How to Configure PIM Dense Mode State Refresh 346

Configuring PIM Dense Mode State Refresh 346

Verifying PIM Dense Mode State Refresh Configuration 347

Monitoring and Maintaining PIM DM State Refresh 348

Configuration Examples for PIM Dense Mode State Refresh 348

| | |
|---|-----|
| Originating Processing and Forwarding PIM Dense Mode State Refresh Control Messages Example | 348 |
| Processing and Forwarding PIM Dense Mode State Refresh Control Messages Example | 349 |
| Additional References | 349 |
| Feature History and Information for PIM Dense Mode State Refresh | 350 |

CHAPTER 19**IP Multicast Optimization: IGMP State Limit 351**

| | |
|--|-----|
| Finding Feature Information | 351 |
| Prerequisites for IGMP State Limit | 351 |
| Restrictions for IGMP State Limit | 351 |
| Information About IGMP State Limit | 352 |
| IGMP State Limit | 352 |
| IGMP State Limit Feature Design | 352 |
| Mechanics of IGMP State Limiters | 352 |
| How to Configure IGMP State Limit | 353 |
| Configuring IGMP State Limiters | 353 |
| Configuring Global IGMP State Limiters | 353 |
| Configuring Per Interface IGMP State Limiters | 354 |
| Configuration examples for IGMP State Limit | 355 |
| Configuring IGMP State Limiters Example | 355 |
| Additional References | 357 |
| Feature History and Information for IGMP State Limit | 357 |



Preface

- [Document Conventions, on page xxi](#)
- [Related Documentation, on page xxiii](#)
- [Obtaining Documentation and Submitting a Service Request, on page xxiii](#)

Document Conventions

This document uses the following conventions:

| Convention | Description |
|--------------------------|--|
| ^ or Ctrl | Both the ^ symbol and Ctrl represent the Control (Ctrl) key on a keyboard. For example, the key combination ^D or Ctrl-D means that you hold down the Control key while you press the D key. (Keys are indicated in capital letters but are not case sensitive.) |
| bold font | Commands and keywords and user-entered text appear in bold font . |
| <i>Italic font</i> | Document titles, new or emphasized terms, and arguments for which you supply values are in <i>italic font</i> . |
| Courier font | Terminal sessions and information the system displays appear in <code>courier font</code> . |
| Bold Courier font | Bold Courier font indicates text that the user must enter. |
| [x] | Elements in square brackets are optional. |
| ... | An ellipsis (three consecutive nonbolded periods without spaces) after a syntax element indicates that the element can be repeated. |
| | A vertical line, called a pipe, indicates a choice within a set of keywords or arguments. |
| [x y] | Optional alternative keywords are grouped in brackets and separated by vertical bars. |
| {x y} | Required alternative keywords are grouped in braces and separated by vertical bars. |

| Convention | Description |
|-------------|---|
| [x {y z}] | Nested set of square brackets or braces indicate optional or required choices within optional or required elements. Braces and a vertical bar within square brackets indicate a required choice within an optional element. |
| string | A nonquoted set of characters. Do not use quotation marks around the string or the string will include the quotation marks. |
| < > | Nonprinting characters such as passwords are in angle brackets. |
| [] | Default responses to system prompts are in square brackets. |
| !, # | An exclamation point (!) or a pound sign (#) at the beginning of a line of code indicates a comment line. |

Reader Alert Conventions

This document may use the following conventions for reader alerts:



Note Means *reader take note*. Notes contain helpful suggestions or references to material not covered in the manual.



Tip Means *the following information will help you solve a problem*.



Caution Means *reader be careful*. In this situation, you might do something that could result in equipment damage or loss of data.



Timesaver Means *the described action saves time*. You can save time by performing the action described in the paragraph.



Warning IMPORTANT SAFETY INSTRUCTIONS

This warning symbol means danger. You are in a situation that could cause bodily injury. Before you work on any equipment, be aware of the hazards involved with electrical circuitry and be familiar with standard practices for preventing accidents. Use the statement number provided at the end of each warning to locate its translation in the translated safety warnings that accompanied this device. Statement 1071

SAVE THESE INSTRUCTIONS

Related Documentation



Note Before installing or upgrading the switch, refer to the switch release notes.

- Cisco Catalyst 3850 Switch documentation, located at:
http://www.cisco.com/go/cat3850_docs
- Cisco SFP, SFP+, and QSFP+ modules documentation, including compatibility matrixes, located at:
http://www.cisco.com/en/US/products/hw/modules/ps5455/tsd_products_support_series_home.html
- Cisco Validated Designs documents, located at:
<http://www.cisco.com/go/designzone>
- Error Message Decoder, located at:
<https://www.cisco.com/cgi-bin/Support/Errordecoder/index.cgi>

Obtaining Documentation and Submitting a Service Request

For information on obtaining documentation, submitting a service request, and gathering additional information, see the monthly *What's New in Cisco Product Documentation*, which also lists all new and revised Cisco technical documentation, at:

<http://www.cisco.com/c/en/us/td/docs/general/whatsnew/whatsnew.html>

Subscribe to the *What's New in Cisco Product Documentation* as a Really Simple Syndication (RSS) feed and set content to be delivered directly to your desktop using a reader application. The RSS feeds are a free service and Cisco currently supports RSS version 2.0.



CHAPTER

1

Using the Command-Line Interface

- [Information About Using the Command-Line Interface, on page 1](#)
- [How to Use the CLI to Configure Features, on page 5](#)

Information About Using the Command-Line Interface

Command Modes

The Cisco IOS user interface is divided into many different modes. The commands available to you depend on which mode you are currently in. Enter a question mark (?) at the system prompt to obtain a list of commands available for each command mode.

You can start a CLI session through a console connection, through Telnet, an SSH, or by using the browser.

When you start a session, you begin in user mode, often called user EXEC mode. Only a limited subset of the commands are available in user EXEC mode. For example, most of the user EXEC commands are one-time commands, such as **show** commands, which show the current configuration status, and **clear** commands, which clear counters or interfaces. The user EXEC commands are not saved when the switch reboots.

To have access to all commands, you must enter privileged EXEC mode. Normally, you must enter a password to enter privileged EXEC mode. From this mode, you can enter any privileged EXEC command or enter global configuration mode.

Using the configuration modes (global, interface, and line), you can make changes to the running configuration. If you save the configuration, these commands are stored and used when the switch reboots. To access the various configuration modes, you must start at global configuration mode. From global configuration mode, you can enter interface configuration mode and line configuration mode .

This table describes the main command modes, how to access each one, the prompt you see in that mode, and how to exit the mode.

Table 1: Command Mode Summary

| Mode | Access Method | Prompt | Exit Method | About This Mode |
|----------------------|---|----------------------|--|--|
| User EXEC | Begin a session using Telnet, SSH, or console. | Switch> | Enter logout or quit . | Use this mode to <ul style="list-style-type: none"> • Change terminal settings. • Perform basic tests. • Display system information. |
| Privileged EXEC | While in user EXEC mode, enter the enable command. | Switch# | Enter disable to exit. | Use this mode to verify commands that you have entered. Use a password to protect access to this mode. |
| Global configuration | While in privileged EXEC mode, enter the configure command. | Switch(config)# | To exit to privileged EXEC mode, enter exit or end , or press Ctrl-Z . | Use this mode to configure parameters that apply to the entire switch. |
| VLAN configuration | While in global configuration mode, enter the vlan <i>vlan-id</i> command. | Switch(config-vlan)# | To exit to global configuration mode, enter the exit command. To return to privileged EXEC mode, press Ctrl-Z or enter end . | Use this mode to configure VLAN parameters. When VTP mode is transparent, you can create extended-range VLANs (VLAN IDs greater than 1005) and save configurations in the switch startup configuration file. |

| Mode | Access Method | Prompt | Exit Method | About This Mode |
|-------------------------|---|-----------------------|---|---|
| Interface configuration | While in global configuration mode, enter the interface command (with a specific interface). | Switch(config-if) # | To exit to global configuration mode, enter exit . To return to privileged EXEC mode, press Ctrl-Z or enter end . | Use this mode to configure parameters for the Ethernet ports. |
| Line configuration | While in global configuration mode, specify a line with the line vty or line console command. | Switch(config-line) # | To exit to global configuration mode, enter exit . To return to privileged EXEC mode, press Ctrl-Z or enter end . | Use this mode to configure parameters for the terminal line. |

Understanding Abbreviated Commands

You need to enter only enough characters for the switch to recognize the command as unique.

This example shows how to enter the **show configuration** privileged EXEC command in an abbreviated form:

```
Switch# show conf
```

No and Default Forms of Commands

Almost every configuration command also has a **no** form. In general, use the **no** form to disable a feature or function or reverse the action of a command. For example, the **no shutdown** interface configuration command reverses the shutdown of an interface. Use the command without the keyword **no** to reenab a disabled feature or to enable a feature that is disabled by default.

Configuration commands can also have a **default** form. The **default** form of a command returns the command setting to its default. Most commands are disabled by default, so the **default** form is the same as the **no** form. However, some commands are enabled by default and have variables set to certain default values. In these cases, the **default** command enables the command and sets variables to their default values.

CLI Error Messages

This table lists some error messages that you might encounter while using the CLI to configure your switch.

Table 2: Common CLI Error Messages

| Error Message | Meaning | How to Get Help |
|---|--|---|
| % Ambiguous command: "show con" | You did not enter enough characters for your switch to recognize the command. | Reenter the command followed by a question mark (?) without any space between the command and the question mark. The possible keywords that you can enter with the command appear. |
| % Incomplete command. | You did not enter all of the keywords or values required by this command. | Reenter the command followed by a question mark (?) with a space between the command and the question mark. The possible keywords that you can enter with the command appear. |
| % Invalid input detected at '^' marker. | You entered the command incorrectly. The caret (^) marks the point of the error. | Enter a question mark (?) to display all of the commands that are available in this command mode. The possible keywords that you can enter with the command appear. |

Configuration Logging

You can log and view changes to the switch configuration. You can use the Configuration Change Logging and Notification feature to track changes on a per-session and per-user basis. The logger tracks each configuration command that is applied, the user who entered the command, the time that the command was entered, and the parser return code for the command. This feature includes a mechanism for asynchronous notification to registered applications whenever the configuration changes. You can choose to have the notifications sent to the syslog.



Note Only CLI or HTTP changes are logged.

Using the Help System

You can enter a question mark (?) at the system prompt to display a list of commands available for each command mode. You can also obtain a list of associated keywords and arguments for any command.

SUMMARY STEPS

1. **help**
2. *abbreviated-command-entry ?*
3. *abbreviated-command-entry <Tab>*
4. **?**
5. *command ?*
6. *command keyword ?*

DETAILED STEPS

| | Command or Action | Purpose |
|--------|--|---|
| Step 1 | help Example: Switch# help | Obtains a brief description of the help system in any command mode. |
| Step 2 | <i>abbreviated-command-entry ?</i> Example: Switch# di? dir disable disconnect | Obtains a list of commands that begin with a particular character string. |
| Step 3 | <i>abbreviated-command-entry <Tab></i> Example: Switch# sh conf<tab> Switch# show configuration | Completes a partial command name. |
| Step 4 | ? Example: Switch> ? | Lists all commands available for a particular command mode. |
| Step 5 | <i>command ?</i> Example: Switch> show ? | Lists the associated keywords for a command. |
| Step 6 | <i>command keyword ?</i> Example: Switch(config)# cdp holdtime ? <10-255> Length of time (in sec) that receiver must keep this packet | Lists the associated arguments for a keyword. |

How to Use the CLI to Configure Features

Configuring the Command History

The software provides a history or record of commands that you have entered. The command history feature is particularly useful for recalling long or complex commands or entries, including access lists. You can customize this feature to suit your needs.

Changing the Command History Buffer Size

By default, the switch records ten command lines in its history buffer. You can alter this number for a current terminal session or for all sessions on a particular line. This procedure is optional.

SUMMARY STEPS

1. `terminal history [size number-of-lines]`

DETAILED STEPS

| | Command or Action | Purpose |
|---------------|---|--|
| Step 1 | <code>terminal history [size number-of-lines]</code> Example: Switch# <code>terminal history size 200</code> | Changes the number of command lines that the switch records during the current terminal session in privileged EXEC mode. You can configure the size from 0 to 256. |

Recalling Commands

To recall commands from the history buffer, perform one of the actions listed in this table. These actions are optional.



Note The arrow keys function only on ANSI-compatible terminals such as VT100s.

SUMMARY STEPS

1. **Ctrl-P** or use the **up arrow** key
2. **Ctrl-N** or use the **down arrow** key
3. `show history`

DETAILED STEPS

| | Command or Action | Purpose |
|---------------|---|---|
| Step 1 | Ctrl-P or use the up arrow key | Recalls commands in the history buffer, beginning with the most recent command. Repeat the key sequence to recall successively older commands. |
| Step 2 | Ctrl-N or use the down arrow key | Returns to more recent commands in the history buffer after recalling commands with Ctrl-P or the up arrow key. Repeat the key sequence to recall successively more recent commands. |
| Step 3 | <code>show history</code> Example: Switch# <code>show history</code> | Lists the last several commands that you just entered in privileged EXEC mode. The number of commands that appear is controlled by the setting of the terminal history global configuration command and the history line configuration command. |

Disabling the Command History Feature

The command history feature is automatically enabled. You can disable it for the current terminal session or for the command line. This procedure is optional.

SUMMARY STEPS

1. terminal no history

DETAILED STEPS

| | Command or Action | Purpose |
|--------|---|---|
| Step 1 | terminal no history Example: Switch# <code>terminal no history</code> | Disables the feature during the current terminal session in privileged EXEC mode. |

Enabling and Disabling Editing Features

Although enhanced editing mode is automatically enabled, you can disable it and reenable it.

SUMMARY STEPS

1. terminal editing
2. terminal no editing

DETAILED STEPS

| | Command or Action | Purpose |
|--------|---|---|
| Step 1 | terminal editing Example: Switch# <code>terminal editing</code> | Reenables the enhanced editing mode for the current terminal session in privileged EXEC mode. |
| Step 2 | terminal no editing Example: Switch# <code>terminal no editing</code> | Disables the enhanced editing mode for the current terminal session in privileged EXEC mode. |

Editing Commands Through Keystrokes

The keystrokes help you to edit the command lines. These keystrokes are optional.



Note The arrow keys function only on ANSI-compatible terminals such as VT100s.

Table 3: Editing Commands

| Editing Commands | Description |
|---|---|
| Ctrl-B or use the left arrow key | Moves the cursor back one character. |
| Ctrl-F or use the right arrow key | Moves the cursor forward one character. |

| | |
|--------------------------------|--|
| Ctrl-A | Moves the cursor to the beginning of the command line. |
| Ctrl-E | Moves the cursor to the end of the command line. |
| Esc B | Moves the cursor back one word. |
| Esc F | Moves the cursor forward one word. |
| Ctrl-T | Transposes the character to the left of the cursor with the character located at the cursor. |
| Delete or Backspace key | Erases the character to the left of the cursor. |
| Ctrl-D | Deletes the character at the cursor. |
| Ctrl-K | Deletes all characters from the cursor to the end of the command line. |
| Ctrl-U or Ctrl-X | Deletes all characters from the cursor to the beginning of the command line. |
| Ctrl-W | Deletes the word to the left of the cursor. |
| Esc D | Deletes from the cursor to the end of the word. |
| Esc C | Capitalizes at the cursor. |
| Esc L | Changes the word at the cursor to lowercase. |
| Esc U | Capitalizes letters from the cursor to the end of the word. |
| Ctrl-V or Esc Q | Designates a particular keystroke as an executable command, perhaps as a shortcut. |
| Return key | <p>Scrolls down a line or screen on displays that are longer than the terminal screen can display.</p> <p>Note The More prompt is used for any output that has more lines than can be displayed on the terminal screen, including show command output. You can use the Return and Space bar keystrokes whenever you see the More prompt.</p> |
| Space bar | Scrolls down one screen. |
| Ctrl-L or Ctrl-R | Redisplays the current command line if the switch suddenly sends a message to your screen. |

Editing Command Lines That Wrap

You can use a wraparound feature for commands that extend beyond a single line on the screen. When the cursor reaches the right margin, the command line shifts ten spaces to the left. You cannot see the first ten characters of the line, but you can scroll back and check the syntax at the beginning of the command. The keystroke actions are optional.

To scroll back to the beginning of the command entry, press **Ctrl-B** or the left arrow key repeatedly. You can also press **Ctrl-A** to immediately move to the beginning of the line.



Note The arrow keys function only on ANSI-compatible terminals such as VT100s.

The following example shows how to wrap a command line that extends beyond a single line on the screen.

SUMMARY STEPS

1. **access-list**
2. **Ctrl-A**
3. **Return key**

DETAILED STEPS

| | Command or Action | Purpose |
|---------------|--|---|
| Step 1 | access-list Example: <pre>Switch(config)# access-list 101 permit tcp 10.15.22.25 255.255.255.0 10.15.22.35 Switch(config)# \$ 101 permit tcp 10.15.22.25 255.255.255.0 10.15.22.35 255.25 Switch(config)# \$t tcp 10.15.22.25 255.255.255.0 131.108.1.20 255.255.255.0 eq Switch(config)# \$15.22.25 255.255.255.0 10.15.22.35 255.255.255.0 eq 45</pre> | Displays the global configuration command entry that extends beyond one line. When the cursor first reaches the end of the line, the line is shifted ten spaces to the left and redisplayed. The dollar sign (\$) shows that the line has been scrolled to the left. Each time the cursor reaches the end of the line, the line is again shifted ten spaces to the left. |
| Step 2 | Ctrl-A Example: <pre>Switch(config)# access-list 101 permit tcp 10.15.22.25 255.255.255.0 10.15.2\$</pre> | Checks the complete syntax. The dollar sign (\$) appears at the end of the line to show that the line has been scrolled to the right. |
| Step 3 | Return key | Execute the commands. The software assumes that you have a terminal screen that is 80 columns wide. If you have a different width, use the terminal width privileged EXEC command to set the width of your terminal. Use line wrapping with the command history feature to recall and modify previous complex command entries. |

Searching and Filtering Output of show and more Commands

You can search and filter the output for **show** and **more** commands. This is useful when you need to sort through large amounts of output or if you want to exclude output that you do not need to see. Using these commands is optional.

SUMMARY STEPS

1. `{show | more} command | {begin | include | exclude} regular-expression`

DETAILED STEPS

| | Command or Action | Purpose |
|---------------|--|--|
| Step 1 | <code>{show more} command {begin include exclude} regular-expression</code> Example: <pre>Switch# show interfaces include protocol Vlan1 is up, line protocol is up Vlan10 is up, line protocol is down GigabitEthernet1/0/1 is up, line protocol is down GigabitEthernet1/0/2 is up, line protocol is up</pre> | Searches and filters the output. Expressions are case sensitive. For example, if you enter <code> exclude output</code> , the lines that contain output are not displayed, but the lines that contain output appear. |

Accessing the CLI on a Switch Stack

You can access the CLI through a console connection, through Telnet, a SSH, or by using the browser.

You manage the switch stack and the stack member interfaces through the active switch. You cannot manage stack members on an individual switch basis. You can connect to the active switch through the console port or the Ethernet management port of one or more stack members. Be careful with using multiple CLI sessions on the active switch. Commands that you enter in one session are not displayed in the other sessions. Therefore, it is possible to lose track of the session from which you entered commands.



Note We recommend using one CLI session when managing the switch stack.

If you want to configure a specific stack member port, you must include the stack member number in the CLI command interface notation.

To debug the standby switch, use the **session standby ios** privileged EXEC command from the active switch to access the IOS console of the standby switch. To debug a specific stack member, use the **session switch stack-member-number** privileged EXEC command from the active switch to access the diagnostic shell of the stack member. For more information about these commands, see the switch command reference.

Accessing the CLI Through a Console Connection or Through Telnet

Before you can access the CLI, you must connect a terminal or a PC to the switch console or connect a PC to the Ethernet management port and then power on the switch, as described in the hardware installation guide that shipped with your switch.

If your switch is already configured, you can access the CLI through a local console connection or through a remote Telnet session, but your switch must first be configured for this type of access.

You can use one of these methods to establish a connection with the switch:

Procedure

- Connect the switch console port to a management station or dial-up modem, or connect the Ethernet management port to a PC. For information about connecting to the console or Ethernet management port, see the switch hardware installation guide.
- Use any Telnet TCP/IP or encrypted Secure Shell (SSH) package from a remote management station. The switch must have network connectivity with the Telnet or SSH client, and the switch must have an enable secret password configured.
 - The switch supports up to 16 simultaneous Telnet sessions. Changes made by one Telnet user are reflected in all other Telnet sessions.
 - The switch supports up to five simultaneous secure SSH sessions.

After you connect through the console port, through the Ethernet management port, through a Telnet session or through an SSH session, the user EXEC prompt appears on the management station.



CHAPTER 2

Using the Web Graphical User Interface

- Prerequisites for Using the Web GUI, on page 13
- Information About Using The Web GUI, on page 14
- Connecting the Console Port of the Switch , on page 15
- Logging On to the GUI, on page 15
- Enabling Web and Secure Web Modes , on page 16
- Configuring the Switch Web GUI, on page 16

Prerequisites for Using the Web GUI

Wired Web UI (Device Manager) System Requirements

Hardware Requirements

Table 4: Minimum Hardware Requirements

| Processor Speed | DRAM | Number of Colors | Resolution | Font Size |
|--------------------------------------|-----------------------------|------------------|------------|-----------|
| 233 MHz minimum 1 | 512 MB 2 | 256 | 1024 x 768 | Small |

¹ We recommend 1 GHz.

² We recommend 1 GB DRAM.

Software Requirements

- – Windows 7, Windows Vista, Windows XP, Windows 2003, or Windows 2000
- – Microsoft Internet Explorer 6.0 and 7.0, and Mozilla Firefox up to version 26.0, with JavaScript enabled.

Wireless Web UI Software Requirements

- Operating Systems
 - Windows 7
 - Windows 8

- Mac OS X 10.8
- Browsers:
 - Google Chrome, version 35
 - Microsoft Internet Explorer, versions 10 or 11
 - Mozilla Firefox, version 30 or later
 - Safari, version 6.1

Information About Using The Web GUI

A web browser, or graphical user interface (GUI), is built into each switch.

You can use either the service port interface or the management interface to access the GUI. We recommend that you use the service-port interface. Click Help at the top of any page in the GUI to display online help. You might need to disable your browser's pop-up blocker to view the online help.

Web GUI Features

The switch web GUI supports the following:

The Configuration Wizard—After initial configuration of the IP address and the local username/password or auth via the authentication server (privilege 15 needed), the wizard provides a method to complete the initial wireless configuration. Start the wizard through Configuration -> Wizard and follow the nine-step process to configure the following:

- Admin Users
- SNMP System Summary
- Management Port
- Wireless Management
- RF Mobility and Country code
- Mobility configuration
- WLANs
- 802.11 Configuration
- Set Time

The Monitor tab:

- Displays summary details of switch, clients, and access points.
- Displays all radio and AP join statistics.
- Displays air quality on access points.
- Displays list of all Cisco Discovery Protocol (CDP) neighbors on all interfaces and the CDP traffic information.
- Displays all rogue access points based on their classification—friendly, malicious, ad hoc, classified, and unclassified.

The Configuration tab:

- Enables you to configure the switch for all initial operation using the web Configuration Wizard. The wizard allows you to configure user details, management interface, and so on.
- Enables you to configure the system, internal DHCP server, management, and mobility management parameters.
- Enables you to configure the switch, WLAN, and radios.
- Enables you to configure and set security policies on your switch.
- Enables you to access the switch operating system software management commands.

The Administration tab enables you to configure system logs.

Connecting the Console Port of the Switch

Before you begin

Before you can configure the switch for basic operations, you need to connect it to a PC that uses a VT-100 terminal emulation program (such as HyperTerminal, ProComm, Minicom, or Tip).

-
- Step 1** Connect one end of a null-modem serial cable to the switch's RJ-45 console port and the other end to your PC's serial port.
- Step 2** Plug the AC power cord into the switch and a grounded 100 to 240 VAC, 50/60-Hz electrical outlet. Turn on the power supply. The bootup script displays operating system software initialization (code download and power-on self-test verification) and basic configuration. If the switch passes the power-on self-test, the bootup script runs the configuration wizard, which prompts you for basic configuration input.
- Step 3** Enter **yes**. Proceed with basic initial setup configuration parameters in the CLI setup wizard. Specify the IP address for the service port which is the gigabitethernet 0/0 interface.

After entering the configuration parameters in the configuration wizard, you can access the Web GUI. Now, the switch is configured with the IP address for service port.

Logging On to the GUI



Note Do not configure TACACS authentication when the controller is set to use local authentication.

Enter the switch IP address in your browser's address bar. For a secure connection, enter **https://ip-address**. For a less secure connection, enter **http://ip-address**.

Enabling Web and Secure Web Modes

- Step 1** Choose **Configuration > Management > Protocol Management > HTTP-HTTPS**.
The **HTTP-HTTPS Configuration** page appears.
- Step 2** To enable web mode, which allows users to access the switch GUI using “http://ip-address,” choose Enabled from the HTTP Access drop-down list. Otherwise, choose Disabled. Web mode (HTTP) is not a secure connection.
- Step 3** To enable secure web mode, which allows users to access the switch GUI using “https://ip-address,” choose Enabled from the HTTPS Access drop-down list. Otherwise, choose Disabled. Secure web mode (HTTPS) is a secure connection.
- Step 4** Choose to track the device in the IP Device Tracking check box.
- Step 5** Choose to enable the trust point in the Enable check box.
- Step 6** Choose the trustpoints from the Trustpoints drop-down list.
- Step 7** Enter the amount of time, in seconds, before the web session times out due to inactivity in the HTTP Timeout-policy (1 to 600 sec) text box.
The valid range is from 1 to 600 seconds.
- Step 8** Enter the server life time in the Server Life Time (1 to 86400 sec) text box.
The valid range is from 1 to 86400 seconds.
- Step 9** Enter the maximum number of connection requests that the server can accept in the Maximum number of Requests (1 to 86400) text box.
The valid range is from 1 to 86400 connections.
- Step 10** Click **Apply**.
- Step 11** Click **Save Configuration**.
-

Configuring the Switch Web GUI

The configuration wizard enables you to configure basic settings on the switch. You can run the wizard after you receive the switch from the factory or after the switch has been reset to factory defaults. The configuration wizard is available in both GUI and CLI formats.

- Step 1** Connect your PC to the service port and configure an IPv4 address to use the same subnet as the switch. The switch is loaded with IOS XE image and the service port interface is configured as gigabitethernet 0/0.
- Step 2** Start Internet Explorer 10 (or later), Firefox 2.0.0.11 (or later), or Google Chrome on your PC and enter the management interface IP address on the browser window. The management interface IP address is same as the gigabitethernet 0/0 (also known as service port interface). When you log in for the first time, you need to enter HTTP username and password. By default, the username is **admin** and the password is **cisco**.
You can use both HTTP and HTTPS when using the service port interface. HTTPS is enabled by default and HTTP can also be enabled.

When you log in for the first time, the <Model Number> <Hostname> page appears.

Step 3 On the page, click the **Wireless Web GUI** link to access switch web GUI **Home** page.

Step 4 Choose **Configuration** > **Wizard** to perform all steps that you need to configure the switch initially.

The **Admin Users** page appears.

Step 5 On the **Admin Users** page, enter the administrative username to be assigned to this switch in the User Name text box and the administrative password to be assigned to this switch in the Password and Confirm Password text boxes. Click **Next**.

The default username is **admin** and the default password is **cisco**. You can also create a new administrator user for the switch. You can enter up to 24 ASCII characters for username and password.

The **SNMP System Summary** page appears.

Step 6 On the **SNMP System Summary** page, enter the following SNMP system parameters for the switch, and click **Next**:

- Customer-definable switch location in the Location text box.
- Customer-definable contact details such as phone number with names in the Contact text box.
- Choose **enabled** to send SNMP notifications for various SNMP traps or **disabled** not to send SNMP notifications for various SNMP traps from the SNMP Global Trap drop-down list.
- Choose **enabled** to send system log messages or **disabled** not to send system log messages from the SNMP Logging drop-down list.

Note The SNMP trap server, must be reachable through the distribution ports (and not through the gigabitethernet0/0 service or management interface).

The **Management Port** page appears.

Step 7 In the **Management Port** page, enter the following parameters for the management port interface (gigabitethernet 0/0) and click **Next**.

- Interface IP address that you assigned for the service port in the IP Address text box.
- Network mask address of the management port interface in the Netmask text box.
- The IPv4 Dynamic Host Configuration Protocol (DHCP) address for the selected port in the IPv4 DHCP Server text box.

The **Wireless Management** page appears.

Step 8 In the **Wireless Management** page, enter the following wireless interface management details, and click **Next**.

- Choose the interface—VLAN, or Ten Gigabit Ethernet from the Select Interface drop-down list.
- VLAN tag identifier, or 0 for no VLAN tag in the VLAN id text box.
- IP address of wireless management interface where access points are connected in the IP Address text box.
- Network mask address of the wireless management interface in the Netmask text box.
- DHCP IPv4 IP address in the IPv4 DHCP Server text box.

When selecting VLAN as interface, you can specify the ports as –Trunk or Access ports from the selected list displayed in the Switch Port Configuration text box.

The **RF Mobility and Country Code** page appears.

Step 9 In the **RF Mobility and Country Code** page, enter the RF mobility domain name in the RF Mobility text box, choose current country code from the Country Code drop-down list, and click **Next**. From the GUI, you can select only one country code.

Note Before configuring RF grouping parameters and mobility configuration, ensure that you refer to the relevant conceptual content and then proceed with the configuration.

The **Mobility Configuration** page with mobility global configuration settings appears.

Step 10 In the **Mobility Configuration** page, view and enter the following mobility global configuration settings, and click **Next**.

- Choose **Mobility Controller** or **Mobility Agent** from the Mobility Role drop-down list:
 - If Mobility Agent is chosen, enter the mobility controller IP address in the Mobility Controller IP Address text box and mobility controller IP address in the Mobility Controller Public IP Address text box.
 - If Mobility Controller is chosen, then the mobility controller IP address and mobility controller public IP address are displayed in the respective text boxes.
- Displays mobility protocol port number in the Mobility Protocol Port text box.
- Displays the mobility switch peer group name in the Mobility Switch Peer Group Name text box.
- Displays whether DTLS is enabled in the DTLS Mode text box.

DTLS is a standards-track Internet Engineering Task Force (IETF) protocol based on TLS.
- Displays mobility domain identifier for 802.11 radios in the Mobility Domain ID for 802.11 radios text box.
- The amount of time (in seconds) between each ping request sent to an peer switch in the Mobility Keepalive Interval (1-30)sec text box.

Valid range is from 1 to 30 seconds, and the default value is 10 seconds.
- Number of times a ping request is sent to an peer switch before the peer is considered to be unreachable in the Mobility Keepalive Count (3-20) text box.

The valid range is from 3 to 20, and the default value is 3.
- The DSCP value that you can set for the mobility switch in the Mobility Control Message DSCP Value (0-63) text box.

The valid range is 0 to 63, and the default value is 0.
- Displays the number of mobility switch peer group member configured in the Switch Peer Group Members Configured text box.

The **WLANs** page appears.

Step 11 In the **WLANs** page, enter the following WLAN configuration parameters, and click **Next**.

- WLAN identifier in the WLAN ID text box.
- SSID of the WLAN that the client is associated with in the SSID text box.
- Name of the WLAN used by the client in the Profile Name text box.

The **802.11 Configuration** page appears.

Step 12 In the **802.11 Configuration** page, check either one or both 802.11a/n/ac and 802.11b/g/n check boxes to enable the 802.11 radios, and click **Next**.

The **Set Time** page appears.

Step 13 In the **Set Time** page, you can configure the time and date on the switch based on the following parameters, and click **Next**.

- Displays current timestamp on the switch in the Current Time text box.
- Choose either Manual or NTP from the Mode drop-down list.
On using the NTP server, all access points connected to the switch, synchronizes its time based on the NTP server settings available.
- Choose date on the switch from the Year, Month, and Day drop-down list.
- Choose time from the Hours, Minutes, and Seconds drop-down list.
- Enter the time zone in the Zone text box and select the off setting required when compared to the current time configured on the switch from the Offset drop-down list.

The **Save Wizard** page appears.

Step 14 In the **Save Wizard** page, you can review the configuration settings performed on the switch using these steps, and if you wish to change any configuration value, click **Previous** and navigate to that page.

You can save the switch configuration created using the wizard only if a success message is displayed for all the wizards. If the **Save Wizard** page displays errors, you must recreate the wizard for initial configuration of the switch.



CHAPTER 3

IP Multicast Routing Technology Overview

- [Finding Feature Information](#), on page 21
- [Information About IP Multicast Technology](#), on page 21
- [Additional References](#), on page 28

Finding Feature Information

Your software release may not support all the features documented in this module. For the latest caveats and feature information, see [Bug Search Tool](#) and the release notes for your platform and software release. To find information about the features documented in this module, and to see a list of the releases in which each feature is supported, see the feature information table.

Use Cisco Feature Navigator to find information about platform support and Cisco software image support. To access Cisco Feature Navigator, go to www.cisco.com/go/cfn. An account on Cisco.com is not required.

Information About IP Multicast Technology

Role of IP Multicast in Information Delivery

IP multicast is a bandwidth-conserving technology that reduces traffic by delivering a single stream of information simultaneously to potentially thousands of businesses and homes. Applications that take advantage of multicast include video conferencing, corporate communications, distance learning, and distribution of software, stock quotes, and news.

IP multicast routing enables a host (source) to send packets to a group of hosts (receivers) anywhere within the IP network by using a special form of IP address called the IP multicast group address. The sending host inserts the multicast group address into the IP destination address field of the packet and IP multicast routers and multilayer switches forward incoming IP multicast packets out all interfaces that lead to the members of the multicast group. Any host, regardless of whether it is a member of a group, can send to a group. However, only the members of a group receive the message.

IP Multicast Routing Protocols

The software supports the following protocols to implement IP multicast routing:

- IGMP is used between hosts on a LAN and the routers (and multilayer switches) on that LAN to track the multicast groups of which hosts are members. To participate in IP multicasting, multicast hosts, routers, and multilayer switches must have the Internet Group Management Protocol (IGMP) operating.
- Protocol Independent Multicast (PIM) is used between routers so that they can track which multicast packets to forward to each other and to their directly connected LANs.
- IGMP Snooping is used for multicasting in a Layer 2 switching environment. It helps reduce the flooding of multicast traffic by dynamically configuring Layer 2 interfaces so that multicast traffic is forwarded to only those interfaces associated with IP multicast devices.

This figure shows where these protocols operate within the IP multicast environment.

Figure 1: IP Multicast Routing Protocols

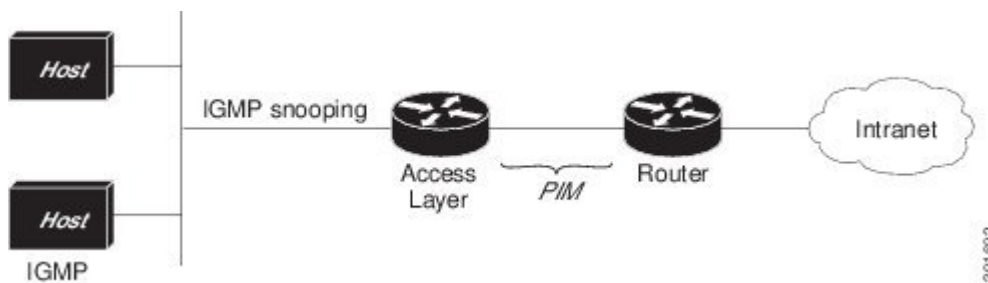

According to IPv4 multicast standards, the MAC destination multicast address begins with 0100:5e and is appended by the last 23 bits of the IP address. For example, if the IP destination address is 239.1.1.39, the MAC destination address is 0100:5e01:0127.

A multicast packet is unmatched when the destination IPv4 address does not match the destination MAC address. The switch forwards the unmatched packet in hardware based upon the MAC address table. If the destination MAC address is not in the MAC address table, the switch floods the packet to the all port in the same VLAN as the receiving port.

Related Topics

[Configuring Basic IP Multicast Routing](#), on page 266

[Prerequisites for Basic IP Multicast Routing](#), on page 263

Multicast Group Transmission Scheme

IP communication consists of hosts that act as senders and receivers of traffic as shown in the first figure. Senders are called sources. Traditional IP communication is accomplished by a single host source sending packets to another single host (unicast transmission) or to all hosts (broadcast transmission). IP multicast provides a third scheme, allowing a host to send packets to a subset of all hosts (multicast transmission). This subset of receiving hosts is called a multicast group. The hosts that belong to a multicast group are called group members.

Multicast is based on this group concept. A multicast group is an arbitrary number of receivers that join a group in order to receive a particular data stream. This multicast group has no physical or geographical boundaries--the hosts can be located anywhere on the Internet or on any private internetwork. Hosts that are interested in receiving data from a source to a particular group must join that group. Joining a group is accomplished by a host receiver by way of the Internet Group Management Protocol (IGMP).

In a multicast environment, any host, regardless of whether it is a member of a group, can send to a group. However, only the members of a group can receive packets sent to that group. Multicast packets are delivered to a group using best-effort reliability, just like IP unicast packets.

Unicast transmission—One host sends and the other receives.



Broadcast transmission—One sender to all receivers.

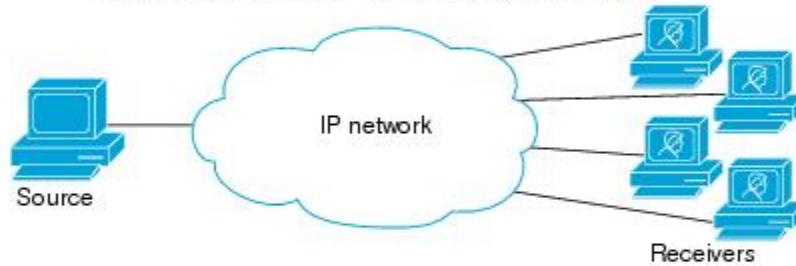

Multicast transmission—One sender to a group of receivers.

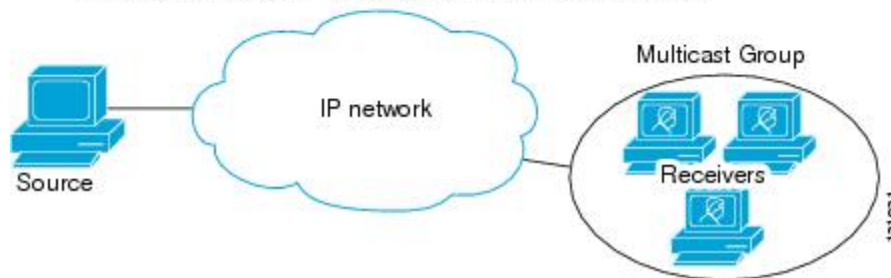

In the next figure, the receivers (the designated multicast group) are interested in receiving the video data stream from the source. The receivers indicate their interest by sending an IGMP host report to the routers in the network. The routers are then responsible for delivering the data from the source to the receivers. The routers use Protocol Independent Multicast (PIM) to dynamically create a multicast distribution tree. The video data stream will then be delivered only to the network segments that are in the path between the source and the receivers.

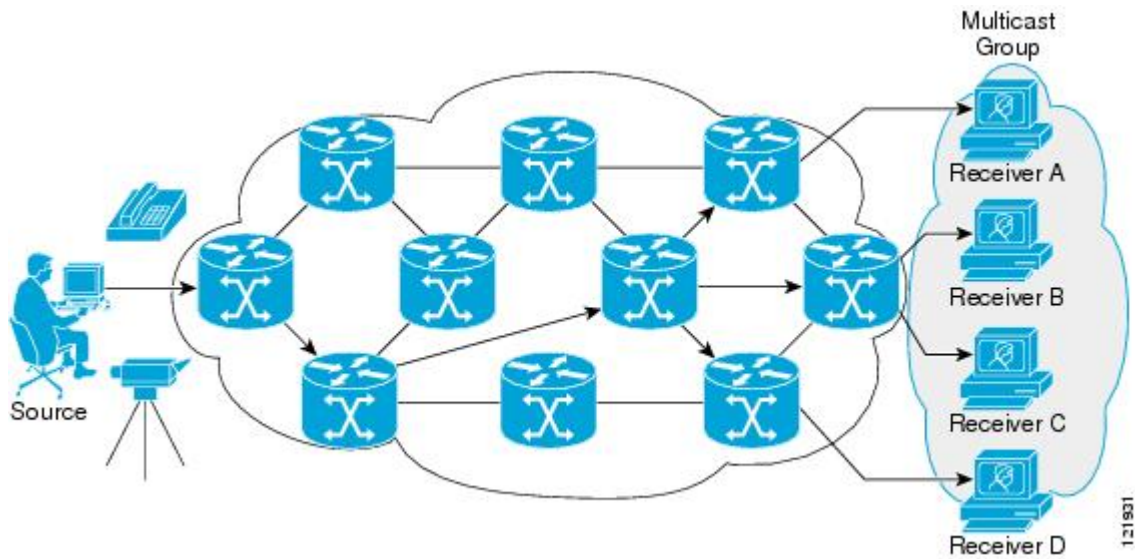

Related Topics

[Defining the IP Multicast Boundary \(CLI\)](#), on page 145

[Example: Configuring an IP Multicast Boundary](#), on page 280

IP Multicast Boundary

As shown in the figure, address scoping defines domain boundaries so that domains with RPs that have the same IP address do not leak into each other. Scoping is performed on the subnet boundaries within large domains and on the boundaries between the domain and the Internet.

Figure 2: Address Scoping at Boundaries

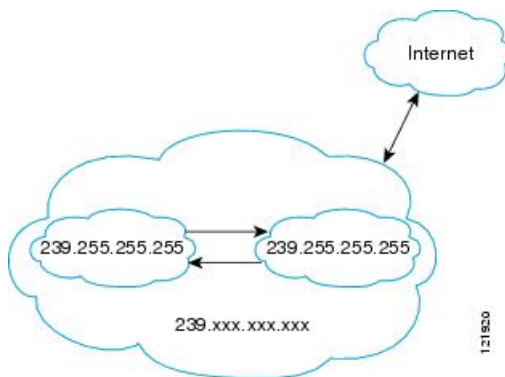

You can set up an administratively scoped boundary on an interface for multicast group addresses using the **ip multicast boundary** command with the *access-list* argument. A standard access list defines the range of addresses affected. When a boundary is set up, no multicast data packets are allowed to flow across the boundary from either direction. The boundary allows the same multicast group address to be reused in different administrative domains.

The Internet Assigned Numbers Authority (IANA) has designated the multicast address range 239.0.0.0 to 239.255.255.255 as the administratively scoped addresses. This range of addresses can be reused in domains administered by different organizations. They would be considered local, not globally unique.

You can configure the **filter-autorp** keyword to examine and filter Auto-RP discovery and announcement messages at the administratively scoped boundary. Any Auto-RP group range announcements from the Auto-RP packets that are denied by the boundary access control list (ACL) are removed. An Auto-RP group range announcement is permitted and passed by the boundary only if all addresses in the Auto-RP group range are permitted by the boundary ACL. If any address is not permitted, the entire group range is filtered and removed from the Auto-RP message before the Auto-RP message is forwarded. In order to block all multicast traffic coming in on interface but allow multicast traffic coming out of the interface, use the `{ ip | ipv6 } multicast boundary block sources` command.

Related Topics

[Defining the IP Multicast Boundary \(CLI\)](#), on page 145

[Example: Configuring an IP Multicast Boundary](#), on page 280

IP Multicast Group Addressing

A multicast group is identified by its multicast group address. Multicast packets are delivered to that multicast group address. Unlike unicast addresses that uniquely identify a single host, multicast IP addresses do not identify a particular host. To receive the data sent to a multicast address, a host must join the group that address identifies. The data is sent to the multicast address and received by all the hosts that have joined the group indicating that they wish to receive traffic sent to that group. The multicast group address is assigned to a group at the source. Network administrators who assign multicast group addresses must make sure the addresses conform to the multicast address range assignments reserved by the Internet Assigned Numbers Authority (IANA).

IP Class D Addresses

IP multicast addresses have been assigned to the IPv4 Class D address space by IANA. The high-order four bits of a Class D address are 1110. Therefore, host group addresses can be in the range 224.0.0.0 to 239.255.255.255. A multicast address is chosen at the source (sender) for the receivers in a multicast group.



Note The Class D address range is used only for the group address or destination address of IP multicast traffic. The source address for multicast datagrams is always the unicast source address.

IP Multicast Address Scoping

The multicast address range is subdivided to provide predictable behavior for various address ranges and for address reuse within smaller domains. The table provides a summary of the multicast address ranges. A brief summary description of each range follows.

Table 5: Multicast Address Range Assignments

| Name | Range | Description |
|-------------------------------|------------------------------|--|
| Reserved Link-Local Addresses | 224.0.0.0 to 224.0.0.255 | Reserved for use by network protocols on a local network segment. |
| Globally Scoped Addresses | 224.0.1.0 to 238.255.255.255 | Reserved to send multicast data between organizations and across the Internet. |

| Name | Range | Description |
|---------------------------|------------------------------|--|
| Source Specific Multicast | 232.0.0.0 to 232.255.255.255 | Reserved for use with the SSM datagram delivery model where data is forwarded only to receivers that have explicitly joined the group. |
| GLOP Addresses | 233.0.0.0 to 233.255.255.255 | Reserved for statically defined addresses by organizations that already have an assigned autonomous system (AS) domain number. |
| Limited Scope Address | 239.0.0.0 to 239.255.255.255 | Reserved as administratively or limited scope addresses for use in private multicast domains. |

Reserved Link-Local Addresses

The IANA has reserved the range 224.0.0.0 to 224.0.0.255 for use by network protocols on a local network segment. Packets with an address in this range are local in scope and are not forwarded by IP routers. Packets with link local destination addresses are typically sent with a time-to-live (TTL) value of 1 and are not forwarded by a router.

Within this range, reserved link-local addresses provide network protocol functions for which they are reserved. Network protocols use these addresses for automatic router discovery and to communicate important routing information. For example, Open Shortest Path First (OSPF) uses the IP addresses 224.0.0.5 and 224.0.0.6 to exchange link-state information.

IANA assigns single multicast address requests for network protocols or network applications out of the 224.0.1.xxx address range. Multicast routers forward these multicast addresses.

Globally Scoped Addresses

Addresses in the range 224.0.1.0 to 238.255.255.255 are called globally scoped addresses. These addresses are used to send multicast data between organizations across the Internet. Some of these addresses have been reserved by IANA for use by multicast applications. For example, the IP address 224.0.1.1 is reserved for Network Time Protocol (NTP).

Source Specific Multicast Addresses

Addresses in the range 232.0.0.0/8 are reserved for Source Specific Multicast (SSM) by IANA. In Cisco IOS software, you can use the `ip pim ssm` command to configure SSM for arbitrary IP multicast addresses also. SSM is an extension of Protocol Independent Multicast (PIM) that allows for an efficient data delivery mechanism in one-to-many communications. SSM is described in the [IP Multicast Delivery Modes, on page 27](#) section.

GLOP Addresses

GLOP addressing (as proposed by RFC 2770, GLOP Addressing in 233/8) proposes that the 233.0.0.0/8 range be reserved for statically defined addresses by organizations that already have an AS number reserved. This practice is called GLOP addressing. The AS number of the domain is embedded into the second and third octets of the 233.0.0.0/8 address range. For example, AS 62010 is written in hexadecimal format as F23A. Separating the two octets F2 and 3A results in 242 and 58 in decimal format. These values result in a subnet of 233.242.58.0/24 that would be globally reserved for AS 62010 to use.

Limited Scope Addresses

The range 239.0.0.0 to 239.255.255.255 is reserved as administratively or limited scoped addresses for use in private multicast domains. These addresses are constrained to a local group or organization. Companies, universities, and other organizations can use limited scope addresses to have local multicast applications that will not be forwarded outside their domain. Routers typically are configured with filters to prevent multicast traffic in this address range from flowing outside an autonomous system (AS) or any user-defined domain. Within an AS or domain, the limited scope address range can be further subdivided so that local multicast boundaries can be defined.



Note Network administrators may use multicast addresses in this range, inside a domain, without conflicting with others elsewhere in the Internet.

Layer 2 Multicast Addresses

Historically, network interface cards (NICs) on a LAN segment could receive only packets destined for their burned-in MAC address or the broadcast MAC address. In IP multicast, several hosts need to be able to receive a single data stream with a common destination MAC address. Some means had to be devised so that multiple hosts could receive the same packet and still be able to differentiate between several multicast groups. One method to accomplish this is to map IP multicast Class D addresses directly to a MAC address. Using this method, NICs can receive packets destined to many different MAC address.

Cisco Group Management Protocol (CGMP) is used on routers connected to Catalyst switches to perform tasks similar to those performed by IGMP. CGMP is necessary for those Catalyst switches that cannot distinguish between IP multicast data packets and IGMP report messages, both of which are addressed to the same group address at the MAC level.

IP Multicast Delivery Modes

IP multicast delivery modes differ only for the receiver hosts, not for the source hosts. A source host sends IP multicast packets with its own IP address as the IP source address of the packet and a group address as the IP destination address of the packet.

Source Specific Multicast

Source Specific Multicast (SSM) is a datagram delivery model that best supports one-to-many applications, also known as broadcast applications. SSM is a core network technology for the Cisco implementation of IP multicast targeted for audio and video broadcast application environments.

For the SSM delivery mode, an IP multicast receiver host must use IGMP Version 3 (IGMPv3) to subscribe to channel (S,G). By subscribing to this channel, the receiver host is indicating that it wants to receive IP multicast traffic sent by source host S to group G. The network will deliver IP multicast packets from source host S to group G to all hosts in the network that have subscribed to the channel (S, G).

SSM does not require group address allocation within the network, only within each source host. Different applications running on the same source host must use different SSM groups. Different applications running on different source hosts can arbitrarily reuse SSM group addresses without causing any excess traffic on the network.

Additional References

Related Documents

| Related Topic | Document Title |
|--|--|
| IP multicast commands: complete command syntax, command mode, command history, defaults, usage guidelines and examples | <i>Cisco IOS IP Multicast Command Reference</i> |
| For complete syntax and usage information for the commands used in this chapter. | <i>IP Multicast Routing Command Reference (Catalyst 3850 Switches)</i> |

MIBs

| MIB | MIBs Link |
|-----|--|
| -- | To locate and download MIBs for selected platforms, Cisco IOS releases, and feature sets, use Cisco MIB Locator found at the following URL: http://www.cisco.com/go/mibs |

RFCs

| RFC | Title |
|----------|---|
| RFC 1112 | Host Extensions for IP Multicasting |
| RFC 2113 | IP Router Alert Option |
| RFC 2362 | Protocol Independent Multicast-Sparse Mode (PIM-SM): Protocol Specification |
| RFC 3180 | GLOP Addressing in 233/8 |

Technical Assistance

| Description | Link |
|---|---|
| <p>The Cisco Support website provides extensive online resources, including documentation and tools for troubleshooting and resolving technical issues with Cisco products and technologies.</p> <p>To receive security and technical information about your products, you can subscribe to various services, such as the Product Alert Tool (accessed from Field Notices), the Cisco Technical Services Newsletter, and Really Simple Syndication (RSS) Feeds.</p> <p>Access to most tools on the Cisco Support website requires a Cisco.com user ID and password.</p> | http://www.cisco.com/cisco/web/support/index.html |



CHAPTER 4

Configuring IGMP

- [Finding Feature Information](#), on page 29
- [Prerequisites for IGMP and IGMP Snooping](#), on page 29
- [Restrictions for IGMP and IGMP Snooping](#), on page 30
- [Information About IGMP](#), on page 31
- [How to Configure IGMP](#), on page 42
- [Monitoring IGMP](#), on page 84
- [Configuration Examples for IGMP](#), on page 86
- [Additional References](#), on page 91
- [Feature History and Information for IGMP](#), on page 92

Finding Feature Information

Your software release may not support all the features documented in this module. For the latest caveats and feature information, see [Bug Search Tool](#) and the release notes for your platform and software release. To find information about the features documented in this module, and to see a list of the releases in which each feature is supported, see the feature information table.

Use Cisco Feature Navigator to find information about platform support and Cisco software image support. To access Cisco Feature Navigator, go to www.cisco.com/go/cfn. An account on Cisco.com is not required.

Prerequisites for IGMP and IGMP Snooping

Prerequisites for IGMP

- Before performing the tasks in this module, you should be familiar with the concepts explained in the "IP Multicast Routing Technology Overview" module.
- The tasks in this module assume that IP multicast has been enabled and that the Protocol Independent Multicast (PIM) interfaces have been configured using the tasks described in the "Configuring Basic IP Multicast Routing" module.

Prerequisites for IGMP Snooping

Observe these guidelines when configuring the IGMP snooping querier:

- Configure the VLAN in global configuration mode.
- Configure an IP address on the VLAN interface. When enabled, the IGMP snooping querier uses the IP address as the query source address.
- If there is no IP address configured on the VLAN interface, the IGMP snooping querier tries to use the configured global IP address for the IGMP querier. If there is no global IP address specified, the IGMP querier tries to use the VLAN switch virtual interface (SVI) IP address (if one exists). If there is no SVI IP address, the switch uses the first available IP address configured on the switch. The first IP address available appears in the output of the **show ip interface** privileged EXEC command. The IGMP snooping querier does not generate an IGMP general query if it cannot find an available IP address on the switch.
- The IGMP snooping querier supports IGMP Versions 1 and 2.
- When administratively enabled, the IGMP snooping querier moves to the nonquerier state if it detects the presence of a multicast router in the network.
- When it is administratively enabled, the IGMP snooping querier moves to the operationally disabled state under these conditions:
 - IGMP snooping is disabled in the VLAN.
 - PIM is enabled on the SVI of the corresponding VLAN.

Restrictions for IGMP and IGMP Snooping

Restrictions for Configuring IGMP

The following are the restrictions for configuring IGMP:

- The switch supports IGMP Versions 1, 2, and 3.



Note For IGMP Version 3, only IGMP Version 3 BISS (Basic IGMPv3 Snooping Support) is supported.

- IGMP Version 3 uses new membership report messages that might not be correctly recognized by older IGMP snooping switches.
- IGMPv3 can operate with both ISM and SSM. In ISM, both exclude and include mode reports are applicable. In SSM, only include mode reports are accepted by the last-hop router. Exclude mode reports are ignored.
- IGMP filtering and throttling is not supported under the WLAN.
- You cannot have a switch stack containing a mix of Catalyst 3850 and Catalyst 3650 switches.

Related Topics

- [Changing the IGMP Version\(CLI\)](#), on page 46
- [IGMP Versions](#), on page 32

Restrictions for IGMP Snooping

The following are the restrictions for IGMP snooping:

- The switch supports IGMPv3 snooping based only on the destination multicast IP address. It does not support snooping based on a source IP address or proxy report.
- IGMPv3 join and leave messages are not supported on switches running IGMP filtering or Multicast VLAN registration (MVR).
- IGMP report suppression is supported only when the multicast query has IGMPv1 and IGMPv2 reports. This feature is not supported when the query includes IGMPv3 reports.
- The IGMP configurable leave time is only supported on hosts running IGMP Version 2. IGMP version 2 is the default version for the switch.

The actual leave latency in the network is usually the configured leave time. However, the leave time might vary around the configured time, depending on real-time CPU load conditions, network delays and the amount of traffic sent through the interface.

- The IGMP throttling action restriction can be applied only to Layer 2 ports. You can use **ip igmp max-groups action replace** interface configuration command on a logical EtherChannel interface but cannot use it on ports that belong to an EtherChannel port group.

When the maximum group limitation is set to the default (no maximum), entering the **ip igmp max-groups action {deny | replace}** command has no effect.

If you configure the throttling action and set the maximum group limitation after an interface has added multicast entries to the forwarding table, the forwarding-table entries are either aged out or removed, depending on the throttling action.

Related Topics

- [Changing the IGMP Version\(CLI\)](#), on page 46
- [IGMP Versions](#), on page 32

Information About IGMP

Role of the Internet Group Management Protocol

IGMP is used to dynamically register individual hosts in a multicast group on a particular LAN. Enabling PIM on an interface also enables IGMP. IGMP provides a means to automatically control and limit the flow of multicast traffic throughout your network with the use of special multicast queriers and hosts.

- A querier is a network device, such as a router, that sends query messages to discover which network devices are members of a given multicast group.
- A host is a receiver, including routers, that sends report messages (in response to query messages) to inform the querier of a host membership. Hosts use IGMP messages to join and leave multicast groups.

Hosts identify group memberships by sending IGMP messages to their local multicast device. Under IGMP, devices listen to IGMP messages and periodically send out queries to discover which groups are active or inactive on a particular subnet.

IGMP Multicast Addresses

IP multicast traffic uses group addresses, which are Class D IP addresses. The high-order four bits of a Class D address are 1110. Therefore, host group addresses can be in the range 224.0.0.0 to 239.255.255.255.

Multicast addresses in the range 224.0.0.0 to 224.0.0.255 are reserved for use by routing protocols and other network control traffic. The address 224.0.0.0 is guaranteed not to be assigned to any group.

IGMP packets are transmitted using IP multicast group addresses as follows:

- IGMP general queries are destined to the address 224.0.0.1 (all systems on a subnet).
- IGMP group-specific queries are destined to the group IP address for which the device is querying.
- IGMP group membership reports are destined to the group IP address for which the device is reporting.
- IGMPv2 leave-group messages are destined to the address 224.0.0.2 (all devices on a subnet).
- IGMPv3 membership reports are destined to the address 224.0.0.22; all IGMPv3-capable multicast devices must listen to this address.

Related Topics

[Configuring the Switch as a Member of a Group \(CLI\)](#), on page 42

[Example: Configuring the Switch as a Member of a Multicast Group](#), on page 86

IGMP Versions

The switch supports IGMP version 1, IGMP version 2, and IGMP version 3. These versions are interoperable on the switch. For example, if IGMP snooping is enabled and the querier's version is IGMPv2, and the switch receives an IGMPv3 report from a host, then the switch can forward the IGMPv3 report to the multicast router.

An IGMPv3 switch can receive messages from and forward messages to a device running the Source Specific Multicast (SSM) feature.

Related Topics

[Changing the IGMP Version \(CLI\)](#), on page 46

[Restrictions for Configuring IGMP](#), on page 30

[Restrictions for IGMP Snooping](#), on page 31

IGMP Version 1

IGMP version 1 (IGMPv1) primarily uses a query-response model that enables the multicast router and multilayer switch to find which multicast groups are active (have one or more hosts interested in a multicast group) on the local subnet. IGMPv1 has other processes that enable a host to join and leave a multicast group. For more information, see RFC 1112.

IGMP Version 2

IGMPv2 extends IGMP functionality by providing such features as the IGMP leave process to reduce leave latency, group-specific queries, and an explicit maximum query response time. IGMPv2 also adds the capability

for routers to elect the IGMP querier without depending on the multicast protocol to perform this task. For more information, see RFC 2236.



Note IGMP version 2 is the default version for the switch.

IGMP Version 3

The switch supports IGMP version 3.

An IGMPv3 switch supports Basic IGMPv3 Snooping Support (BISS), which includes support for the snooping features on IGMPv1 and IGMPv2 switches and for IGMPv3 membership report messages. BISS constrains the flooding of multicast traffic when your network includes IGMPv3 hosts. It constrains traffic to approximately the same set of ports as the IGMP snooping feature on IGMPv2 or IGMPv1 hosts.

An IGMPv3 switch can receive messages from and forward messages to a device running the Source Specific Multicast (SSM) feature.

IGMPv3 Host Signaling

IGMPv3 is the third version of the IETF standards track protocol in which hosts signal membership to last-hop devices of multicast groups. IGMPv3 introduces the ability for hosts to signal group membership that allows filtering capabilities with respect to sources. A host can signal either that it wants to receive traffic from all sources sending to a group except for some specific sources (a mode called EXCLUDE) or that it wants to receive traffic only from some specific sources sending to the group (a mode called INCLUDE).

IGMPv3 can operate with both ISM and SSM. In ISM, both EXCLUDE and INCLUDE mode reports are accepted by the last-hop router. In SSM, only INCLUDE mode reports are accepted by the last-hop router.

IGMP Versions Differences

There are three versions of IGMP, as defined by Request for Comments (RFC) documents of the Internet Engineering Task Force (IETF). IGMPv2 improves over IGMPv1 by adding the ability for a host to signal desire to leave a multicast group and IGMPv3 improves over IGMPv2 mainly by adding the ability to listen to multicast originating from a set of source IP addresses only.

Table 6: IGMP Versions

| IGMP Version | Description |
|--------------|--|
| IGMPv1 | Provides the basic query-response mechanism that allows the multicast device to determine which multicast groups are active and other processes that enable hosts to join and leave a multicast group. RFC 1112 defines the IGMPv1 host extensions for IP multicasting. |
| IGMPv2 | Extends IGMP, allowing such capabilities as the IGMP leave process, group-specific queries, and an explicit maximum response time field. IGMPv2 also adds the capability for devices to elect the IGMP querier without dependence on the multicast protocol to perform this task. RFC 2236 defines IGMPv2. |

**Note**

By default, enabling a PIM on an interface enables IGMPv2 on that device. IGMPv2 was designed to be as backward compatible with IGMPv1 as possible. To accomplish this backward compatibility, RFC 2236 defined special interoperability rules. If your network contains legacy IGMPv1 hosts, you should be familiar with these operability rules. For more information about IGMPv1 and IGMPv2 interoperability, see RFC 2236, Internet Group Management Protocol, Version 2 .

Devices That Run IGMPv1

IGMPv1 devices send IGMP queries to the “all-hosts” multicast address of 224.0.0.1 to solicit multicast groups with active multicast receivers. The multicast receivers also can send IGMP reports to the device to notify it that they are interested in receiving a particular multicast stream. Hosts can send the report asynchronously or in response to the IGMP queries sent by the device. If more than one multicast receiver exists for the same multicast group, only one of these hosts sends an IGMP report message; the other hosts suppress their report messages.

In IGMPv1, there is no election of an IGMP querier. If more than one device on the segment exists, all the devices send periodic IGMP queries. IGMPv1 has no special mechanism by which the hosts can leave the group. If the hosts are no longer interested in receiving multicast packets for a particular group, they simply do not reply to the IGMP query packets sent from the device. The device continues sending query packets. If the device does not hear a response in three IGMP queries, the group times out and the device stops sending multicast packets on the segment for the group. If the host later wants to receive multicast packets after the timeout period, the host simply sends a new IGMP join to the device, and the device begins to forward the multicast packet again.

If there are multiple devices on a LAN, a designated router (DR) must be elected to avoid duplicating multicast traffic for connected hosts. PIM devices follow an election process to select a DR. The PIM device with the highest IP address becomes the DR.

The DR is responsible for the following tasks:

- Sending PIM register and PIM Join and Prune messages toward the rendezvous point (RP) to inform it about host group membership.
- Sending IGMP host-query messages.
- Sending host-query messages by default every 60 seconds in order to keep the IGMP overhead on hosts and networks very low.

Devices That Run IGMPv2

IGMPv2 improves the query messaging capabilities of IGMPv1.

The query and membership report messages in IGMPv2 are identical to the IGMPv1 messages with two exceptions:

- IGMPv2 query messages are broken into two categories: general queries (identical to IGMPv1 queries) and group-specific queries.
- IGMPv1 membership reports and IGMPv2 membership reports have different IGMP type codes.

IGMPv2 also enhances IGMP by providing support for the following capabilities:

- Querier election process--Provides the capability for IGMPv2 devices to elect the IGMP querier without having to rely on the multicast routing protocol to perform the process.
- Maximum Response Time field--A new field in query messages permits the IGMP querier to specify the maximum query-response time. This field permits the tuning of the query-response process to control response burstiness and to fine-tune leave latencies.
- Group-Specific Query messages--Permits the IGMP querier to perform the query operation on a specific group instead of all groups.
- Leave-Group messages--Provides hosts with a method of notifying devices on the network that they wish to leave the group.

Unlike IGMPv1, in which the DR and the IGMP querier are typically the same device, in IGMPv2 the two functions are decoupled. The DR and the IGMP querier are selected based on different criteria and may be different devices on the same subnet. The DR is the device with the highest IP address on the subnet, whereas the IGMP querier is the device with the lowest IP address.

Query messages are used to elect the IGMP querier as follows:

1. When IGMPv2 devices start, they each multicast a general query message to the all-systems group address of 224.0.0.1 with their interface address in the source IP address field of the message.
2. When an IGMPv2 device receives a general query message, the device compares the source IP address in the message with its own interface address. The device with the lowest IP address on the subnet is elected the IGMP querier.
3. All devices (excluding the querier) start the query timer, which is reset whenever a general query message is received from the IGMP querier. If the query timer expires, it is assumed that the IGMP querier has gone down, and the election process is performed again to elect a new IGMP querier.

By default, the timer is two times the query interval.

IGMP Join and Leave Process

IGMP Join Process

When a host wants to join a multicast group, the host sends one or more unsolicited membership reports for the multicast group it wants to join. The IGMP join process is the same for IGMPv1 and IGMPv2 hosts.

In IGMPv3, the join process for hosts proceeds as follows:

- When a host wants to join a group, it sends an IGMPv3 membership report to 224.0.0.22 with an empty EXCLUDE list.
- When a host wants to join a specific channel, it sends an IGMPv3 membership report to 224.0.0.22 with the address of the specific source included in the INCLUDE list.
- When a host wants to join a group excluding particular sources, it sends an IGMPv3 membership report to 224.0.0.22 excluding those sources in the EXCLUDE list.



Note If some IGMPv3 hosts on a LAN wish to exclude a source and others wish to include the source, then the device will send traffic for the source on the LAN (that is, inclusion trumps exclusion in this situation).

IGMP Leave Process

The method that hosts use to leave a group varies depending on the version of IGMP in operation.

IGMPv1 Leave Process

There is no leave-group message in IGMPv1 to notify the devices on the subnet that a host no longer wants to receive the multicast traffic from a specific group. The host simply stops processing traffic for the multicast group and ceases responding to IGMP queries with IGMP membership reports for the group. As a result, the only way IGMPv1 devices know that there are no longer any active receivers for a particular multicast group on a subnet is when the devices stop receiving membership reports. To facilitate this process, IGMPv1 devices associate a countdown timer with an IGMP group on a subnet. When a membership report is received for the group on the subnet, the timer is reset. For IGMPv1 devices, this timeout interval is typically three times the query interval (3 minutes). This timeout interval means that the device may continue to forward multicast traffic onto the subnet for up to 3 minutes after all hosts have left the multicast group.

IGMPv2 Leave Process

IGMPv2 incorporates a leave-group message that provides the means for a host to indicate that it wishes to stop receiving multicast traffic for a specific group. When an IGMPv2 host leaves a multicast group, if it was the last host to respond to a query with a membership report for that group, it sends a leave-group message to the all-devices multicast group (224.0.0.2).

IGMPv3 Leave Process

IGMPv3 enhances the leave process by introducing the capability for a host to stop receiving traffic from a particular group, source, or channel in IGMP by including or excluding sources, groups, or channels in IGMPv3 membership reports.

IGMP Snooping

Layer 2 switches can use IGMP snooping to constrain the flooding of multicast traffic by dynamically configuring Layer 2 interfaces so that multicast traffic is forwarded to only those interfaces associated with IP multicast devices. As the name implies, IGMP snooping requires the LAN switch to snoop on the IGMP transmissions between the host and the router and to keep track of multicast groups and member ports. When the switch receives an IGMP report from a host for a particular multicast group, the switch adds the host port number to the forwarding table entry; when it receives an IGMP Leave Group message from a host, it removes the host port from the table entry. It also periodically deletes entries if it does not receive IGMP membership reports from the multicast clients.



Note For more information on IP multicast and IGMP, see RFC 1112 and RFC 2236.

The multicast router (which could be a switch with the IP services feature set on the active switch) sends out periodic general queries to all VLANs. All hosts interested in this multicast traffic send join requests and are added to the forwarding table entry. The switch creates one entry per VLAN in the IGMP snooping IP multicast forwarding table for each group from which it receives an IGMP join request.

The switch supports IP multicast group-based bridging, instead of MAC-addressed based groups. With multicast MAC address-based groups, if an IP address being configured translates (aliases) to a previously

configured MAC address or to any reserved multicast MAC addresses (in the range 224.0.0.xxx), the command fails. Because the switch uses IP multicast groups, there are no address aliasing issues.

The IP multicast groups learned through IGMP snooping are dynamic. However, you can statically configure multicast groups by using the **ip igmp snooping vlan *vlan-id* static *ip_address* interface *interface-id*** global configuration command. If you specify group membership for a multicast group address statically, your setting supersedes any automatic manipulation by IGMP snooping. Multicast group membership lists can consist of both user-defined and IGMP snooping-learned settings.

You can configure an IGMP snooping querier to support IGMP snooping in subnets without multicast interfaces because the multicast traffic does not need to be routed.

If a port spanning-tree, a port group, or a VLAN ID change occurs, the IGMP snooping-learned multicast groups from this port on the VLAN are deleted.

These sections describe IGMP snooping characteristics:

Joining a Multicast Group

Figure 3: Initial IGMP Join Message

When a host connected to the switch wants to join an IP multicast group and it is an IGMP version 2 client, it sends an unsolicited IGMP join message, specifying the IP multicast group to join. Alternatively, when the switch receives a general query from the router, it forwards the query to all ports in the VLAN. IGMP version 1 or version 2 hosts wanting to join the multicast group respond by sending a join message to the switch. The switch CPU creates a multicast forwarding-table entry for the group if it is not already present. The CPU also adds the interface where the join message was received to the forwarding-table entry. The host associated with that interface receives multicast traffic for that multicast group.

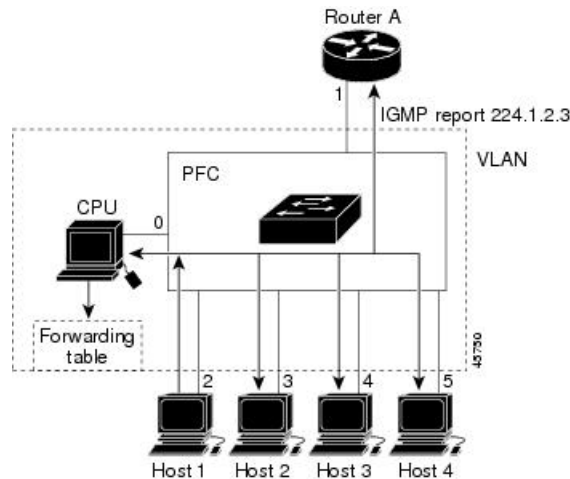

Router A sends a general query to the switch, which forwards the query to ports 2 through 5, all of which are members of the same VLAN. Host 1 wants to join multicast group 224.1.2.3 and multicasts an IGMP membership report (IGMP join message) to the group. The switch CPU uses the information in the IGMP report to set up a forwarding-table entry that includes the port numbers connected to Host 1 and to the router.

Table 7: IGMP Snooping Forwarding Table

| Destination Address | Type of Packet | Ports |
|---------------------|----------------|-------|
| 224.1.2.3 | IGMP | 1, 2 |

The switch hardware can distinguish IGMP information packets from other packets for the multicast group. The information in the table tells the switching engine to send frames addressed to the 224.1.2.3 multicast IP address that are not IGMP packets to the router and to the host that has joined the group.

Figure 4: Second Host Joining a Multicast Group

If another host (for example, Host 4) sends an unsolicited IGMP join message for the same group, the CPU receives that message and adds the port number of Host 4 to the forwarding table. Because the forwarding table directs IGMP messages only to the CPU, the message is not flooded to other ports on the switch. Any known multicast traffic is forwarded to the group and not to the CPU.

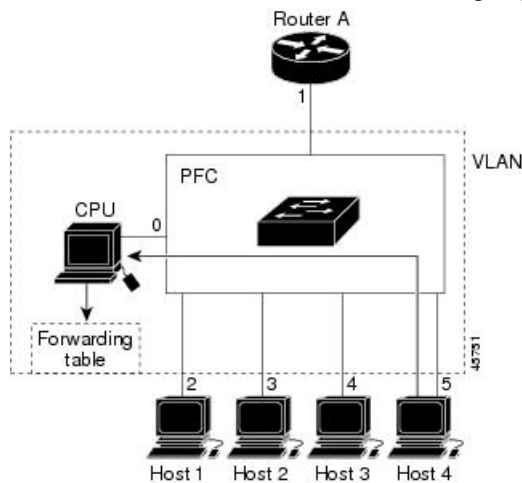

Table 8: Updated IGMP Snooping Forwarding Table

| Destination Address | Type of Packet | Ports |
|---------------------|----------------|---------|
| 224.1.2.3 | IGMP | 1, 2, 5 |

Related Topics

[Configuring the Switch as a Member of a Group \(CLI\)](#), on page 42

[Example: Configuring the Switch as a Member of a Multicast Group](#), on page 86

Leaving a Multicast Group

The router sends periodic multicast general queries, and the switch forwards these queries through all ports in the VLAN. Interested hosts respond to the queries. If at least one host in the VLAN wants to receive multicast traffic, the router continues forwarding the multicast traffic to the VLAN. The switch forwards multicast group traffic only to those hosts listed in the forwarding table for that IP multicast group maintained by IGMP snooping.

When hosts want to leave a multicast group, they can silently leave, or they can send a leave message. When the switch receives a leave message from a host, it sends a group-specific query to learn if any other devices connected to that interface are interested in traffic for the specific multicast group. The switch then updates the forwarding table for that MAC group so that only those hosts interested in receiving multicast traffic for the group are listed in the forwarding table. If the router receives no reports from a VLAN, it removes the group for the VLAN from its IGMP cache.

Immediate Leave

The switch uses IGMP snooping Immediate Leave to remove from the forwarding table an interface that sends a leave message without the switch sending group-specific queries to the interface. The VLAN interface is pruned from the multicast tree for the multicast group specified in the original leave message. Immediate Leave ensures optimal bandwidth management for all hosts on a switched network, even when multiple multicast groups are simultaneously in use.

Immediate Leave is only supported on IGMP version 2 hosts. IGMP version 2 is the default version for the switch.



Note You should use the Immediate Leave feature only on VLANs where a single host is connected to each port. If Immediate Leave is enabled on VLANs where more than one host is connected to a port, some hosts may be dropped inadvertently.

Related Topics

[Enabling IGMP Immediate Leave \(CLI\)](#), on page 71

IGMP Configurable-Leave Timer

You can configure the time that the switch waits after sending a group-specific query to determine if hosts are still interested in a specific multicast group. The IGMP leave response time can be configured from 100 to 32767 milliseconds.

Related Topics

[Configuring the IGMP Leave Timer \(CLI\)](#), on page 72

IGMP Report Suppression



Note IGMP report suppression is supported only when the multicast query has IGMPv1 and IGMPv2 reports. This feature is not supported when the query includes IGMPv3 reports.

The switch uses IGMP report suppression to forward only one IGMP report per multicast router query to multicast devices. When IGMP report suppression is enabled (the default), the switch sends the first IGMP report from all hosts for a group to all the multicast routers. The switch does not send the remaining IGMP reports for the group to the multicast routers. This feature prevents duplicate reports from being sent to the multicast devices.

If the multicast router query includes requests only for IGMPv1 and IGMPv2 reports, the switch forwards only the first IGMPv1 or IGMPv2 report from all hosts for a group to all the multicast routers.

If the multicast router query also includes requests for IGMPv3 reports, the switch forwards all IGMPv1, IGMPv2, and IGMPv3 reports for a group to the multicast devices.

If you disable IGMP report suppression, all IGMP reports are forwarded to the multicast routers.

Related Topics

[Disabling IGMP Report Suppression \(CLI\)](#), on page 82

IGMP Snooping and Switch Stacks

IGMP snooping functions across the switch stack; that is, IGMP control information from one switch is distributed to all switches in the stack. Regardless of the stack member through which IGMP multicast data enters the stack, the data reaches the hosts that have registered for that group.

If a switch in the stack fails or is removed from the stack, only the members of the multicast group that are on that switch will not receive the multicast data. All other members of a multicast group on other switches in the stack continue to receive multicast data streams. However, multicast groups that are common for both Layer 2 and Layer 3 (IP multicast routing) might take longer to converge if the active switch is removed.

IGMP Filtering and Throttling

In some environments, for example, metropolitan or multiple-dwelling unit (MDU) installations, you might want to control the set of multicast groups to which a user on a switch port can belong. You can control the distribution of multicast services, such as IP/TV, based on some type of subscription or service plan. You might also want to limit the number of multicast groups to which a user on a switch port can belong.

With the IGMP filtering feature, you can filter multicast joins on a per-port basis by configuring IP multicast profiles and associating them with individual switch ports. An IGMP profile can contain one or more multicast groups and specifies whether access to the group is permitted or denied. If an IGMP profile denying access to a multicast group is applied to a switch port, the IGMP join report requesting the stream of IP multicast traffic is dropped, and the port is not allowed to receive IP multicast traffic from that group. If the filtering action permits access to the multicast group, the IGMP report from the port is forwarded for normal processing. You can also set the maximum number of IGMP groups that a Layer 2 interface can join.

IGMP filtering controls only group-specific query and membership reports, including join and leave reports. It does not control general IGMP queries. IGMP filtering has no relationship with the function that directs the forwarding of IP multicast traffic. The filtering feature operates in the same manner whether CGMP or MVR is used to forward the multicast traffic.

IGMP filtering applies only to the dynamic learning of IP multicast group addresses, not static configuration.

With the IGMP throttling feature, you can set the maximum number of IGMP groups that a Layer 2 interface can join. If the maximum number of IGMP groups is set, the IGMP snooping forwarding table contains the maximum number of entries, and the interface receives an IGMP join report, you can configure an interface to drop the IGMP report or to replace the randomly selected multicast entry with the received IGMP report.



Note IGMPv3 join and leave messages are not supported on switches running IGMP filtering.

Default IGMP Configuration

This table displays the default IGMP configuration for the switch.

Table 9: Default IGMP Configuration

| Feature | Default Setting |
|--|---|
| Multilayer switch as a member of a multicast group | No group memberships are defined. |
| Access to multicast groups | All groups are allowed on an interface. |

| Feature | Default Setting |
|--|-------------------------------|
| IGMP version | Version 2 on all interfaces. |
| IGMP host-query message interval | 60 seconds on all interfaces. |
| IGMP query timeout | 60 seconds on all interfaces. |
| IGMP maximum query response time | 10 seconds on all interfaces. |
| Multilayer switch as a statically connected member | Disabled. |

Default IGMP Snooping Configuration

This table displays the default IGMP snooping configuration for the switch.

Table 10: Default IGMP Snooping Configuration

| Feature | Default Setting |
|------------------------------------|-------------------------------|
| IGMP snooping | Enabled globally and per VLAN |
| Multicast routers | None configured |
| IGMP snooping Immediate Leave | Disabled |
| Static groups | None configured |
| TCN ³ flood query count | 2 |
| TCN query solicitation | Disabled |
| IGMP snooping querier | Disabled |
| IGMP report suppression | Enabled |

³ (1) TCN = Topology Change Notification

Default IGMP Filtering and Throttling Configuration

This table displays the default IGMP filtering and throttling configuration for the switch.

Table 11: Default IGMP Filtering Configuration

| Feature | Default Setting |
|------------------------------------|---|
| IGMP filters | None applied. |
| IGMP maximum number of IGMP groups | No maximum set. Note When the maximum number of groups is in the forwarding table, the default IGMP throttling action is to deny the IGMP report. |

| Feature | Default Setting |
|---------------------|---------------------------|
| IGMP profiles | None defined. |
| IGMP profile action | Deny the range addresses. |

How to Configure IGMP

Configuring the Switch as a Member of a Group (CLI)

You can configure the switch as a member of a multicast group and discover multicast reachability in a network. If all the multicast-capable routers and multilayer switches that you administer are members of a multicast group, pinging that group causes all of these devices to respond. The devices respond to ICMP echo-request packets addressed to a group of which they are members. Another example is the multicast trace-route tools provided in the software.



Caution Performing this procedure might impact the CPU performance because the CPU will receive all data traffic for the group address.

This procedure is optional.

SUMMARY STEPS

1. **enable**
2. **configure terminal**
3. **interface** *interface-id*
4. **ip igmp join-group** *group-address*
5. **end**
6. **show ip igmp interface** [*interface-id*]
7. **copy running-config startup-config**

DETAILED STEPS

| | Command or Action | Purpose |
|---------------|---|--|
| Step 1 | enable Example: Switch> enable | Enables privileged EXEC mode. Enter your password if prompted. |
| Step 2 | configure terminal Example: Switch# configure terminal | Enters the global configuration mode. |

| | Command or Action | Purpose |
|--------|---|---|
| Step 3 | <p>interface <i>interface-id</i></p> <p>Example:</p> <pre>Switch(config)# interface gigabitethernet 1/0/1</pre> | <p>Specifies the Layer 3 interface on which you want to enable multicast routing, and enters interface configuration mode.</p> <p>The specified interface must be one of the following:</p> <ul style="list-style-type: none"> • A routed port—A physical port that has been configured as a Layer 3 port by entering the no switchport interface configuration command. You will also need to enable IP PIM sparse-dense-mode on the interface, and join the interface as a statically connected member to an IGMP static group. For a configuration example, see Example: Interface Configuration as a Routed Port, on page 88. • An SVI—A VLAN interface created by using the interface vlan <i>vlan-id</i> global configuration command. You will also need to enable IP PIM sparse-dense-mode on the VLAN, join the VLAN as a statically connected member to an IGMP static group, and then enable IGMP snooping on the VLAN, the IGMP static group, and physical interface. For a configuration example, see Example: Interface Configuration as an SVI, on page 89. <p>These interfaces must have IP addresses assigned to them.</p> |
| Step 4 | <p>ip igmp join-group <i>group-address</i></p> <p>Example:</p> <pre>Switch(config-if)# ip igmp join-group 225.2.2.2</pre> | <p>Configures the switch to join a multicast group.</p> <p>By default, no group memberships are defined.</p> <p>For <i>group-address</i>, specify the multicast IP address in dotted decimal notation.</p> |
| Step 5 | <p>end</p> <p>Example:</p> <pre>Switch(config)# end</pre> | <p>Returns to privileged EXEC mode.</p> |
| Step 6 | <p>show ip igmp interface [<i>interface-id</i>]</p> <p>Example:</p> <pre>Switch# show ip igmp interface</pre> | <p>Verifies your entries.</p> |
| Step 7 | <p>copy running-config startup-config</p> <p>Example:</p> <pre>Switch# copy running-config startup-config</pre> | <p>(Optional) Saves your entries in the configuration file.</p> |

Related Topics

[Joining a Multicast Group](#), on page 37

[Example: Configuring the Switch as a Member of a Multicast Group](#), on page 86

[IGMP Multicast Addresses](#), on page 32

Controlling Access to IP Multicast Group (CLI)

The switch sends IGMP host-query messages to find which multicast groups have members on attached local networks. The switch then forwards to these group members all packets addressed to the multicast group. You can place a filter on each interface to restrict the multicast groups that hosts on the subnet serviced by the interface can join.

To limit the number of joins on the interface, configure the port for the filter which associates with the IGMP profile.

This procedure is optional.

SUMMARY STEPS

1. **enable**
2. **configure terminal**
3. **ip igmp profile**
4. **permit**
5. **exit**
6. **interface** *interface-id*
7. **ip igmp filter** *filter_number*
8. **end**
9. **show ip igmp interface** [*interface-id*]
10. **copy running-config startup-config**

DETAILED STEPS

| | Command or Action | Purpose |
|---------------|---|--|
| Step 1 | enable Example: <pre>Switch> enable</pre> | Enables privileged EXEC mode. Enter your password if prompted. |
| Step 2 | configure terminal Example: <pre>Switch# configure terminal</pre> | Enters the global configuration mode. |
| Step 3 | ip igmp profile Example: | Enters an IGMP filter profile number from 1 to 4294967295. |

| | Command or Action | Purpose |
|----------------|---|---|
| | Switch(config)# ip igmp profile 10 Switch(config-igmp-profile)# ? | For additional information about configuring IGMP filter profiles, see Configuring IGMP Profiles (CLI) , on page 54. |
| Step 4 | permit Example: Switch(config-igmp-profile)# permit 229.9.9.0 | Enters an IGMP profile configuration action. The following IGMP profile configuration actions are supported: <ul style="list-style-type: none"> • deny—Matching IP addresses are denied. • exit—Exits from the IGMP profile configuration mode. • no—Negates a command or set its defaults. • permit—Matching addresses are permitted. • range—Adds a range to the set. |
| Step 5 | exit Example: Switch(config-igmp-profile)# exit | Returns to global configuration mode. |
| Step 6 | interface <i>interface-id</i> Example: Switch(config)# interface gigabitethernet 1/0/1 | Specifies the interface to be configured, and enters interface configuration mode. |
| Step 7 | ip igmp filter <i>filter_number</i> Example: Switch(config-if)# ip igmp filter 10 | Specifies the IGMP filter profile number. For additional information about applying IGMP filter profiles, see Applying IGMP Profiles (CLI) , on page 56. |
| Step 8 | end Example: Switch(config)# end | Returns to privileged EXEC mode. |
| Step 9 | show ip igmp interface [<i>interface-id</i>] Example: Switch# show ip igmp interface | Verifies your entries. |
| Step 10 | copy running-config startup-config Example: | (Optional) Saves your entries in the configuration file. |

| | Command or Action | Purpose |
|--|---|---------|
| | Switch# <code>copy running-config startup-config</code> | |

Changing the IGMP Version(CLI)

By default, the switch uses IGMP Version 2, which provides features such as the IGMP query timeout and the maximum query response time.

All systems on the subnet must support the same version. The switch does not automatically detect Version 1 systems and switch to Version 1. You can mix Version 1 and Version 2 hosts on the subnet because Version 2 routers or switches always work correctly with IGMPv1 hosts.

Configure the switch for Version 1 if your hosts do not support Version 2.

This procedure is optional.

SUMMARY STEPS

1. `enable`
2. `configure terminal`
3. `interface interface-id`
4. `ip igmp version {1 | 2 | 3 }`
5. `end`
6. `show ip igmp interface [interface-id]`
7. `copy running-config startup-config`

DETAILED STEPS

| | Command or Action | Purpose |
|---------------|--|--|
| Step 1 | enable Example: Switch> <code>enable</code> | Enables privileged EXEC mode. Enter your password if prompted. |
| Step 2 | configure terminal Example: Switch# <code>configure terminal</code> | Enters the global configuration mode. |
| Step 3 | interface interface-id Example: Switch(config)# <code>interface gigabitethernet 1/0/1</code> | Specifies the interface to be configured, and enters the interface configuration mode. |

| | Command or Action | Purpose |
|--------|---|---|
| Step 4 | <p>ip igmp version {1 2 3 }</p> <p>Example:</p> <pre>Switch(config-if)# ip igmp version 2</pre> | <p>Specifies the IGMP version that the switch uses.</p> <p>Note If you change to Version 1, you cannot configure the ip igmp query-interval or the ip igmp query-max-response-time interface configuration commands.</p> <p>To return to the default setting, use the no ip igmp version interface configuration command.</p> |
| Step 5 | <p>end</p> <p>Example:</p> <pre>Switch(config)# end</pre> | Returns to privileged EXEC mode. |
| Step 6 | <p>show ip igmp interface [<i>interface-id</i>]</p> <p>Example:</p> <pre>Switch# show ip igmp interface</pre> | Verifies your entries. |
| Step 7 | <p>copy running-config startup-config</p> <p>Example:</p> <pre>Switch# copy running-config startup-config</pre> | (Optional) Saves your entries in the configuration file. |

Related Topics

[IGMP Versions](#), on page 32

[Restrictions for Configuring IGMP](#), on page 30

[Restrictions for IGMP Snooping](#), on page 31

Modifying the IGMP Host-Query Message Interval (CLI)

The switch periodically sends IGMP host-query messages to discover which multicast groups are present on attached networks. These messages are sent to the all-hosts multicast group (224.0.0.1) with a time-to-live (TTL) of 1. The switch sends host-query messages to refresh its knowledge of memberships present on the network. If, after some number of queries, the software discovers that no local hosts are members of a multicast group, the software stops forwarding multicast packets to the local network from remote origins for that group and sends a prune message upstream toward the source.

The switch elects a PIM designated router (DR) for the LAN (subnet). The designated router is responsible for sending IGMP host-query messages to all hosts on the LAN. In sparse mode, the designated router also sends PIM register and PIM join messages toward the RP router. With IGMPv2, the DR is the router or multilayer switch with the highest IP address. With IGMPv1, the DR is elected according to the multicast routing protocol that runs on the LAN.

This procedure is optional.

SUMMARY STEPS

1. `enable`
2. `configure terminal`
3. `interface interface-id`
4. `ip igmp query-interval seconds`
5. `end`
6. `show ip igmp interface [interface-id]`
7. `copy running-config startup-config`

DETAILED STEPS

| | Command or Action | Purpose |
|--------|--|--|
| Step 1 | <p><code>enable</code></p> <p>Example:</p> <pre>Switch> enable</pre> | Enables privileged EXEC mode. Enter your password if prompted. |
| Step 2 | <p><code>configure terminal</code></p> <p>Example:</p> <pre>Switch# configure terminal</pre> | Enters the global configuration mode. |
| Step 3 | <p><code>interface interface-id</code></p> <p>Example:</p> <pre>Switch(config)# interface gigabitethernet 1/0/1</pre> | <p>Specifies the Layer 3 interface on which you want to enable multicast routing, and enters interface configuration mode.</p> <p>The specified interface must be one of the following:</p> <ul style="list-style-type: none"> • A routed port—A physical port that has been configured as a Layer 3 port by entering the no switchport interface configuration command. You will also need to enable IP PIM sparse-dense-mode on the interface, and join the interface as a statically connected member to an IGMP static group. For a configuration example, see Example: Interface Configuration as a Routed Port, on page 88. • An SVI—A VLAN interface created by using the interface vlan vlan-id global configuration command. You will also need to enable IP PIM sparse-dense-mode on the VLAN, join the VLAN as a statically connected member to an IGMP static group, and then enable IGMP snooping on the VLAN, the IGMP static group, and physical interface. For a configuration example, see Example: Interface Configuration as an SVI, on page 89. <p>These interfaces must have IP addresses assigned to them.</p> |

| | Command or Action | Purpose |
|--------|--|--|
| Step 4 | ip igmp query-interval <i>seconds</i> Example: <pre>Switch(config-if)# ip igmp query-interval 75</pre> | Configures the frequency at which the designated router sends IGMP host-query messages. By default, the designated router sends IGMP host-query messages every 60 seconds to keep the IGMP overhead very low on hosts and networks. The range is 1 to 65535. |
| Step 5 | end Example: <pre>Switch(config)# end</pre> | Returns to privileged EXEC mode. |
| Step 6 | show ip igmp interface [<i>interface-id</i>] Example: <pre>Switch# show ip igmp interface</pre> | Verifies your entries. |
| Step 7 | copy running-config startup-config Example: <pre>Switch# copy running-config startup-config</pre> | (Optional) Saves your entries in the configuration file. |

Changing the IGMP Query Timeout for IGMPv2 (CLI)

If you are using IGMPv2, you can specify the period of time before the switch takes over as the querier for the interface. By default, the switch waits twice the query interval period controlled by the **ip igmp query-interval** interface configuration command. After that time, if the switch has received no queries, it becomes the querier.

This procedure is optional.

SUMMARY STEPS

1. **enable**
2. **configure terminal**
3. **interface** *interface-id*
4. **ip igmp querier-timeout** *seconds*
5. **end**
6. **show ip igmp interface** [*interface-id*]
7. **copy running-config startup-config**

DETAILED STEPS

| | Command or Action | Purpose |
|---------------|---|---|
| Step 1 | enable Example: <pre>Switch> enable</pre> | Enables privileged EXEC mode. Enter your password if prompted. |
| Step 2 | configure terminal Example: <pre>Switch# configure terminal</pre> | Enters the global configuration mode. |
| Step 3 | interface <i>interface-id</i> Example: <pre>Switch(config)# interface gigabitethernet 1/0/1</pre> | <p>Specifies the Layer 3 interface on which you want to enable multicast routing, and enters interface configuration mode.</p> <p>The specified interface must be one of the following:</p> <ul style="list-style-type: none"> • A routed port—A physical port that has been configured as a Layer 3 port by entering the no switchport interface configuration command. You will also need to enable IP PIM sparse-dense-mode on the interface, and join the interface as a statically connected member to an IGMP static group. For a configuration example, see Example: Interface Configuration as a Routed Port, on page 88. • An SVI—A VLAN interface created by using the interface vlan <i>vlan-id</i> global configuration command. You will also need to enable IP PIM sparse-dense-mode on the VLAN, join the VLAN as a statically connected member to an IGMP static group, and then enable IGMP snooping on the VLAN, the IGMP static group, and physical interface. For a configuration example, see Example: Interface Configuration as an SVI, on page 89. <p>These interfaces must have IP addresses assigned to them.</p> |
| Step 4 | ip igmp querier-timeout <i>seconds</i> Example: <pre>Switch(config-if)# ip igmp querier-timeout 120</pre> | <p>Specifies the IGMP query timeout.</p> <p>The default is 60 seconds (twice the query interval). The range is 60 to 300.</p> |
| Step 5 | end Example: | Returns to privileged EXEC mode. |

| | Command or Action | Purpose |
|---------------|---|--|
| | Switch(config)# end | |
| Step 6 | show ip igmp interface [<i>interface-id</i>] Example: Switch# show ip igmp interface | Verifies your entries. |
| Step 7 | copy running-config startup-config Example: Switch# copy running-config startup-config | (Optional) Saves your entries in the configuration file. |

Changing the Maximum Query Response Time for IGMPv2 (CLI)

If you are using IGMPv2, you can change the maximum query response time advertised in IGMP queries. The maximum query response time enables the switch to quickly detect that there are no more directly connected group members on a LAN. Decreasing the value enables the switch to prune groups faster.

This procedure is optional.

SUMMARY STEPS

1. **enable**
2. **configure terminal**
3. **interface** *interface-id*
4. **ip igmp query-max-response-time** *seconds*
5. **end**
6. **show ip igmp interface** [*interface-id*]
7. **copy running-config startup-config**

DETAILED STEPS

| | Command or Action | Purpose |
|---------------|---|--|
| Step 1 | enable Example: Switch> enable | Enables privileged EXEC mode. Enter your password if prompted. |
| Step 2 | configure terminal Example: Switch# configure terminal | Enters the global configuration mode. |

| | Command or Action | Purpose |
|---------------|--|---|
| Step 3 | <p>interface <i>interface-id</i></p> <p>Example:</p> <pre>Switch(config)# interface gigabitethernet 1/0/1</pre> | <p>Specifies the Layer 3 interface on which you want to enable multicast routing, and enters interface configuration mode.</p> <p>The specified interface must be one of the following:</p> <ul style="list-style-type: none"> • A routed port—A physical port that has been configured as a Layer 3 port by entering the no switchport interface configuration command. You will also need to enable IP PIM sparse-dense-mode on the interface, and join the interface as a statically connected member to an IGMP static group. For a configuration example, see Example: Interface Configuration as a Routed Port, on page 88. • An SVI—A VLAN interface created by using the interface vlan <i>vlan-id</i> global configuration command. You will also need to enable IP PIM sparse-dense-mode on the VLAN, join the VLAN as a statically connected member to an IGMP static group, and then enable IGMP snooping on the VLAN, the IGMP static group, and physical interface. For a configuration example, see Example: Interface Configuration as an SVI, on page 89. <p>These interfaces must have IP addresses assigned to them.</p> |
| Step 4 | <p>ip igmp query-max-response-time <i>seconds</i></p> <p>Example:</p> <pre>Switch(config-if)# ip igmp query-max-response-time 15</pre> | <p>Changes the maximum query response time advertised in IGMP queries.</p> <p>The default is 10 seconds. The range is 1 to 25.</p> |
| Step 5 | <p>end</p> <p>Example:</p> <pre>Switch(config)# end</pre> | <p>Returns to privileged EXEC mode.</p> |
| Step 6 | <p>show ip igmp interface [<i>interface-id</i>]</p> <p>Example:</p> <pre>Switch# show ip igmp interface</pre> | <p>Verifies your entries.</p> |
| Step 7 | <p>copy running-config startup-config</p> <p>Example:</p> <pre>Switch# copy running-config startup-config</pre> | <p>(Optional) Saves your entries in the configuration file.</p> |

Configuring the Switch as a Statically Connected Member (CLI)

At various times, either there is not a group member on a network segment or a host that cannot report its group membership by using IGMP. However, you may want multicast traffic to be sent to that network segment. The following commands are used to pull multicast traffic down to a network segment:

- **ip igmp join-group**—The switch accepts the multicast packets in addition to forwarding them. Accepting the multicast packets prevents the switch from fast switching.
- **ip igmp static-group**—The switch does not accept the packets itself, but only forwards them. This method enables fast switching. The outgoing interface appears in the IGMP cache, but the switch itself is not a member, as evidenced by lack of an L (local) flag in the multicast route entry.

This procedure is optional.

SUMMARY STEPS

1. **enable**
2. **configure terminal**
3. **interface** *interface-id*
4. **ip igmp static-group** *group-address*
5. **end**
6. **show ip igmp interface** [*interface-id*]
7. **copy running-config startup-config**

DETAILED STEPS

| | Command or Action | Purpose |
|--------|---|--|
| Step 1 | enable Example: <pre>Switch> enable</pre> | Enables privileged EXEC mode. Enter your password if prompted. |
| Step 2 | configure terminal Example: <pre>Switch# configure terminal</pre> | Enters the global configuration mode. |
| Step 3 | interface <i>interface-id</i> Example: <pre>Switch(config)# interface gigabitethernet 1/0/1</pre> | Specifies the Layer 3 interface on which you want to enable multicast routing, and enters interface configuration mode. The specified interface must be one of the following: <ul style="list-style-type: none"> • A routed port—A physical port that has been configured as a Layer 3 port by entering the no switchport interface configuration command. You will also need to enable IP PIM sparse-dense-mode on the interface, and join the interface as a statically connected member to an IGMP static group. For a |

| | Command or Action | Purpose |
|---------------|---|---|
| | | <p>configuration example, see Example: Interface Configuration as a Routed Port, on page 88.</p> <ul style="list-style-type: none"> An SVI—A VLAN interface created by using the interface vlan <i>vlan-id</i> global configuration command. You will also need to enable IP PIM sparse-dense-mode on the VLAN, join the VLAN as a statically connected member to an IGMP static group, and then enable IGMP snooping on the VLAN, the IGMP static group, and physical interface. For a configuration example, see Example: Interface Configuration as an SVI, on page 89. <p>These interfaces must have IP addresses assigned to them.</p> |
| Step 4 | <p>ip igmp static-group <i>group-address</i></p> <p>Example:</p> <pre>Switch(config-if)# ip igmp static-group 239.100.100.101</pre> | <p>Configures the switch as a statically connected member of a group.</p> <p>By default, this feature is disabled.</p> |
| Step 5 | <p>end</p> <p>Example:</p> <pre>Switch(config)# end</pre> | <p>Returns to privileged EXEC mode.</p> |
| Step 6 | <p>show ip igmp interface [<i>interface-id</i>]</p> <p>Example:</p> <pre>Switch# show ip igmp interface gigabitethernet 1/0/1</pre> | <p>Verifies your entries.</p> |
| Step 7 | <p>copy running-config startup-config</p> <p>Example:</p> <pre>Switch# copy running-config startup-config</pre> | <p>(Optional) Saves your entries in the configuration file.</p> |

Configuring IGMP Profiles (CLI)

Follow these steps to create an IGMP profile:

This task is optional.

SUMMARY STEPS

1. **enable**

2. **configure terminal**
3. **ip igmp profile** *profile number*
4. **permit | deny**
5. **range** *ip multicast address*
6. **end**
7. **show ip igmp profile** *profile number*
8. **show running-config**
9. **copy running-config startup-config**

DETAILED STEPS

| | Command or Action | Purpose |
|--------|---|---|
| Step 1 | <p>enable</p> <p>Example:</p> <pre>Switch> enable</pre> | Enables privileged EXEC mode. Enter your password if prompted. |
| Step 2 | <p>configure terminal</p> <p>Example:</p> <pre>Switch# configure terminal</pre> | Enters the global configuration mode. |
| Step 3 | <p>ip igmp profile <i>profile number</i></p> <p>Example:</p> <pre>Switch(config)# ip igmp profile 3</pre> | <p>Assigns a number to the profile you are configuring, and enters IGMP profile configuration mode. The profile number range is 1 to 4294967295. When you are in IGMP profile configuration mode, you can create the profile by using these commands:</p> <ul style="list-style-type: none"> • deny—Specifies that matching addresses are denied; this is the default. • exit—Exits from igmp-profile configuration mode. • no—Negates a command or returns to its defaults. • permit—Specifies that matching addresses are permitted. • range—Specifies a range of IP addresses for the profile. You can enter a single IP address or a range with a start and an end address. <p>The default is for the switch to have no IGMP profiles configured.</p> <p>Note To delete a profile, use the no ip igmp profile <i>profile number</i> global configuration command.</p> |

| | Command or Action | Purpose |
|---------------|---|---|
| Step 4 | permit deny Example: Switch(config-igmp-profile)# permit | (Optional) Sets the action to permit or deny access to the IP multicast address. If no action is configured, the default for the profile is to deny access. |
| Step 5 | range ip multicast address Example: Switch(config-igmp-profile)# range 229.9.9.0 | Enters the IP multicast address or range of IP multicast addresses to which access is being controlled. If entering a range, enter the low IP multicast address, a space, and the high IP multicast address. You can use the range command multiple times to enter multiple addresses or ranges of addresses. Note To delete an IP multicast address or range of IP multicast addresses, use the no range ip multicast address IGMP profile configuration command. |
| Step 6 | end Example: Switch(config)# end | Returns to privileged EXEC mode. |
| Step 7 | show ip igmp profile profile number Example: Switch# show ip igmp profile 3 | Verifies the profile configuration. |
| Step 8 | show running-config Example: Switch# show running-config | Verifies your entries. |
| Step 9 | copy running-config startup-config Example: Switch# copy running-config startup-config | (Optional) Saves your entries in the configuration file. |

Applying IGMP Profiles (CLI)

To control access as defined in an IGMP profile, you have to apply the profile to the appropriate interfaces. You can apply IGMP profiles only to Layer 2 access ports; you cannot apply IGMP profiles to routed ports or SVIs. You cannot apply profiles to ports that belong to an EtherChannel port group. You can apply a profile to multiple interfaces, but each interface can have only one profile applied to it.

Follow these steps to apply an IGMP profile to a switch port:

SUMMARY STEPS

1. **enable**
2. **configure terminal**
3. **interface** *interface-id*
4. **ip igmp filter** *profile number*
5. **end**
6. **show running-config**
7. **copy running-config startup-config**

DETAILED STEPS

| | Command or Action | Purpose |
|---------------|--|--|
| Step 1 | enable Example: <pre>Switch> enable</pre> | Enables privileged EXEC mode. Enter your password if prompted. |
| Step 2 | configure terminal Example: <pre>Switch# configure terminal</pre> | Enters the global configuration mode. |
| Step 3 | interface <i>interface-id</i> Example: <pre>Switch(config)# interface gigabitethernet1/0/1</pre> | Specifies the physical interface, and enters interface configuration mode. The interface must be a Layer 2 port that does not belong to an EtherChannel port group. |
| Step 4 | ip igmp filter <i>profile number</i> Example: <pre>Switch(config-if)# ip igmp filter 321</pre> | Applies the specified IGMP profile to the interface. The range is 1 to 4294967295. Note To remove a profile from an interface, use the no ip igmp filter <i>profile number</i> interface configuration command. |
| Step 5 | end Example: <pre>Switch(config-if)# end</pre> | Returns to privileged EXEC mode. |
| Step 6 | show running-config Example: | Verifies your entries. |

| | Command or Action | Purpose |
|---------------|---|--|
| | Switch# <code>show running-config</code> | |
| Step 7 | copy running-config startup-config Example: Switch# <code>copy running-config startup-config</code> | (Optional) Saves your entries in the configuration file. |

Setting the Maximum Number of IGMP Groups (CLI)

Follow these steps to set the maximum number of IGMP groups that a Layer 2 interface can join:

Before you begin

This restriction can be applied to Layer 2 ports only; you cannot set a maximum number of IGMP groups on routed ports or SVIs. You also can use this command on a logical EtherChannel interface but cannot use it on ports that belong to an EtherChannel port group.

SUMMARY STEPS

1. `enable`
2. `configure terminal`
3. `interface interface-id`
4. `ip igmp max-groups number`
5. `end`
6. `show running-config interface interface-id`
7. `copy running-config startup-config`

DETAILED STEPS

| | Command or Action | Purpose |
|---------------|---|--|
| Step 1 | enable Example: Switch> <code>enable</code> | Enables privileged EXEC mode. Enter your password if prompted. |
| Step 2 | configure terminal Example: Switch# <code>configure terminal</code> | Enters the global configuration mode. |
| Step 3 | interface interface-id Example: | Specifies the interface to be configured, and enters interface configuration mode. The interface can be a Layer 2 port |

| | Command or Action | Purpose |
|---------------|--|--|
| | Switch(config)# <code>interface gigabitethernet1/0/2</code> | that does not belong to an EtherChannel group or a EtherChannel interface. |
| Step 4 | ip igmp max-groups <i>number</i> Example: Switch(config-if)# <code>ip igmp max-groups 20</code> | Sets the maximum number of IGMP groups that the interface can join. The range is 0 to 4294967294. The default is to have no maximum set. Note The switch supports a maximum number of 4096 Layer 2 IGMP groups and 2048 Layer 3 IGMP groups. |
| Step 5 | end Example: Switch(config)# <code>end</code> | Returns to privileged EXEC mode. |
| Step 6 | show running-config interface <i>interface-id</i> Example: Switch# <code>show running-config interface gigabitethernet1/0/1</code> | Verifies your entries. |
| Step 7 | copy running-config startup-config Example: Switch# <code>copy running-config startup-config</code> | (Optional) Saves your entries in the configuration file. |

Configuring the IGMP Throttling Action (CLI)

After you set the maximum number of IGMP groups that a Layer 2 interface can join, you can configure an interface to replace the existing group with the new group for which the IGMP report was received.

Follow these steps to configure the throttling action when the maximum number of entries is in the forwarding table:

SUMMARY STEPS

1. `enable`
2. `configure terminal`
3. `interface interface-id`
4. `ip igmp max-groups action {deny | replace}`
5. `end`
6. `show running-config interface interface-id`
7. `copy running-config startup-config`

DETAILED STEPS

| | Command or Action | Purpose |
|---------------|---|---|
| Step 1 | enable Example: <pre>Switch> enable</pre> | Enables privileged EXEC mode. Enter your password if prompted. |
| Step 2 | configure terminal Example: <pre>Switch# configure terminal</pre> | Enters the global configuration mode. |
| Step 3 | interface <i>interface-id</i> Example: <pre>Switch(config)# interface gigabitethernet 1/0/1</pre> | Specifies the physical interface to be configured, and enters interface configuration mode. The interface can be a Layer 2 port that does not belong to an EtherChannel group or an EtherChannel interface. The interface cannot be a trunk port. |
| Step 4 | ip igmp max-groups action {deny replace} Example: <pre>Switch(config-if)# ip igmp max-groups action replace</pre> | <p>When an interface receives an IGMP report and the maximum number of entries is in the forwarding table, specifies the action that the interface takes:</p> <ul style="list-style-type: none"> • deny—Drops the report. If you configure this throttling action, the entries that were previously in the forwarding table are not removed but are aged out. After these entries are aged out and the maximum number of entries is in the forwarding table, the switch drops the next IGMP report received on the interface. • replace—Replaces the existing group with the new group for which the IGMP report was received. If you configure this throttling action, the entries that were previously in the forwarding table are removed. When the maximum number of entries is in the forwarding table, the switch replaces a randomly selected entry with the received IGMP report. <p>To prevent the switch from removing the forwarding-table entries, you can configure the IGMP throttling action before an interface adds entries to the forwarding table.</p> <p>Note To return to the default action of dropping the report, use the no ip igmp max-groups action interface configuration command.</p> |
| Step 5 | end Example: | Returns to privileged EXEC mode. |

| | Command or Action | Purpose |
|---------------|--|--|
| | Switch(config)# end | |
| Step 6 | show running-config interface <i>interface-id</i> Example: <pre>Switch# show running-config interface gigabitethernet1/0/1</pre> | Verifies your entries. |
| Step 7 | copy running-config startup-config Example: <pre>Switch# copy running-config startup-config</pre> | (Optional) Saves your entries in the configuration file. |

Configuring the Device to Forward Multicast Traffic in the Absence of Directly Connected IGMP Hosts

Perform this optional task to configure the device to forward multicast traffic in the absence of directly connected IGMP hosts.

SUMMARY STEPS

1. **enable**
2. **configure terminal**
3. **interface *type number***
4. Do one of the following:
 - **ip igmp join-group *group-address***
 - **ip igmp static-group {* | *group-address* [*source source-address*]}**
5. **end**
6. **show ip igmp interface [*interface-type interface-number*]**
7. **copy running-config startup-config**
8. **show running-config**

DETAILED STEPS

| | Command or Action | Purpose |
|---------------|--|--|
| Step 1 | enable Example: <pre>Switch> enable</pre> | Enables privileged EXEC mode. <ul style="list-style-type: none"> • Enter your password if prompted. |

| | Command or Action | Purpose |
|---------------|---|--|
| Step 2 | configure terminal Example: <pre>Switch# configure terminal</pre> | Enters global configuration mode. |
| Step 3 | interface <i>type number</i> Example: <pre>Switch(config)# interface gigabitethernet 1</pre> | Enters interface configuration mode. <ul style="list-style-type: none"> For the <i>type</i> and <i>number</i> arguments, specify an interface that is connected to hosts. |
| Step 4 | Do one of the following: <ul style="list-style-type: none"> ip igmp join-group <i>group-address</i> ip igmp static-group <i>{* group-address [source source-address]}</i> Example: <pre>Switch(config-if)# ip igmp join-group 225.2.2.2</pre> Example: <pre>Switch(config-if)# ip igmp static-group 225.2.2.2</pre> | The first sample shows how to configure an interface on the device to join the specified group. <ul style="list-style-type: none"> With this method, the device accepts the multicast packets in addition to forwarding them. Accepting the multicast packets prevents the device from fast switching. The second example shows how to configure static group membership entries on an interface. <ul style="list-style-type: none"> With this method, the device does not accept the packets itself, but only forwards them. Hence, this method allows fast switching. The outgoing interface appears in the IGMP cache, but the device itself is not a member, as evidenced by lack of an “L” (local) flag in the multicast route entry. |
| Step 5 | end Example: <pre>Switch(config-if)# end</pre> | Returns to privileged EXEC mode. |
| Step 6 | show ip igmp interface [<i>interface-type interface-number</i>] Example: <pre>Switch# show ip igmp interface</pre> | (Optional) Displays multicast-related information about an interface. |
| Step 7 | copy running-config startup-config Example: <pre>Switch# copy running-config startup-config</pre> | (Optional) Saves your entries in the configuration file. |
| Step 8 | show running-config Example: <pre>Switch# show running-config</pre> | Verifies your entries. |

Controlling Access to an SSM Network Using IGMP Extended Access Lists

Perform this optional task to control access to an SSM network by using an IGMP extended access list that filters SSM traffic based on source address, group address, or both.

SUMMARY STEPS

1. **enable**
2. **configure terminal**
3. **ip multicast-routing [distributed]**
4. **ip pim ssm {default | range *access-list*}**
5. **ip access-list extended *access-list* -name**
6. **deny igmp *source source-wildcard destination destination-wildcard [igmp-type] [precedence precedence] [tos tos] [log] [time-range time-range-name] [fragments]***
7. **permit igmp *source source-wildcard destination destination-wildcard [igmp-type] [precedence precedence] [tos tos] [log] [time-range time-range-name] [fragments]***
8. **exit**
9. interface type number
10. **ip igmp access-group *access-list***
11. **ip pim sparse-mode**
12. Repeat Steps 1 through 11 on all interfaces that require access control of SSM channel membership.
13. **ip igmp version 3**
14. Repeat Step 13 on all host-facing interfaces.
15. **end**

DETAILED STEPS

| | Command or Action | Purpose |
|--------|--|--|
| Step 1 | enable Example: Device> enable | Enables privileged EXEC mode. <ul style="list-style-type: none"> • Enter your password if prompted. |
| Step 2 | configure terminal Example: Device# configure terminal | Enters global configuration mode. |
| Step 3 | ip multicast-routing [distributed] Example: Device(config)# ip multicast-routing distributed | Enables IP multicast routing. <ul style="list-style-type: none"> • The distributed keyword is required for IPv4 multicast.. |
| Step 4 | ip pim ssm {default range <i>access-list</i>} Example: Device(config)# ip pim ssm default | Configures SSM service. <ul style="list-style-type: none"> • The default keyword defines the SSM range access list as 232/8. |

| | Command or Action | Purpose |
|----------------|--|---|
| | | <ul style="list-style-type: none"> The range keyword specifies the standard IP access list number or name that defines the SSM range. |
| Step 5 | ip access-list extended <i>access-list -name</i> Example: <pre>Device(config)# ip access-list extended mygroup</pre> | Specifies an extended named IP access list. |
| Step 6 | deny igmp <i>source source-wildcard destination destination-wildcard [igmp-type] [precedence precedence] [tos tos] [log] [time-range time-range-name] [fragments]</i> Example: <pre>Device(config-ext-nacl)# deny igmp host 10.1.2.3 any</pre> | (Optional) Filters the specified source address or group address from the IGMP report, thereby restricting hosts on a subnet from membership to the (S, G) channel. <ul style="list-style-type: none"> Repeat this step to restrict hosts on a subnet membership to other (S, G) channels. (These sources should be more specific than a subsequent permit statement because any sources or groups not specifically permitted are denied.) Remember that the access list ends in an implicit deny statement. This example shows how to create a deny statement that filters all groups for source 10.1.2.3, which effectively denies the source. |
| Step 7 | permit igmp <i>source source-wildcard destination destination-wildcard [igmp-type] [precedence precedence] [tos tos] [log] [time-range time-range-name] [fragments]</i> Example: <pre>Device(config-ext-nacl)# permit igmp any any</pre> | Allows a source address or group address in an IGMP report to pass the IP access list. <ul style="list-style-type: none"> You must have at least one permit statement in an access list. Repeat this step to allow other sources to pass the IP access list. This example shows how to allow group membership to sources and groups not denied by prior deny statements. |
| Step 8 | exit Example: <pre>Device(config-ext-nacl)# exit</pre> | Exits the current configuration session and returns to global configuration mode. |
| Step 9 | interface type number Example: <pre>Device(config)# interface ethernet 0</pre> | Selects an interface that is connected to hosts on which IGMPv3 can be enabled. |
| Step 10 | ip igmp access-group <i>access-list</i> Example: | Applies the specified access list to IGMP reports. |

| | Command or Action | Purpose |
|----------------|--|--|
| | Device(config-if)# ip igmp access-group mygroup | |
| Step 11 | ip pim sparse-mode Example: Device(config-if)# ip pim sparse-mode | Enables PIM-SM on the interface. Note You must use sparse mode. |
| Step 12 | Repeat Steps 1 through 11 on all interfaces that require access control of SSM channel membership. | -- |
| Step 13 | ip igmp version 3 Example: Device(config-if)# ip igmp version 3 | Enables IGMPv3 on this interface. The default version of IGMP is IGMP version 2. Version 3 is required by SSM. |
| Step 14 | Repeat Step 13 on all host-facing interfaces. | -- |
| Step 15 | end Example: Device(config-if)# end | Returns to privileged EXEC mode. |

How to Configure IGMP Snooping

Enabling IGMP Snooping

SUMMARY STEPS

1. enable
2. configure terminal
3. ip igmp snooping
4. bridge-domain *bridge-id*
5. ip igmp snooping
6. end

DETAILED STEPS

| | Command or Action | Purpose |
|---------------|--|---|
| Step 1 | enable Example: Device> enable | Enables privileged EXEC mode. <ul style="list-style-type: none"> • Enter your password if prompted. |
| Step 2 | configure terminal Example: | Enters global configuration mode. |

| | Command or Action | Purpose |
|---------------|--|---|
| | Device# configure terminal | |
| Step 3 | ip igmp snooping Example: Device(config)# ip igmp snooping | Globally enables IGMP snooping after it has been disabled. |
| Step 4 | bridge-domain <i>bridge-id</i> Example: Device(config) # bridge-domain 100 | (Optional) Enters bridge domain configuration mode. |
| Step 5 | ip igmp snooping Example: Device(config-bdomain)# ip igmp snooping | (Optional) Enables IGMP snooping on the bridge domain interface being configured. <ul style="list-style-type: none"> • Required only if IGMP snooping was previously explicitly disabled on the specified bridge domain. |
| Step 6 | end Example: Device(config-bdomain)# end | Returns to privileged EXEC mode. |

Enabling or Disabling IGMP Snooping on a VLAN Interface (CLI)

Follow these steps to enable IGMP snooping on a VLAN interface:

SUMMARY STEPS

1. enable
2. configure terminal
3. ip igmp snooping vlan *vlan-id*
4. end
5. copy running-config startup-config

DETAILED STEPS

| | Command or Action | Purpose |
|---------------|--|--|
| Step 1 | enable Example: Switch> enable | Enables privileged EXEC mode. Enter your password if prompted. |
| Step 2 | configure terminal Example: | Enters the global configuration mode. |

| | Command or Action | Purpose |
|---------------|---|--|
| | Switch# <code>configure terminal</code> | |
| Step 3 | ip igmp snooping vlan <i>vlan-id</i> Example: Switch(config)# <code>ip igmp snooping vlan 7</code> | Enables IGMP snooping on the VLAN interface. The VLAN ID range is 1 to 1001 and 1006 to 4094. IGMP snooping must be globally enabled before you can enable VLAN snooping. Note To disable IGMP snooping on a VLAN interface, use the no ip igmp snooping vlan <i>vlan-id</i> global configuration command for the specified VLAN number. |
| Step 4 | end Example: Switch(config)# <code>end</code> | Returns to privileged EXEC mode. |
| Step 5 | copy running-config startup-config Example: Switch# <code>copy running-config startup-config</code> | (Optional) Saves your entries in the configuration file. |

Setting the Snooping Method (CLI)

Multicast-capable router ports are added to the forwarding table for every Layer 2 multicast entry. The switch learns of the ports through one of these methods:

- Snooping on IGMP queries, Protocol-Independent Multicast (PIM) packets
- Statically connecting to a multicast router port using the **ip igmp snooping mrouter** global configuration command

Beginning in privileged EXEC mode, follow these steps to alter the method in which a VLAN interface accesses a multicast router:

SUMMARY STEPS

1. `enable`
2. `configure terminal`
3. `ip igmp snooping vlan vlan-id mrouter interface {GigabitEthernet | Port-Channel | TenGigabitEthernet}`
4. `end`
5. `show ip igmp snooping`
6. `copy running-config startup-config`

DETAILED STEPS

| | Command or Action | Purpose |
|---------------|---|--|
| Step 1 | enable Example: <pre>Switch> enable</pre> | Enables privileged EXEC mode. <ul style="list-style-type: none"> • Enter your password if prompted. |
| Step 2 | configure terminal Example: <pre>Switch# configure terminal</pre> | Enters the global configuration mode. |
| Step 3 | ip igmp snooping vlan <i>vlan-id</i> mrouter interface {GigabitEthernet Port-Channel TenGigabitEthernet} Example: <pre>Switch(config)# ip igmp snooping vlan 1 mrouter interface GigabitEthernet1/0/3</pre> | Enables IGMP snooping on a VLAN. The VLAN ID range is 1 to 1001 and 1006 to 4094. |
| Step 4 | end Example: <pre>Switch(config)# end</pre> | Returns to privileged EXEC mode. |
| Step 5 | show ip igmp snooping Example: <pre>Switch# show ip igmp snooping</pre> | Verifies the configuration. |
| Step 6 | copy running-config startup-config Example: <pre>Switch# copy running-config startup-config</pre> | (Optional) Saves your entries in the configuration file. |

Configuring a Multicast Router Port (CLI)

Perform these steps to add a multicast router port (enable a static connection to a multicast router) on the switch.



Note Static connections to multicast routers are supported only on switch ports.

SUMMARY STEPS

1. enable
2. configure terminal
3. ip igmp snooping vlan *vlan-id* mrouter interface *interface-id*
4. end
5. show ip igmp snooping mrouter [vlan *vlan-id*]
6. copy running-config startup-config

DETAILED STEPS

| | Command or Action | Purpose |
|--------|---|--|
| Step 1 | <p>enable</p> <p>Example:</p> <pre>Switch> enable</pre> | Enables privileged EXEC mode. Enter your password if prompted. |
| Step 2 | <p>configure terminal</p> <p>Example:</p> <pre>Switch# configure terminal</pre> | Enters the global configuration mode. |
| Step 3 | <p>ip igmp snooping vlan <i>vlan-id</i> mrouter interface <i>interface-id</i></p> <p>Example:</p> <pre>Switch(config)# ip igmp snooping vlan 5 mrouter interface gigabitethernet1/0/1</pre> | <p>Specifies the multicast router VLAN ID and the interface to the multicast router.</p> <ul style="list-style-type: none"> • The VLAN ID range is 1 to 1001 and 1006 to 4094. • The interface can be a physical interface or a port channel. The port-channel range is 1 to 128. <p>Note To remove a multicast router port from the VLAN, use the no ip igmp snooping vlan <i>vlan-id</i> mrouter interface <i>interface-id</i> global configuration command.</p> |
| Step 4 | <p>end</p> <p>Example:</p> <pre>Switch(config)# end</pre> | Returns to privileged EXEC mode. |
| Step 5 | <p>show ip igmp snooping mrouter [vlan <i>vlan-id</i>]</p> <p>Example:</p> <pre>Switch# show ip igmp snooping mrouter vlan 5</pre> | Verifies that IGMP snooping is enabled on the VLAN interface. |

| | Command or Action | Purpose |
|---------------|---|--|
| Step 6 | copy running-config startup-config Example: <pre>Switch# copy running-config startup-config</pre> | (Optional) Saves your entries in the configuration file. |

Configuring a Host Statically to Join a Group (CLI)

Hosts or Layer 2 ports normally join multicast groups dynamically, but you can also statically configure a host on an interface.

Follow these steps to add a Layer 2 port as a member of a multicast group:

SUMMARY STEPS

1. enable
2. configure terminal
3. ip igmp snooping vlan *vlan-id* static *ip_address* interface *interface-id*
4. end
5. show ip igmp snooping groups
6. copy running-config startup-config

DETAILED STEPS

| | Command or Action | Purpose |
|---------------|---|--|
| Step 1 | enable Example: <pre>Switch> enable</pre> | Enables privileged EXEC mode. Enter your password if prompted. |
| Step 2 | configure terminal Example: <pre>Switch# configure terminal</pre> | Enters the global configuration mode. |
| Step 3 | ip igmp snooping vlan <i>vlan-id</i> static <i>ip_address</i> interface <i>interface-id</i> Example: <pre>Switch(config)# ip igmp snooping vlan 105 static 230.0.0.1 interface gigabitethernet1/0/1</pre> | Statically configures a Layer 2 port as a member of a multicast group: <ul style="list-style-type: none"> • <i>vlan-id</i> is the multicast group VLAN ID. The range is 1 to 1001 and 1006 to 4094. • <i>ip-address</i> is the group IP address. • <i>interface-id</i> is the member port. It can be a physical interface or a port channel (1 to 128). |

| | Command or Action | Purpose |
|---------------|---|--|
| | | Note To remove the Layer 2 port from the multicast group, use the no ip igmp snooping vlan <i>vlan-id</i> static mac-address interface <i>interface-id</i> global configuration command. |
| Step 4 | end Example: Switch(config)# end | Returns to privileged EXEC mode. |
| Step 5 | show ip igmp snooping groups Example: Switch# show ip igmp snooping groups | Verifies the member port and the IP address. |
| Step 6 | copy running-config startup-config Example: Switch# copy running-config startup-config | (Optional) Saves your entries in the configuration file. |

Enabling IGMP Immediate Leave (CLI)

When you enable IGMP Immediate Leave, the switch immediately removes a port when it detects an IGMP Version 2 leave message on that port. You should use the Immediate-Leave feature only when there is a single receiver present on every port in the VLAN.



Note Immediate Leave is supported only on IGMP Version 2 hosts. IGMP Version 2 is the default version for the switch.

SUMMARY STEPS

1. **enable**
2. **configure terminal**
3. **ip igmp snooping vlan *vlan-id* immediate-leave**
4. **end**
5. **show ip igmp snooping vlan *vlan-id***
6. **end**

DETAILED STEPS

| | Command or Action | Purpose |
|---------------|---|--|
| Step 1 | enable Example: Switch> enable | Enables privileged EXEC mode. Enter your password if prompted. |
| Step 2 | configure terminal Example: Switch# configure terminal | Enters the global configuration mode. |
| Step 3 | ip igmp snooping vlan <i>vlan-id</i> immediate-leave Example: Switch(config)# ip igmp snooping vlan 21 immediate-leave | Enables IGMP Immediate Leave on the VLAN interface. Note To disable IGMP Immediate Leave on a VLAN, use the no ip igmp snooping vlan <i>vlan-id</i> immediate-leave global configuration command. |
| Step 4 | end Example: Switch(config)# end | Returns to privileged EXEC mode. |
| Step 5 | show ip igmp snooping vlan <i>vlan-id</i> Example: Switch# show ip igmp snooping vlan 21 | Verifies that Immediate Leave is enabled on the VLAN interface. |
| Step 6 | end Example: Switch(config)# end | Returns to privileged EXEC mode. |

Related Topics

[Immediate Leave](#), on page 39

Configuring the IGMP Leave Timer (CLI)

You can configure the leave time globally or on a per-VLAN basis. Follow these steps to enable the IGMP configurable-leave timer:

SUMMARY STEPS

1. enable
2. configure terminal
3. ip igmp snooping last-member-query-interval *time*
4. ip igmp snooping vlan *vlan-id* last-member-query-interval *time*
5. end
6. show ip igmp snooping
7. copy running-config startup-config

DETAILED STEPS

| | Command or Action | Purpose |
|--------|---|---|
| Step 1 | <p>enable</p> <p>Example:</p> <pre>Switch> enable</pre> | Enables privileged EXEC mode. Enter your password if prompted. |
| Step 2 | <p>configure terminal</p> <p>Example:</p> <pre>Switch# configure terminal</pre> | Enters the global configuration mode. |
| Step 3 | <p>ip igmp snooping last-member-query-interval <i>time</i></p> <p>Example:</p> <pre>Switch(config)# ip igmp snooping last-member-query-interval 1000</pre> | <p>Configures the IGMP leave timer globally. The range is 100 to 32767 milliseconds.</p> <p>The default leave time is 1000 milliseconds.</p> <p>Note To globally reset the IGMP leave timer to the default setting, use the no ip igmp snooping last-member-query-interval global configuration command.</p> |
| Step 4 | <p>ip igmp snooping vlan <i>vlan-id</i> last-member-query-interval <i>time</i></p> <p>Example:</p> <pre>Switch(config)# ip igmp snooping vlan 210 last-member-query-interval 1000</pre> | <p>(Optional) Configures the IGMP leave time on the VLAN interface. The range is 100 to 32767 milliseconds.</p> <p>Note Configuring the leave time on a VLAN overrides the globally configured timer.</p> <p>Note To remove the configured IGMP leave-time setting from the specified VLAN, use the no ip igmp snooping vlan <i>vlan-id</i> last-member-query-interval global configuration command.</p> |
| Step 5 | <p>end</p> <p>Example:</p> | Returns to privileged EXEC mode. |

| | Command or Action | Purpose |
|---------------|---|--|
| | Switch(config)# end | |
| Step 6 | show ip igmp snooping Example: Switch# show ip igmp snooping | (Optional) Displays the configured IGMP leave time. |
| Step 7 | copy running-config startup-config Example: Switch# copy running-config startup-config | (Optional) Saves your entries in the configuration file. |

Related Topics

[IGMP Configurable-Leave Timer](#), on page 39

Configuring the IGMP Robustness-Variable (CLI)

Use the following procedure to configure the IGMP robustness variable on the switch.

The robustness variable is the integer used by IGMP snooping during calculations for IGMP messages. The robustness variable provides fine tuning to allow for expected packet loss.

SUMMARY STEPS

1. **enable**
2. **configure terminal**
3. **ip igmp snooping robustness-variable** *count*
4. **ip igmp snooping vlan** *vlan-id* **robustness-variable** *count*
5. **end**
6. **show ip igmp snooping**
7. **copy running-config startup-config**

DETAILED STEPS

| | Command or Action | Purpose |
|---------------|---|--|
| Step 1 | enable Example: Switch> enable | Enables privileged EXEC mode. <ul style="list-style-type: none"> • Enter your password if prompted. |
| Step 2 | configure terminal Example: | Enters the global configuration mode. |

| | Command or Action | Purpose |
|---------------|--|--|
| | Switch# <code>configure terminal</code> | |
| Step 3 | ip igmp snooping robustness-variable <i>count</i> Example: Switch(config)# <code>ip igmp snooping robustness-variable 3</code> | Configures the IGMP robustness variable. The range is 1 to 3 times. The recommended value for the robustness variable is 2. Use this command to change the value of the robustness variable for IGMP snooping from the default (2) to a specified value. |
| Step 4 | ip igmp snooping vlan <i>vlan-id</i> robustness-variable <i>count</i> Example: Switch(config)# <code>ip igmp snooping vlan 100 robustness-variable 3</code> | (Optional) Configures the IGMP robustness variable on the VLAN interface. The range is 1 to 3 times. The recommended value for the robustness variable is 2. Note Configuring the robustness variable count on a VLAN overrides the globally configured value. |
| Step 5 | end Example: Switch(config)# <code>end</code> | Returns to privileged EXEC mode. |
| Step 6 | show ip igmp snooping Example: Switch# <code>show ip igmp snooping</code> | (Optional) Displays the configured IGMP robustness variable count. |
| Step 7 | copy running-config startup-config Example: Switch# <code>copy running-config startup-config</code> | (Optional) Saves your entries in the configuration file. |

Configuring the IGMP Last Member Query Count (CLI)

To configure the number of times the switch sends IGMP group-specific or group-source-specific (with IGMP version 3) query messages in response to receiving a group-specific or group-source-specific leave message, use this command.

SUMMARY STEPS

1. `enable`
2. `configure terminal`
3. `ip igmp snooping last-member-query-count` *count*
4. `ip igmp snooping vlan` *vlan-id* `last-member-query-count` *count*
5. `end`

6. `show ip igmp snooping`
7. `copy running-config startup-config`

DETAILED STEPS

| | Command or Action | Purpose |
|---------------|---|---|
| Step 1 | enable Example: <pre>Switch> enable</pre> | Enables privileged EXEC mode. <ul style="list-style-type: none"> • Enter your password if prompted. |
| Step 2 | configure terminal Example: <pre>Switch# configure terminal</pre> | Enters the global configuration mode. |
| Step 3 | ip igmp snooping last-member-query-count <i>count</i> Example: <pre>Switch(config)# ip igmp snooping last-member-query-count 3</pre> | Configures the IGMP last member query count. The range is 1 to 7 messages. The default is 2 messages. |
| Step 4 | ip igmp snooping vlan <i>vlan-id</i> last-member-query-count <i>count</i> Example: <pre>Switch(config)# ip igmp snooping vlan 100 last-member-query-count 3</pre> | (Optional) Configures the IGMP last member query count on the VLAN interface. The range is 1 to 7 messages. Note Configuring the last member query count on a VLAN overrides the globally configured timer. |
| Step 5 | end Example: <pre>Switch(config)# end</pre> | Returns to privileged EXEC mode. |
| Step 6 | show ip igmp snooping Example: <pre>Switch# show ip igmp snooping</pre> | (Optional) Displays the configured IGMP last member query count. |
| Step 7 | copy running-config startup-config Example: <pre>Switch# copy running-config startup-config</pre> | (Optional) Saves your entries in the configuration file. |

Configuring TCN-Related Commands

Controlling the Multicast Flooding Time After a TCN Event (CLI)

You can configure the number of general queries by which multicast data traffic is flooded after a topology change notification (TCN) event. If you set the TCN flood query count to 1 the flooding stops after receiving 1 general query. If you set the count to 7, the flooding continues until 7 general queries are received. Groups are relearned based on the general queries received during the TCN event.

Some examples of TCN events are when the client location is changed and the receiver is on same port that was blocked but is now forwarding, and when a port goes down without sending a leave message.

Follow these steps to configure the TCN flood query count:

SUMMARY STEPS

1. **enable**
2. **configure terminal**
3. **ip igmp snooping tcn flood query count** *count*
4. **end**
5. **show ip igmp snooping**
6. **copy running-config startup-config**

DETAILED STEPS

| | Command or Action | Purpose |
|--------|--|--|
| Step 1 | enable Example: <pre>Switch> enable</pre> | Enables privileged EXEC mode. Enter your password if prompted. |
| Step 2 | configure terminal Example: <pre>Switch# configure terminal</pre> | Enters the global configuration mode. |
| Step 3 | ip igmp snooping tcn flood query count <i>count</i> Example: <pre>Switch(config)# ip igmp snooping tcn flood query count 3</pre> | Specifies the number of IGMP general queries for which the multicast traffic is flooded. The range is 1 to 10. The default, the flooding query count is 2. Note To return to the default flooding query count, use the no ip igmp snooping tcn flood query count global configuration command. |
| Step 4 | end Example: | Returns to privileged EXEC mode. |

| | Command or Action | Purpose |
|---------------|---|--|
| | Switch(config)# end | |
| Step 5 | show ip igmp snooping Example: Switch# show ip igmp snooping | Verifies the TCN settings. |
| Step 6 | copy running-config startup-config Example: Switch# copy running-config startup-config | (Optional) Saves your entries in the configuration file. |

Recovering from Flood Mode (CLI)

When a topology change occurs, the spanning-tree root sends a special IGMP leave message (also known as global leave) with the group multicast address 0.0.0.0. However, you can enable the switch to send the global leave message whether it is the spanning-tree root or not. When the router receives this special leave, it immediately sends general queries, which expedite the process of recovering from the flood mode during the TCN event. Leaves are always sent if the switch is the spanning-tree root regardless of this configuration.

Follow these steps to enable sending of leave messages:

SUMMARY STEPS

1. **enable**
2. **configure terminal**
3. **ip igmp snooping tcn query solicit**
4. **end**
5. **show ip igmp snooping**
6. **copy running-config startup-config**

DETAILED STEPS

| | Command or Action | Purpose |
|---------------|---|--|
| Step 1 | enable Example: Switch> enable | Enables privileged EXEC mode. Enter your password if prompted. |
| Step 2 | configure terminal Example: Switch# configure terminal | Enters the global configuration mode. |

| | Command or Action | Purpose |
|--------|---|---|
| Step 3 | ip igmp snooping tcn query solicit Example: <pre>Switch(config)# ip igmp snooping tcn query solicit</pre> | Sends an IGMP leave message (global leave) to speed the process of recovering from the flood mode caused during a TCN event. By default, query solicitation is disabled. Note To return to the default query solicitation, use the no ip igmp snooping tcn query solicit global configuration command. |
| Step 4 | end Example: <pre>Switch(config)# end</pre> | Returns to privileged EXEC mode. |
| Step 5 | show ip igmp snooping Example: <pre>Switch# show ip igmp snooping</pre> | Verifies the TCN settings. |
| Step 6 | copy running-config startup-config Example: <pre>Switch# copy running-config startup-config</pre> | (Optional) Saves your entries in the configuration file. |

Disabling Multicast Flooding During a TCN Event (CLI)

When the switch receives a TCN, multicast traffic is flooded to all the ports until 2 general queries are received. If the switch has many ports with attached hosts that are subscribed to different multicast groups, this flooding might exceed the capacity of the link and cause packet loss. Follow these steps to control TCN flooding:

SUMMARY STEPS

1. **enable**
2. **configure terminal**
3. **interface *interface-id***
4. **no ip igmp snooping tcn flood**
5. **end**
6. **show ip igmp snooping**
7. **copy running-config startup-config**

DETAILED STEPS

| | Command or Action | Purpose |
|--------|----------------------------------|--|
| Step 1 | enable Example: | Enables privileged EXEC mode. Enter your password if prompted. |

| | Command or Action | Purpose |
|---------------|--|---|
| | Switch> enable | |
| Step 2 | configure terminal Example: Switch# configure terminal | Enters the global configuration mode. |
| Step 3 | interface <i>interface-id</i> Example: Switch(config)# interface gigabitethernet 1/0/1 | Specifies the interface to be configured, and enters interface configuration mode. |
| Step 4 | no ip igmp snooping tcn flood Example: Switch(config-if)# no ip igmp snooping tcn flood | Disables the flooding of multicast traffic during a spanning-tree TCN event. By default, multicast flooding is enabled on an interface. Note To re-enable multicast flooding on an interface, use the ip igmp snooping tcn flood interface configuration command. |
| Step 5 | end Example: Switch(config)# end | Returns to privileged EXEC mode. |
| Step 6 | show ip igmp snooping Example: Switch# show ip igmp snooping | Verifies the TCN settings. |
| Step 7 | copy running-config startup-config Example: Switch# copy running-config startup-config | (Optional) Saves your entries in the configuration file. |

Configuring the IGMP Snooping Querier (CLI)

Follow these steps to enable the IGMP snooping querier feature in a VLAN:

SUMMARY STEPS

1. **enable**

2. **configure terminal**
3. **ip igmp snooping querier**
4. **ip igmp snooping querier address *ip_address***
5. **ip igmp snooping querier query-interval *interval-count***
6. **ip igmp snooping querier tcn query [*count count* | *interval interval*]**
7. **ip igmp snooping querier timer expiry *timeout***
8. **ip igmp snooping querier version *version***
9. **end**
10. **show ip igmp snooping vlan *vlan-id***
11. **copy running-config startup-config**

DETAILED STEPS

| | Command or Action | Purpose |
|---------------|--|--|
| Step 1 | enable Example: <pre>Switch> enable</pre> | Enables privileged EXEC mode. Enter your password if prompted. |
| Step 2 | configure terminal Example: <pre>Switch# configure terminal</pre> | Enters the global configuration mode. |
| Step 3 | ip igmp snooping querier Example: <pre>Switch(config)# ip igmp snooping querier</pre> | Enables the IGMP snooping querier. |
| Step 4 | ip igmp snooping querier address <i>ip_address</i> Example: <pre>Switch(config)# ip igmp snooping querier address 172.16.24.1</pre> | (Optional) Specifies an IP address for the IGMP snooping querier. If you do not specify an IP address, the querier tries to use the global IP address configured for the IGMP querier. Note The IGMP snooping querier does not generate an IGMP general query if it cannot find an IP address on the switch. |
| Step 5 | ip igmp snooping querier query-interval <i>interval-count</i> Example: <pre>Switch(config)# ip igmp snooping querier query-interval 30</pre> | (Optional) Sets the interval between IGMP queriers. The range is 1 to 18000 seconds. |

| | Command or Action | Purpose |
|----------------|---|--|
| Step 6 | <p>ip igmp snooping querier tcn query [<i>count count</i> <i>interval interval</i>]</p> <p>Example:</p> <pre>Switch(config)# ip igmp snooping querier tcn query interval 20</pre> | (Optional) Sets the time between Topology Change Notification (TCN) queries. The count range is 1 to 10. The interval range is 1 to 255 seconds. |
| Step 7 | <p>ip igmp snooping querier timer expiry <i>timeout</i></p> <p>Example:</p> <pre>Switch(config)# ip igmp snooping querier timer expiry 180</pre> | (Optional) Sets the length of time until the IGMP querier expires. The range is 60 to 300 seconds. |
| Step 8 | <p>ip igmp snooping querier version <i>version</i></p> <p>Example:</p> <pre>Switch(config)# ip igmp snooping querier version 2</pre> | (Optional) Selects the IGMP version number that the querier feature uses. Select 1 or 2. |
| Step 9 | <p>end</p> <p>Example:</p> <pre>Switch(config)# end</pre> | Returns to privileged EXEC mode. |
| Step 10 | <p>show ip igmp snooping vlan <i>vlan-id</i></p> <p>Example:</p> <pre>Switch# show ip igmp snooping vlan 30</pre> | (Optional) Verifies that the IGMP snooping querier is enabled on the VLAN interface. The VLAN ID range is 1 to 1001 and 1006 to 4094. |
| Step 11 | <p>copy running-config startup-config</p> <p>Example:</p> <pre>Switch# copy running-config startup-config</pre> | (Optional) Saves your entries in the configuration file. |

Disabling IGMP Report Suppression (CLI)

Follow these steps to disable IGMP report suppression:

SUMMARY STEPS

1. enable
2. configure terminal
3. no ip igmp snooping report-suppression

4. end
5. show ip igmp snooping
6. copy running-config startup-config

DETAILED STEPS

| | Command or Action | Purpose |
|--------|---|---|
| Step 1 | <p>enable</p> <p>Example:</p> <pre>Switch> enable</pre> | Enables privileged EXEC mode. Enter your password if prompted. |
| Step 2 | <p>configure terminal</p> <p>Example:</p> <pre>Switch# configure terminal</pre> | Enters the global configuration mode. |
| Step 3 | <p>no ip igmp snooping report-suppression</p> <p>Example:</p> <pre>Switch(config)# no ip igmp snooping report-suppression</pre> | <p>Disables IGMP report suppression. When report suppression is disabled, all IGMP reports are forwarded to the multicast routers.</p> <p>IGMP report suppression is enabled by default.</p> <p>When IGMP report suppression is enabled, the switch forwards only one IGMP report per multicast router query.</p> <p>Note To re-enable IGMP report suppression, use the ip igmp snooping report-suppression global configuration command.</p> |
| Step 4 | <p>end</p> <p>Example:</p> <pre>Switch(config)# end</pre> | Returns to privileged EXEC mode. |
| Step 5 | <p>show ip igmp snooping</p> <p>Example:</p> <pre>Switch# show ip igmp snooping</pre> | Verifies that IGMP report suppression is disabled. |
| Step 6 | <p>copy running-config startup-config</p> <p>Example:</p> <pre>Switch# copy running-config startup-config</pre> | (Optional) Saves your entries in the configuration file. |

Related Topics

[IGMP Report Suppression](#), on page 39

Monitoring IGMP

You can display specific statistics, such as the contents of IP routing tables, caches, and databases.



Note This release does not support per-route statistics.

You can display information to learn resource usage and solve network problems. You can also display information about node reachability and discover the routing path that packets of your device are taking through the network.

You can use any of the privileged EXEC commands in the following table to display various routing statistics.

Table 12: Commands for Displaying System and Network Statistics

| Command | Purpose |
|--|---|
| ping [<i>group-name</i> <i>group-address</i>] | Sends an ICMP Echo Request to a multicast group address. |
| show ip igmp filter | Displays IGMP filter information. |
| show ip igmp groups [<i>type-number</i> <i>detail</i>] | Displays the multicast groups that are directly connected to the switch and that were learned through IGMP. |
| show ip igmp interface [<i>type number</i>] | Displays multicast-related information about an interface. |
| show ip igmp membership [<i>name/group address</i> all tracked] | Displays IGMP membership information for forwarding. |
| show ip igmp profile [<i>profile_number</i>] | Displays IGMP profile information. |
| show ip igmp ssm-mapping [<i>hostname/IP address</i>] | Displays IGMP SSM mapping information. |
| show ip igmp static-group { class-map [interface [<i>type</i>]] | Displays static group information. |
| show ip igmp vrf | Displays the selected VPN routing/forwarding instance by name. |

Monitoring IGMP Snooping Information

You can display IGMP snooping information for dynamically learned and statically configured router ports and VLAN interfaces. You can also display MAC address multicast entries for a VLAN configured for IGMP snooping.

Table 13: Commands for Displaying IGMP Snooping Information

| Command | Purpose |
|--|--|
| <code>show ip igmp snooping detail</code> | Displays the operational state information. |
| <code>show ip igmp snooping groups [count [vlan vlan-id [A.B.C.D count]]</code> | Displays multicast table information for the switch or about a specific parameter: <ul style="list-style-type: none"> • count—Displays the total number of groups. • vlan—Displays group information by VLAN ID. |
| <code>show ip igmp snooping igmpv2-tracking</code> | Displays the IGMP snooping tracking. <p>Note This command displays group and IP address entries only for wireless multicast IGMP joins and not for wired IGMP joins. Wireless IP multicast must be enabled for this command to display.</p> |
| <code>show ip igmp snooping mrouter [vlan vlan-id]</code> | Displays information on dynamically learned and manually configured multicast router interfaces. <p>Note When you enable IGMP snooping, the switch automatically learns the interface to which a multicast router is connected. These are dynamically learned interfaces.</p> <p>(Optional) Enter vlan vlan-id to display information for a single VLAN.</p> |
| <code>show ip igmp snooping querier [detail vlan vlan-id]</code> | Displays information about the IP address and receiving port for the most-recently received IGMP query messages in the VLAN. <p>(Optional) Enter detail to display the detailed IGMP querier information in a VLAN.</p> <p>(Optional) Enter vlan vlan-id to display information for a single VLAN.</p> |
| <code>show ip igmp snooping [vlan vlan-id [detail]]</code> | Displays the snooping configuration information for all VLANs on the switch or for a specified VLAN. <p>(Optional) Enter vlan vlan-id to display information for a single VLAN. The VLAN ID range is 1 to 1001 and 1006 to 4094.</p> |
| <code>show ip igmp snooping wireless mgid</code> | Displays wireless-related events. |

Monitoring IGMP Filtering and Throttling Configuration

You can display IGMP profile characteristics, and you can display the IGMP profile and maximum group configuration for all interfaces on the switch or for a specified interface. You can also display the IGMP throttling configuration for all interfaces on the switch or for a specified interface.

Table 14: Commands for Displaying IGMP Filtering and Throttling Configuration

| Command | Purpose |
|---|---|
| <code>show ip igmp profile [profile number]</code> | Displays the specified IGMP profile or all the IGMP profiles defined on the switch. |
| <code>show running-config [interface interface-id]</code> | Displays the configuration of the specified interface or the configuration of all interfaces on the switch, including (if configured) the maximum number of IGMP groups to which an interface can belong and the IGMP profile applied to the interface. |

Configuration Examples for IGMP

Example: Configuring the Switch as a Member of a Multicast Group

This example shows how to enable the switch to join multicast group 255.2.2.2:

```
Switch(config)# interface gigabitethernet1/0/1
Switch(config-if)# ip igmp join-group 255.2.2.2
Switch(config-if)#
```

Related Topics

- [Configuring the Switch as a Member of a Group \(CLI\)](#), on page 42
- [Joining a Multicast Group](#), on page 37
- [IGMP Multicast Addresses](#), on page 32

Example: Controlling Access to Multicast Groups

To limit the number of joins on the interface, configure the port for filter which associates with the IGMP profile.

```
Switch# configure terminal
Switch(config)# ip igmp profile 10
Switch(config-igmp-profile)# ?
```

```
IGMP profile configuration commands:
deny matching addresses are denied
exit Exit from igmp profile configuration mode
no Negate a command or set its defaults
permit matching addresses are permitted
```

```
range add a range to the set

Switch(config-igmp-profile)# range 172.16.5.1
Switch(config-igmp-profile)# exit
Switch(config)#
Switch(config)# interface gigabitEthernet 2/0/10
Switch(config-if)# ip igmp filter 10
```

Examples: Configuring IGMP Snooping

This example shows how to enable a static connection to a multicast router:

```
Switch# configure terminal
Switch(config)# ip igmp snooping vlan 200 mrouter interface gigabitEthernet1/0/2
Switch(config)# end
```

This example shows how to statically configure a host on a port:

```
Switch# configure terminal
Switch(config)# ip igmp snooping vlan 105 static 224.2.4.12 interface gigabitEthernet1/0/1
Switch(config)# end
```

This example shows how to enable IGMP Immediate Leave on VLAN 130:

```
Switch# configure terminal
Switch(config)# ip igmp snooping vlan 130 immediate-leave
Switch(config)# end
```

This example shows how to set the IGMP snooping querier source address to 10.0.0.64:

```
Switch# configure terminal
Switch(config)# ip igmp snooping querier 10.0.0.64
Switch(config)# end
```

This example shows how to set the IGMP snooping querier maximum response time to 25 seconds:

```
Switch# configure terminal
Switch(config)# ip igmp snooping querier query-interval 25
Switch(config)# end
```

This example shows how to set the IGMP snooping querier timeout to 60 seconds:

```
Switch# configure terminal
Switch(config)# ip igmp snooping querier timer expiry 60
Switch(config)# end
```

This example shows how to set the IGMP snooping querier feature to Version 2:

```
Switch# configure terminal
Switch(config)# no ip igmp snooping querier version 2
```

```
Switch(config)# end
```

Example: Configuring IGMP Profiles

This example shows how to create IGMP profile 4 allowing access to the single IP multicast address and how to verify the configuration. If the action was to deny (the default), it would not appear in the **show ip igmp profile** output display.

```
Switch(config)# ip igmp profile 4
Switch(config-igmp-profile)# permit
Switch(config-igmp-profile)# range 229.9.9.0
Switch(config-igmp-profile)# end
Switch# show ip igmp profile 4
IGMP Profile 4
    permit
    range 229.9.9.0 229.9.9.0
```

Example: Applying IGMP Profile

This example shows how to apply IGMP profile 4 to a port:

```
Switch(config)# interface gigabitEthernet1/0/2
Switch(config-if)# ip igmp filter 4
Switch(config-if)# end
```

Example: Setting the Maximum Number of IGMP Groups

This example shows how to limit to 25 the number of IGMP groups that a port can join:

```
Switch(config)# interface gigabitEthernet1/0/2
Switch(config-if)# ip igmp max-groups 25
Switch(config-if)# end
```

Example: Interface Configuration as a Routed Port

This example shows how to configure an interface on the switch as a routed port. This configuration is required on the interface for several IP multicast routing configuration procedures that require running the **no switchport** command.

```
Switch configure terminal
Switch(config)# interface GigabitEthernet1/0/9
Switch(config-if)# description interface to be use as routed port
Switch(config-if)# no switchport
Switch(config-if)# ip address 20.20.20.1 255.255.255.0
Switch(config-if)# ip pim sparse-dense-mode
Switch(config-if)# ip igmp join-group 224.1.2.3 source 15.15.15.2
Switch(config-if)# end
Switch# configure terminal
Switch# show run interface gigabitEthernet 1/0/9

Current configuration : 166 bytes
!
```



```

interface GigabitEthernet1/0/9
  no switchport
  ip address 20.20.20.1 255.255.255.0
  ip pim sparse-dense-mode
  ip igmp static-group 224.1.2.3 source 15.15.15.2
end

```

Example: Interface Configuration as an SVI

This example shows how to configure an interface on the switch as an SVI. This configuration is required on the interface for several IP multicast routing configuration procedures that require running the **no switchport** command.

```

Switch(config)# interface vlan 150
Switch(config-if)# ip address 20.20.20.1 255.255.255.0
Switch(config-if)# ip pim sparse-dense-mode
Switch(config-if)# ip igmp join-group 224.1.2.3 source 15.15.15.2
Switch(config-if)# end
Switch# configure terminal
Switch(config)# ip igmp snooping vlan 20 static 224.1.2.3
interface gigabitEthernet 1/0/9
Switch# show run interface vlan 150

Current configuration : 137 bytes
!
interface Vlan150
  ip address 20.20.20.1 255.255.255.0
  ip pim sparse-dense-mode
  ip igmp static-group 224.1.2.3 source 15.15.15.2
end

```

Example: Configuring the Device to Forward Multicast Traffic in the Absence of Directly Connected IGMP Hosts

The following example shows how to configure a device to forward multicast traffic in the absence of directly connected IGMP hosts using the **ip igmp join-group** command. With this method, the device accepts the multicast packets in addition to forwarding them. Accepting the multicast packets prevents the device from fast switching.

In this example, Fast Ethernet interface 0/0/0 on the device is configured to join the group 225.2.2.2:

```

interface FastEthernet0/0/0
  ip igmp join-group 225.2.2.2

```

The following example shows how to configure a device to forward multicast traffic in the absence of directly connected IGMP hosts using the **ip igmp static-group** command. With this method, the device does not accept the packets itself, but only forwards them. Hence, this method allows fast switching. The outgoing interface appears in the IGMP cache, but the device itself is not a member, as evidenced by lack of an “L” (local) flag in the multicast route entry.

In this example, static group membership entries for group 225.2.2.2 are configured on Fast Ethernet interface 0/1/0:

```
interface FastEthernet0/1/0
 ip igmp static-group 225.2.2.2
```

Controlling Access to an SSM Network Using IGMP Extended Access Lists

This section contains the following configuration examples for controlling access to an SSM network using IGMP extended access lists:



Note Keep in mind that access lists are very flexible: there are many combinations of permit and deny statements one could use in an access list to filter multicast traffic. The examples in this section simply provide a few examples of how it can be done.

Example: Denying All States for a Group G

The following example shows how to deny all states for a group G. In this example, Fast Ethernet interface 0/0/0 is configured to filter all sources for SSM group 232.2.2.2 in IGMPv3 reports, which effectively denies this group.

```
ip access-list extended test1
 deny igmp any host 232.2.2.2
 permit igmp any any
!
interface FastEthernet0/0/0
 ip igmp access-group test1
```

Example: Denying All States for a Source S

The following example shows how to deny all states for a source S. In this example, Gigabit Ethernet interface 1/1/0 is configured to filter all groups for source 10.2.1.32 in IGMPv3 reports, which effectively denies this source.

```
ip access-list extended test2
 deny igmp host 10.2.1.32 any
 permit igmp any any
!
interface GigabitEthernet1/1/0
 ip igmp access-group test2
```

Example: Permitting All States for a Group G

The following example shows how to permit all states for a group G. In this example, Gigabit Ethernet interface 1/2/0 is configured to accept all sources for SSM group 232.1.1.10 in IGMPv3 reports, which effectively accepts this group altogether.

```
ip access-list extended test3
 permit igmp any host 232.1.1.10
!
interface GigabitEthernet1/2/0
 ip igmp access-group test3
```

Example: Permitting All States for a Source S

The following example shows how to permit all states for a source S. In this example, Gigabit Ethernet interface 1/2 is configured to accept all groups for source 10.6.23.32 in IGMPv3 reports, which effectively accepts this source altogether.

```
ip access-list extended test4
 permit igmp host 10.6.23.32 any
!
interface GigabitEthernet1/2/0
 ip igmp access-group test4
```

Example: Filtering a Source S for a Group G

The following example shows how to filter a particular source S for a group G. In this example, Gigabit Ethernet interface 0/3/0 is configured to filter source 232.2.2.2 for SSM group 232.2.30.30 in IGMPv3 reports.

```
ip access-list extended test5
 deny igmp host 10.4.4.4 host 232.2.30.30
 permit igmp any any
!
interface GigabitEthernet0/3/0
 ip igmp access-group test5
```

Additional References

Related Documents

| Related Topic | Document Title |
|--|--|
| For complete syntax and usage information for the commands used in this chapter. | <i>IP Multicast Routing Command Reference (Catalyst 3850 Switches)</i> |
| Cisco IOS commands | Cisco IOS Master Commands List, All Releases |
| Cisco IOS IP SLAs commands | Cisco IOS IP Multicast Command Reference |

Error Message Decoder

| Description | Link |
|---|---|
| To help you research and resolve system error messages in this release, use the Error Message Decoder tool. | https://www.cisco.com/cgi-bin/Support/Errordecoder/index.cgi |

Standards and RFCs

| Standard/RFC | Title |
|--------------|---|
| RFC 1112 | Host Extensions for IP Multicasting |
| RFC 2236 | Internet Group Management Protocol, Version 2 |

| Standard/RFC | Title |
|--------------|--|
| RFC 3376 | <i>Internet Group Management Protocol, Version 3</i> |

MIBs

| MIB | MIBs Link |
|--------------------------------------|--|
| All supported MIBs for this release. | To locate and download MIBs for selected platforms, Cisco IOS releases, and feature sets, use Cisco MIB Locator found at the following URL: http://www.cisco.com/go/mibs |

Technical Assistance

| Description | Link |
|---|---|
| <p>The Cisco Support website provides extensive online resources, including documentation and tools for troubleshooting and resolving technical issues with Cisco products and technologies.</p> <p>To receive security and technical information about your products, you can subscribe to various services, such as the Product Alert Tool (accessed from Field Notices), the Cisco Technical Services Newsletter, and Really Simple Syndication (RSS) Feeds.</p> <p>Access to most tools on the Cisco Support website requires a Cisco.com user ID and password.</p> | http://www.cisco.com/support |

Feature History and Information for IGMP

| Release | Modification |
|--------------------|------------------------------|
| Cisco IOS XE 3.2SE | This feature was introduced. |



CHAPTER 5

Configuring IGMP Proxy

- [Finding Feature Information, on page 93](#)
- [Prerequisites for IGMP Proxy, on page 93](#)
- [Information about IGMP Proxy, on page 94](#)
- [How to Configure IGMP Proxy, on page 96](#)
- [Configuration Examples for IGMP Proxy, on page 100](#)
- [Additional References, on page 101](#)
- [Feature History and Information for IGMP Proxy, on page 102](#)

Finding Feature Information

Your software release may not support all the features documented in this module. For the latest caveats and feature information, see Bug Search Tool and the release notes for your platform and software release. To find information about the features documented in this module, and to see a list of the releases in which each feature is supported, see the feature information table at the end of this module.

Use Cisco Feature Navigator to find information about platform support and Cisco software image support. To access Cisco Feature Navigator, go to <http://www.cisco.com/go/cfn>. An account on Cisco.com is not required.

Prerequisites for IGMP Proxy

- All devices on the IGMP UDL have the same subnet address. If all devices on the UDL cannot have the same subnet address, the upstream device must be configured with secondary addresses to match all of the subnets to which the downstream devices are attached.
- IP multicast is enabled and the PIM interfaces are configured.



Note Use the following guidelines when configuring PIM interfaces for IGMP proxy:

- Use PIM sparse mode (PIM-SM) when the interface is operating in a sparse-mode region and you are running static RP, bootstrap (BSR), or Auto-RP with the Auto-RP listener capability.
 - Use PIM sparse-dense mode when the interface is running in a sparse-dense mode region and you are running Auto-RP without the Auto-RP listener capability.
 - Use PIM dense mode (PIM-DM) when the interface is operating in dense mode and is, thus, participating in a dense-mode region.
 - Use PIM-DM with the proxy-register capability when the interface is receiving source traffic from a dense-mode region that needs to reach receivers that are in a sparse-mode region.
-

Information about IGMP Proxy

IGMP Proxy

An IGMP proxy enables hosts in a unidirectional link routing (UDLR) environment that are not directly connected to a downstream router to join a multicast group sourced from an upstream network.

The figure below illustrates a sample topology that shows two UDLR scenarios:

- Traditional UDL routing scenario--A UDL device with directly connected receivers.
- IGMP proxy scenario--UDL device without directly connected receivers.



Note IGMP UDLs are needed on the upstream and downstream devices.



Note Although the following illustration and example uses routers in the configuration, any device (router or switch) can be used.

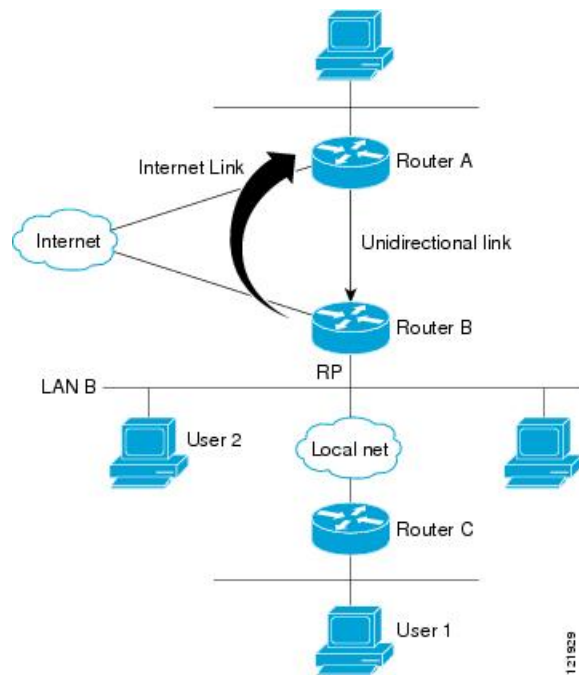

Scenario 1--Traditional UDLR Scenario (UDL Device with Directly Connected Receivers)

For scenario 1, no IGMP proxy mechanism is needed. In this scenario, the following sequence of events occurs:

1. User 2 sends an IGMP membership report requesting interest in group G.
2. Router B receives the IGMP membership report, adds a forwarding entry for group G on LAN B, and proxies the IGMP report to Router A, which is the UDLR upstream device.
3. The IGMP report is then proxied across the Internet link.
4. Router A receives the IGMP proxy and maintains a forwarding entry on the unidirectional link.

Scenario 2--IGMP Proxy Scenario (UDL Device without Directly Connected Receivers)

For scenario 2, the IGMP proxy mechanism is needed to enable hosts that are not directly connected to a downstream device to join a multicast group sourced from an upstream network. In this scenario, the following sequence of events occurs:

1. User 1 sends an IGMP membership report requesting interest in group G.
2. Router C sends a PIM Join message hop-by-hop to the RP (Router B).
3. Router B receives the PIM Join message and adds a forwarding entry for group G on LAN B.
4. Router B periodically checks its mroute table and proxies the IGMP membership report to its upstream UDL device across the Internet link.
5. Router A creates and maintains a forwarding entry on the unidirectional link (UDL).

In an enterprise network, it is desirable to be able to receive IP multicast traffic via satellite and forward the traffic throughout the network. With unidirectional link routing (UDLR) alone, scenario 2 would not be

possible because receiving hosts must be directly connected to the downstream device, Router B. The IGMP proxy mechanism overcomes this limitation by creating an IGMP report for (*, G) entries in the multicast forwarding table. To make this scenario functional, therefore, you must enable IGMP report forwarding of proxied (*, G) multicast static route (mroute) entries (using the **ip igmp mroute-proxy** command) and enable the mroute proxy service (using the **ip igmp proxy-service** command) on interfaces leading to PIM-enabled networks with potential members.



Note Because PIM messages are not forwarded upstream, each downstream network and the upstream network have a separate domain.

Related Topics

[Configuring the Upstream UDL Device for IGMP UDLR](#), on page 96

[Configuring the Downstream UDL Device for IGMP UDLR with IGMP Proxy Support](#), on page 97

[Example: IGMP Proxy Configuration](#), on page 100

How to Configure IGMP Proxy

Configuring the Upstream UDL Device for IGMP UDLR

Perform this task to configure the upstream UDL device for IGMP UDLR.

SUMMARY STEPS

1. **enable**
2. **configure terminal**
3. **interface** *type number*
4. **ip igmp unidirectional-link**
5. **end**

DETAILED STEPS

| | Command or Action | Purpose |
|---------------|--|--|
| Step 1 | enable Example: Device> enable | Enables privileged EXEC mode. <ul style="list-style-type: none"> • Enter your password if prompted. |
| Step 2 | configure terminal Example: Device# configure terminal | Enters global configuration mode. |
| Step 3 | interface <i>type number</i> Example: | Enters interface configuration mode. |

| | Command or Action | Purpose |
|---------------|---|--|
| | Device(config)# interface gigabitethernet 1/0/0 | <ul style="list-style-type: none"> For the <i>type</i> and <i>number</i> arguments, specify the interface to be used as the UDL on the upstream device. |
| Step 4 | ip igmp unidirectional-link Example: Device(config-if)# ip igmp unidirectional-link | Configures IGMP on the interface to be unidirectional for IGMP UDLR. |
| Step 5 | end Example: Device(config-if)# end | Ends the current configuration session and returns to privileged EXEC mode. |

Related Topics

[IGMP Proxy](#), on page 94

[Example: IGMP Proxy Configuration](#), on page 100

Configuring the Downstream UDL Device for IGMP UDLR with IGMP Proxy Support

Perform this task to configure the downstream UDL device for IGMP UDLR with IGMP proxy support.

SUMMARY STEPS

1. **enable**
2. **configure terminal**
3. **interface** *type number*
4. **ip igmp unidirectional-link**
5. **exit**
6. **interface** *type number*
7. **ip igmp mroute-proxy** *type number*
8. **exit**
9. **interface** *type number*
10. **ip igmp helper-address udl** *interface-type interface-number*
11. **ip igmp proxy-service**
12. **end**
13. **show ip igmp interface**
14. **show ip igmp udldr**

DETAILED STEPS

| | Command or Action | Purpose |
|---------------|-------------------|-------------------------------|
| Step 1 | enable | Enables privileged EXEC mode. |

| | Command or Action | Purpose |
|---------------|--|---|
| | Example: Device> enable | <ul style="list-style-type: none"> • Enter your password if prompted. |
| Step 2 | configure terminal Example: Device# configure terminal | Enters global configuration mode. |
| Step 3 | interface <i>type number</i> Example: Device(config)# interface gigabitethernet 0/0/0 | Enters interface configuration mode. <ul style="list-style-type: none"> • For the <i>type</i> and <i>number</i> arguments, specify the interface to be used as the UDL on the downstream device for IGMP UDRL. |
| Step 4 | ip igmp unidirectional-link Example: Device(config-if)# ip igmp unidirectional-link | Configures IGMP on the interface to be unidirectional for IGMP UDRL. |
| Step 5 | exit Example: Device(config-if)# exit | Exits interface configuration mode and returns to global configuration mode. |
| Step 6 | interface <i>type number</i> Example: Device(config)# interface gigabitethernet 1/0/0 | Enters interface configuration mode. <ul style="list-style-type: none"> • For the <i>type</i> and <i>number</i> arguments, select an interface that is facing the nondirectly connected hosts. |
| Step 7 | ip igmp mroute-proxy <i>type number</i> Example: Device(config-if)# ip igmp mroute-proxy loopback 0 | Enables IGMP report forwarding of proxied (*, G) multicast static route (mroute) entries. <ul style="list-style-type: none"> • This step is performed to enable the forwarding of IGMP reports to a proxy service interface for all (*, G) forwarding entries in the multicast forwarding table. • In this example, the ip igmp mroute-proxy command is configured on Gigabit Ethernet interface 1/0/0 to request that IGMP reports be sent to loopback interface 0 for all groups in the mroute table that are forwarded to Gigabit Ethernet interface 1/0/0. |
| Step 8 | exit Example: Device(config-if)# exit | Exits interface configuration mode and returns to global configuration mode. |

| | Command or Action | Purpose |
|---------|---|---|
| Step 9 | <p>interface <i>type number</i></p> <p>Example:</p> <pre>Device(config)# interface loopback 0</pre> | <p>Enters interface configuration mode for the specified interface.</p> <ul style="list-style-type: none"> In this example, loopback interface 0 is specified. |
| Step 10 | <p>ip igmp helper-address udl <i>interface-type interface-number</i></p> <p>Example:</p> <pre>Device(config-if)# ip igmp helper-address udl gigabitethernet 0/0/0</pre> | <p>Configures IGMP helping for UDLR.</p> <ul style="list-style-type: none"> This step allows the downstream device to helper IGMP reports received from hosts to an upstream device connected to a UDL associated with the interface specified for the <i>interface-type</i> and <i>interface-number</i> arguments. In the example topology, IGMP helping is configured over loopback interface 0 on the downstream device. Loopback interface 0, thus, is configured to helper IGMP reports from hosts to an upstream device connected to Gigabit Ethernet interface 0/0/0. |
| Step 11 | <p>ip igmp proxy-service</p> <p>Example:</p> <pre>Device(config-if)# ip igmp proxy-service</pre> | <p>Enables the mroute proxy service.</p> <ul style="list-style-type: none"> When the mroute proxy service is enabled, the device periodically checks the static mroute table for (*, G) forwarding entries that match interfaces configured with the ip igmp mroute-proxy command (see Step 7) based on the IGMP query interval. Where there is a match, one IGMP report is created and received on this interface. <p>Note The ip igmp proxy-service command is intended to be used with the ip igmp helper-address (UDL) command.</p> <ul style="list-style-type: none"> In this example, the ip igmp proxy-service command is configured on loopback interface 0 to enable the forwarding of IGMP reports out the interface for all groups on interfaces registered through the ip igmp mroute-proxy command (see Step 7). |
| Step 12 | <p>end</p> <p>Example:</p> <pre>Device(config-if)# end</pre> | <p>Ends the current configuration session and returns to privileged EXEC mode.</p> |
| Step 13 | <p>show ip igmp interface</p> <p>Example:</p> <pre>Device# show ip igmp interface</pre> | <p>(Optional) Displays multicast-related information about an interface.</p> |

| | Command or Action | Purpose |
|----------------|--|---|
| Step 14 | show ip igmp udldr Example: Device# show ip igmp udldr | (Optional) Displays UDLR information for directly connected multicast groups on interfaces that have a UDL helper address configured. |

Related Topics

[IGMP Proxy](#), on page 94

[Example: IGMP Proxy Configuration](#), on page 100

Configuration Examples for IGMP Proxy

Example: IGMP Proxy Configuration

The following example shows how to configure the upstream UDL device for IGMP UDLR and the downstream UDL device for IGMP UDLR with IGMP proxy support.

Upstream Device Configuration

```
interface gigabitethernet 0/0/0
ip address 10.1.1.1 255.255.255.0
ip pim dense-mode
!
interface gigabitethernet 1/0/0
ip address 10.2.1.1 255.255.255.0
ip pim dense-mode
ip igmp unidirectional-link
!
interface gigabitethernet 2/0/0
ip address 10.3.1.1 255.255.255.0
```

Downstream Device Configuration

```
ip pim rp-address 10.5.1.1 5
access-list 5 permit 239.0.0.0 0.255.255.255
!
interface loopback 0
ip address 10.7.1.1 255.255.255.0
ip pim dense-mode
ip igmp helper-address udl ethernet 0
ip igmp proxy-service
!
interface gigabitethernet 0/0/0
ip address 10.2.1.2 255.255.255.0
ip pim dense-mode
ip igmp unidirectional-link
!
interface gigabitethernet 1/0/0
ip address 10.5.1.1 255.255.255.0
ip pim sparse-mode
ip igmp mroute-proxy loopback 0
!
```

```
interface gigabitethernet 2/0/0
ip address 10.6.1.1 255.255.255.0
```

Related Topics

[Configuring the Upstream UDL Device for IGMP UDLR](#), on page 96

[Configuring the Downstream UDL Device for IGMP UDLR with IGMP Proxy Support](#), on page 97

[IGMP Proxy](#), on page 94

Additional References

The following sections provide references related to customizing IGMP.

Related Documents

| Related Topic | Document Title |
|--|--|
| Cisco IOS commands | Cisco IOS Master Commands List, All Releases |
| Cisco IOS IP SLAs commands | Cisco IOS IP Multicast Command Reference |
| Overview of the IP multicast technology area | “ IP Multicast Technology Overview ” module |
| Basic IP multicast concepts, configuration tasks, and examples | “ Configuring Basic IP Multicast ” or “Configuring IP Multicast in IPv6 Networks” module |

Standards and RFCs

| Standard/RFC | Title |
|--------------|--|
| RFC 1112 | <i>Host extensions for IP multicasting</i> |
| RFC 2236 | <i>Internet Group Management Protocol, Version 2</i> |
| RFC 3376 | <i>Internet Group Management Protocol, Version 3</i> |

MIBs

| MIB | MIBs Link |
|---|---|
| No new or modified MIBs are supported by these features, and support for existing MIBs has not been modified by these features. | To locate and download MIBs for selected platforms, Cisco IOS XE releases, and feature sets, use Cisco MIB Locator found at the following URL: http://www.cisco.com/go/mibs |

Technical Assistance

| Description | Link |
|---|---|
| The Cisco Support and Documentation website provides online resources to download documentation, software, and tools. Use these resources to install and configure the software and to troubleshoot and resolve technical issues with Cisco products and technologies. Access to most tools on the Cisco Support and Documentation website requires a Cisco.com user ID and password. | http://www.cisco.com/cisco/web/support/index.html |

Feature History and Information for IGMP Proxy

| Release | Modification |
|--------------------|------------------------------|
| Cisco IOS XE 3.3SE | This feature was introduced. |



CHAPTER 6

Constraining IP Multicast in Switched Ethernet

- [Finding Feature Information, on page 103](#)
- [Prerequisites for Constraining IP Multicast in a Switched Ethernet Network, on page 103](#)
- [Information About IP Multicast in a Switched Ethernet Network, on page 104](#)
- [How to Constrain Multicast in a Switched Ethernet Network, on page 105](#)
- [Configuration Examples for Constraining IP Multicast in a Switched Ethernet Network, on page 108](#)
- [Additional References, on page 109](#)
- [Feature History and Information for Constraining IP Multicast in a Switched Ethernet Network, on page 110](#)

Finding Feature Information

Your software release may not support all the features documented in this module. For the latest caveats and feature information, see Bug Search Tool and the release notes for your platform and software release. To find information about the features documented in this module, and to see a list of the releases in which each feature is supported, see the feature information table at the end of this module.

Use Cisco Feature Navigator to find information about platform support and Cisco software image support. To access Cisco Feature Navigator, go to <http://www.cisco.com/go/cfn>. An account on Cisco.com is not required.

Prerequisites for Constraining IP Multicast in a Switched Ethernet Network

Before using the tasks in this module, you should be familiar with the concepts described in the “IP Multicast Technology Overview” module.

Information About IP Multicast in a Switched Ethernet Network

IP Multicast Traffic and Layer 2 Switches

The default behavior for a Layer 2 switch is to forward all multicast traffic to every port that belongs to the destination LAN on the switch. This behavior reduces the efficiency of the switch, whose purpose is to limit traffic to the ports that need to receive the data. This behavior requires a constraining mechanism to reduce unnecessary multicast traffic, which improves switch performance.

Cisco Group Management Protocol (CGMP), Router Group Management Protocol (RGMP), and IGMP snooping efficiently constrain IP multicast in a Layer 2 switching environment.

- CGMP and IGMP snooping are used on subnets that include end users or receiver clients.
- RGMP is used on routed segments that contain only routers, such as in a collapsed backbone.
- RGMP and CGMP cannot interoperate. However, Internet Group Management Protocol (IGMP) can interoperate with CGMP and RGMP snooping.

CGMP on Catalyst Switches for IP Multicast

CGMP is a Cisco-developed protocol used on device connected to Catalyst switches to perform tasks similar to those performed by IGMP. CGMP is necessary for those Catalyst switches that do not distinguish between IP multicast data packets and IGMP report messages, both of which are addressed to the same group address at the MAC level. The switch can distinguish IGMP packets, but would need to use software on the switch, greatly impacting its performance.

You must configure CGMP on the multicast device and the Layer 2 switches. The result is that, with CGMP, IP multicast traffic is delivered only to those Catalyst switch ports that are attached to interested receivers. All other ports that have not explicitly requested the traffic will not receive it unless these ports are connected to a multicast router. Multicast router ports must receive every IP multicast data packet.

Using CGMP, when a host joins a multicast group, it multicasts an unsolicited IGMP membership report message to the target group. The IGMP report is passed through the switch to the router for normal IGMP processing. The router (which must have CGMP enabled on this interface) receives the IGMP report and processes it as it normally would, but also creates a CGMP Join message and sends it to the switch. The Join message includes the MAC address of the end station and the MAC address of the group it has joined.

The switch receives this CGMP Join message and then adds the port to its content-addressable memory (CAM) table for that multicast group. All subsequent traffic directed to this multicast group is then forwarded out the port for that host.

The Layer 2 switches are designed so that several destination MAC addresses could be assigned to a single physical port. This design allows switches to be connected in a hierarchy and also allows many multicast destination addresses to be forwarded out a single port.

The device port also is added to the entry for the multicast group. Multicast device must listen to all multicast traffic for every group because IGMP control messages are also sent as multicast traffic. The rest of the multicast traffic is forwarded using the CAM table with the new entries created by CGMP.

Related Topics

[Enabling CGMP](#), on page 106

[Example: CGMP Configuration](#), on page 108

IGMP Snooping

IGMP snooping is an IP multicast constraining mechanism that runs on a Layer 2 LAN switch. IGMP snooping requires the LAN switch to examine, or “snoop,” some Layer 3 information (IGMP Join/Leave messages) in the IGMP packets sent between the hosts and the router. When the switch receives the IGMP host report from a host for a particular multicast group, the switch adds the port number of the host to the associated multicast table entry. When the switch hears the IGMP Leave group message from a host, the switch removes the table entry of the host.

Because IGMP control messages are sent as multicast packets, they are indistinguishable from multicast data at Layer 2. A switch running IGMP snooping must examine every multicast data packet to determine if it contains any pertinent IGMP control information. IGMP snooping implemented on a low-end switch with a slow CPU could have a severe performance impact when data is sent at high rates. The solution is to implement IGMP snooping on high-end switches with special application-specific integrated circuits (ASICs) that can perform the IGMP checks in hardware. CGMP is a better option for low-end switches without special hardware.

Router-Port Group Management Protocol (RGMP)

CGMP and IGMP snooping are IP multicast constraining mechanisms designed to work on routed network segments that have active receivers. They both depend on IGMP control messages that are sent between the hosts and the routers to determine which switch ports are connected to interested receivers.

Switched Ethernet backbone network segments typically consist of several routers connected to a switch without any hosts on that segment. Because routers do not generate IGMP host reports, CGMP and IGMP snooping will not be able to constrain the multicast traffic, which will be flooded to every port on the VLAN. Routers instead generate Protocol Independent Multicast (PIM) messages to Join and Prune multicast traffic flows at a Layer 3 level.

Router-Port Group Management Protocol (RGMP) is an IP multicast constraining mechanism for router-only network segments. RGMP must be enabled on the routers and on the Layer 2 switches. A multicast router indicates that it is interested in receiving a data flow by sending an RGMP Join message for a particular group. The switch then adds the appropriate port to its forwarding table for that multicast group--similar to the way it handles a CGMP Join message. IP multicast data flows will be forwarded only to the interested router ports. When the router no longer is interested in that data flow, it sends an RGMP Leave message and the switch removes the forwarding entry.

If there are any routers that are not RGMP-enabled, they will continue to receive all multicast data.

Related Topics

[Configuring IP Multicast in a Layer 2 Switched Ethernet Network](#), on page 107

[RGMP Configuration Example](#), on page 109

How to Constrain Multicast in a Switched Ethernet Network

Configuring Switches for IP Multicast

If you have switching in your multicast network, consult the documentation for the switch you are working with for information about how to configure IP multicast.

Configuring IGMP Snooping

No configuration is required on the router. Consult the documentation for the switch you are working with to determine how to enable IGMP snooping and follow the provided instructions.

Enabling CGMP

CGMP is a protocol used on devices connected to Catalyst switches to perform tasks similar to those performed by IGMP. CGMP is necessary because the Catalyst switch cannot distinguish between IP multicast data packets and IGMP report messages, which are both at the MAC level and are addressed to the same group address.



Note

- CGMP should be enabled only on 802 or ATM media, or LAN emulation (LANE) over ATM.
- CGMP should be enabled only on devices connected to Catalyst switches.

SUMMARY STEPS

1. **enable**
2. **configure terminal**
3. **interface** *type number*
4. **ip cgmp** [**proxy** | **router-only**]
5. **end**
6. **clear ip cgmp** [*interface-type interface-number*]

DETAILED STEPS

| | Command or Action | Purpose |
|---------------|---|--|
| Step 1 | enable Example: Device> enable | Enables privileged EXEC mode. <ul style="list-style-type: none"> • Enter your password if prompted. |
| Step 2 | configure terminal Example: Device# configure terminal | Enters global configuration mode. |
| Step 3 | interface <i>type number</i> Example: Device(config)# interface ethernet 1 | Selects an interface that is connected to hosts on which IGMPv3 can be enabled. |
| Step 4 | ip cgmp [proxy router-only] Example: Device(config-if)# ip cgmp proxy | Enables CGMP on an interface of a device connected to a Cisco Catalyst 5000 family switch. <ul style="list-style-type: none"> • The proxy keyword enables the CGMP proxy function. When enabled, any device that is not CGMP-capable |

| | Command or Action | Purpose |
|---------------|---|---|
| | | will be advertised by the proxy router. The proxy router advertises the existence of other non-CGMP-capable devices by sending a CGMP Join message with the MAC address of the non-CGMP-capable device and group address of 0000.0000.0000. |
| Step 5 | end Example: Device(config-if)# end | Ends the current configuration session and returns to EXEC mode. |
| Step 6 | clear ip cgmp [<i>interface-type interface-number</i>] Example: Device# clear ip cgmp | (Optional) Clears all group entries from the caches of Catalyst switches. |

Related Topics

[CGMP on Catalyst Switches for IP Multicast](#), on page 104

[Example: CGMP Configuration](#), on page 108

Configuring IP Multicast in a Layer 2 Switched Ethernet Network

Perform this task to configure IP multicast in a Layer 2 Switched Ethernet network using RGMP.

SUMMARY STEPS

1. **enable**
2. **configure terminal**
3. **interface** *type number*
4. **ip rgmp**
5. **end**
6. **debug ip rgmp**
7. **show ip igmp interface**

DETAILED STEPS

| | Command or Action | Purpose |
|---------------|--|--|
| Step 1 | enable Example: Device> enable | Enables privileged EXEC mode. <ul style="list-style-type: none"> • Enter your password if prompted. |
| Step 2 | configure terminal Example: | Enters global configuration mode. |

| | Command or Action | Purpose |
|---------------|--|---|
| | Device# configure terminal | |
| Step 3 | interface <i>type number</i> Example: Device(config)# interface ethernet 1 | Selects an interface that is connected to hosts. |
| Step 4 | ip rgmp Example: Device(config-if)# ip rgmp | Enables RGMP on Ethernet, Fast Ethernet, and Gigabit Ethernet interfaces. |
| Step 5 | end Example: Device(config-if)# end | Ends the current configuration session and returns to EXEC mode. |
| Step 6 | debug ip rgmp Example: Device# debug ip rgmp | (Optional) Logs debug messages sent by an RGMP-enabled device. |
| Step 7 | show ip igmp interface Example: Device# show ip igmp interface | (Optional) Displays multicast-related information about an interface. |

Related Topics

[Router-Port Group Management Protocol \(RGMP\)](#), on page 105

[RGMP Configuration Example](#), on page 109

Configuration Examples for Constraining IP Multicast in a Switched Ethernet Network

Example: CGMP Configuration

The following example is for a basic network environment where multicast source(s) and multicast receivers are in the same VLAN. The desired behavior is that the switch will constrain the multicast forwarding to those ports that request the multicast stream.

A 4908G-L3 router is connected to the Catalyst 4003 on port 3/1 in VLAN 50. The following configuration is applied on the GigabitEthernet1 interface. Note that there is no **ip multicast-routing** command configured because the router is not routing multicast traffic across its interfaces.

```
interface GigabitEthernet1
ip address 192.168.50.11 255.255.255.0
ip pim dense-mode
ip cgmp
```

Related Topics

- [Enabling CGMP](#), on page 106
- [CGMP on Catalyst Switches for IP Multicast](#), on page 104

RGMP Configuration Example

The following example shows how to configure RGMP on a router:

```
ip multicast-routing
ip pim sparse-mode
interface ethernet 0
ip rgmp
```

Related Topics

- [Configuring IP Multicast in a Layer 2 Switched Ethernet Network](#), on page 107
- [Router-Port Group Management Protocol \(RGMP\)](#), on page 105

Additional References

The following sections provide references related to constraining IP multicast in a switched Ethernet network.

Related Documents

| Related Topic | Document Title |
|----------------------------|---|
| Cisco IOS commands | Cisco IOS Master Commands List, All Releases |
| Cisco IOS IP SLAs commands | Cisco IOS IP Multicast Command Reference |
| IGMP snooping | The “IGMP Snooping” module of the <i>IP Multicast: IGMP Configuration Guide</i> |
| RGMP | The “Configuring Router-Port Group Management Protocol” module of the <i>IP Multicast: IGMP Configuration Guide</i> |

MIBs

| MIB | MIBs Link |
|------|--|
| None | To locate and download MIBs for selected platforms, Cisco IOS releases, and feature sets, use Cisco MIB Locator found at the following URL: http://www.cisco.com/go/mibs |

Technical Assistance

| Description | Link |
|--|---|
| Technical Assistance Center (TAC) home page, containing 30,000 pages of searchable technical content, including links to products, technologies, solutions, technical tips, and tools. Registered Cisco.com users can log in from this page to access even more content. | http://www.cisco.com/public/support/tac/home.shtml |

Feature History and Information for Constraining IP Multicast in a Switched Ethernet Network

| Release | Modification |
|--------------------|------------------------------|
| Cisco IOS XE 3.3SE | This feature was introduced. |



CHAPTER 7

Configuring PIM

- [Finding Feature Information, on page 111](#)
- [Prerequisites for PIM, on page 111](#)
- [Restrictions for PIM, on page 112](#)
- [Information About PIM, on page 115](#)
- [How to Configure PIM, on page 130](#)
- [Verifying PIM Operations, on page 159](#)
- [Monitoring and Troubleshooting PIM, on page 167](#)
- [Configuration Examples for PIM, on page 169](#)
- [Additional References, on page 172](#)
- [Feature History and Information for PIM, on page 174](#)

Finding Feature Information

Your software release may not support all the features documented in this module. For the latest caveats and feature information, see [Bug Search Tool](#) and the release notes for your platform and software release. To find information about the features documented in this module, and to see a list of the releases in which each feature is supported, see the feature information table.

Use Cisco Feature Navigator to find information about platform support and Cisco software image support. To access Cisco Feature Navigator, go to www.cisco.com/go/cfn. An account on Cisco.com is not required.

Prerequisites for PIM

- Before you begin the PIM configuration process, decide which PIM mode to use. This is based on the applications you intend to support on your network. Use the following guidelines:
 - In general, if the application is one-to-many or many-to-many in nature, then PIM-SM can be used successfully.
 - For optimal one-to-many application performance, SSM is appropriate but requires IGMP version 3 support.
- Before you configure PIM stub routing, check that you have met these conditions:

- You must have IP multicast routing configured on both the stub router and the central router. You must also have PIM mode (dense-mode, sparse-mode, or sparse-dense-mode) configured on the uplink interface of the stub router.
- You must also configure either Enhanced Interior Gateway Routing Protocol (EIGRP) stub routing or Open Shortest Path First (OSPF) stub routing on the switch.
- The PIM stub router does not route the transit traffic between the distribution routers. Unicast (EIGRP) stub routing enforces this behavior. You must configure unicast stub routing to assist the PIM stub router behavior.



Note For information about EIGRP or OSPF configurations, see the *Catalyst 3850 Routing Configuration Guide, Release 3SE*.

Restrictions for PIM

The following are the restrictions for configuring PIM:

- PIM is not supported when running the LAN Base feature set.
- Bidirectional PIM is not supported.

PIMv1 and PIMv2 Interoperability

To avoid misconfiguring multicast routing on your switch, review the information in this section.

The Cisco PIMv2 implementation provides interoperability and transition between Version 1 and Version 2, although there might be some minor problems.

You can upgrade to PIMv2 incrementally. PIM Versions 1 and 2 can be configured on different routers and multilayer switches within one network. Internally, all routers and multilayer switches on a shared media network must run the same PIM version. Therefore, if a PIMv2 device detects a PIMv1 device, the Version 2 device downgrades itself to Version 1 until all Version 1 devices have been shut down or upgraded.

PIMv2 uses the BSR to discover and announce RP-set information for each group prefix to all the routers and multilayer switches in a PIM domain. PIMv1, together with the Auto-RP feature, can perform the same tasks as the PIMv2 BSR. However, Auto-RP is a standalone protocol, separate from PIMv1, and is a proprietary Cisco protocol. PIMv2 is a standards track protocol in the IETF.



Note We recommend that you use PIMv2. The BSR function interoperates with Auto-RP on Cisco routers and multilayer switches.

When PIMv2 devices interoperate with PIMv1 devices, Auto-RP should have already been deployed. A PIMv2 BSR that is also an Auto-RP mapping agent automatically advertises the RP elected by Auto-RP. That is, Auto-RP sets its single RP on every router or multilayer switch in the group. Not all routers and switches in the domain use the PIMv2 hash function to select multiple RPs.

Dense-mode groups in a mixed PIMv1 and PIMv2 region need no special configuration; they automatically interoperate.

Sparse-mode groups in a mixed PIMv1 and PIMv2 region are possible because the Auto-RP feature in PIMv1 interoperates with the PIMv2 RP feature. Although all PIMv2 devices can also use PIMv1, we recommend that the RPs be upgraded to PIMv2. To ease the transition to PIMv2, we recommend:

- Using Auto-RP throughout the region.
- Configuring sparse-dense mode throughout the region.

If Auto-RP is not already configured in the PIMv1 regions, configure Auto-RP.

Related Topics

[PIM Versions](#), on page 117

Restrictions for Configuring PIM Stub Routing

- The IP services image contains complete multicast routing.
- Only directly connected multicast (IGMP) receivers and sources are allowed in the Layer 2 access domains. The PIM protocol is not supported in access domains.
- In a network using PIM stub routing, the only allowable route for IP traffic to the user is through a switch that is configured with PIM stub routing.
- The redundant PIM stub router topology is not supported. Only the nonredundant access router topology is supported by the PIM stub feature.
- PIM stub routing is supported when running the IP Base and IP Services feature sets.

Related Topics

[Enabling PIM Stub Routing \(CLI\)](#), on page 130

[PIM Stub Routing](#), on page 118

Restrictions for Configuring Auto-RP and BSR

Take into consideration your network configuration, and the following restrictions when configuring Auto-RP and BSR:

Restrictions for Configuring Auto-RP

The following are restrictions for configuring Auto-RP (if used in your network configuration):

- Auto-RP is not supported when running the LAN Base feature set.
- If you configure PIM in sparse mode or sparse-dense mode and do not configure Auto-RP, you must manually configure an RP.
- If routed interfaces are configured in sparse mode, Auto-RP can still be used if all devices are configured with a manual RP address for the Auto-RP groups.
- If routed interfaces are configured in sparse mode and you enter the **ip pim autorp listener** global configuration command, Auto-RP can still be used even if all devices are not configured with a manual RP address for the Auto-RP groups.

Restrictions for Configuring BSR

The following are the restrictions for configuring BSR (if used in your network configuration):

- Configure the candidate BSRs as the RP-mapping agents for Auto-RP.
- For group prefixes advertised through Auto-RP, the PIMv2 BSR mechanism should not advertise a subrange of these group prefixes served by a different set of RPs. In a mixed PIMv1 and PIMv2 domain, have backup RPs serve the same group prefixes. This prevents the PIMv2 DRs from selecting a different RP from those PIMv1 DRs, due to the longest match lookup in the RP-mapping database.

Restrictions and Guidelines for Configuring Auto-RP and BSR

The following are restrictions for configuring Auto-RP and BSR (if used in your network configuration):

- If your network is all Cisco routers and multilayer switches, you can use either Auto-RP or BSR.
- If you have non-Cisco routers in your network, you must use BSR.
- If you have Cisco PIMv1 and PIMv2 routers and multilayer switches and non-Cisco routers, you must use both Auto-RP and BSR. If your network includes routers from other vendors, configure the Auto-RP mapping agent and the BSR on a Cisco PIMv2 device. Ensure that no PIMv1 device is located in the path a between the BSR and a non-Cisco PIMv2 device.



Note There are two approaches to using PIMv2. You can use Version 2 exclusively in your network or migrate to Version 2 by employing a mixed PIM version environment.

- Because bootstrap messages are sent hop-by-hop, a PIMv1 device prevents these messages from reaching all routers and multilayer switches in your network. Therefore, if your network has a PIMv1 device in it and only Cisco routers and multilayer switches, it is best to use Auto-RP.
- If you have a network that includes non-Cisco routers, configure the Auto-RP mapping agent and the BSR on a Cisco PIMv2 router or multilayer switch. Ensure that no PIMv1 device is on the path between the BSR and a non-Cisco PIMv2 router.
- If you have non-Cisco PIMv2 routers that need to interoperate with Cisco PIMv1 routers and multilayer switches, both Auto-RP and a BSR are required. We recommend that a Cisco PIMv2 device be both the Auto-RP mapping agent and the BSR.

Related Topics

[Setting Up Auto-RP in a New Internetwork \(CLI\)](#), on page 135

[Auto-RP](#), on page 120

[Configuring Candidate BSRs \(CLI\)](#), on page 147

[PIMv2 Bootstrap Router](#), on page 123

Restrictions for Auto-RP Enhancement

The simultaneous deployment of Auto-RP and bootstrap router (BSR) is not supported.

Related Topics

[Setting Up Auto-RP in a New Internetwork \(CLI\)](#), on page 135

[Auto-RP](#), on page 120

Information About PIM

Protocol Independent Multicast Overview

The Protocol Independent Multicast (PIM) protocol maintains the current IP multicast service mode of receiver-initiated membership. PIM is not dependent on a specific unicast routing protocol; it is IP routing protocol independent and can leverage whichever unicast routing protocols are used to populate the unicast routing table, including Enhanced Interior Gateway Routing Protocol (EIGRP), Open Shortest Path First (OSPF), Border Gateway Protocol (BGP), and static routes. PIM uses unicast routing information to perform the multicast forwarding function.

Although PIM is called a multicast routing protocol, it actually uses the unicast routing table to perform the reverse path forwarding (RPF) check function instead of building up a completely independent multicast routing table. Unlike other routing protocols, PIM does not send and receive routing updates between routers.

PIM is defined in RFC 4601, Protocol Independent Multicast - Sparse Mode (PIM-SM)

PIM can operate in dense mode or sparse mode. The router can also handle both sparse groups and dense groups at the same time (sparse-dense mode). The mode determines how the router populates its multicast routing table and how the router forwards multicast packets it receives from its directly connected LANs.

For information about PIM forwarding (interface) modes, see the following sections:

PIM Dense Mode

PIM dense mode (PIM-DM) uses a push model to flood multicast traffic to every corner of the network. This push model is a method for delivering data to the receivers without the receivers requesting the data. This method is efficient in certain deployments in which there are active receivers on every subnet in the network.

In dense mode, a router assumes that all other routers want to forward multicast packets for a group. If a router receives a multicast packet and has no directly connected members or PIM neighbors present, a prune message is sent back to the source. Subsequent multicast packets are not flooded to this router on this pruned branch. PIM builds source-based multicast distribution trees.

PIM-DM initially floods multicast traffic throughout the network. Routers that have no downstream neighbors prune back the unwanted traffic. This process repeats every 3 minutes.

Routers accumulate state information by receiving data streams through the flood and prune mechanism. These data streams contain the source and group information so that downstream routers can build up their multicast forwarding table. PIM-DM supports only source trees--that is, (S,G) entries--and cannot be used to build a shared distribution tree.



Note Dense mode is not often used and its use is not recommended. For this reason it is not specified in the configuration tasks in related modules.

PIM Sparse Mode

PIM sparse mode (PIM-SM) uses a pull model to deliver multicast traffic. Only network segments with active receivers that have explicitly requested the data will receive the traffic.

Unlike dense mode interfaces, sparse mode interfaces are added to the multicast routing table only when periodic Join messages are received from downstream routers, or when a directly connected member is on the interface. When forwarding from a LAN, sparse mode operation occurs if an RP is known for the group. If so, the packets are encapsulated and sent toward the RP. When no RP is known, the packet is flooded in a dense mode fashion. If the multicast traffic from a specific source is sufficient, the first hop router of the receiver may send Join messages toward the source to build a source-based distribution tree.

PIM-SM distributes information about active sources by forwarding data packets on the shared tree. Because PIM-SM uses shared trees (at least, initially), it requires the use of a rendezvous point (RP). The RP must be administratively configured in the network. See the [Rendezvous Points, on page 119](#) section for more information.

In sparse mode, a router assumes that other routers do not want to forward multicast packets for a group, unless there is an explicit request for the traffic. When hosts join a multicast group, the directly connected routers send PIM Join messages toward the RP. The RP keeps track of multicast groups. Hosts that send multicast packets are registered with the RP by the first hop router of that host. The RP then sends Join messages toward the source. At this point, packets are forwarded on a shared distribution tree. If the multicast traffic from a specific source is sufficient, the first hop router of the host may send Join messages toward the source to build a source-based distribution tree.

Sources register with the RP and then data is forwarded down the shared tree to the receivers. The edge routers learn about a particular source when they receive data packets on the shared tree from that source through the RP. The edge router then sends PIM (S,G) Join messages toward that source. Each router along the reverse path compares the unicast routing metric of the RP address to the metric of the source address. If the metric for the source address is better, it will forward a PIM (S,G) Join message toward the source. If the metric for the RP is the same or better, then the PIM (S,G) Join message will be sent in the same direction as the RP. In this case, the shared tree and the source tree would be considered congruent.

If the shared tree is not an optimal path between the source and the receiver, the routers dynamically create a source tree and stop traffic from flowing down the shared tree. This behavior is the default behavior in software. Network administrators can force traffic to stay on the shared tree by using the **ip pim spt-threshold infinity** command.

PIM-SM scales well to a network of any size, including those with WAN links. The explicit join mechanism prevents unwanted traffic from flooding the WAN links.

Multicast Source Discovery Protocol (MSDP)

Multicast Source Discovery Protocol (MSDP) is used for inter-domain source discovery when PIM SM is used. Each PIM administrative domain has its own RP. In order for the RP in one domain to signal new sources to the RP in the other domain, MSDP is used.

When RP in a domain receives a PIM register message for a new source, with MSDP configured it sends a new source-active (SA) message to all its MSDP peers in other domains. Each intermediate MSDP peer floods this SA message away from the originating RP. The MSDP peers install this SA message in their MSDP sa-cache. If the RPs in other domains have any join requests for the group in the SA message (indicated by the presence of a (*,G) entry with non empty outgoing interface list), the domain is interested in the group, and the RP triggers an (S,G) join toward the source.

Sparse-Dense Mode

If you configure either sparse mode or dense mode on an interface, then sparseness or denseness is applied to the interface as a whole. However, some environments might require PIM to run in a single region in sparse mode for some groups and in dense mode for other groups.

An alternative to enabling only dense mode or only sparse mode is to enable sparse-dense mode. In this case, the interface is treated as dense mode if the group is in dense mode; the interface is treated in sparse mode if the group is in sparse mode. You must have an RP if the interface is in sparse-dense mode and you want to treat the group as a sparse group.

If you configure sparse-dense mode, the idea of sparseness or denseness is applied to the groups for which the router is a member.

Another benefit of sparse-dense mode is that Auto-RP information can be distributed in a dense mode; yet, multicast groups for user groups can be used in a sparse mode manner. Therefore there is no need to configure a default RP at the leaf routers.

When an interface is treated in dense mode, it is populated in the outgoing interface list of a multicast routing table when either of the following conditions is true:

- Members or DVMRP neighbors are on the interface.
- There are PIM neighbors and the group has not been pruned.

When an interface is treated in sparse mode, it is populated in the outgoing interface list of a multicast routing table when either of the following conditions is true:

- Members or DVMRP neighbors are on the interface.
- An explicit Join message has been received by a PIM neighbor on the interface.

PIM Versions

PIMv2 includes these improvements over PIMv1:

- A single, active rendezvous point (RP) exists per multicast group, with multiple backup RPs. This single RP compares to multiple active RPs for the same group in PIMv1.
- A bootstrap router (BSR) provides a fault-tolerant, automated RP discovery and distribution function that enables routers and multilayer switches to dynamically learn the group-to-RP mappings.
- Sparse mode and dense mode are properties of a group, as opposed to an interface.



Note We strongly recommend using sparse-dense mode as opposed to either sparse mode or dense mode only.

- PIM join and prune messages have more flexible encoding for multiple address families.
- A more flexible hello packet format replaces the query packet to encode current and future capability options.
- Register messages sent to an RP specify whether they are sent by a border router or a designated router.
- PIM packets are no longer inside IGMP packets; they are standalone packets.

Related Topics

[Troubleshooting PIMv1 and PIMv2 Interoperability Problems](#), on page 168

[PIMv1 and PIMv2 Interoperability](#), on page 112

PIM Stub Routing

The PIM stub routing feature, available in all of the switch software images, reduces resource usage by moving routed traffic closer to the end user.

The PIM stub routing feature supports multicast routing between the distribution layer and the access layer. It supports two types of PIM interfaces, uplink PIM interfaces, and PIM passive interfaces. A routed interface configured with the PIM passive mode does not pass or forward PIM control traffic, it only passes and forwards IGMP traffic.

In a network using PIM stub routing, the only allowable route for IP traffic to the user is through a switch that is configured with PIM stub routing. PIM passive interfaces are connected to Layer 2 access domains, such as VLANs, or to interfaces that are connected to other Layer 2 devices. Only directly connected multicast (IGMP) receivers and sources are allowed in the Layer 2 access domains. The PIM passive interfaces do not send or process any received PIM control packets.

When using PIM stub routing, you should configure the distribution and remote routers to use IP multicast routing and configure only the switch as a PIM stub router. The switch does not route transit traffic between distribution routers. You also need to configure a routed uplink port on the switch. The switch uplink port cannot be used with SVIs. If you need PIM for an SVI uplink port, you should upgrade to the IP Services feature set.



Note You must also configure EIGRP stub routing when configuring PIM stub routing on the switch

The redundant PIM stub router topology is not supported. The redundant topology exists when there is more than one PIM router forwarding multicast traffic to a single access domain. PIM messages are blocked, and the PIM asset and designated router election mechanisms are not supported on the PIM passive interfaces. Only the nonredundant access router topology is supported by the PIM stub feature. By using a nonredundant topology, the PIM passive interface assumes that it is the only interface and designated router on that access domain.

Figure 5: PIM Stub Router Configuration

In the following figure, the Switch A routed uplink port 25 is connected to the router and PIM stub routing is enabled on the VLAN 100 interfaces and on Host 3. This configuration allows the directly connected hosts to receive traffic from multicast source 200.1.1.3.

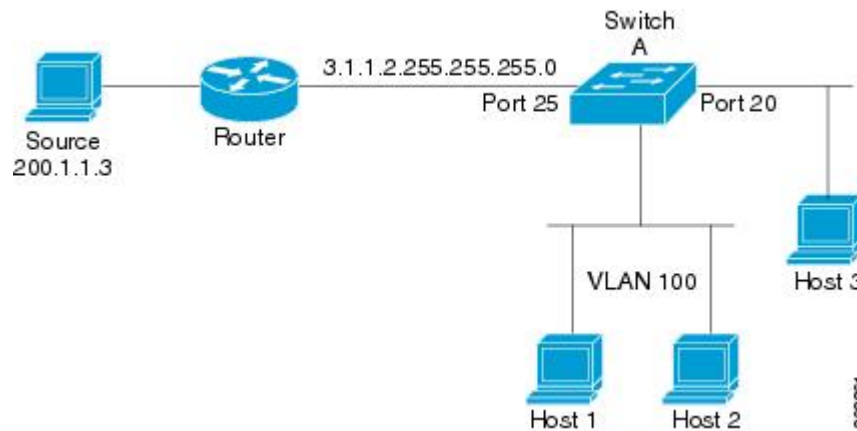

Related Topics

- [Enabling PIM Stub Routing \(CLI\), on page 130](#)
- [Example: Enabling PIM Stub Routing, on page 169](#)
- [Example: Verifying PIM Stub Routing, on page 169](#)
- [Restrictions for Configuring PIM Stub Routing, on page 113](#)

IGMP Helper

PIM stub routing moves routed traffic closer to the end user and reduces network traffic. You can also reduce traffic by configuring a stub router (switch) with the IGMP helper feature.

You can configure a stub router (switch) with the **ip igmp helper-address** *ip-address* interface configuration command to enable the switch to send reports to the next-hop interface. Hosts that are not directly connected to a downstream router can then join a multicast group sourced from an upstream network. The IGMP packets from a host wanting to join a multicast stream are forwarded upstream to the next-hop device when this feature is configured. When the upstream central router receives the helper IGMP reports or leaves, it adds or removes the interfaces from its outgoing interface list for that group.

Rendezvous Points

A rendezvous point (RP) is a role that a device performs when operating in Protocol Independent Multicast (PIM) Sparse Mode (SM). An RP is required only in networks running PIM SM. In the PIM-SM model, only network segments with active receivers that have explicitly requested multicast data will be forwarded the traffic. This method of delivering multicast data is in contrast to PIM Dense Mode (PIM DM). In PIM DM, multicast traffic is initially flooded to all segments of the network. Routers that have no downstream neighbors or directly connected receivers prune back the unwanted traffic.

An RP acts as the meeting place for sources and receivers of multicast data. In a PIM-SM network, sources must send their traffic to the RP. This traffic is then forwarded to receivers down a shared distribution tree. By default, when the first hop device of the receiver learns about the source, it will send a Join message directly to the source, creating a source-based distribution tree from the source to the receiver. This source tree does not include the RP unless the RP is located within the shortest path between the source and receiver.

In most cases, the placement of the RP in the network is not a complex decision. By default, the RP is needed only to start new sessions with sources and receivers. Consequently, the RP experiences little overhead from traffic flow or processing. In PIM version 2, the RP performs less processing than in PIM version 1 because sources must only periodically register with the RP to create state.

Related Topics

[Configuring the Candidate RPs \(CLI\)](#), on page 149

[Configuring a Rendezvous Point](#), on page 132

[Example: Configuring Candidate RPs](#), on page 172

Auto-RP

In the first version of PIM-SM, all leaf routers (routers directly connected to sources or receivers) were required to be manually configured with the IP address of the RP. This type of configuration is also known as static RP configuration. Configuring static RPs is relatively easy in a small network, but it can be laborious in a large, complex network.

Following the introduction of PIM-SM version 1, Cisco implemented a version of PIM-SM with the Auto-RP feature. Auto-RP automates the distribution of group-to-RP mappings in a PIM network. Auto-RP has the following benefits:

- Configuring the use of multiple RPs within a network to serve different groups is easy.
- Auto-RP allows load splitting among different RPs and arrangement of RPs according to the location of group participants.
- Auto-RP avoids inconsistent, manual RP configurations that can cause connectivity problems.

Multiple RPs can be used to serve different group ranges or serve as backups to each other. For Auto-RP to work, a router must be designated as an RP-mapping agent, which receives the RP-announcement messages from the RPs and arbitrates conflicts. The RP-mapping agent then sends the consistent group-to-RP mappings to all other routers. Thus, all routers automatically discover which RP to use for the groups they support.



Note If you configure PIM in sparse mode or sparse-dense mode and do not configure Auto-RP, you must statically configure an RP.



Note If router interfaces are configured in sparse mode, Auto-RP can still be used if all routers are configured with a static RP address for the Auto-RP groups.

To make Auto-RP work, a router must be designated as an RP mapping agent, which receives the RP announcement messages from the RPs and arbitrates conflicts. The RP mapping agent then sends the consistent group-to-RP mappings to all other routers by dense mode flooding. Thus, all routers automatically discover which RP to use for the groups they support. The Internet Assigned Numbers Authority (IANA) has assigned two group addresses, 224.0.1.39 and 224.0.1.40, for Auto-RP. One advantage of Auto-RP is that any change to the RP designation must be configured only on the routers that are RPs and not on the leaf routers. Another advantage of Auto-RP is that it offers the ability to scope the RP address within a domain. Scoping can be achieved by defining the time-to-live (TTL) value allowed for the Auto-RP advertisements.

Each method for configuring an RP has its own strengths, weaknesses, and level of complexity. In conventional IP multicast network scenarios, we recommend using Auto-RP to configure RPs because it is easy to configure, well-tested, and stable. The alternative ways to configure an RP are static RP, Auto-RP, and bootstrap router.

Related Topics

[Setting Up Auto-RP in a New Internetwork \(CLI\)](#), on page 135

[Example: Configuring Auto-RP](#), on page 170

[Example: Sparse Mode with Auto-RP](#), on page 170

[Restrictions for Configuring Auto-RP and BSR](#), on page 113

[Restrictions for Auto-RP Enhancement](#), on page 114

The Role of Auto-RP in a PIM Network

Auto-RP automates the distribution of group-to-rendezvous point (RP) mappings in a PIM network. To make Auto-RP work, a device must be designated as an RP mapping agent, which receives the RP announcement messages from the RPs and arbitrates conflicts. The RP mapping agent then sends the consistent group-to-RP mappings to all other devices by way of dense mode flooding.

Thus, all routers automatically discover which RP to use for the groups they support. The Internet Assigned Numbers Authority (IANA) has assigned two group addresses, 224.0.1.39 and 224.0.1.40, for Auto-RP.

The mapping agent receives announcements of intention to become the RP from Candidate-RPs. The mapping agent then announces the winner of the RP election. This announcement is made independently of the decisions by the other mapping agents.

Multicast Boundaries

Administratively-scoped boundaries can be used to limit the forwarding of multicast traffic outside of a domain or subdomain. This approach uses a special range of multicast addresses, called administratively-scoped addresses, as the boundary mechanism. If you configure an administratively-scoped boundary on a routed interface, multicast traffic whose multicast group addresses fall in this range cannot enter or exit this interface, which provides a firewall for multicast traffic in this address range.



Note Multicast boundaries and TTL thresholds control the scoping of multicast domains; however, TTL thresholds are not supported by the switch. You should use multicast boundaries instead of TTL thresholds to limit the forwarding of multicast traffic outside of a domain or a subdomain.

Figure 6: Administratively-Scoped Boundaries

The following figure shows that Company XYZ has an administratively-scoped boundary set for the multicast address range 239.0.0.0/8 on all routed interfaces at the perimeter of its network. This boundary prevents any multicast traffic in the range 239.0.0.0 through 239.255.255.255 from entering or leaving the network. Similarly, the engineering and marketing departments have an administratively-scoped boundary of 239.128.0.0/16 around the perimeter of their networks. This boundary prevents multicast traffic in the range of 239.128.0.0 through 239.128.255.255 from entering or leaving their respective networks.

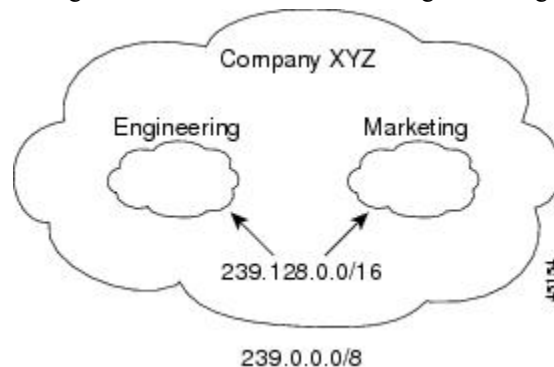

You can define an administratively-scoped boundary on a routed interface for multicast group addresses. A standard access list defines the range of addresses affected. When a boundary is defined, no multicast data packets are allowed to flow across the boundary from either direction. The boundary allows the same multicast group address to be reused in different administrative domains.

The IANA has designated the multicast address range 239.0.0.0 to 239.255.255.255 as the administratively-scoped addresses. This range of addresses can then be reused in domains administered by different organizations. The addresses would be considered local, not globally unique.

You can configure the **filter-autorp** keyword to examine and filter Auto-RP discovery and announcement messages at the administratively scoped boundary. Any Auto-RP group range announcements from the Auto-RP packets that are denied by the boundary access control list (ACL) are removed. An Auto-RP group range announcement is permitted and passed by the boundary only if all addresses in the Auto-RP group range are permitted by the boundary ACL. If any address is not permitted, the entire group range is filtered and removed from the Auto-RP message before the Auto-RP message is forwarded.

Related Topics

[Defining the IP Multicast Boundary \(CLI\)](#), on page 145

[Example: Defining the IP Multicast Boundary to Deny Auto-RP Information](#), on page 170

Sparse-Dense Mode for Auto-RP

A prerequisite of Auto-RP is that all interfaces must be configured in sparse-dense mode using the **ip pim sparse-dense-mode** interface configuration command. An interface configured in sparse-dense mode is treated in either sparse mode or dense mode of operation, depending on which mode the multicast group operates. If a multicast group has a known RP, the interface is treated in sparse mode. If a group has no known RP, by default the interface is treated in dense mode and data will be flooded over this interface. (You can prevent dense-mode fallback; see the module “Configuring Basic IP Multicast.”)

To successfully implement Auto-RP and prevent any groups other than 224.0.1.39 and 224.0.1.40 from operating in dense mode, we recommend configuring a “sink RP” (also known as “RP of last resort”). A sink RP is a statically configured RP that may or may not actually exist in the network. Configuring a sink RP does not interfere with Auto-RP operation because, by default, Auto-RP messages supersede static RP configurations. We recommend configuring a sink RP for all possible multicast groups in your network, because it is possible for an unknown or unexpected source to become active. If no RP is configured to limit source registration, the group may revert to dense mode operation and be flooded with data.

Related Topics

[Adding Auto-RP to an Existing Sparse-Mode Cloud \(CLI\)](#), on page 138

Auto-RP Benefits

Auto-RP uses IP multicast to automate the distribution of group-to-RP mappings to all Cisco routers and multilayer switches in a PIM network. Auto-RP has these benefits:

- Easy to use multiple RPs within a network to serve different group ranges.
- Provides load splitting among different RPs and arrangement of RPs according to the location of group participants.
- Avoids inconsistent, manual RP configurations on every router and multilayer switch in a PIM network, which can cause connectivity problems.

Benefits of Auto-RP in a PIM Network

- Auto-RP allows any change to the RP designation to be configured only on the devices that are RPs, not on the leaf routers.
- Auto-RP offers the ability to scope the RP address within a domain.

PIMv2 Bootstrap Router

PIMv2 Bootstrap Router (BSR) is another method to distribute group-to-RP mapping information to all PIM routers and multilayer switches in the network. It eliminates the need to manually configure RP information in every router and switch in the network. However, instead of using IP multicast to distribute group-to-RP mapping information, BSR uses hop-by-hop flooding of special BSR messages to distribute the mapping information.

The BSR is elected from a set of candidate routers and switches in the domain that have been configured to function as BSRs. The election mechanism is similar to the root-bridge election mechanism used in bridged LANs. The BSR election is based on the BSR priority of the device contained in the BSR messages that are sent hop-by-hop through the network. Each BSR device examines the message and forwards out all interfaces only the message that has either a higher BSR priority than its BSR priority or the same BSR priority, but with a higher BSR IP address. Using this method, the BSR is elected.

The elected BSR sends BSR messages with a TTL of 1. Neighboring PIMv2 routers or multilayer switches receive the BSR message and multicast it out all other interfaces (except the one on which it was received) with a TTL of 1. In this way, BSR messages travel hop-by-hop throughout the PIM domain. Because BSR messages contain the IP address of the current BSR, the flooding mechanism enables candidate RPs to automatically learn which device is the elected BSR.

Candidate RPs send candidate RP advertisements showing the group range for which they are responsible to the BSR, which stores this information in its local candidate-RP cache. The BSR periodically advertises the contents of this cache in BSR messages to all other PIM devices in the domain. These messages travel hop-by-hop through the network to all routers and switches, which store the RP information in the BSR message in their local RP cache. The routers and switches select the same RP for a given group because they all use a common RP hashing algorithm.

Related Topics

[Configuring Candidate BSRs \(CLI\)](#), on page 147

[Configuring PIMv2 BSR](#), on page 143

[Example: Configuring Candidate BSRs](#), on page 171

[Restrictions for Configuring Auto-RP and BSR](#), on page 113

PIM Domain Border

As IP multicast becomes more widespread, the chance of one PIMv2 domain bordering another PIMv2 domain increases. Because two domains probably do not share the same set of RPs, BSR, candidate RPs, and candidate BSRs, you need to constrain PIMv2 BSR messages from flowing into or out of the domain. Allowing messages to leak across the domain borders could adversely affect the normal BSR election mechanism and elect a single BSR across all bordering domains and comingle candidate RP advertisements, resulting in the election of RPs in the wrong domain.

Related Topics

[Defining the PIM Domain Border \(CLI\)](#), on page 143

Multicast Forwarding

Forwarding of multicast traffic is accomplished by multicast-capable routers. These routers create distribution trees that control the path that IP multicast traffic takes through the network in order to deliver traffic to all receivers.

Multicast traffic flows from the source to the multicast group over a distribution tree that connects all of the sources to all of the receivers in the group. This tree may be shared by all sources (a shared tree) or a separate distribution tree can be built for each source (a source tree). The shared tree may be one-way or bidirectional.

Before describing the structure of source and shared trees, it is helpful to explain the notations that are used in multicast routing tables. These notations include the following:

- (S,G) = (unicast source for the multicast group G, multicast group G)
- (*,G) = (any source for the multicast group G, multicast group G)

The notation of (S,G), pronounced “S comma G,” enumerates a shortest path tree where S is the IP address of the source and G is the multicast group address.

Shared trees are (*,G) and the source trees are (S,G) and always rooted at the sources.

Multicast Distribution Source Tree

The simplest form of a multicast distribution tree is a source tree. A source tree has its root at the source host and has branches forming a spanning tree through the network to the receivers. Because this tree uses the shortest path through the network, it is also referred to as a shortest path tree (SPT).

The figure shows an example of an SPT for group 224.1.1.1 rooted at the source, Host A, and connecting two receivers, Hosts B and C.

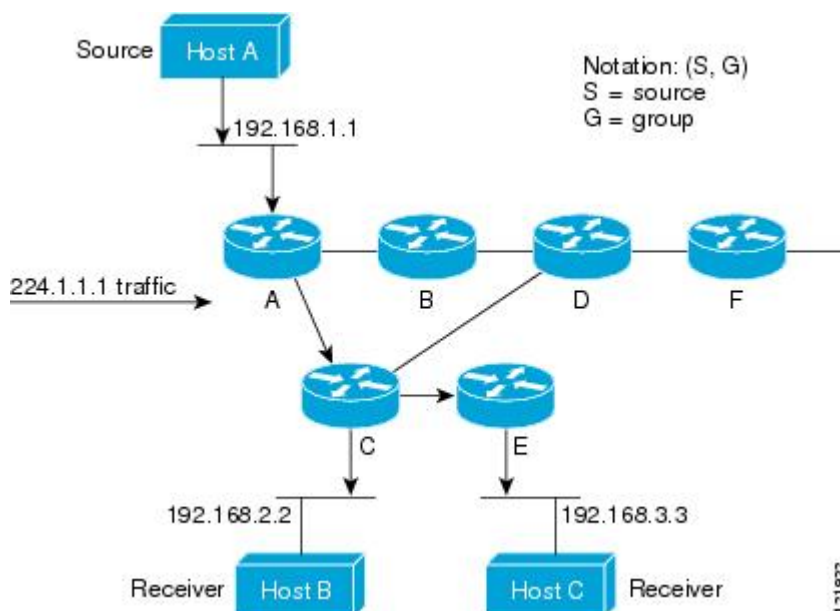

Using standard notation, the SPT for the example shown in the figure would be (192.168.1.1, 224.1.1.1).

The (S,G) notation implies that a separate SPT exists for each individual source sending to each group—which is correct.

Multicast Distribution Shared Tree

Unlike source trees that have their root at the source, shared trees use a single common root placed at some chosen point in the network. This shared root is called a rendezvous point (RP).

The following figure shows a shared tree for the group 224.2.2.2 with the root located at Router D. This shared tree is unidirectional. Source traffic is sent towards the RP on a source tree. The traffic is then forwarded down the shared tree from the RP to reach all of the receivers (unless the receiver is located between the source and the RP, in which case it will be serviced directly).

Figure 7: Shared Tree

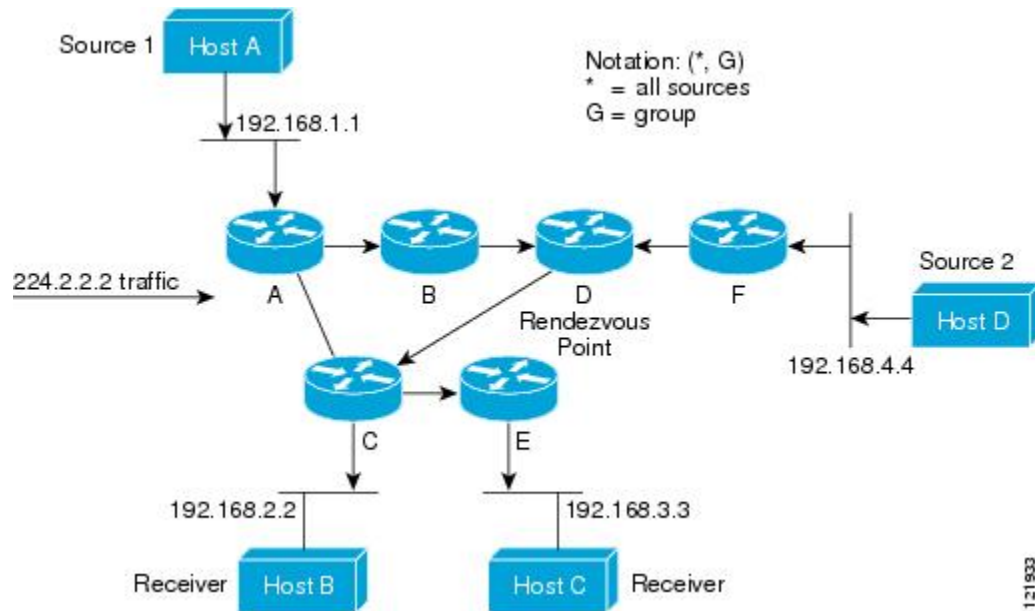

In this example, multicast traffic from the sources, Hosts A and D, travels to the root (Router D) and then down the shared tree to the two receivers, Hosts B and C. Because all sources in the multicast group use a common shared tree, a wildcard notation written as (*, G), pronounced "star comma G", represents the tree. In this case, * means all sources, and G represents the multicast group. Therefore, the shared tree shown in the figure would be written as (*, 224.2.2.2).

Both source trees and shared trees are loop-free. Messages are replicated only where the tree branches. Members of multicast groups can join or leave at any time; therefore the distribution trees must be dynamically updated. When all the active receivers on a particular branch stop requesting the traffic for a particular multicast group, the routers prune that branch from the distribution tree and stop forwarding traffic down that branch. If one receiver on that branch becomes active and requests the multicast traffic, the router will dynamically modify the distribution tree and start forwarding traffic again.

Source Tree Advantage

Source trees have the advantage of creating the optimal path between the source and the receivers. This advantage guarantees the minimum amount of network latency for forwarding multicast traffic. However, this optimization comes at a cost. The routers must maintain path information for each source. In a network that has thousands of sources and thousands of groups, this overhead can quickly become a resource issue on the routers. Memory consumption from the size of the multicast routing table is a factor that network designers must take into consideration.

Shared Tree Advantage

Shared trees have the advantage of requiring the minimum amount of state in each router. This advantage lowers the overall memory requirements for a network that only allows shared trees. The disadvantage of shared trees is that under certain circumstances the paths between the source and receivers might not be the optimal paths, which might introduce some latency in packet delivery. For example, in the figure above the shortest path between Host A (source 1) and Host B (a receiver) would be Router A and Router C. Because we are using Router D as the root for a shared tree, the traffic must traverse Routers A, B, D and then C. Network designers must carefully consider the placement of the rendezvous point (RP) when implementing a shared tree-only environment.

In unicast routing, traffic is routed through the network along a single path from the source to the destination host. A unicast router does not consider the source address; it considers only the destination address and how to forward the traffic toward that destination. The router scans through its routing table for the destination address and then forwards a single copy of the unicast packet out the correct interface in the direction of the destination.

In multicast forwarding, the source is sending traffic to an arbitrary group of hosts that are represented by a multicast group address. The multicast router must determine which direction is the upstream direction (toward the source) and which one is the downstream direction (or directions) toward the receivers. If there are multiple downstream paths, the router replicates the packet and forwards it down the appropriate downstream paths (best unicast route metric)--which is not necessarily all paths. Forwarding multicast traffic away from the source, rather than to the receiver, is called Reverse Path Forwarding (RPF). RPF is described in the following section.

PIM Shared Tree and Source Tree

By default, members of a group receive data from senders to the group across a single data-distribution tree rooted at the RP.

Figure 8: Shared Tree and Source Tree (Shortest-Path Tree)

The following figure shows this type of shared-distribution tree. Data from senders is delivered to the RP for distribution to group members joined to the shared tree.

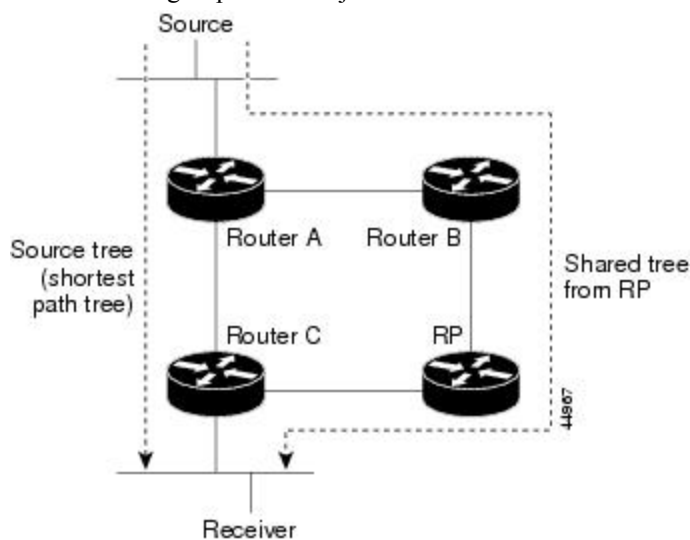

If the data rate warrants, leaf routers (routers without any downstream connections) on the shared tree can use the data distribution tree rooted at the source. This type of distribution tree is called a shortest-path tree.

or source tree. By default, the software switches to a source tree upon receiving the first data packet from a source.

This process describes the move from a shared tree to a source tree:

1. A receiver joins a group; leaf Router C sends a join message toward the RP.
2. The RP puts a link to Router C in its outgoing interface list.
3. A source sends data; Router A encapsulates the data in a register message and sends it to the RP.
4. The RP forwards the data down the shared tree to Router C and sends a join message toward the source. At this point, data might arrive twice at Router C, once encapsulated and once natively.
5. When data arrives natively (unencapsulated) at the RP, it sends a register-stop message to Router A.
6. By default, reception of the first data packet prompts Router C to send a join message toward the source.
7. When Router C receives data on (S, G), it sends a prune message for the source up the shared tree.
8. The RP deletes the link to Router C from the outgoing interface of (S, G). The RP triggers a prune message toward the source.

Join and prune messages are sent for sources and RPs. They are sent hop-by-hop and are processed by each PIM device along the path to the source or RP. Register and register-stop messages are not sent hop-by-hop. They are sent by the designated router that is directly connected to a source and are received by the RP for the group.

Multiple sources sending to groups use the shared tree. You can configure the PIM device to stay on the shared tree.

The change from shared to source tree happens when the first data packet arrives at the last-hop router. This change depends upon the threshold that is configured by using the **ip pim spt-threshold** global configuration command.

The shortest-path tree requires more memory than the shared tree but reduces delay. You may want to postpone its use. Instead of allowing the leaf router to immediately move to the shortest-path tree, you can specify that the traffic must first reach a threshold.

You can configure when a PIM leaf router should join the shortest-path tree for a specified group. If a source sends at a rate greater than or equal to the specified kbps rate, the multilayer switch triggers a PIM join message toward the source to construct a source tree (shortest-path tree). If the traffic rate from the source drops below the threshold value, the leaf router switches back to the shared tree and sends a prune message toward the source.

You can specify to which groups the shortest-path tree threshold applies by using a group list (a standard access list). If a value of 0 is specified or if the group list is not used, the threshold applies to all groups.

Related Topics

[Delaying the Use of PIM Shortest-Path Tree \(CLI\)](#), on page 155

Reverse Path Forwarding

In unicast routing, traffic is routed through the network along a single path from the source to the destination host. A unicast router does not consider the source address; it considers only the destination address and how to forward the traffic toward that destination. The router scans through its routing table for the destination network and then forwards a single copy of the unicast packet out the correct interface in the direction of the destination.

In multicast forwarding, the source is sending traffic to an arbitrary group of hosts that are represented by a multicast group address. The multicast router must determine which direction is the upstream direction (toward the source) and which one is the downstream direction (or directions) toward the receivers. If there are multiple downstream paths, the router replicates the packet and forwards it down the appropriate downstream paths (best unicast route metric)--which is not necessarily all paths. Forwarding multicast traffic away from the source, rather than to the receiver, is called Reverse Path Forwarding (RPF). RPF is an algorithm used for forwarding multicast datagrams.

Protocol Independent Multicast (PIM) uses the unicast routing information to create a distribution tree along the reverse path from the receivers towards the source. The multicast routers then forward packets along the distribution tree from the source to the receivers. RPF is a key concept in multicast forwarding. It enables routers to correctly forward multicast traffic down the distribution tree. RPF makes use of the existing unicast routing table to determine the upstream and downstream neighbors. A router will forward a multicast packet only if it is received on the upstream interface. This RPF check helps to guarantee that the distribution tree will be loop-free.

RPF Check

When a multicast packet arrives at a router, the router performs an RPF check on the packet. If the RPF check succeeds, the packet is forwarded. Otherwise, it is dropped.

For traffic flowing down a source tree, the RPF check procedure works as follows:

1. The router looks up the source address in the unicast routing table to determine if the packet has arrived on the interface that is on the reverse path back to the source.
2. If the packet has arrived on the interface leading back to the source, the RPF check succeeds and the packet is forwarded out the interfaces present in the outgoing interface list of a multicast routing table entry.
3. If the RPF check in Step 2 fails, the packet is dropped.

The figure shows an example of an unsuccessful RPF check.

Figure 9: RPF Check Fails

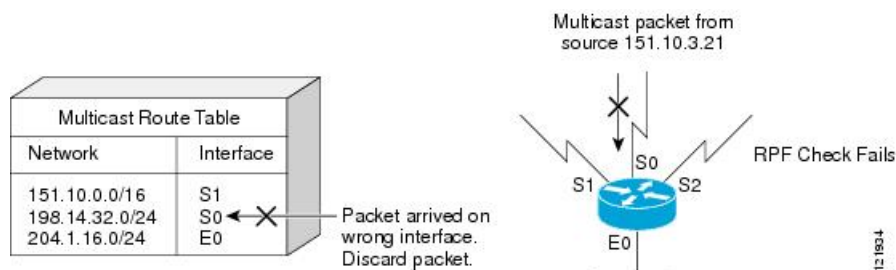

As the figure illustrates, a multicast packet from source 151.10.3.21 is received on serial interface 0 (S0). A check of the unicast route table shows that S1 is the interface this router would use to forward unicast data to 151.10.3.21. Because the packet has arrived on interface S0, the packet is discarded.

The figure shows an example of a successful RPF check.

Figure 10: RPF Check Succeeds

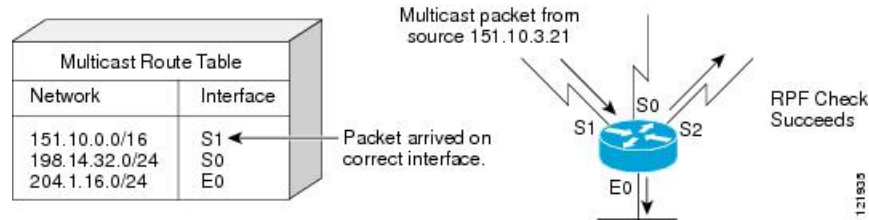

In this example, the multicast packet has arrived on interface S1. The router refers to the unicast routing table and finds that S1 is the correct interface. The RPF check passes, and the packet is forwarded.

PIM uses both source trees and RP-rooted shared trees to forward datagrams. The RPF check is performed differently for each:

- If a PIM router or multilayer switch has a source-tree state (that is, an (S, G) entry is present in the multicast routing table), it performs the RPF check against the IP address of the source of the multicast packet.
- If a PIM router or multilayer switch has a shared-tree state (and no explicit source-tree state), it performs the RPF check on the RP address (which is known when members join the group).

DVMRP and dense-mode PIM use only source trees and use RPF.



Note DVMRP is not supported on the switch.

Sparse-mode PIM uses the RPF lookup function to decide where it needs to send joins and prunes:

- (S, G) joins (which are source-tree states) are sent toward the source.
- (*,G) joins (which are shared-tree states) are sent toward the RP.

Default PIM Routing Configuration

This table displays the default PIM routing configuration for the switch.

Table 15: Default Multicast Routing Configuration

| Feature | Default Setting |
|-------------------|-----------------------------|
| Multicast routing | Disabled on all interfaces. |
| PIM version | Version 2. |
| PIM mode | No mode is defined. |
| PIM stub routing | None configured. |
| PIM RP address | None configured. |
| PIM domain border | Disabled. |

| Feature | Default Setting |
|-----------------------------------|-----------------|
| PIM multicast boundary | None. |
| Candidate BSRs | Disabled. |
| Candidate RPs | Disabled. |
| Shortest-path tree threshold rate | 0 kb/s. |
| PIM router query message interval | 30 seconds. |

How to Configure PIM

Enabling PIM Stub Routing (CLI)

This procedure is optional.

SUMMARY STEPS

1. `enable`
2. `configure terminal`
3. `interface interface-id`
4. `ip pim passive`
5. `end`
6. `show ip pim interface`
7. `show ip igmp groups detail`
8. `show ip mroute`
9. `show running-config`
10. `copy running-config startup-config`

DETAILED STEPS

| | Command or Action | Purpose |
|--------|---|--|
| Step 1 | <p><code>enable</code></p> <p>Example:</p> <pre>Switch> enable</pre> | Enables privileged EXEC mode. Enter your password if prompted. |
| Step 2 | <p><code>configure terminal</code></p> <p>Example:</p> <pre>Switch# configure terminal</pre> | Enters the global configuration mode. |

| | Command or Action | Purpose |
|--------|---|--|
| Step 3 | <p>interface <i>interface-id</i></p> <p>Example:</p> <pre>Switch(config)# interface gigabitethernet 1/0/1</pre> | <p>Specifies the interface on which you want to enable PIM stub routing, and enters interface configuration mode.</p> <p>The specified interface must be one of the following:</p> <ul style="list-style-type: none"> • A routed port—A physical port that has been configured as a Layer 3 port by entering the no switchport interface configuration command. You will also need to enable IP PIM sparse-dense-mode on the interface, and join the interface as a statically connected member to an IGMP static group. For a configuration example, see Example: Interface Configuration as a Routed Port, on page 88 • An SVI—A VLAN interface created by using the interface vlan <i>vlan-id</i> global configuration command. You will also need to enable IP PIM sparse-dense-mode on the VLAN, join the VLAN as a statically connected member to an IGMP static group, and then enable IGMP snooping on the VLAN, the IGMP static group, and physical interface. For a configuration example, see Example: Interface Configuration as an SVI, on page 89 <p>These interfaces must have IP addresses assigned to them.</p> |
| Step 4 | <p>ip pim passive</p> <p>Example:</p> <pre>Switch(config-if)# ip pim passive</pre> | Configures the PIM stub feature on the interface. |
| Step 5 | <p>end</p> <p>Example:</p> <pre>Switch(config)# end</pre> | Returns to privileged EXEC mode. |
| Step 6 | <p>show ip pim interface</p> <p>Example:</p> <pre>Switch# show ip pim interface</pre> | (Optional) Displays the PIM stub that is enabled on each interface. |
| Step 7 | <p>show ip igmp groups detail</p> <p>Example:</p> <pre>Switch# show ip igmp groups detail</pre> | (Optional) Displays the interested clients that have joined the specific multicast source group. |

| | Command or Action | Purpose |
|----------------|---|--|
| Step 8 | show ip mroute Example: Switch# <code>show ip mroute</code> | (Optional) Displays the IP multicast routing table. |
| Step 9 | show running-config Example: Switch# <code>show running-config</code> | Verifies your entries. |
| Step 10 | copy running-config startup-config Example: Switch# <code>copy running-config startup-config</code> | (Optional) Saves your entries in the configuration file. |

Related Topics

- [PIM Stub Routing](#), on page 118
- [Example: Enabling PIM Stub Routing](#), on page 169
- [Example: Verifying PIM Stub Routing](#), on page 169
- [Restrictions for Configuring PIM Stub Routing](#), on page 113

Configuring a Rendezvous Point

You must have a rendezvous point (RP), if the interface is in sparse-dense mode and if you want to handle the group as a sparse group. You can use these methods:

- By manually assigning an RP to multicast groups.
- As a standalone, Cisco-proprietary protocol separate from PIMv1, which includes:
 - Setting up Auto-RP in a new internetwork
 - Adding Auto-RP to an existing sparse-mode cloud
 - Preventing join messages to false RPs
 - Filtering incoming RP announcement messages
- By using a standards track protocol in the Internet Engineering Task Force (IETF), which includes configuring PIMv2 BSR .



Note You can use Auto-RP, BSR, or a combination of both, depending on the PIM version that you are running and the types of routers in your network. For information about working with different PIM versions in your network, see [PIMv1 and PIMv2 Interoperability](#), on page 112.

Related Topics

[Configuring the Candidate RPs \(CLI\)](#), on page 149

[Rendezvous Points](#), on page 119

Manually Assigning an RP to Multicast Groups (CLI)

If the rendezvous point (RP) for a group is learned through a dynamic mechanism (such as Auto-RP or BSR), you need not perform this task for that RP.

Senders of multicast traffic announce their existence through register messages received from the source first-hop router (designated router) and forwarded to the RP. Receivers of multicast packets use RPs to join a multicast group by using explicit join messages.



Note RPs are not members of the multicast group; they serve as a *meeting place* for multicast sources and group members.

You can configure a single RP for multiple groups defined by an access list. If there is no RP configured for a group, the multilayer switch responds to the group as dense and uses the dense-mode PIM techniques.

This procedure is optional.

SUMMARY STEPS

1. **enable**
2. **configure terminal**
3. **ip pim rp-address** *ip-address* [*access-list-number*] [**override**]
4. **access-list** *access-list-number* {**deny** | **permit**} *source* [*source-wildcard*]
5. **end**
6. **show running-config**
7. **copy running-config startup-config**

DETAILED STEPS

| | Command or Action | Purpose |
|---------------|---|--|
| Step 1 | enable Example: Switch> enable | Enables privileged EXEC mode. Enter your password if prompted. |
| Step 2 | configure terminal Example: Switch# configure terminal | Enters the global configuration mode. |
| Step 3 | ip pim rp-address <i>ip-address</i> [<i>access-list-number</i>] [override] | Configures the address of a PIM RP. |

| | Command or Action | Purpose |
|----------------------|---|--|
| | <p>Example:</p> <pre>Switch(config)# ip pim rp-address 10.1.1.1 20 override</pre> | <p>By default, no PIM RP address is configured. You must configure the IP address of RPs on all routers and multilayer switches (including the RP).</p> <p>Note If there is no RP configured for a group, the switch treats the group as dense, using the dense-mode PIM techniques.</p> <p>A PIM device can be an RP for more than one group. Only one RP address can be used at a time within a PIM domain. The access list conditions specify for which groups the device is an RP.</p> <ul style="list-style-type: none"> • For <i>ip-address</i>, enter the unicast address of the RP in dotted-decimal notation. • (Optional) For <i>access-list-number</i>, enter an IP standard access list number from 1 to 99. If no access list is configured, the RP is used for all groups. • (Optional) The override keyword indicates that if there is a conflict between the RP configured with this command and one learned by Auto-RP or BSR, the RP configured with this command prevails. |
| <p>Step 4</p> | <p>access-list <i>access-list-number</i> {deny permit} <i>source</i> [<i>source-wildcard</i>]</p> <p>Example:</p> <pre>Switch(config)# access-list 25 permit 10.5.0.1 255.224.0.0</pre> | <p>Creates a standard access list, repeating the command as many times as necessary.</p> <ul style="list-style-type: none"> • For <i>access-list-number</i>, enter the access list number specified in Step 2. • The deny keyword denies access if the conditions are matched. • The permit keyword permits access if the conditions are matched. • For <i>source</i>, enter the multicast group address for which the RP should be used. • (Optional) For <i>source-wildcard</i>, enter the wildcard bits in dotted decimal notation to be applied to the source. Place ones in the bit positions that you want to ignore. <p>The access list is always terminated by an implicit deny statement for everything.</p> |
| <p>Step 5</p> | <p>end</p> <p>Example:</p> <pre>Switch(config)# end</pre> | <p>Returns to privileged EXEC mode.</p> |

| | Command or Action | Purpose |
|--------|---|--|
| Step 6 | show running-config Example: <pre>Switch# show running-config</pre> | Verifies your entries. |
| Step 7 | copy running-config startup-config Example: <pre>Switch# copy running-config startup-config</pre> | (Optional) Saves your entries in the configuration file. |

Related Topics

[Example: Manually Assigning an RP to Multicast Groups](#), on page 170

Setting Up Auto-RP in a New Internetwork (CLI)

If you are setting up Auto-RP in a new internetwork, you do not need a default RP because you configure all the interfaces for sparse-dense mode.



Note Omit Step 3 in the following procedure, if you want to configure a PIM router as the RP for the local group.

SUMMARY STEPS

1. **enable**
2. **show running-config**
3. **configure terminal**
4. **ip pim send-rp-announce** *interface-id* **scope** *t1* **group-list** *access-list-number* **interval** *seconds*
5. **access-list** *access-list-number* {**deny** | **permit**} *source* [*source-wildcard*]
6. **ip pim send-rp-discovery** **scope** *t1*
7. **end**
8. **show running-config**
9. **show ip pim rp mapping**
10. **show ip pim rp**
11. **copy running-config startup-config**

DETAILED STEPS

| | Command or Action | Purpose |
|--------|--|--|
| Step 1 | enable Example: <pre>Switch> enable</pre> | Enables privileged EXEC mode. Enter your password if prompted. |

| | Command or Action | Purpose |
|---------------|--|--|
| Step 2 | <p>show running-config</p> <p>Example:</p> <pre>Switch# show running-config</pre> | <p>Verifies that a default RP is already configured on all PIM devices and the RP in the sparse-mode network. It was previously configured with the ip pim rp-address global configuration command.</p> <p>Note This step is not required for sparse-dense-mode environments.</p> <p>The selected RP should have good connectivity and be available across the network. Use this RP for the global groups (for example, 224.x.x.x and other global groups). Do not reconfigure the group address range that this RP serves. RPs dynamically discovered through Auto-RP take precedence over statically configured RPs. Assume that it is desirable to use a second RP for the local groups.</p> |
| Step 3 | <p>configure terminal</p> <p>Example:</p> <pre>Switch# configure terminal</pre> | <p>Enters the global configuration mode.</p> |
| Step 4 | <p>ip pim send-rp-announce <i>interface-id</i> scope <i>ttl</i> group-list <i>access-list-number</i> interval <i>seconds</i></p> <p>Example:</p> <pre>Switch(config)# ip pim send-rp-announce gigabitethernet 1/0/5 scope 20 group-list 10 interval 120</pre> | <p>Configures another PIM device to be the candidate RP for local groups.</p> <ul style="list-style-type: none"> For <i>interface-id</i>, enter the interface type and number that identifies the RP address. Valid interfaces include physical ports, port channels, and VLANs. For scope <i>ttl</i>, specify the time-to-live value in hops. Enter a hop count that is high enough so that the RP-announce messages reach all mapping agents in the network. There is no default setting. The range is 1 to 255. For group-list <i>access-list-number</i>, enter an IP standard access list number from 1 to 99. If no access list is configured, the RP is used for all groups. For interval <i>seconds</i>, specify how often the announcement messages must be sent. The default is 60 seconds. The range is 1 to 16383. |
| Step 5 | <p>access-list <i>access-list-number</i> {deny permit} <i>source</i> [<i>source-wildcard</i>]</p> <p>Example:</p> <pre>Switch(config)# access-list 10 permit 10.10.0.0</pre> | <p>Creates a standard access list, repeating the command as many times as necessary.</p> <ul style="list-style-type: none"> For <i>access-list-number</i>, enter the access list number specified in Step 3. The deny keyword denies access if the conditions are matched. |

| | Command or Action | Purpose |
|----------------|--|---|
| | | <ul style="list-style-type: none"> The permit keyword permits access if the conditions are matched. For <i>source</i>, enter the multicast group address range for which the RP should be used. (Optional) For <i>source-wildcard</i>, enter the wildcard bits in dotted decimal notation to be applied to the source. Place ones in the bit positions that you want to ignore. <p>Note Recall that the access list is always terminated by an implicit deny statement for everything.</p> |
| Step 6 | <p>ip pim send-rp-discovery scope ttl</p> <p>Example:</p> <pre>Switch(config)# ip pim send-rp-discovery scope 50</pre> | <p>Finds a switch whose connectivity is not likely to be interrupted, and assign it the role of RP-mapping agent.</p> <p>For scope ttl, specify the time-to-live value in hops to limit the RP discovery packets. All devices within the hop count from the source device receive the Auto-RP discovery messages. These messages tell other devices which group-to-RP mapping to use to avoid conflicts (such as overlapping group-to-RP ranges). There is no default setting. The range is 1 to 255.</p> |
| Step 7 | <p>end</p> <p>Example:</p> <pre>Switch(config)# end</pre> | Returns to privileged EXEC mode. |
| Step 8 | <p>show running-config</p> <p>Example:</p> <pre>Switch# show running-config</pre> | Verifies your entries. |
| Step 9 | <p>show ip pim rp mapping</p> <p>Example:</p> <pre>Switch# show ip pim rp mapping</pre> | Displays active RPs that are cached with associated multicast routing entries. |
| Step 10 | <p>show ip pim rp</p> <p>Example:</p> <pre>Switch# show ip pim rp</pre> | Displays the information cached in the routing table. |
| Step 11 | <p>copy running-config startup-config</p> <p>Example:</p> | (Optional) Saves your entries in the configuration file. |

| | Command or Action | Purpose |
|--|---|---------|
| | Switch# <code>copy running-config startup-config</code> | |

Related Topics

[Auto-RP](#), on page 120

[Example: Configuring Auto-RP](#), on page 170

[Example: Sparse Mode with Auto-RP](#), on page 170

[Restrictions for Configuring Auto-RP and BSR](#), on page 113

[Restrictions for Auto-RP Enhancement](#), on page 114

Adding Auto-RP to an Existing Sparse-Mode Cloud (CLI)

This section contains suggestions for the initial deployment of Auto-RP into an existing sparse-mode cloud to minimize disruption of the existing multicast infrastructure.

This procedure is optional.

SUMMARY STEPS

1. `enable`
2. `show running-config`
3. `configure terminal`
4. `ip pim send-rp-announce interface-id scope ttl group-list access-list-number interval seconds`
5. `access-list access-list-number {deny | permit} source [source-wildcard]`
6. `ip pim send-rp-discovery scope ttl`
7. `end`
8. `show running-config`
9. `show ip pim rp mapping`
10. `show ip pim rp`
11. `copy running-config startup-config`

DETAILED STEPS

| | Command or Action | Purpose |
|---------------|---|--|
| Step 1 | <code>enable</code> Example: Switch> <code>enable</code> | Enables privileged EXEC mode. Enter your password if prompted. |
| Step 2 | <code>show running-config</code> Example: Switch# <code>show running-config</code> | Verifies that a default RP is already configured on all PIM devices and the RP in the sparse-mode network. It was previously configured with the <code>ip pim rp-address</code> global configuration command. Note This step is not required for sparse-dense-mode environments. |

| | Command or Action | Purpose |
|---------------|---|--|
| | | The selected RP should have good connectivity and be available across the network. Use this RP for the global groups (for example, 224.x.x.x and other global groups). Do not reconfigure the group address range that this RP serves. RPs dynamically discovered through Auto-RP take precedence over statically configured RPs. Assume that it is desirable to use a second RP for the local groups. |
| Step 3 | <p>configure terminal</p> <p>Example:</p> <pre>Switch# configure terminal</pre> | Enters the global configuration mode. |
| Step 4 | <p>ip pim send-rp-announce <i>interface-id</i> scope <i>tvl</i> group-list <i>access-list-number</i> interval <i>seconds</i></p> <p>Example:</p> <pre>Switch(config)# ip pim send-rp-announce gigabitethernet 1/0/5 scope 20 group-list 10 interval 120</pre> | <p>Configures another PIM device to be the candidate RP for local groups.</p> <ul style="list-style-type: none"> • For <i>interface-id</i>, enter the interface type and number that identifies the RP address. Valid interfaces include physical ports, port channels, and VLANs. • For scope <i>tvl</i>, specify the time-to-live value in hops. Enter a hop count that is high enough so that the RP-announce messages reach all mapping agents in the network. There is no default setting. The range is 1 to 255. • For group-list <i>access-list-number</i>, enter an IP standard access list number from 1 to 99. If no access list is configured, the RP is used for all groups. • For interval <i>seconds</i>, specify how often the announcement messages must be sent. The default is 60 seconds. The range is 1 to 16383. |
| Step 5 | <p>access-list <i>access-list-number</i> {deny permit} <i>source</i> [<i>source-wildcard</i>]</p> <p>Example:</p> <pre>Switch(config)# access-list 10 permit 224.0.0.0 15.255.255.255</pre> | <p>Creates a standard access list, repeating the command as many times as necessary.</p> <ul style="list-style-type: none"> • For <i>access-list-number</i>, enter the access list number specified in Step 3. • The deny keyword denies access if the conditions are matched. • The permit keyword permits access if the conditions are matched. • For <i>source</i>, enter the multicast group address range for which the RP should be used. • (Optional) For <i>source-wildcard</i>, enter the wildcard bits in dotted decimal notation to be applied to the |

| | Command or Action | Purpose |
|----------------|--|---|
| | | <p>source. Place ones in the bit positions that you want to ignore.</p> <p>Recall that the access list is always terminated by an implicit deny statement for everything.</p> |
| Step 6 | <p>ip pim send-rp-discovery scope ttl</p> <p>Example:</p> <pre>Switch(config)# ip pim send-rp-discovery scope 50</pre> | <p>Finds a switch whose connectivity is not likely to be interrupted, and assigns it the role of RP-mapping agent.</p> <p>For scope ttl, specify the time-to-live value in hops to limit the RP discovery packets. All devices within the hop count from the source device receive the Auto-RP discovery messages. These messages tell other devices which group-to-RP mapping to use to avoid conflicts (such as overlapping group-to-RP ranges). There is no default setting. The range is 1 to 255.</p> <p>Note To remove the switch as the RP-mapping agent, use the no ip pim send-rp-discovery global configuration command.</p> |
| Step 7 | <p>end</p> <p>Example:</p> <pre>Switch(config)# end</pre> | Returns to privileged EXEC mode. |
| Step 8 | <p>show running-config</p> <p>Example:</p> <pre>Switch# show running-config</pre> | Verifies your entries. |
| Step 9 | <p>show ip pim rp mapping</p> <p>Example:</p> <pre>Switch# show ip pim rp mapping</pre> | Displays active RPs that are cached with associated multicast routing entries. |
| Step 10 | <p>show ip pim rp</p> <p>Example:</p> <pre>Switch# show ip pim rp</pre> | Displays the information cached in the routing table. |
| Step 11 | <p>copy running-config startup-config</p> <p>Example:</p> <pre>Switch# copy running-config startup-config</pre> | (Optional) Saves your entries in the configuration file. |

Related Topics

[Sparse-Dense Mode for Auto-RP](#), on page 122

Preventing Join Messages to False RPs (CLI)

Determine whether the **ip pim accept-rp** command was previously configured throughout the network by using the **show running-config** privileged EXEC command. If the **ip pim accept-rp** command is not configured on any device, this problem can be addressed later. In those routers or multilayer switches already configured with the **ip pim accept-rp** command, you must enter the command again to accept the newly advertised RP.

To accept all RPs advertised with Auto-RP and reject all other RPs by default, use the **ip pim accept-rp auto-rp** global configuration command.

This procedure is optional.

Related Topics

[Example: Preventing Join Messages to False RPs](#), on page 171

Filtering Incoming RP Announcement Messages (CLI)

You can add configuration commands to the mapping agents to prevent a maliciously configured router from masquerading as a candidate RP and causing problems.

This procedure is optional.

SUMMARY STEPS

1. **enable**
2. **configure terminal**
3. **ip pim rp-announce-filter rp-list *access-list-number* group-list *access-list-number***
4. **access-list *access-list-number* {deny | permit} source [*source-wildcard*]**
5. **end**
6. **show running-config**
7. **copy running-config startup-config**

DETAILED STEPS

| | Command or Action | Purpose |
|--------|---|--|
| Step 1 | enable Example: Switch> enable | Enables privileged EXEC mode. Enter your password if prompted. |
| Step 2 | configure terminal Example: Switch# configure terminal | Enters the global configuration mode. |
| Step 3 | ip pim rp-announce-filter rp-list <i>access-list-number</i> group-list <i>access-list-number</i> | Filters incoming RP announcement messages. |

| | Command or Action | Purpose |
|---------------|---|--|
| | <p>Example:</p> <pre>Switch(config)# ip pim rp-announce-filter rp-list 10 group-list 14</pre> | <p>Enter this command on each mapping agent in the network. Without this command, all incoming RP-announce messages are accepted by default.</p> <p>For rp-list <i>access-list-number</i>, configure an access list of candidate RP addresses that, if permitted, is accepted for the group ranges supplied in the group-list <i>access-list-number</i> variable. If this variable is omitted, the filter applies to all multicast groups.</p> <p>If more than one mapping agent is used, the filters must be consistent across all mapping agents to ensure that no conflicts occur in the group-to-RP mapping information.</p> |
| Step 4 | <p>access-list <i>access-list-number</i> {deny permit} <i>source</i> [<i>source-wildcard</i>]</p> <p>Example:</p> <pre>Switch(config)# access-list 10 permit 10.8.1.0 255.255.224.0</pre> | <p>Creates a standard access list, repeating the command as many times as necessary.</p> <ul style="list-style-type: none"> • For <i>access-list-number</i>, enter the access list number specified in Step 2. • The deny keyword denies access if the conditions are matched. • The permit keyword permits access if the conditions are matched. • Create an access list that specifies from which routers and multilayer switches the mapping agent accepts candidate RP announcements (rp-list ACL). • Create an access list that specifies the range of multicast groups from which to accept or deny (group-list ACL). • For <i>source</i>, enter the multicast group address range for which the RP should be used. • (Optional) For <i>source-wildcard</i>, enter the wildcard bits in dotted decimal notation to be applied to the source. Place ones in the bit positions that you want to ignore. <p>The access list is always terminated by an implicit deny statement for everything.</p> |
| Step 5 | <p>end</p> <p>Example:</p> <pre>Switch(config)# end</pre> | <p>Returns to privileged EXEC mode.</p> |
| Step 6 | <p>show running-config</p> <p>Example:</p> | <p>Verifies your entries.</p> |

| | Command or Action | Purpose |
|---------------|---|--|
| | Switch# <code>show running-config</code> | |
| Step 7 | copy running-config startup-config Example: Switch# <code>copy running-config startup-config</code> | (Optional) Saves your entries in the configuration file. |

Related Topics

[Example: Filtering Incoming RP Announcement Messages](#), on page 171

Configuring PIMv2 BSR

The process for configuring PIMv2 BSR may involve the following optional tasks:

- Defining the PIM domain border
- Defining the IP multicast boundary
- Configuring candidate BSRs
- Configuring candidate RPs

Related Topics

[Configuring Candidate BSRs \(CLI\)](#), on page 147

[PIMv2 Bootstrap Router](#), on page 123

Defining the PIM Domain Border (CLI)

Perform the following steps to configure the PIM domain border. This procedure is optional.

SUMMARY STEPS

1. `enable`
2. `configure terminal`
3. `interface interface-id`
4. `ip pim bsr-border`
5. `end`
6. `show running-config`
7. `copy running-config startup-config`

DETAILED STEPS

| | Command or Action | Purpose |
|---------------|--|--|
| Step 1 | <code>enable</code> Example: | Enables privileged EXEC mode. Enter your password if prompted. |

| | Command or Action | Purpose |
|---------------|--|--|
| | Switch> enable | |
| Step 2 | configure terminal Example: Switch# configure terminal | Enters the global configuration mode. |
| Step 3 | interface <i>interface-id</i> Example: Switch(config) # interface gigabitethernet 1/0/1 | <p>Specifies the interface to be configured, and enters interface configuration mode.</p> <p>The specified interface must be one of the following:</p> <ul style="list-style-type: none"> • A routed port—A physical port that has been configured as a Layer 3 port by entering the no switchport interface configuration command. You will also need to enable IP PIM sparse-dense-mode on the interface, and join the interface as a statically connected member to an IGMP static group. For a configuration example, see Example: Interface Configuration as a Routed Port, on page 88 • An SVI—A VLAN interface created by using the interface vlan <i>vlan-id</i> global configuration command. You will also need to enable IP PIM sparse-dense-mode on the VLAN, join the VLAN as a statically connected member to an IGMP static group, and then enable IGMP snooping on the VLAN, the IGMP static group, and physical interface. For a configuration example, see Example: Interface Configuration as an SVI, on page 89 <p>These interfaces must have IP addresses assigned to them.</p> |
| Step 4 | ip pim bsr-border Example: Switch(config-if) # ip pim bsr-border | <p>Defines a PIM bootstrap message boundary for the PIM domain.</p> <p>Enter this command on each interface that connects to other bordering PIM domains. This command instructs the switch to neither send nor receive PIMv2 BSR messages on this interface.</p> <p>Note To remove the PIM border, use the no ip pim bsr-border interface configuration command.</p> |
| Step 5 | end Example: Switch(config) # end | Returns to privileged EXEC mode. |

| | Command or Action | Purpose |
|--------|---|--|
| Step 6 | show running-config Example: <pre>Switch# show running-config</pre> | Verifies your entries. |
| Step 7 | copy running-config startup-config Example: <pre>Switch# copy running-config startup-config</pre> | (Optional) Saves your entries in the configuration file. |

Related Topics

[PIM Domain Border](#), on page 123

Defining the IP Multicast Boundary (CLI)

You define a multicast boundary to prevent Auto-RP messages from entering the PIM domain. You create an access list to deny packets destined for 224.0.1.39 and 224.0.1.40, which carry Auto-RP information.

This procedure is optional.

SUMMARY STEPS

1. **enable**
2. **configure terminal**
3. **access-list** *access-list-number* **deny** *source* [*source-wildcard*]
4. **interface** *interface-id*
5. **ip multicast boundary** *access-list-number*
6. **end**
7. **show running-config**
8. **copy running-config startup-config**

DETAILED STEPS

| | Command or Action | Purpose |
|--------|---|--|
| Step 1 | enable Example: <pre>Switch> enable</pre> | Enables privileged EXEC mode. Enter your password if prompted. |
| Step 2 | configure terminal Example: <pre>Switch# configure terminal</pre> | Enters the global configuration mode. |

| | Command or Action | Purpose |
|---------------|--|--|
| Step 3 | <p>access-list <i>access-list-number</i> deny <i>source</i> [<i>source-wildcard</i>]</p> <p>Example:</p> <pre>Switch(config)# access-list 12 deny 224.0.1.39 access-list 12 deny 224.0.1.40</pre> | <p>Creates a standard access list, repeating the command as many times as necessary.</p> <ul style="list-style-type: none"> For <i>access-list-number</i>, the range is 1 to 99. The deny keyword denies access if the conditions are matched. For <i>source</i>, enter multicast addresses 224.0.1.39 and 224.0.1.40, which carry Auto-RP information. (Optional) For <i>source-wildcard</i>, enter the wildcard bits in dotted decimal notation to be applied to the source. Place ones in the bit positions that you want to ignore. <p>The access list is always terminated by an implicit deny statement for everything.</p> |
| Step 4 | <p>interface <i>interface-id</i></p> <p>Example:</p> <pre>Switch(config)# interface gigabitethernet 1/0/1</pre> | <p>Specifies the interface to be configured, and enters interface configuration mode.</p> <p>The specified interface must be one of the following:</p> <ul style="list-style-type: none"> A routed port—A physical port that has been configured as a Layer 3 port by entering the no switchport interface configuration command. You will also need to enable IP PIM sparse-dense-mode on the interface, and join the interface as a statically connected member to an IGMP static group. For a configuration example, see Example: Interface Configuration as a Routed Port, on page 88 An SVI—A VLAN interface created by using the interface vlan <i>vlan-id</i> global configuration command. You will also need to enable IP PIM sparse-dense-mode on the VLAN, join the VLAN as a statically connected member to an IGMP static group, and then enable IGMP snooping on the VLAN, the IGMP static group, and physical interface. For a configuration example, see Example: Interface Configuration as an SVI, on page 89 <p>These interfaces must have IP addresses assigned to them.</p> |
| Step 5 | <p>ip multicast boundary <i>access-list-number</i></p> <p>Example:</p> <pre>Switch(config-if)# ip multicast boundary 12</pre> | <p>Configures the boundary, specifying the access list you created in Step 2.</p> |

| | Command or Action | Purpose |
|---------------|---|--|
| Step 6 | end Example: <pre>Switch(config)# end</pre> | Returns to privileged EXEC mode. |
| Step 7 | show running-config Example: <pre>Switch# show running-config</pre> | Verifies your entries. |
| Step 8 | copy running-config startup-config Example: <pre>Switch# copy running-config startup-config</pre> | (Optional) Saves your entries in the configuration file. |

Related Topics

[Multicast Boundaries](#), on page 121

[Example: Defining the IP Multicast Boundary to Deny Auto-RP Information](#), on page 170

[IP Multicast Boundary](#), on page 24

[Multicast Group Transmission Scheme](#), on page 22

[Example: Configuring an IP Multicast Boundary](#), on page 280

Configuring Candidate BSRs (CLI)

You can configure one or more candidate BSRs. The devices serving as candidate BSRs should have good connectivity to other devices and be in the backbone portion of the network.

This procedure is optional.

SUMMARY STEPS

1. **enable**
2. **configure terminal**
3. **ip pim bsr-candidate interface-id hash-mask-length [priority]**
4. **end**
5. **show running-config**
6. **copy running-config startup-config**

DETAILED STEPS

| | Command or Action | Purpose |
|---------------|----------------------------------|--|
| Step 1 | enable Example: | Enables privileged EXEC mode. Enter your password if prompted. |

| | Command or Action | Purpose |
|---------------|--|--|
| | Switch> <code>enable</code> | |
| Step 2 | configure terminal Example: Switch# <code>configure terminal</code> | Enters the global configuration mode. |
| Step 3 | ip pim bsr-candidate <i>interface-id</i> <i>hash-mask-length</i> [<i>priority</i>] Example: Switch(config)# <code>ip pim bsr-candidate gigabitethernet 1/0/3 28 100</code> | Configures your switch to be a candidate BSR. <ul style="list-style-type: none"> • For <i>interface-id</i>, enter the interface on this switch from which the BSR address is derived to make it a candidate. This interface must be enabled with PIM. Valid interfaces include physical ports, port channels, and VLANs. • For <i>hash-mask-length</i>, specify the mask length (32 bits maximum) that is to be ANDed with the group address before the hash function is called. All groups with the same seed hash correspond to the same RP. For example, if this value is 24, only the first 24 bits of the group addresses matter. • (Optional) For <i>priority</i>, enter a number from 0 to 255. The BSR with the larger priority is preferred. If the priority values are the same, the device with the highest IP address is selected as the BSR. The default is 0. |
| Step 4 | end Example: Switch(config)# <code>end</code> | Returns to privileged EXEC mode. |
| Step 5 | show running-config Example: Switch# <code>show running-config</code> | Verifies your entries. |
| Step 6 | copy running-config startup-config Example: Switch# <code>copy running-config startup-config</code> | (Optional) Saves your entries in the configuration file. |

Related Topics

[PIMv2 Bootstrap Router](#), on page 123

[Configuring PIMv2 BSR](#), on page 143

[Example: Configuring Candidate BSRs](#), on page 171

[Restrictions for Configuring Auto-RP and BSR](#), on page 113

Configuring the Candidate RPs (CLI)

You can configure one or more candidate RPs. Similar to BSRs, the RPs should also have good connectivity to other devices and be in the backbone portion of the network. An RP can serve the entire IP multicast address space or a portion of it. Candidate RPs send candidate RP advertisements to the BSR.

This procedure is optional.

Before you begin

When deciding which devices should be RPs, consider these options:

- In a network of Cisco routers and multilayer switches where only Auto-RP is used, any device can be configured as an RP.
- In a network that includes only Cisco PIMv2 routers and multilayer switches and with routers from other vendors, any device can be used as an RP.
- In a network of Cisco PIMv1 routers, Cisco PIMv2 routers, and routers from other vendors, configure only Cisco PIMv2 routers and multilayer switches as RPs.

SUMMARY STEPS

1. **enable**
2. **configure terminal**
3. **ip pim rp-candidate** *interface-id* [**group-list** *access-list-number*]
4. **access-list** *access-list-number* {**deny** | **permit**} *source* [*source-wildcard*]
5. **end**
6. **show running-config**
7. **copy running-config startup-config**

DETAILED STEPS

| | Command or Action | Purpose |
|--------|---|--|
| Step 1 | enable Example: <pre>Switch> enable</pre> | Enables privileged EXEC mode. Enter your password if prompted. |
| Step 2 | configure terminal Example: <pre>Switch# configure terminal</pre> | Enters the global configuration mode. |

| | Command or Action | Purpose |
|---------------|--|---|
| Step 3 | <p>ip pim rp-candidate <i>interface-id</i> [group-list <i>access-list-number</i>]</p> <p>Example:</p> <pre>Switch(config)# ip pim rp-candidate gigabitethernet 1/0/5 group-list 10</pre> | <p>Configures your switch to be a candidate RP.</p> <ul style="list-style-type: none"> For <i>interface-id</i>, specify the interface whose associated IP address is advertised as a candidate RP address. Valid interfaces include physical ports, port channels, and VLANs. (Optional) For group-list <i>access-list-number</i>, enter an IP standard access list number from 1 to 99. If no group-list is specified, the switch is a candidate RP for all groups. |
| Step 4 | <p>access-list <i>access-list-number</i> {deny permit} <i>source</i> [<i>source-wildcard</i>]</p> <p>Example:</p> <pre>Switch(config)# access-list 10 permit 239.0.0.0 0.255.255.255</pre> | <p>Creates a standard access list, repeating the command as many times as necessary.</p> <ul style="list-style-type: none"> For <i>access-list-number</i>, enter the access list number specified in Step 2. The deny keyword denies access if the conditions are matched. The permit keyword permits access if the conditions are matched. For <i>source</i>, enter the number of the network or host from which the packet is being sent. (Optional) For <i>source-wildcard</i>, enter the wildcard bits in dotted decimal notation to be applied to the source. Place ones in the bit positions that you want to ignore. <p>The access list is always terminated by an implicit deny statement for everything.</p> |
| Step 5 | <p>end</p> <p>Example:</p> <pre>Switch(config)# end</pre> | <p>Returns to privileged EXEC mode.</p> |
| Step 6 | <p>show running-config</p> <p>Example:</p> <pre>Switch# show running-config</pre> | <p>Verifies your entries.</p> |
| Step 7 | <p>copy running-config startup-config</p> <p>Example:</p> <pre>Switch# copy running-config startup-config</pre> | <p>(Optional) Saves your entries in the configuration file.</p> |

Related Topics

[Rendezvous Points](#), on page 119

[Configuring a Rendezvous Point](#), on page 132

[Example: Configuring Candidate RPs](#), on page 172

Configuring Sparse Mode with Auto-RP(CLI)

Before you begin

- An interface configured in sparse-dense mode is treated in either sparse mode or dense mode of operation, depending on the mode in which the multicast group operates. You must decide how to configure your interfaces.
- All access lists that are needed when Auto-RP is configured should be configured prior to beginning the configuration task.

**Note**

- If a group has no known RP and the interface is configured to be sparse-dense mode, the interface is treated as if it were in dense mode, and data is flooded over the interface. To avoid this data flooding, configure the Auto-RP listener and then configure the interface as sparse mode.
- When configuring Auto-RP, you must either configure the Auto-RP listener feature (Step 5) and specify sparse mode (Step 7) or specify sparse-dense mode (Step 8).
- When you configure sparse-dense mode, dense mode failover may result in a network dense-mode flood. To avoid this condition, use PIM sparse mode with the Auto-RP listener feature.

Follow this procedure to configure auto-rendezvous point (Auto-RP). Auto-RP can also be optionally used with anycast RP.

SUMMARY STEPS

1. **enable**
2. **configure terminal**
3. **ip multicast-routing [distributed]**
4. Either perform Steps 5 through 7 or perform Steps 6 and 8.
5. **ip pim autorp listener**
6. **interface** *type number*
7. **ip pim sparse-mode**
8. **ip pim sparse-dense-mode**
9. **exit**
10. Repeat Steps 1 through 9 on all PIM interfaces.
11. **ip pim send-rp-announce** *{interface-type interface-number | ip-address}* **scope** *tvl-value* [**group-list** *access-list*] [**interval** *seconds*] [**bidir**]
12. **ip pim send-rp-discovery** [*interface-type interface-number*] **scope** *tvl-value* [**interval** *seconds*]
13. **ip pim rp-announce-filter** **rp-list** *access-list* **group-list** *access-list*
14. **no ip pim dm-fallback**
15. **interface** *type number*
16. **ip multicast boundary** *access-list* [**filter-autorp**]

17. **end**
18. **show ip pim autorp**
19. **show ip pim rp [mapping] [rp-address]**
20. **show ip igmp groups [group-name | group-address| interface-type interface-number] [detail]**
21. **show ip mroute [group-address | group-name] [source-address | source-name] [interface-type interface-number] [summary] [count] [active kbps]**

DETAILED STEPS

| | Command or Action | Purpose |
|---------------|--|--|
| Step 1 | enable Example: Switch> enable | Enables privileged EXEC mode. <ul style="list-style-type: none"> • Enter your password if prompted. |
| Step 2 | configure terminal Example: Switch# configure terminal | Enters global configuration mode. |
| Step 3 | ip multicast-routing [distributed] Example: Switch(config)# ip multicast-routing | Enables IP multicast routing. <ul style="list-style-type: none"> • Use the distributed keyword to enabled Multicast Distributed Switching. |
| Step 4 | Either perform Steps 5 through 7 or perform Steps 6 and 8. | -- |
| Step 5 | ip pim autorp listener Example: Switch(config)# ip pim autorp listener | Causes IP multicast traffic for the two Auto-RP groups 224.0.1.39 and 224.0.1.40 to be PIM dense mode flooded across interfaces operating in PIM sparse mode. <ul style="list-style-type: none"> • Skip this step if you are configuring sparse-dense mode in Step 8. |
| Step 6 | interface type number Example: Switch(config)# interface GigabitEthernet 1/0/0 | Selects an interface that is connected to hosts on which PIM can be enabled. |
| Step 7 | ip pim sparse-mode Example: Switch(config-if)# ip pim sparse-mode | Enables PIM sparse mode on an interface. When configuring Auto-RP in sparse mode, you must also configure the Auto-RP listener in the next step. <ul style="list-style-type: none"> • Skip this step if you are configuring sparse-dense mode in Step 8. |
| Step 8 | ip pim sparse-dense-mode Example: | Enables PIM sparse-dense mode on an interface. <ul style="list-style-type: none"> • Skip this step if you configured sparse mode in Step 7. |

| | Command or Action | Purpose |
|----------------|--|---|
| | Switch(config-if)# ip pim sparse-dense-mode | |
| Step 9 | <p>exit</p> <p>Example:</p> <pre>Switch(config-if)# exit</pre> | Exits interface configuration mode and returns to global configuration mode. |
| Step 10 | Repeat Steps 1 through 9 on all PIM interfaces. | -- |
| Step 11 | <p>ip pim send-rp-announce <i>{interface-type interface-number ip-address}</i> scope <i>ttl-value</i> [group-list access-list] [interval seconds] [bidir]</p> <p>Example:</p> <pre>Switch(config)# ip pim send-rp-announce loopback0 scope 31 group-list 5</pre> | <p>Sends RP announcements out all PIM-enabled interfaces.</p> <ul style="list-style-type: none"> • Perform this step on the RP device only. • Use the <i>interface-type</i> and <i>interface-number</i> arguments to define which IP address is to be used as the RP address. • Use the <i>ip-address</i> argument to specify a directly connected IP address as the RP address. <p>Note If the <i>ip-address</i> argument is configured for this command, the RP-announce message will be sourced by the interface to which this IP address is connected (that is, the source address in the IP header of the RP-announce message is the IP address of that interface).</p> <ul style="list-style-type: none"> • This example shows that the interface is enabled with a maximum of 31 hops. The IP address by which the device wants to be identified as RP is the IP address associated with loopback interface 0. Access list 5 describes the groups for which this device serves as RP. |
| Step 12 | <p>ip pim send-rp-discovery [<i>interface-type interface-number</i>] scope <i>ttl-value</i> [interval seconds]</p> <p>Example:</p> <pre>Switch(config)# ip pim send-rp-discovery loopback 1 scope 31</pre> | <p>Configures the device to be an RP mapping agent.</p> <ul style="list-style-type: none"> • Perform this step on RP mapping agent devices or on combined RP/RP mapping agent devices. <p>Note Auto-RP allows the RP function to run separately on one device and the RP mapping agent to run on one or multiple devices. It is possible to deploy the RP and the RP mapping agent on a combined RP/RP mapping agent device.</p> <ul style="list-style-type: none"> • Use the optional <i>interface-type</i> and <i>interface-number</i> arguments to define which IP address is to be used as the source address of the RP mapping agent. |

| | Command or Action | Purpose |
|----------------|---|--|
| | | <ul style="list-style-type: none"> Use the scope keyword and <i>tvl-value</i> argument to specify the Time-to-Live (TTL) value in the IP header of Auto-RP discovery messages. Use the optional interval keyword and <i>seconds</i> argument to specify the interval at which Auto-RP discovery messages are sent. <p>Note Lowering the interval at which Auto-RP discovery messages are sent from the default value of 60 seconds results in more frequent floodings of the group-to-RP mappings. In some network environments, the disadvantages of lowering the interval (more control packet overhead) may outweigh the advantages (more frequent group-to-RP mapping updates).</p> <ul style="list-style-type: none"> The example shows limiting the Auto-RP discovery messages to 31 hops on loopback interface 1. |
| Step 13 | <p>ip pim rp-announce-filter rp-list <i>access-list</i> group-list <i>access-list</i></p> <p>Example:</p> <pre>Switch(config)# ip pim rp-announce-filter rp-list 1 group-list 2</pre> | <p>Filters incoming RP announcement messages sent from candidate RPs (C-RPs) to the RP mapping agent.</p> <ul style="list-style-type: none"> Perform this step on the RP mapping agent only. |
| Step 14 | <p>no ip pim dm-fallback</p> <p>Example:</p> <pre>Switch(config)# no ip pim dm-fallback</pre> | <p>(Optional) Prevents PIM dense mode fallback.</p> <ul style="list-style-type: none"> Skip this step if all interfaces have been configured to operate in PIM sparse mode. <p>Note The no ip pim dm-fallback command behavior is enabled by default if all the interfaces are configured to operate in PIM sparse mode (using the ip pim sparse-mode command).</p> |
| Step 15 | <p>interface <i>type number</i></p> <p>Example:</p> <pre>Switch(config)# interface gigabitethernet 1/0/0</pre> | <p>Selects an interface that is connected to hosts on which PIM can be enabled.</p> |
| Step 16 | <p>ip multicast boundary <i>access-list</i> [filter-autorp]</p> <p>Example:</p> <pre>Switch(config-if)# ip multicast boundary 10 filter-autorp</pre> | <p>Configures an administratively scoped boundary.</p> <ul style="list-style-type: none"> Perform this step on the interfaces that are boundaries to other devices. The access list is not shown in this task. |

| | Command or Action | Purpose |
|----------------|---|---|
| | | <ul style="list-style-type: none"> An access list entry that uses the deny keyword creates a multicast boundary for packets that match that entry. |
| Step 17 | end Example: <pre>Switch(config-if)# end</pre> | Returns to global configuration mode. |
| Step 18 | show ip pim autorp Example: <pre>Switch# show ip pim autorp</pre> | (Optional) Displays the Auto-RP information. |
| Step 19 | show ip pim rp [mapping] [rp-address] Example: <pre>Switch# show ip pim rp mapping</pre> | (Optional) Displays RPs known in the network and shows how the device learned about each RP. |
| Step 20 | show ip igmp groups [group-name group-address interface-type interface-number] [detail] Example: <pre>Switch# show ip igmp groups</pre> | (Optional) Displays the multicast groups having receivers that are directly connected to the device and that were learned through Internet Group Management Protocol (IGMP). <ul style="list-style-type: none"> A receiver must be active on the network at the time that this command is issued in order for receiver information to be present on the resulting display. |
| Step 21 | show ip mroute [group-address group-name] [source-address source-name] [interface-type interface-number] [summary] [count] [active kbps] Example: <pre>Switch# show ip mroute cbone-audio</pre> | (Optional) Displays the contents of the IP multicast routing (mroute) table. |

Delaying the Use of PIM Shortest-Path Tree (CLI)

Perform these steps to configure a traffic rate threshold that must be reached before multicast routing is switched from the source tree to the shortest-path tree.

This procedure is optional.

SUMMARY STEPS

1. **enable**
2. **configure terminal**
3. **access-list** *access-list-number* {**deny** | **permit**} *source* [*source-wildcard*]
4. **ip pim spt-threshold** {*kbps* | **infinity**} [**group-list** *access-list-number*]

5. `end`
6. `show running-config`
7. `copy running-config startup-config`

DETAILED STEPS

| | Command or Action | Purpose |
|---------------|--|--|
| Step 1 | <p>enable</p> <p>Example:</p> <pre>Switch> enable</pre> | Enables privileged EXEC mode. Enter your password if prompted. |
| Step 2 | <p>configure terminal</p> <p>Example:</p> <pre>Switch# configure terminal</pre> | Enters global configuration mode. |
| Step 3 | <p>access-list <i>access-list-number</i> {deny permit} <i>source</i> [<i>source-wildcard</i>]</p> <p>Example:</p> <pre>Switch(config)# access-list 16 permit 225.0.0.0 0.255.255.255</pre> | <p>Creates a standard access list.</p> <ul style="list-style-type: none"> • For <i>access-list-number</i>, the range is 1 to 99. • The deny keyword denies access if the conditions are matched. • The permit keyword permits access if the conditions are matched. • For <i>source</i>, specify the multicast group to which the threshold will apply. • (Optional) For <i>source-wildcard</i>, enter the wildcard bits in dotted decimal notation to be applied to the source. Place ones in the bit positions that you want to ignore. <p>The access list is always terminated by an implicit deny statement for everything.</p> |
| Step 4 | <p>ip pim spt-threshold {<i>kbps</i> infinity} [group-list <i>access-list-number</i>]</p> <p>Example:</p> <pre>Switch(config)# ip pim spt-threshold infinity group-list 16</pre> | <p>Specifies the threshold that must be reached before moving to shortest-path tree (spt).</p> <ul style="list-style-type: none"> • For <i>kbps</i>, specify the traffic rate in kilobits per second. The default is 0 kbps. <p>Note Because of switch hardware limitations, 0 kbps is the only valid entry even though the range is 0 to 4294967.</p> <ul style="list-style-type: none"> • Specify infinity if you want all sources for the specified group to use the shared tree, never switching to the source tree. |

| | Command or Action | Purpose |
|---------------|---|---|
| | | <ul style="list-style-type: none"> (Optional) For group-list <i>access-list-number</i>, specify the access list created in Step 2. If the value is 0 or if the group list is not used, the threshold applies to all groups. |
| Step 5 | end Example: <pre>Switch(config)# end</pre> | Returns to privileged EXEC mode. |
| Step 6 | show running-config Example: <pre>Switch# show running-config</pre> | Verifies your entries. |
| Step 7 | copy running-config startup-config Example: <pre>Switch# copy running-config startup-config</pre> | (Optional) Saves your entries in the configuration file. |

Related Topics

[PIM Shared Tree and Source Tree](#), on page 126

Modifying the PIM Router-Query Message Interval (CLI)

PIM routers and multilayer switches send PIM router-query messages to find which device will be the designated router (DR) for each LAN segment (subnet). The DR is responsible for sending IGMP host-query messages to all hosts on the directly connected LAN.

With PIM DM operation, the DR has meaning only if IGMPv1 is in use. IGMPv1 does not have an IGMP querier election process, so the elected DR functions as the IGMP querier. With PIM-SM operation, the DR is the device that is directly connected to the multicast source. It sends PIM register messages to notify the RP that multicast traffic from a source needs to be forwarded down the shared tree. In this case, the DR is the device with the highest IP address.

This procedure is optional.

SUMMARY STEPS

- enable**
- configure terminal**
- interface** *interface-id*
- ip pim query-interval** *seconds*
- end**
- show ip igmp interface** [*interface-id*]

7. copy running-config startup-config

DETAILED STEPS

| | Command or Action | Purpose |
|--------|---|---|
| Step 1 | enable Example: Switch> enable | Enables privileged EXEC mode. Enter your password if prompted. |
| Step 2 | configure terminal Example: Switch# configure terminal | Enters the global configuration mode. |
| Step 3 | interface interface-id Example: Switch(config)# interface gigabitethernet 1/0/1 | Specifies the interface to be configured, and enters interface configuration mode. The specified interface must be one of the following: <ul style="list-style-type: none"> • A routed port—A physical port that has been configured as a Layer 3 port by entering the no switchport interface configuration command. You will also need to enable IP PIM sparse-dense-mode on the interface, and join the interface as a statically connected member to an IGMP static group. For a configuration example, see Example: Interface Configuration as a Routed Port, on page 88 • An SVI—A VLAN interface created by using the interface vlan vlan-id global configuration command. You will also need to enable IP PIM sparse-dense-mode on the VLAN, join the VLAN as a statically connected member to an IGMP static group, and then enable IGMP snooping on the VLAN, the IGMP static group, and physical interface. For a configuration example, see Example: Interface Configuration as an SVI, on page 89 These interfaces must have IP addresses assigned to them. |
| Step 4 | ip pim query-interval seconds Example: Switch(config-if)# ip pim query-interval 45 | Configures the frequency at which the switch sends PIM router-query messages. The default is 30 seconds. The range is 1 to 65535. |
| Step 5 | end Example: | Returns to privileged EXEC mode. |

| | Command or Action | Purpose |
|---------------|---|--|
| | Switch(config)# end | |
| Step 6 | show ip igmp interface [<i>interface-id</i>] Example: Switch# show ip igmp interface | Verifies your entries. |
| Step 7 | copy running-config startup-config Example: Switch# copy running-config startup-config | (Optional) Saves your entries in the configuration file. |

Verifying PIM Operations

Verifying IP Multicast Operation in a PIM-SM or a PIM-SSM Network

When you verify the operation of IP multicast in a PIM-SM network environment or in a PIM-SSM network environment, a useful approach is to begin the verification process on the last hop router, and then continue the verification process on the routers along the SPT until the first hop router has been reached. The goal of the verification is to ensure that IP multicast traffic is being routed properly through an IP multicast network.

Perform the following optional tasks to verify IP multicast operation in a PIM-SM or a PIM-SSM network. The steps in these tasks help to locate a faulty hop when sources and receivers are not operating as expected.



Note If packets are not reaching their expected destinations, you might want consider disabling IP multicast fast switching, which would place the router in process switching mode. If packets begin reaching their proper destinations after IP multicast fast switching has been disabled, then the issue most likely was related to IP multicast fast switching.

Verifying IP Multicast on the First Hop Router

Enter these commands on the first hop router to verify IP multicast operations on the first hop router:

SUMMARY STEPS

1. **enable**
2. **show ip mroute** [*group-address*]
3. **show ip mroute active** [*kb/s*]

DETAILED STEPS

| | Command or Action | Purpose |
|---------------|--|--|
| Step 1 | enable Example: Switch> enable | Enables privileged EXEC mode. Enter your password if prompted. |
| Step 2 | show ip mroute [<i>group-address</i>] Example: Switch# show ip mroute 239.1.2.3 (*, 239.1.2.3), 00:18:10/stopped, RP 172.16.0.1, flags: SPF Incoming interface: Serial1/0, RPF nbr 172.31.200.2 Outgoing interface list: Null (10.0.0.1, 239.1.2.3), 00:18:10/00:03:22, flags: FT Incoming interface: GigabitEthernet0/0/0, RPF nbr 0.0.0.0 Outgoing interface list: Serial1/0, Forward/Sparse-Dense, 00:18:10/00:03:19 | Confirms that the F flag has been set for mroutes on the first hop router. |
| Step 3 | show ip mroute active [<i>kb/s</i>] Example: Switch# show ip mroute active Active IP Multicast Sources - sending >= 4 kbps Group: 239.1.2.3, (?) Source: 10.0.0.1 (?) Rate: 20 pps/4 kbps(1sec), 4 kbps(last 30 secs), 4 kbps(life avg) | Displays information about active multicast sources sending to groups. The output of this command provides information about the multicast packet rate for active sources. Note By default, the output of the show ip mroute command with the active keyword displays information about active sources sending traffic to groups at a rate greater than or equal to 4 kb/s. To display information about active sources sending low-rate traffic to groups (that is, traffic less than 4 kb/s), specify a value of 1 for the <i>kb/s</i> argument. Specifying a value of 1 for this argument displays information about active sources sending traffic to groups at a rate equal to or greater than 1 kb/s, which effectively displays information about all possible active source traffic. |

Verifying IP Multicast on Routers Along the SPT

Enter these commands on routers along the SPT to verify IP multicast operations on routers along the SPT in a PIM-SM or PIM-SSM network:

SUMMARY STEPS

1. **enable**

2. `show ip mroute [group-address]`
3. `show ip mroute active`

DETAILED STEPS

| | Command or Action | Purpose |
|--------|--|---|
| Step 1 | <p>enable</p> <p>Example:</p> <pre>Switch> enable</pre> | Enables privileged EXEC mode. Enter your password if prompted. |
| Step 2 | <p>show ip mroute [group-address]</p> <p>Example:</p> <pre>Switch# show ip mroute 239.1.2.3 (*, 239.1.2.3), 00:17:56/00:03:02, RP 172.16.0.1, flags: S Incoming interface: Null, RPF nbr 0.0.0.0 Outgoing interface list: GigabitEthernet0/0/0, Forward/Sparse-Dense, 00:17:56/00:03:02 (10.0.0.1, 239.1.2.3), 00:15:34/00:03:28, flags: T Incoming interface: Serial1/0, RPF nbr 172.31.200.1 Outgoing interface list: GigabitEthernet0/0/0, Forward/Sparse-Dense, 00:15:34/00:03:02</pre> | Confirms the RPF neighbor towards the source for a particular group or groups. |
| Step 3 | <p>show ip mroute active</p> <p>Example:</p> <pre>Switch# show ip mroute active Active IP Multicast Sources - sending >= 4 kbps Group: 239.1.2.3, (?) Source: 10.0.0.1 (?) Rate: 20 pps/4 kbps(1sec), 4 kbps(last 30 secs), 4 kbps(life avg)</pre> | <p>Displays information about active multicast sources sending to groups. The output of this command provides information about the multicast packet rate for active sources.</p> <p>Note By default, the output of the show ip mroute command with the active keyword displays information about active sources sending traffic to groups at a rate greater than or equal to 4 kb/s. To display information about active sources sending low-rate traffic to groups (that is, traffic less than 4 kb/s), specify a value of 1 for the <i>kb/s</i> argument. Specifying a value of 1 for this argument displays information about active sources sending traffic to groups at a rate equal to or greater than 1 kb/s, which effectively displays information about all possible active source traffic.</p> |

Verifying IP Multicast Operation on the Last Hop Router

Enter these commands on the last hop router to verify IP multicast operations on the last hop router:

SUMMARY STEPS

1. enable
2. show ip igmp groups
3. show ip pim rp mapping
4. show ip mroute
5. show ip interface [type number]
6. show ip mfib
7. show ip pim interface count
8. show ip mroute count
9. show ip mroute active [kb/s]

DETAILED STEPS

| | Command or Action | Purpose |
|--------|--|---|
| Step 1 | <p>enable</p> <p>Example:</p> <pre>Switch> enable</pre> | Enables privileged EXEC mode. Enter your password if prompted. |
| Step 2 | <p>show ip igmp groups</p> <p>Example:</p> <pre>Switch# show ip igmp groups IGMP Connected Group Membership Group Address Interface Uptime Expires Last Reporter 239.1.1.2.3 GigabitEthernet1/0/0 00:05:14 00:02:14 10.1.0.6 224.0.1.39 GigabitEthernet0/0/0 00:09:11 00:02:08 172.31.100.1</pre> | Verifies IGMP memberships on the last hop router. This information will confirm the multicast groups with receivers that are directly connected to the last hop router and that are learned through IGMP. |
| Step 3 | <p>show ip pim rp mapping</p> <p>Example:</p> <pre>Switch# show ip pim rp mapping PIM Group-to-RP Mappings Group(s) 224.0.0.0/4 RP 172.16.0.1 (?), v2v1 Info source: 172.16.0.1 (?), elected via Auto-RP Uptime: 00:09:11, expires: 00:02:47</pre> | <p>Confirms that the group-to-RP mappings are being populated correctly on the last hop router.</p> <p>Note Ignore this step if you are verifying a last hop router in a PIM-SSM network. The show ip pim rp mapping command does not work with routers in a PIM-SSM network because PIM-SSM does not use RPs. In addition, if configured correctly, PIM-SSM groups do not appear in the output of the show ip pim rp mapping command.</p> |
| Step 4 | <p>show ip mroute</p> <p>Example:</p> <pre>Switch# show ip mroute (*, 239.1.1.2.3), 00:05:14/00:03:04, RP 172.16.0.1, flags: SJC Incoming interface: GigabitEthernet0/0/0, RPF nbr 172.31.100.1</pre> | Verifies that the mroute table is being populated properly on the last hop router. |

| | Command or Action | Purpose |
|----------------------|---|--|
| | <pre> Outgoing interface list: GigabitEthernet1/0, Forward/Sparse-Dense, 00:05:10/00:03:04 (10.0.0.1, 239.1.2.3), 00:02:49/00:03:29, flags: T Incoming interface: GigabitEthernet0/0/0, RPF nbr 172.31.100.1 Outgoing interface list: GigabitEthernet1/0, Forward/Sparse-Dense, 00:02:49/00:03:04 (*, 224.0.1.39), 00:10:05/stopped, RP 0.0.0.0, flags: DC Incoming interface: Null, RPF nbr 0.0.0.0 Outgoing interface list: GigabitEthernet1/0, Forward/Sparse-Dense, 00:05:15/00:00:00 GigabitEthernet0/0, Forward/Sparse-Dense, 00:10:05/00:00:00 (172.16.0.1, 224.0.1.39), 00:02:00/00:01:33, flags: PTX Incoming interface: GigabitEthernet0/0/0, RPF nbr 172.31.100.1 </pre> | |
| <p>Step 5</p> | <p>show ip interface <i>[type number]</i></p> <p>Example:</p> <pre> Switch# show ip interface GigabitEthernet 0/0/0 GigabitEthernet0/0 is up, line protocol is up Internet address is 172.31.100.2/24 Broadcast address is 255.255.255.255 Address determined by setup command MTU is 1500 bytes Helper address is not set Directed broadcast forwarding is disabled Multicast reserved groups joined: 224.0.0.1 224.0.0.22 224.0.0.13 224.0.0.5 224.0.0.6 Outgoing access list is not set Inbound access list is not set Proxy ARP is enabled Local Proxy ARP is disabled Security level is default Split horizon is enabled ICMP redirects are always sent ICMP unreachable are always sent ICMP mask replies are never sent IP fast switching is enabled IP fast switching on the same interface is disabled IP Flow switching is disabled IP CEF switching is disabled IP Fast switching turbo vector IP multicast fast switching is enabled IP multicast distributed fast switching is disabled IP route-cache flags are Fast Router Discovery is disabled IP output packet accounting is disabled IP access violation accounting is disabled </pre> | <p>Verifies that multicast fast switching is enabled for optimal performance on the outgoing interface on the last hop router.</p> <p>Note Using the no ip mroute-cache interface command disables IP multicast fast-switching. When IP multicast fast switching is disabled, packets are forwarded through the process-switched path.</p> |

| | Command or Action | Purpose |
|---------------|---|--|
| | <pre>TCP/IP header compression is disabled RTP/IP header compression is disabled Policy routing is disabled Network address translation is disabled WCCP Redirect outbound is disabled WCCP Redirect inbound is disabled WCCP Redirect exclude is disabled BGP Policy Mapping is disabled</pre> | |
| Step 6 | <p>show ip mfib</p> <p>Example:</p> <pre>Switch# show ip mfib</pre> | Displays the forwarding entries and interfaces in the IP Multicast Forwarding Information Base (MFIB). |
| Step 7 | <p>show ip pim interface count</p> <p>Example:</p> <pre>Switch# show ip pim interface count State: * - Fast Switched, D - Distributed Fast Switched H - Hardware Switching Enabled Address Interface FS Mpackets In/Out 172.31.100.2 GigabitEthernet0/0/0 * 4122/0 10.1.0.1 GigabitEthernet1/0/0 * 0/3193</pre> | Confirms that multicast traffic is being forwarded on the last hop router. |
| Step 8 | <p>show ip mroute count</p> <p>Example:</p> <pre>Switch# show ip mroute count IP Multicast Statistics 6 routes using 4008 bytes of memory 3 groups, 1.00 average sources per group Forwarding Counts: Pkt Count/Pkts per second/Avg Pkt Size/Kilobits per second Other counts: Total/RPF failed/Other drops(OIF-null, rate-limit etc) Group: 239.1.2.3, Source count: 1, Packets forwarded: 3165, Packets received: 3165 RP-tree: Forwarding: 0/0/0/0, Other: 0/0/0 Source: 10.0.0.1/32, Forwarding: 3165/20/28/4, Other: 0/0/0 Group: 224.0.1.39, Source count: 1, Packets forwarded: 21, Packets received: 120 Source: 172.16.0.1/32, Forwarding: 21/1/48/0, Other: 120/0/99 Group: 224.0.1.40, Source count: 1, Packets forwarded: 10, Packets received: 10 Source: 172.16.0.1/32, Forwarding: 10/1/48/0, Other: 10/0/0</pre> | Confirms that multicast traffic is being forwarded on the last hop router. |
| Step 9 | <p>show ip mroute active [kb/s]</p> <p>Example:</p> | Displays information about active multicast sources sending traffic to groups on the last hop router. The output of this |

| | Command or Action | Purpose |
|--|---|---|
| | <pre>Switch# show ip mroute active Active IP Multicast Sources - sending >= 4 kbps Group: 239.1.2.3, (?) Source: 10.0.0.1 (?) Rate: 20 pps/4 kbps(1sec), 4 kbps(last 50 secs), 4 kbps(life avg)</pre> | <p>command provides information about the multicast packet rate for active sources.</p> <p>Note By default, the output of the show ip mroute command with the active keyword displays information about active sources sending traffic to groups at a rate greater than or equal to 4 kb/s. To display information about active sources sending low-rate traffic to groups (that is, traffic less than 4 kb/s), specify a value of 1 for the <i>kb/s</i> argument. Specifying a value of 1 for this argument displays information about active sources sending traffic to groups at a rate equal to or greater than 1 kb/s, which effectively displays information about all possible active source traffic.</p> |

Using PIM-Enabled Routers to Test IP Multicast Reachability

If all the PIM-enabled routers and access servers that you administer are members of a multicast group, pinging that group causes all routers to respond, which can be a useful administrative and debugging tool.

To use PIM-enabled routers to test IP multicast reachability, perform the following tasks:

Configuring Routers to Respond to Multicast Pings

Follow these steps to configure a router to respond to multicast pings. Perform the task on all the interfaces of a router and on all the routers participating in the multicast network:

SUMMARY STEPS

1. **enable**
2. **configure terminal**
3. **interface** *type number*
4. **ip igmp join-group** *group-address*
5. Repeat Step 3 and Step 4 for each interface on the router participating in the multicast network.
6. **end**

DETAILED STEPS

| | Command or Action | Purpose |
|--------|--|--|
| Step 1 | <pre>enable Example: Switch> enable</pre> | Enables privileged EXEC mode. Enter your password if prompted. |

| | Command or Action | Purpose |
|---------------|--|--|
| Step 2 | configure terminal Example: Switch# configure terminal | Enters global configuration mode. |
| Step 3 | interface type number Example: Switch(config)# interface gigabitethernet 1/0/0 | Enters interface configuration mode. For the <i>type</i> and <i>number</i> arguments, specify an interface that is directly connected to hosts or is facing hosts. |
| Step 4 | ip igmp join-group group-address Example: Switch(config-if)# ip igmp join-group 225.2.2.2 | (Optional) Configures an interface on the router to join the specified group. For the purpose of this task, configure the same group address for the <i>group-address</i> argument on all interfaces on the router participating in the multicast network. Note With this method, the router accepts the multicast packets in addition to forwarding them. Accepting the multicast packets prevents the router from fast switching. |
| Step 5 | Repeat Step 3 and Step 4 for each interface on the router participating in the multicast network. | -- |
| Step 6 | end Example: Switch(config-if)# end | Ends the current configuration session and returns to privileged EXEC mode. |

Pinging Routers Configured to Respond to Multicast Pings

Follow these steps on a router to initiate a ping test to the routers configured to respond to multicast pings. This task is used to test IP multicast reachability in a network.

SUMMARY STEPS

1. **enable**
2. **ping group-address**

DETAILED STEPS

| | Command or Action | Purpose |
|---------------|---|--|
| Step 1 | enable Example: Switch> enable | Enables privileged EXEC mode. Enter your password if prompted. |

| | Command or Action | Purpose |
|--------|--|---|
| Step 2 | <p><code>ping group-address</code></p> <p>Example:</p> <p>Switch# <code>ping 225.2.2.2</code></p> | <p>Pings an IP multicast group address.</p> <p>A successful response indicates that the group address is functioning.</p> |

Monitoring and Troubleshooting PIM

Monitoring PIM Information

Use the privileged EXEC commands in the following table to monitor your PIM configurations.

Table 16: PIM Monitoring Commands

| Command | Purpose |
|--|--|
| <code>show ip pim all-vrfs tunnel [tunnel tunnel_number verbose]</code> | Displays all VRFs. |
| <code>show ip pim autorp</code> | Displays global auto-RP information. |
| <code>show ip pim boundary</code> | Displays information about mroutes filtered by administratively scoped IPv4 multicast boundaries configured on an interface. |
| <code>show ip pim interface</code> | Displays information about interfaces configured for Protocol Independent Multicast (PIM). |
| <code>show ip pim neighbor</code> | Displays the PIM neighbor information. |
| <code>show ip pim rp[group-name group-address]</code> | Displays RP routers associated with a sparse-mode multicast group. This command is available in all software images. |
| <code>show ip pim tunnel [tunnel verbose]</code> | Displays information about Protocol Independent Multicast (PIM) tunnel interfaces |
| <code>show ip pim vrf { word { all-vrfs autorp boundary bsr-router interface mdt neighbor rp rp-hash tunnel } }</code> | Displays the VPN routing/forwarding instance. |
| <code>show ip igmp groups detail</code> | Displays the interested clients that have joined the specific multicast source group. |

Monitoring the RP Mapping and BSR Information

Use the privileged EXEC mode in the following table to verify the consistency of group-to-RP mappings:

Table 17: RP Mapping Monitoring Commands

| Command | Purpose |
|--|--|
| show ip pim rp [<i>hostname</i> or <i>IP address</i> mapping [<i>hostname</i> or <i>IP address</i> elected in-use] metric [<i>hostname</i> or <i>IP address</i>]] | <p>Displays all available RP mappings and metrics. This tells you how the switch learns of the RP (through the BSR or the Auto-RP mechanism).</p> <ul style="list-style-type: none"> • (Optional) For the <i>hostname</i>, specify the IP name of the group about which to display RPs. • (Optional) For the <i>IP address</i>, specify the IP address of the group about which to display RPs. • (Optional) Use the mapping keyword to display all group-to-RP mappings of which the Cisco device is aware (either configured or learned from Auto-RP). • (Optional) Use the metric keyword to display the RP RPF metric. |
| show ip pim rp-hash <i>group</i> | <p>Displays the RP that was selected for the specified group. That is, on a PIMv2 router or multilayer switch, confirms that the same RP is the one that a PIMv1 system chooses. For <i>group</i>, enter the group address for which to display RP information.</p> |

Use the privileged EXEC commands in the following table to monitor BSR information:

Table 18: BSR Monitoring Commands

| Command | Purpose |
|-------------------------------|---|
| show ip pim bsr | Displays information about the elected BSR. |
| show ip pim bsr-router | Displays information about the BSRv2. |

Troubleshooting PIMv1 and PIMv2 Interoperability Problems

When debugging interoperability problems between PIMv1 and PIMv2, check these in the order shown:

1. Verify RP mapping with the **show ip pim rp-hash** privileged EXEC command, making sure that all systems agree on the same RP for the same group.
2. Verify interoperability between different versions of DRs and RPs. Make sure that the RPs are interacting with the DRs properly (by responding with register-stops and forwarding decapsulated data packets from registers).

Related Topics

[PIM Versions](#), on page 117

Configuration Examples for PIM

Example: Enabling PIM Stub Routing

In this example, IP multicast routing is enabled, Switch A PIM uplink port 25 is configured as a routed uplink port with **spare-dense-mode** enabled. PIM stub routing is enabled on the VLAN 100 interfaces and on Gigabit Ethernet port 20.

```
Switch(config)# ip multicast-routing distributed
Switch(config)# interface GigabitEthernet3/0/25
Switch(config-if)# no switchport
Switch(config-if)# ip address 3.1.1.2 255.255.255.0
Switch(config-if)# ip pim sparse-dense-mode
Switch(config-if)# exit
Switch(config)# interface vlan100
Switch(config-if)# ip pim passive
Switch(config-if)# exit
Switch(config)# interface GigabitEthernet3/0/20
Switch(config-if)# ip pim passive
Switch(config-if)# exit
Switch(config)# interface vlan100
Switch(config-if)# ip address 100.1.1.1 255.255.255.0
Switch(config-if)# ip pim passive
Switch(config-if)# exit
Switch(config)# interface GigabitEthernet3/0/20
Switch(config-if)# no switchport
Switch(config-if)# ip address 10.1.1.1 255.255.255.0
Switch(config-if)# ip pim passive
Switch(config-if)# end
```

Related Topics

[Enabling PIM Stub Routing \(CLI\)](#), on page 130

[PIM Stub Routing](#), on page 118

Example: Verifying PIM Stub Routing

To verify that PIM stub is enabled for each interface, use the **show ip pim interface** privileged EXEC command:

```
Switch# show ip pim interface
Address Interface Ver/ Nbr Query DR DR
Mode Count Intvl Prior
3.1.1.2 GigabitEthernet3/0/25 v2/SD 1 30 1 3.1.1.2
100.1.1.1 Vlan100 v2/P 0 30 1 100.1.1.1
10.1.1.1 GigabitEthernet3/0/20 v2/P 0 30 1 10.1.1.1
```

Related Topics

[Enabling PIM Stub Routing \(CLI\)](#), on page 130

[PIM Stub Routing](#), on page 118

Example: Manually Assigning an RP to Multicast Groups

This example shows how to configure the address of the RP to 147.106.6.22 for multicast group 225.2.2.2 only:

```
Switch(config)# access-list 1 permit 225.2.2.2 0.0.0.0
Switch(config)# ip pim rp-address 147.106.6.22 1
```

Related Topics

[Manually Assigning an RP to Multicast Groups \(CLI\)](#), on page 133

Example: Configuring Auto-RP

This example shows how to send RP announcements out all PIM-enabled interfaces for a maximum of 31 hops. The IP address of port 1 is the RP. Access list 5 describes the group for which this switch serves as RP:

```
Switch(config)# ip pim send-rp-announce gigabitethernet1/0/1 scope 31 group-list 5
Switch(config)# access-list 5 permit 224.0.0.0 15.255.255.255
```

Related Topics

[Setting Up Auto-RP in a New Internetwork \(CLI\)](#), on page 135

[Auto-RP](#), on page 120

Example: Sparse Mode with Auto-RP

The following example configures sparse mode with Auto-RP:

```
ip multicast-routing
ip pim autorp listener
ip pim send-rp-announce Loopback0 scope 16 group-list 1
ip pim send-rp-discovery Loopback1 scope 16
no ip pim dm-fallback
access-list 1 permit 239.254.2.0 0.0.0.255
access-list 1 permit 239.254.3.0 0.0.0.255
.
.
.
access-list 10 permit 224.0.1.39
access-list 10 permit 224.0.1.40
access-list 10 permit 239.254.2.0 0.0.0.255
access-list 10 permit 239.254.3.0 0.0.0.255
```

Related Topics

[Setting Up Auto-RP in a New Internetwork \(CLI\)](#), on page 135

[Auto-RP](#), on page 120

Example: Defining the IP Multicast Boundary to Deny Auto-RP Information

This example shows a portion of an IP multicast boundary configuration that denies Auto-RP information:

```
Switch(config)# access-list 1 deny 224.0.1.39
```

```
Switch(config)# access-list 1 deny 224.0.1.40
Switch(config)# access-list 1 permit all
Switch(config)# interface gigabitethernet1/0/1
Switch(config-if)# ip multicast boundary 1
```

Related Topics

[Defining the IP Multicast Boundary \(CLI\)](#), on page 145

[Multicast Boundaries](#), on page 121

Example: Filtering Incoming RP Announcement Messages

This example shows a sample configuration on an Auto-RP mapping agent that is used to prevent candidate RP announcements from being accepted from unauthorized candidate RPs:

```
Switch(config)# ip pim rp-announce-filter rp-list 10 group-list 20
Switch(config)# access-list 10 permit host 172.16.5.1
Switch(config)# access-list 10 permit host 172.16.2.1
Switch(config)# access-list 20 deny 239.0.0.0 0.0.255.255
Switch(config)# access-list 20 permit 224.0.0.0 15.255.255.255
```

The mapping agent accepts candidate RP announcements from only two devices, 172.16.5.1 and 172.16.2.1. The mapping agent accepts candidate RP announcements from these two devices only for multicast groups that fall in the group range of 224.0.0.0 to 239.255.255.255. The mapping agent does not accept candidate RP announcements from any other devices in the network. Furthermore, the mapping agent does not accept candidate RP announcements from 172.16.5.1 or 172.16.2.1 if the announcements are for any groups in the 239.0.0.0 through 239.255.255.255 range. This range is the administratively scoped address range.

Related Topics

[Filtering Incoming RP Announcement Messages \(CLI\)](#), on page 141

Example: Preventing Join Messages to False RPs

If all interfaces are in sparse mode, use a default-configured RP to support the two well-known groups 224.0.1.39 and 224.0.1.40. Auto-RP uses these two well-known groups to collect and distribute RP-mapping information. When this is the case and the **ip pim accept-rp auto-rp** command is configured, another **ip pim accept-rp** command accepting the RP must be configured as follows:

```
Switch(config)# ip pim accept-rp 172.10.20.1 1
Switch(config)# access-list 1 permit 224.0.1.39
Switch(config)# access-list 1 permit 224.0.1.40
```

Related Topics

[Preventing Join Messages to False RPs \(CLI\)](#), on page 141

Example: Configuring Candidate BSRs

This example shows how to configure a candidate BSR, which uses the IP address 172.21.24.18 on a port as the advertised BSR address, uses 30 bits as the hash-mask-length, and has a priority of 10.

```
Switch(config)# interface gigabitethernet1/0/2
```

```
Switch(config-if) # ip address 172.21.24.18 255.255.255.0
Switch(config-if) # ip pim sparse-dense-mode
Switch(config-if) # ip pim bsr-candidate gigabitethernet1/0/2 30 10
```

Related Topics

[Configuring Candidate BSRs \(CLI\)](#), on page 147

[PIMv2 Bootstrap Router](#), on page 123

Example: Configuring Candidate RPs

This example shows how to configure the switch to advertise itself as a candidate RP to the BSR in its PIM domain. Standard access list number 4 specifies the group prefix associated with the RP that has the address identified by a port. That RP is responsible for the groups with the prefix 239.

```
Switch(config) # ip pim rp-candidate gigabitethernet1/0/2 group-list 4
Switch(config) # access-list 4 permit 239.0.0.0 0.255.255.255
```

Related Topics

[Configuring the Candidate RPs \(CLI\)](#), on page 149

[Rendezvous Points](#), on page 119

Additional References

Related Documents

| Related Topic | Document Title |
|--|---|
| For complete syntax and usage information for the commands used in this chapter. | <i>IP Multicast Routing Command Reference (Catalyst 3850 Switches)</i> |
| IGMP Helper command syntax and usage information. | <i>IP Multicast Routing Command Reference (Catalyst 3850 Switches)</i> |
| Multicast Source Discovery Protocol (MSDP) | <i>IP Routing: Protocol-Independent Configuration Guide, Cisco IOS XE Release 3E (Catalyst 3850 Switches)</i> |
| Enhanced Interior Gateway Routing Protocol (EIGRP) stub routing | <i>IP Routing: EIGRP Configuration Guide, Cisco IOS XE Release 3E (Catalyst 3850 Switches)</i> |
| Open Shortest Path First (OSPF) stub routing | <i>IP Routing: OSPF Configuration Guide, Cisco IOS XE 3E (Catalyst 3850 Switches)</i> |
| Cisco IOS commands | Cisco IOS Master Commands List, All Releases |
| Cisco IOS IP SLAs commands | Cisco IOS IP Multicast Command Reference |

Error Message Decoder

| Description | Link |
|---|---|
| To help you research and resolve system error messages in this release, use the Error Message Decoder tool. | https://www.cisco.com/cgi-bin/Support/Errordecoder/index.cgi |

Standards and RFCs

| Standard/RFC | Title |
|---|---|
| PIM is defined in RFC 4601 and in these Internet Engineering Task Force (IETF) Internet drafts. | <ul style="list-style-type: none"> • <i>Protocol Independent Multicast (PIM): Motivation and Architecture</i> • <i>Protocol Independent Multicast (PIM), Dense Mode Protocol Specification</i> • <i>Protocol Independent Multicast (PIM), Sparse Mode Protocol Specification</i> • <i>draft-ietf-idmr-igmp-v2-06.txt, Internet Group Management Protocol, Version 2</i> • <i>draft-ietf-pim-v2-dm-03.txt, PIM Version 2 Dense Mode</i> |

MIBs

| MIB | MIBs Link |
|--------------------------------------|--|
| All supported MIBs for this release. | To locate and download MIBs for selected platforms, Cisco IOS releases, and feature sets, use Cisco MIB Locator found at the following URL: http://www.cisco.com/go/mibs |

Technical Assistance

| Description | Link |
|---|---|
| <p>The Cisco Support website provides extensive online resources, including documentation and tools for troubleshooting and resolving technical issues with Cisco products and technologies.</p> <p>To receive security and technical information about your products, you can subscribe to various services, such as the Product Alert Tool (accessed from Field Notices), the Cisco Technical Services Newsletter, and Really Simple Syndication (RSS) Feeds.</p> <p>Access to most tools on the Cisco Support website requires a Cisco.com user ID and password.</p> | http://www.cisco.com/support |

Feature History and Information for PIM

| Release | Modification |
|--------------------|------------------------------|
| Cisco IOS XE 3.2SE | This feature was introduced. |



CHAPTER 8

Configuring PIM MIB Extension for IP Multicast

- [Finding Feature Information, on page 175](#)
- [Information About PIM MIB Extension for IP Multicast, on page 175](#)
- [How to Configure PIM MIB Extension for IP Multicast, on page 176](#)
- [Configuration Examples for PIM MIB Extensions, on page 178](#)
- [Additional References, on page 178](#)

Finding Feature Information

Your software release may not support all the features documented in this module. For the latest caveats and feature information, see Bug Search Tool and the release notes for your platform and software release. To find information about the features documented in this module, and to see a list of the releases in which each feature is supported, see the feature information table at the end of this module.

Use Cisco Feature Navigator to find information about platform support and Cisco software image support. To access Cisco Feature Navigator, go to <http://www.cisco.com/go/cfn>. An account on Cisco.com is not required.

Information About PIM MIB Extension for IP Multicast

PIM MIB Extensions for SNMP Traps for IP Multicast

Protocol Independent Multicast (PIM) is an IP multicast routing protocol used for routing multicast data packets to multicast groups. RFC 2934 defines the PIM MIB for IPv4, which describes managed objects that enable users to remotely monitor and configure PIM using Simple Network Management Protocol (SNMP).

PIM MIB extensions introduce the following new classes of PIM notifications:

- neighbor-change--This notification results from the following conditions:
 - A router's PIM interface is disabled or enabled (using the **ip pim** command in interface configuration mode)
 - A router's PIM neighbor adjacency expires (defined in RFC 2934)
- rp-mapping-change--This notification results from a change in the rendezvous point (RP) mapping information due to either Auto-RP messages or bootstrap router (BSR) messages.

- invalid-pim-message--This notification results from the following conditions:
 - An invalid (*, G) Join or Prune message is received by the device (for example, when a router receives a Join or Prune message for which the RP specified in the packet is not the RP for the multicast group)
 - An invalid PIM register message is received by the device (for example, when a router receives a register message from a multicast group for which it is not the RP)

Related Topics

[Enabling PIM MIB Extensions for IP Multicast](#), on page 176

[Example Enabling PIM MIB Extensions for IP Multicast](#), on page 178

Benefits of PIM MIB Extensions

PIM MIB extensions:

- Allow users to identify changes in the multicast topology of their network by detecting changes in the RP mapping.
- Provide traps to monitor the PIM protocol on PIM-enabled interfaces.
- Help users identify routing issues when multicast neighbor adjacencies expire on a multicast interface.
- Enable users to monitor RP configuration errors (for example, errors due to flapping in dynamic RP allocation protocols like Auto-RP).

How to Configure PIM MIB Extension for IP Multicast

Enabling PIM MIB Extensions for IP Multicast

Perform this task to enable PIM MIB extensions for IP multicast.



Note

- The pimInterfaceVersion object was removed from RFC 2934 and, therefore, is no longer supported in software.
- The following MIB tables are not supported in Cisco software:
 - pimIpMRouteTable
 - pimIpMRouteNextHopTable

SUMMARY STEPS

1. **enable**
2. **configure terminal**
3. **snmp-server enable traps pim [neighbor-change | rp-mapping-change | invalid-pim-message]**
4. **snmp-server host host-address [traps | informs] community-string pim**

DETAILED STEPS

| | Command or Action | Purpose |
|--------|---|---|
| Step 1 | enable Example: <pre>Device> enable</pre> | Enables privileged EXEC mode. <ul style="list-style-type: none"> • Enter your password if prompted. |
| Step 2 | configure terminal Example: <pre>Device# configure terminal</pre> | Enters global configuration mode. |
| Step 3 | snmp-server enable traps pim [neighbor-change rp-mapping-change invalid-pim-message] Example: <pre>Device(config)# snmp-server enable traps pim neighbor-change</pre> | Enables a device to send PIM notifications. <ul style="list-style-type: none"> • neighbor-change --This keyword enables notifications indicating when a device's PIM interface is disabled or enabled, or when a device's PIM neighbor adjacency expires. • rp-mapping-change --This keyword enables notifications indicating a change in RP mapping information due to either Auto-RP messages or BSR messages. • invalid-pim-message --This keyword enables notifications for monitoring invalid PIM protocol operations (for example, when a device receives a join or prune message for which the RP specified in the packet is not the RP for the multicast group or when a device receives a register message from a multicast group for which it is not the RP). |
| Step 4 | snmp-server host <i>host-address</i> [traps informs] <i>community-string</i> pim Example: <pre>Device(config)# snmp-server host 10.10.10.10 traps public pim</pre> | Specifies the recipient of a PIM SNMP notification operation. |

Related Topics

[PIM MIB Extensions for SNMP Traps for IP Multicast](#), on page 175

[Example Enabling PIM MIB Extensions for IP Multicast](#), on page 178

Configuration Examples for PIM MIB Extensions

Example Enabling PIM MIB Extensions for IP Multicast

The following example shows how to configure a router to generate notifications indicating that a PIM interface of the router has been enabled. The first line configures PIM traps to be sent as SNMP v2c traps to the host with IP address 10.0.0.1. The second line configures the router to send the neighbor-change class of trap notification to the host.

```
snmp-server host 10.0.0.1 traps version 2c public pim
snmp-server enable traps pim neighbor-change
interface ethernet0/0
 ip pim sparse-dense-mode
```

Related Topics

[Enabling PIM MIB Extensions for IP Multicast](#), on page 176

[PIM MIB Extensions for SNMP Traps for IP Multicast](#), on page 175

Additional References

Related Documents

| Related Topic | Document Title |
|-----------------------|--|
| Cisco IOS commands | Cisco IOS Master Commands List, All Releases |
| IP multicast commands | Cisco IOS IP Multicast Command Reference |

Standards and RFCs

| Standard/RFC | Title |
|-------------------------------------|--|
| draft-kouvelas-pim-bidir-new-00.txt | A New Proposal for Bi-directional PIM |
| RFC 1112 | Host Extensions for IP Multicasting |
| RFC 1918 | Address Allocation for Private Internets |
| RFC 2770 | GLOP Addressing in 233/8 |
| RFC 3569 | An Overview of Source-Specific Multicast (SSM) |

MIBs

| MIB | MIBs Link |
|---|---|
| No new or modified MIBs are supported by this feature, and support for existing MIBs has not been modified by this feature. | To locate and download MIBs for selected platforms, Cisco software releases, and feature sets, use Cisco MIB Locator found at the following URL: http://www.cisco.com/go/mibs |

Technical Assistance

| Description | Link |
|---|---|
| The Cisco Support and Documentation website provides online resources to download documentation, software, and tools. Use these resources to install and configure the software and to troubleshoot and resolve technical issues with Cisco products and technologies. Access to most tools on the Cisco Support and Documentation website requires a Cisco.com user ID and password. | http://www.cisco.com/cisco/web/support/index.html |



CHAPTER 9

Configuring MSDP

- [Finding Feature Information, on page 181](#)
- [, on page 181](#)
- [Information About Using MSDP to Interconnect Multiple PIM-SM Domains, on page 181](#)
- [How to Use MSDP to Interconnect Multiple PIM-SM Domains, on page 195](#)
- [Configuration Examples for Using MSDP to Interconnect Multiple PIM-SM Domains, on page 216](#)
- [Additional References, on page 219](#)
- [Feature History and Information for Multicast Source Discovery Protocol, on page 220](#)

Finding Feature Information

Your software release may not support all the features documented in this module. For the latest caveats and feature information, see Bug Search Tool and the release notes for your platform and software release. To find information about the features documented in this module, and to see a list of the releases in which each feature is supported, see the feature information table at the end of this module.

Use Cisco Feature Navigator to find information about platform support and Cisco software image support. To access Cisco Feature Navigator, go to <http://www.cisco.com/go/cfn>. An account on Cisco.com is not required.

Information About Using MSDP to Interconnect Multiple PIM-SM Domains

Benefits of Using MSDP to Interconnect Multiple PIM-SM Domains

- Allows a rendezvous point (RP) to dynamically discover active sources outside of its domain.
- Introduces a more manageable approach for building multicast distribution trees between multiple domains.

MSDP is a mechanism to connect multiple PIM-SM domains. The purpose of MSDP is to discover multicast sources in other PIM domains. The main advantage of MSDP is that it reduces the complexity of interconnecting multiple PIM-SM domains by allowing PIM-SM domains to use an interdomain source tree (rather than a common shared tree). When MSDP is configured in a network, RPs exchange source information with RPs in other domains. An RP can join the interdomain source tree for sources that are sending to groups for which it has receivers. The RP can do that because it is the root of the shared tree within its domain, which has branches to all points in the domain where there are active receivers. When a last-hop device learns of a new source outside the PIM-SM domain (through the arrival of a multicast packet from the source down the shared tree), it then can send a join toward the source and join the interdomain source tree.



Note If the RP either has no shared tree for a particular group or a shared tree whose outgoing interface list is null, it does not send a join to the source in another domain.

When MSDP is enabled, an RP in a PIM-SM domain maintains MSDP peering relationships with MSDP-enabled devices in other domains. This peering relationship occurs over a TCP connection, where primarily a list of sources sending to multicast groups is exchanged. MSDP uses TCP (port 639) for its peering connections. As with BGP, using point-to-point TCP peering means that each peer must be explicitly configured. The TCP connections between RPs, moreover, are achieved by the underlying routing system. The receiving RP uses the source lists to establish a source path. If the multicast sources are of interest to a domain that has receivers, multicast data is delivered over the normal, source-tree building mechanism provided by PIM-SM. MSDP is also used to announce sources sending to a group. These announcements must originate at the RP of the domain.

The figure illustrates MSDP operating between two MSDP peers. PIM uses MSDP as the standard mechanism to register a source with the RP of a domain.



Note Although the following illustration and example uses routers in the configuration, any device (router or switch) can be used.

Figure 11: MSDP Running Between RP Peers

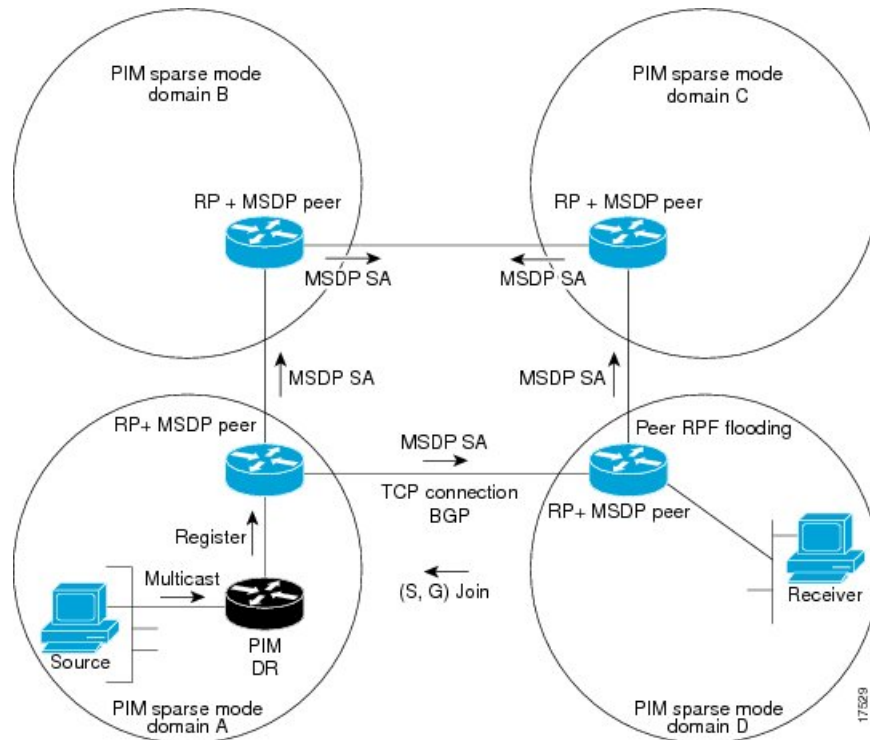

When MSDP is implemented, the following sequence of events occurs:

1. When a PIM designated device (DR) registers a source with its RP as illustrated in the figure, the RP sends a Source-Active (SA) message to all of its MSDP peers.



Note The DR sends the encapsulated data to the RP only once per source (when the source goes active). If the source times out, this process happens again when it goes active again. This situation is different from the periodic SA message that contains all sources that are registered to the originating RP. Those SA messages are MSDP control packets, and, thus, do not contain encapsulated data from active sources.

1. The SA message identifies the source address, the group that the source is sending to, and the address or the originator ID of the RP, if configured.
2. Each MSDP peer that receives the SA message floods the SA message to all of its peers downstream from the originator. In some cases (such as the case with the RPs in PIM-SM domains B and C in the figure), an RP may receive a copy of an SA message from more than one MSDP peer. To prevent looping, the RP consults the BGP next-hop database to determine the next hop toward the originator of the SA message. If both MBGP and unicast BGP are configured, MBGP is checked first, and then unicast BGP. That next-hop neighbor is the RPF-peer for the originator. SA messages that are received from the originator on any interface other than the interface to the RPF peer are dropped. The SA message flooding process, therefore, is referred to as peer-RPF flooding. Because of the peer-RPF flooding mechanism, BGP or MBGP must be running in conjunction with MSDP.

1. When an RP receives an SA message, it checks to see whether there are any members of the advertised groups in its domain by checking to see whether there are interfaces on the group's (*, G) outgoing interface list. If there are no group members, the RP does nothing. If there are group members, the RP sends an (S, G) join toward the source. As a result, a branch of the interdomain source tree is constructed across autonomous system boundaries to the RP. As multicast packets arrive at the RP, they are then forwarded down its own shared tree to the group members in the RP's domain. The members' DRs then have the option of joining the rendezvous point tree (RPT) to the source using standard PIM-SM procedures.
2. The originating RP continues to send periodic SA messages for the (S, G) state every 60 seconds for as long as the source is sending packets to the group. When an RP receives an SA message, it caches the SA message. Suppose, for example, that an RP receives an SA message for (172.16.5.4, 228.1.2.3) from originating RP 10.5.4.3. The RP consults its mroute table and finds that there are no active members for group 228.1.2.3, so it passes the SA message to its peers downstream of 10.5.4.3. If a host in the domain then sends a join to the RP for group 228.1.2.3, the RP adds the interface toward the host to the outgoing interface list of its (*, 228.1.2.3) entry. Because the RP caches SA messages, the device will have an entry for (172.16.5.4, 228.1.2.3) and can join the source tree as soon as a host requests a join.



Note In all current and supported software releases, caching of MSDP SA messages is mandatory and cannot be manually enabled or disabled. By default, when an MSDP peer is configured, the **ip multicast cache-sa-state** command will automatically be added to the running configuration.

MSDP Message Types

There are four basic MSDP message types, each encoded in their own Type, Length, and Value (TLV) data format.

SA Messages

SA messages are used to advertise active sources in a domain. In addition, these SA messages may contain the initial multicast data packet that was sent by the source.

SA messages contain the IP address of the originating RP and one or more (S, G) pairs being advertised. In addition, the SA message may contain an encapsulated data packet.



Note For more information about SA messages, see the [SA Message Origination Receipt and Processing, on page 185](#) section.

SA Request Messages

SA request messages are used to request a list of active sources for a specific group. These messages are sent to an MSDP SA cache that maintains a list of active (S, G) pairs in its SA cache. Join latency can be reduced by using SA request messages to request the list of active sources for a group instead of having to wait up to 60 seconds for all active sources in the group to be readvertised by originating RPs.

SA Response Messages

SA response messages are sent by the MSDP peer in response to an SA request message. SA response messages contain the IP address of the originating RP and one or more (S, G) pairs of the active sources in the originating RP's domain that are stored in the cache.

Keepalive Messages

Keepalive messages are sent every 60 seconds in order to keep the MSDP session active. If no keepalive messages or SA messages are received for 75 seconds, the MSDP session is reset.

SA Message Origination Receipt and Processing

The section describes SA message origination, receipt, and processing in detail.

SA Message Origination

SA messages are triggered by an RP (assuming MSDP is configured) when any new source goes active within a local PIM-SM domain. A local source is a source that is directly connected to the RP or is the first-hop DR that has registered with it. An RP originates SA messages only for local sources in its PIM-SM domain; that is, for local sources that register with it.



Note A local source is denoted by the A flag being set in the (S, G) mroute entry on the RP (which can be viewed in the output of the **show ip mroute** command). This flag indicates that the source is a candidate for advertisement by the RP to other MSDP peers.

When a source is in the local PIM-SM domain, it causes the creation of (S, G) state in the RP. New sources are detected by the RP either by the receipt of a register message or the arrival of the first (S, G) packet from a directly connected source. The initial multicast packet sent by the source (either encapsulated in the register message or received from a directly connected source) is encapsulated in the initial SA message.

SA Message Receipt

SA messages are only accepted from the MSDP RPF peer that is in the best path back toward the originator. The same SA message arriving from other MSDP peers must be ignored or SA loops can occur. Deterministically selecting the MSDP RPF peer for an arriving SA message requires knowledge of the MSDP topology. However, MSDP does not distribute topology information in the form of routing updates. MSDP infers this information by using (M)BGP routing data as the best approximation of the MSDP topology for the SA RPF check mechanism. An MSDP topology, therefore, must follow the same general topology as the BGP peer topology. Besides a few exceptions (such as default MSDP peers and MSDP peers in MSDP mesh groups), MSDP peers, in general should also be (M)BGP peers.

How RPF Check Rules Are Applied to SA Messages

The rules that apply to RPF checks for SA messages are dependent on the BGP peerings between the MSDP peers:

- Rule 1: Applied when the sending MSDP peer is also an interior (M)BGP peer.
- Rule 2: Applied when the sending MSDP peer is also an exterior (M)BGP peer.

- Rule 3: Applied when the sending MSDP peer is not an (M)BGP peer.

RPF checks are not performed in the following cases:

- If the sending MSDP peer is the only MSDP peer, which would be the case if only a single MSDP peer or a default MSDP peer is configured.
- If the sending MSDP peer is a member of a mesh group.
- If the sending MSDP peer address is the RP address contained in the SA message.

How the Software Determines the Rule to Apply to RPF Checks

The software uses the following logic to determine which RPF rule to apply to RPF checks:

- Find the (M)BGP neighbor that has the same IP address as the sending MSDP peer.
 - If the matching (M)BGP neighbor is an internal BGP (iBGP) peer, apply Rule 1.
 - If the matching (M)BGP neighbor is an external BGP (eBGP) peer, apply Rule 2.
 - If no match is found, apply Rule 3.

The implication of the RPF check rule selection is as follows: The IP address used to configure an MSDP peer on a device must match the IP address used to configure the (M)BGP peer on the same device.

Rule 1 of RPF Checking of SA Messages in MSDP

Rule 1 of RPF checking in MSDP is applied when the sending MSDP peer is also an i(M)BGP peer. When Rule 1 is applied, the RPF check proceeds as follows:

1. The peer searches the BGP Multicast Routing Information Base (MRIB) for the best path to the RP that originated the SA message. If a path is not found in the MRIB, the peer then searches the Unicast Routing Information Base (URIB). If a path is still not found, the RPF check fails.
2. If the previous search succeeds (that is, the best path is found), the peer then determines the address of the BGP neighbor for this best path, which will be the address of the BGP neighbor that sent the peer the path in BGP update messages.



Note The BGP neighbor address is not the same as the next-hop address in the path. Because i(M)BGP peers do not update the next-hop attribute of a path, the next-hop address usually is not the same as the address of the BGP peer that sent us the path.



Note The BGP neighbor address is not necessarily the same as the BGP ID of the peer that sent the peer the path.

1. If the IP address of the sending MSDP peer is the same as the BGP neighbor address (that is, the address of the BGP peer that sent the peer the path), then the RPF check succeeds; otherwise it fails.

Implications of Rule 1 of RPF Checking on MSDP

The MSDP topology must mirror the (M)BGP topology. In general, wherever there is an i(M)BGP peer connection between two devices, an MSDP peer connection should be configured. More specifically, the IP

address of the far-end MSDP peer connection must be the same as the far-end i(M)BGP peer connection. The addresses must be the same because the BGP topology between i(M)BGP peers inside an autonomous system is not described by the AS path. If it were always the case that i(M)BGP peers updated the next-hop address in the path when sending an update to another i(M)BGP peer, then the peer could rely on the next-hop address to describe the i(M)BGP topology (and hence the MSDP topology). However, because the default behavior for i(M)BGP peers is to not update the next-hop address, the peer cannot rely on the next-hop address to describe the (M)BGP topology (MSDP topology). Instead, the i(M)BGP peer uses the address of the i(M)BGP peer that sent the path to describe the i(M)BGP topology (MSDP topology) inside the autonomous system.



Tip Care should be taken when configuring the MSDP peer addresses to make sure that the same address is used for both i(M)BGP and MSDP peer addresses.

Rule 2 of RPF Checking of SA Messages in MSDP

Rule 2 of RPF checking in MSDP is applied when the sending MSDP peer is also an e(M)BGP peer. When Rule 2 is applied, the RPF check proceeds as follows:

1. The peer searches the BGP MRIB for the best path to the RP that originated the SA message. If a path is not found in the MRIB, the peer then searches the URIB. If a path is still not found, the RPF check fails.
2. If the previous search succeeds (that is, the best path is found), the peer then examines the path. If the first autonomous system in the best path to the RP is the same as the autonomous system of the e(M)BGP peer (which is also the sending MSDP peer), then the RPF check succeeds; otherwise it fails.

Implications of Rule 2 of RPF Checking on MSDP

The MSDP topology must mirror the (M)BGP topology. In general, wherever there is an e(M)BGP peer connection between two devices, an MSDP peer connection should be configured. As opposed to Rule 1, the IP address of the far-end MSDP peer connection does not have to be the same as the far-end e(M)BGP peer connection. The reason that the addresses do not have to be identical is that BGP topology between two e(M)BGP peers is not described by the AS path.

Rule 3 of RPF Checking of SA Messages in MSDP

Rule 3 of RPF checking is applied when the sending MSDP peer is not a (M)BGP peer at all. When Rule 3 is applied, the RPF check proceeds as follows:

1. The peer searches the BGP MRIB for the best path to the RP that originated the SA message. If a path is not found in the MRIB, the peer then searches the URIB. If a path is still not found, the RPF check fails.
2. If the previous search succeeds (that is, the best path to the RP that originated the SA message is found), the peer then searches the BGP MRIB for the best path to the MSDP peer that sent the SA message. If a path is not found in the MRIB, the peer then searches the URIB. If a path is still not found, the RPF check fails.



Note The autonomous system of the MSDP peer that sent the SA is the origin autonomous system, which is the last autonomous system in the AS path to the MSDP peer.

1. If the first autonomous system in the best path to the RP is the same as the autonomous system of the sending MSDP peer, then the RPF check succeeds; otherwise it fails.

SA Message Processing

The following steps are taken by an MSDP peer whenever it processes an SA message:

1. Using the group address G of the (S, G) pair in the SA message, the peer locates the associated (*, G) entry in the mroute table. If the (*, G) entry is found and its outgoing interface list is not null, then there are active receivers in the PIM-SM domain for the source advertised in the SA message.
2. The MSDP peer then creates an (S, G) entry for the advertised source.
3. If the (S, G) entry did not already exist, the MSDP peer immediately triggers an (S, G) join toward the source in order to join the source tree.
4. The peer then floods the SA message to all other MSDP peers with the exception of:
 - The MSDP peer from which the SA message was received.
 - Any MSDP peers that are in the same MSDP mesh group as this device (if the peer is a member of a mesh group).



Note SA messages are stored locally in the device's SA cache.

MSDP Peers

Like BGP, MSDP establishes neighbor relationships with other MSDP peers. MSDP peers connect using TCP port 639. The lower IP address peer takes the active role of opening the TCP connection. The higher IP address peer waits in LISTEN state for the other to make the connection. MSDP peers send keepalive messages every 60 seconds. The arrival of data performs the same function as the keepalive message and keeps the session from timing out. If no keepalive messages or data is received for 75 seconds, the TCP connection is reset.

Related Topics

[Configuring an MSDP Peer](#), on page 195

[Shutting Down an MSDP Peer](#), on page 196

[Example: Configuring an MSDP Peer](#), on page 216

MSDP MD5 Password Authentication

The MSDP MD5 password authentication feature is an enhancement to support Message Digest 5 (MD5) signature protection on a TCP connection between two MSDP peers. This feature provides added security by protecting MSDP against the threat of spoofed TCP segments being introduced into the TCP connection stream.

Related Topics

[Configuring MSDP MD5 Password Authentication Between MSDP Peers](#), on page 197

[Example: Configuring MSDP MD5 Password Authentication](#), on page 216

How MSDP MD5 Password Authentication Works

Developed in accordance with RFC 2385, the MSDP MD5 password authentication feature is used to verify each segment sent on the TCP connection between MSDP peers. The **ip msdp password peer** command is used to enable MD5 authentication for TCP connections between two MSDP peers. When MD5 authentication

is enabled between two MSDP peers, each segment sent on the TCP connection between the peers is verified. MD5 authentication must be configured with the same password on both MSDP peers; otherwise, the connection between them will not be made. Configuring MD5 authentication causes the Cisco IOS software to generate and verify the MD5 digest of every segment sent on the TCP connection.

Benefits of MSDP MD5 Password Authentication

- Protects MSDP against the threat of spoofed TCP segments being introduced into the TCP connection stream.
- Uses the industry-standard MD5 algorithm for improved reliability and security.

SA Message Limits

The **ip msdp sa-limit** command is used to limit the overall number of SA messages that a device can accept from specified MSDP peers. When the **ip msdp sa-limit** command is configured, the device maintains a per-peer count of SA messages stored in the SA cache and will ignore new messages from a peer if the configured SA message limit for that peer has been reached.

The **ip msdp sa-limit** command was introduced as a means to protect an MSDP-enabled device from denial of service (DoS) attacks. We recommended that you configure SA message limits for all MSDP peerings on the device. An appropriately low SA limit should be configured on peerings with a stub MSDP region (for example, a peer that may have some further downstream peers but that will not act as a transit for SA messages across the rest of the Internet). A high SA limit should be configured for all MSDP peerings that act as transits for SA messages across the Internet.

MSDP Keepalive and Hold-Time Intervals

The **ip msdp keepalive** command is used to adjust the interval at which an MSDP peer will send keepalive messages and the interval at which the MSDP peer will wait for keepalive messages from other peers before declaring them down.

Once an MSDP peering session is established, each side of the connection sends a keepalive message and sets a keepalive timer. If the keepalive timer expires, the local MSDP peer sends a keepalive message and restarts its keepalive timer; this interval is referred to as the keepalive interval. The *keepalive-interval* argument is used to adjust the interval for which keepalive messages will be sent. The keepalive timer is set to the value specified for the *keepalive-interval* argument when the peer comes up. The keepalive timer is reset to the value of the *keepalive-interval* argument whenever an MSDP keepalive message is sent to the peer and reset when the timer expires. The keepalive timer is deleted when an MSDP peering session is closed. By default, the keepalive timer is set to 60 seconds.



Note The value specified for the *keepalive-interval* argument must be less than the value specified for the *holdtime-interval* argument and must be at least one second.

The hold-time timer is initialized to the value of the *hold-time-interval* argument whenever an MSDP peering connection is established, and is reset to the value of the *hold-time-interval* argument whenever an MSDP keepalive message is received. The hold-time timer is deleted whenever an MSDP peering connection is closed. By default, the hold-time interval is set to 75 seconds.

Use the *hold-time-interval* argument to adjust the interval at which the MSDP peer will wait for keepalive messages from other peers before declaring them down.

MSDP Connection-Retry Interval

You can adjust the interval at which all MSDP peers will wait after peering sessions are reset before attempting to reestablish the peering sessions. This interval is referred to as the connection-retry interval. By default, MSDP peers will wait 30 seconds after the session is reset before attempting to reestablish sessions with other peers. The modified configured connection-retry interval applies to all MSDP peering sessions on the device.

Default MSDP Peers

A stub autonomous system also might want to have MSDP peerings with more than one RP for the sake of redundancy. For example, SA messages cannot just be accepted from multiple default peers, because there is no RPF check mechanism. Instead, SA messages are accepted from only one peer. If that peer fails, SA messages are then accepted from the other peer. The underlying assumption here, of course, is that both default peers are sending the same SA messages.

The figure illustrates a scenario where default MSDP peers might be used. In the figure, a customer that owns Device B is connected to the Internet through two Internet service providers (ISPs), one that owns Device A and the other that owns Device C. They are not running BGP or MBGP between them. In order for the customer to learn about sources in the ISP domain or in other domains, Device B identifies Device A as its default MSDP peer. Device B advertises SA messages to both Device A and Device C, but accepts SA messages either from Device A only or Device C only. If Device A is the first default peer in the configuration, it will be used if it is up and running. Only if Device A is not running will Device B accept SA messages from Device C.

The ISP will also likely use a prefix list to define which prefixes it will accept from the customer device. The customer will define multiple default peers, each having one or more prefixes associated with it.

The customer has two ISPs to use. The customer defines both ISPs as default peers. As long as the first default peer identified in the configuration is up and running, it will be the default peer and the customer will accept all SA messages it receives from that peer.



Note

Although the following illustration and example uses routers in the configuration, any device (router or switch) can be used.

Figure 12: Default MSDP Peer Scenario

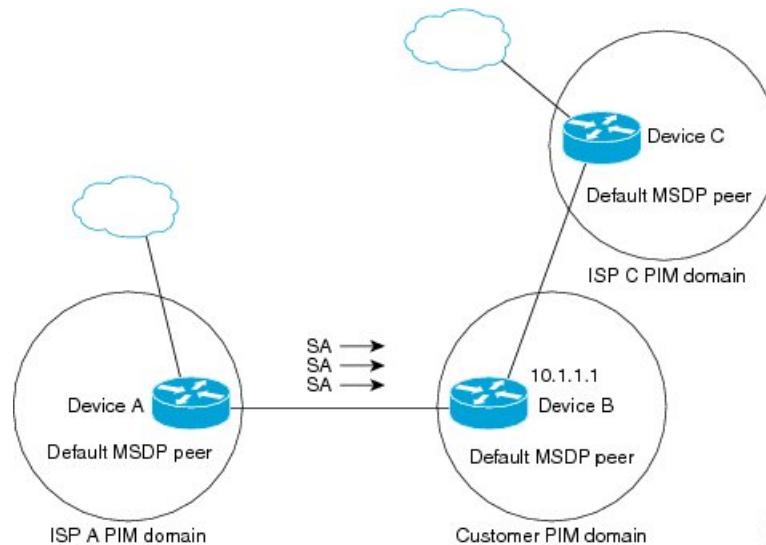

Device B advertises SAs to Device A and Device C, but uses only Device A or Device C to accept SA messages. If Device A is first in the configuration, it will be used if it is up and running. Only when Device A is not running will Device B accept SAs from Device C. This is the behavior without a prefix list.

If you specify a prefix list, the peer will be a default peer only for the prefixes in the list. You can have multiple active default peers when you have a prefix list associated with each. When you do not have any prefix lists, you can configure multiple default peers, but only the first one is the active default peer as long as the device has connectivity to this peer and the peer is alive. If the first configured peer goes down or the connectivity to this peer goes down, the second configured peer becomes the active default, and so on.

Related Topics

[Configuring a Default MSDP Peer](#), on page 202

[Example: Configuring a Default MSDP Peer](#), on page 217

MSDP Mesh Groups

An MSDP mesh group is a group of MSDP speakers that have fully meshed MSDP connectivity between one another. In other words, each of the MSDP peers in the group must have an MSDP peering relationship (MSDP connection) to every other MSDP peer in the group. When an MSDP mesh group is configured between a group of MSDP peers, SA message flooding is reduced. Because when an MSDP peer in the group receives an SA message from another MSDP peer in the group, it assumes that this SA message was sent to all the other MSDP peers in the group. As a result, it is not necessary for the receiving MSDP peer to flood the SA message to the other MSDP peers in the group.

Related Topics

[Configuring an MSDP Mesh Group](#), on page 203

[Example: Configuring MSDP Mesh Groups](#), on page 219

Benefits of MSDP Mesh Groups

- Optimizes SA flooding--MSDP mesh groups are particularly useful for optimizing SA flooding when two or more peers are in a group.

- Reduces the amount of SA traffic across the Internet--When MSDP mesh groups are used, SA messages are not flooded to other mesh group peers.
- Eliminates RPF checks on arriving SA messages--When an MSDP mesh group is configured, SA messages are always accepted from mesh group peers.

SA Origination Filters

By default, an RP that is configured to run MSDP will originate SA messages for all local sources for which it is the RP. Local sources that register with an RP, therefore, will be advertised in SA messages, which in some cases is not desirable. For example, if sources inside a PIM-SM domain are using private addresses (for example, network 10.0.0.0/8), you should configure an SA origination filter to restrict those addresses from being advertised to other MSDP peers across the Internet.

To control what sources are advertised in SA messages, you can configure SA origination filters on an RP. By creating SA origination filters, you can control the sources advertised in SA messages as follows:

- You can configure an RP to prevent the device from advertising local sources in SA messages. The device will still forward SA messages from other MSDP peers in the normal fashion; it will just not originate any SA messages for local sources.
- You can configure the device to only originate SA messages for local sources sending to specific groups that match (S, G) pairs defined in the extended access list. All other local sources will not be advertised in SA messages.
- You can configure the device to only originate SA messages for local sources sending to specific groups that match AS paths defined in an AS-path access list. All other local sources will not be advertised in SA messages.
- You can configure the device to only originate SA messages for local sources that match the criteria defined in the route map. All other local sources will not be advertised in SA messages.
- You configure an SA origination filter that includes an extended access list, an AS-path access list, and route map, or a combination thereof. In this case, all conditions must be true before any local sources are advertised in SA messages.

Use of Outgoing Filter Lists in MSDP

By default, an MSDP-enabled device forwards all SA messages it receives to all of its MSDP peers. However, you can prevent SA messages from being forwarded to MSDP peers by creating outgoing filter lists. Outgoing filter lists apply to all SA messages, whether locally originated or received from another MSDP peer, whereas SA origination filters apply only to locally originated SA messages. For more information about enabling a filter for MSDP SA messages originated by the local device, see the [Controlling SA Messages Originated by an RP for Local Sources, on page 204](#) section.

By creating an outgoing filter list, you can control the SA messages that a device forwards to a peer as follows:

- You can filter all outgoing SA messages forwarded to a specified MSDP peer by configuring the device to stop forwarding its SA messages to the MSDP peer.
- You can filter a subset of outgoing SA messages forwarded to a specified MSDP peer based on (S, G) pairs defined in an extended access list by configuring the device to only forward SA messages to the

MSDP peer that match the (S, G) pairs permitted in an extended access list. The forwarding of all other SA messages to the MSDP peer will be stopped.

- You can filter a subset of outgoing SA messages forwarded to a specified MSDP peer based on match criteria defined in a route map by configuring the device to only forward SA messages that match the criteria defined in the route map. The forwarding of all other SA messages to the MSDP peer will be stopped.
- You can filter a subset of outgoing SA messages from a specified peer based on the announcing RP address contained in the SA message by configuring the device to filter outgoing SA messages based on their origin, even after an SA message has been transmitted across one or more MSDP peers. The forwarding of all other SA messages to the MSDP peer will be stopped.
- You can configure an outgoing filter list that includes an extended access list, a route map, and either an RP access list or an RP route map. In this case, all conditions must be true for the MSDP peer to forward the outgoing SA message.

**Caution**

Arbitrary filtering of SA messages can result in downstream MSDP peers being starved of SA messages for legitimate active sources. Care, therefore, should be taken when using these sorts of filters. Normally, outgoing filter lists are used only to reject undesirable sources, such as sources using private addresses.

Use of Incoming Filter Lists in MSDP

By default, an MSDP-enabled device receives all SA messages sent to it from its MSDP peers. However, you can control the source information that a device receives from its MSDP peers by creating incoming filter lists.

By creating incoming filter lists, you can control the incoming SA messages that a device receives from its peers as follows:

- You can filter all incoming SA messages from a specified MSDP peer by configuring the device to ignore all SA messages sent to it from the specified MSDP peer.
- You can filter a subset of incoming SA messages from a specified peer based on (S, G) pairs defined in an extended access list by configuring the device to only receive SA messages from the MSDP peer that match the (S, G) pairs defined in the extended access list. All other incoming SA messages from the MSDP peer will be ignored.
- You can filter a subset of incoming SA request messages from a specified peer based on match criteria defined in a route map by configuring the device to only receive SA messages that match the criteria defined in the route map. All other incoming SA messages from the MSDP peer will be ignored.
- You can filter a subset of incoming SA messages from a specified peer based on both (S, G) pairs defined in an extended access list and on match criteria defined in a route map by configuring the device to only receive incoming SA messages that both match the (S, G) pairs defined in the extended access list and match the criteria defined in the route map. All other incoming SA messages from the MSDP peer will be ignored.
- You can filter a subset of incoming SA messages from a specified peer based on the announcing RP address contained in the SA message by configuring the device to filter incoming SA messages based on their origin, even after the SA message may have already been transmitted across one or more MSDP peers.

- You can configure an incoming filter list that includes an extended access list, a route map, and either an RP access list or an RP route map. In this case, all conditions must be true for the MSDP peer to receive the incoming SA message.

**Caution**

Arbitrary filtering of SA messages can result in downstream MSDP peers being starved of SA messages for legitimate active sources. Care, therefore, should be taken when using these sorts of filters. Normally, incoming filter lists are used only to reject undesirable sources, such as sources using private addresses.

TTL Thresholds in MSDP

The time-to-live (TTL) value provides a means to limit the number of hops a packet can take before being dropped. The **ip multicast ttl-threshold** command is used to specify a TTL for data-encapsulated SA messages sent to specified MSDP peers. By default, multicast data packets in SA messages are sent to an MSDP peer, provided the TTL value of the packet is greater than 0, which is standard TTL behavior.

In general, a TTL-threshold problem can be introduced by the encapsulation of a source's initial multicast packet in an SA message. Because the multicast packet is encapsulated inside of the unicast SA message (whose TTL is 255), its TTL is not decremented as the SA message travels to the MSDP peer. Furthermore, the total number of hops that the SA message traverses can be drastically different than a normal multicast packet because multicast and unicast traffic may follow completely different paths to the MSDP peer and hence the remote PIM-SM domain. As a result, encapsulated packets can end up violating TTL thresholds. The solution to this problem is to configure a TTL threshold that is associated with any multicast packet that is encapsulated in an SA message sent to a particular MSDP peer using the **ip multicast ttl-threshold** command. The **ip msdp ttl-threshold** command prevents any multicast packet whose TTL in the IP header is less than the TTL value specified for the *ttl-value* argument from being encapsulated in SA messages sent to that peer.

SA Request Messages

You can configure a noncaching device to send SA request messages to one or more specified MSDP peers.

If a noncaching RP has an MSDP peer that is caching SAs, you can reduce the join latency for a noncaching peer by enabling the noncaching peer to send SA request messages. When a host requests a join to a particular group, the noncaching RP sends an SA request message to its caching peers. If a peer has cached source information for the group in question, it sends the information to the requesting RP with an SA response message. The requesting RP uses the information in the SA response but does not forward the message to any other peers. If a noncaching RP receives an SA request, it sends an error message back to the requestor.

**Note**

In all current and supported software releases, caching of MSDP SA messages is mandatory and cannot be manually enabled or disabled. By default, when an MSDP peer is configured, the configured commands are automatically added to the running configuration.

SA Request Filters

By default, a device honors all outgoing SA request messages from its MSDP peers; that is, it sends cached source information to requesting MSDP peers in SA response messages. You can control the outgoing SA

request messages that a device will honor from specified peers by creating an SA request filter. An SA request filter controls the outgoing SA requests that the device will honor from MSDP peers as follows:

- You can filter all SA request messages from a specified peer by configuring the device to ignore all SA requests from the specified MSDP peer.
- You can filter a subset of SA request messages from a specified peer based on groups defined in a standard access list by configuring the device to honor only SA request messages from the MSDP peer that match the groups defined in a standard access list. SA request messages from the specified peer for other groups will be ignored.

How to Use MSDP to Interconnect Multiple PIM-SM Domains

The first task is required; all other tasks are optional.

Configuring an MSDP Peer



Note By enabling an MSDP peer, you implicitly enable MSDP.

Before you begin

- IP multicast routing must be enabled and PIM-SM must be configured.
- With the exception of a single MSDP peer, default MSDP peer, and MSDP mesh group scenarios, all MSDP peers must be configured to run BGP prior to being configured for MSDP.

SUMMARY STEPS

1. **enable**
2. **configure terminal**
3. **ip msdp peer** {peer-name| peer-address} [connect-source type number] [**remote-as** as-number]
4. **ip msdp description** {peer-name| peer-address} text
5. **end**

DETAILED STEPS

| | Command or Action | Purpose |
|--------|--|--|
| Step 1 | enable Example: Device> enable | Enables privileged EXEC mode. <ul style="list-style-type: none"> • Enter your password if prompted. |
| Step 2 | configure terminal Example: | Enters global configuration mode. |

| | Command or Action | Purpose |
|---------------|---|---|
| | Device# configure terminal | |
| Step 3 | <p>ip msdp peer {<i>peer-name</i> <i>peer-address</i>} [<i>connect-source type number</i>] [remote-as <i>as-number</i>]</p> <p>Example:</p> <pre>Device(config)# ip msdp peer 192.168.1.2 connect-source loopback0</pre> | <p>Enables MSDP and configures an MSDP peer as specified by the DNS name or IP address.</p> <p>Note The device that is selected to be configured as an MSDP peer is also usually a BGP neighbor. If it is not, see the Configuring a Default MSDP Peer, on page 202 section or the Configuring an MSDP Mesh Group, on page 203 section.</p> <ul style="list-style-type: none"> If you specify the connect-source keyword, the primary address of the specified local interface <i>type</i> and <i>number</i> values are used as the source IP address for the TCP connection. The connect-source keyword is recommended, especially for MSDP peers on a border that peer with a device inside of a remote domain. |
| Step 4 | <p>ip msdp description {<i>peer-name</i> <i>peer-address</i>} <i>text</i></p> <p>Example:</p> <pre>Device(config)# ip msdp description 192.168.1.2 router at customer a</pre> | (Optional) Configures a description for a specified peer to make it easier to identify in a configuration or in show command output. |
| Step 5 | <p>end</p> <p>Example:</p> <pre>Device(config)# end</pre> | Exits global configuration mode and returns to privileged EXEC mode. |

Related Topics

[MSDP Peers](#), on page 188

[Example: Configuring an MSDP Peer](#), on page 216

Shutting Down an MSDP Peer

Perform this optional task to shut down an MSDP peer.

If you are configuring several MSDP peers and you do not want any of the peers to go active until you have finished configuring all of them, you can shut down each peer, configure each peer, and later bring each peer up. You might also want to shut down an MSDP session without losing the configuration for that MSDP peer.

**Note**

When an MSDP peer is shut down, the TCP connection is terminated and not restarted until the peer is brought back up using the **no ip msdp shutdown** command (for the specified peer).

Before you begin

MSDP is running and the MSDP peers must be configured.

SUMMARY STEPS

1. **enable**
2. **configure terminal**
3. **ip msdp shutdown** *{peer-name | peer-address}*
4. Repeat Step 3 to shut down additional MSDP peers.
5. **end**

DETAILED STEPS

| | Command or Action | Purpose |
|---------------|--|--|
| Step 1 | enable Example: Switch> enable | Enables privileged EXEC mode. <ul style="list-style-type: none"> • Enter your password if prompted. |
| Step 2 | configure terminal Example: Switch# configure terminal | Enters global configuration mode. |
| Step 3 | ip msdp shutdown <i>{peer-name peer-address}</i> Example: Switch(config)# ip msdp shutdown 192.168.1.3 | Administratively shuts down the specified MSDP peer. |
| Step 4 | Repeat Step 3 to shut down additional MSDP peers. | -- |
| Step 5 | end Example: Switch(config)# end | Exits global configuration mode and returns to privileged EXEC mode. |

Related Topics

[MSDP Peers](#), on page 188

[Example: Configuring an MSDP Peer](#), on page 216

Configuring MSDP MD5 Password Authentication Between MSDP Peers

Perform this optional task to configure MSDP MD5 password authentication between MSDP peers.

SUMMARY STEPS

1. **enable**
2. **configure terminal**

3. `ip msdp password peer {peer-name | peer-address} [encryption-type] string`
4. `exit`
5. `show ip msdp peer [peer-address | peer-name]`

DETAILED STEPS

| | Command or Action | Purpose |
|---------------|---|--|
| Step 1 | enable Example: <pre>Device> enable</pre> | Enables privileged EXEC mode. <ul style="list-style-type: none"> • Enter your password if prompted. |
| Step 2 | configure terminal Example: <pre>Device# configure terminal</pre> | Enters global configuration mode. |
| Step 3 | ip msdp password peer {peer-name peer-address} [encryption-type] string Example: <pre>Device(config)# ip msdp password peer 10.32.43.144 0 test</pre> | Enables MD5 password encryption for a TCP connection between two MSDP peers. <p>Note MD5 authentication must be configured with the same password on both MSDP peers; otherwise, the connection between them will not be made.</p> <ul style="list-style-type: none"> • If you configure or change the password or key, which is used for MD5 authentication between two MSDP peers, the local device does not disconnect the existing session after you configure the password. You must manually disconnect the session to activate the new or changed password. |
| Step 4 | exit Example: <pre>Device(config)# exit</pre> | Exits global configuration mode and returns to privileged EXEC mode. |
| Step 5 | show ip msdp peer [peer-address peer-name] Example: <pre>Device# show ip msdp peer</pre> | (Optional) Displays detailed information about MSDP peers. <p>Note Use this command to verify whether MD5 password authentication is enabled on an MSDP peer.</p> |

Related Topics

[MSDP MD5 Password Authentication](#), on page 188

[Example: Configuring MSDP MD5 Password Authentication](#), on page 216

Troubleshooting Tips

If a device has a password configured for an MSDP peer but the MSDP peer does not, a message such as the following will appear on the console while the devices attempt to establish an MSDP session between them:

```
%TCP-6-BADAUTH: No MD5 digest from [peer's IP address]:11003 to [local router's IP address]:179
```

Similarly, if the two devices have different passwords configured, a message such as the following will appear on the console:

```
%TCP-6-BADAUTH: Invalid MD5 digest from [peer's IP address]:11004 to [local router's IP address]:179
```

The **debug ip tcp transactions** command is used to display information on significant TCP transactions such as state changes, retransmissions, and duplicate packets. In the context of monitoring or troubleshooting MSDP MD5 password authentication, use the **debug ip tcp transactions** command to verify that the MD5 password is enabled and that the keepalive message is received by the MSDP peer.

Preventing DoS Attacks by Limiting the Number of SA Messages Allowed in the SA Cache from Specified MSDP Peers

Perform this optional (but highly recommended) task to limit the overall number of SA messages that the device can accept from specified MSDP peers. Performing this task protects an MSDP-enabled device from distributed denial-of-service (DoS) attacks.



Note We recommend that you perform this task for all MSDP peerings on the device.

SUMMARY STEPS

1. **enable**
2. **configure terminal**
3. **ip msdp sa-limit** *{peer-address | peer-name} sa-limit*
4. Repeat Step 3 to configure SA limits for additional MSDP peers.
5. **exit**
6. **show ip msdp count** *[as-number]*
7. **show ip msdp peer** *[peer-address | peer-name]*
8. **show ip msdp summary**

DETAILED STEPS

| | Command or Action | Purpose |
|--------|--|--|
| Step 1 | enable Example: Device> enable | Enables privileged EXEC mode. <ul style="list-style-type: none"> • Enter your password if prompted. |

| | Command or Action | Purpose |
|---------------|--|--|
| Step 2 | configure terminal Example: Device# configure terminal | Enters global configuration mode. |
| Step 3 | ip msdp sa-limit { <i>peer-address</i> <i>peer-name</i> } <i>sa-limit</i> Example: Device(config)# ip msdp sa-limit 192.168.10.1 100 | Limits the number of SA messages allowed in the SA cache from the specified MSDP. |
| Step 4 | Repeat Step 3 to configure SA limits for additional MSDP peers. | -- |
| Step 5 | exit Example: Device(config)# exit | Exits global configuration mode and returns to privileged EXEC mode. |
| Step 6 | show ip msdp count [<i>as-number</i>] Example: Device# show ip msdp count | (Optional) Displays the number of sources and groups originated in MSDP SA messages and the number of SA messages from an MSDP peer in the SA cache. |
| Step 7 | show ip msdp peer [<i>peer-address</i> <i>peer-name</i>] Example: Device# show ip msdp peer | (Optional) Displays detailed information about MSDP peers. Note The output of this command displays the number of SA messages received from MSDP peers that are stored in the cache. |
| Step 8 | show ip msdp summary Example: Device# show ip msdp summary | (Optional) Displays MSDP peer status. Note The output of this command displays a per-peer “SA Count” field that displays the number of SAs stored in the cache. |

Adjusting the MSDP Keepalive and Hold-Time Intervals

Perform this optional task to adjust the interval at which an MSDP peer will send keepalive messages and the interval at which the MSDP peer will wait for keepalive messages from other peers before declaring them down. By default, it may take as long as 75 seconds for an MSDP peer to detect that a peering session with another MSDP peer has gone down. In network environments with redundant MSDP peers, decreasing the hold-time interval can expedite the reconvergence time of MSDP peers in the event that an MSDP peer fails.



Note We recommend that you do not change the command defaults for the **ip msdp keepalive** command, because the command defaults are in accordance with RFC 3618, *Multicast Source Discovery Protocol*. If your network environment requires that you modify the defaults, you must configure the same time values for the *keepalive-interval* and *hold-time-interval* arguments on both ends of the MSDP peering session.

SUMMARY STEPS

1. **enable**
2. **configure terminal**
3. **ip msdp keepalive** {*peer-address* | *peer-name*} *keepalive-interval* *hold-time-interval*
4. Repeat Step 3 to adjust the keepalive message interval for additional MSDP peers.
5. **exit**

DETAILED STEPS

| | Command or Action | Purpose |
|---------------|---|--|
| Step 1 | enable Example: Device> enable | Enables privileged EXEC mode. • Enter your password if prompted. |
| Step 2 | configure terminal Example: Device# configure terminal | Enters global configuration mode. |
| Step 3 | ip msdp keepalive { <i>peer-address</i> <i>peer-name</i> } <i>keepalive-interval</i> <i>hold-time-interval</i> Example: Device(config)# ip msdp keepalive 10.1.1.3 40 55 | Configures the interval at which an MSDP peer will send keepalive messages and the interval at which the MSDP peer will wait for keepalive messages from other peers before declaring them down. |
| Step 4 | Repeat Step 3 to adjust the keepalive message interval for additional MSDP peers. | -- |
| Step 5 | exit Example: Device(config)# exit | Exits global configuration mode and returns to privileged EXEC mode. |

Adjusting the MSDP Connection-Retry Interval

Perform this optional task to adjust the interval at which MSDP peers will wait after peering sessions are reset before attempting to reestablish the peering sessions. In network environments where fast recovery of SA messages is required, such as in trading floor network environments, you may want to decrease the connection-retry interval to a time value less than the default value of 30 seconds.

SUMMARY STEPS

1. enable
2. configure terminal
3. ip msdp timer *connection-retry-interval*
4. exit

DETAILED STEPS

| | Command or Action | Purpose |
|---------------|--|---|
| Step 1 | enable Example: Device> enable | Enables privileged EXEC mode. <ul style="list-style-type: none"> • Enter your password if prompted. |
| Step 2 | configure terminal Example: Device# configure terminal | Enters global configuration mode. |
| Step 3 | ip msdp timer <i>connection-retry-interval</i> Example: Device# ip msdp timer 45 | Configures the interval at which MSDP peers will wait after peering sessions are reset before attempting to reestablish the peering sessions. |
| Step 4 | exit Example: Device(config)# exit | Exits global configuration mode and returns to privileged EXEC mode. |

Configuring a Default MSDP Peer

Perform this optional task to configure a default MSDP peer.

Before you begin

An MSDP default peer must be a previously configured MSDP peer. Before configuring a default MSDP peer, you must first configure an MSDP peer.

SUMMARY STEPS

1. enable
2. configure terminal
3. ip msdp default-peer {*peer-address* | *peer-name*} [**prefix-list** *list*]
4. exit

DETAILED STEPS

| | Command or Action | Purpose |
|--------|--|--|
| Step 1 | enable Example: Device> enable | Enables privileged EXEC mode. <ul style="list-style-type: none"> • Enter your password if prompted. |
| Step 2 | configure terminal Example: Device# configure terminal | Enters global configuration mode. |
| Step 3 | ip msdp default-peer <i>{peer-address peer-name}</i> [prefix-list <i>list</i>] Example: Device(config)# ip msdp default-peer 192.168.1.3 | Configures a default peer from which to accept all MSDP SA messages |
| Step 4 | exit Example: Device(config)# exit | Exits global configuration mode and returns to privileged EXEC mode. |

Related Topics

[Default MSDP Peers](#), on page 190

[Example: Configuring a Default MSDP Peer](#), on page 217

Configuring an MSDP Mesh Group

Perform this optional task to configure an MSDP mesh group.



Note You can configure multiple mesh groups per device.

SUMMARY STEPS

1. **enable**
2. **configure terminal**
3. **ip msdp mesh-group** *mesh-name* *{peer-address | peer-name}*
4. Repeat Step 3 to add MSDP peers as members of the mesh group.
5. **exit**

DETAILED STEPS

| | Command or Action | Purpose |
|---------------|--|--|
| Step 1 | enable Example: <pre>Switch> enable</pre> | Enables privileged EXEC mode. <ul style="list-style-type: none"> • Enter your password if prompted. |
| Step 2 | configure terminal Example: <pre>Switch# configure terminal</pre> | Enters global configuration mode. |
| Step 3 | ip msdp mesh-group <i>mesh-name</i> { <i>peer-address</i> <i>peer-name</i> } Example: <pre>Switch(config)# ip msdp mesh-group peermesh</pre> | Configures an MSDP mesh group and indicates that an MSDP peer belongs to that mesh group. Note All MSDP peers on a device that participate in a mesh group must be fully meshed with all other MSDP peers in the group. Each MSDP peer on each device must be configured as a peer using the ip msdp peer command and also as a member of the mesh group using the ip msdp mesh-group command. |
| Step 4 | Repeat Step 3 to add MSDP peers as members of the mesh group. | -- |
| Step 5 | exit Example: <pre>Switch(config)# exit</pre> | Exits global configuration mode and returns to privileged EXEC mode. |

Related Topics

[MSDP Mesh Groups](#), on page 191

[Example: Configuring MSDP Mesh Groups](#), on page 219

Controlling SA Messages Originated by an RP for Local Sources

Perform this task to control SA messages originated by an RP by enabling a filter to restrict which registered sources are advertised in SA messages.



Note For best practice information related to configuring MSDP SA message filters, see the [Multicast Source Discovery Protocol SA Filter Recommendations](#) tech note.

SUMMARY STEPS

1. enable

2. `configure terminal`
3. `ip msdp redistribute [list access-list] [asn as-access-list] [route-map map-name]`
4. `exit`

DETAILED STEPS

| | Command or Action | Purpose |
|--------|---|---|
| Step 1 | enable Example: <pre>Device> enable</pre> | Enables privileged EXEC mode. <ul style="list-style-type: none"> • Enter your password if prompted. |
| Step 2 | configure terminal Example: <pre>Device# configure terminal</pre> | Enters global configuration mode. |
| Step 3 | ip msdp redistribute [list access-list] [asn as-access-list] [route-map map-name] Example: <pre>Device(config)# ip msdp redistribute route-map customer-sources</pre> | Enables a filter for MSDP SA messages originated by the local device. Note The <code>ip msdp redistribute</code> command can also be used to advertise sources that are known to the RP but not registered. However, it is strongly recommended that you not originate advertisements for sources that have not registered with the RP. |
| Step 4 | exit Example: <pre>Device(config)# exit</pre> | Exits global configuration mode and returns to privileged EXEC mode. |

Controlling the Forwarding of SA Messages to MSDP Peers Using Outgoing Filter Lists

Perform this optional task to control the forwarding of SA messages to MSDP peers by configuring outgoing filter lists.



Note For best practice information related to configuring MSDP SA message filters, see the [Multicast Source Discovery Protocol SA Filter Recommendations](#) tech note.

SUMMARY STEPS

1. `enable`
2. `configure terminal`

3. **ip msdp sa-filter out** *{peer-address | peer-name}* [**list** *access-list*] [**route-map** *map-name*] [**rp-list** *access-list* | **rp-route-map** *map-name*]
4. Repeat Step 3 to configure outgoing filter lists for additional MSDP peers.
5. **exit**

DETAILED STEPS

| | Command or Action | Purpose |
|---------------|---|--|
| Step 1 | enable Example: Device> enable | Enables privileged EXEC mode. <ul style="list-style-type: none"> • Enter your password if prompted. |
| Step 2 | configure terminal Example: Device# configure terminal | Enters global configuration mode. |
| Step 3 | ip msdp sa-filter out <i>{peer-address peer-name}</i> [list <i>access-list</i>] [route-map <i>map-name</i>] [rp-list <i>access-list</i> rp-route-map <i>map-name</i>] Example: Device(config)# ip msdp sa-filter out 192.168.1.5 peerone | Enables a filter for outgoing MSDP messages. |
| Step 4 | Repeat Step 3 to configure outgoing filter lists for additional MSDP peers. | -- |
| Step 5 | exit Example: Device(config)# exit | Exits global configuration mode and returns to privileged EXEC mode. |

Controlling the Receipt of SA Messages from MSDP Peers Using Incoming Filter Lists

Perform this optional task to control the receipt of incoming SA messages from MSDP peers.



Note For best practice information related to configuring MSDP SA message filters, see the [Multicast Source Discovery Protocol SA Filter Recommendations](#) tech note.

SUMMARY STEPS

1. **enable**
2. **configure terminal**

3. **ip msdp sa-filter in** *{peer-address | peer-name}* [**list** *access-list*] [**route-map** *map-name*] [**rp-list** *access-list* | **rp-route-map** *map-name*]
4. Repeat Step 3 to configure incoming filter lists for additional MSDP peers.
5. **exit**

DETAILED STEPS

| | Command or Action | Purpose |
|--------|--|--|
| Step 1 | enable Example: Device> enable | Enables privileged EXEC mode. <ul style="list-style-type: none"> • Enter your password if prompted. |
| Step 2 | configure terminal Example: Device# configure terminal | Enters global configuration mode. |
| Step 3 | ip msdp sa-filter in <i>{peer-address peer-name}</i> [list <i>access-list</i>] [route-map <i>map-name</i>] [rp-list <i>access-list</i> rp-route-map <i>map-name</i>] Example: Device(config)# ip msdp sa-filter in 192.168.1.3 | Enables a filter for incoming MSDP SA messages. |
| Step 4 | Repeat Step 3 to configure incoming filter lists for additional MSDP peers. | -- |
| Step 5 | exit Example: Device(config)# exit | Exits global configuration mode and returns to privileged EXEC mode. |

Using TTL Thresholds to Limit the Multicast Data Sent in SA Messages

Perform this optional task to establish a time to live (TTL) threshold to limit the multicast data sent in SA messages.

SUMMARY STEPS

1. **enable**
2. **configure terminal**
3. **ip msdp ttl-threshold** *{peer-address | peer-name}* *ttl-value*
4. **exit**

DETAILED STEPS

| | Command or Action | Purpose |
|---------------|--|---|
| Step 1 | enable Example: Device> enable | Enables privileged EXEC mode. • Enter your password if prompted. |
| Step 2 | configure terminal Example: Device# configure terminal | Enters global configuration mode. |
| Step 3 | ip msdp ttl-threshold <i>{peer-address peer-name} ttl-value</i> Example: Example: Device(config)# ip msdp ttl-threshold 192.168.1.5 8 | Sets a TTL value for MSDP messages originated by the local device. • By default, multicast data packets in SA messages are sent to an MSDP peer, provided the TTL value of the packet is greater than 0, which is standard TTL behavior. |
| Step 4 | exit Example: Device(config)# exit | Exits global configuration mode and returns to privileged EXEC mode. |

Controlling the Response to Outgoing SA Request Messages from MSDP Peers Using SA Request Filters

Perform this optional task to control the outgoing SA request messages that the device will honor from MSDP peers.

SUMMARY STEPS

1. **enable**
2. **configure terminal**
3. **ip msdp filter-sa-request** *{peer-address | peer-name} [list access-list]*
4. Repeat Step 3 to configure SA request filters for additional MSDP peers.
5. **exit**

DETAILED STEPS

| | Command or Action | Purpose |
|---------------|----------------------------------|---|
| Step 1 | enable Example: | Enables privileged EXEC mode. • Enter your password if prompted. |

| | Command or Action | Purpose |
|---------------|--|---|
| | Device> enable | |
| Step 2 | configure terminal Example: Device# configure terminal | Enters global configuration mode. |
| Step 3 | ip msdp filter-sa-request { <i>peer-address</i> <i>peer-name</i> } [list <i>access-list</i>] Example: Device(config)# ip msdp filter sa-request 172.31.2.2 list 1 | Enables a filter for outgoing SA request messages. Note Only one SA request filter can be configured per MSDP peer. |
| Step 4 | Repeat Step 3 to configure SA request filters for additional MSDP peers. | -- |
| Step 5 | exit Example: Device(config)# exit | Exits global configuration mode and returns to privileged EXEC mode. |

Including a Bordering PIM Dense Mode Region in MSDP

Perform this optional task to configure a border device to send SA messages for sources active in a PIM dense mode (PIM-DM) region.

You can have a device that borders a PIM-SM region and a PIM-DM region. By default, sources in the PIM-DM domain are not included in MSDP. You can configure this border device to send SA messages for sources active in the PIM-DM domain. If you do so, it is very important to also configure the **ip msdp redistribute** command to control what local sources from the PIM-DM domain are advertised. Not configuring this command can result in the (S, G) state remaining long after a source in the PIM-DM domain has stopped sending. For configuration information, see the [Controlling SA Messages Originated by an RP for Local Sources, on page 204](#) section.

SUMMARY STEPS

1. **enable**
2. **configure terminal**
3. **ip msdp border sa-address** *type number*
4. **exit**

DETAILED STEPS

| | Command or Action | Purpose |
|---------------|----------------------------------|---|
| Step 1 | enable Example: | Enables privileged EXEC mode. • Enter your password if prompted. |

| | Command or Action | Purpose |
|---------------|---|---|
| | Device> enable | |
| Step 2 | configure terminal Example: Device# configure terminal | Enters global configuration mode. |
| Step 3 | ip msdp border sa-address <i>type number</i> Example: Device(config)# ip msdp border sa-address gigabitethernet0/0/0 | Configures the device on the border between a PIM-SM and PIM-DM domain to originate SA messages for active sources in the PIM-DM domain. <ul style="list-style-type: none"> The IP address of the interface is used as the originator ID, which is the RP field in the SA message. |
| Step 4 | exit Example: Device(config)# exit | Exits global configuration mode and returns to privileged EXEC mode. |

Configuring an Originating Address Other Than the RP Address

Perform this optional task to allow an MSDP speaker that originates an SA message to use the IP address of its interface as the RP address in the SA message.

You can also change the originator ID for any one of the following reasons:

- If you configure multiple devices in an MSDP mesh group for Anycast RP.
- If you have a device that borders a PIM-SM domain and a PIM-DM domain. If a device borders a PIM-SM domain and a PIM-DM domain and you want to advertise active sources within the PIM-DM domain, configure the RP address in SA messages to be the address of the originating device's interface.

Before you begin

MSDP is enabled and the MSDP peers are configured. For more information about configuring MSDP peers, see the [Configuring an MSDP Peer, on page 195](#) section.

SUMMARY STEPS

- enable
- configure terminal
- ip msdp originator-id *type number*
- exit

DETAILED STEPS

| | Command or Action | Purpose |
|---------------|-------------------|-------------------------------|
| Step 1 | enable | Enables privileged EXEC mode. |

| | Command or Action | Purpose |
|---------------|--|---|
| | Example: Device> enable | <ul style="list-style-type: none"> Enter your password if prompted. |
| Step 2 | configure terminal Example: Device# configure terminal | Enters global configuration mode. |
| Step 3 | ip msdp originator-id <i>type number</i> Example: Device(config)# ip msdp originator-id ethernet 1 | Configures the RP address in SA messages to be the address of the originating device's interface. |
| Step 4 | exit Example: Device(config)# exit | Exits global configuration mode and returns to privileged EXEC mode. |

Monitoring MSDP

Perform this optional task to monitor MSDP SA messages, peers, state, and peer status.

SUMMARY STEPS

1. enable
2. debug ip msdp [*peer-address* | *peer-name*] [**detail**] [**routes**]
3. debug ip msdp resets
4. show ip msdp count [*as-number*]
5. show ip msdp peer [*peer-address* | *peer-name*]
6. show ip msdp sa-cache [*group-address* | *source-address* | *group-name* | *source-name*] [*as-number*]
7. show ip msdp summary

DETAILED STEPS

Step 1 enable

Example:

```
Device# enable
```

Enables privileged EXEC mode.

- Enter your password if prompted.

Step 2 debug ip msdp [*peer-address* | *peer-name*] [**detail**] [**routes**]

Use this command to debug MSDP activity.

Use the optional *peer-address* or *peer-name* argument to specify for which peer debug events are logged.

The following is sample output from the **debug ip msdp** command:

Example:

```
Device# debug ip msdp
MSDP debugging is on
Device#
MSDP: 224.150.44.254: Received 1388-byte message from peer
MSDP: 224.150.44.254: SA TLV, len: 1388, ec: 115, RP: 172.31.3.92
MSDP: 224.150.44.254: Peer RPF check passed for 172.31.3.92, used EMBGP peer
MSDP: 224.150.44.250: Forward 1388-byte SA to peer
MSDP: 224.150.44.254: Received 1028-byte message from peer
MSDP: 224.150.44.254: SA TLV, len: 1028, ec: 85, RP: 172.31.3.92
MSDP: 224.150.44.254: Peer RPF check passed for 172.31.3.92, used EMBGP peer
MSDP: 224.150.44.250: Forward 1028-byte SA to peer
MSDP: 224.150.44.254: Received 1388-byte message from peer
MSDP: 224.150.44.254: SA TLV, len: 1388, ec: 115, RP: 172.31.3.111
MSDP: 224.150.44.254: Peer RPF check passed for 172.31.3.111, used EMBGP peer
MSDP: 224.150.44.250: Forward 1388-byte SA to peer
MSDP: 224.150.44.250: Received 56-byte message from peer
MSDP: 224.150.44.250: SA TLV, len: 56, ec: 4, RP: 192.168.76.241
MSDP: 224.150.44.250: Peer RPF check passed for 192.168.76.241, used EMBGP peer
MSDP: 224.150.44.254: Forward 56-byte SA to peer
MSDP: 224.150.44.254: Received 116-byte message from peer
MSDP: 224.150.44.254: SA TLV, len: 116, ec: 9, RP: 172.31.3.111
MSDP: 224.150.44.254: Peer RPF check passed for 172.31.3.111, used EMBGP peer
MSDP: 224.150.44.250: Forward 116-byte SA to peer
MSDP: 224.150.44.254: Received 32-byte message from peer
MSDP: 224.150.44.254: SA TLV, len: 32, ec: 2, RP: 172.31.3.78
MSDP: 224.150.44.254: Peer RPF check passed for 172.31.3.78, used EMBGP peer
MSDP: 224.150.44.250: Forward 32-byte SA to peer
```

Step 3 **debug ip msdp resets**

Use this command to debug MSDP peer reset reasons.

Example:

```
Device# debug ip msdp resets
```

Step 4 **show ip msdp count [as-number]**

Use this command to display the number of sources and groups originated in MSDP SA messages and the number of SA messages from an MSDP peer in the SA cache. The **ip msdp cache-sa-state** command must be configured for this command to produce any output.

The following is sample output from the **show ip msdp count** command:

Example:

```
Device# show ip msdp count
SA State per Peer Counters, <Peer>: <# SA learned>
 192.168.4.4: 8
SA State per ASN Counters, <asn>: <# sources>/<# groups>
  Total entries: 8
  ?: 8/8
```

Step 5 **show ip msdp peer [peer-address | peer-name]**

Use this command to display detailed information about MSDP peers.

Use the optional *peer-address* or *peer-name* argument to display information about a particular peer.

The following is sample output from the **show ip msdp peer** command:

Example:

```
Device# show ip msdp peer 192.168.4.4
MSDP Peer 192.168.4.4 (?), AS 64512 (configured AS)
Connection status:
  State: Up, Resets: 0, Connection source: Loopback0 (2.2.2.2)
  Uptime(Downtime): 00:07:55, Messages sent/received: 8/18
  Output messages discarded: 0
  Connection and counters cleared 00:08:55 ago
SA Filtering:
  Input (S,G) filter: none, route-map: none
  Input RP filter: none, route-map: none
  Output (S,G) filter: none, route-map: none
  Output RP filter: none, route-map: none
SA-Requests:
  Input filter: none
Peer ttl threshold: 0
SAs learned from this peer: 8
Input queue size: 0, Output queue size: 0
MD5 signature protection on MSDP TCP connection: not enabled
```

Step 6 **show ip msdp sa-cache** [*group-address* | *source-address* | *group-name* | *source-name*] [*as-number*]

Use this command to display the (S, G) state learned from MSDP peers.

The following is sample output from the **show ip msdp sa-cache** command:

Example:

```
Device# show ip msdp sa-cache
MSDP Source-Active Cache - 8 entries
(10.44.44.5, 239.232.1.0), RP 192.168.4.4, BGP/AS 64512, 00:01:20/00:05:32, Peer 192.168.4.4
(10.44.44.5, 239.232.1.1), RP 192.168.4.4, BGP/AS 64512, 00:01:20/00:05:32, Peer 192.168.4.4
(10.44.44.5, 239.232.1.2), RP 192.168.4.4, BGP/AS 64512, 00:01:19/00:05:32, Peer 192.168.4.4
(10.44.44.5, 239.232.1.3), RP 192.168.4.4, BGP/AS 64512, 00:01:19/00:05:32, Peer 192.168.4.4
(10.44.44.5, 239.232.1.4), RP 192.168.4.4, BGP/AS 64512, 00:01:19/00:05:32, Peer 192.168.4.4
(10.44.44.5, 239.232.1.5), RP 192.168.4.4, BGP/AS 64512, 00:01:19/00:05:32, Peer 192.168.4.4
(10.44.44.5, 239.232.1.6), RP 192.168.4.4, BGP/AS 64512, 00:01:19/00:05:32, Peer 192.168.4.4
(10.44.44.5, 239.232.1.7), RP 192.168.4.4, BGP/AS 64512, 00:01:19/00:05:32, Peer 192.168.4.4
```

Step 7 **show ip msdp summary**

Use this command to display MSDP peer status.

The following is sample output from the **show ip msdp summary** command:

Example:

```
Device# show ip msdp summary
MSDP Peer Status Summary
Peer Address      AS      State   Uptime/  Reset SA   Peer Name
                  AS      State   Downtime Count Count
192.168.4.4      4       Up      00:08:05 0       8       ?
```

Clearing MSDP Connections Statistics and SA Cache Entries

Perform this optional task to clear MSDP connections, statistics, and SA cache entries.

SUMMARY STEPS

1. **enable**
2. **clear ip msdp peer** [*peer-address* | *peer-name*]
3. **clear ip msdp statistics** [*peer-address* | *peer-name*]
4. **clear ip msdp sa-cache** [*group-address*]

DETAILED STEPS

| | Command or Action | Purpose |
|---------------|---|---|
| Step 1 | enable Example: Device> enable | Enables privileged EXEC mode. <ul style="list-style-type: none"> • Enter your password if prompted. |
| Step 2 | clear ip msdp peer [<i>peer-address</i> <i>peer-name</i>] Example: Device# clear ip msdp peer | Clears the TCP connection to the specified MSDP peer and resets all MSDP message counters. |
| Step 3 | clear ip msdp statistics [<i>peer-address</i> <i>peer-name</i>] Example: Device# clear ip msdp statistics | Clears the statistics counters for the specified MSDP peer and resets all MSDP message counters. |
| Step 4 | clear ip msdp sa-cache [<i>group-address</i>] Example: Device# clear ip msdp sa-cache | Clears SA cache entries. <ul style="list-style-type: none"> • If the clear ip msdp sa-cache is specified with the optional <i>group-address</i> argument or <i>source-address</i> argument, all SA cache entries are cleared. • Use the optional <i>group-address</i> argument to clear all SA cache entries associated with a specific group. |

Enabling SNMP Monitoring of MSDP

Perform this optional task to enable Simple Network Management Protocol (SNMP) monitoring of MSDP.

Before you begin

- SNMP and MSDP is configured on your devices.
- In each PIM-SM domain there should be a device that is configured as the MSDP speaker. This device must have SNMP and the MSDP MIB enabled.

**Note**

- All MSDP-MIB objects are implemented as read-only.
- The Requests table is not supported in Cisco's implementation of the MSDP MIB.
- The msdpEstablished notification is not supported in Cisco's implementation of the MSDP MIB.

SUMMARY STEPS

1. **enable**
2. **snmp-server enable traps msdp**
3. **snmp-server host** *host* [**traps** | **informs**] [**version** {**1** | **2c** | **3** [**auth** | **priv** | **noauth**]}] *community-string* [**udp-port** *port-number*] **msdp**
4. **exit**

DETAILED STEPS

| | Command or Action | Purpose |
|---------------|---|--|
| Step 1 | enable Example: Device> enable | Enables privileged EXEC mode. <ul style="list-style-type: none"> • Enter your password if prompted. |
| Step 2 | snmp-server enable traps msdp Example: Device# snmp-server enable traps msdp | Enables the sending of MSDP notifications for use with SNMP. Note The snmp-server enable traps msdp command enables both traps and informs. |
| Step 3 | snmp-server host <i>host</i> [traps informs] [version { 1 2c 3 [auth priv noauth]}] <i>community-string</i> [udp-port <i>port-number</i>] msdp Example: Device# snmp-server host examplehost msdp | Specifies the recipient (host) for MSDP traps or informs. |
| Step 4 | exit Example: Device(config)# exit | Exits global configuration mode and returns to privileged EXEC mode. |

Troubleshooting Tips

You can compare the results of MSDP MIB notifications to the output from the software by using the **show ip msdp summary** and **show ip msdp peer** commands on the appropriate device. You can also compare the results of these commands to the results from SNMP Get operations. You can verify SA cache table entries using the **show ip msdp sa-cache** command. Additional troubleshooting information, such as the local address of the connection, the local port, and the remote port, can be obtained using the output from the **debug ip msdp** command.

Configuration Examples for Using MSDP to Interconnect Multiple PIM-SM Domains

Example: Configuring an MSDP Peer

The following example shows how to establish MSDP peering connections between three MSDP peers:

Device A

```
!  
interface Loopback 0  
 ip address 10.220.8.1 255.255.255.255  
!  
ip msdp peer 10.220.16.1 connect-source Loopback0  
ip msdp peer 10.220.32.1 connect-source Loopback0  
!
```

Device B

```
!  
interface Loopback 0  
 ip address 10.220.16.1 255.255.255.255  
!  
ip msdp peer 10.220.8.1 connect connect-source Loopback0  
ip msdp peer 10.220.32.1 connect connect-source Loopback0  
!
```

Device C

```
!  
interface Loopback 0  
 ip address 10.220.32.1 255.255.255.255  
!  
ip msdp peer 10.220.8.1 connect 10.220.8.1 connect-source Loopback0  
ip msdp peer 10.220.16.1 connect 10.220.16.1 connect-source Loopback0  
!
```

Related Topics

[MSDP Peers](#), on page 188

[Configuring an MSDP Peer](#), on page 195

[Shutting Down an MSDP Peer](#), on page 196

Example: Configuring MSDP MD5 Password Authentication

The following example shows how to enable MD5 password authentication for TCP connections between two MSDP peers:

Device A

```
!  
ip msdp peer 10.3.32.154  
ip msdp password peer 10.3.32.154 0 test  
!
```

Device B

```
!  
ip msdp peer 10.3.32.153  
ip msdp password peer 10.3.32.153 0 test  
!
```

Related Topics

[Configuring MSDP MD5 Password Authentication Between MSDP Peers](#), on page 197

[MSDP MD5 Password Authentication](#), on page 188

Example: Configuring a Default MSDP Peer

The figure illustrates a scenario where default MSDP peers might be used. In the figure, a customer that owns Device B is connected to the internet through two ISPs, one that owns Device A and the other that owns Device C. They are not running (M)BGP between them. In order for the customer to learn about sources in the ISP domain or in other domains, Device B identifies Device A as its default MSDP peer. Device B advertises SA messages to both Device A and Device C, but accepts SA messages either from Device A only or Device C only. If Device A is the first default peer in the configuration, it will be used if it is up and running. Only if Device A is not running will Device B accept SA messages from Device C.

The ISP will also likely use a prefix list to define which prefixes it will accept from the customer device. The customer will define multiple default peers, each having one or more prefixes associated with it.

The customer has two ISPs to use. The customer defines both ISPs as default peers. As long as the first default peer identified in the configuration is up and running, it will be the default peer and the customer will accept all SA messages it receives from that peer.



Note Although the following illustration and example uses routers in the configuration, any device (router or switch) can be used.

Figure 13: Default MSDP Peer Scenario

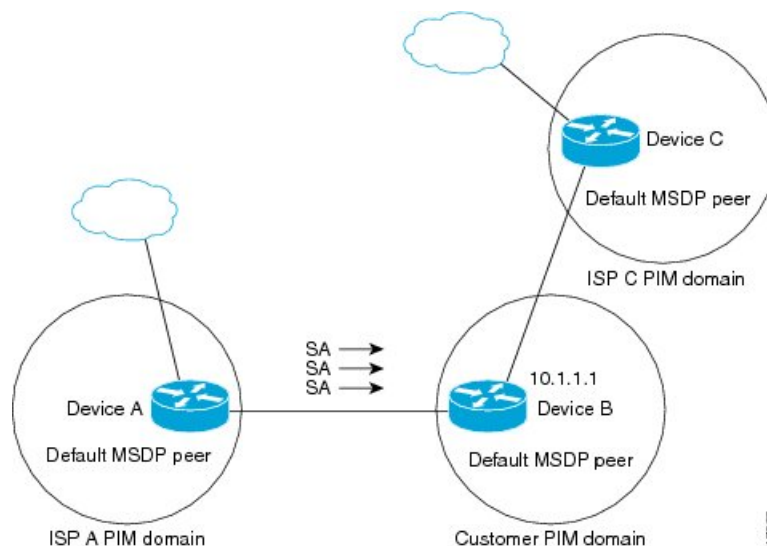

Device B advertises SAs to Device A and Device C, but uses only Device A or Device C to accept SA messages. If Device A is first in the configuration file, it will be used if it is up and running. Only when Device A is not running will Device B accept SAs from Device C. This is the behavior without a prefix list.

If you specify a prefix list, the peer will be a default peer only for the prefixes in the list. You can have multiple active default peers when you have a prefix list associated with each. When you do not have any prefix lists, you can configure multiple default peers, but only the first one is the active default peer as long as the device has connectivity to this peer and the peer is alive. If the first configured peer goes down or the connectivity to this peer goes down, the second configured peer becomes the active default, and so on.

The following example shows a partial configuration of Device A and Device C in the figure. Each of these ISPs may have more than one customer using default peering, like the customer in the figure. In that case, they may have similar configurations. That is, they will only accept SAs from a default peer if the SA is permitted by the corresponding prefix list.

Device A Configuration

```
ip msdp default-peer 10.1.1.1
ip msdp default-peer 10.1.1.1 prefix-list site-b ge 32
ip prefix-list site-b permit 10.0.0.0/8
```

Device C Configuration

```
ip msdp default-peer 10.1.1.1 prefix-list site-b ge 32
ip prefix-list site-b permit 10.0.0.0/8
```

Related Topics

[Configuring a Default MSDP Peer](#), on page 202

[Default MSDP Peers](#), on page 190

Example: Configuring MSDP Mesh Groups

The following example shows how to configure three devices to be fully meshed members of an MSDP mesh group:

Device A Configuration

```
ip msdp peer 10.2.2.2
ip msdp peer 10.3.3.3
ip msdp mesh-group test-mesh-group 10.2.2.2
ip msdp mesh-group test-mesh-group 10.3.3.3
```

Device B Configuration

```
ip msdp peer 10.1.1.1
ip msdp peer 10.3.3.3
ip msdp mesh-group test-mesh-group 10.1.1.1
ip msdp mesh-group test-mesh-group 10.3.3.3
```

Device C Configuration

```
ip msdp peer 10.1.1.1
ip msdp peer 10.2.2.2
ip msdp mesh-group test-mesh-group 10.1.1.1
ip msdp mesh-group test-mesh-group 10.2.2.2
```

Related Topics

[Configuring an MSDP Mesh Group](#), on page 203

[MSDP Mesh Groups](#), on page 191

Additional References

Related Documents

| Related Topic | Document Title |
|----------------------------------|--|
| IPv6 addressing and connectivity | IPv6 Configuration Guide |
| Cisco IOS commands | Cisco IOS Master Commands List, All Releases |
| IP multicast commands | Cisco IOS IP Multicast Command Reference |
| IPv6 commands | Cisco IOS IPv6 Command Reference |
| Cisco IOS IPv6 features | Cisco IOS IPv6 Feature Mapping |

Standards and RFCs

| Standard/RFC | Title |
|---------------|------------------|
| RFCs for IPv6 | <i>IPv6 RFCs</i> |

MIBs

| MIB | MIBs Link |
|-----|--|
| | To locate and download MIBs for selected platforms, Cisco IOS releases, and feature sets, use Cisco MIB Locator found at the following URL: http://www.cisco.com/go/mibs |

Technical Assistance

| Description | Link |
|---|---|
| The Cisco Support and Documentation website provides online resources to download documentation, software, and tools. Use these resources to install and configure the software and to troubleshoot and resolve technical issues with Cisco products and technologies. Access to most tools on the Cisco Support and Documentation website requires a Cisco.com user ID and password. | http://www.cisco.com/cisco/web/support/index.html |

Feature History and Information for Multicast Source Discovery Protocol

| Release | Modification |
|--------------------|------------------------------|
| Cisco IOS XE 3.3SE | This feature was introduced. |



CHAPTER 10

Configuring Wireless Multicast

- [Finding Feature Information, on page 221](#)
- [Prerequisites for Configuring Wireless Multicast, on page 221](#)
- [Restrictions for Configuring Wireless Multicast, on page 221](#)
- [Information About Wireless Multicast, on page 222](#)
- [How to Configure Wireless Multicast, on page 226](#)
- [Monitoring Wireless Multicast, on page 234](#)
- [Where to Go Next for Wireless Multicast, on page 235](#)

Finding Feature Information

Your software release may not support all the features documented in this module. For the latest caveats and feature information, see Bug Search Tool and the release notes for your platform and software release. To find information about the features documented in this module, and to see a list of the releases in which each feature is supported, see the feature information table at the end of this module.

Use Cisco Feature Navigator to find information about platform support and Cisco software image support. To access Cisco Feature Navigator, go to <http://www.cisco.com/go/cfn>. An account on Cisco.com is not required.

Prerequisites for Configuring Wireless Multicast

- The IP multicast routing must be enabled and the PIM version and PIM mode must be configured. The default routes should be available in the device. After performing these tasks, the device can then forward multicast packets and can populate its multicast routing table.
- To participate in IP multicasting, the multicast hosts, routers, and multilayer switches must have IGMP operating.
- When enabling multicast mode on the switch, a CAPWAP multicast group address should also be configured. Access points listen to the CAPWAP multicast group using IGMP.

Restrictions for Configuring Wireless Multicast

The following are the restrictions for configuring IP multicast routing:

- Access points in monitor mode, sniffer mode, or rogue detector mode do not join the CAPWAP multicast group address.
- The CAPWAP multicast group configured on the switch should be different for different switches.
- Multicast routing should not be enabled for the management interface.

Restrictions for IPv6 Snooping

The IPv6 snooping feature is not supported on Etherchannel ports.

Restrictions for IPv6 RA Guard

- The IPv6 RA Guard feature does not offer protection in environments where IPv6 traffic is tunneled.
- This feature is supported only in hardware when the ternary content addressable memory (TCAM) is programmed.
- This feature can be configured on a switch port interface in the ingress direction.
- This feature supports host mode and router mode.
- This feature is supported only in the ingress direction; it is not supported in the egress direction.
- This feature is not supported on EtherChannel and EtherChannel port members.
- This feature is not supported on trunk ports with merge mode.
- This feature is supported on auxiliary VLANs and private VLANs (PVLANS). In the case of PVLANS, primary VLAN features are inherited and merged with port features.
- Packets dropped by the IPv6 RA Guard feature can be spanned.
- If the **platform ipv6 acl icmp optimize neighbor-discovery command** is configured, the IPv6 RA Guard feature cannot be configured and an error message will be displayed. This command adds default global Internet Control Message Protocol (ICMP) entries that will override the RA guard ICMP entries.

Information About Wireless Multicast

If the network supports packet multicasting, the multicast method that the switch uses can be configured. The switch performs multicasting in two modes:

- Unicast mode—The switch unicasts every multicast packet to every access point associated to the switch. This mode is inefficient but might be required on networks that do not support multicasting.
- Multicast mode—The switch sends multicast packets to a CAPWAP multicast group. This method reduces overhead on the switch processor and shifts the work of packet replication to the network, which is much more efficient than the unicast method.

When the multicast mode is enabled and the switch receives a multicast packet from the wired LAN, the switch encapsulates the packet using CAPWAP and forwards the packet to the CAPWAP multicast group address. The switch always uses the management VLAN for sending multicast packets. Access points in the

multicast group receive the packet and forward it to all the BSSIDs mapped to the VLAN on which clients receive multicast traffic.

The switch supports all the capabilities of v1 including Multicast Listener Discovery (MLD) v1 snooping but the v2 and v3 capabilities are limited. This feature keeps track of and delivers IPv6 multicast flows to the clients that request them. To support IPv6 multicast, global multicast mode should be enabled.

Internet Group Management Protocol (IGMP) snooping is introduced to better direct multicast packets. When this feature is enabled, the switch snooping gathers IGMP reports from the clients, processes them, creates unique multicast group IDs (MGIDs) based on the Layer 3 multicast address and the VLAN number, and sends the IGMP reports to the IGMP querier. The switch then updates the access point MGID table on the access point with the client MAC address. When the switch receives multicast traffic for a particular multicast group, it forwards it to all the access points, but only those access points that have active clients listening or subscribed to that multicast group send multicast traffic on that particular WLAN. IP packets are forwarded with an MGID that is unique for an ingress VLAN and the destination multicast group. Layer 2 multicast packets are forwarded with an MGID that is unique for the ingress VLAN.

MGID is a 14-bit value filled in the 16-bit reserved field of wireless information in CAPWAP header. The remaining 2 bits should be set to zero.

Related Topics

[Configuring Wireless Multicast-MCMC Mode \(CLI\)](#), on page 226

[Configuring Wireless Multicast-MCUC Mode \(CLI\)](#), on page 227

Information About Multicast Optimization

Multicast used to be based on the group of the multicast addresses and the VLAN as one entity, MGID. With the VLAN group, duplicate packets might increase. Using the VLAN group feature, every client listens to the multicast stream on a different VLAN. As a result, the switch creates different MGIDs for each multicast address and VLAN. Therefore, in a worst case situation, the upstream router sends one copy for each VLAN, which results in as many copies as the number of VLANs in the group. Because the WLAN remains the same for all clients, multiple copies of the multicast packet are sent over the wireless network. To suppress the duplication of a multicast stream on the wireless medium between the switch and the access points, the multicast optimization feature can be used.

Multicast optimization enables you to create a multicast VLAN that can be used for multicast traffic. One of the VLANs in the switch can be configured as a multicast VLAN where multicast groups are registered. The clients are allowed to listen to a multicast stream on the multicast VLAN. The MGID is generated using the multicast VLAN and multicast IP addresses. If multiple clients on different VLANs of the same WLAN are listening to a single multicast IP address, a single MGID is generated. The switch makes sure that all multicast streams from the clients on this VLAN group always go out on the multicast VLAN to ensure that the upstream router has one entry for all the VLANs of the VLAN group. Only one multicast stream hits the VLAN group even if the clients are on different VLANs. Therefore, the multicast packets that are sent out over the network is just one stream.

Related Topics

[Configuring IP Multicast VLAN for WLAN \(CLI\)](#), on page 233

IPv6 Global Policies

IPv6 global policies provide storage and access policy database services. IPv6 ND inspection and IPv6 RA guard are IPv6 global policies features. Every time an ND inspection or RA guard is configured globally, the

policy attributes are stored in the software policy database. The policy is then applied to an interface, and the software policy database entry is updated to include this interface to which the policy is applied.

IPv6 RA Guard

The IPv6 RA Guard feature provides support for allowing the network administrator to block or reject unwanted or rogue RA guard messages that arrive at the network device platform. RAs are used by devices to announce themselves on the link. The IPv6 RA Guard feature analyzes these RAs and filters out RAs that are sent by unauthorized devices. In host mode, all RA and router redirect messages are disallowed on the port. The RA guard feature compares configuration information on the Layer 2 (L2) device with the information found in the received RA frame. Once the L2 device has validated the content of the RA frame and router redirect frame against the configuration, it forwards the RA to its unicast or multicast destination. If the RA frame content is not validated, the RA is dropped.

Information About IPv6 Snooping

IPv6 Neighbor Discovery Inspection

The IPv6 Neighbor Discovery Inspection, or IPv6 "snooping," feature bundles several Layer 2 IPv6 first-hop security features, including IPv6 Address Glean and IPv6 Device Tracking. IPv6 neighbor discovery (ND) inspection operates at Layer 2, or between Layer 2 and Layer 3, and provides IPv6 features with security and scalability. This feature mitigates some of the inherent vulnerabilities for the neighbor discovery mechanism, such as attacks on duplicate address detection (DAD), address resolution, device discovery, and the neighbor cache.

IPv6 ND inspection learns and secures bindings for stateless autoconfiguration addresses in Layer 2 neighbor tables and analyzes ND messages in order to build a trusted binding table. IPv6 ND messages that do not have valid bindings are dropped. An ND message is considered trustworthy if its IPv6-to-MAC mapping is verifiable.

When IPv6 ND inspection is configured on a target (which varies depending on platform target support and may include device ports, switch ports, Layer 2 interfaces, Layer 3 interfaces, and VLANs), capture instructions are downloaded to the hardware to redirect the ND protocol and Dynamic Host Configuration Protocol (DHCP) for IPv6 traffic up to the switch integrated security features (SISF) infrastructure in the routing device. For ND traffic, messages such as NS, NA, RS, RA, and REDIRECT are directed to SISF. For DHCP, UDP messages sourced from port 546 or 547 are redirected.

IPv6 ND inspection registers its "capture rules" to the classifier, which aggregates all rules from all features on a given target and installs the corresponding ACL down into the platform-dependent modules. Upon receiving redirected traffic, the classifier calls all entry points from any registered feature (for the target on which the traffic is being received), including the IPv6 ND inspection entry point. This entry point is the last to be called, so any decision (such as drop) made by another feature supersedes the IPv6 ND inspection decision.

IPv6 ND Inspection

IPv6 ND inspection learns and secures bindings for stateless autoconfiguration addresses in Layer 2 neighbor tables. IPv6 ND inspection analyzes neighbor discovery messages in order to build a trusted binding table database, and IPv6 neighbor discovery messages that do not have valid bindings are dropped. A neighbor discovery message is considered trustworthy if its IPv6-to-MAC mapping is verifiable.

This feature mitigates some of the inherent vulnerabilities for the neighbor discovery mechanism, such as attacks on duplicate address detection (DAD), address resolution, device discovery, and the neighbor cache.

IPv6 Device Tracking

IPv6 device tracking provides IPv6 host liveness tracking so that a neighbor table can be immediately updated when an IPv6 host disappears.

IPv6 First-Hop Security Binding Table

The IPv6 First-Hop Security Binding Table recovery mechanism feature enables the binding table to recover in the event of a device reboot. A database table of IPv6 neighbors connected to the device is created from information sources such as ND snooping. This database, or binding, table is used by various IPv6 guard features to validate the link-layer address (LLA), the IPv4 or IPv6 address, and prefix binding of the neighbors to prevent spoofing and redirect attacks.

This mechanism enables the binding table to recover in the event of a device reboot. The recovery mechanism will block any data traffic sourced from an unknown source; that is, a source not already specified in the binding table and previously learned through ND or DHCP gleaning. This feature recovers the missing binding table entries when the resolution for a destination address fails in the destination guard. When a failure occurs, a binding table entry is recovered by querying the DHCP server or the destination host, depending on the configuration.

Recovery Protocols and Prefix Lists

The IPv6 First-Hop Security Binding Table Recovery Mechanism feature introduces the capability to provide a prefix list that is matched before the recovery is attempted for both DHCP and NDP.

If an address does not match the prefix list associated with the protocol, then the recovery of the binding table entry will not be attempted with that protocol. The prefix list should correspond to the prefixes that are valid for address assignment in the Layer 2 domain using the protocol. The default is that there is no prefix list, in which case the recovery is attempted for all addresses. The command to associate a prefix list to a protocol is **protocol {dhcp | ndp} [prefix-list *prefix-list-name*]**.

IPv6 Device Tracking

IPv6 device tracking provides IPv6 host liveness tracking so that a neighbor table can be immediately updated when an IPv6 host disappears.

IPv6 Address Glean

IPv6 address glean is the foundation for many other IPv6 features that depend on an accurate binding table. It inspects ND and DHCP messages on a link to glean addresses, and then populates the binding table with these addresses. This feature also enforces address ownership and limits the number of addresses any given node is allowed to claim.

The following figure shows how IPv6 address glean works.

Figure 14: IPv6 Address Glean

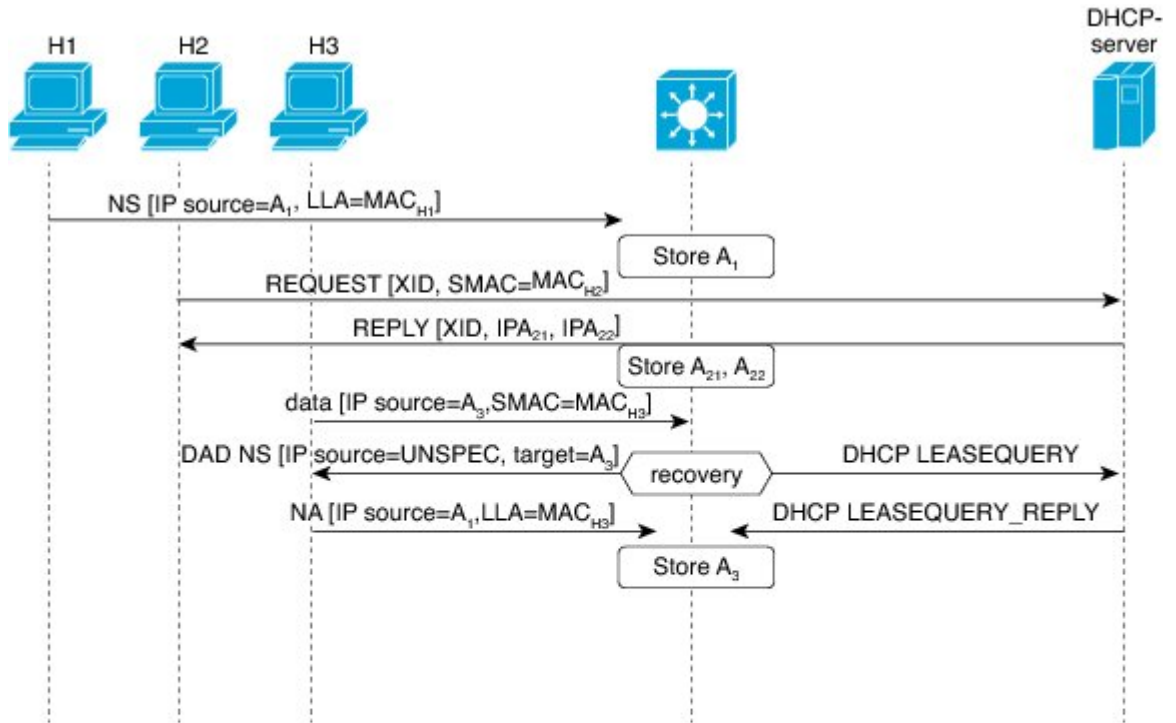

Binding Table

| IPv6 | MAC | VLAN | IF |
|-----------------|-------------------|------|----|
| A ₁ | MAC _{H1} | 100 | P1 |
| A ₂₁ | MAC _{H2} | 100 | P2 |
| A ₂₂ | MAC _{H2} | 100 | P2 |
| A ₃ | MAC _{H3} | 100 | P3 |

2855966

How to Configure Wireless Multicast

Configuring Wireless Multicast-MCMC Mode (CLI)

SUMMARY STEPS

1. enable
2. configure terminal
3. wireless multicast
4. ap capwap multicast ipaddr
5. end

DETAILED STEPS

| | Command or Action | Purpose |
|--------|---|---|
| Step 1 | enable Example: Switch> enable | Enables privileged EXEC mode. <ul style="list-style-type: none"> • Enter your password if prompted. |
| Step 2 | configure terminal Example: Switch# configure terminal | Enters global command mode. |
| Step 3 | wireless multicast Example: Switch(config)# wireless multicast Switch(config)# no wireless multicast | Enables the multicast traffic for wireless clients. The default value is disable. Add no in the command to disable the multicast traffic for wireless clients. |
| Step 4 | ap capwap multicast ipaddr Example: Switch(config)# ap capwap multicast 231.1.1.1 Switch(config)# no ap capwap multicast 231.1.1.1 | Enables the forwarding mode in multicast. Add no in the command to disable the multicast mode. |
| Step 5 | end Example: Switch(config)# end | Exits the configuration mode. Alternatively, press Ctrl-Z to exit the configuration mode. |

Related Topics

[Information About Wireless Multicast](#), on page 222

Configuring Wireless Multicast-MCUC Mode (CLI)

SUMMARY STEPS

1. **enable**
2. **configure terminal**
3. **wireless multicast**
4. **no ap capwap multicast ipaddr**
5. **end**

DETAILED STEPS

| | Command or Action | Purpose |
|--------|-------------------|-------------------------------|
| Step 1 | enable | Enables privileged EXEC mode. |

| | Command or Action | Purpose |
|---------------|--|---|
| | Example: Switch> enable | <ul style="list-style-type: none"> Enter your password if prompted. |
| Step 2 | configure terminal Example: Switch# configure terminal | Enters global command mode. |
| Step 3 | wireless multicast Example: Switch(config)# wireless multicast | Enables the multicast traffic for wireless clients and enables mDNS bridging. The default value is disable. Add no in the command to disable the multicast traffic for wireless clients and disable mDNS bridging. |
| Step 4 | no ap capwap multicast ipaddr Example: Switch(config)# no ap capwap multicast 231.1.1.1 | Enables forwarding mode in multicast. Add no in the command to disable the multicast mode. |
| Step 5 | end Example: Switch(config)# end | Exits the configuration mode. Alternatively, press Ctrl-Z to exit the configuration mode. |

Related Topics

[Information About Wireless Multicast](#), on page 222

Configuring IPv6 Snooping (CLI)

SUMMARY STEPS

- enable
- configure terminal
- ipv6 mld snooping

DETAILED STEPS

| | Command or Action | Purpose |
|---------------|---|--|
| Step 1 | enable Example: Switch> enable | Enables privileged EXEC mode. <ul style="list-style-type: none"> Enter your password if prompted. |
| Step 2 | configure terminal Example: Switch# configure terminal | Enters global command mode. |

| | Command or Action | Purpose |
|--------|---|-----------------------|
| Step 3 | ipv6 mld snooping Example: Switch(config)# ipv6 mld snooping | Enables MLD snooping. |

Configuring IPv6 Snooping Policy (CLI)

SUMMARY STEPS

1. enable
2. configure terminal
3. ipv6 snooping policy *policy-name*
4. security-level guard
5. device-role node
6. protocol {dhcp | ndp}

DETAILED STEPS

| | Command or Action | Purpose |
|--------|---|--|
| Step 1 | enable Example: Switch> enable | Enables privileged EXEC mode. <ul style="list-style-type: none"> • Enter your password if prompted. |
| Step 2 | configure terminal Example: Switch# configure terminal | Enters global command mode. |
| Step 3 | ipv6 snooping policy <i>policy-name</i> Example: Switch(config)# ipv6 snooping policy mypolicy | Configures an IPv6 snooping policy with a name. |
| Step 4 | security-level guard Example: Switch(config-ipv6-snooping)# security-level guard | Configures security level to inspect and drop any unauthorized messages. |
| Step 5 | device-role node Example: Switch(config-ipv6-snooping)# device-role node | Configures the role of the device, which is a node, to the attached port. |
| Step 6 | protocol {dhcp ndp} Example: Switch(config-ipv6-snooping)# protocol ndp | Sets the protocol to glean addresses in DHCP or NDP packets. |

Configuring Layer 2 Port as Multicast Router Port (CLI)

SUMMARY STEPS

1. enable
2. configure terminal
3. `ipv6 mld snooping vlan vlan-id mrouter interface Port-channel port-channel-interface-number`

DETAILED STEPS

| | Command or Action | Purpose |
|--------|--|--|
| Step 1 | enable Example: Switch> <code>enable</code> | Enables privileged EXEC mode. <ul style="list-style-type: none"> • Enter your password if prompted. |
| Step 2 | configure terminal Example: Switch# <code>configure terminal</code> | Enters global command mode. |
| Step 3 | ipv6 mld snooping vlan <i>vlan-id</i> mrouter interface Port-channel <i>port-channel-interface-number</i> Example: Switch(config)# <code>ipv6 mld snooping vlan 2 mrouter interface Port-channel 22</code> | Configures a Layer 2 port as a Multicast router port. The VLAN is the client VLAN. |

Configuring IPv6 RA Guard (CLI)

SUMMARY STEPS

1. enable
2. configure terminal
3. `ipv6 nd raguard policy policy-name`
4. trusted-port
5. device-role {host | monitor | router | switch}

DETAILED STEPS

| | Command or Action | Purpose |
|--------|---|--|
| Step 1 | enable Example: Switch> <code>enable</code> | Enables privileged EXEC mode. <ul style="list-style-type: none"> • Enter your password if prompted. |

| | Command or Action | Purpose |
|--------|--|---|
| Step 2 | configure terminal Example: Switch# <code>configure terminal</code> | Enters global command mode. |
| Step 3 | ipv6 nd raguard policy <i>policy-name</i> Example: Switch(config)# <code>ipv6 nd raguard policy myraguardpolicy</code> | Configures a policy for RA Guard. |
| Step 4 | trusted-port Example: Switch(config-nd-raguard)# <code>trusted-port</code> | Sets up a trusted port. |
| Step 5 | device-role {host monitor router switch} Example: Switch(config-nd-raguard)# <code>device-role router</code> | Sets the role of the device attached to the port. |

Configuring Non-IP Wireless Multicast (CLI)

SUMMARY STEPS

1. `enable`
2. `configure terminal`
3. `wireless multicast non-ip`
4. `wireless multicast non-ip vlanid`
5. `end`

DETAILED STEPS

| | Command or Action | Purpose |
|--------|---|--|
| Step 1 | enable Example: Switch> <code>enable</code> | Enables privileged EXEC mode. <ul style="list-style-type: none"> • Enter your password if prompted. |
| Step 2 | configure terminal Example: Switch# <code>configure terminal</code> | Enters global command mode. |
| Step 3 | wireless multicast non-ip Example: | Enables non-IP multicast in all VLANs. Default value is enable . Wireless multicast must be enabled for the traffic to pass. Add no in the command to disable the non-IP multicast in all VLANs. |

| | Command or Action | Purpose |
|---------------|--|---|
| | Switch(config) # wireless multicast non-ip Switch(config) # no wireless multicast non-ip | |
| Step 4 | wireless multicast non-ip <i>vlanid</i> Example: Switch(config) # wireless multicast non-ip 5 Switch(config) # no wireless multicast non-ip 5 | Enables non-IP multicast per VLAN. Default value is enable . Both wireless multicast and wireless multicast non-IP must be enabled for traffic to pass. Add no in the command to disable the non-IP multicast per VLAN. |
| Step 5 | end Example: Switch(config) # end | Exits the configuration mode. Alternatively, press Ctrl-Z to exit the configuration mode. |

Configuring Wireless Broadcast (CLI)

SUMMARY STEPS

1. **enable**
2. **configure terminal**
3. **wireless broadcast**
4. **wireless broadcast vlan** *vlanid*
5. **end**

DETAILED STEPS

| | Command or Action | Purpose |
|---------------|---|---|
| Step 1 | enable Example: Switch> enable | Enables privileged EXEC mode. <ul style="list-style-type: none">• Enter your password if prompted. |
| Step 2 | configure terminal Example: Switch# configure terminal | Enters global command mode. |
| Step 3 | wireless broadcast Example: Switch(config) # wireless broadcast Switch(config) # no wireless broadcast | Enables broadcast packets for wireless clients. Default value is disable. Enabling wireless broadcast enables broadcast traffic for each VLAN. Add no in the command to disable broadcasting packets. |
| Step 4 | wireless broadcast vlan <i>vlanid</i> Example: | Enables broadcast packets for single VLAN. Default value is enable . Wireless broadcast must be enabled for |

| | Command or Action | Purpose |
|---------------|--|--|
| | <pre>Switch(config)# wireless broadcast vlan 3</pre> <pre>Switch(config)# no wireless broadcast vlan 3</pre> | broadcasting. Add no in the command to disable the broadcast traffic for each VLAN. |
| Step 5 | end Example: <pre>Switch(config)# end</pre> | Exits the configuration mode. Alternatively, press Ctrl-Z to exit the configuration mode. |

Configuring IP Multicast VLAN for WLAN (CLI)

SUMMARY STEPS

1. **enable**
2. **configure terminal**
3. **wlan *wlan_name***
4. **shutdown**
5. **ip multicast vlan {*vlan_name* *vlan_id*}**
6. **no shutdown**
7. **end**

DETAILED STEPS

| | Command or Action | Purpose |
|---------------|---|--|
| Step 1 | enable Example: <pre>Switch> enable</pre> | Enables privileged EXEC mode. <ul style="list-style-type: none"> • Enter your password if prompted. |
| Step 2 | configure terminal Example: <pre>Switch# configure terminal</pre> | Enters global command mode. |
| Step 3 | wlan <i>wlan_name</i> Example: <pre>Switch(config)# wlan test 1</pre> | Enters the configuration mode to configure various parameters in the WLAN. |
| Step 4 | shutdown Example: <pre>Switch(config-wlan)# shutdown</pre> | Disables WLAN. |
| Step 5 | ip multicast vlan {<i>vlan_name</i> <i>vlan_id</i>} Example: | Configures multicast VLAN for WLAN. Add no in the command to disable the multicast VLAN for WLAN. |

| | Command or Action | Purpose |
|---------------|---|--|
| | <pre>Switch(config-wlan) # ip multicast vlan 5 Switch(config-wlan) # no ip multicast vlan 5</pre> | |
| Step 6 | no shutdown Example: <pre>Switch(config-wlan) # no shutdown</pre> | Enables the disabled WLAN. |
| Step 7 | end Example: <pre>Switch(config) # end</pre> | Exits the configuration mode. Alternatively, press Ctrl-Z to exit the configuration mode. |

Related Topics

[Information About Multicast Optimization](#), on page 223

Monitoring Wireless Multicast

Table 19: Commands for Monitoring Wireless Multicast

| Commands | Description |
|--|--|
| show wireless multicast | Displays the multicast status and IP multicast mode, each VLAN's broadcast and non-IP multicast status. Also displays the mDNS bridging state. |
| show wireless multicast group summary | Displays all (Source, Group and VLAN) lists and the corresponding MGID value. |
| show wireless multicast [source source] group group vlan vlanid | Displays details of the given (S,G,V) and shows all of the clients associated with it and their MC2UC status. |
| show ip igmp snooping wireless mcast-spi-count | Displays statistics of the number of multicast SPIs per MGID sent between IOS and the Wireless Controller Module. |
| show ip igmp snooping wireless mgid | Displays the MGID mappings. |
| show ip igmp snooping igmpv2-tracking | Displays the client-to-SGV mappings and SGV-to-client mappings. |
| show ip igmp snooping querier vlan vlanid | Displays IGMP querier information for the specified VLAN. |
| show ip igmp snooping querier detail | Displays detailed IGMP querier information of all the VLANs. |
| show ipv6 mld snooping querier vlan vlanid | Displays MLD querier information for the specified VLAN. |
| show ipv6 mld snooping wireless mgid | Displays MGIDs for IPv6 multicast group. |

Where to Go Next for Wireless Multicast

You can configure the following:

- IGMP
- PIM
- SSM
- IP Multicast Routing
- Service Discovery Gateway

You can also review the following IP Multicast Optimization processes for your configuration:

- Optimizing PIM Sparse Mode in a Large IP Multicast Deployment
- Multicast Subsecond Convergence
- IP Multicast Load Splitting across Equal-Cost Paths
- SSM Channel Based Filtering for Multicast
- PIM Dense Mode State Refresh
- IGMP State Limit



CHAPTER 11

Configuring SSM

- [Finding Feature Information, on page 237](#)
- [Prerequisites for Configuring SSM, on page 237](#)
- [Restrictions for Configuring SSM, on page 238](#)
- [Information About SSM and SSM Mapping, on page 239](#)
- [How to Configure SSM and SSM Mapping, on page 245](#)
- [Monitoring SSM and SSM Mapping, on page 256](#)
- [Configuration Examples for SSM and SSM Mapping, on page 256](#)
- [Additional References, on page 261](#)
- [Feature History and Information for SSM, on page 262](#)

Finding Feature Information

Your software release may not support all the features documented in this module. For the latest caveats and feature information, see [Bug Search Tool](#) and the release notes for your platform and software release. To find information about the features documented in this module, and to see a list of the releases in which each feature is supported, see the feature information table.

Use Cisco Feature Navigator to find information about platform support and Cisco software image support. To access Cisco Feature Navigator, go to www.cisco.com/go/cfn. An account on Cisco.com is not required.

Prerequisites for Configuring SSM

The following are the prerequisites for configuring source-specific multicast (SSM) and SSM mapping:

- Before you configure SSM mapping, you must perform the following tasks:
 - Enable IP multicast routing.
 - Enable PIM sparse mode.
 - Configure SSM.
- Before you configure static SSM mapping, you must configure access control lists (ACLs) that define the group ranges to be mapped to source addresses.

- Before you can configure and use SSM mapping with DNS lookups, you need to add records to a running DNS server. If you do not already have a DNS server running, you need to install one.



Note You can use a product such as *Cisco Network Registrar* to add records to a running DNS server.

Related Topics

[Configuring Basic IP Multicast Routing](#), on page 266

[Configuring Source Specific Multicast](#), on page 245

Restrictions for Configuring SSM

The following are the restrictions for configuring SSM:

- To run SSM with IGMPv3, SSM must be supported in the Cisco IOS router, the host where the application is running, and the application itself.
- Existing applications in a network predating SSM will not work within the SSM range unless they are modified to support (S, G) channel subscriptions. Therefore, enabling SSM in a network may cause problems for existing applications if they use addresses within the designated SSM range.
- IGMP Snooping—IGMPv3 uses new membership report messages that might not be correctly recognized by older IGMP snooping switches.
- Address management is still necessary to some degree when SSM is used with Layer 2 switching mechanisms. Cisco Group Management Protocol (CGMP), IGMP snooping, or Router-Port Group Management Protocol (RGMP) support only group-specific filtering, not (S, G) channel-specific filtering. If different receivers in a switched network request different (S, G) channels sharing the same group, they do not benefit from these existing mechanisms. Instead, both receivers receive all (S, G) channel traffic and filter out the unwanted traffic on input. Because SSM can re-use the group addresses in the SSM range for many independent applications, this situation can lead to decreased traffic filtering in a switched network. For this reason, it is important to use random IP addresses from the SSM range for an application to minimize the chance for re-use of a single address within the SSM range between different applications. For example, an application service providing a set of television channels should, even with SSM, use a different group for each television (S, G) channel. This setup guarantees that multiple receivers to different channels within the same application service never experience traffic aliasing in networks that include Layer 2 devices.
- In PIM-SSM, the last hop router will continue to periodically send (S, G) join messages if appropriate (S, G) subscriptions are on the interfaces. Therefore, as long as receivers send (S, G) subscriptions, the shortest path tree (SPT) state from the receivers to the source will be maintained, even if the source is not sending traffic for longer periods of time (or even never).

The opposite situation occurs with PIM-SM, where (S, G) state is maintained only if the source is sending traffic and receivers are joining the group. If a source stops sending traffic for more than 3 minutes in PIM-SM, the (S, G) state is deleted and only reestablished after packets from the source arrive again through the RPT (rendezvous point tree). Because no mechanism in PIM-SSM notifies a receiver that a source is active, the network must maintain the (S, G) state in PIM-SSM as long as receivers are requesting receipt of that channel.

The following are the restrictions for configuring SSM mapping:

- The SSM Mapping feature does not share the benefit of full SSM. SSM mapping takes a group G join from a host and identifies this group with an application associated with one or more sources, therefore, it can only support one such application per group G. Nevertheless, full SSM applications may still share the same group also used in SSM mapping.
- Enable IGMPv3 with care on the last hop router when you rely solely on SSM mapping as a transition solution for full SSM. When you enable both SSM mapping and IGMPv3 and the hosts already support IGMPv3 (but not SSM), the hosts send IGMPv3 group reports. SSM mapping does not support these IGMPv3 group reports, and the router does not correctly associate sources with these reports.

Information About SSM and SSM Mapping

SSM Components Overview

SSM is a datagram delivery model that best supports one-to-many applications, also known as broadcast applications.

SSM is a core networking technology for Cisco's implementation of IP multicast solutions targeted for audio and video broadcast application environments and is described in RFC 3569. The following components together support the implementation of SSM:

- Protocol Independent Multicast source-specific mode (PIM-SSM)
- Internet Group Management Protocol Version 3 (IGMPv3)

Protocol Independent Multicast (PIM) SSM, or PIM-SSM, is the routing protocol that supports the implementation of SSM and is derived from PIM sparse mode (PIM-SM). IGMP is the Internet Engineering Task Force (IETF) standards track protocol used for hosts to signal multicast group membership to routers. IGMP Version 3 supports source filtering, which is required for SSM. For SSM to run with IGMPv3, SSM must be supported in the router, the host where the application is running, and the application itself.

Related Topics

[Configuring Source Specific Multicast](#), on page 245

[SSM with IGMPv3 Example](#), on page 256

How SSM Differs from Internet Standard Multicast

The standard IP multicast infrastructure in the Internet and many enterprise intranets is based on the PIM-SM protocol and Multicast Source Discovery Protocol (MSDP). These protocols have proved to be reliable, extensive, and efficient. However, they are bound to the complexity and functionality limitations of the Internet Standard Multicast (ISM) service model. For example, with ISM, the network must maintain knowledge about which hosts in the network are actively sending multicast traffic. With SSM, this information is provided by receivers through the source addresses relayed to the last-hop devices by IGMPv3. SSM is an incremental response to the issues associated with ISM and is intended to coexist in the network with the protocols developed for ISM. In general, SSM provides IP multicast service for applications that utilize SSM.

ISM service is described in RFC 1112. This service consists of the delivery of IP datagrams from any source to a group of receivers called the multicast host group. The datagram traffic for the multicast host group consists of datagrams with an arbitrary IP unicast source address S and the multicast group address G as the

IP destination address. Systems will receive this traffic by becoming members of the host group. Membership in a host group simply requires signaling the host group through IGMP Version 1, 2, or 3.

In SSM, delivery of datagrams is based on (S, G) channels. Traffic for one (S, G) channel consists of datagrams with an IP unicast source address S and the multicast group address G as the IP destination address. Systems will receive this traffic by becoming members of the (S, G) channel. In both SSM and ISM, no signaling is required to become a source. However, in SSM, receivers must subscribe or unsubscribe to (S, G) channels to receive or not receive traffic from specific sources. In other words, receivers can receive traffic only from (S, G) channels to which they are subscribed, whereas in ISM, receivers need not know the IP addresses of sources from which they receive their traffic. The proposed standard approach for channel subscription signaling utilizes IGMP INCLUDE mode membership reports, which are supported only in IGMP Version 3.

SSM can coexist with the ISM service by applying the SSM delivery model to a configured subset of the IP multicast group address range. The Internet Assigned Numbers Authority (IANA) has reserved the address range from 232.0.0.0 through 232.255.255.255 for SSM applications and protocols. The software allows SSM configuration for an arbitrary subset of the IP multicast address range from 224.0.0.0 through 239.255.255.255. When an SSM range is defined, an existing IP multicast receiver application will not receive any traffic when it tries to use addresses in the SSM range unless the application is modified to use explicit (S, G) channel subscription or is SSM-enabled through a URL Rendezvous Directory (URD).

SSM Operations

An established network in which IP multicast service is based on PIM-SM can support SSM services. SSM can also be deployed alone in a network without the full range of protocols that are required for interdomain PIM-SM. That is, SSM does not require an RP, so there is no need for an RP mechanism such as Auto-RP, MSDP, or bootstrap router (BSR).

If SSM is deployed in a network that is already configured for PIM-SM, then only the last-hop routers must be upgraded to a software image that supports SSM. Routers that are not directly connected to receivers do not have to upgrade to a software image that supports SSM. In general, these non-last-hop routers must only run PIM-SM in the SSM range. They may need additional access control configuration to suppress MSDP signaling, registering, or PIM-SM shared-tree operations from occurring within the SSM range.

The SSM mode of operation is enabled by configuring the SSM range using the **ip pim ssm** global configuration command. This configuration has the following effects:

- For groups within the SSM range, (S, G) channel subscriptions are accepted through IGMPv3 INCLUDE mode membership reports.
- PIM operations within the SSM range of addresses change to PIM-SSM, a mode derived from PIM-SM. In this mode, only PIM (S, G) Join and Prune messages are generated by the router. Incoming messages related to rendezvous point tree (RPT) operations are ignored or rejected, and incoming PIM register messages are immediately answered with Register-Stop messages. PIM-SSM is backward-compatible with PIM-SM unless a router is a last-hop router. Therefore, routers that are not last-hop routers can run PIM-SM for SSM groups (for example, if they do not yet support SSM).
- For groups within the SSM range, no MSDP Source-Active (SA) messages within the SSM range will be accepted, generated, or forwarded.

IGMPv3 Host Signaling

IGMPv3 is the third version of the IETF standards track protocol in which hosts signal membership to last-hop routers of multicast groups. IGMPv3 introduces the ability for hosts to signal group membership that allows filtering capabilities with respect to sources. A host can signal either that it wants to receive traffic from all sources sending to a group except for some specific sources (a mode called EXCLUDE) or that it wants to receive traffic only from some specific sources sending to the group (a mode called INCLUDE).

IGMPv3 can operate with both ISM and SSM. In ISM, both EXCLUDE and INCLUDE mode reports are accepted by the last-hop router. In SSM, only INCLUDE mode reports are accepted by the last-hop router.

Benefits of SSM

IP Multicast Address Management Not Required

In the ISM service, applications must acquire a unique IP multicast group address because traffic distribution is based only on the IP multicast group address used. If two applications with different sources and receivers use the same IP multicast group address, then receivers of both applications will receive traffic from the senders of both applications. Even though the receivers, if programmed appropriately, can filter out the unwanted traffic, this situation would cause generally unacceptable levels of unwanted traffic.

Allocating a unique IP multicast group address for an application is still a problem. Most short-lived applications use mechanisms like Session Description Protocol (SDP) and Session Announcement Protocol (SAP) to get a random address, a solution that does not work well with a rising number of applications in the Internet. The best current solution for long-lived applications is described in RFC 2770, but this solution suffers from the restriction that each autonomous system is limited to only 255 usable IP multicast addresses.

In SSM, traffic from each source is forwarded between routers in the network independent of traffic from other sources. Thus different sources can reuse multicast group addresses in the SSM range.

Denial of Service Attacks from Unwanted Sources Inhibited

In SSM, multicast traffic from each individual source will be transported across the network only if it was requested (through IGMPv3, IGMP v3lite, or URD memberships) from a receiver. In contrast, ISM forwards traffic from any active source sending to a multicast group to all receivers requesting that multicast group. In Internet broadcast applications, this ISM behavior is highly undesirable because it allows unwanted sources to easily disturb the actual Internet broadcast source by simply sending traffic to the same multicast group. This situation depletes bandwidth at the receiver side with unwanted traffic and thus disrupts the undisturbed reception of the Internet broadcast. In SSM, this type of denial of service (DoS) attack cannot be made by simply sending traffic to a multicast group.

Easy to Install and Manage

SSM is easy to install and provision in a network because it does not require the network to maintain which active sources are sending to multicast groups. This requirement exists in ISM (with IGMPv1, IGMPv2, or IGMPv3).

The current standard solutions for ISM service are PIM-SM and MSDP. Rendezvous point (RP) management in PIM-SM (including the necessity for Auto-RP or BSR) and MSDP is required only for the network to learn about active sources. This management is not necessary in SSM, which makes SSM easier than ISM to install and manage, and therefore easier than ISM to operationally scale in deployment. Another factor that contributes to the ease of installation of SSM is the fact that it can leverage preexisting PIM-SM networks and requires only the upgrade of last hop routers to support IGMPv3, IGMP v3lite, or URD.

Ideal for Internet Broadcast Applications

The three benefits previously described make SSM ideal for Internet broadcast-style applications for the following reasons:

- The ability to provide Internet broadcast services through SSM without the need for unique IP multicast addresses allows content providers to easily offer their service (IP multicast address allocation has been a serious problem for content providers in the past).
- The prevention against DoS attacks is an important factor for Internet broadcast services because, with their exposure to a large number of receivers, they are the most common targets for such attacks.
- The ease of installation and operation of SSM makes it ideal for network operators, especially in those cases where content needs to be forwarded between multiple independent PIM domains (because there is no need to manage MSDP for SSM between PIM domains).

SSM Mapping Overview

SSM mapping supports SSM transition when supporting SSM on the end system is impossible or unwanted due to administrative or technical reasons. Using SSM to deliver live streaming video to legacy STBs that do not support IGMPv3 or for applications that do not use the IGMPv3 host stack is a typical application of SSM mapping.

In a typical STB deployment, each TV channel uses one separate IP multicast group and has one active server host sending the TV channel. A single server may of course send multiple TV channels, but each to a different group. In this network environment, if a router receives an IGMPv1 or IGMPv2 membership report for a particular group G, the report implicitly addresses the well-known TV server for the TV channel associated with the multicast group.

SSM mapping introduces a means for the last hop router to discover sources sending to groups. When SSM mapping is configured, if a router receives an IGMPv1 or IGMPv2 membership report for a particular group G, the router translates this report into one or more (S, G) channel memberships for the well-known sources associated with this group.

When the router receives an IGMPv1 or IGMPv2 membership report for group G, the router uses SSM mapping to determine one or more source IP addresses for group G. SSM mapping then translates the membership report as an IGMPv3 report INCLUDE (G, [S1, G], [S2, G]...[Sn, G] and continues as if it had received an IGMPv3 report. The router then sends out PIM joins toward (S1, G) to (Sn, G) and continues to be joined to these groups as long as it continues to receive the IGMPv1 or IGMPv2 membership reports and as long as it continues to receive the IGMPv1 or IGMPv2 membership reports, and the SSM mapping for the group remains the same. SSM mapping, thus, enables you to leverage SSM for video delivery to legacy STBs that do not support IGMPv3 or for applications that do not take advantage of the IGMPv3 host stack.

SSM mapping enables the last hop router to determine the source addresses either by a statically configured table on the router or by consulting a DNS server. When the statically configured table is changed, or when the DNS mapping changes, the router will leave the current sources associated with the joined groups.

Related Topics

[Configuring Static SSM Mapping\(CLI\)](#), on page 247

[Verifying SSM Mapping Configuration and Operation](#), on page 253

[Configuring Basic IP Multicast Routing](#), on page 266

[Configuring DNS-Based SSM Mapping\(CLI\)](#), on page 248

[Configuring Static Traffic Forwarding with SSM Mapping \(CLI\)](#), on page 251

Static SSM Mapping

SSM static mapping enables you to configure the last hop router to use a static map to determine the sources sending to groups. Static SSM mapping requires that you configure access lists (ACLs) to define group ranges. The groups permitted by those ACLs then can be mapped to sources using the `ip igmp static ssm-map` global configuration command.

You can configure static SSM mapping in smaller networks when a DNS is not needed or to locally override DNS mappings that may be temporarily incorrect. When configured, static SSM mappings take precedence over DNS mappings.

Related Topics

[Configuring Static SSM Mapping\(CLI\)](#), on page 247

[Verifying SSM Mapping Configuration and Operation](#), on page 253

[Configuring Basic IP Multicast Routing](#), on page 266

DNS-Based SSM Mapping

DNS-based SSM mapping enables you to configure the last hop router to perform a reverse DNS lookup to determine sources sending to groups (see the figure below). When DNS-based SSM mapping is configured, the router constructs a domain name that includes the group address G and performs a reverse lookup into the DNS. The router looks up IP address resource records (IP A RRs) to be returned for this constructed domain name and uses the returned IP addresses as the source addresses associated with this group. SSM mapping supports up to 20 sources for each group. The router joins all sources configured for a group.

Figure 15: DNS-Based SSM-Mapping

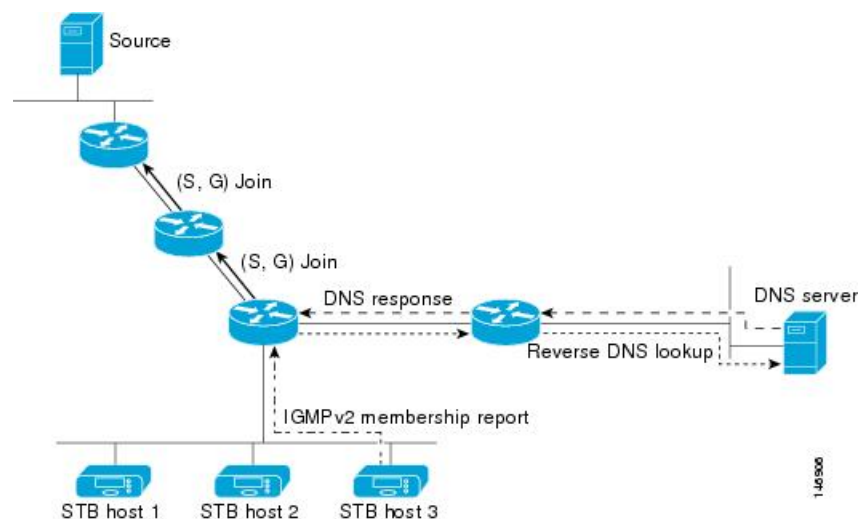

The SSM mapping mechanism that enables the last hop router to join multiple sources for a group can be used to provide source redundancy for a TV broadcast. In this context, the redundancy is provided by the last hop router using SSM mapping to join two video sources simultaneously for the same TV channel. However, to prevent the last hop router from duplicating the video traffic, it is necessary that the video sources utilize a server-side switchover mechanism where one video source is active while the other backup video source is passive. The passive source waits until an active source failure is detected before sending the video traffic for the TV channel. The server-side switchover mechanism, thus, ensures that only one of the servers is actively sending the video traffic for the TV channel.

To look up one or more source addresses for a group G that includes G1, G2, G3, and G4, the following DNS resource records (RRs) must be configured on the DNS server:

| | |
|--|------------------------------|
| G4.G3.G2.G1 [<i>multicast-domain</i>] [<i>timeout</i>] | IN A <i>source-address-1</i> |
| | IN A <i>source-address-2</i> |
| | IN A <i>source-address-n</i> |

The *multicast-domain* argument is a configurable DNS prefix. The default DNS prefix is in-addr.arpa. You should only use the default prefix when your installation is either separate from the internet or if the group names that you map are global scope group addresses (RFC 2770 type addresses that you configure for SSM) that you own.

The *timeout* argument configures the length of time for which the router performing SSM mapping will cache the DNS lookup. This argument is optional and defaults to the timeout of the zone in which this entry is configured. The timeout indicates how long the router will keep the current mapping before querying the DNS server for this group. The timeout is derived from the cache time of the DNS RR entry and can be configured for each group/source entry on the DNS server. You can configure this time for larger values if you want to minimize the number of DNS queries generated by the router. Configure this time for a low value if you want to be able to quickly update all routers with new source addresses.



Note Refer to your DNS server documentation for more information about configuring DNS RRs.

To configure DNS-based SSM mapping in the software, you must configure a few global commands but no per-channel specific configuration is needed. There is no change to the configuration for SSM mapping if additional channels are added. When DNS-based SSM mapping is configured, the mappings are handled entirely by one or more DNS servers. All DNS techniques for configuration and redundancy management can be applied to the entries needed for DNS-based SSM mapping.

Related Topics

- [Configuring DNS-Based SSM Mapping\(CLI\)](#), on page 248
- [Verifying SSM Mapping Configuration and Operation](#), on page 253
- [Configuring Basic IP Multicast Routing](#), on page 266
- [Configuring Static Traffic Forwarding with SSM Mapping \(CLI\)](#), on page 251

SSM Mapping Benefits

- The SSM Mapping feature provides almost the same ease of network installation and management as a pure SSM solution based on IGMPv3. Some additional configuration is necessary to enable SSM mapping.
- The SSM benefit of inhibition of DoS attacks applies when SSM mapping is configured. When SSM mapping is configured the only segment of the network that may still be vulnerable to DoS attacks are receivers on the LAN connected to the last hop router. Since those receivers may still be using IGMPv1 and IGMPv2, they are vulnerable to attacks from unwanted sources on the same LAN. SSM mapping, however, does protect those receivers (and the network path leading towards them) from multicast traffic from unwanted sources anywhere else in the network.
- Address assignment within a network using SSM mapping needs to be coordinated, but it does not need assignment from outside authorities, even if the content from the network is to be transited into other networks.

How to Configure SSM and SSM Mapping

Configuring Source Specific Multicast

Follow these steps to configure SSM:

Before you begin

If you want to use an access list to define the Source Specific Multicast (SSM) range, configure the access list before you reference the access list in the **ip pim ssm** command.

SUMMARY STEPS

1. **enable**
2. **configure terminal**
3. **ip multicast-routing [distributed]**
4. **ip pim ssm {default | range *access-list*}**
5. **interface *type number***
6. **ip pim sparse-mode**
7. Repeat Steps 1 through 6 on every interface that uses IP multicast.
8. **ip igmp version 3**
9. Repeat Step 8 on all host-facing interfaces.
10. **end**
11. **show ip igmp groups [*group-name* | *group-address* | *interface-type interface-number*] [detail]**
12. **show ip mroute**

DETAILED STEPS

| | Command or Action | Purpose |
|--------|---|---|
| Step 1 | enable Example: Switch> enable | Enables privileged EXEC mode. Enter your password if prompted. |
| Step 2 | configure terminal Example: Switch# configure terminal | Enters global configuration mode. |
| Step 3 | ip multicast-routing [distributed] Example: Switch(config)# ip multicast-routing | Enables IP multicast routing. <ul style="list-style-type: none"> • Use the distributed keyword to enable Multicast Distributed Switching. |
| Step 4 | ip pim ssm {default range <i>access-list</i>} | Configures SSM service. |

| | Command or Action | Purpose |
|----------------|---|---|
| | <p>Example:</p> <pre>Switch(config)# ip pim ssm default</pre> | <ul style="list-style-type: none"> The default keyword defines the SSM range access list as 232/8. The range keyword specifies the standard IP access list number or name that defines the SSM range. |
| Step 5 | <p>interface <i>type number</i></p> <p>Example:</p> <pre>Switch(config)# interface gigabitethernet 1/0/0</pre> | Selects an interface that is connected to hosts on which IGMPv3 can be enabled. |
| Step 6 | <p>ip pim sparse-mode</p> <p>Example:</p> <pre>Switch(config-if)# ip pim sparse-mode</pre> | Enables PIM on an interface. You must use sparse mode. |
| Step 7 | Repeat Steps 1 through 6 on every interface that uses IP multicast. | -- |
| Step 8 | <p>ip igmp version 3</p> <p>Example:</p> <pre>Switch(config-if)# ip igmp version 3</pre> | Enables IGMPv3 on this interface. The default version of IGMP is set to Version 2. Version 3 is required by SSM. |
| Step 9 | Repeat Step 8 on all host-facing interfaces. | -- |
| Step 10 | <p>end</p> <p>Example:</p> <pre>Switch(config-if)# end</pre> | Ends the current configuration session and returns to privileged EXEC mode. |
| Step 11 | <p>show ip igmp groups [<i>group-name</i> <i>group-address</i> <i>interface-type interface-number</i>] [detail]</p> <p>Example:</p> <pre>Switch# show ip igmp groups</pre> | <p>(Optional) Displays the multicast groups having receivers that are directly connected to the device and that were learned through IGMP.</p> <ul style="list-style-type: none"> A receiver must be active on the network at the time that this command is issued in order for receiver information to be present on the resulting display. |
| Step 12 | <p>show ip mroute</p> <p>Example:</p> <pre>Switch# show ip mroute</pre> | <p>(Optional) Displays the contents of the IP mroute table.</p> <ul style="list-style-type: none"> This command displays whether a multicast group is configured for SSM service or a source-specific host report has been received. |

Related Topics

[Prerequisites for Configuring SSM](#), on page 237

[SSM Components Overview](#), on page 239

[SSM with IGMPv3 Example](#), on page 256

Configuring SSM Mapping

Configuring Static SSM Mapping(CLI)

Perform this task to configure the last hop router in an SSM deployment to use static SSM mapping to determine the IP addresses of sources sending to groups.

Before you begin

- Enable IP multicast routing, enable PIM sparse mode, and configure SSM before performing this task.
- Before you configure static SSM mapping, you must configure ACLs that define the group ranges to be mapped to source addresses.

SUMMARY STEPS

1. **enable**
2. **configure terminal**
3. **ip igmp ssm-map enable**
4. **no ip igmp ssm-map query dns**
5. **ip igmp ssm-map static** *access-list source-address*
6. Repeat Step 5 to configure additional static SSM mappings, if required.
7. **end**
8. **show running-config**
9. **copy running-config startup-config**

DETAILED STEPS

| | Command or Action | Purpose |
|--------|---|--|
| Step 1 | enable Example: <pre>Switch> enable</pre> | Enables privileged EXEC mode. Enter your password if prompted. |
| Step 2 | configure terminal Example: <pre>Switch# configure terminal</pre> | Enters global configuration mode. |
| Step 3 | ip igmp ssm-map enable Example: <pre>Switch(config)# ip igmp ssm-map enable</pre> | Enables SSM mapping for groups in the configured SSM range. Note By default, this command enables DNS-based SSM mapping. |
| Step 4 | no ip igmp ssm-map query dns Example: | (Optional) Disables DNS-based SSM mapping. |

| | Command or Action | Purpose |
|---------------|--|---|
| | Switch(config)# no ip igmp ssm-map query dns | Note Disable DNS-based SSM mapping if you only want to rely on static SSM mapping. By default, the ip igmp ssm-map command enables DNS-based SSM mapping. |
| Step 5 | ip igmp ssm-map static <i>access-list source-address</i> Example: Switch(config)# ip igmp ssm-map static 11 172.16.8.11 | Configures static SSM mapping. <ul style="list-style-type: none"> The ACL supplied for the <i>access-list</i> argument defines the groups to be mapped to the source IP address entered for the <i>source-address</i> argument. Note You can configure additional static SSM mappings. If additional SSM mappings are configured and the router receives an IGMPv1 or IGMPv2 membership report for a group in the SSM range, the switch determines the source addresses associated with the group by walking each configured ip igmp ssm-map static command. The switch associates up to 20 sources per group. |
| Step 6 | Repeat Step 5 to configure additional static SSM mappings, if required. | -- |
| Step 7 | end Example: Switch(config)# end | Ends the current configuration session and returns to privileged EXEC mode. |
| Step 8 | show running-config Example: Switch# show running-config | Verifies your entries. |
| Step 9 | copy running-config startup-config Example: Switch# copy running-config startup-config | (Optional) Saves your entries in the configuration file. |

Configuring DNS-Based SSM Mapping(CLI)

Perform this task to configure the last hop router to perform DNS lookups to learn the IP addresses of sources sending to a group.

Before you begin

- Enable IP multicast routing, enable PIM sparse mode, and configure SSM before performing this task.
- Before you can configure and use SSM mapping with DNS lookups, you need to be able to add records to a running DNS server. If you do not already have a DNS server running, you need to install one.

SUMMARY STEPS

1. **enable**
2. **configure terminal**
3. **ip igmp ssm-map enable**
4. **ip igmp ssm-map query dns**
5. **ip domain multicast** *domain-prefix*
6. **ip name-server** *server-address1* [*server-address2...server-address6*]
7. Repeat Step [Step 6, on page 250](#) to configure additional DNS servers for redundancy, if required.
8. **end**
9. **show running-config**
10. **copy running-config startup-config**

DETAILED STEPS

| | Command or Action | Purpose |
|---------------|---|---|
| Step 1 | enable Example: <pre>Switch> enable</pre> | Enables privileged EXEC mode. Enter your password if prompted. |
| Step 2 | configure terminal Example: <pre>Switch# configure terminal</pre> | Enters global configuration mode. |
| Step 3 | ip igmp ssm-map enable Example: <pre>Switch(config)# ip igmp ssm-map enable</pre> | Enables SSM mapping for groups in a configured SSM range. |
| Step 4 | ip igmp ssm-map query dns Example: <pre>Switch(config)# ip igmp ssm-map query dns</pre> | (Optional) Enables DNS-based SSM mapping. <ul style="list-style-type: none"> • By default, the ip igmp ssm-map command enables DNS-based SSM mapping. Only the noform of this command is saved to the running configuration. Note Use this command to reenble DNS-based SSM mapping if DNS-based SSM mapping is disabled. |

| | Command or Action | Purpose |
|----------------|---|---|
| Step 5 | ip domain multicast <i>domain-prefix</i> Example: Switch(config)# ip domain multicast ssm-map.cisco.com | (Optional) Changes the domain prefix used for DNS-based SSM mapping. • By default, the software uses the ip-addr.arpa domain prefix. |
| Step 6 | ip name-server <i>server-address1</i> [<i>server-address2...server-address6</i>] Example: Switch(config)# ip name-server 10.48.81.21 | Specifies the address of one or more name servers to use for name and address resolution. |
| Step 7 | Repeat Step Step 6, on page 250 to configure additional DNS servers for redundancy, if required. | -- |
| Step 8 | end Example: Switch(config-if)# end | Returns to privileged EXEC mode. |
| Step 9 | show running-config Example: Switch# show running-config | Verifies your entries. |
| Step 10 | copy running-config startup-config Example: Switch# copy running-config startup-config | (Optional) Saves your entries in the configuration file. |

Configuring Static Traffic Forwarding with SSM Mapping

Perform this task to configure static traffic forwarding with SSM mapping on the last hop router. Static traffic forwarding can be used in conjunction with SSM mapping to statically forward SSM traffic for certain groups. When static traffic forwarding with SSM mapping is configured, the last hop router uses DNS-based SSM mapping to determine the sources associated with a group. The resulting (S, G) channels are then statically forwarded.

Before you begin

This task does not include the steps for configuring DNS-based SSM mapping. See the [Configuring DNS-Based SSM Mapping\(CLI\), on page 248](#) task for more information about configuring DNS-based SSM mapping.

SUMMARY STEPS

1. **enable**
2. **configure terminal**

3. `interface type number`
4. `ip igmp static-group group-address source ssm-map`

DETAILED STEPS

| | Command or Action | Purpose |
|--------|--|--|
| Step 1 | enable Example: <pre>Router> enable</pre> | Enables privileged EXEC mode. <ul style="list-style-type: none"> • Enter your password if prompted. |
| Step 2 | configure terminal Example: <pre>Router# configure terminal</pre> | Enters global configuration mode. |
| Step 3 | interface type number Example: <pre>Router(config)# interface gigabitethernet 1/0/0</pre> | Selects an interface on which to statically forward traffic for a multicast group using SSM mapping and enters interface configuration mode. Note Static forwarding of traffic with SSM mapping works with either DNS-based SSM mapping or statically-configured SSM mapping. |
| Step 4 | ip igmp static-group group-address source ssm-map Example: <pre>Router(config-if)# ip igmp static-group 232.1.2.1 source ssm-map</pre> | Configures SSM mapping to be used to statically forward a (S, G) channel out of the interface. <ul style="list-style-type: none"> • Use this command if you want to statically forward SSM traffic for certain groups, but you want to use DNS-based SSM mapping to determine the source addresses of the channels. |

Configuring Static Traffic Forwarding with SSM Mapping (CLI)

Follow these steps to configure static traffic forwarding with SSM mapping on the last hop router:

SUMMARY STEPS

1. `enable`
2. `configure terminal`
3. `interface interface-id`
4. `ip igmp static-group group-address source ssm-map`
5. `end`
6. `show running-config`
7. `copy running-config startup-config`

DETAILED STEPS

| | Command or Action | Purpose |
|---------------|---|--|
| Step 1 | enable Example: <pre>Switch> enable</pre> | Enables privileged EXEC mode. Enter your password if prompted. |
| Step 2 | configure terminal Example: <pre>Switch# configure terminal</pre> | Enters the global configuration mode. |
| Step 3 | interface <i>interface-id</i> Example: <pre>Switch(config)# interface gigabitethernet 1/0/1</pre> | <p>Selects an interface on which to statically forward traffic for a multicast group using SSM mapping, and enters interface configuration mode.</p> <p>The specified interface must be one of the following:</p> <ul style="list-style-type: none"> • A routed port—A physical port that has been configured as a Layer 3 port by entering the no switchport interface configuration command. You will also need to enable IP PIM sparse-dense-mode on the interface, and join the interface as a statically connected member to an IGMP static group. For a configuration example, see Example: Interface Configuration as a Routed Port, on page 88 • An SVI—A VLAN interface created by using the interface vlan <i>vlan-id</i> global configuration command. You will also need to enable IP PIM sparse-dense-mode on the VLAN, join the VLAN as a statically connected member to an IGMP static group, and then enable IGMP snooping on the VLAN, the IGMP static group, and physical interface. For a configuration example, see Example: Interface Configuration as an SVI, on page 89 <p>These interfaces must have IP addresses assigned to them.</p> <p>Note Static forwarding of traffic with SSM mapping works with either DNS-based SSM mapping or statically configured SSM mapping.</p> |
| Step 4 | ip igmp static-group <i>group-address</i> source ssm-map Example: <pre>Switch(config-if)# ip igmp static-group 239.1.2.1 source</pre> | <p>Configures SSM mapping to statically forward a (S, G) channel from the interface.</p> <p>Use this command if you want to statically forward SSM traffic for certain groups. Use DNS-based SSM mapping to determine the source addresses of the channels.</p> |

| | Command or Action | Purpose |
|---------------|---|--|
| | <code>ssm-map</code> | |
| Step 5 | end Example: <pre>Switch(config)# end</pre> | Returns to privileged EXEC mode. |
| Step 6 | show running-config Example: <pre>Switch# show running-config</pre> | Verifies your entries. |
| Step 7 | copy running-config startup-config Example: <pre>Switch# copy running-config startup-config</pre> | (Optional) Saves your entries in the configuration file. |

Related Topics

[Configuring DNS-Based SSM Mapping\(CLI\)](#), on page 248

[Verifying SSM Mapping Configuration and Operation](#), on page 253

[DNS-Based SSM Mapping](#), on page 243

[SSM Mapping Overview](#), on page 242

Verifying SSM Mapping Configuration and Operation

Perform this optional task to verify SSM mapping configuration and operation.

SUMMARY STEPS

1. `enable`
2. `show ip igmp ssm-mapping`
3. `show ip igmp ssm-mapping group-address`
4. `show ip igmp groups [group-name | group-address | interface-type interface-number] [detail]`
5. `show host`
6. `debug ip igmp group-address`

DETAILED STEPS

Step 1

`enable`

Enables privileged EXEC mode. Enter your password if prompted.

Example:

```
Switch> enable
```

Step 2 show ip igmp ssm-mapping

(Optional) Displays information about SSM mapping.

The following example shows how to display information about SSM mapping configuration. In this example, SSM static mapping and DNS-based SSM mapping are enabled.

Example:

```
Switch# show ip igmp ssm-mapping
SSM Mapping : Enabled
DNS Lookup  : Enabled
Mcast domain : ssm-map.cisco.com
Name servers : 10.0.0.3
              10.0.0.4
```

Step 3 show ip igmp ssm-mapping group-address

(Optional) Displays the sources that SSM mapping uses for a particular group.

The following example shows how to display information about the configured DNS-based SSM mapping. In this example, the router has used DNS-based mapping to map group 232.1.1.4 to sources 172.16.8.5 and 172.16.8.6. The timeout for this entry is 860000 milliseconds (860 seconds).

Example:

```
Switch# show ip igmp ssm-mapping 232.1.1.4
Group address: 232.1.1.4
Database      : DNS
DNS name      : 4.1.1.232.ssm-map.cisco.com
Expire time   : 860000
Source list   : 172.16.8.5
              : 172.16.8.6
```

Step 4 show ip igmp groups [group-name | group-address | interface-type interface-number] [detail]

(Optional) Displays the multicast groups with receivers that are directly connected to the router and that were learned through IGMP.

The following is sample output from the **show ip igmp groups** command with the *group-address* argument and **detail** keyword. In this example the “M” flag indicates that SSM mapping is configured.

Example:

```
Switch# show ip igmp group 232.1.1.4 detail
Interface:      GigabitEthernet2/0/0
Group:          232.1.1.4 SSM
Uptime:         00:03:20
Group mode:     INCLUDE
Last reporter:  0.0.0.0
CSR Grp Exp:    00:02:59
Group source list: (C - Cisco Src Report, U - URD, R - Remote,
                  S - Static, M - SSM Mapping)
Source Address  Uptime    v3 Exp  CSR Exp  Fwd  Flags
172.16.8.3      00:03:20  stopped 00:02:59 Yes  CM
172.16.8.4      00:03:20  stopped 00:02:59 Yes  CM
172.16.8.5      00:03:20  stopped 00:02:59 Yes  CM
172.16.8.6      00:03:20  stopped 00:02:59 Yes  CM
```

Step 5 **show host**

(Optional) Displays the default domain name, the style of name lookup service, a list of name server hosts, and the cached list of hostnames and addresses.

The following is sample output from the **show host** command. Use this command to display DNS entries as they are learned by the router.

Example:

```
Switch# show host
Default domain is cisco.com
Name/address lookup uses domain service
Name servers are 10.48.81.21
Codes: UN - unknown, EX - expired, OK - OK, ?? - revalidate
       temp - temporary, perm - permanent
       NA - Not Applicable None - Not defined
Host      Port  Flags  Age  Type  Address(es)
10.0.0.0.ssm-map.cisco.c None (temp, OK) 0 IP 172.16.8.5
                                     172.16.8.6
                                     172.16.8.3

172.16.8.4
```

Step 6 **debug ip igmp group-address**

(Optional) Displays the IGMP packets received and sent and IGMP host-related events.

The following is sample output from the **debug ip igmp** command when SSM static mapping is enabled. The following output indicates that the router is converting an IGMPv2 join for group G into an IGMPv3 join:

Example:

```
IGMP(0): Convert IGMPv2 report (*,232.1.2.3) to IGMPv3 with 2 source(s) using STATIC.
```

The following is sample output from the **debug ip igmp** command when DNS-based SSM mapping is enabled. The following output indicates that a DNS lookup has succeeded:

Example:

```
IGMP(0): Convert IGMPv2 report (*,232.1.2.3) to IGMPv3 with 2 source(s) using DNS.
```

The following is sample output from the **debug ip igmp** command when DNS-based SSM mapping is enabled and a DNS lookup has failed:

```
IGMP(0): DNS source lookup failed for (*, 232.1.2.3), IGMPv2 report failed
```

Related Topics

[Static SSM Mapping](#), on page 243

[SSM Mapping Overview](#), on page 242

[Configuring Basic IP Multicast Routing](#), on page 266

[DNS-Based SSM Mapping](#), on page 243

[Configuring Static Traffic Forwarding with SSM Mapping \(CLI\)](#), on page 251

Monitoring SSM and SSM Mapping

Monitoring SSM

To monitor SSM, use the following commands in privileged EXEC mode, as needed:

| Command | Purpose |
|---|--|
| Switch# show ip igmp groups detail | Displays the (S, G) channel subscription through IGMPv3. |
| Switch# show ip mroute | Displays whether a multicast group supports SSM service or whether a source-specific host report was received. |

Monitoring SSM Mapping

Use the privileged EXEC commands in the following table to monitor SSM mapping.

Table 20: SSM Mapping Monitoring Commands

| Command | Purpose |
|--|--|
| Switch# show ip igmp ssm-mapping | Displays information about SSM mapping. |
| Switch# show ip igmp ssm-mapping group-address | Displays the sources that SSM mapping uses for a particular group. |
| Switch# show ip igmp groups [<i>group-name</i> <i>group-address</i> <i>interface-type interface-number</i>] [detail] | Displays the multicast groups with receivers that are directly connected to the router and that were learned through IGMP. |
| Switch# show host | Displays the default domain name, the style of name lookup service, a list of name server hosts, and the cached list of hostnames and addresses. |
| Switch# debug ip igmp group-address | Displays the IGMP packets received and sent and IGMP host-related events. |

Configuration Examples for SSM and SSM Mapping

SSM with IGMPv3 Example

The following example shows how to configure a device (running IGMPv3) for SSM:

```
ip multicast-routing
!
```



```

interface GigabitEthernet3/1/0
 ip address 172.21.200.203 255.255.255.0
 description backbone interface
 ip pim sparse-mode
!
interface GigabitEthernet3/2/0
 ip address 131.108.1.2 255.255.255.0
 ip pim sparse-mode
 description ethernet connected to hosts
 ip igmp version 3
!
ip pim ssm default

```

Related Topics

[Configuring Source Specific Multicast](#), on page 245

[SSM Components Overview](#), on page 239

SSM Filtering Example

The following example shows how to configure filtering on legacy RP routers running software releases that do not support SSM routing. This filtering will suppress all unwanted PIM-SM and MSDP traffic in the SSM range. Without this filtering, SSM will still operate, but there may be additional RPT traffic if legacy first hop and last hop routers exist in the network.

```

ip access-list extended no-ssm-range
 deny ip any 232.0.0.0 0.255.255.255 ! SSM range
 permit ip any any
! Deny registering in SSM range
ip pim accept-register list no-ssm-range
ip access-list extended msdp-nono-list
 deny ip any 232.0.0.0 0.255.255.255 ! SSM Range
! .
! .
! .
! See ftp://ftpeng.cisco.com/ipmulticast/config-notes/msdp-sa-filter.txt for other SA
! messages that typically need to be filtered.
 permit ip any any
! Filter generated SA messages in SSM range. This configuration is only needed if there
! are directly connected sources to this router. The "ip pim accept-register" command
! filters remote sources.
ip msdp redistribute list msdp-nono-list
! Filter received SA messages in SSM range. "Filtered on receipt" means messages are
! neither processed or forwarded. Needs to be configured for each MSDP peer.
ip msdp sa-filter in msdp-peer1 list msdp-nono-list
! .
! .
! .
ip msdp sa-filter in msdp-peerN list msdp-nono-list

```

SSM Mapping Example

The following configuration example shows a router configuration for SSM mapping. This example also displays a range of other IGMP and SSM configuration options to show compatibility between features. Do not use this configuration example as a model unless you understand all of the features used in the example.



Note Address assignment in the global SSM range 232.0.0.0/8 should be random. If you copy parts or all of this sample configuration, make sure to select a random address range but not 232.1.1.x as shown in this example. Using a random address range minimizes the possibility of address collision and may prevent conflicts when other SSM content is imported while SSM mapping is used.

```

!
no ip domain lookup
ip domain multicast ssm.map.cisco.com
ip name-server 10.48.81.21
!
!
ip multicast-routing distributed
ip igmp ssm-map enable
ip igmp ssm-map static 10 172.16.8.10
ip igmp ssm-map static 11 172.16.8.11
!
!
.
.
.
!
interface GigabitEthernet0/0/0
description Sample IGMP Interface Configuration for SSM-Mapping Example
ip address 10.20.1.2 255.0.0.0
ip pim sparse-mode
ip igmp last-member-query-interval 100
ip igmp static-group 232.1.2.1 source ssm-map
ip igmp version 3
ip igmp explicit-tracking
ip igmp limit 2
ip igmp v3lite
ip urd
!
.
.
.
!
ip pim ssm default
!
access-list 10 permit 232.1.2.10
access-list 11 permit 232.1.2.0 0.0.0.255
!

```

This table describes the significant commands shown in the SSM mapping configuration example.

Table 21: SSM Mapping Configuration Example Command Descriptions

| Command | Description |
|----------------------------|---|
| no ip domain lookup | <p>Disables IP DNS-based hostname-to-address translation.</p> <p>Note The no ip domain-list command is shown in the configuration only to demonstrate that disabling IP DNS-based hostname-to-address translation does not conflict with configuring SSM mapping. If this command is enabled, the Cisco IOS XE software will try to resolve unknown strings as hostnames.</p> |

| Command | Description |
|--|--|
| ip domain multicast ssm-map.cisco.com | Specifies ssm-map.cisco.com as the domain prefix for SSM mapping. |
| ip name-server 10.48.81.21 | Specifies 10.48.81.21 as the IP address of the DNS server to be used by SSM mapping and any other service in the software that utilizes DNS. |
| ip multicast-routing | Enables IP multicast routing. |
| ip igmp ssm-map enable | Enables SSM mapping. |
| ip igmp ssm-map static 10 172.16.8.10 | Configures the groups permitted by ACL 10 to use source address 172.16.8.10. <ul style="list-style-type: none"> In this example, ACL 10 permits all groups in the 232.1.2.0/25 range except 232.1.2.10. |
| ip igmp ssm-map static 11 172.16.8.11 | Configures the groups permitted by ACL 11 to use source address 172.16.8.11. <ul style="list-style-type: none"> In this example, ACL 11 permits group 232.1.2.10. |
| ip pim sparse-mode | Enables PIM sparse mode. |
| ip igmp last-member-query-interval 100 | Reduces the leave latency for IGMPv2 hosts. Note This command is not required for configuring SSM mapping; however, configuring this command can be beneficial for IGMPv2 hosts relying on SSM mapping. |
| ip igmp static-group 232.1.2.1 source ssm-map | Configures SSM mapping to be used to determine the sources associated with group 232.1.2.1. The resulting (S, G) channels are statically forwarded. |
| ip igmp version 3 | Enables IGMPv3 on this interface. Note This command is shown in the configuration only to demonstrate that IGMPv3 can be configured simultaneously with SSM mapping; however, it is not required. |
| ip igmp explicit-tracking | Minimizes the leave latency for IGMPv3 host leaving a multicast channel. Note This command is not required for configuring SSM mapping. |
| ip igmp limit 2 | Limits the number of IGMP states resulting from IGMP membership states on a per-interface basis. Note This command is not required for configuring SSM mapping. |

| Command | Description |
|---|--|
| ip igmp v3lite | Enables the acceptance and processing of IGMP v3lite membership reports on this interface. Note This command is shown in the configuration only to demonstrate that IGMP v3lite can be configured simultaneously with SSM mapping; however, it is not required. |
| ip urd | Enables interception of TCP packets sent to the reserved URD port 465 on an interface and processing of URD channel subscription reports. Note This command is shown in the configuration only to demonstrate that URD can be configured simultaneously with SSM mapping; however, it is not required. |
| ip pim ssm default | Configures SSM service. • The default keyword defines the SSM range access list as 232/8. |
| access-list 10 permit 232.1.2.10 access-list 11 permit 232.1.2.0 0.0.0.255 | Configures the ACLs to be used for static SSM mapping. Note These are the ACLs that are referenced by the ip igmp ssm-map static commands in this configuration example. |

DNS Server Configuration Example

To configure DNS-based SSM mapping, you need to create a DNS server zone or add records to an existing zone. If the routers that are using DNS-based SSM mapping are also using DNS for other purposes besides SSM mapping, you should use a normally-configured DNS server. If DNS-based SSM mapping is the only DNS implementation being used on the router, you can configure a fake DNS setup with an empty root zone, or a root zone that points back to itself.

The following example shows how to create a zone and import the zone data using Network Registrar:

```
Router> zone 1.1.232.ssm-map.cisco.com. create primary file=named.ssm-map
100 Ok
Router> dns reload
100 Ok
```

The following example shows how to import the zone files from a named.conf file for BIND 8:

```
Router> ::import named.conf /etc/named.conf
Router> dns reload
100 Ok:
```



Note Network Registrar version 8.0 and later support import BIND 8 format definitions.

Additional References

Related Documents

| Related Topic | Document Title |
|--|---|
| For complete syntax and usage information for the commands used in this chapter. | <i>IP Multicast Routing Command Reference (Catalyst 3850 Switches)</i> |
| Platform-independent configuration information | <ul style="list-style-type: none"> • <i>IP Multicast: PIM Configuration Guide, Cisco IOS XE Release 3SE (Catalyst 3850 Switches)</i> • <i>IP Multicast: IGMP Configuration Guide, Cisco IOS XE Release 3SE (Catalyst 3850 Switches)</i> • <i>IP Multicast: Multicast Optimization Configuration Guide, Cisco IOS XE Release 3SE (Catalyst 3850 Switches)</i> |
| Cisco IOS commands | Cisco IOS Master Commands List, All Releases |

Error Message Decoder

| Description | Link |
|---|---|
| To help you research and resolve system error messages in this release, use the Error Message Decoder tool. | https://www.cisco.com/cgi-bin/Support/Errordecoder/index.cgi |

Standards and RFCs

| Standard/RFC | Title |
|--------------|--|
| RFC 4601 | <i>Protocol-Independent Multicast-Sparse Mode (PIM-SM): Protocol Specification</i> |

MIBs

| MIB | MIBs Link |
|--------------------------------------|--|
| All supported MIBs for this release. | To locate and download MIBs for selected platforms, Cisco IOS releases, and feature sets, use Cisco MIB Locator found at the following URL: http://www.cisco.com/go/mibs |

Technical Assistance

| Description | Link |
|---|---|
| <p>The Cisco Support website provides extensive online resources, including documentation and tools for troubleshooting and resolving technical issues with Cisco products and technologies.</p> <p>To receive security and technical information about your products, you can subscribe to various services, such as the Product Alert Tool (accessed from Field Notices), the Cisco Technical Services Newsletter, and Really Simple Syndication (RSS) Feeds.</p> <p>Access to most tools on the Cisco Support website requires a Cisco.com user ID and password.</p> | http://www.cisco.com/support |

Feature History and Information for SSM

| Release | Modification |
|--------------------|------------------------------|
| Cisco IOS XE 3.2SE | This feature was introduced. |



CHAPTER 12

Configuring Basic IP Multicast Routing

- [Finding Feature Information, on page 263](#)
- [Prerequisites for Basic IP Multicast Routing, on page 263](#)
- [Restrictions for Basic IP Multicast Routing, on page 264](#)
- [Information About Basic IP Multicast Routing, on page 264](#)
- [How to Configure Basic IP Multicast Routing, on page 266](#)
- [Monitoring and Maintaining Basic IP Multicast Routing, on page 277](#)
- [Additional References, on page 281](#)
- [Feature History and Information for IP Multicast, on page 282](#)

Finding Feature Information

Your software release may not support all the features documented in this module. For the latest caveats and feature information, see [Bug Search Tool](#) and the release notes for your platform and software release. To find information about the features documented in this module, and to see a list of the releases in which each feature is supported, see the feature information table.

Use Cisco Feature Navigator to find information about platform support and Cisco software image support. To access Cisco Feature Navigator, go to www.cisco.com/go/cfn. An account on Cisco.com is not required.

Prerequisites for Basic IP Multicast Routing

The following are the prerequisites for configuring basic IP multicast routing:

- To use this feature, the switch or active switch must be running the IP services feature set. The IP Services image contains complete multicast routing.
- You must configure the PIM version and the PIM mode in order to perform IP multicast routing. The switch populates its multicast routing table and forwards multicast packets it receives from its directly connected LANs according to the mode setting. You can configure an interface to be in the PIM dense mode, sparse mode, or sparse-dense mode.
- Enabling PIM on an interface also enables IGMP operation on that interface. (To participate in IP multicasting, the multicast hosts, routers, and multilayer device must have IGMP operating.)

If you enable PIM on multiple interfaces, when most of these interfaces are not on the outgoing interface list, and IGMP snooping is disabled, the outgoing interface might not be able to sustain line rate for multicast traffic because of the extra replication.

Related Topics

[Configuring Basic IP Multicast Routing](#), on page 266

[Information About Basic IP Multicast Routing](#), on page 264

[IP Multicast Routing Protocols](#), on page 21

Restrictions for Basic IP Multicast Routing

The following are the restrictions for IP multicast routing:

- IP multicast routing is not supported on switches running the LAN base feature set.
- High-availability support for Layer 3 multicast routing is not supported.
- You cannot have a switch stack containing a mix of Catalyst 3850 and Catalyst 3650 switches.

Information About Basic IP Multicast Routing

IP multicasting is an efficient way to use network resources, especially for bandwidth-intensive services such as audio and video. IP multicast routing enables a host (source) to send packets to a group of hosts (receivers) anywhere within the IP network by using a special form of IP address called the IP multicast group address.

The sending host inserts the multicast group address into the IP destination address field of the packet, and IP multicast routers and multilayer switches forward incoming IP multicast packets out all interfaces that lead to members of the multicast group. Any host, regardless of whether it is a member of a group, can send to a group. However, only the members of a group receive the message.



Note

For complete syntax and usage information for the commands used in this chapter, see the *IP Multicast Command Reference, Cisco IOS XE Release 3SE (Catalyst 3850 Switches)*. For information on configuring the Multicast Source Discovery Protocol (MSDP), see the *Catalyst 3850 Routing Configuration Guide*.

Related Topics

[Configuring Basic IP Multicast Routing](#), on page 266

[Prerequisites for Basic IP Multicast Routing](#), on page 263

Multicast Forwarding Information Base Overview

The switch uses the Multicast Forwarding Information Base (MFIB) architecture and the Multicast Routing Information Base (MRIB) for IP multicast.

The MFIB architecture provides both modularity and separation between the multicast control plane (Protocol Independent Multicast [PIM] and Internet Group Management Protocol [IGMP]) and the multicast forwarding plane (MFIB). This architecture is used in Cisco IOS IPv6 multicast implementations.

MFIB itself is a multicast routing protocol independent forwarding engine; that is, it does not depend on PIM or any other multicast routing protocol. It is responsible for:

- Forwarding multicast packets
- Registering with the MRIB to learn the entry and interface flags set by the control plane
- Handling data-driven events that must be sent to the control plane
- Maintaining counts, rates, and bytes of received, dropped, and forwarded multicast packets

The MRIB is the communication channel between MRIB clients. Examples of MRIB clients are PIM, IGMP, the multicast routing (mroute) table, and the MFIB.

Related Topics

[Configuring IP Multicast Forwarding \(CLI\)](#), on page 268

Multicast Routing and Switch Stacks

For all multicast routing protocols, the entire stack appears as a single router to the network and operates as a single multicast router.

In a switch stack, the active switch performs these functions:

- It is responsible for completing the IP multicast routing functions of the stack. It fully initializes and runs the IP multicast routing protocols.
- It builds and maintains the multicast routing table for the entire stack.
- It is responsible for distributing the multicast routing table to all stack members.

The stack members perform these functions:

- They act as multicast routing standby devices and are ready to take over if there is a active switch failure. If the active switch fails, all stack members delete their multicast routing tables. The newly elected active switch starts building the routing tables and distributes them to the stack members.
- They do not build multicast routing tables. Instead, they use the multicast routing table that is distributed by the active switch.

Default IP Multicast Routing Configuration

This table displays the default IP multicast routing configuration.

Table 22: Default IP Multicast Routing Configuration

| Feature | Default Setting |
|-------------------|-----------------------------|
| Multicast routing | Disabled on all interfaces. |
| PIM version | Version 2. |
| PIM mode | No mode is defined. |
| PIM stub routing | None configured. |

| Feature | Default Setting |
|-----------------------------------|------------------|
| PIM RP address | None configured. |
| PIM domain border | Disabled. |
| PIM multicast boundary | None. |
| Candidate BSRs | Disabled. |
| Candidate RPs | Disabled. |
| Shortest-path tree threshold rate | 0 kb/s. |
| PIM router query message interval | 30 seconds. |

How to Configure Basic IP Multicast Routing

Configuring Basic IP Multicast Routing

By default, multicast routing is disabled, and there is no default mode setting.

This procedure is required.

Before you begin

You must configure the PIM version and the PIM mode. The switch populates its multicast routing table and forwards multicast packets it receives from its directly connected LANs according to the mode setting.

In populating the multicast routing table, dense-mode interfaces are always added to the table. Sparse-mode interfaces are added to the table only when periodic join messages are received from downstream devices or when there is a directly connected member on the interface. When forwarding from a LAN, sparse-mode operation occurs if there is an RP known for the group. If so, the packets are encapsulated and sent toward the RP. When no RP is known, the packet is flooded in a dense-mode fashion. If the multicast traffic from a specific source is sufficient, the receiver's first-hop router might send join messages toward the source to build a source-based distribution tree.

SUMMARY STEPS

1. **enable**
2. **configure terminal**
3. **ip multicast-routing**
4. **interface *interface-id***
5. **ip pim {dense-mode | sparse-mode | sparse-dense-mode}**
6. **end**
7. **show running-config**
8. **copy running-config startup-config**

DETAILED STEPS

| | Command or Action | Purpose |
|--------|---|---|
| Step 1 | enable Example: <pre>Switch> enable</pre> | Enables privileged EXEC mode. <ul style="list-style-type: none"> • Enter your password if prompted. |
| Step 2 | configure terminal Example: <pre>Switch# configure terminal</pre> | Enters the global configuration mode. |
| Step 3 | ip multicast-routing Example: <pre>Switch(config)# ip multicast-routing</pre> | Enables IP multicast routing. IP multicast routing is supported with Multicast Forwarding Information Base (MFIB) and Multicast Routing Information Base (MRIB). |
| Step 4 | interface <i>interface-id</i> Example: <pre>Switch(config)# interface gigabitethernet 1/0/1</pre> | Specifies the Layer 3 interface on which you want to enable multicast routing, and enters interface configuration mode. The specified interface must be one of the following: <ul style="list-style-type: none"> • A routed port—A physical port that has been configured as a Layer 3 port by entering the no switchport interface configuration command. You will also need to enable IP PIM sparse-dense-mode on the interface, and join the interface as a statically connected member to an IGMP static group. For a configuration example, see Example: Interface Configuration as a Routed Port, on page 88 • An SVI—A VLAN interface created by using the interface vlan <i>vlan-id</i> global configuration command. You will also need to enable IP PIM sparse-dense-mode on the VLAN, join the VLAN as a statically connected member to an IGMP static group, and then enable IGMP snooping on the VLAN, the IGMP static group, and physical interface. For a configuration example, see Example: Interface Configuration as an SVI, on page 89 These interfaces must have IP addresses assigned to them. |
| Step 5 | ip pim {dense-mode sparse-mode sparse-dense-mode} Example: <pre>Switch(config-if)# ip pim</pre> | Enables a PIM mode on the interface. By default, no mode is configured. The keywords have these meanings: |

| | Command or Action | Purpose |
|---------------|---|---|
| | <code>sparse-dense-mode</code> | <ul style="list-style-type: none"> • dense-mode—Enables dense mode of operation. • sparse-mode—Enables sparse mode of operation. If you configure sparse mode, you must also configure an RP. • sparse-dense-mode—Causes the interface to be treated in the mode in which the group belongs. Sparse-dense mode is the recommended setting. <p>Note To disable PIM on an interface, use the no ip pim interface configuration command.</p> |
| Step 6 | end Example: <pre>Switch(config-if)# end</pre> | Returns to privileged EXEC mode. |
| Step 7 | show running-config Example: <pre>Switch# show running-config</pre> | Verifies your entries. |
| Step 8 | copy running-config startup-config Example: <pre>Switch# copy running-config startup-config</pre> | (Optional) Saves your entries in the configuration file. |

Related Topics

- [Prerequisites for Configuring SSM](#), on page 237
- [Configuring Static SSM Mapping\(CLI\)](#), on page 247
- [Verifying SSM Mapping Configuration and Operation](#), on page 253
- [Static SSM Mapping](#), on page 243
- [SSM Mapping Overview](#), on page 242
- [Configuring DNS-Based SSM Mapping\(CLI\)](#), on page 248
- [DNS-Based SSM Mapping](#), on page 243
- [Information About Basic IP Multicast Routing](#), on page 264
- [IP Multicast Routing Protocols](#), on page 21
- [Prerequisites for Basic IP Multicast Routing](#), on page 263

Configuring IP Multicast Forwarding (CLI)

You can use the following procedure to configure IPv4 Multicast Forwarding Information Base (MFIB) interrupt-level IP multicast forwarding of incoming packets or outgoing packets on the switch.



Note After you have enabled IP multicast routing by using the **ip multicast-routing** command, IPv4 multicast forwarding is enabled. Because IPv4 multicast forwarding is enabled by default, you can use the **no** form of the **ip mfib** command to disable IPv4 multicast forwarding.

SUMMARY STEPS

1. **enable**
2. **configure terminal**
3. **ip mfib**
4. **exit**
5. **show running-config**
6. **copy running-config startup-config**

DETAILED STEPS

| | Command or Action | Purpose |
|--------|---|--|
| Step 1 | enable Example: <pre>Switch> enable</pre> | Enables privileged EXEC mode. <ul style="list-style-type: none"> • Enter your password if prompted. |
| Step 2 | configure terminal Example: <pre>Switch# configure terminal</pre> | Enters the global configuration mode. |
| Step 3 | ip mfib Example: <pre>Switch(config)# ip mfib</pre> | Enables IP multicast forwarding. |
| Step 4 | exit Example: <pre>Switch(config)# exit</pre> | Returns to privileged EXEC mode. |
| Step 5 | show running-config Example: <pre>Switch# show running-config</pre> | Verifies your entries. |

| | Command or Action | Purpose |
|--------|---|--|
| Step 6 | copy running-config startup-config Example: <pre>Switch# copy running-config startup-config</pre> | (Optional) Saves your entries in the configuration file. |

Related Topics

[Multicast Forwarding Information Base Overview](#) , on page 264

Configuring a Static Multicast Route (mroute) (CLI)

You can use the following procedure to configure static mroutes. Static mroutes are similar to unicast static routes but differ in the following ways:

- Static mroutes are used to calculate RPF information, not to forward traffic.
- Static mroutes cannot be redistributed.

Static mroutes are strictly local to the switch on which they are defined. Because Protocol Independent Multicast (PIM) does not have its own routing protocol, there is no mechanism to distribute static mroutes throughout the network. Consequently, the administration of static mroutes tends to be more complicated than the administration of unicast static routes.

When static mroutes are configured, they are stored on the switch in a separate table referred to as the static mroute table. When configured, the **ip mroute** command enters a static mroute into the static mroute table for the source address or source address range specified for the source-address and mask arguments. Sources that match the source address or that fall in the source address range specified for the source-address argument will RPF to either the interface associated with the IP address specified for the *rpf-address* argument or the local interface on the switch specified for the *interface-type* and *interface-number* arguments. If an IP address is specified for the *rpf-address* argument, a recursive lookup is done from the unicast routing table on this address to find the directly connected neighbor.

If there are multiple static mroutes configured, the switch performs a longest-match lookup of the mroute table. When the mroute with the longest match (of the source-address) is found, the search terminates and the information in the matching static mroute is used. The order in which the static mroutes are configured is not important.

The administrative distance of an mroute may be specified for the optional distance argument. If a value is not specified for the distance argument, the distance of the mroute defaults to zero. If the static mroute has the same distance as another RPF source, the static mroute will take precedence. There are only two exceptions to this rule: directly connected routes and the default unicast route.

SUMMARY STEPS

1. **enable**
2. **configure terminal**
3. **ip mroute** [*vrf vrf-name*] *source-address mask* { **fallback-lookup** {**global** | **vrf vrf-name** } [*protocol*] {*rpf-address* | *interface-type interface-number*}} [**distance**]
4. **exit**

5. `show running-config`
6. `copy running-config startup-config`

DETAILED STEPS

| | Command or Action | Purpose |
|--------|--|--|
| Step 1 | <p><code>enable</code></p> <p>Example:</p> <pre>Switch> enable</pre> | <p>Enables privileged EXEC mode.</p> <ul style="list-style-type: none"> • Enter your password if prompted. |
| Step 2 | <p><code>configure terminal</code></p> <p>Example:</p> <pre>Switch# configure terminal</pre> | <p>Enters the global configuration mode.</p> |
| Step 3 | <p><code>ip mroute [vrf vrf-name] source-address mask { fallback-lookup {global vrf vrf-name } [protocol] {rpf-address interface-type interface-number} } [distance]</code></p> <p>Example:</p> <pre>Switch(configure)# ip mroute 10.1.1.1 255.255.255.255 10.2.2.2</pre> | <p>The source IP address 10.1.1.1 is configured to be reachable through the interface associated with IP address 10.2.2.2.</p> |
| Step 4 | <p><code>exit</code></p> <p>Example:</p> <pre>Switch(config)# exit</pre> | <p>Returns to privileged EXEC mode.</p> |
| Step 5 | <p><code>show running-config</code></p> <p>Example:</p> <pre>Switch# show running-config</pre> | <p>(Optional) Verifies your entries.</p> |
| Step 6 | <p><code>copy running-config startup-config</code></p> <p>Example:</p> <pre>Switch# copy running-config startup-config</pre> | <p>(Optional) Saves your entries in the configuration file.</p> |

Configuring Optional IP Multicast Routing Features

Defining the IP Multicast Boundary (CLI)

You define a multicast boundary to prevent Auto-RP messages from entering the PIM domain. You create an access list to deny packets destined for 224.0.1.39 and 224.0.1.40, which carry Auto-RP information.

This procedure is optional.

SUMMARY STEPS

1. **enable**
2. **configure terminal**
3. **access-list** *access-list-number* **deny** *source* [*source-wildcard*]
4. **interface** *interface-id*
5. **ip multicast boundary** *access-list-number*
6. **end**
7. **show running-config**
8. **copy running-config startup-config**

DETAILED STEPS

| | Command or Action | Purpose |
|---------------|--|---|
| Step 1 | enable Example: <pre>Switch> enable</pre> | Enables privileged EXEC mode. Enter your password if prompted. |
| Step 2 | configure terminal Example: <pre>Switch# configure terminal</pre> | Enters the global configuration mode. |
| Step 3 | access-list <i>access-list-number</i> deny <i>source</i> [<i>source-wildcard</i>] Example: <pre>Switch(config)# access-list 12 deny 224.0.1.39 access-list 12 deny 224.0.1.40</pre> | Creates a standard access list, repeating the command as many times as necessary. <ul style="list-style-type: none"> • For <i>access-list-number</i>, the range is 1 to 99. • The deny keyword denies access if the conditions are matched. • For <i>source</i>, enter multicast addresses 224.0.1.39 and 224.0.1.40, which carry Auto-RP information. • (Optional) For <i>source-wildcard</i>, enter the wildcard bits in dotted decimal notation to be applied to the source. Place ones in the bit positions that you want to ignore. |

| | Command or Action | Purpose |
|---------------|--|--|
| | | The access list is always terminated by an implicit deny statement for everything. |
| Step 4 | <p>interface <i>interface-id</i></p> <p>Example:</p> <pre>Switch(config)# interface gigabitethernet 1/0/1</pre> | <p>Specifies the interface to be configured, and enters interface configuration mode.</p> <p>The specified interface must be one of the following:</p> <ul style="list-style-type: none"> • A routed port—A physical port that has been configured as a Layer 3 port by entering the no switchport interface configuration command. You will also need to enable IP PIM sparse-dense-mode on the interface, and join the interface as a statically connected member to an IGMP static group. For a configuration example, see Example: Interface Configuration as a Routed Port, on page 88 • An SVI—A VLAN interface created by using the interface vlan <i>vlan-id</i> global configuration command. You will also need to enable IP PIM sparse-dense-mode on the VLAN, join the VLAN as a statically connected member to an IGMP static group, and then enable IGMP snooping on the VLAN, the IGMP static group, and physical interface. For a configuration example, see Example: Interface Configuration as an SVI, on page 89 <p>These interfaces must have IP addresses assigned to them.</p> |
| Step 5 | <p>ip multicast boundary <i>access-list-number</i></p> <p>Example:</p> <pre>Switch(config-if)# ip multicast boundary 12</pre> | Configures the boundary, specifying the access list you created in Step 2. |
| Step 6 | <p>end</p> <p>Example:</p> <pre>Switch(config)# end</pre> | Returns to privileged EXEC mode. |
| Step 7 | <p>show running-config</p> <p>Example:</p> <pre>Switch# show running-config</pre> | Verifies your entries. |
| Step 8 | <p>copy running-config startup-config</p> <p>Example:</p> | (Optional) Saves your entries in the configuration file. |

| | Command or Action | Purpose |
|--|---|---------|
| | Switch# <code>copy running-config startup-config</code> | |

Related Topics

[Multicast Boundaries](#), on page 121

[Example: Defining the IP Multicast Boundary to Deny Auto-RP Information](#), on page 170

[IP Multicast Boundary](#), on page 24

[Multicast Group Transmission Scheme](#), on page 22

[Example: Configuring an IP Multicast Boundary](#), on page 280

Configuring sdr Listener Support

Enabling sdr Listener Support (CLI)

By default, the switch does not listen to session directory advertisements.

This procedure is optional.

SUMMARY STEPS

1. `enable`
2. `configure terminal`
3. `interface interface-id`
4. `ip sdr listen`
5. `end`
6. `show running-config`
7. `copy running-config startup-config`

DETAILED STEPS

| | Command or Action | Purpose |
|---------------|--|--|
| Step 1 | enable Example: Switch> <code>enable</code> | Enables privileged EXEC mode. <ul style="list-style-type: none"> • Enter your password if prompted. |
| Step 2 | configure terminal Example: Switch# <code>configure terminal</code> | Enters the global configuration mode. |
| Step 3 | interface interface-id Example: Switch(config)# <code>interface</code> | Specifies the interface to be enabled for sdr, and enters interface configuration mode. The specified interface must be one of the following: |

| | Command or Action | Purpose |
|---------------|---|---|
| | <code>gigabitethernet 1/0/1</code> | <ul style="list-style-type: none"> A routed port—A physical port that has been configured as a Layer 3 port by entering the no switchport interface configuration command. You will also need to enable IP PIM sparse-dense-mode on the interface, and join the interface as a statically connected member to an IGMP static group. For a configuration example, see Example: Interface Configuration as a Routed Port, on page 88 An SVI—A VLAN interface created by using the interface vlan <i>vlan-id</i> global configuration command. You will also need to enable IP PIM sparse-dense-mode on the VLAN, join the VLAN as a statically connected member to an IGMP static group, and then enable IGMP snooping on the VLAN, the IGMP static group, and physical interface. For a configuration example, see Example: Interface Configuration as an SVI, on page 89 <p>These interfaces must have IP addresses assigned to them.</p> |
| Step 4 | ip sap listen Example: <pre>Switch(config-if)# ip sap listen</pre> | Enables the switch software to listen to session directory announcements. |
| Step 5 | end Example: <pre>Switch(config-if)# end</pre> | Returns to privileged EXEC mode. |
| Step 6 | show running-config Example: <pre>Switch# show running-config</pre> | Verifies your entries. |
| Step 7 | copy running-config startup-config Example: <pre>Switch# copy running-config startup-config</pre> | (Optional) Saves your entries in the configuration file. |

Limiting How Long an sdr Cache Entry Exists (CLI)

By default, entries are never deleted from the sdr cache. You can limit how long the entry remains active so that if a source stops advertising SAP information, old advertisements are not unnecessarily kept.

This procedure is optional.

SUMMARY STEPS

1. **enable**
2. **configure terminal**
3. **ip sap cache-timeout** *minutes*
4. **end**
5. **show running-config**
6. **show ip sap**
7. **copy running-config startup-config**

DETAILED STEPS

| | Command or Action | Purpose |
|---------------|---|--|
| Step 1 | enable Example: Switch> enable | Enables privileged EXEC mode. • Enter your password if prompted. |
| Step 2 | configure terminal Example: Switch# configure terminal | Enters the global configuration mode. |
| Step 3 | ip sap cache-timeout <i>minutes</i> Example: Switch(config)# ip sap cache-timeout 30 | Limits how long a Session Announcement Protocol (SAP) cache entry stays active in the cache. By default, entries are never deleted from the cache. For <i>minutes</i> , the range is 1 to 1440 minutes (24 hours). |
| Step 4 | end Example: Switch(config)# end | Returns to privileged EXEC mode. |
| Step 5 | show running-config Example: Switch# show running-config | Verifies your entries. |
| Step 6 | show ip sap Example: | Displays the SAP cache. |

| | Command or Action | Purpose |
|---------------|---|--|
| | Switch# <code>show ip sap</code> | |
| Step 7 | copy running-config startup-config Example: Switch# <code>copy running-config startup-config</code> | (Optional) Saves your entries in the configuration file. |

Monitoring and Maintaining Basic IP Multicast Routing

Clearing Caches, Tables, and Databases

You can remove all contents of a particular cache, table, or database. Clearing a cache, table, or database might be necessary when the contents of the particular structure are or suspected to be invalid.

You can use any of the privileged EXEC commands in the following table to clear IP multicast caches, tables, and databases.

Table 23: Commands for Clearing Caches, Tables, and Databases

| Command | Purpose |
|---|---|
| <code>clear ip igmp group {group [hostname IP address] vrf name group [hostname IP address]}</code> | Deletes entries from the IGMP cache. |
| <code>clear ip mfib {counters [group source] global counters [group source] vrf * }</code> | Clears all active IPv4 Multicast Forwarding Information Base (MFIB) traffic counters. |
| <code>clear ip mrm {status-report [source]}</code> | IP multicast routing clear commands. |
| <code>clear ip mroute { * [hostname IP address] vrf name group [hostname IP address]}</code> | Deletes entries from the IP multicast routing table. |
| <code>clear ip msdp {peer sa-cache statistics vrf }</code> | Clears the Multicast Source Discovery Protocol (MSDP) cache. |
| <code>clear ip multicast {limit redundancy statistics }</code> | Clears the IP multicast information. |
| <code>clear ip pim {df [int rp rp address] interface rp-mapping [rp address] vrf vpn name {df interface rp-mapping}}</code> | Clears the PIM cache. |
| <code>clear ip sap [group-address "session-name"]</code> | Deletes the Session Directory Protocol Version 2 cache or an sdr cache entry. |

Displaying System and Network Statistics

You can display specific statistics, such as the contents of IP routing tables, caches, and databases.



Note This release does not support per-route statistics.

You can display information to learn resource usage and solve network problems. You can also display information about node reachability and discover the routing path that packets of your device are taking through the network.

You can use any of the privileged EXEC commands in the following table to display various routing statistics.

Table 24: Commands for Displaying System and Network Statistics

| Command | Purpose |
|--|---|
| ping [<i>group-name</i> <i>group-address</i>] | Sends an ICMP Echo Request to a multicast group address. |
| show ip igmp filter | Displays IGMP filter information. |
| show ip igmp groups [<i>group-name</i> <i>group-address</i> <i>type-number</i>] | Displays the multicast groups that are directly connected to the switch and that were learned through IGMP. |
| show ip igmp interface [<i>type number</i>] | Displays multicast-related information about an interface. |
| show ip igmp profile [<i>profile_number</i>] | Displays IGMP profile information. |
| show ip igmp ssm-mapping [<i>hostname/IP address</i>] | Displays IGMP SSM mapping information. |
| show ip igmp static-group { class-map [interface [<i>type</i>]]} | Displays static group information. |
| show ip igmp membership [<i>name/group address</i> all tracked] | Displays IGMP membership information for forwarding. |
| show ip igmp vrf | Displays the selected VPN Routing/Forwarding instance by name. |
| show ip mfib [<i>type number</i>] | Displays the IP multicast forwarding information base. |
| show ip mrib { client route vrf } | Displays the multicast routing information base. |
| show ip mrm { interface manager status-report } | Displays the IP multicast routing monitor information. |
| show ip mroute [<i>group-name</i> <i>group-address</i>] [<i>source</i>] [count interface proxy pruned summary verbose] | Displays the contents of the IP multicast routing table. |

| Command | Purpose |
|--|---|
| show ip msdp { count peer rpf-peer sa-cache summary vrf } | Displays the Multicast Source Discovery Protocol (MSDP) information. |
| show ip multicast [interface limit mpls redundancy vrf] | Displays global multicast information. |
| show ip pim all-vrfs { tunnel } | Display all VRFs. |
| show ip pim autorp | Display global auto-RP information. |
| show ip pim boundary [<i>type number</i>] | Displays boundary information. |
| show ip pim bsr-router | Display bootstrap router information (version 2). |
| show ip pim interface [<i>type number</i>] [count detail df stats] | Displays information about interfaces configured for PIM. This command is available in all software images. |
| show ip pim neighbor [<i>type number</i>] | Lists the PIM neighbors discovered by the switch. This command is available in all software images. |
| show ip pim mdt [bgp] | Displays multicast tunnel information. |
| show ip pim rp [<i>group-name</i> <i>group-address</i>] | Displays the RP routers associated with a sparse-mode multicast group. This command is available in all software images. |
| show ip pim rp-hash [<i>group-name</i> <i>group-address</i>] | Displays the RP to be chosen based upon the group selected. |
| show ip pim tunnel [<i>tunnel</i> <i>verbose</i>] | Displays the registered tunnels. |
| show ip pim vrf <i>name</i> | Displays VPN routing and forwarding instances. |
| show ip rpf { <i>source-address</i> <i>name</i> } | <p>Displays how the switch is doing Reverse-Path Forwarding (that is, from the unicast routing table, DVMRP routing table, or static mroutes).</p> <p>Command parameters include:</p> <ul style="list-style-type: none"> • <i>Host name</i> or <i>IP address</i>—IP name or group address. • Select—Group-based VRF select information. • vrf—Selects VPN Routing/Forwarding instance. |

| Command | Purpose |
|--|--|
| <code>show ip sap [group "session-name" detail]</code> | <p>Displays the Session Announcement Protocol (SAP) Version 2 cache.</p> <p>Command parameters include:</p> <ul style="list-style-type: none"> • <i>A.B.C.D</i>—IP group address. • <i>WORD</i>—Session name (in double quotes). • detail—Session details. |

Displaying Multicast Peers, Packet Rates and Loss Information, and Path Tracing

You can use the privileged EXEC commands in the following table to monitor IP multicast routers, packets, and paths.

Table 25: Commands for Displaying Multicast Peers, Packet Rates and Loss Information, and Path Tracing

| Command | Purpose |
|--|--|
| <code>mrinfo { [hostname address] vrf }</code> | Queries a multicast router or multilayer switch about which neighboring multicast devices are peering with it. |
| <code>mstat { [hostname address] vrf }</code> | Displays IP multicast packet rate and information loss. |
| <code>mtrace { [hostname address] vrf }</code> | Traces the path from a source to a destination branch for a multicast distribution tree for a given group. |

Configuration Examples for IP Multicast Routing

Example: Configuring an IP Multicast Boundary

This example shows how to set up a boundary for all administratively-scoped addresses:

```
Switch(config)# access-list 1 deny 239.0.0.0 0.255.255.255
Switch(config)# access-list 1 permit 224.0.0.0 15.255.255.255
Switch(config)# interface gigabitethernet1/0/1
Switch(config-if)# ip multicast boundary 1
```

Related Topics

[Defining the IP Multicast Boundary \(CLI\)](#), on page 145

[IP Multicast Boundary](#), on page 24

[Multicast Group Transmission Scheme](#), on page 22

Example: Responding to mriinfo Requests

The software answers mriinfo requests sent by mrouter systems and Cisco routers and multilayer switches. The software returns information about neighbors through DVMRP tunnels and all the routed interfaces. This information includes the metric (always set to 1), the configured TTL threshold, the status of the interface, and various flags. You can also use the **mriinfo** privileged EXEC command to query the router or switch itself, as in this example:

```
Switch# mriinfo
171.69.214.27 (mm1-7kd.cisco.com) [version cisco 11.1] [flags: PMS]:
171.69.214.27 -> 171.69.214.26 (mm1-r7kb.cisco.com) [1/0/pim/querier]
171.69.214.27 -> 171.69.214.25 (mm1-45a.cisco.com) [1/0/pim/querier]
171.69.214.33 -> 171.69.214.34 (mm1-45c.cisco.com) [1/0/pim]
171.69.214.137 -> 0.0.0.0 [1/0/pim/querier/down/leaf]
171.69.214.203 -> 0.0.0.0 [1/0/pim/querier/down/leaf]
171.69.214.18 -> 171.69.214.20 (mm1-45e.cisco.com) [1/0/pim]
171.69.214.18 -> 171.69.214.19 (mm1-45c.cisco.com) [1/0/pim]
171.69.214.18 -> 171.69.214.17 (mm1-45a.cisco.com) [1/0/pim]
```

Additional References

Related Documents

| Related Topic | Document Title |
|--|---|
| For complete syntax and usage information for the commands used in this chapter. | <i>IP Multicast Routing Command Reference (Catalyst 3850 Switches)</i> |
| For information on configuring the Multicast Source Discovery Protocol (MSDP). | <i>Routing Command Reference (Catalyst 3850 Switches)</i> |
| Platform-independent configuration information | <ul style="list-style-type: none"> <i>IP Multicast: PIM Configuration Guide, Cisco IOS XE Release 3SE (Catalyst 3850 Switches)</i> <i>IP Multicast: IGMP Configuration Guide, Cisco IOS XE Release 3SE (Catalyst 3850 Switches)</i> <i>IP Multicast: Multicast Optimization Configuration Guide, Cisco IOS XE Release 3SE (Catalyst 3850 Switches)</i> |
| Cisco IOS commands | Cisco IOS Master Commands List, All Releases |
| Cisco IOS IP multicast commands | Cisco IOS IP Multicast Command Reference |

Error Message Decoder

| Description | Link |
|---|---|
| To help you research and resolve system error messages in this release, use the Error Message Decoder tool. | https://www.cisco.com/cgi-bin/Support/Errordecoder/index.cgi |

Standards and RFCs

| Standard/RFC | Title |
|--------------|--|
| RFC 1112 | <i>Host Extensions for IP Multicasting</i> |
| RFC 2236 | <i>Internet Group Management Protocol, Version 2</i> |
| RFC 4601 | <i>Protocol-Independent Multicast-Sparse Mode (PIM-SM): Protocol Specification</i> |

MIBs

| MIB | MIBs Link |
|--------------------------------------|--|
| All supported MIBs for this release. | To locate and download MIBs for selected platforms, Cisco IOS releases, and feature sets, use Cisco MIB Locator found at the following URL: http://www.cisco.com/go/mibs |

Technical Assistance

| Description | Link |
|---|---|
| <p>The Cisco Support website provides extensive online resources, including documentation and tools for troubleshooting and resolving technical issues with Cisco products and technologies.</p> <p>To receive security and technical information about your products, you can subscribe to various services, such as the Product Alert Tool (accessed from Field Notices), the Cisco Technical Services Newsletter, and Really Simple Syndication (RSS) Feeds.</p> <p>Access to most tools on the Cisco Support website requires a Cisco.com user ID and password.</p> | http://www.cisco.com/support |

Feature History and Information for IP Multicast

| Release | Modification |
|--------------------|------------------------------|
| Cisco IOS XE 3.2SE | This feature was introduced. |



CHAPTER 13

Configuring the Service Discovery Gateway

- [Finding Feature Information, on page 283](#)
- [Restrictions for Configuring the Service Discovery Gateway, on page 283](#)
- [Information about the Service Discovery Gateway and mDNS, on page 284](#)
- [How to Configure the Service Discovery Gateway, on page 287](#)
- [Monitoring Service Discovery Gateway, on page 294](#)
- [Configuration Examples, on page 294](#)
- [Monitoring Service Cache \(GUI\), on page 297](#)
- [Monitoring Static Service Cache \(GUI\), on page 297](#)
- [Where to Go Next for Configuring Services Discovery Gateway, on page 298](#)
- [Additional References, on page 299](#)
- [Feature History and Information for Services Discovery Gateway, on page 300](#)

Finding Feature Information

Your software release may not support all the features documented in this module. For the latest caveats and feature information, see Bug Search Tool and the release notes for your platform and software release. To find information about the features documented in this module, and to see a list of the releases in which each feature is supported, see the feature information table at the end of this module.

Use Cisco Feature Navigator to find information about platform support and Cisco software image support. To access Cisco Feature Navigator, go to <http://www.cisco.com/go/cfn>. An account on Cisco.com is not required.

Restrictions for Configuring the Service Discovery Gateway

The following are restrictions for configuring the Service Discovery Gateway:

- The Service Discovery Gateway does not support topologies with multiple hops. All network segments must be connected directly to it. The Service Discovery Gateway can learn services from all connected segments to build its cache and respond to requests acting as a proxy.
- The use of third-party mDNS servers or applications are not supported with this feature.

Information about the Service Discovery Gateway and mDNS

mDNS

mDNS was defined to achieve zero configuration, with zero configuration being defined as providing the following features:

- Addressing—Allocating IP addresses to hosts
- Naming—Using names to refer to hosts instead of IP addresses
- Service discovery—Finding services automatically on the network

With mDNS, network users no longer have to assign IP addresses, assign host names, or type in names to access services on the network. Users only need to ask to see what network services are available, and choose from a list.

With mDNS, *addressing* is accomplished through the use of DHCP/DHCPv6 or IPv4 and IPv6 Link Local scoped addresses. The benefit of zero-configuration occurs when no infrastructure services such as DHCP or DNS are present and self-assigned link-local addressing can be used. The client can then select a random IPv4 address in the link-local range (169.254.0.0/24) or use its IPv6 link-local address (FE80::/10) for communication.

With mDNS, *naming* (name-to-address translation on a local network using mDNS) queries are sent over the local network using link-local scoped IP multicast. Because these DNS queries are sent to a multicast address (IPv4 address 224.0.0.251 or IPv6 address FF02::FB), no single DNS server with global knowledge is required to answer the queries. When a service or device sees a query for any service it is aware of, it provides a DNS response with the information from its cache.

With mDNS, *service discovery* is accomplished by browsing. An mDNS query is sent out for a given service type and domain, and any device that is aware of matching services replies with service information. The result is a list of available services for the user to choose from.

The mDNS protocol (mDNS-RFC), together with DNS Service Discovery (DNS-SD-RFC) achieves the zero-configuration addressing, naming, and service discovery.

mDNS-SD

Multicast DNS Service Discovery (mDNS-SD) uses DNS protocol semantics and multicast over well-known multicast addresses to achieve zero configuration service discovery. DNS packets are sent to and received on port 5353 using a multicast address of 224.0.0.251 and its IPv6 equivalent FF02::FB.

Because mDNS uses a link-local multicast address, its scope is limited to a single physical or logical LAN. If the networking reach needs to be extended to a distributed campus or to a wide-area environment consisting of many different networking technologies, mDNS gateway is implemented. An mDNS gateway provides a transport for mDNS packets across Layer 3 boundaries by filtering, caching, and redistributing services from one Layer 3 domain to another.

mDNS-SD Considerations for Wireless Clients

- mDNS packets can be sent out of Layer 3 interfaces that might not have an IP address.
- Packets with mDNS multicast IP and multicast MAC are sent on a multicast CAPWAP tunnel, if multicast-multicast mode is enabled. A multicast CAPWAP tunnel is a special CAPWAP tunnel used

for reducing the number of copies of multicast packet that are required to be generated for each AP CAPWAP tunnel. Sending packets on the multicast CAPWAP tunnel requires the outer IP header to be destined to the multicast CAPWAP tunnel's address, which all APs are subscribed to.

- All mDNS packet handling is done at a foreign switch for roamed clients. A foreign switch is the new switch that a roamed wireless client is actually attached to, which is called the point of attachment.

Service Discovery Gateway

The Service Discovery Gateway feature enables multicast Domain Name System (mDNS) to operate across Layer 3 boundaries (different subnets). An mDNS gateway provides transport for service discovery across Layer 3 boundaries by filtering, caching, and redistributing services from one Layer 3 domain (subnet) to another. Prior to implementation of this feature, mDNS was limited in scope to within a subnet because of the use of link-local scoped multicast addresses. This feature enhances Bring Your Own Device (BYOD).

Related Topics

[Configuring the Service List \(CLI\)](#), on page 287

[Example: Creating a Service-List, Applying a Filter and Configuring Parameters](#), on page 295

[Enabling mDNS Gateway and Redistributing Services \(CLI\)](#), on page 290

[Example: Specify Alternative Source Interface for Outgoing mDNS Packets](#), on page 294

[Example: Redistribute Service Announcements](#), on page 295

[Example: Disable Bridging of mDNS Packets to Wireless Clients](#), on page 295

[Example: Enabling mDNS Gateway and Redistributing Services](#), on page 296

[Example: Global mDNS Configuration](#), on page 296

[Example: Interface mDNS Configuration](#), on page 296

mDNS Gateway and Subnets

You need to enable an mDNS gateway for service discovery to operate across subnets. You can enable mDNS gateway for a device or for an interface.



Note You need to configure service routing globally before configuring at the interface level.

After the device or interface is enabled, you can redistribute service discovery information across subnets. You can create service policies and apply filters on either incoming service discovery information (called IN-bound filtering) or outgoing service discovery information (called OUT-bound filtering).



Note If redistribution is enabled globally, global configuration is given higher priority than interface configuration.

Figure 16: Sample Networking Scenario

For example, if the mDNS gateway functionality is enabled on the router in this figure, then service information can be sent from one subnet to another and vice-versa. For example, the printer and fax service information being advertised in the network with IP address 192.0.2.6 are redistributed to the network with IP address 198.51.100.4. The printer and fax service information in the network with IP address 192.0.2.6 is learned by

mDNS-enabled hosts and devices in the other network.

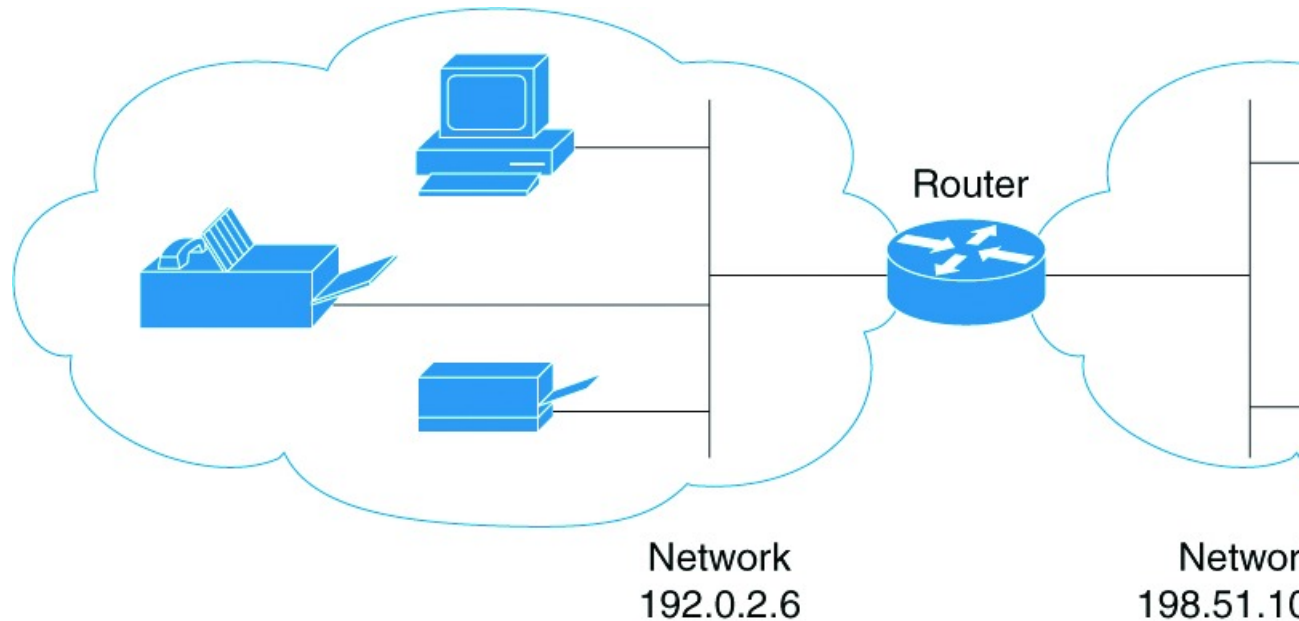

Filtering

After configuring the mDNS gateway and subnets, you can filter services that you want to redistribute. While creating a service list, the **permit** or **deny** command options are used:

- The **permit** command option allows you to permit or transport specific service list information.
- The **deny** option allows you to deny service list information that is available to be transported to other subnets.

You need to include a sequence number when using the **permit** or **deny** command option. The same service list name can be associated with multiple sequence numbers and each sequence number will be mapped to a rule.



Note If no filters are configured, then the default action is to deny service list information to be transported through the device or interface.

Query is another option provided when creating service lists. You can create queries using a service list. If you want to browse for a service, then active queries can be used. This function is helpful to keep the records refreshed in the cache.



Note Active queries can only be used globally and cannot be used at the interface level.

A service end-point (such as a printer or fax) sends unsolicited announcements when a service starts up. After that, it sends unsolicited announcements whenever a network change event occurs (such as an interface coming up or going down). The device always respond to queries.

After creating a service list and using the **permit** or **deny** command options, you can filter using match statements (commands) based on *service-instance*, *service-type*, or *message-type* (announcement or query).

Related Topics

[Configuring the Service List \(CLI\)](#), on page 287

[Example: Creating a Service-List, Applying a Filter and Configuring Parameters](#), on page 295

[Enabling mDNS Gateway and Redistributing Services \(CLI\)](#), on page 290

[Example: Specify Alternative Source Interface for Outgoing mDNS Packets](#), on page 294

[Example: Redistribute Service Announcements](#), on page 295

[Example: Disable Bridging of mDNS Packets to Wireless Clients](#), on page 295

[Example: Enabling mDNS Gateway and Redistributing Services](#), on page 296

[Example: Global mDNS Configuration](#), on page 296

[Example: Interface mDNS Configuration](#), on page 296

How to Configure the Service Discovery Gateway

Configuring the Service List (CLI)

This procedure describes how to create a service list, apply a filter for the service list, and configure parameters for the service list name.

SUMMARY STEPS

1. **enable**
2. **configure terminal**
3. **service-list mdns-sd *service-list-name* {deny *sequence-number* | permit *sequence-number* | query}**
4. **match message-type {announcement | any | query}**
5. **match service-instance { *LINE* }**
6. **match service-type { *LINE* }**
7. **end**

DETAILED STEPS

| | Command or Action | Purpose |
|--------|---|---|
| Step 1 | enable Example: Switch> enable | Enables privileged EXEC mode. <ul style="list-style-type: none"> • Enter your password if prompted. |
| Step 2 | configure terminal Example: Switch# configure terminal | Enters the global configuration mode. |

| | Command or Action | Purpose |
|---------------|--|---|
| Step 3 | <p>service-list mdns-sd <i>service-list-name</i> {deny <i>sequence-number</i> permit <i>sequence-number</i> query}</p> <p>Example:</p> <pre>Switch(config)# service-list mdns-sd s11 permit 3</pre> <pre>Switch(config)# service-list mdns-sd s14 query</pre> | <p>Enters mDNS service discovery service list mode. In this mode, you can:</p> <ul style="list-style-type: none"> • Create a service list and apply a filter on the service list according to the permit or deny option applied to the sequence number. • Create a service list and associate a query for the service list name if the query option is used. <p>Note The sequence number sets the priority of the rule. A rule with a lower sequence number is selected first and the service announcement or query is allowed or denied accordingly. You define the sequence number as per your network requirements.</p> |
| Step 4 | <p>match message-type {announcement any query}</p> <p>Example:</p> <pre>Switch(config-mdns-sd-sl)# match message-type announcement</pre> | <p>(Optional) Sets the message type to match. You can match the following message types:</p> <ul style="list-style-type: none"> • announcement • any • query <p>These commands configure the parameters for the service list name that is created in step 2.</p> <p>If the match message-type is an announcement, then the service list rule only allows service advertisements or announcements for the device. If the match message-type is a query, then only a query from the client for a certain service in the network is allowed.</p> <p>Multiple service maps of the same name with different sequence numbers can be created and the evaluation of the filters will be ordered on the sequence number. Service lists are an ordered sequence of individual statements, each one has a permit or deny result. Evaluation of service list consists of a list scan, in a predetermined order, and an evaluation of the criteria of each statement that matches. A list scan is stopped once the first statement match is found and an action permit/deny associated with the statement match is performed. The default action after scanning through the entire list is to deny.</p> <p>Note You cannot use the match command if you have used the query option in the previous step. The match command can be used only for the permit or deny option.</p> |

| | Command or Action | Purpose |
|--------|--|--|
| Step 5 | <p>match service-instance { <i>LINE</i> }</p> <p>Example:</p> <pre>Switch(config-mdns-sd-sl)## match service-instance servInst 1</pre> | <p>(Optional) Sets the service instance to match.</p> <p>This command configures the parameters for the service list name that is created in step 2.</p> <p>Note You cannot use the match command if you have used the query option in the previous step. The match command can be used only for the permit or deny option.</p> |
| Step 6 | <p>match service-type { <i>LINE</i> }</p> <p>Example:</p> <pre>Switch(config-mdns-sd-sl)# match service-type _ipp._tcp</pre> | <p>(Optional) Sets the value of the mDNS service type string to match.</p> <p>This command configures the parameters for the service list name that is created in step 2.</p> <p>Note You cannot use the match command if you have used the query option in the previous step. The match command can be used only for the permit or deny option.</p> |
| Step 7 | <p>end</p> <p>Example:</p> <pre>Switch(config-mdns-sd-sl)# end</pre> | <p>Returns to privileged EXEC mode.</p> |

What to do next

Proceed to enable the mDNS gateway and redistribution of services.

Related Topics

[Service Discovery Gateway](#) , on page 285

[Filtering](#), on page 286

[Example: Creating a Service-List, Applying a Filter and Configuring Parameters](#), on page 295

Configuring the Service List (GUI)

- Step 1** Choose **Configuration > Controller > mDNS > Static Service**.
- Step 2** Click **Create Service**.
The **Service List > Create Service** page is displayed.
- Step 3** In the **Service List Name** text box, enter the service list name.
- Step 4** From the **Service rule** drop-down list, choose from the following options:
- **permit**—permits the service list.
 - **deny**—denies the service list.
- Step 5** In the **Sequence number** text box, enter the priority of the rule.

A rule with a lower sequence number is selected first and the service announcement or query is allowed or denied accordingly. You define the sequence number as per your network requirements.

Step 6 From the **Message type** drop-down list, choose the message type to match from the following options:

- **announcement**—The service list rule allows only service advertisements or announcements for the device.
- **query**—The service list rule allows only a query from the client for a service in the network.
- **any**—The service list rule allows any type of message.

Multiple service maps of the same name with different sequence numbers can be created and the evaluation of the filters will be ordered on the sequence number. Service lists are an ordered sequence of individual statements, each one has a permit or deny result. Evaluation of service list consists of a list scan, in a predetermined order, and an evaluation of the criteria of each statement that matches. A list scan is stopped once the first statement match is found and an action permit/deny associated with the statement match is performed. The default action after scanning through the entire list is to deny.

Step 7 In the **Service instance** text box, enter the service instance to match.

Step 8 In the **Custom** text box, enter the mDNS service type string to match.

The **Learned Service** box shows the services that are added after enabling the learned service type configured by navigating to **Configuration > Controller > mDNS > Global**. For example, `_roap._tcp.local`.

The **Selected Service** box shows the learned service that you have selected for an mDNS service.

Step 9 Click **Apply**.

Step 10 Click **Save Configuration**.

What to do next

Proceed to enable the mDNS gateway and redistribution of services.

Enabling mDNS Gateway and Redistributing Services (CLI)

After enabling mDNS gateway for a device, you can apply filters (apply IN-bound filtering or OUT-bound filtering) and active queries by using **service-policy** and **service-policy-query** commands, respectively. You can redistribute services and service announcements using the **redistribute mdns-sd** command, and set some part of the system memory for cache using the **cache-memory-max** command.



Note By default, mDNS gateway is disabled on all interfaces.

SUMMARY STEPS

1. **enable**
2. **configure terminal**
3. **service-routing mdns-sd**
4. **service-policy** *service-policy-name* {IN | OUT}
5. **redistribute mdns-sd**
6. **cache-memory-max** *cache-config-percentage*
7. **service-policy-query** *service-list-query-name* *service-list-query-periodicity*

8. `exit`
9. `wireless multicast`
10. `no wireless mdns-bridging`
11. `end`

DETAILED STEPS

| | Command or Action | Purpose |
|--------|---|---|
| Step 1 | <p>enable</p> <p>Example:</p> <pre>Switch> enable</pre> | <p>Enables privileged EXEC mode.</p> <ul style="list-style-type: none"> • Enter your password if prompted. |
| Step 2 | <p>configure terminal</p> <p>Example:</p> <pre>Switch# configure terminal</pre> | <p>Enters the global configuration mode.</p> |
| Step 3 | <p>service-routing mdns-sd</p> <p>Example:</p> <pre>Switch (config)# service-routing mdns-sd</pre> | <p>Enables mDNS gateway functionality for a device and enters multicast DNS configuration (config-mdns) mode.</p> <p>Note This command enables the mDNS function globally.</p> <p>Note Enter the service-routing mdns-sd source-interface if-name command in either global-config or interface-config mode, to specify an alternate source interface for outgoing mDNS packets, so its IP address can be used when there is none configured on the outgoing interface.</p> |
| Step 4 | <p>service-policy service-policy-name {IN OUT}</p> <p>Example:</p> <pre>Switch (config-mdns)# service-policy serv-poll IN</pre> | <p>(Optional) For a service list, applies a filter on incoming service discovery information (IN-bound filtering) or outgoing service discovery information (OUT-bound filtering).</p> |
| Step 5 | <p>redistribute mdns-sd</p> <p>Example:</p> <pre>Switch (config-mdns)# redistribute mdns-sd</pre> | <p>(Optional) Redistributes services or service announcements across subnets.</p> <p>Note If redistribution is enabled globally, global configuration is given higher priority than interface configuration.</p> |
| Step 6 | <p>cache-memory-max cache-config-percentage</p> <p>Example:</p> | <p>(Optional) Sets some part of the system memory (in percentage) for cache.</p> |

| | Command or Action | Purpose |
|----------------|---|---|
| | Switch (config-mdns)# cache-memory-max 20 | Note By default, 10 percent of the system memory is set aside for cache. You can override the default value by using this command. |
| Step 7 | service-policy-query <i>service-list-query-name</i> <i>service-list-query-periodicity</i> Example: Switch (config-mdns)# service-policy-query s1-query1 100 | (Optional) Configures service list-query periodicity. |
| Step 8 | exit Example: Switch (config-mdns)# exit | (Optional) Returns to global configuration mode. |
| Step 9 | wireless multicast Example: Switch (config)# wireless multicast | (Optional) Enables wireless Ethernet multicast support. |
| Step 10 | no wireless mdns-bridging Example: Switch (config)# no wireless mdns-bridging | (Optional) Disables bridging of mDNS packets to wireless clients. |
| Step 11 | end Example: Switch(config)# end | Returns to privileged EXEC mode. |

Related Topics

[Service Discovery Gateway](#) , on page 285

[Filtering](#), on page 286

[Example: Specify Alternative Source Interface for Outgoing mDNS Packets](#), on page 294

[Example: Redistribute Service Announcements](#), on page 295

[Example: Disable Bridging of mDNS Packets to Wireless Clients](#), on page 295

[Example: Enabling mDNS Gateway and Redistributing Services](#), on page 296

[Example: Global mDNS Configuration](#), on page 296

[Example: Interface mDNS Configuration](#), on page 296

Configuring Interface Service Rules (GUI)

- Step 1** Choose **Configuration > Controller > mDNS > Interface**.
- Step 2** Click an interface name.
The **Interface Service Rules** page is displayed.
- Step 3** From the **Service Policy IN** drop-down list, choose the service policy that should be applied for incoming mDNS messages.
- Step 4** From the **Service Policy OUT** drop-down list, choose the service policy that should be applied for outgoing mDNS messages.
- Step 5** Select or unselect the **Redistribution** check box to enable or disable redistribution of service announcements received on one interface over all the interfaces or over a specific interface.
- Step 6** Check **Enable** to enable a self designated gateway for the interface.
- Step 7** Enter values for proximity- **maximum service** option and **service list active query** in the text box.
The value ranges from 1 to 100 for **maximum service**.
- Step 8** To create a new **Service Type**, select **Create New** from the drop-down box.
- Step 9** Click **Apply**.
- Step 10** Click **Save Configuration**.
-

Configuring mDNS Global Rules (GUI)

- Step 1** Choose **Configuration > Controller > mDNS > Global**.
- Step 2** Select the **mDNS gateway** check box.
- Step 3** Follow these steps to configure downstream rules that include service lists and service rules that you can apply for all the downstream traffic on the switch.
- Click the **Down Stream Rules** tab.
 - From the **Service List Name** drop-down list, choose **Create New**. In the **Service List Name** box, enter a name.
 - Click **Add** to add a service rule, and follow on-screen instructions to specify the service rules that include **Action**, **Message Type**, **Service Instance**, and **Service Type**.
See the online help for detailed descriptions of the fields.
- Step 4** Follow these steps to configure the upstream rules that include service lists and service rules that you can apply for all the upstream traffic on the switch.
- Click the **Up Stream Rules** tab.
 - From the **Service List Name** drop-down list, choose **Create New**. In the **New Service List Name** box, enter a name.
 - Click **Add** to add a service rule, and follow on-screen instructions to specify the service rules that include **Action**, **Message Type**, **Service Instance**, and **Service Type**.
See the online help for detailed descriptions of the fields.
- Step 5** Follow these steps to configure the switch as designated gateway and apply proximity rules:
- Click the **Advanced** tab.
 - Select or unselect the **Self Designated Gateway** check box.

- c) Under **Proximity**, in the **Max Services Option** box, enter the maximum number of devices supported with a particular service type that are in proximity. The valid range is between 1 and 100.
- d) From the **Service List Active Query** drop-down list, choose the services that are filtered for proximity.
You can create a custom service list, by choosing **Create New** and then specifying the service list name.
- e) Click **New** to add a service type, and from the **Service Type** drop-down list, choose the service type to be added, and click **OK**.
See the online help for detailed descriptions of the fields.

Step 6 From the **Learn Service** drop-down list, choose from the following options:

- **Enable**— Allows the switch to learn all the announced services. It is used to learn services by enabling all announcement/queries by using Service Policy IN of type GUI-permit-all and in Service Policy OUT of type GUI-deny-all.
- **Disable**— Denies all the traffics IN and OUT. It is used to deny services by disabling all announcement/queries by using Service Policy IN of type GUI-deny-all and in Service Policy OUT of type GUI-deny-all.
- **Custom**— You can set your own IN and OUT policy. It allows you to define a custom service list.

Step 7 Click **Apply**.

Step 8 Click **Save Configuration**.

Monitoring Service Discovery Gateway

Table 26: Monitoring Service Discovery Gateway

| Command | Purpose |
|---|---|
| show mdns requests [detail name <i>record-name</i> type <i>record-type</i> [name <i>record-name</i>]] | This command displays information for outstanding mDNS requests, including record name and record type information. |
| show mdns cache [interface <i>type number</i> name <i>record-name</i> [type <i>record-type</i>] type <i>record-type</i>] | This command displays mDNS cache information. |
| show mdns statistics { all service-list <i>list-name</i> service-policy { all interface <i>type number</i> } } | This command displays mDNS statistics. |

Configuration Examples

Example: Specify Alternative Source Interface for Outgoing mDNS Packets

The following example displays how to specify an alternate source interface for outgoing mDNS packets, so its IP address can be used when there is none configured on the outgoing interface.

```
Switch(config)# service-routing mdns-sd
```

```
Switch(config-mdns)# source-interface if-name
```

Related Topics

[Enabling mDNS Gateway and Redistributing Services \(CLI\)](#), on page 290

[Service Discovery Gateway](#) , on page 285

[Filtering](#), on page 286

Example: Redistribute Service Announcements

The following example displays how to redistribute service announcements received on one interface over all the interfaces or over a specific interface.

```
Switch(config)# service-routing mdns-sd
Switch(config-mdns)# Redistribute mdns-sd if-name
```

Related Topics

[Enabling mDNS Gateway and Redistributing Services \(CLI\)](#), on page 290

[Service Discovery Gateway](#) , on page 285

[Filtering](#), on page 286

Example: Disable Bridging of mDNS Packets to Wireless Clients

The following example displays how to disable bridging of mDNS packets to wireless clients.

```
Switch(config)# wireless multicast
Switch(config)# no wireless mdns-bridging
```

Related Topics

[Enabling mDNS Gateway and Redistributing Services \(CLI\)](#), on page 290

[Service Discovery Gateway](#) , on page 285

[Filtering](#), on page 286

Example: Creating a Service-List, Applying a Filter and Configuring Parameters

The following example shows the creation of a service-list s11. The **permit** command option is being applied on sequence number 3 and all services with message-type announcement are filtered and available for transport across various subnets associated with the device.

```
Switch# configure terminal
Switch(config)# service-list mdns-sd s11 permit 3
Switch(config-mdns-sd-s1)#match message-type announcement
Switch(config-mdns)# exit
```

Related Topics

[Configuring the Service List \(CLI\)](#), on page 287

[Service Discovery Gateway](#) , on page 285

[Filtering](#), on page 286

Example: Enabling mDNS Gateway and Redistributing Services

The following example shows how to enable an mDNS gateway for a device and enable redistribution of services across subnets. IN-bound filtering is applied on the service-list serv-poll. Twenty percent of system memory is made available for cache and service-list-query periodicity is configured at 100 seconds.

```
Switch# configure terminal
Switch# service-routing mdns-sd
Switch(config-mdns) # service-policy serv-poll IN
Switch(config-mdns) # redistribute mdns-sd
Switch(config-mdns) # cache-memory-max 20
Switch(config-mdns) # service-policy-query sl-query1 100
Switch(config-mdns) # exit
```

Related Topics

[Enabling mDNS Gateway and Redistributing Services \(CLI\)](#), on page 290

[Service Discovery Gateway](#), on page 285

[Filtering](#), on page 286

Example: Global mDNS Configuration

The following example displays how to globally configure mDNS.

```
Switch# configure terminal
Switch(config)# service-list mdns-sd mypermit-all permit 10
Switch(config-mdns-sd-s1) # exit
Switch(config)# service-list mdns-sd querier query
Switch(config-mdns-sd-s1) # service-type _dns._udp
Switch(config-mdns-sd-s1) # end
Switch# configure terminal
Switch(config)# service-routing mdns-sd
Switch(config-mdns) # service-policy mypermit-all IN
Switch(config-mdns) # service-policy mypermit-all OUT
```

Related Topics

[Enabling mDNS Gateway and Redistributing Services \(CLI\)](#), on page 290

[Service Discovery Gateway](#), on page 285

[Filtering](#), on page 286

Example: Interface mDNS Configuration

The following example displays how to configure mDNS for an interface.

```
Switch(config)# interface Vlan136
Switch(config-if) # description *** Mgmt VLAN ***
Switch(config-if) # ip address 9.7.136.10 255.255.255.0
Switch(config-if) # ip helper-address 9.1.0.100
Switch(config-if) # service-routing mdns-sd
Switch(config-if-mdns-sd) # service-policy mypermit-all IN
Switch(config-if-mdns-sd) # service-policy mypermit-all OUT
```



```
Switch(config-if-mdns-sd) # service-policy-query querier 60
```

Related Topics

[Enabling mDNS Gateway and Redistributing Services \(CLI\)](#), on page 290

[Service Discovery Gateway](#), on page 285

[Filtering](#), on page 286

Monitoring Service Cache (GUI)

Click **Monitor > Controller > mDNS > Service Cache** to view domain names and other details of the service providers.

Each service advertisement contains a record that maps the domain name of the service provider to the IP address. The details of the following parameters is displayed:

| | |
|----------------|---|
| Name | Displays the hostname assigned to each service provider machine. |
| VLAN ID | Displays the VLAN ID of the service provider. |
| MAC ID | Displays the MAC address of the service provider machine. |
| TTL | Displays the Time to Live (TTL) value in seconds that determines the validity of the service offered by the service provider. The service provider is removed from the Switch when the TTL expires. |
| Remaining | Displays the time left in seconds before the service provider is removed from the Switch. |
| Type | Displays the service type record. Values are as follow: <ul style="list-style-type: none"> • PTR • TXT • SRV |
| RR Record Data | Displays IP addresses, service names of the announced services. |

Monitoring Static Service Cache (GUI)

Click **Monitor > Controller > mDNS > Static Service Cache** to view domain names and other details of the service providers.

Each service advertisement contains a record that maps the domain name of the service provider to the IP address. The details of the following parameters is displayed:

| | |
|---------|--|
| Name | Displays the hostname assigned to each service provider machine. |
| VLAN ID | Displays the VLAN ID of the service provider. |

| | |
|----------------|---|
| MAC ID | Displays the MAC address of the service provider machine. |
| TTL | Displays the Time to Live (TTL) value in seconds that determines the validity of the service offered by the service provider. The service provider is removed from the Switch when the TTL expires. |
| Remaining | Displays the time left in seconds before the service provider is removed from the Switch. |
| Type | Displays the service type record. Values are as follow: <ul style="list-style-type: none"> • PTR • TXT • SRV |
| RR Record Data | Displays IP addresses, service names of the announced services. |

Where to Go Next for Configuring Services Discovery Gateway

You can configure the following:

- IGMP
- Wireless Multicast
- PIM
- SSM
- IP Multicast Routing

You can also review the following IP Multicast Optimization processes for your configuration:

- Optimizing PIM Sparse Mode in a Large IP Multicast Deployment
- Multicast Subsecond Convergence
- IP Multicast Load Splitting across Equal-Cost Paths
- SSM Channel Based Filtering for Multicast
- PIM Dense Mode State Refresh
- IGMP State Limit

Additional References

Related Documents

| Related Topic | Document Title |
|--|--|
| Configuring DNS | <i>IP Addressing: DNS Configuration Guide, Cisco IOS XE Release 3SE</i> |
| DNS conceptual information | 'Information About DNS' section in <i>IP Addressing: DNS Configuration Guide, Cisco IOS XE Release 3SE</i> |
| Platform-independent configuration information | <i>IP Addressing: DNS Configuration Guide, Cisco IOS XE Release 3SE</i> |

Error Message Decoder

| Description | Link |
|---|---|
| To help you research and resolve system error messages in this release, use the Error Message Decoder tool. | https://www.cisco.com/cgi-bin/Support/Errordecoder/index.cgi |

Standards and RFCs

| Standard/RFC | Title |
|------------------------------|------------------------------------|
| RFC 6763 | <i>DNS-Based Service Discovery</i> |
| Multicast DNS Internet-Draft | Multicast |

MIBs

| MIB | MIBs Link |
|--------------------------------------|--|
| All supported MIBs for this release. | To locate and download MIBs for selected platforms, Cisco IOS releases, and feature sets, use Cisco MIB Locator found at the following URL: http://www.cisco.com/go/mibs |

Technical Assistance

| Description | Link |
|---|---|
| <p>The Cisco Support website provides extensive online resources, including documentation and tools for troubleshooting and resolving technical issues with Cisco products and technologies.</p> <p>To receive security and technical information about your products, you can subscribe to various services, such as the Product Alert Tool (accessed from Field Notices), the Cisco Technical Services Newsletter, and Really Simple Syndication (RSS) Feeds.</p> <p>Access to most tools on the Cisco Support website requires a Cisco.com user ID and password.</p> | http://www.cisco.com/support |

Feature History and Information for Services Discovery Gateway

| Release | Modification |
|--------------------|------------------------------|
| Cisco IOS XE 3.3SE | This feature was introduced. |



CHAPTER 14

IP Multicast Optimization: Optimizing PIM Sparse Mode in a Large IP Multicast Deployment

- [Finding Feature Information, on page 301](#)
- [Prerequisites for Optimizing PIM Sparse Mode in a Large IP Multicast Deployment, on page 301](#)
- [Information About Optimizing PIM Sparse Mode in a Large IP Multicast Deployment, on page 302](#)
- [How to Optimize PIM Sparse Mode in a Large IP Multicast Deployment, on page 305](#)
- [Configuration Examples for Optimizing PIM Sparse Mode in a Large Multicast Deployment, on page 307](#)
- [Additional References, on page 307](#)
- [Feature History and Information for Optimizing PIM Sparse Mode in a Large IP Multicast Deployment, on page 308](#)

Finding Feature Information

Your software release may not support all the features documented in this module. For the latest caveats and feature information, see Bug Search Tool and the release notes for your platform and software release. To find information about the features documented in this module, and to see a list of the releases in which each feature is supported, see the feature information table at the end of this module.

Use Cisco Feature Navigator to find information about platform support and Cisco software image support. To access Cisco Feature Navigator, go to <http://www.cisco.com/go/cfn>. An account on Cisco.com is not required.

Prerequisites for Optimizing PIM Sparse Mode in a Large IP Multicast Deployment

- You must have PIM sparse mode running in your network.
- If you plan to use a group list to control to which groups the shortest-path tree (SPT) threshold applies, you must have configured your access list before performing the task.

Information About Optimizing PIM Sparse Mode in a Large IP Multicast Deployment

PIM Registering Process

IP multicast sources do not use a signaling mechanism to announce their presence. Sources just send their data into the attached network, as opposed to receivers that use Internet Group Management Protocol (IGMP) to announce their presence. If a source sends traffic to a multicast group configured in PIM sparse mode (PIM-SM), the Designated Router (DR) leading toward the source must inform the rendezvous point (RP) about the presence of this source. If the RP has downstream receivers that want to receive the multicast traffic (natively) from this source and has not joined the shortest path leading toward the source, then the DR must send the traffic from the source to the RP. The PIM registering process, which is individually run for each (S, G) entry, accomplishes these tasks between the DR and RP.

The registering process begins when a DR creates a new (S, G) state. The DR encapsulates all the data packets that match the (S, G) state into PIM register messages and unicasts those register messages to the RP.

If an RP has downstream receivers that want to receive register messages from a new source, the RP can either continue to receive the register messages through the DR or join the shortest path leading toward the source. By default, the RP will join the shortest path, because delivery of native multicast traffic provides the highest throughput. Upon receipt of the first packet that arrives natively through the shortest path, the RP will send a register-stop message back to the DR. When the DR receives this register-stop message, it will stop sending register messages to the RP.

If an RP has no downstream receivers that want to receive register messages from a new source, the RP will not join the shortest path. Instead, the RP will immediately send a register-stop message back to the DR. When the DR receives this register-stop message, it will stop sending register messages to the RP.

Once a routing entry is established for a source, a periodic reregistering takes place between the DR and RP. One minute before the multicast routing table state times out, the DR will send one dataless register message to the RP each second that the source is active until the DR receives a register-stop message from the RP.

This action restarts the timeout time of the multicast routing table entry, typically resulting in one reregistering exchange every 2 minutes. Reregistering is necessary to maintain state, to recover from lost state, and to keep track of sources on the RP. It will take place independently of the RP joining the shortest path.

PIM Version 1 Compatibility

If an RP is running PIM Version 1, it will not understand dataless register messages. In this case, the DR will not send dataless register messages to the RP. Instead, approximately every 3 minutes after receipt of a register-stop message from the RP, the DR encapsulates the incoming data packets from the source into register messages and sends them to the RP. The DR continues to send register messages until it receives another register-stop message from the RP. The same behavior occurs if the DR is running PIM Version 1.

When a DR running PIM Version 1 encapsulates data packets into register messages for a specific (S, G) entry, the entry is process-switched, not fast-switched or hardware-switched. On platforms that support these faster paths, the PIM registering process for an RP or DR running PIM Version 1 may lead to periodic out-of-order packet delivery. For this reason, we recommend upgrading your network from PIM Version 1 to PIM Version 2.

PIM Designated Router

Devices configured for IP multicast send PIM hello messages to determine which device will be the designated router (DR) for each LAN segment (subnet). The hello messages contain the device's IP address, and the device with the highest IP address becomes the DR.

The DR sends Internet Group Management Protocol (IGMP) host query messages to all hosts on the directly connected LAN. When operating in sparse mode, the DR sends source registration messages to the rendezvous point (RP).

By default, multicast devices send PIM router query messages every 30 seconds. By enabling a device to send PIM hello messages more often, the device can discover unresponsive neighbors more quickly. As a result, the device can implement failover or recovery procedures more efficiently. It is appropriate to make this change only on redundant devices on the edge of the network.

PIM Sparse-Mode Register Messages

Dataless register messages are sent at a rate of one message per second. Continuous high rates of register messages might occur if a DR is registering bursty sources (sources with high data rates) and if the RP is not running PIM Version 2.

By default, PIM sparse-mode register messages are sent without limiting their rate. Limiting the rate of register messages will limit the load on the DR and RP, at the expense of dropping those register messages that exceed the set limit. Receivers may experience data packet loss within the first second in which packets are sent from bursty sources.

Preventing Use of Shortest-Path Tree to Reduce Memory Requirement

Understanding PIM shared tree and source tree will help you understand how preventing the use of the shortest-path tree can reduce memory requirements.

PIM Shared Tree and Source Tree - Shortest-Path Tree

By default, members of a multicast group receive data from senders to the group across a single data distribution tree rooted at the rendezvous point (RP). This type of distribution tree is called shared tree, as shown in the figure. Data from senders is delivered to the RP for distribution to group members joined to the shared tree.

Figure 17: Shared Tree versus Source Tree (Shortest-Path Tree)

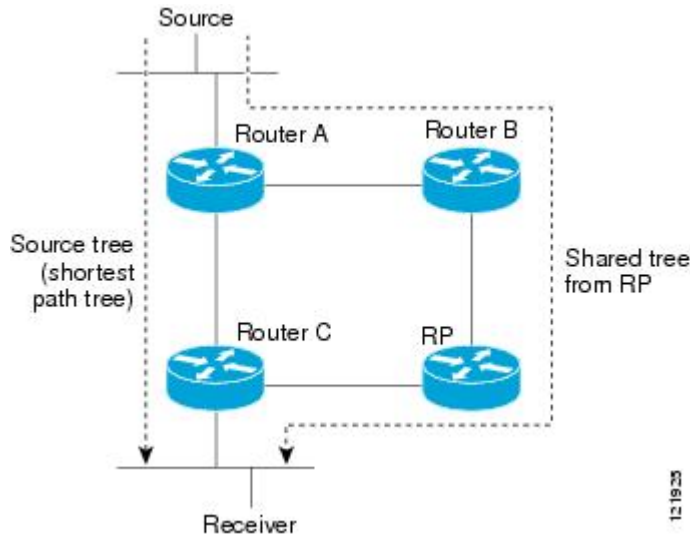

If the data rate warrants, leaf routers on the shared tree may initiate a switch to the data distribution tree rooted at the source. This type of distribution tree is called a shortest-path tree (SPT) or source tree. By default, the software switches to a source tree upon receiving the first data packet from a source.

The following process describes the move from shared tree to source tree in more detail:

1. Receiver joins a group; leaf Router C sends a Join message toward the RP.
2. The RP puts the link to Router C in its outgoing interface list.
3. Source sends data; Router A encapsulates data in a register message and sends it to the RP.
4. The RP forwards data down the shared tree to Router C and sends a Join message toward the source. At this point, data may arrive twice at Router C, once encapsulated and once natively.
5. When data arrives natively (through multicast) at the RP, the RP sends a register-stop message to Router A.
6. By default, reception of the first data packet prompts Router C to send a Join message toward the source.
7. When Router C receives data on (S, G), it sends a Prune message for the source up the shared tree.
8. The RP deletes the link to Router C from the outgoing interface of (S, G). The RP triggers a Prune message toward the source.

Join and Prune messages are sent for sources and RPs. They are sent hop-by-hop and are processed by each PIM router along the path to the source or RP. Register and register-stop messages are not sent hop-by-hop. They are sent by the designated router that is directly connected to a source and are received by the RP for the group.

Multiple sources sending to groups use the shared tree.

Benefit of Preventing or Delaying the Use of the Shortest-Path Tree

The switch from shared to source tree happens upon the arrival of the first data packet at the last hop device (Router C in the figure *Shared Tree and Source Tree (Shortest-Path Tree)*). This switch occurs because the **ip pim spt-threshold** command controls that timing, and its default setting is 0 kbps.

The shortest-path tree requires more memory than the shared tree, but reduces delay. You might want to prevent or delay its use to reduce memory requirements. Instead of allowing the leaf device to move to the shortest-path tree immediately, you can prevent use of the SPT or specify that the traffic must first reach a threshold.

You can configure when a PIM leaf device should join the shortest-path tree for a specified group. If a source sends at a rate greater than or equal to the specified *kbps* rate, the device triggers a PIM Join message toward the source to construct a source tree (shortest-path tree). If the **infinity** keyword is specified, all sources for the specified group use the shared tree, never switching to the source tree.

How to Optimize PIM Sparse Mode in a Large IP Multicast Deployment

Optimizing PIM Sparse Mode in a Large Deployment

Consider performing this task if your deployment of IP multicast is large.

Steps 3, 5, and 6 in this task are independent of each other and are therefore considered optional. Any one of these steps will help optimize PIM sparse mode. If you are going to perform Step 5 or 6, you must perform Step 4. Step 6 applies only to a designated router; changing the PIM query interval is only appropriate on redundant routers on the edge of the PIM domain.

SUMMARY STEPS

1. **enable**
2. **configure terminal**
3. **ip pim register-rate-limit** *rate*
4. **ip pim spt-threshold** *{kbps| infinity}***[group-list** *access-list***]**
5. **interface** *type number*
6. **ip pim query-interval** *period* **[msec]**

DETAILED STEPS

| | Command or Action | Purpose |
|--------|--|--|
| Step 1 | enable Example: Router> enable | Enables privileged EXEC mode. <ul style="list-style-type: none"> • Enter your password if prompted. |
| Step 2 | configure terminal Example: | Enters global configuration mode. |

| | Command or Action | Purpose |
|---------------|---|---|
| | Router# configure terminal | |
| Step 3 | <p>ip pim register-rate-limit <i>rate</i></p> <p>Example:</p> <pre>Router(config)# ip pim register-rate-limit 10</pre> | <p>(Optional) Sets a limit on the maximum number of PIM sparse mode register messages sent per second for each (S, G) routing entry.</p> <ul style="list-style-type: none"> • Use this command to limit the number of register messages that the designated router (DR) will allow for each (S, G) entry. • By default, there is no maximum rate set. • Configuring this command will limit the load on the DR and RP at the expense of dropping those register messages that exceed the set limit. • Receivers may experience data packet loss within the first second in which register messages are sent from bursty sources. |
| Step 4 | <p>ip pim spt-threshold {<i>kpbs</i> infinity} [group-list <i>access-list</i>]</p> <p>Example:</p> <pre>Router(config)# ip pim spt-threshold infinity group-list 5</pre> | <p>(Optional) Specifies the threshold that must be reached before moving to the shortest-path tree.</p> <ul style="list-style-type: none"> • The default value is 0, which causes the router to join the SPT immediately upon the first data packet it receives. • Specifying the infinity keyword causes the router never to move to the shortest-path tree; it remains on the shared tree. This keyword applies to a multicast environment of “many-to-many” communication. • The group list is a standard access list that controls which groups the SPT threshold applies to. If a value of 0 is specified or the group list is not used, the threshold applies to all groups. • In the example, group-list 5 is already configured to permit the multicast groups 239.254.2.0 and 239.254.3.0: <pre>access-list 5 permit 239.254.2.0 0.0.0.255 access-list 5 permit 239.254.3.0 0.0.0.255</pre> |
| Step 5 | <p>interface <i>type number</i></p> <p>Example:</p> <pre>Router(config)# interface ethernet 0</pre> | <p>Configures an interface.</p> <ul style="list-style-type: none"> • If you do not want to change the default values of the PIM SPT threshold or the PIM query interval, do not perform this step; you are done with this task. |
| Step 6 | <p>ip pim query-interval <i>period</i> [msec]</p> <p>Example:</p> <pre>Router(config-if)# ip pim query-interval 1</pre> | <p>(Optional) Configures the frequency at which multicast routers send PIM router query messages.</p> <ul style="list-style-type: none"> • Perform this step only on redundant routers on the edge of a PIM domain. |

| | Command or Action | Purpose |
|--|-------------------|---|
| | | <ul style="list-style-type: none"> • The default query interval is 30 seconds. • The <i>period</i> argument is in seconds unless the msec keyword is specified. • Set the query interval to a smaller number of seconds for faster convergence, but keep in mind the trade-off between faster convergence and higher CPU and bandwidth usage. |

Related Topics

[Optimizing PIM Sparse Mode in a Large IP Multicast Deployment Example](#), on page 307

Configuration Examples for Optimizing PIM Sparse Mode in a Large Multicast Deployment

Optimizing PIM Sparse Mode in a Large IP Multicast Deployment Example

The following example shows how to:

- Set the query interval to 1 second for faster convergence.
- Configure the router to never move to the SPT but to remain on the shared tree.
- Set a limit of 10 PIM sparse mode register messages sent per second for each (S, G) routing entry.

```
interface ethernet 0
 ip pim query-interval 1
 .
 .
 .
 !
 ip pim spt-threshold infinity
 ip pim register-rate-limit 10
 !
```

Related Topics

[Optimizing PIM Sparse Mode in a Large Deployment](#), on page 305

Additional References

Related Documents

| Related Topic | Document Title |
|--------------------|--|
| Cisco IOS commands | Cisco IOS Master Commands List, All Releases |

| Related Topic | Document Title |
|--|---|
| Cisco IOS IP SLAs commands | Cisco IOS IP Multicast Command Reference |
| PIM Sparse Mode concepts and configuration | “Configuring Basic IP Multicast” module or “Configuring IP Multicast in IPv6 Networks” module |

MIBs

| MIB | MIBs Link |
|---|---|
| No new or modified MIBs are supported by these features, and support for existing MIBs has not been modified by these features. | To locate and download MIBs for selected platforms, Cisco IOS XE releases, and feature sets, use Cisco MIB Locator found at the following URL: http://www.cisco.com/go/mibs |

Technical Assistance

| Description | Link |
|---|---|
| The Cisco Support and Documentation website provides online resources to download documentation, software, and tools. Use these resources to install and configure the software and to troubleshoot and resolve technical issues with Cisco products and technologies. Access to most tools on the Cisco Support and Documentation website requires a Cisco.com user ID and password. | http://www.cisco.com/cisco/web/support/index.html |

Feature History and Information for Optimizing PIM Sparse Mode in a Large IP Multicast Deployment

| Release | Modification |
|--------------------|------------------------------|
| Cisco IOS XE 3.3SE | This feature was introduced. |



CHAPTER 15

IP Multicast Optimization: Multicast Subsecond Convergence

- [Finding Feature Information, on page 309](#)
- [Prerequisites for Multicast Subsecond Convergence, on page 309](#)
- [Restrictions for Multicast Subsecond Convergence, on page 309](#)
- [Information About Multicast Subsecond Convergence, on page 310](#)
- [How to Configure Multicast Subsecond Convergence, on page 312](#)
- [Configuration Examples for Multicast Subsecond Convergence, on page 315](#)
- [Additional References, on page 317](#)
- [Feature History and Information for Multicast Subsecond Convergence, on page 317](#)

Finding Feature Information

Your software release may not support all the features documented in this module. For the latest caveats and feature information, see Bug Search Tool and the release notes for your platform and software release. To find information about the features documented in this module, and to see a list of the releases in which each feature is supported, see the feature information table at the end of this module.

Use Cisco Feature Navigator to find information about platform support and Cisco software image support. To access Cisco Feature Navigator, go to <http://www.cisco.com/go/cfn>. An account on Cisco.com is not required.

Prerequisites for Multicast Subsecond Convergence

Service providers must have a multicast-enabled core in order to use the Cisco Multicast Subsecond Convergence feature.

Restrictions for Multicast Subsecond Convergence

Devices that use the subsecond designated router (DR) failover enhancement must be able to process hello interval information arriving in milliseconds. Devices that are congested or do not have enough CPU cycles to process the hello interval can assume that the Protocol Independent Multicast (PIM) neighbor is disconnected, although this may not be the case.

Information About Multicast Subsecond Convergence

Benefits of Multicast Subsecond Convergence

- The scalability components improve on the efficiency of handling increases (or decreases) in service users (receivers) and service load (sources or content).
- New algorithms and processes (such as aggregated join messages, which deliver up to 1000 individual messages in a single packet) reduce the time to reach convergence by a factor of 10.
- Multicast subsecond convergence improves service availability for large multicast networks.
- Multicast users such as financial services firms and brokerages receive better quality of service (QoS), because multicast functionality is restored in a fraction of the time previously required.

Multicast Subsecond Convergence Scalability Enhancements

The Multicast Subsecond Convergence feature provides scalability enhancements that improve on the efficiency of handling increases (or decreases) in service users (receivers) and service load (sources or content). Scalability enhancements in this release include the following:

- Improved Internet Group Management Protocol (IGMP) and PIM state maintenance through new timer management techniques
- Improved scaling of the Multicast Source Discovery Protocol (MSDP) Source-Active (SA) cache

The scalability enhancements provide the following benefits:

- Increased potential PIM multicast route (mroute), IGMP, and MSDP SA cache state capacity
- Decreased CPU usage

PIM Router Query Messages

Multicast subsecond convergence allows you to send PIM router query messages (PIM hellos) every few milliseconds. The PIM hello message is used to locate neighboring PIM devices. Before the introduction of this feature, the device could send the PIM hellos only every few seconds. By enabling a device to send PIM hello messages more often, this feature allows the device to discover unresponsive neighbors more quickly. As a result, the device can implement failover or recovery procedures more efficiently.

Related Topics

[Modifying the PIM Router Query Message Interval](#), on page 313

[Modifying the PIM Router Query Message Interval Example](#), on page 316

Reverse Path Forwarding

Unicast Reverse Path Forwarding (RPF) helps to mitigate problems caused by the introduction of malformed or forged IP source addresses into a network by discarding IP packets that lack a verifiable IP source address.

Malformed or forged source addresses can indicate denial-of-service (DoS) attacks based on source IP address spoofing.

RPF uses access control lists (ACLs) in determining whether to drop or forward data packets that have malformed or forged IP source addresses. An option in the ACL commands allows system administrators to log information about dropped or forwarded packets. Logging information about forged packets can help in uncovering information about possible network attacks.

Per-interface statistics can help system administrators quickly discover the interface serving as the entry point for an attack on the network.

RPF Checks

PIM is designed to forward IP multicast traffic using the standard unicast routing table. PIM uses the unicast routing table to decide if the source of the IP multicast packet has arrived on the optimal path from the source. This process, the RPF check, is protocol-independent because it is based on the contents of the unicast routing table and not on any particular routing protocol.

Related Topics

[Modifying the Periodic RPF Check Interval](#), on page 312

[Example Modifying the Periodic RPF Check Interval](#), on page 315

Triggered RPF Checks

Multicast subsecond convergence provides the ability to trigger a check of RPF changes for mroute states. This check is triggered by unicast routing changes. By performing a triggered RPF check, users can set the periodic RPF check to a relatively high value (for example, 10 seconds) and still fail over quickly.

The triggered RPF check enhancement reduces the time needed for service to be restored after disruption, such as for single service events (for example, in a situation with one source and one receiver) or as the service scales along any parameter (for example, many sources, many receivers, and many interfaces). This enhancement decreases in time-to-converge PIM (mroute), IGMP, and MSDP (SA cache) states.

RPF Failover

In an unstable unicast routing environment that uses triggered RPF checks, the environment could be constantly triggering RPF checks, which places a burden on the resources of the device. To avoid this problem, use the **ip multicast rpf backoff** command to prevent a second triggered RPF check from occurring for the length of time configured. That is, the PIM “backs off” from another triggered RPF check for a minimum amount of milliseconds as configured by the user.

If the backoff period expires without further routing table changes, PIM then scans for routing changes and accordingly establishes multicast RPF changes. However, if more routing changes occur during the backoff period, PIM doubles the backoff period to avoid overloading the device with PIM RPF changes while the routing table is still converging.

Related Topics

[Configuring PIM RPF Failover Intervals](#), on page 313

[Example Configuring PIM RPF Failover Intervals](#), on page 316

Topology Changes and Multicast Routing Recovery

The Multicast Subsecond Convergence feature set enhances both enterprise and service provider network backbones by providing almost instantaneous recovery of multicast paths after unicast routing recovery.

Because PIM relies on the unicast routing table to calculate its RPF when a change in the network topology occurs, unicast protocols first need to calculate options for the best paths for traffic, and then multicast can determine the best path.

Multicast subsecond convergence allows multicast protocol calculations to finish almost immediately after the unicast calculations are completed. As a result, multicast traffic forwarding is restored substantially faster after a topology change.

How to Configure Multicast Subsecond Convergence

Modifying the Periodic RPF Check Interval

Perform this optional task to modify the intervals at which periodic RPF checks occur.



Note

Cisco recommends that you do *not* change the default values for the **ip rpf interval** command. The default values allow subsecond RPF failover. The default interval at which periodic RPF checks occur is 10 seconds.

SUMMARY STEPS

1. **enable**
2. **configure terminal**
3. **ip multicast rpf interval** *seconds* [**list** *access-list* | **route-map** *route-map*]

DETAILED STEPS

| | Command or Action | Purpose |
|--------|---|--|
| Step 1 | enable Example: Device> enable | Enables privileged EXEC mode. <ul style="list-style-type: none"> • Enter your password if prompted. |
| Step 2 | configure terminal Example: Device# configure terminal | Enters global configuration mode. |
| Step 3 | ip multicast rpf interval <i>seconds</i> [list <i>access-list</i> route-map <i>route-map</i>] Example: Device(config)# ip multicast rpf interval 10 | Configures the periodic RPF check intervals to occur at a specified interval, in seconds. |

Related Topics[RPF Checks](#), on page 311[Example Modifying the Periodic RPF Check Interval](#), on page 315

Configuring PIM RPF Failover Intervals

Perform this optional task to configure the intervals at which PIM RPF failover will be triggered by changes in the routing tables.



Note Cisco recommends that you do *not* modify the default values for the **ip multicast rpf backoff** command. The default values allow subsecond RPF failover.

SUMMARY STEPS

1. **enable**
2. **configure terminal**
3. **ip multicast rpf backoff** *minimum maximum* [**disable**]

DETAILED STEPS

| | Command or Action | Purpose |
|--------|---|---|
| Step 1 | enable Example: Device> enable | Enables privileged EXEC mode. • Enter your password if prompted. |
| Step 2 | configure terminal Example: Device# configure terminal | Enters global configuration mode. |
| Step 3 | ip multicast rpf backoff <i>minimum maximum</i> [disable] Example: Device(config)# ip multicast rpf backoff 100 2500 | Configures the minimum and the maximum backoff intervals. |

Related Topics[RPF Failover](#), on page 311[Example Configuring PIM RPF Failover Intervals](#), on page 316

Modifying the PIM Router Query Message Interval

Perform this task to modify the PIM router query message interval.

SUMMARY STEPS

1. **enable**
2. **configure terminal**
3. **interface** *type slot / subslot / port*
4. **ip pim query-interval** *period [msec]*

DETAILED STEPS

| | Command or Action | Purpose |
|---------------|--|--|
| Step 1 | enable Example: Device> enable | Enables privileged EXEC mode. <ul style="list-style-type: none"> • Enter your password if prompted. |
| Step 2 | configure terminal Example: Device# configure terminal | Enters global configuration mode. |
| Step 3 | interface <i>type slot / subslot / port</i> Example: Device(config)# interface gigabitethernet 1/0/0 | Specifies the interface and enters interface configuration mode. |
| Step 4 | ip pim query-interval <i>period [msec]</i> Example: Device(config-if)# ip pim query-interval 45 | Configures the frequency at which multicast routers send PIM router query messages. |

Related Topics

[PIM Router Query Messages](#), on page 310

[Modifying the PIM Router Query Message Interval Example](#), on page 316

Verifying Multicast Subsecond Convergence Configurations

Perform this task to display detailed information about and to verify information regarding the Multicast Subsecond Convergence feature.

SUMMARY STEPS

1. **enable**
2. **show ip pim interface** *type number*
3. **show ip pim neighbor**

DETAILED STEPS

Step 1 enable

Example:

```
Device> enable
```

Enables privileged EXEC mode.

- Enter your password if prompted.

Step 2 show ip pim interface *type number*

Use this command to display information about interfaces configured for PIM.

The following is sample output from the **show ip pim interface** command:

Example:

```
Device# show ip pim interface GigabitEthernet 1/0/0
Address          Interface          Ver/   Nbr   Query  DR    DR
                  Mode              Count  Intvl Prior
172.16.1.4       GigabitEthernet1/0/0 v2/S   1     100 ms 1     172.16.1.4
```

Step 3 show ip pim neighbor

Use this command to display the PIM neighbors discovered by the Cisco IOS XE software.

The following is sample output from the **show ip pim neighbor** command:

Example:

```
Device# show ip pim neighbor
PIM Neighbor Table
Neighbor          Interface          Uptime/Expires   Ver  DR
Address           Prio/Mode
172.16.1.3        GigabitEthernet1/0/0 00:03:41/250 msec v2   1 / S
```

Configuration Examples for Multicast Subsecond Convergence

Example Modifying the Periodic RPF Check Interval

In the following example, the **ip multicast rpf interval** has been set to 10 seconds. This command does not show up in **show running-config** output unless the interval value has been configured to be the nondefault value.

```
!
ip multicast-routing
ip multicast rpf interval 10
.
.
.
interface Ethernet0/0
 ip address 172.16.2.1 255.255.255.0
```

```

.
.
.
ip pim sparse-mode
!

```

Related Topics

[Modifying the Periodic RPF Check Interval](#), on page 312

[RPF Checks](#), on page 311

Example Configuring PIM RPF Failover Intervals

In the following example, the **ip multicast rpf backoff** command has been configured with a minimum backoff interval value of 100 and a maximum backoff interval value of 2500. This command does not show up in **show running-config** command output unless the interval value has been configured to be the nondefault value.

```

!
ip multicast-routing
.
.
.
ip multicast rpf backoff 100 2500
!
!
interface Ethernet0/0
 ip address 172.16.2.1 255.255.255.0
.
.
.
ip pim sparse-mode
!

```

Related Topics

[Configuring PIM RPF Failover Intervals](#), on page 313

[RPF Failover](#), on page 311

Modifying the PIM Router Query Message Interval Example

In the following example, the **ip pim query-interval** command has been set to 100 milliseconds. This command does not show up in **show running-config** command output unless the interval value has been configured to be the nondefault value.

```

!
interface gigabitethernet0/0/1
 ip address 172.16.2.1 255.255.255.0
ip pim query-interval 100 msec
ip pim sparse-mode

```

Related Topics

[Modifying the PIM Router Query Message Interval](#), on page 313

[PIM Router Query Messages](#), on page 310

Additional References

Related Documents

| Related Topic | Document Title |
|--|---|
| Cisco IOS commands | Cisco IOS Master Commands List, All Releases |
| Cisco IOS IP SLAs commands | Cisco IOS IP Multicast Command Reference |
| PIM Sparse Mode concepts and configuration | “Configuring Basic IP Multicast” module or “Configuring IP Multicast in IPv6 Networks” module |

MIBs

| MIB | MIBs Link |
|---|---|
| No new or modified MIBs are supported by these features, and support for existing MIBs has not been modified by these features. | To locate and download MIBs for selected platforms, Cisco IOS XE releases, and feature sets, use Cisco MIB Locator found at the following URL: http://www.cisco.com/go/mibs |

Technical Assistance

| Description | Link |
|---|---|
| The Cisco Support and Documentation website provides online resources to download documentation, software, and tools. Use these resources to install and configure the software and to troubleshoot and resolve technical issues with Cisco products and technologies. Access to most tools on the Cisco Support and Documentation website requires a Cisco.com user ID and password. | http://www.cisco.com/cisco/web/support/index.html |

Feature History and Information for Multicast Subsecond Convergence

| Release | Modification |
|--------------------|------------------------------|
| Cisco IOS XE 3.3SE | This feature was introduced. |



CHAPTER 16

IP Multicast Optimization: IP Multicast Load Splitting across Equal-Cost Paths

- [Finding Feature Information, on page 319](#)
- [Prerequisites for IP Multicast Load Splitting across Equal-Cost Paths, on page 319](#)
- [Information About IP Multicast Load Splitting across Equal-Cost Paths, on page 320](#)
- [How to Load Split IP Multicast Traffic over ECMP, on page 329](#)
- [Configuration Examples for Load Splitting IP Multicast Traffic over ECMP, on page 336](#)
- [Additional References, on page 337](#)
- [Feature History and Information for Load Splitting IP Multicast Traffic over ECMP, on page 338](#)

Finding Feature Information

Your software release may not support all the features documented in this module. For the latest caveats and feature information, see Bug Search Tool and the release notes for your platform and software release. To find information about the features documented in this module, and to see a list of the releases in which each feature is supported, see the feature information table at the end of this module.

Use Cisco Feature Navigator to find information about platform support and Cisco software image support. To access Cisco Feature Navigator, go to <http://www.cisco.com/go/cfn>. An account on Cisco.com is not required.

Prerequisites for IP Multicast Load Splitting across Equal-Cost Paths

IP multicast is enabled on the device using the tasks described in the “Configuring Basic IP Multicast” module of the *IP Multicast: PIM Configuration Guide*.

Information About IP Multicast Load Splitting across Equal-Cost Paths

Load Splitting Versus Load Balancing

Load splitting and load balancing are not the same. Load splitting provides a means to randomly distribute (*, G) and (S, G) traffic streams across multiple equal-cost reverse path forwarding (RPF) paths, which does not necessarily result in a balanced IP multicast traffic load on those equal-cost RPF paths. By randomly distributing (*, G) and (S, G) traffic streams, the methods used for load splitting IP multicast traffic attempt to distribute an equal amount of traffic flows on each of the available RPF paths not by counting the flows, but, rather, by making a pseudorandom decision. These methods are collectively referred to as equal-cost multipath (ECMP) multicast load splitting methods and result in better load-sharing in networks where there are many traffic streams that utilize approximately the same amount of bandwidth.

If there are just a few (S, G) or (*, G) states flowing across a set of equal-cost links, the chance that they are well balanced is quite low. To overcome this limitation, precalculated source addresses--for (S, G) states or rendezvous point (RP) addresses for (*, G) states, can be used to achieve a reasonable form of load balancing. This limitation applies equally to the per-flow load splitting in Cisco Express Forwarding (CEF) or with EtherChannels: As long as there are only a few flows, those methods of load splitting will not result in good load distribution without some form of manual engineering.

Default Behavior for IP Multicast When Multiple Equal-Cost Paths Exist

By default, for Protocol Independent Multicast sparse mode (PIM-SM), Source Specific Multicast (PIM-SSM), bidirectional PIM (bidir-PIM), and PIM dense mode (PIM-DM) groups, if multiple equal-cost paths are available, Reverse Path Forwarding (RPF) for IPv4 multicast traffic is based on the PIM neighbor with the highest IP address. This method is referred to as the highest PIM neighbor behavior. This behavior is in accordance with RFC 2362 for PIM-SM, but also applies to PIM-SSM, PIM-DM, and bidir-PIM.

The figure illustrates a sample topology that is used in this section to explain the default behavior for IP multicast when multiple equal-cost paths exist.



Note Although the following illustration and example uses routers in the configuration, any device (router or switch) can be used.

Figure 18: Default Behavior for IP Multicast When Multiple Equal-Cost Paths Exist

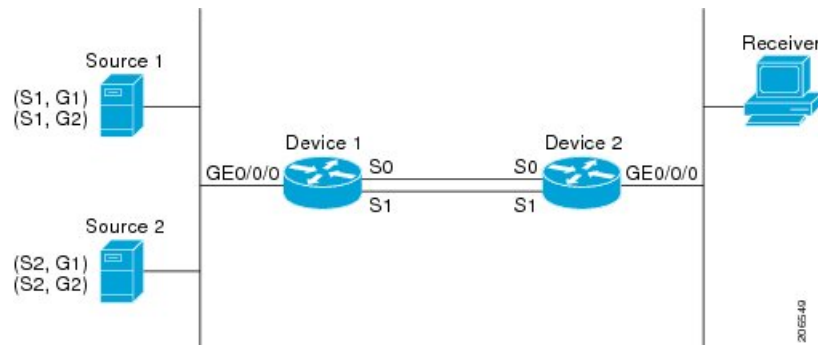

In the figure, two sources, S1 and S2, are sending traffic to IPv4 multicast groups, G1 and G2. Either PIM-SM, PIM-SSM, or PIM-DM can be used in this topology. If PIM-SM is used, assume that the default of 0 for the `ip pim spt-threshold` command is being used on Device 2, that an Interior Gateway Protocol (IGP) is being run, and that the output of the `show ip route` command for S1 and for S2 (when entered on Device 2) displays serial interface 0 and serial interface 1 on Device 1 as equal-cost next-hop PIM neighbors of Device 2.

Without further configuration, IPv4 multicast traffic in the topology illustrated in the figure would always flow across one serial interface (either serial interface 0 or serial interface 1), depending on which interface has the higher IP address. For example, suppose that the IP addresses configured on serial interface 0 and serial interface 1 on Device 1 are 10.1.1.1 and 10.1.2.1, respectively. Given that scenario, in the case of PIM-SM and PIM-SSM, Device 2 would always send PIM join messages towards 10.1.2.1 and would always receive IPv4 multicast traffic on serial interface 1 for all sources and groups shown in the figure. In the case of PIM-DM, Device 2 would always receive IP multicast traffic on serial interface 1, only that in this case, PIM join messages are not used in PIM-DM; instead Device 2 would prune the IP multicast traffic across serial interface 0 and would receive it through serial interface 1 because that interface has the higher IP address on Device 1.

IPv4 RPF lookups are performed by intermediate multicast device to determine the RPF interface and RPF neighbor for IPv4 (*,G) and (S, G) multicast routes (trees). An RPF lookup consists of RPF route-selection and route-path-selection. RPF route-selection operates solely on the IP unicast address to identify the root of the multicast tree. For (*, G) routes (PIM-SM and Bidir-PIM), the root of the multicast tree is the RP address for the group G; for (S, G) trees (PIM-SM, PIM-SSM and PIM-DM), the root of the multicast tree is the source S. RPF route-selection finds the best route towards the RP or source in the routing information base (RIB), and, if configured (or available), the Distance Vector Multicast Routing Protocol (DVMRP) routing table, the Multiprotocol Border Gateway Protocol (MBGP) routing table or configured static mroutes. If the resulting route has only one available path, then the RPF lookup is complete, and the next-hop device and interface of the route become the RPF neighbor and RPF interface of this multicast tree. If the route has more than one path available, then route-path-selection is used to determine which path to choose.

For IP multicast, the following route-path-selection methods are available:



Note All methods but the default method of route-path-selection available in IP multicast enable some form of ECMP multicast load splitting.

- Highest PIM neighbor--This is the default method; thus, no configuration is required. If multiple equal-cost paths are available, RPF for IPv4 multicast traffic is based on the PIM neighbor with the highest IP address; as a result, without configuration, ECMP multicast load splitting is disabled by default.

- ECMP multicast load splitting method based on source address--You can configure ECMP multicast load splitting using the **ip multicast multipath** command. Entering this form of the **ip multicast multipath** command enables ECMP multicast load splitting based on source address using the S-hash algorithm. For more information, see the [ECMP Multicast Load Splitting Based on Source Address Using the S-Hash Algorithm, on page 322](#) section.
- ECMP multicast load splitting method based on source and group address--You can configure ECMP multicast load splitting using the **ip multicast multipath** command with the **s-g-hash** and **basic** keywords. Entering this form of the **ip multicast multipath** command enables ECMP multicast load splitting based on source and group address using the basic S-G-hash algorithm. For more information, see the [ECMP Multicast Load Splitting Based on Source and Group Address Using the Basic S-G-Hash Algorithm, on page 323](#) section.
- ECMP multicast load splitting method based on source, group, and next-hop address--You can configure ECMP multicast load splitting using the **ip multicast multipath** command with the **s-g-hash** and **next-hop-based** keywords. Entering this form of the command enables ECMP multicast load splitting based on source, group, and next-hop address using the next-hop-based S-G-hash algorithm. For more information, see the [ECMP Multicast Load Splitting Based on Source Group and Next-Hop Address, on page 324](#) section.

The default behavior (the highest PIM neighbor behavior) does not result in any form of ECMP load-splitting in IP multicast, but instead selects the PIM neighbor that has the highest IP address among the next-hop PIM neighbors for the available paths. A next hop is considered to be a PIM neighbor when it displays in the output of the **show ip pim neighbor** command, which is the case when PIM hello messages have been received from it and have not timed out. If none of the available next hops are PIM neighbors, then simply the next hop with the highest IP address is chosen.

Methods to Load Split IP Multicast Traffic

In general, the following methods are available to load split IP multicast traffic:

- You can enable ECMP multicast load splitting based on source address, based on source and group address, or based on source, group, and next-hop address. After the equal-cost paths are recognized, ECMP multicast load splitting operates on a per (S, G) basis, rather than a per packet basis as in unicast traffic.
- Alternative methods to load split IP multicast are to consolidate two or more equal-cost paths into a generic routing encapsulation (GRE) tunnel and allow the unicast routing protocol to perform the load splitting, or to load split across bundle interfaces, such as Fast or Gigabit EtherChannel interfaces, Multilink PPP (MLPPP) link bundles, or Multilink Frame Relay (FR.16) link bundles.

Overview of ECMP Multicast Load Splitting

By default, ECMP multicast load splitting of IPv4 multicast traffic is disabled. ECMP multicast load splitting can be enabled using the **ip multicast multipath** command.

ECMP Multicast Load Splitting Based on Source Address Using the S-Hash Algorithm

ECMP multicast load splitting traffic based on source address uses the S-hash algorithm, enabling the RPF interface for each (*, G) or (S, G) state to be selected among the available equal-cost paths, depending on the

RPF address to which the state resolves. For an (S, G) state, the RPF address is the source address of the state; for a (*, G) state, the RPF address is the address of the RP associated with the group address of the state.

When ECMP multicast load splitting based on source address is configured, multicast traffic for different states can be received across more than just one of the equal-cost interfaces. The method applied by IPv4 multicast is quite similar in principle to the default per-flow load splitting in IPv4 CEF or the load splitting used with Fast and Gigabit EtherChannels. This method of ECMP multicast load splitting, however, is subject to polarization.

Related Topics

[Enabling ECMP Multicast Load Splitting Based on Source Address](#), on page 330

[Example Enabling ECMP Multicast Load Splitting Based on Source Address](#), on page 336

ECMP Multicast Load Splitting Based on Source and Group Address Using the Basic S-G-Hash Algorithm

ECMP multicast load splitting based on source and group address uses a simple hash, referred to as the basic S-G-hash algorithm, which is based on source and group address. The basic S-G-hash algorithm is predictable because no randomization is used in coming up with the hash value. The S-G-hash mechanism, however, is subject to polarization because for a given source and group, the same hash is always picked irrespective of the device this hash is being calculated on.



Note The basic S-G-hash algorithm ignores bidir-PIM groups.

Related Topics

[Enabling ECMP Multicast Load Splitting Based on Source and Group Address](#), on page 332

[Example Enabling ECMP Multicast Load Splitting Based on Source and Group Address](#), on page 336

Predictability As a By-Product of Using the S-Hash and Basic S-G-Hash Algorithms

The method used by ECMP multicast load splitting in IPv4 multicast allows for consistent load splitting in a network where the same number of equal-cost paths are present in multiple places in a topology. If an RP address or source addresses are calculated once to have flows split across N paths, then they will be split across those N paths in the same way in all places in the topology. Consistent load splitting allows for predictability, which, in turn, enables load splitting of IPv4 multicast traffic to be manually engineered.

Polarization As a By-Product of Using the S-Hash and Basic S-G-Hash Algorithms

The hash mechanism used in IPv4 multicast to load split multicast traffic by source address or by source and group address is subject to a problem usually referred to as polarization. A by-product of ECMP multicast load splitting based on source address or on source and group address, polarization is a problem that prevents routers in some topologies from effectively utilizing all available paths for load splitting.

The figure illustrates a sample topology that is used in this section to explain the problem of polarization when configuring ECMP multicast load splitting based on source address or on source and group address.



Note Although the following illustration and example uses routers in the configuration, any device (router or switch) can be used.

Figure 19: Polarization Topology

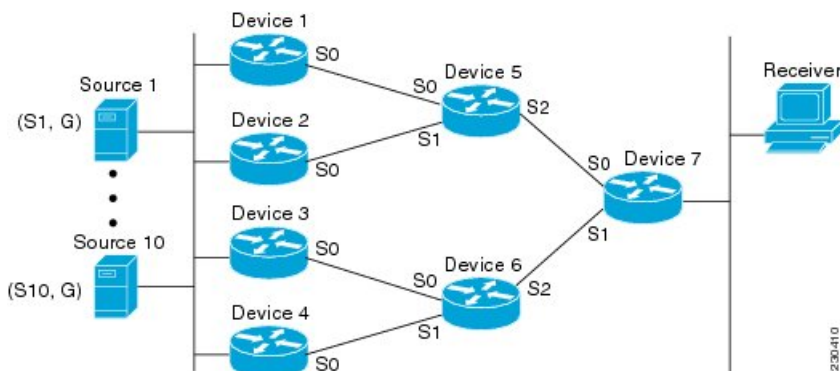

In the topology illustrated in the figure, notice that Router 7 has two equal-cost paths towards the sources, S1 to S10, through Router 5 and Router 6. For this topology, suppose that ECMP multicast load splitting is enabled with the **ip multicast multipath** command on all routers in the topology. In that scenario, Router 7 would apply equal-cost load splitting to the 10 (S, G) states. The problem of polarization in this scenario would affect Router 7 because that router would end up choosing serial interface 0 on Router 5 for sources S1 to S5 and serial interface 1 on Router 6 for sources S6 to S10. The problem of polarization, furthermore, would also affect Router 5 and Router 6 in this topology. Router 5 has two equal-cost paths for S1 to S5 through serial interface 0 on Router 1 and serial interface 1 on Router 2. Because Router 5 would apply the same hash algorithm to select which of the two paths to use, it would end up using just one of these two upstream paths for sources S1 to S5; that is, either all the traffic would flow across Router 1 and Router 5 or across Router 2 and Router 5. It would be impossible in this topology to utilize Router 1 and Router 5 and Router 2 and Router 5 for load splitting. Likewise, the polarization problem would apply to Router 3 and Router 6 and Router 4 and Router 6; that is, it would be impossible in this topology to utilize both Router 3 and Router 6 and Router 4 and Router 6 for load splitting.

ECMP Multicast Load Splitting Based on Source Group and Next-Hop Address

Configuring ECMP multicast load splitting based on source, group, and next-hop address enables a more complex hash, the next-hop-based S-G-hash algorithm, which is based on source, group, and next-hop address. The next-hop-based S-G-hash algorithm is predictable because no randomization is used in calculating the hash value. Unlike the S-hash and basic S-G-hash algorithms, the hash mechanism used by the next-hop-based S-G-hash algorithm is not subject to polarization.



Note The next-hop-based S-G-hash algorithm in IPv4 multicast is the same algorithm used in IPv6 ECMP multicast load splitting, which, in turn, utilizes the same hash function used for PIM-SM bootstrap device (BSR).

The next-hop-based hash mechanism does not produce polarization and also maintains better RPF stability when paths fail. These benefits come at the cost that the source or RP IP addresses cannot be used to reliably predict and engineer the outcome of load splitting when the next-hop-based S-G-hash algorithm is used. Because many customer networks have implemented equal-cost multipath topologies, the manual engineering of load splitting, thus, is not a requirement in many cases. Rather, it is more of a requirement that the default behavior of IP multicast be similar to IP unicast; that is, it is expected that IP multicast use multiple equal-cost paths on a best-effort basis. Load splitting for IPv4 multicast, therefore, could not be enabled by default because of the anomaly of polarization.



Note Load splitting for CEF unicast also uses a method that does not exhibit polarization and likewise cannot be used to predict the results of load splitting or engineer the outcome of load splitting.

The next-hop-based hash function avoids polarization because it introduces the actual next-hop IP address of PIM neighbors into the calculation, so the hash results are different for each device, and in effect, there is no problem of polarization. In addition to avoiding polarization, this hash mechanism also increases stability of the RPF paths chosen in the face of path failures. Consider a device with four equal-cost paths and a large number of states that are load split across these paths. Suppose that one of these paths fails, leaving only three available paths. With the hash mechanism used by the polarizing hash mechanisms (the hash mechanism used by the S-hash and basic S-G-hash algorithms), the RPF paths of all states would likely reconverge and thus change between those three paths, especially those paths that were already using one of those three paths. These states, therefore, may unnecessarily change their RPF interface and next-hop neighbor. This problem exists simply because the chosen path is determined by taking the total number of paths available into consideration by the algorithm, so once a path changes, the RPF selection for all states is subject to change too. For the next-hop-based hash mechanism, only the states that were using the changed path for RPF would need to reconverge onto one of the three remaining paths. The states that were already using one of those paths would not change. If the fourth path came back up, the states that initially used it would immediately reconverge back to that path without affecting the other states.



Note The next-hop-based S-G-hash algorithm ignores bidir-PIM groups.

Related Topics

[Enabling ECMP Multicast Load Splitting Based on Source Group and Next-Hop Address](#), on page 334
[Example Enabling ECMP Multicast Load Splitting Based on Source Group and Next-Hop Address](#), on page 336

Effect of ECMP Multicast Load Splitting on PIM Neighbor Query and Hello Messages for RPF Path Selection

If load splitting of IP multicast traffic over ECMP is *not* enabled and there are multiple equal-cost paths towards an RP or a source, IPv4 multicast will first elect the highest IP address PIM neighbor. A PIM neighbor is a device from which PIM hello (or PIMv1 query) messages are received. For example, consider a device that has two equal-cost paths learned by an IGP or configured through two static routes. The next hops of these two paths are 10.1.1.1 and 10.1.2.1. If both of these next-hop devices send PIM hello messages, then 10.1.2.1 would be selected as the highest IP address PIM neighbor. If only 10.1.1.1 sends PIM hello messages, then 10.1.1.1 would be selected. If neither of these devices sends PIM hello messages, then 10.1.2.1 would be selected. This deference to PIM hello messages allows the construction of certain types of dynamic failover scenarios with only static multicast routes (mroutes); it is otherwise not very useful.



Note For more information about configuring static mroutes, see the [Configuring Multiple Static Mroutes in Cisco IOS](#) configuration note on the Cisco IOS IP multicast FTP site, which is available at: <ftp://ftpeng.cisco.com/ipmulticast/config-notes/static-mroutes.txt>.

When load splitting of IP multicast traffic over ECMP is enabled, the presence of PIM hello message from neighbors is not considered; that is, the chosen RPF neighbor does not depend on whether or not PIM hello

messages are received from that neighbor--it only depends on the presence or absence of an equal-cost route entry.

Effect of ECMP Multicast Loading Splitting on Assert Processing in PIM-DM and DF Election in Bidir-PIM

The **ip multicast multipath** command only changes the RPF selection on the downstream device; it does not have an effect on designated forwarder (DF) election in bidir-PIM or the assert processing on upstream devices in PIM-DM.

The figure illustrates a sample topology that is used in this section to explain the effect of ECMP multicast load splitting on assert processing in PIM-DM and DF election in bidir-PIM.



Note Although the following illustration and example uses routers in the configuration, any device (router or switch) can be used.

Figure 20: ECMP Multicast Load Splitting and Assert Processing in PIM-DM and DF Election in Bidir-PIM

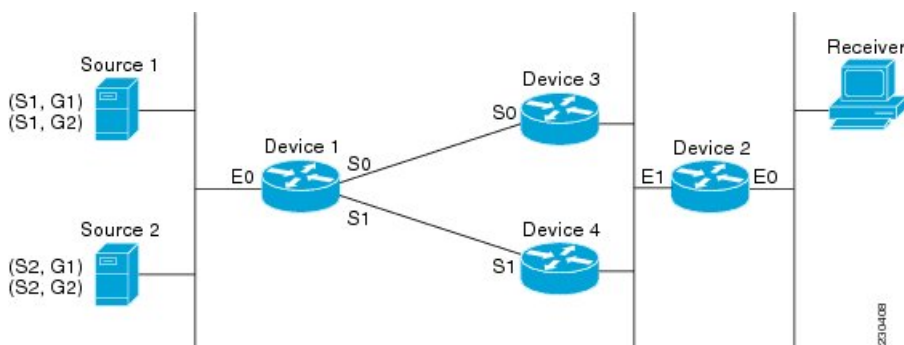

In the figure, Device 2 has two equal-cost paths to S1 and S2 and the RP addresses on Device 1. Both paths are across Gigabit Ethernet interface 1/0/0: one path towards Device 3 and one path towards Device 4. For PIM-SM and PIM-SSM (*, G) and (S, G) RPF selection, there is no difference in the behavior of Device 2 in this topology versus Device 2 in the topology illustrated in the figure. There is, however, a difference when using PIM-DM or bidir-PIM.

If PIM-DM is used in the topology illustrated in the figure, Device 3 and Device 4 would start flooding traffic for the states onto Gigabit Ethernet interface 1/0/0 and would use the PIM assert process to elect one device among them to forward the traffic and to avoid traffic duplication. As both Device 3 and Device 4 would have the same route cost, the device with the higher IP address on Gigabit Ethernet interface 1/0/0 would always win the assert process. As a result, if PIM-DM is used in this topology, traffic would not be load split across Device 3 and Device 4.

If bidir-PIM is used in the topology illustrated in the figure, a process called DF election would take place between Device 2, Device 3, and Device 4 on Gigabit Ethernet interface 1/0/0. The process of DF election would elect one device for each RP to forward traffic across Gigabit Ethernet interface 1/0/0 for any groups using that particular RP, based on the device with the highest IP address configured for that interface. Even if multiple RPs are used (for example one for G1 and another one for G2), the DF election for those RPs would always be won by the device that has the higher IP address configured on Gigabit Ethernet interface 1/0/0 (either Device 3 or Device 4 in this topology). The election rules used for DF election are virtually the same as the election rules used for the PIM assert process, only the protocol mechanisms to negotiate them

are more refined for DF election (in order to return the results more expediently). As a result, when bidir-PIM is used in this topology, load splitting would always occur across Gigabit Ethernet interface 1/0/0.

The reason that ECMP multicast load splitting does influence the RPF selection but not the assert process in PIM-DM or DF election in bidir-PIM is because both the assert process and DF election are cooperative processes that need to be implemented consistently between participating devices. Changing them would require some form of protocol change that would also need to be agreed upon by the participating devices. RPF selection is a purely device local policy and, thus, can be enabled or disabled without protocol changes individually on each device.

For PIM-DM and bidir-PIM, configuring ECMP multicast load splitting with the **ip multicast multipath** command is only effective in topologies where the equal-cost paths are not upstream PIM neighbors on the same LAN, but rather neighbors on different LANs or point-to-point links.

Effect of ECMP Multicast Load Splitting on the PIM Assert Process in PIM-SM and PIM-SSM

There are also cases where ECMP multicast load splitting with the **ip multicast multipath** command can become ineffective due to the PIM assert process taking over, even when using PIM-SM with (*, G) or (S, G) forwarding or PIM-SSM with (S, G) forwarding.

The figure illustrates a sample topology that is used in this section to explain the effect of ECMP multicast load splitting on the PIM assert process in PIM-SM and PIM-SSM.



Note Although the following illustration and example uses routers in the configuration, any device (router or switch) can be used.

Figure 21: ECMP Multicast Load Splitting and the PIM Assert Process in PIM-SM and PIM-SSM

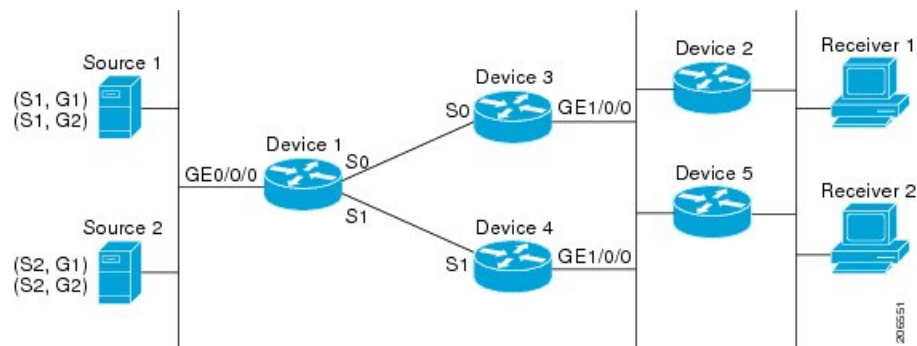

In the topology illustrated in the figure, if both Device 2 and Device 5 are Cisco devices and are consistently configured for ECMP multicast load splitting with the **ip multicast multipath** command, then load splitting would continue to work as expected; that is, both devices would have Device 3 and Device 4 as equal-cost next hops and would sort the list of equal-cost paths in the same way (by IP address). When applying the multipath hash function, for each (S, G) or (*, G) state, they would choose the same RPF neighbor (either Device 3 or Device 4) and send their PIM joins to this neighbor.

If Device 5 and Device 2 are inconsistently configured with the **ip multicast multipath** command, or if Device 5 is a third-party device, then Device 2 and Device 5 may choose different RPF neighbors for some (*, G) or (S, G) states. For example Device 2 could choose Device 3 for a particular (S, G) state or Device 5 could choose Device 4 for a particular (S, G) state. In this scenario, Device 3 and Device 4 would both start to forward traffic for that state onto Gigabit Ethernet interface 1/0/0, see each other's forwarded traffic, and--to

avoid traffic duplication--start the assert process. As a result, for that (S, G) state, the device with the higher IP address for Gigabit Ethernet interface 1/0/0 would forward the traffic. However, both Device 2 and Device 5 would be tracking the winner of the assert election and would send their PIM joins for that state to this assert winner, even if this assert winner is not the same device as the one that they calculated in their RPF selection. For PIM-SM and PIM-SSM, therefore, the operation of ECMP multicast load splitting can only be guaranteed when all downstream devices on a LAN are consistently configured Cisco devices.

ECMP Multicast Load Splitting and Reconvergence When Unicast Routing Changes

When unicast routing changes, all IP multicast routing states reconverge immediately based on the available unicast routing information. Specifically, if one path goes down, the remaining paths reconverge immediately, and if the path comes up again, multicast forwarding will subsequently reconverge to the same RPF paths that were used before the path failed. Reconvergence occurs whether load splitting of IP multicast traffic over ECMP is configured or not.

Use of BGP with ECMP Multicast Load Splitting

ECMP multicast load splitting works with RPF information learned through BGP in the same way as with RPF information learned from other protocols: It chooses one path out of the multiple paths installed by the protocol. The main difference with BGP is that it only installs a single path, by default. For example, when a BGP speaker learns two identical external BGP (eBGP) paths for a prefix, it will choose the path with the lowest device ID as the best path. The best path is then installed in the IP routing table. If BGP multipath support is enabled and the eBGP paths are learned from the same neighboring AS, instead of picking the single best path, BGP installs multiple paths in the IP routing table. By default, BGP will install only one path to the IP routing table.

To leverage ECMP multicast load splitting for BGP learned prefixes, you must enable BGP multipath. Once configured, when BGP installs the remote next-hop information, RPF lookups will execute recursively to find the best next hop towards that BGP next hop (as in unicast). If for example there is only a single BGP path for a given prefix, but there are two IGP paths to reach that BGP next hop, then multicast RPF will correctly load split between the two different IGP paths.

Use of ECMP Multicast Load Splitting with Static Mroutes

If it is not possible to use an IGP to install equal cost routes for certain sources or RPs, static routes can be configured to specify the equal-cost paths for load splitting. You cannot use static mroutes to configure equal-cost paths because the software does not support the configuration of one static mroute per prefix. There are some workarounds for this limitation using recursive route lookups but the workarounds cannot be applied to equal-cost multipath routing.



Note

For more information about configuring static mroutes, see the [Configuring Multiple Static Mroutes in Cisco IOS](http://ftpeng.cisco.com/ipmulticast/config-notes/static-mroutes.txt) configuration note on the Cisco IOS IP multicast FTP site at [ftp://ftpeng.cisco.com/ipmulticast/config-notes/static-mroutes.txt](http://ftpeng.cisco.com/ipmulticast/config-notes/static-mroutes.txt).

You can specify only static mroutes for equal-cost multipaths in IPv4 multicast; however, those static mroutes would only apply to multicast, or you can specify that the equal-cost multipaths apply to both unicast and multicast routing. In IPv6 multicast, there is no such restriction. Equal-cost multipath mroutes can be configured for static IPv6 mroutes that apply to only unicast routing, only multicast routing, or both unicast and multicast routing.

Alternative Methods of Load Splitting IP Multicast Traffic

Load splitting of IP multicast traffic can also be achieved by consolidating multiple parallel links into a single tunnel over which the multicast traffic is then routed. This method of load splitting is more complex to configure than ECMP multicast load splitting. One such case where configuring load splitting across equal-cost paths using GRE links can be beneficial is the case where the total number of (S, G) or (*, G) states is so small and the bandwidth carried by each state so variable that even the manual engineering of the source or RP addresses cannot guarantee the appropriate load splitting of the traffic.



Note With the availability of ECMP multicast load splitting, tunnels typically only need to be used if per-packet load sharing is required.

IP multicast traffic can also be used to load split across bundle interfaces, such as Fast or Gigabit EtherChannel interfaces, MLPPP link bundles or Multilink Frame Relay (FRF.16) bundles. GRE or other type of tunnels can also constitute such forms of Layer 2 link bundles. Before using such a Layer 2 mechanism, it is necessary to understand how unicast and multicast traffic is load split.

Before load splitting IP multicast traffic across equal-cost paths over a tunnel, you must configure CEF per-packet load balancing or else the GRE packets will not be load balanced per packet.

How to Load Split IP Multicast Traffic over ECMP

Enabling ECMP Multicast Load Splitting

Perform the following tasks to load split IP multicast traffic across multiple equal-cost paths, based on source address.

If two or more equal-cost paths from a source are available, unicast traffic will be load split across those paths. However, by default, multicast traffic is not load split across multiple equal-cost paths. In general, multicast traffic flows down from the RPF neighbor. According to PIM specifications, this neighbor must have the highest IP address if more than one neighbor has the same metric.

Configuring load splitting with the **ip multicast multipath** command causes the system to load split multicast traffic across multiple equal-cost paths based on source address using the S-hash algorithm. When the **ip multicast multipath** command is configured and multiple equal-cost paths exist, the path in which multicast traffic will travel is selected based on the source IP address. Multicast traffic from different sources will be load split across the different equal-cost paths. Load splitting will not occur across equal-cost paths for multicast traffic from the same source sent to different multicast groups.



Note The **ip multicast multipath** command load splits the traffic and does not load balance the traffic. Traffic from a source will use only one path, even if the traffic far outweighs traffic from other sources.

Prerequisites for IP Multicast Load Splitting - ECMP

- You must have an adequate number of sources (at least more than two sources) to enable ECMP multicast load splitting based on source address.

- You must have multiple paths available to the RP to configure ECMP multicast load splitting.



Note Use the **show ip route** command with either the IP address of the source for the *ip-address* argument or the IP address of the RP to validate that there are multiple paths available to the source or RP, respectively. If you do not see multiple paths in the output of the command, you will not be able to configure ECMP multicast load splitting.

- When using PIM-SM with shortest path tree (SPT) forwarding, the T-bit must be set for the forwarding of all (S, G) states.
- Before configuring ECMP multicast load splitting, it is best practice to use the **show ip rpf** command to validate whether sources can take advantage of IP multicast multipath capabilities.
- BGP does not install multiple equal-cost paths by default. Use the **maximum-paths** command to configure multipath (for example in BGP). For more information, see the [Use of BGP with ECMP Multicast Load Splitting, on page 328](#) section.

Restrictions

- If two or more equal-cost paths from a source are available, unicast traffic will be load split across those paths. However, by default, multicast traffic is not load split across multiple equal-cost paths. In general, multicast traffic flows down from the RPF neighbor. According to PIM specifications, this neighbor must have the highest IP address if more than one neighbor has the same metric.
- The **ip multicast multipath** command does not support configurations in which the same PIM neighbor IP address is reachable through multiple equal-cost paths. This situation typically occurs if unnumbered interfaces are used. Use different IP addresses for all interfaces when configuring the **ip multicast multipath** command.
- The **ip multicast multipath** command load splits the traffic and does not load balance the traffic. Traffic from a source will use only one path, even if the traffic far outweighs traffic from other sources.

Enabling ECMP Multicast Load Splitting Based on Source Address

Perform this task to enable ECMP multicast load splitting of multicast traffic based on source address (using the S-hash algorithm) to take advantage of multiple paths through the network. The S-hash algorithm is predictable because no randomization is used in calculating the hash value. The S-hash algorithm, however, is subject to polarization because for a given source, the same hash is always picked irrespective of the device on which the hash is being calculated.



Note Enable ECMP multicast load splitting on the device that is to be the receiver for traffic from more than one incoming interfaces, which is opposite to unicast routing. From the perspective of unicast, multicast is active on the sending device connecting to more than one outgoing interfaces.

Before you begin

- You must have an adequate number of sources (at least more than two sources) to enable ECMP multicast load splitting based on source address.
- You must have multiple paths available to the RP to configure ECMP multicast load splitting.



Note Use the **show ip route** command with either the IP address of the source for the *ip-address* argument or the IP address of the RP to validate that there are multiple paths available to the source or RP, respectively. If you do not see multiple paths in the output of the command, you will not be able to configure ECMP multicast load splitting.

- When using PIM-SM with shortest path tree (SPT) forwarding, the T-bit must be set for the forwarding of all (S, G) states.
- Before configuring ECMP multicast load splitting, it is best practice to use the **show ip rpf** command to validate whether sources can take advantage of IP multicast multipath capabilities.
- BGP does not install multiple equal-cost paths by default. Use the **maximum-paths** command to configure multipath (for example in BGP). For more information, see the [Use of BGP with ECMP Multicast Load Splitting, on page 328](#) section.

SUMMARY STEPS

1. **enable**
2. **configure terminal**
3. **ip multicast multipath**
4. Repeat step 3 on all the devices in a redundant topology.
5. **exit**
6. **show ip rpf** *source-address* [*group-address*]
7. **show ip route** *ip-address*

DETAILED STEPS

| | Command or Action | Purpose |
|--------|--|--|
| Step 1 | enable Example: Device> enable | Enables privileged EXEC mode. <ul style="list-style-type: none"> • Enter your password if prompted. |
| Step 2 | configure terminal Example: Device# configure terminal | Enters global configuration mode. |
| Step 3 | ip multicast multipath Example: | Enables ECMP multicast load splitting based on source address using the S-hash algorithm. |

| | Command or Action | Purpose |
|---------------|---|--|
| | <pre>Device(config)# ip multicast multipath</pre> | <ul style="list-style-type: none"> • Because this command changes the way an RPF neighbor is selected, it must be configured consistently on all devices in a redundant topology to avoid looping. • This command does not support configurations in which the same PIM neighbor IP address is reachable through multiple equal-cost paths. This situation typically occurs if unnumbered interfaces are used. Use a different IP address for each interface in a device on which this command is to be configured. • This command load splits the traffic and does not load balance the traffic. Traffic from a source will use only one path, even if the traffic far outweighs traffic from other sources. |
| Step 4 | Repeat step 3 on all the devices in a redundant topology. | -- |
| Step 5 | <p>exit</p> <p>Example:</p> <pre>Device(config)# exit</pre> | Exits global configuration mode and returns to privileged EXEC mode. |
| Step 6 | <p>show ip rpf <i>source-address</i> [<i>group-address</i>]</p> <p>Example:</p> <pre>Device# show ip rpf 10.1.1.2</pre> | <p>(Optional) Displays the information that IP multicast routing uses to perform the RPF check.</p> <ul style="list-style-type: none"> • Use this command to verify RPF selection so as to ensure that IP multicast traffic is being properly load split. |
| Step 7 | <p>show ip route <i>ip-address</i></p> <p>Example:</p> <pre>Device# show ip route 10.1.1.2</pre> | <p>(Optional) Displays the current state of the IP routing table.</p> <ul style="list-style-type: none"> • Use this command to verify that there multiple paths available to a source or RP for ECMP multicast load splitting. • For the <i>ip-address</i> argument, enter the IP address of a source to validate that there are multiple paths available to the source (for shortest path trees) or the IP address of an RP to validate that there are multiple paths available to the RP (for shared trees). |

Related Topics

[ECMP Multicast Load Splitting Based on Source Address Using the S-Hash Algorithm](#), on page 322

[Example Enabling ECMP Multicast Load Splitting Based on Source Address](#), on page 336

Enabling ECMP Multicast Load Splitting Based on Source and Group Address

Perform this task to enable ECMP multicast load splitting of multicast traffic based on source and group address (using the basic S-G-hash algorithm) to take advantage of multiple paths through the network. The

basic S-G-hash algorithm is predictable because no randomization is used in calculating the hash value. The basic S-G-hash algorithm, however, is subject to polarization because for a given source and group, the same hash is always picked irrespective of the device on which the hash is being calculated.

The basic S-G-hash algorithm provides more flexible support for ECMP multicast load splitting than the S-hash algorithm. Using the basic S-G-hash algorithm for load splitting, in particular, enables multicast traffic from devices that send many streams to groups or that broadcast many channels, such as IPTV servers or MPEG video servers, to be more effectively load split across equal-cost paths.



Note Enable ECMP multicast load splitting on the device that is to be the receiver for traffic from more than one incoming interfaces, which is opposite to unicast routing. From the perspective of unicast, multicast is active on the sending device connecting to more than one outgoing interfaces.

SUMMARY STEPS

1. **enable**
2. **configure terminal**
3. **ip multicast multipath s-g-hash basic**
4. Repeat Step 3 on all the devices in a redundant topology.
5. **exit**
6. **show ip rpf source-address [group-address]**
7. **show ip route ip-address**

DETAILED STEPS

| | Command or Action | Purpose |
|--------|--|---|
| Step 1 | enable Example: Device> enable | Enables privileged EXEC mode. <ul style="list-style-type: none"> • Enter your password if prompted. |
| Step 2 | configure terminal Example: Device# configure terminal | Enters global configuration mode. |
| Step 3 | ip multicast multipath s-g-hash basic Example: Device(config)# ip multicast multipath s-g-hash basic | Enables ECMP multicast load splitting based on source and group address using the basic S-G-hash algorithm. <ul style="list-style-type: none"> • Because this command changes the way an RPF neighbor is selected, it must be configured consistently on all devices in a redundant topology to avoid looping. |
| Step 4 | Repeat Step 3 on all the devices in a redundant topology. | -- |
| Step 5 | exit Example: | Exits global configuration mode and returns to privileged EXEC mode. |

| | Command or Action | Purpose |
|---------------|--|---|
| | Device(config)# exit | |
| Step 6 | show ip rpf <i>source-address</i> [<i>group-address</i>] Example: Device# show ip rpf 10.1.1.2 | (Optional) Displays the information that IP multicast routing uses to perform the RPF check. <ul style="list-style-type: none"> • Use this command to verify RPF selection so as to ensure that IP multicast traffic is being properly load split. |
| Step 7 | show ip route <i>ip-address</i> Example: Device# show ip route 10.1.1.2 | (Optional) Displays the current state of the IP routing table. <ul style="list-style-type: none"> • Use this command to verify that there multiple paths available to a source or RP for ECMP multicast load splitting. • For the <i>ip-address</i> argument, enter the IP address of a source to validate that there are multiple paths available to the source (for shortest path trees) or the IP address of an RP to validate that there are multiple paths available to the RP (for shared trees). |

Related Topics

[ECMP Multicast Load Splitting Based on Source and Group Address Using the Basic S-G-Hash Algorithm](#), on page 323

[Example Enabling ECMP Multicast Load Splitting Based on Source and Group Address](#), on page 336

Enabling ECMP Multicast Load Splitting Based on Source Group and Next-Hop Address

Perform this task to enable ECMP multicast load splitting of multicast traffic based on source, group, and next-hop address (using the next-hop-based S-G-hash algorithm) to take advantage of multiple paths through the network. The next-hop-based S-G-hash algorithm is predictable because no randomization is used in calculating the hash value. Unlike the S-hash and basic S-G-hash algorithms, the hash mechanism used by the next-hop-based S-G-hash algorithm is not subject to polarization.

The next-hop-based S-G-hash algorithm provides more flexible support for ECMP multicast load splitting than S-hash algorithm and eliminates the polarization problem. Using the next-hop-based S-G-hash algorithm for ECMP multicast load splitting enables multicast traffic from devices that send many streams to groups or that broadcast many channels, such as IPTV servers or MPEG video servers, to be more effectively load split across equal-cost paths.

SUMMARY STEPS

1. **enable**
2. **configure terminal**
3. **ip multicast multipath s-g-hash next-hop-based**
4. Repeat Steps 1 through 3 on all the routers in a redundant topology.
5. **end**
6. **show ip rpf** *source-address* [*group-address*]
7. **show ip route** *ip-address*

DETAILED STEPS

| | Command or Action | Purpose |
|---------------|---|--|
| Step 1 | enable Example: <pre>Router> enable</pre> | Enables privileged EXEC mode. <ul style="list-style-type: none"> • Enter your password if prompted. |
| Step 2 | configure terminal Example: <pre>Router# configure terminal</pre> | Enters global configuration mode. |
| Step 3 | ip multicast multipath s-g-hash next-hop-based Example: <pre>Router(config)# ip multicast multipath s-g-hash next-hop-based</pre> | Enables ECMP multicast load splitting based on source, group, and next-hop-address using the next-hop-based S-G-hash algorithm. <ul style="list-style-type: none"> • Because this command changes the way an RPF neighbor is selected, it must be configured consistently on all routers in a redundant topology to avoid looping. <p>Note Be sure to enable the ip multicast multipath command on the router that is supposed to be the receiver for traffic from more than one incoming interfaces, which is opposite to unicast routing. From the perspective of unicast, multicast is active on the sending router connecting to more than one outgoing interfaces.</p> |
| Step 4 | Repeat Steps 1 through 3 on all the routers in a redundant topology. | -- |
| Step 5 | end Example: <pre>Router(config)# end</pre> | Exits global configuration mode and returns to privileged EXEC mode. |
| Step 6 | show ip rpf source-address [group-address] Example: <pre>Router# show ip rpf 10.1.1.2</pre> | (Optional) Displays the information that IP multicast routing uses to perform the RPF check. <ul style="list-style-type: none"> • Use this command to verify RPF selection so as to ensure that IP multicast traffic is being properly load split. |
| Step 7 | show ip route ip-address Example: <pre>Router# show ip route 10.1.1.2</pre> | (Optional) Displays the current state of the IP routing table. <ul style="list-style-type: none"> • Use this command to verify that there multiple paths available to a source or RP for ECMP multicast load splitting. • For the <i>ip-address</i> argument, enter the IP address of a source to validate that there are multiple paths available |

| | Command or Action | Purpose |
|--|-------------------|--|
| | | to the source (for shortest path trees) or the IP address of an RP to validate that there are multiple paths available to the RP (for shared trees). |

Related Topics

[ECMP Multicast Load Splitting Based on Source Group and Next-Hop Address](#), on page 324

[Example Enabling ECMP Multicast Load Splitting Based on Source Group and Next-Hop Address](#), on page 336

Configuration Examples for Load Splitting IP Multicast Traffic over ECMP

Example Enabling ECMP Multicast Load Splitting Based on Source Address

The following example shows how to enable ECMP multicast load splitting on a router based on source address using the S-hash algorithm:

```
ip multicast multipath
```

Related Topics

[Enabling ECMP Multicast Load Splitting Based on Source Address](#), on page 330

[ECMP Multicast Load Splitting Based on Source Address Using the S-Hash Algorithm](#), on page 322

Example Enabling ECMP Multicast Load Splitting Based on Source and Group Address

The following example shows how to enable ECMP multicast load splitting on a router based on source and group address using the basic S-G-hash algorithm:

```
ip multicast multipath s-g-hash basic
```

Related Topics

[Enabling ECMP Multicast Load Splitting Based on Source and Group Address](#), on page 332

[ECMP Multicast Load Splitting Based on Source and Group Address Using the Basic S-G-Hash Algorithm](#), on page 323

Example Enabling ECMP Multicast Load Splitting Based on Source Group and Next-Hop Address

The following example shows how to enable ECMP multicast load splitting on a router based on source, group, and next-hop address using the next-hop-based S-G-hash algorithm:

```
ip multicast multipath s-g-hash next-hop-based
```

Related Topics

- [Enabling ECMP Multicast Load Splitting Based on Source Group and Next-Hop Address](#), on page 334
- [ECMP Multicast Load Splitting Based on Source Group and Next-Hop Address](#), on page 324

Additional References

Related Documents

| Related Topic | Document Title |
|---------------------------------|--|
| Cisco IOS commands | Cisco IOS Master Commands List, All Releases |
| Cisco IOS IP Multicast commands | Cisco IOS IP Multicast Command Reference |

Standards and RFCs

| Standard/RFC | Title |
|-----------------|---|
| <i>RFC 4601</i> | Protocol Independent Multicast-Sparse Mode (PIM-SM): Protocol Specification |

MIBs

| MIB | MIBs Link |
|--|---|
| No new or modified MIBs are supported by this feature, and support for existing standards has not been modified by this feature. | To locate and download MIBs for selected platforms, Cisco IOS XE releases, and feature sets, use Cisco MIB Locator found at the following URL: http://www.cisco.com/go/mibs |

Technical Assistance

| Description | Link |
|---|---|
| The Cisco Support and Documentation website provides online resources to download documentation, software, and tools. Use these resources to install and configure the software and to troubleshoot and resolve technical issues with Cisco products and technologies. Access to most tools on the Cisco Support and Documentation website requires a Cisco.com user ID and password. | http://www.cisco.com/cisco/web/support/index.html |

Feature History and Information for Load Splitting IP Multicast Traffic over ECMP

| Release | Modification |
|--------------------|------------------------------|
| Cisco IOS XE 3.3SE | This feature was introduced. |



CHAPTER 17

IP Multicast Optimization: SSM Channel Based Filtering for Multicast

- [Finding Feature Information, on page 339](#)
- [Finding Feature Information, on page 339](#)
- [Prerequisites for SSM Channel Based Filtering for Multicast Boundaries, on page 340](#)
- [Information About the SSM Channel Based Filtering for Multicast Boundaries Feature, on page 340](#)
- [How to Configure SSM Channel Based Filtering for Multicast Boundaries, on page 341](#)
- [Configuration Examples for SSM Channel Based Filtering for Multicast Boundaries, on page 342](#)
- [Additional References, on page 343](#)
- [Feature History and Information for SSM Channel Based Filtering for Multicast Boundaries, on page 344](#)

Finding Feature Information

Your software release may not support all the features documented in this module. For the latest caveats and feature information, see [Bug Search Tool](#) and the release notes for your platform and software release. To find information about the features documented in this module, and to see a list of the releases in which each feature is supported, see the feature information table at the end of this module.

Use Cisco Feature Navigator to find information about platform support and Cisco software image support. To access Cisco Feature Navigator, go to <http://www.cisco.com/go/cfn>. An account on Cisco.com is not required.

Finding Feature Information

Your software release may not support all the features documented in this module. For the latest caveats and feature information, see [Bug Search Tool](#) and the release notes for your platform and software release. To find information about the features documented in this module, and to see a list of the releases in which each feature is supported, see the feature information table.

Use Cisco Feature Navigator to find information about platform support and Cisco software image support. To access Cisco Feature Navigator, go to www.cisco.com/go/cfn. An account on Cisco.com is not required.

Prerequisites for SSM Channel Based Filtering for Multicast Boundaries

IP multicast is enabled on the device using the tasks described in the "Configuring Basic IP Multicast" module of the *IP Multicast: PIM Configuration Guide*.

Information About the SSM Channel Based Filtering for Multicast Boundaries Feature

Rules for Multicast Boundaries

The SSM Channel Based Filtering for Multicast Boundaries feature expands the **ip multicast boundary** command for control plane filtering support. More than one **ip multicast boundary** command can be applied to an interface.

The following rules govern the **ip multicast boundary** command:

- One instance of the **in** and **out** keywords can be configured on an interface.
- The **in** and **out** keywords can be used for standard or extended access lists.
- Only standard access lists are permitted with the use of the **filter-autorp** keyword or no keyword.
- A maximum of three instances of a command will be allowed on an interface: one instance of **in**, one instance of **out**, and one instance of **filter-autorp** or no keyword.
- When multiple instances of the command are used, the filtering will be cumulative. If a boundary statement with no keyword exists with a boundary statement with the **in** keyword, both access lists will be applied on the in direction and a match on either one will be sufficient.
- All instances of the command apply to both control and data plane traffic.
- Protocol information on the extended access list is parsed to allow reuse and filtering for consistency. An (S,G) operation will be filtered by an extended access list under all conditions stated above for keywords if the access list filters (S,G) traffic for all protocols.

Related Topics

[Configuring Multicast Boundaries](#), on page 341

[Configuring the Multicast Boundaries Permitting and Denying Traffic Example](#), on page 342

[Configuring the Multicast Boundaries Permitting Traffic Example](#), on page 342

[Configuring the Multicast Boundaries Denying Traffic Example](#), on page 343

Benefits of SSM Channel Based Filtering for Multicast Boundaries

- This feature allows input on the source interface.
- The access control capabilities are the same for SSM and Any Source Multicast (ASM).

How to Configure SSM Channel Based Filtering for Multicast Boundaries

Configuring Multicast Boundaries

SUMMARY STEPS

1. **enable**
2. **configure terminal**
3. **ip access-list {standard| extended} access-list-name**
4. **permit protocol host address host address**
5. **deny protocol host address host address**
6. Repeat Step 4 or Step 5 as needed.
7. **interface type interface-number port -number**
8. **ip multicast boundary access-list-name [in| out | filter-autorp]**

DETAILED STEPS

| | Command or Action | Purpose |
|--------|---|---|
| Step 1 | enable Example: Device> enable | Enables privileged EXEC mode. |
| Step 2 | configure terminal Example: Device# configure terminal | Enters global configuration mode. |
| Step 3 | ip access-list {standard extended} access-list-name Example: Device(config)# ip access-list 101 | Configures the standard or extended access list. |
| Step 4 | permit protocol host address host address Example: Device(config-ext-nacl)# permit ip host 181.1.2.201 host 232.1.1.11 | Permits specified ip host traffic. |
| Step 5 | deny protocol host address host address Example: Device(config-acl-nacl)# deny ip host 181.1.2.203 host 232.1.1.1 | Denies specified multicast ip group and source traffic. |

| | Command or Action | Purpose |
|---------------|--|--|
| Step 6 | Repeat Step 4 or Step 5 as needed. | Permits and denies specified host and source traffic. |
| Step 7 | interface <i>type</i> interface-number <i>port-number</i> Example: Device(config)# interface gigabitethernet 2/3/0 | Enables interface configuration mode. |
| Step 8 | ip multicast boundary <i>access-list-name</i> [in out filter-autorp] Example: Device(config-if)# ip multicast boundary acc_grp1 out | Configures the multicast boundary. Note The filter-autorp keyword does not support extended access lists. |

Related Topics

[Rules for Multicast Boundaries](#), on page 340

[Configuring the Multicast Boundaries Permitting and Denying Traffic Example](#), on page 342

[Configuring the Multicast Boundaries Permitting Traffic Example](#), on page 342

[Configuring the Multicast Boundaries Denying Traffic Example](#), on page 343

Configuration Examples for SSM Channel Based Filtering for Multicast Boundaries

Configuring the Multicast Boundaries Permitting and Denying Traffic Example

The following example permits outgoing traffic for (181.1.2.201, 232.1.1.1) and (181.1.2.202, 232.1.1.1) and denies all other (S,G)s.

```
configure terminal
ip access-list extended acc_grp1
permit ip host 0.0.0.0 232.1.1.1 0.0.0.255
permit ip host 181.1.2.201 host 232.1.1.1
permit udp host 181.1.2.202 host 232.1.1.1
permit ip host 181.1.2.202 host 232.1.1.1
deny igmp host 181.2.3.303 host 232.1.1.1
interface gigabitethernet 2/3/0
ip multicast boundary acc_grp1 out
```

Related Topics

[Configuring Multicast Boundaries](#), on page 341

[Rules for Multicast Boundaries](#), on page 340

Configuring the Multicast Boundaries Permitting Traffic Example

The following example permits outgoing traffic for (192.168.2.201, 232.1.1.5) and (192.168.2.202, 232.1.1.5).

```

configure terminal
ip access-list extended acc_grp6
 permit ip host 0.0.0.0 232.1.1.1 5.0.0.255
 deny udp host 192.168.2.201 host 232.1.1.5
 permit ip host 192.168.2.201 host 232.1.1.5
 deny pim host 192.168.2.201 host 232.1.1.5
 permit ip host 192.168.2.202 host 232.1.1.5
 deny igmp host 192.2.3.303 host 232.1.1.1
interface gigabitethernet 2/3/0
 ip multicast boundary acc_grp6 out

```

Related Topics

[Configuring Multicast Boundaries](#), on page 341

[Rules for Multicast Boundaries](#), on page 340

Configuring the Multicast Boundaries Denying Traffic Example

The following example denies a group-range that is announced by the candidate RP. Because the group range is denied, no pim auto-rp mappings are created.

```

configure terminal
ip access-list standard acc_grp10
 deny 225.0.0.0 0.255.255.255
 permit any
access-list extended acc_grp12
 permit pim host 181.1.2.201 host 232.1.1.8
 deny udp host 181.1.2.201 host 232.1.1.8
 permit pim host 181.1.2.203 0.0.0.255 host 227.7.7.7
 permit ip host 0.0.0.0 host 227.7.7.7
 permit ip 181.1.2.203 0.0.0.255 host 227.7.7.7
 permit ip host 181.1.2.201 host 232.1.1.7
ip access-list extended acc_grp13
 deny ip host 181.1.2.201 host 232.1.1.8
 permit ip any any
interface gigabitethernet 2/3/0
 ip multicast boundary acc_grp10 filter-autorp
 ip multicast boundary acc_grp12 out
 ip multicast boundary acc_grp13 in

```

Related Topics

[Configuring Multicast Boundaries](#), on page 341

[Rules for Multicast Boundaries](#), on page 340

Additional References

Related Documents

| Related Topic | Document Title |
|---------------------------------|--|
| Cisco IOS commands | Cisco IOS Master Commands List, All Releases |
| Cisco IOS IP Multicast commands | Cisco IOS IP Multicast Command Reference |

MIBs

| MIB | MIBs Link |
|--|---|
| No new or modified MIBs are supported by this feature, and support for existing standards has not been modified by this feature. | To locate and download MIBs for selected platforms, Cisco IOS XE releases, and feature sets, use Cisco MIB Locator found at the following URL: http://www.cisco.com/go/mibs |

Technical Assistance

| Description | Link |
|---|---|
| The Cisco Support and Documentation website provides online resources to download documentation, software, and tools. Use these resources to install and configure the software and to troubleshoot and resolve technical issues with Cisco products and technologies. Access to most tools on the Cisco Support and Documentation website requires a Cisco.com user ID and password. | http://www.cisco.com/cisco/web/support/index.html |

Feature History and Information for SSM Channel Based Filtering for Multicast Boundaries

| Release | Modification |
|--------------------|------------------------------|
| Cisco IOS XE 3.3SE | This feature was introduced. |



CHAPTER 18

IP Multicast Optimization: PIM Dense Mode State Refresh

- [Finding Feature Information, on page 345](#)
- [Prerequisite for PIM Dense Mode State Refresh, on page 345](#)
- [Restrictions on PIM Dense Mode State Refresh, on page 345](#)
- [Information About PIM Dense Mode State Refresh, on page 346](#)
- [How to Configure PIM Dense Mode State Refresh, on page 346](#)
- [Configuration Examples for PIM Dense Mode State Refresh, on page 348](#)
- [Additional References, on page 349](#)
- [Feature History and Information for PIM Dense Mode State Refresh, on page 350](#)

Finding Feature Information

Your software release may not support all the features documented in this module. For the latest caveats and feature information, see Bug Search Tool and the release notes for your platform and software release. To find information about the features documented in this module, and to see a list of the releases in which each feature is supported, see the feature information table at the end of this module.

Use Cisco Feature Navigator to find information about platform support and Cisco software image support. To access Cisco Feature Navigator, go to <http://www.cisco.com/go/cfn>. An account on Cisco.com is not required.

Prerequisite for PIM Dense Mode State Refresh

- You must have PIM dense mode enabled on an interface before configuring the PIM Dense Mode State Refresh feature.

Restrictions on PIM Dense Mode State Refresh

- All routers in a PIM dense mode network must run a software release that supports the PIM Dense Mode State Refresh feature to process and forward state refresh control messages.

- The origination interval for the state refresh control message must be the same for all PIM routers on the same LAN. Specifically, the same origination interval must be configured on each router interface that is directly connected to the LAN.

Information About PIM Dense Mode State Refresh

PIM Dense Mode State Refresh Overview

The PIM Dense Mode State Refresh feature is an extension of the PIM Version 2 multicast routing architecture.

PIM dense mode builds source-based multicast distribution trees that operate on a flood and prune principle. Multicast packets from a source are flooded to all areas of a PIM dense mode network. PIM routers that receive multicast packets and have no directly connected multicast group members or PIM neighbors send a prune message back up the source-based distribution tree toward the source of the packets. As a result, subsequent multicast packets are not flooded to pruned branches of the distribution tree. However, the pruned state in PIM dense mode times out approximately every 3 minutes and the entire PIM dense mode network is reflooded with multicast packets and prune messages. This reflooding of unwanted traffic throughout the PIM dense mode network consumes network bandwidth.

The PIM Dense Mode State Refresh feature keeps the pruned state in PIM dense mode from timing out by periodically forwarding a control message down the source-based distribution tree. The control message refreshes the prune state on the outgoing interfaces of each router in the distribution tree.

Related Topics

[Configuring PIM Dense Mode State Refresh](#), on page 346

[Originating Processing and Forwarding PIM Dense Mode State Refresh Control Messages Example](#), on page 348

[Processing and Forwarding PIM Dense Mode State Refresh Control Messages Example](#), on page 349

Benefits of PIM Dense Mode State Refresh

The PIM Dense Mode State Refresh feature keeps the pruned state in PIM dense mode from timing out, which saves network bandwidth by greatly reducing the reflooding of unwanted multicast traffic to pruned branches of the PIM dense mode network. This feature also enables PIM routers in a PIM dense mode multicast network to recognize topology changes (sources joining or leaving a multicast group) before the default 3-minute state refresh timeout period.

How to Configure PIM Dense Mode State Refresh

Configuring PIM Dense Mode State Refresh

There are no configuration tasks for enabling the PIM Dense Mode State Refresh feature. By default, all PIM routers that are running a Cisco IOS XE software release that supports the PIM Dense Mode State Refresh feature automatically process and forward state refresh control messages.

To disable the processing and forwarding of state refresh control messages on a PIM router, use the **ip pim state-refresh disable** global configuration command. To enable state refresh again if it has been disabled, use the **no ip pim state-refresh disable** global configuration command.

The origination of state refresh control messages is disabled by default. To configure the origination of the control messages on a PIM router, use the following commands beginning in global configuration mode:

| Command | Purpose |
|---|--|
| Router(config)# interface <i>type number</i> | Specifies an interface and places the router in interface configuration mode. |
| Router(config-if)# ip pim state-refresh origination-interval [<i>interval</i>] | Configures the origination of the PIM Dense Mode State Refresh control message. Optionally, you can configure the number of seconds between control messages by using the <i>interval</i> argument. The default interval is 60 seconds. The interval range is 1 second to 100 seconds. |

Related Topics

[PIM Dense Mode State Refresh Overview](#), on page 346

[Originating Processing and Forwarding PIM Dense Mode State Refresh Control Messages Example](#), on page 348

[Processing and Forwarding PIM Dense Mode State Refresh Control Messages Example](#), on page 349

Verifying PIM Dense Mode State Refresh Configuration

Use the **show ip pim interface** [*type number*] **detail** and the **show ip pim neighbor** [*interface*] commands to verify that the PIM Dense Mode State Refresh feature is configured correctly. The following output of the **show ip pim interface** [*type number*] **detail** command indicates that processing, forwarding, and origination of state refresh control messages is enabled.

```
Router# show ip pim interface fastethernet 0/1/0 detail
FastEthernet0/1/0 is up, line protocol is up
  Internet address is 172.16.8.1/24
  Multicast switching:process
  Multicast packets in/out:0/0
  Multicast boundary:not set
  Multicast TTL threshold:0
  PIM:enabled
    PIM version:2, mode:dense
    PIM DR:172.16.8.1 (this system)
    PIM neighbor count:0
    PIM Hello/Query interval:30 seconds
  PIM State-Refresh processing:enabled
  PIM State-Refresh origination:enabled, interval:60 seconds
  PIM NBMA mode:disabled
  PIM ATM multipoint signalling:disabled
  PIM domain border:disabled
  Multicast Tagswitching:disabled
```

The S in the Mode field of the following **show ip pim neighbor** [*interface*] command output indicates that the neighbor has the PIM Dense Mode State Refresh feature configured.

```
Router# show ip pim neighbor
PIM Neighbor Table
```

| Neighbor Address | Interface | Uptime/Expires | Ver | DR Priority/Mode |
|------------------|-------------|-------------------|-----|------------------|
| 172.16.5.1 | Ethernet1/1 | 00:09:03/00:01:41 | v2 | 1 / B S |

Monitoring and Maintaining PIM DM State Refresh

Following are the PIM Dense Mode State Refresh control messages that are sent and received by a PIM router after the **debug ip pim** privileged EXEC command is configured for multicast group 239.0.0.1:

```
Router# debug ip pim 239.0.0.1
*Mar 1 00:25:10.416:PIM:Originating refresh message for
(172.16.8.3,239.0.0.1)
*Mar 1 00:25:10.416:PIM:Send SR on GigabitEthernet1/1/0 for (172.16.8.3,239.0.0.1)
TTL=9
```

The following output from the **show ip mroute** command displays are the resulting prune timer changes for GigabitEthernet interface 1/0/0 and multicast group 239.0.0.1. (The following output assumes that the **debug ip pim** privileged EXEC command has already been configured on the router.) In the first output from the **show ip mroute** command, the prune timer reads 00:02:06. The debug messages indicate that a PIM Dense Mode State Refresh control message is received and sent on Ethernet interface 1/0, and that other PIM Dense Mode State Refresh routers were discovered. In the second output from the **show ip mroute** command, the prune timer has been reset to 00:02:55.

```
Router# show ip mroute 239.0.0.1
(172.16.8.3, 239.0.0.1), 00:09:50/00:02:06, flags:PT
  Incoming interface:GigabitEthernet1/1/0, RPF nbr 172.16.5.2
  Outgoing interface list:
  GigabitEthernet1/0/0, Prune/Dense, 00:09:43/00:02:06
Router#
*Mar 1 00:32:06.657:PIM:SR on iif from 172.16.5.2 orig 172.16.8.1 for
(172.16.8.3,239.0.0.1)
*Mar 1 00:32:06.661:      flags:prune-indicator
*Mar 1 00:32:06.661:PIM:Cached metric is [0/0]
*Mar 1 00:32:06.661:PIM:Keep RPF nbr 172.16.5.2
*Mar 1 00:32:06.661:PIM:Send SR on Ethernet1/0 for (172.16.8.3,239.0.0.1)
TTL=8
*Mar 1 00:32:06.661:      flags:prune-indicator
Router# show ip mroute 239.0.0.1
(172.16.8.3, 239.0.0.1), 00:10:01/00:02:55, flags:PT
  Incoming interface:GigabitEthernet1/1/0, RPF nbr 172.16.5.2
  Outgoing interface list:
  GigabitEthernet1/0/0, Prune/Dense, 00:09:55/00:02:55
```

Configuration Examples for PIM Dense Mode State Refresh

Originating Processing and Forwarding PIM Dense Mode State Refresh Control Messages Example

The following example is for a PIM router that is originating, processing, and forwarding PIM Dense Mode State Refresh control messages on Fast Ethernet interface 0/1/0 every 60 seconds:

```
ip multicast-routing distributed
interface FastEthernet0/1/0
```

```
ip address 172.16.8.1 255.255.255.0
ip pim state-refresh origination-interval 60
ip pim dense-mode
```

Related Topics

[Configuring PIM Dense Mode State Refresh](#), on page 346

[PIM Dense Mode State Refresh Overview](#), on page 346

Processing and Forwarding PIM Dense Mode State Refresh Control Messages Example

The following example is for a PIM router that is just processing and forwarding PIM Dense Mode State Refresh control messages on Fast Ethernet interface 1/1/0:

```
ip multicast-routing
interface FastEthernet1/1/0
 ip address 172.16.7.3 255.255.255.0
 ip pim dense-mode
```

Related Topics

[Configuring PIM Dense Mode State Refresh](#), on page 346

[PIM Dense Mode State Refresh Overview](#), on page 346

Additional References

Related Documents

| Related Topic | Document Title |
|---|---|
| The PIM Dense Mode State Refresh feature is an extension of the PIM Version 2 multicast routing architecture | “Configuring Basic IP Multicast” module |
| IP multicast commands: complete command syntax, command mode, defaults, command history, usage guidelines, and examples | <i>Cisco IOS IP Multicast Command Reference</i> |

Standards

| Standard | Title |
|---|-------|
| No new or modified standards are supported by this feature, and support for existing standards has not been modified by this feature. | -- |

MIBs

| MIB | MIBs Link |
|--|--|
| No new or modified MIBs are supported by this feature, and support for existing standards has not been modified by this feature. | To locate and download MIBs for selected platforms, Cisco IOS releases, and feature sets, use Cisco MIB Locator found at the following URL: http://www.cisco.com/go/mibs |

RFCs

| RFC | Title |
|--|--------------|
| No new or modified RFCs are supported by this feature, and support for existing standards has not been modified by this feature. | -- |

Technical Assistance

| Description | Link |
|---|---|
| <p>The Cisco Support website provides extensive online resources, including documentation and tools for troubleshooting and resolving technical issues with Cisco products and technologies.</p> <p>To receive security and technical information about your products, you can subscribe to various services, such as the Product Alert Tool (accessed from Field Notices), the Cisco Technical Services Newsletter, and Really Simple Syndication (RSS) Feeds.</p> <p>Access to most tools on the Cisco Support website requires a Cisco.com user ID and password.</p> | http://www.cisco.com/techsupport |

Feature History and Information for PIM Dense Mode State Refresh

| Release | Modification |
|--------------------|------------------------------|
| Cisco IOS XE 3.3SE | This feature was introduced. |



CHAPTER 19

IP Multicast Optimization: IGMP State Limit

- [Finding Feature Information, on page 351](#)
- [Prerequisites for IGMP State Limit, on page 351](#)
- [Restrictions for IGMP State Limit, on page 351](#)
- [Information About IGMP State Limit, on page 352](#)
- [How to Configure IGMP State Limit, on page 353](#)
- [Configuration examples for IGMP State Limit, on page 355](#)
- [Additional References, on page 357](#)
- [Feature History and Information for IGMP State Limit, on page 357](#)

Finding Feature Information

Your software release may not support all the features documented in this module. For the latest caveats and feature information, see Bug Search Tool and the release notes for your platform and software release. To find information about the features documented in this module, and to see a list of the releases in which each feature is supported, see the feature information table at the end of this module.

Use Cisco Feature Navigator to find information about platform support and Cisco software image support. To access Cisco Feature Navigator, go to <http://www.cisco.com/go/cfn>. An account on Cisco.com is not required.

Prerequisites for IGMP State Limit

- IP multicast is enabled and the Protocol Independent Multicast (PIM) interfaces are configured using the tasks described in the "Configuring Basic IP Multicast" module of the *IP Multicast: PIM Configuration Guide*.
- ALL ACLs must be configured. For information, see the "Creating an IP Access List and Applying It to an Interface" module of the *Security Configuration Guide: Access Control Lists* guide.

Restrictions for IGMP State Limit

You can configure only one global limit per device and one limit per interface.

Information About IGMP State Limit

IGMP State Limit

The IGMP State Limit feature allows for the configuration of IGMP state limiters, which impose limits on mroute states resulting from IGMP membership reports (IGMP joins) on a global or per interface basis. Membership reports exceeding the configured limits are not entered into the IGMP cache. This feature can be used to prevent DoS attacks or to provide a multicast CAC mechanism in network environments where all the multicast flows roughly utilize the same amount of bandwidth.



Note IGMP state limiters impose limits on the number of mroute states resulting from IGMP, IGMP v3lite, and URL Rendezvous Directory (URD) membership reports on a global or per interface basis.

Related Topics

[Configuring Global IGMP State Limiters](#), on page 353

[Configuring IGMP State Limiters Example](#), on page 355

IGMP State Limit Feature Design

- Configuring IGMP state limiters in global configuration mode specifies a global limit on the number of IGMP membership reports that can be cached.
- Configuring IGMP state limiters in interface configuration mode specifies a limit on the number of IGMP membership reports on a per interface basis.
- Use ACLs to prevent groups or channels from being counted against the interface limit. A standard or an extended ACL can be specified. A standard ACL can be used to define the (*, G) state to be excluded from the limit on an interface. An extended ACLs can be used to define the (S, G) state to be excluded from the limit on an interface. An extended ACL also can be used to define the (*, G) state to be excluded from the limit on an interface, by specifying 0.0.0.0 for the source address and source wildcard--referred to as (0, G)--in the permit or deny statements that compose the extended access list.
- You can only configure one global limit per device and one limit per interface.

Mechanics of IGMP State Limiters

The mechanics of IGMP state limiters are as follows:

- Each time a router receives an IGMP membership report for a particular group or channel, the Cisco IOS software checks to see if either the limit for the global IGMP state limiter or the limit for the per interface IGMP state limiter has been reached.
- If only a global IGMP state limiter has been configured and the limit has not been reached, IGMP membership reports are honored. When the configured limit has been reached, subsequent IGMP membership reports are then ignored (dropped) and a warning message in one of the following formats is generated:

- %IGMP-6-IGMP_GROUP_LIMIT: IGMP limit exceeded for <group (*, group address)> on <interface type number> by host <ip address>
 - %IGMP-6-IGMP_CHANNEL_LIMIT: IGMP limit exceeded for <channel (source address, group address)> on <interface type number> by host <ip address>
- If only per interface IGMP state limiters are configured, then each limit is only counted against the interface on which it was configured.
 - If both a global IGMP state limiter and per interface IGMP state limiters are configured, the limits configured for the per interface IGMP state limiters are still enforced but are constrained by the global limit.

How to Configure IGMP State Limit

Configuring IGMP State Limiters



Note IGMP state limiters impose limits on the number of mroute states resulting from IGMP, IGMP v3lite, and URD membership reports on a global or per interface basis.

Configuring Global IGMP State Limiters

Perform this optional task to configure one global IGMP state limiter per device.

SUMMARY STEPS

1. **enable**
2. **configure terminal**
3. **ip igmp limit *number***
4. **end**
5. **show ip igmp groups**

DETAILED STEPS

| | Command or Action | Purpose |
|--------|--|--|
| Step 1 | enable Example: Device> enable | Enables privileged EXEC mode. <ul style="list-style-type: none"> • Enter your password if prompted. |
| Step 2 | configure terminal Example: | Enters global configuration mode. |

| | Command or Action | Purpose |
|---------------|--|---|
| | Device# configure terminal | |
| Step 3 | ip igmp limit <i>number</i> Example: Device(config)# ip igmp limit 150 | Configures a global limit on the number of mroute states resulting from IGMP membership reports (IGMP joins). |
| Step 4 | end Example: Device(config-if)# end | Ends the current configuration session and returns to privileged EXEC mode. |
| Step 5 | show ip igmp groups Example: Device# show ip igmp groups | (Optional) Displays the multicast groups with receivers that are directly connected to the device and that were learned through IGMP. |

Related Topics

[IGMP State Limit](#), on page 352

[Configuring IGMP State Limiters Example](#), on page 355

Configuring Per Interface IGMP State Limiters

Perform this optional task to configure a per interface IGMP state limiter.

SUMMARY STEPS

1. **enable**
2. **configure terminal**
3. **interface** *type number*
4. **ip igmp limit** *number* [**except** *access-list*]
5. Do one of the following:
 - **exit**
 - **end**
6. **show ip igmp interface** [*type number*]
7. **show ip igmp groups**

DETAILED STEPS

| | Command or Action | Purpose |
|---------------|--|--|
| Step 1 | enable Example: Device> enable | Enables privileged EXEC mode. <ul style="list-style-type: none"> • Enter your password if prompted. |

| | Command or Action | Purpose |
|--------|---|--|
| Step 2 | configure terminal Example: <pre>Device# configure terminal</pre> | Enters global configuration mode. |
| Step 3 | interface <i>type number</i> Example: <pre>Device(config)# interface GigabitEthernet0/0</pre> | Enters interface configuration mode. <ul style="list-style-type: none"> Specify an interface that is connected to hosts. |
| Step 4 | ip igmp limit <i>number</i> [except <i>access-list</i>] Example: <pre>Device(config-if)# ip igmp limit 100</pre> | Configures a per interface limit on the number of mroutes states created as a result of IGMP membership reports (IGMP joins). |
| Step 5 | Do one of the following: <ul style="list-style-type: none"> exit end Example: <pre>Device(config-if)# exit Device(config-if)# end</pre> | <ul style="list-style-type: none"> (Optional) Ends the current configuration session and returns to global configuration mode. Repeat steps 3 and 4 to configure a per interface limiter on another interface. Ends the current configuration session and returns to privileged EXEC mode. |
| Step 6 | show ip igmp interface [<i>type number</i>] Example: <pre>Device# show ip igmp interface</pre> | (Optional) Displays information about the status and configuration of IGMP and multicast routing on interfaces. |
| Step 7 | show ip igmp groups Example: <pre>Device# show ip igmp groups</pre> | (Optional) Displays the multicast groups with receivers that are directly connected to the device and that were learned through IGMP. |

Configuration examples for IGMP State Limit

Configuring IGMP State Limiters Example

The following example shows how to configure IGMP state limiters to provide multicast CAC in a network environment where all the multicast flows roughly utilize the same amount of bandwidth.

This example uses the topology illustrated in the figure.



Note Although the following illustration and example uses routers in the configuration, any device (router or switch) can be used.

Figure 22: IGMP State Limit Example Topology

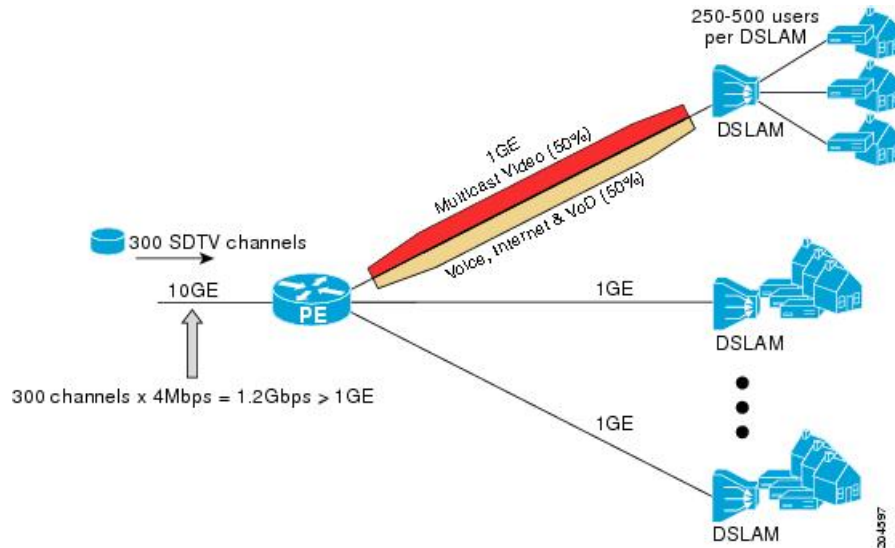

In this example, a service provider is offering 300 Standard Definition (SD) TV channels. Each SD channel utilizes approximately 4 Mbps.

The service provider must provision the Gigabit Ethernet interfaces on the PE router connected to the Digital Subscriber Line Access Multiplexers (DSLAMs) as follows: 50% of the link's bandwidth (500 Mbps) must be available to subscribers of the Internet, voice, and video on demand (VoD) service offerings while the remaining 50% (500 Mbps) of the link's bandwidth must be available to subscribers of the SD channel offerings.

Because each SD channel utilizes the same amount of bandwidth (4 Mbps), per interface IGMP state limiters can be used to provide the necessary CAC to provision the services being offered by the service provider. To determine the required CAC needed per interface, the total number of channels is divided by 4 (because each channel utilizes 4 Mbps of bandwidth). The required CAC needed per interface, therefore, is as follows:

$$500\text{Mbps} / 4\text{Mbps} = 125 \text{ mroutes}$$

Once the required CAC is determined, the service provider uses the results to configure the per IGMP state limiters required to provision the Gigabit Ethernet interfaces on the PE router. Based on the network's CAC requirements, the service provider must limit the SD channels that can be transmitted out a Gigabit Ethernet interface (at any given time) to 125. Configuring a per interface IGMP state limit of 125 for the SD channels provisions the interface for 500 Mbps of bandwidth, the 50% of the link's bandwidth that must always be available (but never exceeded) for the SD channel offerings.

The following configuration shows how the service provider uses a per interface mroute state limiter to provision interface Gigabit Ethernet 0/0/0 for the SD channels and Internet, Voice, and VoD services being offered to subscribers:

```
interface GigabitEthernet0/0/0
description --- Interface towards the DSLAM ---
```

```

.
.
.
ip igmp limit 125

```

Related Topics

[Configuring Global IGMP State Limiters](#), on page 353

[IGMP State Limit](#), on page 352

Additional References

Related Documents

| Related Topic | Document Title |
|---------------------------------|--|
| Cisco IOS commands | Cisco IOS Master Commands List, All Releases |
| Cisco IOS IP Multicast commands | Cisco IOS IP Multicast Command Reference |

MIBs

| MIB | MIBs Link |
|--|---|
| No new or modified MIBs are supported by this feature, and support for existing standards has not been modified by this feature. | To locate and download MIBs for selected platforms, Cisco IOS XE releases, and feature sets, use Cisco MIB Locator found at the following URL: http://www.cisco.com/go/mibs |

Technical Assistance

| Description | Link |
|---|---|
| The Cisco Support and Documentation website provides online resources to download documentation, software, and tools. Use these resources to install and configure the software and to troubleshoot and resolve technical issues with Cisco products and technologies. Access to most tools on the Cisco Support and Documentation website requires a Cisco.com user ID and password. | http://www.cisco.com/cisco/web/support/index.html |

Feature History and Information for IGMP State Limit

| Release | Modification |
|--------------------|------------------------------|
| Cisco IOS XE 3.3SE | This feature was introduced. |



INDEX

- A**
 - address aliasing [36](#)
 - addresses [25, 27](#)
 - globally scoped [25](#)
 - GLOP [25](#)
 - IP multicast class D [25](#)
 - layer 2 multicast [27](#)
 - limited scope [25](#)
 - multicast [25](#)
 - reserved link-local [25](#)
 - SSM [25](#)
 - Auto-RP [122, 123, 135](#)
 - benefits [122, 123](#)
- B**
 - BIP multicast routing [264](#)
 - bootstrap router (BSR), described [123](#)
 - BSRs [147](#)
 - candidate [147](#)
- C**
 - CGMP [104](#)
 - CGMP (example) [108](#)
 - Class D addresses [25](#)
 - clearing [277](#)
 - cached [277](#)
 - databases [277](#)
 - tables [277](#)
 - configurable leave timer, IGMP [39](#)
- D**
 - default configuration [40, 41, 129](#)
 - IGMP [40](#)
 - IGMP filtering [41](#)
 - IGMP snooping [41](#)
 - IGMP throttling [41](#)
 - PIM [129](#)
 - dense mode [115](#)
 - designated router (DR) [303](#)
- DVMRP [281](#)
 - mrinfo requests, responding to [281](#)
 - neighbors [281](#)
 - displaying information [281](#)
 - tunnels [281](#)
 - displaying neighbor information [281](#)
- DVMRP (Distance Vector Multicast Routing Protocol) [21](#)
 - See IP multicast routing, DVMRP [21](#)
- F**
 - false RPs [141](#)
 - feature information [92, 174, 262, 282](#)
 - IGMP [92](#)
 - IP Multicast [282](#)
 - PIM [174](#)
 - SSM [262](#)
- G**
 - global leave, IGMP [78](#)
 - globally scoped addresses [25](#)
 - GLOP addresses [25](#)
- I**
 - IGMP [31, 32, 33, 35, 36, 37, 38, 39, 40, 42, 47, 49, 51, 53, 72, 75, 77, 78, 79, 82](#)
 - configurable last member query count [75](#)
 - enabling [75](#)
 - configurable leave timer [39, 72](#)
 - described [39](#)
 - enabling [72](#)
 - configuring the switch [42, 53](#)
 - as a member of a group [42](#)
 - statically connected member [53](#)
 - default configuration [40](#)
 - flooded multicast traffic [77, 78, 79](#)
 - controlling the length of time [77](#)
 - disabling on an interface [79](#)
 - global leave [78](#)
 - recovering from flood mode [78](#)
 - host-query interval, modifying [47](#)
 - join messages [37](#)

- IGMP (*continued*)
 - join process [35](#)
 - leave process [36](#)
 - leaving multicast group [38](#)
 - maximum query response time value [51](#)
 - multicast addresses [32](#)
 - multicast reachability [42](#)
 - pruning groups [51](#)
 - queries [37](#)
 - query timeout [49](#)
 - query timeout [49](#)
 - report suppression [39, 82](#)
 - described [39](#)
 - disabling [82](#)
 - role [31](#)
 - supported versions [32](#)
 - Version 1 [32](#)
 - Version 2 [32](#)
 - Version 3 [33](#)
 - version differences [33](#)
 - IGMP filtering [40, 41](#)
 - default configuration [41](#)
 - described [40](#)
 - IGMP groups [58, 59](#)
 - configuring filtering [59](#)
 - setting the maximum number [58](#)
 - IGMP helper [119](#)
 - IGMP Immediate Leave [31, 71](#)
 - enabling [71](#)
 - IGMP profile [54, 56](#)
 - applying [56](#)
 - configuration mode [54](#)
 - IGMP proxy (example) [100](#)
 - IGMP report suppression [31](#)
 - IGMP robustness-variable [74](#)
 - IGMP snooping [30, 32, 36, 39, 40, 41, 66, 67, 80, 84, 105](#)
 - and address aliasing [36](#)
 - and stack changes [40](#)
 - default configuration [41](#)
 - definition [36](#)
 - Immediate Leave [39](#)
 - in the switch stack [40](#)
 - method [67](#)
 - monitoring [84](#)
 - querier [30, 80](#)
 - configuration guidelines [30](#)
 - configuring [80](#)
 - supported versions [32](#)
 - VLAN configuration [66](#)
 - IGMP throttling [40, 41, 59, 86](#)
 - configuring [59](#)
 - default configuration [41](#)
 - described [40](#)
 - displaying action [86](#)
 - IGMP Throttling Action [31](#)
 - configuration guidelines [31](#)
 - IGMP version [46](#)
 - Immediate Leave, IGMP [39](#)
 - described [39](#)
 - IP [21](#)
 - PIM [21](#)
 - See IP multicast routing, PIM [21](#)
 - IP multicast [21, 25, 27](#)
 - delivery modesany source multicast [27](#)
 - group addressing [25](#)
 - role in information delivery [21](#)
 - IP multicast boundaries [121](#)
 - IP multicast boundary [145, 272](#)
 - IP multicast routing [21, 112, 123, 143, 168, 265, 267, 268, 270, 274, 275, 278](#)
 - bootstrap router [123](#)
 - overview [123](#)
 - configuring [268, 270](#)
 - IP multicast forwarding [268](#)
 - IP static multicast route [270](#)
 - DVMRP [21](#)
 - definition [21](#)
 - enabling [267](#)
 - PIM mode [267](#)
 - group-to-RP mappings [123](#)
 - BSR [123](#)
 - IGMP [21](#)
 - purpose [21](#)
 - MBONE [21, 274, 275](#)
 - enabling sdr listener support [274](#)
 - limiting sdr cache entry lifetime [275](#)
 - PIMv1 and PIMv2 interoperability [112](#)
 - RP [143, 168](#)
 - configuring PIMv2 BSR [143](#)
 - monitoring mapping information [168](#)
 - stacking [265](#)
 - active switch functions [265](#)
 - stack member functions [265](#)
 - statistics, displaying system and network [278](#)
 - ip pim state-refresh origination-interval command [346](#)
- J**
 - join messages, IGMP [37](#)
- L**
 - Layer 2 switches [104](#)
 - limited scope addresses [25](#)
- M**
 - MBONE (multicast backbone) [21](#)
 - mDNS [284](#)
 - mDNS gateway [285](#)
 - mDNS Gateway [285](#)

- mDNS-SD [284](#)
- mDNS-SD, wireless [284](#)
- MFIB [264](#)
- monitoring [84, 85, 168, 256, 277, 280](#)
 - BSR information [168](#)
 - IGMP [84](#)
 - snooping [84](#)
 - IP [277](#)
 - multicast routing [277](#)
 - IP multicast routing [280](#)
 - multicast router interfaces [85](#)
 - RP mapping information [168](#)
 - SSM mapping [256](#)
- MSDP [116](#)
- multicast forwarding [124](#)
- multicast group transmission scheme [22](#)
- multicast groups [37, 38, 70](#)
 - joining [37](#)
 - leaving [38](#)
 - static joins [70](#)
- Multicast Pings [165, 166](#)
 - configuring routers [165](#)
 - pinging routers [166](#)
- multicast router interfaces, monitoring [85](#)
- multicast router ports, adding [68](#)
- Multicast Source Discovery Protocol [116](#)

P

- PIM [112, 117, 129, 155, 157, 167, 168, 267](#)
 - default configuration [129](#)
 - dense mode [129](#)
 - RPF lookups [129](#)
 - enabling a mode [267](#)
 - monitoring [167](#)
 - router-query message interval, modifying [157](#)
 - shortest path tree, delaying the use of [155](#)
 - sparse mode [129](#)
 - RPF lookups [129](#)
 - versions [112, 117, 168](#)
 - interoperability [112](#)
 - troubleshooting interoperability problems [168](#)
 - v2 improvements [117](#)
- PIM dense mode [115](#)
- PIM Dense Mode State Refresh [345, 346, 348](#)
 - benefits [346](#)
 - configuration examples [348](#)
 - configuration tasks [346](#)
 - monitoring and maintaining [348](#)
 - overview [346](#)
 - prerequisites [345](#)
 - related features and technologies [346](#)
 - restrictions [345](#)
- PIM domain border [123, 143](#)
- PIM registering process [302](#)

- PIM shared tree [126](#)
- PIM source tree [126](#)
- PIM stub routing [113, 118, 130](#)
- PIM-SSM [239](#)
- prerequisites [30, 237](#)
 - IGMP snooping [30](#)
 - SSM [237](#)
- Protocol Independent Multicast [115](#)

Q

- queries, IGMP [37](#)

R

- rendezvous point [132](#)
- report suppression, IGMP [39, 82](#)
 - described [39](#)
 - disabling [82](#)
- reserved link-local addresses [25](#)
- restrictions [30, 31, 238](#)
 - IGMP [30](#)
 - IGMP snooping [31](#)
 - SSM [238](#)
- RFC [36](#)
 - 1112, IP multicast and IGMP [36](#)
- RGMP [105](#)
- RGMP (example) [109](#)
- Router-Port Group Management Protocol [105](#)
 - See RGMP [105](#)
- RP [133, 138](#)
 - sparse-mode cloud [138](#)
- RP announcement messages [141](#)
- RPF [127](#)
- RPF check fails (figure) [128](#)
- RPF check succeeds (figure) [128](#)
- RPs [149](#)
 - candidate [149](#)

S

- Service Discovery Gateway [286](#)
 - filtering [286](#)
 - query [286](#)
 - service list [286](#)
- service list [287](#)
- shared tree [125, 126](#)
 - advantage [126](#)
- shared tree versus source tree (figure) [303](#)
- shortest path tree [303](#)
- shortest-path tree, preventing [303](#)
- source specific multicast [27](#)
- Source Specific Multicast [245](#)
 - See SSM [245](#)

- source tree [125](#)
 - advantage [125](#)
 - sparse mode [116](#)
 - sparse-dense mode [117](#)
 - sparse-mode register messages [303](#)
 - SSM [25, 239, 241](#)
 - addresses [25](#)
 - IGMPv3 host signalling [241](#)
 - overview [239](#)
 - SSM (Source Specific Multicast) [239, 240](#)
 - differences from ISM [239](#)
 - operations [240](#)
 - SSM mapping [242, 243, 251, 256](#)
 - DNS-based SSM mapping [243](#)
 - monitoring [256](#)
 - overview [242](#)
 - static SSM mapping [243](#)
 - static traffic forwarding [251](#)
 - SSM Mapping [248](#)
 - configuring DNS-based SSM mapping [248](#)
 - SSM, ISM and IGMPv3 [241](#)
 - stack changes, effects on [40, 265](#)
 - IGMP snooping [40](#)
 - multicast routing [265](#)
 - stacks, switch [265](#)
 - multicast routing, active switch and member roles [265](#)
 - statistics [278](#)
 - IP multicast routing [278](#)
 - subnets [285](#)
- ## T
- troubleshooting [168](#)
 - PIMv1 and PIMv2 interoperability problems [168](#)
- ## V
- Verifying multicast operations [159, 160, 161](#)
 - last hop router [161](#)
 - on routers along the SPT [159, 160](#)