



## CHAPTER 39

# Configuring 802.1X Port-Based Authentication

---

This chapter describes how to configure IEEE 802.1X port-based authentication to prevent unauthorized client devices from gaining access to the network.

This chapter includes the following major sections:

- [Understanding 802.1X Port-Based Authentication, page 39-1](#)
- [Configuring 802.1X Port-Based Authentication, page 39-22](#)
- [Displaying 802.1X Statistics and Status, page 39-67](#)
- [Displaying Authentication Details, page 39-67](#)



**Note**

For complete syntax and usage information for the switch commands used in this chapter, look at the *Cisco Catalyst 4500 Series Switch Command Reference* and related publications at this location:

<http://www.cisco.com/en/US/products/hw/switches/ps4324/index.html>

If the command is not found in the Catalyst 4500 Command Reference, it is located in the larger Cisco IOS library. Refer to the *Catalyst 4500 Series Switch Cisco IOS Command Reference* and related publications at this location:

<http://www.cisco.com/en/US/products/ps6350/index.html>

---

## Understanding 802.1X Port-Based Authentication

802.1X defines 802.1X port-based authentication as a client-server based access control and authentication protocol that restricts unauthorized clients from connecting to a LAN through publicly accessible ports. An authentication server validates each supplicant (client) connected to an authenticator (network access switch) port before making available any services offered by the switch or the LAN.



**Note**

802.1X support requires an authentication server that is configured for Remote Authentication Dial-In User Service (RADIUS). 802.1X authentication does not work unless the network access switch can route packets to the configured RADIUS server. To verify that the switch can route packets, you must ping the server from the switch.

---

Until a client is authenticated, only Extensible Authentication Protocol over LAN (EAPOL) traffic is allowed through the port to which the client is connected. After authentication succeeds, normal traffic can pass through the port.

To configure 802.1X port-based authentication, you need to understand the concepts in these sections:

- [Device Roles](#), page 39-2
- [802.1X and Network Access Control](#), page 39-3
- [Authentication Initiation and Message Exchange](#), page 39-3
- [Ports in Authorized and Unauthorized States](#), page 39-4
- [802.1X Host Mode](#), page 39-6
- [802.1X Violation Mode](#), page 39-9
- [Using 802.1X with VLAN Assignment](#), page 39-9
- [Using 802.1X for Guest VLANs](#), page 39-10
- [Using 802.1X with MAC Authentication Bypass](#), page 39-11
- [Using 802.1X with Web-Based Authentication](#), page 39-13
- [Using 802.1X with Inaccessible Authentication Bypass](#), page 39-13
- [Using 802.1X with Unidirectional Controlled Port](#), page 39-14
- [Using 802.1X with Authentication Failed VLAN Assignment](#), page 39-14
- [Using 802.1X with Port Security](#), page 39-16
- [Using 802.1X Authentication with ACL Assignments and Redirect URLs](#), page 39-17
- [Using 802.1X with RADIUS-Provided Session Timeouts](#), page 39-18
- [Using 802.1X with Voice VLAN Ports](#), page 39-19
- [Using Multiple Domain Authentication and Multiple Authentication](#), page 39-20
- [Supported Topologies](#), page 39-21

## Device Roles

With 802.1X port-based authentication, network devices have specific roles. [Figure 39-1](#) shows the role of each device, which is described below.

**Figure 39-1** 802.1X Device Roles

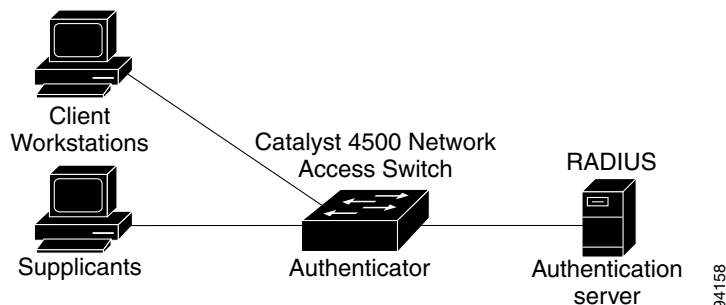

- Client—The workstation that requests access to the LAN, and responds to requests from the switch. The workstation must be running 802.1X-compliant client software.



**Note** For more information on 802.1X-compliant client application software such as Microsoft Windows 2000 Professional or Windows XP, refer to the Microsoft Knowledge Base article at this URL: <http://support.microsoft.com>

- Authenticator—Controls physical access to the network based on the authentication status of the client. The Catalyst 4500 series switch acts as an intermediary between the client and the authentication server, requesting identity information from the client, verifying that information with the authentication server, and relaying a response to the client. The switch encapsulates and decapsulates the Extensible Authentication Protocol (EAP) frames and interacts with the RADIUS authentication server.

When the switch receives EAPOL frames and relays them to the authentication server, the Ethernet header is stripped and the remaining EAP frame is reencapsulated in the RADIUS format. The EAP frames are not modified or examined during encapsulation, and the authentication server must support EAP within the native frame format. When the switch receives frames from the authentication server, the frame header is removed from the server, leaving the EAP frame, which is then encapsulated for Ethernet and sent to the client.



**Note** The Catalyst 4500 series switches must be running software that supports the RADIUS client and 802.1X.

- Authentication server—Performs the actual authentication of the client. The authentication server validates the identity of the client and notifies the switch that the client is authorized to access the LAN and switch services. (The only supported authentication server is the RADIUS authentication server with EAP extensions; it is available in Cisco Secure Access Control Server version 3.2 and later.)

## 802.1X and Network Access Control

Network Access Control is a feature that allows port access policies to be influenced by the anti-virus posture of the authenticating device.

Anti-virus posture includes such elements as the operating system running on the device, the operating system version, whether anti-virus software is installed, what version of anti-virus signatures is available, etc. If the authenticating device has a NAC-aware 802.1X supplicant and the authentication server is configured to support NAC via 802.1X, anti-virus posture information is automatically included as part of the 802.1X authentication exchange.

For information on NAC, refer to the URL:

<http://www.cisco.com/en/US/products/ps6128/index.html>

## Authentication Initiation and Message Exchange

The switch or the client can initiate authentication. If you enable authentication on a port with the **authentication port-control auto** interface configuration command (**dot1x port-control auto** command in Cisco IOS Release 12.2(46)SG and earlier releases), the switch must initiate authentication

when it determines that the port link state has changed. It then sends an EAP-request/identity frame to the client to request its identity (typically, the switch sends an initial identity/request frame followed by one or more requests for authentication information). Upon receipt of the frame, the client responds with an EAP-response/identity frame.

However, if during bootup, the client does not receive an EAP-request/identity frame from the switch, the client can initiate authentication by sending an EAPOL-start frame, which prompts the switch to request the client's identity.

If 802.1X is not enabled or supported on the network access switch, any EAPOL frames from the client are dropped. If the client does not receive an EAP-request/identity frame after three attempts to start authentication, the client transmits frames as if the port is in the authorized state. A port in the authorized state means that the client has been successfully authenticated. When the client supplies its identity, the switch begins its role as the intermediary, passing EAP frames between the client and the authentication server until authentication succeeds or fails. If the authentication succeeds, the switch port becomes authorized.

The specific exchange of EAP frames depends on the authentication method being used. [Figure 39-2](#) shows a message exchange that is initiated by the client using the One-Time Password (OTP) authentication method with an authentication server.

**Figure 39-2 Message Exchange**

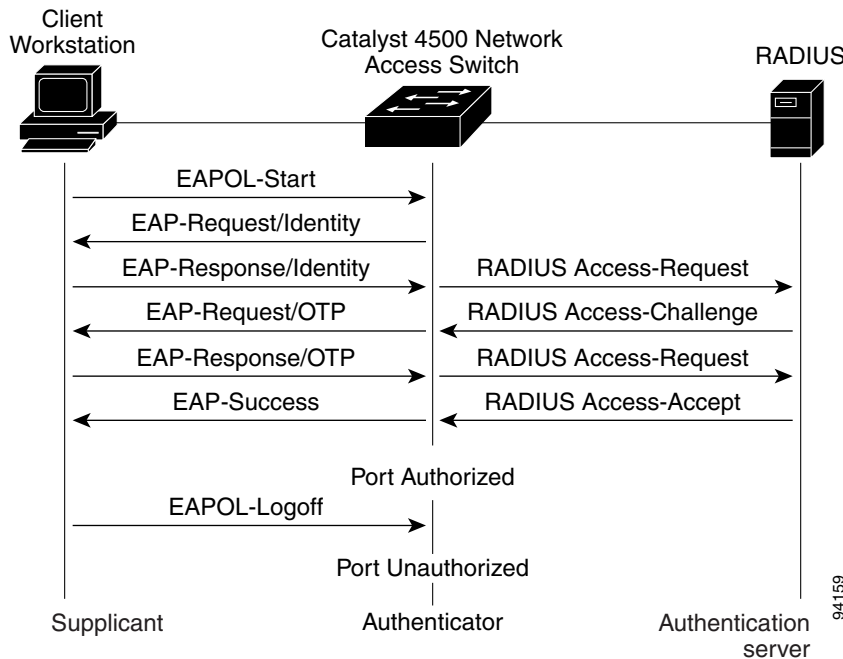

## Ports in Authorized and Unauthorized States

The switch port state determines whether the client is granted access to the network. The port starts in the unauthorized state. While in this state, the port disallows all ingress and egress traffic except for 802.1X protocol packets. When a client is successfully authenticated, the port transitions to the authorized state, allowing all traffic for the client to flow normally.

If a non-802.1X capable client is connected to an unauthorized 802.1X port, the switch requests the client's identity. In this situation, the client does not respond to the request, the port remains in the unauthorized state, and the client is not granted access to the network. If a guest VLAN is configured on a port that connects to a client that does not support 802.1X, the port is placed in the configured guest VLAN and in the authorized state. For more information, see the [“Using 802.1X for Guest VLANs” section on page 39-10](#).

In contrast, when an 802.1X-enabled client connects to a port that is not running the 802.1X protocol, the client initiates the authentication process by sending the EAPOL-start frame. When no response is received, the client sends the request a fixed number of times. Because no response is received, the client begins sending frames as if the port is in the authorized state.

You can control the port authorization state with the **authentication port-control** interface configuration command (**dot1x port-control auto** command in Cisco IOS Release 12.2(46)SG and earlier releases) and these keywords:

- **force-authorized**—Disables 802.1X authentication and causes the port to transition to the authorized state without requiring authentication exchange. The port transmits and receives normal traffic without 802.1X-based authentication of the client. This setting is the default.
- **force-unauthorized**—Causes the port to remain in the unauthorized state, ignoring all attempts by the client to authenticate. The switch cannot provide authentication services to the client through the interface.
- **auto**—Enables 802.1X authentication and causes the port to begin in the unauthorized state, allowing only EAPOL frames to be sent and received through the port. The authentication process begins when the link state of the port transitions from down to up or when an EAPOL-start frame is received. The switch requests the identity of the client and begins relaying authentication messages between the client and the authentication server. The switch can uniquely identify each client attempting to access the network by the client's MAC address.

If the client is successfully authenticated (receives an Accept frame from the authentication server), the port state changes to authorized, and all frames from the authenticated client are allowed through the port. If authentication fails, the port remains in the unauthorized state, but authentication can be retried. If the authentication server cannot be reached, the switch can retransmit the request. If no response is received from the server after the specified number of attempts, authentication fails and network access is not granted.

If the link state of a port transitions from up to down, or if an EAPOL-logoff frame is received by the port, the port returns to the unauthorized state.

[Figure 39-3](#) shows the authentication process.

If Multidomain Authentication (MDA) is enabled on a port, this flow can be used with some exceptions that are applicable to voice authorization. For more information on MDA, see the [“Using Multiple Domain Authentication and Multiple Authentication” section on page 39-20](#).

Figure 39-3 Authentication Flowchart

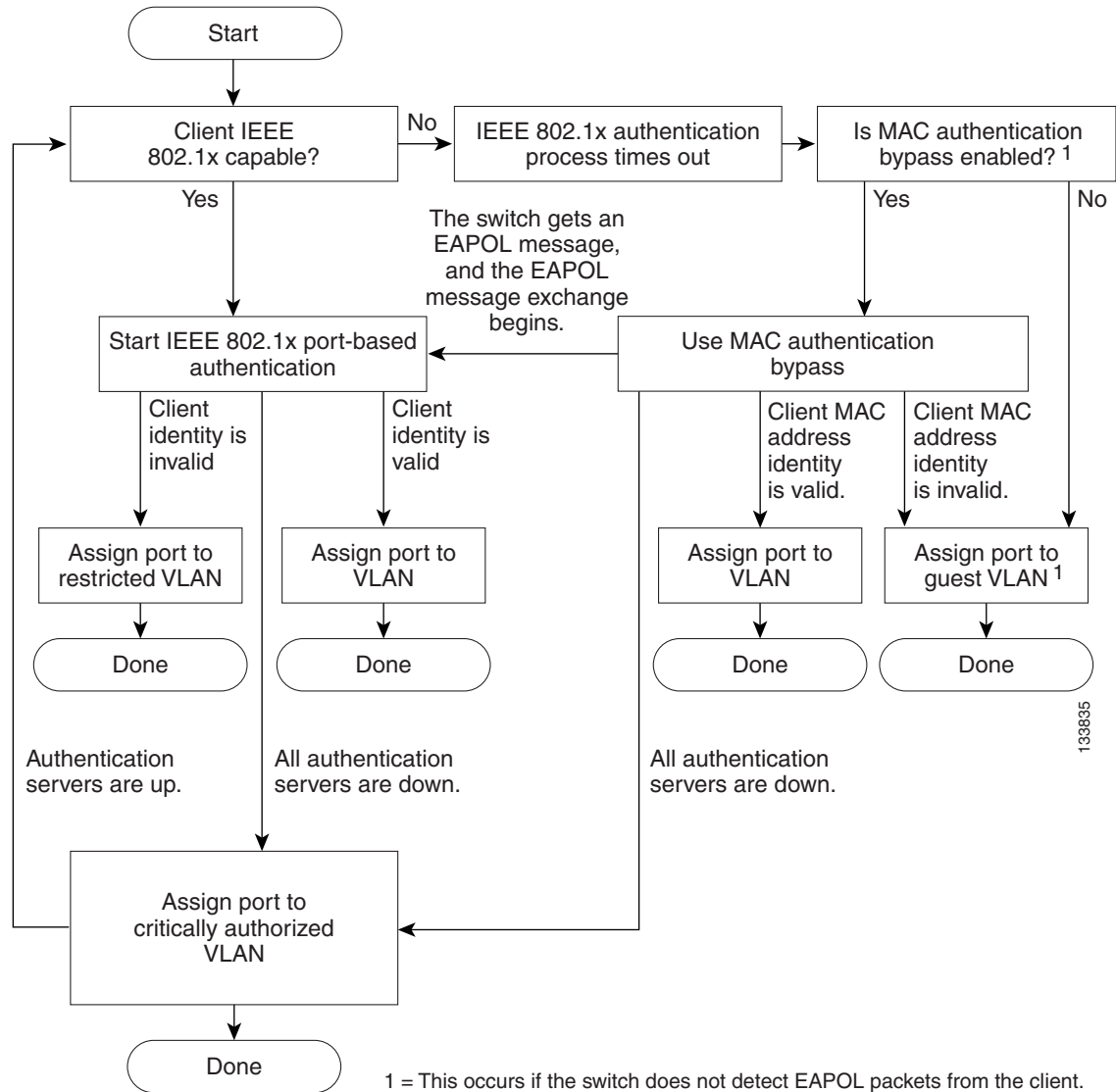

## 802.1X Host Mode

The 802.1X port's host mode determines whether more than one client can be authenticated on the port and how authentication is enforced. You can configure an 802.1X port to use any of the five host modes described in the following sections. In addition, each mode may be modified to allow pre-authentication open access:

- [Single-Host Mode, page 39-7](#)
- [Multiple-Hosts Mode, page 39-7](#)
- [Multidomain Authentication Mode, page 39-7](#)
- [Multiauthentication Mode, page 39-8](#)
- [Pre-Authentication Open Access, page 39-8](#)

## Single-Host Mode

You can configure an 802.1X port for single-host or multiple-hosts mode. In single-host mode (see [Figure 39-1 on page 39-2](#)), only one client can be connected to the 802.1X-enabled switch port. The switch detects the client by sending an EAPOL frame when the port link state changes to the up state. If a client leaves or is replaced with another client, the switch changes the port link state to down, and the port returns to the unauthorized state.

## Multiple-Hosts Mode

In multiple-hosts mode, you can attach multiple hosts to a single 802.1X-enabled port. [Figure 39-4 on page 39-7](#) shows 802.1X port-based authentication in a wireless LAN. In this mode, only one of the attached clients must be authorized for all clients to be granted network access. If the port becomes unauthorized (re-authentication fails or an EAPOL-logoff message is received), the switch denies network access to all of the attached clients. In this topology, the wireless access point is responsible for authenticating the clients attached to it, and it also acts as a client to the switch.

With multiple-hosts mode enabled, you can use 802.1X authentication to authenticate the port and port security to manage network access for all MAC addresses, including that of the client.

**Figure 39-4 Multiple Host Mode Example**

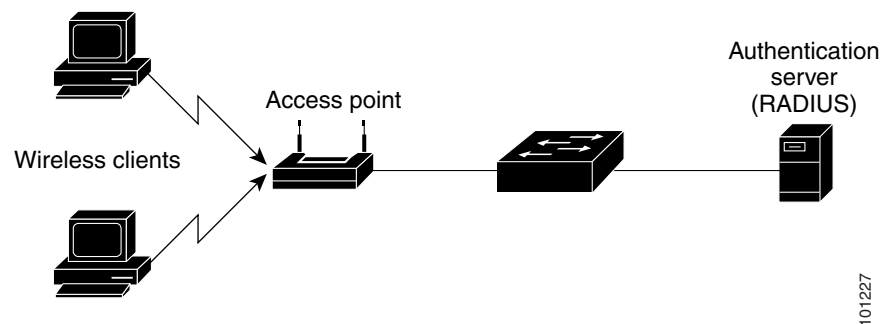

## Multidomain Authentication Mode

Cisco IOS Release 12.2(37)SG and later releases support Multidomain Authentication (MDA), which allows an IP phone (Cisco or third-party) and a single host behind the IP phone to authenticate independently, using 802.1X, MAC authentication bypass (MAB) or (for the host only) web-based authentication. In this application, *multidomain* refers to two domains — data and voice — and only two MAC addresses are allowed per port. A switch can place the host in the data VLAN and the IP phone in the voice VLAN, even though they appear on the same switch port. The data VLAN assignment can be obtained from the vendor-specific attributes (VSAs) received from the authentication, authorization, and accounting (AAA) server during authentication.

**Figure 39-5** Multidomain Authentication Mode Example

Figure 39-5 shows a typical MDA application with a single host behind an IP phone connected to the 802.1X-enabled port. Because the client is not directly connected to the switch, the switch cannot detect a loss of port link if the client is disconnected. To prevent another device from using the established authentication of the disconnected client later, Cisco IP phones send a Cisco Discovery Protocol (CDP) host presence type length value (TLV) to notify the switch of changes in the attached client's port link state.

For details on how to configure MDA, see the [“Using Multiple Domain Authentication and Multiple Authentication”](#) section on page 39-20.

## Multiauthentication Mode

Available in Cisco IOS Release 12.2(50)SG, multiauthentication mode allows one client on the voice VLAN and multiple authenticated clients on the data VLAN. When a hub or access point is connected to an 802.1X port, multiauthentication mode provides enhanced security over multiple-hosts mode by requiring authentication of each connected client. For non-802.1X devices, you can use MAB or web-based authentication as the fallback method for individual host authentications, allowing you to authenticate different hosts through different methods on a single port.

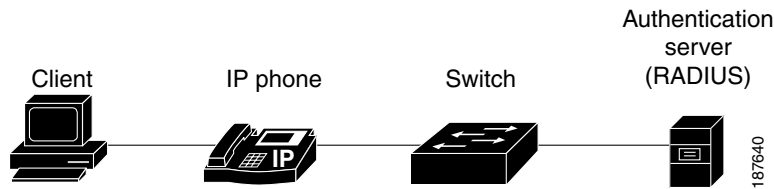
Multiauthentication also supports MDA functionality on the voice VLAN by assigning authenticated devices to either a data or voice VLAN depending on the VSAs received from the authentication server.



### Note

When a port is in multiauthentication mode, all VLAN assignment features including RADIUS server supplied VLAN assignment, Guest VLAN, Inaccessible Authentication Bypass, and Authentication Failed VLAN will not activate.

## Pre-Authentication Open Access

With Cisco IOS Release 12.2(50)SG, any of the four host modes may be additionally configured to allow a device to gain network access before authentication. This pre-authentication open access is useful in an application such as the Pre-boot eXecution Environment (PXE), where a device must access the network to download a bootable image containing an authentication client.

Enable pre-authentication open access by entering the **authentication open** command after host mode configuration. It acts as an extension to the configured host mode. For example, if pre-authentication open access is enabled with single-host mode, then the port allows only one MAC address. When pre-authentication open access is enabled, initial traffic on the port is restricted only by whatever other access restriction, independent of 802.1X, is configured on the port. If no access restriction other than 802.1X is configured on the port, then a client device will have full access on the configured VLAN.



## 802.1X Violation Mode

You can use the **authentication violation** interface configuration command to configure the violation mode: restrict or shutdown.

In single-host mode, a security violation is triggered when more than one device are detected on the data vlan. In multidomain authentication mode, a security violation is triggered when more than one device are detected on the data or voice VLAN.

Security violation cannot be triggered in multiple-host mode or multiauthentication mode.

When security violation occurs, the port is protected depending on the configured violation action:

Shutdown—Errdisables the port; the default behavior on a port.

Restrict—The port state is unaffected. However the platform is notified to restrict the traffic from offending MAC-address.

For more information see the [“Configuring Violation Action” section on page 39-41](#)”.

## Using 802.1X with VLAN Assignment

You can use the VLAN assignment to limit network access for certain users. With the VLAN assignment, 802.1X-authenticated ports are assigned to a VLAN based on the username of the client connected to that port. The RADIUS server database maintains the username-to-VLAN mappings. After successful 802.1X authentication of the port, the RADIUS server sends the VLAN assignment to the switch. The VLAN can be a standard VLAN or a private VLAN (PVLAN).

On platforms that support PVLANS, you can isolate hosts by assigning ports into PVLANS.

When configured on the switch and the RADIUS server, 802.1X with VLAN assignment has these characteristics:

- If no VLAN is supplied by the RADIUS server, the port is configured in its access VLAN or isolated PVLAN when authentication succeeds.
- If the authentication server provides invalid VLAN information, the port remains unauthorized. This situation prevents ports from appearing unexpectedly in an inappropriate VLAN due to a configuration error.
- If the multiauthentication mode is enabled on an 802.1X port, the VLAN assignment is ignored.
- If the authentication server provides valid VLAN information, the port is authorized and placed in the specified VLAN when authentication succeeds.
- If the multiple-hosts mode is enabled, all hosts are in the same VLAN as the first authenticated user.
- If 802.1X is disabled on the port, the port is returned to the configured access VLAN.
- A port must be configured as an access port (which can be assigned only into “regular” VLANs), or as a PVLAN host port (which can be assigned only into PVLANS). Configuring a port as a PVLAN host port implies that all hosts on the port are assigned into PVLANS, whether their posture is compliant or non-compliant. If the type of the VLAN named in the Access-Accept does not match the type of VLAN expected to be assigned to the port (regular VLAN to access port, secondary PVLAN to PVLAN host port), the VLAN assignment fails.
- If a guest VLAN is configured to handle non-responsive hosts, the type of VLAN configured as the guest VLAN must match the port type (that is, guest VLANs configured on access ports must be standard VLANs, and guest VLANs configured on PVLAN host ports must be PVLANS). If the guest VLAN’s type does not match the port type, non-responsive hosts are treated as if no guest VLAN is configured (that is, they are denied network access).

- To assign a port into a PVLAN, the named VLAN must be a secondary PVLAN. The switch determines the implied primary VLAN from the locally configured secondary-primary association.

**Note**

If you change the access VLAN or PVLAN host VLAN mapping on a port that is already authorized in a RADIUS assigned VLAN, the port remains in the RADIUS assigned VLAN.

To configure VLAN assignment you need to perform these tasks:

- Enable AAA authorization with the **network** keyword to allow interface configuration from the RADIUS server. For an illustration of how to apply the **aaa authorization network group radius** command, refer to the section “Enabling 802.1X Authentication” on page 24.
- Enable 802.1X. (The VLAN assignment feature is automatically enabled when you configure 802.1X on an access port.)
- Assign vendor-specific tunnel attributes in the RADIUS server. To ensure proper VLAN assignment, the RADIUS server must return these attributes to the switch:
  - Tunnel-Type = VLAN
  - Tunnel-Medium-Type = 802
  - Tunnel-Private-Group-ID = VLAN NAME

## Using 802.1X for Guest VLANs

You can use guest VLANs to enable non-802.1X-capable hosts to access networks that use 802.1X authentication. For example, you can use guest VLANs while you are upgrading your system to support 802.1X authentication.

Guest VLANs are supported on a per-port basis, and you can use any VLAN as a guest VLAN as long as its type matches the type of the port. If a port is already forwarding on the guest VLAN and you enable 802.1X support on the network interface of the host, the port is immediately moved out of the guest VLAN and the authenticator waits for authentication to occur.

Enabling 802.1X authentication on a port starts the 802.1X protocol. If the host fails to respond to packets from the authenticator within a certain amount of time, the authenticator brings the port up in the configured guest VLAN.

If the port is configured as a PVLAN host port, the guest VLAN must be a secondary PVLAN. If the port is configured as an access port, the guest VLAN must be a regular VLAN. If the guest VLAN configured on a port is not appropriate for the type of the port, the switch behaves as if no guest VLAN is configured (that is, non-responsive hosts are denied network access).

For details on how to configure guest VLANs, see the [“Configuring 802.1X with Guest VLANs” section on page 39-41](#).

## Usage Guidelines for Using 802.1X Authentication with Guest VLANs

The usage guidelines for using 802.1X authentication with guest VLANs are as follows:

- When you reconfigure a guest VLAN to a different VLAN, any authentication failed ports are also moved and the ports stay in their current authorized state.
- When you shut down or remove a guest VLAN from the VLAN database, any authentication failed ports are immediately moved to an unauthorized state and the authentication process is restarted.

**Note**

No periodic reauthentication is allowed with guest VLANs.

## Usage Guidelines for Using 802.1X Authentication with Guest VLANs on Windows-XP Hosts

The usage guidelines for using 802.1X authentication with guest VLANs on Windows-XP hosts are as follows:

- If the host fails to respond to the authenticator, the port attempts to connect three times (with a 30 second timeout between each attempt). After this time, the login/password window does not appear on the host, so you must unplug and reconnect the network interface cable.
- Hosts responding with an incorrect login/password fail authentication. Hosts failing authentication are not put in the guest VLAN. The first time that a host fails authentication, the quiet-period timer starts, and no activity occurs for the duration of the quiet-period timer. When the quiet-period timer expires, the host is presented with the login/password window. If the host fails authentication for the second time, the quiet-period timer starts again, and no activity occurs for the duration of the quiet-period timer. The host is presented with the login/password window a third time. If the host fails authentication the third time, the port is placed in the unauthorized state, and you must disconnect and reconnect the network interface cable.

## Using 802.1X with MAC Authentication Bypass

The 802.1X protocol has 3 entities: client (supplicant), authenticator, and authentication server. Typically, the host PC runs the supplicant software and tries to authenticate itself by sending its credentials to the authenticator which in turn relays that info to the authentication server for authentication.

However, not all hosts may have supplicant functionality. Devices that cannot authenticate themselves using 802.1X but still need network access can use MAC Authentication Bypass (MAB), which uses the connecting device's MAC address to grant or deny network access.

Typically, you would use this feature on ports where devices such as printers are connected. Such devices do not have 802.1X supplicant functionality.

In a typical deployment, the RADIUS server maintains a database of MAC addresses that require access. When this feature detects a new MAC address on a port, it generates a RADIUS request with both username and password as the device's MAC address. After authorization succeeds, the port is accessible to the particular device through the same code path that 802.1X authentication would take when processing an 802.1X supplicant. If authentication fails, the port moves to the guest VLAN if configured, or it remains unauthorized.

The Catalyst 4500 series switch also supports re-authentication of MACs on a per port level. Be aware that the re-authentication functionality is provided by 802.1X and is not MAB specific. In the re-authentication mode, a port stays in the previous RADIUS-sent VLAN and tries to re-authenticate itself. If the re-authentication succeeds, the port stays in the RADIUS-sent VLAN. Otherwise, the port becomes unauthorized and moves to the guest VLAN if one is configured.

For details on how to configure MAB, see the [“Configuring 802.1X with MAC Authentication Bypass” section on page 39-45](#).

## Feature Interaction

This section lists feature interactions and restrictions when MAB is enabled. If a feature is not listed, assume that it interacts seamlessly with MAB (such as Unidirectional Controlled Port).

- MAB can only be enabled if 802.1X is configured on a port. MAB functions as a fall back mechanism for authorizing MACs. If you configure both MAB and 802.1X on a port, the port attempts to authenticate using 802.1X. If the host fails to respond to EAPOL requests and MAB is configured, the 802.1X port is opened up to listen to packets and to grab a MAC address, rather than attempt to authenticate endlessly.

Based on the default 802.1X timer values, the transition between mechanisms takes approximately 90 seconds. You can shorten the time by reducing the value of the transmission period time, which affects the frequency of EAPOL transmission. A smaller timer value results in EAPOLs sent during a shorter period of time. With MAB enabled, after 802.1X performs one full set of EAPOLs, the learned MAC address is forwarded to the authentication server for processing.

The MAB module performs authorization for the first MAC address detected on the wire. The port is considered authorized once a valid MAC address is received that RADIUS approves of.

802.1X authentication can re-start if an EAPOL packet is received on a port that was initially authorized as a result of MAB.

Figure 39-6 shows the message exchange during MAB.

**Figure 39-6** Message Exchange during MAC Authentication Bypass

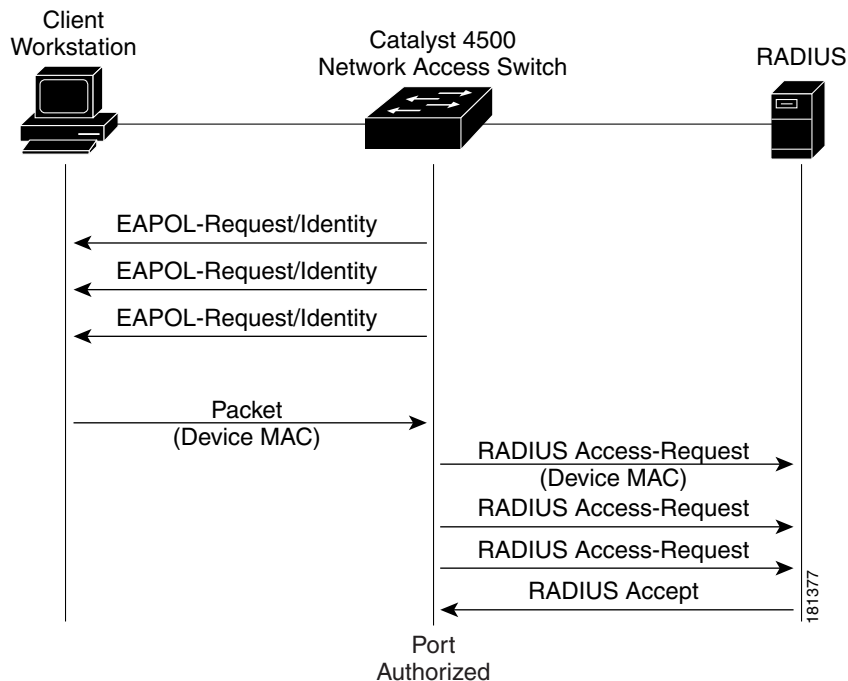

- The authentication-failed VLAN is used only with dot1x-authentication-failed users. MAB is not attempted with dot1x-authentication-failed users. If 802.1X authentication fails, a port moves to the authentication-failed VLAN (if configured) whether MAB is configured or not.

- When both MAB and guest VLAN are configured and no EAPOL packets are received on a port, the 802.1X state-machine is moved to a MAB state where it opens the port to listen to traffic and grab MAC addresses. The port remains in this state forever waiting to see a MAC on the port. A detected MAC address that fails authorization causes the port to be moved to the guest VLAN if configured. While in a guest VLAN, a port is open to all traffic on the specified guest VLAN. Therefore, non-802.1X supplicants that normally would be authorized but are in guest VLAN due to the earlier detection of a device that failed authorization, would remain in the guest VLAN indefinitely. However, loss of link or the detection of an EAPOL on the wire causes a transition out of the guest VLAN and back to the default 802.1X mode.
- Once a new MAC has been authenticated by MAB, the responsibility to limit access falls upon the 802.1X Authenticator (or port security) to secure the port. The 802.1X default host parameter is defined only for a single host. If the port is changed to multi-user host, port security must be employed to enforce the number of MAC addresses allowed thru this port.
- Catalyst 4500 series switch supports MAB with VVID, with the restriction that the MAC address appears on a port data VLAN only. All IP phone MACs learned via CDP are allowed on voice VLANs.
- MAB and VMPS are mutually exclusive because their functionality overlaps.

## Using 802.1X with Web-Based Authentication

The web-based authentication feature, known as Web Authentication Proxy, enables you to authenticate end users on host systems that do not run the IEEE 802.1X supplicant.

When configuring web-based authentication, note the following guidelines:

- Fallback to web-based authentication is configured on switch ports in access mode. Ports in trunk mode are not supported.
- Fallback to web-based authentication is not supported on EtherChannels or EtherChannel members.
- Although fallback to web-based authentication is an interface-specific configuration, the web-based authentication fallback behavior is defined in a global fallback profile. If the global fallback configuration changes, the new profile is not used until the next instance of authentication fallback.

For detailed information on configuring web-based authentication, see [Chapter 41, “Configuring Web-Based Authentication.”](#)

## Using 802.1X with Inaccessible Authentication Bypass

When a switch cannot reach the configured RADIUS servers and clients (supplicants) cannot be authenticated, you can configure a switch to allow network access to hosts connected to *critical* ports that are enabled for Inaccessible Authentication Bypass.

When this feature is enabled, a switch monitors the status of the configured RADIUS servers. If no RADIUS servers are available, ports with Inaccessible Authentication Bypass enabled are authorized. You can specify a Inaccessible Authentication Bypass VLAN on a per-port basis.

Ports that were already authorized when RADIUS becomes unavailable are unaffected by Inaccessible Authentication Bypass.

When RADIUS becomes available, critically-authorized ports may be configured to automatically reauthenticate themselves.

For details on how to configure Inaccessible Authentication Bypass, see the [“Configuring 802.1X with Inaccessible Authentication Bypass”](#) section on page 39-47.

## Using 802.1X with Unidirectional Controlled Port

Unidirectional Controlled Port is a combined hardware/software feature that allows dormant PCs to be “powered on” based on the receipt of a specific Ethernet frame, known as the *magic packet*. Generally, Unidirectional Controlled Port is used in environments where administrators plan to manage remote systems during off-hours, when it’s likely that the systems have been powered down.

Use of Unidirectional Controlled Port with hosts attached through 802.1X ports presents a unique problem; when the host powers down, a 802.1X port becomes unauthorized. In this state, the port allows the receipt and transmission of EAPoL packets only. Therefore, the Unidirectional Controlled Port magic packet cannot reach the host; without powering up, the PC cannot authenticate and open the port.

Unidirectional Controlled Port solves this problem by allowing packets to be transmitted on unauthorized 802.1X ports.



### Note

---

Unidirectional Controlled Port only works when Spanning Tree Portfast is enabled on the port.

---

For details on how to configure 802.1X with Unidirectional Controlled Port, see the [“Configuring 802.1X with Unidirectional Controlled Port”](#) section on page 39-50

## Unidirectional State

When you configure a port as unidirectional with the **authentication control-direction in** interface configuration command (or the **dot1x control-direction in** interface configuration command for Cisco IOS Release 12.2(46) or earlier), the port changes to the spanning-tree forwarding state.

When Unidirectional Controlled Port is enabled, the connected host is in the sleeping mode or power-down state. The host does not exchange traffic with other devices in the network. If the host connected to the unidirectional port that cannot send traffic to the network, the host can only receive traffic from other devices in the network.

## Bidirectional State

When you configure a port as bidirectional with the **authentication control-direction both** interface configuration command (or the **dot1x control-direction both** interface configuration command for Cisco IOS Release 12.2(46) or earlier), the port is access-controlled in both directions. In this state, except for EAPoL packets, a switch port does not receive or send packets.

## Using 802.1X with Authentication Failed VLAN Assignment

You can use authentication-failed VLAN assignment on a per-port basis to provide access for authentication failed users. Authentication failed users are end hosts that are 802.1X- capable but do not have valid credentials in an authentication server or end hosts that do not give any username and password combination in the authentication pop-up window on the user side.

If a user fails the authentication process, that port is placed in the authentication-failed VLAN. The port remains in the authentication-failed VLAN until the reauthentication timer expires. When the reauthentication timer expires the switch starts sending the port re-authentication requests. If the port

fails reauthentication it remains in the authentication-failed VLAN. If the port is successfully reauthenticated, the port is moved either to the VLAN sent by RADIUS server or to the newly authenticated ports configured VLAN; the location depends on whether RADIUS is configured to send VLAN information.

**Note**

When enabling periodic reauthentication (see the [“Enabling Periodic Reauthentication”](#) section on page 39-59), only local reauthentication timer values are allowed. You cannot use a RADIUS server to assign the reauthentication timer value.

You can set the maximum number of authentication attempts that the authenticator sends before moving a port into the authentication-failed VLAN. The authenticator keeps a count of the failed authentication attempts for each port. A failed authentication attempt is either an empty response or an EAP failure. The authenticator tracks any mix of failed authentication attempts towards the authentication attempt count. After the maximum number of attempts is reached the port is placed in the authentication-failed VLAN until the reauthentication timer expires again.

**Note**

RADIUS may send a response without an EAP packet in it when it does not support EAP, and sometimes third party RADIUS servers also send empty responses. When this happens, the authentication attempt counter is incremented.

For details on how to configure Authentication Failed VLAN Assignment, see the [“Configuring 802.1X with Authentication Failed VLAN Assignment”](#) section on page 39-52.

## Usage Guidelines for Using Authentication Failed VLAN Assignment

- You should enable reauthentication. The ports in authentication-failed VLANs do not receive reauthentication attempts if reauthentication is disabled. In order to start the reauthentication process the authentication-failed VLAN must receive a link down event or an EAP logoff event from the port. If the host is behind a hub, you may never get a link down event and may not detect the new host until the next reauthentication occurs. Therefore, it is recommended to have re-authentication enabled in that case.
- EAP failure messages are not sent to the user. If the user fails authentication the port is moved to an authentication-failed VLAN and a EAP success message is sent to the user. Because the user is not notified of the authentication failure there may be confusion as to why there is restricted access to the network. A EAP Success message is sent for the following reasons:
  - If the EAP Success message is not sent, the user tries to authenticate every 60 seconds (by default) by sending an EAP-start message.
  - In some cases, users have configured DHCP to EAP-Success and unless the user sees a success, DHCP does not work on the port.
- Sometimes a user caches an incorrect username and password combination after receiving a EAP success message from the authenticator and reuses that information in every re-authentication. Until the user passes the correct username and password combination the port remains in the authentication-failed VLAN.
- When an authentication failed port is moved to an unauthorized state the authentication process is restarted. If you should fail the authentication process again the authenticator waits in the held state. After you have correctly reauthenticated all 802.1X ports are reinitialized and treated as normal 802.1X ports.



- When you reconfigure an authentication-failed VLAN to a different VLAN, any authentication failed ports are also moved and the ports stay in their current authorized state.
- When you shut down or remove an authentication-failed VLAN from the VLAN database, any authentication failed ports are immediately moved to an unauthorized state and the authentication process is restarted. The authenticator does not wait in a held state because the authentication-failed VLAN configuration still exists. While the authentication-failed VLAN is inactive, all authentication attempts are counted, and as soon as the VLAN becomes active the port is placed in the authentication-failed VLAN.
- If you reconfigure the maximum number of authentication failures allowed by the VLAN, the change takes affect after the reauthentication timer expires.
- Internal VLANs that are used for Layer 3 ports cannot be configured as authentication-failed VLANs.
- The authentication-failed VLAN is supported only in single-host mode (the default port mode).
- When a port is placed in an authentication-failed VLAN the user's MAC address is added to the mac-address-table. If a new MAC address appears on the port, it is treated as a security violation.
- When an authentication failed port is moved to an authentication-failed VLAN, the Catalyst 4500 series switch does not transmit a RADIUS-Account Start Message like it does for regular 802.1X authentication.

## Using 802.1X with Port Security

You can enable port security on an 802.1X port in either single- or multiple-host mode. (To do so, you must configure port security with the **switchport port-security** interface configuration command.) When you enable port security and 802.1X on a port, 802.1X authenticates the port, and port security manages the number of MAC addresses allowed on that port, including that of the client. Hence, you can use an 802.1X port with port security enabled to limit the number or group of clients that can access the network.

For information on selecting multi-host mode, see the [“Resetting the 802.1X Configuration to the Default Values”](#) section on page 39-66.

These examples describe the interaction between 802.1X and port security on a switch:

- When a client is authenticated, and the port security table is not full, the client's MAC address is added to the port security list of secure hosts. The port then proceeds to come up normally.

When a client is authenticated and manually configured for port security, it is guaranteed an entry in the secure host table (unless port security static aging has been enabled).

A security violation occurs if an additional host is learned on the port. The action taken depends on which feature (802.1X or port security) detects the security violation:

- If 802.1X detects the violation, the action is to err-disable the port.
- If port security detects the violation, the action is to shutdown or restrict the port (the action is configurable).

The following describes when port security and 802.1X security violations occur:

- In single host mode, after the port is authorized, any MAC address received other than the client's causes a 802.1X security violation.
- In single host mode, if installation of an 802.1X client's MAC address fails because port security has already reached its limit (due to a configured secure MAC addresses), a port security violation is triggered.



- In multi host mode, once the port is authorized, any additional MAC addresses that cannot be installed because the port security has reached its limit triggers a port security violation.
- When an 802.1X client logs off, the port transitions back to an unauthenticated state, and all dynamic entries in the secure host table are cleared, including the entry for the client. Normal authentication then ensues.
- If you administratively shut down the port, the port becomes unauthenticated, and all dynamic entries are removed from the secure host table.
- Only 802.1X can remove the client's MAC address from the port security table. Note that in multi host mode, with the exception of the client's MAC address, all MAC addresses that are learned by port security can be deleted using port security CLIs.
- Whenever port security ages out a 802.1X client's MAC address, 802.1X attempts to reauthenticate the client. Only if the reauthentication succeeds is the client's MAC address be retained in the port security table.
- All of the 802.1X client's MAC addresses are tagged with (dot1x) when you display the port security table by using CLI.

## Using 802.1X Authentication with ACL Assignments and Redirect URLs

With Cisco IOS Release 12.2(50)SG, you can download per-host policies such as ACLs and redirect URLs to the switch from the RADIUS server during 802.1X or MAB authentication of the host. ACL download is also supported with web authentication after a fallback from 802.1X or MAB.

When the 802.1X host mode of the port is either single-host, MDA, or multiauthentication, the downloaded ACLs (DAACLs) are modified to use the authenticated host's IP address as the source address. When the host mode is multiple-hosts, the source address is configured as ANY, and the downloaded ACLs or redirects apply to all devices on the port.

If no ACLs are provided during the authentication of a host, the static default ACL configured on the port is applied to the host. On a voice VLAN port, only the static default ACL of the port is applied to the phone.

Topics include:

- [Cisco Secure ACS and AV Pairs for URL-Redirect, page 39-17](#)
- [ACLs, page 39-18](#)

For details on how to configure downloadable ACL and URL redirect, refer to the “[Configuring 802.1X Authentication with ACL Assignments and Redirect URLs](#)” section on page 39-33.

### Cisco Secure ACS and AV Pairs for URL-Redirect

When downloadable ACL is enabled, Cisco Secure ACS provides AAA services through RADIUS.

You can set these Attribute-Value (AV) pairs on the Cisco Secure ACS with RADIUS *cisco-av-pair* vendor-specific attributes (VSAs).

CiscoSecure-Defined-ACL specifies the names of the DAACLs on the Cisco Secure ACS. The switch receives the ACL name through the CiscoSecure-Defined-ACL AV pair in the format:

*#ACL#-IP-name-number*

*name* is the ACL name. *number* is the version number (like 3f783768).

The Auth-Manager code verifies whether the access control entries (ACEs) of the specified downloadable ACL were previously downloaded. If not, the Auth-Manager code sends an AAA request with the downloadable ACL name as the username so that the ACEs are downloaded. The downloadable ACL is then created as a named ACL on the switch. This ACL has ACEs with a source address of any and does not have an implicit deny statement at the end. When the downloadable ACL is applied to an interface after authentication completes, the source address changes from any to the host source IP address depending on the host mode of the interface. The ACEs are prepended to the downloadable ACL applied to the switch interface to which the endpoint device is connected. If traffic matches the CiscoSecure-Defined-ACL ACEs, the appropriate actions are taken.

`url-redirect` and `url-redirect-acl` specify the local URL policy on the switch. The switches use these `cisco-av-pair` VSAs as follows:

- `url-redirect` = <HTTP or HTTPS URL>
- `url-redirect-acl` = switch ACL name or number

These AV pairs enable the switch to intercept an HTTP or HTTPS request from the endpoint device and forward the client web browser to the specified redirect address from which the latest antivirus files can be downloaded. The `url-redirect` AV pair on the Cisco Secure ACS contains the URL to which the web browser is redirected. The `url-redirect-acl` AV pair contains the name or number of an ACL that specifies the HTTP or HTTPS traffic to be redirected. Traffic that matches a permit entry in the redirect ACL is redirected.

**Note**

---

The redirect or default ACL must be defined on the switch.

---

## ACLs

If downloadable ACL is configured for a particular client on the authentication server, you must configure a default port ACL on a client-facing switch port.

If the default ACL is configured on the switch and the Cisco Secure ACS sends a host access policy to the switch, it applies the policy to traffic from the host connected to a switch port. If the policy does not apply, the switch applies the default ACL. If the Cisco Secure ACS sends the switch a downloadable ACL, this ACL takes precedence over the default ACL already configured on the switch port. However, if the switch receives a host access policy from the Cisco Secure ACS, but the default ACL is not configured, the authorization failure is declared.

For details on how to configure a downloadable policy, refer to the [“Configuring a Downloadable Policy” section on page 39-38](#).

## Using 802.1X with RADIUS-Provided Session Timeouts

You can specify whether a switch uses a locally configured or a RADIUS-provided reauthentication timeout. If the switch is configured to use the local timeout, it reauthenticates the host when the timer expires.

If the switch is configured to use the RADIUS-provided timeout, it scans the RADIUS Access-Accept message for the Session-Timeout and optional Termination-Action attributes. The switch uses the value of the Session-Timeout attribute to determine the duration of the session, and it uses the value of the Termination-Action attribute to determine the switch action when the session's timer expires.

If the Termination-Action attribute is present and its value is RADIUS-Request, the switch reauthenticates the host. If the Termination-Action attribute is not present, or its value is Default, the switch terminates the session.

**Note**

The supplicant on the port detects that its session has been terminated and attempts to initiate a new session. Unless the authentication server treats this new session differently, the client may see only a brief interruption in network connectivity as the switch sets up a new session.

If the switch is configured to use the RADIUS-supplied timeout, but the Access-Accept message does not include a Session-Timeout attribute, the switch never reauthenticates the supplicant. This behavior is consistent with Cisco's wireless access points.

For details on how to configure RADIUS-provided session timeouts, see the [“Configuring RADIUS-Provided Session Timeouts”](#) section on page 39-39.

## Using 802.1X with Voice VLAN Ports

A voice VLAN port is a special access port associated with two VLAN identifiers:

- Voice VLAN ID (VVID) to carry voice traffic to and from the IP phone. The VVID is used to configure the IP phone connected to the port.
- Port VLAN ID (PVID) to carry the data traffic to and from the workstation connected to the switch through the IP phone. The PVID is the native VLAN of the port.

Each port that you configure for a voice VLAN is associated with a VVID and a PVID. This configuration allows voice traffic and data traffic to be separated onto different VLANs.

A voice VLAN port becomes active when a link exists whether the port is AUTHORIZED or UNAUTHORIZED. All traffic exiting the voice VLAN is obtained correctly and appears in the MAC address table. Cisco IP phones do not relay CDP messages from other devices. So, if several Cisco IP phones are connected in a series, the switch recognizes only the one directly connected to it. When 802.1X is enabled on a voice VLAN port, the switch drops packets from unrecognized Cisco IP phones more than one hop away.

When 802.1X is enabled on a port, you cannot configure a PVID that is equal to a VVID. For more information about voice VLANs, see [Chapter 37, “Configuring Voice Interfaces.”](#)

Observe the following feature interactions:

- 802.1X VLAN assignment cannot assign to the port the same VLAN as the voice VLAN; otherwise, the 802.1X authentication fails.
- 802.1X guest VLAN works with the 802.1X voice VLAN port feature. However, the guest VLAN cannot be the same as the voice VLAN.
- 802.1X port security works with the 802.1X voice VLAN port feature and is configured per port. Two MAC addresses must be configured: one for the Cisco IP phone MAC address on the VVID and one for the PC MAC address on PVID.

However, you cannot use the 802.1X voice VLAN port feature with 802.1X port security's sticky MAC address configuration and statically configured MAC address configuration.

- 802.1X accounting is unaffected by the 802.1X voice VLAN port feature.
- When 802.1X is configured on a port, you cannot connect multiple IP phones to a Catalyst 4500 series switch through a hub.
- Because voice VLANs cannot be configured as PVLAN host ports, and because only PVLANs can be assigned to PVLAN host ports, VLAN assignment cannot assign a PVLAN to a port with a voice VLAN configured.

For details on how to configure 802.1X with voice VLANs, see the [“Configuring 802.1X with Voice VLAN”](#) section on page 39-54.

## Using Multiple Domain Authentication and Multiple Authentication

Multiple Domain Authentication (MDA) allows both a data device and a voice device, such as an IP phone (Cisco or 3rd party non-Cisco), to authenticate on the same switch port, which is divided into a data domain and a voice domain.

Multiple Authentication allows multiple data devices and a voice device. When a voice VLAN is configured on a multi-authentication port, the port can perform authentication in the voice domain as on an MDA port.

MDA does not enforce the order of device authentication. For best results, however, you should authenticate a voice device before you authenticate a data device on an MDA-enabled port.

Observe the following guidelines for configuring MDA:



### Note

---

The same guidelines also apply for Multiple Authentication when voice VLAN is configured.

---

- It is highly recommended that you enable CoPP on an MDA-enabled port to protect against a DoS attack. Refer to [Chapter 43, “Configuring Control Plane Policing.”](#)
- To configure a switch port for MDA or Multiple Authentication, see the [“Configuring Multiple Domain Authentication and Multiple Authorization”](#) section on page 39-29.
- You must configure the voice VLAN for the IP phone when the host mode is set to multidomain. For more information, see [Chapter 37, “Configuring Voice Interfaces.”](#)
- To authorize a voice device, the AAA server must be configured to send a Cisco Attribute-Value (AV) pair attribute with a value of `device-traffic-class=voice`. Without this value, the switch treats the voice device as a data device.
- The guest VLAN and restricted VLAN features only apply to the data devices on an MDA-enabled port. The switch treats a voice device that fails authorization as a data device.
- If more than one device attempts authorization on either the voice or the data domain of a port, it is error disabled.
- Until a device is authorized, the port drops its traffic. Non-Cisco IP phones or voice devices are allowed into both the data and voice VLANs. The data VLAN allows the voice device to contact a DHCP server to obtain an IP address and acquire the voice VLAN information. After the voice device starts sending on the voice VLAN, its access to the data VLAN is blocked. A security violation may occur in MDA if the voice device continues to send traffic on the data VLAN.
- You can use dynamic VLAN assignment from a RADIUS server only for data devices.
- MDA can use MAC authentication bypass as a fallback mechanism to allow the switch port to connect to devices that do not support 802.1X authentication. This is especially useful for 3rd-party phones without 802.1X supplicant. For more information, see the [“Using 802.1X with MAC Authentication Bypass”](#) section on page 39-11.
- When a *data* or a *voice* device is detected on a port, its MAC address is blocked until authorization succeeds. If the authorization fails, the MAC address remains blocked for 5 minutes.
- If more than one device is detected on the *data* VLAN or more than one voice device is detected on the *voice* VLAN while a port is unauthorized, the port is error disabled.

- When a port host mode is changed from single- or multihost to multidomain mode, an authorized data device remains authorized on the port. However, a Cisco IP phone that has been allowed on the port in the voice VLAN is automatically removed and must be reauthenticated on that port.
- Active fallback mechanisms such as guest VLAN and restricted VLAN remain configured after a port changes from single- or multihost mode to multidomain mode.
- Switching a port host mode from multidomain to single- or multihost mode removes all authorized devices from the port.
- If a data domain is authorized first and placed in the guest VLAN, non-802.1X-capable voice devices need to tag their packets on the voice VLAN to trigger authentication.
- We do not recommend per-user ACLs with an MDA-enabled port. An authorized device with a per-user ACL policy might impact traffic on both the voice and data VLANs of the port. If used, only one device on the port should enforce per-user ACLs.

## Supported Topologies

The 802.1X port-based authentication supports two topologies:

- Point-to-point
- Wireless LAN

In a point-to-point configuration (see [Figure 39-1 on page 39-2](#)), only one client can be connected to the 802.1X-enabled switch port when the multi-host mode is not enabled (the default). The switch detects the client when the port link state changes to the up state. If a client leaves or is replaced with another client, the switch changes the port link state to down, and the port returns to the unauthorized state.

For 802.1X port-based authentication in a wireless LAN ([Figure 39-7](#)), you must configure the 802.1X port as a multiple-host port that is authorized as a wireless access point once the client is authenticated. (See the “[Resetting the 802.1X Configuration to the Default Values](#)” section on page 39-66.) When the port is authorized, all other hosts that are indirectly attached to the port are granted access to the network. If the port becomes unauthorized (reauthentication fails or an EAPOL-logoff message is received), the switch denies access to the network for all wireless access point-attached clients. In this topology, the wireless access point is responsible for authenticating clients attached to it, and the wireless access point acts as a client to the switch.

**Figure 39-7** Wireless LAN Example

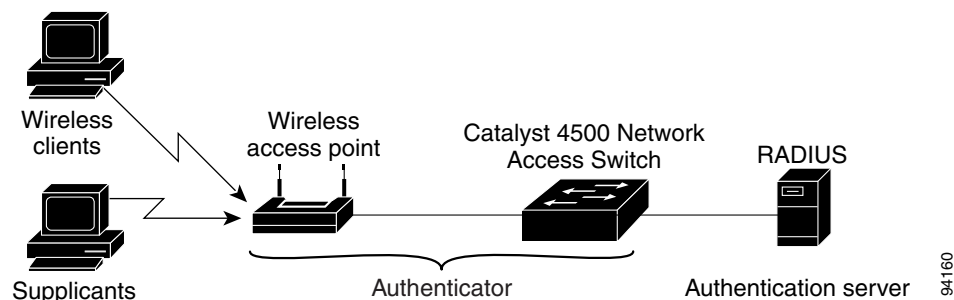

# Configuring 802.1X Port-Based Authentication

To configure 802.1X, follow this procedure:

- 
- |               |   |
|---------------|---|
| <b>Step 1</b> | Enable 802.1X authentication. See the “ <a href="#">Enabling 802.1X Authentication</a> ” section on page 39-24.                                       |
| <b>Step 2</b> | Configure switch to RADIUS server communication. See the “ <a href="#">Configuring Switch-to-RADIUS-Server Communication</a> ” section on page 39-27. |
| <b>Step 3</b> | Adjust the 802.1X timer values. See the “ <a href="#">Changing the Quiet Period</a> ” section on page 39-62.  |
| <b>Step 4</b> | Configure optional features. See the “ <a href="#">Configuring RADIUS-Provided Session Timeouts</a> ” section on page 39-39.                          |
- 

These sections describe how to configure 802.1X:

- [Default 802.1X Configuration](#), page 39-23
- [802.1X Configuration Guidelines](#), page 39-23
- [Enabling 802.1X Authentication](#), page 39-24 (required)
- [Configuring Switch-to-RADIUS-Server Communication](#), page 39-27 (required)
- [Configuring Multiple Domain Authentication and Multiple Authorization](#), page 39-29
- [Configuring RADIUS-Provided Session Timeouts](#), page 39-39 (optional)
- [Configuring Violation Action](#), page 39-41 (optional)
- [Configuring 802.1X with Guest VLANs](#), page 39-41 (optional)
- [Configuring 802.1X with MAC Authentication Bypass](#), page 39-45 (optional)
- [Configuring 802.1X with Inaccessible Authentication Bypass](#), page 39-47 (optional)
- [Configuring 802.1X with Unidirectional Controlled Port](#), page 39-50 (optional)
- [Configuring 802.1X with Authentication Failed VLAN Assignment](#), page 39-52 (optional)
- [Configuring 802.1X with Voice VLAN](#), page 39-54 (optional)
- [Enabling Fallback Authentication](#), page 39-55
- [Enabling Periodic Reauthentication](#), page 39-59 (optional)
- [Enabling Multiple Hosts](#), page 39-61 (optional)
- [Changing the Quiet Period](#), page 39-62 (optional)
- [Changing the Switch-to-Client Retransmission Time](#), page 39-63 (optional)
- [Setting the Switch-to-Client Frame-Retransmission Number](#), page 39-64 (optional)
- [Manually Reauthenticating a Client Connected to a Port](#), page 39-66 (optional)
- [Initializing the 802.1X Authentication State](#), page 39-66
- [Removing 802.1X Client Information](#), page 39-66
- [Resetting the 802.1X Configuration to the Default Values](#), page 39-66 (optional)

## Default 802.1X Configuration

Table 39-1 shows the default 802.1X configuration.

**Table 39-1**      *Default 802.1X Configuration*

Feature	Default Setting
Authentication, authorization, and accounting (AAA)	Disabled
RADIUS server <ul style="list-style-type: none"> <li>• IP address</li> <li>• UDP authentication port</li> <li>• Key</li> </ul>	<ul style="list-style-type: none"> <li>• None specified</li> <li>• 1645</li> <li>• None specified</li> </ul>
Per-interface 802.1X protocol enable state	Force-authorized The port transmits and receives normal traffic without 802.1X-based authentication of the client.
Periodic reauthentication	Disabled
Time between reauthentication attempts	3600 sec
Quiet period	60 sec Number of seconds that the switch remains in the quiet state following a failed authentication exchange with the client.
Retransmission time	30 sec Number of seconds that the switch should wait for a response to an EAP request/identity frame from the client before retransmitting the request.
Maximum retransmission number	2 Number of times that the switch sends an EAP-request/identity frame before restarting the authentication process.
Multiple host support	Disabled
Client timeout period	30 sec When relaying a request from the authentication server to the client, the amount of time that the switch waits for a response before retransmitting the request to the client.
Authentication server timeout period	30 sec When relaying a response from the client to the authentication server, the amount of time that the switch waits for a reply before retransmitting the response to the server. This setting is not configurable.

## 802.1X Configuration Guidelines

This section describes the guidelines for configuring 802.1X authentication:

- The 802.1X protocol is supported only on Layer 2 static access, PVLAN host ports, and Layer 3 routed ports. You cannot configure 802.1X for any other port modes.



- If you are planning to use VLAN assignment, be aware that the features use general AAA commands. For information on how to configure AAA, refer to the “[Enabling 802.1X Authentication](#)” section on page 39-24. Alternatively, you can refer to the Cisco IOS security documentation:
  - [http://www.cisco.com/univercd/cc/td/doc/product/software/ios123/123cgcr/fsecur\\_c/index.htm](http://www.cisco.com/univercd/cc/td/doc/product/software/ios123/123cgcr/fsecur_c/index.htm)
  - [http://www.cisco.com/univercd/cc/td/doc/product/software/ios123/123cgcr/fsecur\\_r/index.htm](http://www.cisco.com/univercd/cc/td/doc/product/software/ios123/123cgcr/fsecur_r/index.htm)

## Enabling 802.1X Authentication

To enable 802.1X port-based authentication, you first must enable 802.1X globally on your switch, then enable AAA and specify the authentication method list. A method list describes the sequence and authentication methods that must be queried to authenticate a user.

The software uses the first method listed in the method list to authenticate users; if that method fails to respond, the software selects the next authentication method in the list. This process continues until there is successful communication with a listed authentication method or until all defined methods are exhausted. If authentication fails at any point in this cycle, the authentication process stops, and no other authentication methods are attempted.



### Note

To allow VLAN assignment, you must enable AAA authorization to configure the switch for all network-related service requests.

To configure 802.1X port-based authentication, perform this task:

	Command	Purpose
Step 1	Switch# <b>configure terminal</b>	Enters global configuration mode.
Step 2	Switch(config)# <b>dot1x system-auth-control</b>	Enables 802.1X on your switch.  To disable 802.1X globally on the switch, use the <b>no dot1x system-auth-control</b> command.
Step 3	Switch(config)# <b>aaa new-model</b>	Enables AAA.  To disable AAA, use the <b>no aaa new-model</b> command.
Step 4	Switch(config)# <b>aaa authentication dot1x {default} method1 [method2...]</b>	Creates an 802.1X AAA authentication method list.  To create a default list that is used when a named list is not specified in the <b>authentication</b> command, use the <b>default</b> keyword followed by the methods that are to be used in default situations. The default method list is automatically applied to all interfaces.  Enter at least one of these keywords: <ul style="list-style-type: none"> <li>• <b>group radius</b>—Use the list of all RADIUS servers for authentication.</li> <li>• <b>none</b>—Use no authentication. The client is automatically authenticated by the switch without using the information supplied by the client.</li> </ul> To disable 802.1X AAA authentication, use the <b>no aaa authentication dot1x {default   list-name} method1 [method2...]</b> global configuration command.



	Command	Purpose
Step 5	Switch(config)# <b>aaa authorization network {default} group radius</b>	(Optional) Configure the switch for user RADIUS authorization for all network-related service requests, such as VLAN assignment.
Step 6	Switch(config)# <b>interface interface-id</b>	Enters interface configuration mode and specifies the interface to be enabled for 802.1X authentication.
Step 7	Switch(config-if)# <b>switchport mode access</b>	Specifies a nontrunking, nontagged single VLAN Layer 2 interface.
Step 8	Switch(config-if)# <b>dot1x pae authenticator</b>	Enables 802.1X authentication on the port with default parameters. Refer to the “Default 802.1X Configuration” section on page 39-23.
Step 9	<b>Cisco IOS Release 12.2(50)SG</b> Switch(config-if)# <b>authentication port-control auto</b>  <b>Cisco IOS Release 12.2(46)SG or earlier releases</b> Switch(config-if)# <b>dot1x port-control auto</b>	Enables 802.1X authentication on the interface.
Step 10	Switch(config-if)# <b>end</b>	Returns to privileged EXEC mode.
Step 11	Switch # <b>show dot1x interface interface-id details</b>	Verifies your entries.  Check the PortControl row in the 802.1X port summary section of this display. The PortControl value is set to <b>auto</b> .
Step 12	Switch# <b>show running-config</b>	Verifies your entries.
Step 13	Switch# <b>copy running-config startup-config</b>	(Optional) Saves your entries in the configuration file.



**Note** Enabling Spanning Tree PortFast ensures that a port comes up immediately after authorization.



**Note** Whenever you configure any 802.1X parameter on a port, a **dot1x authenticator** is automatically created on the port. As a result **dot1x pae authenticator** appears in the configuration. This is to ensure that dot1x authentication still works on legacy configurations without manual intervention. This is likely to change in future releases.

This example shows how to enable 802.1X and AAA on Fast Ethernet port 2/1, and how to verify the configuration:

#### Cisco IOS Release 12.2(50)SG

```
Switch# configure terminal
Switch(config)# dot1x system-auth-control
Switch(config)# aaa new-model
Switch(config)# aaa authentication dot1x default group radius
Switch(config)# interface fastethernet2/1
Switch(config-if)# switchport mode access
Switch(config-if)# dot1x pae authenticator
Switch(config-if)# authentication port-control auto
Switch(config-if)# end
```

```
Switch# show authentication sessions interface f9/2
Interface: FastEthernet9/2
MAC Address: 0007.e95d.83c4
```

```

        IP Address: Unknown
        Status: Running
        Domain: UNKNOWN
    Oper host mode: single-host
    Oper control dir: both
    Session timeout: N/A
    Idle timeout: N/A
    Common Session ID: 0A050B160000009505106398
    Acct Session ID: 0x0000009B
    Handle: 0x0D000095

```

```

Runnable methods list:
  Method   State
  dot1x    Running
  mab      Not run

```

### Cisco IOS Release 12.2(46)SG or earlier

```

Switch# configure terminal
Switch(config)# dot1x system-auth-control
Switch(config)# aaa new-model
Switch(config)# aaa authentication dot1x default group radius
Switch(config)# interface fastethernet2/1
Switch(config-if)# switchport mode access
Switch(config-if)# dot1x pae authenticator
Switch(config-if)# dot1x port-control auto
Switch(config-if)# end

```

```
Switch# show dot1x interface f9/2 details
```

```

Dot1x Info for FastEthernet9/2
-----
PAE                               = AUTHENTICATOR
PortControl                       = AUTO
ControlDirection                 = Both
HostMode                         = SINGLE_HOST
QuietPeriod                      = 60
ServerTimeout                    = 0
SuppTimeout                      = 30
ReAuthMax                        = 2
MaxReq                           = 2
TxPeriod                         = 30

```

```
Dot1x Authenticator Client List
```

```

-----
Supplicant                       = 0007.e95d.83c4
Session ID                       = 0A050B160000009505106398
  Auth SM State                  = AUTHENTICATING
  Auth BEND SM State            = REQUEST
Port Status                      = UNAUTHORIZED

```

The following example illustrates when a port is authorized:

```

Switch# show authentication sessions int G4/5
        Interface: GigabitEthernet4/5
        MAC Address: 0015.e981.0531
        IP Address: Unknown
        User-Name: ctssxp
        Status: Authz Success
        Domain: DATA
    Oper host mode: single-host
    Oper control dir: both
    Session timeout: N/A
    Idle timeout: N/A

```

```
Common Session ID: 0A053F0F00000004041E6B0C
Acct Session ID: 0x00000021
Handle: 0x2C000004
```

```
Runnable methods list:
Method State
dot1x Authc Success
```

```
Switch# show dot1x interface G4/5 details
```

```
Dot1x Info for GigabitEthernet4/5
-----
PAE = AUTHENTICATOR
PortControl = AUTO
ControlDirection = Both
HostMode = SINGLE_HOST
QuietPeriod = 60
ServerTimeout = 0
SuppTimeout = 30
ReAuthMax = 2
MaxReq = 2
TxPeriod = 30
```

```
Dot1x Authenticator Client List
-----
Supplicant = 0015.e981.0531
Session ID = 0A053F0F00000004041E6B0C
Auth SM State = AUTHENTICATED
Auth BEND SM State = IDLE
Port Status = AUTHORIZED
```

## Configuring Switch-to-RADIUS-Server Communication

A RADIUS security server is identified by its host name or IP address, host name and specific UDP port number, or IP address and specific UDP port numbers. The combination of the IP address and UDP port number creates a unique identifier, which enables RADIUS requests to be sent to multiple UDP ports on a server at the same IP address. If two different host entries on the same RADIUS server are configured for the same service—for example, authentication—the second host entry configured acts as the fail-over backup to the first one. The RADIUS host entries are tried in the order they were configured.

To configure the RADIUS server parameters on the switch, perform this task:

Command	Purpose
<b>Step 1</b> Switch# <b>configure terminal</b>	Enters global configuration mode.
<b>Step 2</b> Switch(config)# <b>radius-server host</b> {hostname   ip-address} <b>auth-port</b> port-number [ <b>acct-port</b> port-number] [ <b>test username</b> name] [ <b>ignore-auth-port</b> ] [ <b>ignore-acct-port</b> ] [ <b>idle-time</b> min] <b>key</b> string	Configures the RADIUS server parameters on the switch.  For <i>hostname</i>   <i>ip-address</i> , specify the hostname or IP address of the remote RADIUS server.  To delete the specified RADIUS server, use the <b>no radius-server host</b> { <i>hostname</i>   <i>ip-address</i> } global configuration command.  The <b>auth-port</b> <i>port-number</i> specifies the UDP destination port for authentication requests. The default is 1645.  The <b>acct-port</b> <i>port-number</i> specifies the UDP destination port for accounting requests. The default is 1646.  Use <b>test username</b> <i>name</i> to enable automated RADIUS server testing, and to detect the RADIUS server going up and down. The <b>name</b> parameter is the username used in the test access request sent to the RADIUS server; it does not need to be a valid user configured on the server. The <b>ignore-auth-port</b> and <b>ignore-acct-port</b> options disable testing on the authentication and accounting ports respectively.  The <b>idle-time</b> <i>min</i> parameter specifies the number of minutes before an idle RADIUS server is tested to verify that it is still up. The default is 60 minutes.  The <b>key</b> <i>string</i> specifies the authentication and encryption key used between the switch and the RADIUS daemon running on the RADIUS server. The key is a text string that must match the encryption key used on the RADIUS server.  <b>Note</b> Always configure the key as the last item in the <b>radius-server host</b> command syntax because leading spaces are ignored, but spaces within and at the end of the key are used. If you use spaces in the key, do not enclose the key in quotation marks unless the quotation marks are part of the key. This key must match the encryption used on the RADIUS daemon.  If you want to use multiple RADIUS servers, use this command multiple times.
<b>Step 3</b> Switch(config-if)# <b>radius</b> <b>deadtime</b> <i>min</i>	(Optional) Configures the number of minutes before a dead RADIUS server is tested to check whether it has come back up. The default is 1 minute.
<b>Step 4</b> Switch(config-if)# <b>radius</b> <b>dead-criteria</b> <b>time</b> <i>seconds</i> <b>tries</b> <i>num</i>	(Optional) Configures the criteria used to decide whether a RADIUS server is dead. The <b>time</b> parameter specifies the number of seconds after which a request to the server is unanswered before it is considered dead. The <b>tries</b> parameter specifies the number of times a request to the server is unanswered before it is considered dead.  The recommended values for these parameters are <b>tries</b> equal to <b>radius-server retransmit</b> and <b>time</b> equal to <b>radius-server retransmit x radius-server timeout</b> .

	Command	Purpose
Step 5	Switch(config-if)# <b>ip radius source-interface m/p</b>	Establishes the IP address to be used as the source address for all outgoing RADIUS packets.
Step 6	Switch(config)# <b>end</b>	Returns to privileged EXEC mode.
Step 7	Switch# <b>show running-config</b>	Verifies your entries.
Step 8	Switch# <b>copy running-config startup-config</b>	(Optional) Saves your entries in the configuration file.

This example shows how to specify the server with IP address 172.120.39.46 as the RADIUS server. The first command specifies port 1612 as the authorization port, sets the encryption key to rad123.

The second command dictates that key matches are performed on the RADIUS server:

```
Switch# configure terminal
Switch(config)# radius-server host 172.120.39.46 auth-port 1612 key rad123
Switch(config)# ip radius source-interface g3/2
Switch(config)# end
Switch#
```

You can globally configure the timeout, retransmission, and encryption key values for all RADIUS servers by using the **radius-server host** global configuration command. If you want to configure these options on a per-server basis, use the **radius-server timeout**, **radius-server retransmit**, and the **radius-server key** global configuration commands.

You also need to create a AAA client setting on the RADIUS server. These settings include the IP address of the switch and the key string to be shared by both the server and the switch.

## Configuring Multiple Domain Authentication and Multiple Authorization



### Note

Multiple Authentication requires Cisco IOS Release 12.2(50)SG and later releases.

To configure MDA and Multiple Authentication, perform these steps.

	Command	Purpose
Step 1	Switch# <b>configure terminal</b>	Enters global configuration mode.
Step 2	Switch(config)# <b>radius-server vsa send authentication</b>	Configures the network access server to recognize and use vendor-specific attributes (VSAs).
Step 3	Switch(config)# <b>interface interface-id</b>	Specifies the port to which multiple hosts are indirectly attached, and enters interface configuration mode.

	Command	Purpose
Step 4	<p><b>Cisco IOS Release 12.2(50)SG</b>  Switch(config-if)# [no]  <b>authentication host-mode</b>  {single-host   multi-host    multi-domain}   multi-auth}</p> <p><b>Cisco IOS Release 12.2(46)SG or earlier releases</b>  Switch(config-if)# [no] dot1x  <b>host-mode</b> {single-host   multi-host    multi-domain}</p>	<p>The keywords allow the following:</p> <ul style="list-style-type: none"> <li>• <b>single-host</b>—Single host (client) on an IEEE 802.1X-authorized port.</li> <li>• <b>multi-host</b>—Multiple hosts on an 802.1X-authorized port after authenticating a single host.</li> <li>• <b>multi-domain</b>—Both a host and a voice device (like an IP phone, Cisco or non-Cisco), to authenticate on an IEEE 802.1X-authorized port.</li> </ul> <p><b>Note</b> You must configure a voice VLAN for an IP phone when the host mode is set to <b>multi-domain</b>. For more information, see <a href="#">Chapter 37, “Configuring Voice Interfaces.”</a></p> <ul style="list-style-type: none"> <li>• <b>multi-auth</b>—Allows multiple hosts and a voice device, such as an IP phone (Cisco or non-Cisco), to be authenticated on an IEEE 802.1x-authorized port. This keyword requires Cisco IOS Release 12.2(50)SG.</li> </ul> <p>Ensure that the <b>dot1x port-control</b> interface configuration command is set to <b>auto</b> for the specified interface.</p> <p>To disable multiple hosts on the port, use the <b>no authentication host-mode {multi-host   multi-domain   multi-auth}</b> interface configuration command (for earlier releases, use the <b>no dot1x host-mode {multi-host   multi-domain}</b> interface configuration command).</p>
Step 5	Switch(config-if)# <b>switchport voice vlan</b> <i>vlan-id</i>	(Optional) Configures the voice VLAN.
Step 6	Switch(config-if)# <b>end</b>	Returns to privileged EXEC mode.
Step 7	Switch# <b>show dot1x interface</b> <i>interface-id</i> [detail]	Verifies your entries.
Step 8	Switch# <b>copy running-config startup-config</b>	(Optional) Saves your entries in the configuration file.

This example shows how to enable 802.1X authentication and to allow multiple hosts:

#### Cisco IOS Release 12.2(50)SG

```
Switch(config)# interface gigabitethernet2/1
Switch(config-if)# authentication port-control auto
Switch(config-if)# authentication host-mode multi-host
Switch(config-if)# end
```

#### Cisco IOS Release 12.2(46)SG or earlier

```
Switch(config)# interface gigabitethernet2/1
Switch(config-if)# dot1x port-control auto
Switch(config-if)# dot1x host-mode multi-host
Switch(config-if)# end
```

This example shows how to enable MDA and to allow both a host and a 802.1X voice device (a Cisco or third-party phone with 802.1X supplicant) on the port:

#### Cisco IOS Release 12.2(50)SG

```
Switch# conf terminal
Enter configuration commands, one per line. End with CNTL/Z.
Switch(config)# interface FastEthernet3/1
Switch(config-if)# shut
Switch(config-if)# switchport access vlan 12
Switch(config-if)# switchport mode access
Switch(config-if)# switchport voice vlan 10
Switch(config-if)# dot1x pae authenticator
Switch(config-if)# authentication port-control auto
Switch(config-if)# authentication host-mode multi-domain
Switch(config-if)# no shut
Switch(config-if)# end
```

#### Cisco IOS Release 12.2(46)SG or earlier

```
Switch# conf t
Enter configuration commands, one per line. End with CNTL/Z.
Switch(config)# interface FastEthernet3/1
Switch(config-if)# shut
Switch(config-if)# switchport access vlan 12
Switch(config-if)# switchport mode access
Switch(config-if)# switchport voice vlan 10
Switch(config-if)# dot1x pae authenticator
Switch(config-if)# dot1x port-control auto
Switch(config-if)# dot1x host-mode multi-domain
Switch(config-if)# no shut
Switch(config-if)# end
```

This example shows how to enable MDA and to allow both a host and a non-802.1X voice device on the port:

#### Cisco IOS Release 12.2(50)SG

```
Switch# conf t
Enter configuration commands, one per line. End with CNTL/Z.
Switch(config)# interface FastEthernet3/1
Switch(config-if)# shut
Switch(config-if)# switchport access vlan 12
Switch(config-if)# switchport mode access
Switch(config-if)# switchport voice vlan 10
Switch(config-if)# dot1x pae authenticator
Switch(config-if)# authentication port-control auto
Switch(config-if)# authentication host-mode multi-domain
Switch(config-if)# map eap
Switch(config-if)# no shut
Switch(config-if)# end
```

#### Cisco IOS Release 12.2(46)SG or earlier

```
Switch# conf t
Enter configuration commands, one per line. End with CNTL/Z.
Switch(config)# interface FastEthernet3/1
Switch(config-if)# shut
Switch(config-if)# switchport access vlan 12
Switch(config-if)# switchport mode access
Switch(config-if)# switchport voice vlan 10
Switch(config-if)# dot1x pae authenticator
```

```
Switch(config-if)# dot1x port-control auto
Switch(config-if)# dot1x host-mode multi-domain
Switch(config-if)# dot1x mac-auth-bypass
Switch(config-if)# no shut
Switch(config-if)# end
```

This example shows how to verify the dot1x MDA settings on interface FastEthernet3/1:

```
Switch# show dot1x interface FastEthernet3/1 detail
```

```
Dot1x Info for FastEthernet3/1
-----
PAE                               = AUTHENTICATOR
PortControl                        = AUTO
ControlDirection                  = Both
HostMode                          = MULTI_DOMAIN
ReAuthentication                   = Disabled
QuietPeriod                       = 60
ServerTimeout                     = 30
SuppTimeout                       = 30
ReAuthPeriod                      = 3600 (Locally configured)
ReAuthMax                         = 2
MaxReq                            = 2
TxPeriod                          = 30
RateLimitPeriod                   = 0

Dot1x Authenticator Client List
-----
Domain                            = DATA
Supplicant                        = 0000.0000.ab01
    Auth SM State                  = AUTHENTICATED
    Auth BEND SM Stat              = IDLE
Port Status                       = AUTHORIZED
Authentication Method              = Dot1x
Authorized By                      = Authentication Server
Vlan Policy                        = 12

Domain                            = VOICE
Supplicant                        = 0060.b057.4687
    Auth SM State                  = AUTHENTICATED
    Auth BEND SM Stat              = IDLE
Port Status                       = AUTHORIZED
Authentication Method              = Dot1x
Authorized By                      = Authentication Server

Switch#
```

This example shows how to enable MDA and to authentication of multiple hosts and a voice device on an IEEE 802.1x-authorized port:



**Note** This example applies to Cisco IOS Release 12.2(50)SG and later releases.

```
Switch# conf t
Enter configuration commands, one per line. End with CNTL/Z.
Switch(config)# interface FastEthernet3/1
Switch(config-if)# shut
Switch(config-if)# switchport access vlan 12
Switch(config-if)# switchport mode access
Switch(config-if)# switchport voice vlan 10
Switch(config-if)# dot1x pae authenticator
```



```
Switch(config-if)# authentication port-control auto
Switch(config-if)# authentication host-mode multi-auth
Switch(config-if)# map eap
Switch(config-if)# no shut
Switch(config-if)# end
```

## Configuring 802.1X Authentication with ACL Assignments and Redirect URLs

Topics include:

- [Downloadable ACL, page 39-33](#)
- [URL-Redirect, page 39-35](#)
- [Configuring a Downloadable Policy, page 39-38](#)

### Downloadable ACL

The Downloadable ACL feature enables you to download device specific authorization policies from the authentication server. These policies activate after authentication succeeds for the respective client and the client's IP address has been populated in the IP device tracking table. (Downloadable ACL is applied on the port, once the port is authenticated and the IP device tracking table has the host IP address entry).

The following sections illustrates the configuration needed to complement the related authentication (802.1X or MAB) configuration. (No unique configuration is required on the switch. All of the configuration is on the ACS.) After authentication succeeds, enter the **show ip access-list** command to display the downloadable ACLs.

### Switch Configuration

- 
- Step 1** Configure the IP device tracking table.
- ```
Switch(config)# ip device tracking
```
- Step 2** Configure RADIUS VSA to forward authentication.
- ```
Switch(config)# radius-server vsa send authentication
```
- Step 3** Configure Static ACL (PACL) for the interface.
- ```
Switch(config)# int g2/9
Switch(config-if)# ip access-group pacl-4 in
```
- 

### Sample Interface Configuration

```
Switch# show running-configuration interface g2/9
Building configuration...

Current configuration : 617 bytes
!
interface GigabitEthernet2/9
 switchport
 switchport access vlan 29
 switchport mode access
 switchport voice vlan 1234
 access-group mode prefer port
 ip access-group pacl-4 in
```

```

speed 100
duplex full
authentication event fail action authorize vlan 111
authentication event server dead action authorize vlan 333
authentication event server alive action reinitialize
authentication host-mode multi-auth
authentication order dot1x
authentication port-control auto
authentication timer restart 100
authentication timer reauthenticate 20
authentication timer inactivity 200
mab eap
dot1x pae authenticator
end

Switch#
Switch# show ip access-list pacl-4
    10 permit ip host 1.1.1.1 host 2.2.2.2
    20 permit icmp host 1.1.1.1 host 2.2.2.2
Switch#

```

## Debug Commands for DACL

The IP device tracking table contains the host IP address learned through ARP or DHCP.

The following commands displays the constraints on the IP device tracking table:

```

Switch# show ip device tracking all
IP Device Tracking = Enabled
IP Device Tracking Probe Count = 3
IP Device Tracking Probe Interval = 30
-----
   IP Address      MAC Address      Interface          STATE
-----
50.0.0.12         0015.60a4.5e84  GigabitEthernet2/9  ACTIVE

```

The following command shows that the EPM (Policy Enforced Module) session contains the DACL downloaded from ACS:

```

Switch# show epm session ip 50.0.0.12
Admission feature      : DOT1X
AAA Policies           :
ACS ACL                : xACSACLx-IP-auth-48b79b6e

```

The following command reveals the contents of the downloadable ACL:

```

Switch# show ip accesslists xACSACLx-IP-auth-48b79b6e
Extended IP access list xACSACLx-IP-auth-48b79b6e (per-user)
    10 permit udp any any
Switch(config)#

```

## Cisco ACS Configuration for DACL



**Note** Only Cisco ACS supports DACL.

Follow these steps to ensure correct functioning of the ACS configuration required for DACL:

- Step 1** Configure a downloadable IP ACL on the window that appears when you select **Radius Shared Profile > Downloadable IP ACL Content**:

Figure 39-8 Shared Profile Components

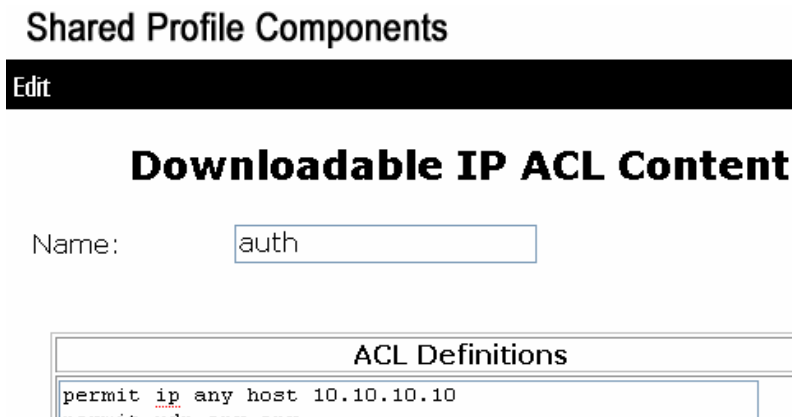

**Step 2** Attach this DACL with the USER on the window that appears when you select **User > DACLs**:

Figure 39-9 Downloadable ACLs

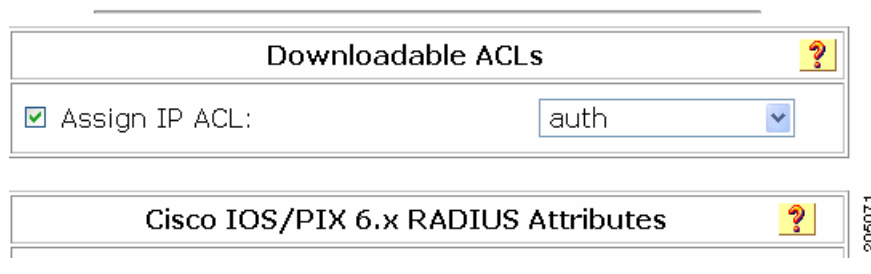

## URL-Redirect

This configuration consists of two configurations: one on ACS, and one on the switch.

### ACS configuration

To configure two Cisco-AV pairs, add the following statements under the user or group Cisco IOS/PIX 6x RADIUS attributes:

```
url-redirect-acl=urlacl
url-redirect=http://www.cisco.com
```



**Note** A default port ACL must be configured on the interface.

### Switch configuration

To configure the switch for URL redirect, do the following:

**Step 1** Configure the IP device tracking table.

```
Switch(config)# ip device tracking
```

**Step 2** Configure RADIUS with the **send authentication** command.

```
Switch(config)# radius-server vsa send authentication
```

**Step 3** Configure the URL redirect ACL (URLACL).

```
Switch# ip access-list urlacl
 10 permit tcp any any
Switch#
```

**Step 4** Configure static ACL (PACL) for the interface.

```
Switch(config)# int g2/9
Switch(config-if)# ip access-group pacl-4 in
```

---

## Sample Interface Configuration

```
Switch# show running-configuration int g2/9
Building configuration...

Current configuration : 617 bytes
!
interface GigabitEthernet2/9
 switchport
 switchport access vlan 29
 switchport mode access
 switchport voice vlan 1234
 access-group mode prefer port
 ip access-group pacl-4 in
 speed 100
 duplex full
 authentication event fail action authorize vlan 111
 authentication event server dead action authorize vlan 333
 authentication event server alive action reinitialize
 authentication host-mode multi-auth
 authentication order dot1x
 authentication port-control auto
 authentication timer restart 100
 authentication timer reauthenticate 20
 authentication timer inactivity 200
 mab
 dot1x pae authenticator
end

Switch#

Switch# show access-list pacl-4
 10 permit ip host 1.1.1.1 host 2.2.2.2
 20 permit icmp host 1.1.1.1 host 2.2.2.2
Switch#
```

Verify URL-redirect with the following commands.

The **show ip device tracking** command illustrates the constraints on the IP device tracking table:

```
Switch(config)# show ip device tracking all
IP Device Tracking = Enabled
IP Device Tracking Probe Count = 3
IP Device Tracking Probe Interval = 30
-----
  IP Address      MAC Address      Interface      STATE
-----
50.0.0.12        0015.60a4.5e84  GigabitEthernet2/9  ACTIVE
```

The **show epm session ip** command displays the EPM session table for a particular host. Observe the URL-redirect-acl and URL-redirect URL information that downloads from the ACS.

```
Switch# show epm session ip 50.0.0.12
Admission feature      : DOT1X
AAA Policies           :
URL Redirect ACL       : urlacl
URL Redirect           : http://www.cisco.com
```

For more information about AV pairs that are supported by Cisco IOS software, see the ACS configuration and command reference documentation about the software releases running on the AAA clients.

### Guidelines and Restrictions for DACL and URL Redirect

For downloadable ACL or URL redirect, the ACL source must be ANY (permit TCP ANY host 1.1.1.1 eq 80 or permit TCP ANY host 1.1.1.1 eq 443).

## Configuring a Downloadable Policy

To configure downloadable policies, follow these steps:

|         | Command                                                                                                                                    | Purpose                                                                                                                                                                                                                                                                                                                                                                                                                                                                                                                                                                                                                                                                                                                                                                                                                                                                                                                                                                              |
|---------|--------------------------------------------------------------------------------------------------------------------------------------------|--------------------------------------------------------------------------------------------------------------------------------------------------------------------------------------------------------------------------------------------------------------------------------------------------------------------------------------------------------------------------------------------------------------------------------------------------------------------------------------------------------------------------------------------------------------------------------------------------------------------------------------------------------------------------------------------------------------------------------------------------------------------------------------------------------------------------------------------------------------------------------------------------------------------------------------------------------------------------------------|
| Step 1  | Switch# <b>configure terminal</b>                                                                                                          | Enters global configuration mode.                                                                                                                                                                                                                                                                                                                                                                                                                                                                                                                                                                                                                                                                                                                                                                                                                                                                                                                                                    |
| Step 2  | Switch(config)# <b>access-list</b><br><i>access-list-number</i> {deny   permit}<br><i>source</i> [ <i>source-wildcard</i> ] [ <b>log</b> ] | <p>Defines the default port ACL through a source address and wildcard. The <i>access-list-number</i> is a decimal from 1 to 99 or 1300 to 1999.</p> <p>Enter <b>deny</b> or <b>permit</b> to specify whether to deny or permit access if conditions match.</p> <p><i>source</i> is the address of the network or host from which the packet is sent, specified as follows:</p> <ul style="list-style-type: none"> <li>The 32-bit quantity in dotted-decimal format</li> <li>The keyword <b>any</b> as an abbreviation for source and source-wildcard value of 0.0.0.0 255.255.255.255</li> <li>You do not need a source-wildcard value.</li> <li>The keyword <b>host</b> as an abbreviation for source and source-wildcard of source 0.0.0.0.</li> </ul> <p>(Optional) Applies the source-wildcard wildcard bits to the source.</p> <p>(Optional) Enters <b>log</b> to cause an informational logging message about the packet that matches the entry to be sent to the console.</p> |
| Step 3  | Switch(config-if)# <b>interface</b><br><i>interface-id</i>                                                                                 | Enters interface configuration mode.                                                                                                                                                                                                                                                                                                                                                                                                                                                                                                                                                                                                                                                                                                                                                                                                                                                                                                                                                 |
| Step 4  | Switch(config-if)# <b>ip access-group</b><br>{ <i>access-list-number</i>   <i>name</i> } <b>in</b>                                         | <p>Controls access to the specified interface.</p> <p>This step is mandatory for a functioning downloaded policy.</p>                                                                                                                                                                                                                                                                                                                                                                                                                                                                                                                                                                                                                                                                                                                                                                                                                                                                |
| Step 5  | Switch(config)# <b>exit</b>                                                                                                                | Returns to global configuration mode.                                                                                                                                                                                                                                                                                                                                                                                                                                                                                                                                                                                                                                                                                                                                                                                                                                                                                                                                                |
| Step 6  | Switch(config)# <b>aaa new-model</b>                                                                                                       | Enables AAA.                                                                                                                                                                                                                                                                                                                                                                                                                                                                                                                                                                                                                                                                                                                                                                                                                                                                                                                                                                         |
| Step 7  | Switch(config)# <b>aaa authorization</b><br><b>network default local</b>                                                                   | Sets the authorization method to local. To remove the authorization method, use the <b>no aaa authorization network default local</b> command.                                                                                                                                                                                                                                                                                                                                                                                                                                                                                                                                                                                                                                                                                                                                                                                                                                       |
| Step 8  | Switch(config)# <b>ip device tracking</b>                                                                                                  | <p>Enables the IP device tracking table.</p> <p>To disable the IP device tracking table, use the <b>no ip device tracking</b> global configuration commands.</p>                                                                                                                                                                                                                                                                                                                                                                                                                                                                                                                                                                                                                                                                                                                                                                                                                     |
| Step 9  | Switch(config)# <b>ip device tracking</b><br>[ <b>probe</b> { <b>count</b> <i>count</i>   <b>interval</b><br><i>interval</i> }]            | <p>(Optional) Configures these parameters for the IP device tracking table:</p> <ul style="list-style-type: none"> <li><b>count</b> - Number of times that the switch sends the ARP probe. The range is 1 to 5. The default is 3.</li> <li><b>interval</b> - Number of seconds that the switch waits for a response before resending the ARP probe. The range is 30 to 300 seconds. The default is 30 seconds.</li> </ul>                                                                                                                                                                                                                                                                                                                                                                                                                                                                                                                                                            |
| Step 10 | Switch(config)# <b>radius-server vsa</b><br><b>send authentication</b>                                                                     | <p>Configures the network access server to recognize and use vendor-specific attributes.</p> <p><b>Note</b> The downloadable ACL must be operational.</p>                                                                                                                                                                                                                                                                                                                                                                                                                                                                                                                                                                                                                                                                                                                                                                                                                            |
| Step 11 | Switch(config)# <b>end</b>                                                                                                                 | Returns to privileged EXEC mode.                                                                                                                                                                                                                                                                                                                                                                                                                                                                                                                                                                                                                                                                                                                                                                                                                                                                                                                                                     |

|         | Command                                                                                                                                                          | Purpose                                                                 |
|---------|------------------------------------------------------------------------------------------------------------------------------------------------------------------|-------------------------------------------------------------------------|
| Step 12 | Switch# <b>show ip device tracking</b><br>{ <b>all</b>   <b>interface</b> <i>interface-id</i>   <b>ip</b><br><i>ip-address</i>   <b>mac</b> <i>mac-address</i> } | Displays information about the entries in the IP device tracking table. |
| Step 13 | Switch# <b>copy running-config</b><br><b>startup-config</b>                                                                                                      | (Optional) Saves your entries in the configuration file.                |

The following example illustrates how to configure a switch for downloadable policy:

```
Switch# config t
Enter configuration commands, one per line. End with CNTL/Z.
Switch(config)# aaa new-model
Switch(config)# aaa authorization network default local
Switch(config)# ip device tracking
Switch(config)# ip access-list extended default_acl
Switch(config-ext-nacl)# permit ip any any
Switch(config-ext-nacl)# exit
Switch(config)# radius-server vsa send authentication
Switch(config)# int fastEthernet 2/13
Switch(config-if)# ip access-group default_acl in
Switch(config-if)# exit
```

## Configuring RADIUS-Provided Session Timeouts

You can configure the Catalyst 4500 series switch to use a RADIUS-provided reauthentication timeout.

To configure RADIUS-provided timeouts, perform this task:

|        | Command                                                                                                                                                                                                                                                                                                                                    | Purpose                                                                                                                                  |
|--------|--------------------------------------------------------------------------------------------------------------------------------------------------------------------------------------------------------------------------------------------------------------------------------------------------------------------------------------------|------------------------------------------------------------------------------------------------------------------------------------------|
| Step 1 | Switch# <b>configure terminal</b>                                                                                                                                                                                                                                                                                                          | Enters global configuration mode.                                                                                                        |
| Step 2 | Switch(config)# <b>interface</b><br><i>interface-id</i>                                                                                                                                                                                                                                                                                    | Enters interface configuration mode.                                                                                                     |
| Step 3 | Switch(config-if)# <b>switchport mode</b><br><b>access</b>                                                                                                                                                                                                                                                                                 | Specifies a nontrunking, nontagged single VLAN Layer 2 interface.                                                                        |
| Step 4 | Switch(config-if)# <b>dot1x pae</b><br><b>authenticator</b>                                                                                                                                                                                                                                                                                | Enables 802.1X authentication on the port with default parameters.<br>Refer to the “Default 802.1X Configuration” section on page 39-23. |
| Step 5 | <b>Cisco IOS Release 12.2(50)SG</b><br>Switch(config-if)# <b>authentication</b><br><b>timer reauthenticate</b> { <i>interface</i>  <br><i>server</i> })<br><br><b>Cisco IOS Release 12.2(46)SG or earlier</b><br><b>releases</b><br>Switch(config-if)# <b>dot1x timeout</b><br><b>reauth-attempts</b> { <i>interface</i>   <i>server</i> } | Sets the re-authentication period (seconds).                                                                                             |
| Step 6 | Switch(config-if)# <b>end</b>                                                                                                                                                                                                                                                                                                              | Returns to privileged EXEC mode.                                                                                                         |
| Step 7 | Switch# <b>show dot1x interface</b><br><i>interface-id</i> <b>details</b>                                                                                                                                                                                                                                                                  | Verifies your entries.                                                                                                                   |
| Step 8 | Switch # <b>copy running-config</b><br><b>startup-config</b>                                                                                                                                                                                                                                                                               | (Optional) Saves your entries in the configuration file.                                                                                 |

This example shows how to configure a switch to derive the re-authentication period from the server and to verify the configuration:

#### Cisco IOS Release 12.2(50):

```
Switch# configure terminal
Switch(config)# interface f7/1
Switch(config-if)# switchport mode access
Switch(config-if)# dot1x pae authenticator
Switch(config-if)# authentication timer reauthenticate server
Switch(config-if)# end
Switch# show dot1x interface f7/1 det
```

```
Dot1x Info for FastEthernet7/11
-----
PAE                               = AUTHENTICATOR
PortControl                       = FORCE_AUTHORIZED
ControlDirection                 = Both
HostMode                         = SINGLE_HOST
ReAuthentication                 = Disabled
QuietPeriod                      = 60
ServerTimeout                   = 30
SuppTimeout                     = 30
ReAuthPeriod                    = (From Authentication Server)
ReAuthMax                       = 2
MaxReq                          = 2
TxPeriod                        = 30
RateLimitPeriod                 = 0
```

```
Dot1x Authenticator Client List Empty
```

```
Port Status                       = AUTHORIZED
```

```
Switch#
```

#### Cisco IOS Release 12.2(46) or earlier

```
Switch# configure terminal
Switch(config)# interface f7/1
Switch(config-if)# switchport mode access
Switch(config-if)# dot1x pae authenticator
Switch(config-if)# dot1x timeout reauth-attempts server
Switch(config-if)# end
Switch# show dot1x interface f7/1 det
```

```
Dot1x Info for FastEthernet7/11
-----
PAE                               = AUTHENTICATOR
PortControl                       = FORCE_AUTHORIZED
ControlDirection                 = Both
HostMode                         = SINGLE_HOST
ReAuthentication                 = Disabled
QuietPeriod                      = 60
ServerTimeout                   = 30
SuppTimeout                     = 30
ReAuthPeriod                    = (From Authentication Server)
ReAuthMax                       = 2
MaxReq                          = 2
TxPeriod                        = 30
```



```

RateLimitPeriod          = 0

Dot1x Authenticator Client List Empty

Port Status              = AUTHORIZED

Switch#

```

## Configuring Violation Action

You can configure 802.1X security violation behavior as either shutdown or restrict mode, based on the response to the violation.

To configure the violation action, performing the following task:

|        | Command                                                                                      | Purpose                                                                                                                                                                                                          |
|--------|----------------------------------------------------------------------------------------------|------------------------------------------------------------------------------------------------------------------------------------------------------------------------------------------------------------------|
| Step 1 | Switch# <b>configure terminal</b>                                                            | Enters global configuration mode.                                                                                                                                                                                |
| Step 2 | Switch(config)# <b>interface</b><br><i>interface-id</i>                                      | Enters interface configuration mode.                                                                                                                                                                             |
| Step 3 | Switch(config-if)# <b>authentication</b><br><b>violation [restrict  </b><br><b>shutdown]</b> | (Optional) Configures the disposition of the port if a security violation occurs.<br><br>The default action is to shut down the port. If the <b>restrict</b> keyword is configured, the port does not shut down. |
| Step 4 | Switch(config-if)# <b>end</b>                                                                | Returns to privileged EXEC mode.                                                                                                                                                                                 |
| Step 5 | Switch# <b>show run</b>                                                                      | Verifies your entries.                                                                                                                                                                                           |
| Step 6 | Switch # <b>copy running-config</b><br><b>startup-config</b>                                 | (Optional) Saves your entries in the configuration file.                                                                                                                                                         |

This example shows how to configure violation mode shutdown on a switch:

```

Switch# configure terminal
Switch(config)# authentication violation shutdown

```

A port is error-disabled when a security violation triggers on shutdown mode. The following syslog messages displays:

```

%AUTHMGR-5-SECURITY_VIOLATION: Security violation on the interface <interface name>, new
MAC address <mac-address> is seen.
%PM-4-ERR_DISABLE: security-violation error detected on <interface name>, putting
<interface name> in err-disable state

```

## Configuring 802.1X with Guest VLANs

You can configure a guest VLAN for each 802.1X port on the Catalyst 4500 series switch to provide limited services to clients, such as downloading the 802.1X client. These clients might be upgrading their system for 802.1X authentication, and some hosts, such as Windows 98 systems, might not be 802.1X-capable.

When you enable a guest VLAN on an 802.1X port, the Catalyst 4500 series switch assigns clients to a guest VLAN provided (1) the authentication server does not receive a response to its EAPOL request or identity frame, or (2) the EAPOL packets are not sent by the client.

Starting with Cisco IOS Release 12.2(25)EWA, the Catalyst 4500 series switch maintains the EAPOL packet history. If another EAPOL packet is detected on the interface during the lifetime of the link, network access is denied. The EAPOL history is reset upon loss of the link.

Any number of 802.1X-incapable clients are allowed access when the switch port is moved to the guest VLAN. If an 802.1X-capable client joins the same port on which the guest VLAN is configured, the port is put into the unauthorized state in the user-configured access VLAN, and authentication is restarted.

Guest VLANs are supported on 802.1X ports in single-host or multiple-hosts mode.



**Note** When a port is put into a guest VLAN, it is automatically placed into multihost mode, and an unlimited number of hosts can connect through the port. Changing the multihost configuration does not effect a port in a guest VLAN.



**Note** Except for an RSPAN VLAN or a voice VLAN, you can configure any active VLAN as an 802.1X guest VLAN.

To configure 802.1X with guest VLAN on a port, perform this task:

|        | Command                                                                                                                                                                                                                                                                                             | Purpose                                                                                                                                                                                                                                                                                                             |
|--------|-----------------------------------------------------------------------------------------------------------------------------------------------------------------------------------------------------------------------------------------------------------------------------------------------------|---------------------------------------------------------------------------------------------------------------------------------------------------------------------------------------------------------------------------------------------------------------------------------------------------------------------|
| Step 1 | Switch# <b>configure terminal</b>                                                                                                                                                                                                                                                                   | Enters global configuration mode.                                                                                                                                                                                                                                                                                   |
| Step 2 | Switch(config)# <b>interface</b><br><i>interface-id</i>                                                                                                                                                                                                                                             | Enters interface configuration mode and specifies the interface to be enabled for 802.1X authentication.                                                                                                                                                                                                            |
| Step 3 | Switch(config-if)# <b>switchport mode</b><br><b>access</b><br>or<br>Switch(config-if)# <b>switchport mode</b><br><b>private-vlan host</b>                                                                                                                                                           | Specifies a nontrunking, nontagged single VLAN Layer 2 interface.<br><br>Specifies that the ports with a valid PVLAN trunk association become active host PVLAN trunk ports.                                                                                                                                        |
| Step 4 | Switch(config-if)# <b>dot1x pae</b><br><b>authenticator</b>                                                                                                                                                                                                                                         | Enables 802.1X authentication on the port with default parameters.<br><br>Refer to the “ <a href="#">Default 802.1X Configuration</a> ” section on page 39-23.                                                                                                                                                      |
| Step 5 | <b>Cisco IOS Release 12.2(50)SG</b><br>Switch(config-if)# <b>authentication</b><br><b>event no-response action authorize</b><br><b>vlan</b> <i>vlan-id</i><br><br><b>Cisco IOS Release 12.2(46)SG or earlier</b><br><b>releases</b><br>Switch(config-if)# <b>dot1x guest-vlan</b><br><i>vlan-id</i> | Enables a guest VLAN on a particular interface.<br><br>To disable the guest VLAN feature on a particular port, use the <b>no authentication event no-response action authorize vlan</b> interface configuration command (for earlier releases, use the <b>no dot1x guest-vlan</b> interface configuration command). |
| Step 6 | <b>Cisco IOS Release 12.2(50)SG</b><br>Switch(config-if)# <b>authentication</b><br><b>port-control auto</b><br><br><b>Cisco IOS Release 12.2(46)SG or earlier</b><br><b>releases</b><br>Switch(config-if)# <b>dot1x</b><br><b>port-control auto</b>                                                 | Enables 802.1X authentication on the interface.                                                                                                                                                                                                                                                                     |
| Step 7 | Switch(config-if)# <b>end</b>                                                                                                                                                                                                                                                                       | Returns to configuration mode.                                                                                                                                                                                                                                                                                      |
| Step 8 | Switch(config)# <b>end</b>                                                                                                                                                                                                                                                                          | Returns to privileged EXEC mode.                                                                                                                                                                                                                                                                                    |

This example shows how to enable regular VLAN 50 on Fast Ethernet 4/3 as a guest VLAN on a static access port:

#### Cisco IOS Release 12.2(50)SG

```
Switch# configure terminal
Switch(config)# interface fa4/3
Switch(config-if)# switchport mode access
Switch(config-if)# dot1x pae authenticator
Switch(config-if)# authentication event no-response action authorize vlan 50
Switch(config-if)# authentication port-control auto
Switch(config-if)# end
Switch#
```

#### Cisco IOS Release 12.2(46)SG or earlier

```
Switch# configure terminal
Switch(config)# interface fa4/3
Switch(config-if)# switchport mode access
Switch(config-if)# dot1x pae authenticator
Switch(config-if)# dot1x guest-vlan 50
Switch(config-if)# dot1x port-control auto
Switch(config-if)# end
Switch#
```

This example shows how to enable a secondary PVLAN 100 as a guest VLAN on a PVLAN host port:

#### Cisco IOS Release 12.2(50)SG

```
Switch# configure terminal
Switch(config)# interface fa4/3
Switch(config-if)# switchport mode private-vlan host
Switch(config-if)# authentication port-control auto
Switch(config-if)# authentication event no-response action authorize vlan 100
Switch(config-if)# end
Switch#
```

#### Cisco IOS Release 12.2(46)SG or earlier

```
Switch# configure terminal
Switch(config)# interface fa4/3
Switch(config-if)# switchport mode private-vlan host
Switch(config-if)# dot1x port-control auto
Switch(config-if)# dot1x guest-vlan 100
Switch(config-if)# end
Switch#
```

To allow supplicants into a guest VLAN on a switch, perform this task:

|         | Command                                                                                                                                                                                                               | Purpose                                                                                                                                                                                                                                                                                                                                                                                                                                                                                                                                       |
|---------|-----------------------------------------------------------------------------------------------------------------------------------------------------------------------------------------------------------------------|-----------------------------------------------------------------------------------------------------------------------------------------------------------------------------------------------------------------------------------------------------------------------------------------------------------------------------------------------------------------------------------------------------------------------------------------------------------------------------------------------------------------------------------------------|
| Step 1  | Switch# <b>configure terminal</b>                                                                                                                                                                                     | Enters global configuration mode.                                                                                                                                                                                                                                                                                                                                                                                                                                                                                                             |
| Step 2  | Switch# <b>dot1x guest-vlan supplicant</b>                                                                                                                                                                            | (Optional) Enables supplicants to be allowed into the guest VLANs globally on the switch.<br><br><b>Note</b> Although not visible in the CLI for Cisco IOS Release 12.3(31)SG, legacy configurations that include the <b>dot1x guest-vlan supplicant</b> command still work. Using this command is not recommended, however, because the authentication failed VLAN option makes it unnecessary.<br><br>To disable the supplicant guest VLAN feature on a switch, use the <b>no dot1x guest-vlan supplicant</b> global configuration command. |
| Step 3  | Switch(config)# <b>interface</b><br><i>interface-id</i>                                                                                                                                                               | Enters interface configuration mode and specifies the interface to be enabled for 802.1X authentication.                                                                                                                                                                                                                                                                                                                                                                                                                                      |
| Step 4  | Switch(config-if)# <b>switchport mode access</b><br>or<br>Switch(config-if)# <b>switchport mode private-vlan host</b>                                                                                                 | Specifies a nontrunking, nontagged single VLAN Layer 2 interface.<br><br>Specifies that the ports with a valid PVLAN trunk association become active host PVLAN trunk ports.                                                                                                                                                                                                                                                                                                                                                                  |
| Step 5  | Switch(config-if)# <b>dot1x pae authenticator</b>                                                                                                                                                                     | Enables 802.1X authentication on the port with default parameters.<br>Refer to the “ <a href="#">Default 802.1X Configuration</a> ” section on page 39-23.                                                                                                                                                                                                                                                                                                                                                                                    |
| Step 6  | Switch(config-if)# <b>dot1x guest-vlan</b><br><i>vlan-id</i>                                                                                                                                                          | Specifies an active VLAN as an 802.1X guest VLAN. The range is 1 to 4094.                                                                                                                                                                                                                                                                                                                                                                                                                                                                     |
| Step 7  | <b>Cisco IOS Release 12.2(50)SG</b><br>Switch(config-if)# <b>authentication port-control auto</b><br><br><b>Cisco IOS Release 12.2(46)SG or earlier releases</b><br>Switch(config-if)# <b>dot1x port-control auto</b> | Enables 802.1X authentication on the interface.                                                                                                                                                                                                                                                                                                                                                                                                                                                                                               |
| Step 8  | Switch(config-if)# <b>end</b>                                                                                                                                                                                         | Returns to privileged EXEC mode.                                                                                                                                                                                                                                                                                                                                                                                                                                                                                                              |
| Step 9  | Switch# <b>show dot1x interface</b><br><i>interface-id</i>                                                                                                                                                            | Verifies your entries.                                                                                                                                                                                                                                                                                                                                                                                                                                                                                                                        |
| Step 10 | Switch# <b>copy running-config startup-config</b>                                                                                                                                                                     | (Optional) Saves your entries in the configuration file.                                                                                                                                                                                                                                                                                                                                                                                                                                                                                      |

This example shows how to enable the guest VLAN feature and to specify VLAN 5 as a guest VLAN:

#### Cisco IOS Release 12.2(50)SG

```
Switch# configure terminal
Switch(config)# dot1x guest-vlan supplicant
Switch(config)# interface gigabitEthernet5/9
Switch(config-if)# switchport mode access
Switch(config-if)# dot1x pae authenticator
Switch(config-if)# authentication event no-response action authorize vlan 5
Switch(config-if)# authentication port-control auto
Switch(config-if)# end
Switch#
```

#### Cisco IOS Release 12.2(46)SG or earlier

```

Switch# configure terminal
Switch(config)# dot1x guest-vlan supplicant
Switch(config)# interface gigabitethernet5/9
Switch(config-if)# switchport mode access
Switch(config-if)# dot1x pae authenticator
Switch(config-if)# dot1x guest-vlan 5
Switch(config-if)# dot1x port-control auto
Switch(config-if)# end
Switch#

```

## Configuring 802.1X with MAC Authentication Bypass

To enable MAB, perform this task:

|        | Command                                                                                                                                                                                                               | Purpose                                                                                                                                                                      |
|--------|-----------------------------------------------------------------------------------------------------------------------------------------------------------------------------------------------------------------------|------------------------------------------------------------------------------------------------------------------------------------------------------------------------------|
| Step 1 | Switch# <b>configure terminal</b>                                                                                                                                                                                     | Enters global configuration mode.                                                                                                                                            |
| Step 2 | Switch(config)# <b>interface</b><br><i>interface-id</i>                                                                                                                                                               | Specifies the port to be configured, and enters interface configuration mode.                                                                                                |
| Step 3 | Switch(config-if)# <b>switchport mode access</b><br>or<br>Switch(config-if)# <b>switchport mode private-vlan host</b>                                                                                                 | Specifies a nontrunking, nontagged single VLAN Layer 2 interface.<br><br>Specifies that the ports with a valid PVLAN trunk association become active host PVLAN trunk ports. |
| Step 4 | Switch(config-if)# <b>dot1x pae authenticator</b>                                                                                                                                                                     | Enables 802.1X authentication on the port with default parameters.<br>Refer to the <a href="#">“Default 802.1X Configuration”</a> section on page 39-23.                     |
| Step 5 | <b>Cisco IOS Release 12.2(50)SG</b><br>Switch(config-if)# <b>authentication port-control auto</b><br><br><b>Cisco IOS Release 12.2(46)SG or earlier releases</b><br>Switch(config-if)# <b>dot1x port-control auto</b> | Enables 802.1X authentication on the interface.                                                                                                                              |
| Step 6 | <b>Cisco IOS Release 12.2(50)SG</b><br>Switch(config-if)# <b>mab [eap]</b><br><br><b>Cisco IOS Release 12.2(46)SG or earlier releases</b><br>Switch(config-if)# <b>dot1x mac-auth-bypass [eap]</b>                    | Enables MAB on a switch.                                                                                                                                                     |
| Step 7 | Switch(config)# <b>end</b>                                                                                                                                                                                            | Returns to privileged EXEC mode.                                                                                                                                             |
| Step 8 | Switch# <b>show mab interface</b><br><i>interface-id details</i>                                                                                                                                                      | (Optional) Verifies your entries.                                                                                                                                            |
| Step 9 | Switch# <b>copy running-config startup-config</b>                                                                                                                                                                     | (Optional) Saves your entries in the configuration file.                                                                                                                     |



### Note

Removing a 802.1X MAB configuration from a port does not impact the authorized or authenticated state of the port. If the port is in an unauthenticated state, it remains in that state. If the port is in an authenticated state because of MAB, the switch reverts to the 802.1X Authenticator. If the port was

already authorized with a MAC address and the MAB configuration was removed, the port remains in an authorized state until re-authentication occurs. At that time, if an 802.1X supplicant is detected on the wire, the MAC address is removed.

This example shows how to enable MAB on Gigabit Ethernet interface 3/3 and to verify the configuration:

### Cisco IOS Release 12.2(50)SG

```
Switch# configure terminal
Switch(config)# interface gigabitethernet3/3
Switch(config-if)# switchport mode access
Switch(config-if)# dot1x pae authenticator
Switch(config-if)# authentication port-control auto
Switch(config-if)# mab
Switch(config-if)# end
Switch# show mab int g3/3 details
MAB details for GigabitEthernet3/3
-----
Mac-Auth-Bypass           = Enabled

MAB Client List
-----
Client MAC                 = 0001.0001.0001
Session ID                 = COA8016F0000002304175914
MAB SM state               = TERMINATE
Auth Status                = AUTHORIZED
```

### Cisco IOS Release 12.2(46)SG or earlier

```
Switch# configure terminal
Switch(config)# interface gigabitethernet3/3
Switch(config-if)# switchport mode access
Switch(config-if)# dot1x pae authenticator
Switch(config-if)# dot1x port-control auto
Switch(config-if)# dot1x mac-auth-bypass
Switch(config-if)# end
Switch# show dot1x int g3/3 details
Dot1x Info for GigabitEthernet3/3
-----
PAE                        = AUTHENTICATOR
PortControl                = AUTO
ControlDirection          = Both
HostMode                   = SINGLE_HOST
ReAuthentication           = Disabled
QuietPeriod                = 60
ServerTimeout              = 30
SuppTimeout                = 30
ReAuthPeriod               = 3600 (Locally configured)
ReAuthMax                  = 2
MaxReq                     = 2
TxPeriod                   = 1
RateLimitPeriod           = 0
Mac-Auth-Bypass           = Enabled

Dot1x Authenticator Client List
-----
Supplicant                 = 0000.0000.0001
Auth SM State              = AUTHENTICATED
Auth BEND SM Stat         = IDLE
Port Status                = AUTHORIZED
Authentication Method      = MAB
Authorized By              = Authentication Server
```

Vlan Policy = N/A  
Switch#

## Configuring 802.1X with Inaccessible Authentication Bypass



### Caution

You must configure the switch to monitor the state of the RADIUS server as described in the section [Configuring Switch-to-RADIUS-Server Communication, page 39-27](#) for Inaccessible Authentication Bypass to work properly. Specifically, you must configure the RADIUS test username, idle-time, deadtime and dead-criteria. Failure to do so results in the switch failing to detect that the RADIUS server has gone down, or prematurely marking a dead RADIUS server as alive again.

To configure a port as a critical port and to enable the Inaccessible Authentication Bypass feature, perform this task:

|        | Command                                                                                                                                                                                                                               | Purpose                                                                                                                                                                                                                                                                             |
|--------|---------------------------------------------------------------------------------------------------------------------------------------------------------------------------------------------------------------------------------------|-------------------------------------------------------------------------------------------------------------------------------------------------------------------------------------------------------------------------------------------------------------------------------------|
| Step 1 | Switch# <b>configure terminal</b>                                                                                                                                                                                                     | Enters global configuration mode.                                                                                                                                                                                                                                                   |
| Step 2 | <b>Cisco IOS Release 12.2(50)SG</b><br>Switch(config)# <b>authentication critical eapol</b><br><br><b>Cisco IOS Release 12.2(46)SG or earlier releases</b><br>Switch(config)# <b>dot1x critical eapol</b>                             | (Optional) Configures whether to send an EAPOL-Success packet when a port is critically authorized partway through an EAP exchange.<br><br><b>Note</b> Some supplicants require this.<br><br>The default is not to send EAPOL-Success packets when ports are critically authorized. |
| Step 3 | <b>Cisco IOS Release 12.2(50)SG</b><br>Switch(config)# <b>authentication critical recovery delay msec</b><br><br><b>Cisco IOS Release 12.2(46)SG or earlier releases</b><br>Switch(config)# <b>dot1x critical recovery delay msec</b> | (Optional) Specifies a throttle rate for the reinitialization of critically authorized ports when the RADIUS server becomes available. The default throttle rate is 100 milliseconds. This means that 10 ports reinitialize per second.                                             |
| Step 4 | Switch(config)# <b>interface interface-id</b>                                                                                                                                                                                         | Specifies the port to be configured and enters interface configuration mode.                                                                                                                                                                                                        |
| Step 5 | Switch(config-if)# <b>switchport mode access</b><br>or<br>Switch(config-if)# <b>switchport mode private-vlan host</b>                                                                                                                 | Specifies a nontrunking, nontagged single VLAN Layer 2 interface.<br><br>Specifies that the ports with a valid PVLAN trunk association become active host PVLAN trunk ports.                                                                                                        |
| Step 6 | Switch(config-if)# <b>dot1x pae authenticator</b>                                                                                                                                                                                     | Enables 802.1X authentication on the port with default parameters.<br><br>Refer to the <a href="#">“Default 802.1X Configuration”</a> section on page 39-23.                                                                                                                        |
| Step 7 | Switch(config-if)# <b>authentication port-control auto</b>                                                                                                                                                                            | Enables 802.1X authentication on the interface.                                                                                                                                                                                                                                     |

|         | Command                                                                                                                                                                                                                                                                 | Purpose                                                                                                                                                                                                                                                                                                      |
|---------|-------------------------------------------------------------------------------------------------------------------------------------------------------------------------------------------------------------------------------------------------------------------------|--------------------------------------------------------------------------------------------------------------------------------------------------------------------------------------------------------------------------------------------------------------------------------------------------------------|
| Step 8  | <p><b>Cisco IOS Release 12.2(50)SG</b><br/>Switch(config-if)# <b>authentication event server dead action authorize vlan</b></p> <p><b>Cisco IOS Release 12.2(46)SG or earlier releases</b><br/>Switch(config-if)# <b>dot1x critical</b></p>                             | <p>Enables the Inaccessible Authentication Bypass feature on the port.</p> <p>To disable the feature, use the <b>no authentication event server dead action authorize vlan</b> interface configuration command (for earlier releases, use the <b>no dot1x critical</b> interface configuration command).</p> |
| Step 9  | Switch(config-if)# <b>dot1x critical vlan vlan</b>                                                                                                                                                                                                                      | <p>(Optional) Specifies a VLAN into which the port is assigned when it is critically authorized.</p> <p>The default is to use the configured VLAN on the port.</p>                                                                                                                                           |
| Step 10 | <p><b>Cisco IOS Release 12.2(50)SG</b><br/>Switch(config-if)# <b>authentication event server alive action reinitialize</b></p> <p><b>Cisco IOS Release 12.2(46)SG or earlier releases</b><br/>Switch(config-if)# <b>dot1x critical recovery action reinitialize</b></p> | <p>(Optional) Specifies that the port should be reinitialized if it is critically authorized and RADIUS becomes available.</p> <p>The default is not to reinitialize the port.</p>                                                                                                                           |
| Step 11 | Switch(config)# <b>end</b>                                                                                                                                                                                                                                              | Returns to privileged EXEC mode.                                                                                                                                                                                                                                                                             |
| Step 12 | Switch# <b>show dot1x interface interface-id details</b>                                                                                                                                                                                                                | (Optional) Verifies your entries.                                                                                                                                                                                                                                                                            |
| Step 13 | Switch# <b>copy running-config startup-config</b>                                                                                                                                                                                                                       | (Optional) Saves your entries in the configuration file.                                                                                                                                                                                                                                                     |

The following example shows a full configuration of 802.1X with Inaccessible Authentication Bypass, including required AAA and RADIUS configuration as specified in the “[Enabling 802.1X Authentication](#)” section on page 39-24 and “[Configuring Switch-to-RADIUS-Server Communication](#)” section on page 39-27.

The RADIUS server configured is at IP address 10.1.2.3, using port 1645 for authentication and 1646 for accounting. The RADIUS secret key is *mykey*. The username used for the test server probes is *randomuser*. The test probes for both living and dead servers are generated once per minute. The interface FastEthernet 3/1 is configured to critically authenticate into VLAN 17 when AAA becomes unresponsive, and to reinitialize automatically when AAA becomes available again.

#### Cisco IOS Release 12.2(50)SG

```
Switch# configure terminal
Switch(config)# aaa new-model
Switch(config)# aaa authentication dot1x default group radius
Switch(config)# dot1x system-auth-control
Switch(config)# radius-server host 10.1.2.3 auth-port 1645 acct-port 1646 test username
randomuser idle-time 1 key mykey
Switch(config)# radius deadtime 1
Switch(config)# radius dead-criteria time 15 tries 3
Switch(config)# interface f3/1
Switch(config-if)# switchport mode access
Switch(config-if)# dot1x pae authenticator
Switch(config-if)# authentication port-control auto
Switch(config-if)# authentication event server dead action authorize vlan
Switch(config-if)# dot1x critical vlan 17
Switch(config-if)# dot1x critical recovery action reinitialize
Switch(config-if)# end
Switch# show dot1x int fastethernet 3/1 det
```



```

Dot1x Info for FastEthernet3/1
-----
PAE                               = AUTHENTICATOR
PortControl                       = AUTO
ControlDirection                 = Both
HostMode                         = SINGLE_HOST
ReAuthentication                 = Disabled
QuietPeriod                      = 60
ServerTimeout                    = 30
SuppTimeout                      = 30
ReAuthPeriod                    = 3600 (Locally configured)
ReAuthMax                       = 2
MaxReq                           = 2
TxPeriod                         = 30
RateLimitPeriod                 = 0
Critical-Auth                    = Enabled
Critical Recovery Action         = Reinitialize
Critical-Auth VLAN              = 17

```

```

Dot1x Authenticator Client List
-----
Supplicant                       = 0000.0000.0001

Auth SM State                   = AUTHENTICATING
Auth BEND SM Stat               = RESPONSE
Port Status                    = AUTHORIZED
Authentication Method          = Dot1x
Authorized By                  = Critical-Auth
Operational HostMode           = SINGLE_HOST
Vlan Policy                    = 17

```

```
Switch#
```

### Cisco IOS Release 12.2(46)SG or earlier

```

Switch# configure terminal
Switch(config)# aaa new-model
Switch(config)# aaa authentication dot1x default group radius
Switch(config)# dot1x system-auth-control
Switch(config)# radius-server host 10.1.2.3 auth-port 1645 acct-port 1646 test username
randomuser idle-time 1 key mykey
Switch(config)# radius deadtime 1
Switch(config)# radius dead-criteria time 15 tries 3
Switch(config)# interface f3/1
Switch(config-if)# switchport mode access
Switch(config-if)# dot1x pae authenticator
Switch(config-if)# dot1x port-control auto
Switch(config-if)# dot1x critical
Switch(config-if)# dot1x critical vlan 17
Switch(config-if)# authentication event server alive action reinitialize
Switch(config-if)# end
Switch# show dot1x int fastethernet 3/1 det

```

```

Dot1x Info for FastEthernet3/1
-----
PAE                               = AUTHENTICATOR
PortControl                       = AUTO
ControlDirection                 = Both
HostMode                         = SINGLE_HOST
ReAuthentication                 = Disabled
QuietPeriod                      = 60
ServerTimeout                    = 30

```

```

SuppTimeout                = 30
ReAuthPeriod               = 3600 (Locally configured)
ReAuthMax                  = 2
MaxReq                     = 2
TxPeriod                   = 30
RateLimitPeriod            = 0
Critical-Auth              = Enabled
Critical Recovery Action    = Reinitialize
Critical-Auth VLAN         = 17

Dot1x Authenticator Client List
-----
Supplicant                  = 0000.0000.0001

Auth SM State              = AUTHENTICATING
Auth BEND SM Stat          = RESPONSE
Port Status                = AUTHORIZED
Authentication Method       = Dot1x
Authorized By              = Critical-Auth
Operational HostMode       = SINGLE_HOST
Vlan Policy                 = 17

Switch#

```

## Configuring 802.1X with Unidirectional Controlled Port

To configure unidirectional controlled port, perform this task:

|        | Command                                                                                                                                                                                                                                       | Purpose                                                                                                                                                                  |
|--------|-----------------------------------------------------------------------------------------------------------------------------------------------------------------------------------------------------------------------------------------------|--------------------------------------------------------------------------------------------------------------------------------------------------------------------------|
| Step 1 | Switch# <b>configure terminal</b>                                                                                                                                                                                                             | Enters global configuration mode.                                                                                                                                        |
| Step 2 | Switch(config)# <b>interface interface-id</b>                                                                                                                                                                                                 | Specifies the port to be configured and enters interface configuration mode.                                                                                             |
| Step 3 | Switch(config-if)# <b>switchport mode access</b><br>or<br>Switch(config-if)# <b>switchport mode private-vlan host</b>                                                                                                                         | Specifies a nontrunking, nontagged single VLAN Layer 2 interface.<br>Specifies that the ports with a valid PVLAN trunk association become active host PVLAN trunk ports. |
| Step 4 | Switch(config-if)# <b>dot1x pae authenticator</b>                                                                                                                                                                                             | Enables 802.1X authentication on the port with default parameters.<br>Refer to the “ <a href="#">Default 802.1X Configuration</a> ” section on page 39-23.               |
| Step 5 | Switch(config-if)# <b>authentication port-control auto</b>                                                                                                                                                                                    | Enables 802.1X authentication on the interface.                                                                                                                          |
| Step 6 | <b>Cisco IOS Release 12.2(50)SG</b><br>Switch(config-if)# <b>authentication control-direction {in   both}</b><br><br><b>Cisco IOS Release 12.2(46)SG or earlier releases</b><br>Switch(config-if)# <b>dot1x control-direction {in   both}</b> | Enables unidirectional port control on each port.                                                                                                                        |
| Step 7 | Switch(config)# <b>end</b>                                                                                                                                                                                                                    | Returns to privileged EXEC mode.                                                                                                                                         |
| Step 8 | Switch# <b>show dot1x interface interface-id details</b>                                                                                                                                                                                      | (Optional) Verifies your entries.                                                                                                                                        |
| Step 9 | Switch# <b>copy running-config startup-config</b>                                                                                                                                                                                             | (Optional) Saves your entries in the configuration file.                                                                                                                 |

**Note**

Unidirectional Controlled Port only works when Spanning Tree Portfast is enabled on the port. Unidirectional Controlled Port and Spanning Tree Portfast should be configured on a switch port that connects to a host. If two such ports are connected together with an Ethernet cable, high CPU utilization may result because host learning will be flapping between the two ports.

When a device is enabled for unidirectional controlled port (also termed Wake On LAN), its interface stays up when the device sleeps. So, the port connected to the device displays as link up (connected). When you forward special packets to the port, the device wakes up.

This example shows how to enable unidirectional port control:

**Cisco IOS Release 12.2(50)SG**

```
Switch# configure terminal
Switch(config)# interface gigabitEthernet3/3
Switch(config-if)# switchport mode access
Switch(config-if)# dot1x pae authenticator
Switch(config-if)# authentication port-control auto
Switch(config-if)# authentication control-direction in
Switch(config-if)# end
Switch# show dot1x int g3/3
Dot1x Info for GigabitEthernet3/3
-----
PAE                               = AUTHENTICATOR
PortControl                       = AUTO
ControlDirection                 = In
HostMode                         = SINGLE_HOST
ReAuthentication                 = Disabled
QuietPeriod                      = 60
ServerTimeout                    = 30
SuppTimeout                      = 30
ReAuthPeriod                    = 3600 (Locally configured)
ReAuthMax                       = 2
MaxReq                           = 2
TxPeriod                         = 30
RateLimitPeriod                 = 0

Switch#
```

**Cisco IOS Release 12.2(46)SG or earlier**

```
Switch# configure terminal
Switch(config)# interface gigabitEthernet3/3
Switch(config-if)# switchport mode access
Switch(config-if)# dot1x pae authenticator
Switch(config-if)# authentication port-control auto
Switch(config-if)# dot1x control-direction in
Switch(config-if)# end
Switch# show dot1x int g3/3
Dot1x Info for GigabitEthernet3/3
-----
PAE                               = AUTHENTICATOR
PortControl                       = AUTO
ControlDirection                 = In
HostMode                         = SINGLE_HOST
ReAuthentication                 = Disabled
QuietPeriod                      = 60
ServerTimeout                    = 30
SuppTimeout                      = 30
ReAuthPeriod                    = 3600 (Locally configured)
ReAuthMax                       = 2
```

```

MaxReq          = 2
TxPeriod        = 30
RateLimitPeriod = 0

Switch#

```

## Configuring 802.1X with Authentication Failed VLAN Assignment

By configuring authentication-failed VLAN alignment on any Layer 2 port on the Catalyst 4500 series switch, you can provide limited network services to clients that fail the authentication process.



### Note

You can use authentication-failed VLAN assignment with other security features, such as Dynamic ARP Inspection (DAI), Dynamic Host Configuration Protocol (DHCP) snooping, and IP Source Guard. Each of these features can be enabled and disabled independently on the authentication-failed VLAN.

To configure 802.1X with authentication-failed VLAN assignment, perform this task:

|         | Command                                                                                                                                                                                                                                                                                          | Purpose                                                                                                                                                                                                                                         |
|---------|--------------------------------------------------------------------------------------------------------------------------------------------------------------------------------------------------------------------------------------------------------------------------------------------------|-------------------------------------------------------------------------------------------------------------------------------------------------------------------------------------------------------------------------------------------------|
| Step 1  | Switch# <b>configure terminal</b>                                                                                                                                                                                                                                                                | Enters global configuration mode.                                                                                                                                                                                                               |
| Step 2  | Switch(config)# <b>interface</b><br><i>interface-id</i>                                                                                                                                                                                                                                          | Enters interface configuration mode and specifies the interface to be enabled for 802.1X authentication.                                                                                                                                        |
| Step 3  | Switch(config-if)# <b>switchport mode</b><br><b>access</b>                                                                                                                                                                                                                                       | Specifies a nontrunking, nontagged single VLAN Layer 2 interface.                                                                                                                                                                               |
| Step 4  | Switch(config-if)# <b>authentication</b><br><b>port-control auto</b>                                                                                                                                                                                                                             | Enables 802.1X authentication on the interface.                                                                                                                                                                                                 |
| Step 5  | <b>Cisco IOS Release 12.2(50)SG</b><br>Switch(config-if)# <b>authentication</b><br><b>event fail action authorize vlan</b><br><i>vlan-id</i><br><br><b>Cisco IOS Release 12.2(46)SG or earlier</b><br><b>releases</b><br>Switch(config-if)# <b>dot1x auth-fail</b><br><b>vlan</b> <i>vlan-id</i> | Enables authentication-failed VLAN on a particular interface.<br><br>To disable the authentication-failed VLAN feature on a particular port, use the <b>no authentication event fail action authorize vlan</b> interface configuration command. |
| Step 6  | <b>Cisco IOS Release 12.2(50)SG</b><br>Switch(config-if)# <b>authentication</b><br><b>event fail retry</b> <i>max-attempts</i><br><br><b>Cisco IOS Release 12.2(46)SG or earlier</b><br><b>releases</b><br>Switch(config-if)# <b>dot1x auth-fail</b><br><b>max-attempts</b> <i>max-attempts</i>  | Configure a maximum number of attempts before the port is moved to authentication-failed VLAN.<br><br>Default is 3 attempts.                                                                                                                    |
| Step 7  | Switch(config-if)# <b>end</b>                                                                                                                                                                                                                                                                    | Returns to configuration mode.                                                                                                                                                                                                                  |
| Step 8  | Switch(config)# <b>end</b>                                                                                                                                                                                                                                                                       | Returns to privileged EXEC mode.                                                                                                                                                                                                                |
| Step 9  | Switch# <b>show dot1x interface</b><br><i>interface-id</i> <b>details</b>                                                                                                                                                                                                                        | (Optional) Verifies your entries.                                                                                                                                                                                                               |
| Step 10 | Switch# <b>copy running-config</b><br><b>startup-config</b>                                                                                                                                                                                                                                      | (Optional) Saves your entries in the configuration file.                                                                                                                                                                                        |

This example shows how to enable a regular VLAN 40 on Fast Ethernet 4/3 as a authentication-failed VLAN on a static access port:

### Cisco IOS Release 12.2(50)SG

```
Switch# configure terminal
Switch(config)# interface gigabitethernet3/1
Switch(config-if)# switchport mode access
Switch(config-if)# authentication port-control auto
Switch(config-if)# authentication event fail action authorize vlan 40
Switch(config-if)# authentication event fail retry 5
Switch(config-if)# end
Switch(config)# end
Switch# show dot1x all
Dot1x Info for interface GigabitEthernet3/1
-----
PortStatus          = AUTHORIZED(AUTH-FAIL-VLAN)
MaxReq              = 2
MaxAuthReq          = 2
HostMode            = Single(AUTH-FAIL-VLAN)
PortControl         = Auto
QuietPeriod         = 60 Seconds
Re-authentication   = Disabled
ReAuthPeriod        = 3600 Seconds
ServerTimeout       = 30 Seconds
SuppTimeout         = 30 Seconds
TxPeriod            = 30 Seconds
Guest-Vlan          = 6
Switch
```

### Cisco IOS Release 12.2(46)SG or earlier

```
Switch# configure terminal
Switch(config)# interface gigabitethernet3/1
Switch(config-if)# switchport mode access
Switch(config-if)# dot1x port-control auto
Switch(config-if)# dot1x auth-fail vlan 40
Switch(config-if)# dot1x auth-fail max-attempts 5
Switch(config-if)# end
Switch(config)# end
Switch# show dot1x all
Dot1x Info for interface GigabitEthernet3/1
-----
PortStatus          = AUTHORIZED(AUTH-FAIL-VLAN)
MaxReq              = 2
MaxAuthReq          = 2
HostMode            = Single(AUTH-FAIL-VLAN)
PortControl         = Auto
QuietPeriod         = 60 Seconds
Re-authentication   = Disabled
ReAuthPeriod        = 3600 Seconds
ServerTimeout       = 30 Seconds
SuppTimeout         = 30 Seconds
TxPeriod            = 30 Seconds
Guest-Vlan          = 6
Switch
```

## Configuring 802.1X with Voice VLAN



**Note** You must configure 802.1X and voice VLAN simultaneously.



**Note** You cannot configure an authentication-failed VLAN and a voice VLAN on the same port. When you try to configure these two features on the same port, a syslog message appears.

To enable 802.1X with voice VLAN, perform this task:

|         | Command                                                                                                                                                                                                                                             | Purpose                                                                                                                                                  |
|---------|-----------------------------------------------------------------------------------------------------------------------------------------------------------------------------------------------------------------------------------------------------|----------------------------------------------------------------------------------------------------------------------------------------------------------|
| Step 1  | Switch# <b>configure terminal</b>                                                                                                                                                                                                                   | Enters global configuration mode.                                                                                                                        |
| Step 2  | Switch(config)# <b>interface</b><br><i>interface-id</i>                                                                                                                                                                                             | Enters interface configuration mode.                                                                                                                     |
| Step 3  | Switch(config-if)# <b>switchport</b><br><b>access vlan</b> <i>vlan-id</i>                                                                                                                                                                           | Sets the VLAN for a switched interface in access mode.                                                                                                   |
| Step 4  | Switch(config-if)# <b>switchport mode</b><br><b>access</b>                                                                                                                                                                                          | Specifies a nontrunking, nontagged single VLAN Layer 2 interface.                                                                                        |
| Step 5  | Switch(config-if)# <b>switchport voice</b><br><b>vlan</b> <i>vlan-id</i>                                                                                                                                                                            | Sets the voice VLAN for the interface.                                                                                                                   |
| Step 6  | Switch(config-if)# <b>dot1x pae</b><br><b>authenticator</b>                                                                                                                                                                                         | Enables 802.1X authentication on the port with default parameters.<br>Refer to the <a href="#">“Default 802.1X Configuration”</a> section on page 39-23. |
| Step 7  | <b>Cisco IOS Release 12.2(50)SG</b><br>Switch(config-if)# <b>authentication</b><br><b>port-control auto</b><br><br><b>Cisco IOS Release 12.2(46)SG or earlier</b><br><b>releases</b><br>Switch(config-if)# <b>dot1x</b><br><b>port-control auto</b> | Enables 802.1X authentication on the interface.                                                                                                          |
| Step 8  | Switch(config-if)# <b>end</b>                                                                                                                                                                                                                       | Returns to configuration mode.                                                                                                                           |
| Step 9  | Switch(config)# <b>end</b>                                                                                                                                                                                                                          | Returns to privileged EXEC mode.                                                                                                                         |
| Step 10 | Switch# <b>show dot1x interface</b><br><i>interface-id details</i>                                                                                                                                                                                  | (Optional) Verifies your entries.                                                                                                                        |
| Step 11 | Switch# <b>copy running-config</b><br><b>startup-config</b>                                                                                                                                                                                         | (Optional) Saves your entries in the configuration file.                                                                                                 |

This example shows how to enable 802.1X with voice VLAN feature on Fast Ethernet interface 5/9:

### Cisco IOS Release 12.2(50)SG

```
Switch# configure terminal
Switch(config)# interface fastethernet5/9
Switch(config-if)# switchport access vlan 2
Switch(config-if)# switchport mode access
Switch(config-if)# switchport voice vlan 10
Switch(config-if)# dot1x pae authenticator
```

```
Switch(config-if)# authentication port-control auto
Switch(config-if)# end
Switch(config)# end
Switch#
```

### Cisco IOS Release 12.2(46)SG or earlier

```
Switch# configure terminal
Switch(config)# interface fastethernet5/9
Switch(config-if)# switchport access vlan 2
Switch(config-if)# switchport mode access
Switch(config-if)# switchport voice vlan 10
Switch(config-if)# dot1x pae authenticator
Switch(config-if)# dot1x port-control auto
Switch(config-if)# end
Switch(config)# end
Switch#
```

## Enabling Fallback Authentication

On a port in multiauthentication mode, either or both of MAB and web-based authentication can be configured as fallback authentication methods for non-802.1X hosts (those that do not respond to EAPOL). You can configure the order and priority of the authentication methods.

For detailed configuration information for MAB, see the [“Configuring 802.1X with MAC Authentication Bypass”](#) section on page 39-45.

For detailed configuration information for web-based authentication, see [Chapter 41, “Configuring Web-Based Authentication.”](#)



#### Note

When Webauth and other authentication methods are configured on an MDA or multiauthentication port, downloadable ACL policies must be configured for all devices attached to that port.

To enable fallback authentication, perform this task:

|        | Command                                                                            | Purpose                                                                                                                                                                       |
|--------|------------------------------------------------------------------------------------|-------------------------------------------------------------------------------------------------------------------------------------------------------------------------------|
| Step 1 | Switch(config)# <b>ip admission name</b> <i>rule-name</i> <b>proxy http</b>        | Configures an authentication rule for web-based authentication.                                                                                                               |
| Step 2 | Switch(config)# <b>fallback profile</b> <i>profile-name</i>                        | Creates a fallback profile for web-based authentication.                                                                                                                      |
| Step 3 | Switch(config-fallback-profile)# <b>ip access-group</b> <i>rule-name</i> <b>in</b> | Specifies the default ACL to apply to network traffic before web-based authentication.                                                                                        |
| Step 4 | Switch(config-fallback-profile)# <b>ip admission name</b> <i>rule-name</i>         | Associates an IP admission rule with the profile and specifies that a client connecting by web-based authentication uses this rule.                                           |
| Step 5 | Switch(config-fallback-profile)# <b>exit</b>                                       | Returns to global configuration mode.                                                                                                                                         |
| Step 6 | Switch(config)# <b>interface</b> <i>type slot/port</i>                             | Specifies the port to be configured and enters interface configuration mode.<br><br><i>type</i> = <b>fastethernet</b> , <b>gigabitethernet</b> , or <b>tengigabitethernet</b> |

|         | Command                                                                                                                                                                                                                        | Purpose                                                                                                                                                                                                                                                                                                                                                                                              |
|---------|--------------------------------------------------------------------------------------------------------------------------------------------------------------------------------------------------------------------------------|------------------------------------------------------------------------------------------------------------------------------------------------------------------------------------------------------------------------------------------------------------------------------------------------------------------------------------------------------------------------------------------------------|
| Step 7  | <p><b>Cisco IOS Release 12.2(50)SG</b><br/>Switch(config-if)# <b>authentication port-control auto</b></p> <p><b>Cisco IOS Release 12.2(46)SG or earlier releases</b><br/>Switch(config-if)# <b>dot1x port-control auto</b></p> | Enables authentication on the port.                                                                                                                                                                                                                                                                                                                                                                  |
| Step 8  | Switch(config-if)# <b>authentication order</b> <i>method1</i> [ <i>method2</i> ] [ <i>method3</i> ]                                                                                                                            | (Optional) Specifies the fallback order of authentication methods to be used. The three values of <i>method</i> , in the default order, are <b>dot1x</b> , <b>mab</b> , and <b>webauth</b> . The specified order also determines the relative priority of the methods for reauthentication (highest to lowest).                                                                                      |
| Step 9  | Switch(config-if)# <b>authentication priority</b> <i>method1</i> [ <i>method2</i> ] [ <i>method3</i> ]                                                                                                                         | (Optional) Overrides the relative priority of authentication methods to be used. The three values of <i>method</i> , in the default order of priority, are <b>dot1x</b> , <b>mab</b> , and <b>webauth</b> .                                                                                                                                                                                          |
| Step 10 | Switch(config-if)# <b>authentication event fail action next-method</b>                                                                                                                                                         | Specifies that the next configured authentication method be applied if authentication fails.                                                                                                                                                                                                                                                                                                         |
| Step 11 | <p><b>Cisco IOS Release 12.2(50)SG</b><br/>Switch(config-if)# <b>mab</b> [<b>eap</b>]</p> <p><b>Cisco IOS Release 12.2(46)SG or earlier releases</b><br/>Switch(config-if)# <b>dot1x mac-auth-bypass</b> [<b>eap</b>]</p>      | Enables MAC authentication bypass. The optional <b>eap</b> keyword specifies that the EAP extension be used during RADIUS authentication.                                                                                                                                                                                                                                                            |
| Step 12 | Switch(config-if)# <b>authentication fallback</b> <i>profile-name</i>                                                                                                                                                          | Enables web-based authentication using the specified profile.                                                                                                                                                                                                                                                                                                                                        |
| Step 13 | Switch(config-if)# <b>authentication violation</b> [ <b>shutdown</b>   <b>restrict</b> ]                                                                                                                                       | (Optional) Configures the disposition of the port if a security violation occurs. The default action is to shut down the port. If the <b>restrict</b> keyword is configured, the port does not shutdown, but trap entries are installed for the violating MAC address, and traffic from that MAC address is dropped.                                                                                 |
| Step 14 | Switch(config-if)# <b>authentication timer inactivity</b> { <i>seconds</i>   <b>server</b> }                                                                                                                                   | <p>(Optional) Configures the inactivity timeout value for MAB and 802.1X. By default, inactivity aging is disabled for a port.</p> <ul style="list-style-type: none"> <li><i>seconds</i>—Specifies inactivity timeout period. The range is from 1 to 65535 seconds.</li> <li><b>server</b>—Specifies that the inactivity timeout period value be obtained from the authentication server.</li> </ul> |
| Step 15 | Switch(config-if)# <b>authentication timer restart</b> <i>seconds</i>                                                                                                                                                          | <p>(Optional) Specifies a period after which the authentication process restarts in an attempt to authenticate an unauthorized port.</p> <ul style="list-style-type: none"> <li><i>seconds</i>—Specifies the restart period. The range is from 1 to 65535 seconds.</li> </ul>                                                                                                                        |
| Step 16 | Switch(config-if)# <b>exit</b>                                                                                                                                                                                                 | Returns to global configuration mode.                                                                                                                                                                                                                                                                                                                                                                |
| Step 17 | Switch(config)# <b>ip device tracking</b>                                                                                                                                                                                      | Enables the IP device tracking table, which is required for web-based authentication.                                                                                                                                                                                                                                                                                                                |
| Step 18 | Switch(config)# <b>exit</b>                                                                                                                                                                                                    | Returns to privileged EXEC mode.                                                                                                                                                                                                                                                                                                                                                                     |
| Step 19 | Switch# <b>show dot1x interface</b> <i>type slot/port</i>                                                                                                                                                                      | Verifies your entries.                                                                                                                                                                                                                                                                                                                                                                               |



This example shows how to enable 802.1X fallback to MAB, and then to enable web-based authentication, on an 802.1X-enabled port:

```
Switch(config)# ip admission name rule1 proxy http
Switch(config)# fallback profile fallback1
Switch(config-fallback-profile)# ip access-group default-policy in
Switch(config-fallback-profile)# ip admission rule1
Switch(config-fallback-profile)# exit
Switch(config)# interface gigabit5/9
Switch(config-if)# switchport mode access
Switch(config-if)# authentication port-control auto
Switch(config-if)# dot1x pae authenticator
Switch(config-if)# authentication order dot1x mab webauth
Switch(config-if)# mab eap
Switch(config-if)# authentication fallback fallback1
Switch(config-if)# exit
Switch(config)# ip device tracking
Switch(config)# exit
```

To determine if a host has been authenticated using 802.1X when fallback authentication is configured on the port, enter the following commands:

```
Switch# show authentication sessions interface g7/2
```

```
Interface: GigabitEthernet7/2
MAC Address: 0060.b057.4687
IP Address: Unknown
User-Name: test2
Status: Authz Success
Domain: DATA
Oper host mode: multi-auth
Oper control dir: both
Authorized By: Authentication Server
Vlan Policy: N/A
Session timeout: N/A
Idle timeout: N/A
Common Session ID: C0A8013F0000000901BAB560
Acct Session ID: 0x0000000B
Handle: 0xE8000009
```

```
Runnable methods list:
```

```
Method State
dot1x Authc Success
mab Not run
```

```
Switch# show dot1x interfaces g7/2 detail
```

```
Dot1x Info for GigabitEthernet7/2
```

```
-----
PAE = AUTHENTICATOR
PortControl = AUTO
ControlDirection = Both
HostMode = MULTI_AUTH
QuietPeriod = 60
ServerTimeout = 0
SuppTimeout = 30
ReAuthMax = 2
MaxReq = 2
TxPeriod = 2
```

```

Dot1x Authenticator Client List
-----
Supplicant           = 0060.b057.4687
Session ID          = COA8013F0000000901BAB560
  Auth SM State     = AUTHENTICATED
  Auth BEND SM State = IDLE
Port Status         = AUTHORIZED

```

To determine if a host has been authenticated using MAB when fallback authentication is configured on the port, enter the following commands:

```
Switch# show authentication sessions interface g7/2
```

```

Interface: GigabitEthernet7/2
MAC Address: 0060.b057.4687
IP Address: 192.168.22.22
User-Name: 0060b0574687
Status: Authz Success
Domain: DATA
Oper host mode: multi-auth
Oper control dir: both
Authorized By: Authentication Server
Vlan Policy: N/A
Session timeout: N/A
Idle timeout: N/A
Common Session ID: COA8013F0000000B01BBD278
Acct Session ID: 0x0000000D
Handle: 0xF500000B

```

```

Runnable methods list:
Method State
dot1x Failed over
mab Authc Success

```

```
Switch# show mab interface g7/2 detail
```

```
MAB details for GigabitEthernet7/2
```

```
-----
Mac-Auth-Bypass = Enabled
```

```
MAB Client List
```

```
-----
Client MAC           = 0060.b057.4687
Session ID          = COA8013F0000000B01BBD278
MAB SM state       = TERMINATE
Auth Status        = AUTHORIZED

```

To determine if a host has been authenticated using web authentication when fallback authentication is configured on the port, enter the following commands:

```
Switch# show authentication sessions interface G4/3
```

```

Interface: GigabitEthernet4/3
MAC Address: 0015.e981.0531
IP Address: 10.5.63.13
Status: Authz Success
Domain: DATA
Oper host mode: single-host
Oper control dir: both
Authorized By: Authentication Server
Vlan Policy: N/A

```

```

Session timeout: N/A
Idle timeout: N/A
Common Session ID: 0A053F0F0000000200112FFC
Acct Session ID: 0x00000003
Handle: 0x09000002

```

```

Runnable methods list:
Method State
dot1x Failed over
mab Failed over
webauth Authc Success

```

```

Switch# show ip admission cache
Authentication Proxy Cache
Total Sessions: 1 Init Sessions: 0
Client IP 10.5.63.13 Port 4643, timeout 1000, state ESTAB

```

### Cisco IOS Release 12.2(46)SG or earlier

```

Switch(config)# ip admission name rule1 proxy http
Switch(config)# fallback profile fallback1
Switch(config-fallback-profile)# ip access-group default-policy in
Switch(config-fallback-profile)# ip admission rule1
Switch(config-fallback-profile)# exit
Switch(config)# interface gigabit5/9
Switch(config-if)# switchport mode access
Switch(config-if)# dot1x port-control auto
Switch(config-if)# dot1x pae authenticator
Switch(config-if)# authentication order dot1x mab webauth
Switch(config-if)# dot1x mac-auth-bypass eap
Switch(config-if)# adot1x fallback fallback1
Switch(config-if)# exit
Switch(config)# ip device tracking
Switch(config)# exit

```

## Enabling Periodic Reauthentication

You can enable periodic 802.1X client reauthentication and specify how often it occurs. If you do not specify a time value before enabling reauthentication, the interval between reauthentication attempts is 3600 seconds.

Automatic 802.1X client reauthentication is a per-interface setting and can be set for clients connected to individual ports. To manually reauthenticate the client connected to a specific port, see the [“Changing the Quiet Period”](#) section on page 39-62.

To enable periodic reauthentication of the client and to configure the number of seconds between reauthentication attempts, perform this task:

|        | Command                                                     | Purpose                                                                                                                                                  |
|--------|-------------------------------------------------------------|----------------------------------------------------------------------------------------------------------------------------------------------------------|
| Step 1 | Switch# <b>configure terminal</b>                           | Enters global configuration mode.                                                                                                                        |
| Step 2 | Switch(config)# <b>interface</b><br><i>interface-id</i>     | Enters interface configuration mode and specifies the interface to be enabled for periodic reauthentication.                                             |
| Step 3 | Switch(config-if)# <b>switchport mode</b><br><b>access</b>  | Specifies a nontrunking, nontagged single VLAN Layer 2 interface.                                                                                        |
| Step 4 | Switch(config-if)# <b>dot1x pae</b><br><b>authenticator</b> | Enables 802.1X authentication on the port with default parameters.<br>Refer to the <a href="#">“Default 802.1X Configuration”</a> section on page 39-23. |

|        | Command                                                                                                                                                                                                               | Purpose                                                                                                                                                                                                                                                                                                                                             |
|--------|-----------------------------------------------------------------------------------------------------------------------------------------------------------------------------------------------------------------------|-----------------------------------------------------------------------------------------------------------------------------------------------------------------------------------------------------------------------------------------------------------------------------------------------------------------------------------------------------|
| Step 5 | <b>Cisco IOS Release 12.2(50)SG and later</b><br>Switch(config-if)# <b>authentication periodic</b>                                                                                                                    | Enables periodic reauthentication of the client, which is disabled by default.                                                                                                                                                                                                                                                                      |
|        | <b>Cisco IOS Release 12.2(46)SG or earlier releases</b><br>Switch(config-if)# <b>dot1x reauthenticator</b>                                                                                                            | To disable periodic reauthentication, use the <b>no authentication periodic</b> interface configuration command (for earlier releases, use the <b>no dot1x reauthentication</b> interface configuration command).                                                                                                                                   |
| Step 6 | <b>Cisco IOS Release 12.2(50)SG and later</b><br>Switch(config-if)# <b>authentication timer reauthenticate {seconds / server}</b>                                                                                     | Specifies the number of seconds between reauthentication attempts or have the switch use a RADIUS-provided session timeout.<br><br>The range is 1 to 65,535; the default is 3600 seconds.                                                                                                                                                           |
|        | <b>Cisco IOS Release 12.2(46)SG or earlier releases</b><br>Switch(config-if)# <b>dot1x timeout reauth-period {seconds / server}</b>                                                                                   | To return to the default number of seconds between reauthentication attempts, use the <b>no authentication timer reauthenticate</b> global configuration command (for earlier releases, use the <b>dot1x timeout reauth-attempts</b> command).<br><br>This command affects the behavior of the switch only if periodic reauthentication is enabled. |
| Step 7 | <b>Cisco IOS Release 12.2(50)SG</b><br>Switch(config-if)# <b>authentication port-control auto</b><br><br><b>Cisco IOS Release 12.2(46)SG or earlier releases</b><br>Switch(config-if)# <b>dot1x port-control auto</b> | Enables 802.1X authentication on the interface.                                                                                                                                                                                                                                                                                                     |
| Step 8 | Switch(config-if)# <b>end</b>                                                                                                                                                                                         | Returns to privileged EXEC mode.                                                                                                                                                                                                                                                                                                                    |

This example shows how to enable periodic reauthentication and set the number of seconds between reauthentication attempts to 4000:

#### Cisco IOS Release 12.2(50)SG

```
Switch# configure terminal
Switch(config)# interface fastethernet5/9
Switch(config-if)# switchport mode access
Switch(config-if)# dot1x pae authenticator
Switch(config-if)# authentication periodic
Switch(config-if)# authentication timer reauthenticate 4000
Switch(config-if)# authentication port-control auto
Switch(config-if)# end
Switch#
```

#### Cisco IOS Release 12.2(46)SG or earlier

```
Switch# configure terminal
Switch(config)# interface fastethernet5/9
Switch(config-if)# switchport mode access
Switch(config-if)# dot1x pae authenticator
Switch(config-if)# dot1x reauthentication
Switch(config-if)# dot1x timeout reauth-period 4000
Switch(config-if)# dot1x port-control auto
Switch(config-if)# end
Switch#
```

## Enabling Multiple Hosts

You can attach multiple hosts (clients) to a single 802.1X-enabled port as shown in [Figure 39-7 on page 39-21](#). In this mode, when the port is authorized, all other hosts that are indirectly attached to the port are granted access to the network. If the port becomes unauthorized (reauthentication fails or an EAPOL-logoff message is received), the switch denies access to the network for all wireless access point-attached clients.

To allow multiple hosts (clients) on an 802.1X-authorized port that has the **dot1x port-control** interface configuration command set to **auto**, perform this task:

|        | Command                                                                                                                                                                                                                     | Purpose                                                                                                                                                                                                                                                                                                                                                                                                                                                 |
|--------|-----------------------------------------------------------------------------------------------------------------------------------------------------------------------------------------------------------------------------|---------------------------------------------------------------------------------------------------------------------------------------------------------------------------------------------------------------------------------------------------------------------------------------------------------------------------------------------------------------------------------------------------------------------------------------------------------|
| Step 1 | Switch# <b>configure terminal</b>                                                                                                                                                                                           | Enters global configuration mode.                                                                                                                                                                                                                                                                                                                                                                                                                       |
| Step 2 | Switch(config)# <b>interface interface-id</b>                                                                                                                                                                               | Enters interface configuration mode and specifies the interface to which multiple hosts are indirectly attached.                                                                                                                                                                                                                                                                                                                                        |
| Step 3 | Switch(config-if)# <b>switchport mode access</b>                                                                                                                                                                            | Specifies a nontrunking, nontagged single VLAN Layer 2 interface.                                                                                                                                                                                                                                                                                                                                                                                       |
| Step 4 | Switch(config-if)# <b>dot1x pae authenticator</b>                                                                                                                                                                           | Enables 802.1X authentication on the port with default parameters. Refer to the “ <a href="#">Default 802.1X Configuration</a> ” section on page 39-23.                                                                                                                                                                                                                                                                                                 |
| Step 5 | <b>Cisco IOS Release 12.2(50)SG</b><br>Switch(config-if)# <b>authentication host-mode multi-host</b><br><br><b>Cisco IOS Release 12.2(46)SG or earlier releases</b><br>Switch(config-if)# <b>dot1x host-mode multi-host</b> | Allows multiple hosts (clients) on an 802.1X-authorized port.<br><b>Note</b> Ensure that the <b>dot1x port-control</b> interface configuration command set is set to <b>auto</b> for the specified interface.<br><br>To disable multiple hosts on the port, use the <b>no authentication host-mode multi-host</b> interface configuration command (for earlier releases, use the <b>no dot1x host-mode multi-host</b> interface configuration command). |
| Step 6 | <b>Cisco IOS Release 12.2(50)SG</b><br>Switch(config-if)# <b>authentication port-control auto</b><br><br><b>Cisco IOS Release 12.2(46)SG or earlier releases</b><br>Switch(config-if)# <b>dot1x port-control auto</b>       | Enables 802.1X authentication on the interface.                                                                                                                                                                                                                                                                                                                                                                                                         |
| Step 7 | Switch(config-if)# <b>end</b>                                                                                                                                                                                               | Returns to privileged EXEC mode.                                                                                                                                                                                                                                                                                                                                                                                                                        |
| Step 8 | Switch# <b>show dot1x all interface interface-id</b>                                                                                                                                                                        | Verifies your entries.                                                                                                                                                                                                                                                                                                                                                                                                                                  |
| Step 9 | Switch# <b>copy running-config startup-config</b>                                                                                                                                                                           | (Optional) Saves your entries in the configuration file.                                                                                                                                                                                                                                                                                                                                                                                                |

This example shows how to enable 802.1X on Fast Ethernet interface 5/9 and to allow multiple hosts:

### Cisco IOS Release 12.2(50)SG

```
Switch# configure terminal
Switch(config)# interface fastethernet5/9
Switch(config-if)# switchport mode access
Switch(config-if)# dot1x pae authenticator
Switch(config-if)# authentication host-mode multi-host
Switch(config-if)# authentication port-control auto
Switch(config-if)# end
Switch#
```

**Cisco IOS Release 12.2(46)SG or earlier**

```
Switch# configure terminal
Switch(config)# interface fastethernet5/9
Switch(config-if)# switchport mode access
Switch(config-if)# dot1x pae authenticator
Switch(config-if)# dot1x host-mode multi-host
Switch(config-if)# dot1x port-control auto
Switch(config-if)# end
Switch#
```

## Changing the Quiet Period

When the switch cannot authenticate the client, the switch remains idle for a set period of time, and then tries again. The idle time is determined by the **quiet-period** value. A failed authentication of the client might occur because the client provided an invalid password. You can provide a faster response time to the user by entering a number smaller than the default.

To change the quiet period, perform this task:

|               | <b>Command</b>                                                                | <b>Purpose</b>                                                                                                                                                                                                                                                                                                          |
|---------------|-------------------------------------------------------------------------------|-------------------------------------------------------------------------------------------------------------------------------------------------------------------------------------------------------------------------------------------------------------------------------------------------------------------------|
| <b>Step 1</b> | Switch# <b>configure terminal</b>                                             | Enters global configuration mode.                                                                                                                                                                                                                                                                                       |
| <b>Step 2</b> | Switch(config)# <b>interface</b><br><i>interface-id</i>                       | Enters interface configuration mode and specifies the interface to be enabled for timeout <b>quiet-period</b> .                                                                                                                                                                                                         |
| <b>Step 3</b> | Switch(config-if)# <b>switchport mode</b><br><b>access</b>                    | Specifies a nontrunking, nontagged single VLAN Layer 2 interface.                                                                                                                                                                                                                                                       |
| <b>Step 4</b> | Switch(config-if)# <b>dot1x pae</b><br><b>authenticator</b>                   | Enables 802.1X authentication on the port with default parameters.<br>Refer to the <a href="#">“Default 802.1X Configuration” section on page 39-23</a> .                                                                                                                                                               |
| <b>Step 5</b> | Switch(config-if)# <b>dot1x timeout</b><br><b>quiet-period</b> <i>seconds</i> | Sets the number of seconds that the switch remains in the <b>quiet-period</b> following a failed authentication exchange with the client.<br><br>To return to the default quiet-period, use the <b>no dot1x timeout quiet-period</b> configuration command.<br><br>The range is 0 to 65,535 seconds; the default is 60. |
| <b>Step 6</b> | Switch(config-if)# <b>authentication</b><br><b>port-control auto</b>          | Enables 802.1X authentication on the interface.                                                                                                                                                                                                                                                                         |
| <b>Step 7</b> | Switch(config-if)# <b>end</b>                                                 | Returns to privileged EXEC mode.                                                                                                                                                                                                                                                                                        |
| <b>Step 8</b> | Switch# <b>show dot1x all</b>                                                 | Verifies your entries.                                                                                                                                                                                                                                                                                                  |
| <b>Step 9</b> | Switch# <b>copy running-config</b><br><b>startup-config</b>                   | (Optional) Saves your entries in the configuration file.                                                                                                                                                                                                                                                                |

This example shows how to set the quiet period on the switch to 30 seconds:

**Cisco IOS Release 12.2(50)SG**

```
Switch# configure terminal
Switch(config)# interface fastethernet4/1
Switch(config-if)# switchport mode access
Switch(config-if)# dot1x pae authenticator
```

```
Switch(config-if)# dot1x timeout quiet-period 30
Switch(config-if)# authentication port-control auto
Switch(config-if)# end
Switch#
```

### Cisco IOS Release 12.2(46)SG or earlier

```
Switch# configure terminal
Switch(config)# interface fastethernet4/1
Switch(config-if)# switchport mode access
Switch(config-if)# dot1x pae authenticator
Switch(config-if)# dot1x timeout quiet-period 30
Switch(config-if)# dot1x port-control auto
Switch(config-if)# end
Switch#
```

## Changing the Switch-to-Client Retransmission Time

The client responds to the EAP-request/identity frame from the switch with an EAP-response/identity frame. If the switch does not receive this response, it waits a set period of time (known as the retransmission time) and then retransmits the frame.



### Note

You should change the default value of this command only to adjust for unusual circumstances, such as unreliable links or specific behavioral problems with certain clients and authentication servers.

To change the amount of time that the switch waits for client notification, perform this task:

|        | Command                                                                                                                                                                                                                                             | Purpose                                                                                                                                                                                                                                                                                                                                         |
|--------|-----------------------------------------------------------------------------------------------------------------------------------------------------------------------------------------------------------------------------------------------------|-------------------------------------------------------------------------------------------------------------------------------------------------------------------------------------------------------------------------------------------------------------------------------------------------------------------------------------------------|
| Step 1 | Switch# <b>configure terminal</b>                                                                                                                                                                                                                   | Enters global configuration mode.                                                                                                                                                                                                                                                                                                               |
| Step 2 | Switch(config)# <b>interface</b><br><i>interface-id</i>                                                                                                                                                                                             | Enters interface configuration mode and specifies the interface to be enabled for timeout tx-period.                                                                                                                                                                                                                                            |
| Step 3 | Switch(config-if)# <b>switchport mode</b><br><b>access</b>                                                                                                                                                                                          | Specifies a nontrunking, nontagged single VLAN Layer 2 interface.                                                                                                                                                                                                                                                                               |
| Step 4 | Switch(config-if)# <b>dot1x pae</b><br><b>authenticator</b>                                                                                                                                                                                         | Enables 802.1X authentication on the port with default parameters.<br>Refer to the “ <a href="#">Default 802.1X Configuration</a> ” section on page 39-23.                                                                                                                                                                                      |
| Step 5 | Switch(config-if)# <b>dot1x timeout</b><br><b>tx-period</b> <i>seconds</i>                                                                                                                                                                          | Sets the number of seconds that the switch waits for a response to an EAP-request/identity frame from the client before retransmitting the request.<br><br>The range is 1 to 65,535 seconds; the default is 30.<br><br>To return to the default retransmission time, use the <b>no dot1x timeout tx-period</b> interface configuration command. |
| Step 6 | <b>Cisco IOS Release 12.2(50)SG</b><br>Switch(config-if)# <b>authentication</b><br><b>port-control auto</b><br><br><b>Cisco IOS Release 12.2(46)SG or earlier</b><br><b>releases</b><br>Switch(config-if)# <b>dot1x</b><br><b>port-control auto</b> | Enables 802.1X authentication on the interface.                                                                                                                                                                                                                                                                                                 |
| Step 7 | Switch(config-if)# <b>end</b>                                                                                                                                                                                                                       | Returns to privileged EXEC mode.                                                                                                                                                                                                                                                                                                                |

|        | Command                                           | Purpose                                                  |
|--------|---------------------------------------------------|----------------------------------------------------------|
| Step 8 | Switch# <b>show dot1x all</b>                     | Verifies your entries.                                   |
| Step 9 | Switch# <b>copy running-config startup-config</b> | (Optional) Saves your entries in the configuration file. |

This example shows how to set the retransmission time to 60 seconds:

#### Cisco IOS Release 12.2(50)SG

```
Switch# configure terminal
Switch(config)# interface fastethernet5/9
Switch(config-if)# switchport mode access
Switch(config-if)# dot1x pae authenticator
Switch(config-if)# dot1x timeout tx-period 60
Switch(config-if)# authentication port-control auto
Switch(config-if)# end
Switch#
```

#### Cisco IOS Release 12.2(46)SG or earlier

```
Switch# configure terminal
Switch(config)# interface fastethernet5/9
Switch(config-if)# switchport mode access
Switch(config-if)# dot1x pae authenticator
Switch(config-if)# dot1x timeout tx-period 60
Switch(config-if)# dot1x port-control auto
Switch(config-if)# end
Switch#
```

## Setting the Switch-to-Client Frame-Retransmission Number

In addition to changing the switch-to-client retransmission times, you can change the number of times that the switch sends EAP-Request/Identity and other EAP-Request frames to the client before restarting the authentication process. The number of EAP-Request/Identity retransmissions is controlled by the **dot1x max-reauth-req** command; the number of retransmissions for other EAP-Request frames is controlled by the **dot1x max-req** command.



### Note

You should change the default values of these commands only to adjust for unusual circumstances such as unreliable links or specific behavioral problems with certain clients and authentication servers.

To set the switch-to-client frame-retransmission numbers, perform this task:

|        | Command                                           | Purpose                                                                                                                                               |
|--------|---------------------------------------------------|-------------------------------------------------------------------------------------------------------------------------------------------------------|
| Step 1 | Switch# <b>configure terminal</b>                 | Enters global configuration mode.                                                                                                                     |
| Step 2 | Switch(config)# <b>interface interface-id</b>     | Enters interface configuration mode and specifies the interface to be enabled for <b>max-reauth-req</b> and/or <b>max-req</b> .                       |
| Step 3 | Switch(config-if)# <b>switchport mode access</b>  | Specifies a non-trunking, nontagged single VLAN Layer 2 interface.                                                                                    |
| Step 4 | Switch(config-if)# <b>dot1x pae authenticator</b> | Enables 802.1X authentication on the port with default parameters. Refer to the <a href="#">“Default 802.1X Configuration”</a> section on page 39-23. |



|        | Command                                                                                              | Purpose                                                                                                                                                                                                                                                                                                                                                                                                                                                                                                                                                                                                                                                                                                                                                                                                                                                                   |
|--------|------------------------------------------------------------------------------------------------------|---------------------------------------------------------------------------------------------------------------------------------------------------------------------------------------------------------------------------------------------------------------------------------------------------------------------------------------------------------------------------------------------------------------------------------------------------------------------------------------------------------------------------------------------------------------------------------------------------------------------------------------------------------------------------------------------------------------------------------------------------------------------------------------------------------------------------------------------------------------------------|
| Step 5 | <pre>Switch(config-if)# dot1x max-req count  or  Switch(config-if)# dot1x max-reauth-req count</pre> | <p>Specifies the number of times EAPOL DATA packets are re-transmitted (if lost or not replied to). For example, if you have a supplicant in the midst of authenticating and it experiences a problem, the authenticator re-transmits requests for data three times before abandoning the authentication request. The range for <i>count</i> is 1 to 10; the default is 2.</p> <p>Specifies the timer for EAPOL-Identity-Request frames (only). If you plug in a device incapable of 802.1X, three EAPOL-Id-Req frames are sent before the state machine resets. Alternatively, if you have configured Guest-VLAN, three frames are sent before the port is enabled. This parameter has a default value of 2.</p> <p>To return to the default retransmission number, use the <b>no dot1x max-req</b> and <b>no dot1x max-reauth-req</b> global configuration command.</p> |
| Step 6 | <pre>Switch(config-if)# authentication port-control auto</pre>                                       | Enables 802.1X authentication on the interface.                                                                                                                                                                                                                                                                                                                                                                                                                                                                                                                                                                                                                                                                                                                                                                                                                           |
| Step 7 | <pre>Switch(config-if)# end</pre>                                                                    | Returns to privileged EXEC mode.                                                                                                                                                                                                                                                                                                                                                                                                                                                                                                                                                                                                                                                                                                                                                                                                                                          |
| Step 8 | <pre>Switch# show dot1x all</pre>                                                                    | Verifies your entries.                                                                                                                                                                                                                                                                                                                                                                                                                                                                                                                                                                                                                                                                                                                                                                                                                                                    |
| Step 9 | <pre>Switch# copy running-config startup-config</pre>                                                | (Optional) Saves your entries in the configuration file.                                                                                                                                                                                                                                                                                                                                                                                                                                                                                                                                                                                                                                                                                                                                                                                                                  |

This example shows how to set 5 as the number of times that the switch retransmits an EAP-request/identity request before restarting the authentication process:

#### Cisco IOS Release 12.2(50)SG

```
Switch# configure terminal
Switch(config)# interface fastethernet5/9
Switch(config-if)# switchport mode access
Switch(config-if)# dot1x pae authenticator
Switch(config-if)# dot1x max-reauth-req 5
Switch(config-if)# authentication port-control auto
Switch(config-if)# end
Switch#
```

#### Cisco IOS Release 12.2(46)SG or earlier

```
Switch# configure terminal
Switch(config)# interface fastethernet5/9
Switch(config-if)# switchport mode access
Switch(config-if)# dot1x pae authenticator
Switch(config-if)# dot1x max-reauth-req 5
Switch(config-if)# dot1x port-control auto
Switch(config-if)# end
Switch#
```

## Manually Reauthenticating a Client Connected to a Port

You can manually reauthenticate a client connected to a specific port at any time by entering the **dot1x re-authenticate interface** privileged EXEC command. If you want to enable or disable periodic reauthentication, see the “[Enabling Periodic Reauthentication](#)” section on page 39-59.

This example shows how to manually reauthenticate the client connected to Fast Ethernet port 1/1:

```
Switch# dot1x re-authenticate interface fastethernet1/1
Starting reauthentication on FastEthernet1/1
```

## Initializing the 802.1X Authentication State

The **dot1x initialize** command causes the authentication process to be restarted irrespective of the state it is in currently.

This example shows how to restart the authentication process on Fast Ethernet port 1/1:

```
Switch# dot1x initialize interface fastethernet1/1
```

This example shows how to restart the authentication process on all ports of the switch:

```
Switch# dot1x initialize
```

## Removing 802.1X Client Information

The **clear dot1x** command causes all existing supplicants to be completely deleted from an interface or from all the interfaces on a switch.

This example shows how to remove 802.1X client information on Fast Ethernet port 1/1:

```
Switch# clear dot1x interface fastethernet1/1
```

This example shows how to remove 802.1X client information on all ports of the switch:

```
Switch# clear dot1x all
```

## Resetting the 802.1X Configuration to the Default Values

To reset the 802.1X configuration to the default values, perform this task:

|        | Command                                           | Purpose                                                          |
|--------|---------------------------------------------------|------------------------------------------------------------------|
| Step 1 | Switch# <b>configure terminal</b>                 | Enters global configuration mode.                                |
| Step 2 | Switch(config)# <b>dot1x default</b>              | Resets the configurable 802.1X parameters to the default values. |
| Step 3 | Switch(config)# <b>end</b>                        | Returns to privileged EXEC mode.                                 |
| Step 4 | Switch# <b>show dot1x all</b>                     | Verifies your entries.                                           |
| Step 5 | Switch# <b>copy running-config startup-config</b> | (Optional) Saves your entries in the configuration file.         |

## Displaying 802.1X Statistics and Status

To display 802.1X statistics for all interfaces, use the **show dot1x all statistics** privileged EXEC command.

To display the 802.1X administrative and operational status for the switch, use the **show dot1x all details** privileged EXEC command. To display the 802.1X administrative and operational status for a specific interface, use the **show dot1x interface details** privileged EXEC command.

## Displaying Authentication Details

Topics in this section include:

- [Determining the Authentication Methods Registered with the Auth Manager, page 39-67](#)
- [Displaying the Auth Manager Summary for an Interface, page 39-67](#)
- [Displaying the Summary of All Auth Manager Sessions on the Switch, page 39-68](#)
- [Displaying a Summary of All Auth Manager Sessions on the Switch Authorized for a Specified Authentication Method, page 39-68](#)
- [Verifying the Auth Manager Session for an Interface, page 39-68](#)
- [Displaying MAB Details, page 39-70](#)

## Determining the Authentication Methods Registered with the Auth Manager

Enter the following:

```
Switch# show authentication registrations
Handle  Priority  Name
      3         0    dot1x
      2         1     mab
      1         2   webauth
```

## Displaying the Auth Manager Summary for an Interface

In the following example, MAB has been configured for a higher priority (lower value) than 802.1X:

```
Switch# show authentication int gi1/5
Client list:
Interface  MAC Address      Method  Domain  Status      Session ID
Gi1/5     000f.23c4.a401  mab     DATA   Authz Success 0A3462B10000000D24F80B58
Gi1/5     0014.bf5d.d26d  dot1x   DATA   Authz Success 0A3462B10000000E29811B94

Available methods list:
Handle  Priority  Name
      3         0    dot1x
      2         1     mab
Runnable methods list:
Handle  Priority  Name
      2         0     mab
      3         1    dot1x
```

## Displaying the Summary of All Auth Manager Sessions on the Switch

Enter the following:

```
Switch# show authentication sessions
Interface  MAC Address      Method  Domain  Status      Session ID
Gi1/48     0015.63b0.f676   dot1x   DATA   Authz Success 0A3462B1000000102983C05C
Gi1/5      000f.23c4.a401   mab     DATA   Authz Success 0A3462B10000000D24F80B58
Gi1/5      0014.bf5d.d26d   dot1x   DATA   Authz Success 0A3462B10000000E29811B94
```

## Displaying a Summary of All Auth Manager Sessions on the Switch Authorized for a Specified Authentication Method

Enter the following:

```
Switch# show authentication method dot1x
Interface  MAC Address      Method  Domain  Status      Session ID
Gi1/48     0015.63b0.f676   dot1x   DATA   Authz Success 0A3462B1000000102983C05C
Gi1/5      0014.bf5d.d26d   dot1x   DATA   Authz Success 0A3462B10000000E29811B94
```

## Verifying the Auth Manager Session for an Interface

The Auth manage session could be verified with the `show authentication sessions` command.

```
Switch# show authentication sessions int gi1/5
Interface: GigabitEthernet1/5
MAC Address: 000f.23c4.a401
IP Address: Unknown
User-Name: 000f23c4a401
Status: Authz Success
Domain: DATA
Oper host mode: multi-auth
Oper control dir: both
Authorized By: Authentication Server
Vlan Policy: N/A
Session timeout: N/A
Idle timeout: N/A
Common Session ID: 0A3462B10000000D24F80B58
Acct Session ID: 0x0000000F
Handle: 0x2400000D
Runnable methods list:
Method State
dot1x Failed over
mab Authc Success
-----
Interface: GigabitEthernet1/5
MAC Address: 0014.bf5d.d26d
IP Address: 20.0.0.7
User-Name: johndoe
Status: Authz Success
Domain: DATA
Oper host mode: multi-auth
Oper control dir: both
Authorized By: Authentication Server
Vlan Policy: N/A
Session timeout: N/A
```

```
Idle timeout: N/A
Common Session ID: 0A3462B10000000E29811B94
Acct Session ID: 0x00000010
Handle: 0x1100000E
Runnable methods list:
Method State
dot1x Authc Success
mab Not run
```

The individual output could be further refined with the **handle**, **interface**, **MAC**, **session-id**, or **method** keywords:

```
Switch# show authentication sessions mac 000f.23c4.a401
Interface: GigabitEthernet1/5
MAC Address: 000f.23c4.a401
IP Address: Unknown
User-Name: 000f23c4a401
Status: Authz Success
Domain: DATA
Oper host mode: multi-auth
Oper control dir: both
Authorized By: Authentication Server
Vlan Policy: N/A
Session timeout: N/A
Idle timeout: N/A
Common Session ID: 0A3462B10000000D24F80B58
Acct Session ID: 0x0000000F
Handle: 0x2400000D
Runnable methods list:
Method State
dot1x Failed over
mab Authc Success
```

```
Switch# show authentication sessions session-id 0A3462B10000000D24F80B58
Interface: GigabitEthernet1/5
MAC Address: 000f.23c4.a401
IP Address: Unknown
User-Name: 000f23c4a401
Status: Authz Success
Domain: DATA
Oper host mode: multi-auth
Oper control dir: both
Authorized By: Authentication Server
Vlan Policy: N/A
Session timeout: N/A
Idle timeout: N/A
Common Session ID: 0A3462B10000000D24F80B58
Acct Session ID: 0x0000000F
Handle: 0x2400000D
Runnable methods list:
Method State
dot1x Failed over
mab uthc Success
```

```
Switch# show authentication session method dot1x int gi1/5
Interface: GigabitEthernet1/5
MAC Address: 0014.bf5d.d26d
IP Address: 20.0.0.7
User-Name: johndoe
Status: Authz Success
Domain: DATA
```

```

Oper host mode: multi-auth
Oper control dir: both
Authorized By: Authentication Server
Vlan Policy: N/A
Session timeout: N/A
Idle timeout: N/A
Common Session ID: 0A3462B10000000E29811B94
Acct Session ID: 0x00000010
Handle: 0x1100000E
Runnable methods list:
Method State
dot1x Authc Success
mab Not run

```

## Displaying MAB Details

Enter one of the following commands:

```

Switch# show mab all
MAB details for FastEthernet5/9
-----
Mac-Auth-Bypass           = Enabled
Inactivity Timeout        = None

Switch# show mab all detail
MAB details for FastEthernet5/9
-----
Mac-Auth-Bypass           = Enabled
Inactivity Timeout        = None
MAB Client List
-----
Client MAC                 = 000f.23c4.a401
MAB SM state               = TERMINATE
Auth Status                = AUTHORIZED

Switch# show mab int fa5/9
MAB details for FastEthernet5/9
-----
Mac-Auth-Bypass           = Enabled
Inactivity Timeout        = None

Switch# show mab int fa5/9 detail
MAB details for FastEthernet5/9
-----
Mac-Auth-Bypass           = Enabled
Inactivity Timeout        = None
MAB Client List
-----
Client MAC                 = 000f.23c4.a401
MAB SM state               = TERMINATE
Auth Status                = AUTHORIZED

```