



## **Multiprotocol Label Switching (MPLS) Configuration Guide, Cisco IOS XE Bengaluru 17.5.x (Catalyst 9300 Switches)**

**First Published:** 2021-03-31

### **Americas Headquarters**

Cisco Systems, Inc.  
170 West Tasman Drive  
San Jose, CA 95134-1706  
USA  
<http://www.cisco.com>  
Tel: 408 526-4000  
800 553-NETS (6387)  
Fax: 408 527-0883

THE SPECIFICATIONS AND INFORMATION REGARDING THE PRODUCTS IN THIS MANUAL ARE SUBJECT TO CHANGE WITHOUT NOTICE. ALL STATEMENTS, INFORMATION, AND RECOMMENDATIONS IN THIS MANUAL ARE BELIEVED TO BE ACCURATE BUT ARE PRESENTED WITHOUT WARRANTY OF ANY KIND, EXPRESS OR IMPLIED. USERS MUST TAKE FULL RESPONSIBILITY FOR THEIR APPLICATION OF ANY PRODUCTS.

THE SOFTWARE LICENSE AND LIMITED WARRANTY FOR THE ACCOMPANYING PRODUCT ARE SET FORTH IN THE INFORMATION PACKET THAT SHIPPED WITH THE PRODUCT AND ARE INCORPORATED HEREIN BY THIS REFERENCE. IF YOU ARE UNABLE TO LOCATE THE SOFTWARE LICENSE OR LIMITED WARRANTY, CONTACT YOUR CISCO REPRESENTATIVE FOR A COPY.

The Cisco implementation of TCP header compression is an adaptation of a program developed by the University of California, Berkeley (UCB) as part of UCB's public domain version of the UNIX operating system. All rights reserved. Copyright © 1981, Regents of the University of California.

NOTWITHSTANDING ANY OTHER WARRANTY HEREIN, ALL DOCUMENT FILES AND SOFTWARE OF THESE SUPPLIERS ARE PROVIDED "AS IS" WITH ALL FAULTS. CISCO AND THE ABOVE-NAMED SUPPLIERS DISCLAIM ALL WARRANTIES, EXPRESSED OR IMPLIED, INCLUDING, WITHOUT LIMITATION, THOSE OF MERCHANTABILITY, FITNESS FOR A PARTICULAR PURPOSE AND NON-INFRINGEMENT OR ARISING FROM A COURSE OF DEALING, USAGE, OR TRADE PRACTICE.

IN NO EVENT SHALL CISCO OR ITS SUPPLIERS BE LIABLE FOR ANY INDIRECT, SPECIAL, CONSEQUENTIAL, OR INCIDENTAL DAMAGES, INCLUDING, WITHOUT LIMITATION, LOST PROFITS OR LOSS OR DAMAGE TO DATA ARISING OUT OF THE USE OR INABILITY TO USE THIS MANUAL, EVEN IF CISCO OR ITS SUPPLIERS HAVE BEEN ADVISED OF THE POSSIBILITY OF SUCH DAMAGES.

Any Internet Protocol (IP) addresses and phone numbers used in this document are not intended to be actual addresses and phone numbers. Any examples, command display output, network topology diagrams, and other figures included in the document are shown for illustrative purposes only. Any use of actual IP addresses or phone numbers in illustrative content is unintentional and coincidental.

All printed copies and duplicate soft copies of this document are considered uncontrolled. See the current online version for the latest version.

Cisco has more than 200 offices worldwide. Addresses and phone numbers are listed on the Cisco website at [www.cisco.com/go/offices](http://www.cisco.com/go/offices).

Cisco and the Cisco logo are trademarks or registered trademarks of Cisco and/or its affiliates in the U.S. and other countries. To view a list of Cisco trademarks, go to this URL: [www.cisco.com go trademarks](http://www.cisco.com/go/trademarks). Third-party trademarks mentioned are the property of their respective owners. The use of the word partner does not imply a partnership relationship between Cisco and any other company. (1721R)

© 2021 Cisco Systems, Inc. All rights reserved.



## CONTENTS

---

### CHAPTER 1

#### **Configuring Multiprotocol Label Switching (MPLS) 1**

- Multiprotocol Label Switching 1
- Restrictions for Multiprotocol Label Switching 1
- Information about Multiprotocol Label Switching 1
  - Functional Description of Multiprotocol Label Switching 2
  - Label Switching Functions 2
  - Distribution of Label Bindings 2
  - MPLS Layer 3 VPN 3
  - Classifying and Marking MPLS QoS EXP 3
- How to Configure Multiprotocol Label Switching 3
  - Configuring a Switch for MPLS Switching 4
  - Configuring a Switch for MPLS Forwarding 4
- Verifying Multiprotocol Label Switching Configuration 5
  - Verifying Configuration of MPLS Switching 5
  - Verifying Configuration of MPLS Forwarding 6
- Additional References for Multiprotocol Label Switching 8
- Feature History for Multiprotocol Label Switching 8

---

### CHAPTER 2

#### **Configuring MPLS Layer 3 VPN 9**

- MPLS Layer 3 VPNs 9
  - Prerequisites for MPLS Virtual Private Networks 9
  - Restrictions for MPLS Virtual Private Networks 10
  - Information About MPLS Virtual Private Networks 11
    - MPLS Virtual Private Network Definition 12
    - How an MPLS Virtual Private Network Works 13
    - Major Components of an MPLS Virtual Private Network 13

Benefits of an MPLS Virtual Private Network	13
How to Configure MPLS Virtual Private Networks	15
Configuring the Core Network	15
Connecting the MPLS Virtual Private Network Customers	16
Verifying the Virtual Private Network Configuration	19
Verifying Connectivity Between MPLS Virtual Private Network Sites	19
Configuration Examples for MPLS Virtual Private Networks	20
Example: Configuring an MPLS Virtual Private Network Using RIP	21
Example: Configuring an MPLS Virtual Private Network Using Static Routes	22
Example: Configuring an MPLS Virtual Private Network Using BGP	23
Additional References	25
Feature History for MPLS Virtual Private Networks	25

**CHAPTER 3****Configuring eBGP and iBGP Multipath 27**

BGP Multipath Load Sharing for Both eBGP and iBGP in an MPLS-VPN	27
Prerequisites for BGP Multipath Load Sharing for Both eBGP and iBGP in an MPLS-VPN	27
Restrictions for BGP Multipath Load Sharing for Both eBGP and iBGP in an MPLS-VPN	27
Information About BGP Multipath Load Sharing for Both eBGP and iBGP in an MPLS-VPN	28
Multipath Load Sharing Between eBGP and iBGP	28
eBGP and iBGP Multipath Load Sharing in a BGP MPLS Network	29
Benefits of Multipath Load Sharing for Both eBGP and iBGP	29
How to Configure BGP Multipath Load Sharing for Both eBGP and iBGP in an MPLS-VPN	30
Configuring Multipath Load Sharing for Both eBGP and iBGP	30
Verifying Multipath Load Sharing for Both eBGP and iBGP	31
Configuration Examples for the BGP Multipath Load Sharing for Both eBGP and iBGP in an MPLS-VPN	31
eBGP and iBGP Multipath Load Sharing Configuration Example	32
Feature Information for BGP Multipath Load Sharing for Both eBGP and iBGP in an MPLS-VPN	32

**CHAPTER 4****Configuring EIGRP MPLS VPN PE-CE Site of Origin 33**

EIGRP MPLS VPN PE-CE Site of Origin	33
Prerequisites for EIGRP MPLS VPN PE-CE Site of Origin	33
Restrictions for EIGRP MPLS VPN PE-CE Site of Origin	33
Information About EIGRP MPLS VPN PE-CE Site of Origin	34

EIGRP MPLS VPN PE-CE Site of Origin Support Overview	34
Site of Origin Support for Backdoor Links	34
Router Interoperation with the Site of Origin Extended Community	35
Redistribution of BGP VPN Routes That Carry the Site of Origin into EIGRP	35
Benefits of the EIGRP MPLS VPN PE-CE Site of Origin Support Feature	35
How to Configure EIGRP MPLS VPN PE-CE Site of Origin Support	35
Configuring the Site of Origin Extended Community	36
Verifying the Configuration of the SoO Extended Community	38
Configuration Examples for EIGRP MPLS VPN PE-CE SoO	38
Example Configuring the Site of Origin Extended Community	38
Example Verifying the Site of Origin Extended Community	38
Feature History for EIGRP MPLS VPN PE-CE Site of Origin	39

**CHAPTER 5****Configuring Ethernet-over-MPLS and Pseudowire Redundancy 41**

Configuring Ethernet-over-MPLS	41
Prerequisites for Ethernet-over-MPLS	41
Restrictions for Ethernet-over-MPLS	41
Restrictions for Ethernet-over-MPLS Port Mode	42
Restrictions for EoMPLS VLAN Mode	42
Information About Ethernet-over-MPLS	43
How to Configure Ethernet-over-MPLS	43
Configuring Ethernet-over-MPLS Port Mode	43
Configuring Ethernet-over-MPLS VLAN Mode	47
Configuration Examples for Ethernet-over-MPLS	51
Configuring Pseudowire Redundancy	56
Prerequisites for Pseudowire Redundancy	56
Restrictions for Pseudowire Redundancy	56
Restrictions for Pseudowire Redundancy Port Mode	56
Restrictions for Pseudowire Redundancy VLAN Mode	57
Information About Pseudowire Redundancy	57
How to Configure Pseudowire Redundancy	57
Configuring Pseudowire Redundancy Port Mode	57
Configuring Pseudowire Redundancy VLAN Mode	62
Configuration Examples for Pseudowire Redundancy	68

Feature History for Ethernet-over-MPLS and Pseudowire Redundancy 71

---

**CHAPTER 6**

**Configuring IPv6 Provider Edge over MPLS (6PE) 73**

Prerequisites for 6PE 73

Restrictions for 6PE 73

Information About 6PE 73

Configuring 6PE 74

Configuration Examples for 6PE 77

Feature History for IPv6 Provider Edge over MPLS (6PE) 79

---

**CHAPTER 7**

**Configuring IPv6 VPN Provider Edge over MPLS (6VPE) 81**

Configuring 6VPE 81

Restrictions for 6VPE 81

Information About 6VPE 81

Configuration Examples for 6VPE 82

Feature History for IPv6 VPN Provider Edge over MPLS (6VPE) 86

---

**CHAPTER 8**

**Configuring MPLS VPN InterAS Options 87**

Information About MPLS VPN InterAS Options 87

ASes and ASBRs 87

MPLS VPN InterAS Options 88

InterAS Option B 88

InterAS Option AB 91

How to Configure MPLS VPN InterAS Options 94

Configuring MPLS VPN InterAS Option B 94

Configuring InterAS Option B using the Next-Hop-Self Method 94

Configuring InterAS Option B using Redistribute Connected Method 99

Configuring MPLS VPN Inter-AS Option AB 102

Configuring the VRFs on the ASBR Interface for Each VPN Customer 102

Configuring the MP-BGP Session Between ASBR Peers 103

Configuring the Routing Policy for VPNs that Need Inter-AS Connections 105

Changing an Inter-AS Option A Deployment to an Option AB Deployment 107

Verifying MPLS VPN InterAS Options Configuration 108

Configuration Examples for MPLS VPN InterAS Options 110

InterAS Option B	110
Next-Hop-Self Method	110
IGP Redistribute Connected Subnets Method	116
InterAS OptionAB	122
Additional References for MPLS VPN InterAS Options	126
Feature History for MPLS VPN InterAS Options	126

**CHAPTER 9**

<b>Configuring MPLS over GRE</b>	<b>129</b>
Prerequisites for MPLS over GRE	129
Restrictions for MPLS over GRE	129
Information About MPLS over GRE	130
PE-to-PE Tunneling	130
P-to-PE Tunneling	131
P-to-P Tunneling	131
How to Configure MPLS over GRE	131
Configuring the MPLS over GRE Tunnel Interface	131
Configuration Examples for MPLS over GRE	133
Example: PE-to-PE Tunneling	133
Example: P-to-PE Tunneling	134
Example: P-to-P Tunneling	135
Additional References for MPLS over GRE	136
Feature History for MPLS over GRE	136

**CHAPTER 10**

<b>Configuring MPLS Layer 2 VPN over GRE</b>	<b>139</b>
Information About MPLS Layer 2 VPN over GRE	139
Types of Tunneling Configurations	139
PE-to-PE Tunneling	139
P-to-PE Tunneling	140
P-to-P Tunneling	140
How to Configure MPLS Layer 3 VPN over GRE	141
Configuration Examples for MPLS Layer 2 VPN over GRE	142
Example: Configuring a GRE Tunnel That Spans a non-MPLS Network	142
Additional References for Configuring MPLS Layer 2 VPN over GRE	143
Feature History for Configuring MPLS Layer 2 VPN over GRE	143

---

<b>CHAPTER 11</b>	<b>Configuring MPLS Layer 3 VPN over GRE</b>	<b>145</b>
	Prerequisites for MPLS Layer 3 VPN over GRE	145
	Restrictions for MPLS Layer 3 VPN over GRE	145
	Information About MPLS Layer 3 VPN over GRE	146
	Types of Tunneling Configurations	146
	PE-to-PE Tunneling	146
	P-to-PE Tunneling	147
	P-to-P Tunneling	147
	How to Configure MPLS Layer 3 VPN over GRE	148
	Configuration Examples for MPLS Layer 3 VPN over GRE	149
	Example: Configuring MPLS Layer 3 VPN over GRE (PE-to-PE Tunneling)	149
	Example: Configuring MPLS Layer 3 VPN over GRE (P-to-PE Tunneling)	151
	Feature History for Configuring MPLS Layer 3 VPN over GRE	155

---

<b>CHAPTER 12</b>	<b>Configuring MPLS QoS</b>	<b>157</b>
	Classifying and Marking MPLS EXP	157
	Prerequisites for MPLS QoS	157
	Restrictions for MPLS QoS	157
	Information About MPLS QoS	158
	MPLS QoS Overview	158
	MPLS Experimental Field	158
	Benefits of MPLS EXP Classification and Marking	159
	How to Configure MPLS QoS	159
	Classifying MPLS Encapsulated Packets	159
	Marking MPLS EXP on the Outermost Label	160
	Marking MPLS EXP on Label Switched Packets	162
	Configuring Conditional Marking	163
	Configuring WRED for MPLS EXP	164
	Configuration Examples for MPLS QoS	165
	Example: Classifying MPLS Encapsulated Packets	165
	Example: Marking MPLS EXP on Outermost Label	166
	Example: Marking MPLS EXP on Label Switched Packets	167
	Example: Configuring Conditional Marking	167



Example: Configuring WRED for MPLS EXP	168
Additional References	168
Feature History for QoS MPLS EXP	168

**CHAPTER 13****Configuring MPLS Static Labels 171**

MPLS Static Labels	171
Prerequisites for MPLS Static Labels	171
Restrictions for MPLS Static Labels	171
Information About MPLS Static Labels	171
MPLS Static Labels Overview	171
Benefits of MPLS Static Labels	172
How to Configure MPLS Static Labels	172
Configuring MPLS Static Prefix Label Bindings	172
Verifying MPLS Static Prefix Label Bindings	173
Monitoring and Maintaining MPLS Static Labels	174
Configuration Examples for MPLS Static Labels	174
Example: Configuring MPLS Static Prefixes Labels	174
Additional References	175
Feature History for MPLS Static Labels	176

**CHAPTER 14****Configuring Virtual Private LAN Service (VPLS) and VPLS BGP-Based Autodiscovery 177**

Restrictions for VPLS	177
Information About VPLS, VPLS BGP-Based Autodiscovery and Flow-Aware Transport	177
VPLS Overview	178
About Full-Mesh Configuration	178
About VPLS BGP-Based Autodiscovery	179
About Flow-Aware Transport Pseudowire	179
Interoperability Between Cisco Catalyst 6000 Series Switches and Cisco Catalyst 9000 Series Switches	180
How to Configure VPLS, VPLS BGP-Based Autodiscovery and Flow-Aware Transport	181
Configuring Layer 2 PE Device Interfaces to CE Devices	181
Configuring 802.1Q Trunks on a PE Device for Tagged Traffic from a CE Device	181
Configuring 802.1Q Access Ports on a PE Device for Untagged Traffic from a CE Device	182
Configuring Layer 2 VLAN Instances on a PE Device	183

Configuring VPLS	184
Configuring VPLS in Xconnect Mode	184
Configuring VPLS in Protocol-CLI Mode	187
Configuring VPLS BGP-based Autodiscovery	194
Enabling VPLS BGP-based Autodiscovery	194
Configuring BGP to Enable VPLS Autodiscovery	195
Configuring VPLS BGP-based Autodiscovery in Protocol-CLI Mode	197
Configuration Examples for VPLS and VPLS BGP-Based Autodiscovery	201
Example: Configuring VPLS in Xconnect Mode	201
Examples: Verifying VPLS Configured in Xconnect Mode	202
Example: Configuring VPLS Flow-Aware Transport Using a Template (in Protocol-CLI Mode)	204
Example: Configuring VPLS BGP-Auto Discovery	205
Example: Verifying VPLS BGP-Auto Discovery	205
Feature History for VPLS and VPLS BGP-Based Autodiscovery	206

**CHAPTER 15**

<b>Configuring MPLS VPN Route Target Rewrite</b>	<b>207</b>
Prerequisites for MPLS VPN Route Target Rewrite	207
Restrictions for MPLS VPN Route Target Rewrite	207
Information About MPLS VPN Route Target Rewrite	207
Route Target Replacement Policy	207
Route Maps and Route Target Replacement	208
How to Configure MPLS VPN Route Target Rewrite	208
Configuring a Route Target Replacement Policy	208
Applying the Route Target Replacement Policy	212
Associating Route Maps with Specific BGP Neighbors	212
Verifying the Route Target Replacement Policy	214
Configuration Examples for MPLS VPN Route Target Rewrite	215
Examples: Applying Route Target Replacement Policies	215
Examples: Associating Route Maps with Specific BGP Neighbor	215
Feature History for MPLS VPN Route Target Rewrite	215

**CHAPTER 16**

<b>Configuring MPLS VPN-Inter-AS-IPv4 BGP Label Distribution</b>	<b>217</b>
MPLS VPN Inter-AS IPv4 BGP Label Distribution	217
Restrictions for MPLS VPN Inter-AS IPv4 BGP Label Distribution	218

Information About MPLS VPN Inter-AS IPv4 BGP Label Distribution	218
MPLS VPN Inter-AS IPv4 BGP Label Distribution Overview	218
BGP Routing Information	219
How BGP Sends MPLS Labels with Routes	219
Using Route Maps to Filter Routes	219
How to Configure MPLS VPN Inter-AS IPv4 BGP Label Distribution	220
Configuring the ASBRs to Exchange IPv4 Routes and MPLS Labels	220
Configuring the Route Reflectors to Exchange VPNv4 Routes	222
Configuring the Route Reflectors to Reflect Remote Routes in Its autonomous system	224
Creating Route Maps	226
Configuring a Route Map for Arriving Routes	227
Configuring a Route Map for Departing Routes	228
Applying the Route Maps to the ASBRs	230
Verifying the MPLS VPN Inter-AS IPv4 BGP Label Distribution Configuration	231
Verifying the Route Reflector Configuration	232
Verifying that CE1 Has Network Reachability Information for CE2	233
Verifying that PE1 Has Network Layer Reachability Information for CE2	233
Verifying that PE2 Has Network Reachability Information for CE2	235
Verifying the ASBR Configuration	236
Configuration Examples for MPLS VPN Inter-AS IPv4 BGP Label Distribution	237
Configuration Examples for Inter-AS Using BGP to Distribute Routes and MPLS Labels Over an MPLS VPN Service Provider	237
Example: Route Reflector 1 (MPLS VPN Service Provider)	238
Configuration Example: ASBR1 (MPLS VPN Service Provider)	239
Configuration Example: Route Reflector 2 (MPLS VPN Service Provider)	241
Configuration Example: ASBR2 (MPLS VPN Service Provider)	242
Configuration Examples: Inter-AS Using BGP to Distribute Routes and MPLS Labels Over a Non MPLS VPN Service Provider	243
Configuration Example: Route Reflector 1 (Non MPLS VPN Service Provider)	244
Configuration Example: ASBR1 (Non MPLS VPN Service Provider)	245
Configuration Example: Route Reflector 2 (Non MPLS VPN Service Provider)	247
Configuration Examples: ASBR2 (Non MPLS VPN Service Provider)	248
Configuration Example: ASBR3 (Non MPLS VPN Service Provider)	249
Configuration Example: Route Reflector 3 (Non MPLS VPN Service Provider)	250

Configuration Example: ASBR4 (Non MPLS VPN Service Provider) 251  
 Feature History for Configuring MPLS VPN Inter-AS IPv4 BGP Label Distribution 253

**CHAPTER 17**

**Configuring Seamless MPLS 255**

Information about Seamless MPLS 255  
     Overview of Seamless MPLS 255  
     Architecture for Seamless MPLS 256  
 How to configure Seamless MPLS 256  
     Configuring Seamless MPLS on the PE Router 257  
     Configuring Seamless MPLS on the Route Reflector 259  
 Configuration Examples for Seamless MPLS 262  
     Example: Configuring Seamless MPLS on PE Router 1 262  
     Example: Configuring Seamless MPLS on Route Reflector 1 262  
     Example: Configuring Seamless MPLS on PE Router 2 263  
     Example: Configuring Seamless MPLS on Route Reflector 2 263  
 Feature History for Seamless MPLS 264



# CHAPTER 1

## Configuring Multiprotocol Label Switching (MPLS)

---

- [Multiprotocol Label Switching](#), on page 1
- [Restrictions for Multiprotocol Label Switching](#), on page 1
- [Information about Multiprotocol Label Switching](#), on page 1
- [How to Configure Multiprotocol Label Switching](#), on page 3
- [Verifying Multiprotocol Label Switching Configuration](#), on page 5
- [Additional References for Multiprotocol Label Switching](#), on page 8
- [Feature History for Multiprotocol Label Switching](#), on page 8

### Multiprotocol Label Switching

This module describes Multiprotocol Label Switching and how to configure it on Cisco switches.

### Restrictions for Multiprotocol Label Switching

- Multiprotocol Label Switching (MPLS) fragmentation is not supported.
- MPLS maximum transmission unit (MTU) is not supported.

### Information about Multiprotocol Label Switching

Multiprotocol label switching (MPLS) combines the performance and capabilities of Layer 2 (data link layer) switching with the proven scalability of Layer 3 (network layer) routing. MPLS enables you to meet the challenges of explosive growth in network utilization while providing the opportunity to differentiate services without sacrificing the existing network infrastructure. The MPLS architecture is flexible and can be employed in any combination of Layer 2 technologies. MPLS support is offered for all Layer 3 protocols, and scaling is possible well beyond that typically offered in today's networks.

## Functional Description of Multiprotocol Label Switching

Label switching is a high-performance packet forwarding technology that integrates the performance and traffic management capabilities of data link layer (Layer 2) switching with the scalability, flexibility, and performance of network layer (Layer 3) routing.

### Label Switching Functions

In conventional Layer 3 forwarding mechanisms, as a packet traverses the network, each switch extracts all the information relevant to forwarding the packet from the Layer 3 header. This information is then used as an index for a routing table lookup to determine the next hop for the packet.

In the most common case, the only relevant field in the header is the destination address field, but in some cases, other header fields might also be relevant. As a result, the header analysis must be done independently at each switch through which the packet passes. In addition, a complicated table lookup must also be done at each switch.

In label switching, the analysis of the Layer 3 header is done only once. The Layer 3 header is then mapped into a fixed length, unstructured value called a *label*.

Many different headers can map to the same label, as long as those headers always result in the same choice of next hop. In effect, a label represents a *forwarding equivalence class*--that is, a set of packets which, however different they may be, are indistinguishable by the forwarding function.

The initial choice of a label need not be based exclusively on the contents of the Layer 3 packet header; for example, forwarding decisions at subsequent hops can also be based on routing policy.

Once a label is assigned, a short label header is added at the front of the Layer 3 packet. This header is carried across the network as part of the packet. At subsequent hops through each MPLS switch in the network, labels are swapped and forwarding decisions are made by means of MPLS forwarding table lookup for the label carried in the packet header. Hence, the packet header does not need to be reevaluated during packet transit through the network. Because the label is of fixed length and unstructured, the MPLS forwarding table lookup process is both straightforward and fast.

### Distribution of Label Bindings

Each label switching router (LSR) in the network makes an independent, local decision as to which label value to use to represent a forwarding equivalence class. This association is known as a label binding. Each LSR informs its neighbors of the label bindings it has made. This awareness of label bindings by neighboring switches is facilitated by the following protocols:

- Label Distribution Protocol (LDP)--enables peer LSRs in an MPLS network to exchange label binding information for supporting hop-by-hop forwarding in an MPLS network
- Border Gateway Protocol (BGP)--Used to support MPLS virtual private networks (VPNs)

When a labeled packet is being sent from LSR A to the neighboring LSR B, the label value carried by the IP packet is the label value that LSR B assigned to represent the forwarding equivalence class of the packet. Thus, the label value changes as the IP packet traverses the network.

For more information about LDP configuration, see the see MPLS: LDP Configuration Guide at [http://www.cisco.com/c/en/us/td/docs/ios-xml/ios/mpls/config\\_library/xe-3s/mp-xe-3s-library.html](http://www.cisco.com/c/en/us/td/docs/ios-xml/ios/mpls/config_library/xe-3s/mp-xe-3s-library.html)



---

**Note** As the scale of label entries is limited in, especially with ECMP, it is recommended to enable LDP label filtering. LDP labels shall be allocated only for well known prefixes like loopback interfaces of routers and any prefix that needs to be reachable in the global routing table.

---

## MPLS Layer 3 VPN

A Multiprotocol Label Switching (MPLS) Virtual Private Network (VPN) consists of a set of sites that are interconnected by means of an MPLS provider core network. At each customer site, one or more customer edge (CE) routers attach to one or more provider edge (PE) routers.

Before configuring MPLS Layer 3 VPNs, you should have MPLS, Label Distribution Protocol (LDP), and Cisco Express Forwarding (CEF) installed in your network. All routers in the core, including the PE routers, must be able to support CEF and MPLS forwarding.

## Classifying and Marking MPLS QoS EXP

The QoS EXP Matching feature allows you to classify and mark network traffic by modifying the Multiprotocol Label Switching (MPLS) experimental bits (EXP) field in IP packets.

The QoS EXP Matching feature allows you to organize network traffic by setting values for the MPLS EXP field in MPLS packets. By choosing different values for the MPLS EXP field, you can mark packets so that packets have the priority that they require during periods of congestion. Setting the MPLS EXP value allows you to:

- **Classify traffic:** The classification process selects the traffic to be marked. Classification accomplishes this by partitioning traffic into multiple priority levels, or classes of service. Traffic classification is the primary component of class-based QoS provisioning.
- **Police and mark traffic:** Policing causes traffic that exceeds the configured rate to be discarded or marked to a different drop level. Marking traffic is a way to identify packet flows to differentiate them. Packet marking allows you to partition your network into multiple priority levels or classes of service.

### Restrictions

Following is the list of restrictions for classifying and marking MPLS QoS EXP:

- Only Uniform mode and Pipe mode are supported; Short-pipe mode is not supported.
- Support range of QoS-group values range between 0 and 30. (Total 31 QoS-groups).
- EXP marking using QoS policy is supported only on the outer label; inner EXP marking is not supported.

## How to Configure Multiprotocol Label Switching

This section explains how to perform the basic configuration required to prepare a switch for MPLS switching and forwarding.

## Configuring a Switch for MPLS Switching

MPLS switching on Cisco switches requires that Cisco Express Forwarding be enabled.



**Note** `ip unnumbered` command is not supported in MPLS configuration.

### Procedure

	Command or Action	Purpose
<b>Step 1</b>	<b>enable</b> <b>Example:</b> Device> <code>enable</code>	Enables privileged EXEC mode. Enter your password, if prompted.
<b>Step 2</b>	<b>configure terminal</b> <b>Example:</b> Device# <code>configure terminal</code>	Enters global configuration mode.
<b>Step 3</b>	<b>ip cef distributed</b> <b>Example:</b> Device(config)# <code>ip cef distributed</code>	Enables Cisco Express Forwarding on the switch.
<b>Step 4</b>	<b>mpls label range</b> <i>minimum-value</i> <i>maximum-value</i> <b>Example:</b> Device(config)# <code>mpls label range 16 4096</code>	Configure the range of local labels available for use with MPLS applications on packet interfaces.
<b>Step 5</b>	<b>mpls label protocol ldp</b> <b>Example:</b> Device(config)# <code>mpls label protocol ldp</code>	Specifies the label distribution protocol for the platform.

## Configuring a Switch for MPLS Forwarding

MPLS forwarding on Cisco switches requires that forwarding of IPv4 packets be enabled.



**Note** `ip unnumbered` command is not supported in MPLS configuration.



**Procedure**

	<b>Command or Action</b>	<b>Purpose</b>
<b>Step 1</b>	<b>enable</b> <b>Example:</b> Device> <b>enable</b>	Enables privileged EXEC mode. Enter your password, if prompted.
<b>Step 2</b>	<b>configure terminal</b> <b>Example:</b> Device# <b>configure terminal</b>	Enters global configuration mode.
<b>Step 3</b>	<b>interface</b> <i>type slot/subslot /port</i> <b>Example:</b> Device(config)# <b>interface</b> gigabitethernet 1/0/0	Specifies the Gigabit Ethernet interface and enters interface configuration mode. For Switch Virtual Interface (SVI), the example is Device(config)# <b>interface</b> vlan 1000
<b>Step 4</b>	<b>mpls ip</b> <b>Example:</b> Device(config-if)# <b>mpls ip</b>	Enables MPLS forwarding of IPv4 packets along routed physical interfaces (Gigabit Ethernet), Switch Virtual Interface (SVI), or port channels.
<b>Step 5</b>	<b>mpls label protocol ldp</b> <b>Example:</b> Device(config-if)# <b>mpls label protocol ldp</b>	Specifies the label distribution protocol for an interface.  <b>Note</b> MPLS LDP cannot be enabled on a Virtual Routing and Forwarding (VRF) interface.
<b>Step 6</b>	<b>end</b> <b>Example:</b> Device(config-if)# <b>end</b>	Exits interface configuration mode and returns to privileged EXEC mode.

## Verifying Multiprotocol Label Switching Configuration

This section explains how to verify successful configuration of MPLS switching and forwarding.

### Verifying Configuration of MPLS Switching

To verify that Cisco Express Forwarding has been configured properly, issue the **show ip cef summary** command, which generates output similar to that shown below:

## Procedure

---

### show ip cef summary

#### Example:

```
Device# show ip cef summary

IPv4 CEF is enabled for distributed and running
VRF Default
 150 prefixes (149/1 fwd/non-fwd)
Table id 0x0
Database epoch:      4 (150 entries at this epoch)
Device#
```

---

## Verifying Configuration of MPLS Forwarding

To verify that MPLS forwarding has been configured properly, issue the **show mpls interfaces detail** command, which generates output similar to that shown below:



**Note** The MPLS MTU value is equivalent to the IP MTU value of the port or switch by default. MTU configuration for MPLS is not supported.

---

## Procedure

---

### Step 1 show mpls interfaces detail

#### Example:

For physical (Gigabit Ethernet) interface:  
 Device# **show mpls interfaces detail interface GigabitEthernet 1/0/0**

```
Type Unknown
IP labeling enabled
LSP Tunnel labeling not enabled
IP FRR labeling not enabled
BGP labeling not enabled
MPLS not operational
MTU = 1500
```

For Switch Virtual Interface (SVI):  
 Device# **show mpls interfaces detail interface Vlan1000**

```
Type Unknown
IP labeling enabled (ldp) :
  Interface config
LSP Tunnel labeling not enabled
IP FRR labeling not enabled
BGP labeling not enabled
MPLS operational
MTU = 1500
```

**Step 2 show running-config interface****Example:**

For physical (Gigabit Ethernet) interface:

```
Device# show running-config interface interface GigabitEthernet 1/0/0
```

Building configuration...

```
Current configuration : 307 bytes
!
interface TenGigabitEthernet1/0/0
no switchport
ip address xx.xx.x.x xxx.xxx.xxx.x
mpls ip
mpls label protocol ldp
end
```

For Switch Virtual Interface (SVI):

```
Device# show running-config interface interface Vlan1000
```

Building configuration...

```
Current configuration : 187 bytes
!
interface Vlan1000
ip address xx.xx.x.x xxx.xxx.xxx.x
mpls ip
mpls label protocol ldp
end
```

**Step 3 show mpls forwarding****Example:**

For physical (Gigabit Ethernet) interface:

```
Device# show mpls forwarding-table
```

Local Label	Outgoing Label	Prefix or Tunnel Id	Bytes Switched	Label	Outgoing interface	Next Hop
500	No Label	l2ckt(3)	0		Gi3/0/22	point2point
501	No Label	l2ckt(1)	12310411816789	none		point2point
502	No Label	l2ckt(2)	0		none	point2point
503	566	15.15.15.15/32	0		Po5	192.1.1.2
504	530	7.7.7.7/32	538728528		Po5	192.1.1.2
505	573	6.6.6.10/32	0		Po5	192.1.1.2
506	606	6.6.6.6/32	0		Po5	192.1.1.2
507	explicit-n	1.1.1.1/32	0		Po5	192.1.1.2
556	543	19.10.1.0/24	0		Po5	192.1.1.2
567	568	20.1.1.0/24	0		Po5	192.1.1.2
568	574	21.1.1.0/24	0		Po5	192.1.1.2
574	No Label	213.1.1.0/24[V]	0		aggregate/vpn113	
575	No Label	213.1.2.0/24[V]	0		aggregate/vpn114	
576	No Label	213.1.3.0/24[V]	0		aggregate/vpn115	
577	No Label	213:1:1::/64	0		aggregate	
594	502	103.1.1.0/24	0		Po5	192.1.1.2
595	509	31.1.1.0/24	0		Po5	192.1.1.2
596	539	15.15.1.0/24	0		Po5	192.1.1.2
597	550	14.14.1.0/24	0		Po5	192.1.1.2
633	614	2.2.2.0/24	0		Po5	192.1.1.2
634	577	90.90.90.90/32	873684		Po5	192.1.1.2
635	608	154.1.1.0/24	0		Po5	192.1.1.2

```

636          609          153.1.1.0/24    0          Po5          192.1.1.2
Device# end

```

## Additional References for Multiprotocol Label Switching

### Related Documents

Related Topic	Document Title
For complete syntax and usage information for the commands used in this chapter.	See the Multiprotocol Label Switching (MPLS) Commands section of the <i>Command Reference (Catalyst 9300 Series Switches)</i>

## Feature History for Multiprotocol Label Switching

This table provides release and related information for features explained in this module.

These features are available on all releases subsequent to the one they were introduced in, unless noted otherwise.

Release	Feature	Feature Information
Cisco IOS XE Everest 16.5.1a	Multiprotocol Label Switching	Multiprotocol Label Switching combines the performance and capabilities of Layer 2 (data link layer) switching with the proven scalability of Layer 3 (network layer) routing.

Use Cisco Feature Navigator to find information about platform and software image support. To access Cisco Feature Navigator, go to <http://www.cisco.com/go/cfn>.



## CHAPTER 2

# Configuring MPLS Layer 3 VPN

An MPLS Virtual Private Network (VPN) consists of a set of sites that are interconnected by means of a Multiprotocol Label Switching (MPLS) provider core network. At each customer site, one or more customer edge (CE) devices attach to one or more provider edge (PE) devices. This module explains how to create an MPLS Layer 3 VPN.

- [MPLS Layer 3 VPNs, on page 9](#)

## MPLS Layer 3 VPNs

An MPLS Virtual Private Network (VPN) consists of a set of sites that are interconnected by means of a Multiprotocol Label Switching (MPLS) provider core network. At each customer site, one or more customer edge (CE) devices attach to one or more provider edge (PE) devices. This module explains how to create an MPLS VPN.

## Prerequisites for MPLS Virtual Private Networks

- Make sure that you have installed Multiprotocol Label Switching (MPLS), Label Distribution Protocol (LDP), and Cisco Express Forwarding in your network.
- All devices in the core, including the provider edge (PE) devices, must be able to support Cisco Express Forwarding and MPLS forwarding. See the “Assessing the Needs of the MPLS Virtual Private Network Customers” section.
- Enable Cisco Express Forwarding on all devices in the core, including the PE devices. For information about how to determine if Cisco Express Forwarding is enabled, see the “Configuring Basic Cisco Express Forwarding” module in the *Cisco Express Forwarding Configuration Guide*.
- The **mpls ldp graceful-restart** command must be configured to enable the device to protect LDP bindings and MPLS forwarding state during a disruption in service. We recommend you to configure this command (even if you do not want to preserve the forwarding state) to avoid device failure during SSO in a high availability setup with scale configurations.

## Restrictions for MPLS Virtual Private Networks

When static routes are configured in a Multiprotocol Label Switching (MPLS) or MPLS virtual private network (VPN) environment, some variations of the **ip route** and **ip route vrf** commands are not supported. Use the following guidelines when configuring static routes.

### Supported Static Routes in an MPLS Environment

The following **ip route** command is supported when you configure static routes in an MPLS environment:

- **ip route** *destination-prefix mask interface next-hop-address*

The following **ip route** commands are supported when you configure static routes in an MPLS environment and configure load sharing with static nonrecursive routes and a specific outbound interface:

- **ip route** *destination-prefix mask interface1 next-hop1*
- **ip route** *destination-prefix mask interface2 next-hop2*

### Unsupported Static Routes in an MPLS Environment That Uses the TFIB

The following **ip route** command is not supported when you configure static routes in an MPLS environment:

- **ip route** *destination-prefix mask next-hop-address*

The following **ip route** command is not supported when you configure static routes in an MPLS environment and enable load sharing where the next hop can be reached through two paths:

- **ip route** *destination-prefix mask next-hop-address*

The following **ip route** commands are not supported when you configure static routes in an MPLS environment and enable load sharing where the destination can be reached through two next hops:

- **ip route** *destination-prefix mask next-hop1*
- **ip route** *destination-prefix mask next-hop2*

Use the *interface* and *next-hop* arguments when specifying static routes.

### Supported Static Routes in an MPLS VPN Environment

The following **ip route vrf** commands are supported when you configure static routes in an MPLS VPN environment, and the next hop and interface are in the same VRF:

- **ip route vrf** *vrf-name destination-prefix mask next-hop-address*
- **ip route vrf** *vrf-name destination-prefix mask interface next-hop-address*
- **ip route vrf** *vrf-name destination-prefix mask interface1 next-hop1*
- **ip route vrf** *vrf-name destination-prefix mask interface2 next-hop2*

The following **ip route vrf** commands are supported when you configure static routes in an MPLS VPN environment, and the next hop is in the global table in the MPLS cloud in the global routing table. For example, these commands are supported when the next hop is pointing to the Internet gateway.

- **ip route vrf** *vrf-name destination-prefix mask next-hop-address global*

- **ip route vrf** *vrf-name destination-prefix mask interface next-hop-address* (This command is supported when the next hop and interface are in the core.)

The following **ip route** commands are supported when you configure static routes in an MPLS VPN environment and enable load sharing with static nonrecursive routes and a specific outbound interface:

- **ip route** *destination-prefix mask interface1 next-hop1*
- **ip route** *destination-prefix mask interface2 next-hop2*

### Unsupported Static Routes in an MPLS VPN Environment That Uses the TFIB

The following **ip route** command is not supported when you configure static routes in an MPLS VPN environment, the next hop is in the global table in the MPLS cloud within the core, and you enable load sharing where the next hop can be reached through two paths:

- **ip route vrf** *destination-prefix mask next-hop-address global*

The following **ip route** commands are not supported when you configure static routes in an MPLS VPN environment, the next hop is in the global table in the MPLS cloud within the core, and you enable load sharing where the destination can be reached through two next hops:

- **ip route vrf** *destination-prefix mask next-hop1 global*
- **ip route vrf** *destination-prefix mask next-hop2 global*

The following **ip route vrf** commands are not supported when you configure static routes in an MPLS VPN environment, and the next hop and interface are in the same VRF:

- **ip route vrf** *vrf-name destination-prefix mask next-hop1 vrf-name destination-prefix mask next-hop1*
- **ip route vrf** *vrf-name destination-prefix mask next-hop2*

### Supported Static Routes in an MPLS VPN Environment Where the Next Hop Resides in the Global Table on the CE Device

The following **ip route vrf** command is supported when you configure static routes in an MPLS VPN environment, and the next hop is in the global table on the customer edge (CE) side. For example, the following command is supported when the destination prefix is the CE device's loopback address, as in external Border Gateway Protocol (EBGP) multihop cases.

- **ip route vrf** *vrf-name destination-prefix mask interface next-hop-address*

The following **ip route** commands are supported when you configure static routes in an MPLS VPN environment, the next hop is in the global table on the CE side, and you enable load sharing with static nonrecursive routes and a specific outbound interface:

- **ip route** *destination-prefix mask interface1 nexthop1*
- **ip route** *destination-prefix mask interface2 nexthop2*

## Information About MPLS Virtual Private Networks

This section provides information about MPLS Virtual Private Networks:

## MPLS Virtual Private Network Definition

Before defining a Multiprotocol Label Switching virtual private network (MPLS VPN), you must define a VPN in general. A VPN is:

- An IP-based network delivering private network services over a public infrastructure
- A set of sites that communicate with each other privately over the Internet or other public or private networks

Conventional VPNs are created by configuring a full mesh of tunnels or permanent virtual circuits (PVCs) to all sites in a VPN. This type of VPN is not easy to maintain or expand, because adding a new site requires changing each edge device in the VPN.

MPLS-based VPNs are created in Layer 3 and are based on the peer model. The peer model enables the service provider and the customer to exchange Layer 3 routing information. The service provider relays the data between the customer sites without the customer's involvement.

MPLS VPNs are easier to manage and expand than conventional VPNs. When a new site is added to an MPLS VPN, only the service provider's edge device that provides services to the customer site needs to be updated.

The different parts of the MPLS VPN are described as follows:

- Provider (P) device—Device in the core of the provider network. P devices run MPLS switching, and do not attach VPN labels to routed packets. The MPLS label in each route is assigned by the provider edge (PE) device. VPN labels are used to direct data packets to the correct egress device.
- PE device—Device that attaches the VPN label to incoming packets based on the interface or subinterface on which they are received. A PE device attaches directly to a customer edge (CE) device.
- Customer (C) device—Device in the ISP or enterprise network.
- CE device—Edge device on the network of the ISP that connects to the PE device on the network. A CE device must interface with a PE device.

The figure below shows a basic MPLS VPN.

**Figure 1: Basic MPLS VPN Terminology**

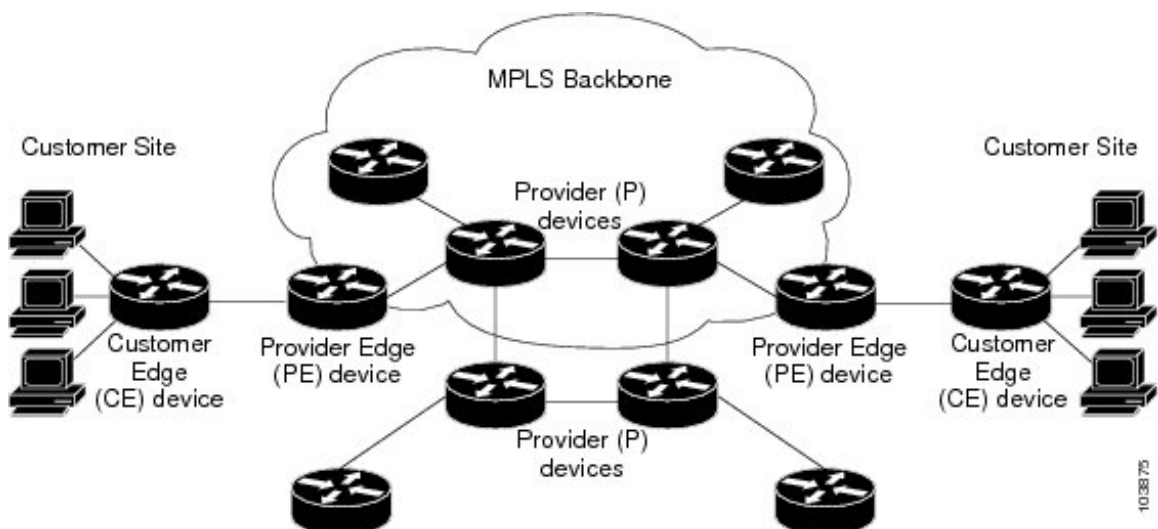



## How an MPLS Virtual Private Network Works

Multiprotocol Label Switching virtual private network (MPLS VPN) functionality is enabled at the edge of an MPLS network. The provider edge (PE) device performs the following:

- Exchanges routing updates with the customer edge (CE) device.
- Translates the CE routing information into VPNv4 routes.
- Exchanges VPNv4 routes with other PE devices through the Multiprotocol Border Gateway Protocol (MP-BGP).

The following sections describe how MPLS VPN works:

## Major Components of an MPLS Virtual Private Network

A Multiprotocol Label Switching (MPLS)-based virtual private network (VPN) has three major components:

- VPN route target communities—A VPN route target community is a list of all members of a VPN community. VPN route targets need to be configured for each VPN community member.
- Multiprotocol BGP (MP-BGP) peering of VPN community provider edge (PE) devices—MP-BGP propagates virtual routing and forwarding (VRF) reachability information to all members of a VPN community. MP-BGP peering must be configured on all PE devices within a VPN community.
- MPLS forwarding—MPLS transports all traffic between all VPN community members across a VPN service-provider network.

A one-to-one relationship does not necessarily exist between customer sites and VPNs. A given site can be a member of multiple VPNs. However, a site can associate with only one VRF. A customer-site VRF contains all the routes available to the site from the VPNs of which it is a member.

## Benefits of an MPLS Virtual Private Network

Multiprotocol Label Switching virtual private networks (MPLS VPNs) allow service providers to deploy scalable VPNs. They build the foundation to deliver value-added services, such as the following:

### Connectionless Service

A significant technical advantage of MPLS VPNs is that they are connectionless. The Internet owes its success to its basic technology, TCP/IP. TCP/IP is built on a packet-based, connectionless network paradigm. This means that no prior action is necessary to establish communication between hosts, making it easy for two parties to communicate. To establish privacy in a connectionless IP environment, current VPN solutions impose a connection-oriented, point-to-point overlay on the network. Even if it runs over a connectionless network, a VPN cannot take advantage of the ease of connectivity and multiple services available in connectionless networks. When you create a connectionless VPN, you do not need tunnels and encryption for network privacy, thus eliminating significant complexity.

### Centralized Service

Building VPNs in Layer 3 allows delivery of targeted services to a group of users represented by a VPN. A VPN must give service providers more than a mechanism for privately connecting users to intranet services. It must also provide a way to flexibly deliver value-added services to targeted customers. Scalability is critical, because you want to use services privately in their intranets and extranets. Because MPLS VPNs are seen as private intranets, you may use new IP services such as:

- Multicast
- Quality of service (QoS)
- Telephony support within a VPN
- Centralized services including content and web hosting to a VPN

You can customize several combinations of specialized services for individual customers. For example, a service that combines IP multicast with a low-latency service class enables video conferencing within an intranet.

### Scalability

If you create a VPN using connection-oriented, point-to-point overlays, Frame Relay, or ATM virtual connections (VCs), the VPN's key deficiency is scalability. Specifically, connection-oriented VPNs without fully meshed connections between customer sites are not optimal. MPLS-based VPNs, instead, use the peer model and Layer 3 connectionless architecture to leverage a highly scalable VPN solution. The peer model requires a customer site to peer with only one provider edge (PE) device as opposed to all other customer edge (CE) devices that are members of the VPN. The connectionless architecture allows the creation of VPNs in Layer 3, eliminating the need for tunnels or VCs.

Other scalability issues of MPLS VPNs are due to the partitioning of VPN routes between PE devices. And the further partitioning of VPN and Interior Gateway Protocol (IGP) routes between PE devices and provider (P) devices in a core network.

- PE devices must maintain VPN routes for those VPNs who are members.
- P devices do not maintain any VPN routes.

This increases the scalability of the provider's core and ensures that no one device is a scalability bottleneck.

### Security

MPLS VPNs offer the same level of security as connection-oriented VPNs. Packets from one VPN do not inadvertently go to another VPN.

Security is provided in the following areas:

- At the edge of a provider network, ensuring packets that are received from a customer are placed on the correct VPN.
- At the backbone, VPN traffic is kept separate. Malicious spoofing (an attempt to gain access to a PE device) is nearly impossible because the packets that are received from customers are IP packets. These IP packets must be received on a particular interface or subinterface to be uniquely identified with a VPN label.

### Ease of Creation

To take full advantage of VPNs, customers must be able to easily create new VPNs and user communities. Because MPLS VPNs are connectionless, no specific point-to-point connection maps or topologies are required. You can add sites to intranets and extranets and form closed user groups. Managing VPNs in this manner enables membership of any given site in multiple VPNs, maximizing flexibility in building intranets and extranets.

### Flexible Addressing

To make a VPN service more accessible, customers of a service provider can design their own addressing plan. This addressing plan can be independent of addressing plans for other service provider customers. Many customers use private address spaces, as defined in RFC 1918. They do not want to invest the time and expense of converting to public IP addresses to enable intranet connectivity. MPLS VPNs allow customers to continue to use their present address spaces without Network Address Translation (NAT) by providing a public and private view of the address. A NAT is required only if two VPNs with overlapping address spaces want to communicate. This enables customers to use their own unregistered private addresses, and communicate freely across a public IP network.

### Integrated QoS Support

QoS is an important requirement for many IP VPN customers. It provides the ability to address two fundamental VPN requirements:

- Predictable performance and policy implementation
- Support for multiple levels of service in an MPLS VPN

Network traffic is classified and labeled at the edge of the network. The traffic is then aggregated according to policies defined by subscribers and implemented by the provider and transported across the provider core. Traffic at the edge and core of the network can then be differentiated into different classes by drop probability or delay.

### Straightforward Migration

For service providers to quickly deploy VPN services, use a straightforward migration path. MPLS VPNs are unique because you can build them over multiple network architectures, including IP, ATM, Frame Relay, and hybrid networks.

Migration for the end customer is simplified because there is no requirement to support MPLS on the CE device. No modifications are required to a customer's intranet.

## How to Configure MPLS Virtual Private Networks

The following section provides the steps to configure MPLS Virtual Private Networks:

### Configuring the Core Network

The following section provides the steps to configure the core network:

#### Assessing the Needs of MPLS Virtual Private Network Customers

Before you configure a Multiprotocol Label Switching virtual private network (MPLS VPN), you need to identify the core network topology so that it can best serve MPLS VPN customers. Perform this task to identify the core network topology.

#### Procedure

	Command or Action	Purpose
Step 1	Identify the size of the network.	Identify the following to determine the number of devices and ports that you need:

	Command or Action	Purpose
		<ul style="list-style-type: none"> <li>• How many customers do you need to support?</li> <li>• How many VPNs are needed per customer?</li> <li>• How many virtual routing and forwarding instances are there for each VPN?</li> </ul>
<b>Step 2</b>	Identify the routing protocols in the core.	Determine which routing protocols you need in the core network.
<b>Step 3</b>	Determine if you need MPLS VPN High Availability support.	MPLS VPN Nonstop Forwarding and Graceful Restart are supported on select devices and Cisco software releases. Contact Cisco Support for the exact requirements and hardware support.
<b>Step 4</b>	Determine if you need Border Gateway Protocol (BGP) load sharing and redundant paths in the MPLS VPN core.	For configuration steps, see the “Load Sharing MPLS VPN Traffic” feature module in the <i>MPLS Layer 3 VPNs Inter-AS and CSC Configuration Guide</i> .

### Configuring MPLS in the Core

To enable Multiprotocol Label Switching (MPLS) on all devices in the core, you must configure either of the following as a label distribution protocol:

- MPLS Label Distribution Protocol (LDP). For configuration information, see the “MPLS Label Distribution Protocol (LDP)” module in the *MPLS Label Distribution Protocol Configuration Guide*.

## Connecting the MPLS Virtual Private Network Customers

The following section provides information about Connecting the MPLS Virtual Private Network Customers:

### Defining VRFs on the PE Devices to Enable Customer Connectivity

Use this procedure to define a virtual routing and forwarding (VRF) configuration for IPv4. To define a VRF for IPv4 and IPv6, see the “Configuring a Virtual Routing and Forwarding Instance for IPv6” section in the “IPv6 VPN over MPLS” module in the *MPLS Layer 3 VPNs Configuration Guide*.

#### Procedure

	Command or Action	Purpose
<b>Step 1</b>	<b>enable</b>  <b>Example:</b>  Device> enable	Enables privileged EXEC mode. <ul style="list-style-type: none"> <li>• Enter your password if prompted.</li> </ul>

	Command or Action	Purpose
<b>Step 2</b>	<b>configure terminal</b> <b>Example:</b> <pre>Device# configure terminal</pre>	Enters global configuration mode.
<b>Step 3</b>	<b>vrf definition</b> <i>vrf-name</i> <b>Example:</b> <pre>Device(config)# vrf definition vrf1</pre>	Defines the virtual private network (VPN) routing instance by assigning a virtual routing and forwarding (VRF) name and enters VRF configuration mode. <ul style="list-style-type: none"> <li>The <i>vrf-name</i> argument is the name assigned to a VRF.</li> </ul>
<b>Step 4</b>	<b>rd</b> <i>route-distinguisher</i> <b>Example:</b> <pre>Device(config-vrf)# rd 100:1</pre>	Creates routing and forwarding tables. <ul style="list-style-type: none"> <li>The <i>route-distinguisher</i> argument adds an 8-byte value to an IPv4 prefix to create a VPN IPv4 prefix. You can enter a route distinguisher (RD) in either of these formats:               <ul style="list-style-type: none"> <li>16-bit AS number:your 32-bit number, for example, 101:3</li> <li>32-bit IP address:your 16-bit number, for example, 10.0.0.1:1</li> </ul> </li> </ul>
<b>Step 5</b>	<b>address-family</b> <i>ipv4</i>   <i>ipv6</i> <b>Example:</b> <pre>Device(config-vrf)# address-family ipv6</pre>	Enters IPv4 or IPv6 address family mode
<b>Step 6</b>	<b>route-target</b> { <b>import</b>   <b>export</b>   <b>both</b> } <i>route-target-ext-community</i> <b>Example:</b> <pre>Device(config-vrf-af)# route-target both 100:1</pre>	Creates a route-target extended community for a VRF. <ul style="list-style-type: none"> <li>The <b>import</b> keyword imports routing information from the target VPN extended community.</li> <li>The <b>export</b> keyword exports routing information to the target VPN extended community.</li> <li>The <b>both</b> keyword imports routing information from and exports routing information to the target VPN extended community.</li> <li>The <i>route-target-ext-community</i> argument adds the route-target extended community attributes to the VRF's list of import,</li> </ul>

	Command or Action	Purpose
		export, or both route-target extended communities.
<b>Step 7</b>	<b>exit</b> <b>Example:</b> Device(config-vrf)# exit	(Optional) Exits to global configuration mode.

### Configuring VRF Interfaces on PE Devices for Each VPN Customer

To associate a virtual routing and forwarding (VRF) instance with an interface or subinterface on the provider edge (PE) devices, perform this task.

#### Procedure

	Command or Action	Purpose
<b>Step 1</b>	<b>enable</b> <b>Example:</b> Device> enable	Enables privileged EXEC mode. <ul style="list-style-type: none"> <li>• Enter your password if prompted.</li> </ul>
<b>Step 2</b>	<b>configure terminal</b> <b>Example:</b> Device# configure terminal	Enters global configuration mode.
<b>Step 3</b>	<b>interface</b> <i>type number</i> <b>Example:</b> Device(config)# interface GigabitEthernet 0/0/1	Specifies the interface to configure and enters interface configuration mode. <ul style="list-style-type: none"> <li>• The <i>type</i> argument specifies the type of interface to be configured.</li> <li>• The <i>number</i> argument specifies the port, connector, or interface card number.</li> </ul>
<b>Step 4</b>	<b>vrf forwarding</b> <i>vrf-name</i> <b>Example:</b> Device(config-if)# vrf forwarding vrf1	Associates a VRF with the specified interface or subinterface. <ul style="list-style-type: none"> <li>• The <i>vrf-name</i> argument is the name that is assigned to a VRF.</li> </ul>
<b>Step 5</b>	<b>end</b> <b>Example:</b> Device(config-if)# end	(Optional) Exits to privileged EXEC mode.

## Configuring Routing Protocols Between the PE and CE Devices

Configure the provider edge (PE) device with the same routing protocol that the customer edge (CE) device uses. You can configure the Border Gateway Protocol (BGP), Routing Information Protocol version 2 (RIPv2), EIGRP, Open Shortest Path First (OSPF) or static routes between the PE and CE devices.

## Verifying the Virtual Private Network Configuration

A route distinguisher must be configured for the virtual routing and forwarding (VRF) instance. Multiprotocol Label Switching (MPLS) must be configured on the interfaces that carry the VRF. Use the **show ip vrf** command to verify the route distinguisher (RD) and interface configured for the VRF.

### Procedure

---

#### **show ip vrf**

Displays the set of defined VRF instances and associated interfaces. The output also maps the VRF instances to the configured route distinguisher.

---

## Verifying Connectivity Between MPLS Virtual Private Network Sites

To verify that the local and remote customer edge (CE) devices can communicate across the Multiprotocol Label Switching (MPLS) core, perform the following tasks:

### Verifying IP Connectivity from CE Device to CE Device Across the MPLS Core

#### Procedure

---

- Step 1**     **enable**
- Enables privileged EXEC mode.
- Step 2**     **ping** [*protocol*] {*host-name* | *system-address*}
- Diagnoses basic network connectivity on AppleTalk, Connectionless-mode Network Service (CLNS), IP, Novell, Apollo, Virtual Integrated Network Service (VINES), DECnet, or Xerox Network Service (XNS) networks. Use the **ping** command to verify the connectivity from one CE device to another.
- Step 3**     **trace** [*protocol*] [*destination*]
- Discovers the routes that packets take when traveling to their destination. The **trace** command can help isolate a trouble spot if two devices cannot communicate.
- Step 4**     **show ip route** [*ip-address* [*mask*] [**longer-prefixes**]] | *protocol* [*process-id*]] | [**list** [*access-list-name* | *access-list-number*]
- Displays the current state of the routing table. Use the *ip-address* argument to verify that CE1 has a route to CE2. Verify the routes learned by CE1. Make sure that the route for CE2 is listed.
-

## Verifying That the Local and Remote CE Devices Are in the PE Routing Table

### Procedure

---

- Step 1**     **enable**  
Enables privileged EXEC mode.
- Step 2**     **show ip route vrf *vrf-name* [*prefix*]**  
Displays the IP routing table that is associated with a virtual routing and forwarding (VRF) instance. Check that the loopback addresses of the local and remote customer edge (CE) devices are in the routing table of the provider edge (PE) devices.
- Step 3**     **show ip cef vrf *vrf-name* [*ip-prefix*]**  
Displays the Cisco Express Forwarding forwarding table that is associated with a VRF. Check that the prefix of the remote CE device is in the Cisco Express Forwarding table.
- 

## Configuration Examples for MPLS Virtual Private Networks

The following section provides the configuration examples for MPLS Virtual Private Networks:



## Example: Configuring an MPLS Virtual Private Network Using RIP

PE Configuration	CE Configuration
<pre> vrf vpn1  rd 100:1   route-target export 100:1   route-target import 100:1 ! ip cef mpls ldp router-id Loopback0 force mpls label protocol ldp ! interface Loopback0  ip address 10.0.0.1 255.255.255.255 ! interface GigabitEthernet 1/0/1  vrf forwarding vpn1  ip address 192.0.2.3 255.255.255.0  no cdp enable interface GigabitEthernet 1/0/1  ip address 192.0.2.2 255.255.255.0 mpls label protocol ldp mpls ip ! router rip version 2 timers basic 30 60 60 120 ! address-family ipv4 vrf vpn1 version 2 redistribute bgp 100 metric transparent network 192.0.2.0 distribute-list 20 in no auto-summary exit-address-family ! router bgp 100 no synchronization bgp log-neighbor changes neighbor 10.0.0.3 remote-as 100 neighbor 10.0.0.3 update-source Loopback0 no auto-summary ! address-family vpnv4  neighbor 10.0.0.3 activate  neighbor 10.0.0.3 send-community extended  bgp scan-time import 5 exit-address-family ! address-family ipv4 vrf vpn1  redistribute connected  redistribute rip  no auto-summary  no synchronization  exit-address-family </pre>	<pre> ip cef mpls ldp router-id Loopback0 force mpls label protocol ldp ! interface Loopback0  ip address 10.0.0.9 255.255.255.255 ! interface GigabitEthernet 1/0/1  ip address 192.0.2.1 255.255.255.0  no cdp enable router rip version 2 timers basic 30 60 60 120 redistribute connected network 10.0.0.0 network 192.0.2.0 no auto-summary </pre>

## Example: Configuring an MPLS Virtual Private Network Using Static Routes

PE Configuration	CE Configuration
<pre>vrf vpn1  rd 100:1   route-target export 100:1   route-target import 100:1 ! ip cef mpls ldp router-id Loopback0 force mpls label protocol ldp ! interface Loopback0  ip address 10.0.0.1 255.255.255.255 ! interface GigabitEthernet 1/0/1  vrf forwarding vpn1  ip address 192.0.2.3 255.255.255.0  no cdp enable ! interface GigabitEthernet 1/0/1  ip address 192.168.0.1 255.255.0.0  mpls label protocol ldp  mpls ip ! router ospf 100  network 10.0.0. 0.0.0.0 area 100  network 192.168.0.0 255.255.0.0 area 100 ! router bgp 100  no synchronization  bgp log-neighbor changes  neighbor 10.0.0.3 remote-as 100  neighbor 10.0.0.3 update-source Loopback0  no auto-summary ! address-family vpnv4  neighbor 10.0.0.3 activate  neighbor 10.0.0.3 send-community extended  bgp scan-time import 5  exit-address-family ! address-family ipv4 vrf vpn1  redistribute connected  redistribute static  no auto-summary  no synchronization  exit-address-family ! ip route vrf vpn1 10.0.0.9 255.255.255.255 192.0.2.2 ip route vrf vpn1 192.0.2.0 255.255.0.0 192.0.2.2</pre>	<pre>ip cef ! interface Loopback0  ip address 10.0.0.9 255.255.255.255 ! interface GigabitEthernet 1/0/1  ip address 192.0.2.2 255.255.0.0  no cdp enable ! ip route 10.0.0.9 255.255.255.255 192.0.2.3 3 ip route 198.51.100.0 255.255.255.0 192.0.2.3 3</pre>

## Example: Configuring an MPLS Virtual Private Network Using BGP

PE Configuration	CE Configuration
	<pre> router bgp 5000   bgp log-neighbor-changes   neighbor 5.5.5.6 remote-as 5001   neighbor 5.5.5.6 ebgp-multihop 2   neighbor 5.5.5.6 update-source Loopback5   neighbor 35.2.2.2 remote-as 5001   neighbor 35.2.2.2 ebgp-multihop 2   neighbor 35.2.2.2 update-source Loopback1   neighbor 3500::1 remote-as 5001   neighbor 3500::1 ebgp-multihop 2   neighbor 3500::1 update-source Loopback1 ! address-family ipv4   redistribute connected   neighbor 5.5.5.6 activate   neighbor 35.2.2.2 activate   no neighbor 3500::1 activate exit-address-family ! address-family ipv6   redistribute connected   neighbor 3500::1 activate exit-address-family Device-RP(config)# </pre>

PE Configuration	CE Configuration
<pre> router bgp 5001   bgp log-neighbor-changes   bgp graceful-restart   bgp sso route-refresh-enable   bgp refresh max-eor-time 600   redistribute connected   neighbor 102.1.1.1 remote-as 5001   neighbor 102.1.1.1 update-source Loopback1   neighbor 105.1.1.1 remote-as 5001   neighbor 105.1.1.1 update-source Loopback10   neighbor 160.1.1.2 remote-as 5002   !   address-family vpnv4     neighbor 102.1.1.1 activate     neighbor 102.1.1.1 send-community both     neighbor 105.1.1.1 activate     neighbor 105.1.1.1 send-community extended   exit-address-family   !   address-family vpnv6     neighbor 102.1.1.1 activate     neighbor 102.1.1.1 send-community extended     neighbor 105.1.1.1 activate     neighbor 105.1.1.1 send-community extended   exit-address-family   !   address-family ipv4 vrf full     redistribute connected     neighbor 20.1.1.1 remote-as 5000     neighbor 20.1.1.1 ebgp-multihop 2     neighbor 20.1.1.1 update-source Loopback2     neighbor 20.1.1.1 activate     neighbor 20.1.1.1 send-community both   exit-address-family   !   address-family ipv6 vrf full     redistribute connected     neighbor 2000::1 remote-as 5000     neighbor 2000::1 ebgp-multihop 2     neighbor 2000::1 update-source Loopback2     neighbor 2000::1 activate   exit-address-family   !   address-family ipv4 vrf orange     network 87.1.0.0 mask 255.255.252.0     network 87.1.1.0 mask 255.255.255.0     redistribute connected     neighbor 40.1.1.1 remote-as 7000     neighbor 40.1.1.1 ebgp-multihop 2     neighbor 40.1.1.1 update-source Loopback3     neighbor 40.1.1.1 activate     neighbor 40.1.1.1 send-community extended     neighbor 40.1.1.1 route-map orange-lp in     maximum-paths eibgp 2   exit-address-family   !   address-family ipv6 vrf orange     redistribute connected     maximum-paths eibgp 2     neighbor 4000::1 remote-as 7000     neighbor 4000::1 ebgp-multihop 2     neighbor 4000::1 update-source Loopback3 </pre>	

PE Configuration	CE Configuration
<pre> neighbor 4000::1 activate exit-address-family ! address-family ipv4 vrf sona  redistribute connected  neighbor 160.1.1.2 remote-as 5002  neighbor 160.1.1.2 activate  neighbor 160.1.1.4 remote-as 5003  neighbor 160.1.1.4 activate exit-address-family </pre>	

## Additional References

### Related Documents

Related Topic	Document Title
For complete syntax and usage information for the commands used in this chapter.	See the MPLS Commands section of the <i>Command Reference (Catalyst 9300 Series Switches)</i>
Configuring Cisco Express Forwarding	“Configuring Basic Cisco Express Forwarding” module in the <i>Cisco Express Forwarding Configuration Guide</i>
Configuring LDP	“MPLS Label Distribution Protocol (LDP)” module in the <i>MPLS Label Distribution Protocol Configuration Guide</i>

## Feature History for MPLS Virtual Private Networks

This table provides release and related information for features explained in this module.

These features are available on all releases subsequent to the one they were introduced in, unless noted otherwise.

Release	Feature	Feature Information
Cisco IOS XE Everest 16.5.1a	MPLS Virtual Private Networks	An MPLS Virtual Private Network (VPN) consists of a set of sites that are interconnected by means of a Multiprotocol Label Switching (MPLS) provider core network. At each customer site, one or more customer edge (CE) devices attach to one or more provider edge (PE) devices.
Cisco IOS XE Gibraltar 16.11.1	BGP PE-CE support for MPLS Layer 3 VPNs	Support for BGP as a routing protocol between the provider edge (PE) device and the customer edge (CE) device was introduced.

Use Cisco Feature Navigator to find information about platform and software image support. To access Cisco Feature Navigator, go to <http://www.cisco.com/go/cfn>.



## CHAPTER 3

# Configuring eBGP and iBGP Multipath

- [BGP Multipath Load Sharing for Both eBGP and iBGP in an MPLS-VPN, on page 27](#)
- [Information About BGP Multipath Load Sharing for Both eBGP and iBGP in an MPLS-VPN, on page 28](#)
- [How to Configure BGP Multipath Load Sharing for Both eBGP and iBGP in an MPLS-VPN, on page 30](#)
- [Configuration Examples for the BGP Multipath Load Sharing for Both eBGP and iBGP in an MPLS-VPN Feature, on page 31](#)
- [Feature Information for BGP Multipath Load Sharing for Both eBGP and iBGP in an MPLS-VPN, on page 32](#)

## BGP Multipath Load Sharing for Both eBGP and iBGP in an MPLS-VPN

The BGP Multipath Load Sharing for eBGP and iBGP feature allows you to configure multipath load balancing with both external BGP (eBGP) and internal BGP (iBGP) paths in Border Gateway Protocol (BGP) networks that are configured to use Multiprotocol Label Switching (MPLS) Virtual Private Networks (VPNs). This feature provides improved load balancing deployment and service offering capabilities and is useful for multi-homed autonomous systems and Provider Edge (PE) routers that import both eBGP and iBGP paths from multihomed and stub networks.

## Prerequisites for BGP Multipath Load Sharing for Both eBGP and iBGP in an MPLS-VPN

Cisco Express Forwarding (CEF) or distributed CEF (dCEF) must be enabled on all participating devices.

## Restrictions for BGP Multipath Load Sharing for Both eBGP and iBGP in an MPLS-VPN

### Address Family Support

This feature is configured on a per VPN routing and forwarding instance (VRF) basis. This feature can be configured under both IPv4 and IPv6 VRF address families.

### Memory Consumption Restriction

Each BGP multipath routing table entry will use additional memory. We recommend that you do not use this feature on a device with a low amount of available memory and especially if the device carries full Internet routing tables.

### Number of Paths Limitation

- The number of paths supported are limited to 2 BGP multipaths. This could either be 2 iBGP multipaths or 1 iBGP multipath and 1 eBGP multipath.
- If pairing of equal cost routing is more than 64 unique paths, the routes are not learnt and traffic is dropped.

### Unsupported Commands

`ip unnumbered` command is not supported in MPLS configuration.

## Information About BGP Multipath Load Sharing for Both eBGP and iBGP in an MPLS-VPN

### Multipath Load Sharing Between eBGP and iBGP

A BGP routing process will install a single path as the best path in the routing information base (RIB) by default. The **maximum-paths** command allows you to configure BGP to install multiple paths in the RIB for multipath load sharing. BGP uses the best path algorithm to select a single multipath as the best path and advertise the best path to BGP peers.



---

**Note** The valid values for the **maximum-paths** command range from 1 to 32. However, the maximum value that can be configured is 2.

---

Load balancing over the multipaths is performed by CEF. CEF load balancing is configured on a per-packet round robin or on a per session (source and destination pair) basis. For information about CEF, see [IP Switching Cisco Express Forwarding Configuration Guide](#). The BGP Multipath Load Sharing for Both eBGP and iBGP in an MPLS VPN feature is enabled under the IPv4 VRF address family and IPv6 VRF address family configuration modes. When enabled, this feature can perform load balancing on eBGP and/or iBGP paths that are imported into the VRF. The number of multipaths is configured on a per VRF basis. Separate VRF multipath configurations are isolated by unique route distinguisher.



---

**Note** The BGP Multipath Load Sharing for Both eBGP and iBGP in an MPLS VPN feature operates within the parameters of configured outbound routing policy.

---



## eBGP and iBGP Multipath Load Sharing in a BGP MPLS Network

The following figure shows a service provider BGP MPLS network that connects two remote networks to PE router 1 and PE router 2. PE router 1 and PE router 2 are both configured for VPNv4 unicast iBGP peering. Network 2 is a multihomed network that is connected to PE router 1 and PE router 2. Network 2 also has extranet VPN services configured with Network 1. Both Network 1 and Network 2 are configured for eBGP peering with the PE routers.

**Figure 2: Service Provider BGP MPLS Network**

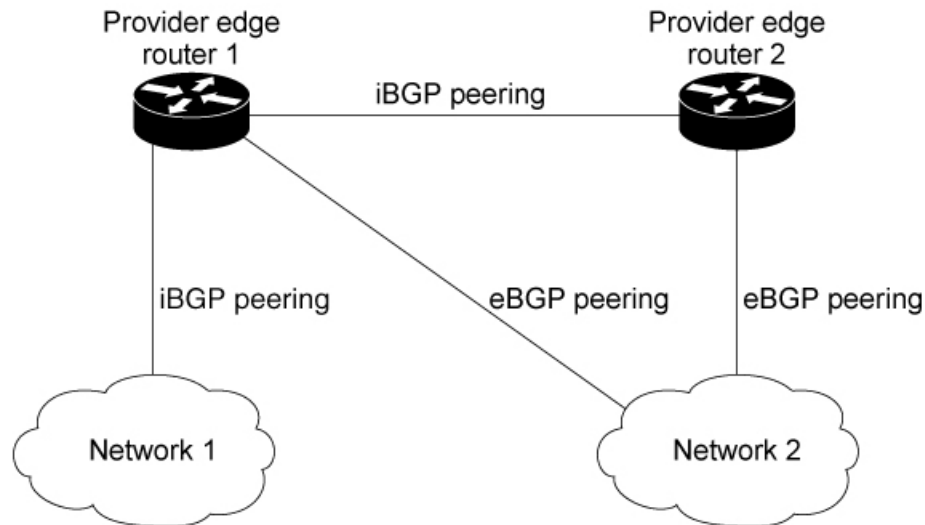

PE router 1 can be configured with the BGP Multipath Load Sharing for Both eBGP and iBGP in an MPLS VPN feature so that both iBGP and eBGP paths can be selected as multipaths and imported into the VRF. The multipaths will be used by CEF to perform load balancing. IP traffic that is sent from Network 1 to Network 2, PE router 1 will Load Share with eBGP paths as IP traffic & iBGP path will be sent as MPLS traffic.



### Note

- eBGP session between local CE & local PE is not supported.
- eBGP session from a local PE to a remote CE is supported.
- eiBGP Multipath is supported in per prefix label allocation mode only. It is not supported in other label allocation modes.

## Benefits of Multipath Load Sharing for Both eBGP and iBGP

The BGP Multipath Load Sharing for Both eBGP and iBGP in an MPLS VPN feature allows multihomed autonomous systems and PE routers to be configured to distribute traffic across both eBGP and iBGP paths.

# How to Configure BGP Multipath Load Sharing for Both eBGP and iBGP in an MPLS-VPN

This section contains the following procedures:

## Configuring Multipath Load Sharing for Both eBGP and iBGP

### Procedure

	Command or Action	Purpose
<b>Step 1</b>	<b>enable</b> <b>Example:</b> Device> <b>enable</b>	Enables privileged EXEC mode. <ul style="list-style-type: none"><li>• Enter your password if prompted.</li></ul>
<b>Step 2</b>	<b>configure { terminal   memory   network }</b> <b>Example:</b> Device# <b>configure terminal</b>	Enters global configuration mode.
<b>Step 3</b>	<b>router bgp as-number</b> <b>Example:</b> Device(config)# <b>router bgp 40000</b>	Enters router configuration mode to create or configure a BGP routing process.
<b>Step 4</b>	<b>neighbor {ip-address   ipv6-address   peer-group-name }</b> <b>Example:</b> Device(config-router)# <b>neighbor group192</b>	Accepts and attempts BGP connections to external peers residing on networks that are not directly connected.
<b>Step 5</b>	<b>address-family ipv4 vrfvrf-name</b> <b>Example:</b> Device(config-router)# <b>address-family ipv4 vrf RED</b>	Places the router in address family configuration mode. <ul style="list-style-type: none"><li>• Separate VRF multipath configurations are isolated by unique route distinguisher.</li></ul>
<b>Step 6</b>	<b>address-family ipv6 vrfvrf-name</b> <b>Example:</b> Device(config-router)# <b>address-family ipv6 vrf RED</b>	Places the router in address family configuration mode. <ul style="list-style-type: none"><li>• Separate VRF multipath configurations are isolated by unique route distinguisher.</li></ul>
<b>Step 7</b>	<b>neighbor {ip-address   ipv6-address   peer-group-name } update-source interface-type interface-name</b> <b>Example:</b>	Specifies the link-local address over which the peering is to occur.

	Command or Action	Purpose
	Device(config-router)# <b>neighbor FE80::1234:BFF:FE0E:A471 update-source GigabitEthernet 1/0/0</b>	
<b>Step 8</b>	<b>neighbor</b> {ip-address   ipv6-address   peer-group-name } <b>activate</b>  <b>Example:</b> (config-router)# <b>neighbor group192 activate</b>	Activates the neighbor or listen range peer group for the configured address family.
<b>Step 9</b>	<b>maximum-paths eibgp</b> [import-number]  <b>Example:</b> (config-router-af)# <b>maximum-paths eibgp 2</b>	Configures the number of parallel iBGP and eBGP routes that can be installed into a routing table.

## Verifying Multipath Load Sharing for Both eBGP and iBGP

### Procedure

	Command or Action	Purpose
<b>Step 1</b>	<b>enable</b>  <b>Example:</b> Device> <b>enable</b>	Enables privileged EXEC mode.  • Enter your password if prompted.
<b>Step 2</b>	<b>show ip bgp neighbors</b>  <b>Example:</b> Device# <b>show ip bgp neighbors</b>	Displays information about the TCP and BGP connections to neighbors.
<b>Step 3</b>	<b>show ip bgp vpnv4 vrf vrf name</b>  <b>Example:</b> Device# <b>show ip bgp vpnv4 vrf RED</b>	Displays VPN address information from the BGP table. This command is used to verify that the VRF has been received by BGP.
<b>Step 4</b>	<b>show ip route vrf vrf-name</b>  <b>Example:</b> Device# <b>show ip route vrf RED</b>	Displays the IP routing table associated with a VRF instance. The show ip route vrf command is used to verify that the VRF is in the routing table.

## Configuration Examples for the BGP Multipath Load Sharing for Both eBGP and iBGP in an MPLS-VPN Feature

The following examples show how to configure and verify this feature:

## eBGP and iBGP Multipath Load Sharing Configuration Example

This following configuration example configures a router in IPv4 address-family mode to select two BGP routes (eBGP or iBGP) as multipaths:

```
Device(config)# router bgp 40000
Device(config-router)# address-family ipv4 vrf RED
Device(config-router-af)# maximum-paths eibgp 2
Device(config-router-af)# end
```

This following configuration example configures a router in IPv6 address-family mode to select two BGP routes (eBGP or iBGP) as multipaths:

```
Device(config)#router bgp 40000
Device(config-router)# address-family ipv6 vrf RED
Device(config-router-af)# maximum-paths eibgp 2
Device(config-router-af)# end
```

## Feature Information for BGP Multipath Load Sharing for Both eBGP and iBGP in an MPLS-VPN

The following table provides release information about the feature or features described in this module. This table lists only the software release that introduced support for a given feature in a given software release train. Unless noted otherwise, subsequent releases of that software release train also support that feature.

**Table 1: Feature Information for BGP Multipath Load Sharing for Both eBGP and iBGP in an MPLS-VPN**

Feature Name	Releases	Feature Information
BGP Multipath Load Sharing for Both eBGP and iBGP in an MPLS-VPN	Cisco IOS XE Everest 16.6.1	The BGP Multipath Load Sharing for eBGP and iBGP feature allows you to configure multipath load balancing with both external BGP (eBGP) and internal BGP (iBGP) paths in Border Gateway Protocol (BGP) networks that are configured to use Multiprotocol Label Switching (MPLS) Virtual Private Networks (VPNs). This feature provides improved load balancing deployment and service offering capabilities and is useful for multi-homed autonomous systems and Provider Edge (PE) routers that import both eBGP and iBGP paths from multihomed and stub networks.



## CHAPTER 4

# Configuring EIGRP MPLS VPN PE-CE Site of Origin

---

- [EIGRP MPLS VPN PE-CE Site of Origin, on page 33](#)
- [Information About EIGRP MPLS VPN PE-CE Site of Origin, on page 34](#)
- [How to Configure EIGRP MPLS VPN PE-CE Site of Origin Support, on page 35](#)
- [Configuration Examples for EIGRP MPLS VPN PE-CE SoO, on page 38](#)
- [Feature History for EIGRP MPLS VPN PE-CE Site of Origin, on page 39](#)

## EIGRP MPLS VPN PE-CE Site of Origin

The EIGRP MPLS VPN PE-CE Site of Origin feature introduces the capability to filter Multiprotocol Label Switching (MPLS) Virtual Private Network (VPN) traffic on a per-site basis for Enhanced Interior Gateway Routing Protocol (EIGRP) networks. Site of Origin (SoO) filtering is configured at the interface level and is used to manage MPLS VPN traffic and to prevent transient routing loops from occurring in complex and mixed network topologies. This feature is designed to support the MPLS VPN Support for EIGRP Between Provider Edge (PE) and Customer Edge (CE) feature. Support for backdoor links is provided by this feature when installed on PE routers that support EIGRP MPLS VPNs.

## Prerequisites for EIGRP MPLS VPN PE-CE Site of Origin

This document assumes that Border Gateway Protocol (BGP) is configured in the network core (or the service provider backbone). The following tasks will also need to be completed before you can configure this feature:

- This feature was introduced to support the MPLS VPN Support for EIGRP Between Provider Edge and Customer Edge feature and should be configured after the EIGRP MPLS VPN is created.
- All PE routers that are configured to support the EIGRP MPLS VPN must run Cisco IOS XE Gibraltar 16.11.1 or a later release, which provides support for the SoO extended community.

## Restrictions for EIGRP MPLS VPN PE-CE Site of Origin

- If a VPN site is partitioned and the SoO extended community attribute is configured on a backdoor router interface, the backdoor link cannot be used as an alternate path to reach prefixes originated in other partitions of the same site

- A unique SoO value must be configured for each individual VPN site. The same value must be configured on all provider edge and customer edge interfaces (if SoO is configured on the CE routers) that support the same VPN site.
- `ip unnumbered` command is not supported in MPLS configuration.

## Information About EIGRP MPLS VPN PE-CE Site of Origin

The following section describes information about EIGRP MPLS VPN PE-CE Site of Origin.

### EIGRP MPLS VPN PE-CE Site of Origin Support Overview

The EIGRP MPLS VPN PE-CE Site of Origin feature introduces SoO support for EIGRP-to-BGP and BGP-to-EIGRP redistribution. The SoO extended community is a BGP extended community attribute that is used to identify routes that have originated from a site so that the readvertisement of that prefix back to the source site can be prevented. The SoO extended community uniquely identifies the site from which a PE router has learned a route. SoO support provides the capability to filter MPLS VPN traffic on a per-EIGRP-site basis. SoO filtering is configured at the interface level and is used to manage MPLS VPN traffic and to prevent routing loops from occurring in complex and mixed network topologies, such as EIGRP VPN sites that contain both VPN and backdoor links.

The configuration of the SoO extended community allows MPLS VPN traffic to be filtered on a per-site basis. The SoO extended community is configured in an inbound BGP route map on the PE router and is applied to the interface. The SoO extended community can be applied to all exit points at the customer site for more specific filtering but must be configured on all interfaces of PE routers that provide VPN services to CE routers.

### Site of Origin Support for Backdoor Links

The EIGRP MPLS VPN PE-CE Site of Origin (SoO) feature introduces support for backdoor links. A backdoor link or a route is a connection that is configured outside of the VPN between a remote and main site; for example, a WAN leased line that connects a remote site to the corporate network. Backdoor links are typically used as back up routes between EIGRP sites if the VPN link is down or not available. A metric is set on the backdoor link so that the route through the backdoor router is not selected unless there is a VPN link failure.

The SoO extended community is defined on the interface of the backdoor router. It identifies the local site ID, which should match the value that is used on the PE routers that support the same site. When the backdoor router receives an EIGRP update (or reply) from a neighbor across the backdoor link, the router checks the update for an SoO value. If the SoO value in the EIGRP update matches the SoO value on the local backdoor interface, the route is rejected and not added to the EIGRP topology table. This scenario typically occurs when the route with the local SoO value in the received EIGRP update was learned by the other VPN site and then advertised through the backdoor link by the backdoor router in the other VPN site. SoO filtering on the backdoor link prevents transient routing loops from occurring by filtering out EIGRP updates that contain routes that carry the local site ID.

If this feature is enabled on the PE routers and the backdoor routers in the customer sites, and SoO values are defined on both the PE and backdoor routers, both the PE and backdoor routers will support convergence between the VPN sites. The other routers in the customer sites need only propagate the SoO values carried by the routes, as the routes are forwarded to neighbors. These routers do not otherwise affect or support convergence beyond normal Diffusing Update Algorithm (DUAL) computations.

## Router Interoperation with the Site of Origin Extended Community

The configuration of an SoO extended community allows routers that support EIGRP MPLS VPN PE-CE Site of Origin feature to identify the site from which each route originated. When this feature is enabled, the EIGRP routing process on the PE or CE router checks each received route for the SoO extended community and filters based on the following conditions:

- A received route from BGP or a CE router contains an SoO value that matches the SoO value on the receiving interface : If a route is received with an associated SoO value that matches the SoO value that is configured on the receiving interface, the route is filtered because it was learned from another PE router or from a backdoor link. This behavior is designed to prevent routing loops.
- A received route from a CE router is configured with an SoO value that does not match: If a route is received with an associated SoO value that does not match the SoO value that is configured on the receiving interface, the route is added to the EIGRP topology table so that it can be redistributed into BGP. If the route is already installed to the EIGRP topology table but is associated with a different SoO value, the SoO value from the topology table will be used when the route is redistributed into BGP.
- A received route from a CE router does not contain an SoO value: If a route is received without a SoO value, the route is accepted into the EIGRP topology table, and the SoO value from the interface that is used to reach the next hop CE router is appended to the route before it is redistributed into BGP.

When BGP and EIGRP peers that support the SoO extended community receive these routes, they will also receive the associated SoO values and pass them to other BGP and EIGRP peers that support the SoO extended community. This filtering is designed to prevent transient routes from being relearned from the originating site, which prevents transient routing loops from occurring.

## Redistribution of BGP VPN Routes That Carry the Site of Origin into EIGRP

When an EIGRP routing process on a PE router redistributes BGP VPN routes into an EIGRP topology table, EIGRP extracts the SoO value (if one is present) from the appended BGP extended community attributes and appends the SoO value to the route before adding it to the EIGRP topology table. EIGRP tests the SoO value for each route before sending updates to CE routers. Routes that are associated with SoO values that match the SoO value configured on the interface are filtered out before they are passed to the CE routers. When an EIGRP routing process receives routes that are associated with different SoO values, the SoO value is passed to the CE router and carried through the CE site.

## Benefits of the EIGRP MPLS VPN PE-CE Site of Origin Support Feature

The configuration of the EIGRP MPLS VPN PE-CE Site of Origin Support feature introduces per-site VPN filtering, which improves support for complex topologies, such as MPLS VPNs with backdoor links, CE routers that are dual-homed to different PE routers, and PE routers that support CE routers from different sites within the same virtual routing and forwarding (VRF) instance.

## How to Configure EIGRP MPLS VPN PE-CE Site of Origin Support

The following sections provide information about how to configure EIGRP MPLS VPN PE-CE Site of Origin Support:

## Configuring the Site of Origin Extended Community

The configuration of the SoO extended community allows MPLS VPN traffic to be filtered on a per-site basis. The SoO extended community is configured in an inbound BGP route map on the PE router and is applied to the interface. The SoO extended community can be applied to all exit points at the customer site for more specific filtering but must be configured on all interfaces of PE routers that provide VPN services to CE routers.

### Before you begin

- Confirm that the Border Gateway Protocol (BGP) is configured in the network core (or the service provider backbone).
- Configure an EIGRP MPLS VPN before configuring this feature.
- All PE routers that are configured to support the EIGRP MPLS VPN must support the SoO extended community.
- A unique SoO value must be configured for each VPN site. The same value must be used on the interface of the PE router that connects to the CE router for each VPN site.

### Procedure

	Command or Action	Purpose
<b>Step 1</b>	<b>enable</b> <b>Example:</b> Device> <b>enable</b>	Enables privileged EXEC mode. <ul style="list-style-type: none"> <li>• Enter your password if prompted.</li> </ul>
<b>Step 2</b>	<b>configure terminal</b> <b>Example:</b> Device# <b>configure terminal</b>	Enters global configuration mode.
<b>Step 3</b>	<b>route-map</b> <i>map-name</i> { <b>permit</b>   <b>deny</b> } [ <i>sequence-number</i> ] <b>Example:</b> Device(config)# <b>route-map Site-of-Origin</b> <b>permit 10</b>	Enters route-map configuration mode and creates a route map. <ul style="list-style-type: none"> <li>• The route map is created in this step so that SoO extended community can be applied.</li> </ul>
<b>Step 4</b>	<b>set extcommunity</b> <b>soo</b> <i>extended-community-value</i> <b>Example:</b> Device(config-route-map)# <b>set</b> <b>extcommunity soo 100:1</b>	Sets BGP extended community attributes. <ul style="list-style-type: none"> <li>• The soo keyword specifies the site of origin extended community attribute.</li> <li>• The extended-community-value argument specifies the value to be set. The value can be one of the following formats:               <ul style="list-style-type: none"> <li>• autonomous-system-number: network-number</li> <li>• ip-address: network-number</li> </ul> </li> </ul>



	Command or Action	Purpose
		The colon is used to separate the autonomous system number and network number or IP address and network number.
<b>Step 5</b>	<b>exit</b> <b>Example:</b> Device(config-route-map)# <b>exit</b>	Exits route-map configuration mode and enters global configuration mode.
<b>Step 6</b>	<b>interface</b> <i>type number</i> <b>Example:</b> Device(config)# <b>interface</b> <b>GigabitEthernet 1/0/1</b>	Enters interface configuration mode to configure the specified interface.
<b>Step 7</b>	<b>no switchport</b> <b>Example:</b> Device(config-if)# <b>no switchport</b>	causes the interface to cease operating as a Layer 2 port and become a Cisco-routed (Layer 3) port:
<b>Step 8</b>	<b>vrf forwarding</b> <i>vrf-name</i> <b>Example:</b> Device(config-if)# <b>vrf forwarding VRF1</b>	Associates the VRF with an interface or subinterface. <ul style="list-style-type: none"> <li>The VRF name configured in this step should match the VRF name created for the EIGRP MPLS VPN with the MPLS VPN Support for EIGRP Between Provider Edge and Customer Edge feature.</li> </ul>
<b>Step 9</b>	<b>ip vrf sitemap</b> <i>route-map-name</i> <b>Example:</b> Device(config-if)# <b>ip vrf sitemap</b> <b>Site-of-Origin</b>	Associates the VRF with an interface or subinterface. <ul style="list-style-type: none"> <li>The route map name configured in this step should match the route map name created to apply the SoO extended community in Step 3.</li> </ul>
<b>Step 10</b>	<b>ip address</b> <i>ip-address subnet-mask</i> <b>Example:</b> Device(config-if)# <b>ip address 10.0.0.1</b> <b>255.255.255.255</b>	Configures the IP address for the interface. <ul style="list-style-type: none"> <li>The IP address needs to be reconfigured after enabling VRF forwarding.</li> </ul>
<b>Step 11</b>	<b>end</b> <b>Example:</b> Device(config-if)# <b>end</b>	Exits interface configuration mode and enters privileged EXEC mode.

### What to do next

- For mixed EIGRP MPLS VPN network topologies that contain backdoor routes, the next task is to configure the “prebest path” cost community for backdoor routes.

## Verifying the Configuration of the SoO Extended Community

### Procedure

	Command or Action	Purpose
<b>Step 1</b>	<b>enable</b> <b>Example:</b> Device> <b>enable</b>	Enables privileged EXEC mode. <ul style="list-style-type: none"> <li>• Enter your password if prompted.</li> </ul>
<b>Step 2</b>	<b>show ip bgp vpnv4</b> { <b>all</b>   <b>rd</b>   <b>route-distinguisher</b>   <b>vrf</b>   <b>vrf-name</b> } [ <b>ip-prefix/length</b> ] <b>Example:</b> Device# <b>ip bgp vpnv4 vrf SOO-1</b> <b>20.2.1.1/32</b>	Displays VPN address information from the BGP table. <ul style="list-style-type: none"> <li>• Use the show ip bgp vpnv4 command with the all keyword to verify that the specified route has been configured with the SoO extended community attribute.</li> </ul>

## Configuration Examples for EIGRP MPLS VPN PE-CE SoO

The following section shows configuration examples for EIGRP MPLS VPN PE-CE SoO:

### Example Configuring the Site of Origin Extended Community

The following example, beginning in global configuration mode, configures SoO extended community on an interface:

```

route-map Site-of-Origin permit 10
  set extcommunity soo 100:1
exit
GigabitEthernet1/0/1
vrf forwarding RED
ip vrf sitemap Site-of-Origin
ip address 10.0.0.1 255.255.255.255
end

```

### Example Verifying the Site of Origin Extended Community

The following example shows VPN address information from the BGP table and verifies the configuration of the SoO extended community:

```

Device# show ip bgp vpnv4 all 10.0.0.1
  BGP routing table entry for 100:1:10.0.0.1/32, version 6
  Paths: (1 available, best #1, no table)
  Advertised to update-groups:
  1
  100 300
  192.168.0.2 from 192.168.0.2 (172.16.13.13)
  Origin incomplete, localpref 100, valid, external, best
  Extended Community: SOO:100:1

```

### Show command Customer Edge Device

```
Device# show ip eigrp topo 20.2.1.1/32
EIGRP-IPv4 Topology Entry for AS(30)/ID(30.0.0.1) for 20.2.1.1/32
  State is Passive, Query origin flag is 1, 2 Successor(s), FD is 131072
  Descriptor Blocks:
    31.1.1.2 (GigabitEthernet1/0/13), from 31.1.1.2, Send flag is 0x0
      Composite metric is (131072/130816), route is External
      Vector metric:
        Minimum bandwidth is 1000000 Kbit
        Total delay is 5020 microseconds
        Reliability is 255/255
        Load is 1/255
        Minimum MTU is 1500
        Hop count is 2
        Originating router is 30.0.0.2
      Extended Community: SoO:100:1
  External data:
    AS number of route is 0
    External protocol is Connected, external metric is 0
    Administrator tag is 0 (0x00000000)
```

### Show command Provider Edge Device

```
Device# show ip eigrp vrf SOO-1 topology 31.1.1.0/24
EIGRP-IPv4 VR(L3VPN) Topology Entry for AS(30)/ID(2.2.2.22)
  Topology(base) TID(0) VRF(SOO-1)
EIGRP-IPv4(30): Topology base(0) entry for 31.1.1.0/24
  State is Passive, Query origin flag is 1, 1 Successor(s), FD is 1310720
  Descriptor Blocks:
    1.1.1.1, from VPNv4 Sourced, Send flag is 0x0
      Composite metric is (1310720/0), route is Internal (VPNv4 Sourced)
      Vector metric:
        Minimum bandwidth is 1000000 Kbit
        Total delay is 10000000 picoseconds
        Reliability is 255/255
        Load is 1/255
        Minimum MTU is 1500
        Hop count is 0
        Originating router is 1.1.1.11
      Extended Community: SoO:100:1
```

## Feature History for EIGRP MPLS VPN PE-CE Site of Origin

This table provides release and related information for features explained in this module.

These features are available on all releases subsequent to the one they were introduced in, unless noted otherwise.

Release	Feature	Feature Information
Cisco IOS XE Everest 16.6.1	EIGRP MPLS VPN PE-CE Site of Origin	The EIGRP MPLS VPN PE-CE Site of Origin feature introduces the capability to filter Multiprotocol Label Switching (MPLS) Virtual Private Network (VPN) traffic on a per-site basis for Enhanced Interior Gateway Routing Protocol (EIGRP) networks.

Use Cisco Feature Navigator to find information about platform and software image support. To access Cisco Feature Navigator, go to <http://www.cisco.com/go/cfn>.



## CHAPTER 5

# Configuring Ethernet-over-MPLS and Pseudowire Redundancy

---

- [Configuring Ethernet-over-MPLS, on page 41](#)
- [Configuring Pseudowire Redundancy, on page 56](#)
- [Feature History for Ethernet-over-MPLS and Pseudowire Redundancy, on page 71](#)

## Configuring Ethernet-over-MPLS

This section provides information about how to configure Ethernet over Multiprotocol Label Switching (EoMPLS).

### Prerequisites for Ethernet-over-MPLS

Before you configure EoMPLS, ensure that the network is configured as follows:

- Configure IP routing in the core so that the provider edge (PE) devices can reach each other through IP.
- Configure MPLS in the core so that a label switched path (LSP) exists between the PE devices.
- Configure the **no switchport**, **no keepalive**, and **no ip address** commands before configuring Xconnect on the attachment circuit.
- For load-balancing, configuring the **port-channel load-balance** command is mandatory.
- Subinterfaces must be supported to enable EoMPLS VLAN mode.
- The **mpls ldp graceful-restart** command must be configured to enable the device to protect LDP bindings and MPLS forwarding state during a disruption in service. We recommend you to configure this command (even if you do not want to preserve the forwarding state) to avoid device failure during SSO in a high availability setup with scale configurations.

### Restrictions for Ethernet-over-MPLS

The following sections list the restrictions for EoMPLS port mode and EoMPLS VLAN mode.

## Restrictions for Ethernet-over-MPLS Port Mode

- Ethernet Flow Point is not supported.
- Quality of Service (QoS): Customer differentiated services code point (DSCP) re-marking is not supported with virtual private wire service (VPWS) and EoMPLS.
- Virtual Circuit Connectivity Verification (VCCV) ping with explicit null is not supported.
- Layer 2 Protocol Tunneling CLI is not supported.
- Flow-Aware Transport (FAT) Pseudowire Redundancy is supported only in Protocol-CLI mode. Supported load-balancing parameters are Source IP, Source MAC address, Destination IP, and Destination MAC address.
- MPLS QoS is supported only in pipe and uniform mode. Default mode is pipe mode.
- Both legacy Xconnect and Protocol-CLI (interface pseudowire configuration) modes are supported.
- Xconnect mode cannot be configured on SVI.
- Xconnect and MACSec cannot be configured on the same interface.
- MACSec should be configured on CE devices and Xconnect should be configured on PE devices.
- A MACSec session should be available between CE devices.
- By default, EoMPLS PW tunnels all the protocols such as Cisco Discovery Protocol and Spanning Tree Protocol (STP). EoMPLS PW cannot perform selective protocol tunneling as part of L2 Protocol Tunneling CLI.
- Link Aggregation Control Protocol (LACP) and Port Aggregation Protocol (PAgP) packets are not forwarded over Ethernet-over-MPLS Pseudowire, as these are processed by the local PE.

## Restrictions for EoMPLS VLAN Mode

- Virtual circuit will not work if the same interworking type is not configured on PE devices.
- Untagged traffic is not supported as incoming traffic.
- Xconnect mode cannot be enabled on Layer 2 subinterfaces because multiplexer user-network interface (MUX UNI) is not supported.
- Xconnect mode cannot be configured on subinterfaces if it is enabled on the main interface for port-to-port transport.
- FAT can be configured on Protocol CLI mode only.
- In VLAN mode EoMPLS, only those packets encrypted with the dot1q in clear by the CE device will be processed by the PE device.
- QoS: Customer DSCP Remarking is not supported with VPWS and EoMPLS.
- MPLS QoS is supported in pipe and uniform mode. Default mode is pipe mode.
- In VLAN mode EoMPLS, Cisco Discovery Protocol packets from the CE will be processed by the PE, but will not be carried over the EoMPLS virtual circuit, whereas in port mode, Cisco Discovery Protocol packets from the CE will be carried over the virtual circuit.

- Only Ethernet and VLAN interworking types are supported.
- L2 Protocol Tunneling CLI is not supported.
- Link Aggregation Control Protocol (LACP) and Port Aggregation Protocol (PAgP) packets are not forwarded over Ethernet-over-MPLS Pseudowire, as these are processed by the local PE.

## Information About Ethernet-over-MPLS

EoMPLS is one of the Any Transport over MPLS (AToM) transport types. EoMPLS works by encapsulating Ethernet protocol data units (PDUs) in MPLS packets and forwarding them across the MPLS network. Each PDU is transported as a single packet.

The following modes are supported:

- Port mode: Allows all traffic on a port to share a single virtual circuit across an MPLS network. Port mode uses virtual circuit type 5.
- VLAN mode: Transports Ethernet traffic from a source 802.1Q VLAN to a destination 802.1Q VLAN through a single virtual circuit over an MPLS network. VLAN mode uses virtual circuit type 5 as the default (does not transport dot1q tag); however, uses virtual circuit type 4 (transports dot1 tag) if the remote PE does not support virtual circuit type 5 for subinterface-based (VLAN-based) EoMPLS.

Interworking between EoMPLS port mode and EoMPLS VLAN mode: If EoMPLS port mode is configured on a local PE and EoMPLS VLAN mode on a remote PE, then the customer edge (CE) Layer 2 switchport interface must be configured as an *access* on the port mode side and the Spanning Tree Protocol must be disabled on the VLAN mode side of the CE device.

The maximum transmission unit (MTU) of all the intermediate links between PEs must be able to carry the largest Layer 2 packet received on ingress PE.

## How to Configure Ethernet-over-MPLS

EoMPLS can be configured in the port mode or VLAN mode.

### Configuring Ethernet-over-MPLS Port Mode

EoMPLS port mode can be configured using either the Xconnect mode or protocol CLI method.

#### Xconnect Mode

To configure EoMPLS port mode in Xconnect mode, perform the following task:

#### Procedure

	Command or Action	Purpose
<b>Step 1</b>	<b>enable</b> <b>Example:</b> Device> <b>enable</b>	Enables privileged EXEC mode. Enter your password if prompted.

	Command or Action	Purpose
<b>Step 2</b>	<b>configure terminal</b> <b>Example:</b>  Device# <b>configure terminal</b>	Enters global configuration mode.
<b>Step 3</b>	<b>interface <i>interface-id</i></b> <b>Example:</b>  Device(config)# <b>interface</b> <b>TenGigabitEthernet1/0/36</b>	Defines the interface to be configured as a trunk, and enters interface configuration mode.
<b>Step 4</b>	<b>no switchport</b> <b>Example:</b>  Device(config-if)# <b>no switchport</b>	Enters Layer 3 mode for physical ports only.
<b>Step 5</b>	<b>no ip address</b> <b>Example:</b>  Device(config-if)# <b>no ip address</b>	Ensures that no IP address is assigned to the physical port.
<b>Step 6</b>	<b>no keepalive</b> <b>Example:</b>  Device(config-if)# <b>no keepalive</b>	Ensures that the device does not send keepalive messages.
<b>Step 7</b>	<b>xconnect <i>peer-device-id</i> <i>vc-id</i> encapsulation mpls</b> <b>Example:</b>  Device(config-if)# <b>xconnect 10.1.1.1 962</b> <b>encapsulation mpls</b>	Binds the attachment circuit to a pseudowire virtual circuit (VC). The syntax for this command is the same as for all other Layer 2 transports.
<b>Step 8</b>	<b>end</b> <b>Example:</b>  Device(config-if)# <b>end</b>	Exits interface configuration mode and returns to privileged EXEC mode.



## Protocol CLI Method

To configure EoMPLS port mode in protocol CLI mode, perform the following task:

## Procedure

	Command or Action	Purpose
<b>Step 1</b>	<b>enable</b> <b>Example:</b>  Device> <b>enable</b>	Enables privileged EXEC mode. Enter your password if prompted.
<b>Step 2</b>	<b>configure terminal</b> <b>Example:</b>  Device# <b>configure terminal</b>	Enters global configuration mode.
<b>Step 3</b>	<b>port-channel load-balance dst-ip</b> <b>Example:</b>  Device (config)# <b>port-channel load-balance dst-ip</b>	Sets the load distribution method to the destination IP address.
<b>Step 4</b>	<b>interface interface-id</b> <b>Example:</b>  Device (config)# <b>interface TenGigabitEthernet1/0/21</b>	Defines the interface to be configured as a trunk, and enters interface configuration mode.
<b>Step 5</b>	<b>no switchport</b> <b>Example:</b>  Device (config-if)# <b>no switchport</b>	Enters Layer 3 mode for physical ports only.
<b>Step 6</b>	<b>no ip address</b> <b>Example:</b>  Device (config-if)# <b>no ip address</b>	Ensures that no IP address is assigned to the physical port.
<b>Step 7</b>	<b>no keepalive</b> <b>Example:</b>	Ensures that the device does not send keepalive messages.

	Command or Action	Purpose
	Device (config-if) # <b>no keepalive</b>	
<b>Step 8</b>	<b>exit</b> <b>Example:</b> Device (config-if) # <b>exit</b>	Exits interface configuration mode and returns to global configuration mode.
<b>Step 9</b>	<b>interface pseudowire <i>number</i></b> <b>Example:</b> Device (config) # <b>interface pseudowire 17</b>	Establishes a pseudowire interface with a value that you specify and enters pseudowire configuration mode.
<b>Step 10</b>	<b>encapsulation mpls</b> <b>Example:</b> Device (config-if) # <b>encapsulation mpls</b>	Specifies the tunneling encapsulation.
<b>Step 11</b>	<b>neighbor <i>peer-ip-addr vc-id</i></b> <b>Example:</b> Device (config-if) # <b>neighbor 10.10.0.10 17</b>	Specifies the peer IP address and virtual circuit (VC) ID value of a Layer 2 VPN (L2VPN) pseudowire.
<b>Step 12</b>	<b>l2vpn xconnect context <i>context-name</i></b> <b>Example:</b> Device (config-if) # <b>l2vpn xconnect context vpws17</b>	Creates an L2VPN cross connect context and enters Xconnect context configuration mode.
<b>Step 13</b>	<b>member <i>interface-id</i></b> <b>Example:</b> Device (config-if-xconn) # <b>member TenGigabitEthernet1/0/21</b>	Specifies interface that forms an L2VPN cross connect.

	Command or Action	Purpose
<b>Step 14</b>	<b>member pseudowire <i>number</i></b> <b>Example:</b> <pre>Device(config-if-xconn)# member pseudowire 17</pre>	Specifies the pseudowire interface that forms an L2VPN cross connect.
<b>Step 15</b>	<b>end</b> <b>Example:</b> <pre>Device(config-if-xconn)# end</pre>	Exits Xconnect interface configuration mode and returns to privileged EXEC mode.

## Configuring Ethernet-over-MPLS VLAN Mode

EoMPLS VLAN mode can be configured using either the Xconnect mode or protocol-CLI method.

### Xconnect Mode

To configure EoMPLS VLAN mode in Xconnect mode, perform the following task:

#### Procedure

	Command or Action	Purpose
<b>Step 1</b>	<b>enable</b> <b>Example:</b> <pre>Device&gt; enable</pre>	Enables privileged EXEC mode. Enter your password if prompted.
<b>Step 2</b>	<b>configure terminal</b> <b>Example:</b> <pre>Device# configure terminal</pre>	Enters global configuration mode.
<b>Step 3</b>	<b>interface <i>interface-id</i></b> <b>Example:</b> <pre>Device(config)# interface TenGigabitEthernet1/0/36</pre>	Defines the interface to be configured as a trunk, and enters interface configuration mode.
<b>Step 4</b>	<b>no switchport</b> <b>Example:</b> <pre>Device(config-if)# no switchport</pre>	Enters Layer 3 mode, for physical ports only.

	Command or Action	Purpose
<b>Step 5</b>	<b>no ip address</b> <b>Example:</b> Device(config-if)# <b>no ip address</b>	Ensures that there is no IP address assigned to the physical port.
<b>Step 6</b>	<b>no keepalive</b> <b>Example:</b> Device(config-if)# <b>no keepalive</b>	Ensures that the device does not send keepalive messages.
<b>Step 7</b>	<b>exit</b> <b>Example:</b> Device(config-if)# <b>exit</b>	Exits interface configuration mode and returns to global configuration mode.
<b>Step 8</b>	<b>interface interface-id.subinterface</b> <b>Example:</b> Device(config)# <b>interface</b> <b>TenGigabitEthernet1/0/36.1105</b>	Defines the subinterface to be configured, and enters subinterface configuration mode.
<b>Step 9</b>	<b>encapsulation dot1Q vlan-id</b> <b>Example:</b> Device(config-subif)# <b>encapsulation</b> <b>dot1Q 1105</b>	Enables IEEE 802.1Q encapsulation of traffic on the subinterface.
<b>Step 10</b>	<b>xconnect peer-ip-addr vc-id encapsulation mpls</b> <b>Example:</b> Device(config-subif)# <b>xconnect 10.0.0.1</b> <b>1105 encapsulation mpls</b>	Binds the attachment circuit to a pseudowire VC. The syntax for this command is the same as for all other Layer 2 transports.
<b>Step 11</b>	<b>end</b> <b>Example:</b> Device(config-subif-xconn)# <b>end</b>	Returns to privileged EXEC mode.

## Protocol CLI Method

To configure EoMPLS VLAN mode in protocol-CLI mode, perform the following task:

## Procedure

	Command or Action	Purpose
<b>Step 1</b>	<b>enable</b> <b>Example:</b>  Device> <b>enable</b>	Enables privileged EXEC mode. Enter your password if prompted.
<b>Step 2</b>	<b>configure terminal</b> <b>Example:</b>  Device# <b>configure terminal</b>	Enters global configuration mode.
<b>Step 3</b>	<b>port-channel load-balance dst-ip</b> <b>Example:</b>  Device(config)# <b>port-channel load-balance dst-ip</b>	Sets the load-distribution method to the destination IP address.
<b>Step 4</b>	<b>interface interface-id</b> <b>Example:</b>  Device(config)# <b>interface TenGigabitEthernet1/0/36</b>	Defines the interface to be configured as a trunk, and enters interface configuration mode.
<b>Step 5</b>	<b>no switchport</b> <b>Example:</b>  Device(config-if)# <b>no switchport</b>	Enters Layer 3 mode, for physical ports only.
<b>Step 6</b>	<b>no ip address</b> <b>Example:</b>  Device(config-if)# <b>no ip address</b>	Ensures that there is no IP address assigned to the physical port.
<b>Step 7</b>	<b>no keepalive</b> <b>Example:</b>  Device(config-if)# <b>no keepalive</b>	Ensures that the device does not send keepalive messages.

	Command or Action	Purpose
<b>Step 8</b>	<b>exit</b> <b>Example:</b> Device (config-if) # <b>exit</b>	Exits interface configuration mode and returns to global configuration mode.
<b>Step 9</b>	<b>interface</b> <i>interface-id.subinterface</i> <b>Example:</b> Device (config) # <b>interface</b> <b>TenGigabitEthernet1/0/36.1105</b>	Defines the subinterface to be configured, and enters subinterface configuration mode.
<b>Step 10</b>	<b>encapsulation dot1Q</b> <i>vlan-id</i> <b>Example:</b> Device (config-subif) # <b>encapsulation</b> <b>dot1Q 1105</b>	Enables IEEE 802.1Q encapsulation of traffic on the subinterface.
<b>Step 11</b>	<b>exit</b> <b>Example:</b> Device (config-subif) # <b>exit</b>	Exits subinterface configuration mode and returns to interface configuration mode.
<b>Step 12</b>	<b>interface pseudowire</b> <i>number</i> <b>Example:</b> Device (config) # <b>interface pseudowire 17</b>	Establishes a pseudowire interface with a value that you specify and enters pseudowire configuration mode.
<b>Step 13</b>	<b>encapsulation mpls</b> <b>Example:</b> Device (config-if) # <b>encapsulation mpls</b>	Specifies the tunneling encapsulation.
<b>Step 14</b>	<b>neighbor</b> <i>peer-ip-addr vc-id</i> <b>Example:</b> Device (config-if) # <b>neighbor 10.10.0.10</b> <b>17</b>	Specifies the peer IP address and VC ID value of a L2VPN pseudowire.

	Command or Action	Purpose
<b>Step 15</b>	<b>l2vpn xconnect context</b> <i>context-name</i> <b>Example:</b>  Device (config-if) # <b>l2vpn xconnect context vpws17</b>	Creates a L2VPN cross connect context, and enters Xconnect context configuration mode.
<b>Step 16</b>	<b>member interface-id.subinterface</b> <b>Example:</b>  Device (config-if-xconn) # <b>member TenGigabitEthernet1/0/36.1105</b>	Specifies the subinterface that forms a L2VPN cross connect.
<b>Step 17</b>	<b>member pseudowire number</b> <b>Example:</b>  Device (config-if-xconn) # <b>member pseudowire 17</b>	Specifies pseudowire interface that forms a L2VPN cross connect.
<b>Step 18</b>	<b>end</b> <b>Example:</b>  Device (config-if-xconn) # <b>end</b>	Exits Xconnect configuration mode and returns to privileged EXEC mode.

## Configuration Examples for Ethernet-over-MPLS

Figure 3: EoMPLS Topology

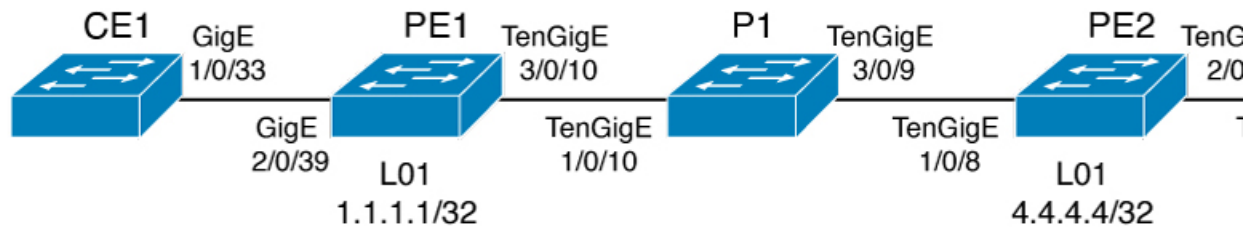

Table 2: EoMPLS Port Mode Configuration

PE Configuration	CE Configuration
<pre> mpls ip mpls label protocol ldp mpls ldp graceful-restart mpls ldp router-id loopback 1 force interface Loopback1 ip address 10.1.1.1 255.255.255.255 ip ospf 100 area 0 router ospf 100 router-id 10.1.1.1 nsf system mtu 9198 port-channel load-balance dst-ip ! interface gigabitethernet 2/0/39 no switchport no ip address no keepalive ! interface pseudowire101 encapsulation mpls neighbor 10.10.10.10 101 load-balance flow ip dst-ip load-balance flow-label both l2vpn xconnect context pw101 member pseudowire101 member gigabitethernet 2/0/39 ! interface tengigabitethernet 3/0/10 switchport trunk allowed vlan 142 switchport mode trunk channel-group 42 mode active ! interface Port-channel42 switchport trunk allowed vlan 142 switchport mode trunk ! interface Vlan142 ip address 10.11.11.11 255.255.255.0  ip ospf 100 area 0 mpls ip mpls label protocol ldp ! </pre>	<pre> interface gigabitethernet 1/0/33 switchport trunk allowed vlan 912 switchport mode trunk spanning-tree portfast trunk ! interface Vlan912 ip address 10.91.2.3 255.255.255.0 ! </pre>



**Table 3: EoMPLS VLAN Mode Configuration**

PE Configuration	CE Configuration
<pre> interface tengigabitethernet 1/0/36 no switchport no ip address no keepalive exit ! interface tengigabitethernet 1/0/36.1105 encapsulation dot1Q 1105 exit ! interface pseudowire1105 encapsulation mpls neighbor 10.10.0.10 1105 exit ! l2vpn xconnect context vme1105 member tengigabitethernet 1/0/36.1105 member pseudowire1105 end !                     </pre>	<pre> interface fortygigabitethernet 1/9 switchport switchport mode trunk switchport trunk allowed vlan 1105  mtu 9216 end !                     </pre>

**Table 4: Interworking Between EoMPLS Port Mode and EoMPLS VLAN Mode Configuration**

PE Configuration: Port Mode	CE Configuration: Port Mode
<pre> interface tengigabitethernet 1/0/37 no switchport no ip address no keepalive exit ! interface pseudowire1105 encapsulation mpls neighbor 10.11.11.11 1105 exit ! l2vpn xconnect context vme1105 member tengigabitethernet 1/0/37 member pseudowire1105 end !                     </pre>	<pre> interface fortygigabitethernet1/10 switchport switchport mode access switchport access vlan 1105 end  no spanning-tree vlan 1105 !                     </pre>

PE Configuration: VLAN Mode	CE Configuration: VLAN Mode
<pre> interface tengigabitethernet 1/0/36  no switchport  no ip address  no keepalive exit ! interface tengigabitethernet 1/0/36.1105   encapsulation dot1Q 1105 exit ! interface pseudowire1105  encapsulation mpls  neighbor 10.10.0.10 1105 exit ! l2vpn xconnect context vme1105  member tengigabitethernet 1/0/36.1105  member pseudowire1105 end ! </pre>	<pre> interface fortygigabitethernet 1/9  switchport  switchport mode trunk  switchport trunk allowed vlan 1105   mtu 9216 end  no spanning-tree vlan 1105 ! </pre>

Another scenario for interworking between EoMPLS port mode and EoMPLS VLAN mode is to configure the following commands on both CE devices:

- **switchport mode trunk**
- **switchport trunk allowed vlan *vlan-id***
- **spanning-tree vlan *vlan-id***

Data traffic will flow through by disabling STP on both CE devices, if the traffic sent is not double VLAN tagged.

The following is a sample output of the **show mpls l2 vc vcid *vc-id* detail** command:

```

Device# show mpls l2 vc vcid 1105 detail
Local interface: TenGigabitEthernet1/0/36.1105 up, line protocol up, Eth VLAN 1105 up
  Interworking type is Ethernet
  Destination address: 10.0.0.1, VC ID: 1105, VC status: up
  Output interface: Po10, imposed label stack {33 10041}
  Preferred path: not configured
  Default path: active
  Next hop: 10.10.0.1
  Create time: 00:04:09, last status change time: 00:02:13
  Last label FSM state change time: 00:02:12
  Signaling protocol: LDP, peer 10.0.0.1:0 up
  Targeted Hello: 10.0.0.10(LDP Id) -> 10.0.0.1, LDP is UP
  Graceful restart: configured and enabled
  Non stop routing: not configured and not enabled
  Status TLV support (local/remote) : enabled/supported
  LDP route watch : enabled
  Label/status state machine : established, LruRru
  Last local dataplane status rcvd: No fault
  Last BFD dataplane status rcvd: Not sent
  Last BFD peer monitor status rcvd: No fault
  Last local AC circuit status rcvd: No fault
  Last local AC circuit status sent: No fault
  Last local PW i/f circ status rcvd: No fault

```

```

Last local LDP TLV      status sent: No fault
Last remote LDP TLV   status rcvd: No fault
Last remote LDP ADJ   status rcvd: No fault
MPLS VC labels: local 124, remote 10041
Group ID: local 336, remote 352
MTU: local 9198, remote 9198
Remote interface description:
MAC Withdraw: sent:1, received:0
Sequencing: receive disabled, send disabled
Control Word: On (configured: autosense)
SSO Descriptor: 10.0.0.1/1105, local label: 124
Dataplane:
  SSM segment/switch IDs: 9465983/446574 (used), PWID: 109
VC statistics:
  transit packet totals: receive 0, send 0
  transit byte totals:  receive 0, send 0
  transit packet drops:  receive 0, seq error 0, send 0

```

The following is a sample output of the **show l2vpn atom vc vcid vc-id detail** command:

```

Device# show l2vpn atom vc vcid 1105 detail
pseudowire100109 is up, VC status is up PW type: Ethernet
  Create time: 00:04:17, last status change time: 00:02:22
  Last label FSM state change time: 00:02:20
  Destination address: 10.0.0.1 VC ID: 1105
  Output interface: Po10, imposed label stack {33 10041}
  Preferred path: not configured
  Default path: active
  Next hop: 10.10.0.1
Member of xconnect service TenGigabitEthernet1/0/36.1105-1105, group right
Associated member TenGigabitEthernet1/0/36.1105 is up, status is up
Interworking type is Ethernet
Service id: 0x1f000037
Signaling protocol: LDP, peer 10.0.0.1:0 up
Targeted Hello: 10.0.0.10(LDP Id) -> 10.0.0.1, LDP is UP
Graceful restart: configured and enabled
Non stop routing: not configured and not enabled
PWid FEC (128), VC ID: 1105
Status TLV support (local/remote)      : enabled/supported
  LDP route watch                       : enabled
  Label/status state machine            : established, LruRru
  Local dataplane status received       : No fault
  BFD dataplane status received         : Not sent
  BFD peer monitor status received      : No fault
  Status received from access circuit   : No fault
  Status sent to access circuit         : No fault
  Status received from pseudowire i/f   : No fault
  Status sent to network peer           : No fault
  Status received from network peer     : No fault
  Adjacency status of remote peer       : No fault
Sequencing: receive disabled, send disabled
Bindings
Parameter      Local                               Remote
-----
Label          124                                           10041
Group ID       336                                           352
Interface
MTU            9198                                           9198
Control word on (configured: autosense) on
PW type        Ethernet                                     Ethernet
VCCV CV type  0x02                                           0x02
                LSPV [2]                                       LSPV [2]
VCCV CC type  0x06                                           0x06
                RA [2], TTL [3]                             RA [2], TTL [3]

```

```

    Status TLV   enabled                               supported
SSO Descriptor: 10.0.0.1/1105, local label: 124
Dataplane:
  SSM segment/switch IDs: 9465983/446574 (used), PWID: 109
Rx Counters
  0 input transit packets, 0 bytes
  0 drops, 0 seq err
  0 MAC withdraw
Tx Counters
  0 output transit packets, 0 bytes
  0 drops
  1 MAC withdraw

```

The following is a sample output of the **show mpls forwarding-table** command:

```

Device# show mpls forwarding-table 10.0.0.1

Local      Outgoing  Prefix          Bytes Label  Outgoing      Next Hop
Label      Label     or Tunnel Id    Switched     interface
2049      33        10.0.0.1/32     38540        Hu2/0/30/2.1  10.0.0.2
          33        10.0.0.1/32     112236       Hu2/0/30/2.2  10.0.0.6
          33        10.0.0.1/32     46188        Hu2/0/30/2.3  10.0.0.8

```

## Configuring Pseudowire Redundancy

This section provides information about how to configure pseudowire redundancy.

### Prerequisites for Pseudowire Redundancy

- Configure the **no switchport**, **no keepalive**, and **no ip address** before configuring Xconnect mode to connect the attachment circuit.
- For load-balancing, configure the **port-channel load-balance** command.
- Subinterfaces must be supported to enable pseudowire redundancy VLAN mode.

### Restrictions for Pseudowire Redundancy

The following sections list the restrictions for pseudowire redundancy port mode and pseudowire redundancy VLAN mode.

#### Restrictions for Pseudowire Redundancy Port Mode

- Ethernet Flow Point (EFP) and Internet Group Management Protocol (IGMP) Snooping is not supported.
- Flow Label for ECMP load balancing in a core network based on customer's source IP, destination IP, source MAC and destination MAC.
- MPLS QoS is supported in Pipe and Uniform Mode. Default mode is Pipe Mode.
- QoS: Customer DSCP Re-marking is not supported with VPWS and EoMPLS.
- VCCV Ping with explicit null is not supported.

- The **ip unnumbered** command is not supported in MPLS configuration.
- Not more than one backup pseudowire supported.
- PW redundancy group switchover is not supported

## Restrictions for Pseudowire Redundancy VLAN Mode

- Virtual circuit will not work if the same interworking type is not configured on PE devices.
- Untagged traffic is not supported as incoming traffic.
- Xconnect mode cannot be enabled on Layer 2 subinterfaces because multiplexer user-network interface (MUX UNI) is not supported.
- Xconnect mode cannot be configured on subinterfaces if it is enabled on the main interface for port-to-port transport.
- Flow Aware Transport (FAT) can be configured on Protocol CLI mode only.
- MACsec is not supported on pseudowire redundancy VLAN mode.
- QoS: Customer DSCP Remarking is not supported with VPWS and pseudowire redundancy.
- MPLS QoS is supported only in pipe and uniform mode. Default mode is pipe mode.
- In VLAN mode pseudowire redundancy, Cisco Discovery Protocol packets from the CE will be processed by the PE, but is not carried over the pseudowire redundancy virtual circuit, whereas in port mode, Cisco Discovery Protocol packets from the CE will be carried over the virtual circuit.
- Only Ethernet and VLAN interworking types are supported.
- L2 Protocol Tunneling CLI is not supported.

## Information About Pseudowire Redundancy

The L2VPN pseudowire redundancy feature enables you to configure your network to detect a failure in the network and reroute the Layer 2 service to another endpoint that can continue to provide service. This feature provides the ability to recover from a failure either of the remote provider edge (PE) device or of the link between the PE and customer edge (CE) devices.

The maximum transmission unit (MTU) of all the intermediate links between PEs must be able to carry the largest Layer 2 packet received on ingress PE.

Pseudowire redundancy can be configured using both the Xconnect and the protocol CLI method.

## How to Configure Pseudowire Redundancy

Pseudowire redundancy can be configured in the port mode or VLAN mode.

### Configuring Pseudowire Redundancy Port Mode

Pseudowire redundancy port-mode can be configured using either the Xconnect mode or protocol-CLI method.

## Xconnect Mode

To configure pseudowire redundancy port mode in Xconnect mode, perform the following task:



**Note** To enable load balance, use the corresponding **load-balance** commands from Xconnect Mode procedure of the 'How to Configure Ethernet-over-MPLS section.

## Procedure

	Command or Action	Purpose
<b>Step 1</b>	<b>enable</b> <b>Example:</b> Device> <b>enable</b>	Enables privileged EXEC mode. Enter your password if prompted.
<b>Step 2</b>	<b>configure terminal</b> <b>Example:</b> Device# <b>configure terminal</b>	Enters global configuration mode.
<b>Step 3</b>	<b>interface <i>interface-id</i></b> <b>Example:</b> Device(config)# <b>interface</b> <b>GigabitEthernet1/0/44</b>	Defines the interface to be configured as a trunk, and enters interface configuration mode.
<b>Step 4</b>	<b>no switchport</b> <b>Example:</b> Device(config-if)# <b>no switchport</b>	Enters Layer 3 mode, for physical ports only.
<b>Step 5</b>	<b>no ip address</b> <b>Example:</b> Device(config-if)# <b>no ip address</b>	Ensures that there is no IP address assigned to the physical port.
<b>Step 6</b>	<b>no keepalive</b> <b>Example:</b> Device(config-if)# <b>no keepalive</b>	Ensures that the device does not send keepalive messages.

	Command or Action	Purpose
<b>Step 7</b>	<b>xconnect</b> <i>peer-device-id</i> <i>vc-id</i> <b>encapsulation mpls</b> <b>Example:</b> Device(config-if)# <b>xconnect</b> 10.1.1.1 117 <b>encapsulation mpls</b>	Binds the attachment circuit to a pseudowire VC. The syntax for this command is the same as for all other Layer 2 transports.
<b>Step 8</b>	<b>backup peer</b> <i>peer-router-ip-addr</i> <b>vcid</b> <i>vc-id</i> [ <b>priority</b> <i>value</i> ] <b>Example:</b> Device(config-if)# <b>backup peer</b> 10.11.11.11 118 <b>priority 9</b>	Specifies a redundant peer for a pseudowire VC.
<b>Step 9</b>	<b>end</b> <b>Example:</b> Device(config)# <b>end</b>	Exits interface configuration mode and returns to privileged EXEC mode.

### Protocol CLI Method

To configure pseudowire redundancy port mode in protocol CLI mode, perform the following task:

#### Procedure

	Command or Action	Purpose
<b>Step 1</b>	<b>enable</b> <b>Example:</b> Device> <b>enable</b>	Enables privileged EXEC mode. Enter your password if prompted.
<b>Step 2</b>	<b>configure terminal</b> <b>Example:</b> Device# <b>configure terminal</b>	Enters global configuration mode.
<b>Step 3</b>	<b>port-channel load-balance dst-ip</b> <b>Example:</b> Device(config)# <b>port-channel</b>	Sets the load-distribution method to the destination IP address.

	Command or Action	Purpose
	<code>load-balance dst-ip</code>	
<b>Step 4</b>	<b>interface</b> <i>interface-id</i> <b>Example:</b> <pre>Device(config)# interface TenGigabitEthernet1/0/36</pre>	Defines the interface to be configured as a trunk, and enters interface configuration mode.
<b>Step 5</b>	<b>no switchport</b> <b>Example:</b> <pre>Device(config-if)# no switchport</pre>	Enters Layer 3 mode, for physical ports only.
<b>Step 6</b>	<b>no ip address</b> <b>Example:</b> <pre>Device(config-if)# no ip address</pre>	Ensures that there is no IP address assigned to the physical port.
<b>Step 7</b>	<b>no keepalive</b> <b>Example:</b> <pre>Device(config-if)# no keepalive</pre>	Ensures that the device does not send keepalive messages.
<b>Step 8</b>	<b>exit</b> <b>Example:</b> <pre>Device(config-if)# exit</pre>	Exits interface configuration mode.
<b>Step 9</b>	<b>interface pseudowire</b> <i>number-active</i> <b>Example:</b> <pre>Device(config)# interface pseudowire 17</pre>	Establishes an active pseudowire interface with a value that you specify and enters pseudowire configuration mode.
<b>Step 10</b>	<b>encapsulation mpls</b> <b>Example:</b> <pre>Device(config-if)# encapsulation mpls</pre>	Specifies the tunneling encapsulation.



	Command or Action	Purpose
<b>Step 11</b>	<b>neighbor</b> <i>active-peer-ip-addr vc-id</i> <b>Example:</b> <pre>Device(config-if)# neighbor 10.10.0.10 17</pre>	Specifies the active peer IP address and VC ID value of a L2VPN pseudowire.
<b>Step 12</b>	<b>exit</b> <b>Example:</b> <pre>Device(config-if)# exit</pre>	Exits interface configuration mode and returns to global configuration mode.
<b>Step 13</b>	<b>interface pseudowire</b> <i>number-standby</i> <b>Example:</b> <pre>Device(config)# interface pseudowire 18</pre>	Establishes a standby pseudowire interface with a value that you specify and enters pseudowire configuration mode.
<b>Step 14</b>	<b>encapsulation mpls</b> <b>Example:</b> <pre>Device(config-if)# encapsulation mpls</pre>	Specifies the tunneling encapsulation.
<b>Step 15</b>	<b>neighbor</b> <i>standby-peer-ip-addr vc-id</i> <b>Example:</b> <pre>Device(config-if)# neighbor 10.10.0.11 18</pre>	Specifies the standby peer IP address and VC ID value of a L2VPN pseudowire.
<b>Step 16</b>	<b>l2vpn xconnect context</b> <i>context-name</i> <b>Example:</b> <pre>Device(config-if)# l2vpn xconnect context vpws17</pre>	Creates a L2VPN cross connect context, and attaches the VLAN mode EoMPLS attachment circuit to the active and standby pseudowire interfaces.
<b>Step 17</b>	<b>member</b> <i>interface-id</i> <b>Example:</b> <pre>Device(config-if-xconn)# member TenGigabitEthernet1/0/36</pre>	Specifies interface that forms a L2VPN cross connect.

	Command or Action	Purpose
<b>Step 18</b>	<b>member pseudowire</b> <i>number-active</i> <b>group</b> <i>group-name</i> [ <b>priority</b> <i>value</i> ] <b>Example:</b> <pre>Device(config-if-xconn)# member pseudowire 17 group pwr10</pre>	Specifies active pseudowire interface that forms a L2VPN cross connect.
<b>Step 19</b>	<b>member pseudowire</b> <i>number-standby</i> <b>group</b> <i>group-name</i> [ <b>priority</b> <i>value</i> ] <b>Example:</b> <pre>Device(config-if-xconn)# member pseudowire 18 group pwr10 priority 6</pre>	Specifies standby pseudowire interface that forms a L2VPN cross connect.
<b>Step 20</b>	<b>end</b> <b>Example:</b> <pre>Device(config-if-xconn)# end</pre>	Exits Xconnect configuration mode and returns to privileged EXEC mode.

## Configuring Pseudowire Redundancy VLAN Mode

Pseudowire redundancy VLAN mode can be configured using either the Xconnect mode or the protocol CLI method.

### Xconnect Mode

To configure pseudowire redundancy VLAN mode in Xconnect mode, perform the following task:

#### Procedure

	Command or Action	Purpose
<b>Step 1</b>	<b>enable</b> <b>Example:</b> <pre>Device&gt; enable</pre>	Enables privileged EXEC mode. Enter your password if prompted.
<b>Step 2</b>	<b>configure terminal</b> <b>Example:</b> <pre>Device# configure terminal</pre>	Enters global configuration mode.

	Command or Action	Purpose
<b>Step 3</b>	<b>interface</b> <i>interface-id</i> <b>Example:</b> <pre>Device(config)# interface TenGigabitEthernet1/0/36</pre>	Defines the interface to be configured as a trunk, and enters interface configuration mode.
<b>Step 4</b>	<b>no switchport</b> <b>Example:</b> <pre>Device(config-if)# no switchport</pre>	Enters Layer 3 mode for physical ports only.
<b>Step 5</b>	<b>no ip address</b> <b>Example:</b> <pre>Device(config-if)# no ip address</pre>	Ensures that no IP address is assigned to the physical port.
<b>Step 6</b>	<b>no keepalive</b> <b>Example:</b> <pre>Device(config-if)# no keepalive</pre>	Ensures that the device does not send keepalive messages.
<b>Step 7</b>	<b>exit</b> <b>Example:</b> <pre>Device(config-if)# exit</pre>	Exits interface configuration mode and returns to global configuration mode.
<b>Step 8</b>	<b>interface</b> <i>interface-id.subinterface</i> <b>Example:</b> <pre>Device(config)# interface TenGigabitEthernet1/0/36.1105</pre>	Defines the subinterface to be configured, and enters subinterface configuration mode.
<b>Step 9</b>	<b>encapsulation dot1Q</b> <i>vlan-id</i> <b>Example:</b> <pre>Device(config-subif)# encapsulation dot1Q 1105</pre>	Enables IEEE 802.1Q encapsulation of traffic on the subinterface.

	Command or Action	Purpose
<b>Step 10</b>	<b>xconnect</b> <i>peer-ip-addr</i> <i>vc-id</i> <b>encapsulation mpls</b> <b>Example:</b> <pre>Device(config-subif)# xconnect 10.0.0.1 1105 encapsulation mpls</pre>	Binds the attachment circuit to a pseudowire VC. The syntax for this command is the same as for all other Layer 2 transports.
<b>Step 11</b>	<b>backup peer</b> <i>peer-ip-addr</i> <i>vc-id</i> [ <b>priority value</b> ] <b>Example:</b> <pre>Device(config-subif-xconn)# backup peer 10.10.10.10 1105 priority 8</pre>	Specifies a redundant peer for the pseudowire VC.
<b>Step 12</b>	<b>end</b> <b>Example:</b> <pre>Device(config-subif-xconn)# end</pre>	Exits Xconnect configuration mode and returns to privileged EXEC mode.

## Protocol CLI Method

To configure pseudowire redundancy VLAN mode in protocol CLI mode, perform the following task:

## Procedure

	Command or Action	Purpose
<b>Step 1</b>	<b>enable</b> <b>Example:</b> <pre>Device&gt; enable</pre>	Enables privileged EXEC mode. Enter your password if prompted.
<b>Step 2</b>	<b>configure terminal</b> <b>Example:</b> <pre>Device# configure terminal</pre>	Enters global configuration mode.
<b>Step 3</b>	<b>port-channel load-balance dst-ip</b> <b>Example:</b> <pre>Device(config)# port-channel load-balance dst-ip</pre>	Sets the load-distribution method to the destination IP address.

	Command or Action	Purpose
<b>Step 4</b>	<b>interface</b> <i>interface-id</i> <b>Example:</b> <pre>Device(config)# interface TenGigabitEthernet1/0/36</pre>	Defines the interface to be configured as a trunk, and enters interface configuration mode.
<b>Step 5</b>	<b>no switchport</b> <b>Example:</b> <pre>Device(config-if)# no switchport</pre>	Enters Layer 3 mode for physical ports only.
<b>Step 6</b>	<b>no ip address</b> <b>Example:</b> <pre>Device(config-if)# no ip address</pre>	Ensures that there is no IP address assigned to the physical port.
<b>Step 7</b>	<b>no keepalive</b> <b>Example:</b> <pre>Device(config-if)# no keepalive</pre>	Ensures that the device does not send keepalive messages.
<b>Step 8</b>	<b>exit</b> <b>Example:</b> <pre>Device(config-if)# exit</pre>	Exits interface configuration mode.
<b>Step 9</b>	<b>interface</b> <i>interface-id.subinterface</i> <b>Example:</b> <pre>Device(config)# interface TenGigabitEthernet1/0/36.1105</pre>	Defines the subinterface to be configured, and enters subinterface configuration mode.
<b>Step 10</b>	<b>encapsulation dot1Q</b> <i>vlan-id</i> <b>Example:</b> <pre>Device(config-subif)# encapsulation dot1Q 1105</pre>	Enables IEEE 802.1Q encapsulation of traffic on the subinterface.

	Command or Action	Purpose
<b>Step 11</b>	<b>exit</b> <b>Example:</b> <pre>Device(config-subif)# exit</pre>	Exits subinterface configuration mode.
<b>Step 12</b>	<b>interface pseudowire <i>number-active</i></b> <b>Example:</b> <pre>Device(config)# interface pseudowire 17</pre>	Establishes an active pseudowire interface with a value that you specify, and enters pseudowire configuration mode.
<b>Step 13</b>	<b>encapsulation mpls</b> <b>Example:</b> <pre>Device(config-if)# encapsulation mpls</pre>	Specifies the tunneling encapsulation.
<b>Step 14</b>	<b>neighbor <i>active-peer-ip-addr vc-id</i></b> <b>Example:</b> <pre>Device(config-if)# neighbor 10.10.0.10 17</pre>	Specifies the active peer IP address and virtual circuit (VC) ID value of a Layer 2 VPN (L2VPN) pseudowire.
<b>Step 15</b>	<b>exit</b> <b>Example:</b> <pre>Device(config-if)# exit</pre>	Exits interface configuration mode.
<b>Step 16</b>	<b>interface pseudowire <i>number-standby</i></b> <b>Example:</b> <pre>Device(config)# interface pseudowire 18</pre>	Establishes a standby pseudowire interface with a value that you specify, and enters pseudowire configuration mode.
<b>Step 17</b>	<b>encapsulation mpls</b> <b>Example:</b> <pre>Device(config-if)# encapsulation mpls</pre>	Specifies the tunneling encapsulation.

	Command or Action	Purpose
<b>Step 18</b>	<b>neighbor</b> <i>standby-peer-ip-addr</i> <i>vc-id</i> <b>Example:</b> <pre>Device(config-if)# neighbor 10.10.0.11 18</pre>	Specifies the standby peer IP address and VC ID value of an L2VPN pseudowire.
<b>Step 19</b>	<b>l2vpn xconnect context</b> <i>context-name</i> <b>Example:</b> <pre>Device(config-if)# l2vpn xconnect context vpws17</pre>	Creates an L2VPN cross-connect context, and attaches the VLAN mode EoMPLS attachment circuit to the active and standby pseudowire interfaces.
<b>Step 20</b>	<b>member</b> <i>interface-id.subinterface</i> <b>Example:</b> <pre>Device(config-if-xconn)# member TenGigabitEthernet1/0/36.1105</pre>	Specifies the interface that forms an L2VPN cross connect.
<b>Step 21</b>	<b>member pseudowire</b> <i>number-active</i> <b>group</b> <i>group-name</i> [ <i>priority value</i> ] <b>Example:</b> <pre>Device(config-if-xconn)# member pseudowire 17 group pwr10</pre>	Specifies the active pseudowire interface that forms an L2VPN cross connect.
<b>Step 22</b>	<b>member pseudowire</b> <i>number-standby</i> <b>group</b> <i>group-name</i> [ <i>priority value</i> ] <b>Example:</b> <pre>Device(config-if-xconn)# member pseudowire 18 group pwr10 priority 6</pre>	Specifies standby pseudowire interface that forms an L2VPN cross connect.
<b>Step 23</b>	<b>end</b> <b>Example:</b> <pre>Device(config-if-xconn)# end</pre>	Exits Xconnect configuration mode and returns to privileged EXEC mode.

## Configuration Examples for Pseudowire Redundancy

**Table 5: Pseudowire Redundancy Port Mode Configuration**

PE Configuration	CE Configuration
<pre> mpls ip mpls label protocol ldp mpls ldp graceful-restart mpls ldp router-id loopback 1 force ! interface Loopback1 ip address 10.1.1.1 255.255.255.255 ip ospf 100 area 0 router ospf 100 router-id 10.1.1.1 nsf ! interface gigabitethernet 2/0/39 no switchport no ip address no keepalive ! interface pseudowire101 encapsulation mpls neighbor 10.10.10.10 101 ! interface pseudowire102 encapsulation mpls neighbor 10.10.10.11 101 l2vpn xconnect context pw101 member pseudowire101 group pwgrp1 priority 1 member pseudowire102 group pwgrp1 priority 15  member GigabitEthernet2/0/39 ! interface tengigabitethernet 3/0/10 switchport trunk allowed vlan 142 switchport mode trunk channel-group 42 mode active ! interface Port-channel42 switchport trunk allowed vlan 142 switchport mode trunk ! interface Vlan142 ip address 10.11.11.11 255.255.255.0 ip ospf 100 area 0 mpls ip mpls label protocol ldp ! </pre>	<pre> interface gigabitethernet 1/0/33 switchport trunk allowed vlan 912 switchport mode trunk spanning-tree portfast trunk ! interface Vlan912 ip address 10.91.2.3 255.255.255.0 ! </pre>



Table 6: Pseudowire Redundancy VLAN Mode Configuration

PE Configuration	CE Configuration
<pre> interface tengigabitethernet 1/0/36 no switchport no ip address no keepalive exit ! interface tengigabitethernet 1/0/36.1105 encapsulation dot1Q 1105 exit ! interface pseudowire1105 encapsulation mpls neighbor 10.10.0.10 1105 exit ! interface pseudowire1106 encapsulation mpls neighbor 10.10.0.11 1106 ! l2vpn xconnect context vme1105 member tengigabitethernet 1/0/36.1105 member pseudowire1105 group pwr10 member pseudowire1106 group pwr10 priority 6 end ! </pre>	<pre> interface fortygigabitethernet 1/9 switchport switchport mode trunk switchport trunk allowed vlan 1105  mtu 9216 end ! </pre>

The following is a sample output of the **show mpls l2 vc vcid vc-id detail** command:

```

Device# show mpls l2 vc vcid 1105 detail
Local interface: TenGigabitEthernet1/0/36.1105 up, line protocol up, Eth VLAN 1105 up
  Interworking type is Ethernet
  Destination address: 10.11.11.11, VC ID: 1105, VC status: standby
  Output interface: Po10, imposed label stack {1616}
  Preferred path: not configured
  Default path: active
  Next hop: 10.10.0.1
  Create time: 00:04:09, last status change time: 00:02:13
  Last label FSM state change time: 00:02:15
  Signaling protocol: LDP, peer 10.11.11.11:0 up
  Targeted Hello: 10.10.0.10(LDP Id) -> 10.11.11.11, LDP is UP
  Graceful restart: configured and enabled
  Non stop routing: not configured and not enabled
  Status TLV support (local/remote)   : enabled/supported
    LDP route watch                    : enabled
    Label/status state machine         : established, LrdRru
  Last local dataplane   status rcvd: No fault
  Last BFD dataplane    status rcvd: Not sent
  Last BFD peer monitor status rcvd: No fault
  Last local AC circuit status rcvd: DOWN(standby)
  Last local AC circuit status sent: No fault
  Last local PW i/f circ status rcvd: No fault
  Last local LDP TLV    status sent: DOWN(standby)
  Last remote LDP TLV   status rcvd: No fault
  Last remote LDP ADJ   status rcvd: No fault
  MPLS VC labels: local 125, remote 1616
  Group ID: local 336, remote 0

```

```

MTU: local 9198, remote 9198
Remote interface description:
MAC Withdraw: sent:1, received:0
Sequencing: receive disabled, send disabled
Control Word: On (configured: autosense)
SSO Descriptor: 10.11.11.11/1105, local label: 125
Dataplane:
  SSM segment/switch IDs: 96143/450671 (used), PWID: 110
VC statistics:
  transit packet totals: receive 0, send 0
  transit byte totals:   receive 0, send 0
  transit packet drops: receive 0, seq error 0, send 0

```

The following is a sample output of the **show l2vpn atom vc vcid vc-id detail** command:

```

Device# show l2vpn atom vc vcid 1105 detail
pseudowire100110 is up, VC status is standby PW type: Ethernet
Create time: 00:04:17, last status change time: 00:02:22
  Last label FSM state change time: 00:02:24
Destination address: 10.11.11.11 VC ID: 1105
  Output interface: Po10, imposed label stack {1616}
  Preferred path: not configured
  Default path: active
  Next hop: 10.0.0.1
Member of xconnect service TenGigabitEthernet1/0/36.1105-1105, group right
  Associated member TenGigabitEthernet1/0/36.1105 is up, status is up
  Interworking type is Ethernet
  Service id: 0x1f000037
Signaling protocol: LDP, peer 10.11.11.11:0 up
  Targeted Hello: 10.0.0.10(LDP Id) -> 10.11.11.11, LDP is UP
  Graceful restart: configured and enabled
  Non stop routing: not configured and not enabled
  PWid FEC (128), VC ID: 1105
  Status TLV support (local/remote)           : enabled/supported
    LDP route watch                           : enabled
    Label/status state machine                 : established, LrdRru
    Local dataplane status received           : No fault
    BFD dataplane status received             : Not sent
    BFD peer monitor status received          : No fault
    Status received from access circuit       : DOWN(standby)
    Status sent to access circuit             : No fault
    Status received from pseudowire i/f      : No fault
    Status sent to network peer              : DOWN(standby)
    Status received from network peer        : No fault
    Adjacency status of remote peer          : No fault
Sequencing: receive disabled, send disabled
Bindings
  Parameter      Local                               Remote
  -----
  Label          125                               1616
  Group ID       336                               0
  Interface
  MTU            9198                               9198
  Control word on (configured: autosense)    on
  PW type        Ethernet
  VCCV CV type  0x02                               0x02
                LSPV [2]                               LSPV [2]
  VCCV CC type  0x06                               0x02
                RA [2], TTL [3]                          RA [2]
  Status TLV    enabled                          supported
SSO Descriptor: 10.11.11.11/1105, local label: 125
Dataplane:
  SSM segment/switch IDs: 96143/450671 (used), PWID: 110
Rx Counters

```

```

0 input transit packets, 0 bytes
0 drops, 0 seq err
0 MAC withdraw
Tx Counters
0 output transit packets, 0 bytes
0 drops
1 MAC withdraw

```

The following is a sample output of the **show mpls l2transport vc vc-id** command:

```
Device# show mpls l2transport vc 101
```

```

Local intf                Local circuit  Dest address  VC ID  Status
-----
TenGigabitEthernet1/0/36.1105  Eth VLAN 1105  10.0.0.1     1105   UP
TenGigabitEthernet1/0/36.1105  Eth VLAN 1105  10.11.11.11  1105   STANDBY

```

## Feature History for Ethernet-over-MPLS and Pseudowire Redundancy

This table provides release and related information for the features explained in this module.

These features are available in all the releases subsequent to the one they were introduced in, unless noted otherwise.

Release	Feature	Feature Information
Cisco IOS XE Everest 16.6.1	Ethernet-over-MPLS and Pseudowire Redundancy	<p>Ethernet-over-MPLS is one of the Any Transport over MPLS (AToM) transport types. EoMPLS works by encapsulating Ethernet protocol data units (PDUs) in MPLS packets and forwarding them across the MPLS network. Each PDU is transported as a single packet.</p> <p>The L2VPN pseudowire redundancy feature enables you to configure your network to detect a failure in the network and reroute the Layer 2 service to another endpoint that can continue to provide service.</p> <p>Port mode support is introduced.</p>
Cisco IOS XE Gibraltar 16.12.1	VLAN support for Ethernet-over-MPLS	EoMPLS VLAN mode can be configured using either the Xconnect mode or protocol-CLI method.

Release	Feature	Feature Information
Cisco IOS XE Amsterdam 17.1.1	Macsec over EoMPLS	In VLAN mode EoMPLS, only those packets configured with macsec dot1q-in-clear 1 command on the CE device will be processed by the PE device.

Use the Cisco Feature Navigator to find information about platform and software image support. To access Cisco Feature Navigator, go to <https://cfng.cisco.com/>

<http://www.cisco.com/go/cfn>.



## CHAPTER 6

# Configuring IPv6 Provider Edge over MPLS (6PE)

- [Prerequisites for 6PE, on page 73](#)
- [Restrictions for 6PE, on page 73](#)
- [Information About 6PE, on page 73](#)
- [Configuring 6PE, on page 74](#)
- [Configuration Examples for 6PE, on page 77](#)
- [Feature History for IPv6 Provider Edge over MPLS \(6PE\), on page 79](#)

## Prerequisites for 6PE

Redistribute PE-CE IGP IPv6 routes into core BGP and vice-versa

## Restrictions for 6PE

eBGP as CE-PE is not supported. Static Routes, OSPFv3, ISIS, RIPv2 are supported as CE-PE.

## Information About 6PE

6PE is a technique that provides global IPv6 reachability over IPv4 MPLS. It allows one shared routing table for all other devices. 6PE allows IPv6 domains to communicate with one another over the IPv4 without an explicit tunnel setup, requiring only one IPv4 address per IPv6 domain.

While implementing 6PE, the provider edge routers are upgraded to support 6PE, while the rest of the core network is not touched (IPv6 unaware). This implementation requires no reconfiguration of core routers because forwarding is based on labels rather than on the IP header itself. This provides a cost-effective strategy for deploying IPv6. The IPv6 reachability information is exchanged by PE routers using multiprotocol Border Gateway Protocol (mp-iBGP) extensions.

6PE relies on mp-iBGP extensions in the IPv4 network configuration on the PE router to exchange IPv6 reachability information in addition to an MPLS label for each IPv6 address prefix to be advertised. PE routers are configured as dual stacks, running both IPv4 and IPv6, and use the IPv4 mapped IPv6 address for IPv6 prefix reachability exchange. The next hop advertised by the PE router for 6PE and 6VPE prefixes is still the IPv4 address that is used for IPv4 L3 VPN routes. A value of `::FFFF:` is prepended to the IPv4 next hop, which is an IPv4-mapped IPv6 address.

The following figure illustrates the 6PE topology.

Figure 4: 6PE Topology

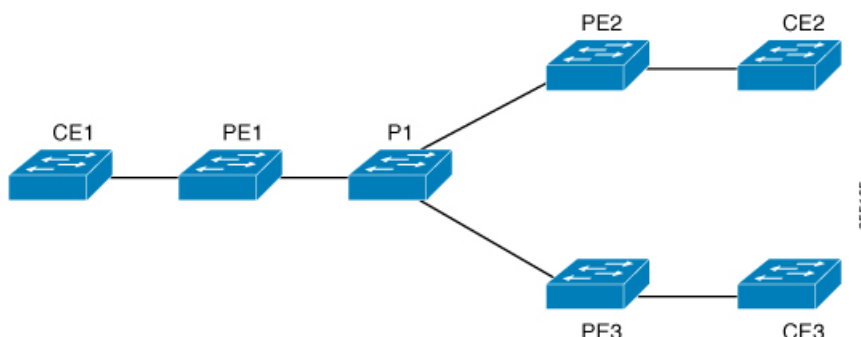

## Configuring 6PE

Ensure that you configure 6PE on PE routers participating in both the IPv4 cloud and IPv6 clouds.

BGP running on a PE router should establish (IPv4) neighborhood with BGP running on other PEs. Subsequently, it should advertise the IPv6 prefixes learnt from the IPv6 table to the neighbors. The IPv6 prefixes advertised by BGP would automatically have IPv4-encoded-IPv6 addresses as the next-hop-address in the advertisement.

To configure 6PE, complete the following steps:

### Procedure

	Command or Action	Purpose
<b>Step 1</b>	<b>enable</b> <b>Example:</b> Device> <b>enable</b>	Enables privileged EXEC mode. <ul style="list-style-type: none"> <li>• Enter your password if prompted.</li> </ul>
<b>Step 2</b>	<b>configure terminal</b> <b>Example:</b> Device# <b>configure terminal</b>	Enters global configuration mode.
<b>Step 3</b>	<b>ipv6 unicast-routing</b> <b>Example:</b> Device(config)# <b>ipv6 unicast-routing</b>	Enables the forwarding of IPv6 unicast datagrams.

	Command or Action	Purpose
<b>Step 4</b>	<b>router bgp</b> <i>as-number</i> <b>Example:</b> Device(config)# <b>router bgp</b> 65001	Enters the number that identifies the autonomous system (AS) in which the router resides.  <i>as-number</i> —Autonomous system number. Range for 2-byte numbers is 1 to 65535. Range for 4-byte numbers is 1.0 to 65535.65535.
<b>Step 5</b>	<b>bgp router-id interface</b> <i>interface-id</i> <b>Example:</b> Device(config-router)# <b>bgp router-id interface</b> Loopback1	Configures a fixed router ID for the local Border Gateway Protocol (BGP) routing process.
<b>Step 6</b>	<b>bgp log-neighbor-changes</b> <b>Example:</b> Device(config-router)# <b>bgp log-neighbor-changes</b>	Enables logging of BGP neighbor resets.
<b>Step 7</b>	<b>bgp graceful-restart</b> <b>Example:</b> Device(config-router)# <b>bgp graceful-restart</b>	Enables the Border Gateway Protocol (BGP) graceful restart capability globally for all BGP neighbors.
<b>Step 8</b>	<b>neighbor</b> { <i>ip-address</i>   <i>ipv6-address</i>   <i>peer-group-name</i> } <b>remote-as</b> <i>as-number</i> <b>Example:</b> Device(config-router)# <b>neighbor</b> 33.33.33.33 <b>remote-as</b> 65001	Adds an entry to the BGP or multiprotocol BGP neighbor table. <ul style="list-style-type: none"> <li>• <i>ip-address</i>—IP address of a peer router with which routing information will be exchanged.</li> <li>• <i>ipv6-address</i>—IPv6 address of a peer router with which routing information will be exchanged.</li> <li>• <i>peer-group-name</i>—Name of the BGP peer group.</li> <li>• <i>remote-as</i>—Specifies a remote autonomous system.</li> <li>• <i>as-number</i>—Number of an autonomous system to which the neighbor belongs, ranging from 1 to 65535.</li> </ul>
<b>Step 9</b>	<b>neighbor</b> { <i>ip-address</i>   <i>ipv6-address</i>   <i>peer-group-name</i> } <b>update-source</b> <i>interface-type interface-number</i> <b>Example:</b>	Configures BGP sessions to use any operational interface for TCP connections.

	Command or Action	Purpose
	Device(config-router)# <b>neighbor 33.33.33.33 update-source Loopback1</b>	
<b>Step 10</b>	<b>address-family ipv6</b> <b>Example:</b> Device(config-router)# <b>address-family ipv6</b>	Enters address family configuration mode for configuring routing sessions, such as BGP, that use standard IPv6 address prefixes.
<b>Step 11</b>	<b>redistribute protocol as-number match { internal   external 1   external 2</b> <b>Example:</b> Device(config-router-af)# <b>redistribute ospf 11 match internal external 1</b>	Redistributes routes from one routing domain into another routing domain.
<b>Step 12</b>	<b>neighbor { ip-address   ipv6-address   peer-group-name } activate</b> <b>Example:</b> Device(config-router-af)# <b>neighbor 33.33.33.33 activate</b>	Enables the exchange of information with a BGP neighbor.
<b>Step 13</b>	<b>neighbor { ip-address   ipv6-address   peer-group-name } send-label</b> <b>Example:</b> Device(config-router-af)# <b>neighbor 33.33.33.33 send-label</b>	Sends MPLS labels with BGP routes to a neighboring BGP router.
<b>Step 14</b>	<b>exit-address-family</b> <b>Example:</b> Device(config-router-af)# <b>exit-address-family</b>	Exits BGP address-family submode.
<b>Step 15</b>	<b>end</b> <b>Example:</b> Device(config)# <b>end</b>	Returns to privileged EXEC mode.



# Configuration Examples for 6PE

Figure 5: 6PE Topology

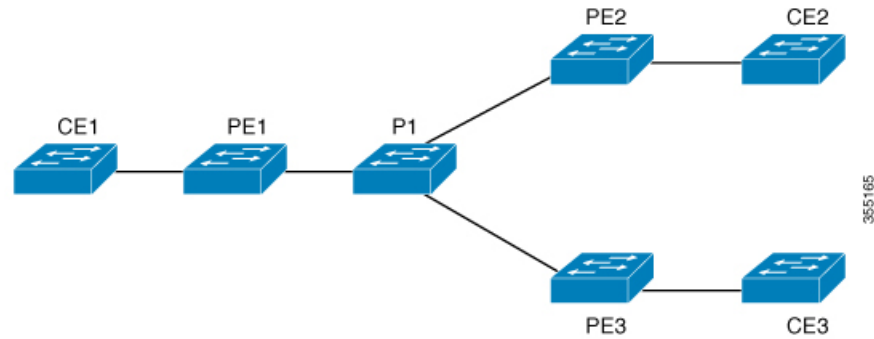

## PE Configuration

```

router ospfv3 11
ip routing
ipv6 unicast-routing
address-family ipv6 unicast
redistribute bgp 65001
exit-address-family
!
router bgp 65001
bgp router-id interface Loopback1
bgp log-neighbor-changes
bgp graceful-restart
neighbor 33.33.33.33 remote-as 65001
neighbor 33.33.33.33 update-source Loopback1
!
address-family ipv4
neighbor 33.33.33.33 activate
!
address-family ipv6
redistribute ospf 11 match internal external 1 external 2 include-connected
neighbor 33.33.33.33 activate
neighbor 33.33.33.33 send-label
neighbor 33.33.33.33 send-community extended
!

```

The following is a sample output of **show bgp ipv6 unicast summary** :

```

BGP router identifier 1.1.1.1, local AS number 100
BGP table version is 34, main routing table version 34
4 network entries using 1088 bytes of memory
4 path entries using 608 bytes of memory
4/4 BGP path/bestpath attribute entries using 1120 bytes of memory
0 BGP route-map cache entries using 0 bytes of memory
0 BGP filter-list cache entries using 0 bytes of memory
BGP using 2816 total bytes of memory
BGP activity 6/2 prefixes, 16/12 paths, scan interval 60 secs

```

```
Neighbor          V          AS MsgRcvd MsgSent   TblVer  InQ OutQ Up/Down
State/PfxRcd
2.2.2.2           4          100      21      21       34   0   0 00:04:57
                2
```

```
sh ipv route
IPv6 Routing Table - default - 7 entries
Codes: C - Connected, L - Local, S - Static, U - Per-user Static route
       B - BGP, R - RIP, I1 - ISIS L1, I2 - ISIS L2
       IA - ISIS interarea, IS - ISIS summary, D - EIGRP, EX - EIGRP
external
       ND - ND Default, NDp - ND Prefix, DCE - Destination, NDr - Redirect

       RL - RPL, O - OSPF Intra, OI - OSPF Inter, OE1 - OSPF ext 1
       OE2 - OSPF ext 2, ON1 - OSPF NSSA ext 1, ON2 - OSPF NSSA ext 2
       la - LISP alt, lr - LISP site-registrations, ld - LISP dyn-eid la
- LISP away
C   10:1:1:2::/64 [0/0]
    via Vlan4, directly connected
L   10:1:1:2::1/128 [0/0]
    via Vlan4, receive
LC  11:11:11:11::11/128 [0/0]
    via Loopback1, receive
B   30:1:1:2::/64 [200/0]
    via 33.33.33.33%default, indirectly connected
B   40:1:1:2::/64 [200/0]
    via 44.44.44.44%default, indirectly connected
```

The following is a sample output of **show bgp ipv6 unicast** command :

```
BGP table version is 112, local router ID is 11.11.11.11
Status codes: s suppressed, d damped, h history, * valid, > best, i -
internal,
              r RIB-failure, S Stale, m multipath, b backup-path, f
RT-Filter,
              x best-external, a additional-path, c RIB-compressed,
              t secondary path,
Origin codes: i - IGP, e - EGP, ? - incomplete
RPKI validation codes: V valid, I invalid, N Not found
      Network          Next Hop          Metric LocPrf Weight Path
*>  10:1:1:2::/64      ::                0          32768 ?
*>i  30:1:1:2::/64      ::FFFF:33.33.33.33
                                0      100      0 ?
*>i  40:1:1:2::/64      ::FFFF:44.44.44.44
                                0      100      0 ?
*>i  173:1:1:2::/64     ::FFFF:33.33.33.33
                                2      100      0 ?
```

The following is a sample output of **show ipv6 cef 40:1:1:2::0/64 detail** command :

```
40:1:1:2::/64, epoch 6, flags [rib defined all labels]
recursive via 44.44.44.44 label 67
nexthop 1.20.4.2 Port-channel103 label 99-(local:147)
```

## Feature History for IPv6 Provider Edge over MPLS (6PE)

This table provides release and related information for features explained in this module.

These features are available on all releases subsequent to the one they were introduced in, unless noted otherwise.

Release	Feature	Feature Information
Cisco IOS XE Everest 16.6.1	IPv6 Provider Edge over MPLS (6PE)	IPv6 Provider Edge over MPLS (6PE) provides global IPv6 reachability over IPv4 MPLS and allows one shared routing table for all other devices.

Use Cisco Feature Navigator to find information about platform and software image support. To access Cisco Feature Navigator, go to <http://www.cisco.com/go/cfn>.





## CHAPTER 7

# Configuring IPv6 VPN Provider Edge over MPLS (6VPE)

---

- [Configuring 6VPE, on page 81](#)

## Configuring 6VPE

This section provides information about Configuring 6VPE on the switch.

## Restrictions for 6VPE

- Inter-AS and carrier supporting carrier (CSC) is not supported.
- VRF Route-Leaking is not supported.
- eBGP as CE-PE is not supported.
- EIGRP, OSPFv3, RIP, ISIS, Static Routes are supported as CE-PE.
- MPLS Label Allocation modes supported are Per-VRF and Per-Prefix. Per-Prefix is the default mode.
- IP fragmentation is not supported in the Per-Prefix mode of Layer 3 VPN.
- DHCPv6 is not supported on a 6VPE topology with per-port trust enabled.

## Information About 6VPE

6VPE is a mechanism to use the IPv4 backbone to provide VPN IPv6 services. It takes advantage of operational IPv4 MPLS backbones, eliminating the need for dual-stacking within the MPLS core. This translates to savings in operational costs and addresses the security limitations of the 6PE approach. 6VPE is more like a regular IPv4 MPLS-VPN provider edge, with an addition of IPv6 support within VRF. It provides logically separate routing table entries for VPN member devices.

### Components of MPLS-based 6VPE Network

- VPN route target communities – A list of all other members of a VPN community.

- Multiprotocol BGP (MP-BGP) peering of VPN community PE routers – Propagates VRF reachability information to all members of a VPN community.
- MPLS forwarding – Transports all traffic between all VPN community members across a VPN service-provider network.

In the MPLS-VPN model a VPN is defined as a collection of sites sharing a common routing table. A customer site is connected to the service provider network by one or more interfaces, where the service provider associates each interface with a VPN routing table—known as the VRF table.

## Configuration Examples for 6VPE

*Figure 6: 6VPE Topology*

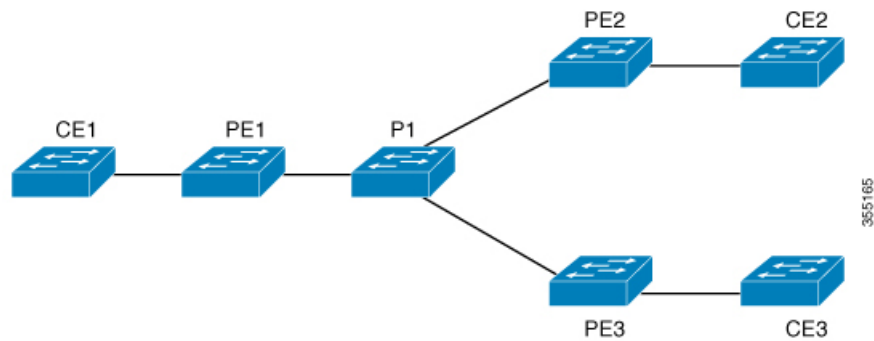

**PE Configuration**

**PE Configuration**

```

vrf definition 6VPE-1
 rd 65001:11
  route-target export 1:1
  route-target import 1:1
 !
 address-family ipv4
  exit-address-family
 !
 address-family ipv6
  exit-address-family
 !
interface TenGigabitEthernet1/0/38
 no switchport
 vrf forwarding 6VPE-1
 ip address 10.3.1.1 255.255.255.0
 ip ospf 2 area 0
 ipv6 address 10:111:111:111::1/64
 ipv6 enable
 ospfv3 1 ipv6 area 0
 !
router ospf 2 vrf 6VPE-1
 router-id 1.1.11.11
 redistribute bgp 65001 subnets
 !
router ospfv3 1
 nsr
 graceful-restart
 !
address-family ipv6 unicast vrf 6VPE-1
 redistribute bgp 65001
 exit-address-family
 !
router bgp 65001
 bgp router-id interface Loopback1
 bgp log-neighbor-changes
 bgp graceful-restart
 neighbor 33.33.33.33 remote-as 65001
 neighbor 33.33.33.33 update-source Loopback1
 !
 address-family ipv4 vrf 6VPE-1
  redistribute ospf 2 match internal external 1 external 2
  exit-address-family
 address-family ipv6 vrf 6VPE-1
  redistribute ospf 1 match internal external 1 external 2 include-connected
  exit-address-family
 !
address-family vpnv4
 neighbor 33.33.33.33 activate
 neighbor 33.33.33.33 send-community both
 neighbor 44.44.44.44 activate
 neighbor 44.44.44.44 send-community both
 neighbor 55.55.55.55 activate
 neighbor 55.55.55.55 send-community both
 exit-address-family
 !
address-family vpnv6
 neighbor 33.33.33.33 activate
 neighbor 33.33.33.33 send-community both
 neighbor 44.44.44.44 activate
 neighbor 44.44.44.44 send-community both
 neighbor 55.55.55.55 activate

```



**PE Configuration**

```
neighbor 55.55.55.55 send-community both
exit-address-family
!
```

The following is a sample output of **show mpls forwarding-table vrf** :

```
Local Outgoing Prefix Bytes Label Outgoing Next Hop
Label Label or Tunnel Id Switched interface
29 No Label A:A:A:565::/64[V] \ 0 aggregate/VRF601
32 No Label A:B5:1:5::/64[V] 2474160 V1601 FE80::200:7BFF:FE62:2636
33 No Label A:B5:1:4::/64[V] 2477978 V1601 FE80::200:7BFF:FE62:2636
35 No Label A:B5:1:3::/64[V] 2477442 V1601 FE80::200:7BFF:FE62:2636
36 No Label A:B5:1:2::/64[V] 2476906 V1601 FE80::200:7BFF:FE62:2636
37 No Label A:B5:1:1::/64[V] 2476370 V1601 FE80::200:7BFF:FE62:2636
```

The following is a sample output of **show vrf counter** command :

```
Maximum number of VRFs supported: 256
Maximum number of IPv4 VRFs supported: 256
Maximum number of IPv6 VRFs supported: 256
Maximum number of platform iVRFs supported: 10
Current number of VRFs: 127
Current number of IPv4 VRFs: 6
Current number of IPv6 VRFs: 127
Current number of VRFs in delete state: 0
Current number of platform iVRFs: 1
```

The following is a sample output of **show ipv6 route vrf** command :

```
IPv6 Routing Table - VRF1 - 8 entries Codes: C - Connected, L - Local, S
- Static, U - Per-user Static route B - BGP, R - RIP, I1 - ISIS L1, I2
- ISIS L2 IA - ISIS interarea, IS - ISIS summary, D - EIGRP, EX - EIGRP
external ND - ND Default, NDp - ND Prefix, DCE - Destination, NDr -
Redirect RL - RPL, O - OSPF Intra, OI - OSPF Inter, OE1 - OSPF ext 1 OE2
- OSPF ext 2, ON1 - OSPF NSSA ext 1, ON2 - OSPF NSSA ext 2 la - LISP
alt, lr - LISP site-registrations, ld - LISP dyn-eid la - LISP away

B 1:1:1:1::1/128 [200/1] via 1.1.1.11%default, indirectly connected
O 2:2:2:2::2/128 [110/1] via FE80::A2E0:AFFF:FE30:3E40,
TenGigabitEthernet1/0/7
B 3:3:3:3::3/128 [200/1] via 3.3.3.33%default, indirectly connected
B 10:1:1:1::/64 [200/0] via 1.1.1.11%default, indirectly connected
C 10:2:2:2::/64 [0/0] via TenGigabitEthernet1/0/7, directly connected
L 10:2:2:2::1/128 [0/0] via TenGigabitEthernet1/0/7, receive
B 10:3:3:3::/64 [200/0] via 3.3.3.33%default, indirectly connected
L FF00::/8 [0/0] via Null0, receive
```

## Feature History for IPv6 VPN Provider Edge over MPLS (6VPE)

This table provides release and related information for features explained in this module.

These features are available on all releases subsequent to the one they were introduced in, unless noted otherwise.

Release	Feature	Feature Information
Cisco IOS XE Everest 16.6.1	IPv6 VPN Provider Edge over MPLS (6VPE)	IPv6 VPN Provider Edge over MPLS (6VPE) is a mechanism to use the IPv4 backbone to provide VPN IPv6 services. It takes advantage of operational IPv4 MPLS backbones, eliminating the need for dual-stacking within the MPLS core.

Use Cisco Feature Navigator to find information about platform and software image support. To access Cisco Feature Navigator, go to <http://www.cisco.com/go/cfn>.



## CHAPTER 8

# Configuring MPLS VPN InterAS Options

- [Information About MPLS VPN InterAS Options, on page 87](#)
- [How to Configure MPLS VPN InterAS Options, on page 94](#)
- [Verifying MPLS VPN InterAS Options Configuration, on page 108](#)
- [Configuration Examples for MPLS VPN InterAS Options, on page 110](#)
- [Additional References for MPLS VPN InterAS Options, on page 126](#)
- [Feature History for MPLS VPN InterAS Options, on page 126](#)

## Information About MPLS VPN InterAS Options

The MPLS VPN InterAS Options provide various ways of interconnecting VPNs between different MPLS VPN service providers. This allows sites of a customer to exist on several carrier networks (autonomous systems) and have seamless VPN connectivity between these sites.

### ASes and ASBRs

An autonomous system (AS) is a single network or group of networks that is controlled by a common system administration group and using a single, clearly defined protocol. In many cases, VPNs extend to different ASes in different geographical areas. Some VPNs must extend across multiple service providers; these VPNs are called overlapping VPNs. The connection between ASes must be seamless to the customer, regardless of the complexity or location of the VPNs.

An AS boundary router (ASBR) is a device in an AS that is configured by using more than one routing protocol, and exchanges routing information with other ASBRs by using an exterior routing protocol (for example, eBGP), or use static routes, or both.

Separate ASes from different service providers communicate by exchanging information in the form of VPN IP addresses and they use the following protocols to share routing information:

- Within an AS, routing information is shared using iBGP.

iBGP distributes network layer information for IP prefixes within each VPN and each AS.

- Between ASes, routing information is shared using eBGP.

eBGP allows service providers to set up an interdomain routing system that guarantees loop-free exchange of routing information between separate ASes. The primary function of eBGP is to exchange network reachability information between ASes, including information about the list of AS routes. The ASes use

eBGP border edge routers to distribute the routes, which includes label-switching information. Each border edge router rewrites the next-hop and MPLS labels.

MPLS VPN InterAS Options configuration is supported and can include an inter provider VPN, which is MPLS VPNs that include two or more ASes, connected by separate border edge routers. The ASes exchange routes using eBGP, and no iBGP or routing information is exchanged between the ASes.

## MPLS VPN InterAS Options

The following options defined in RFC4364 provide MPLS VPN connectivity between different ASes:

- InterAS Option B – This option provides VPNv4 route distribution between ASBRs.
- InterAS Option AB – This option combines the best functionality of an interAS option A and interAS option B network to allow an MPLS VPN service provider to interconnect different autonomous systems to provide VPN services.

### InterAS Option B

In an interAS option B network, ASBR ports are connected by one or more interfaces that are enabled to receive MPLS traffic. With this option, the ASBRs peer with each other using eBGP session. The ASBR also functions as a PE router and peers with every PE router in their AS. The ASBR does not hold any VRFs but holds all or a subset of VPNv4 routes from PE router that need to be passed to the other AS. VPNv4 routes are kept unique in ASBR using route-distinguisher and are filtered using route targets. The ASBRs exchange VPNv4 routes and VPN labels using eBGP.

**Figure 7: Topology for InterAS Option B**

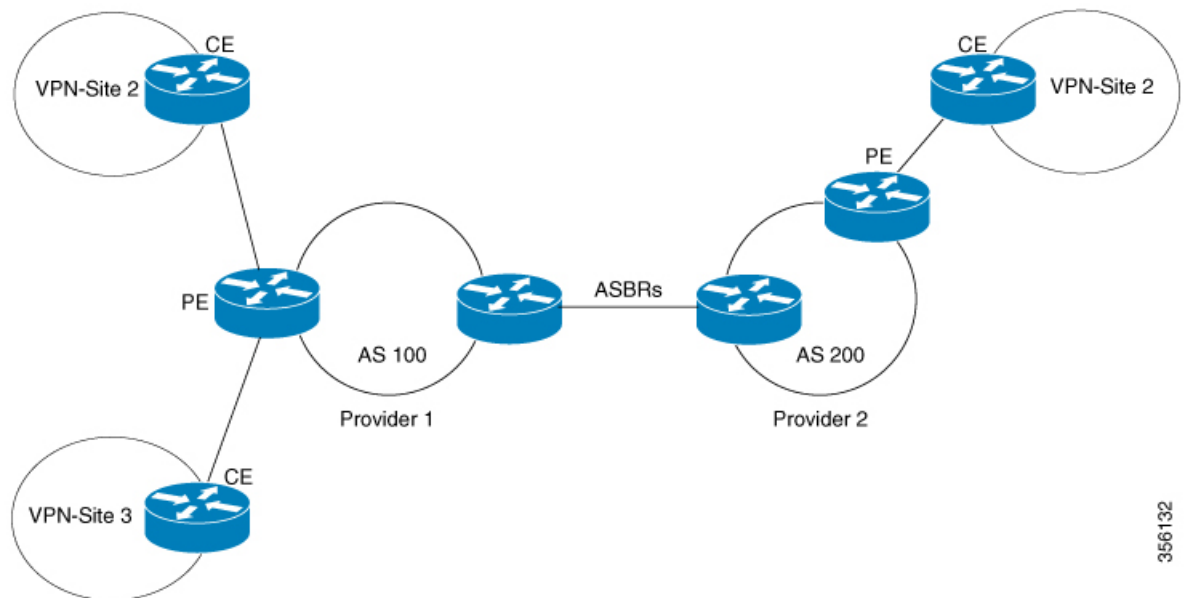

Two methods are supported to distribute the next hop for VPNv4 routes between ASBRs. There is no requirement for LDP or any IGP to be enabled on the link connecting the two ASBRs. The MP-eBGP session between directly connected interfaces on the ASBRs enables the interfaces to forward labeled packets. To ensure this MPLS forwarding for directly connected BGP peers, you must configure `mpls bgp forwarding`

command on the interface connecting to ASBR. This command is implemented in the IOS for directly connected interfaces. Upto 200 BGP neighbors can be configured.

- **Next-hop-self Method:** Changing next-hop to that of the local ASBR for all VPNv4 routes learnt from the other ASBR.
- **Redistribute Connected Subnets Method:** Redistributing the next hop address of the remote ASBR into the local IGP using redistribute connected subnets command , i.e., the next hop is not changed when the VPNv4 routes are redistributed into the local AS.



---

**Note** In case of multiple equal paths - ECMP towards remote AS, you have to configure MPLS static label bindings towards remote Loopback on ASBR. Otherwise, you may experience packet loss.

---

The label switch path forwarding sections described below has AS200 configured with the Next-hop-self method and the AS300 is configured with Redistribute-subnet method.

### Next-Hop Self Method

The following figure shows the label forwarding path for next-hop-self method. The labels get pushed, swapped and popped on the stack as packet makes its way from PE-200 in AS 200 to PE-300 in AS 300. In step 5, ASBR-A300 receives labeled frame, replaces label 164 with label 161 pushes IGP label 162 onto the label stack.

Redistribute Connected Subnet Method

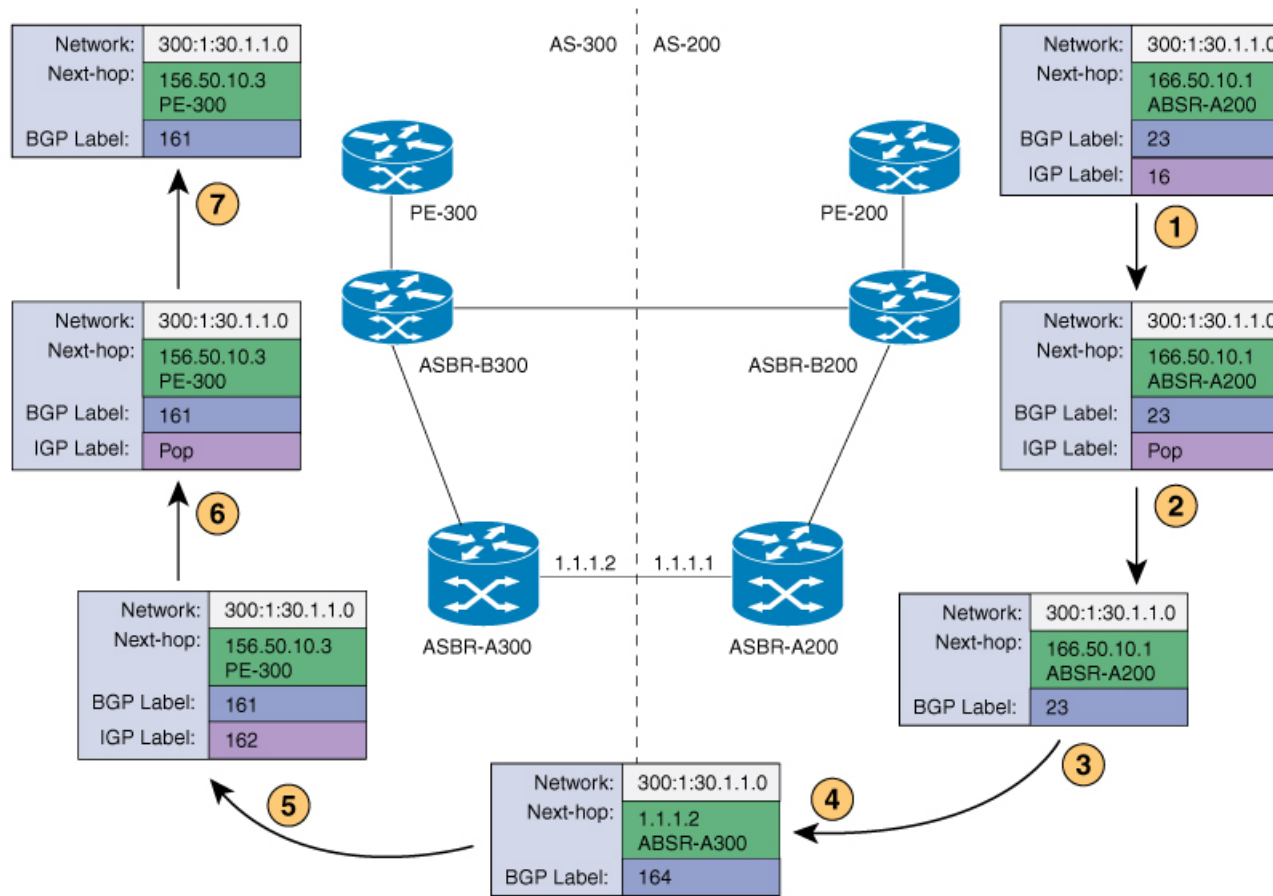

Redistribute Connected Subnet Method

The following figure shows the label forwarding path for Redistribute connected subnets method. The labels get pushed, swapped and popped on the stack as packet travels from PE- 300 in AS 300 to PE-200 in AS 200. In step 5, ASBR-A200 receives frame with BGP label 20, swaps it with label 29 and pushes label 17.

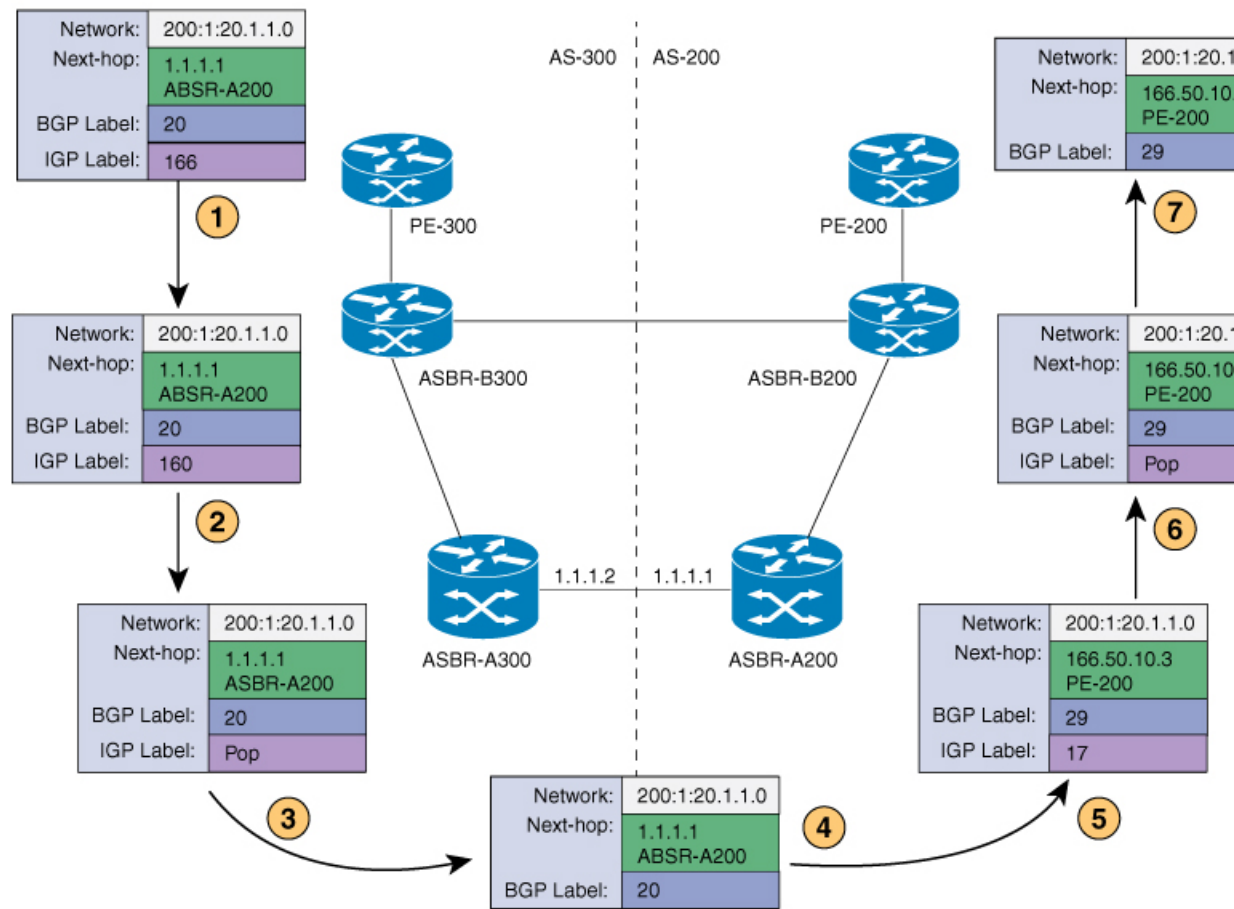

## InterAS Option AB

MPLS VPN service providers need to interconnect different autonomous systems to provide service for multiple VPN customers. The MPLS VPN InterAS Option AB feature allows the different autonomous systems to interconnect by using a single MP-BGP session in the global routing table to carry control plane traffic. This MP-BGP session signals VPN prefixes between two ASBRs for each VRF instance. This traffic can either be IP or MPLS.

MPLS BGP forwarding or LDP does not have to be configured between the two ASBRs as the VPN traffic sent is IP traffic over a VRF specific interface.

The interAS option AB feature provides the following benefits for service providers:

- IP QoS functions between ASBR peers are maintained for customer SLAs.
- Dataplane traffic is isolated on a per-VRF basis for security purposes.
- A dedicated QoS policy can be applied on each VRF by attaching the policy on an SVI.

## Route Distribution and Packet Forwarding

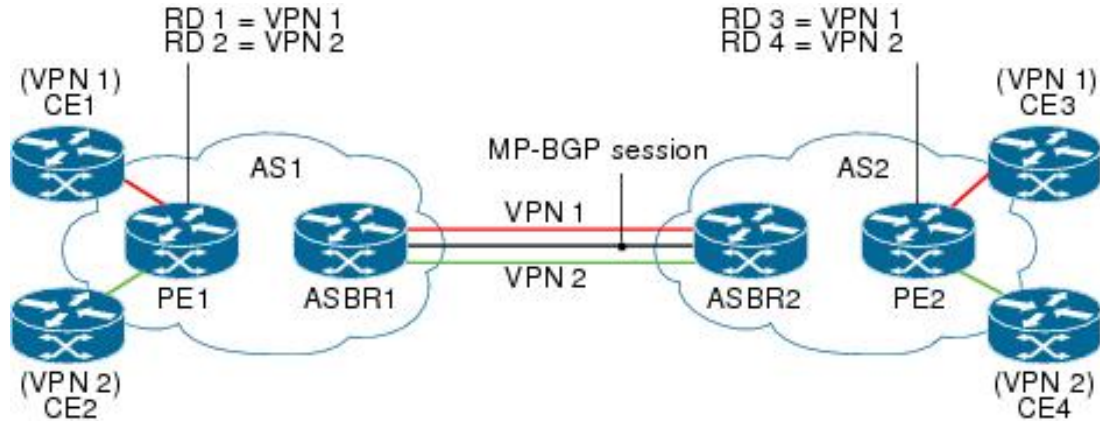

The following attributes describe the topology of the sample interAS Option AB network shown in the figure above:

- CE1 and CE3 belong to VPN 1.
- CE2 and CE 4 belong to VPN 2.
- PE1 uses route distinguisher 1 (RD 1) for VPN 1 (VRF 1) and RD 2 for VPN 2 (VRF 2).
- PE2 uses RD 3 for VPN 1 (VRF 1) and RD 4 for VPN 2 (VRF 2).
- ASBR1 has VRF 1 provisioned with RD 5 and VRF 2 provisioned with RD 6.
- ASBR2 has VRF 1 provisioned with RD 7 and VRF 2 provisioned and RD 8.
- ASBR1 and ASBR2 have three links between them:
  - VRF 1
  - VRF 2
  - MP-BGP session

## Route Distribution for VPN 1

A route distinguisher (RD) is an identifier attached to a route that identifies which VPN belongs to each route. Each routing instance must have a unique RD autonomous system associated with it. The RD is used to place a boundary around a VPN so that the same IP address prefixes can be used in different VPNs without having these IP address prefixes overlap. An RD statement is required if the instance type is a VRF.

The following process describes the route distribution process for VPN 1 in the figure above. Prefix “N” is used in this process to indicate the IP address of a VPN.

## ASBR 1

- CE1 advertises the prefix N to PE1.
- PE1 advertises a VPN prefix RD 1:N to ASBR1 through MP-iBGP.
- ASBR1 imports the prefix into VPN 1 and creates a prefix RD 5:N.



- ASBR1 advertises the imported prefix RD 5:N to ASBR2. ASBR1 sets itself as the next hop for prefix RD 5:N and allocates a local label that is signaled with this prefix.
- ASBR1 advertises the route with the export RT configured on the VRF rather than the originally received RTs. By default, ASBR1 does not advertise the source prefix RD 1:N to ASBR2. This advertisement is suppressed because the prefix is being imported into an Option AB VRF.

#### ASBR 2

- ASBR2 receives the prefix RD 5:N and imports it into VPN 1 as RD 7:N.
- ASBR2 advertises the route with the export RT configured on the VRF rather than the originally received RTs.
- While importing the prefix, ASBR2 sets the next hop of RD 7:N to the ASBR1 interface IP address in VRF 1. The next hop table ID is also set to VRF 1. When installing the MPLS forwarding entry for RD 7:N, by default ASBR2 does not install the outgoing label in the forwarding process. This enables the traffic between the ASBRs to be IP.
- ASBR2 advertises the imported prefix RD 7:N to PE2. It sets itself as the next hop for this prefix and also allocates a local label that is signalled with the prefix. By default, ASBR2 does not advertise the source prefix RD 5:N to PE2. This advertisement is suppressed because the prefix is being imported into an Option AB VRF.
- PE2 imports the RD 7:N into VRF 1 as RD 3:N.

#### Packet Forwarding for VPN 1

The following packet forwarding process works the same as it does in an Option A scenario. The ASBR acts like the PE by terminating the VPN and then forwards its traffic as standard IP packets with no VPN label to the next PE, which in turn repeats the VPN process. Each PE device, therefore, treats the adjacent PE device as a CE device, and the standard Layer 3 MPLS VPN mechanisms are used for route redistribution with each autonomous system; that is, the PEs use external BGP (eBGP) to distribute unlabeled IPv4 addresses to each other.

- CE3 sends a packet destined for N to PE2.
- PE2 encapsulates the packet with the VPN label allocated by ASBR2 and the Interior Gateway Protocol (IGP) label needed to tunnel the packet to ASBR2.
- The packet arrives on ASBR2 with the VPN label. ASBR2 removes the VPN label and sends the packet as IP to ASBR1 on the VRF 1 interface.
- The IP packet arrives at ASBR1 on the VRF 1 interface. ASBR1 then encapsulates the packet with the VPN label allocated by PE1 and the IGP label needed to tunnel the packet to PE1.
- The packet arrives on PE1 with the VPN label. PE1 disposes the VPN label and forwards the IP packet to CE1.

#### Route Distribution for VPN 2

The following information describes the route distribution process for VPN 2 in the figure above:

##### ASBR 1

- CE2 advertises prefix N to PE1, where N is the VPN IP address.

- PE1 advertises a VPN prefix RD 2:N to ASBR1 through MP-iBGP.
- ASBR1 imports the prefix into VPN 2 and creates a prefix RD 6:N.
- ASBR1 advertises the imported prefix RD 6:N to ASBR2. It sets itself as the next hop for this prefix and also allocates a local label that is signalled with the prefix. By default, ASBR1 does not advertise the source prefix RD 2:N to ASBR2. This advertisement is suppressed as the prefix is being imported into an Option AB VRF.

#### ASBR 2

- ASBR2 receives the prefix RD 6:N and imports it into VPN 2 as RD 8:N.
- While importing the prefix, ASBR2 sets the next hop of RD 8:N to ASBR1's interface address in VRF 2. The next hop table ID is also set to that of VRF 2. While installing the MPLS forwarding entry for RD 8:N, by default ASBR2 does not install the outgoing label in the forwarding process. This enables traffic between the ASBRs to be IP.
- ASBR2 advertises the imported prefix RD 8:N to PE2. It sets itself as the next hop for this prefix and also allocates a local label that is signalled with the prefix. By default, ASBR2 does not advertise the source prefix RD 6:N to PE2. This advertisement is suppressed because the prefix is being imported into an Option AB VRF.
- PE2 imports the RD 8:N into VRF 2 as RD 4:N.

## How to Configure MPLS VPN InterAS Options

The following section provides information about how to configure MPLS VPN InterAS Options.

### Configuring MPLS VPN InterAS Option B

#### Configuring InterAS Option B using the Next-Hop-Self Method

To configure interAS Option B on ASBRs using the next-hop-self method, complete the following steps:

##### Procedure

	Command or Action	Purpose
<b>Step 1</b>	<b>enable</b> <b>Example:</b> Device> <b>enable</b>	Enables privileged EXEC mode. <ul style="list-style-type: none"> <li>• Enter your password if prompted.</li> </ul>
<b>Step 2</b>	<b>configure terminal</b> <b>Example:</b> Device# <b>configure terminal</b>	Enters global configuration mode.

	Command or Action	Purpose
<b>Step 3</b>	<b>router ospf</b> <i>process-id</i> <b>Example:</b>  Device (config) # <b>router ospf 1</b>	Configures an OSPF routing process and assign a process number.
<b>Step 4</b>	<b>router-id</b> <i>ip-address</i> <b>Example:</b>  Device (config) # <b>router-id 4.1.1.1</b>	Specifies a fixed router ID.
<b>Step 5</b>	<b>nsr</b> <b>Example:</b>  Device (config-router) # <b>nsr</b>	Configures OSPF non-stop routing (NSR).
<b>Step 6</b>	<b>nsf</b> <b>Example:</b>  Device (config-router) # <b>nsf</b>	Configures OSPF non-stop forwarding (NSF).
<b>Step 7</b>	<b>redistribute bgp</b> <i>autonomous-system-number</i> <b>Example:</b>  Device (config-router) # <b>redistribute bgp 200</b>	Redistributes routes from a BGP autonomous system into an OSPF routing process.
<b>Step 8</b>	<b>passive-interface</b> <i>interface-type interface-number</i> <b>Example:</b>  Device (config-router) # <b>passive-interface GigabitEthernet 1/0/10</b> Device (config-router) # <b>passive-interface Tunnel0</b>	Disables Open Shortest Path First (OSPF) routing updates on an interface.
<b>Step 9</b>	<b>network</b> <i>ip-address wildcard-mask area-id</i> <b>Example:</b>  Device (config-router) # <b>network 4.1.1.0 0.0.0.0.255 area 0</b>	Defines an interface on which OSPF runs and defines the area ID for that interface.
<b>Step 10</b>	<b>exit</b> <b>Example:</b>  Device (config-router) # <b>exit</b>	Exits router configuration mode.
<b>Step 11</b>	<b>router bgp</b> <i>autonomous-system-number</i> <b>Example:</b>	Configures a BGP routing process.

	Command or Action	Purpose
	Device(config)# <b>router bgp 200</b>	
<b>Step 12</b>	<b>bgp router-id <i>ip-address</i></b> <b>Example:</b> Device(config-router)# <b>bgp router-id 4.1.1.1</b>	Configures a fixed router ID for the BGP routing process.
<b>Step 13</b>	<b>bgp log-neighbor changes</b> <b>Example:</b> Device(config-router)# <b>bgp log-neighbor changes</b>	Enables logging of BGP neighbor resets.
<b>Step 14</b>	<b>no bgp default ipv4-unicast</b> <b>Example:</b> Device(config-router)# <b>no bgp default ipv4-unicast</b>	Disables advertisement of routing information for address family IPv4.
<b>Step 15</b>	<b>no bgp default route-target filter</b> <b>Example:</b> Device(config-router)# <b>no bgp default route-target filter</b>	Disables automatic BGP route-target community filtering.
<b>Step 16</b>	<b>neighbor <i>ip-address</i> remote-as <i>as-number</i></b> <b>Example:</b> Device(config-router)# <b>neighbor 4.1.1.3 remote-as 200</b>	Configures an entry to the BGP neighbor table.
<b>Step 17</b>	<b>neighbor <i>ip-address</i> update-source <i>interface-type interface-number</i></b> <b>Example:</b> Device(config-router)# <b>neighbor 4.1.1.3 update-source Loopback0</b>	Allows Cisco IOS software to use a specific operational interface for TCP connections by the BGP sessions.
<b>Step 18</b>	<b>neighbor <i>ip-address</i> remote-as <i>as-number</i></b> <b>Example:</b> Device(config-router)# <b>neighbor 4.1.1.3 remote-as 300</b>	Configures an entry to the BGP neighbor table.

	Command or Action	Purpose
<b>Step 19</b>	<b>address-family <i>ipv4</i></b> <b>Example:</b> Device(config-router)# <b>address-family ipv4</b>	Enters address family configuration mode for configuring BGP routing sessions that use standard IP Version 4 address prefixes.
<b>Step 20</b>	<b>neighbor <i>ip-address activate</i></b> <b>Example:</b> Device(config-router-af)# <b>neighbor 10.32.1.2 activate</b>	Enables the exchange of information with a BGP neighbor.
<b>Step 21</b>	<b>neighbor <i>ip-address send-label</i></b> <b>Example:</b> Device(config-router-af)# <b>neighbor 10.32.1.2 send-label</b>	Sends MPLS labels with BGP routes to a neighboring BGP router.
<b>Step 22</b>	<b>exit address-family</b> <b>Example:</b> Device(config-router-af)# <b>exit address-family</b>	Exits BGP address-family submode.
<b>Step 23</b>	<b>address-family <i>vpn4</i></b> <b>Example:</b> Device(config-router)# <b>address-family vpn4</b>	Configures the device in address family configuration mode for configuring routing sessions, such as BGP, that use standard VPNv4 address prefixes.
<b>Step 24</b>	<b>neighbor <i>ip-address activate</i></b> <b>Example:</b> Device(config-router-af)# <b>neighbor 4.1.1.3 activate</b>	Enables the exchange of information with a BGP neighbor.
<b>Step 25</b>	<b>neighbor <i>ip-address send-community extended</i></b> <b>Example:</b> Device(config-router-af)# <b>neighbor 4.1.1.3 send-community extended</b>	Specifies that a communities attribute should be sent to a BGP neighbor.
<b>Step 26</b>	<b>neighbor <i>ip-address next-hop-self</i></b> <b>Example:</b> Device(config-router-af)# <b>neighbor 4.1.1.3 next-hop-self</b>	Configure a router as the next hop for a BGP-speaking neighbor. This is the command that implements the next-hop-self method.

	Command or Action	Purpose
Step 27	<b>neighbor ip-address activate</b> <b>Example:</b> <pre>Device(config-router-af)# neighbor 10.30.1.2 activate</pre>	Enables the exchange of information with a BGP neighbor.
Step 28	<b>neighbor ip-address send-community extended</b> <b>Example:</b> <pre>Device(config-router-af)# neighbor 10.30.1.2 send-community extended</pre>	Specifies that a communities attribute should be sent to a BGP neighbor.
Step 29	<b>exit address-family</b> <b>Example:</b> <pre>Device(config-router-af)# exit address-family</pre>	Exits BGP address-family submode.
Step 30	<b>bgp router-id ip-address</b> <b>Example:</b> <pre>Device(config-router)# bgp router-id 4.1.1.3</pre>	Configures a fixed router ID for the BGP routing process.
Step 31	<b>bgp log-neighbor changes</b> <b>Example:</b> <pre>Device(config-router)# bgp log-neighbor changes</pre>	Enables logging of BGP neighbor resets.
Step 32	<b>neighbor ip-address remote-as as-number</b> <b>Example:</b> <pre>Device(config-router)# neighbor 4.1.1.1 remote-as 200</pre>	Configures an entry to the BGP neighbor table.
Step 33	<b>neighbor ip-address update-source interface-type interface-number</b> <b>Example:</b> <pre>Device(config-router)# neighbor 4.1.1.1 update-source Loopback0</pre>	Allows Cisco IOS software to use a specific operational interface for TCP connections by the BGP sessions.
Step 34	<b>address-family vpv4</b> <b>Example:</b> <pre>Device(config-router)# address-family vpv4</pre>	Configures the device in address family configuration mode for configuring routing sessions, such as BGP, that use standard VPNv4 address prefixes.

	Command or Action	Purpose
<b>Step 35</b>	<b>neighbor ip-address activate</b> <b>Example:</b>  Device(config-router-af)# <b>neighbor 4.1.1.1 activate</b>	Enables the exchange of information with a BGP neighbor.
<b>Step 36</b>	<b>neighbor ip-address send-community extended</b> <b>Example:</b>  Device(config-router-af)# <b>neighbor 4.1.1.1 send-community extended</b>	Specifies that a communities attribute should be sent to a BGP neighbor.
<b>Step 37</b>	<b>exit address-family</b> <b>Example:</b>  Device(config-router-af)# <b>exit address-family</b>	Exits BGP address-family submode.

## Configuring InterAS Option B using Redistribute Connected Method

To configure interAS Option B on ASBRs using the redistribute connected method, complete the following steps:

### Procedure

	Command or Action	Purpose
<b>Step 1</b>	<b>enable</b> <b>Example:</b>  Device> <b>enable</b>	Enables privileged EXEC mode. <ul style="list-style-type: none"> <li>• Enter your password if prompted.</li> </ul>
<b>Step 2</b>	<b>configure terminal</b> <b>Example:</b>  Device# <b>configure terminal</b>	Enters global configuration mode.
<b>Step 3</b>	<b>router ospf process-id</b> <b>Example:</b>  Device(config)# <b>router ospf 1</b>	Configures an OSPF routing process and assign a process number.
<b>Step 4</b>	<b>router-id ip-address</b> <b>Example:</b>  Device(config)# <b>router-id 5.1.1.1</b>	Specifies a fixed router ID.

	Command or Action	Purpose
<b>Step 5</b>	<b>nsr</b> <b>Example:</b>  Device (config-router) # <b>nsr</b>	Configures OSPF non-stop routing (NSR).
<b>Step 6</b>	<b>nsf</b> <b>Example:</b>  Device (config-router) # <b>nsf</b>	Configures OSPF non-stop forwarding (NSF).
<b>Step 7</b>	<b>redistribute connected</b> <b>Example:</b>  Device (config-router) # <b>redistribute connected</b>	Redistributes the next hop address of the remote ASBR into the local IGP. This is the command that implements redistribute connected method.
<b>Step 8</b>	<b>passive-interface interface-type interface-number</b> <b>Example:</b>  Device (config-router) # <b>passive-interface GigabitEthernet 1/0/10</b> Device (config-router) # <b>passive-interface Tunnel0</b>	Disables Open Shortest Path First (OSPF) routing updates on an interface.
<b>Step 9</b>	<b>network ip-address wildcard-mask aread area-id</b> <b>Example:</b>  Device (config-router) # <b>network 5.1.1.0 0.0.0.0.255 area 0</b>	Defines an interface on which OSPF runs and defines the area ID for that interface.
<b>Step 10</b>	<b>exit</b> <b>Example:</b>  Device (config-router) # <b>exit</b>	Exits router configuration mode.
<b>Step 11</b>	<b>router bgp autonomous-system-number</b> <b>Example:</b>  Device (config) # <b>router bgp 300</b>	Configures a BGP routing process.
<b>Step 12</b>	<b>bgp router-id ip-address</b> <b>Example:</b>  Device (config-router) # <b>bgp router-id 5.1.1.1</b>	Configures a fixed router ID for the BGP routing process.



	Command or Action	Purpose
<b>Step 13</b>	<b>bgp log-neighbor changes</b> <b>Example:</b> <pre>Device(config-router)# bgp log-neighbor changes</pre>	Enables logging of BGP neighbor resets.
<b>Step 14</b>	<b>no bgp default ipv4-unicast</b> <b>Example:</b> <pre>Device(config-router)# no bgp default ipv4-unicast</pre>	Disables advertisement of routing information for address family IPv4.
<b>Step 15</b>	<b>no bgp default route-target filter</b> <b>Example:</b> <pre>Device(config-router)# no bgp default route-target filter</pre>	Disables automatic BGP route-target community filtering.
<b>Step 16</b>	<b>neighbor ip-address remote-as as-number</b> <b>Example:</b> <pre>Device(config-router)# neighbor 5.1.1.3 remote-as 300</pre>	Configures an entry to the BGP neighbor table.
<b>Step 17</b>	<b>neighbor ip-address update-source interface-type interface-number</b> <b>Example:</b> <pre>Device(config-router)# neighbor 4.1.1.3 update-source Loopback0</pre>	Allows Cisco IOS software to use a specific operational interface for TCP connections by the BGP sessions.
<b>Step 18</b>	<b>neighbor ip-address remote-as as-number</b> <b>Example:</b> <pre>Device(config-router)# neighbor 10.30.1.2 remote-as 200</pre>	Configures an entry to the BGP neighbor table.
<b>Step 19</b>	<b>address-family vpnv4</b> <b>Example:</b> <pre>Device(config-router)# address-family vpnv4</pre>	Configures the device in address family configuration mode for configuring routing sessions, such as BGP, that use standard VPNv4 address prefixes.
<b>Step 20</b>	<b>neighbor ip-address activate</b> <b>Example:</b> <pre>Device(config-router-af)# neighbor 5.1.1.3 activate</pre>	Enables the exchange of information with a BGP neighbor.

	Command or Action	Purpose
<b>Step 21</b>	<b>neighbor ip-address send-community extended</b>  <b>Example:</b>  Device(config-router-af)# <b>neighbor 5.1.1.3 send-community extended</b>	Specifies that a communities attribute should be sent to a BGP neighbor.
<b>Step 22</b>	<b>neighbor ip-address activate</b>  <b>Example:</b>  Device(config-router-af)# <b>neighbor 10.30.1.1 activate</b>	Enables the exchange of information with a BGP neighbor.
<b>Step 23</b>	<b>neighbor ip-address send-community extended</b>  <b>Example:</b>  Device(config-router-af)# <b>neighbor 10.30.1.2 send-community extended</b>	Specifies that a communities attribute should be sent to a BGP neighbor.
<b>Step 24</b>	<b>exit address-family</b>  <b>Example:</b>  Device(config-router-af)# <b>exit address-family</b>	Exits BGP address-family submode.
<b>Step 25</b>	<b>mpls ldp router-id interface-id [force]</b>  <b>Example:</b>  Device(config-router)# <b>mpls ldp router-id Loopback0 force</b>	Specifies the preferred interface for determining the LDP router ID.

## Configuring MPLS VPN Inter-AS Option AB

The following sections describe how to configure the interAS option AB feature on an ASBR for an MPLS VPN:

### Configuring the VRFs on the ASBR Interface for Each VPN Customer

Use the following steps to configure the VRFs on the ASBR interface for each VPN customer so that these VPNs have connectivity over the interAS Option AB network.

#### Procedure

	Command or Action	Purpose
<b>Step 1</b>	<b>enable</b>  <b>Example:</b>	Enables privileged EXEC mode.  • Enter your password if prompted.

	Command or Action	Purpose
	Device> <b>enable</b>	
<b>Step 2</b>	<b>configure terminal</b> <b>Example:</b> Device# <b>configure terminal</b>	Enters global configuration mode.
<b>Step 3</b>	<b>interface</b> <i>type number</i> <b>Example:</b> Device (config) # <b>interface gigabitethernet 1/0/1</b>	Specifies the interface to configure and enters interface configuration mode.
<b>Step 4</b>	<b>ip vrf forwarding</b> <i>vrf-name</i> <b>Example:</b> Device (config-if) # <b>ip vrf forwarding vpn1</b>	Associates a VRF with the specified interface. <ul style="list-style-type: none"> <li>The vrf-name argument is the name assigned to a VRF.</li> </ul>
<b>Step 5</b>	<b>end</b> <b>Example:</b> Device (config-if) # <b>end</b>	(Optional) Exits to privileged EXEC mode.

## Configuring the MP-BGP Session Between ASBR Peers

BGP propagates reachability information for VPN-IPv4 prefixes among PE devices by means of the BGP multiprotocol extensions (see RFC 2283, Multiprotocol Extensions for BGP-4 ), which define support for address families other than IPv4. Using the extensions ensures that the routes for a given VPN are learned only by other members of that VPN, enabling members of the VPN to communicate with each other.

Follow the steps in this section to configure the MP-BGP session on the ASBR.

### Procedure

	Command or Action	Purpose
<b>Step 1</b>	<b>enable</b> <b>Example:</b> Device> <b>enable</b>	Enables privileged EXEC mode. <ul style="list-style-type: none"> <li>Enter your password if prompted.</li> </ul>
<b>Step 2</b>	<b>configure terminal</b> <b>Example:</b>	Enters global configuration mode.

	Command or Action	Purpose
	Device# <code>configure terminal</code>	
<b>Step 3</b>	<b>router bgp</b> <i>as-number</i> <b>Example:</b> Device(config)# <code>router bgp 100</code>	Configures a BGP routing process and places the device in router configuration mode. <ul style="list-style-type: none"> <li>The <i>as-number</i> argument indicates the number of an autonomous system that identifies the device to other BGP devices and tags the routing information passed along. Valid numbers are from 0 to 65535. Private autonomous system numbers that can be used in internal networks range from 64512 to 65535.</li> </ul>
<b>Step 4</b>	<b>neighbor</b> { <i>ip-address</i>   <i>peer-group-name</i> } <b>remote-as</b> <i>as-number</i> <b>Example:</b> Device(config-router)# <code>neighbor 192.168.0.1 remote-as 200</code>	Adds an entry to the BGP or multiprotocol BGP neighbor table. <ul style="list-style-type: none"> <li>The <i>ip-address</i> argument specifies the IP address of the neighbor.</li> <li>The <i>peer-group-name</i> argument specifies the name of a BGP peer group.</li> <li>The <i>as-number</i> argument specifies the autonomous system to which the neighbor belongs.</li> </ul>
<b>Step 5</b>	<b>address-family vpnv4</b> [ <b>unicast</b> ] <b>Example:</b> Device(config-router)# <code>address-family vpnv4</code>	Enters address family configuration mode for configuring routing sessions, such as BGP, that use standard VPNv4 address prefixes. <ul style="list-style-type: none"> <li>The <b>unicast</b> keyword specifies IPv4 unicast address prefixes.</li> </ul>
<b>Step 6</b>	<b>neighbor</b> { <i>ip-address</i>   <i>peer-group-name</i> } <b>activate</b> <b>Example:</b> Device(config-router-af)# <code>neighbor 192.168.0.1 activate</code>	Enables the exchange of information with a neighboring device. <ul style="list-style-type: none"> <li>The <i>ip-address</i> argument specifies the IP address of the neighbor.</li> <li>The <i>peer-group-name</i> argument specifies the name of a BGP peer group.</li> </ul>
<b>Step 7</b>	<b>neighbor</b> { <i>ip-address</i>   <i>peer-group-name</i> } <b>inter-as-hybrid</b> <b>Example:</b> Device(config-router-af)# <code>neighbor 192.168.0.1 inter-as-hybrid</code>	Configures eBGP peer device (ASBR) as an Inter-AS Option AB peer. <ul style="list-style-type: none"> <li>The <i>ip-address</i> argument specifies the IP address of the neighbor.</li> <li>The <i>peer-group-name</i> argument specifies the name of a BGP peer group.</li> </ul>

	Command or Action	Purpose
		<ul style="list-style-type: none"> <li>If any prefixes are imported into Option AB VRFs, then the imported paths are advertised to this peer.</li> <li>If any prefixes are received from this peer and are imported into Option AB VRFs, then the imported paths are advertised to iBGP peers.</li> </ul> <p><b>Note</b> Advertised routes have RTs that are configured on the VRF. Advertised routes do not have their original RTs.</p>
<b>Step 8</b>	<b>exit-address-family</b>  <b>Example:</b> Device(config-router)# <b>exit-address-family</b>	Exits from address family configuration mode.

## Configuring the Routing Policy for VPNs that Need Inter-AS Connections

Use the steps in this section to configure VRFs for the VPNs that need Inter-AS connections between ASBR peers, by configuring the appropriate routing policy and Option AB configuration.

### Procedure

	Command or Action	Purpose
<b>Step 1</b>	<b>enable</b>  <b>Example:</b> Device> <b>enable</b>	Enables privileged EXEC mode. <ul style="list-style-type: none"> <li>Enter your password if prompted.</li> </ul>
<b>Step 2</b>	<b>configure terminal</b>  <b>Example:</b> Device# <b>configure terminal</b>	Enters global configuration mode.
<b>Step 3</b>	<b>vrf definition</b> <i>vrf-name</i>  <b>Example:</b> Device(config)# <b>vrf definition</b> <i>vpn1</i>	Defines the VPN routing instance by assigning a VRF name and enters VRF configuration mode. <ul style="list-style-type: none"> <li>The <i>vrf-name</i> argument is the name assigned to a VRF.</li> </ul>
<b>Step 4</b>	<b>rd</b> <i>route-distinguisher</i>  <b>Example:</b> Device(config-vrf)# <b>rd</b> 100:1	Creates routing and forwarding tables. <ul style="list-style-type: none"> <li>The <i>route-distinguisher</i> argument adds an 8-byte value to an IPv4 prefix to create a VPN IPv4 prefix. You can enter an RD in either of these formats:</li> </ul>

	Command or Action	Purpose
		<ul style="list-style-type: none"> <li>• 16-bit autonomous system number: your 32-bit number, for example, 101:3.</li> <li>• 32-bit IP address: your 16-bit number, for example, 192.168.122.15:1.</li> </ul>
<b>Step 5</b>	<b>address-family ipv4</b> <b>Example:</b> <pre>Device(config-vrf)# address-family ipv4</pre>	<p>Enters VRF address family configuration mode to specify an address family for a VRF.</p> <ul style="list-style-type: none"> <li>• The <b>ipv4</b> keyword specifies an IPv4 address family for a VRF.</li> <li>• 16-bit autonomous system number: your 32-bit number, for example, 101:3.</li> <li>• 32-bit IP address: your 16-bit number, for example, 192.168.122.15:1.</li> </ul>
<b>Step 6</b>	<del>route-target</del> <b>route-target {import   export   both} route-target-ext-community</b> <b>Example:</b> <pre>Device(config-vrf-af)# route-target import 100:1</pre>	<p>Creates a route-target extended community for a VRF.</p> <ul style="list-style-type: none"> <li>• The <b>import</b> keyword imports routing information from the target VPN extended community.</li> <li>• The <b>export</b> keyword exports routing information to the target VPN extended community.</li> <li>• The <b>both</b> keyword imports routing information from and exports routing information to the target VPN extended community.</li> <li>• The <i>route-target-ext-community</i> argument adds the route-targetextended community attributes to the VRF list of import, export, or both (import and export) route-target extended communities.</li> </ul>
<b>Step 7</b>	<b>inter-as-hybrid</b> <b>Example:</b> <pre>Device(config-vrf-af)# inter-as-hybrid</pre>	<p>Specifies the VRF as an option AB VRF, which has the following effects:</p> <ul style="list-style-type: none"> <li>• Routes imported to this VRF can be advertised to option AB peers and VPNv4 iBGP peers.</li> <li>• When routes received from option AB peers and are imported into the VRF, the</li> </ul>

	Command or Action	Purpose
		next hop table ID of the route is set to the table ID of the VRF.
<b>Step 8</b>	<b>inter-as-hybrid</b> [ <i>next-hopip-address</i> ]  <b>Example:</b> Device(config-vrf-af) # <b>inter-as-hybrid</b> <b>next-hop</b> 192.168.1.0	(Optional) Specifies the next hop IP address to be set on paths that are imported into the VRF and that are received from an Option AB peer. <ul style="list-style-type: none"> <li>• The next hop context is also set to the VRF, which imports these paths.</li> </ul>
<b>Step 9</b>	<b>end</b>  <b>Example:</b> Device(config-vrf-af) # <b>end</b>	(Optional) Exits to privileged EXEC mode.

## Changing an Inter-AS Option A Deployment to an Option AB Deployment

In an option A deployment, the VRF instances are back-to-back between the ASBR devices and there is direct connectivity between PE devices of different autonomous systems. The PE devices are attached by multiple physical or logical interfaces, each of which is associated with a given VPN (through a VRF instance).

In the Option AB deployment, the different autonomous systems interconnect by using a single MP-BGP session in the global routing table to carry control plane traffic.

Use the following steps to change an MPLS VPN Inter-AS Option A deployment to an Option AB deployment.

1. Configure the MP-BGP session on the ASBR. BGP multiprotocol extensions are used to define support for address families other than IPv4 so that the routes for a given VPN are learned only by other members of that VPN, enabling members of the VPN to communicate with each other.
2. Identify the VRFs that need an upgrade from Option A and configure them for Option AB by using the **inter-as-hybrid** command.
3. Use the following steps in this section to remove the configuration for the eBGP (peer ASBR) neighbor.
4. Repeat all the steps in the following procedure to remove the configuration for additional eBGP (peer ASBR) neighbors.

### Procedure

	Command or Action	Purpose
<b>Step 1</b>	<b>enable</b>  <b>Example:</b> Device> <b>enable</b>	Enables privileged EXEC mode. <ul style="list-style-type: none"> <li>• Enter your password if prompted.</li> </ul>
<b>Step 2</b>	<b>configure terminal</b>  <b>Example:</b> Device# <b>configure terminal</b>	Enters global configuration mode.

	Command or Action	Purpose
<b>Step 3</b>	<b>router bgp</b> <i>as-number</i> <b>Example:</b> Device(config)# <b>router bgp</b> 100	Configures a BGP routing process and places the device in router configuration mode. <ul style="list-style-type: none"> <li>The <i>as-number</i> argument indicates the number of an autonomous system that identifies the device to other BGP devices and tags the routing information passed along. Valid numbers are from 0 to 65535. Private autonomous system numbers that can be used in internal networks range from 64512 to 65535.</li> </ul>
<b>Step 4</b>	<b>address-family ipv4 vrf</b> <i>vrf-name</i> <b>Example:</b> Device(config-router)# <b>address-family ipv4 vrf</b> vpn4	Configures each VRF that is identified in the MP-BGP session on the ASBR so that the routes for a given VPN are learned only by other members of that VPN, enabling members of the VPN to communicate with each other. <ul style="list-style-type: none"> <li>Enters address family configuration mode to specify an address family for a VRF.</li> </ul>
<b>Step 5</b>	<b>no neighbor</b> { <i>ip-address</i>   <i>peer-group-name</i> } <b>Example:</b> Device(config-router-af)# <b>no neighbor</b> 192.168.0.1	Removes the configuration for the exchange of information with the neighboring eBGP (ASBR) device. <ul style="list-style-type: none"> <li>The <i>ip-address</i> argument specifies the IP address of the neighbor.</li> </ul>
<b>Step 6</b>	<b>exit-address-family</b> <b>Example:</b> Device(config-router-af)# <b>exit-address-family</b>	Exits from address family configuration mode.
<b>Step 7</b>	<b>end</b> <b>Example:</b> Device(config-router-af)# <b>end</b>	Exits to privileged EXEC mode.

## Verifying MPLS VPN InterAS Options Configuration

To verify InterAS option B configuration information, perform one of the following tasks:

Command	Purpose
<b>ping</b> <i>ip-address source interface-type</i>	Checks the accessibility of devices. Use this command to check the connection between CE1 and CE2 using the loopback interface.
<b>show bgp vpnv4 unicast labels</b>	Displays incoming and outgoing BGP labels.



Command	Purpose
<b>show mpls forwarding-table</b>	Display the contents of the MPLS Label Forwarding Information Base.
<b>show ip bgp</b>	Displays entries in the BGP routing table.
<b>show { ip   ipv6 } bgp [ vrf vrf-name ]</b>	Displays information about BGP on a VRF.
<b>show ip route [ ip-address [ mask ] ] [ protocol ] vrf vrf-name</b>	Displays the current state of the routing table. Use the ip-address argument to verify that CE1 has a route to CE2. Verify the routes learned by CE1. Make sure that the route for CE2 is listed.
<b>show { ip   ipv6 } route vrf vrf-name</b>	Displays the IP routing table that is associated with a VRF. Check that the loopback addresses of the local and remote CE routers are in the routing table of the PE routers.
<b>show running-config bgp</b>	Displays the running configuration for BGP.
<b>show running-config vrf vrf-name</b>	Displays the running configuration for VRFs.
<b>show vrf vrf-name interface interface-type interface-id</b>	Verifies the route distinguisher (RD) and interface that are configured for the VRF.
<b>trace destination [ vrf vrf-name ]</b>	Discovers the routes that packets take when traveling to their destination. The <b>trace</b> command can help isolate a problem if two routers cannot communicate.

# Configuration Examples for MPLS VPN InterAS Options

## InterAS Option B

### Next-Hop-Self Method

Figure 8: Topology for InterAS Option B using Next-Hop-Self Method

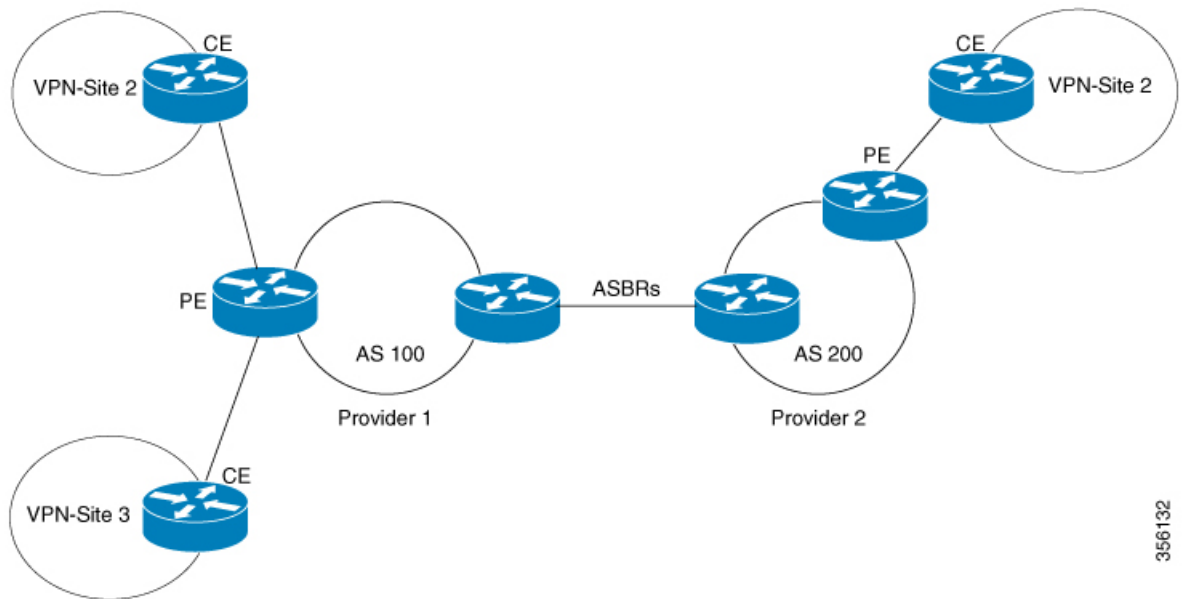

356132

Configuration for PE1-P1-ASBR1

PE1	P1	ASBR1
	<pre> interface Loopback0 ip address 4.1.1.2 255.255.255.255 ip ospf 1 area 0 interface GigabitEthernet1/0/4 no switchport ip address 10.10.1.2 255.255.255.0 ip ospf 1 area 0 mpls ip mpls label protocol ldp ! interface GigabitEthernet1/0/23 no switchport ip address 10.20.1.1 255.255.255.0 ip ospf 1 area 0 mpls ip mpls label protocol ldp                     </pre>	<pre> interface Loopback0 ip address 4.1.1.1 255.255.255.255 ip ospf 1 area 0 interface GigabitEthernet1/0/10 no switchport ip address 10.30.1.1 255.255.255.0 mpls bgp forwarding interface GigabitEthernet1/0/23 no switchport ip address 10.20.1.2 255.255.255.0 ip ospf 1 area 0 mpls ip mpls label protocol ldp router ospf 1 router-id 4.1.1.1 nsr nsf redistribute bgp 200 passive-interface GigabitEthernet1/0/10 passive-interface Tunnel0 network 4.1.1.0 0.0.0.255 area 0 router bgp 200 bgp router-id 4.1.1.1 bgp log-neighbor-changes no bgp default ipv4-unicast no bgp default route-target filter neighbor 4.1.1.3 remote-as 200 neighbor 4.1.1.3 update-source Loopback0 neighbor 10.30.1.2 remote-as 300 ! address-family ipv4 neighbor 10.30.1.2 activate neighbor 10.30.1.2 send-label exit-address-family ! address-family vpnv4 neighbor 4.1.1.3 activate neighbor 4.1.1.3 send-community extended neighbor 4.1.1.3 next-hop-self neighbor 10.30.1.2 activate neighbor 10.30.1.2 send-community extended exit-address-family                     </pre>

PE1	P1	ASBR1
<pre> vrf definition Mgmt-vrf ! address-family ipv4 exit-address-family ! address-family ipv6 exit-address-family ! vrf definition vrf1 rd 200:1 route-target export 200:1 route-target import 200:1 route-target import 300:1 ! address-family ipv4 exit-address-family interface Loopback0 ip address 4.1.1.3 255.255.255.255 ip ospf 1 area 0 ! interface Loopback1 vrf forwarding vrf1 ip address 192.1.1.1 255.255.255.255 ip ospf 200 area 0 ! interface GigabitEthernet2/0/4 no switchport ip address 10.10.1.1 255.255.255.0 ip ospf 1 area 0 mpls ip mpls label protocol ldp interface GigabitEthernet2/0/9 description to-IXIA-1:p8 no switchport vrf forwarding vrf1 ip address 192.2.1.1 255.255.255.0 ip ospf 200 area 0 router ospf 200 vrf vrf1 router-id 192.1.1.1 nsr nsf redistribute connected redistribute bgp 200 network 192.1.1.1 0.0.0.0 area 0 network 192.2.1.0 0.0.0.255 area 0 router ospf 1 router-id 4.1.1.3 nsr nsf redistribute connected router bgp 200 bgp router-id 4.1.1.3 bgp log-neighbor-changes neighbor 4.1.1.1 remote-as 200 neighbor 4.1.1.1 update-source Loopback0 </pre>		

PE1	P1	ASBR1
<pre>! address-family vpv4 neighbor 4.1.1.1 activate neighbor 4.1.1.1 send-community extended exit-address-family ! address-family ipv4 vrf vrf1 redistribute connected redistribute ospf 200 maximum-paths ibgp 2 exit-address-family</pre>		

## Configuration for ASBR2 – P2 – PE2

Table 7:

PE2	P2	ASBR2
	<pre> interface Loopback0 ip address 5.1.1.2 255.255.255.255 ip ospf 1 area 0 interface GigabitEthernet1/0/1 no switchport ip address 10.50.1.1 255.255.255.0 ip ospf 1 area 0 mpls ip mpls label protocol ldp interface GigabitEthernet2/0/3 no switchport ip address 10.40.1.2 255.255.255.0 ip ospf 1 area 0 mpls ip mpls label protocol ldp </pre>	<pre> interface Loopback0 ip address 5.1.1.1 255.255.255.255 ip ospf 1 area 0 ! interface GigabitEthernet1/0/37 no switchport ip address 10.30.1.2 255.255.255.0 mpls bgp forwarding interface GigabitEthernet1/0/47 no switchport ip address 10.40.1.1 255.255.255.0 ip ospf 1 area 0 mpls ip mpls label protocol ldp router ospf 1 router-id 5.1.1.1 nsr nsf passive-interface GigabitEthernet1/0/37 passive-interface Tunnel0 network 5.1.1.0 0.0.0.255 area 0 ! router bgp 300 bgp router-id 5.1.1.1 bgp log-neighbor-changes no bgp default ipv4-unicast no bgp default route-target filter neighbor 5.1.1.3 remote-as 300 neighbor 5.1.1.3 update-source Loopback0 neighbor 10.30.1.1 remote-as 200 ! address-family ipv4 neighbor 10.30.1.1 activate neighbor 10.30.1.1 send-label exit-address-family ! address-family vpnv4 neighbor 5.1.1.3 activate neighbor 5.1.1.3 send-community extended neighbor 5.1.1.3 next-hop-self neighbor 10.30.1.1 activate neighbor 10.30.1.1 send-community extended exit-address-family </pre>

PE2	P2	ASBR2
<pre> vrf definition vrf1 rd 300:1 route-target export 300:1 route-target import 300:1 route-target import 200:1 ! address-family ipv4 exit-address-family interface Loopback0 ip address 5.1.1.3 255.255.255.255 ip ospf 1 area 0 ! interface Loopback1 vrf forwarding vrf1 ip address 193.1.1.1 255.255.255.255 ip ospf 300 area 0 interface GigabitEthernet1/0/1 no switchport ip address 10.50.1.2 255.255.255.0 ip ospf 1 area 0 mpls ip mpls label protocol ldp ! interface GigabitEthernet1/0/2 no switchport vrf forwarding vrf1 ip address 193.2.1.1 255.255.255.0 ip ospf 300 area 0 router ospf 300 vrf vrf1 router-id 193.1.1.1 nsr nsf redistribute connected redistribute bgp 300 network 193.1.1.1 0.0.0.0 area 0 network 193.2.1.0 0.0.0.255 area 0 ! router ospf 1 router-id 5.1.1.3 nsr nsf redistribute connected router bgp 300 bgp router-id 5.1.1.3 bgp log-neighbor-changes neighbor 5.1.1.1 remote-as 300 neighbor 5.1.1.1 update-source Loopback0 ! address-family ipv4 neighbor 5.1.1.1 activate neighbor 5.1.1.1 send-label exit-address-family ! address-family vpnv4 neighbor 5.1.1.1 activate </pre>		

PE2	P2	ASBR2
<pre>neighbor 5.1.1.1 send-community extended exit-address-family ! address-family ipv4 vrf vrfl redistribute connected redistribute ospf 300 maximum-paths ibgp 2 exit-address-family</pre>		

## IGP Redistribute Connected Subnets Method

Figure 9: Topology for InterAS Option B using Redistribute Connected Subnets Method

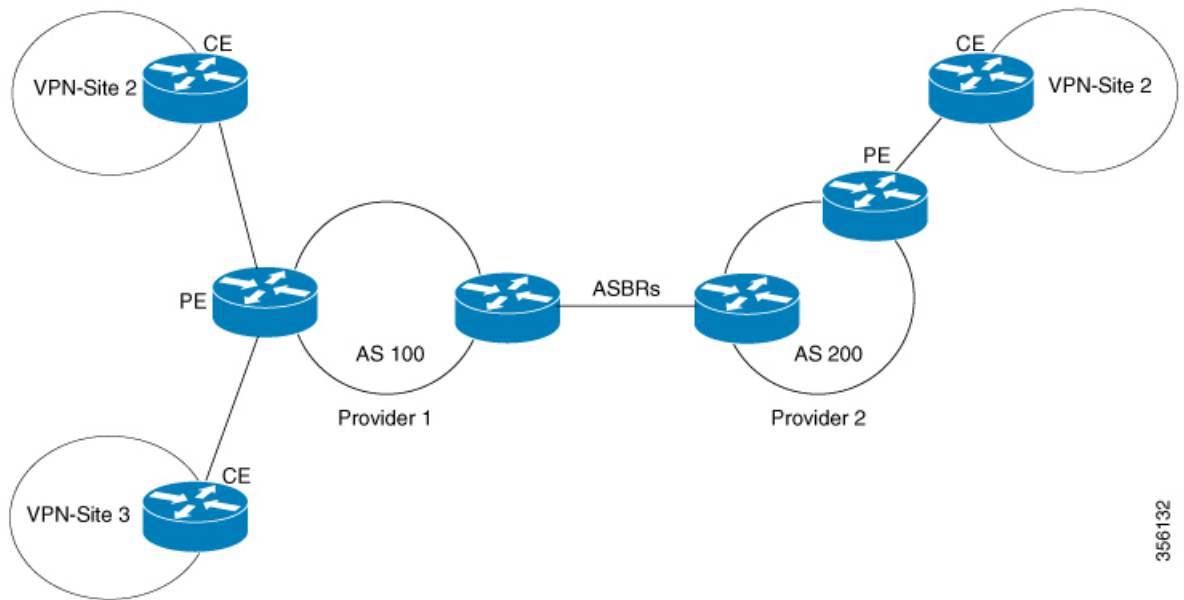

356132



**Configuration for PE1-P1-ASBR1**

PE1	P1	ASBR1
	<pre> interface Loopback0 ip address 4.1.1.2 255.255.255.255 ip ospf 1 area 0 interface GigabitEthernet1/0/4 no switchport ip address 10.10.1.2 255.255.255.0 ip ospf 1 area 0 mpls ip mpls label protocol ldp ! interface GigabitEthernet1/0/23 no switchport ip address 10.20.1.1 255.255.255.0 ip ospf 1 area 0 mpls ip mpls label protocol ldp                     </pre>	<pre> router ospf 1 router-id 4.1.1.1 nsr nsf redistribute connected passive-interface GigabitEthernet1/0/10 passive-interface Tunnel0 network 4.1.1.0 0.0.0.255 area 0 router bgp 200 bgp router-id 4.1.1.1 bgp log-neighbor-changes no bgp default ipv4-unicast no bgp default route-target filter neighbor 4.1.1.3 remote-as 200 neighbor 4.1.1.3 update-source Loopback0 neighbor 10.30.1.2 remote-as 300 ! address-family vpnv4 neighbor 4.1.1.3 activate neighbor 4.1.1.3 send-community extended neighbor 10.30.1.2 activate neighbor 10.30.1.2 send-community extended exit-address-family mpls ldp router-id Loopback0 force                     </pre>

PE1	P1	ASBR1
<pre> vrf definition Mgmt-vrf ! address-family ipv4 exit-address-family ! address-family ipv6 exit-address-family ! vrf definition vrf1 rd 200:1 route-target export 200:1 route-target import 200:1 route-target import 300:1 ! address-family ipv4 exit-address-family interface Loopback0 ip address 4.1.1.3 255.255.255.255 ip ospf 1 area 0 ! interface Loopback1 vrf forwarding vrf1 ip address 192.1.1.1 255.255.255.255 ip ospf 200 area 0 ! interface GigabitEthernet2/0/4 no switchport ip address 10.10.1.1 255.255.255.0 ip ospf 1 area 0 mpls ip mpls label protocol ldp interface GigabitEthernet2/0/9 description to-IXIA-1:p8 no switchport vrf forwarding vrf1 ip address 192.2.1.1 255.255.255.0 ip ospf 200 area 0 router ospf 200 vrf vrf1 router-id 192.1.1.1 nsr nsf redistribute connected redistribute bgp 200 network 192.1.1.1 0.0.0.0 area 0 network 192.2.1.0 0.0.0.255 area 0 router ospf 1 router-id 4.1.1.3 nsr nsf redistribute connected router bgp 200 bgp router-id 4.1.1.3 bgp log-neighbor-changes neighbor 4.1.1.1 remote-as 200 neighbor 4.1.1.1 update-source Loopback0 </pre>		

PE1	P1	ASBR1
<pre>! address-family vpv4 neighbor 4.1.1.1 activate neighbor 4.1.1.1 send-community extended exit-address-family ! address-family ipv4 vrf vrf1 redistribute connected redistribute ospf 200 maximum-paths ibgp 2 exit-address-family</pre>		

## Configuration for ASBR2 – P2 – PE2

PE2	P2	ASBR2
	<pre> interface Loopback0 ip address 5.1.1.2 255.255.255.255 ip ospf 1 area 0 interface GigabitEthernet1/0/1 no switchport ip address 10.50.1.1 255.255.255.0 ip ospf 1 area 0 mpls ip mpls label protocol ldp interface GigabitEthernet2/0/3 no switchport ip address 10.40.1.2 255.255.255.0 ip ospf 1 area 0 mpls ip mpls label protocol ldp </pre>	<pre> router ospf 1 router-id 5.1.1.1 nsr nsf redistribute connected passive-interface GigabitEthernet1/0/10 passive-interface Tunnel0 network 5.1.1.0 0.0.0.255 area 0 router bgp 300 bgp router-id 5.1.1.1 bgp log-neighbor-changes no bgp default ipv4-unicast no bgp default route-target filter neighbor 5.1.1.3 remote-as 300 neighbor 5.1.1.3 update-source Loopback0 neighbor 10.30.1.1 remote-as 200 ! address-family vpnv4 neighbor 5.1.1.3 activate neighbor 5.1.1.3 send-community extended neighbor 10.30.1.1 activate neighbor 10.30.1.1 send-community extended exit-address-family mpls ldp router-id Loopback0 force </pre>

PE2	P2	ASBR2
<pre> vrf definition vrf1 rd 300:1 route-target export 300:1 route-target import 300:1 route-target import 200:1 ! address-family ipv4 exit-address-family interface Loopback0 ip address 5.1.1.3 255.255.255.255 ip ospf 1 area 0 ! interface Loopback1 vrf forwarding vrf1 ip address 193.1.1.1 255.255.255.255 ip ospf 300 area 0 interface GigabitEthernet1/0/1 no switchport ip address 10.50.1.2 255.255.255.0 ip ospf 1 area 0 mpls ip mpls label protocol ldp ! interface GigabitEthernet1/0/2 no switchport vrf forwarding vrf1 ip address 193.2.1.1 255.255.255.0 ip ospf 300 area 0 router ospf 300 vrf vrf1 router-id 193.1.1.1 nsr nsf redistribute connected redistribute bgp 300 network 193.1.1.1 0.0.0.0 area 0 network 193.2.1.0 0.0.0.255 area 0 ! router ospf 1 router-id 5.1.1.3 nsr nsf redistribute connected router bgp 300 bgp router-id 5.1.1.3 bgp log-neighbor-changes neighbor 5.1.1.1 remote-as 300 neighbor 5.1.1.1 update-source Loopback0 ! address-family ipv4 neighbor 5.1.1.1 activate neighbor 5.1.1.1 send-label exit-address-family ! address-family vpnv4 neighbor 5.1.1.1 activate </pre>		

PE2	P2	ASBR2
<pre>neighbor 5.1.1.1 send-community extended exit-address-family ! address-family ipv4 vrf vrf1 redistribute connected redistribute ospf 300 maximum-paths ibgp 2 exit-address-family</pre>		

## InterAS OptionAB

The following example displays the topology and the configuration on each device:

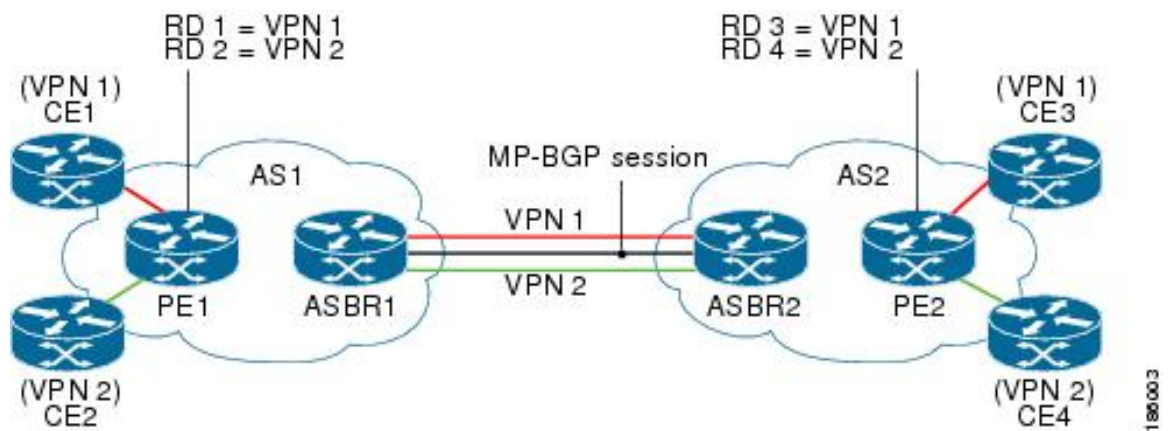

Table 8:

PE1 Config	P1 Config	ASBR1 Config	ASBR2 Config	PE2 Config
	<pre> interface Loopback0 ip address 2.2.2.2  255.255.255.255 ! interface TenGigabitEthernet1/1  ip address 10.1.1.2 255.255.255.0 mpls ip ! interface TenGigabitEthernet1/2  no ip address ! interface TenGigabitEthernet1/3  ip address 20.1.1.1 255.255.255.0 mpls ip ! router ospf 1 router-id 2.2.2.2  network 2.2.2.2 0.0.0.0 area 0 network 10.1.1.0 0.0.0.255 area 0 network 20.1.1.0 0.0.0.255 area 0 ! </pre>			

PE1 Config	P1 Config	ASBR1 Config	ASBR2 Config	PE2 Config
<pre> ip vrf cust-1 rd 100:1 route-target export 100:1 route-target import 100:1 ! ip vrf cust-2 rd 100:2 route-target export 100:2 route-target import 100:2 ! interface Loopback0 ip address 1.1.1.1  255.255.255.255 ! interface Loopback1 ip address 11.11.11.11 255.255.255.255 ! interface Loopback2 ip address 12.12.12.12 255.255.255.255 ! ! interface HundredGigE1/0/1/1 no switchport ip address 10.1.1.1 255.255.255.0 mpls ip ! ! interface HundredGigE1/0/1/4 no switchport no ip address ! interface HundredGigE1/0/1/4.100  encapsulation dot1Q 100 ip vrf forwarding cust-1 ip address 11.1.1.1 255.255.255.0 ! interface HundredGigE1/0/1/4.101  encapsulation </pre>		<pre> ip vrf cust-1 rd 100:10001 route-target export 100:1 route-target import 100:1 route-target import 200:1 inter-as-hybrid next-hop 160.1.1.2 ! ip vrf cust-2 rd 100:20001 route-target export 100:2 route-target import 100:2 route-target import 200:2 inter-as-hybrid next-hop 170.1.1.2 ! interface Loopback0 ip address 3.3.3.3  255.255.255.255 ! ! interface TwentyFiveGigE1/0/3 no switchport ip address 20.1.1.2 255.255.255.0 mpls ip ! interface TwentyFiveGigE1/0/10.10  encapsulation dot1Q 10 ip address 150.1.1.1 255.255.255.0 mpls bgp forwarding ! interface TwentyFiveGigE1/0/10.20  encapsulation dot1Q 20 ip vrf forwarding cust-1 ip address 160.1.1.1 255.255.255.0 ! interface </pre>	<pre> ip vrf cust-1 rd 200:10001 route-target export 200:1 route-target import 200:1 route-target import 100:1 inter-as-hybrid next-hop 160.1.1.1 ! ip vrf cust-2 rd 200:20001 route-target export 200:2 route-target import 200:2 route-target import 100:2 inter-as-hybrid next-hop 170.1.1.1 ! interface Loopback0 ip address 4.4.4.4  255.255.255.255 ! ! interface TwentyFiveGigE1/0/2 no switchport ip address 30.1.1.1 255.255.255.0 mpls ip ! ! interface TwentyFiveGigE1/0/10.10  encapsulation dot1Q 10 ip address 150.1.1.2 255.255.255.0 mpls bgp forwarding ! interface TwentyFiveGigE1/0/10.20  encapsulation dot1Q 20 ip vrf forwarding cust-1 ip address 160.1.1.2 255.255.255.0 </pre>	<pre> ip vrf cust-1 rd 200:1 route-target export 200:1 route-target import 200:1 route-target import 100:1 ! ip vrf cust-2 rd 200:2 route-target export 200:2 route-target import 200:2 route-target import 100:2 ! interface Loopback0 ip address 5.5.5.5  255.255.255.255 ! interface Loopback1 ip address 55.55.55.55 255.255.255.255 ! interface Loopback2 ip address 56.56.56.56 255.255.255.255 ! ! interface HundredGigE1/0/1/1.200  encapsulation dot1Q 200 ip vrf forwarding cust-1 ip address 55.1.1.1 255.255.255.0 ! interface HundredGigE1/0/1/1.201  encapsulation dot1Q 201 ip vrf forwarding cust-2 ip address 56.1.1.1 255.255.255.0 ! interface HundredGigE1/0/1/1.3  no switchport ip address </pre>



PE1 Config	P1 Config	ASBR1 Config	ASBR2 Config	PE2 Config
<pre> dot1Q 101 ip vrf forwarding   cust-2 ip address 12.1.1.1 255.255.255.0 ! router ospf 2 vrf   cust-1 router-id 11.11.11.11 network 11.1.1.0 0.0.0.255 area 0 network 11.11.11.11 0.0.0.0 area 0 ! router ospf 3 vrf   cust-2 router-id 12.12.12.12 network 12.1.1.0 0.0.0.255 area 0 network 12.12.12.12 0.0.0.0 area 0 ! router ospf 1 router-id 1.1.1.1  network 1.1.1.1 0.0.0.0 area 0 network 10.1.1.0 0.0.0.255 area 0 ! router bgp 100 bgp router-id 1.1.1.1 bgp log-neighbor- changes neighbor 3.3.3.3 remote-as 100 neighbor 3.3.3.3 update- source Loopback0 ! address-family vpnv4 neighbor 3.3.3.3 activate neighbor 3.3.3.3 send- community extended ! address-family ipv4 vrf cust-1 redistribute connected </pre>		<pre> TwentyFiveGigE1/0/10.30 ! encapsulation dot1Q 30 ip vrf forwarding   cust-2 ip address 170.1.1.1 255.255.255.0 ! router ospf 1 router-id 3.3.3.3 network 3.3.3.3 0.0.0.0 area 0 network 20.1.1.0 0.0.0.255 area 0 ! router bgp 100 bgp router-id 3.3.3.3 bgp log-neighbor- changes neighbor 1.1.1.1 remote- as 100 neighbor 150.1.1.2  remote-as 200 ! address-family ipv4 redistribute connected neighbor 1.1.1.1 activate neighbor 150.1.1.2 activate exit-address-family ! address-family vpng4 neighbor 1.1.1.1 activate neighbor 1.1.1.1 send- community both neighbor 150.1.1.2 activate neighbor 150.1.1.2 send- community both neighbor 150.1.1.2  inter- as-hybrid exit-address-family ! address-family ipv4 vrf cust-1 redistribute connected exit-address-family </pre>	<pre> ! interface TwentyFiveGigE1/0/10.30 ! encapsulation dot1Q 30 ip vrf forwarding   cust-2 ip address 170.1.1.2 255.255.255.0 ! router ospf 1 router-id 4.4.4.4 network 4.4.4.4 0.0.0.0 area 0 network 30.1.1.0 0.0.0.255 area 0 ! router bgp 200 bgp router-id 4.4.4.4 bgp log-neighbor- changes neighbor 5.5.5.5 remote- as 200 neighbor 150.1.1.1  remote-as 100 ! address-family ipv4 neighbor 5.5.5.5 activate neighbor 5.5.5.5 send-community both neighbor 150.1.1.1 activate neighbor 150.1.1.1 send-community both neighbor 150.1.1.1  inter-as-hybrid ! exit-address-family ! address-family ipv4 vrf cust-1 redistribute connected address-family ipv4 vrf cust-1 redistribute </pre>	<pre> 30.1.1.2 255.255.255.0 mpls ip ! router ospf 2 vrf   cust-1 router-id 55.55.55.55 network 55.1.1.0 0.0.0.255 area 0 network 55.55.55.55 0.0.0.0 area 0 ! router ospf 3 vrf   cust-2 router-id 56.56.56.56 network 56.1.1.0 0.0.0.255 area 0 network 56.56.56.56 0.0.0.0 area 0 ! router ospf 1 router-id 5.5.5.5 network 5.5.5.5 0.0.0.0 area 0 network 30.1.1.0 0.0.0.255 area 0 ! router bgp 200 bgp router-id 5.5.5.5 bgp log-neighbor-changes neighbor 4.4.4.4 remote-as 200 neighbor 4.4.4.4 update-source Loopback0 ! address-family vpng4 neighbor 4.4.4.4 activate neighbor 4.4.4.4 send-community extended exit-address-family ! address-family ipv4 vrf cust-1 redistribute connected address-family 2 maximum-paths ibgp </pre>

PE1 Config	P1 Config	ASBR1 Config	ASBR2 Config	PE2 Config
<pre> redistribute ospf  2 maximum-paths ibgp  2 exit-address-family ! address-family ipv4 vrf cust-2 redistribute connected redistribute ospf  3 maximum-paths ibgp  2 exit-address-family </pre>		<pre> ! address-family ipv4 vrf cust-2 redistribute connected exit-address-family ! </pre>	<pre> connected exit-address-family ! address-family ipv4 vrf cust-2 redistribute connected exit-address-family ! </pre>	<pre> 2 exit-address-family ! address-family ipv4 vrf cust-2 redistribute connected redistribute ospf  3 maximum-paths ibgp  2 exit-address-family ! </pre>

## Additional References for MPLS VPN InterAS Options

### Related Documents

Related Topic	Document Title
For complete syntax and usage information for the commands used in this chapter.	See the MPLS Commands section of the <i>Command Reference (Catalyst 9300 Series Switches)</i>

## Feature History for MPLS VPN InterAS Options

This table provides release and related information for features explained in this module.

These features are available on all releases subsequent to the one they were introduced in, unless noted otherwise.

Release	Feature	Feature Information
Cisco IOS XE Gibraltar 16.11.1	MPLS VPN InterAS Option B	InterAS Options use iBGP and eBGP peering to allow VPNs in different AS to communicate with each other. In an interAS option B network, ASBR ports are connected by one or more interfaces that are enabled to receive MPLS traffic.

Release	Feature	Feature Information
Cisco IOS XE Amsterdam 17.3.1	MPLS VPN InterAS Option AB	MPLS VPN InterAS Option AB enables different autonomous systems to interconnect by using a single Multiprotocol Border Gateway Protocol (MP-BGP) session, which is enabled globally on the router.

Use Cisco Feature Navigator to find information about platform and software image support. To access Cisco Feature Navigator, go to <http://www.cisco.com/go/cfn>.





## CHAPTER 9

# Configuring MPLS over GRE

- [Prerequisites for MPLS over GRE, on page 129](#)
- [Restrictions for MPLS over GRE, on page 129](#)
- [Information About MPLS over GRE, on page 130](#)
- [How to Configure MPLS over GRE, on page 131](#)
- [Configuration Examples for MPLS over GRE, on page 133](#)
- [Additional References for MPLS over GRE, on page 136](#)
- [Feature History for MPLS over GRE, on page 136](#)

## Prerequisites for MPLS over GRE

Ensure that the following routing protocols are configured and working properly.

- Label Distribution Protocol (LDP)—for MPLS label distribution.
- Routing protocol (ISIS or OSPF) between the core devices P1-P2
- MPLS between PE1-P1 and PE2-P2
- Since the ingress traffic enters the IP core from MPLS network and egress traffic leaves the IP core to enter the MPLS network, it is recommended to use QoS group value for defining QoS policies as we traverse the protocol boundary.

## Restrictions for MPLS over GRE

- GRE Tunneling :
  - L2VPN over mGRE and L3VPN over mGRE is not supported.
  - The tunnel source can only be a loopback or a Layer 3 interface. These interfaces could either be physical interfaces or etherchannels.
  - Tunnel interface supports Static Routes, Enhanced Interior Gateway Routing Protocol (EIGRP) and Open Shortest Path First (OSPF) routing protocols.
  - GRE Options - Sequencing, Checksum and Source Route are not supported.

- IPv6 generic routing encapsulation (GRE) is not supported.
- Carrier Supporting Carrier (CSC) is not supported.
- Tunnel source cannot be a subinterface.

## Information About MPLS over GRE

The MPLS over GRE feature provides a mechanism for tunneling Multiprotocol Label Switching (MPLS) packets over a non-MPLS network. This feature allows you to create a generic routing encapsulation (GRE) tunnel across a non-MPLS network. The MPLS packets are encapsulated within the GRE tunnel packets, and the encapsulated packets traverse the non-MPLS network through the GRE tunnel. When GRE tunnel packets are received at the other side of the non-MPLS network, the GRE tunnel packet header is removed and the inner MPLS packet is forwarded to its final destination. The core network between the end-points of the GRE tunnel uses ISIS or OSPF routing protocol whereas the GRE tunnel uses OSPF or EIGRP.

## PE-to-PE Tunneling

The provider-edge-to-provider-edge (PE-to-PE) tunneling configuration provides a scalable way to connect multiple customer networks across a non-MPLS network. With this configuration, traffic that is destined to multiple customer networks is multiplexed through a single generic routing encapsulation (GRE) tunnel.



**Note** A similar nonscalable alternative is to connect each customer network through separate GRE tunnels (for example, connecting one customer network to each GRE tunnel).

The PE device on one side of the non-MPLS network uses the routing protocols (that operate within the non-MPLS network) to learn about the PE device on the other side of the non-MPLS network. The learned routes that are established between the PE devices are then stored in the main or default routing table.

The opposing PE device uses OSPF or EIGRP to learn about the routes that are associated with the customer networks that are behind the PE devices. These learned routes are not known to the non-MPLS network.

The following figure shows an end-to-end IP core from one PE device to another through the GRE tunnel that spans the non-MPLS network.

**Figure 10: PE-to-PE Tunneling**

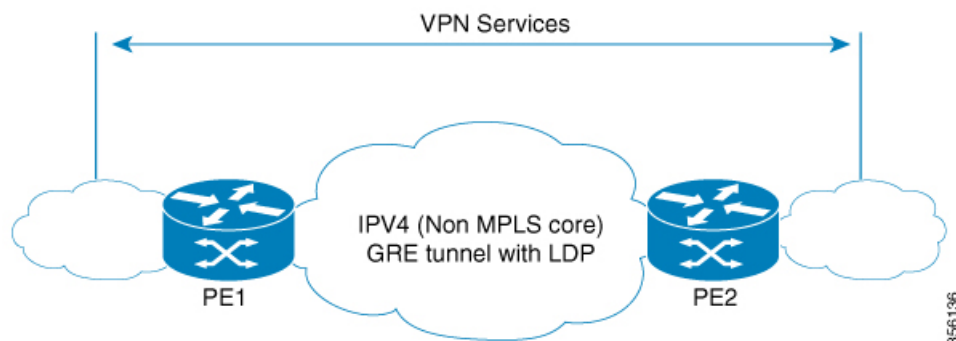

## P-to-PE Tunneling

The provider-to-provider-edge (P-to-PE) tunneling configuration provides a way to connect a PE device (P1) to a Multiprotocol Label Switching (MPLS) segment (PE-2) across a non-MPLS network. In this configuration, MPLS traffic that is destined to the other side of the non-MPLS network is sent through a single generic routing encapsulation (GRE) tunnel.

Figure 11: P-to-PE Tunneling

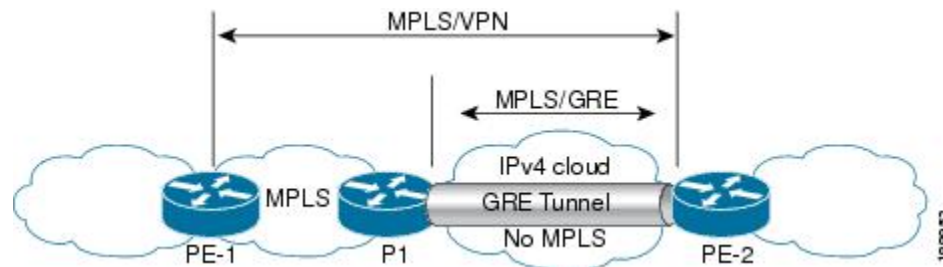

## P-to-P Tunneling

As shown in the figure below, the provider-to-provider (P-to-P) configuration provides a method of connecting two Multiprotocol Label Switching (MPLS) segments (P1 to P2) across a non-MPLS network. In this configuration, MPLS traffic that is destined to the other side of the non-MPLS network is sent through a single generic routing encapsulation (GRE) tunnel.

Figure 12: P-to-P Tunneling

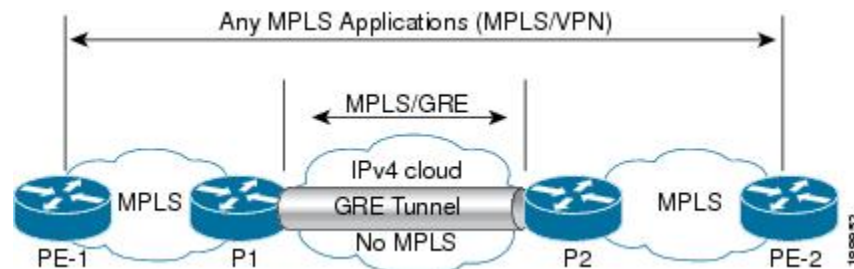

## How to Configure MPLS over GRE

The following section provides the various configuration steps for MPLS over GRE:

### Configuring the MPLS over GRE Tunnel Interface

To configure the MPLS over GRE feature, you must create a generic routing encapsulation (GRE) tunnel to span the non-MPLS networks. You must perform the following procedure on the devices located at both ends of the GRE tunnel.

## Procedure

	Command or Action	Purpose
<b>Step 1</b>	<b>enable</b> <b>Example:</b> Device> enable	Enables privileged EXEC mode. <ul style="list-style-type: none"> <li>• Enter your password if prompted.</li> </ul>
<b>Step 2</b>	<b>configure terminal</b> <b>Example:</b> Device# configure terminal	Enters global configuration mode.
<b>Step 3</b>	<b>interface tunnel <i>tunnel-number</i></b> <b>Example:</b> Device(config)# interface tunnel 1	Creates a tunnel interface and enters interface configuration mode.
<b>Step 4</b>	<b>ip address <i>ip-address mask</i></b> <b>Example:</b> Device(config-if)# ip address 10.0.0.1 255.255.255.0	Assigns an IP address to the tunnel interface.
<b>Step 5</b>	<b>tunnel source <i>source-address</i></b> <b>Example:</b> Device(config-if)# tunnel source 10.1.1.1	Specifies the tunnel's source IP address.
<b>Step 6</b>	<b>tunnel destination <i>destination-address</i></b> <b>Example:</b> Device(config-if)# tunnel destination 10.1.1.2	Specifies the tunnel's destination IP address.
<b>Step 7</b>	<b>mpls ip</b> <b>Example:</b> Device(config-if)# mpls ip	Enables Multiprotocol Label Switching (MPLS) on the tunnel's physical interface.
<b>Step 8</b>	<b>end</b> <b>Example:</b> Device(config-if)# end	Returns to privileged EXEC mode.



# Configuration Examples for MPLS over GRE

The following section provides configuration examples for MPLS over GRE:

## Example: PE-to-PE Tunneling

The following shows basic MPLS configuration on two Provider Edge (PE) devices, PE-to-PE tunneling, which use GRE tunnel to send traffic over non-MPLS network.

**Figure 13: Topology for PE-to-PE Tunneling**

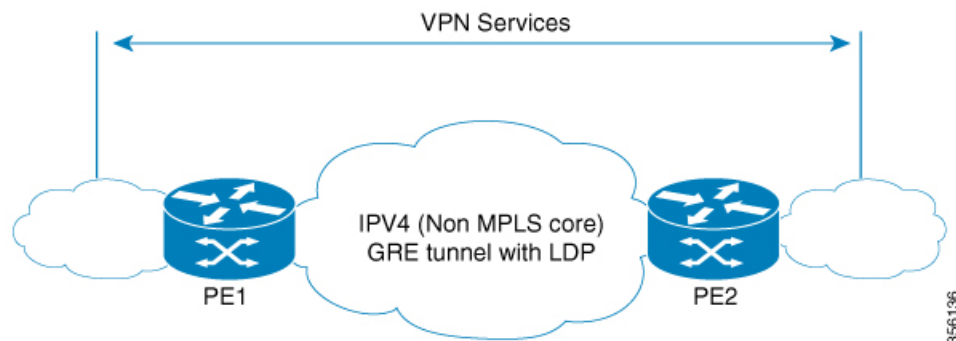

### PE1 Configuration

```
!
mpls ip
!
interface loopback 10
ip address 11.2.2.2 255.255.255.255
ip router isis
!
interface GigabitEthernet 1/1/1
ip address 1.1.1.1 255.255.255.0
ip router isis
!
interface Tunnel 1
ip address 10.0.0.1 255.255.255.0
ip ospf 1 are 0
tunnel source 11.2.2.2
tunnel destination 11.1.1.1
mpls ip
!
interface Vlan701
ip address 65.1.1.1 255.255.255.0
ip ospf 1 area 0
!
```

### PE2 Configuration

```
!
mpls ip
!
interface loopback 10
```

## Example: P-to-PE Tunneling

```

ip address 11.1.1.1 255.255.255.255
ip router isis
!
interface GigabitEthernet 1/1/1
ip address 2.1.1.1 255.255.255.0
ip router isis
!
interface Tunnel 1
ip address 10.0.0.2 255.255.255.0
ip ospf 1 are 0
tunnel source 11.1.1.1
tunnel destination 11.2.2.2
mpls ip
!
interface Vlan701
ip address 75.1.1.1 255.255.255.0
ip ospf 1 area 0
!

```

## Example: P-to-PE Tunneling

The following shows basic MPLS configuration on two Provider (P) devices, P-to-PE tunneling, which use GRE tunnel to send traffic over non-MPLS network.

**Figure 14: Topology for P-to-PE Tunneling**

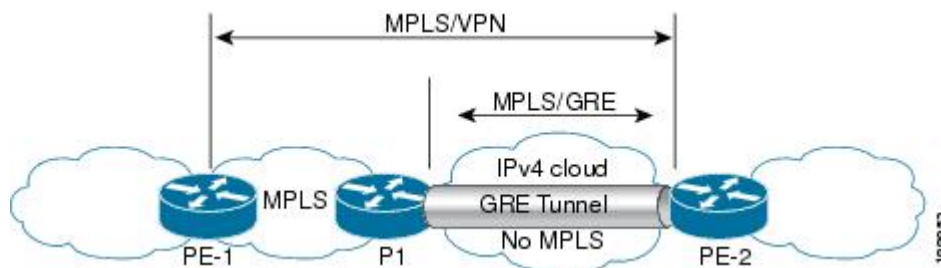

### PE1 Configuration

```

!
mpls ip
!
interface GigabitEthernet 1/1/1
ip address 3.1.1.2 255.255.255.0
ip ospf 1 are 0
mpls ip
!
interface Vlan701
ip address 75.1.1.1 255.255.255.0
ip ospf 1 area 0
!

```

### P1 Configuration

```

!
mpls ip
!
interface loopback 10
ip address 11.2.2.2 255.255.255.255

```

```

ip router isis
!
interface GigabitEthernet 1/1/1
ip address 1.1.1.1 255.255.255.0
ip router isis
!
interface GigabitEthernet 1/1/2
ip address 3.1.1.1 255.255.255.0
ip ospf 1 are 0
mpls ip
!
interface Tunnel 1
ip address 10.0.0.1 255.255.255.0
ip ospf 1 are 0
tunnel source 11.2.2.2
tunnel destination 11.1.1.1
mpls ip
!

```

### PE2 Configuration

```

!
mpls ip
!
interface loopback 10
ip address 11.1.1.1 255.255.255.255
ip router isis
!
interface GigabitEthernet 1/1/1
ip address 2.2.1.1 255.255.255.0
ip router isis
!
interface Tunnel 1
ip address 10.0.0.2 255.255.255.0
ip ospf 1 are 0
tunnel source 11.1.1.1
tunnel destination 11.2.2.2
mpls ip
!
interface Vlan701
ip address 75.1.1.1 255.255.255.0
ip ospf 1 area 0
!

```

## Example: P-to-P Tunneling

The following example shows basic MPLS configuration on two Provider (P) devices, P-to-P tunneling, which use GRE tunnel to send traffic over non-MPLS network.

Figure 15: Topology for P-to-P Tunneling

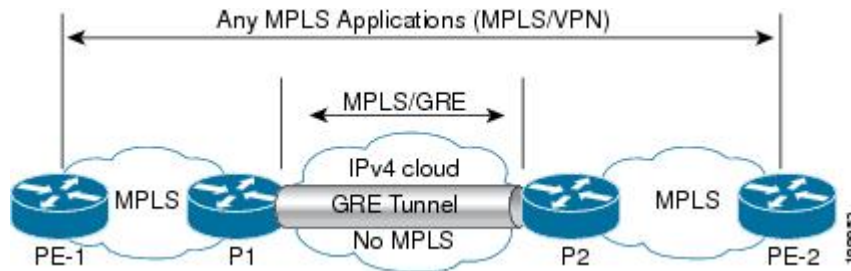

### P1 Configuration

```
!
interface Loopback10
 ip address 10.1.1.1 255.255.255.255
 ip router isis
!
interface Tunnel10
 ip address 10.10.10.1 255.255.255.252
 ip ospf 1 area 0
 mpls ip
 tunnel source 10.1.1.1
 tunnel destination 10.2.1.1
```

### P2 Configuration

```
!
interface Tunnel10
 ip address 10.10.10.2 255.255.255.252
 ip ospf 1 area 0
 mpls ip
 tunnel source 10.2.1.1
 tunnel destination 10.1.1.1
!
interface Loopback10
 ip address 10.2.1.1 255.255.255.255
 ip router isis
```

## Additional References for MPLS over GRE

### Related Documents

Related Topic	Document Title
For complete syntax and usage information for the commands used in this chapter.	See the MPLS Commands section of the <i>Command Reference (Catalyst 9300 Series Switches)</i>

## Feature History for MPLS over GRE

This table provides release and related information for the features explained in this module.

These features are available in all the releases subsequent to the one they were introduced in, unless noted otherwise.

Release	Feature	Feature Information
Cisco IOS XE Gibraltar 16.11.1	MPLS over GRE	MPLS over GRE feature provides a mechanism for tunneling Multiprotocol Label Switching (MPLS) packets over non-MPLS networks by creating a generic routing encapsulation (GRE) tunnel. The MPLS packets are encapsulated within the GRE tunnel packets, and the encapsulated packets traverse the non-MPLS network through the GRE tunnel. When GRE tunnel packets are received at the other side of the non-MPLS network, the GRE tunnel packet header is removed and the inner MPLS packet is forwarded to its final destination.

Use the Cisco Feature Navigator to find information about platform and software image support. To access Cisco Feature Navigator, go to <https://cfng.cisco.com/>

<http://www.cisco.com/go/cfn>.





## CHAPTER 10

# Configuring MPLS Layer 2 VPN over GRE

- [Information About MPLS Layer 2 VPN over GRE, on page 139](#)
- [How to Configure MPLS Layer 3 VPN over GRE, on page 141](#)
- [Configuration Examples for MPLS Layer 2 VPN over GRE, on page 142](#)
- [Additional References for Configuring MPLS Layer 2 VPN over GRE, on page 143](#)
- [Feature History for Configuring MPLS Layer 2 VPN over GRE, on page 143](#)

## Information About MPLS Layer 2 VPN over GRE

The MPLS Layer 2 VPN over GRE feature provides a mechanism for tunneling Multiprotocol Label Switching (MPLS) packets over non-MPLS networks. This feature allows you to create a generic routing encapsulation (GRE) tunnel across a non-MPLS network. The MPLS packets are encapsulated within the GRE tunnel packets, and the encapsulated packets traverse the non-MPLS network through the GRE tunnel. When GRE tunnel packets are received at the other side of the non-MPLS network, the GRE tunnel packet header is removed and the inner MPLS packet is forwarded to its final destination.

To configure MPLS Layer 2 VPN over GRE, you must have configured either Virtual Private LAN Service (VPLS) or EoMPLS (Ethernet over MPLS).

## Types of Tunneling Configurations

The following sections provide information about the different types of tunneling configurations that are supported.

### PE-to-PE Tunneling

The provider edge-to-provider edge (PE-to-PE) tunneling configuration provides a scalable way to connect multiple customer networks across a non-MPLS network. With this configuration, traffic that is destined to multiple customer networks is multiplexed through a single GRE tunnel.

The PE device on one side of the non-MPLS network uses the routing protocols (that operate within the non-MPLS network) to learn about the PE device on the other side of the non-MPLS network. The learned routes that are established between the PE devices are then stored in the main or default routing table.

The opposing PE device uses Border Gateway Protocol (BGP) to learn about the routes that are associated with the customer networks that are behind the PE devices. These learned routes are not known to the non-MPLS network.

Figure 16: PE-to-PE Tunneling, on page 140 shows an end-to-end IP core from one PE device to another through the GRE tunnel that spans the non-MPLS network.

Figure 16: PE-to-PE Tunneling

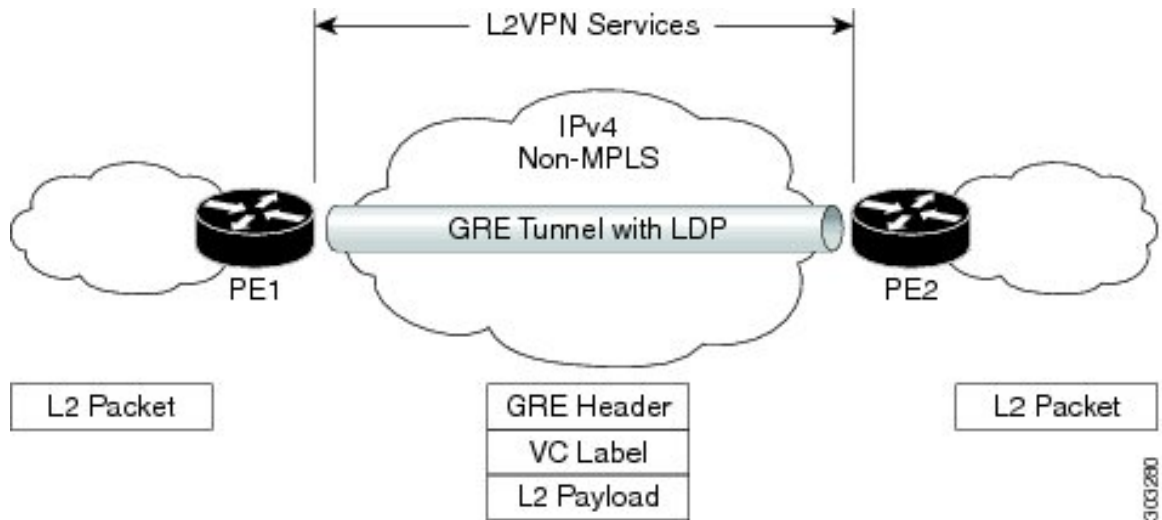

## P-to-PE Tunneling

Figure 17: P-to-PE Tunneling, on page 140 shows a method of connecting two MPLS segments (P2 to PE2) across a non-MPLS network. In this configuration, MPLS traffic that is destined to the other side of the non-MPLS network is sent through a single GRE tunnel.

Figure 17: P-to-PE Tunneling

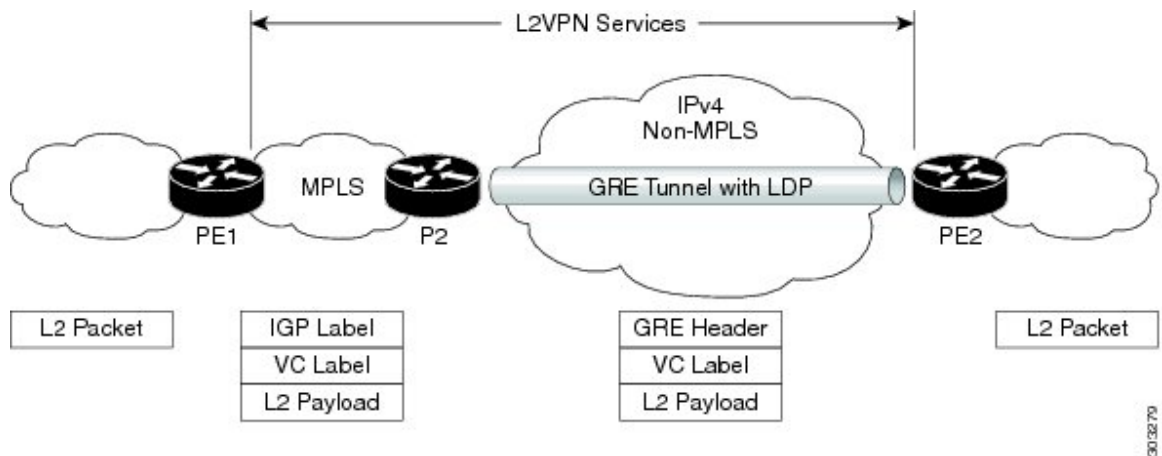

## P-to-P Tunneling

Figure 18: P-to-P Tunneling, on page 141 shows a method of connecting two MPLS segments (P1 to P2) across a non-MPLS network. In this configuration, MPLS traffic that is destined to the other side of the non-MPLS network is sent through a single GRE tunnel.



Figure 18: P-to-P Tunneling

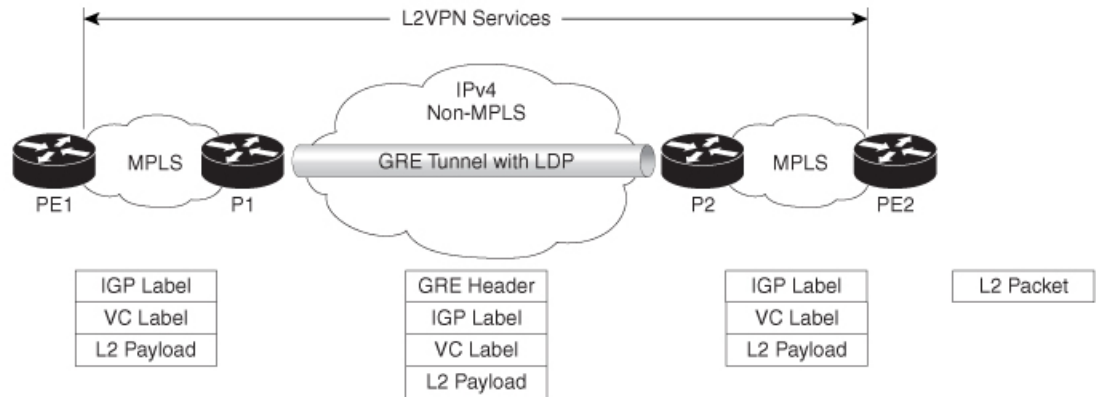

356834

## How to Configure MPLS Layer 3 VPN over GRE

To configure the MPLS over GRE feature, you must create a GRE tunnel to span the non-MPLS networks. Perform the following procedure on the devices that are located at both ends of the GRE tunnel.

### Procedure

	Command or Action	Purpose
<b>Step 1</b>	<b>enable</b> <b>Example:</b> Device> <b>enable</b>	Enables privileged EXEC mode. Enter your password, if prompted.
<b>Step 2</b>	<b>configure terminal</b> <b>Example:</b> Device# <b>configure terminal</b>	Enters global configuration mode.
<b>Step 3</b>	<b>interface tunnel <i>tunnel-number</i></b> <b>Example:</b> Device(config)# <b>interface tunnel 1</b>	Creates a tunnel interface and enters interface configuration mode.
<b>Step 4</b>	<b>ip address <i>ip-address mask</i></b> <b>Example:</b> Device(config-if)# <b>ip address 10.0.0.1 255.255.255.0</b>	Assigns an IP address to the tunnel interface.
<b>Step 5</b>	<b>tunnel source <i>source-address</i></b> <b>Example:</b> Device(config-if)# <b>tunnel source 10.1.1.1</b>	Configures the tunnel's source IP address.

	Command or Action	Purpose
<b>Step 6</b>	<b>tunnel destination</b> <i>destination-address</i> <b>Example:</b> Device(config-if)# <b>tunnel destination</b> 10.1.1.2	Configures the tunnel's destination IP address.
<b>Step 7</b>	<b>mpls ip</b> <b>Example:</b> Device(config-if)# <b>mpls ip</b>	Enables MPLS on the tunnel's physical interface.
<b>Step 8</b>	<b>end</b> <b>Example:</b> Device(config-if)# <b>end</b>	Returns to privileged EXEC mode.

## Configuration Examples for MPLS Layer 2 VPN over GRE

The following section provides an example for configuring MPLS Layer 2 VPN over GRE.

### Example: Configuring a GRE Tunnel That Spans a non-MPLS Network

The following examples show how to configure a generic GRE tunnel configuration that spans a non-MPLS network.

The following example shows the tunnel configuration on the PE1 device:

```
Device> enable
Device# configure terminal
Device(config)# interface Tunnel 1
Device(config-if)# ip address 10.1.1.1 255.255.255.0
Device(config-if)# tunnel source 10.0.0.1
Device(config-if)# tunnel destination 10.0.0.2
Device(config-if)# ip ospf 1 area 0
Device(config-if)# mpls ip
```

The following example shows the tunnel configuration on the PE2 device:

```
Device> enable
Device# configure terminal
Device(config)# interface Tunnel 1
Device(config-if)# ip address 10.1.1.2 255.255.255.0
Device(config-if)# tunnel source 10.0.0.2
Device(config-if)# tunnel destination 10.0.0.1
Device(config-if)# ip ospf 1 area 0
Device(config-if)# mpls ip
```

# Additional References for Configuring MPLS Layer 2 VPN over GRE

## Related Documents

Related Topic	Document Title
Configuring VPLS	For more information, see Information About VPLS.
Configuring Ethernet-over-MPLS (EoMPLS) and Pseudowire Redundancy (PWR)	For more information, see <a href="#">How to Configure Ethernet-over-MPLS</a> , on page 43

## Feature History for Configuring MPLS Layer 2 VPN over GRE

This table provides release and related information for the features explained in this module.

These features are available in all the releases subsequent to the one they were introduced in, unless noted otherwise.

Release	Feature	Feature Information
Cisco IOS XE Gibraltar 16.12.1	MPLS Layer 2 VPN over GRE	The MPLS Layer 2 VPN over GRE feature provides a mechanism for tunneling MPLS packets over non-MPLS networks.

Use the Cisco Feature Navigator to find information about platform and software image support. To access Cisco Feature Navigator, go to <https://cfng.cisco.com/>

<http://www.cisco.com/go/cfn>.





## CHAPTER 11

# Configuring MPLS Layer 3 VPN over GRE

- [Prerequisites for MPLS Layer 3 VPN over GRE, on page 145](#)
- [Restrictions for MPLS Layer 3 VPN over GRE, on page 145](#)
- [Information About MPLS Layer 3 VPN over GRE, on page 146](#)
- [How to Configure MPLS Layer 3 VPN over GRE, on page 148](#)
- [Configuration Examples for MPLS Layer 3 VPN over GRE, on page 149](#)
- [Feature History for Configuring MPLS Layer 3 VPN over GRE, on page 155](#)

## Prerequisites for MPLS Layer 3 VPN over GRE

- Ensure that your Multiprotocol Label Switching (MPLS) virtual private network (VPN) is configured.
- Ensure that the following routing protocols are configured:
  - Label Distribution Protocol (LDP): For MPLS label distribution.
  - Multiprotocol Border Gateway Protocol (MP-BGP): For VPN route and label distribution.
- We recommend that you use the Quality of Service (QoS) group value for defining QoS policies to traverse the protocol boundary. QoS group values are required because the ingress traffic enters the IP core from the MPLS network and the egress traffic leaves the IP core to enter the MPLS network.
- Before configuring a generic routing encapsulation (GRE) tunnel, configure a loopback interface (that is not attached to a virtual routing and forwarding [VRF] interface with an IP address. This dummy loopback interface with an IPv4 address enables the internally created tunnel interface for IPv4 forwarding. You do not have to configure a loopback interface if the system has at least one interface that is not attached to the VRF and is configured with an IPv4 address.

## Restrictions for MPLS Layer 3 VPN over GRE

The MPLS Layer 3 VPN over GRE feature does not support the following:

- QoS service policies that are configured on the tunnel interface



---

**Note** Although QoS service policies configured on the tunnel interface are not supported, QoS service policies configured on a physical interface or a sub-interface are supported.

---

- GRE options such as sequencing, checksum, and source route
- IPv6 GRE configurations
- Advanced features such as Carrier Supporting Carrier (CSC)

## Information About MPLS Layer 3 VPN over GRE

The MPLS Layer 3 VPN over GRE feature provides a mechanism for tunneling MPLS packets over non-MPLS networks. This feature allows you to create a GRE tunnel across a non-MPLS network. The MPLS packets are encapsulated within the GRE tunnel packets, and the encapsulated packets traverse the non-MPLS network through the GRE tunnel. When GRE tunnel packets are received at the other side of the non-MPLS network, the GRE tunnel packet header is removed and the inner MPLS packet is forwarded to its final destination.

### Types of Tunneling Configurations

The following sections provide information about the different types of tunneling configurations that are supported.

#### PE-to-PE Tunneling

The provider edge-to-provider edge (PE-to-PE) tunneling configuration provides a scalable way to connect multiple customer networks across a non-MPLS network. With this configuration, traffic that is destined to multiple customer networks is multiplexed through a single GRE tunnel.

As shown in the [Figure 19: PE-to-PE Tunneling, on page 147](#), the PE devices assign VRF numbers to the customer edge (CE) devices on each side of the non-MPLS network.

The PE devices use routing protocols such as Border Gateway Protocol (BGP), Open Shortest Path First (OSPF), or Routing Information Protocol (RIP) to learn about the IP networks behind the CE devices. The routes to the IP networks behind the CE devices are stored in the associated CE device's VRF routing table.

The PE device on one side of the non-MPLS network uses routing protocols (that operate within the non-MPLS network) to learn about the PE device on the other side of the non-MPLS network. The learned routes that are established between the PE devices are then stored in the main or default routing table.

The opposing PE device uses BGP to learn about the routes that are associated with the customer networks that are behind the PE devices. These learned routes are not known to the non-MPLS network.

[Figure 19: PE-to-PE Tunneling, on page 147](#) shows BGP defining a static route to the BGP neighbor (the opposing PE device) through the GRE tunnel that spans the non-MPLS network. Because the routes that are learned by the BGP neighbor include the GRE tunnel next hop, all the customer network traffic is sent using the GRE tunnel.

Figure 19: PE-to-PE Tunneling

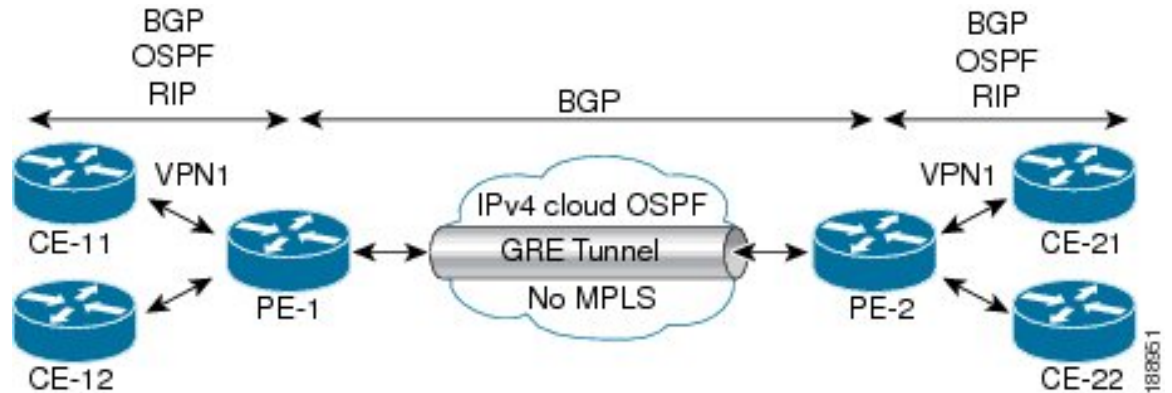

### P-to-PE Tunneling

Figure 20: P-to-PE Tunneling, on page 147 shows a method of connecting two MPLS segments (P2 to PE2) across a non-MPLS network. In this configuration, MPLS traffic that is destined to the other side of the non-MPLS network is sent through a single GRE tunnel.

Figure 20: P-to-PE Tunneling

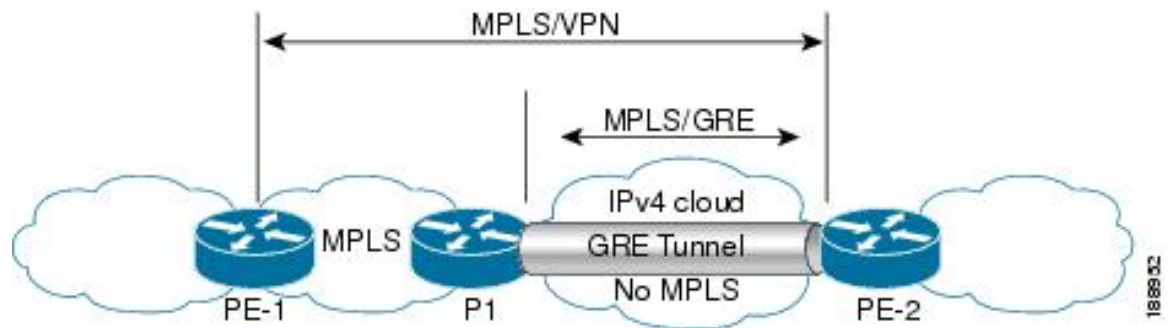

### P-to-P Tunneling

Figure 21: P-to-P Tunneling, on page 148 shows a method of connecting two MPLS segments (P1 to P2) across a non-MPLS network. In this configuration, MPLS traffic that is destined to the other side of the non-MPLS network is sent through a single GRE tunnel.

Figure 21: P-to-P Tunneling

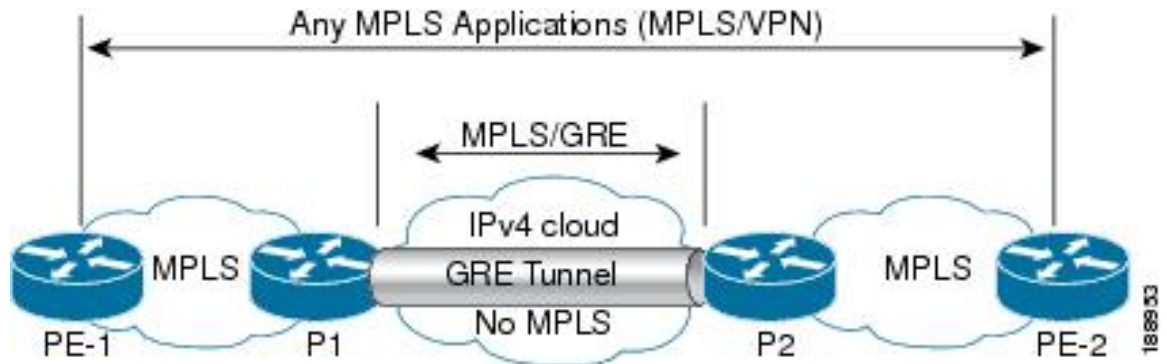

## How to Configure MPLS Layer 3 VPN over GRE

To configure the MPLS over GRE feature, you must create a GRE tunnel to span the non-MPLS networks. Perform the following procedure on the devices that are located at both ends of the GRE tunnel.

### Procedure

	Command or Action	Purpose
<b>Step 1</b>	<b>enable</b> <b>Example:</b> Device> <b>enable</b>	Enables privileged EXEC mode. Enter your password, if prompted.
<b>Step 2</b>	<b>configure terminal</b> <b>Example:</b> Device# <b>configure terminal</b>	Enters global configuration mode.
<b>Step 3</b>	<b>interface tunnel <i>tunnel-number</i></b> <b>Example:</b> Device(config)# <b>interface tunnel 1</b>	Creates a tunnel interface and enters interface configuration mode.
<b>Step 4</b>	<b>ip address <i>ip-address mask</i></b> <b>Example:</b> Device(config-if)# <b>ip address 10.0.0.1 255.255.255.0</b>	Assigns an IP address to the tunnel interface.
<b>Step 5</b>	<b>tunnel source <i>source-address</i></b> <b>Example:</b> Device(config-if)# <b>tunnel source 10.1.1.1</b>	Configures the tunnel's source IP address.
<b>Step 6</b>	<b>tunnel destination <i>destination-address</i></b> <b>Example:</b> Device(config-if)# <b>tunnel destination 10.1.1.2</b>	Configures the tunnel's destination IP address.



	Command or Action	Purpose
<b>Step 7</b>	<b>mpls ip</b> <b>Example:</b> Device(config-if)# <b>mpls ip</b>	Enables MPLS on the tunnel's physical interface.
<b>Step 8</b>	<b>end</b> <b>Example:</b> Device(config-if)# <b>end</b>	Returns to privileged EXEC mode.

## Configuration Examples for MPLS Layer 3 VPN over GRE

The following sections provide various configuration examples for MPLS Layer 3 VPN over GRE.

### Example: Configuring MPLS Layer 3 VPN over GRE (PE-to-PE Tunneling)

The following examples show how to configure Layer 3 VPN and the GRE tunnel from PE1 to PE2 (see [Figure 19: PE-to-PE Tunneling, on page 147](#)).

The following example shows how to configure a loopback interface on PE1:

```
Device> enable
Device# configure terminal
Device(config)# interface Loopback10
Device(config-if)# ip address 209.165.200.225 255.255.255.255
Device(config-if)# end
```

The following example shows how to configure a loopback interface on PE2:

```
Device> enable
Device# configure terminal
Device(config)# interface Loopback3
Device(config-if)# ip address 209.165.202.129 255.255.255.255
Device(config-if)# end
```

The following example shows how to advertise a loopback in IGP on PE1:

```
Device> enable
Device# configure terminal
Device(config)# router ospf 10
Device(config-router)# router-id 198.51.100.10
Device(config-router)# end
```

The following example shows how to configure a GRE tunnel, configure a different IGP instance on the tunnel, and enable MPLS on the tunnel on PE1:

```
Device> enable
Device# configure terminal
Device(config)# interface Tunnel13
Device(config-if)# ip address 203.0.113.200 255.255.255.248
Device(config-if)# ip ospf 11 area 0
Device(config-if)# mpls ip
Device(config-if)# tunnel source 209.165.200.225
Device(config-if)# tunnel destination 209.165.202.129
Device(config-if)# end
```

The following example shows how to configure a GRE tunnel, configure a different IGP instance on the tunnel, and enable MPLS on the tunnel on PE2:

```
Device> enable
Device# configure terminal
Device(config)# interface Tunnel31
Device(config-if)# ip address 203.0.113.201 255.255.255.248
Device(config-if)# ip ospf 11 area 0
Device(config-if)# mpls ip
Device(config-if)# tunnel source 209.165.202.129
Device(config-if)# tunnel destination 209.165.200.225
Device(config-if)# end
```

The following example shows how to advertise PE1 loopback IP for BGP in IGP instance configured on the tunnel:

```
Device> enable
Device# configure terminal
Device(config)# router ospf 11
Device(config-router)# router-id 198.51.100.11
Device(config-router)# network 192.0.1.1 0.0.0.0 area 0
Device(config-router)# end
```

The following example shows how to advertise PE2 loopback IP for BGP in IGP instance configured on the tunnel:

```
Device> enable
Device# configure terminal
Device(config)# router ospf 11
Device(config-router)# router-id 203.0.113.201
Device(config-router)# network 192.0.1.1 0.0.0.0 area 0
Device(config-router)# end
```

The following example shows how to configure VRF on PE1 where CE1 is connected:

```
Device> enable
Device# configure terminal
Device(config)# vrf definition vrf-1
Device (config-vrf)# rd 1:1
Device (config-vrf)# address-family ipv4
Device (config-vrf-af)# route-target import 1:2
Device (config-vrf-af)# route-target export 1:1
Device (config-vrf) # end
```

The following example shows how to configure VRF on PE2 where CE2 is connected:

```
Device> enable
Device# configure terminal
Device (config)# vrf definition vrf-1
Device (config-vrf)# rd 2:2
Device (config-vrf)# address-family ipv4
Device (config-vrf-af)# route-target import 1:1
Device (config-vrf-af)# route-target export 1:2
Device (config-vrf) # end
```

The following example shows how to configure PE1-CE1 interface:

```
Device> enable
Device# configure terminal
Device (config)# int po14.1
Device (config-subif)# encapsulation dot1Q 10
Device (config-subif)# vrf forwarding vrf-1
Device (config-subif)# ip address 14.2.1.1 255.255.255.0
Device (config-subif) # end
```

The following example shows how to configure PE2-CE2 interface:

```
Device> enable
Device# configure terminal
Device (config)# int po24.1
Device (config-subif)# encapsulation dot1Q 10
Device (config-subif)# vrf forwarding vrf-1
Device (config-subif)# ip address 24.2.1.1 255.255.255.0
Device(config-subif)# end
```

The following example shows how to configure PE1-CE1 External Border Gateway Protocol (EBGP):

```
Device> enable
Device# configure terminal
Device (config)# router bgp 65040
Device (config-router)# address-family ipv4 vrf vrf-1
Device (config-router-af)# neighbor 14.2.1.2 remote-as 65041
Device (config-router-af)# neighbor 14.2.1.2 activate
Device (config-router-af)# exit-address-family
Device(config-router)# end
```

The following example shows how to configure PE2-CE2 EBGp:

```
Device> enable
Device# configure terminal
Device (config)# router bgp 65040
Device (config-router)# address-family ipv4 vrf vrf-1
Device (config-router-af)# neighbor 24.2.1.2 remote-as 65041
Device (config-router-af)# neighbor 24.2.1.2 activate
Device (config-router-af)# exit-address-family
Device (config-router)# end
```

The following example shows how to configure PE1-PE2 MP-BGP on PE1:

```
Device> enable
Device# configure terminal
Device (config)# router bgp 65040
Device (config-router)# neighbor 192.0.2.1 remote-as 65040
Device (config-router)# neighbor 192.0.2.1 update-source Loopback0
Device (config-router)# address-family ipv4
Device (config-router-af)# neighbor 192.0.2.1 activate
Device (config-router-af)# exit
Device (config-router)# address-family vpnv4
Device (config-router-af)# neighbor 192.0.2.1 activate
Device (config-router-af)# neighbor 192.0.2.1 send-community both
Device (config-router-af)# exit
Device (config-router)# end
```

## Example: Configuring MPLS Layer 3 VPN over GRE (P-to-PE Tunneling)

The following examples show how to configure Layer 3 VPN on the PE devices (PE1 and PE2) and MPLS segment (P1), and the GRE tunnel from PE1 to P1 to PE2 (see [Figure 20: P-to-PE Tunneling, on page 147](#)).

The following example shows how to configure loopback interface for GRE tunnel for PE1:

```
Device> enable
Device# configure terminal
Device(config)# interface Loopback4
```

```
Device(config-if)# ip address 209.165.200.230 255.255.255.255
Device(config-if)# end
```

The following example shows how to configure loopback interface for GRE tunnel for P1:

```
Device> enable
Device# configure terminal
Device(config)# interface Loopback100
Device(config-if)# ip address 209.165.200.235 255.255.255.255
Device(config-if)# end
```

The following example shows how to configure interface from PE1-P1 and configure IGP:

```
Device> enable
Device# configure terminal
Device(config)# interface Port-channel11
Device(config-if)# no switchport
Device(config-if)# ip address 209.165.201.1 255.255.255.248
Device(config-if)# ip ospf 10 area 0
Device(config-if)# end
```

The following example shows how to configure interface from P1-PE1 and configure IGP:

```
Device> enable
Device# configure terminal
Device(config)# interface Port-channel1
Device(config-if)# no switchport
Device(config-if)# ip address 209.165.201.2 255.255.255.248
Device(config-if)# ip broadcast-address 209.165.201.31
Device(config-if)# ip ospf 10 area 0
Device(config-if)# end
```

The following example shows how to advertise loopback in IGP on PE1:

```
Device> enable
Device# configure terminal
Device(config)# router ospf 10
Device(config-router)# router-id 198.51.100.10
Device(config-router)# network 209.165.200.230 0.0.0.0 area 0
Device(config-router)# end
```

The following example shows how to advertise loopback in IGP on P1:

```
Device> enable
Device# configure terminal
Device(config)# router ospf 10
Device(config-router)# router-id 198.51.100.20
Device(config-router)# network 209.165.200.235 0.0.0.0 area 0
Device(config-router)# end
```

The following example shows how to configure GRE tunnel, configure an IGP instance on the tunnel, and enable MPLS on the tunnel on PE1:

```
Device> enable
Device# configure terminal
Device(config)# interface Tunnell111
Device(config-if)# ip address 209.165.202.140 255.255.255.248
Device(config-if)# ip ospf 11 area 0
Device(config-if)# mpls ip
Device(config-if)# tunnel source 209.165.200.230
Device(config-if)# tunnel destination 209.165.200.235
Device(config-if)# end
```

The following example shows how to configure GRE tunnel, configure an IGP instance on the tunnel, and enable MPLS on the tunnel on P1:

```

Device> enable
Device# configure terminal
Device(config)# interface Tunnel111
Device(config-if)# ip address 209.165.202.141 255.255.255.248
Device(config-if)# ip ospf 11 area 0
Device(config-if)# mpls ip
Device(config-if)# tunnel source 209.165.200.235
Device(config-if)# tunnel destination 209.165.200.230
Device(config-if)# end

```

The following example shows how to advertise PE loopback IP for BGP in tunnel's IGP instance on PE1:

```

Device> enable
Device# configure terminal
Device(config)# interface Tunnel111
Device(config)# router ospf 11
Device(config-router)# router-id 198.51.100.11
Device(config-router)# network 192.0.1.1 0.0.0.0 area 0
Device(config-router)# end

```

The following example shows how to configure interface from PE2-P1, and configure IGP and MPLS:

```

Device> enable
Device# configure terminal
Device(config)# interface Port-channel12
Device(config-if)# no switchport
Device(config-if)# ip address 209.165.201.1 255.255.255.248
Device(config-if)# ip ospf 11 area 0
Device(config-if)# mpls ip
Device(config-if)# end

```

The following example shows how to configure interface from P1-PE2, and configure IGP:

```

Device> enable
Device# configure terminal
Device(config)# interface Port-channel12
Device(config-if)# no switchport
Device(config-if)# ip address 209.165.201.2 255.255.255.248
Device(config-if)# ip ospf 11 area 0
Device(config-if)# mpls ip
Device(config-if)# end

```

The following example shows how to create VRF on PE1 where CE1 is connected:

```

Device> enable
Device# configure terminal
Device(config)# vrf definition vrf-1
Device (config-vrf)# rd 1:1
Device (config-vrf)# address-family ipv4
Device (config-vrf-af)# route-target import 1:2
Device (config-vrf-af)# route-target export 1:1
Device (config-vrf-af)# exit
Device (config-vrf)# end

```

The following example shows how to create VRF on PE2 where CE2 is connected:

```

Device> enable
Device# configure terminal
Device (config)# vrf definition vrf-1
Device (config-vrf)# rd 2:2
Device (config-vrf)# address-family ipv4
Device (config-vrf-af)# route-target import 1:1
Device (config-vrf-af)# route-target export 1:2

```

```
Device (config-vrf-af)# exit
Device (config-vrf)# end
```

The following example shows how to configure PE1-CE1 interface:

```
Device> enable
Device# configure terminal
Device (config)# int po14.1
Device (config-subif)# encapsulation dot1Q 10
Device (config-subif)# vrf forwarding vrf-1
Device (config-subif)# ip address 14.2.1.1 255.255.255.0
Device (config-subif)# exit
Device (config)# end
```

The following example shows how to configure PE2-CE2 interface:

```
Device> enable
Device# configure terminal
Device (config)# int po24.1
Device (config-subif)# encapsulation dot1Q 10
Device (config-subif)# vrf forwarding vrf-1
Device (config-subif)# ip address 24.2.1.1 255.255.255.0
Device (config-subif)# exit
Device (config)# end
```

The following example shows how to configure PE1-CE1 EBGP:

```
Device> enable
Device# configure terminal
Device (config)# router bgp 65040
Device (config-router)# address-family ipv4 vrf vrf-1
Device (config-router-af)# neighbor 14.2.1.2 remote-as 65041
Device (config-router-af)# neighbor 14.2.1.2 activate
Device (config-router-af)# exit-address-family
Device (config-router)# end
```

The following example shows how to configure PE2-CE2 EBGP:

```
Device> enable
Device# configure terminal
Device (config)# router bgp 65040
Device (config-router)# address-family ipv4 vrf vrf-1
Device (config-router-af)# neighbor 24.2.1.2 remote-as 65041
Device (config-router-af)# neighbor 24.2.1.2 activate
Device (config-router-af)# exit-address-family
Device (config-router)# end
```

The following example shows how to configure PE1-PE2 MP-BGP on PE1:

```
Device> enable
Device# configure terminal
Device (config)# router bgp 65040
Device (config-router)# neighbor 192.0.2.1 remote-as 65040
Device (config-router)# neighbor 192.0.2.1 update-source Loopback0
Device (config-router)# address-family ipv4
Device (config-router-af)# neighbor 192.0.2.1 activate
Device (config-router-af)# exit
Device (config-router)# address-family vpv4
Device (config-router-af)# neighbor 192.0.2.1 activate
Device (config-router-af)# neighbor 192.0.2.1 send-community both
Device (config-router-af)# exit
Device (config-router)# end
```

The following example shows how to configure PE2-PE1 MP-BGP on PE2:

```

Device> enable
Device# configure terminal
Device (config)# router bgp 65040
Device (config-router)# neighbor 192.0.1.1 remote-as 65040
Device (config-router)# neighbor 192.0.1.1 update-source Loopback0
Device (config-router)# address-family ipv4
Device (config-router-af)# neighbor 192.0.1.1 activate
Device (config-router-af)# exit
Device (config-router)# address-family vpnv4
Device (config-router-af)# neighbor 192.0.1.1 activate
Device (config-router-af)# neighbor 192.0.1.1 send-community both
Device (config-router-af)# exit
Device (config-router)# end

```

## Feature History for Configuring MPLS Layer 3 VPN over GRE

This table provides release and related information for the features explained in this module.

These features are available in all the releases subsequent to the one they were introduced in, unless noted otherwise.

Release	Feature	Feature Information
Cisco IOS XE Gibraltar 16.12.1	MPLS Layer 3 VPN over GRE	The MPLS Layer 3 VPN over GRE feature provides a mechanism for tunneling MPLS packets over a non-MPLS network.

Use the Cisco Feature Navigator to find information about platform and software image support. To access Cisco Feature Navigator, go to <https://cfng.cisco.com/>

<http://www.cisco.com/go/cfn>.







## CHAPTER 12

# Configuring MPLS QoS

- [Classifying and Marking MPLS EXP, on page 157](#)
- [Information About MPLS QoS, on page 158](#)
- [How to Configure MPLS QoS, on page 159](#)
- [Configuration Examples for MPLS QoS, on page 165](#)
- [Additional References, on page 168](#)
- [Feature History for QoS MPLS EXP, on page 168](#)

## Classifying and Marking MPLS EXP

The QoS EXP Matching feature allows you to classify, mark and queue network traffic by modifying the Multiprotocol Label Switching (MPLS) experimental bits (EXP) field. This module contains conceptual information and the configuration tasks for classifying and marking network traffic using the MPLS EXP field.

## Prerequisites for MPLS QoS

- The switch must be configured as an MPLS provider edge (PE) or provider (P) router, which can include the configuration of a valid label protocol and underlying IP routing protocols.

## Restrictions for MPLS QoS

- MPLS classification and marking can only occur in an operational MPLS network.
- If a packet is classified by IP type of service (ToS) or class of service (CoS) at ingress, it cannot be reclassified by MPLS EXP at egress (imposition case). However, if a packet is classified by MPLS at ingress, it can be reclassified by IP ToS, CoS, or Quality of Service (QoS) group at egress (disposition case).
- To apply QoS on traffic across protocol boundaries, use QoS-group. You can classify and assign ingress traffic to the QoS-group. Thereafter, you can use the QoS-group at egress to classify and apply QoS.
- If a packet is encapsulated in MPLS, the MPLS payload cannot be checked for other protocols, such as IP, for classification or marking. Only MPLS EXP marking affects packets that are encapsulated by MPLS.

- The short pipe mode is not supported to transport packets through the MPLS network. You can transport packets using any one of the following modes—uniform mode or pipe mode.

## Information About MPLS QoS

This section provides information about MPLS QoS:

### MPLS QoS Overview

MPLS QoS functionality enables network administrators to provide differentiated services across an MPLS network. Network administrators can satisfy a wide range of networking requirements by specifying the class of service applicable to each transmitted IP packet. Different classes of service can be established for IP packets by setting the IP precedence bit in the header of each packet. Classification, remarking, and queuing on an MPLS network is performed over MPLS EXP bits. In the MPLS network the packets are differentiated by the MPLS EXP field marking and treated appropriately, depending on the weighted early random detection (WRED) configuration.

MPLS EXP field in MPLS packet allows you to:

- Classify traffic

The classification process selects the traffic to be marked. Classification accomplishes this by partitioning traffic into multiple priority levels, or classes of service. Traffic classification is the primary component of class-based QoS provisioning. For more information, see the “Classifying Network Traffic” module.

- Police and mark traffic

Policing causes traffic that exceeds the configured rate to be discarded or marked to a different drop level. Marking traffic is a way to identify packet flows to differentiate them. Packet marking allows you to partition your network into multiple priority levels or classes of service. For more information, see the “Marking Network Traffic” module.

- Queuing

Queuing helps prevent traffic congestion. This includes priority level queuing, weighted tail drop (WTD), scheduling, shaping and weighted random early detection (WRED) features.

### MPLS Experimental Field

The MPLS experimental bits (EXP) field is a 3-bit field in the MPLS header that you can use to define the QoS treatment (per-hop behavior) that a node should give to a packet. In an IP network, the DiffServ Code Point (DSCP) (a 6-bit field) defines a class and drop precedence. The EXP bits can be used to carry some of the information encoded in the IP DSCP and can also be used to encode the dropping precedence.

By default, Cisco IOS Software copies the three most significant bits of the DSCP or the IP precedence of the IP packet to the EXP field in the MPLS header. This action happens when the MPLS header is initially imposed on the IP packet. However, you can also set the EXP field by defining a mapping between the DSCP or IP precedence and the EXP bits. This mapping is configured using the **set mpls experimental** or **police** commands. For more information, see the “How to Classify and Mark MPLS EXP” section.



**Note** A policy map configured with **set ip dscp** is not supported on the provider edge device because the policy action for MPLS label imposition node should be based on **set mpls experimental imposition** value. However, a policy map with action **set ip dscp** is supported when both the ingress and egress interfaces are Layer 3 ports.

You can perform MPLS EXP marking operations using table-maps. It is recommended to assign QoS-group to a different class of traffic in ingress policy and translate QoS-group to DSCP and EXP markings in egress policy using table-map.

If a service provider does not want to modify the value of the IP precedence field in packets transported through the network, they can use the MPLS EXP field value to classify and mark IP packets.

By choosing different values for the MPLS EXP field, you can mark critical packets so that those packets have priority if network congestion occurs.

WRED monitors network traffic to anticipate and prevent congestion at common network and internetwork bottlenecks. WRED can selectively discard lower priority traffic when an interface becomes congested. This feature can also provide differentiated performance characteristics for different classes of service.

There are two ways to transport packets through the MPLS network:

**Uniform mode:** Uniform mode of transferring packets operates on one layer of QoS. The Provider Edge at ingress copies the DSCP information from the incoming IP packet into the MPLS EXP bits of the imposed labels and the IP precedence bits are mapped to the MPLS EXP field. As the EXP bits travel through the core, they may or may not be modified by the intermediate devices on the network. The Provider Edge at egress copies the EXP bits to the DSCP bits of the newly exposed IP packet.

**Pipe mode:** Pipe mode of transferring packets operates on two layers of QoS. An underlying QoS for the data that remains unchanged when traversing the core. A per-core QoS, which is separate from that of the underlying IP packets. The DSCP information is saved and stored as the packet travels through the MPLS network. The MPLS EXP label is applied by the PE at ingress but the IP precedence bits are not stored. At egress, the original IP precedence value is preserved.

## Benefits of MPLS EXP Classification and Marking

If a service provider does not want to modify the value of the IP precedence field in packets transported through the network, they can use the MPLS EXP field value to classify and mark IP packets.

By choosing different values for the MPLS EXP field, you can mark critical packets so that those packets have priority if network congestion occurs.

## How to Configure MPLS QoS

This section provides information about how to configure MPLS QoS:

### Classifying MPLS Encapsulated Packets

You can use the **match mpls experimental topmost** command to define traffic classes based on the packet EXP values, inside the MPLS domain. You can use these classes to define services policies to mark the EXP traffic using the **police** command.

**Procedure**

	<b>Command or Action</b>	<b>Purpose</b>
<b>Step 1</b>	<b>enable</b> <b>Example:</b> <pre>Device&gt; enable</pre>	Enables privileged EXEC mode. <ul style="list-style-type: none"> <li>• Enter your password if prompted.</li> </ul>
<b>Step 2</b>	<b>configure terminal</b> <b>Example:</b> <pre>Device# configure terminal</pre>	Enters global configuration mode.
<b>Step 3</b>	<b>class-map [match-all   match-any]</b> <i>class-map-name</i> <b>Example:</b> <pre>Device(config)# class-map exp3</pre>	Creates a class map to be used for matching traffic to a specified class, and enters class-map configuration mode. <ul style="list-style-type: none"> <li>• Enter the class map name.</li> </ul>
<b>Step 4</b>	<b>match mpls experimental topmost</b> <i>mpls-exp-value</i> <b>Example:</b> <pre>Device(config-cmap)# match mpls experimental topmost 3</pre>	Specifies the match criteria.  <b>Note</b> The <b>match mpls experimental topmost</b> command classifies traffic on the basis of the EXP value in the topmost label header.
<b>Step 5</b>	<b>end</b> <b>Example:</b> <pre>Device(config-cmap)# end</pre>	(Optional) Returns to privileged EXEC mode.

## Marking MPLS EXP on the Outermost Label

Perform this task to set the value of the MPLS EXP field on imposed label entries.

### Before you begin

In typical configurations, marking MPLS packets at imposition is used with ingress classification on IP ToS or CoS fields.



**Note** For IP imposition marking, the IP precedence value is copied to the MPLS EXP value by default.



**Note** The egress policy on provider edge works with MPLS EXP class match, only if there is a remarking policy at ingress. The provider edge at ingress is an IP interface and only DSCP value is trusted by default. If you do not configure remarking policy at ingress the label for queueing is generated based on DSCP value and not MPLS EXP value. However, a transit provider router works without configuring remarking policy at ingress as the router works on MPLS interfaces.



**Note** The `set mpls experimental imposition` command works only on packets that have new or additional MPLS labels added to them.

### Procedure

	Command or Action	Purpose
<b>Step 1</b>	<b>enable</b> <b>Example:</b>  Device> enable	Enables privileged EXEC mode.  • Enter your password if prompted.
<b>Step 2</b>	<b>configure terminal</b> <b>Example:</b>  Device# configure terminal	Enters global configuration mode.
<b>Step 3</b>	<b>policy-map <i>policy-map-name</i></b> <b>Example:</b>  Device(config)# policy-map mark-up-exp-2	Specifies the name of the policy map to be created and enters policy-map configuration mode.  • Enter the policy map name.
<b>Step 4</b>	<b>class <i>class-map-name</i></b> <b>Example:</b>  Device(config-pmap)# class prec012	Creates a class map to be used for matching traffic to a specified class, and enters class-map configuration mode.  • Enter the class map name.
<b>Step 5</b>	<b>set mpls experimental imposition</b> <i>mpls-exp-value</i> <b>Example:</b>  Device(config-pmap-c)# set mpls experimental imposition 2	Sets the value of the MPLS EXP field on top label.
<b>Step 6</b>	<b>end</b> <b>Example:</b>  Device(config-pmap-c)# end	(Optional) Returns to privileged EXEC mode.

## Marking MPLS EXP on Label Switched Packets

Perform this task to set the MPLS EXP field on label switched packets.

### Before you begin



**Note** The **set mpls experimental topmost** command marks EXP for the outermost label of MPLS traffic. Due to this marking at ingress policy, the egress policy must include classification based on the MPLS EXP values.

### Procedure

	Command or Action	Purpose
<b>Step 1</b>	<b>enable</b> <b>Example:</b> Device> enable	Enables privileged EXEC mode. <ul style="list-style-type: none"> <li>• Enter your password if prompted.</li> </ul>
<b>Step 2</b>	<b>configure terminal</b> <b>Example:</b> Device# configure terminal	Enters global configuration mode.
<b>Step 3</b>	<b>policy-map <i>policy-map-name</i></b> <b>Example:</b> Device(config)# policy-map mark-up-exp-2	Specifies the name of the policy map to be created and enters policy-map configuration mode. <ul style="list-style-type: none"> <li>• Enter the policy map name.</li> </ul>
<b>Step 4</b>	<b>class <i>class-map-name</i></b> <b>Example:</b> Device(config-pmap)# class-map exp012	Creates a class map to be used for matching traffic to a specified class, and enters class-map configuration mode. <ul style="list-style-type: none"> <li>• Enter the class map name.</li> </ul>
<b>Step 5</b>	<b>set mpls experimental topmost <i>mpls-exp-value</i></b> <b>Example:</b> Device(config-pmap-c)# set mpls experimental topmost 2	Sets the MPLS EXP field value in the topmost label on the output interface.
<b>Step 6</b>	<b>end</b> <b>Example:</b> Device(config-pmap-c)# end	(Optional) Returns to privileged EXEC mode.

## Configuring Conditional Marking

To conditionally set the value of the MPLS EXP field on all imposed label, perform the following task:

### Before you begin



**Note** The `set-mpls-exp-topmost-transmit` action affects MPLS encapsulated packets only. The `set-mpls-exp-imposition-transmit` action affects any new labels that are added to the packet.

### Procedure

	Command or Action	Purpose
<b>Step 1</b>	<b>enable</b> <b>Example:</b>  Device> enable	Enables privileged EXEC mode.  • Enter your password if prompted.
<b>Step 2</b>	<b>configure terminal</b> <b>Example:</b>  Device# configure terminal	Enters global configuration mode.
<b>Step 3</b>	<b>policy-map <i>policy-map-name</i></b> <b>Example:</b>  Device(config)# policy-map ip2tag	Specifies the name of the policy map to be created and enters policy-map configuration mode.  • Enter the policy map name.
<b>Step 4</b>	<b>class <i>class-map-name</i></b> <b>Example:</b>  Device(config-pmap)# class iptcp	Creates a class map to be used for matching traffic to a specified class, and enters policy-map class configuration mode.  • Enter the class map name.
<b>Step 5</b>	<b>police cir <i>bps</i> bc <i>pir</i> <i>bps</i> be</b> <b>Example:</b>  Device(config-pmap-c)# police cir 1000000 pir 2000000	Defines a policer for classified traffic and enters policy-map class police configuration mode.
<b>Step 6</b>	<b>conform-action transmit</b> <b>Example:</b>  Device(config-pmap-c-police)# conform-action transmit 3	Defines the action to take on packets that conform to the values specified by the policer.  • In this example, if the packet conforms to the committed information rate (cir) or is within the conform burst (bc) size, the MPLS EXP field is set to 3.

	Command or Action	Purpose
<b>Step 7</b>	<b>exceed-action set-mpls-exp-topmost-transmit exp table <i>table-map-name</i></b>  <b>Example:</b>  <pre>Device(config-pmap-c-police)# exceed-action set-mpls-exp-topmost-transmit exp table dscp2exp</pre>	Defines the action to take on packets that exceed the values specified by the policer.
<b>Step 8</b>	<b>violate-action drop</b>  <b>Example:</b>  <pre>Device(config-pmap-c-police)# violate-action drop</pre>	Defines the action to take on packets whose rate exceeds the peak information rate (pir) and is outside the bc and be ranges. <ul style="list-style-type: none"> <li>• You must specify the exceed action before you specify the violate action.</li> <li>• In this example, if the packet rate exceeds the pir rate and is outside the bc and be ranges, the packet is dropped.</li> </ul>
<b>Step 9</b>	<b>end</b>  <b>Example:</b>  <pre>Device(config-pmap-c-police)# end</pre>	(Optional) Returns to privileged EXEC mode.

## Configuring WRED for MPLS EXP

Perform this task to enable WRED for MPLS EXP.

### Procedure

	Command or Action	Purpose
<b>Step 1</b>	<b>enable</b>  <b>Example:</b> <pre>Device&gt; enable</pre>	Enables privileged EXEC mode. <ul style="list-style-type: none"> <li>• Enter your password if prompted.</li> </ul>
<b>Step 2</b>	<b>configure terminal</b>  <b>Example:</b> <pre>Device# configure terminal</pre>	Enters global configuration mode.
<b>Step 3</b>	<b>policy-map <i>policy-map-name</i></b>  <b>Example:</b> <pre>Device(config)# policy-map wred_exp</pre>	Specifies the name of the policy map to be created and enters policy-map configuration mode. <ul style="list-style-type: none"> <li>• Enter the policy map name.</li> </ul>



	Command or Action	Purpose
<b>Step 4</b>	<b>class</b> <i>class-map-name</i> <b>Example:</b> <pre>Device(config-pmap)# class exp</pre>	Creates a class map to be used for matching traffic to a specified class, and enters class-map configuration mode. <ul style="list-style-type: none"> <li>• Enter the class map name.</li> </ul>
<b>Step 5</b>	<b>bandwidth</b> { <i>kbps</i>   <b>remaining</b> <i>percentage</i>   <b>percent</b> <i>percentage</i> } <b>Example:</b> <pre>Device(config-pmap-c)# bandwidth percent 30</pre>	Specify either the bandwidth allocated for a class belonging to a policy map or the traffic shaping.
<b>Step 6</b>	<del>random-detect</del> <b>Example:</b> <pre>Device(config-pmap-c)# random-detect mpls-exp-based</pre>	Configures WRED to use the MPLS EXP value when it calculates the drop probability for the packet.
<b>Step 7</b>	<b>random-detect</b> <i>exp-value</i> <b>percent</b> <i>min-threshold</i> <i>max-threshold</i> <b>Example:</b> <pre>Device(config-pmap-c)# random-detect exp 1 10 20 Device(config-pmap-c)# random-detect exp 2 30 40 Device(config-pmap-c)# random-detect exp 2 40 80</pre>	Specifies the MPLS EXP value, minimum and maximum thresholds, in percentage.
<b>Step 8</b>	<b>end</b> <b>Example:</b> <pre>Device(config-pmap-c-police)# end</pre>	(Optional) Returns to privileged EXEC mode.

## Configuration Examples for MPLS QoS

This section provides configuration examples for MPLS QoS:

### Example: Classifying MPLS Encapsulated Packets

#### Defining an MPLS EXP Class Map

The following example defines a class map named `exp3` that matches packets that contains MPLS experimental value 3:

**Example: Marking MPLS EXP on Outermost Label**

```
Device(config)# class-map exp3
Device(config-cmap)# match mpls experimental topmost 3
Device(config-cmap)# exit
```

**Defining a Policy Map and Applying the Policy Map to an Ingress Interface**

The following example uses the class map created in the example above to define a policy map. This example also applies the policy map to a physical interface for ingress traffic.

```
Device(config)# policy-map change-exp-3-to-2
Device(config-pmap)# class exp3
Device(config-pmap-c)# set mpls experimental topmost 2
Device(config-pmap)# exit
Device(config)# interface GigabitEthernet 0/0/0
Device(config-if)# service-policy input change-exp-3-to-2
Device(config-if)# exit
```

**Defining a Policy Map and Applying the Policy Map to an Egress Interface**

The following example uses the class map created in the example above to define a policy map. This example also applies the policy map to a physical interface for egress traffic.

```
Device(config)# policy-map WAN-out
Device(config-pmap)# class exp3
Device(config-pmap-c)# shape average 10000000
Device(config-pmap-c)# exit
Device(config-pmap)# exit
Device(config)# interface GigabitEthernet 0/0/0
Device(config-if)# service-policy output WAN-out
Device(config-if)# exit
```

**Example: Marking MPLS EXP on Outermost Label****Defining an MPLS EXP Imposition Policy Map**

The following example defines a policy map that sets the MPLS EXP imposition value to 2 based on the IP precedence value of the forwarded packet:

```
Device# configure terminal
Enter configuration commands, one per line. End with CNTL/Z.
Device(config)# class-map prec012
Device(config-cmap)# match ip prec 0 1 2
Device(config-cmap)# exit
Device(config)# policy-map mark-up-exp-2
Device(config-pmap)# class prec012
Device(config-pmap-c)# set mpls experimental imposition 2
Device(config-pmap-c)# exit
Device(config-pmap)# exit
```

**Applying the MPLS EXP Imposition Policy Map to a Main Interface**

The following example applies a policy map to Gigabit Ethernet interface 0/0/0:

```

Device# configure terminal
Enter configuration commands, one per line. End with CNTL/Z.
Device(config)# interface GigabitEthernet 0/0/0
Device(config-if)# service-policy input mark-up-exp-2
Device(config-if)# exit

```

## Example: Marking MPLS EXP on Label Switched Packets

### Defining an MPLS EXP Label Switched Packets Policy Map

The following example defines a policy map that sets the MPLS EXP topmost value to 2 according to the MPLS EXP value of the forwarded packet:

```

Device# configure terminal
Enter configuration commands, one per line. End with CNTL/Z.
Device(config)# class-map exp012
Device(config-cmap)# match mpls experimental topmost 0 1 2
Device(config-cmap)# exit
Device(config-cmap)# policy-map mark-up-exp-2
Device(config-pmap)# class exp012
Device(config-pmap-c)# set mpls experimental topmost 2
Device(config-pmap-c)# exit
Device(config-pmap)# exit

```

### Applying the MPLS EXP Label Switched Packets Policy Map to a Main Interface

The following example shows how to apply the policy map to a main interface:

```

Switch# configure terminal
Enter configuration commands, one per line. End with CNTL/Z.
Device(config)# interface GigabitEthernet 0/0/0
Device(config-if)# service-policy input mark-up-exp-2
Device(config-if)# exit

```

## Example: Configuring Conditional Marking

The example in this section creates a policer for the **iptcp** class, which is part of the **ip2tag** policy map, and attaches the policy map to the Gigabit Ethernet interface.

```

Device(config)# policy-map ip2tag
Device(config-pmap)# class iptcp
Device(config-pmap-c)# police cir 1000000 pir 2000000
Device(config-pmap-c-police)# conform-action transmit
Device(config-pmap-c-police)# exceed-action set-mpls-exp-imposition-transmit 2
Device(config-pmap-c-police)# violate-action drop
Device(config-pmap-c-police)# exit
Device(config-pmap-c)# exit
Device(config-pmap)# exit
Device(config)# interface GigabitEthernet 0/0/1
Device(config-if)# service-policy input ip2tag

```

## Example: Configuring WRED for MPLS EXP

The example in this section enables WRED for MPLS EXP.

```
Device# configure terminal
Device(config)# policy-map wred_exp
Device(config-pmap-c)# bandwidth percent 30
Device(config-pmap-c)# random-detect mpls-exp-based
Device(config-pmap-c)# random-detect exp 1 10 20
Device(config-pmap-c)# random-detect exp 2 30 40
Device(config-pmap-c)# random-detect exp 2 40 80
```

### Displaying WRED threshold labels

Use the **show policy-map***policy-map-name* command to verify WRED Configuration for MPLS EXP.

The following sample output displays WRED threshold labels.

```
Device# show policy-map wred_exp
Policy Map wred_exp
Class exp
bandwidth 30 (%)
percent-based wred, exponential weight 9
exp  min-threshold  max-threshold
-----
0          -          -
1          10         20
2          30         40
3          40         80
4          -          -
5          -          -
6          -          -
7          -          -
```

## Additional References

### Related Documents

Related Topic	Document Title
QoS commands	<i>Cisco IOS Quality of Service Solutions Command Reference</i>

## Feature History for QoS MPLS EXP

This table provides release and related information for features explained in this module.

These features are available on all releases subsequent to the one they were introduced in, unless noted otherwise.

Release	Feature	Feature Information
Cisco IOS XE Everest 16.5.1a	QoS MPLS EXP	The QoS EXP Matching feature allows you to classify, mark and queue network traffic by modifying the Multiprotocol Label Switching (MPLS) experimental bits (EXP) field.
Cisco IOS XE Amsterdam 17.3.1	MPLS QoS - WRED	Introduces support for weighted random early detection (WRED) in MPLS Quality of Service (QoS). This feature configures WRED to use the MPLS experimental bits (EXP) to calculate the drop probability of a packet.

Use Cisco Feature Navigator to find information about platform and software image support. To access Cisco Feature Navigator, go to <http://www.cisco.com/go/cfn>.





## CHAPTER 13

# Configuring MPLS Static Labels

- [MPLS Static Labels, on page 171](#)

## MPLS Static Labels

This document describes the Cisco MPLS Static Labels feature. The MPLS Static Labels feature provides the means to configure the binding between a label and an IPv4 prefix statically.

## Prerequisites for MPLS Static Labels

The network must support the following Cisco IOS features before you enable MPLS Static Labels:

- Multiprotocol Label Switching (MPLS)
- Cisco Express Forwarding

## Restrictions for MPLS Static Labels

- On a provider edge (PE) router for MPLS VPNs, there's no mechanism for statically binding a label to a customer network prefix (VPN IPv4 prefix).
- MPLS Static Crossconnect is not supported.
- MPLS Static Labels is not supported for label-controlled Asynchronous Transfer Mode (lc-atm).
- MPLS static bindings are not supported for local prefixes.
- VRF aware Static Labels is not supported,

## Information About MPLS Static Labels

### MPLS Static Labels Overview

Generally, label switching routers (LSRs) dynamically learn the labels they should use to label-switch packets. They do this by means of label distribution protocols that include:

- Label Distribution Protocol (LDP), the Internet Engineering Task Force (IETF) standard, used to bind labels to network addresses.
- Resource Reservation Protocol (RSVP) used to distribute labels for traffic engineering (TE)
- Border Gateway Protocol (BGP) used to distribute labels for Multiprotocol Label Switching (MPLS) Virtual Private Networks (VPNs)

To use a learned label to label-switch packets, an LSR installs the label into its Label Forwarding Information Base (LFIB).

The MPLS Static Labels feature provides the means to configure the binding between a label and an IPv4 prefix statically.

## Benefits of MPLS Static Labels

### Static Bindings Between Labels and IPv4 Prefixes

You can configure static bindings between labels and IPv4 prefixes to support MPLS hop-by-hop forwarding through neighbor routers that don't implement LDP label distribution.

## How to Configure MPLS Static Labels

### Configuring MPLS Static Prefix Label Bindings

To configure MPLS static prefix/label bindings, use the following commands beginning in global configuration mode:

#### Procedure

	Command or Action	Purpose
<b>Step 1</b>	<b>enable</b> <b>Example:</b>  Device> enable	Enables privileged EXEC mode. Enter your password if prompted.
<b>Step 2</b>	<b>configure terminal</b> <b>Example:</b>  Device# configure terminal	Enters global configuration mode.
<b>Step 3</b>	<b>mpls label range</b> <i>min-label max-label</i> [ <b>static</b> <i>min-static-label max-static-label</i> ] <b>Example:</b>  Device(config)# mpls label range 200 100000 static 16 199	Specifies a range of labels for use with MPLS Static Labels feature.  (Default is no labels reserved for static assignment.)
<b>Step 4</b>	<b>mpls static binding ipv4</b> <i>prefix mask</i> [ <b>input</b> <i>output nexthop</i> ] label	Specifies static binding of labels to IPv4 prefixes.



	Command or Action	Purpose
	<b>Example:</b>  Device(config)# mpls static binding ipv4 10.0.0.0 255.0.0.0 55	Bindings specified are installed automatically in the MPLS forwarding table as routing demands.

## Verifying MPLS Static Prefix Label Bindings

To verify the configuration for MPLS static prefix/label bindings, use this procedure:

### Procedure

**Step 1** Enter **show mpls label range** command. The output shows that the new label ranges do not take effect until a reload occurs:

#### Example:

```
Device# show mpls label range

Downstream label pool: Min/Max label: 16/983039
  [Configured range for next reload: Min/Max label: 200/100000]
Range for static labels: Min/Max/Number: 16/199
```

The following output from the **show mpls label range** command, executed after a reload, indicates that the new label ranges are in effect:

#### Example:

```
Device# show mpls label range

Downstream label pool: Min/Max label: 200/100000
Range for static labels: Min/Max/Number: 16/199
```

**Step 2** Enter the **show mpls static binding ipv4** command to show the configured static prefix/label bindings:

#### Example:

```
Device# show mpls static binding ipv4
10.17.17.17/32: Incoming label: 251 (in LIB)
  Outgoing labels:
    10.0.0.1                18
10.18.18.18/32: Incoming label: 201 (in LIB)
  Outgoing labels:
    10.0.0.1 implicit-null
```

**Step 3** Use the **show mpls forwarding-table** command to determine which static prefix/label bindings are currently in use for MPLS forwarding.

#### Example:

```
Device# show mpls forwarding-table
Local  Outgoing  Prefix          Bytes tag  Outgoing   Next Hop
tag    tag or VC  or Tunnel Id    switched   interface
201    Pop tag    10.18.18.18/32  0          PO1/1/0    point2point
```

```

                2/35          10.18.18.18/32  0          AT4/1/0.1  point2point
251          18          10.17.17.17/32  0          PO1/1/0    point2point

```

## Monitoring and Maintaining MPLS Static Labels

To monitor and maintain MPLS Static Labels, use one or more of the following commands:

### Procedure

	Command or Action	Purpose
<b>Step 1</b>	<b>enable</b> <b>Example:</b> Devie> enable	Enables privileged EXEC mode. Enter your password if prompted.
<b>Step 2</b>	<b>show mpls forwarding-table</b> <b>Example:</b> Device# show mpls forwarding-table	Displays the contents of the MPLS LFIB.
<b>Step 3</b>	<b>show mpls label range</b> <b>Example:</b> Device# show mpls label range	Displays information about the static label range.
<b>Step 4</b>	<b>show mpls static binding ipv4</b> <b>Example:</b> Device# show mpls static binding ipv4	Displays information about the configured static prefix/label bindings.

## Configuration Examples for MPLS Static Labels

### Example: Configuring MPLS Static Prefixes Labels

In the following output, the **mpls label range** command reconfigures the range used for dynamically assigned labels 16–983039 to 200–100000. It configures a static label range of 16–199.

```

Device# configure terminal
Enter configuration commands, one per line. End with CNTL/Z.
Router(config)# mpls label range 200 100000 static 16 199
% Label range changes take effect at the next reload.
Router(config)# end

```

In the following output, the **show mpls label range** command indicates that the new label ranges don't take effect until a reload occurs:

```

Device# show mpls label range

```

```
Downstream label pool: Min/Max label: 16/983039
 [Configured range for next reload: Min/Max label: 200/100000]
Range for static labels: Min/Max/Number: 16/199
```

In the following output, the **show mpls label range** command, executed after a reload, indicates that the new label ranges are in effect:

```
Device# show mpls label range

Downstream label pool: Min/Max label: 200/100000
Range for static labels: Min/Max/Number: 16/199
```

In the following output, the **mpls static binding ipv4** commands configure static prefix/label bindings. They also configure input (local) and output (remote) labels for various prefixes:

```
Device# configure terminal
Enter configuration commands, one per line. End with CNTL/Z.
Device(config)# mpls static binding ipv4 10.0.0.0 255.0.0.0 55
Device(config)# mpls static binding ipv4 10.0.0.0 255.0.0.0 output 10.0.0.66 2607
Device(config)# mpls static binding ipv4 10.6.0.0 255.255.0.0 input 17
Device(config)# mpls static binding ipv4 10.0.0.0 255.0.0.0 output 10.13.0.8 explicit-null
Device(config)# end
```

In the following output, the **show mpls static binding ipv4** command displays the configured static prefix/label bindings:

```
Device# show mpls static binding ipv4

10.0.0.0/8: Incoming label: none;
  Outgoing labels:
10.13.0.8          explicit-null
10.0.0.0/8: Incoming label: 55 (in LIB)
  Outgoing labels:
   10.0.0.66          2607
10.66.0.0/16: Incoming label: 17 (in LIB)
  Outgoing labels: None
```

## Additional References

### Related Documents

Related Topic	Document Title
MPLS commands	<i>Multiprotocol Label Switching Command Reference</i>

### Standards

Standard	Title
No new or modified standards are supported by this feature. Support for existing standards has not been modified by this feature.	--

**MIBs**

MIB	MIBs Link
No new or modified MIBs are supported by this feature, and support for existing MIBs has not been modified by this feature.	To locate and download MIBs for selected platforms, Cisco software releases, and feature sets, use Cisco MIB Locator found at the following URL: <a href="http://www.cisco.com/go/mibs">http://www.cisco.com/go/mibs</a>

**RFCs**

RFC	Title
No new or modified RFCs are supported by this feature, and support for existing RFCs has not been modified by this feature.	--

**Technical Assistance**

Description	Link
The Cisco Support and Documentation website provides online resources to download documentation, software, and tools. Use these resources to install and configure the software and to troubleshoot and resolve technical issues with Cisco products and technologies. Access to most tools on the Cisco Support and Documentation website requires a Cisco.com user ID and password.	<a href="http://www.cisco.com/cisco/web/support/index.html">http://www.cisco.com/cisco/web/support/index.html</a>

## Feature History for MPLS Static Labels

This table provides release and related information for features explained in this module.

These features are available on all releases subsequent to the one they were introduced in, unless noted otherwise.

Release	Feature	Feature Information
Cisco IOS XE Everest 16.5.1a	MPLS Static Labels	The MPLS Static Labels feature provides the means to configure the binding between a label and an IPv4 prefix statically.  The following commands were introduced or modified: <b>debug mpls static binding</b> , <b>mpls label range</b> , <b>mpls static binding ipv4</b> , <b>show mpls label range</b> , <b>show mpls static binding ipv4</b>

Use Cisco Feature Navigator to find information about platform and software image support. To access Cisco Feature Navigator, go to <http://www.cisco.com/go/cfn>.



## CHAPTER 14

# Configuring Virtual Private LAN Service (VPLS) and VPLS BGP-Based Autodiscovery

- [Restrictions for VPLS, on page 177](#)
- [Information About VPLS, VPLS BGP-Based Autodiscovery and Flow-Aware Transport, on page 177](#)
- [How to Configure VPLS, VPLS BGP-Based Autodiscovery and Flow-Aware Transport, on page 181](#)
- [Configuration Examples for VPLS and VPLS BGP-Based Autodiscovery, on page 201](#)
- [Feature History for VPLS and VPLS BGP-Based Autodiscovery, on page 206](#)

## Restrictions for VPLS

- Integrated Routing and Bridging (IRB) configuration is not supported.
- Layer 2 protocol tunneling configuration is not supported
- Virtual Circuit Connectivity Verification (VCCV) ping with explicit null is not supported.
- The switch is supported if configured only as a spoke in hierarchical Virtual Private LAN Services (VPLS) and not as a hub.
- Layer 2 VPN interworking functions are not supported.
- **ip unnumbered** command is not supported in Multiprotocol Label Switching (MPLS) configuration.
- Virtual Circuit (VC) statistics are not displayed for flood traffic in the output of **show mpls l2 vc veid detail** command.
- Dot1q tunnel configuration is not supported in the attachment circuit.

## Information About VPLS, VPLS BGP-Based Autodiscovery and Flow-Aware Transport

The following sections provide information about VPLS, VPLS BGP-based autodiscovery and flow-aware transport.

## VPLS Overview

VPLS enables enterprises to link together their Ethernet-based LANs from multiple sites through the infrastructure provided by their service provider. From the enterprise perspective, the service provider's public network looks like one large Ethernet LAN. For the service provider, VPLS provides an opportunity to deploy another revenue-generating service on top of their existing network without major capital expenditures. Operators can extend the operational life of equipment in their network.

VPLS uses the provider core to join multiple attachment circuits together to simulate a virtual bridge between multiple attachment circuits. From a customer point of view, there is no topology for VPLS. All of the customer edge (CE) devices appear to connect to a logical bridge emulated by the provider core.

**Figure 22: VPLS Topology**

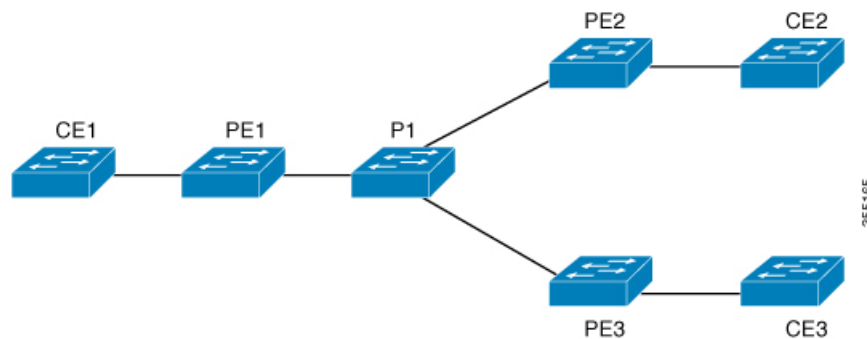

## About Full-Mesh Configuration

The full-mesh configuration requires a full mesh of tunnel label switched paths (LSPs) between all the provider edge (PE) devices that participate in the VPLS. With full-mesh configuration, signaling overhead and packet replication requirements for each provisioned VC on a PE device are high.

For a full-mesh configuration, a virtual forwarding instance (VFI) is required on each participating PE device. The VFI includes the VPN ID of a VPLS domain, the addresses of other PE devices in the domain, and the type of tunnel signaling and encapsulation mechanism for each peer PE device.

A VPLS instance constitutes a set of VFIs formed by the interconnection of the emulated VCs. The VPLS instance forms the logic bridge over the packet switched network. The VPLS instance is assigned a unique VPN ID.

The PE devices use the VFI to establish a full-mesh LSP of emulated VCs to all the other PE devices in the VPLS instance. PE devices obtain the membership of a VPLS instance through the static configuration using the Cisco IOS CLI.

The full-mesh configuration allows the PE device to maintain a single broadcast domain. So when the PE device receives a broadcast, multicast, or unknown unicast packet on an attachment circuit, it sends the packet out on all other attachment circuits and emulated circuits, to all the other CE devices participating in that VPLS instance. The CE devices see the VPLS instance as an emulated LAN.

To avoid the problem of a packet looping in the provider core, the PE devices enforce a 'split-horizon' principle for the emulated VCs. The split-horizon principle ensures that a packet received on an emulated VC is not forwarded on any other emulated VC.

After the VFI has been defined, it needs to be bound to an attachment circuit to the CE device.

The packet forwarding decision is made by looking up the Layer 2 VFI of a particular VPLS domain.

A VPLS instance on a particular PE device receives Ethernet frames that enter on specific physical or logical ports and populates a MAC address table similarly to how an Ethernet switch works. The PE device uses the MAC address to switch those frames into the appropriate LSP, for delivery to the other PE device at a remote site.

If a MAC address is not populated in the MAC address table, the PE device replicates the Ethernet frame and floods it to all logical ports associated with that VPLS instance, except on the ingress port where the Ethernet frame had entered. The PE device updates the MAC address table as it receives packets on specific ports and removes addresses not used after specific periods.

## About VPLS BGP-Based Autodiscovery

VPLS autodiscovery enables each PE device to discover other PE devices that are part of the same VPLS domain. VPLS autodiscovery also tracks PE devices when they are added to or removed from a VPLS domain. With VPLS autodiscovery enabled, it is no longer needed to manually configure a VPLS domain and maintain the configuration when a PE device is added or deleted. VPLS autodiscovery uses the Border Gateway Protocol (BGP) to discover VPLS members and set up and tear down pseudowires (PWs) in a VPLS domain.

BGP uses the Layer 2 VPN Routing Information Base (RIB) to store endpoint provisioning information, which is updated each time any Layer 2 VFI is configured. The prefix and path information is stored in the Layer 2 VPN database, which allows BGP to make decisions about the best path. When BGP distributes the endpoint provisioning information in an update message to all its BGP neighbors, this endpoint information is used to configure a pseudowire mesh to support Layer 2 VPN-based services.

The BGP autodiscovery mechanism facilitates the configuration of Layer 2 VPN services, which are an integral part of the VPLS feature. VPLS enables flexibility in deploying services by connecting geographically dispersed sites as a large LAN over high-speed Ethernet in a robust and scalable IP MPLS network.

## About Flow-Aware Transport Pseudowire

Devices typically load-balance traffic based on the lower most label in the label stack which is the same label for all flows on a given pseudowire. This can lead to asymmetric loadbalancing. The flow, in this context, refers to a sequence of packets that have the same source and destination pair. The packets are transported from a source provider edge (PE) device to a destination PE device.

Flow-aware transport PWs provide the capability to identify individual flows within a PW and provide devices the ability to use these flows to load-balance traffic. Flow-aware transport PWs are used to load-balance traffic in the core when equal cost multipaths (ECMP) are used. A flow label is created based on individual packet flows entering a PW; and is inserted as the lower most label in the packet. Devices can use the flow label for load-balancing which provides a better traffic distribution across ECMP paths or link-bundled paths in the core.

[Figure 23: Flow-aware transport PW with two flows distributing over ECMPs and Bundle-Links](#) shows a flow-aware transport PW with two flows distributing over ECMPs and bundle links.

Figure 23: Flow-aware transport PW with two flows distributing over ECMPs and Bundle-Links

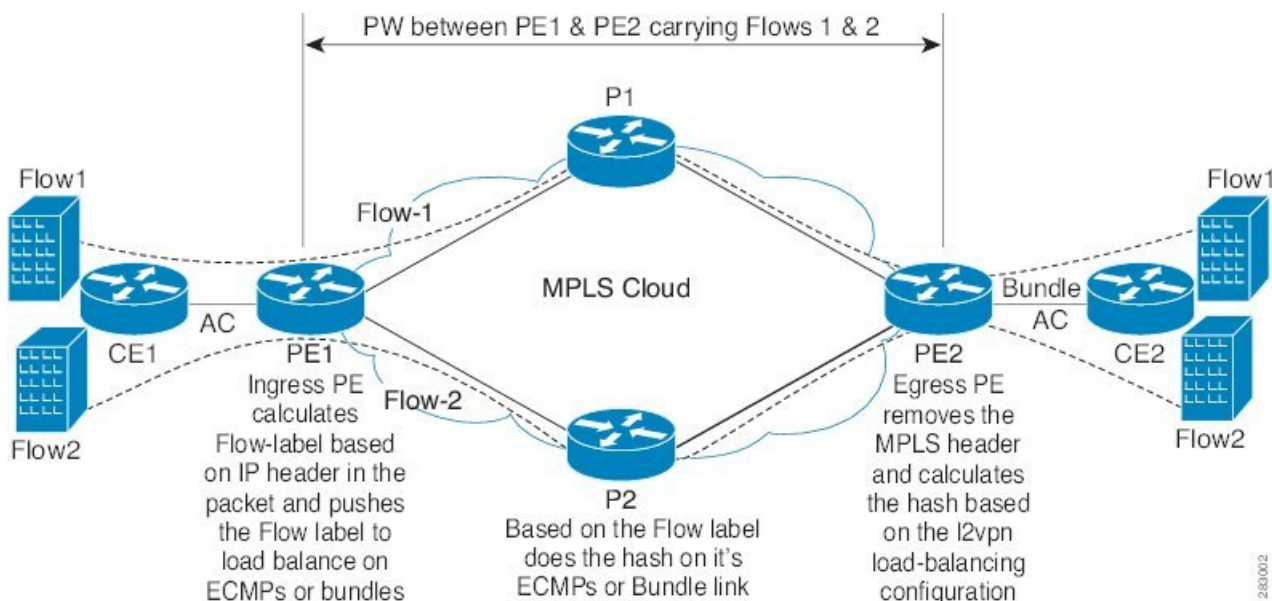

An extra label is added to the stack, called the flow label, which contains the flow information of a virtual circuit (VC). A flow label is a unique identifier that distinguishes a flow within the PW, and is derived from source and destination MAC addresses, and source and destination IP addresses. The flow label contains the end of label stack (EOS) bit set and inserted after the VC label and before the control word (if any). The ingress PE calculates and forwards the flow label. The flow-aware transport PW configuration enables the flow label. The egress PE discards the flow label such that no decisions are made.

All core devices perform load balancing based on the flow-label in the flow-aware transport PW. Therefore, it is possible to distribute flows over ECMPs and link bundles.

Flow-aware transport PW works based on port-channel load-balance algorithm only.

## Interoperability Between Cisco Catalyst 6000 Series Switches and Cisco Catalyst 9000 Series Switches

The following section describes how to enable sending and receiving flow labels between Cisco Catalyst 6000 Series Switches and Cisco Catalyst 9000 Series Switches.

On a Cisco Catalyst 6000 Series Switch configured with flow-aware transport PW (using Advanced VPLS) flow label negotiations are not supported. If the Cisco Catalyst 6000 Series Switch is in interoperability with a remote PE device such as a Cisco Catalyst 9000 Series Switch, then the Cisco Catalyst 9000 Series Switch cannot receive and send the flow label for data traffic. Configuring the **load-balance flow-label both static** command on the Cisco Catalyst 9000 Series Switch allows the Cisco Catalyst 9000 Series Switch to receive and send the flow labels even though the Cisco Catalyst 6000 Series Switch does not support flow label negotiations.

The following is a configuration example to enable sending and receiving flow labels:

```
Device> enable
Device# configure terminal
Device(config)# template type pseudowire mpls
Device(config-template)# encapsulation mpls
Device(config-template)# load-balance flow ip dst-ip
```



```
Device(config-template)# load-balance flow-label both static
Device(config-template)# end
```

# How to Configure VPLS, VPLS BGP-Based Autodiscovery and Flow-Aware Transport

The following sections provide configuration information about VPLS, VPLS BGP-based autodiscovery and flow-aware transport.

## Configuring Layer 2 PE Device Interfaces to CE Devices

You must configure Layer 2 PE device interfaces to CE devices. The following sections provide various configuration tasks that need to be completed before configuring VPLS.

### Configuring 802.1Q Trunks on a PE Device for Tagged Traffic from a CE Device

To configure 802.1Q trunks on a PE device, perform this procedure:

#### Procedure

	Command or Action	Purpose
<b>Step 1</b>	<b>enable</b> <b>Example:</b>  Device> <b>enable</b>	Enables privileged EXEC mode. Enter your password if prompted.
<b>Step 2</b>	<b>configure terminal</b> <b>Example:</b>  Device# <b>configure terminal</b>	Enters global configuration mode.
<b>Step 3</b>	<b>interface <i>interface-id</i></b> <b>Example:</b>  Device(config)# <b>interface</b> <b>TenGigabitEthernet1/0/24</b>	Defines the interface to be configured as a trunk, and enters interface configuration mode.
<b>Step 4</b>	<b>no ip address <i>ip_address mask</i> [secondary]</b> <b>Example:</b>  Device(config-if)# <b>no ip address</b>	Disables IP processing and enters interface configuration mode.
<b>Step 5</b>	<b>switchport</b> <b>Example:</b>  Device(config-if)# <b>switchport</b>	Modifies the switching characteristics of the Layer 2 switched interface.

	Command or Action	Purpose
<b>Step 6</b>	<b>switchport trunk encapsulation dot1q</b> <b>Example:</b> Device(config-if) # <b>switchport trunk encapsulation dot1q</b>	Sets the switch port encapsulation format to 802.1Q.
<b>Step 7</b>	<b>switchport trunk allow vlan <i>vlan_ID</i></b> <b>Example:</b> Device(config-if) # <b>switchport trunk allow vlan 2129</b>	Sets the list of allowed VLANs.
<b>Step 8</b>	<b>switchport mode trunk</b> <b>Example:</b> Device(config-if) # <b>switchport mode trunk</b>	Sets the interface to a trunking VLAN Layer 2 interface.
<b>Step 9</b>	<b>end</b> <b>Example:</b> Device(config-if) # <b>end</b>	Returns to privileged EXEC mode.

## Configuring 802.1Q Access Ports on a PE Device for Untagged Traffic from a CE Device

To configure 802.1Q access ports on a PE device, perform this procedure:

### Procedure

	Command or Action	Purpose
<b>Step 1</b>	<b>enable</b> <b>Example:</b> Device> <b>enable</b>	Enables privileged EXEC mode. Enter your password if prompted.
<b>Step 2</b>	<b>configure terminal</b> <b>Example:</b> Device# <b>configure terminal</b>	Enters global configuration mode.
<b>Step 3</b>	<b>interface <i>interface-id</i></b> <b>Example:</b> Device(config)# <b>interface TenGigabitEthernet1/0/24</b>	Defines the interface to be configured as a trunk, and enters interface configuration mode.

	Command or Action	Purpose
<b>Step 4</b>	<b>no ip address</b> <i>ip_address mask</i> [secondary ] <b>Example:</b>  Device(config-if)# <b>no ip address</b>	Disables IP processing.
<b>Step 5</b>	<b>switchport</b> <b>Example:</b>  Device(config-if)# <b>switchport</b>	Modifies the switching characteristics of the Layer 2 switched interface.
<b>Step 6</b>	<b>switchport mode access</b> <b>Example:</b>  Device(config-if)# <b>switchport mode access</b>	Sets the interface type to nontrunking and nontagged single VLAN Layer 2 interface.
<b>Step 7</b>	<b>switchport access vlan</b> <i>vlan_ID</i> <b>Example:</b>  Device(config-if)# <b>switchport access vlan</b> <b>2129</b>	Sets the VLAN when the interface is in access mode.
<b>Step 8</b>	<b>end</b> <b>Example:</b>  Device(config-if)# <b>end</b>	Returns to privileged EXEC mode.

## Configuring Layer 2 VLAN Instances on a PE Device

Configuring the Layer 2 VLAN interface on the PE device, enables the Layer 2 VLAN instance on the PE device to the VLAN database, to set up the mapping between the VPLS and VLANs.

To configure Layer 2 VLAN instance on a PE device, perform this procedure:

### Procedure

	Command or Action	Purpose
<b>Step 1</b>	<b>enable</b> <b>Example:</b>  Device> <b>enable</b>	Enables privileged EXEC mode.  Enter your password if prompted.
<b>Step 2</b>	<b>configure terminal</b> <b>Example:</b>  Device# <b>configure terminal</b>	Enters global configuration mode.

	Command or Action	Purpose
<b>Step 3</b>	<b>vlan</b> <i>vlan-id</i> <b>Example:</b>  Device(config)# <b>vlan 2129</b>	Configures a specific VLAN.
<b>Step 4</b>	<b>interface vlan</b> <i>vlan-id</i> <b>Example:</b>  Device(config-vlan)# <b>interface vlan 2129</b>	Configures an interface on the VLAN.
<b>Step 5</b>	<b>end</b> <b>Example:</b>  Device(config-vlan)# <b>end</b>	Returns to privileged EXEC mode.

## Configuring VPLS

VPLS can be configured using either the Xconnect mode or protocol-CLI method. The following sections provide information about how to configure VPLS.

### Configuring VPLS in Xconnect Mode

The following sections provide information on configuring VPLS in Xconnect mode.

#### Configuring MPLS on a PE Device

To configure MPLS on a PE device, perform this procedure:

##### Procedure

	Command or Action	Purpose
<b>Step 1</b>	<b>enable</b> <b>Example:</b>  Device> <b>enable</b>	Enables privileged EXEC mode. Enter your password if prompted.
<b>Step 2</b>	<b>configure terminal</b> <b>Example:</b>  Device# <b>configure terminal</b>	Enters global configuration mode.
<b>Step 3</b>	<b>mpls ip</b> <b>Example:</b>  Device(config)# <b>mpls ip</b>	Configures MPLS hop-by-hop forwarding.

	Command or Action	Purpose
<b>Step 4</b>	<b>mpls label protocol ldp</b> <b>Example:</b>  Device(config)# <b>mpls label protocol ldp</b>	Specifies the default Label Distribution Protocol (LDP) for a platform.
<b>Step 5</b>	<b>mpls ldp logging neighbor-changes</b> <b>Example:</b>  Device(config)# <b>mpls ldp logging neighbor-changes</b>	(Optional) Determines logging neighbor changes.
<b>Step 6</b>	<b>end</b> <b>Example:</b>  Device(config)# <b>end</b>	Returns to privileged EXEC mode.

### Configuring VFI on a PE Device

The VFI specifies the VPN ID of a VPLS domain, the addresses of other PE devices in this domain, and the type of tunnel signaling and encapsulation mechanism for each peer device.

To configure VFI and associated VCs on the PE device, perform this procedure:

#### Procedure

	Command or Action	Purpose
<b>Step 1</b>	<b>enable</b> <b>Example:</b>  Device> <b>enable</b>	Enables privileged EXEC mode.  Enter your password if prompted.
<b>Step 2</b>	<b>configure terminal</b> <b>Example:</b>  Device# <b>configure terminal</b>	Enters global configuration mode.
<b>Step 3</b>	<b>l2 vfi vfi-name manual</b> <b>Example:</b>  Device(config)# <b>l2 vfi 2129 manual</b>	Enables the Layer 2 VFI manual configuration mode.
<b>Step 4</b>	<b>vpn id vpn-id</b> <b>Example:</b>  Device(config-vfi)# <b>vpn id 2129</b>	Configures a VPN ID for a VPLS domain. The emulated VCs bound to this Layer 2 virtual routing and forwarding (VRF) use this VPN ID for signaling.  <b>Note</b> <i>vpn-id</i> is the same as <i>vlan-id</i> .

## Associating the Attachment Circuit with the VFI on the PE Device

	Command or Action	Purpose
<b>Step 5</b>	<b>neighbor</b> <i>router-id</i> { <b>encapsulation</b> <i>mpls</i> } <b>Example:</b> Device(config-vfi)# <b>neighbor</b> <b>remote-router-id encapsulation mpls</b>	Specifies the remote peering router ID and the tunnel encapsulation type or the pseudowire (PW) property to be used to set up the emulated VC.
<b>Step 6</b>	<b>end</b> <b>Example:</b> Device(config-vfi)# <b>end</b>	Returns to privileged EXEC mode.

## Associating the Attachment Circuit with the VFI on the PE Device

After defining the VFI, you must associate it to one or more attachment circuits.

To associate the attachment circuit with the VFI, perform this procedure:

## Procedure

	Command or Action	Purpose
<b>Step 1</b>	<b>enable</b> <b>Example:</b> Device> <b>enable</b>	Enables privileged EXEC mode. Enter your password if prompted.
<b>Step 2</b>	<b>configure terminal</b> <b>Example:</b> Device# <b>configure terminal</b>	Enters global configuration mode.
<b>Step 3</b>	<b>interface</b> <b>vlan</b> <i>vlan-id</i> <b>Example:</b> Device(config)# <b>interface</b> <b>vlan</b> <b>2129</b>	Creates or accesses a dynamic switched virtual interface (SVI).  <b>Note</b> <i>vlan-id</i> is the same as <i>vpn-id</i> .
<b>Step 4</b>	<b>no ip address</b> <b>Example:</b> Device(config-if)# <b>no ip address</b>	Disables IP processing. (You can configure a Layer 3 interface for the VLAN if you need to configure an IP address.)
<b>Step 5</b>	<b>xconnect</b> <b>vfi</b> <i>vfi-name</i> <b>Example:</b> Device(config-if)# <b>xconnect</b> <b>vfi</b> <b>2129</b>	Specifies the Layer 2 VFI that you are binding to the VLAN port.

	Command or Action	Purpose
<b>Step 6</b>	<b>end</b> <b>Example:</b> Device(config-if) # <b>end</b>	Returns to privileged EXEC mode.

## Configuring VPLS in Protocol-CLI Mode

The following sections provide information on configuring VPLS in protocol-CLI mode.

### Configuring VPLS in Protocol-CLI Mode

To configure VPLS in protocol-CLI mode, perform this procedure:

#### Procedure

	Command or Action	Purpose
<b>Step 1</b>	<b>enable</b> <b>Example:</b> Device> <b>enable</b>	Enables privileged EXEC mode. Enter your password if prompted.
<b>Step 2</b>	<b>configure terminal</b> <b>Example:</b> Device# <b>configure terminal</b>	Enters global configuration mode.
<b>Step 3</b>	<b>l2vpn vfi context <i>vfi-name</i></b> <b>Example:</b> Device(config) # <b>l2vpn vfi context vpls1</b>	Establishes an Layer 2 VPN VFI context and enters Layer 2 VFI configuration mode.
<b>Step 4</b>	<b>vpn id <i>vpn-id</i></b> <b>Example:</b> Device(config-vfi) # <b>vpn id 10</b>	Configures a VPN ID for the VPLS domain.
<b>Step 5</b>	<b>member <i>ip-address</i> encapsulation mpls</b> <b>Example:</b> Device(config-vfi) # <b>member 2.2.2.2 encapsulation mpls</b>	Specifies the devices that form a point-to-point Layer 2 VPN VFI connection.
<b>Step 6</b>	<b>exit</b> <b>Example:</b> Device(config-vfi) # <b>exit</b>	Exits to privileged EXEC mode.

	Command or Action	Purpose
<b>Step 7</b>	Select one of the following: <ul style="list-style-type: none"> <li>• <b>vlan configuration</b> <i>vlan-id</i></li> <li>• <b>interface vlan</b> <i>vlan-id</i></li> </ul> <b>Example:</b>  Device(config)# <b>vlan configuration</b> 100 OR Device(config)# <b>interface vlan</b> 100	Applies configuration to be applied on the VLAN or interface and enters VLAN or interface configuration mode.
<b>Step 8</b>	<b>member vfi</b> <i>vfi-name</i>  <b>Example:</b>  Device(config-vlan-config)# <b>member vfi</b> vpls1	Binds a VFI instance to a VLAN or an interface.
<b>Step 9</b>	<b>end</b>  <b>Example:</b>  Device(config-vlan-config)# <b>end</b>	Returns to privileged EXEC mode.

### Configuring VPLS Flow-Aware Transport with Pseudowire Interface (in Protocol-CLI Mode)

To configure VPLS flow-aware transport with pseudowire interface, perform this procedure:

#### Procedure

	Command or Action	Purpose
<b>Step 1</b>	<b>enable</b>  <b>Example:</b>  Device> <b>enable</b>	Enables privileged EXEC mode. Enter your password if prompted.
<b>Step 2</b>	<b>configure terminal</b>  <b>Example:</b>  Device# <b>configure terminal</b>	Enters global configuration mode.
<b>Step 3</b>	<b>interface pseudowire</b> <i>number</i>  <b>Example:</b>  Device(config)# <b>interface pseudowire</b> 1001	Establishes a PW with the specified name, and enters pseudowire interface configuration mode.
<b>Step 4</b>	<b>encapsulation mpls</b>  <b>Example:</b>  Device(config-if)# <b>encapsulation mpls</b>	Specifies the tunneling encapsulation as MPLS.



	Command or Action	Purpose
<b>Step 5</b>	<b>neighbor</b> <i>peer-address</i> <i>vcid-value</i> <b>Example:</b> Device(config-if)# <b>neighbor</b> 10.1.1.200 200	Specifies the peer IP address and VC ID value of a Layer 2 VPN PW.
<b>Step 6</b>	<b>load-balance flow</b> <b>Example:</b> Device(config-if)# <b>load-balance flow</b>	Enables the load balancing with PW feature so that load balancing is done on a per-flow basis.
<b>Step 7</b>	<b>load-balance flow-label</b> <b>Example:</b> Device(config-if)# <b>load-balance flow-label both</b>	Enables the flow-aware transport of MPLS PW feature and specifies how flow labels are to be used.
<b>Step 8</b>	<b>exit</b> <b>Example:</b> Device(config-if)# <b>exit</b>	Exits to privileged EXEC mode.
<b>Step 9</b>	<b>l2vpn vfi context</b> <i>vfi-name</i> <b>Example:</b> Device(config)# <b>l2vpn vfi context vpls1</b>	Establishes an Layer 2 VPN VFI context and enters Layer 2 VFI configuration mode.
<b>Step 10</b>	<b>vpn id</b> <i>vpn-id</i> <b>Example:</b> Device(config-vfi)# <b>vpn id 10</b>	Configures a VPN ID for the VPLS domain.
<b>Step 11</b>	<b>member pseudowire</b> <i>number</i> <b>Example:</b> Device(config-vfi)# <b>member pseudowire 1001</b>	Adds the pseudowire interface as a member of the VFI.
<b>Step 12</b>	<b>exit</b> <b>Example:</b> Device(config-vfi)# <b>exit</b>	Exits to privileged EXEC mode.
<b>Step 13</b>	Select one of the following: <ul style="list-style-type: none"> <li>• <b>vlan configuration</b> <i>vlan-id</i></li> <li>• <b>interface vlan</b> <i>vlan-id</i></li> </ul> <b>Example:</b>	Applies configuration to be applied on the VLAN or interface and enters VLAN or interface configuration mode.

	Command or Action	Purpose
	Device (config) # <b>vlan configuration 100</b> OR Device (config) # <b>interface vlan 100</b>	
<b>Step 14</b>	<b>member vfi</b> <i>vfi-name</i> <b>Example:</b> Device (config-vlan-config) # <b>member vfi</b> <b>vp1s1</b>	Binds a VFI instance to a VLAN or an interface.
<b>Step 15</b>	<b>end</b> <b>Example:</b> Device (config-vlan-config) # <b>end</b>	Returns to privileged EXEC mode.

### Configuring VPLS Flow-Aware Transport Using a Template (in Protocol-CLI Mode)

Configuring VPLS flow-aware transport using a template allows multiple PWs to share the same configuration. To configure VPLS flow-aware transport using a template, perform this procedure:

#### Procedure

	Command or Action	Purpose
<b>Step 1</b>	<b>enable</b> <b>Example:</b> Device> <b>enable</b>	Enables privileged EXEC mode. Enter your password if prompted.
<b>Step 2</b>	<b>configure terminal</b> <b>Example:</b> Device# <b>configure terminal</b>	Enters global configuration mode.
<b>Step 3</b>	<b>template type pseudowire</b> [ <i>template-name</i> ] <b>Example:</b> Device (config) # <b>template type pseudowire</b> <b>mpls</b>	Specifies the name of a Layer 2 PW and enters pseudowire template configuration mode.
<b>Step 4</b>	<b>encapsulation mpls</b> <b>Example:</b> Device (config-template) # <b>encapsulation</b> <b>mpls</b>	Specifies the tunneling encapsulation as MPLS.

	Command or Action	Purpose
<b>Step 5</b>	<b>load-balance flow</b> <b>Example:</b> Device(config-template)# <b>load-balance flow</b>	Enables the load balancing with PW feature so that load balancing is done on a per-flow basis.
<b>Step 6</b>	<b>load-balance flow-label</b> <b>Example:</b> Device(config-template)# <b>load-balance flow-label both</b>	Enables the flow-aware transport of MPLS PW feature and specifies how flow labels are to be used.
<b>Step 7</b>	<b>exit</b> <b>Example:</b> Device(config-template)# <b>exit</b>	Exits to privileged EXEC mode.
<b>Step 8</b>	<b>l2vpn vfi context vfi-name</b> <b>Example:</b> Device(config)# <b>l2vpn vfi context vpls1</b>	Establishes an Layer 2 VPN VFI context and enters Layer 2 VFI configuration mode.
<b>Step 9</b>	<b>vpn id vpn-id</b> <b>Example:</b> Device(config-vfi)# <b>vpn id 10</b>	Configures a VPN ID for the VPLS domain.
<b>Step 10</b>	<b>member ip-address template template-name</b> <b>Example:</b> Device(config-vfi)# <b>member 102.102.102.102 template mpls</b>	Specifies the devices that form a point-to-point Layer 2 VPN VFI connection. <ul style="list-style-type: none"> <li>• <b>ip-address</b>: IP address of the VFI neighbor.</li> <li>• <b>template template-name</b>: Specifies the template name mpls as the template method.</li> </ul>
<b>Step 11</b>	<b>exit</b> <b>Example:</b> Device(config-vfi)# <b>exit</b>	Exits to privileged EXEC mode.
<b>Step 12</b>	Select one of the following: <ul style="list-style-type: none"> <li>• <b>vlan configuration vlan-id</b></li> <li>• <b>interface vlan vlan-id</b></li> </ul> <b>Example:</b> Device(config)# <b>vlan configuration 100</b>	Applies configuration to be applied on the VLAN or interface and enters VLAN or interface configuration mode.

	Command or Action	Purpose
	OR Device (config) # <b>interface</b> vlan 100	
<b>Step 13</b>	<b>member vfi</b> <i>vfi-name</i> <b>Example:</b>  Device (config-vlan-config) # <b>member vfi</b> <b>vpls1</b>	Binds a VFI instance to a VLAN or an interface.
<b>Step 14</b>	<b>end</b> <b>Example:</b>  Device (config-vlan-config) # <b>end</b>	Exits to privileged EXEC mode.

**Configuring VPLS Flow-Aware Transport Using Pseudowire and a Template (in Protocol-CLI Mode)**

To configure VPLS flow-aware transport using both PW and a template, perform this procedure:

**Procedure**

	Command or Action	Purpose
<b>Step 1</b>	<b>enable</b> <b>Example:</b>  Device> <b>enable</b>	Enables privileged EXEC mode.  Enter your password if prompted.
<b>Step 2</b>	<b>configure terminal</b> <b>Example:</b>  Device# <b>configure terminal</b>	Enters global configuration mode.
<b>Step 3</b>	<b>template type pseudowire</b> [ <i>template-name</i> ] <b>Example:</b>  Device (config) # <b>template type pseudowire</b> <b>mpls</b>	Specifies the name of a Layer 2 PW and enters pseudowire template configuration mode.
<b>Step 4</b>	<b>encapsulation mpls</b> <b>Example:</b>  Device (config-template) # <b>encapsulation</b> <b>mpls</b>	Specifies the tunneling encapsulation as MPLS.
<b>Step 5</b>	<b>load-balance flow</b> <b>Example:</b>  Device (config-template) # <b>load-balance</b> <b>flow</b>	Enables the load balancing with PW feature so that load balancing is done on a per-flow basis.

	Command or Action	Purpose
<b>Step 6</b>	<b>load-balance flow-label</b> <b>Example:</b> Device(config-template)# <b>load-balance flow-label both</b>	Enables the flow-aware transport of MPLS PW feature and specifies how flow labels are to be used.
<b>Step 7</b>	<b>exit</b> <b>Example:</b> Device(config-template)# <b>exit</b>	Exits to privileged EXEC mode.
<b>Step 8</b>	<b>interface pseudowire number</b> <b>Example:</b> Device(config)# <b>interface pseudowire 1001</b>	Establishes a PW with the specified name, and enters pseudowire interface configuration mode.
<b>Step 9</b>	<b>source template type pseudowire [template-name]</b> <b>Example:</b> Device(config-if)# <b>source template type pseudowire mpls</b>	Configures the source template of type pseudowire named mpls.
<b>Step 10</b>	<b>neighbor peer-address vcid-value</b> <b>Example:</b> Device(config-if)# <b>neighbor 10.1.1.200 200</b>	Specifies the peer IP address and VC ID value of a Layer 2 VPN PW.
<b>Step 11</b>	<b>exit</b> <b>Example:</b> Device(config-if)# <b>exit</b>	Exits to privileged EXEC mode.
<b>Step 12</b>	<b>l2vpn vfi context vfi-name</b> <b>Example:</b> Device(config)# <b>l2vpn vfi context vpls1</b>	Establishes an Layer 2 VPN VFI context and enters Layer 2 VFI configuration mode.
<b>Step 13</b>	<b>vpn id vpn-id</b> <b>Example:</b> Device(config-vfi)# <b>vpn id 10</b>	Configures a VPN ID for the VPLS domain.
<b>Step 14</b>	<b>member pseudowire number</b> <b>Example:</b>	Adds the pseudowire interface as a member of the VFI.

	Command or Action	Purpose
	Device (config-vfi) # <b>member pseudowire 1001</b>	
<b>Step 15</b>	<b>exit</b> <b>Example:</b> Device (config-vfi) # <b>exit</b>	Exits to privileged EXEC mode.
<b>Step 16</b>	Select one of the following: <ul style="list-style-type: none"> <li>• <b>vlan configuration</b> <i>vlan-id</i></li> <li>• <b>interface vlan</b> <i>vlan-id</i></li> </ul> <b>Example:</b> Device (config) # <b>vlan configuration 100</b> OR Device (config) # <b>interface vlan 100</b>	Applies configuration to be applied on the VLAN or interface and enters VLAN or interface configuration mode.
<b>Step 17</b>	<b>member vfi</b> <i>vfi-name</i> <b>Example:</b> Device (config-vlan-config) # <b>member vfi vpls1</b>	Binds a VFI instance to a VLAN or an interface.
<b>Step 18</b>	<b>end</b> <b>Example:</b> Device (config-vlan-config) # <b>end</b>	Exits to privileged EXEC mode.

## Configuring VPLS BGP-based Autodiscovery

The following sections provide information about how to configure VPLS BGP-based Autodiscovery.

### Enabling VPLS BGP-based Autodiscovery

To enabling VPLS BGP-based autodiscovery, perform this procedure:

#### Procedure

	Command or Action	Purpose
<b>Step 1</b>	<b>enable</b> <b>Example:</b> Device> <b>enable</b>	Enables privileged EXEC mode. Enter your password if prompted.

	Command or Action	Purpose
<b>Step 2</b>	<b>configure terminal</b> <b>Example:</b>  Device# <code>configure terminal</code>	Enters global configuration mode.
<b>Step 3</b>	<b>l2 vfi <i>vfi-name</i> autodiscovery</b> <b>Example:</b>  Device(config)# <code>l2 vfi 2128 autodiscovery</code>	Enables VPLS autodiscovery on a PE device and enters L2 VFI configuration mode.
<b>Step 4</b>	<b>vpn id <i>vpn-id</i></b> <b>Example:</b>  Device(config-vfi)# <code>vpn id 2128</code>	Configures a VPN ID for the VPLS domain.
<b>Step 5</b>	<b>end</b> <b>Example:</b>  Device(config-vfi)# <code>end</code>	Returns to privileged EXEC mode.

## Configuring BGP to Enable VPLS Autodiscovery

To configure BGP to enable VPLS autodiscovery, perform this procedure:

### Procedure

	Command or Action	Purpose
<b>Step 1</b>	<b>enable</b> <b>Example:</b>  Device> <code>enable</code>	Enables privileged EXEC mode.  Enter your password if prompted.
<b>Step 2</b>	<b>configure terminal</b> <b>Example:</b>  Device# <code>configure terminal</code>	Enters global configuration mode.
<b>Step 3</b>	<b>router bgp <i>autonomous-system-number</i></b> <b>Example:</b>	Enters router configuration mode for the specified routing process.

	Command or Action	Purpose
	Device(config)# <b>router bgp 1000</b>	
<b>Step 4</b>	<p><b>no bgp default ipv4-unicast</b></p> <p><b>Example:</b></p> <pre>Device(config-router)# no bgp default ipv4-unicast</pre>	<p>Disables the IPv4 unicast address family for the BGP routing process.</p> <p><b>Note</b> Routing information for the IPv4 unicast address family is advertised by default for each BGP routing session configured using the <b>neighbor remote-as router</b> command unless you configure the <b>no bgp default ipv4-unicast</b> command before configuring the <b>neighbor remote-as</b> command. Existing neighbor configurations are not affected.</p>
<b>Step 5</b>	<p><b>bgp log-neighbor-changes</b></p> <p><b>Example:</b></p> <pre>Device(config-router)# bgp log-neighbor-changes</pre>	Enables logging of BGP neighbor resets.
<b>Step 6</b>	<p><b>neighbor remote-as { ip-address   peer-group-name } remote-as autonomous-system-number</b></p> <p><b>Example:</b></p> <pre>Device(config-router)# neighbor 44.254.44.44 remote-as 1000</pre>	<p>Adds the IP address or peer group name of the neighbor in the specified autonomous system to the IPv4 multiprotocol BGP neighbor table of the local device.</p> <ul style="list-style-type: none"> <li>• If the <i>autonomous-system-number</i> argument matches the autonomous system number specified in the <b>router bgp</b> command, the neighbor is an internal neighbor.</li> <li>• If the <i>autonomous-system-number</i> argument does not match the autonomous system number specified in the <b>router bgp</b> command, the neighbor is an external neighbor.</li> </ul>
<b>Step 7</b>	<p><b>neighbor { ip-address   peer-group-name } update-source interface-type interface-number</b></p> <p><b>Example:</b></p> <pre>Device(config-router)# neighbor 44.254.44.44 update-source Loopback300</pre>	(Optional) Configures a device to select a specific source or interface to receive routing table updates.



	Command or Action	Purpose
<b>Step 8</b>	Repeat Steps 6 and 7 to configure other BGP neighbors.	Exits interface configuration mode.
<b>Step 9</b>	<b>address-family l2vpn [vpls]</b> <b>Example:</b>  Device(config-router)# <b>address-family l2vpn vpls</b>	Specifies the Layer 2 VPN address family and enters address family configuration mode.  The optional <b>vpls</b> keyword specifies that the VPLS endpoint provisioning information is to be distributed to BGP peers.
<b>Step 10</b>	<b>neighbor { ip-address   peer-group-name } activate</b> <b>Example:</b>  Device(config-router-af)# <b>neighbor 44.254.44.44 activate</b>	Enables the exchange of information with a BGP neighbor.
<b>Step 11</b>	<b>neighbor { ip-address   peer-group-name } send-community { both   standard   extended }</b> <b>Example:</b>  Device(config-router-af)# <b>neighbor 44.254.44.44 send-community both</b>	Specifies that a communities attribute should be sent to a BGP neighbor.
<b>Step 12</b>	Repeat Steps 10 and 11 to activate other BGP neighbors under an L2VPN address family.	
<b>Step 13</b>	<b>exit-address-family</b> <b>Example:</b>  Device(config-router-af)# <b>exit-address-family</b>	Exits address family configuration mode and returns to router configuration mode.
<b>Step 14</b>	<b>end</b> <b>Example:</b>  Device(config-router)# <b>end</b>	Exits router configuration mode and returns to privileged EXEC mode.

## Configuring VPLS BGP-based Autodiscovery in Protocol-CLI Mode

The following sections provide information on configuring VPLS BGP-based autodiscovery in protocol-CLI mode.

**Configuring VPLS BGP based Autodiscovery in Protocol-CLI mode**

To configure VPLS BGP based autodiscovery in protocol-CLI mode, perform this procedure

**Procedure**

	<b>Command or Action</b>	<b>Purpose</b>
<b>Step 1</b>	<b>enable</b> <b>Example:</b> Device> <b>enable</b>	Enables privileged EXEC mode. Enter your password if prompted.
<b>Step 2</b>	<b>configure terminal</b> <b>Example:</b> Device# <b>configure terminal</b>	Enters global configuration mode.
<b>Step 3</b>	<b>l2vpn vfi context <i>vfi-name</i></b> <b>Example:</b> Device (config)# <b>l2vpn vfi context vpls1</b>	Establishes an Layer 2 VPN VFI context and enters Layer 2 VFI configuration mode.
<b>Step 4</b>	<b>vpn id <i>vpn-id</i></b> <b>Example:</b> Device (config-vfi)# <b>vpn id 10</b>	Configures a VPN ID for the VPLS domain.
<b>Step 5</b>	<b>autodiscovery bgp signaling ldp</b> <b>Example:</b> Device (config-vfi)# <b>autodiscovery bgp signaling ldp</b>	Enables BGP signaling and LDP signaling.
<b>Step 6</b>	<b>exit</b> <b>Example:</b> Device (config-vfi-autodiscovery)# <b>exit</b>	Exits to privileged EXEC mode.
<b>Step 7</b>	<b>exit</b> <b>Example:</b> Device (config-vfi)# <b>exit</b>	Exits to privileged EXEC mode.
<b>Step 8</b>	Select one of the following: <ul style="list-style-type: none"> <li>• <b>vlan configuration <i>vlan-id</i></b></li> <li>• <b>interface vlan <i>vlan-id</i></b></li> </ul> <b>Example:</b>	Applies configuration to be applied on the VLAN or interface and enters VLAN or interface configuration mode.

	Command or Action	Purpose
	Device (config) # <b>vlan configuration 100</b> OR Device (config) # <b>interface vlan 100</b>	
<b>Step 9</b>	<b>member vfi</b> <i>vfi-name</i> <b>Example:</b> Device (config-vlan-config) # <b>member vfi vpls1</b>	Binds a VFI instance to a VLAN or an interface.
<b>Step 10</b>	<b>end</b> <b>Example:</b> Device (config-vlan-config) # <b>end</b>	Exits to privileged EXEC mode.

### Configuring VPLS BGP based Autodiscovery Flow-Aware Transport using Template (in Protocol-CLI Mode)

To configure VPLS BGP based autodiscovery flow-aware transport using template, perform this procedure

#### Procedure

	Command or Action	Purpose
<b>Step 1</b>	<b>enable</b> <b>Example:</b> Device> <b>enable</b>	Enables privileged EXEC mode. Enter your password if prompted.
<b>Step 2</b>	<b>configure terminal</b> <b>Example:</b> Device# <b>configure terminal</b>	Enters global configuration mode.
<b>Step 3</b>	<b>template type pseudowire</b> [ <i>template-name</i> ] <b>Example:</b> Device (config) # <b>template type pseudowire mpls</b>	Specifies the name of a Layer 2 PW and enters pseudowire template configuration mode.
<b>Step 4</b>	<b>encapsulation mpls</b> <b>Example:</b> Device (config-template) # <b>encapsulation mpls</b>	Specifies the tunneling encapsulation as MPLS.

	Command or Action	Purpose
<b>Step 5</b>	<b>load-balance flow</b> <b>Example:</b> Device(config-template) # <b>load-balance flow</b>	Enables the Any Transport over MPLS (AToM) load balancing with PW feature so that load balancing is done on a per-flow basis.
<b>Step 6</b>	<b>load-balance flow-label</b> <b>Example:</b> Device(config-template) # <b>load-balance flow-label both</b>	Enables the flow-aware transport of MPLS PW feature and specifies how flow labels are to be used.
<b>Step 7</b>	<b>exit</b> <b>Example:</b> Device(config-template) # <b>exit</b>	Exits to privileged EXEC mode.
<b>Step 8</b>	<b>l2vpn vfi context vfi-name</b> <b>Example:</b> Device(config) # <b>l2vpn vfi context vpls1</b>	Establishes an Layer 2 VPN VFI context and enters Layer 2 VFI configuration mode.
<b>Step 9</b>	<b>vpn id vpn-id</b> <b>Example:</b> Device(config-vfi) # <b>vpn id 10</b>	Configures a VPN ID for the VPLS domain.
<b>Step 10</b>	<b>autodiscovery bgp signaling ldp template name</b> <b>Example:</b> Device(config-vfi) # <b>autodiscovery bgp signaling ldp template mpls</b>	Enables BGP signaling and LDP signaling.
<b>Step 11</b>	<b>exit</b> <b>Example:</b> Device(config-vfi) # <b>exit</b>	Exits to privileged EXEC mode.
<b>Step 12</b>	Select one of the following: <ul style="list-style-type: none"> <li>• <b>vlan configuration vlan-id</b></li> <li>• <b>interface vlan vlan-id</b></li> </ul> <b>Example:</b> Device(config) # <b>vlan configuration 100</b> OR Device(config) # <b>interface vlan 100</b>	Applies configuration to be applied on the VLAN or interface and enters VLAN or interface configuration mode.

	Command or Action	Purpose
Step 13	<b>member vfi</b> <i>vfi-name</i> <b>Example:</b> Device (config-vlan-config) # <b>member vfi</b> <b>vpls1</b>	Binds a VFI instance to a VLAN or an interface.
Step 14	<b>end</b> <b>Example:</b> Device (config-vlan-config) # <b>end</b>	Exits to privileged EXEC mode.

## Configuration Examples for VPLS and VPLS BGP-Based Autodiscovery

This section provides the configuration examples for VPLS and VPLS BGP-Based Autodiscovery.

### Example: Configuring VPLS in Xconnect Mode

The following example shows how to configure VPLS on a PE1 and PE2 devices:

Figure 24: VPLS Topology

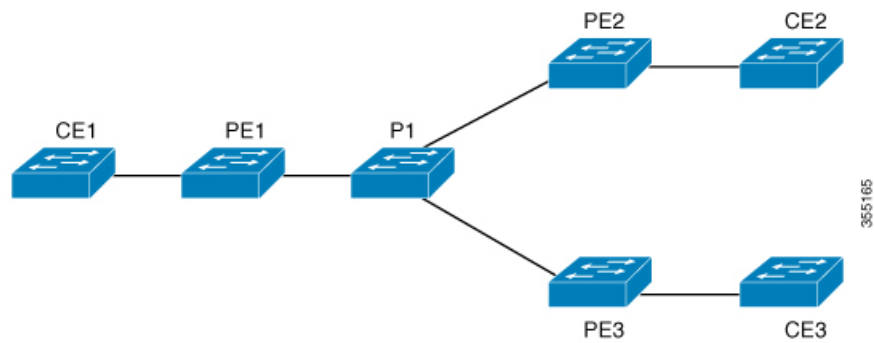

**PE1 Configuration**

```

Device> enable
Device# configure terminal
Device(config)# pseudowire-class vpls2129
Device(config-if)# encapsulation mpls
Device(config-if)# exit
Device(config)# 12 vfi 2129 manual
Device(config-vfi)# vpn id 2129
Device(config-vfi)# neighbor 44.254.44.44 pw-class vpls2129
Device(config-vfi)# neighbor 188.98.89.98 pw-class vpls2129
Device(config-vfi)# exit
Device(config)# interface TenGigabitEthernet1/0/24
Device(config-if)# switchport trunk allowed vlan 2129
Device(config-if)# switchport mode trunk
Device(config-if)# exit
Device(config)# interface vlan 2129
Device(config-vlan-config)# no ip address
Device(config-vlan-config)# xconnect vfi 2129

```

**Examples: Verifying VPLS Configured in Xconnect Mode**

The following example is a sample output of the **show mpls 12transport vc detail** command. This command provides information about the virtual circuits.

```

Device# show mpls 12transport vc detail
Local interface: VFI 2129 vfi up
Interworking type is Ethernet
Destination address: 44.254.44.44, VC ID: 2129, VC status: up
Output interface: Gi1/0/9, imposed label stack {18 17}
Preferred path: not configured
Default path: active
Next hop: 177.77.177.2
Create time: 19:09:33, last status change time: 09:24:14
Last label FSM state change time: 09:24:14
Signaling protocol: LDP, peer 44.254.44.44:0 up
Targeted Hello: 1.1.1.72(LDP Id) -> 44.254.44.44, LDP is UP
Graceful restart: configured and enabled
Non stop routing: not configured and not enabled
Status TLV support (local/remote) : enabled/supported
LDP route watch : enabled
Label/status state machine : established, LruRru
Last local dataplane status rcvd: No fault
Last BFD dataplane status rcvd: Not sent
Last BFD peer monitor status rcvd: No fault
Last local AC circuit status rcvd: No fault
Last local AC circuit status sent: No fault
Last local PW i/f circ status rcvd: No fault
Last local LDP TLV status sent: No fault
Last remote LDP TLV status rcvd: No fault
Last remote LDP ADJ status rcvd: No fault
MPLS VC labels: local 512, remote 17
Group ID: local n/a, remote 0
MTU: local 1500, remote 1500
Remote interface description:
Sequencing: receive disabled, send disabled
Control Word: Off

```

```
SSO Descriptor: 44.254.44.44/2129, local label: 512
Dataplane:
  SSM segment/switch IDs: 20498/20492 (used), PWID: 2
VC statistics:
  transit packet totals: receive 0, send 0
  transit byte totals:   receive 0, send 0
  transit packet drops: receive 0, seq error 0, send 0
```

The following example is a sample output of the **show l2vpn atom vc** command. The command shows that AToM over MPLS is configured on a VC.

```
Device# show l2vpn atom vc detail

pseudowire100005 is up, VC status is up PW type: Ethernet
  Create time: 19:25:56, last status change time: 09:40:37
  Last label FSM state change time: 09:40:37
  Destination address: 44.254.44.44 VC ID: 2129
  Output interface: Gi1/0/9, imposed label stack {18 17}
  Preferred path: not configured
  Default path: active
  Next hop: 177.77.177.2
Member of vfi service 2129
  Bridge-Domain id: 2129
  Service id: 0x32000003
Signaling protocol: LDP, peer 44.254.44.44:0 up
  Targeted Hello: 1.1.1.72(LDP Id) -> 44.254.44.44, LDP is UP
  Graceful restart: configured and enabled
  Non stop routing: not configured and not enabled
  Pwid FEC (128), VC ID: 2129
  Status TLV support (local/remote)      : enabled/supported
  LDP route watch                       : enabled
  Label/status state machine            : established, LruRru
  Local dataplane status received       : No fault
  BFD dataplane status received         : Not sent
  BFD peer monitor status received      : No fault
  Status received from access circuit   : No fault
  Status sent to access circuit         : No fault
  Status received from pseudowire i/f   : No fault
  Status sent to network peer           : No fault
  Status received from network peer     : No fault
  Adjacency status of remote peer       : No fault
Sequencing: receive disabled, send disabled
Bindings
  Parameter      Local                               Remote
  -----
  Label          512                                           17
  Group ID      n/a                                           0
  Interface
  MTU           1500                                           1500
  Control word  off                                           off
  PW type       Ethernet                                         Ethernet
  VCCV CV type  0x02                                           0x02
                LSPV [2]                               LSPV [2]
  VCCV CC type  0x06                                           0x06
                RA [2], TTL [3]                         RA [2], TTL [3]
  Status TLV    enabled                                         supported
SSO Descriptor: 44.254.44.44/2129, local label: 512
Dataplane:
  SSM segment/switch IDs: 20498/20492 (used), PWID: 2
Rx Counters
  0 input transit packets, 0 bytes
```

```

0 drops, 0 seq err
Tx Counters
0 output transit packets, 0 bytes
0 drops

```

## Example: Configuring VPLS Flow-Aware Transport Using a Template (in Protocol-CLI Mode)

The following example shows how to configure VPLS on a PE1 and PE2 devices:

Figure 25: VPLS Topology

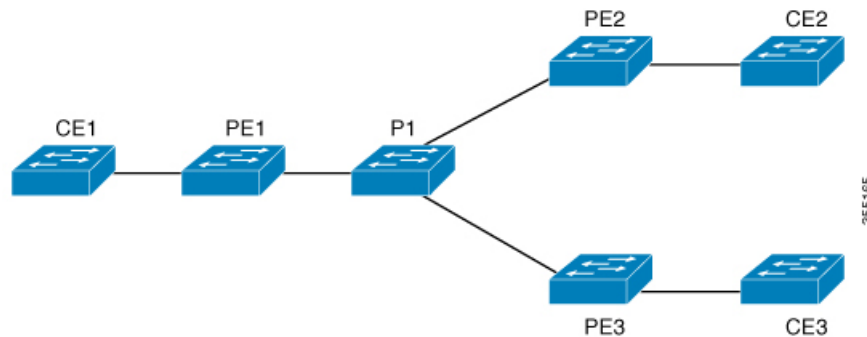

### PE1 Configuration

```

Device> enable
Device# configure terminal
Device(config)# template type pseudowire mpls
Device(config-template)# encapsulation mpls
Device(config-template)# load-balance flow ip dst-ip
Device(config-template)# load-balance flow-label both
Device(config-template)# exit
Device(config)# interface Loopback0
Device(config-if)# ip address 1.1.1.30 255.255.255.255
Device(config-if)# ip ospf 1 area 0
Device(config-if)# exit
Device(config)# interface TwentyFiveGigE1/0/9
Device(config-if)# no switchport
Device(config-if)# ip address 80.0.0.30 255.255.255.0
Device(config-if)# ip ospf 1 area 0
Device(config-if)# mpls ip
Device(config-if)# exit
Device(config)# l2vpn vfi context foo
Device(config-vfi)# vpn id 2129
Device(config-vfi)# member 1.1.1.20 template mpls
Device(config-vfi)# exit
Device(config)# interface TwentyFiveGigE1/0/2
Device(config-if)# switchport mode access
Device(config-if)# switchport access vlan 100
Device(config-if)# exit
Device(config)# interface vlan 100
Device(config-vlan-config)# member vfi foo
Device(config-vlan-config)# end

```



## Example: Configuring VPLS BGP-Auto Discovery

The following example shows how to configure VPLS on a PE device:

```
Device> enable
Device# configure terminal
Device(config)# router bgp 1000
Device(config-router)# bgp log-neighbor-changes
Device(config-router)# bgp graceful-restart
Device(config-router)# neighbor 44.254.44.44 remote-as 1000
Device(config-router)# neighbor 44.254.44.44 update-source Loopback300
Device(config-router)# address-family l2vpn vpls
Device(config-router-af)# neighbor 44.254.44.44 activate
Device(config-router-af)# neighbor 44.254.44.44 send-community both
Device(config-router-af)# exit-address-family
Device(config-router-af)# end
Device(config)# l2 vfi 2128 autodiscovery
Device(config-vfi)# vpn id 2128
Device(config-vfi)# exit
Device(config)# interface vlan 2128
Device(config-vlan-config)# no ip address
Device(config-vlan-config)# xconnect vfi 2128
!
```

## Example: Verifying VPLS BGP-Auto Discovery

The following example is a sample output of the **show platform software fed sw 1 matm macTable vlan 2000** command.

```
Device# show platform software fed sw 1 matm macTable vlan 2000

VLAN  MAC                Type      Seq#   macHandle          siHandle          diHandle
     *a_time *e_time  ports
2000  2852.6134.05c8      0x8002   0      0xffbba312c8      0xffbb9ef938     0x5154
     0          0      Vlan2000
2000  0000.0078.9012      0x1     32627  0xffbb665ec8      0xffbb60b198     0xffbb653f98
     300      278448  Port-channel11
2000  2852.6134.0000      0x1     32651  0xffba15e1a8      0xff454c2328     0xffbb653f98
     300      63      Port-channel11
2000  0000.0012.3456      0x2000001 32655  0xffba15c508      0xff44f9ec98     0x0
     300      1      2000:33.33.33

Total Mac number of addresses:: 4
*a_time=aging_time(secs) *e_time=total_elapsed_time(secs)
Type:
MAT_DYNAMIC_ADDR      0x1      MAT_STATIC_ADDR      0x2
MAT_CPU_ADDR          0x4      MAT_DISCARD_ADDR      0x8
MAT_ALL_VLANS         0x10     MAT_NO_FORWARD        0x20
MAT_IPMULT_ADDR       0x40     MAT_RESYNC            0x80
MAT_DO_NOT_AGE        0x100    MAT_SECURE_ADDR       0x200
MAT_NO_PORT           0x400    MAT_DROP_ADDR         0x800
MAT_DUP_ADDR          0x1000   MAT_NULL_DESTINATION  0x2000
MAT_DOT1X_ADDR        0x4000   MAT_ROUTER_ADDR       0x8000
MAT_WIRELESS_ADDR     0x10000  MAT_SECURE_CFG_ADDR   0x20000
MAT_OPQ_DATA_PRESENT  0x40000  MAT_WIRED_TUNNEL_ADDR 0x80000
MAT_DLR_ADDR          0x100000 MAT_MRP_ADDR          0x200000
```

```
MAT_MSRP_ADDR      0x400000  MAT_LISP_LOCAL_ADDR  0x800000
MAT_LISP_REMOTE_ADDR 0x1000000 MAT_VPLS_ADDR      0x2000000
```

The following example is a sample output of the **show bgp l2vpn vpls all** command.

```
Device# show bgp l2vpn vpls all

BGP table version is 6, local router ID is 222.5.1.1
Status codes: s suppressed, d damped, h history, * valid, > best, i - internal,
               r RIB-failure, S Stale, m multipath, b backup-path, f RT-Filter,
               x best-external, a additional-path, c RIB-compressed,
               t secondary path,
Origin codes: i - IGP, e - EGP, ? - incomplete
RPKI validation codes: V valid, I invalid, N Not found
Network        Next Hop           Metric LocPrf Weight Path
Route Distinguisher: 1000:2128
*> 1000:2128:1.1.1.72/96
                   0.0.0.0                       32768 ?
*>i 1000:2128:44.254.44.44/96
                   44.254.44.44                   0    100    0 ?
```

## Feature History for VPLS and VPLS BGP-Based Autodiscovery

This table provides release and related information for the features explained in this module.

These features are available in all the releases subsequent to the one they were introduced in, unless noted otherwise.

Release	Feature	Feature Information
Cisco IOS XE Everest 16.5.1a	Configuring VPLS and VPLS BGP-based Autodiscovery	VPLS enables enterprises to link together their Ethernet-based LANs from multiple sites via the infrastructure provided by their service provider.  VPLS Autodiscovery enables each PE device to discover other PE devices that are part of the same VPLS domain.
Cisco IOS XE Amsterdam 17.1.1	VPLS Layer 2 Snooping : IGMP (IPv4)	IGMP snooping is supported on a VPLS configured network.

Use the Cisco Feature Navigator to find information about platform and software image support. To access Cisco Feature Navigator, go to <https://cfng.cisco.com/>

<http://www.cisco.com/go/cfn>.



## CHAPTER 15

# Configuring MPLS VPN Route Target Rewrite

- [Prerequisites for MPLS VPN Route Target Rewrite, on page 207](#)
- [Restrictions for MPLS VPN Route Target Rewrite, on page 207](#)
- [Information About MPLS VPN Route Target Rewrite, on page 207](#)
- [How to Configure MPLS VPN Route Target Rewrite, on page 208](#)
- [Configuration Examples for MPLS VPN Route Target Rewrite, on page 215](#)
- [Feature History for MPLS VPN Route Target Rewrite, on page 215](#)

## Prerequisites for MPLS VPN Route Target Rewrite

- You should know how to configure Multiprotocol Label Switching (MPLS) Virtual Private Networks (VPNs).
- You need to identify the RT replacement policy and target device for the autonomous system (AS).

## Restrictions for MPLS VPN Route Target Rewrite

Route Target Rewrite can only be implemented in a single AS topology.

`ip unnumbered` command is not supported in MPLS configuration.

## Information About MPLS VPN Route Target Rewrite

This section provides information about MPLS VPN Route Target Rewrite:

### Route Target Replacement Policy

Routing policies for a peer include all configurations that may impact inbound or outbound routing table updates. The MPLS VPN Route Target Rewrite feature can influence routing table updates by allowing the replacement of route targets on inbound and outbound Border Gateway Protocol (BGP) updates. Route targets are carried as extended community attributes in BGP Virtual Private Network IP Version 4 (VPNv4) updates. Route target extended community attributes are used to identify a set of sites and VPN routing and forwarding (VRF) instances that can receive routes with a configured route target.

You can configure the MPLS VPN Route Target Rewrite feature on provider edge (PE) devices.

The figure below shows an example of route target replacement on PE devices in an Multiprotocol Label Switching (MPLS) VPN single autonomous system topology. This example includes the following configurations:

- PE1 is configured to import and export RT 65000:1 for VRF Customer A and to rewrite all inbound VPNv4 prefixes with RT 65000:1 to RT 65000:2.
- PE2 is configured to import and export RT 65000:2 for VRF Customer B and to rewrite all inbound VPNv4 prefixes with RT 65000:2 to RT 65000:1.

*Figure 26: Route Target Replacement on Provide Edge(PE) devices in a single MPLS VPN Autonomous System Topology*

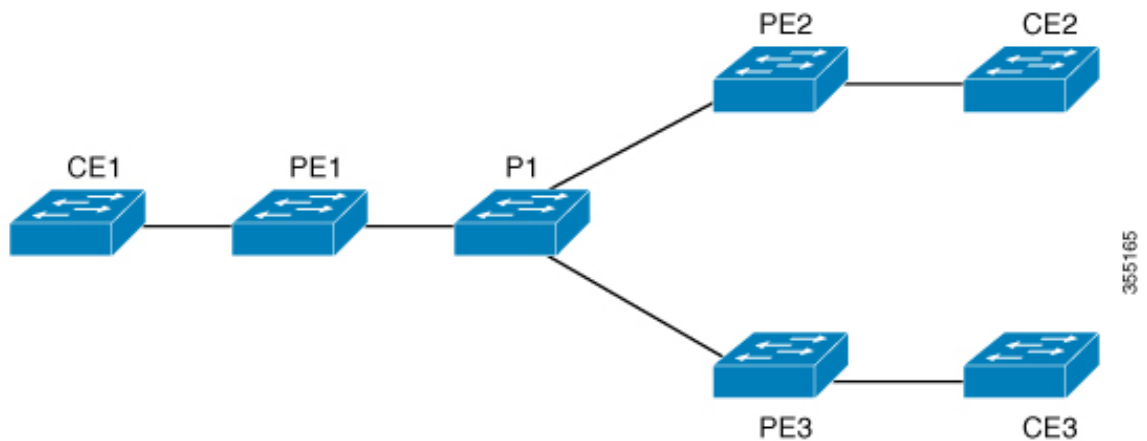

## Route Maps and Route Target Replacement

The MPLS VPN Route Target Rewrite feature extends the Border Gateway Protocol (BGP) inbound/outbound route map functionality to enable route target replacement. The `set extcomm-list delete` command entered in route-map configuration mode allows the deletion of a route target extended community attribute based on an extended community list.

## How to Configure MPLS VPN Route Target Rewrite

This section provides the configuration steps for MPLS VPN Route Target Rewrite:

### Configuring a Route Target Replacement Policy

Perform this task to configure a route target (RT) replacement policy for your internetwork.

If you configure a provider edge (PE) device to rewrite RT  $x$  to RT  $y$  and the PE has a virtual routing and forwarding (VRF) instance that imports RT  $x$ , you need to configure the VRF to import RT  $y$  in addition to RT  $x$ .

## Procedure

	Command or Action	Purpose
<b>Step 1</b>	<b>enable</b> <b>Example:</b> <pre>Device&gt; enable</pre>	Enables privileged EXEC mode. <ul style="list-style-type: none"> <li>• Enter your password if prompted.</li> </ul>
<b>Step 2</b>	<b>configure terminal</b> <b>Example:</b> <pre>Device# configure terminal</pre>	Enters global configuration mode.
<b>Step 3</b>	<b>ip extcommunity-list</b> <i>{standard-list-number   expanded-list-number}</i> <b>{permit   deny}</b> [ <i>regular-expression</i> ] [ <b>rt   soo</b> <i>extended-community-value</i> ] <b>Example:</b> <pre>Device(config)# ip extcommunity-list 1 permit rt 65000:2</pre>	Creates an extended community access list and controls access to it. <ul style="list-style-type: none"> <li>• The <i>standard-list-number</i> argument is an integer from 1 to 99 that identifies one or more permit or deny groups of extended communities.</li> <li>• The <i>expanded-list-number</i> argument is an integer from 100 to 500 that identifies one or more permit or deny groups of extended communities. Regular expressions can be configured with expanded lists but not standard lists.</li> <li>• The <b>permit</b> keyword permits access for a matching condition.</li> <li>• The <b>deny</b> keyword denies access for a matching condition.</li> <li>• The <i>regular-expression</i> argument specifies an input string pattern to match against. When you use an expanded extended community list to match route targets, include the pattern RT: in the regular expression.</li> <li>• The <b>rt</b> keyword specifies the route target extended community attribute. The <b>rt</b> keyword can be configured only with standard extended community lists and not expanded community lists.</li> <li>• The <b>soo</b> keyword specifies the site of origin (SOO) extended community attribute. The <b>soo</b> keyword can be configured only with standard extended community lists and not expanded community lists.</li> </ul>

	Command or Action	Purpose
		<ul style="list-style-type: none"> <li>The <i>extended-community-value</i> argument specifies the route target or site of origin. The value can be one of the following combinations: <ul style="list-style-type: none"> <li>autonomous-system-number:network-number</li> <li>ip-address:network-number</li> </ul> </li> </ul> <p>The colon is used to separate the autonomous system number and network number or IP address and network number.</p>
<b>Step 4</b>	<p><b>route-map</b> <i>map-name</i> [<b>permit</b>   <b>deny</b>] [<i>sequence-number</i>]</p> <p><b>Example:</b></p> <pre>Device(config)# route-map rtrewrite permit 10</pre>	<p>Defines the conditions for redistributing routes from one routing protocol into another or enables policy routing and enables route-map configuration mode.</p> <ul style="list-style-type: none"> <li>The <i>map-name</i> argument defines a meaningful name for the route map. The <b>redistribute</b> router configuration command uses this name to reference this route map. Multiple route maps can share the same map name.</li> <li>If the match criteria are met for this route map, and the <b>permit</b> keyword is specified, the route is redistributed as controlled by the set actions. In the case of policy routing, the packet is policy routed.</li> </ul> <p>If the match criteria are not met, and the <b>permit</b> keyword is specified, the next route map with the same map tag is tested. If a route passes none of the match criteria for the set of route maps sharing the same name, it is not redistributed by that set.</p> <p>The <b>permit</b> keyword is the default.</p> <ul style="list-style-type: none"> <li>If the match criteria are met for the route map and the <b>deny</b> keyword is specified, the route is not redistributed. In the case of policy routing, the packet is not policy routed, and no further route maps sharing the same map tag name will be examined. If the packet is not policy routed, the normal forwarding algorithm is used.</li> <li>The <i>sequence-number</i> argument is a number that indicates the position a new route map will have in the list of route maps already configured with the same</li> </ul>

	Command or Action	Purpose
		name. If given with the <b>no</b> form of this command, the position of the route map should be deleted.
<b>Step 5</b>	<p><b>match extcommunity</b> {<i>standard-list-number</i>   <i>expanded-list-number</i>}</p> <p><b>Example:</b></p> <pre>Device(config-route-map)# match extcommunity 1</pre> <p><b>Example:</b></p> <pre>Device(config-route-map)# match extcommunity 101</pre>	<p>Matches the Border Gateway Protocol (BGP) extended community list attributes.</p> <ul style="list-style-type: none"> <li>• The <i>standard-list-number</i> argument is a number from 1 to 99 that identifies one or more permit or deny groups of extended community attributes.</li> <li>• The <i>expanded-list-number</i> argument is a number from 100 to 500 that identifies one or more permit or deny groups of extended community attributes.</li> </ul>
<b>Step 6</b>	<p><b>set extcomm-list</b> <i>extended-community-list-number delete</i></p> <p><b>Example:</b></p> <pre>Device(config-route-map)# set extcomm-list 1 delete</pre>	<p>Removes a route target from an extended community attribute of an inbound or outbound BGP Virtual Private Network Version 4 (VPNv4) update.</p> <ul style="list-style-type: none"> <li>• The <i>extended-community-list-number</i> argument specifies the extended community list number.</li> </ul>
<b>Step 7</b>	<p><b>set extcommunity</b> {<b>rt</b> <i>extended-community-value</i> [<b>additive</b>]   <b>soo</b> <i>extended-community-value</i>}</p> <p><b>Example:</b></p> <pre>Device(config-route-map)# set extcommunity rt 65000:1 additive</pre>	<p>Sets BGP extended community attributes.</p> <ul style="list-style-type: none"> <li>• The <b>rt</b> keyword specifies the route target extended community attribute.</li> <li>• The <b>soo</b> keyword specifies the site of origin extended community attribute.</li> <li>• The <i>extended-community-value</i> argument specifies the value to be set. The value can be one of the following combinations: <ul style="list-style-type: none"> <li>• autonomous-system-number : network-number</li> <li>• ip-address : network-number</li> </ul> </li> </ul> <p>The colon is used to separate the autonomous system number and network number or IP address and network number.</p> <ul style="list-style-type: none"> <li>• The <b>additive</b> keyword adds a route target to the existing route target list without replacing any existing route targets.</li> </ul>

	Command or Action	Purpose
<b>Step 8</b>	<b>end</b> <b>Example:</b> <pre>Device(config-route-map)# end</pre>	(Optional) Returns to privileged EXEC mode.
<b>Step 9</b>	<b>show route-map <i>map-name</i></b> <b>Example:</b> <pre>Device# show route-map extmap</pre>	(Optional) Verifies that the match and set entries are correct. <ul style="list-style-type: none"> <li>The <i>map-name</i> argument is the name of a specific route map.</li> </ul>

## Applying the Route Target Replacement Policy

Perform the following tasks to apply the route target replacement policy to your network:

### Associating Route Maps with Specific BGP Neighbors

#### Procedure

	Command or Action	Purpose
<b>Step 1</b>	<b>enable</b> <b>Example:</b> <pre>Device&gt; enable</pre>	Enables privileged EXEC mode. <ul style="list-style-type: none"> <li>Enter your password if prompted.</li> </ul>
<b>Step 2</b>	<b>configure terminal</b> <b>Example:</b> <pre>Device# configure terminal</pre>	Enters global configuration mode.
<b>Step 3</b>	<b>router bgp <i>as-number</i></b> <b>Example:</b> <pre>Device(config)# router bgp 100</pre>	Configures a Border Gateway Protocol (BGP) routing process and places the device in router configuration mode. <ul style="list-style-type: none"> <li>The <i>as-number</i> argument indicates the number of an autonomous system that identifies the device to other BGP devices and tags the routing information passed along.</li> </ul> <p>The range is 0 to 65535. Private autonomous system numbers that can be used in internal networks range from 64512 to 65535.</p>
<b>Step 4</b>	<b>neighbor {<i>ip-address</i>   <i>peer-group-name</i>}</b> <b>remote-as <i>as-number</i></b> <b>Example:</b>	Adds an entry to the BGP or multiprotocol BGP neighbor table.



	Command or Action	Purpose
	<pre>Device(config-router)# neighbor 172.10.0.2 remote-as 200</pre>	<ul style="list-style-type: none"> <li>• The <i>ip-address</i> argument specifies the IP address of the neighbor.</li> <li>• The <i>peer-group-name</i> argument specifies the name of a BGP peer group.</li> <li>• The <i>as-number</i> argument specifies the autonomous system to which the neighbor belongs.</li> </ul>
<b>Step 5</b>	<p><b>address-family vpnv4 [unicast]</b></p> <p><b>Example:</b></p> <pre>Device(config-router)# address-family vpnv4</pre>	<p>Enters address family configuration mode for configuring routing sessions, such as BGP, that use standard Virtual Private Network Version 4 (VPNv4) address prefixes.</p> <ul style="list-style-type: none"> <li>• The optional <b>unicast</b> keyword specifies VPNv4 unicast address prefixes.</li> </ul>
<b>Step 6</b>	<p><b>neighbor {ip-address   peer-group-name} activate</b></p> <p><b>Example:</b></p> <pre>Device(config-router-af)# neighbor 172.16.0.2 activate</pre>	<p>Enables the exchange of information with a neighboring BGP device.</p> <ul style="list-style-type: none"> <li>• The <i>ip-address</i> argument specifies the IP address of the neighbor.</li> <li>• The <i>peer-group-name</i> argument specifies the name of a BGP peer group.</li> </ul>
<b>Step 7</b>	<p><b>neighbor {ip-address   peer-group-name} send-community [both   extended   standard]</b></p> <p><b>Example:</b></p> <pre>Device(config-router-af)# neighbor 172.16.0.2 send-community extended</pre>	<p>Specifies that a communities attribute should be sent to a BGP neighbor.</p> <ul style="list-style-type: none"> <li>• The <i>ip-address</i> argument specifies the IP address of the BGP-speaking neighbor.</li> <li>• The <i>peer-group-name</i> argument specifies the name of a BGP peer group.</li> <li>• The <b>both</b> keyword sends standard and extended community attributes.</li> <li>• The <b>extended</b> keyword sends an extended community attribute.</li> <li>• The <b>standard</b> keyword sends a standard community attribute.</li> </ul>
<b>Step 8</b>	<p><b>neighbor {ip-address   peer-group-name} route-map map-name {in   out}</b></p> <p><b>Example:</b></p> <pre>Device(config-router-af)# neighbor 172.16.0.2 route-map extmap in</pre>	<p>Apply a route map to incoming or outgoing routes</p> <ul style="list-style-type: none"> <li>• The <i>ip-address</i> argument specifies the IP address of the neighbor.</li> </ul>

	Command or Action	Purpose
		<ul style="list-style-type: none"> <li>The <i>peer-group-name</i> argument specifies the name of a BGP or multiprotocol peer group.</li> <li>The <i>map-name</i> argument specifies the name of a route map.</li> <li>The <b>in</b> keyword applies route map to incoming routes.</li> <li>The <b>out</b> keyword applies route map to outgoing routes.</li> </ul>
<b>Step 9</b>	<b>end</b>  <b>Example:</b>  Device(config-router-af)# end	(Optional) Returns to privileged EXEC mode.

## Verifying the Route Target Replacement Policy

### Procedure

#### Step 1 enable

Enables privileged EXEC mode. Enter your password if prompted.

#### Example:

```
Device> enable
Device#
```

#### Step 2 show ip bgp vpnv4 vrf vrf-name

Verifies that Virtual Private Network Version 4 (VPNv4) prefixes with a specified route target (RT) extended community attribute are replaced with the proper RT extended community attribute to verify that the provider edge (PE) devices receive the rewritten RT extended community attributes.

Verify route target replacement on PE1:

#### Example:

```
Device# show ip bgp vpnv4 vrf Customer_A 192.168.1.1/32 internal
BGP routing table entry for 65000:1:192.168.1.1/32, version 6901
Paths: (1 available, best #1, table Customer_A)
  Advertised to update-groups:
    5
  Refresh Epoch 1
  650002
    3.3.3.3 (metric 3) (via default) from 3.3.3.3 (55.5.4.1)
      Origin IGP, metric 0, localpref 100, valid, internal, best
      Extended Community: RT:65000:1
      mpls labels in/out nolabel/3025
```

```
rx pathid: 0, tx pathid: 0x0
net: 0xFFB0A72E38, path: 0xFFB0E6A370, pathext: 0xFFB0E5D970
flags: net: 0x0, path: 0x7, pathext: 0x181
```

**Step 3**    **exit**

Returns to user EXEC mode:

**Example:**

```
Device# exit
Device>
```

## Configuration Examples for MPLS VPN Route Target Rewrite

The following section provides configuration examples for MPLS VPN Route Target Rewrite:

### Examples: Applying Route Target Replacement Policies

#### Examples: Associating Route Maps with Specific BGP Neighbor

This example shows the association of route map extmap with a Border Gateway Protocol (BGP) neighbor. The BGP inbound route map is configured to replace route targets (RTs) on incoming updates.

```
router bgp 1
address-family vpnv4
neighbor 2.2.2.2 route-map rtrewrite in
```

This example shows the association of the same route map with the outbound BGP neighbor. The route map is configured to replace RTs on outgoing updates.

```
router bgp 1
address-family vpnv4
neighbor 2.2.2.2 route-map rtrewrite out
```

## Feature History for MPLS VPN Route Target Rewrite

This table provides release and related information for features explained in this module.

These features are available on all releases subsequent to the one they were introduced in, unless noted otherwise.

Release	Feature	Feature Information
Cisco IOS XE Everest 16.6.1	MPLS VPN Route Target Rewrite	The MPLS VPN Route Target Rewrite feature can influence routing table updates by allowing the replacement of route targets on inbound and outbound Border Gateway Protocol (BGP) updates.

Use Cisco Feature Navigator to find information about platform and software image support. To access Cisco Feature Navigator, go to <http://www.cisco.com/go/cfn>.



## CHAPTER 16

# Configuring MPLS VPN-Inter-AS-IPv4 BGP Label Distribution

- [MPLS VPN Inter-AS IPv4 BGP Label Distribution, on page 217](#)
- [Restrictions for MPLS VPN Inter-AS IPv4 BGP Label Distribution, on page 218](#)
- [Information About MPLS VPN Inter-AS IPv4 BGP Label Distribution, on page 218](#)
- [How to Configure MPLS VPN Inter-AS IPv4 BGP Label Distribution, on page 220](#)
- [Creating Route Maps, on page 226](#)
- [Verifying the MPLS VPN Inter-AS IPv4 BGP Label Distribution Configuration, on page 231](#)
- [Configuration Examples for MPLS VPN Inter-AS IPv4 BGP Label Distribution, on page 237](#)
- [Feature History for Configuring MPLS VPN Inter-AS IPv4 BGP Label Distribution, on page 253](#)

## MPLS VPN Inter-AS IPv4 BGP Label Distribution

This feature enables you to set up a Virtual Private Network (VPN) service provider network. In this network, the Autonomous System Boundary Routers (ASBRs) exchange IPv4 routes with Multiprotocol Label Switching (MPLS) labels of the provider edge (PE) routers. Route reflectors (RRs) exchange VPNv4 routes by using multihop, multiprotocol, External Border Gateway Protocol (EBGP). This configuration saves the ASBRs from having to store all the VPNv4 routes. Using the route reflectors to store the VPNv4 routes and forward them to the PE routers results in improved scalability.

The MPLS VPN—Inter-AS—IPv4 BGP Label Distribution feature has the following benefits:

- Having the route reflectors store VPNv4 routes results in improved scalability—This configuration scales better than configurations where the ASBR holds all the VPNv4 routes and forwards the routes based on VPNv4 labels. With this configuration, route reflectors hold the VPNv4 route, which simplifies the configuration at the border of the network.
- Enables a non-VPN core network to act as a transit network for VPN traffic—You can transport IPv4 routes with MPLS labels over a non MPLS VPN service provider.
- Eliminates the need for any other label distribution protocol between adjacent LSRs—If two adjacent label switch routers (LSRs) are also BGP peers, BGP can handle the distribution of the MPLS labels. No other label distribution protocol is needed between the two LSRs.
- Includes EBGP multipath support to enable load balancing for IPv4 routes across autonomous system (AS) boundaries.

## Restrictions for MPLS VPN Inter-AS IPv4 BGP Label Distribution

This feature includes the following restrictions:

- For networks configured with EBGp multihop, a labeled switched path (LSP) must be established between nonadjacent devices. (RFC 3107)
- The PE devices must run images that support BGP label distribution. Otherwise, you cannot run EBGp between them.
- Point-to-Point Protocol (PPP) encapsulation on the ASBRs is not supported with this feature.
- The physical interfaces that connect the BGP speakers must support Cisco Express Forwarding (CEF) or distributed CEF and MPLS

## Information About MPLS VPN Inter-AS IPv4 BGP Label Distribution

To configure MPLS VPN Inter-AS IPv4 BGP Label Distribution, you need the following information:

### MPLS VPN Inter-AS IPv4 BGP Label Distribution Overview

This feature enables you to set up a VPN service provider network to exchange IPv4 routes with MPLS labels. You can configure the VPN service provider network as follows:

- Route reflectors exchange VPNv4 routes by using multihop, multiprotocol EBGp. This configuration also preserves the next hop information and the VPN labels across the autonomous systems.
- A local PE router (for example, PE1 in Figure 1) needs to know the routes and label information for the remote PE router (PE2). This information can be exchanged between the PE routers and ASBRs in one of two ways:
  - Internal Gateway Protocol (IGP) and Label Distribution Protocol (LDP): The ASBR can redistribute the IPv4 routes and MPLS labels it learned from EBGp into IGP and LDP and vice versa.
  - Internal Border Gateway Protocol (IBGP) IPv4 label distribution: The ASBR and PE router can use direct IBGP sessions to exchange VPNv4 and IPv4 routes and MPLS labels.

Alternatively, the route reflector can reflect the IPv4 routes and MPLS labels learned from the ASBR to the PE routers in the VPN. This is accomplished by enabling the ASBR to exchange IPv4 routes and MPLS labels with the route reflector. The route reflector also reflects the VPNv4 routes to the PE routers in the VPN (as mentioned in the first bullet). For example, in VPN1, RR1 reflects to PE1 the VPNv4 routes it learned and IPv4 routes and MPLS labels learned from ASBR1. Using the route reflectors to store the VPNv4 routes and forward them through the PE routers and ASBRs allows for a scalable configuration.

- ASBRs exchange IPv4 routes and MPLS labels for the PE routers by using EBGp. This enables load balancing across CSC boundaries.

Figure 27: VPNs Using EBGP and IBGP to Distribute Routes and MPLS Labels

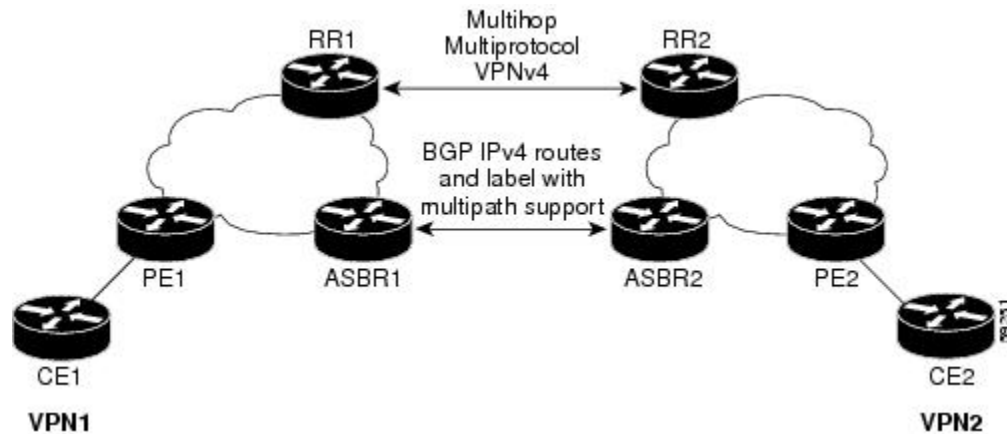

## BGP Routing Information

BGP routing information includes the following items:

- A network number (prefix), which is the IP address of the destination.
- Autonomous system (AS) path, which is a list of the other ASs through which a route passes on its way to the local router. The first autonomous system in the list is closest to the local router. The last autonomous system in the list is farthest from the local router and usually the autonomous system where the route began.
- Path attributes, which provide other information about the autonomous system path, for example, the next hop.

## How BGP Sends MPLS Labels with Routes

When BGP (EBGP and IBGP) distributes a route, it can also distribute an MPLS label that is mapped to that route. The MPLS label-mapping information for the route is carried in the BGP update message that contains the information about the route. If the next hop is not changed, the label is preserved.

When you issue the **neighbor send-label** command on both BGP routers, the routers advertise to each other that they can then send MPLS labels with the routes. If the routers successfully negotiate their ability to send MPLS labels, the routers add MPLS labels to all outgoing BGP updates.

## Using Route Maps to Filter Routes

When both routers are configured to distribute routes with MPLS labels, all the routes are encoded with the multiprotocol extensions and contain an MPLS label. You can use a route map to control the distribution of MPLS labels between routers. Route maps enable you to specify the following:

- For a router distributing MPLS labels, you can specify which routes are distributed with an MPLS label.
- For a router receiving MPLS labels, you can specify which routes are accepted and installed in the BGP table.

# How to Configure MPLS VPN Inter-AS IPv4 BGP Label Distribution

The figure below shows the following configuration:

- The configuration consists of two VPNs.
- The ASBRs exchange the IPv4 routes with MPLS labels.
- The route reflectors exchange the VPNv4 routes using multi-hop MPLS EBGP.
- The route reflectors reflect the IPv4 and VPNv4 routes to the other routers in its autonomous system.

Figure 28: Configuring Two VPN Service Providers to Exchange IPv4 Routes and MPLS Labels

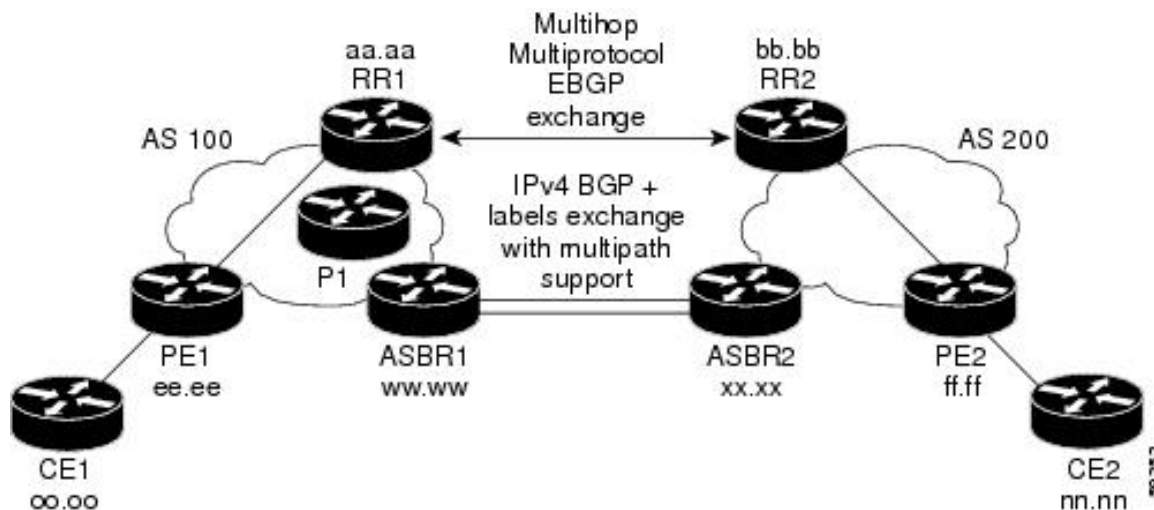

## Configuring the ASBRs to Exchange IPv4 Routes and MPLS Labels

Perform this task to configure the ASBRs so that they can distribute BGP routes with MPLS labels.

### Procedure

	Command or Action	Purpose
Step 1	<b>enable</b> <b>Example:</b> Device> enable	Enables privileged EXEC mode. <ul style="list-style-type: none"> <li>• Enter your password if prompted.</li> </ul>
Step 2	<b>configure terminal</b> <b>Example:</b> Device# configure terminal	Enters global configuration mode.



	Command or Action	Purpose
Step 3	<b>router bgp</b> <i>as-number</i> <b>Example:</b> <pre>Device(config)# router bgp 100</pre>	Enters router configuration mode. <ul style="list-style-type: none"> <li>• <i>as-number</i>—Number of an autonomous system that identifies the router to other BGP routers and tags the routing information that is passed along. The valid values range from 1 through 65535. Private autonomous system numbers that can be used in internal networks range from 64512 through 65535.</li> </ul>
Step 4	<b>neighbor</b> { <i>ip-address</i>   <i>peer-group-name</i> } <b>remote-as</b> <i>as-number</i> <b>Example:</b> <pre>Device(config)# neighbor 209.165.201.2 remote-as 200</pre>	Adds an entry to the BGP or multiprotocol BGP neighbor table. <ul style="list-style-type: none"> <li>• The <i>ip-address</i> argument specifies the IP address of the neighbor.</li> <li>• The <i>peer-group-name</i> argument specifies the name of a BGP peer group.</li> <li>• The <i>as-number</i> argument specifies the autonomous system to which the neighbor belongs.</li> </ul>
Step 5	<b>address-family ipv4</b> [ <b>multicast</b>   <b>unicast</b>   <b>vrf</b> <i>vrf-name</i> ] <b>Example:</b> <pre>Device(config-router)# address-family ipv4</pre>	Enters address family configuration mode for configuring routing sessions such as BGP that use standard IPv4 address prefixes. <ul style="list-style-type: none"> <li>• The <b>multicast</b> keyword specifies IPv4 multicast address prefixes.</li> <li>• The <b>unicast</b> keyword specifies IPv4 unicast address prefixes.</li> <li>• The <b>vrf</b> <i>vrf-name</i> keyword and argument specifies the name of the VPN routing/forwarding instance (VRF) to associate with subsequent IPv4 address family configuration mode commands.</li> </ul>
Step 6	<b>maximum-paths</b> <i>number-paths</i> <b>Example:</b> <pre>Device(config-router)# maximum-paths 2</pre>	(Optional) Controls the maximum number of parallel routes an IP routing protocol can support.  The <i>number-paths</i> argument specifies the maximum number of parallel routes an IP routing protocol installs in a routing table, in the range from 1 through 6.

	Command or Action	Purpose
		<b>Note</b> The valid values of the <b>maximum-paths</b> command range from 1 to 32. However, the maximum value that can be configured is 2.
<b>Step 7</b>	<b>neighbor</b> { <i>ip-address</i>   <i>peer-group-name</i> } <b>activate</b>  <b>Example:</b> <pre>Device(config-router-af)# neighbor 209.165.201.2 activate</pre>	Enables the exchange of information with a neighboring router. <ul style="list-style-type: none"> <li>• The <i>ip-address</i> argument specifies the IP address of the neighbor.</li> <li>• The <i>peer-group-name</i> argument specifies the name of a BGP peer group.</li> </ul>
<b>Step 8</b>	<b>neighbor</b> <i>ip-address</i> <b>send-label</b>  <b>Example:</b> <pre>Device(config-router-af)# neighbor 10.0.0.1 send-label</pre>	Enables a BGP router to send MPLS labels with BGP routes to a neighboring BGP router. <ul style="list-style-type: none"> <li>• The <i>ip-address</i> argument specifies the IP address of the neighboring router.</li> </ul>
<b>Step 9</b>	<b>exit-address-family</b>  <b>Example:</b> <pre>Device(config-router-af)# exit-address-family</pre>	Exits from the address family submode.
<b>Step 10</b>	<b>end</b>  <b>Example:</b> <pre>Device(config-router-af)# end</pre>	(Optional) Exits to privileged EXEC mode.

## Configuring the Route Reflectors to Exchange VPNv4 Routes

### Before you begin

Perform this task to enable the route reflectors to exchange VPNv4 routes by using multihop, multiprotocol EBGP.

This procedure also specifies that the next hop information and the VPN label are preserved across the autonomous systems. This procedure uses RR1 as an example.

### Procedure

	Command or Action	Purpose
<b>Step 1</b>	<b>enable</b>  <b>Example:</b> <pre>Device&gt; enable</pre>	Enables privileged EXEC mode. <ul style="list-style-type: none"> <li>• Enter your password if prompted.</li> </ul>

	Command or Action	Purpose
<b>Step 2</b>	<b>configure terminal</b> <b>Example:</b> <pre>Device# configure terminal</pre>	Enters global configuration mode.
<b>Step 3</b>	<b>router bgp <i>as-number</i></b> <b>Example:</b> <pre>Device(config)# router bgp 100</pre>	Enters router configuration mode. <ul style="list-style-type: none"> <li>• <i>as-number</i>—Number of an autonomous system that identifies the router to other BGP routers and tags the routing information that is passed along. The valid values range from 1 through 65535. Private autonomous system numbers that can be used in internal networks range from 64512 through 65535.</li> </ul> The autonomous system number identifies RR1 to routers in other autonomous systems.
<b>Step 4</b>	<b>neighbor { <i>ip-address</i>   <i>peer-group-name</i> }</b> <b>remote-as <i>as-number</i></b> <b>Example:</b> <pre>Device(config)# neighbor 192.0.2.1 remote-as 200</pre>	Adds an entry to the BGP or multiprotocol BGP neighbor table. <ul style="list-style-type: none"> <li>• The <i>ip-address</i> argument specifies the IP address of the neighbor.</li> <li>• The <i>peer-group-name</i> argument specifies the name of a BGP peer group.</li> <li>• The <i>as-number</i> argument specifies the autonomous system to which the neighbor belongs.</li> </ul>
<b>Step 5</b>	<b>address-family vpnv4 [unicast]</b> <b>Example:</b> <pre>Device(config-router)# address-family vpnv4</pre>	Enters address family configuration mode for configuring routing sessions, such as BGP, that uses standard Virtual Private Network Version 4 (VPNv4) address prefixes. <ul style="list-style-type: none"> <li>• The optional <b>unicast</b> keyword specifies VPNv4 unicast address prefixes.</li> </ul>
<b>Step 6</b>	<b>neighbor { <i>ip-address</i>   <i>peer-group-name</i> }</b> <b>ebgp-multihop [<i>tll</i>]</b> <b>Example:</b> <pre>Device(config-router-af)# neighbor 192.0.2.1 ebgp-multihop 255</pre>	Accepts and attempts BGP connections to external peers residing on networks that are not directly connected. <ul style="list-style-type: none"> <li>• The <i>ip-address</i> argument specifies the IP address of the BGP-speaking neighbor.</li> <li>• The <i>peer-group-name</i> argument specifies the name of a BGP peer group.</li> </ul>

	Command or Action	Purpose
		<ul style="list-style-type: none"> <li>The <i>ttl</i> argument specifies the time-to-live in the range from 1 through 255 hops.</li> </ul>
<b>Step 7</b>	<b>neighbor</b> { <i>ip-address</i>   <i>peer-group-name</i> } <b>activate</b>  <b>Example:</b> <pre>Device(config-router-af)# neighbor 192.0.2.1 activate</pre>	Enables the exchange of information with a neighboring router. <ul style="list-style-type: none"> <li>The <i>ip-address</i> argument specifies the IP address of the neighbor.</li> <li>The <i>peer-group-name</i> argument specifies the name of a BGP peer group.</li> </ul>
<b>Step 8</b>	<b>neighbor</b> { <i>ip-address</i>   <i>peer-group-name</i> } <b>next-hop unchanged</b>  <b>Example:</b> <pre>Device(config-router-af)# neighbor 10.0.0.2 next-hop unchanged</pre>	Enables an External BGP (EBGP) multihop peer to propagate the next hop unchanged. <ul style="list-style-type: none"> <li>The <i>ip-address</i> argument specifies the IP address of the next hop.</li> <li>The <i>peer-group-name</i> argument specifies the name of a BGP peer group that is the next hop.</li> </ul>
<b>Step 9</b>	<b>exit-address-family</b>  <b>Example:</b> <pre>Device(config-router-af)# exit-address-family</pre>	Exits from the address family submode.
<b>Step 10</b>	<b>end</b>  <b>Example:</b> <pre>Device(config-router-af)# end</pre>	(Optional) Exits to privileged EXEC mode.

## Configuring the Route Reflectors to Reflect Remote Routes in Its autonomous system

Perform this task to enable the RR to reflect the IPv4 routes and labels that are learned by the ASBR to the PE routers in the autonomous system.

This is accomplished by making the ASBR and PE router the route reflector clients of the RR. This procedure also explains how to enable the RR to reflect the VPNv4 routes.

### Procedure

	Command or Action	Purpose
<b>Step 1</b>	<b>enable</b>  <b>Example:</b> <pre>Device&gt; enable</pre>	Enables privileged EXEC mode. <ul style="list-style-type: none"> <li>Enter your password if prompted.</li> </ul>

	Command or Action	Purpose
<b>Step 2</b>	<b>configure terminal</b> <b>Example:</b> <pre>Device# configure terminal</pre>	Enters global configuration mode.
<b>Step 3</b>	<b>router bgp <i>as-number</i></b> <b>Example:</b> <pre>Device(config)# router bgp 100</pre>	Enters router configuration mode. <ul style="list-style-type: none"> <li>• <b>as-number</b>—Number of an autonomous system that identifies the router to other BGP routers and tags the routing information that is passed along. The valid values range from 1 through 65535. Private autonomous system numbers that can be used in internal networks range from 64512 through 65535.</li> </ul> The autonomous system number identifies RR1 to routers in other autonomous systems.
<b>Step 4</b>	<b>address-family ipv4</b> <b>[ <i>multicast</i>   <i>unicast</i>   <i>vrf vrf-name</i> ]</b> <b>Example:</b> <pre>Device(config-router)# address-family ipv4</pre>	Enters address family configuration mode for configuring routing sessions, such as BGP, that use standard IPv4 address prefixes. <ul style="list-style-type: none"> <li>• The <b>multicast</b> keyword specifies IPv4 multicast address prefixes.</li> <li>• The <b>unicast</b> keyword specifies IPv4 unicast address prefixes.</li> <li>• The <b>vrf vrf-name</b> keyword and argument specifies the name of the VPN routing/forwarding instance (VRF) to associate with subsequent IPv4 address family configuration mode commands.</li> </ul>
<b>Step 5</b>	<b>neighbor { <i>ip-address</i>   <i>peer-group-name</i> }</b> <b>activate</b> <b>Example:</b> <pre>Device(config-router-af)# neighbor 203.0.113.1 activate</pre>	Enables the exchange of information with a neighboring router. <ul style="list-style-type: none"> <li>• The <b><i>ip-address</i></b> argument specifies the IP address of the neighbor.</li> <li>• The <b><i>peer-group-name</i></b> argument specifies the name of a BGP peer group.</li> </ul>
<b>Step 6</b>	<b>neighbor <i>ip-address</i> route-reflector-client</b> <b>Example:</b> <pre>Device(config-router-af)# neighbor 203.0.113.1 route-reflector-client</pre>	Configures the router as a BGP route reflector and configures the specified neighbor as its client. <ul style="list-style-type: none"> <li>• The <b><i>ip-address</i></b> argument specifies the IP address of the BGP neighbor being identified as a client.</li> </ul>

	Command or Action	Purpose
Step 7	<b>neighbor</b> <i>ip-address</i> <b>send-label</b> <b>Example:</b> Device(config-router-af)# neighbor 203.0.113.1 send-label	Enables a BGP router to send MPLS labels with BGP routes to a neighboring BGP router. <ul style="list-style-type: none"> <li>The <i>ip-address</i> argument specifies the IP address of the neighboring router.</li> </ul>
Step 8	<b>exit-address-family</b> <b>Example:</b> Device(config-router-af)# exit-address-family	Exits from the address family submode.
Step 9	<b>address-family vpvv4 [unicast]</b> <b>Example:</b> Device(config-router)# address-family vpvv4	Enters address family configuration mode for configuring routing sessions, such as BGP, that use standard VPNv4 address prefixes. <ul style="list-style-type: none"> <li>The optional <b>unicast</b> keyword specifies VPNv4 unicast address prefixes.</li> </ul>
Step 10	<b>neighbor</b> { <i>ip-address</i>   <i>peer-group-name</i> } <b>activate</b> <b>Example:</b> Device(config-router-af)# neighbor 203.0.113.1 activate	Enables the exchange of information with a neighboring router. <ul style="list-style-type: none"> <li>The <i>ip-address</i> argument specifies the IP address of the neighbor.</li> <li>The <i>peer-group-name</i> argument specifies the name of a BGP peer group.</li> </ul>
Step 11	<b>neighbor</b> <i>ip-address</i> <b>route-reflector-client</b> <b>Example:</b> Device(config-router-af)# neighbor 203.0.113.1 route-reflector-client	Enables the RR to pass IBGP routes to the neighboring router.
Step 12	<b>exit-address-family</b> <b>Example:</b> Device(config-router-af)# exit-address-family	Exits from the address family submode.
Step 13	<b>end</b> <b>Example:</b> Device(config-router-af)# end	(Optional) Exits to privileged EXEC mode.

## Creating Route Maps

Route maps enable you to specify which routes are distributed with MPLS labels. Route maps also enable you to specify which routes with MPLS labels a router receives and adds to its BGP table.

Route maps work with access lists. You enter the routes into an access list and then specify the access list when you configure the route map.

The following procedures enable the ASBRs to send MPLS labels with the routes specified in the route maps. Further, the ASBRs accept only the routes that are specified in the route map.

## Configuring a Route Map for Arriving Routes

Perform this task to create a route map to filter arriving routes. You create an access list and specify the routes that the router accepts and adds to the BGP table.

### Procedure

	Command or Action	Purpose
<b>Step 1</b>	<b>enable</b> <b>Example:</b> Device> enable	Enables privileged EXEC mode. <ul style="list-style-type: none"> <li>• Enter your password if prompted.</li> </ul>
<b>Step 2</b>	<b>configure terminal</b> <b>Example:</b> Device# configure terminal	Enters global configuration mode.
<b>Step 3</b>	<b>router bgp <i>as-number</i></b> <b>Example:</b> Device(config)# router bgp 100	Enters router configuration mode. <ul style="list-style-type: none"> <li>• <b>as-number</b>—Number of an autonomous system that identifies the router to other BGP routers and tags the routing information that is passed along. The valid values range from 1 through 65535. Private autonomous system numbers that can be used in internal networks range from 64512 through 65535.</li> </ul> The autonomous system number identifies RR1 to routers in other autonomous systems.
<b>Step 4</b>	<b>route-map <i>route-map name</i> [permit   deny] [<i>sequence-number</i>]</b> <b>Example:</b> Device(config-router)# route-map IN permit 11	Creates a route map with the name you specify. <ul style="list-style-type: none"> <li>• The <b>permit</b> keyword allows the actions to happen if all conditions are met.</li> <li>• The <b>deny</b> keyword prevents any actions from happening if all conditions are met.</li> <li>• The <b>sequence-number</b> argument allows you to prioritize route maps. If you have multiple route maps and want to prioritize them, assign each one a number. The route map with the lowest number is implemented first, followed by the route map with the second lowest number, and so on.</li> </ul>

	Command or Action	Purpose
<b>Step 5</b>	<b>match ip address</b> { <i>access-list-number</i>   <i>access-list-name</i> } [... <i>access-list-number</i>   ... <i>access-list-name</i> ]  <b>Example:</b> Device(config-route-map)# match ip address 2	Distributes any routes that have a destination network number address that is permitted by a standard or extended access list, or performs policy routing on packets. <ul style="list-style-type: none"> <li>• The <i>access-list-number</i> argument is a number of a standard or extended access list. It can be an integer from 1 through 199.</li> <li>• The <i>access-list-name</i> argument is a name of a standard or extended access list. It can be an integer from 1 through 199.</li> </ul>
<b>Step 6</b>	<b>match mpls-label</b>  <b>Example:</b> Device(config-route-map)# match mpls-label	Redistributes routes that include MPLS labels if the routes meet the conditions that are specified in the route map.
<b>Step 7</b>	<b>end</b>  <b>Example:</b> Device(config-router-af)# end	(Optional) Exits to privileged EXEC mode.

## Configuring a Route Map for Departing Routes

Perform this task to create a route map to filter departing routes. You create an access list and specify the routes that the router distributes with MPLS labels.

### Procedure

	Command or Action	Purpose
<b>Step 1</b>	<b>enable</b>  <b>Example:</b>  Device> enable	Enables privileged EXEC mode. <ul style="list-style-type: none"> <li>• Enter your password if prompted.</li> </ul>
<b>Step 2</b>	<b>configure terminal</b>  <b>Example:</b>  Device# configure terminal	Enters global configuration mode.
<b>Step 3</b>	<b>router bgp as-number</b>  <b>Example:</b> Device(config)# router bgp 100	Enters router configuration mode. <ul style="list-style-type: none"> <li>• <i>as-number</i>—Number of an autonomous system that identifies the router to other BGP routers and tags the routing information that is passed along. The valid</li> </ul>



	Command or Action	Purpose
		<p>values range from 1 through 65535. Private autonomous system numbers that can be used in internal networks range from 64512 through 65535.</p> <p>The AS number identifies RR1 to routers in other autonomous systems.</p>
<b>Step 4</b>	<p><b>route-map</b> <i>route-map name</i> [<b>permit</b>   <b>deny</b>] [<i>sequence-number</i>]</p> <p><b>Example:</b></p> <pre>Device(config-router)# route-map OUT permit 10</pre>	<p>Creates a route map with the name you specify.</p> <ul style="list-style-type: none"> <li>• The <b>permit</b> keyword allows the actions to happen if all conditions are met.</li> <li>• The <b>deny</b> keyword prevents any actions from happening if all conditions are met.</li> <li>• The <i>sequence-number</i> argument allows you to prioritize route maps. If you have multiple route maps and want to prioritize them, assign each one a number. The route map with the lowest number is implemented first, followed by the route map with the second lowest number, and so on.</li> </ul>
<b>Step 5</b>	<p><b>match ip address</b> {<i>access-list-number</i>   <i>access-list-name</i>} [...<i>access-list-number</i>   ...<i>access-list-name</i>]</p> <p><b>Example:</b></p> <pre>Device(config-route-map)# match 10.0.0.2 1</pre>	<p>Distributes any routes that have a destination network number address that is permitted by a standard or extended access list, or performs policy routing on packets.</p> <ul style="list-style-type: none"> <li>• The <i>access-list-number</i> argument is a number of a standard or extended access list. It can be an integer from 1 through 199.</li> <li>• The <i>access-list-name</i> argument is a name of a standard or extended access list. It can be an integer from 1 through 199.</li> </ul>
<b>Step 6</b>	<p><b>set mpls-label</b></p> <p><b>Example:</b></p> <pre>Device(config-route-map)# set mpls-label</pre>	<p>Enables a route to be distributed with an MPLS label if the route matches the conditions that are specified in the route map.</p>
<b>Step 7</b>	<p><b>end</b></p> <p><b>Example:</b></p> <pre>Device(config-router-af)# end</pre>	<p>(Optional) Exits to privileged EXEC mode.</p>

## Applying the Route Maps to the ASBRs

Perform this task to enable the ASBRs to use the route maps.

### Procedure

	Command or Action	Purpose
<b>Step 1</b>	<b>enable</b> <b>Example:</b> Device> enable	Enables privileged EXEC mode. <ul style="list-style-type: none"> <li>• Enter your password if prompted.</li> </ul>
<b>Step 2</b>	<b>configure terminal</b> <b>Example:</b> Device# configure terminal	Enters global configuration mode.
<b>Step 3</b>	<b>router bgp <i>as-number</i></b> <b>Example:</b> Device(config)# router bgp 100	Enters router configuration mode. <ul style="list-style-type: none"> <li>• <b>as-number</b>—Number of an autonomous system that identifies the router to other BGP routers and tags the routing information that is passed along. The valid values range from 1 through 65535. Private autonomous system numbers that can be used in internal networks range from 64512 through 65535.</li> </ul> The autonomous system number identifies RR1 to routers in other autonomous systems.
<b>Step 4</b>	<b>address-family ipv4</b> <b>[multicast   unicast   vrf <i>vrf-name</i>]</b> <b>Example:</b> Device(config-router)# address-family ipv4	Enters address family configuration mode for configuring routing sessions such as BGP that use standard IPv4 address prefixes. <ul style="list-style-type: none"> <li>• The <b>multicast</b> keyword specifies IPv4 multicast address prefixes.</li> <li>• The <b>unicast</b> keyword specifies IPv4 unicast address prefixes.</li> <li>• The <b>vrf <i>vrf-name</i></b> keyword and argument specifies the name of the VPN routing/forwarding instance (VRF) to associate with subsequent IPv4 address family configuration mode commands.</li> </ul>
<b>Step 5</b>	<b>neighbor <i>ip-address</i> route-map <i>route-map-name</i> out</b> <b>Example:</b>	Applies a route map to incoming routes.

	Command or Action	Purpose
	<pre>Device(config-router-af) # neighbor 209.165.200.225 route-map OUT out</pre>	<ul style="list-style-type: none"> <li>• The <i>ip-address</i> argument specifies the device to which the route map is to be applied.</li> <li>• The <i>route-map-name</i> argument specifies the name of the route map.</li> <li>• The <b>out</b> keyword applies the route map to outgoing routes.</li> </ul>
<b>Step 6</b>	<p><b>neighbor ip-address send-label</b></p> <p><b>Example:</b></p> <pre>Device(config-router-af) # neighbor 209.165.200.225 send-label</pre>	<p>Advertises the ability of the router to send MPLS labels with routes.</p> <ul style="list-style-type: none"> <li>• The <i>ip-address</i> argument specifies the router that is enabled to send MPLS labels with routes.</li> </ul>
<b>Step 7</b>	<p><b>exit-address-family</b></p> <p><b>Example:</b></p> <pre>Device(config-router-af) # exit-address-family</pre>	<p>Exits from the address family submode.</p>
<b>Step 8</b>	<p><b>end</b></p> <p><b>Example:</b></p> <pre>Device(config-router-af) # end</pre>	<p>(Optional) Exits to privileged EXEC mode.</p>

## Verifying the MPLS VPN Inter-AS IPv4 BGP Label Distribution Configuration

The following figure is a reference for the configuration.

Figure 29: Configuring Two VPN Service Providers to Exchange IPv4 Routes and MPLS Labels

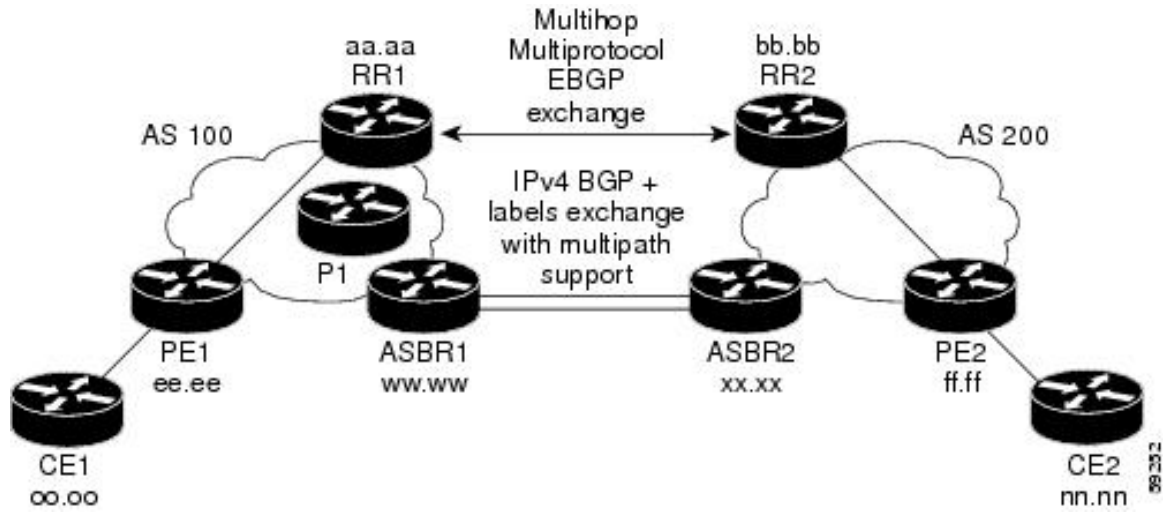

If you use route reflectors to distribute the VPNv4 routes and use the ASBRs to distribute the IPv4 labels, use the following procedures to help verify the configuration:

## Verifying the Route Reflector Configuration

Perform this task to verify the route reflector configuration.

### Procedure

	Command or Action	Purpose
<b>Step 1</b>	<b>enable</b> <b>Example:</b> Device> enable	Enables privileged EXEC mode. <ul style="list-style-type: none"> <li>• Enter your password if prompted.</li> </ul>
<b>Step 2</b>	<b>show ip bgp vpnv4 { all   rd route-distinguisher   vrf vrf-name } [summary] [labels]</b> <b>Example:</b> Device# show ip bgp vpnv4 all summary <b>Example:</b> Device# show ip bgp vpnv4 all labels	(Optional) Displays VPN address information from the BGP table. <ul style="list-style-type: none"> <li>• Use the <b>show ip bgp vpnv4</b> command with the <b>all</b> and <b>summary</b> keywords to verify that a multihop, multiprotocol, EBGP session exists between the route reflectors and that the VPNv4 routes are being exchanged between the route reflectors.</li> <li>• The last two lines of the command output show the following information:               <ul style="list-style-type: none"> <li>• Prefixes are being learned from PE1 and then passed to RR2.</li> </ul> </li> </ul>

	Command or Action	Purpose
		<ul style="list-style-type: none"> <li>• Prefixes are being learned from RR2 and then passed to PE1.</li> <li>• Use the <b>show ip bgp vpnv4</b> command with the <b>all</b> and <b>labels</b> keywords to verify that the route reflectors are exchanging VPNv4 label information.</li> </ul>
<b>Step 3</b>	<b>disable</b> <b>Example:</b> Device# disable	(Optional) Exits to user EXEC mode.

## Verifying that CE1 Has Network Reachability Information for CE2

Perform this task to verify that router CE1 has NLRI for router CE2.

### Procedure

	Command or Action	Purpose
<b>Step 1</b>	<b>enable</b> <b>Example:</b> Device> enable	Enables privileged EXEC mode. <ul style="list-style-type: none"> <li>• Enter your password if prompted.</li> </ul>
<b>Step 2</b>	<b>show ip route</b> [ <i>ip-address</i> [ <i>mask</i> ] [ <b>longer prefixes</b> ] ]   [ <i>protocol</i> [ <i>process-id</i> ] ]   [ <b>list access-list-number</b>   <i>access-list-name</i> ] <b>Example:</b> Device# show ip route 209.165.201.1	Displays the current state of the routing table. <ul style="list-style-type: none"> <li>• Use the <b>show ip route</b> command with the <b>ip-address</b> argument to verify that CE1 has a route to CE2.</li> <li>• Use the <b>show ip route</b> command to verify the routes learned by CE1. Make sure to list the route for CE2.</li> </ul>
<b>Step 3</b>	<b>disable</b> <b>Example:</b> Device# disable	(Optional) Exits to user EXEC mode.

## Verifying that PE1 Has Network Layer Reachability Information for CE2

Perform this task to verify that router PE1 has NLRI for router CE2.

## Procedure

	Command or Action	Purpose
<b>Step 1</b>	<b>enable</b> <b>Example:</b> <pre>Device&gt; enable</pre>	Enables privileged EXEC mode. <ul style="list-style-type: none"> <li>• Enter your password if prompted.</li> </ul>
<b>Step 2</b>	<b>show ip route vrf</b> <i>vrf-name</i> [ <b>connected</b> ] [ <i>protocols</i> [ <i>as-number</i> ] [ <i>tag</i> ] [ <i>output-modifiers</i> ] ] [ <b>list</b> <i>number</i> [ <i>output-modifiers</i> ] ] [ <b>profile</b> ] [ <b>static</b> [ <i>output-modifiers</i> ] ] [ <b>summary</b> [ <i>output-modifiers</i> ] ] [ <b>supernets-only</b> [ <i>output-modifiers</i> ] ] [ <b>traffic engineering</b> [ <i>output-modifiers</i> ] ] <b>Example:</b> <pre>Device# show ip route vrf vpn1 209.165.201.1</pre>	(Optional) Displays the IP routing table that is associated with a VRF. <ul style="list-style-type: none"> <li>• Use the <b>show ip route vrf</b> command to verify that router PE1 learns routes from router CE2 (nn.nn.nn.nn).</li> </ul>
<b>Step 3</b>	<b>show ip bgp vpnv4</b> { <b>all</b>   <b>rd</b> <i>route-distinguisher</i>   <b>vrf</b> <i>vrf-name</i> } { <i>ip-prefix/length</i> [ <b>longer-prefixes</b> ] [ <i>output-modifiers</i> ] ] [ <i>network-address</i> [ <i>mask</i> ] [ <b>longer-prefixes</b> ] [ <i>output-modifiers</i> ] ] [ <b>cidr-only</b> ] [ <i>community</i> ] [ <b>community-list</b> ] [ <b>dampened-paths</b> ] [ <b>filter-list</b> ] [ <b>flap-statistics</b> ] [ <b>inconsistent-as</b> ] [ <b>neighbors</b> ] [ <b>path</b> [ <i>line</i> ] ] [ <b>peer-group</b> ] [ <b>quote-regexp</b> ] [ <b>regexp</b> ] [ <b>summary</b> ] [ <b>tags</b> ] <b>Example:</b> <pre>Device# show ip bgp vpnv4 vrf vpn1 209.165.201.1</pre>	(Optional) Displays VPN address information from the BGP table. <ul style="list-style-type: none"> <li>• Use the <b>show ip bgp vpnv4</b> command with the <b>vrf</b> or <b>all</b> keyword to verify that router PE2 is the BGP next-hop to router CE2.</li> </ul>
<b>Step 4</b>	<b>show ip cef</b> [ <b>vrf</b> <i>vrf-name</i> ] [ <i>network</i> [ <i>mask</i> ] ] [ <b>longer-prefixes</b> ] [ <b>detail</b> ] <b>Example:</b> <pre>Device# show ip cef vrf vpn1 209.165.201.1</pre>	(Optional) Displays entries in the forwarding information base (FIB) or displays a summary of the FIB. <ul style="list-style-type: none"> <li>• Use the <b>show ip cef</b> command to verify that the Cisco Express Forwarding (CEF) entries are correct.</li> </ul>
<b>Step 5</b>	<b>show mpls forwarding-table</b> [ { <i>network</i> { <i>mask</i>   <i>length</i> }   <b>labels</b> <i>label</i> [- <i>label</i> ]   <b>interface</b> <i>interface</i>   <b>next-hop</b> <i>address</i>   <b>lsp-tunnel</b> [ <i>tunnel-id</i> ] } ] [ <b>detail</b> ] <b>Example:</b>	(Optional) Displays the contents of the MPLS forwarding information base (LFIB). <ul style="list-style-type: none"> <li>• Use the <b>show mpls forwarding-table</b> command to verify the IGP label for the BGP next hop router (autonomous system boundary).</li> </ul>

	Command or Action	Purpose
	Device# show mpls forwarding-table	
<b>Step 6</b>	<b>show ip bgp</b> [network] [network-mask] [longer-prefixes]  <b>Example:</b> Device# show ip bgp 209.165.202.129	(Optional) Displays entries in the BGP routing table.  <ul style="list-style-type: none"> <li>Use the <b>show ip bgp</b> command to verify the label for the remote egress PE router (PE2).</li> </ul>
<b>Step 7</b>	<b>show ip bgp vpnv4</b> {all   rd route-distinguisher   vrf vrf-name } [summary] [labels]  <b>Example:</b> Device# show ip bgp vpnv4 all labels	(Optional) Displays VPN address information from the BGP table.  <ul style="list-style-type: none"> <li>Use the <b>show ip bgp vpnv4 all summary</b> command to verify the VPN label of CE2, as advertised by PE2.</li> </ul>
<b>Step 8</b>	<b>disable</b>  <b>Example:</b> Device# disable	(Optional) Exits to user EXEC mode.

## Verifying that PE2 Has Network Reachability Information for CE2

Perform this task to ensure that PE2 can access CE2.

### Procedure

	Command or Action	Purpose
<b>Step 1</b>	<b>enable</b>  <b>Example:</b> Device> enable	Enables privileged EXEC mode.  <ul style="list-style-type: none"> <li>Enter your password if prompted.</li> </ul>
<b>Step 2</b>	<b>show ip route vrf vrf-name</b> [connected] [protocol [as-number] [tag] [output-modifiers] ] [list number [output-modifiers] ] [profile] [static [output-modifiers] ] [summary [output-modifiers] ] [supernets-only [output-modifiers] ] [traffic-engineering [output-modifiers] ]  <b>Example:</b> Device# show ip route vrf vpn1 209.165.201.1	(Optional) Displays the IP routing table that is associated with a VRF.  <ul style="list-style-type: none"> <li>Use the <b>show ip route vrf</b> command to check the VPN routing and forwarding table for CE2. The output provides next hop information.</li> </ul>
<b>Step 3</b>	<b>show mpls forwarding-table</b> [vrf vpn-name] [ {network {mask   length }   labels	(Optional) Displays the contents of the LFIB.  <ul style="list-style-type: none"> <li>Use the <b>show mpls forwarding-table</b> command with the <b>vrf</b> keyword to check</li> </ul>

	Command or Action	Purpose
	<b>label</b> [-label]   <b>interface</b> interface   <b>next-hop</b> address   <b>lsp-tunnel</b> [tunnel-id ]}] [detail] <b>Example:</b> Device# show mpls forwarding-table vrf vpn1 209.165.201.1	the VPN routing and forwarding table for CE2. The output provides the label for CE2 and the outgoing interface.
<b>Step 4</b>	<b>show ip bgp vpnv4</b> {all   rd route-distinguisher   vrf vrf-name} [summary] [labels] <b>Example:</b> Device# show ip bgp vpnv4 all labels	(Optional) Displays VPN address information from the BGP table. <ul style="list-style-type: none"> <li>Use the <b>show ip bgp vpnv4</b> command with the <b>all</b> and <b>labels</b> keywords to check the VPN label for CE2 in the multiprotocol BGP table.</li> </ul>
<b>Step 5</b>	<b>show ip cef</b> [vrf vrf-name ] [network [mask]] [longer-prefixes] [detail] <b>Example:</b> Device# show ip cef <vrf-name> 209.165.201.1	(Optional) Displays entries in the forwarding information base (FIB) or displays a summary of the FIB. <ul style="list-style-type: none"> <li>Use the <b>show ip cef</b> command to check the CEF entry for CE2. The command output shows the local label for CE2 and the outgoing interface.</li> </ul>
<b>Step 6</b>	<b>disable</b> <b>Example:</b> Device# disable	(Optional) Exits to user EXEC mode.

## Verifying the ASBR Configuration

Perform this task to verify that the ASBRs exchange IPv4 routes with MPLS labels or IPv4 routes without labels as prescribed by a route map.

### Procedure

	Command or Action	Purpose
<b>Step 1</b>	<b>enable</b> <b>Example:</b> Device> enable	Enables privileged EXEC mode. <ul style="list-style-type: none"> <li>Enter your password if prompted.</li> </ul>
<b>Step 2</b>	<b>show ip bgp</b> [network] [network-mask] [longer-prefixes] <b>Example:</b> Device# show ip bgp 209.165.202.129 <b>Example:</b> Device# show ip bgp 192.0.2.1	(Optional) Displays entries in the BGP routing table. <ul style="list-style-type: none"> <li>Use the <b>show ip bgp</b> command to verify that               <ul style="list-style-type: none"> <li>ASBR1 receives an MPLS label for PE2 from ASBR2.</li> </ul> </li> </ul>



	Command or Action	Purpose
		<ul style="list-style-type: none"> <li>ASBR1 received from ASBR2 IPv4 routes for RR2 without labels. If the command output does not display the MPLS label information, the route was received without an MPLS label.</li> <li>ASBR2 distributes an MPLS label for PE2 to ASBR1.</li> <li>ASBR2 does not distribute a label for RR2 to ASBR1.</li> </ul>
<b>Step 3</b>	<b>show ip cef</b> [ <b>vrf vrf-name</b> ] [ <b>network [mask]</b> ] [ <b>longer-prefixes</b> ] [ <b>detail</b> ] <b>Example:</b> Device# show ip cef 209.165.202.129 <b>Example:</b> Device# show ip cef 192.0.2.1	(Optional) Displays entries in the forwarding information base (FIB) or displays a summary of the FIB. <ul style="list-style-type: none"> <li>Use the <b>show ip cef</b> command from ASBR1 and ASBR2 to check that <ul style="list-style-type: none"> <li>The CEF entry for PE2 is correct.</li> <li>The CEF entry for RR2 is correct.</li> </ul> </li> </ul>
<b>Step 4</b>	<b>disable</b> <b>Example:</b> Device# disable	(Optional) Exits to the user EXEC mode.

## Configuration Examples for MPLS VPN Inter-AS IPv4 BGP Label Distribution

Configuration examples for MPLS VPN Inter-AS IPv4 BGP Label Distribution feature include the following:

### Configuration Examples for Inter-AS Using BGP to Distribute Routes and MPLS Labels Over an MPLS VPN Service Provider

The figure shows two MPLS VPN service providers. The service provider distributes the VPNv4 routes between the route reflectors. They distribute the IPv4 routes with MPLS labels between the ASBRs.

Figure 30: Distributing IPv4 Routes and MPLS Labels Between MPLS VPN Service Providers

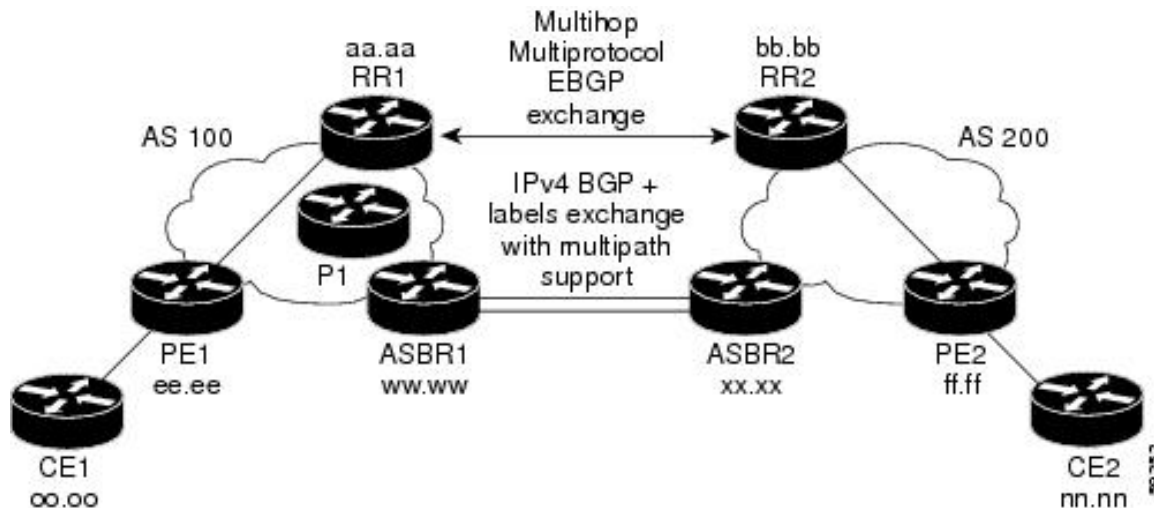

The configuration examples show the two techniques that you can use to distribute the VPNv4 routes and the IPv4 routes with MPLS labels, from the remote RRs and PEs to the local RRs and PEs:

- Autonomous system 100 uses the RRs to distribute the VPNv4 routes learned from the remote RRs. The RRs also distribute the remote PE address and label that is learned from ASBR1 using IPv4 + labels.
- In autonomous system 200, the IPv4 routes that ASBR2 learned are redistributed into IGP.

The configuration examples in this section are as follow:

### Example: Route Reflector 1 (MPLS VPN Service Provider)

The configuration example for RR1 specifies the following:

- RR1 exchanges VPNv4 routes with RR2 using multiprotocol, multihop EBGP.
- The VPNv4 next hop information and the VPN label preserved across the autonomous systems.
- RR1 reflects to PE1:
  - The VPNv4 routes learned from RR2.
  - The IPv4 routes and MPLS labels learned from ASBR1

```
ip subnet-zero
ip cef
!
interface Loopback0
 ip address 10.0.0.1 255.255.255.255
 no ip directed-broadcast
!
interface Serial11/2
 ip address 209.165.201.8 255.0.0.0
 no ip directed-broadcast
 clockrate 124061
!
router ospf 10
 log-adjacency-changes
 auto-cost reference-bandwidth 1000
```

```

network 10.0.0.1 0.0.0.0 area 100
network 209.165.201.9 0.255.255.255 area 100
!
router bgp 100
  bgp cluster-id 1
  bgp log-neighbor-changes
  timers bgp 10 30
  neighbor 203.0.113.1 remote-as 100
  neighbor 203.0.113.1 update-source Loopback0
  neighbor 209.165.200.225 remote-as 100
  neighbor 209.165.200.225 update-source Loopback0
  neighbor 192.0.2.1 remote-as 200
  neighbor 192.0.2.1 ebgp-multihop 255
  neighbor 192.0.2.1 update-source Loopback0
  no auto-summary
  !
  address-family ipv4
    neighbor 203.0.113.1 activate
    neighbor 203.0.113.1 route-reflector-client           !IPv4+labels session to PE1
    neighbor 203.0.113.1 send-label
    neighbor 209.165.200.225 activate
    neighbor 209.165.200.225 route-reflector-client       !IPv4+labels session to
ASBR1
    neighbor 209.165.200.225 send-label
    no neighbor 192.0.2.1 activate
    no auto-summary
    no synchronization
    exit-address-family
    !
    address-family vpnv4
      neighbor 203.0.113.1 activate
      neighbor 203.0.113.1 route-reflector-client         !VPNv4 session with PE1
      neighbor 203.0.113.1 send-community extended
      neighbor 192.0.2.1 activate
      neighbor 192.0.2.1 next-hop-unchanged              !MH-VPNv4 session with RR2
      neighbor 192.0.2.1 send-community extended         !with next hop unchanged
      exit-address-family
    !
  ip default-gateway 3.3.0.1
  no ip classless
  !
  snmp-server engineID local 00000009020000D0584B25C0
  snmp-server community public RO
  snmp-server community write RW
  no snmp-server ifindex persist
  snmp-server packetsize 2048
  !
end

```

## Configuration Example: ASBR1 (MPLS VPN Service Provider)

ASBR1 exchanges IPv4 routes and MPLS labels with ASBR2.

In this example, ASBR1 uses route maps to filter routes.

- A route map called OUT specifies that ASBR1 should distribute the PE1 route (ee.ee) with labels and the RR1 route (aa.aa) without labels.
- A route map called IN specifies that ASBR1 should accept the PE2 route (ff.ff) with labels and the RR2 route (bb.bb) without labels.

```

ip subnet-zero
mpls label protocol tdp

```

```

!
interface Loopback0
 ip address 209.165.200.225 255.255.255.255
 no ip directed-broadcast
 no ip route-cache
 no ip mroute-cache
!
interface Ethernet0/2
 ip address 209.165.201.6 255.0.0.0
 no ip directed-broadcast
 no ip mroute-cache
!
interface Ethernet0/3
 ip address 209.165.201.18 255.0.0.0
 no ip directed-broadcast
 no ip mroute-cache
 mpls label protocol ldp
 mpls ip
!router ospf 10
 log-adjacency-changes
 auto-cost reference-bandwidth 1000
 redistribute connected subnets
 passive-interface Ethernet0/2
 network 209.165.200.225 0.0.0.0 area 100
 network 209.165.201.9 0.255.255.255 area 100

router bgp 100
 bgp log-neighbor-changes
 timers bgp 10 30
 neighbor 10.0.0.1 remote-as 100
 neighbor 10.0.0.1 update-source Loopback0
 neighbor 209.165.201.2 remote-as 200
 no auto-summary
!
address-family ipv4
 redistribute ospf 10
 neighbor 10.0.0.1 activate
 neighbor 10.0.0.1 send-label
 neighbor 209.165.201.2 activate
 neighbor 209.165.201.2 advertisement-interval 5
 neighbor 209.165.201.2 send-label
 neighbor 209.165.201.2 route-map IN in
 neighbor 209.165.201.2 route-map OUT out
 neighbor 209.165.201.3 activate
 neighbor 209.165.201.3 advertisement-interval 5
 neighbor 209.165.201.3 send-label
 neighbor 209.165.201.3 route-map IN in
 neighbor 209.165.201.3 route-map OUT out
 no auto-summary
 no synchronization
 exit-address-family
!
 ip default-gateway 3.3.0.1
 ip classless
!
 access-list 1 permit 203.0.113.1 log
 access-list 2 permit 209.165.202.129 log
 access-list 3 permit 10.0.0.1 log
 access-list 4 permit 192.0.2.1 log

route-map IN permit 10
 match ip address 2
 match mpls-label
!

```

```

route-map IN permit 11
  match ip address 4
!
route-map OUT permit 12
  match ip address 3
!
route-map OUT permit 13
  match ip address 1
  set mpls-label
!
end

```

## Configuration Example: Route Reflector 2 (MPLS VPN Service Provider)

RR2 exchanges VPNv4 routes with RR1 through multihop, multiprotocol EBGP. This configuration also specifies that the next hop information and the VPN label are preserved across the autonomous systems.

```

ip subnet-zero
ip cef
!
interface Loopback0
  ip address 192.0.2.1 255.255.255.255
  no ip directed-broadcast
!
interface Serial1/1
  ip address 209.165.201.10 255.0.0.0
  no ip directed-broadcast
  no ip mroute-cache
!
router ospf 20
  log-adjacency-changes
  network 192.0.2.1 0.0.0.0 area 200
  network 209.165.201.20 0.255.255.255 area 200
!
router bgp 200
  bgp cluster-id 1
  bgp log-neighbor-changes
  timers bgp 10 30
  neighbor 10.0.0.1 remote-as 100
  neighbor 10.0.0.1 ebgp-multihop 255
  neighbor 10.0.0.1 update-source Loopback0
  neighbor 209.165.202.129 remote-as 200
  neighbor 209.165.202.129 update-source Loopback0
  no auto-summary
!
  address-family vpnv4
    neighbor 10.0.0.1 activate
    neighbor 10.0.0.1 next-hop-unchanged           !Multihop VPNv4 session with RR1
    neighbor 10.0.0.1 send-community extended     !with next-hop-unchanged
    neighbor 209.165.202.129 activate
    neighbor 209.165.202.129 route-reflector-client !VPNv4 session with PE2
    neighbor 209.165.202.129 send-community extended
  exit-address-family
!
ip default-gateway 3.3.0.1
no ip classless
!
end

```

## Configuration Example: ASBR2 (MPLS VPN Service Provider)

ASBR2 exchanges IPv4 routes and MPLS labels with ASBR1. However, in contrast to ASBR1, ASBR2 does not use the RR to reflect IPv4 routes and MPLS labels to PE2. ASBR2 redistributes the IPv4 routes and MPLS labels learned from ASBR1 into IGP. PE2 can now reach these prefixes.

```

ip subnet-zero
ip cef
!
mpls label protocol tdp
!
interface Loopback0
ip address 209.165.200.226 255.255.255.255
no ip directed-broadcast
!
interface Ethernet1/0
ip address 209.165.201.2 255.0.0.0
no ip directed-broadcast
no ip mroute-cache
!
interface Ethernet1/2
ip address 209.165.201.4 255.0.0.0
no ip directed-broadcast
no ip mroute-cache
mpls label protocol tdp
mpls ip
!
router ospf 20
log-adjacency-changes
auto-cost reference-bandwidth 1000
redistribute connected subnets
redistribute bgp 200 subnets          ! Redistributing the routes learned from
passive-interface Ethernet1/0        ! ASBR1 (EBGP+labels session) into IGP
network 209.165.200.226 0.0.0.0 area 200 ! so that PE2 will learn them
network 209.165.201.5 0.255.255.255 area 200
!
router bgp 200
bgp log-neighbor-changes
timers bgp 10 30
neighbor 192.0.2.1 remote-as 200
neighbor 192.0.2.1 update-source Loopback0
neighbor 209.165.201.6 remote-as 100
no auto-summary
!
address-family ipv4
redistribute ospf 20          ! Redistributing IGP into BGP
neighbor 209.165.201.6 activate ! so that PE2 & RR2 loopbacks
neighbor 209.165.201.6 advertisement-interval 5 ! will get into the BGP-4 table.
neighbor 209.165.201.6 route-map IN in
neighbor 209.165.201.6 route-map OUT out
neighbor 209.165.201.6 send-label
neighbor 209.165.201.7 activate
neighbor 209.165.201.7 advertisement-interval 5
neighbor 209.165.201.7 route-map IN in
neighbor 209.165.201.7 route-map OUT out
neighbor 209.165.201.7 send-label
no auto-summary
no synchronization
exit-address-family
!
address-family vpnv4
neighbor 192.0.2.1 activate
neighbor 192.0.2.1 send-community extended
exit-address-family

```

```
!
ip default-gateway 3.3.0.1
ip classless
!
access-list 1 permit 209.165.202.129 log           !Setting up the access lists
access-list 2 permit 203.0.113.1 log
access-list 3 permit 192.0.2.1 log
access-list 4 permit 10.0.0.1 log

route-map IN permit 11                           !Setting up the route maps
  match ip address 2
  match mpls-label
!
route-map IN permit 12
  match ip address 4
!
route-map OUT permit 10
  match ip address 1
  set mpls-label
!
route-map OUT permit 13
  match ip address 3
end
```

## Configuration Examples: Inter-AS Using BGP to Distribute Routes and MPLS Labels Over a Non MPLS VPN Service Provider

The figure shows two MPLS VPN service providers that are connected through a non MPLS VPN service provider. The autonomous system in the middle of the network is configured as a backbone autonomous system that uses Label Distribution Protocol (LDP) or Tag Distribution Protocol (TDP) to distribute MPLS labels. You can also use traffic engineering tunnels instead of TDP or LDP to build the LSP across the non MPLS VPN service provider.

Figure 31: Distributing Routes and MPLS Labels Over a Non MPLS VPN Service Provider

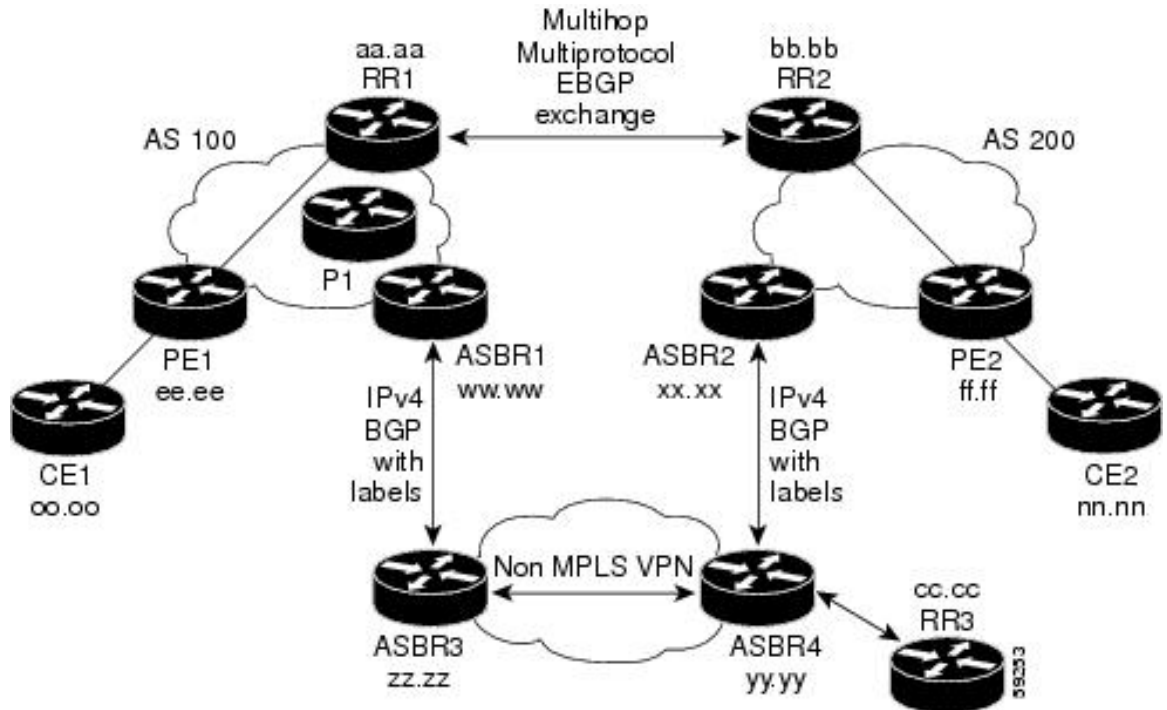

Configuration examples for Inter-AS using BGP to distribute routes and MPLS labels over a non MPLS VPN service provider included in this section are as follows:

### Configuration Example: Route Reflector 1 (Non MPLS VPN Service Provider)

The configuration example for RR1 specifies the following:

- RR1 exchanges VPNv4 routes with RR2 using multiprotocol, multihop EBGP.
- The VPNv4 next hop information and the VPN label are preserved across the autonomous systems.
- RR1 reflects to PE1:
  - The VPNv4 routes learned from RR2
  - The IPv4 routes and MPLS labels learned from ASBR 1

```
ip subnet-zero
ip cef
!
interface Loopback0
 ip address 10.0.0.1 255.255.255.255
 no ip directed-broadcast
!
interface Serial1/2
 ip address 209.165.201.8 255.0.0.0
 no ip directed-broadcast
 clockrate 124061
!
router ospf 10
 log-adjacency-changes
```



```

auto-cost reference-bandwidth 1000
network 10.0.0.1 0.0.0.0 area 100
network 209.165.201.9 0.255.255.255 area 100
!
router bgp 100
  bgp cluster-id 1
  bgp log-neighbor-changes
  timers bgp 10 30
  neighbor 203.0.113.1 remote-as 100
  neighbor 203.0.113.1 update-source Loopback0
  neighbor 209.165.200.225 remote-as 100
  neighbor 209.165.200.225 update-source Loopback0
  neighbor 192.0.2.1 remote-as 200
  neighbor 192.0.2.1 ebgp-multihop 255
  neighbor 192.0.2.1 update-source Loopback0
  no auto-summary
!
address-family ipv4
  neighbor 203.0.113.1 activate
  neighbor 203.0.113.1 route-reflector-client           !IPv4+labels session to PE1
  neighbor 203.0.113.1 send-label
  neighbor 209.165.200.225 activate
  neighbor 209.165.200.225 route-reflector-client       !IPv4+labels session to
ASBR1
  neighbor 209.165.200.225 send-label
  no neighbor 192.0.2.1 activate
  no auto-summary
  no synchronization
  exit-address-family
!
address-family vpnv4
  neighbor 203.0.113.1 activate
  neighbor 203.0.113.1 route-reflector-client           !VPNv4 session with PE1
  neighbor 203.0.113.1 send-community extended
  neighbor 192.0.2.1 activate
  neighbor 192.0.2.1 next-hop-unchanged                !MH-VPNv4 session with RR2
  neighbor 192.0.2.1 send-community extended           with next-hop-unchanged
  exit-address-family
!
ip default-gateway 3.3.0.1
no ip classless
!
snmp-server engineID local 00000009020000D0584B25C0
snmp-server community public RO
snmp-server community write RW
no snmp-server ifindex persist
snmp-server packetsize 2048
!
end

```

## Configuration Example: ASBR1 (Non MPLS VPN Service Provider)

ASBR1 exchanges IPv4 routes and MPLS labels with ASBR2.

In this example, ASBR1 uses route maps to filter routes.

- A route map called OUT specifies that ASBR1 should distribute the PE1 route (ee.aa) with labels and the RR1 route (aa.aa) without labels.
- A route map called IN specifies that ASBR1 should accept the PE2 route (ff.bb) with labels and the RR2 route (bb.bb) without labels.

```

ip subnet-zero
ip cef distributed
mpls label protocol tdp
!
interface Loopback0
ip address 209.165.200.225 255.255.255.255
no ip directed-broadcast
no ip route-cache
no ip mroute-cache
!
interface Serial3/0/0
ip address 209.165.201.7 255.0.0.0
no ip directed-broadcast
ip route-cache distributed
!
interface Ethernet0/3
ip address 209.165.201.18 255.0.0.0
no ip directed-broadcast
no ip mroute-cache
mpls label protocol ldp
mpls ip
!
router ospf 10
log-adjacency-changes
auto-cost reference-bandwidth 1000
redistribute connected subnets
passive-interface Serial3/0/0
network 209.165.200.225 0.0.0.0 area 100
network dd.0.0.0 0.255.255.255 area 100

router bgp 100
bgp log-neighbor-changes
timers bgp 10 30
neighbor 10.0.0.1 remote-as 100
neighbor 10.0.0.1 update-source Loopback0
neighbor kk.0.0.1 remote-as 200
no auto-summary
!
address-family ipv4
redistribute ospf 10 ! Redistributing IGP into BGP
neighbor 10.0.0.1 activate ! so that PE1 & RR1 loopbacks
neighbor 10.0.0.1 send-label ! get into BGP table
neighbor 209.165.201.3 activate
neighbor 209.165.201.3 advertisement-interval 5
neighbor 209.165.201.3 send-label
neighbor 209.165.201.3 route-map IN in ! Accepting routes specified in route map IN
neighbor 209.165.201.3 route-map OUT out ! Distributing routes specified in route map
OUT
no auto-summary
no synchronization
exit-address-family
!
ip default-gateway 3.3.0.1
ip classless
!
access-list 1 permit 203.0.113.1 log
access-list 2 permit 209.165.202.129 log
access-list 3 permit 10.0.0.1 log
access-list 4 permit 192.0.2.1 log
!
route-map IN permit 10
match ip address 2
match mpls-label
!

```

```

route-map IN permit 11
  match ip address 4
  !
route-map OUT permit 12
  match ip address 3
  !
route-map OUT permit 13
  match ip address 1
  set mpls-label
  !
end

```

## Configuration Example: Route Reflector 2 (Non MPLS VPN Service Provider)

RR2 exchanges VPNv4 routes with RR1 using multihop, multiprotocol EBGP. This configuration also specifies that the next hop information and the VPN label are preserved across the autonomous systems.

```

ip subnet-zero
ip cef
!
interface Loopback0
  ip address 192.0.2.1 255.255.255.255
  no ip directed-broadcast
  !
interface Serial1/1
  ip address 209.165.201.10 255.0.0.0
  no ip directed-broadcast
  no ip mroute-cache
  !
router ospf 20
  log-adjacency-changes
  network 192.0.2.1 0.0.0.0 area 200
  network 209.165.201.20 0.255.255.255 area 200
  !
router bgp 200
  bgp cluster-id 1
  bgp log-neighbor-changes
  timers bgp 10 30
  neighbor 10.0.0.1 remote-as 100
  neighbor 10.0.0.1 ebgp-multihop 255
  neighbor 10.0.0.1 update-source Loopback0
  neighbor 209.165.202.129 remote-as 200
  neighbor 209.165.202.129 update-source Loopback0
  no auto-summary
  !
  address-family vpnv4
  neighbor 10.0.0.1 activate
  neighbor 10.0.0.1 next-hop-unchanged           !MH vpnv4 session with RR1
  neighbor 10.0.0.1 send-community extended     !with next-hop-unchanged
  neighbor 209.165.202.129 activate
  neighbor 209.165.202.129 route-reflector-client !vpnv4 session with PE2
  neighbor 209.165.202.129 send-community extended
  exit-address-family
  !
ip default-gateway 3.3.0.1
no ip classless
!
end

```

## Configuration Examples: ASBR2 (Non MPLS VPN Service Provider)

ASBR2 exchanges IPv4 routes and MPLS labels with ASBR1. However, in contrast to ASBR1, ASBR2 does not use the RR to reflect IPv4 routes and MPLS labels to PE2. ASBR2 redistributes the IPv4 routes and MPLS labels learned from ASBR1 into IGP. PE2 can now reach these prefixes.

```
ip subnet-zero
ip cef
!
mpls label protocol tdp
!
interface Loopback0
 ip address 209.165.200.226 255.255.255.255
 no ip directed-broadcast
!
interface Ethernet0/1
 ip address 209.165.201.11 255.0.0.0
 no ip directed-broadcast
!
interface Ethernet1/2
 ip address 209.165.201.4 255.0.0.0
 no ip directed-broadcast
 no ip mroute-cache
 mpls label protocol tdp
 mpls ip
!
router ospf 20
 log-adjacency-changes
 auto-cost reference-bandwidth 1000
 redistribute connected subnets
 redistribute bgp 200 subnets          !redistributing the routes learned from
 passive-interface Ethernet0/1        !ASBR2 (EBGP+labels session) into IGP
 network 209.165.200.226 0.0.0.0 area 200      !so that PE2 will learn them
 network 209.165.201.5 0.255.255.255 area 200
!
router bgp 200
 bgp log-neighbor-changes
 timers bgp 10 30
 neighbor 192.0.2.1 remote-as 200
 neighbor 192.0.2.1 update-source Loopback0
 neighbor 209.165.201.21 remote-as 100
 no auto-summary
!
address-family ipv4          ! Redistributing IGP into BGP
 redistribute ospf 20        ! so that PE2 & RR2 loopbacks
 neighbor 209.165.201.21 activate          ! will get into the BGP-4 table
 neighbor 209.165.201.21 advertisement-interval 5
 neighbor 209.165.201.21 route-map IN in
 neighbor 209.165.201.21 route-map OUT out
 neighbor 209.165.201.21 send-label
 no auto-summary
 no synchronization
 exit-address-family
!
address-family vpnv4
 neighbor 192.0.2.1 activate
 neighbor 192.0.2.1 send-community extended
 exit-address-family
!
ip default-gateway 3.3.0.1
ip classless
!
access-list 1 permit 209.165.202.129 log
```

```

access-list 2 permit 203.0.113.1 log
access-list 3 permit 192.0.2.1 log
access-list 4 permit 10.0.0.1 log
!
route-map IN permit 11
  match ip address 2
  match mpls-label
!
route-map IN permit 12
  match ip address 4
!
route-map OUT permit 10
  match ip address 1
  set mpls-label
!
route-map OUT permit 13
  match ip address 3
!
end

```

## Configuration Example: ASBR3 (Non MPLS VPN Service Provider)

ASBR3 belongs to a non MPLS VPN service provider. ASBR3 exchanges IPv4 routes and MPLS labels with ASBR1. ASBR3 also passes the routes learned from ASBR1 to ASBR3 through RR3.



---

**Note** Do not redistribute EBGP routes learned into IBGP if you are using IBGP to distribute the routes and labels. This is not a supported configuration.

---

```

ip subnet-zero
ip cef
!
interface Loopback0
  ip address 209.165.200.227 255.255.255.255
  no ip directed-broadcast
  no ip route-cache
  no ip mroute-cache
!
ip routing
mpls label protocol ldp
mpls ldp router-id Loopback0 force

interface GigabitEthernet1/0/1
ip address 209.165.201.12 255.0.0.0

interface TenGigabitEthernet1/1/1
no switchport
ip address 209.165.201.3 255.0.0.0
load-interval 30
mpls ip

!
router ospf 30
log-adjacency-changes
auto-cost reference-bandwidth 1000
redistribute connected subnets
network 209.165.200.227 0.0.0.0 area 300
network 209.165.201.13 0.255.255.255 area 300
!
router bgp 300
  bgp log-neighbor-changes

```

## Configuration Example: Route Reflector 3 (Non MPLS VPN Service Provider)

```

timers bgp 10 30
neighbor 10.0.0.3 remote-as 300
neighbor 10.0.0.3 update-source Loopback0
neighbor 209.165.201.7 remote-as 100
no auto-summary
!
address-family ipv4
neighbor 10.0.0.3 activate ! IBGP+labels session with RR3
neighbor 10.0.0.3 send-label
neighbor 209.165.201.7 activate ! EBGp+labels session with ASBR1
neighbor 209.165.201.7 advertisement-interval 5
neighbor 209.165.201.7 send-label
neighbor 209.165.201.7 route-map IN in
neighbor 209.165.201.7 route-map OUT out
no auto-summary
no synchronization
exit-address-family
!
ip classless
!
access-list 1 permit 203.0.113.1 log
access-list 2 permit 209.165.202.129 log
access-list 3 permit 10.0.0.1 log
access-list 4 permit 192.0.2.1 log
!
route-map IN permit 10
match ip address 1
match mpls-label
!
route-map IN permit 11
match ip address 3
!
route-map OUT permit 12
match ip address 2
set mpls-label
!
route-map OUT permit 13
match ip address 4
!
ip default-gateway 3.3.0.1
ip classless
!
end

```

## Configuration Example: Route Reflector 3 (Non MPLS VPN Service Provider)

RR3 is a non MPLS VPN RR that reflects IPv4 routes with MPLS labels to ASBR3 and ASBR4.

```

ip subnet-zero
mpls label protocol tdp
mpls traffic-eng auto-bw timers
no mpls ip
!
interface Loopback0
ip address 10.0.0.3 255.255.255.255
no ip directed-broadcast
!
interface POS0/2
ip address 209.165.201.15 255.0.0.0
no ip directed-broadcast
no ip route-cache cef
no ip route-cache
no ip mroute-cache
crc 16

```

```

clock source internal
!
router ospf 30
 log-adjacency-changes
 network 10.0.0.3 0.0.0.0 area 300
 network 209.165.201.16 0.255.255.255 area 300
!
router bgp 300
 bgp log-neighbor-changes
 neighbor 209.165.201.2 remote-as 300
 neighbor 209.165.201.2 update-source Loopback0
 neighbor 209.165.200.227 remote-as 300
 neighbor 209.165.200.227 update-source Loopback0
 no auto-summary
!
address-family ipv4
 neighbor 209.165.201.2 activate
 neighbor 209.165.201.2 route-reflector-client
 neighbor 209.165.201.2 send-label ! IBGP+labels session with ASBR3
 neighbor 209.165.200.227 activate
 neighbor 209.165.200.227 route-reflector-client
 neighbor 209.165.200.227 send-label ! IBGP+labels session with ASBR4
 no auto-summary
 no synchronization
 exit-address-family
!
ip default-gateway 3.3.0.1
ip classless
!
end

```

## Configuration Example: ASBR4 (Non MPLS VPN Service Provider)

ASBR4 belongs to a non MPLS VPN service provider. ASBR4 and ASBR3 exchange IPv4 routes and MPLS labels by means of RR3.



---

**Note** Do not redistribute EBGP routes learned into IBG if you are using IBGP to distribute the routes and labels. This is not a supported configuration.

---

```

ip subnet-zero
ip cef distributed
!
interface Loopback0
 ip address 209.165.201.2 255.255.255.255
 no ip directed-broadcast
 no ip route-cache
 no ip mroute-cache
!
interface Ethernet0/2
 ip address 209.165.201.21 255.0.0.0
 no ip directed-broadcast
 no ip mroute-cache
!
ip routing
mpls label protocol ldp
mpls ldp router-id Loopback0 force

interface GigabitEthernet1/0/1
 ip address 209.165.201.17 255.0.0.0

```

```

interface TenGigabitEthernet1/1/1
no switchport
ip address 209.165.201.14 255.0.0.0
load-interval 30
mpls ip

!
router ospf 30
 log-adjacency-changes
 auto-cost reference-bandwidth 1000
 redistribute connected subnets
passive-interface Ethernet0/2
 network 209.165.201.2 0.0.0.0 area 300
 network 209.165.201.16 0.255.255.255 area 300
 network 209.165.201.13 0.255.255.255 area 300
!
router bgp 300
 bgp log-neighbor-changes
 timers bgp 10 30
 neighbor 10.0.0.3 remote-as 300
 neighbor 10.0.0.3 update-source Loopback0
 neighbor 209.165.201.11 remote-as 200
 no auto-summary
!
 address-family ipv4
 neighbor 10.0.0.3 activate
 neighbor 10.0.0.3 send-label
 neighbor 209.165.201.11 activate
 neighbor 209.165.201.11 advertisement-interval 5
 neighbor 209.165.201.11 send-label
 neighbor 209.165.201.11 route-map IN in
 neighbor 209.165.201.11 route-map OUT out
 no auto-summary
 no synchronization
 exit-address-family
!
ip classless
!
access-list 1 permit 209.165.202.129 log
access-list 2 permit 203.0.113.1 log
access-list 3 permit 192.0.2.1 log
access-list 4 permit 10.0.0.1 log
!
route-map IN permit 10
 match ip address 1
 match mpls-label
!
route-map IN permit 11
 match ip address 3
!
route-map OUT permit 12
 match ip address 2
 set mpls-label
!
route-map OUT permit 13
 match ip address 4
!
ip default-gateway 3.3.0.1
ip classless
!
end

```



## Feature History for Configuring MPLS VPN Inter-AS IPv4 BGP Label Distribution

The following table provides release information about the feature or features described in this module. This table lists only the software release that introduced support for a given feature in a given software release train. Unless noted otherwise, subsequent releases of that software release train also support that feature.

Use Cisco Feature Navigator to find information about platform support and Cisco software image support. To access Cisco Feature Navigator, go to [www.cisco.com/go/cfn](http://www.cisco.com/go/cfn). An account on Cisco.com is not required.

Release	Feature	Feature Information
Cisco IOS XE Gibraltar 16.11.1	MPLS VPN Inter-AS IPv4 BGP Label Distribution	This feature enables you to set up a Virtual Private Network (VPN) service provider network. In this network, the Autonomous System Boundary Routers (ASBRs) exchange IPv4 routes with Multiprotocol Label Switching (MPLS) labels of the provider edge (PE) routers.

Use Cisco Feature Navigator to find information about platform and software image support. To access Cisco Feature Navigator, go to <http://www.cisco.com/go/cfn>.





## CHAPTER 17

# Configuring Seamless MPLS

- [Information about Seamless MPLS, on page 255](#)
- [How to configure Seamless MPLS, on page 256](#)
- [Configuration Examples for Seamless MPLS, on page 262](#)
- [Feature History for Seamless MPLS, on page 264](#)

## Information about Seamless MPLS

The following sections provide information about Seamless MPLS.

### Overview of Seamless MPLS

Seamless MPLS provides a highly flexible and scalable architecture to integrate multiple networks into a single MPLS domain. It is based on existing and well known protocols.

A large MPLS network can have several types of platforms and services in different parts of the network. Such a network would usually be divided into areas such as a core area and aggregation areas, and each of these areas have different Interior Gateway Protocols (IGPs). The IGP prefixes from one area cannot be distributed to another area. If the IGP prefixes cannot be distributed, then end-to-end Label-Switched-Paths (LSP) cannot be established. This affects the scalability of the network.

Seamless MPLS introduces greater scalability by establishing end-to-end LSPs. Seamless MPLS uses the Border Gateway Protocol (BGP) instead of IGP to forward the loopback prefixes of the Provider Edge (PE) routers. BGP distributes the prefixes end-to-end. This eliminates the need to install IGP prefixes of one domain in another domain.

Seamless MPLS introduces separation of the service and transport planes and provides end to end service independent transport. It removes the need for service specific configurations in network transport nodes.

## Architecture for Seamless MPLS

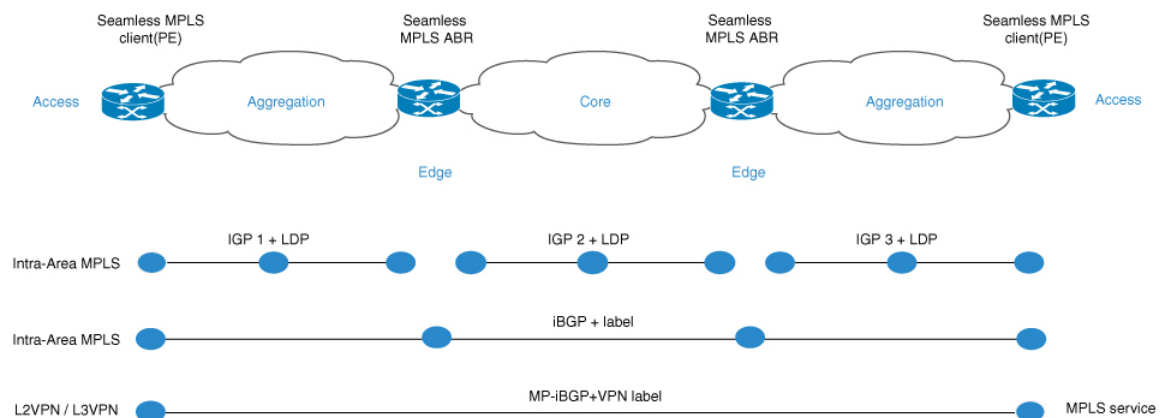

The figure shows a network with three different areas: one core and two aggregation areas on the side. Each area runs its own IGP, with no redistribution between them on the Area Border Router (ABR). Use of BGP is needed in order to provide an end-to-end MPLS LSP. BGP advertises the loopbacks of the PE routers with a label across the whole domain, and provides an end-to-end LSP. BGP is deployed between the PEs and ABRs.

Seamless MPLS uses BGP to provide an end-to-end MPLS LSP. BGP is deployed between the PEs and the ABRs. BGP sends the IPv4 prefix and label. BGP advertises the loopbacks of the PE routers with a label across the whole domain and provides an end-to-end LSP.

When using IGP in the network, the next-hop address of the prefixes is the loopback prefix of the PE routers. This prefix is not known to the IGP being used in other parts of the network. The next hop address cannot be used to recurse to an IGP prefix. To avoid this the prefixes are carried in BGP. The ABRs are configured as Route Reflectors (RR). And the RRs are configured to set the next hop to self even for the reflected iBGP prefixes.

There are two possible scenarios.

- The ABR does not set the next hop to self for the prefixes advertised (reflected by BGP) by the ABR into the aggregation part of the network. The ABR needs to redistribute the loopback prefixes of the ABRs from the core IGP into the aggregation IGP. Only the ABR loopback prefixes (from the core) need to be advertised into the aggregation part, not the loopback prefixes from the PE routers from the remote aggregation parts.
- The ABR sets the next hop to self for the prefixes advertised (reflected by BGP) by the ABR into the aggregation part. Because of this, the ABR does not need to redistribute the loopback prefixes of the ABRs from the core IGP into the aggregation IGP.

In both scenarios, the ABR sets the next hop to self for the prefixes advertised (reflected by BGP) by the ABR from the aggregation part of the network into the core part.

## How to configure Seamless MPLS

The following sections provide information on how to configure Seamless MPLS.

## Configuring Seamless MPLS on the PE Router

The following steps can be used to configure Seamless MPLS on the PE Router

### Procedure

	Command or Action	Purpose
<b>Step 1</b>	<b>enable</b> <b>Example:</b>  Device> enable	Enables privileged EXEC mode.  • Enter your password if prompted.
<b>Step 2</b>	<b>configure terminal</b> <b>Example:</b>  Device# configure terminal	Enters global configuration mode.
<b>Step 3</b>	<b>interface loopback slot/port</b> <b>Example:</b>  Device(config-if)# interface Loopback0	Configures a Loopback interface and enters interface configuration mode.
<b>Step 4</b>	<b>ip address ip-address subnet-mask</b> <b>Example:</b>  Device(config-if) ip address 10.100.1.4 255.255.255.255	Enters the IP address for the interface.
<b>Step 5</b>	<b>interface ethernet slot/port</b> <b>Example:</b>  Device(config-if)# interface Ethernet1/0	Configures an Ethernet interface and enters interface configuration mode.
<b>Step 6</b>	<b>no ip address</b> <b>Example:</b>  Device(config-if)# no ip address	Removes an IP address definition.
<b>Step 7</b>	<b>xconnect peer-ip-address vcid encapsulation mpls</b> <b>Example:</b>  Device(config-if)# xconnect 10.100.1.5 100 encapsulation mpls	Specifies MPLS as the tunneling method to encapsulate.
<b>Step 8</b>	<b>router ospf process-id</b> <b>Example:</b>  Device(config)# router ospf 2	Configures the OSPF routing process.
<b>Step 9</b>	<b>network ip-address wild-mask area area-id</b> <b>Example:</b>	Defines the interfaces on which OSPF runs and defines the area ID for those interfaces.

	Command or Action	Purpose
	Device(config-router)# network 10.2.0.0 0.0.255.255 area 0	
<b>Step 10</b>	<b>network</b> <i>ip-address wild-mask area area-id</i> <b>Example:</b> Device(config-router)# network 10.100.1.4 0.0.0.0 area 0	Defines the interfaces on which OSPF runs and defines the area ID for those interfaces.
<b>Step 11</b>	<b>router bgp</b> <i>autonomous-system-number</i> <b>Example:</b> Device(config)# router bgp 1	Configures the BGP routing process.
<b>Step 12</b>	<b>bgp log neighbor changes</b> <b>Example:</b> Device(config-router)# bgp log neighbor changes	Enables logging of BGP neighbor resets.
<b>Step 13</b>	<b>address-family ipv4</b> <b>Example:</b> Device(config-router)# address-family ipv4	Enters address family configuration mode.
<b>Step 14</b>	<b>network</b> <i>network-number mask network-mask</i> <b>Example:</b> Device(config-router-af)# network 10.100.1.4 mask 255.255.255.255	Specifies the networks to be advertised by BGP and multiprotocol BGP routing processes.
<b>Step 15</b>	<b>no bgp default ipv4 unicast</b> <b>Example:</b> Device(config-router-af)# no bgp default ipv4 unicast	Disables default IPv4 unicast address family for peering session establishment
<b>Step 16</b>	<b>no bgp default route-target filter</b> <b>Example:</b> Device(config-router-af)# no bgp default route-target filter	Disables automatic BGP route-target community filtering.
<b>Step 17</b>	<b>neighbor</b> <i>ip-address remote-as autonomous-system-number</i> <b>Example:</b> Device(config-router-af)# neighbor 10.100.1.1 remote-as 1	Adds an entry to the BGP or multiprotocol BGP neighbor table.
<b>Step 18</b>	<b>neighbor</b> <i>ip-address update-source interface-type interface-number</i> <b>Example:</b> Device(config-router-af)# neighbor 10.100.1.1 update-source Loopback0	Allows BGP sessions to use any operational interface for TCP connections.

	Command or Action	Purpose
<b>Step 19</b>	<b>neighbor <i>ip-address</i> send-label</b> <b>Example:</b> <pre>Device(config-router-af)# neighbor 10.100.1.1 send-label</pre>	Enables a BGP router to send MPLS labels with BGP routes to a neighboring BGP router.

## Configuring Seamless MPLS on the Route Reflector

The following steps can be used to configure Seamless MPLS on the Route Reflector.

### Procedure

	Command or Action	Purpose
<b>Step 1</b>	<b>enable</b> <b>Example:</b> <pre>Device&gt; enable</pre>	Enables privileged EXEC mode. <ul style="list-style-type: none"> <li>• Enter your password if prompted.</li> </ul>
<b>Step 2</b>	<b>configure terminal</b> <b>Example:</b> <pre>Device# configure terminal</pre>	Enters global configuration mode.
<b>Step 3</b>	<b>interface loopback <i>slot/port</i></b> <b>Example:</b> <pre>Device(config-if)# interface Loopback0</pre>	Configures a Loopback interface and enters interface configuration mode.
<b>Step 4</b>	<b>ip address <i>ip-address subnet-mask</i></b> <b>Example:</b> <pre>Device(config-if)# ip address 10.100.1.1 255.255.255.255</pre>	Enters the IP address for the interface.
<b>Step 5</b>	<b>router ospf <i>process-id</i></b> <b>Example:</b> <pre>Device(config)# router ospf 1</pre>	Configures the OSPF routing process.
<b>Step 6</b>	<b>network <i>ip-address wild-mask area area-id</i></b> <b>Example:</b> <pre>Device(config-router)# network 10.1.0.0 0.0.255.255 area 0</pre>	Defines the interfaces on which OSPF runs and defines the area ID for those interfaces.
<b>Step 7</b>	<b>network <i>ip-address wild-mask area area-id</i></b> <b>Example:</b> <pre>Device(config-router)# 10.100.1.1 0.0.0.0 area 0</pre>	Defines the interfaces on which OSPF runs and defines the area ID for those interfaces.

	Command or Action	Purpose
<b>Step 8</b>	<b>exit</b> <b>Example:</b> Device(config-router)#exit	Exits the configuration mode.
<b>Step 9</b>	<b>router ospf process-id</b> <b>Example:</b> Device(config)# router ospf 2	Configures the OSPF routing process.
<b>Step 10</b>	<b>redistribute ospf instance-tag route-map map-name</b> <b>Example:</b> Device(config-router)# redistribute ospf 1 subnets match internal route-map ospf1-into-ospf2	Injects routes from one routing domain into OSPF.
<b>Step 11</b>	<b>network ip-address wild-mask area area-id</b> <b>Example:</b> Device(config-router)# network 10.2.0.0 0.0.255.255 area 0	Defines the interfaces on which OSPF runs and defines the area ID for those interfaces.
<b>Step 12</b>	<b>exit</b> <b>Example:</b> Device(config-router)#exit	Exits the configuration mode.
<b>Step 13</b>	<b>router bgp autonomous-system-number</b> <b>Example:</b> Device(config)# router bgp 1	Configures the BGP routing process.
<b>Step 14</b>	<b>bgp log neighbor changes</b> <b>Example:</b> Device(config-router)# bgp log neighbor changes	Enables logging of BGP neighbor resets.
<b>Step 15</b>	<b>address-family ipv4</b> <b>Example:</b> Device(config-router)# address family ipv4	Enters address family configuration mode.
<b>Step 16</b>	<b>neighbor ip-address remote-as autonomous-system-number</b> <b>Example:</b> Device(config-route-af)# neighbor 10.100.1.2 remote-as 1	Adds an entry to the BGP or multiprotocol BGP neighbor table.



	<b>Command or Action</b>	<b>Purpose</b>
<b>Step 17</b>	<b>neighbor ip-address update-source interface-type interface-number</b>  <b>Example:</b> <pre>Device(config-router-af)# neighbor 10.100.1.2 update-source Loopback0</pre>	Allows BGP sessions to use any operational interface for TCP connections.
<b>Step 18</b>	<b>neighbor ip-address next-hop-self all</b>  <b>Example:</b> <pre>Device(config-router-af)# neighbor 10.100.1.2 next-hop-self all</pre>	Configures a router as the next hop for a BGP-speaking neighbor or peer group.
<b>Step 19</b>	<b>neighbor ip-address send-label</b>  <b>Example:</b> <pre>Device(config-router-af)# neighbor 10.100.1.2 send-label</pre>	Enables a BGP router to send MPLS labels with BGP routes to a neighboring BGP router.
<b>Step 20</b>	<b>neighbor ip-address remote-as autonomous-system-number</b>  <b>Example:</b> <pre>Device(config-router-af)# neighbor 10.100.1.4 remote-as 1</pre>	Adds an entry to the BGP or multiprotocol BGP neighbor table.
<b>Step 21</b>	<b>neighbor ip-address update-source interface-type interface-number</b>  <b>Example:</b> <pre>Device(config-router-af)# neighbor 10.100.1.4 update-source Loopback0</pre>	Allows BGP sessions to use any operational interface for TCP connections.
<b>Step 22</b>	<b>neighbor ip-address route-reflector-client</b>  <b>Example:</b> <pre>Device(config_router-af)# neighbor 10.100.1.4 route-reflector-client</pre>	Configures the router as a BGP route reflector and configure the specified neighbor as its client.
<b>Step 23</b>	<b>neighbor ip-address next-hop-self all</b>  <b>Example:</b> <pre>Device(config-router-af)# neighbor 10.100.1.4 next-hop-self all</pre>	Configures a router as the next hop for a BGP-speaking neighbor or peer group.
<b>Step 24</b>	<b>neighbor ip-address send-label</b>  <b>Example:</b> <pre>Device(config-router-af)# neighbor 10.100.1.4 send-label</pre>	Enables a BGP router to send MPLS labels with BGP routes to a neighboring BGP router.
<b>Step 25</b>	<b>exit</b>  <b>Example:</b> <pre>Device(config-router)#exit</pre>	Exits the configuration mode.

	Command or Action	Purpose
<b>Step 26</b>	<b>ip prefix-list name seq number permit prefix</b> <b>Example:</b> Device(config)# ip prefix-list prefix-list-ospf1-into-ospf2 seq 5 permit 10.100.1.1/32	Creates a prefix list to match IP packets or routes against.
<b>Step 27</b>	<b>route-map name permit sequence-number</b> <b>Example:</b> Device(config)# route-map ospf1-into-ospf2 permit 10	Creates the route map entry. Enters route-map configuration mode.
<b>Step 28</b>	<b>match ip address prefix-list prefix-list-name</b> <b>Example:</b> Device(config-route-map)# match ip address prefix-list prefix-list-ospf1-into-ospf2	Distributes routes that have a destination IP network number address that is permitted by a prefix list.

## Configuration Examples for Seamless MPLS

The following sections provide examples for configuring Seamless MPLS.

### Example: Configuring Seamless MPLS on PE Router 1

The following example shows how to configure Seamless MPLS on PE router 1.

```

Device(config-if)#interface Loopback0
 Device(config-if)#ip address 10.100.1.4 255.255.255.255
!
Device(config-if)# interface Ethernet1/0
Device(config-if)# no ip address
Device(config-if)# xconnect 10.100.1.5 100 encapsulation mpls
!
Device(config)# router ospf 2
Device(config-router)# network 10.2.0.0 0.0.255.255 area 0
Device(config-router)# network 10.100.1.4 0.0.0.0 area 0
!
Device(config)#router bgp 1
Device(config-router)# bgp log-neighbor-changes
Device(config-router)# address family ipv4
Device(config-router-af)# network 10.100.1.4 mask 255.255.255.255
Device(config-router-af)# no bgp default ipv4 unicast
Device(config-router-af)# no bgp default route-target filter
Device(config-router-af)# neighbor 10.100.1.1 remote-as 1
Device(config-router-af)# neighbor 10.100.1.1 update-source Loopback0
Device(config-router-af)# neighbor 10.100.1.1 send-label

```

### Example: Configuring Seamless MPLS on Route Reflector 1

The following examples shows how to configure Seamless MPLS on route reflector 1.

```

Device(config-if)# interface Loopback0
Device(config-if)# ip address 10.100.1.1 255.255.255.255
Device(config)# router ospf 1
Device(config-router)# network 10.1.0.0 0.0.255.255 area 0
Device(config-router)# network 10.100.1.1 0.0.0.0 area 0
!
Device(config)# router ospf 2
Device(config-router)# redistribute ospf 1 subnets match internal route-map ospf1-into-ospf2
Device(config-router)# network 10.2.0.0 0.0.255.255 area 0
!
Device(config)# router bgp 1
Device(config-router)# bgp log-neighbor-changes
Device(config-router)# address family ipv4
Device(config-router-af)# neighbor 10.100.1.2 remote-as 1
Device(config-router-af)# neighbor 10.100.1.2 update-source Loopback0
Device(config-router-af)# neighbor 10.100.1.2 next-hop-self all
Device(config-router-af)# neighbor 10.100.1.2 send-label
Device(config-router-af)# neighbor 10.100.1.4 remote-as 1
Device(config-router-af)# neighbor 10.100.1.4 update-source Loopback0
Device(config-router-af)# neighbor 10.100.1.4 route-reflector-client
Device(config-router-af)# neighbor 10.100.1.4 next-hop-self all
Device(config-router-af)# neighbor 10.100.1.4 send-label

Device(config)# ip prefix-list prefix-list-ospf1-into-ospf2 seq 5 permit 10.100.1.1/32

Device(config)# route-map ospf1-into-ospf2 permit 10
Device(config-route-map)# match ip address prefix-list prefix-list-ospf1-into-ospf2

```

## Example: Configuring Seamless MPLS on PE Router 2

The following example shows how to configure Seamless MPLS on PE router 2.

```

Device(config-if)#interface Loopback0
Device(config-if)#ip address 10.100.1.5 255.255.255.255
!
Device(config-if)# interface Ethernet1/0
Device(config-if)# no ip address
Device(config-if)# xconnect 10.100.1.4 100 encapsulation mpls
!
Device(config)# router ospf 3
Device(config-router)# network 10.3.0.0 0.0.255.255 area 0
Device(config-router)# network 10.100.1.5 0.0.0.0 area 0
!
Device(config)#router bgp 1
Device(config-router)# bgp log-neighbor-changes
Device(config-router)# address family ipv4
Device(config-router-af)# network 10.100.1.5 mask 255.255.255.255
Device(config-router-af)# no bgp default ipv4 unicast
Device(config-router-af)# no bgp default route-target filter
Device(config-router-af)# neighbor 10.100.1.2 remote-as 1
Device(config-router-af)# neighbor 10.100.1.2 update-source Loopback0
Device(config-router-af)# neighbor 10.100.1.2 send-label

```

## Example: Configuring Seamless MPLS on Route Reflector 2

The following examples shows how to configure Seamless MPLS on route reflector 2.

```

Device(config-if)# interface Loopback0
Device(config-if)# ip address 10.100.1.2 255.255.255.255
Device(config)# router ospf 1
Device(config-router)# network 10.1.0.0 0.0.255.255 area 0

```

```

Device(config-router)# network 10.100.1.2 0.0.0.0 area 0
!
Device(config)# router ospf 3
Device(config-router)# redistribute ospf 1 subnets match internal route-map ospf1-into-ospf3
Device(config-router)# network 10.3.0.0 0.0.255.255 area 0
!
Device(config)# router bgp 1
Device(config-router)# bgp log-neighbor-changes
Device(config-router)# address family ipv4
Device(config-router-af)# neighbor 10.100.1.1 remote-as 1
Device(config-router-af)# neighbor 10.100.1.1 update-source Loopback0
Device(config-router-af)# neighbor 10.100.1.1 next-hop-self all
Device(config-router-af)# neighbor 10.100.1.1 send-label
Device(config-router-af)# neighbor 10.100.1.5 remote-as 1
Device(config-router-af)# neighbor 10.100.1.5 update-source Loopback0
Device(config-router-af)# neighbor 10.100.1.5 route-reflector-client
Device(config-router-af)# neighbor 10.100.1.5 next-hop-self all
Device(config-router-af)# neighbor 10.100.1.5 send-label

Device(config)# ip prefix-list prefix-list-ospf1-into-ospf3 seq 5 permit 10.100.1.1/32

Device(config)# route-map ospf1-into-ospf3 permit 10
Device(config-route-map)# match ip address prefix-list prefix-list-ospf1-into-ospf3

```

## Feature History for Seamless MPLS

This table provides release and related information for features explained in this module.

These features are available on all releases subsequent to the one they were introduced in, unless noted otherwise.

Release	Feature	Feature Information
Cisco IOS XE Gibraltar 16.12.1	Seamless MPLS	Seamless MPLS provides a highly flexible and scalable architecture to integrate multiple networks into a single MPLS domain. It is based on existing and well known protocols.

Use Cisco Feature Navigator to find information about platform and software image support. To access Cisco Feature Navigator, go to <http://www.cisco.com/go/cfn>.