



Cisco Catalyst IE9300 Rugged Series Switch Hardware Installation Guide

First Published: 2022-04-26

Last Modified: 2024-02-26

Americas Headquarters

Cisco Systems, Inc.
170 West Tasman Drive
San Jose, CA 95134-1706
USA
<http://www.cisco.com>
Tel: 408 526-4000
800 553-NETS (6387)
Fax: 408 527-0883

THE SPECIFICATIONS AND INFORMATION REGARDING THE PRODUCTS IN THIS MANUAL ARE SUBJECT TO CHANGE WITHOUT NOTICE. ALL STATEMENTS, INFORMATION, AND RECOMMENDATIONS IN THIS MANUAL ARE BELIEVED TO BE ACCURATE BUT ARE PRESENTED WITHOUT WARRANTY OF ANY KIND, EXPRESS OR IMPLIED. USERS MUST TAKE FULL RESPONSIBILITY FOR THEIR APPLICATION OF ANY PRODUCTS.

THE SOFTWARE LICENSE AND LIMITED WARRANTY FOR THE ACCOMPANYING PRODUCT ARE SET FORTH IN THE INFORMATION PACKET THAT SHIPPED WITH THE PRODUCT AND ARE INCORPORATED HEREIN BY THIS REFERENCE. IF YOU ARE UNABLE TO LOCATE THE SOFTWARE LICENSE OR LIMITED WARRANTY, CONTACT YOUR CISCO REPRESENTATIVE FOR A COPY.

The following information is for FCC compliance of Class A devices: This equipment has been tested and found to comply with the limits for a Class A digital device, pursuant to part 15 of the FCC rules. These limits are designed to provide reasonable protection against harmful interference when the equipment is operated in a commercial environment. This equipment generates, uses, and can radiate radio-frequency energy and, if not installed and used in accordance with the instruction manual, may cause harmful interference to radio communications. Operation of this equipment in a residential area is likely to cause harmful interference, in which case users will be required to correct the interference at their own expense.

The following information is for FCC compliance of Class B devices: This equipment has been tested and found to comply with the limits for a Class B digital device, pursuant to part 15 of the FCC rules. These limits are designed to provide reasonable protection against harmful interference in a residential installation. This equipment generates, uses and can radiate radio frequency energy and, if not installed and used in accordance with the instructions, may cause harmful interference to radio communications. However, there is no guarantee that interference will not occur in a particular installation. If the equipment causes interference to radio or television reception, which can be determined by turning the equipment off and on, users are encouraged to try to correct the interference by using one or more of the following measures:

- Reorient or relocate the receiving antenna.
- Increase the separation between the equipment and receiver.
- Connect the equipment into an outlet on a circuit different from that to which the receiver is connected.
- Consult the dealer or an experienced radio/TV technician for help.

Modifications to this product not authorized by Cisco could void the FCC approval and negate your authority to operate the product.

The Cisco implementation of TCP header compression is an adaptation of a program developed by the University of California, Berkeley (UCB) as part of UCB's public domain version of the UNIX operating system. All rights reserved. Copyright © 1981, Regents of the University of California.

NOTWITHSTANDING ANY OTHER WARRANTY HEREIN, ALL DOCUMENT FILES AND SOFTWARE OF THESE SUPPLIERS ARE PROVIDED "AS IS" WITH ALL FAULTS. CISCO AND THE ABOVE-NAMED SUPPLIERS DISCLAIM ALL WARRANTIES, EXPRESSED OR IMPLIED, INCLUDING, WITHOUT LIMITATION, THOSE OF MERCHANTABILITY, FITNESS FOR A PARTICULAR PURPOSE AND NONINFRINGEMENT OR ARISING FROM A COURSE OF DEALING, USAGE, OR TRADE PRACTICE.

IN NO EVENT SHALL CISCO OR ITS SUPPLIERS BE LIABLE FOR ANY INDIRECT, SPECIAL, CONSEQUENTIAL, OR INCIDENTAL DAMAGES, INCLUDING, WITHOUT LIMITATION, LOST PROFITS OR LOSS OR DAMAGE TO DATA ARISING OUT OF THE USE OR INABILITY TO USE THIS MANUAL, EVEN IF CISCO OR ITS SUPPLIERS HAVE BEEN ADVISED OF THE POSSIBILITY OF SUCH DAMAGES.

Any Internet Protocol (IP) addresses and phone numbers used in this document are not intended to be actual addresses and phone numbers. Any examples, command display output, network topology diagrams, and other figures included in the document are shown for illustrative purposes only. Any use of actual IP addresses or phone numbers in illustrative content is unintentional and coincidental.

All printed copies and duplicate soft copies of this document are considered uncontrolled. See the current online version for the latest version.

Cisco has more than 200 offices worldwide. Addresses and phone numbers are listed on the Cisco website at www.cisco.com/go/offices.

Cisco and the Cisco logo are trademarks or registered trademarks of Cisco and/or its affiliates in the U.S. and other countries. To view a list of Cisco trademarks, go to this URL: <https://www.cisco.com/c/en/us/about/legal/trademarks.html>. Third-party trademarks mentioned are the property of their respective owners. The use of the word partner does not imply a partnership relationship between Cisco and any other company. (1721R)

© 2021 –2024 Cisco Systems, Inc. All rights reserved.

Communications, Services, and Additional Information

- To receive timely, relevant information from Cisco, sign up at [Cisco Profile Manager](#).
- To get the business impact you're looking for with the technologies that matter, visit [Cisco Services](#).
- To submit a service request, visit [Cisco Support](#).
- To discover and browse secure, validated enterprise-class apps, products, solutions, and services, visit [Cisco DevNet](#).
- To obtain general networking, training, and certification titles, visit [Cisco Press](#).
- To find warranty information for a specific product or product family, access [Cisco Warranty Finder](#).

Cisco Bug Search Tool

[Cisco Bug Search Tool](#) (BST) is a gateway to the Cisco bug-tracking system, which maintains a comprehensive list of defects and vulnerabilities in Cisco products and software. The BST provides you with detailed defect information about your products and software.

Documentation Feedback

To provide feedback about Cisco technical documentation, use the feedback form available in the right pane of every online document.

Bias Free Language

The documentation set for this product strives to use bias-free language. For purposes of this documentation set, bias-free is defined as language that does not imply discrimination based on age, disability, gender, racial identity, ethnic identity, sexual orientation, socioeconomic status, and intersectionality. Exceptions may be present in the documentation due to language that is hardcoded in the user interfaces of the product software, language used based on standards documentation, or language that is used by a referenced third-party product.



CONTENTS

Full Cisco Trademarks with Hardware License	?
Communications, Services, and Additional Information	ii
Cisco Bug Search Tool	iii
Documentation Feedback	iii
Bias Free Language	iii

CHAPTER 1

Cisco Catalyst IE9300 Rugged Series Switches	1
Cisco Catalyst IE9300 Rugged Series Switches	1
Switch Models	1
Front Panel	3
Display Mode Button	5
Express Setup Button	5
System LED	6
Power Supplies	6
Ethernet Ports	8
Alarms	10
Console Ports	11
SD Card Connector	11
USB Host Port	12
Stacking Interface	12
Timing Features	13
GNSS Antenna	13
GNSS Antenna Requirements	14
IRIG Timecode	15

CHAPTER 2

Switch Installation	19
----------------------------	-----------

Preparing for Installation	19
Warnings	19
Installation Guidelines	22
Required Tools and Equipment	22
Verifying the Package Contents	23
Verifying the Switch Operation	23
Switch Installation	23
Rack-Mount Installation	23
Attach Brackets for 19-Inch Racks	24
Install Hole Plugs for IP-30 Compliance (Optional)	26
Attach Brackets for 23-Inch Racks	27
Attach Brackets for ETSI Racks	29
Rack-Mount the Switch	30
Installing Multiple Switches in the Rack	32
Wall-Mount Installation	34
Attach Wall-Mount Brackets	36
Wall-Mount the Switch	37
SFP Installation	39
SFP Installation Considerations and Guidelines	39
Install Fiber Optic SFP Modules	41
Install 100/1000BASE-T SFP Modules	41
Guidance for Connecting to SFP Modules	43
Connect to a Fiber Optic SFP Module	44
Connect to a 1000BASE-T SFP Module	44
Remove SFP Modules	45
Replace the SD Flash Memory Card	46
Connecting Devices to the Ethernet Ports	46

CHAPTER 3

Power Supply Installation	49
Power Supply Installation	49
Power Supply Modules	49
Power Supply Installation Guidelines	51
Installing a Power-Supply Module	52
Required Tools and Equipment	52

Ground the Switch	53
Install the Power-Supply Module in the Switch	55
Wire the Power Source	56
Remove the Power-Supply Module	61

CHAPTER 4**Express Setup 63**

Express Setup	63
Required Equipment	63
Run Express Setup	64

CHAPTER 5**Switch Configuration with the CLI Setup Program 69**

Configuring the Switch with the CLI-Based Setup Program	69
Accessing the CLI Through the Console Port	69
RJ-45 Console Port	69
USB Micro-Type B Console Port	70
Entering the Initial Configuration Information	71
IP Settings	72
Complete the Setup Program	72

CHAPTER 6**Troubleshooting 77**

Diagnosing Problems	77
Switch Boot Fast	77
Switch LEDs	77
Switch Connections	78
Bad or Damaged Cable	78
Ethernet and Fiber-Optic Cables	78
Link Status	78
10/100/1000/2500 Port Connections	79
SFP Module	79
Interface Settings	79
Ping End Device	79
Spanning Tree Loops	79
Switch Performance	80
Speed, Duplex, and Autonegotiation	80

Autonegotiation and Network Interface Cards 80

Cabling Distance 80

Reset the Switch 80

Recovering Passwords 81

Enabling Secure Data Wipe 81

Finding the Switch Serial Number 85

CHAPTER 7

Cables and Connectors 87

Connector Specifications 87

 10/100/1000/2500 Ports 87

 SFP Module Connectors 87

 Console Port 88

 Alarm Port 89

Cables and Adapters 90

 SFP Module Cables 90

 Console Port Adapter Pinouts 90

CHAPTER 8

Hazardous Location Installation Information 93

Hazardous Area Installation Warnings 93

North American Hazardous Location Approval 97

EMC Environmental Conditions for Products Installed in the European Union 98

Hazardous Locations Standards 98

CHAPTER 9

Technical Specifications 101

Switch Specifications 101

Power-Supply Module Specifications 103

Alarm Ratings 104



CHAPTER 1

Cisco Catalyst IE9300 Rugged Series Switches

- [Cisco Catalyst IE9300 Rugged Series Switches, on page 1](#)
- [Switch Models, on page 1](#)
- [Front Panel, on page 3](#)
- [Display Mode Button, on page 5](#)
- [Express Setup Button, on page 5](#)
- [System LED, on page 6](#)
- [Power Supplies, on page 6](#)
- [Ethernet Ports, on page 8](#)
- [Alarms, on page 10](#)
- [Console Ports, on page 11](#)
- [SD Card Connector, on page 11](#)
- [USB Host Port, on page 12](#)
- [Stacking Interface, on page 12](#)
- [Timing Features, on page 13](#)

Cisco Catalyst IE9300 Rugged Series Switches

The Cisco Catalyst IE9300 Rugged Series Switch provides rugged and secure switching infrastructure for harsh environments. It is suitable for industrial Ethernet applications, including manufacturing, utility substations, intelligent transportation systems (ITSs), rail transportation, and other similar deployments. Several versions of the switch offer a GNSS receiver, IRIG-B connectors, and PoE.

The switch fulfills the need for a high-density rack-, or wall-mount switch that can function as a software-defined (SD)-Access fabric edge. It provides end-to-end architectural uniformity in the Cisco Digital Network Architecture (DNA) for Internet of Things (IoT) for connected communities and extended enterprise applications.

In industrial environments, the switch can be connected to any Ethernet-enabled industrial communication devices. These devices include programmable logic controllers (PLCs), human-machine interfaces (HMIs), drives, sensors, and input and output (I/O) devices.

Switch Models

The Cisco Catalyst IE9300 Rugged Series Switch is available in several hardware models.

All switches have a total of 28 ports and support two field-replaceable redundant AC or DC power supplies.

Table 1: Cisco Catalyst IE9300 Rugged Series Switch Models

Model	SFP/SFP+ Uplinks	SFP/SFP+ Downlinks	Default Software License	Stacking Support	GNSS and IRIG-B
IE-9310-26S2C-A	4x 1 Gb SFP	22x 1 Gb SFP 2x 1 Gb dual-media ports	Network Advantage	No	No
IE-9310-26S2C-E			Network Essentials		
IE-9320-26S2C-A	4x 1 Gb SFP	22x 1 Gb SFP 2x 1 Gb dual-media ports	Network Advantage	Yes	No
IE-9320-26S2C-E			Network Essentials		
IE-9320-22S2C4X-A	4x 10 Gb SFP+	22x 1 Gb SFP 2x 1 Gb dual-media ports	Network Advantage	Yes	Yes
IE-9320-22S2C4X-E			Network Essentials		
IE-9320-24T4X-A	4x 10 Gb SFP+	24x 1 Gb RJ45	Network Advantage	Yes	No
IE-9320-24T4X-E			Network Essentials		
IE-9320-24P4X-A	4x 10 Gb SFP+	24x 1 Gb RJ45 PoE+	Network Advantage	Yes	No
IE-9320-24P4X-E			Network Essentials		
IE-9320-16P8U4X-A	4x 10 Gb SFP+	16x 1 Gb RJ45 PoE+	Network Advantage	Yes	No
IE-9320-16P8U4X-E		8x 2.5 Gb RJ45 4PPoE (90W/port)	Network Essentials		
IE-9320-24P4S-A	4x 1 Gb SFP	24x 1 Gb RJ45 PoE+	Network Advantage	Yes	No
IE-9320-24P4S-E			Network Essentials		



Note In the preceding table, -A at the end of a model name indicates that the model has a Network Advantage license. An -E indicates that the model has a Network Essentials license. For information about differences between the licenses, see the [Cisco Catalyst IE9300 Rugged Series Data Sheet](#) on Cisco.com.

All Cisco Catalyst IE9300 Rugged Series Switch models have 4 GB of DRAM, four alarm inputs, and one alarm output. Other I/O includes the following:

- SD-card slot
- Power input
- RJ-45 (RS-232) console
- Micro-USB console
- USB-A host port

The IE9320 10 GE Fiber switch also has a GNSS receiver and IRIG-B time code input/output connectors. For more information, see the section [Timing Features, on page 13](#) in this guide.

**Note**

- IE9310 GE Fiber refers to both IE-9310-26S2C-A and IE-9310-26S2C-E switches.
- IE9320 GE Fiber refers to both IE-9320-26S2C-A and IE-9320-26S2C-E switches.
- IE9320 Fiber switch with 10 GE uplinks refers to IE-9320-22S2C4X-A and IE-9320-22S2C4X-E switches.
- IE9320 10 GE Copper Data switch refers to IE-9320-24T4X-A and IE-9320-24T4X-E switches.
- IE9320 10 GE PoE switch refers to IE-9320-24P4X-A and IE-9320-24P4X-E switches.
- IE9320 10 G mGig 4PPoE switch refers to IE-9320-16P8U4X-A and IE-9320-16P8U4X-E switches.
- IE9320 GE PoE switch refers to IE-9320-24P4S-A and IE-9320-24P4S-E switches.

Front Panel

All the ports and LEDs of Cisco Catalyst IE9300 Rugged Series Switches are on the front panel. This section shows the arrangement of features on the front panel; see other sections for detailed information about ports and LEDs.

**Note**

- LEDs are distributed over the front panel, each one near the interface it relates to. System status LEDs that are not associated with a specific interface are on the left side of the front panel.
- The front panels of IE9310 GE Fiber and IE9320 GE Fiber models are nearly identical. Later sections note the few differences.
- The front panels of IE9320 10 GE models are similar to those of IE9310 GE Fiber and IE9320 GE Fiber models. Later sections note the few differences.
- The front panels of IE9320 PoE models are similar to those of IE9320 GE Fiber models. Later sections note the few differences.
- The power supply LEDs are also visible on the rear of the switch, where the power supply units are installed.

Figure 1: Front Panel: IE9310 GE Fiber and IE9320 GE Fiber Switches

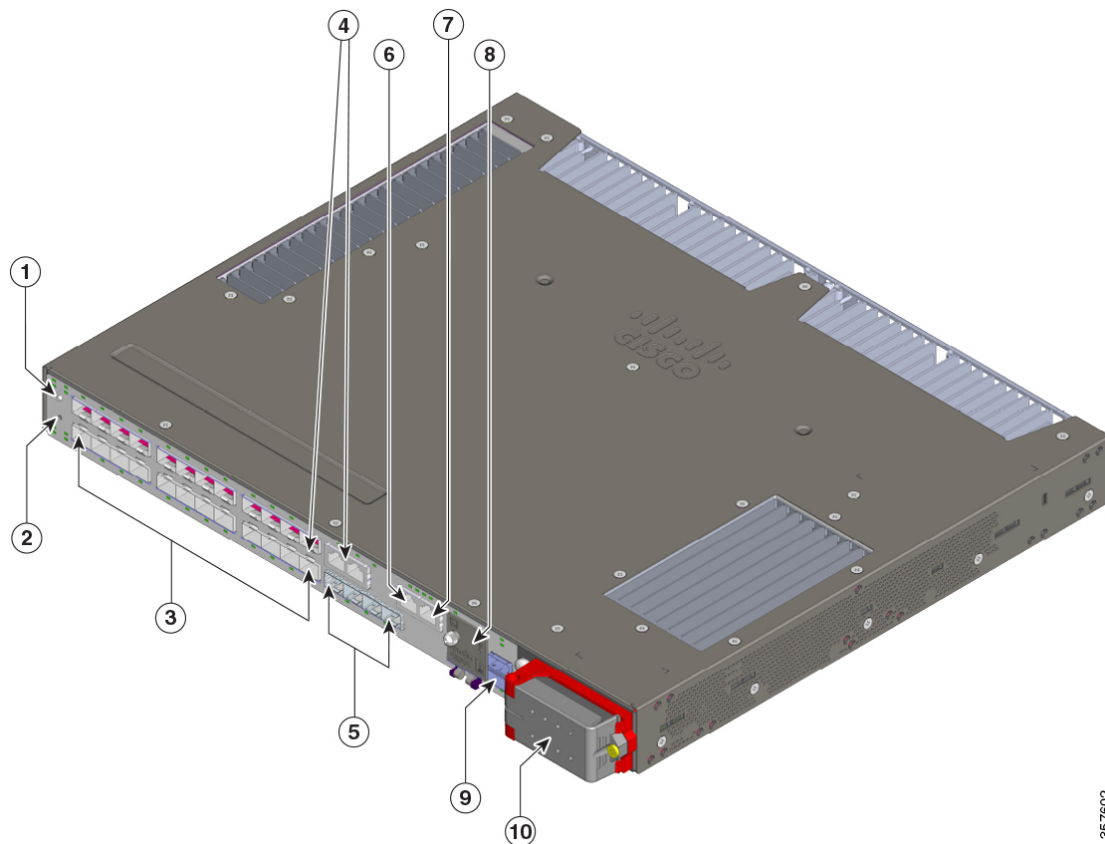

357602

1	Display mode button	6	Alarms
2	Express Setup button	7	RJ-45 console port
3	Ethernet SFP downlinks	8	(Beneath cover) Micro-USB console port, USB-A host port, and SD slot
4	Dual-media downlink ports	9	Stacking interface (IE9320 switches only)
5	Ethernet SFP uplinks	10	AC/DC power input



Note *Dual-media downlink ports* are sometimes referred to as *combination ports* or *combo ports*.

The following image shows the front panel of IE9320 10 GE switches, calling out features not found on other switch model. The other front panel features are the same as on the IE9310 GE Fiber and IE9320 GE Fiber switches.

Display Mode Button

Each Ethernet port has an LED, which displays information about the port. You can control the type of information that the port LEDs display by pressing the display mode button and its LEDs.

The Cisco Catalyst IE9300 Rugged Series Switch has multiple LEDs, one for each different mode. To select or change a mode, press the display mode button until the desired mode LED is lit. When you choose a mode, the display mode button LED turns solid green, and the port LEDs light up according to the mode. When you change port modes, the meanings of the port LED colors also change. The display mode button LED turns off after 5 seconds or when you choose a different mode.

The IE9310 and IE9320 switches have Speed, Duplex, and Redundancy modes and LEDs. IE9320 switches also have a Stack LED.



Note The modes apply to SFP and copper ports. Combination ports have two port LEDs, one by the SFP connector and the second by the RJ-45 connector. Only one can be active at a time.

For details about the display modes and corresponding port LEDs, see the section [Ethernet Ports, on page 8](#) in this document.

Express Setup Button

Express Setup is a web-based procedure to configure initial IP address information to the new switch. It provides a simple way to manage the switch and connect it to an existing network of local routers and the internet.

The front panel of the Cisco Catalyst IE9300 Rugged Series Switch has an Express Setup button and a setup LED. The button is recessed to prevent accidental activation; you need a paper clip or similar object to press it. Express Setup has three modes, which you trigger by varying the amount of time that you press the button.

Table 2: Express Setup Modes

Mode	Seconds Required to Trigger Mode	Description
Short Press	1 to 5 seconds	Places the switch into Express Setup mode.
Medium Press	6 to 10 seconds	Causes the switch to start DHCP discovery phase on the Vlan 1 interface.
Long Press	16 to 20	Causes the switch to erase its startup configuration and reload. This in turn causes the switch to revert to its Day 1 default configuration.

The setup LED displays the Express Setup mode for the initial configuration.

Table 3: Setup LED States

Color	Status
Off	Switch is configured as a managed switch.
Solid green	System is operating normally.
Blinking green	Switch is in initial setup, in recovery, or initial setup is incomplete.
Red	Switch failed to start initial setup or recovery because there is no available switch port to connect the management station. Disconnect a device from a switch port, and then press the Express Setup button.

System LED

The system LED provides basic status about the health of the Cisco Catalyst IE9300 Rugged Series Switch.

Table 4: System LED

Color	System Status
Off	System is not powered on.
Blinking green	Power-on self-test (POST) is in progress.
Green	System is operating normally.
Red	System is receiving power but is not functioning properly.
Blinking red	Boot failure.

Power Supplies

The Cisco Catalyst IE9300 Rugged Series Switch supports two hot-swappable, redundant, load-sharing FRU power supplies. It requires one power supply for system operation, and the second power supplies is optional for redundancy. A second power supply can also increase the PoE power budget on switches that support PoE.

Both power supplies are installed on the back of the switch.

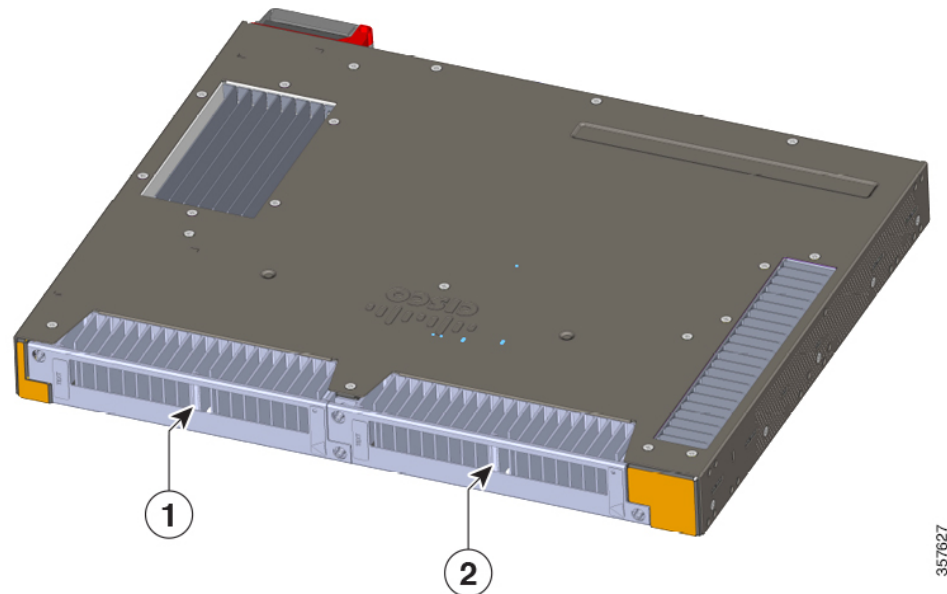
Figure 2: Power Supply Units

357627

1	Power Supply 1	2	Power Supply 2
---	----------------	---	----------------

The power supply AC/DC power input is on the front of the switch.

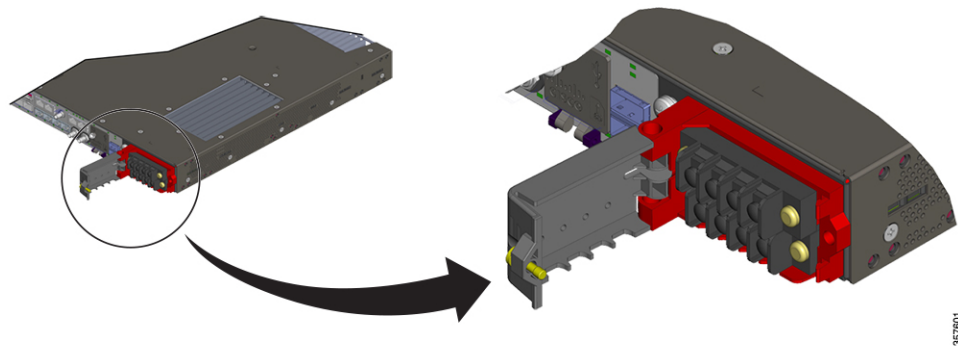
Figure 3: Power Supply AC/DC Input

357601

Each power supply has its own LED, which shows if the power supply is receiving power and if it is working properly. The LEDs are driven directly by the power supplies and are not under software control. Control by the power supplies ensures that the LEDs turn on when the power is available and remain on regardless of the software state.

For details about the power supply and its LED, see the section [Power Supply Modules, on page 49](#).

Ethernet Ports

The Cisco Catalyst IE9300 Rugged Series Switch supports four uplink (1 G or 10 G) ports and 24 downlink ports. Two of the downlink ports on fiber switches can function as dual-media downlink ports, providing an SFP interface and a copper interface.

- IE9320 GE Fiber switches: SFP downlinks and uplinks support 1 Gb and 100 Mb SFPs.
- IE9310 GE Fiber switches: SFP downlinks support 1 Gb and 100 Mb SFPs; uplinks support 1 Gb SFPs.
- IE9320 10 GE Fiber switches: SFP downlinks support 1 Gb and 100 Mb SFPs; uplinks support 1 Gb and 10 Gb SFPs.
- IE9320 GE Copper switches: Uplinks support 1 Gb SFPs. Downlinks support 1 Gb, 100 Mb, 10 Mb.
- IE9320 10 GE Copper switches: Uplinks support 1 Gb and 10 Gb SFPs. Gigabit downlinks support 1Gb, 100 Mb, 10 Mb, 2.5 Gb downlinks support 2.5 Gb, 1Gb, and 100Mb (full-duplex only).



Note Each port has an LED above or below it.

- *Ethernet dual-media downlink ports*: All dual-media downlink ports support 1 Gb and 100 Mb SFPs on the SFP interface. The copper media support 1000BASE-T, 100BASE-TX, and 10BASE-T with autonegotiation, auto-MDIX, and cable diagnostics on an RJ-45 connector. Each dual-media downlink port has two LEDs, one by the SFP connector, and one by the RJ-45 connector.



-
- Note**
- Only one interface on dual-media downlink ports can be active at a time.
 - *Dual-media downlink ports* are sometimes referred to as *combination ports* or *combo ports*.
-

Each port LED displays information about its individual port. However, you can use the display mode button to cycle through the different LED modes, which determines the kind of information that is shown by the port LEDs. When you choose a mode, the mode LED lights up solid green, and the port LEDs light up as described in the following table. After 5 seconds, the mode LED turns off, its default state.

Table 5: Ethernet Port LEDs

Port Mode	LED Color	Status
Not illuminated (Default)	Off	No link, or port that is administratively shut down.
	Green	Link present but no activity.
	Blinking green	Activity. Port is sending or receiving data.
	Alternating green and amber	Link fault. Error frames can affect connectivity, and errors such as excessive collisions, CRC errors, and alignment and jabber errors are monitored for a link fault.
	Amber	Port is blocked by Spanning Tree Protocol (STP) and is not forwarding data. After a port is reconfigured, the port LED can remain amber for up to 30 seconds while STP checks the switch for possible loops.
	Blinking amber	System is sending Spanning Tree bridge protocol data units (BPDUs) on an STP blocked port.
SPEED	Off	Port is operating at 10 Mb/s.
	Green	Port is operating at 100 Mb/s.
	Single green flash (On for 100 ms., off for 1900 ms.)	Port is operating at 1000 Mb/s.
	Double green flash	Port is operating at 2.5 or 10 GB/s.
DUPLEX	Off	Port is operating in half duplex.
	Green	Port is operating in full duplex.
REDUNDANCY	Off	Port is not participating in a redundancy protocol.
	Green	Port is participating in a redundancy protocol (REP, HSR, PRP, MRP, and so on.)
	Blinking amber	Port is participating in a redundancy protocol, and a redundancy fault is present.
STACK	Off	No stack member corresponding to that member number.
	Green	Member numbers of other stack member switches.
	Blinking green	Stack member number.

Port Mode	LED Color	Status
PoE	Off	PoE is off. The switch port is not providing power.
	Green	PoE is on. The switch port is providing power.
	Alternating green and amber	PoE is denied because providing power to the powered device will exceed the switch power capacity.
	Blinking amber	PoE is off because of a fault or because it has exceeded a limit set in the switch software.
	Amber	PoE+ for the port has been disabled.

Alarms

Each Cisco Catalyst IE9300 Rugged Series Switch has four alarm inputs and one output. You can connect up to four alarm inputs from different devices—such as a cabinet tamper switch or over-temperature sensor—to the alarm port. You can use the CLI to set the alarm severity to minor or major.

The switch software monitors switch conditions for each port or the switch overall. If the conditions present on the switch or a port do not match the set parameters, the switch software triggers an alarm or a system message and turns on an LED.

You can configure the system to respond to alarm input in three different ways, as shown in the following table:

Table 6: Alarm Notification Types

Color	Status
Logging	Logging is the default configuration. It sends the message syslog. You can use the WebUI or CLI to choose another alarm notification method.
SNMP trap	Configure the SNMP traps on the switch to send the notification to the SNMP server.
External	Configure the switch to trigger an external alarm device by using the alarm relay.

Table 7: Alarm Input LEDs

Color	Status
Off	Alarm is not configured.
Green	Alarm is configured but no alarm detected.
Red	Minor alarm is present.
Blinking red	Major alarm is present.

Table 8: Alarm Output LEDs

Color	Status
Green	Alarm is not present.
Red	Minor alarm condition is present.
Blinking red	Major alarm condition is present.

Console Ports

The Cisco Catalyst IE9300 Rugged Series Switch has two console ports: one RS-232 port with an RJ-45 connector, and one USB port with a micro-USB connector. The USB port is behind a small door on the front panel.

Output from the switch is always sent to both ports, but input is accepted only from one port at a time. The USB console LED shows which console port is in use. If both RS-232 and USB console ports are connected, the USB console port has priority unless the USB console is disabled in the switch configuration.

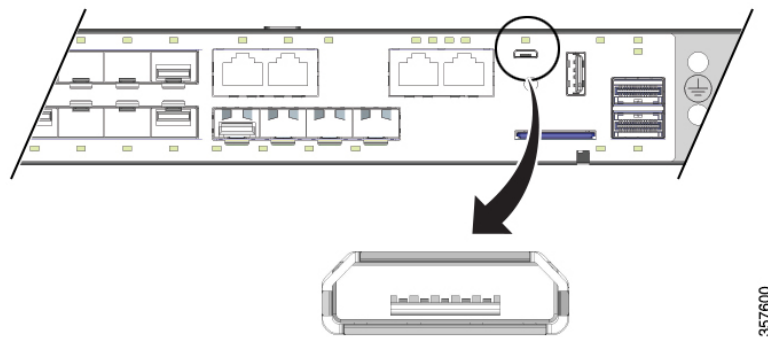
Figure 4: Micro-USB Connector**Table 9: Console Port LEDs**

Color	Status
Off	USB port is inactive. RJ-45 console port is active.
Green	USB port is active. RJ-45 console port is inactive.

SD Card Connector

The Cisco Catalyst IE9300 Rugged Series Switch has a secure digital (SD) card connector. You can use the connector for the Swap Drive feature and to copy files on and off the system. The slot is behind a door on the front panel.

The following table shows the SD card connector states and what they mean.

Table 10: SD Card LED

Color	Status
Off	SD card is not present.
Green	SD card is present and working.
Blinking green	SD card transfer is in progress.
Fast blinking amber	Unsupported SD card is detected.



Caution Do not install or remove the SD card when an explosive environment may be present.

Attention :

Ne pas installer ni retirer la carte SD dans un environnement présentant un risque d'explosion.

USB Host Port

The Cisco Catalyst IE9300 Rugged Series Switch has a USB-A host port on the front panel. Note that the port is intended only for service operation and not for continuous use.

Table 11: USB Host Port LEDs

Color	Status
Off	No USB device is connected.
Green	A USB device is connected and active.
Blinking amber	An unrecognized USB device is connected.

Stacking Interface

The stacking interface allows a group of IE9320 GE Fiber switches or IE9320 Fiber switches with 10 GE uplinks to act as a single large switch. IE9320 GE Fiber switches have two stack interface connectors, and each connector has its own LEDs.

The stacking interface allows a group of supported switches to act as a single large switch. The following Cisco Catalyst IE9300 Rugged Series Switches support stacking:

- IE-9320-26S2C-E, IE-9320-22S2C4X-E
- IE-9320-22S2C4X-E, IE-9320-22S2C4X-A
- IE-9320-24T4X-E, IE-9320-24T4X-A
- IE-9320-24P4X-E, IE-9320-24P4X-A
- IE-9320-16P8U4X-E, IE-9320-16P8U4X-A
- IE-9320-24P4S-E, IE-9320-24P4S-A

The stacking interface has an LED that shows the status of active and standby managers.

Table 12: Stacking interface LEDs

Color	Status
Off	Switch is a stack member (not the active or standby stack manager).
Green	Switch is the active stack manager or not part of a stack (standalone operation).
Slow blinking green	Switch is the standby stack manager.
Amber	An error occurred during stack manager election, or another type of stack error occurred.

Each of the two stack connectors has an LED that shows the status of that stack link.

Color	Status
Off	Stack link is not established on this port.
Green	Stack link is established on this port.
Blinking green	Activity. Stack port is sending or receiving data.
Amber	Stack fault. Stack communication is not working on this port.

Timing Features

IE9320 GE Fiber (IE-9320-22S2C4X-E and IE-9320-22S2C4X-E) switches have integrated hardware support for external time sources: GNSS antenna and Inter-Range Instrumentation Group (IRIG-B) interfaces. These interfaces are complemented by the network time-distribution protocol Precision Time Protocol (PTP).

GNSS antenna and IRIG-B are supported in Cisco IOS XE Dublin 17.12.x and later releases.

GNSS Antenna

IE9320 GE Fiber (IE-9320-22S2C4X-E and IE-9320-22S2C4X-E) switches have a built-in Global Navigation Satellite System (GNSS) receiver. (GNSS is often referred to as GPS.)

The receiver enables the switch to determine its own location and get an accurate time from a satellite constellation. The switch can then become the source (Grand Master Clock) for time distribution in the network. GNSS capability simplifies network synchronization planning and provides flexibility and resilience in resolving network synchronization issues in a hierarchical network.



Note For information about GNSS, including guidelines and configuration, see the chapter "Global Navigation Satellite System" in the *Precision Time Protocol Configuration Guide, Cisco Catalyst IE9300 Rugged Series Switches*.

The following illustration shows the placement of the GNSS receiver on the front panel of IE9320 Fiber switches with 10 GE uplinks. The receiver is circled.

Figure 5: GNSS Receiver

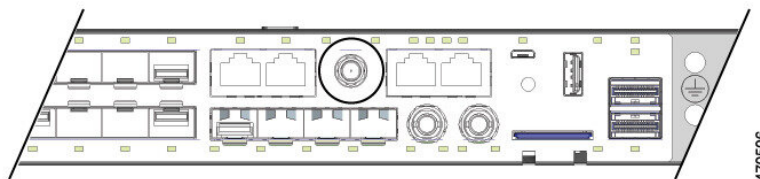

The system has an SMA connector to attach an external GNSS antenna. It can provide current-limited power to power an active (amplified) antenna.

The GNSS receiver supports multiple satellite constellations as shown in the following table.

Band	Frequency	Constellations
L1	1602MHz 1575.42 MHz	GPS, GLONASS, QZSS, Galileo
	1561.098 MHz	BeiDou
L5	1176.45 MHz	GPS, QZSS, Galileo, BeiDou, NavIC

The following table shows the behavior of the GNSS LEDs.

LED	Color	System Status
GPS	Off	GNSS is not configured.
	Solid Green	Active with satellite fix.
	Blinking Green	Attempting to acquire satellite fix.
	Blinking Amber	Antenna Fault.

GNSS Antenna Requirements

GNSS RF Input

GNSS input requires a GPS/GNSS receive antenna with built-in low-noise amplifier (LNA) for optimal performance. The LNA amplifies the received satellite signals:

- To compensate for cable loss
- To increase the signal amplitude to a suitable range for the receiver front-end

The amplification required is 22dB gain + cable loss + connector loss.

The recommended range of LNA gain (LNA gain minus all cable and connector losses) at the connector of the receiver input is 22dB to 30dB with a minimum of 20dB and a maximum of 35dB.

- The GPS/GNSS input on the switch provides 3.3 or 5VDC (software configurable) to the antenna through the same RF connector. The antenna should draw between 10 and 100mA. An antenna that draws less than 10mA may wrongly report an "Antenna Open" fault even though the antenna is operating properly.

Power Input

When deployed in a hazardous environment the antenna shall only use power provided by the RF input from a single switch. No additional power may be supplied to the antenna and associated equipment.



Caution Supplying additional power, such as with a powered splitter or amplified repeater, may provide enough energy to create an arc that could ignite the explosive atmosphere.

Attention :

L'ajout d'un dispositif d'alimentation électrique, comme un répartiteur électrique ou un répéteur amplifié, peut générer suffisamment d'énergie pour créer un arc qui pourrait enflammer une atmosphère présentant un risque d'explosion.

Surge Protection

The GNSS input has built-in ESD protection. If an outdoor antenna is being connected, additional surge protection is required to meet the regulations and standards for lightning protection in the countries where the end product is installed.

The lightning protection must be mounted at the place where the antenna cable enters the building. The primary lightning protection must be certified for conducting all potentially dangerous electrical energy to PE (protective earth). Surge arrestors should support DC-pass and be suitable for the GPS/GNSS frequency range with low RF attenuation.



Caution The antenna terminal should be earthed at the building entrance in accordance with the ANSI/NFPA 70, the National Electrical Code (NEC), in particular Section 820.93, Grounding of Outer Conductive Shield of a Coaxial Cable.

Attention :

La borne de l'antenne doit être mise à la terre à l'entrée du bâtiment conformément à la norme ANSI/NFPA 70 et au National Electrical Code (NEC), en particulier l'article 820.93, « Grounding of Outer Conductive Shield of a Coaxial Cable » (mise à la terre du blindage externe conducteur d'un câble coaxial).

Antenna Sky Visibility

GPS signals require a direct line of sight between antenna and satellite. The antenna should see as much of the sky as possible. Fixed installations require four satellites in view for an initial time fix, while subsequent updates may be possible with fewer satellites.

IRIG Timecode

(IE-9320-22S2C4X-E and IE-9320-22S2C4X-E) switches have IRIG-B timecode input and output capability. The IRIG-B time protocol is widely used to establish and maintain time synchronization between system devices. It is supported beginning with the Cisco IOS XE 17.12.1 release.



Note For detailed information about IRIG-B, including configuration information, see the chapter "IRIG Time Code B" in the *Precision Time Protocol Configuration Guide, Cisco Catalyst IE9300 Rugged Series Switches*.

There are two mini-BNC connectors on the front panel: one for digital timecode, and a second for analog timecode, each of which can be configured separately as input or output. The following illustration shows the two IRIG-B connectors on the front of the switch.

Figure 6: IRIG Timecode Connectors

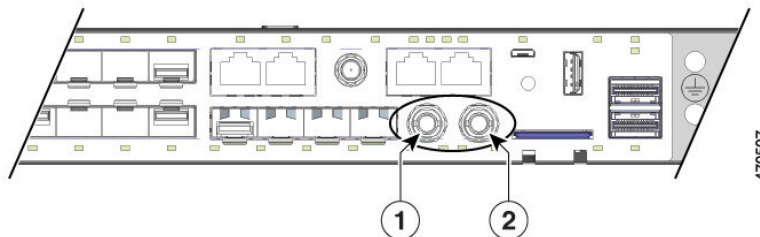

1	IRIG-B digital timecode connector (mini-BNC connector)	2	IRIG-B analog timecode connector (mini-BNC connector)
---	--	---	---



Note You must buy or build cables for IRIG-B connectivity following the IRIG-B standard and switch's specifics. These cables are *not* provided with the platform.

The following table shows the behavior of IRIG timecode LEDs.

LED	Color	System Status
Analog In	Off	Analog timecode input is not configured.
	Solid Green	Analog timecode input is present and operating properly.
	Alternating Green and Amber	Analog timecode signal is present with errors.
	Blinking Amber	Analog timecode input configured, no signal present.
Analog Out	Off	Analog timecode output is not configured.
	Solid Green	Analog timecode output is configured and sending a signal.

LED	Color	System Status
Digital In	Off	Digital timecode input is not configured.
	Solid Green	Digital timecode input is present and operating properly.
	Alternating Green and Amber	Digital timecode signal is present with errors.
	Blinking Amber	Digital timecode input configured, no signal present.
Digital Out	Off	Digital timecode output is not configured.
	Solid Green	Digital timecode output is configured and sending a signal.



CHAPTER 2

Switch Installation

- [Preparing for Installation, on page 19](#)
- [Switch Installation, on page 23](#)
- [SFP Installation, on page 39](#)
- [Replace the SD Flash Memory Card, on page 46](#)
- [Connecting Devices to the Ethernet Ports, on page 46](#)

Preparing for Installation

Before you install a Cisco Catalyst IE9300 Rugged Series Switch, you must read, understand, and observe the warnings and guidelines in this section. You also must verify the switch package contents, gather the required tools and equipment, and verify the switch operations.

Warnings

These warnings are translated into several languages in the Regulatory Compliance and Safety Information for [Cisco Catalyst IE9300 Rugged Series Switch](#). They apply to all the switch models.



Warning Before working on equipment that is connected to power lines, remove jewelry (including rings, necklaces, and watches). Metal objects will heat up when connected to power and ground and can cause serious burns or weld the metal object to the terminals. Statement 43

Avertissement :

Avant de travailler sur un appareil raccordé au réseau électrique, retirez vos bijoux (y compris bagues, colliers et montre). En cas de contact avec l'alimentation et la mise à la terre, les objets métalliques peuvent chauffer et provoquer de graves brûlures ou encore se souder aux terminaux. Énoncé 43



Warning Read the installation instructions before you connect the system to its power source. Statement 1004

Avertissement :

Lisez les instructions d'installation avant de brancher le système à sa source d'alimentation. Énoncé 1004

**Warning**

This unit is intended for installation in restricted access areas. A restricted access area can be accessed only through the use of a special tool, lock and key, or other means of security. Statement 1017

Avertissement :

Cet appareil est conçu pour une installation dans les zones à accès limité. Une zone à accès limité est accessible uniquement si vous utilisez un outil, une clé et un verrou spéciaux ou d'autres moyens de protection. Énoncé 1017

**Warning**

This equipment must be grounded. Never defeat the ground conductor or operate the equipment in the absence of a suitably installed ground conductor. Contact the appropriate electrical inspection authority or an electrician if you are uncertain that suitable grounding is available. Statement 1024

Avertissement :

Cet équipement doit être mis à la terre. Ne supprimez jamais le conducteur de mise à la terre et n'utilisez jamais l'appareil en l'absence d'un conducteur de mise à la terre installé convenablement. Communiquez avec l'organisme d'inspection électrique approprié ou avec un maître-électricien si vous n'êtes pas sûr que la mise à la terre est adéquate. Énoncé 1024

**Warning**

This unit might have more than one power supply connection. All connections must be removed to de-energize the unit. Statement 1028

Avertissement :

Il se peut que cet appareil ait plus d'une connexion de bloc d'alimentation. Pour mettre l'appareil hors tension, vous devez débrancher toutes les connexions. Énoncé 1028

**Warning**

Only trained and qualified personnel should be allowed to install, replace, or service this equipment. Statement 1030

Avertissement :

Toute installation, tout remplacement ou toute réparation de cet équipement doit être effectué par un personnel qualifié et compétent. Énoncé 1030

**Warning**

Ultimate disposal of this product should be handled according to all national laws and regulations. Statement 1040

Avertissement :

L'élimination finale de ce produit doit être effectuée conformément à toutes les réglementations et lois nationales. Énoncé 1040

**Warning**

For connections outside the building where the equipment is installed, the following ports must be connected through an approved network termination unit with integral circuit protection. 10/100/1000 Ethernet Statement 1044

Avertissement :

Pour les connexions extérieures au bâtiment équipé, les ports suivants doivent être connectés à un point approuvé de terminaison de réseau, avec protection complète du circuit. Énoncé 1044 pour Ethernet 10/100/1000

**Note**

Statement 1044 also applies to 2.5 Gbps ports on IE9320 10 G mGig 4PPoE switches (IE-9320-16P8U4X-A and IE-9320-16P8U4X-E switches).

**Warning**

To prevent the system from overheating, do not operate it in an area that exceeds the maximum recommended ambient temperature of: 140°F (60°C). Statement 1047

Operating temperatures exceeding 60°C are not covered by the product safety certifications and approvals. However, the switch can function in the installations under the environmental conditions listed in Switch Specifications.

Avertissement :

Pour éviter toute surchauffe du système, il est recommandé de maintenir une température ambiante inférieure à 60 °C (140 °F). Énoncé 1047

Les températures de fonctionnement supérieures à 60 °C ne sont pas couvertes par les certifications et les approbations de sécurité du produit. Cependant, le commutateur peut fonctionner dans les installations respectant les conditions environnementales indiquées dans les spécifications du commutateur.

**Warning**

Installation of the equipment must comply with local and national electrical codes. Statement 1074

For U.S. installations, refer to national electrical code ANSI/NFPA 70. Also consult your state and municipal codes.

Avertissement :

Installez l'équipement en respectant les réglementations locales et nationales en matière de câblage. Énoncé 1074

Pour les installations aux États-Unis, se reporter au code électrique national ANSI/NFPA 70. Consultez également les codes de votre État et de votre municipalité.

**Warning**

To prevent airflow restriction, allow clearance around the ventilation openings to be at least: 1.75 in. (4.4 cm). Statement 1076

Avertissement :

Pour faciliter la circulation de l'air, aménagez autour des bouches d'aération un dégagement d'au moins 1,75 po (4,4 cm). Énoncé 1076

**Warning**

Avoid using or servicing any equipment that has outdoor connections during an electrical storm. There may be a risk of electric shock from lightning. Statement 1088

Avertissement :

Les équipements pourvus de connexions extérieures ne doivent pas être utilisés ni entretenus pendant un orage. La foudre est susceptible de provoquer des décharges électriques. Énoncé 1088

Installation Guidelines

Before installing the Cisco Catalyst IE9300 Rugged Series Switch, be sure to meet the following guidelines:

- Ensure that cabling is away from sources of electrical noise, such as radios, power lines, and fluorescent lighting fixtures. Also ensure that the cabling is away from other devices that might damage the cables.
- Ensure that the operating environment is within the ranges that are listed in Technical Specifications.
- Ensure that relative humidity around the switch does not exceed 95 percent (noncondensing).
- Ensure that the altitude at the installation site is no higher than 15,000 feet (4572 m).
- For 10/100/1000 fixed ports, ensure that cable lengths from the switch to connected devices are not more than 328 feet (100 meters).
- For more information about SFP/SFP+ modules and cables, see Transceiver Modules.
- Ensure that airflow around the switch and through the vents is unrestricted. To prevent overheating, the switch must meet the minimum clearance of 1.75 in. (4.4 cm) at the top, bottom, and sides.

**Note**

If the switch is installed in a closed or multirack assembly, the temperature around it might be greater than normal room temperature. Ensure that the internal temperature does not exceed the maximum ambient temperature specifications for the switch.

Required Tools and Equipment

Obtain the necessary tools and equipment:

- Phillips screwdriver

Verifying the Package Contents

The shipping box contains the model of the switch you ordered and other components that you need for installation. Some components are optional, depending on your order.



Note Verify that you have received these items. If any item is missing or damaged, contact your Cisco representative or reseller for instructions.

Verifying the Switch Operation

Before installing the switch in a rack or on a wall, you should power the switch and verify that the switch passes the power-on self-test (POST).

To wire the switch to the power source, see Power-Supply Module Installation.

When the switch begins POST, the SYS LED blinks green, and the other LEDs stay green. When the switch passes POST, the SYS LED turns green. The other LEDs turn off and return to their operating status. If the switch fails POST, the SYS LED is red.



Note Contact Cisco Systems immediately if your switch fails POST.

After a successful POST, disconnect the power from the switch. For more information, see Wiring the Power Source. See the Installing the Switch to install the switch in a rack or on a wall.

Switch Installation

You can install the Cisco Catalyst IE9300 Rugged Series Switch in a 19-inch, 23-inch, or ETSI rack or on a wall. Follow the instructions in the appropriate section.

Rack-Mount Installation

To rack-mount the switch, select the rack size and follow the steps in these sections:

- [Attach Brackets for 19-Inch Racks, on page 24](#)
- [Attach Brackets for 23-Inch Racks, on page 27](#)
- [Attach Brackets for ETSI Racks, on page 29](#)
- [Rack-Mount the Switch, on page 30](#)

**Warning**

To prevent bodily injury when mounting or servicing this unit in a rack, you must take special precautions to ensure that the system remains stable. Observe the following guidelines to ensure your safety:

- Mount the unit at the bottom of the rack if it is the only unit in the rack.
- When mounting this unit in a partially filled rack, load the rack from the bottom to the top with the heaviest component at the bottom of the rack.
- If the rack is provided with stabilizing devices, install the stabilizers before mounting or servicing the unit in the rack. Statement 1006

Avertissement :

Pour éviter des blessures corporelles lors du montage ou de l'entretien de l'appareil dans un bâti, vous devez prendre des précautions particulières afin de garantir la stabilité du système. Suivez les directives suivantes pour assurer votre sécurité :

- S'il n'y a qu'une unité, elle doit être installée au bas du bâti.
- Si vous montez l'appareil sur un bâti partiellement rempli, chargez le bâti du bas vers le haut en plaçant le composant le plus lourd en bas du bâti.
- Si le bâti est équipé de dispositifs de stabilisation, installez les stabilisateurs avant de monter l'unité sur le bâti ou d'effectuer son entretien. Énoncé 1006

Attach Brackets for 19-Inch Racks

Before you begin

Complete the tasks in the section Preparing for Installation.

-
- Step 1** Decide whether you will use a front, middle, or rear mounting of the switch in the rack.
- Step 2** Attach the brackets to the switches, following the steps in the appropriate illustrations.

Figure 7: Attaching Brackets: Front Mounting

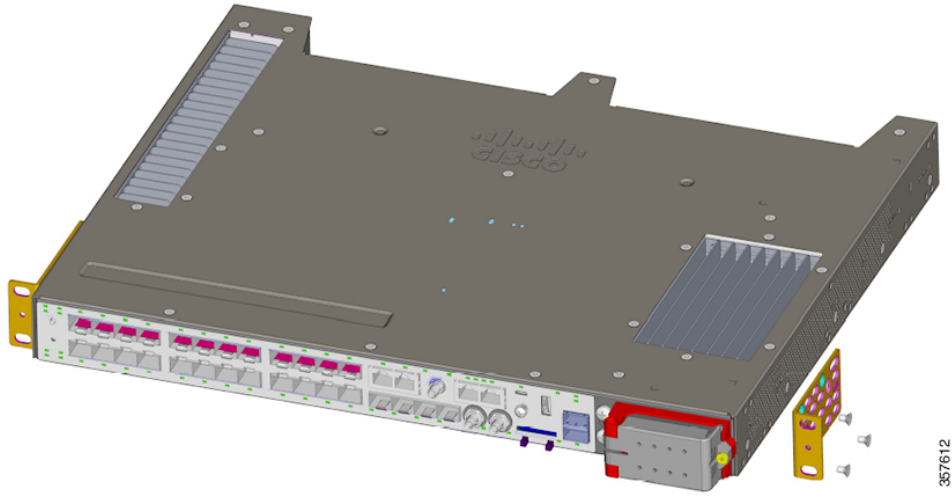

Figure 8: Attaching Brackets: Middle Mounting

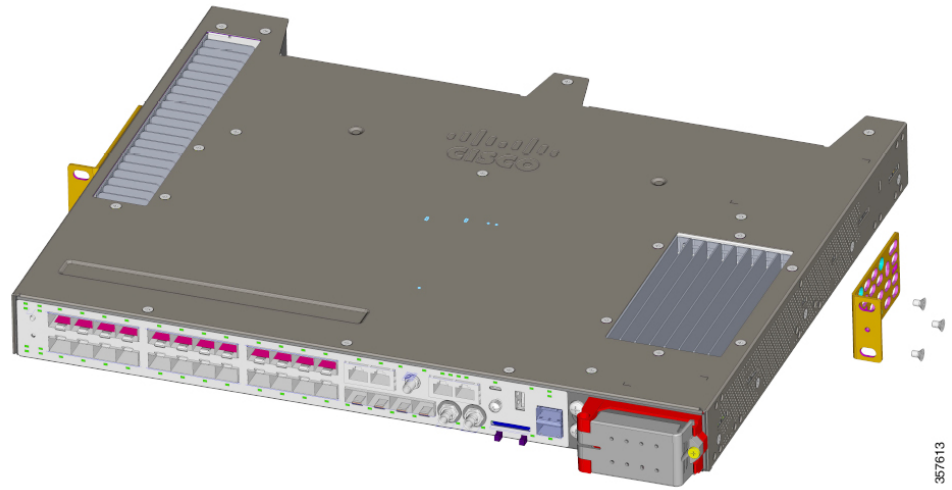
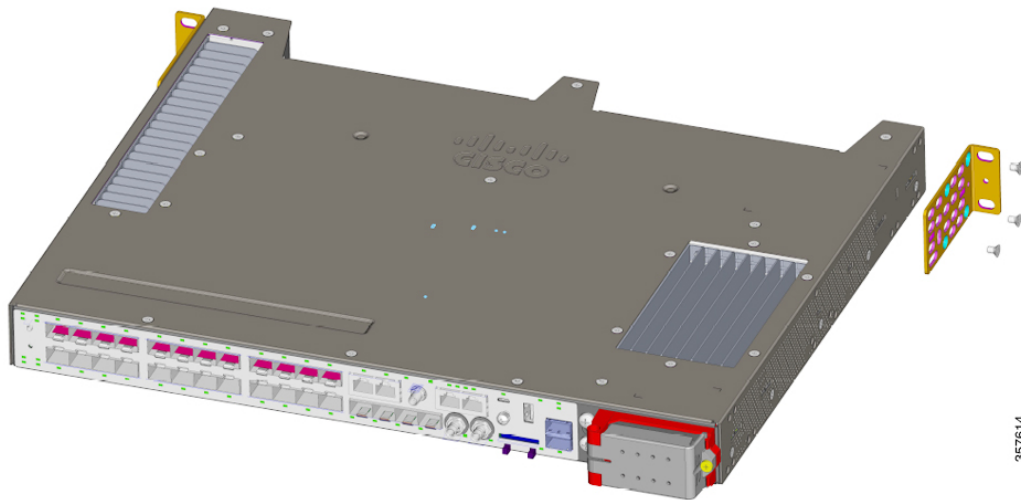

Figure 9: Attaching Brackets: Rear Mounting

**What to do next**

Complete the steps in the section [Rack-Mount the Switch](#), on page 30.

Install Hole Plugs for IP-30 Compliance (Optional)

Before installing the mounting brackets, install the rubber plugs in the unused mounting holes. The following figure shows a close-up of the rubber plugs and how to install the rubber plugs in the holes.

Figure 10: Inserting a Rubber Plug

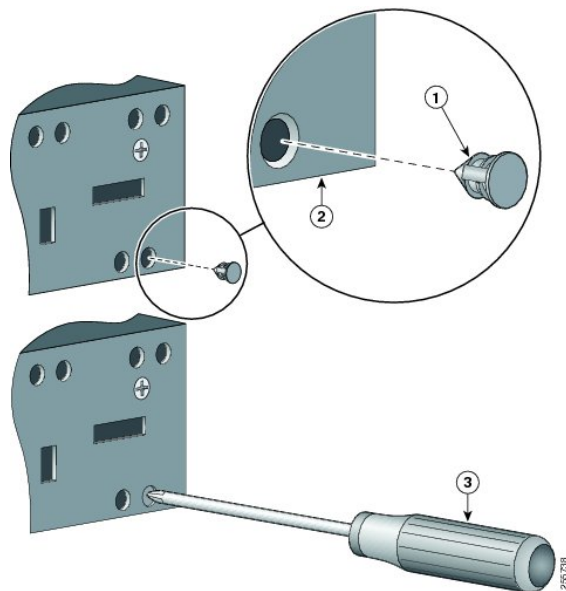

1	Rubber plug	3	Screwdriver
---	-------------	---	-------------

2	Switch		
---	--------	--	--



Note If you use 23-inch brackets or ETSI brackets, you can insert the rubber plugs for IP-30 compliance. Before installing the 23-inch or ETSI brackets, insert the rubber plugs in the same holes as shown in this section.

- Step 1** Identify your bracket mounting position.
- Step 2** Install the brackets on both sides of the switch, as described in the section [Attach Brackets for 19-Inch Racks, on page 24](#).
- Step 3** Note the holes on the switch that you will not use for mounting.
- The following illustration shows the location of holes on the switch.

Figure 11: Switch Hole Locations

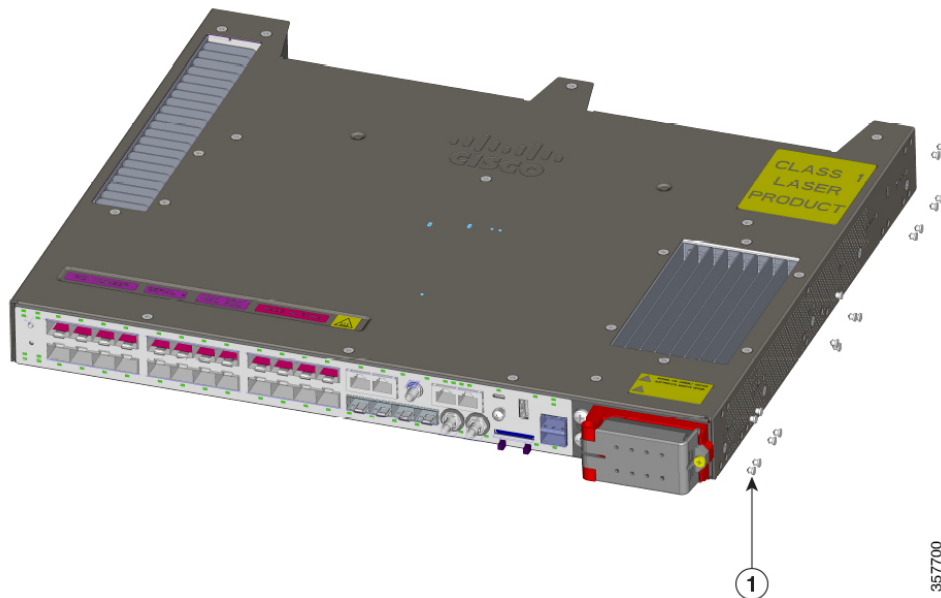

1	Rubber plug
---	-------------

- Step 4** Insert the rubber plugs in the appropriate holes on both sides of the switch, as shown in the first illustration in this section.
- Step 5** Use a screwdriver or pen to push in the rubber plugs completely.

What to do next

Complete the steps in the section [Rack-Mount the Switch, on page 30](#).

Attach Brackets for 23-Inch Racks

Follow the instructions in this section to attach 23-inch brackets (RM-RGD-23IN=).



Note 23-inch and ETSI brackets should not be used in high vibration environments, including any railway application (EN50155).



Note For IP-30 compliance, insert rubber plugs in the same holes as described in the section [Install Hole Plugs for IP-30 Compliance \(Optional\)](#), on page 26. Do so before installing the brackets.

Before you begin

Complete the tasks in the section Preparing for Installation.

Attach the brackets to the switch, as shown in one of the illustrations.

Figure 12: Attaching Brackets for 23-inch Racks (Front Mounting)

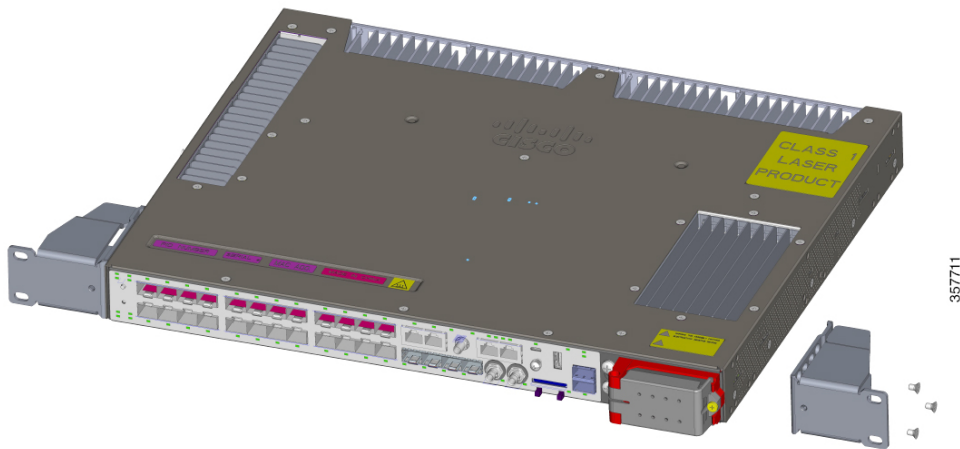
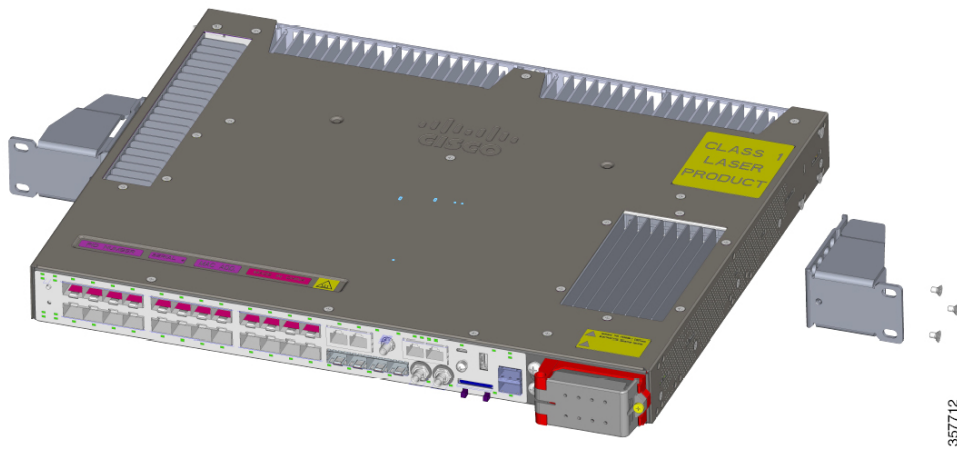

Figure 13: Attaching Brackets for 23-inch Racks (Middle Mounting)



What to do next

Complete the steps in the section [Rack-Mount the Switch](#), on page 30.

Attach Brackets for ETSI Racks

Follow the instructions in this section to attach brackets for ETSI racks.



Note

- 23-inch and ETSI brackets should not be used in high vibration environments, including any railway application (EN50155).
- If you use ETSI brackets you can insert rubber plugs into switch holes for IP-30 compliance. Insert them into the same holes as shown in the image Plug Locations by Position in the section [Install Hole Plugs for IP-30 Compliance \(Optional\)](#), on page 26. Do so before installing the brackets.

Before you begin

Complete the tasks in the section [Preparing for Installation](#).

Attach the brackets to the switch, following the steps in the illustration.

Note

In the illustration, mountings are shown as follows: top image, middle mounting; center image, front mounting; bottom image, rear rounding.

Figure 14: Attaching Brackets (RM-RGD-ETSI-) for ETSI Racks

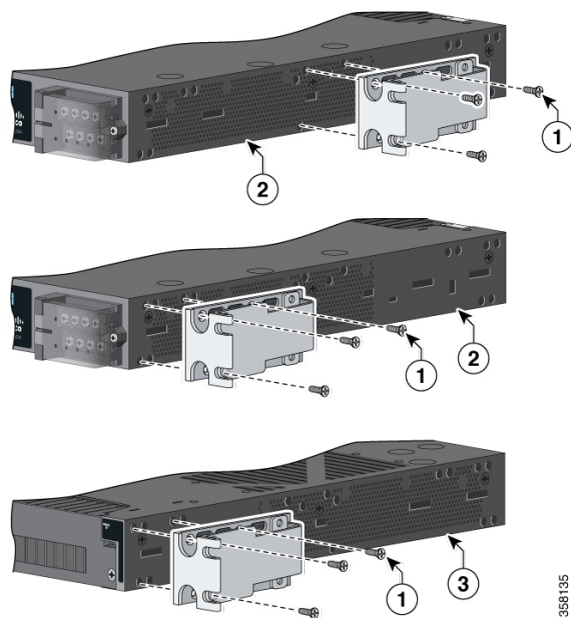

1	Phillips flat-head screws	3	Power-supply-side mounting position
2	Cable-side mounting position		

What to do next

Complete the steps in the section [Rack-Mount the Switch](#), on page 30.

Rack-Mount the Switch

After you attach the brackets on the switch, attach the brackets to the rack, using the following illustrations and steps. The illustration displays, from top to bottom, midrack mounting, front mounting, and rear mounting.

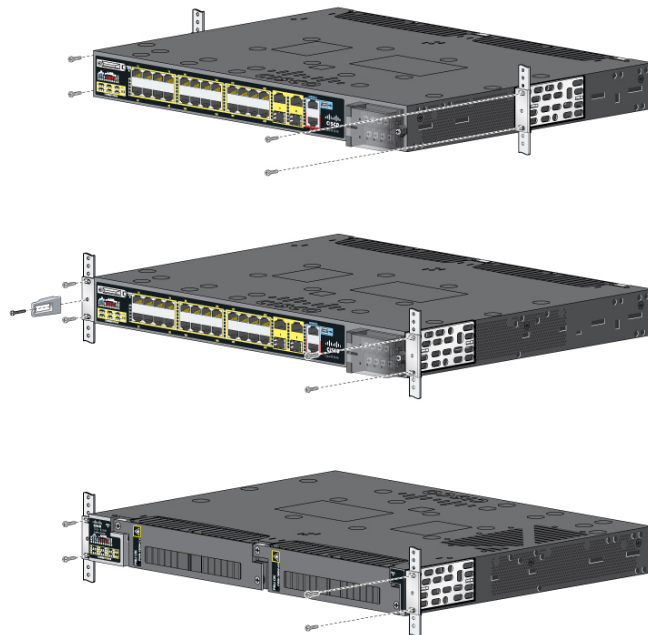
Figure 15: Rack-Mounting the Switch

Note The preceding illustration shows rack mounting for a representative IE switch, but the mounting is the same as for Cisco Catalyst IE9300 Rugged Series Switches.

Before you begin

Attach the brackets to the rack, following instructions in one of the following sections:

- [Attach Brackets for 19-Inch Racks, on page 24](#)
- [Attach Brackets for 23-Inch Racks, on page 27](#)
- [Attach Brackets for ETSI Racks, on page 29](#)



Warning

For mounting railway-application equipment and for EN50155 standard compliance, the switch must be installed only in a rack midmounting position. If you install the switch in a front rack-mounting (cable side or power supply side) position or in a wall-mounting position, a mechanical failure can occur that results in the switch becoming detached from the rack. Statement 403

Avertissement :

Pour le montage de l'équipement d'application ferroviaire et pour la conformité à la norme EN50155, le commutateur ne doit être installé que dans une position de montage au milieu du bâti. Si vous installez le commutateur en position de montage en bâti à l'avant (côté câble ou alimentation) ou en position de montage mural, une défaillance mécanique peut se produire et entraîner le détachement du commutateur du bâti. Énoncé 403



Note If you want to mount the switch to a wall, follow instructions in the section [Wall-Mount the Switch, on page 37](#).

-
- Step 1** Use the illustration to install the switch in the rack.
- Step 2** Wire the switch to a power source, following instructions in the section [Wiring the Power Source](#).
- Step 3** Attach the cable guide to prevent the cables from obscuring the LED panels on the devices in the rack.
- Use the supplied black screw to attach the cable guide to the left or right bracket.
-

What to do next

- If you want to mount multiple switches in the rack, see the section [Installing Multiple Switches in the Rack, on page 32](#).
- Wire the switch to a power source. See [Wire the Power Source, on page 56](#).
- Connect the switch ports. See the section [Connecting Devices to the Ethernet Ports](#).

Installing Multiple Switches in the Rack

You can mount two Cisco Catalyst IE9320 switches in 19-inch, 23-inch, or ETSI racks. To install each switch, follow the instructions for the appropriate rack earlier in this chapter.

You can also mount two IE9320 switches in a rack and connect them with a stacking cable. The connection enables you to treat multiple switches as if they were one.



Note For detailed information about electronically stacking switches, see the [Stacking and High Availability Configuration Guide, Cisco Catalyst IE9300 Rugged Series Switches](#) on Cisco.com.

When you mount multiple switches in a rack, you must install the switches with the correct clearances, as shown in the following illustration and table.

When you mount switches in the rack, ensure that there is 1 RU (1.75 in) above the top switch and 1 RU below the bottom switch. The space in the center gap can vary. However, note in the following table that temperature derating for the top switch occurs when using IE9320 GE Fiber switches.

Figure 16: Two Switches Mounted in a Rack

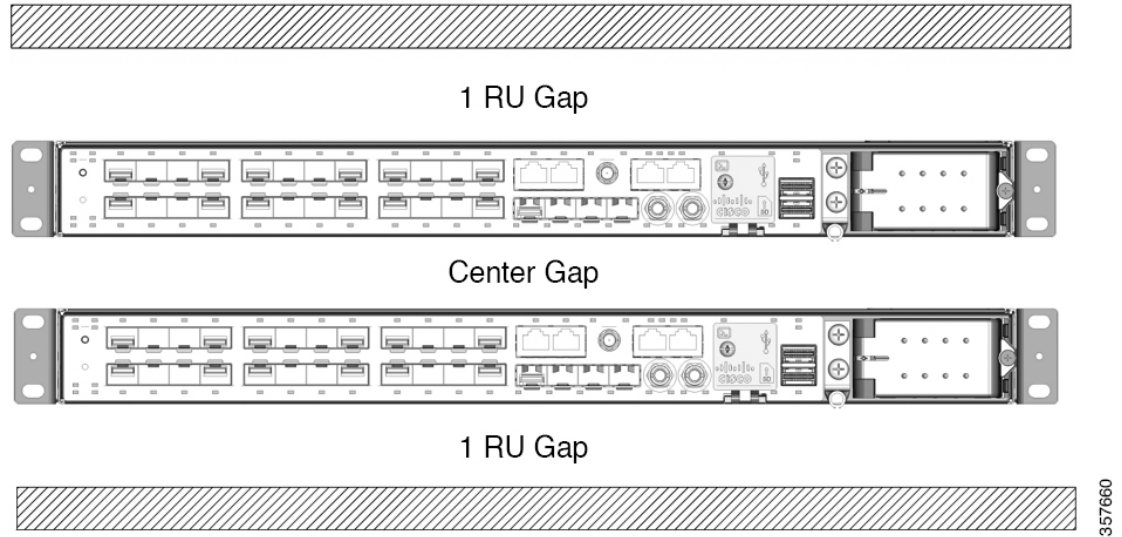

Table 13: Clearances for Rack-Mounting Cisco Catalyst IE9300 Rugged Series Switches

Switch Model	Center Gap	Temperature Derating: Top Unit
IE9310 GE Fiber (IE-9310-26S2C)	1 RU	No derating
	1/2 RU	No derating
	0 RU	No derating
IE9320 GE Fiber (IE-9320-26S2C)	1 RU	2°C derating
	1/2 RU	4°C derating
	0 RU	8°C derating
IE9320 Fiber switch with 10 GE uplinks (IE-9320-22S2C4X)	1 RU	2°C derating
	1/2 RU	4°C derating
	0 RU	8°C derating
IE9320 10 GE Copper Data switch (IE-9320-24T4X)	1 RU	No derating
	1/2 RU	No derating
	0 RU	5°C derating
IE9320 10 GE PoE switch (IE-9320-24P4X)	1 RU	No derating
	1/2 RU	No derating
	0 RU	5°C derating

Switch Model	Center Gap	Temperature Derating: Top Unit
IE9320 10 G mGig 4PPoE switch (IE-9320-16P8U4X)	1 RU	No derating
	1/2 RU	No derating
	0 RU	8°C derating
IE9320 GE PoE (IE-9320-24P4S)	1 RU	No derating
	1/2 RU	No derating
	0 RU	5°C derating



Note The temperature derating for the top unit applies to the entire stack.

Wall-Mount Installation

To wall-mount the switch, follow the steps in these sections:

- [Attach Wall-Mount Brackets, on page 36](#)
- [Wall-Mount the Switch, on page 37](#)



Warning Read the wall-mounting instructions carefully before beginning installation. Failure to use the correct hardware or to follow the correct procedures could result in a hazardous situation to people and damage to the system. Statement 378

Avertissement :

Lisez attentivement les instructions de montage mural avant de commencer l'installation. Ne pas utiliser le bon matériel ou ne pas suivre les procédures appropriées peut entraîner une situation dangereuse pour les personnes et endommager le système. Énoncé 378

You can mount the switch flush to the wall or 0.75 in away from the wall, as shown in the following illustration and table.

Figure 17: Wall-Mount Clearance

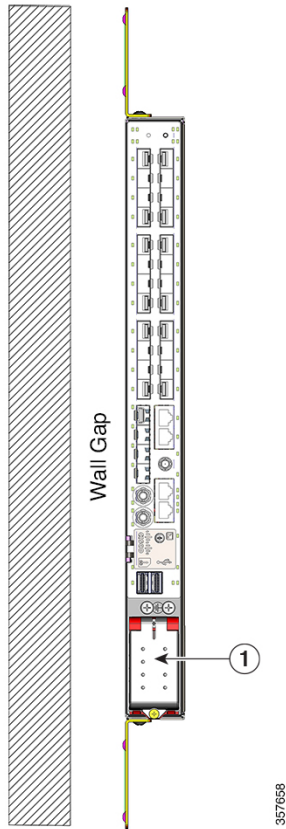

1	AC/DC power input
---	-------------------

Table 14: Clearances for Wall-Mounting Cisco Catalyst IE9300 Rugged Series Switches

Switch	Wall Gap	Temperature Derating
IE9310 GE Fiber (IE-9310-26S2C-A and IE-9310-26S2C-E)	0.75 in	No derating
	Flush	No derating
IE9320 GE Fiber (IE-9320-26S2C-A and IE-9320-26S2C-E)	0.75 in	No derating
	Flush	5°C derating
IE9320 Fiber with 10 G uplinks (IE-9320-22S2C4X-A and IE-9320-22S2C4X-E)	0.75 in	No derating
	Flush	5°C derating
IE9320 10 GE Copper Data switches (IE-9320-24T4X-A and IE-9320-24T4X-E)	0.75 in	No derating
	Flush	5°C derating

Switch	Wall Gap	Temperature Derating
IE9320 10 GE PoE switch (IE-9320-24P4X-A and IE-9320-24P4X-E)	0.75 in	No derating
	Flush	5°C derating
IE9320 10 G mGig 4PPoE switch (IE-9320-16P8U4X-A and IE-9320-16P8U4X-E)	0.75 in	No derating
	Flush	5°C derating
IE9320 GE PoE (IE-9320-24P4S-A and IE-9320-24P4S-E)	0.75 in	No derating
	Flush	5°C derating



Warning For mounting railway-application equipment and for EN50155 standard compliance, the switch must be installed only in a rack mid-mounting position. If you install the switch in a front rack-mounting (cable side or power supply side) position or in a wall-mounting position, a mechanical failure can occur that results in the switch becoming detached from the rack. Statement 403

Avertissement :

Pour le montage de l'équipement d'application ferroviaire et pour la conformité à la norme EN50155, le commutateur ne doit être installé que dans une position de montage au milieu du bâti. Si vous installez le commutateur en position de montage en bâti à l'avant (côté câble ou alimentation) ou en position de montage mural, une défaillance mécanique peut se produire et entraîner le détachement du commutateur du bâti. Énoncé 403

The following minimum clearances apply when mounting the switch vertically in an enclosure:

- Sides of switch (facing up and facing down): 3.75 in (9.52 cm)
- Port side 3.0 in (7.62 cm)
- Power supply side: 5.25 in (13.33 cm)
- Cover side (not facing wall): 1.75 in (4.44 cm)
- Base side (facing wall): See the preceding table, *Clearances for Wall-Mounting Cisco Catalyst IE9300 Rugged Series Switches*. The wall gap depends on the switch model.

Attach Wall-Mount Brackets

Attach the brackets to the switch so that you can attach it to a wall.

Attach the switch to the wall, as shown in the following illustration:

Figure 18: Attaching the Brackets for Wall Mounting

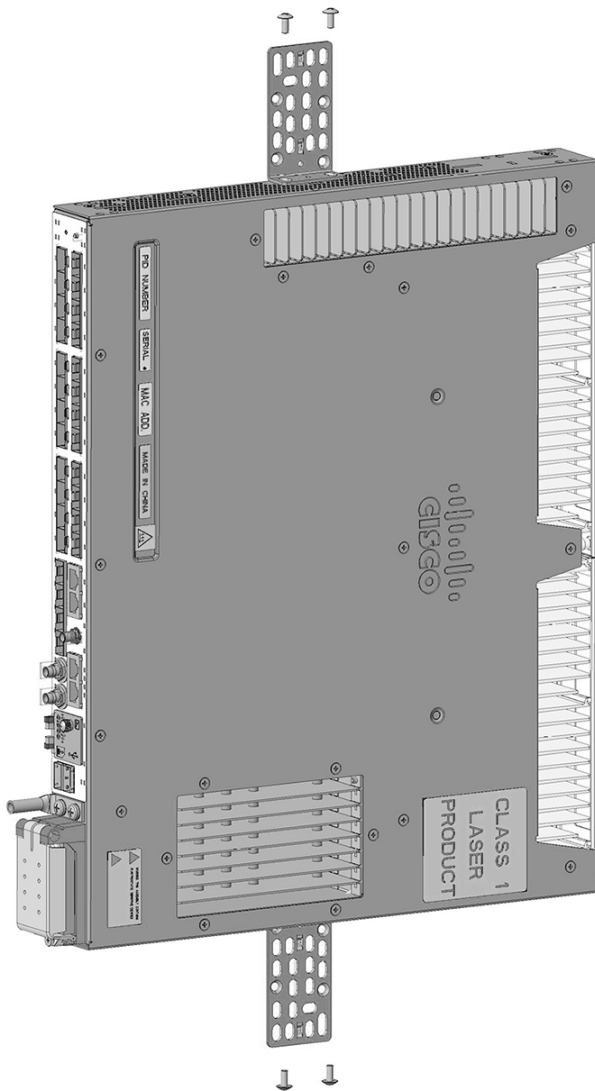

Note Only wall-mounting with the power terminal block in the down position is supported.

What to do next

Follow instructions in the section [Wall-Mount the Switch](#), on page 37.

Wall-Mount the Switch

For the best support of the switch and cables, ensure that the switch is attached securely to wall studs or to a firmly attached mounting backboard.

Orientation should exactly match the following figure, with the embossed Cisco logo facing away from the wall.

Before you begin

Complete the tasks in the section [Preparing for Installation](#).

Install the switch, following the orientation in the following illustration:

Figure 19: Wall-mounting the Switch

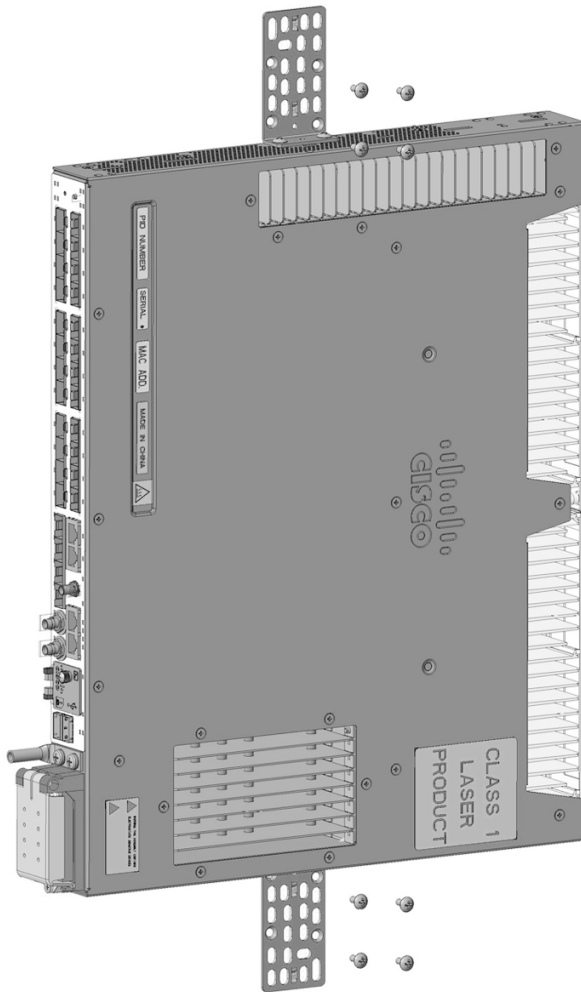

Note Only wall-mounting with the power terminal block in the down position is supported.

What to do next

Complete the following tasks:

- Wire the switch to a power source. See [Wire the Power Source](#).
- Connect the switch ports. See the section [Connecting Devices to the Ethernet Ports](#).

SFP Installation

This section presents procedures to install and remove fiber-optic and 1000BASE-T SFP transceiver modules.

SFP modules are inserted into SFP module slots on the front of the switch.

You can use any combination of rugged SFP modules. Each SFP module must be of the same type as the SFP module on the other end of the cable, and the cable must not exceed the stipulated cable length for reliable communications.

SFP Installation Considerations and Guidelines

Observe the following guidelines when installing SFP modules in the switch.

General Guidelines

Removing and installing an SFP module can shorten its useful life. Do not remove and insert any module more often than absolutely necessary.



Caution To prevent electrostatic-discharge (ESD) damage, follow standard board and component handling procedures.

Attention :

Pour éviter les dommages causés par les décharges électrostatiques (ESD), suivez les procédures standard de manipulation de la carte et des composants.



Caution Do not install or remove the SFP module with fiber-optic cables attached. Doing so could result in damage to the cables, the cable connector, or the optical interfaces in the SFP module. Disconnect all cables before removing or installing an SFP module.

Attention :

Ne pas installer ni retirer le module SFP lorsque des câbles à fibre optique sont branchés. Cela pourrait endommager les câbles, le connecteur de câble ou les interfaces optiques du module SFP. Avant le retrait ou l'installation d'un module SFP, déconnectez tous les câbles.

Power Guidelines



Caution The uplink SFP and SFP+ ports support up to 4 W of total SFP power. Most SFP modules draw 1 W or less and allow use of all four SFP uplinks. When installing higher power modules, ensure that the total rated power draw remains below 4 W. When installing modules that draw higher than 1 W, leave at least one empty slot between them.

Attention :

Les ports de liaison ascendante SFP et SFP+ prennent en charge jusqu'à 4 W d'alimentation SFP totale. La plupart des modules SFP consomment 1 W ou moins et permettent l'utilisation des quatre liaisons ascendantes SFP. Lors de l'installation de modules d'alimentation de plus grande puissance, assurez-vous que la puissance nominale totale reste inférieure à 4 W. Lors de l'installation de modules dont la consommation est supérieure à 1 W, laissez au moins un logement vide entre eux.



Caution The following requirement applies only to installations in a hazardous location where an explosive atmosphere may be present.

Do not insert and remove SFP modules while power is on; an electrical arc can occur. This could cause an explosion in hazardous location installations. Be sure that power is removed or the area is nonhazardous before proceeding. Statement 1087

Attention :

L'exigence suivante s'applique uniquement aux installations dans un emplacement dangereux où il y a une atmosphère présentant un risque d'explosion.

N'insérez pas et ne retirez pas les modules SFP lorsque l'appareil est sous tension; un arc électrique peut se produire. Cela risque d'entraîner une explosion dans les installations situées dans des emplacements dangereux. Avant de poursuivre, assurez-vous que l'alimentation est coupée ou que la zone est sécurisée. Énoncé 1087

Temperature Considerations

Some SFP modules are not rated to work at very low temperatures.



Caution Depending on the SFP module you use, the operating temperature limits may be affected. Choose an SFP module appropriate to the installed environment. For a complete list of supported SFP modules, see the [Cisco Catalyst IE9300 Rugged Series Data Sheet](#) on Cisco.com.

Attention :

Selon le module SFP utilisé, les limites de température de fonctionnement peuvent être affectées. Sélectionnez un module SFP approprié à l'environnement où il est installé. Pour obtenir une liste complète des modules SFP pris en charge, consultez [la fiche technique des commutateurs robustes de la gamme Cisco Catalyst IE9300](#) sur Cisco.com.

Install Fiber Optic SFP Modules

Complete the steps in this section to install and cable an optical SFP transceiver uplink port. Refer to the illustration in the section [Front Panel](#), on page 3.



Warning Class 1 laser product. Statement 1008

Avertissement :

Produit laser de classe 1. Énoncé 1008



Warning Do not remove the dust plugs from the fiber-optic SFP module port or the rubber caps from the fiber-optic cable until you are ready to connect the cable. The plugs and caps protect the SFP module ports and cables from contamination and ambient light.

Avertissement :

Ne retirez pas les bouchons antipoussière du port du module SFP de fibre optique ni les capuchons en caoutchouc du câble à fibre optique avant d'être prêt à connecter le câble. Les bouchons et capuchons protègent les ports et les câbles du module SPF contre la contamination et la lumière ambiante.

Step 1 Attach an ESD-preventive wrist strap to your wrist and to a bare metal surface.

Step 2 Find the send (TX) and receive (RX) markings on the module top.

On some SFP modules, the send and receive (TX and RX) markings might be replaced by arrows that show the direction of the connection, either send or receive (TX or RX).

Step 3 If the module has a bale-clasp latch, move it to the open, unlocked position.

Step 4 Align the module in front of the slot opening, and push until you feel the connector snap into place, as shown in the preceding illustration.

Step 5 If the module has a bale-clasp latch, close it.

Step 6 For fiber-optic SFP modules, remove the dust plugs and save.

Step 7 Connect the SFP cables.

Install 100/1000BASE-T SFP Modules

To install a 100/1000BASE-T SFP transceiver, read the guidance and complete the steps in this section.

The 100/1000BASE-T (copper) SFP transceiver, shown in the following illustration, has a bale-clasp locking mechanism that secures the transceiver in the module socket. The SFP network interface is an RJ-45 connector.



Caution To comply with secondary lightning immunity requirements, you must use grounded, shielded, twisted-pair CAT5 or later cabling.

Attention :

Aux fins de conformité avec les exigences secondaires en matière de protection contre la foudre à l'intérieur des bâtiments, vous devez utiliser un câble à paires torsadées blindé et mis à la terre de catégorie 5 ou supérieure.



Note When connecting to a 100/1000BASE-T-compatible server, workstation, or router, use four twisted-pair, straight-through CAT5E or later cabling for the SFP transceiver port. When connecting to a 100/1000BASE-T-compatible switch or repeater, use four twisted-pair, crossover CAT5E cabling. We recommend CAT6 for 2.5 Gb ports.



Note 100/1000BASE-T SFPs reduce the accuracy of PTP performance.

Figure 20: 1000BASE-T SFP Transceiver

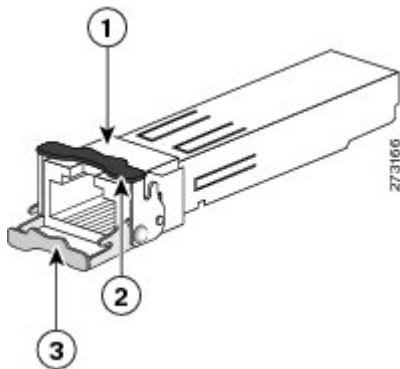

1	RJ-45 connector
1	Bale-clasp latching mechanism in the closed (locked) position
3	Bale-clasp latching mechanism in the open (unlocked) position

Step 1 Attach an ESD-preventive wrist strap to your wrist and to the ESD ground connector on the chassis or to a properly grounded bare metal surface.

Note To avoid ESD damage, handle the SFP by its sides; do not touch the connector pins.

Step 2 Remove the SFP module from its protective packaging.

Step 3 Check the markings on the SFP transceiver to verify that you have the correct model for your network.

Step 4 Position the SFP transceiver in front of the port socket opening.

Note Different Cisco devices have different SFP transceiver socket configurations. Your Cisco device might require that the SFP transceiver be installed with the bale-clasp either in a latch-up or a latch-down orientation. Verify that you have the SFP transceiver oriented correctly when you position it in front of the port socket.

Step 5 With the bale-clasp closed (locked), slide the SFP transceiver into the socket until you feel it snap in place in the socket. You may hear an audible click as the SFP transceiver latch engages in the socket.

Step 6 Connect the network interface cable RJ-45 plug to the SFP RJ-45 connector.

Step 7 Observe the port status LED:

- Green indicates that the SFP transceiver and the target device established a link.
- Amber indicates that the port is discovering the network topology and searching for loops.
This process takes about 30 seconds, and then the LED turns green.
- Off indicates that the target device might not be turned on, there might be a cable problem, or there might be a problem with the adapter installed in the target device. Refer to Troubleshooting for solutions to cabling problems.

Guidance for Connecting to SFP Modules

Before you connect the switch to SFP modules, read and understand the guidance in this section.

Before connecting to the SFP module, be sure that you understand the port and cabling guidelines in *Installing and Removing SFP Modules*. See *Cable and Connectors* for information about the LC on the SFP module.



Warning Class 1 laser product. Statement 1008

Avertissement :

Produit laser de classe 1. Énoncé 1008



Warning Do not connect or disconnect cables to the ports while power is applied to the switch or any device on the network because an electrical arc can occur. This could cause an explosion in hazardous location installations. Be sure that power is removed from the switch and cannot be accidentally be turned on, or verify that the area is nonhazardous before proceeding. Statement 1070

Avertissement :

Ne pas brancher ou débrancher les câbles de ports lorsque le commutateur ou un périphérique du réseau est sous tension, car un arc électrique risque de se produire. Cela risque d'entraîner une explosion dans les installations situées dans des emplacements dangereux. Avant de poursuivre, assurez-vous que l'alimentation au commutateur est coupée et qu'il est impossible de la brancher accidentellement ou que la zone est sécurisée. Énoncé 1070



Caution Do not remove the dust plugs from the fiber-optic SFP module port or the rubber caps from the fiber-optic cable until you are ready to connect the cable. The plugs and caps protect the SFP module ports and cables from contamination and ambient light.

Attention :

Ne retirez pas les bouchons antipoussière du port du module SFP de fibre optique ni les capuchons en caoutchouc du câble à fibre optique avant d'être prêt à connecter le câble. Les bouchons et capuchons protègent les ports et les câbles du module SPF contre la contamination et la lumière ambiante.



Caution To prevent ESD damage, follow standard board and component handling procedures.

Attention :

Pour éviter les dommages causés par les décharges électrostatiques (ESD), suivez les procédures standard de manipulation de la carte et des composants.

Connect to a Fiber Optic SFP Module

Connect a fiber-optic cable to an SFP module.

Before you begin

Read and understand the section [Guidance for Connecting to SFP Modules, on page 43](#).

-
- Step 1** Remove the rubber plugs from the module port and fiber-optic cable, and store them for future use.
- Step 2** Insert one end of the fiber-optic cable into the SFP module port.
- Step 3** Insert the other cable end into a fiber-optic receptacle on a target device.
- Step 4** Observe the port status LED:
- The LED turns green when the switch and the target device have an established link.
 - The LED turns amber while the STP discovers the network topology and searches for loops. This process takes about 30 seconds, and then the port LED turns green.
 - If the LED is off, the target device might not be turned on, there might be a cable problem, or there might be a problem with the adapter installed in the target device. See Troubleshooting for solutions to cabling problems.
- Step 5** If necessary, reconfigure and restart the switch or the target device.
-

Connect to a 1000BASE-T SFP Module

Connect a CAT5E or later cable to a 1000BASE-T SFP module. We recommend CAT6 cables for 2.5 Gb ports.



Caution To prevent ESD damage, follow standard board and component handling procedures.

Attention :

Pour éviter les dommages causés par les décharges électrostatiques (ESD), suivez les procédures standard de manipulation de la carte et des composants.

Before you begin

Read and understand the section [Guidance for Connecting to SFP Modules, on page 43](#).

-
- Step 1** When connecting to servers, workstations, and routers, insert a four twisted-pair, straight-through cable in the RJ-45 connector. When connecting to switches or repeaters, insert a four twisted-pair, crossover cable.
- When connecting to a 1000BASE-T device, use a four twisted-pair CAT5E cable. We recommend CAT6 cables for 2.5 Gb ports.
- Step 2** Insert the other cable end in an RJ-45 connector on a target device.
- Step 3** Observe the port status LED.
- The LED turns green when the switch and the target device have an established link.
 - The LED turns amber while the STP discovers the network topology and searches for loops. This process takes about 30 seconds, and then the port LED turns green.
 - If the LED is off, the target device might not be turned on, there might be a cable problem, or there might be problem with the adapter installed in the target device. See Troubleshooting for solutions to cabling problems.
- Step 4** If necessary, reconfigure and restart the switch or target device.
-

Remove SFP Modules

Remove an SFP module.

- Step 1** Attach an ESD-preventive wrist strap to your wrist and to a bare metal surface.
- Step 2** Disconnect the cable from the SFP module.
- For reattachment, note which cable connector plug is send (TX) and which is receive (RX).
- Step 3** Insert a dust plug into the optical ports of the SFP module.
- Step 4** If the module has a bale-clasp latch, pull the bale out and down to eject it.
- For a view of the latch, see the illustration of the 1000BASE-T SFP transceiver in the section [Install 100/1000BASE-T SFP Modules, on page 41](#).
- If the latch is obstructed and you cannot use your finger, use a small, flat-blade screwdriver or other long, narrow instrument.
- Step 5** Grasp the SFP module, and carefully remove it from the slot.

Step 6 Place the module in an antistatic bag or other protective environment.

Replace the SD Flash Memory Card

Step 1 Locate the flash memory card slot on the front of the switch.

Step 2 Loosen the captive thumbscrew. (Be careful not to cross-thread or overtighten the thumbscrew.)

Step 3 Pull the cover open, and pull the cover tab from the hinge.

Step 4 Gently push the flash memory card to eject it.

Place it in an antistatic bag to protect it from static discharge.

Step 5 Push the replacement card into the slot, and press it firmly in place.

The card is keyed so that you cannot insert it the wrong way.

Step 6 Place the flash card slot cover tabs into the hinge.

Step 7 Close the cover, and then hand-tighten the screw.

Connecting Devices to the Ethernet Ports

The Ethernet ports use standard RJ-45 connectors with Ethernet pinouts. The maximum cable length is 328 feet (100 meters). The 100BASE-TX and 1000BASE-T traffic requires Category 5, Category 5e, Category 6 UTP, or later cable. The 10BASE-T traffic uses Category 3 or Category 4 cable.



Note Use shielded Ethernet cables to improve EMI/EMC performance.

The autonegotiation feature is enabled by default on the switch. At this setting, the switch ports configure themselves to operate at the speed of the attached device. If the device does not support autonegotiation, you can set the switch port speed and duplex parameters. To maximize performance, either let the ports autonegotiate both speed and duplex, or set the port speed and duplex parameters on both ends of the connection.

See the switch software configuration guide or the switch command reference on Cisco.com for more information about autonegotiation and auto-MDIX.

For simplified cabling, the automatic medium-dependent interface crossover (auto-MDIX) feature is enabled by default. With auto-MDIX enabled, the switch detects the required cable type for copper Ethernet connections and configures the interface accordingly. Therefore, you can use either a crossover or a straight-through cable for connections to an Ethernet port, regardless of the type of connected device.

If auto-MDIX is disabled, use the guidelines in Cables and Adapters to select the cable for connecting the Ethernet ports to other devices.

When using PoE/PoE+, those ports have the same autonegotiation settings and cabling requirements as those in the Connecting Devices to the Ethernet Ports. These ports provide PoE power.

See the section [Cables and Connectors](#) for information on the cables and connectors.

The ports provide PoE/PoE+ support for devices compliant with IEEE 802.3af/at.

On a per-port basis, you can control whether or not a port automatically provides power to a connected PoE powered device (PD).

**Warning**

Voltages that present a shock hazard may exist on Power over Ethernet (PoE) circuits if interconnections are made using uninsulated exposed metal contacts, conductors, or terminals. Avoid using such interconnection methods, unless the exposed metal parts are located within a restricted access location and users and service people who are authorized within the restricted access location are made aware of the hazard. A restricted access area can be accessed only through the use of a special tool, lock and key or other means of security. Statement 1072

Avertissement :

Les risques de décharge électrique sont présents sur des circuits d'alimentation par Ethernet (PoE) si des interconnexions sont effectuées en utilisant du matériel métallique exposé, des conducteurs, ou des terminaux. Évitez d'utiliser de telles méthodes d'interconnexion, à moins que les pièces métalliques exposées se trouvent dans un emplacement d'accès restreint et que les utilisateurs et le personnel de soutien dont l'accès à l'emplacement restreint est autorisé soient avisés du risque. Une zone à accès limité est accessible uniquement si vous utilisez des outils, des clés et des verrous spéciaux ou d'autres moyens de protection. Énoncé 1072

**Caution**

Category 5e and Category 6 cables can store high levels of static electricity. Always ground the cables to a suitable and safe earth ground before connecting them to the switch or other devices.

Attention :

Les câbles de catégories 5e et 6 peuvent contenir des niveaux élevés d'électricité statique. Procédez à une mise à la terre adaptée et sûre avant de les connecter au commutateur ou aux autres appareils.



CHAPTER 3

Power Supply Installation

- [Power Supply Installation, on page 49](#)
- [Power Supply Modules, on page 49](#)
- [Power Supply Installation Guidelines, on page 51](#)
- [Installing a Power-Supply Module, on page 52](#)
- [Remove the Power-Supply Module, on page 61](#)

Power Supply Installation

This chapter describes how to remove and install a new or replacement power supply. Your switch ships with at least one power-supply module (AC or DC, depending on your order).

The power-supply modules are field-replaceable units (FRUs) and are hot-swappable when deployed in nonhazardous locations.

For translations of the safety warnings in this chapter, see the *Regulatory Compliance and Safety Information for the Cisco IE9300 Rugged Series Switches* on Cisco.com.

Power Supply Modules

This section contains information about the power supply modules compatible with the switch.

All the power supply modules in the following table are compliant for hazardous environments.

Table 15: Power Supply Modules

Model	Description
PWR-RGD-LOW-DC-H	Low voltage DC.
PWR-RGD-AC-DC-H	AC and high-voltage DC.
PWR-RGD-AC-DC-250	AC and high-voltage DC.
PWR-RGD-AC-DC-400	AC and high-voltage DC.



Note For detailed specifications of the products in the preceding table, see the Cisco Catalyst IE9300 Rugged Series Switch data sheet.

The 250- and 400-watt power supplies provide a higher PoE power budget on IE9310 and IE9320 systems that support PoE. These higher capacity supplies are also compatible with optical and non-PoE copper systems, although the higher capacity is not necessary for operation.



Note The power supplies in the preceding table are recommended for new installations. The older PWR-RGD-LOW-DC and PWR-RGD-AC-DC power supplies (without the -H suffix) are supported for users who already own them. However, these older supplies are not approved for use in hazardous locations and must not be used in HazLoc applications.

The following illustration shows a PWR-RGD-AC-DC-H power supply. The PWR-RGD-LOW-DC-H power supply appears identical; the only visual difference is the label. The PWR-RGD-AC-DC-250 power supply is similar to the other power supplies. However, it extends 30 mm (1.18 inches) from the rear of the switch. The PWR-RGD-AC-DC-400 switch also is similar to other power supplies, but extends 39.88 mm (1.57 inches) from the rear of the switch.

Figure 21: PWR-RGD-AC-DC-H Power Supply

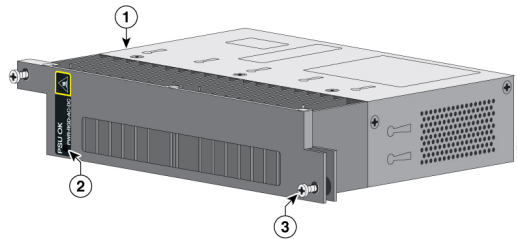

1	Power-supply module	3	Captive screw
2	PSU OK LED		

The LED behavior is the same for all power supply models.

Table 16: Power Supply LED

LED Color	Status
Off	Power supply module is not installed.
Green	Valid input is present and operating properly.
Red	Valid input is present, but output has failed.
Blinking red	Power supply module is present but does not have power input.

Power Supply Installation Guidelines

Observe the guidelines in this section when removing or installing a power-supply module.

A power-supply module that is only partially connected to the switch disrupts the system operation.

**Warning**

Blank faceplates and cover panels serve three important functions: they prevent exposure to hazardous voltages and currents inside the chassis; they contain electromagnetic interference (EMI) that might disrupt other equipment; and they direct the flow of cooling air through the chassis. Do not operate the system unless all cards, faceplates, front covers, and rear covers are in place. Statement 1029

Avertissement :

Les plastrons et les panneaux de protection remplissent trois fonctions importantes : ils protègent l'utilisateur des tensions et des flux électriques dangereux présents à l'intérieur du châssis; ils aident à limiter les interférences électromagnétiques (EMI) qui pourraient perturber d'autres appareils; enfin, ils dirigent la circulation d'air de refroidissement dans le châssis. Utilisez le système uniquement si les cartes, les plastrons, ainsi que les caches avant et arrière sont en place. Énoncé 1029

**Warning**

Do not reach into a vacant slot while installing or removing a module. Exposed circuitry is an energy hazard. Statement 206

Avertissement :

Évitez de toucher à un logement vide lors de l'installation ou du retrait d'un module. Les circuits exposés représentent un risque de décharge électrique. Énoncé 206

**Warning**

Only trained and qualified personnel should be allowed to install, replace, or service this equipment. Statement 1030

Avertissement :

Toute installation, tout remplacement ou toute réparation de cet équipement doit être effectué par un personnel qualifié et compétent. Énoncé 1030

**Warning**

Avoid using or servicing any equipment that has outdoor connections during an electrical storm. There may be a risk of electric shock from lightning. Statement 1088

Avertissement :

es équipements pourvus de connexions extérieures ne doivent pas être utilisés ni entretenus pendant un orage. La foudre est susceptible de provoquer des décharges électriques. Énoncé 1088

Installing a Power-Supply Module

Follow the guidelines and procedures in this section to install a power-supply module in the PSU1 or PSU2 slot.



Warning The covers are an integral part of the safety design of the product. Do not operate the unit without the covers installed. Statement 1077

Avertissement :

Les couvercles font partie intégrante de la sécurité du produit. N'utilisez pas l'unité si les couvercles ne sont pas installés. Énoncé 1077



Warning This unit might have more than one power supply connection. All connections must be removed to de-energize the unit. Statement 1028

Avertissement :

Il se peut que cet appareil ait plus d'une connexion de bloc d'alimentation. Pour mettre l'appareil hors tension, vous devez débrancher toutes les connexions. Énoncé 1028



Caution Equipment installation must comply with local and national electrical codes.

Attention :

l'installation de l'appareil doit respecter les codes électriques nationaux et locaux.

Required Tools and Equipment

Obtain the following tools and equipment:

- Torque driver(s) capable of 5 to 35 in-lbs
- Ring, spade, or flanged spade terminal (terminals should be insulated)
 - Ring terminal (such as TE part number 2-34158-1 for 16-14 AWG or 2-34852-1 for 12-10 AWG wire)
 - Spade terminal (such as TE part number 54367-2 for 16-14 AWG wire)
 - Flanged spade terminal (such as TE part number 2-324165-1 for 16-14 AWG wire or 1-324581-1 for 12-10 AWG wire)
- Use the 16-14 AWG wire and appropriate terminals for the AC or high-voltage DC power supply
- Use the 12-10 AWG wire and appropriate terminals for the low-voltage DC power supply.
- Crimping tool (such as Thomas & Bett part number WT2000, ERG-2001)

- 6-gauge copper ground wire
- 12-AWG wire (minimum) for the low-voltage power-supply module and 16-AWG (minimum) wire for the high-voltage power-supply module
- For power source connections, use wires rated for at least 194°F (90°C).
- UL- and CSA-rated style 1007 or 1569 twisted-pair copper wire
- Wire-stripping tools for stripping 6-, 10-, 12-, 14-, and 16-gauge wires
- Number-2 Phillips screwdriver
- Flat-blade screwdriver
- Ratcheting torque screwdriver with a number-2 and a number-1 Phillips head that exerts up to 15 pound-force inches (lbf-in.) or 240 ounce-force inches (ozf-in.) of pressure
- Panduit crimping tool with optional controlled-cycle mechanism (model CT-720, CT-920, CT-920CH, CT-930, or CT-940CH)
- Wire-stripping tools
- 12-gauge copper ground wire (insulated or noninsulated) when using the single-ground connection
- 6-gauge copper ground wire (insulated or noninsulated) when using the dual-ground connection
- The supplied dual-hole lug from the accessory kit for the dual ground connection
- Four leads of 16-gauge copper wire

Ground the Switch

Follow the grounding procedures at your site and observe the following warnings:



Warning

This equipment must be grounded. Never defeat the ground conductor or operate the equipment in the absence of a suitably installed ground conductor. Contact the appropriate electrical inspection authority or an electrician if you are uncertain that suitable grounding is available. Statement 1024

Avertissement :

Cet équipement doit être mis à la terre. Ne supprimez jamais le conducteur de mise à la terre et n'utilisez jamais l'appareil en l'absence d'un conducteur de mise à la terre installé convenablement. Communiquez avec l'organisme d'inspection électrique approprié ou avec un maître-électricien si vous n'êtes pas sûr que la mise à la terre est adéquate. Énoncé 1024



Warning

When installing or replacing the unit, the ground connection must always be made first and disconnected last. Statement 1046

Avertissement :

Lors de l'installation ou du remplacement de l'appareil, la prise de terre doit toujours être branchée en premier et débranchée en dernier. Énoncé 1046



Caution Follow the grounding procedure instructions, and use an appropriately Listed or certified lug (included with the switch) for number-6 AWG wire and 10-32 ground-lug screws.

Attention :

Suivez les instructions de la procédure de mise à la terre et utilisez une cosse répertoriée ou certifiée appropriée (incluse avec le commutateur) pour le fil AWG numéro 6 et les vis de cosse de mise à la terre 10-32.



Note You can use the grounding lug to attach a wrist strap for ESD protection during servicing.

Complete the following steps to install a dual-hole lug on the switch, making sure to follow any grounding requirements at your site.

Step 1 Use a Phillips screwdriver or a ratcheting torque screwdriver with a Phillips head to remove the ground screw from the cable side of the switch.

You need the screw in Step 4.

Step 2 Strip the 6-gauge ground wire to 0.5 inch (12.7 mm) \pm 0.02 inch (0.5 mm), as shown in the following illustration.

Note Stripping more than the recommended amount of wire can leave exposed wire from the connector.

Figure 22: Stripping the Ground Wire

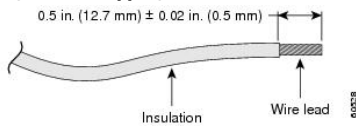

Step 3 Insert the ground wire into the terminal lug, and crimp the terminal to the wire, as shown in the following illustration.

Figure 23: Crimping the Terminal Lug

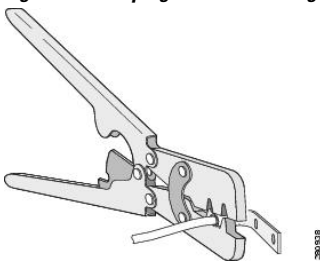

Step 4 Slide the ground screw from Step 1 through the terminal lug and insert the ground screws into the opening on the cable side, as shown in the following illustration.

Figure 24: Attaching the Terminal Lug

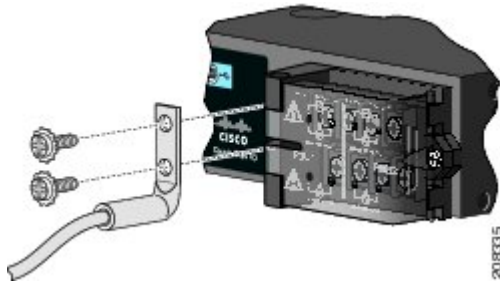

- Step 5** Use a ratcheting torque screwdriver to tighten the ground screws to 30 in-lb (± 2 in-lb).
- Step 6** Attach the other end of the ground wire to an appropriate ground.

Install the Power-Supply Module in the Switch

Complete the following steps to install the AC or DC power supply module or modules.



Note This procedure assumes that there are blanks installed in the switch.

Before you begin

Ensure that you have the required tools and that you have properly grounded the switch.

- Step 1** Locate the circuit breakers or disconnects, turn them off, and then lock them out.

Warning If the power is not off at the AC or DC circuit breaker, do not touch the power-input terminal.

Avertissement :

Si l'alimentation n'est pas coupée au niveau du disjoncteur CA ou CC, ne pas toucher la borne d'entrée d'alimentation.

- Step 2** Use a Phillips screwdriver to loosen the two captive screws of the blank power-supply module and gently pull it out, as shown in the following illustrations.

Figure 25: Loosening the Screws on the Power-Supply Blank



Figure 26: Removing the Power-Supply Blank

Step 3 Insert the power-supply module into the slot and gently push it in, as shown in the following illustration.

Figure 27: Insert the Power-Supply Module

When correctly inserted, the PWR-RGD-LOW-DC-H or PWR-RGD-AC-DC-H power supply is flush with the switch rear panel. The PWR-RGD-AC-DC-250 extends 30 mm from the rear of the switch. The PWR-RGD-AC-DC-400 extends 40 mm from the rear of the switch.

Step 4 Use a ratcheting torque screwdriver to torque each screw to 8 to 10 in-lb (0.904 -1.13 Nm).

Step 5 If desired, repeat the preceding steps to add a second power supply.

Wire the Power Source

Before you begin

Review the following warnings:



Note The values in the following warning, Statement 1005, apply to North America only. Outside of North America, ensure that the rating is not greater than AC: 16 A, DC: 15 A.

Note :

Les valeurs indiquées dans l'avertissement suivant, l'énoncé 1005, s'appliquent uniquement à l'Amérique du Nord. À l'extérieur de l'Amérique du Nord, assurez-vous que la valeur nominale n'est pas supérieure à CA : 16 A, CC : 15 A.

**Warning**

This product relies on the building installation for short-circuit (overcurrent) protection. Ensure that the protective device is rated not greater than: AC: 20 A, DC: 15 A. Statement 1005

Avertissement :

Ce produit repose sur l'installation du bâtiment en ce qui a trait à la protection contre les courts-circuits (surintensité). Assurez-vous que le dispositif de protection est inférieur ou égal à CA : 20 A, CC : 15 A. Énoncé 1005

**Note**

The following warning, Statement 1022, applies when power is supplied by more than one ungrounded conductor (such as Line-to-Line 208 VAC Three Phase or Line-to-Line on a center-tapped 240 VAC).

Note :

L'avertissement suivant, l'énoncé 1022, s'applique lorsque l'alimentation est fournie par plus d'un conducteur non mis à la terre (comme un courant phase à phase de 208 VCA triphasée ou phase à phase sur 240 VCA à prise médiane).

**Warning**

A readily accessible two-poled disconnect device must be incorporated in the fixed wiring. Statement 1022

Avertissement :

Un dispositif de déconnexion bipolaire à accès rapide doit être intégré au câblage fixe. Énoncé 1022

**Warning**

Only trained and qualified personnel should be allowed to install or replace this equipment. Statement 1030

Avertissement :

Toute installation, tout remplacement ou toute réparation de cet équipement doit être effectué par un personnel qualifié et compétent. Énoncé 1030

**Warning**

Hazardous voltage or energy may be present on power terminals. Always replace cover when terminals are not in service. Be sure that uninsulated conductors are not accessible when cover is in place. Statement 1086

Avertissement :

Une tension ou une énergie dangereuse peut être présente dans les bornes d'alimentation. Remplacez toujours le cache lorsque les bornes ne sont pas utilisées. Assurez-vous que des conducteurs non isolés ne sont pas accessibles lorsque le cache est installé. Énoncé 1086

Step 1

Ensure that the power is off at the AC or DC circuits.

Locate the circuit breakers, turn them OFF, and lock out the circuit.

Warning If the power is not off at the AC or DC circuit breaker, do not touch the power-input terminal.

Avertissement :

Si l'alimentation n'est pas coupée au niveau du disjoncteur CA ou CC, ne pas toucher la borne d'entrée d'alimentation.

Step 2 Use a Phillips screwdriver to loosen the captive screw on the power-input terminal, and open the cover, as shown in the following illustration.

Figure 28: Opening the Power-Input Terminal Cover

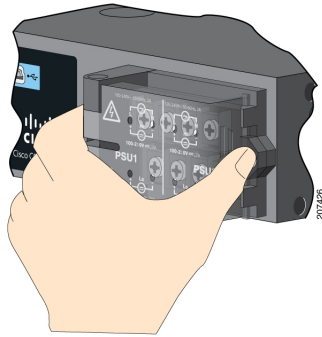

The terminal screws labels are on the power-input terminal cover.

Figure 29: Power-Input Terminal Cover Label

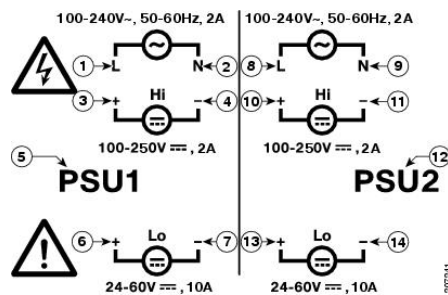

Note The power-supply module 1 connection is labeled PSU1, and the power-supply module 2 connection is labeled PSU2. Make sure that you connect the wires to the correct terminal screws.

1	Line connection for high-voltage AC (PSU1)	8	Line connection for high-voltage AC (for PSU2)
2	Neutral connection for high-voltage AC (PSU1)	9	Neutral connection for high-voltage AC (PSU2)
3	Positive connection for high-voltage DC (PSU1)	10	Positive connection for high-voltage DC (PSU2)
4	Negative connection for high-voltage DC (PSU1)	11	Negative connection for high-voltage DC (PSU2)
5	PSU1 (power-supply module 1)	12	PSU2 (power-supply module 2)

6	Positive connection for low-voltage DC (PSU1)	13	Positive connection for low-voltage DC (PSU2)
7	Negative connection for low-voltage DC (PSU1)	14	Negative connection for low-voltage DC (PSU2)

Step 3 Use the appropriate copper wire to connect from the power-input terminal to the power source.

Step 4 Strip each of the two wires to 0.25 inch (6.3 mm) \pm 0.02 inch (0.5 mm), as shown in the following illustration.

Note Do not strip more than 0.27 inch (6.8 mm) of insulation from the wire. Stripping more than the recommended amount of wire can leave exposed wire from the connector after installation.

Figure 30: Stripping the Input Power Source Wire

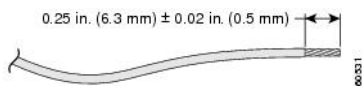

Step 5 Insert the wire into a spade terminal, and crimp it to the wire, as shown in the following illustration.

You can also use a ring or flanged spade terminal as listed in [Required Tools and Equipment, on page 52](#).

Figure 31: Crimping the Spade Terminal Lug

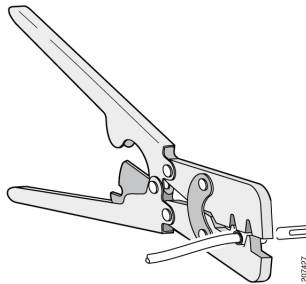

Step 6 Loosen the terminal screw, and slide the terminal under the screw and washer.

Note Use the appropriate terminal screws based on power supply type: high-voltage (AC or DC) or low-voltage (DC).

Step 7 Make the power connection, following the instructions appropriate to your connection:

- **AC Power Connection:** Connect the line wire into the terminal screw labeled *L* and the neutral wire into the terminal screw labeled *N* to complete the AC connection, as shown in the following illustration.

Figure 32: Connecting the Wires to the High-Voltage AC Power (PSU1)

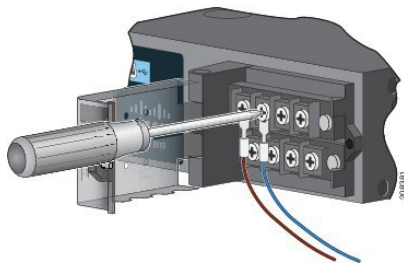

- *DC Power Connection:* Connect the positive wire into the terminal screw labeled “+”, and the negative wire into the terminal screw labeled “-”.
- *Low-voltage DC Power-Supply Module:* Connect the wires to the terminals labeled "Lo."
- *High-voltage DC Power-Supply Module:* Connect the wires to the terminals labeled "Hi," as shown in the following illustration.

Note Ensure that you cannot see any wire lead. Only wire with insulation should extend from the terminal screw.

Figure 33: Connecting the Wires to the Low-Voltage DC Power (PSU2)

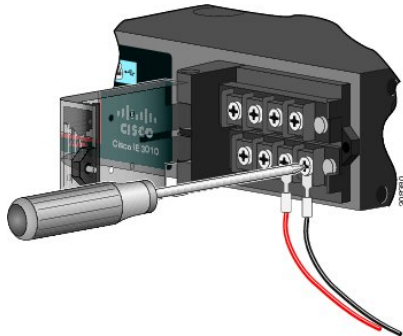

Step 8 Torque the captive screws (above the wires) to 8.5 in-lb (± 0.5 in-lb).

Step 9 Complete the power connection, following the instructions appropriate to your connection:

- *AC Power Connection:* Connect the other end of the line wire (the one connected to L) to the line terminal on the AC-power source, and connect the other end of the neutral wire (the one connected to N) to the neutral terminal on the AC power source.
- *DC Power Connection:* Connect the other end of the positive wire (the one connected to “+”) to the positive terminal on the DC-power source, and connect the other end of the negative wire (the one connected to “-”) to the negative terminal on the DC power source.

Note Ensure that you cannot see any wire lead. Only wire with insulation should extend from the terminal screw.

Note If you have two power supplies, repeat steps 1 through 9.

Step 10 Close the power-input terminal cover.

Step 11 Use a ratcheting torque screwdriver to torque the screw to 7 in-lb (± 1 in-lb) (0.79 Nm).

Step 12 Turn on the power at the AC or DC circuit.

Step 13 Verify that the PSU1 or PSU2 LED on the switch and PSU OK LED on the power-supply module are green.

Remove the Power-Supply Module

The power-supply modules are hot-swappable. By removing the power-supply modules, you can power off the switch without disconnecting the wiring from the power-input terminal.

Step 1 Ensure that the power is off at the AC or DC circuits.

Locate the circuit breakers, turn them OFF, and lock out the circuit.

Warning If the power is not off at the AC or DC circuit breaker, do not touch the power-input terminal.

Avertissement :

If the power is not off at the AC or DC circuit breaker, do not touch the power-input terminal.

Step 2 Verify that the PSU LED and PSU OK LED is blinking red or is off.

Step 3 Use a Phillips screwdriver to loosen the captive screws that secure the power-supply module to the switch, as shown in the following illustration.

Warning Hot surface. Statement 1079

Avertissement :

Surface chaude. Énoncé 1079

Figure 34: Removing the Screws



Step 4 Remove the power-supply module from the power slot, as shown in the following illustration.

Note The power-supply module might be hot.

Step 5 Install a new power-supply module or a blank cover.

Caution To prevent exposure to hazardous voltages and to contain electromagnetic interference (EMI), either a power-supply module or a blank cover must be in each power-supply module slot at all times.

Attention :

Pour éviter toute exposition à des tensions dangereuses et pour limiter les interférences électromagnétiques (IEM), un module d'alimentation ou un caisson vide doit se trouver en permanence dans chaque fente du module d'alimentation.

Remove the Power-Supply Module

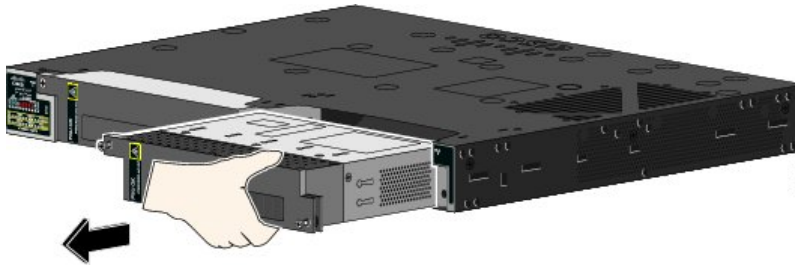
Figure 35: Removing the Power-Supply Module



CHAPTER 4

Express Setup

- [Express Setup, on page 63](#)
- [Required Equipment, on page 63](#)
- [Run Express Setup, on page 64](#)

Express Setup

When you first set up the switch, you should use Express Setup to enter the initial IP information. This process enables the switch to connect to local routers and the Internet. You can then access the switch through the IP address for additional configuration.

Required Equipment

You need this equipment to set up the switch:

- Computer running Windows or a Mac.
- A web browser with JavaScript enabled.
Google Chrome 38 or later, Mozilla Firefox 35 or later, or Apple Safari 7 or later.
- A straight-through Category 5 Ethernet cable to connect your computer to the switch port.



Note Do not use the RS-232 serial console port for Express Setup.

- A small paper clip to reach the button.



Note Before running Express Setup, disable any pop-up blockers or proxy settings on your browser and any wireless client running on your computer.

Run Express Setup

Complete the steps in this section to use Express Setup to enter the initial IP information.

Before you begin

Perform the following checks before you use Express Setup.

- Make sure that the switch is in default factory mode.
- Make sure that nothing is connected to the switch.

During Express Setup, the switch acts as a DHCP server.



Note Exception: You can add a serial console cable to monitor the booting sequence. *Do not hit [return key] on the console screen.* Make sure that the computer that is connected to the switch is configured with DHCP.

Step 1 Complete one of the following actions:

If the switch...	Then...
Is fresh out of the box	Go to the next step.
Is not fresh out of the box	Use a paper clip to reset the switch for 15 seconds until the System LED turns red, then release the paper clip. The switch automatically reboots once the System LED goes red.

Step 2 On the computer that is connected to the switch, disable web browser pop-up blockers and proxy settings.

Step 3 Connect power to the switch.

Step 4 See the wiring instructions in the sections [Ground the Switch, on page 53](#) and [Wire the Power Source, on page 56](#).

Step 5 Power on or reset the switch.

Use LEDs to monitor boot progress:

- Blinking System LED: bootloader
- Off System LED: POST
- Solid Green System LED: POST exit, initializing IOS
- Green System and Alarm LEDs green: IOS initialization done
- Blinking Express Setup LED: Ready for express setup process

Step 6 Insert paper clip into express setup button for 1 to 2 seconds.

When released, the LED of one of the dual-media downlink ports starts flashing green, depending on whether downlink ports are connected. If no dual-media downlink ports are connected, the lowest port flashes (Gi1/0/1). If both dual-media downlink ports are connected, the lowest port flashes (Gi1/0/23).

Note *Dual-media downlink ports* are sometimes referred to as *combination ports* or *combo ports*.

Step 7 Connect the computer to port Gi1/0/23.

The LED continues to blink.

Step 8 After the computer has the IP Address 192.168.1.1, point the browser to <http://192.168.1.254>.

Step 9 Enter the username and password.

The username is admin, and the password is the system serial number.

The **Account Settings** window appears.

Step 10 In the **Account Settings** window, complete the following tasks:

a) Fill out the fields in the **Account Settings** window as follows:

- *Login Name*: admin
You can change the login name here, if you like.
- *Login User Password*: By default, the login user password is the serial number of the switch.
You can change the login user password here if you like.
- *Confirm Login User Password*: Retype the password that you used earlier.
- *Command-Line Password* (Optional): This defaults to Sync to Login Password.
You can change the command login password here by using the drop-down menu.
- *Device Name*: Create an identifier for the device in the network.
- *NTP Server* (Optional): You may identify an NTP server for the device here.
- *Date & Time Mode* (Optional): Identify the mode here, through the drop-down.

Trouble If the account settings window does not appear, make sure that any pop-up blockers or proxy settings on your browser are disabled. Also make sure that any wireless client is disabled on your computer.

b) After you finish filling in the fields in the **Account Settings** window, click **Basic Settings**.

Step 11 In the **Basic Settings** window, complete the following tasks:

a) Fill out the fields as follows, using English letters and Arabic numbers:

- *IP Address*: Choose Static or DHCP.
- *VLAN ID*: Enter a valid VLAN ID.
This is the management VLAN for the switch.
- *IP Address*: Enter a valid IP Address.
- *Subnet Mask*: Enter a valid subnet mask.
- *Default Gateway*: Enter the IP address of the router (not optional if IP is static).
You must enter the router IP address if the IP address is static.

(Optional) On this screen you can also enable or disable Telnet and SSH and configure CIP settings.

The CIP VLAN can be the same as the management VLAN, or you can isolate CIP traffic on another VLAN that is already configured on the switch. The default CIP VLAN is VLAN 1. Only one VLAN on a switch can have CIP enabled. If the CIP VLAN is different from the management VLAN, you must specify an IP address for the CIP VLAN. Make sure that the IP address that you assign to the switch is not being used by another device in your network.

For more information about the CIP VLAN settings, click Help on the toolbar.

- b) After you finish filling in the fields in the **Basic Settings** window, click **Switch Wide Settings**.

Step 12

In the **Switch Wide Settings** window, complete the following tasks:

- a) Fill out the fields as follows:

- *Data VLAN*: You can enable or disable the data VLAN with the button here.
- *Voice VLAN*: You can enable/disable Voice VLAN here.
- *STP Mode* (Optional): Select an STP Mode from the drop-down
- *Bridge Priority*: You can update, enable, or disable Bridge Priority here.
- *Domain Name* (Optional): Enter a valid Domain Name.

- b) After you finish filling in the fields in the **Switch Wide Settings** window, click **Day 0 Config Summary**.

The **Summary** window displays the configuration settings that you made.

Step 13

In the **Summary** window, confirm that the settings are accurate and complete one of the following actions:

If the settings...	Then...
Are correct	Click Submit to complete the initial setup.
Are not correct	<p>a. Click the back button and make the required changes.</p> <p>b. Navigate back to the Summary window.</p> <p>c. Click Submit to complete the initial setup.</p>

After you click **Submit**, the following events occur:

- a. The switch is configured and exits Express Setup mode.
- b. The browser displays a warning message and tries to connect with the earlier switch IP address.
- c. Success dialogue appears. Click **OK**.

Typically, connectivity between the computer and the switch is lost because the configured switch IP address is in a different subnet from the IP address on the computer.

Step 14

Turn off DC power at the source, disconnect all cables to the switch, and install the switch in your network.

Step 15

If you changed the static IP address on your computer, change it to the previously configured static IP address.

What to do next

You can display Web UI by following these steps:

1. Start a web browser on your computer.
2. Enter the switch IP address, username, and password in the web browser, and press Enter. The WebUI page appears.

**Trouble**

If the WebUI page does not appear:

- Confirm that the port LED for the switch port connected to your network is green.
- Confirm that the computer that you are using to access the switch has network connectivity by connecting it to a well-known web server in your network. If there is no network connection, troubleshoot the network settings on the computer.
- Make sure that the switch IP address in the browser is correct.
- Ping the Switch IP Address and confirm IP reachability.
- If the switch IP address in the browser is correct, the switch port LED is green, and the computer has network connectivity, continue troubleshooting by reconnecting the computer to the switch. Configure a static IP address on the computer that is in the same subnet as the switch IP address.
- When the LED on the switch port that is connected to the computer is green, reenter the switch IP address in a web browser to display the Web UI. When Web UI appears, you can continue with the switch configuration.



CHAPTER 5

Switch Configuration with the CLI Setup Program

- [Configuring the Switch with the CLI-Based Setup Program, on page 69](#)
- [Accessing the CLI Through the Console Port, on page 69](#)
- [Entering the Initial Configuration Information, on page 71](#)

Configuring the Switch with the CLI-Based Setup Program

This chapter provides a command-line interface (CLI)-based setup procedure for the switch.

Before connecting the switch to a power source, review the safety warnings in [Warnings, on page 19](#) section of the [Switch Installation](#) chapter.

Accessing the CLI Through the Console Port

You can enter Cisco IOS commands and parameters through the CLI. Use one of these options to access the CLI:

RJ-45 Console Port

Complete the steps in this section to access the CLI through the RJ-45 console port. The following image shows the port on Cisco Catalyst IE9300 Rugged Series Switches.

Figure 36: RJ-45 Console Port

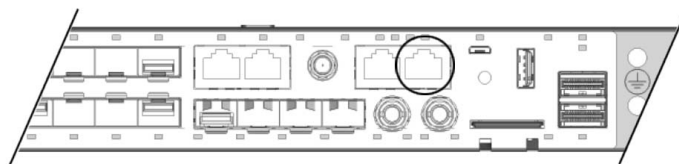

-
- Step 1** Connect one end of the console cable to your PC.
Doing so may require an adapter for USB to RJ45 or DB-9 to RJ-45.
- Step 2** Connect the other end of the cable or adapter to the switch console port.

- Step 3** Start the terminal-emulation program on the PC or the terminal.
- The program, frequently a PC application such as HyperTerminal or ProcommPlus, makes communication between the switch and your PC or terminal possible.
- Step 4** Configure the baud rate and character format of the PC or terminal to match the console port characteristics:
- 9600 baud
 - 8 data bits
 - 1 stop bit
 - No parity
 - None (flow control)
- Step 5** Connect power to the switch as described in [Wire the Power Source, on page 56](#). The PC or terminal displays the bootloader sequence.
- Step 6** Press Enter to display the setup prompt.
- Step 7** Complete the setup by following the steps in [Complete the Setup Program, on page 72](#).
-

USB Micro-Type B Console Port

Complete the following steps to access the CLI through the USB Micro Type B console port.

Before you begin

If you are connecting the switch USB-mini console port to a Windows-based PC for the first time, complete the following steps to install the Silicon Labs Windows USB device driver.

1. Connect a USB cable to the PC USB port, and then connect the other end of the cable to the switch mini-B (5-pin-connector) USB console port.
2. Launch the Windows Update page by clicking on the **Update & Security** button on the Windows Settings.
3. Click **View optional updates**.
4. Expand **Driver updates** and select **Silicon Laboratories Inc. – Ports 10.x.x.x**.
5. Click the **Download and install** button.

After the driver installation is complete, disconnect the USB cable from the PC USB port and the switch.



Note Windows assigns different COM ports to the Silicon Labs USB device. To view the COM port assignment, see the Device Manager.

- Step 1** Connect a USB cable to the PC USB port, and connect the other end of the cable to the switch micro-B USB console port.

Figure 37: Micro-B USB Console Port

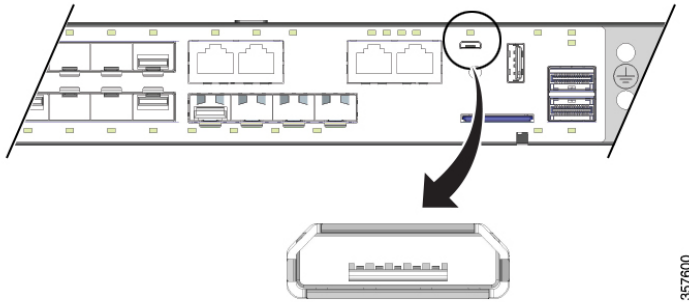

Step 2 Identify the COM port that is assigned to the USB console port:

- a) Choose **Start > Control Panel > Systems**.
- b) Click the **Hardware** tab and then choose **Device Manager**.
- c) Expand **Ports**.

The assigned COM port appears in parenthesis at the end of the line with this entry: Cisco USB System Management Console.

Step 3 Start the terminal-emulation program on the PC or the terminal.

The program, frequently a PC application such as HyperTerminal, ProcommPlus, or PuTTY, makes communication possible between the switch and your PC or terminal.

Step 4 Configure the COM port.

Step 5 Configure the baud rate and character format of the PC or terminal to match the console port characteristics:

- 9600 baud
- 8 data bits
- 1 stop bit
- No parity
- None (flow control)

Step 6 Connect power to the switch as described in [Wire the Power Source, on page 56](#).

The PC or terminal displays the bootloader sequence.

Step 7 Press Enter to display the setup prompt.

Step 8 Complete the setup by following the steps in [Complete the Setup Program, on page 72](#).

Entering the Initial Configuration Information

To set up the switch, you need to complete the setup program, which runs automatically after the switch is powered on. You must assign an IP address and other configuration information necessary for the switch to

communicate with the local routers and the Internet. This information is also required if you plan to use Web UI to configure and manage the switch.

IP Settings

Make sure to get the following information from your network administrator before you complete the setup program:

- Switch IP address
- Subnet mask (IP netmask)
- Default gateway (router)
- Enable secret password
- Enable password
- Telnet password

Complete the Setup Program

Complete the following steps to complete the setup program and to create an initial configuration for the switch:

Step 1 Enter **Yes** at these two prompts as shown in the following example:

```
Would you like to enter the initial configuration dialog? [yes/no]: yes
At any point you may enter a question mark '?' for help.
Use ctrl-c to abort configuration dialog at any prompt.
Default settings are in square brackets '[]'.
Basic management setup configures only enough connectivity
for management of the system, extended setup will ask you
to configure each interface on the system.
Would you like to enter basic management setup? [yes/no]: yes
```

Step 2 Enter a hostname for the switch, and press Return.

On a command switch, the hostname can have no more than 28 characters; on a member switch, it can have no more than 31 characters. Do not use *-n*, where *n* is a number, as the last character in a hostname for any switch.

```
Enter host name [Switch]: host_name
```

Step 3 Enter an enable secret password, and press Return.

The password can be from 1 to 25 alphanumeric characters, can start with a number, is case-sensitive, allows spaces, but ignores leading spaces. The secret password is encrypted, and the enable password is in plain text.

```
Enter enable secret: secret_password
```

Step 4 Enter an enable password, and press Return.

```
Enter enable password: enable_password
```

Step 5 Enter a virtual terminal (Telnet) password, and press Return.

The password can be from 1 to 25 alphanumeric characters, is case sensitive, allows spaces, but ignores leading spaces.

```
Enter virtual terminal password: terminal-password
```

Step 6 (Optional) Configure Simple Network Management Protocol (SNMP) by responding to the prompts.

You can also configure SNMP later through the CLI, Cisco Device Manager, or the Cisco Network Assistant application. To configure SNMP later, enter **no**.

```
Configure SNMP Network Management? [no]: no
```

Step 7 Enter the interface name (physical interface or VLAN name) of the interface that connects to the management network, and press Return.

For this release, always use `vlan1` as that interface.

```
Current interface summary
Any interface listed with OK? value "NO" does not have a valid configuration
Interface IP-Address OK? Method Status Protocol
Vlan1 unassigned NO unset up down
GigabitEthernet1/0/1 unassigned YES unset down down
GigabitEthernet1/0/2 unassigned YES unset down down
GigabitEthernet1/0/3 unassigned YES unset down down
GigabitEthernet1/0/4 unassigned YES unset down down
GigabitEthernet1/0/5 unassigned YES unset down down
GigabitEthernet1/0/6 unassigned YES unset down down
GigabitEthernet1/0/7 unassigned YES unset down down
GigabitEthernet1/0/8 unassigned YES unset down down
GigabitEthernet1/0/9 unassigned YES unset down down
GigabitEthernet1/0/10 unassigned YES unset down down
Enter interface name used to connect to the
management network from the above interface summary: vlan1
Enter interface name used to connect to the
management network from the above interface summary: vlan1
```

Step 8 Configure the interface by entering the switch IP address and subnet mask and pressing Return.

The following IP address and subnet masks are examples.

```
Configuring interface Vlan1:
Configure IP on this interface? [yes]:
IP address for this interface: 10.1.1.2
Subnet mask for this interface [255.255.255.0] :
Class A network is 10.0.0.0, 8 subnet bits; mask is /24
```

The following summary appears:

```
Current interface summary

Interface IP-Address OK? Method Status Protocol
Vlan1 unassigned YES unset administratively down down
GigabitEthernet1/0/1 unassigned YES unset down down
GigabitEthernet1/0/2 unassigned YES unset down down
GigabitEthernet1/0/3 unassigned YES unset down down
GigabitEthernet1/0/4 unassigned YES unset down down
GigabitEthernet1/0/5 unassigned YES unset down down
GigabitEthernet1/0/6 unassigned YES unset down down
GigabitEthernet1/0/7 unassigned YES unset down down
GigabitEthernet1/0/8 unassigned YES unset down down
GigabitEthernet1/0/9 unassigned YES unset down down
GigabitEthernet1/0/10 unassigned YES unset down down
```

Complete the Setup Program

```
GigabitEthernet1/0/11 unassigned YES unset down down
GigabitEthernet1/0/12 unassigned YES unset down down
GigabitEthernet1/0/13 unassigned YES unset down down
GigabitEthernet1/0/14 unassigned YES unset down down
GigabitEthernet1/0/15 unassigned YES unset down down
GigabitEthernet1/0/16 unassigned YES unset down down
GigabitEthernet1/0/17 unassigned YES unset down down
GigabitEthernet1/0/18 unassigned YES unset up up
GigabitEthernet1/0/19 unassigned YES unset down down
GigabitEthernet1/0/20 unassigned YES unset down down
GigabitEthernet1/0/21 unassigned YES unset down down
GigabitEthernet1/0/22 unassigned YES unset up up
GigabitEthernet1/0/23 unassigned YES unset down down
GigabitEthernet1/0/24 unassigned YES unset down down
GigabitEthernet1/0/25 unassigned YES unset down down
GigabitEthernet1/0/26 unassigned YES unset down down
GigabitEthernet1/0/27 unassigned YES unset down down
GigabitEthernet1/0/28 unassigned YES unset down down
Apl/0/1 unassigned YES unset up up
```

Enter interface name used to connect to the management network from the above interface summary: % Error: The application: day0guestshell, does not exist

GigabitEthernet1/0/18

Configuring interface GigabitEthernet1/0/18:

The following configuration command script was created:

```
hostname Clarke_DUAL
enable secret 9 $9$AZAmDMsIKNr/D.$OLlhR8VYAamo3DBeaVl09WVw9Wust.HJM3Z3o0lWBw
enable password Iotg@123
line vty 0 15
password Iotg@12345
no snmp-server
!
no ip routing

!
interface Vlan1
shutdown
no ip address
!
interface GigabitEthernet1/0/1
!
interface GigabitEthernet1/0/2
!
interface GigabitEthernet1/0/3
!
interface GigabitEthernet1/0/4
!
interface GigabitEthernet1/0/5
!
interface GigabitEthernet1/0/6
!
interface GigabitEthernet1/0/7
!
interface GigabitEthernet1/0/8
!
interface GigabitEthernet1/0/9
!
interface GigabitEthernet1/0/10
!
interface GigabitEthernet1/0/11
```

```
!  
interface GigabitEthernet1/0/12  
!  
interface GigabitEthernet1/0/13  
!  
interface GigabitEthernet1/0/14  
!  
interface GigabitEthernet1/0/15  
!  
interface GigabitEthernet1/0/16  
!  
interface GigabitEthernet1/0/17  
!  
interface GigabitEthernet1/0/18  
no switchport  
no shutdown  
no ip address  
!  
interface GigabitEthernet1/0/19  
!  
interface GigabitEthernet1/0/20  
!  
interface GigabitEthernet1/0/21  
!  
interface GigabitEthernet1/0/22  
!  
interface GigabitEthernet1/0/23  
!  
interface GigabitEthernet1/0/24  
!  
interface GigabitEthernet1/0/25  
!  
interface GigabitEthernet1/0/26  
!  
interface GigabitEthernet1/0/27  
!  
interface GigabitEthernet1/0/28  
!  
interface AppGigabitEthernet1/0/1  
!  
end
```

- [0] Go to the IOS command prompt without saving this config.
- [1] Return back to the setup without saving this config.
- [2] Save this configuration to nvram and exit.

Enter your selection [2]: 2

Building configuration...

[OK]

Use the enabled mode 'configure' command to modify this configuration.

Press RETURN to get started!

What to do next

After you complete the setup program, the switch can run the default configuration that you created. If you want to change this configuration or want to perform other management tasks, you can do so through the CLI.

To use the CLI, enter commands at the Switch > prompt through the console port by using a terminal emulation program or through the network by using Telnet. For configuration information, see the switch software configuration guides on Cisco.com.



CHAPTER 6

Troubleshooting

- [Diagnosing Problems, on page 77](#)
- [Switch Boot Fast, on page 77](#)
- [Switch LEDs, on page 77](#)
- [Switch Connections, on page 78](#)
- [Switch Performance, on page 80](#)
- [Reset the Switch, on page 80](#)
- [Recovering Passwords, on page 81](#)
- [Enabling Secure Data Wipe, on page 81](#)
- [Finding the Switch Serial Number, on page 85](#)

Diagnosing Problems

The switch LEDs provide troubleshooting information about the switch. They show boot fast failures, port-connectivity problems, and overall switch performance. You can also get statistics from Web UI, the CLI, or an SNMP workstation. See the appropriate configuration guide, or the documentation that came with your SNMP application for details.

Switch Boot Fast

Contact your Cisco TAC representative if your switch does not successfully boot.



Note You can disable boot fast and run POST by using the Cisco IOS CLI. See the appropriate configuration guide for more information.

Switch LEDs

Look at the port LEDs information when troubleshooting the switch. See details about LEDs colors and their meanings in the [Cisco Catalyst IE9300 Rugged Series Switches, on page 1](#) chapter.

Switch Connections

Bad or Damaged Cable

Always examine the cable for marginal damage or failure. A cable might be just good enough to connect at the physical layer, but it could corrupt packets as a result of subtle damage to the wiring or connectors. You can identify this problem because the port has many packet errors or it constantly flaps. That is, it loses and regains the link.

- Exchange the copper or fiber-optic cable with a known good cable.
- Look for broken or missing pins on cable connectors.
- Rule out any bad patch panel connections or media converters between the source and the destination. If possible, bypass the patch panel, or eliminate media converters (fiber-optic-to-copper).
- Try the cable in another port to see if the problem follows the cable.

Ethernet and Fiber-Optic Cables

Make sure that you have the correct cable:

- For Ethernet, use Category 3 or better copper cable for 10 Mb/s UTP connections. Use either Category 5, Category 5e, or Category 6 UTP for 10/100/1000 Mb/s, and PoE connections.
- Verify that you have the correct fiber-optic cable for the distance and port type. Make sure that the connected device ports match and use the same type encoding, optical frequency, and fiber type.
- Determine if a copper crossover cable was used when a straight-through was required or the reverse. Enable auto-MDIX on the switch, or replace the cable.

Link Status

Verify that both sides have a link. A broken wire or a shutdown port can cause one side to show a link even though the other side does not have a link.

A port LED that is on does not guarantee that the cable is functional. It might have encountered physical stress, causing it to function at a marginal level. If the port LED does not turn on:

- Connect the cable from the switch to a known good device.
- Make sure that both ends of the cable are connected to the correct ports.
- Verify that both devices have power.
- Verify that you are using the correct cable type. See [Cables and Connectors](#) for information.
- Look for loose connections. Sometimes a cable appears to be seated but is not. Disconnect the cable, and then reconnect it.

10/100/1000/2500 Port Connections

If a port appears to malfunction:

- Verify the status of all ports by checking the LEDs. For more information, see sections about the different panel features in the chapter [Cisco Catalyst IE9300 Rugged Series Switches, on page 1](#).
- See the **show interfaces** command to see if the port is error-disabled, disabled, or shut down. Re-enable the port if necessary.
- Verify the cable type. See the chapter [Cables and Connectors, on page 87](#).

SFP Module

Use only Cisco SFP modules. Each Cisco module has an internal serial EEPROM that is encoded with security information. This encoding verifies that the module meets the requirements for the switch.

- Inspect the SFP module. Exchange the suspect module with a known good module.
- Verify that the module is supported on this platform. (The switch release notes on Cisco.com list the SFP modules that the switch supports.)
- Use the **show interfaces** command to see if the port or module is error-disabled, disabled, or shutdown. Reenable the port if needed.
- Make sure that all fiber-optic connections are clean and securely connected.

Interface Settings

Verify that the interface is not disabled or powered off. If an interface is manually shut down on either side of the link, it does not come up until you reenables the interface. Use the **show interfaces** command to see if the interface is error-disabled, disabled, or shut down on either side of the connection. If needed, reenables the interface.

Ping End Device

Ping from the directly connected switch first, and then work your way back port by port, interface by interface, trunk by trunk, until you find the source of the connectivity issue. Make sure that each switch can identify the end device MAC address in its Content-Addressable Memory (CAM) table.

Spanning Tree Loops

A Spanning Tree Protocol (STP) loops can cause serious performance issues that look like port or interface problems.

A unidirectional link can cause loops. It occurs when the traffic sent by the switch is received by the neighbor, but the traffic from the neighbor is not received by the switch. A broken cable, other cabling problems, or a port issue can cause this one-way communication.

You can enable UniDirectional Link Detection (UDLD) on the switch to help identify unidirectional link problems. For information about enabling UDLD on the switch, see the “Understanding UDLD” section in the switch software configuration guide on Cisco.com.

Switch Performance

Speed, Duplex, and Autonegotiation

Port statistics that show a large number of alignment errors, frame check sequence (FCS), or late-collisions errors, might mean a speed or duplex mismatch.

A common issue occurs when duplex and speed settings are mismatched between two switches, between a switch and a router, or between the switch and a workstation or server. Mismatches can happen when manually setting the speed and duplex or from autonegotiation issues between the two devices.

To maximize switch performance and to ensure a link, follow one of these guidelines when changing the duplex or the speed settings.

- Let both ports autonegotiate both speed and duplex.
- Manually set the speed and duplex parameters for the interfaces on both ends of the connection.
- If a remote device does not autonegotiate, use the same duplex settings on the two ports. The speed parameter adjusts itself even if the connected port does not autonegotiate.

Autonegotiation and Network Interface Cards

Problems sometimes occur between the switch and third-party network interface cards (NICs). By default, the switch ports and interfaces autonegotiate. Laptops or other devices are commonly set to autonegotiate, yet sometimes issues occur.

To troubleshoot autonegotiation problems, try manually setting both sides of the connection. If this does not solve the problem, there could be a problem with the firmware or software on the NIC. You can resolve this by upgrading the NIC driver to the latest version.

Cabling Distance

If the port statistics show excessive FCS, late-collision, or alignment errors, verify that the cable distance from the switch to the connected device meets the recommended guidelines. See the chapter [Cables and Connectors](#), on page 87.

Reset the Switch

These are reasons why you might want to reset the switch to the factory default settings:

- You installed the switch in your network and cannot connect to it because you assigned the wrong IP address.
- You want to reset the password on the switch.



Note Resetting the switch deletes the configuration and reboots the switch.



Caution If you press the Express Setup button when you power on, the automatic boot sequence stops, and the switch enters bootloader mode.

Attention :

Si vous appuyez sur le bouton de configuration express lors de la mise sous tension, la séquence de démarrage automatique s'arrête et le commutateur passe en mode de chargeur de démarrage.

Step 1 Press and hold the Express Setup button (recessed behind a small hole in the faceplate) for about 10 seconds with a paper clip or similar object.

The switch reboots. The system LED turns green after the switch completes rebooting.

Step 2 Press the Express Setup button again for 3 seconds.

A switch 10/100/1000 Ethernet port blinks green.

What to do next

The switch now behaves like an unconfigured switch. You can configure the switch by using the CLI setup procedure described in the chapter Configuring the Switch with the CLI Setup Program.

Recovering Passwords

Password recovery is a feature that a system administrator can enable or disable. If password recovery is disabled, the only way to recover from a lost or forgotten password is to clear the switch configuration entirely.

The software configuration guides provide details about enabling and disabling the password recovery feature and the procedure for recovering passwords.

Enabling Secure Data Wipe

Secure data wipe is a Cisco wide initiative to ensure storage devices on all IOS XE based platforms are properly purged using NIST SP 800-88r1 compliant secure erase commands.

This feature is supported in Cisco IOS XE 17.11.1 and later on the following IoT switches for all license levels:

- IE9310
- IE9320

When secure data wipe is enabled, everything in flash, SDflash, and USB flash is erased, including:

- User configuration and passwords
- Cisco IOS XE image
- Embedded MultiMediaCard (eMMC)
- rommon variables
- ACT2 Secure Storage

The switch will be in rommon prompt with default factory settings (baud rate 9600) after the command is executed. The internal flash memory will not get formatted until the IOS image is rebooted.



Note If an sdflash/usbflash with a valid image inserted, the device will boot with the image in the external media based on the boot precedence. The device will be in rommon only if no external media with an image is inserted in the device.

Performing a Secure Data Wipe

To enable secure data wipe, enter the **factory-reset all secure** command in privileged exec mode, as shown in the following example:

```
Switch#factory-reset all secure
The factory reset operation is irreversible for securely reset all. Are you sure? [confirm]

The following will be deleted as a part of factory reset: NIST SP-800-88r1
1: Crash info and logs
2: User data, startup and running configuration
3: All IOS images, including the current boot image
4: OBFL logs
5: User added rommon variables
6: Data on Field Replaceable Units(USB/SD/SSD/SATA)
7: License usage log files
Note:
Secure erase logs/reports will be stored in flash.
The system will reload to perform factory reset.
It will take some time to complete and bring it to rommon.
DO NOT UNPLUG THE POWER OR INTERRUPT THE OPERATION
Are you sure you want to continue? [confirm]
Protection key not found
Switch#
Chassis 1 reloading, reason - Factory Reset
Jan 13 03:17:21.551: %PMAN-5-EXITACTION: C0/0: pvp: Process manager is exiting: reload cc
action requested
Jan 13 03:17:21.645: %PMAN-5-EXITACTION: F0/0: pvp: Process manager is exiting: reload fp
action requested
Jan 13 03:17:23.672: %PMAN-5-EXITACTION: R0/0: pvp: Process manager is exiting: rp processes
exit with reload switch code

Enabling factory reset for this reload cycle Switch booted with Switch booted with
flash:packages.conf
Switch booted via packages.conf
% FACTORYRESET - Started Data Sanitization...
% FACTORYRESET - Unmounting sd1
% FACTORYRESET - Unmounting sd2
% FACTORYRESET - Unmounting sd3
% FACTORYRESET - Unmounting sd4
% FACTORYRESET - Unmounting sd5
```

```
% FACTORYRESET - Unmounting sd6
% FACTORYRESET - Unmounting sd7
% FACTORYRESET - Unmounting sd8
% FACTORYRESET - Unmounting sd9
% FACTORYRESET - Unmounting sd10
% FACTORYRESET - Unmounting sd11
% FACTORYRESET - Unmounting sd12
Executing Data Sanitization...
eMMC Data Sanitization started ...
!!! Please, wait - Reading EXT_CSD !!!
!!! Please, wait - Reading EXT_CSD !!!
!!! Please, wait - Erasing(Legacy) /dev/mmcblk0p1 !!!
!!! Please, wait - Erasing(Legacy) /dev/mmcblk0p7 !!!
!!! Please, wait - Erasing(Legacy) /dev/mmcblk0p8 !!!
!!! Please, wait - Erasing(Legacy) /dev/mmcblk0p9 !!!
!!! Please, wait - Erasing(Legacy) /dev/mmcblk0p10 !!!
!!! Please, wait - Erasing(Legacy) /dev/mmcblk0p11 !!!
!!! Please, wait - Erasing(Legacy) /dev/mmcblk0p12 !!!
!!! Please, wait - Sanitizing /dev/mmcblk0 !!!
!!! Please, wait - Validating Erase for /dev/mmcblk0p1 !!!
!!! Please, wait - Validating Erase for /dev/mmcblk0p7 !!!
!!! Please, wait - Validating Erase for /dev/mmcblk0p8 !!!
!!! Please, wait - Validating Erase for /dev/mmcblk0p9 !!!
!!! Please, wait - Validating Erase for /dev/mmcblk0p10 !!!
!!! Please, wait - Validating Erase for /dev/mmcblk0p11 !!!
!!! Please, wait - Validating Erase for /dev/mmcblk0p12 !!!
eMMC Data Sanitization completed ...
Data Sanitization Success! Exiting...
% FACTORYRESET - Data Sanitization Success...

% FACTORYRESET - Making File System sd1 [0]
Discarding device blocks: done
Creating filesystem with 131072 4k blocks and 32768 inodes
Filesystem UUID: 80a9c93f-544c-4d27-93c7-3d5d4a422d76
Superblock backups stored on blocks:
    32768, 98304

Allocating group tables: done
Writing inode tables: done
Writing superblocks and filesystem accounting information: done

% FACTORYRESET - Mounting Back sd1 [0]
% FACTORYRESET - Handling Mounted sd1
% FACTORYRESET - Factory Reset Done for sd1

% FACTORYRESET - Making File System sd3 [0]
Discarding device blocks: done
Creating filesystem with 662528 4k blocks and 165648 inodes
Filesystem UUID: a9dd813b-c690-4346-914e-6dfb22d477ad
Superblock backups stored on blocks:
    32768, 98304, 163840, 229376, 294912

Allocating group tables: done
Writing inode tables: done
Writing superblocks and filesystem accounting information: done

% FACTORYRESET - Mounting Back sd3 [0]
% FACTORYRESET - Handling Mounted sd3
% FACTORYRESET - Factory Reset Done for sd3

% FACTORYRESET - Making File System sd4 [0]
Creating filesystem with 2048 4k blocks and 2048 inodes

Allocating group tables: done
```

```

Writing inode tables: done
Writing superblocks and filesystem accounting information: done

% FACTORYRESET - Mounting Back sd4 [0]
% FACTORYRESET - Handling Mounted sd4
% FACTORYRESET - Factory Reset Done for sd4

% FACTORYRESET - Making File System sd5 [0]
Creating filesystem with 2048 4k blocks and 2048 inodes

Allocating group tables: done
Writing inode tables: done
Writing superblocks and filesystem accounting information: done

% FACTORYRESET - Mounting Back sd5 [0]
% FACTORYRESET - Handling Mounted sd5
% FACTORYRESET - Factory Reset Done for sd5

% FACTORYRESET - Making File System sd6 [0]
Discarding device blocks: done
Creating filesystem with 32768 4k blocks and 32768 inodes

Allocating group tables: done
Writing inode tables: done
Writing superblocks and filesystem accounting information: done

% FACTORYRESET - Mounting Back sd6 [0]
% FACTORYRESET - Handling Mounted sd6
% FACTORYRESET - Factory Reset Done for sd6

% FACTORYRESET - Making File System sd11 [0]
mkfs.fat 4.1 (2017-01-24)
% FACTORYRESET - Mounting Back sd11 [0]
% FACTORYRESET - Handling Mounted sd11
% FACTORYRESET - Factory Reset Done for sd11

% FACTORYRESET - Making File System sd12 [0]
mkfs.fat 4.1 (2017-01-24)
% FACTORYRESET - Mounting Back sd12 [0]
% FACTORYRESET - Handling Mounted sd12
% FACTORYRESET - Factory Reset Done for sd12
act2 cleaning ...
% act2 cleaning success
act2 logging ...
% act2 logging success
% FACTORYRESET - Restore lic0 Files
Factory reset Secure Completed ...
FACTORYRESET - Secure Successful
% FACTORYRESET - Check if sdflash is mounted...
% FACTORYRESET - sdflash detected..
fstype is vfat
% FACTORYRESET - Proceed with Unmounting the SD card...
% FACTORYRESET - Cleaning Up /mnt/usb2
% FACTORYRESET - In progress.. please wait for completion...
% FACTORYRESET - Making File System sdflash [0]
mkfs.fat 4.1 (2017-01-24)
mkfs result 0
% FACTORYRESET - Mounting Back sdflash
% FACTORYRESET - Factory reset done for sdflash
% FACTORYRESET - Check if usbflash is mounted...
Factory reset successful. Rebooting...
watchdog: watchdog0: watchdog did not stop!
reboot: Restarting system

```

factory-reset command options:

- **factory-reset all**: Remove everything from flash
- **factory-reset all secure** : Remove everything from flash, and also unmount and sanitize the partitions before mounting back. This ensures that the data from those partitions cannot be recovered.



Important The **factory-reset all secure** operation may take hours. Please do not power cycle.

To check the log after the switch executes the command, boot up IOS XE and enter the following **show** command:

```
Switch#sh platform software factory-reset secure log
Factory reset log:
#CISCO IE9K DATA SANITIZATION REPORT#
START : 03-02-2023, 08:15:42
  END : 03-02-2023, 08:19:18
-eMMC-
MID : 'Micron'
PNM : 'S0J56X'
SN : 0x00000001
Status : SUCCESS
NIST : PURGE

Switch#
```

Finding the Switch Serial Number

If you contact Cisco Technical Assistance, you need to know the serial number of your switch. The serial number is on the top of the switch. You can also use the `show version` command to obtain the switch serial number.



CHAPTER 7

Cables and Connectors

- [Connector Specifications, on page 87](#)
- [Cables and Adapters, on page 90](#)

Connector Specifications

10/100/1000/2500 Ports

The 10/100/1000 Ethernet ports on the switches use RJ-45 connectors.

Figure 38: 10/100/1000 Port Pinouts

Pin	Label	1 2 3 4 5 6 7 8
1	TP0+	
2	TP0-	
3	TP1+	
4	TP2+	
5	TP2-	
6	TP1-	
7	TP3+	
8	TP3-	



Note Connector pins 1, 2, 3, and 6 are used for PoE.

SFP Module Connectors

The illustration below shows an LC style connector that is used with the SFP Module slots. It is a fiber-optic cable connector.

Figure 39: Fiber-Optic SFP Module LC Connector



Warning Invisible laser radiation may be emitted from disconnected fibers or connectors. Do not stare into beams or view directly with optical instruments. Statement 1051

Avertissement :

Les fibres ou les connecteurs déconnectés peuvent émettre des rayonnements laser invisibles. Ne fixez pas les rayons ou ne les regardez pas directement avec des instruments optiques. Énoncé 1051

Console Port

The switch has two console ports: a USB micro-Type B port and an RJ-45 console port, both on the front panel.

Figure 40: USB Micro-Type B Port

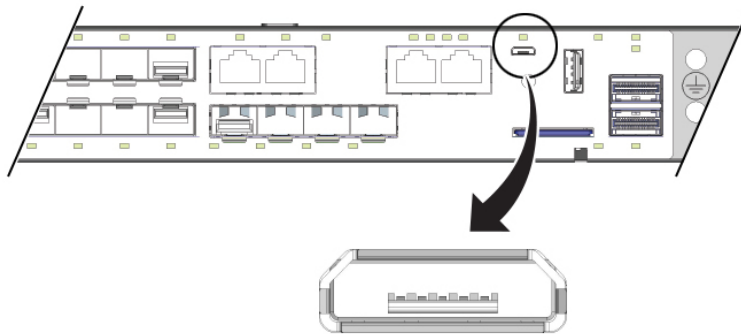

The USB console port uses a USB Type B to 5-pin mini-Type B cable, shown in the following illustration. The USB micro Type A-to-USB mini-Type B cable is not supplied.



Note When running Linux, access the USB Console using **Minicom** instead of **Screen**.

Figure 41: USB Micro Type B-to-USB 5-Pin Micro-Type B Cable

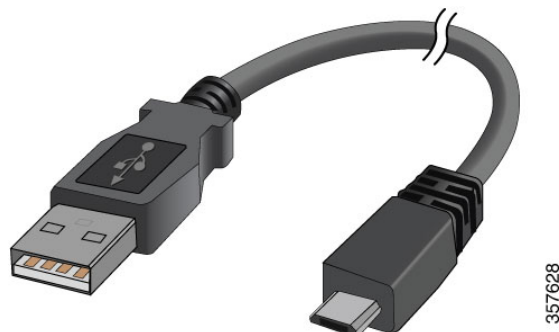

The RJ-45 console port uses an 8-pin RJ-45 connector. The supplied RJ-45-to-DB-9 adapter cable is used to connect the console port of the switch to a console PC. You must provide a RJ-45-to-DB-25 female DTE adapter if you want to connect the switch console port to a terminal. You can order a kit (part number ACS-DSBUASYN=) containing that adapter.

Alarm Port

The alarm port uses an RJ-45 connector.

Figure 42: Alarm Port Details

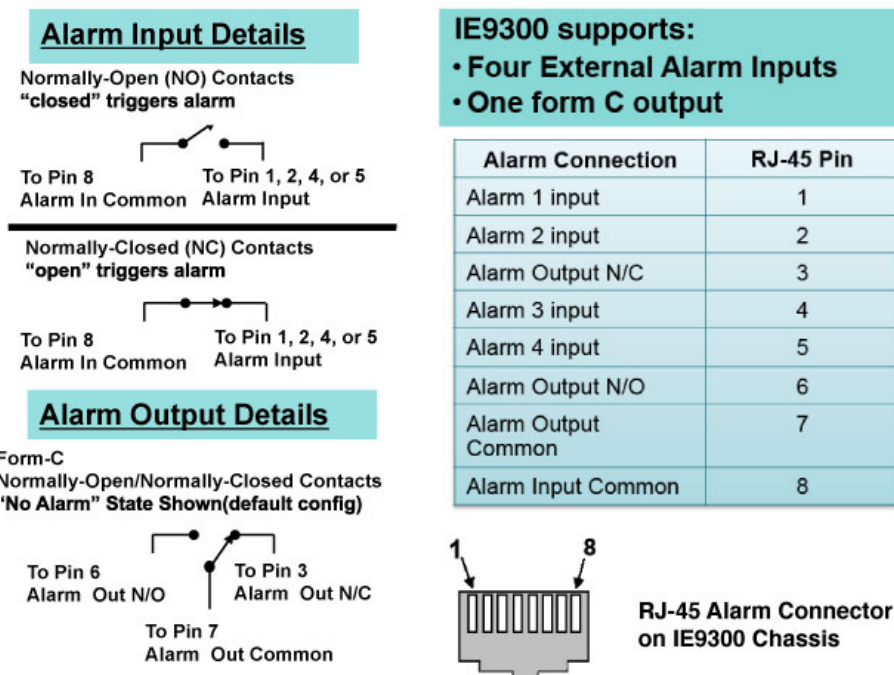

See the sections [Alarms](#), on page 10 and Alarm Ratings for more information.

Cables and Adapters

SFP Module Cables

Each port must match the wave-length specifications on each end of the cable, and for reliable communications, the cable must not exceed the allowable length.

For more information about SFP/SFP+ modules and cables, see [Transceiver Modules](#) on Cisco.com.

Console Port Adapter Pinouts

The console port uses an 8-pin RJ-45 connector. If you did not order a console cable, you must provide an RJ-45-to-DB-9 adapter cable to connect the switch console port to a PC console port. You must provide an RJ-45-to-DB-25 female DTE adapter if you want to connect the switch console port to a terminal. You can order an adapter (part number ACS-DSBUASYN=).

The following table lists the pinouts for the console port, the RJ-45-to-DB-9 adapter cable, and the console device.

Table 17: Console Port Adapter Pinouts (RJ-45-to-DB-9)

Switch Console Port (DTE) Signal	RJ-45-to- DB-9 Terminal Adapter DB-9 Pin	Console Device Signal
RTS	8	CTS
DTR	6	DSR
TxD	2	RxD
GND	5	GND
RxD	3	TxD
DSR	4	DTR
CTS	7	RTS



Note The RJ-45-to-DB-25 female DTE adapter is not supplied with the switch. You can order this adapter from Cisco (part number ACS-DSBUASYN=).

The following table lists the pinouts.

Table 18: Console Port Adapter Pinouts (RJ-45-to-DB-25)

Switch Console Port (DTE) Signal	RJ-45-to-DB-25 Adapter DB-25 Pin	Console Device Signal
RTS	5	CTS
DTR	3	DSR
TxD	6	RxD
GND	7	GND
RxD	2	TxD
DSR	20	DTR
CTS	4	RTS



CHAPTER 8

Hazardous Location Installation Information

This appendix provides hazardous location installation information for the Cisco Catalyst IE9300 Rugged Series switch.

Also refer to the [Cisco Catalyst IE 9300 Rugged Series Switch Regulatory and Compliance Document](#).

- [Hazardous Area Installation Warnings, on page 93](#)
- [North American Hazardous Location Approval, on page 97](#)
- [EMC Environmental Conditions for Products Installed in the European Union, on page 98](#)
- [Hazardous Locations Standards, on page 98](#)

Hazardous Area Installation Warnings

Read and understand the warnings in this section before installing the switch in a hazardous environment.



Caution

When installed in a Class I, Div/Zone 2 hazardous location environment, this equipment must be installed in a min. IP54 certified enclosure.

Attention :

Lorsqu'il est installé dans un environnement dangereux de Classe I, Division/Zone 2, cet équipement doit être monté dans un boîtier certifié aux normes IP54 au minimum.



Caution Airflow around the switch must be unrestricted. To prevent the switch from overheating, there must be the following minimum clearances:

- Top and bottom: 1 RU (1.75 in. or 4.4 cm)
- Sides: 1 RU
- Front: 1 RU

Contact your Cisco Technical Assistance Center (TAC) if tighter spacings are required.

Attention :

Le flux d'air autour du commutateur ne doit pas être bloqué. Pour empêcher le commutateur de surchauffer, vous devez respecter les dégagements minimaux suivants :

- Haut et bas : 1 RU (1,75 po ou 4,4 cm)
- Côtés : 1 RU
- Avant : 1 RU

Communiquez avec le Centre d'assistance technique de Cisco (Cisco TAC) si le dégagement est inférieur.



Caution When installed in a Class I, Div/Zone 2 hazardous location environment. This equipment must be installed in a pollution degree 2 environment per IEC 60664-1)

Attention :

Lorsqu'il est installé dans un environnement dangereux de classe I ou de zone 2. Cet équipement doit être installé dans un environnement de niveau de pollution 2 selon la norme CEI 60664-1).



Caution This equipment is suitable for use in Class I, Division 2, Groups A, B, C, D, or only nonhazardous locations.

Attention :

Cet appareil est destiné à une utilisation dans un environnement de Classe I, Division 2, Groupes A, B, C, D ou dans des emplacements non dangereux.



Caution Do not install or remove SFP or SFP+ modules when an explosive atmosphere may be present.

Attention :

N'installez pas et ne retirez pas les modules SFP ou SFP+ dans une atmosphère présentant un risque d'explosion.



Caution Do not install or remove power supplies when an explosive atmosphere may be present.

Attention :

N'installez pas et ne retirez pas les blocs d'alimentation dans une atmosphère présentant un risque d'explosion.



Caution Do not use the USB Console Service Port when an explosive atmosphere may be present.

Attention :

N'utilisez pas le port de service de console USB dans une atmosphère présentant un risque d'explosion.



Caution Do not install or remove the SD card when an explosive environment may be present.

Attention :

Ne pas installer ni retirer la carte SD dans un environnement présentant un risque d'explosion



Caution Do not use the USB type-A host port when an explosive atmosphere may be present

Attention :

N'utilisez pas le port hôte USB de type A dans une atmosphère présentant un risque d'explosion.



Warning Exposure to some chemicals could degrade the sealing properties of materials that are used in the sealed relay device. Statement 381

Avertissement :

L'exposition à certains produits chimiques pourrait dégrader les propriétés d'étanchéité des matériaux utilisés dans le dispositif de relais scellé. Énoncé 381



Warning This unit is intended for installation in restricted access areas. A restricted access area can be accessed only by using a special tool, lock and key, or other means of security. Statement 1017

Avertissement :

Cet appareil est conçu pour une installation dans les zones à accès limité. Une zone d'accès restreint ne peut être accessible qu'à l'aide d'un outil spécial, d'un cadenas et d'une clé ou d'un autre moyen de sécurité. Énoncé 1017

**Warning**

To prevent the system from overheating, do not operate it in an area that exceeds the maximum recommended ambient temperature of: 140°F (60°C) Statement 1047

Avertissement :

Pour éviter toute surchauffe du système, il est recommandé de maintenir une température ambiante inférieure à 60 °C (140 °F). Énoncé 1047

**Warning**

When you connect or disconnect the power and/or alarm connector with power applied, an electrical arc can occur. This could cause an explosion in hazardous area installations. Be sure that all power is removed from the switch and any other circuits. Be sure that power cannot be accidentally turned on or verify that the area is nonhazardous before proceeding. Statement 1058

Avertissement :

Si vous branchez ou débranchez le connecteur d'alimentation ou d'alarme, un arc électrique risque de se produire. Cela risque d'entraîner une explosion dans les installations situées dans des environnements dangereux. Assurez-vous que le commutateur et tous les autres circuits ne sont pas sous tension. Avant de commencer, assurez-vous qu'il est impossible de brancher accidentellement l'alimentation électrique et vérifiez que la zone n'est pas dangereuse. Énoncé 1058

**Warning**

In switch installations in a hazardous location, the DC power source could be located away from the vicinity of the switch. Before performing any of the following procedures, locate the DC circuit to ensure that the power is removed and cannot be turned on accidentally, or verify that the area is nonhazardous before proceeding. Statement 1059

Avertissement :

Pour les installations de commutateurs dans un emplacement dangereux, la source d'alimentation en CC peut être éloignée des environs du commutateur. Avant d'effectuer l'une des procédures suivantes, localisez le circuit de CC pour vous assurer que l'alimentation est coupée et qu'elle ne peut pas être remise en marche accidentellement, ou vérifiez que la zone était sécuritaire avant de procéder. Énoncé 1059

**Warning**

This equipment is supplied as “open type” equipment. It must be mounted within an enclosure that is suitably designed for those specific environmental conditions that will be present and appropriately designed to prevent personal injury resulting from accessibility to live parts. The interior of the enclosure must be accessible only by the use of a tool. The enclosure must meet IP 54 or NEMA type 4 minimum enclosure rating standards. Statement 1063

Avertissement :

Cet équipement est fourni en tant qu'équipement de « type ouvert ». Il doit être monté dans un boîtier spécialement conçu pour les conditions environnementales spécifiques qui seront présentes et conçu de manière à éviter les blessures corporelles découlant de l'accessibilité aux pièces sous tension. L'intérieur du boîtier ne doit être accessible qu'à l'aide d'un outil. Le boîtier doit être conforme aux normes minimales de protection IP54 ou NEMA de type 4 pour boîtier. Énoncé 1063

**Warning**

Use twisted-pair copper wire (16- to 14-AWG or 1.31- to 2.08-mm²) to connect from the power input terminal to the high-voltage AC or DC power supply module. Use 12-AWG or 3.31-mm² (minimum) for the low-voltage DC power supply module. For power source connections, use wires rated for at least 194°F (90°C).

Avertissement :

Utilisez un fil de cuivre à paire torsadée (16 à 14 AWG ou 1,31 à 2,08 mm²) pour le raccordement de la borne d'entrée d'alimentation au module d'alimentation CA ou CC à haute tension. Utilisez un module d'alimentation CC de 12 AWG ou de 3,31 mm² (minimum). Pour les connexions de source d'alimentation, utilisez des câbles conçus pour une température minimale de 90 °C (194 °F).

**Warning**

When used in a Class I, Division 2, hazardous location, this equipment must be mounted in a suitable enclosure with a proper wiring method that complies with the governing electrical codes. Statement 1069

Avertissement :

Lorsqu'il est utilisé dans un emplacement dangereux de classe I, division 2, cet équipement doit être monté dans un boîtier approprié à l'aide d'une méthode de câblage appropriée, conforme aux codes électriques en vigueur. Énoncé 1069

**Warning**

Explosion Hazard—The area must be known to be nonhazardous before installing, servicing, or replacing the unit. Statement 1082

Avertissement :

Risque d'explosion – La zone doit être formellement identifiée comme sans risque avant de procéder à l'installation, à l'entretien ou au remplacement de l'appareil. Énoncé 1082

**Note**

This equipment has been tested by UL for the explosion, fire, shock, and casualty hazards required by the applicable hazardous locations standards. UL certification does not cover the performance or reliability of any GPS hardware, GPS operating software, or other GPS-related aspects of equipment covered under this category. Accordingly, UL makes no representations, warranties or certifications regarding the performance or reliability of any GPS-related functions of equipment covered under this category.

North American Hazardous Location Approval

The following information applies when operating this equipment in hazardous locations:

English:	Products marked "Class I, Div 2, GP A, B, C, D" are suitable for use in Class I Division 2 Groups A, B, C, D, Hazardous Locations and nonhazardous locations only. Each product is supplied with markings on the rating nameplate indicating the hazardous location temperature code. When combining products within a system, the most adverse temperature code (lowest "T" number) may be used to help determine the overall temperature code of the system. Combinations of equipment in your system are subject to investigation by the local Authority Having Jurisdiction at the time of installation.
Français:	Informations sur l'utilisation de cet équipement en environnements dangereux: Les produits marqués "Class I, Div 2, GP A, B, C, D" ne conviennent qu'à une utilisation en environnements de Classe I Division 2 Groupes A, B, C, D dangereux et non dangereux. Chaque produit est livré avec des marquages sur sa plaque d'identification qui indiquent le code de température pour les environnements dangereux. Lorsque plusieurs produits sont combinés dans un système, le code de température le plus défavorable (code de température le plus faible) peut être utilisé pour déterminer le code de température global du système. Les combinaisons d'équipements dans le système sont sujettes à inspection par les autorités locales qualifiées au moment de l'installation.

EMC Environmental Conditions for Products Installed in the European Union

This section applies to products to be installed in the European Union.

The equipment is intended to operate under the following environmental conditions with respect to EMC:

- A separate defined location under the user's control.
- Earthing and bonding shall meet the requirements of ETS 300 253 or CCITT K27.
- AC-power distribution shall be one of the following types, where applicable: TN-S and TN-C as defined in IEC 364-3.

In addition, if equipment is operated in a domestic environment, interference could occur.

Hazardous Locations Standards

The following table lists the standards that are used for hazardous locations approval and certification in English and French.

Table 19: Standards for Hazardous Locations

The following standards were used for the hazardous locations approvals and certifications:	Les normes suivantes ont été appliquées pour les approbations et les certifications dans le cadre d'environnements dangereux:
UL 121201, Ed. 9	UL 121201, Éd. 9

CAN/CSA C22.2 No. 60079-0:19, 4th Edition, February 2019	CAN/CSA C22.2 No. 60079-0:19, 4e éd., février 2019
CAN/CSA C22.2 No. 60079-7:16	AN/CSA C22.2 No. 60079-7:16
CSA C22.2 No. 213-Ed. 3	A C22.2 No. 213-Éd. 3
EN IEC 60079-0:2018	EN IEC 60079-0:2018
EN 60079-7: 2015+A1:2018	EN 60079-7: 2015+A1:2018
UL 60079-0 7th Edition, 2019-03-26	UL 60079-0, 7e éd., 2019-03-26
UL 60079-7, 5th Edition, 2017-02-24	UL 60079-7, 5e éd., 2017-02-24
UL 60079-15 5th Edition, 2020-04-07	UL 60079-15, 5e éd., 2020-04-07
CAN/CSA-C22.2 No 60079-15:18, November 2018	CAN/CSA-C22.2 No 60079-15:18, novembre 2018
EN IEC 60079-15: 2019	EN IEC 60079-15: 2019

The following table lists the hazardous location strings in English and French.

Table 20: Hazardous Location Strings

The following hazardous locations strings are provided on the Cisco Catalyst IE9300 Rugged Series Switch:	Les marques d'homologation relatives aux environnements dangereux suivantes sont apposées sur le commutateur robuste Cisco Catalyst IE9300:
Class 1, Div 2, Groups A, B, C, D	Classe 1, Div 2, Groupes A, B, C, D
Class 1, Zone 2, Ex ec nC IIC T4 Gc X	Classe 1, Zone 2, Ex ec nC IIC T4 Gc X
☑ II 3 G, Ex ec nC IIC T4 Gc	☑ II 3 G, Ex ec nC IIC T4 Gc
UL 21 ATEX 2657X UL23UKEX2871X	UL 21 ATEX 2657X UL23UKEX2871X
Class 1, Zone 2, AEx ec nC IIC T4 Gc X	Classe 1, Zone 2, AEx ec nC IIC T4 Gc X



CHAPTER 9

Technical Specifications

- [Switch Specifications, on page 101](#)
- [Power-Supply Module Specifications, on page 103](#)
- [Alarm Ratings, on page 104](#)

Switch Specifications

This section contains physical and environmental information about the switch.

Table 21: Physical Specifications

Switch	Weight	Dimensions (H x W x D)
IE9310 GE Fiber	12.2 lbs (5.53 kg) Note Weight is without power supply and blank filler.	<ul style="list-style-type: none"> • 1.72 x 17.5 x 14.0 in. (4.36 x 44.45 x 35.56 cm) with PWR-RGDAC-DC-H / PWR-RGD-LOW-DC-H • 1.72 x 17.5 x 15.18 in. (4.36 x 44.45 x 38.55 cm) with PWR-RGDAC-DC-250
IE9320 GE Fiber	12.2 lbs (5.53 kg) Note Weight is without power supply and blank filler.	<ul style="list-style-type: none"> • 1.72 x 17.5 x 14.0 in. (4.36 x 44.45 x 35.56 cm) with PWR-RGDAC-DC-H / PWR-RGD-LOW-DC-H • 1.72 x 17.5 x 15.18 in. (4.36 x 44.45 x 38.55 cm) with PWR-RGDAC-DC-250
IE9320 10GE Copper Data (IE-9320-24T4X)	9.5 lb (4.3 kg) Note Weight is without power supply and blank filler.	1.72 x 17.5 x 14.0 in. (4.36 x 44.45 x 35.56 cm) with PWR-RGD-AC-DC-H / PWR-RGD-LOW-DC-H

Switch	Weight	Dimensions (H x W x D)
IE9320 10GE PoE (IE-9320-24P4X)	9.7 lb (4.4 kg) Note Weight is without power supply and blank filler.	1.72 x 17.5 x 14.0 in. (4.36 x 44.45 x 35.56 cm) with PWR-RGD-AC-DC-H / PWR-RGD-LOW-DC-H
IE9320 10G mGig 4PPoE (IE-9320-16P8U4X)	9.9 lb (4.5 kg) Note Weight is without power supply and blank filler.	<ul style="list-style-type: none"> • 1.72 x 17.5 x 14.0 in. (4.36 x 44.45 x 35.56 cm) with PWR-RGD-AC-DC-H / PWR-RGD-LOW-DC-H • 1.72 x 17.5 x 15.18 in. (4.36 x 44.45 x 38.55 cm) with PWR-RGD-AC-DC-250 • 1.72 x 17.5 x 15.57 in. (4.36 x 44.45 x 39.55 cm) with PWR-RGD-AC-DC-400
IE9320 GE PoE (IE-9320-24P4S)	9.7 lb (4.4 kg) Note Weight is without power supply and blank filler.	<ul style="list-style-type: none"> • 1.72 x 17.5 x 14.0 in. (4.36 x 44.45 x 35.56 cm) with PWR-RGD-AC-DC-H / PWR-RGD-LOW-DC-H • 1.72 x 17.5 x 15.18 in. (4.36 x 44.45 x 38.55 cm) with PWR-RGD-AC-DC-250 • 1.72 x 17.5 x 15.57 in. (4.36 x 44.45 x 39.55 cm) with PWR-RGD-AC-DC-400

Table 22: Environmental Ranges

Measure	Range
Operating temperature	<ul style="list-style-type: none"> • -40° C to +75° C (blower equipped cabinet) • -40° C to +70° C (vented cabinet) • -40° C to +60° C (sealed cabinet)
Storage temperature	-40°C to +85°C
Relative humidity	5 percent to 95 percent noncondensing
Operating altitude	<ul style="list-style-type: none"> • Up to 15,000 feet (4572 m) with no temperature derating • Up to 40,000 feet (12,192 m) with temperature derating down to 25° C

Measure	Range
Storage altitude	Up to 40,000 feet (12,192 m)
Thermal spacing	1.75 in (4.4 cm) clearance top, sides, and bottom
Operational shock	50G at 11ms, half sine and 200G at 2.11ms, half sine
Nonoperational shock	65 to 80G at 9ms, trapezoidal

Power-Supply Module Specifications

PSU Module	Weight	Dimensions
PWR-RGD-AC-DC-H	2.55 lb (1.15 kg)	1.58 x 7 x 5 in. (4 x 17.8 x 12.7 cm) (without mounting flanges)
PWR-RGD-LOW-DC-H	2.5 lb (1.13 kg)	
PWR-RGD-LOW-DC-250	3.2 lb (1.45 kg)	1.58 x 7 x 6.18 in. (4 x 17.8 x 15.7 cm) (without mounting flanges)
PWR-RGD-AC-DC-400	3.55 lb (1.61 kg)	1.58 x 7 x 6.58 in. (4 x 17.8 x 16.7 cm) (without mounting flanges)
Blank cover	.8 lbs	N/A



Note The safety certifications apply only to ambient temperatures under 140 F (60 C).

Table 23: Switch Power Requirements

Measure	Requirement
Nominal input voltage	<ul style="list-style-type: none"> • PWR-RGD-AC-DC-H: 100 to 240 VAC, 50 to 60 Hz 100 to 250 VDC • PWR-RGD-AC-DC-250: 100 to 240 VAC, 50 to 60 Hz 100 to 250 VDC • PWR-RGD-LOW-DC-H: 24 to 60 VDC • PWR-RGD-AC-DC-400: 100 to 240 VAC, 50 to 60Hz 100 to 250 VDC

The 400W power supplies are required to support 4PPoE Type 4 (PoE Class 7 and 8). Any of the supported power supplies can be used for PoE+ and 4PPoE Type 3 (PoE Class 1 through 6).

Table 24: Cisco IE9300 Rugged Series PoE and PoE+ Power Budget

PID	Available PoE Power						
	One 150W PSU	Two 150W PSUs	One 250W PSU	One 150W PSU + one 250W PSU	Two 250W PSUs	400W	Two 400W PSUs
IE-9320-24P4S	70W	190W	170W	280W	370W	320W	385W
IE-9320-24P4X-E	70W	190W	170W	280W	370W	320W	720W
IE-9320-16P8U4X	70W	190W	170W	280W	370W	320W	720W



Note 150W and 250W power supplies cannot be used with the 400W power supply in a load-sharing configuration.

Alarm Ratings

Specification	Description
Alarm input electrical specification	Senses an external dry contact. The open circuit voltage between any alarm input (1 to 4) and alarm input common is 3.3 VDC. The loop current is 3 mA max per input. Do not apply external power to the alarm input.
Alarm output electrical specification	30VDC @ 1A, 60VDC @ 0.5A (resistive load only)



Caution To reduce risk of electric shock and fire, the alarm ports must be connected to an IEC 60950/IEC 62368-compliant limited power source (LPS).

Attention :

Pour réduire les risques d'incendie et de décharge électrique, les ports d'alarme doivent être connectés à une source d'alimentation limitée (LPS) conforme aux normes IEC 60950/IEC 62368.