



Network Infrastructure

Revised: February 7, 2017

This chapter describes the requirements of the network infrastructure needed to build a Cisco Unified Communications System in an enterprise environment. [Figure 3-1](#) illustrates the roles of the various devices that form the network infrastructure, and [Table 3-1](#) summarizes the features required to support each of these roles.

Unified Communications places strict requirements on IP packet loss, packet delay, and delay variation (or jitter). Therefore, it is important to enable most of the Quality of Service (QoS) mechanisms available on Cisco switches and routers throughout the network. For the same reasons, redundant devices and network links that provide quick convergence after network failures or topology changes are also important to ensure a highly available infrastructure

The following sections describe the network infrastructure features as they relate to:

- [LAN Infrastructure, page 3-4](#)
- [WAN Infrastructure, page 3-32](#)
- [Wireless LAN Infrastructure, page 3-60](#)

Figure 3-1 Typical Campus Network Infrastructure

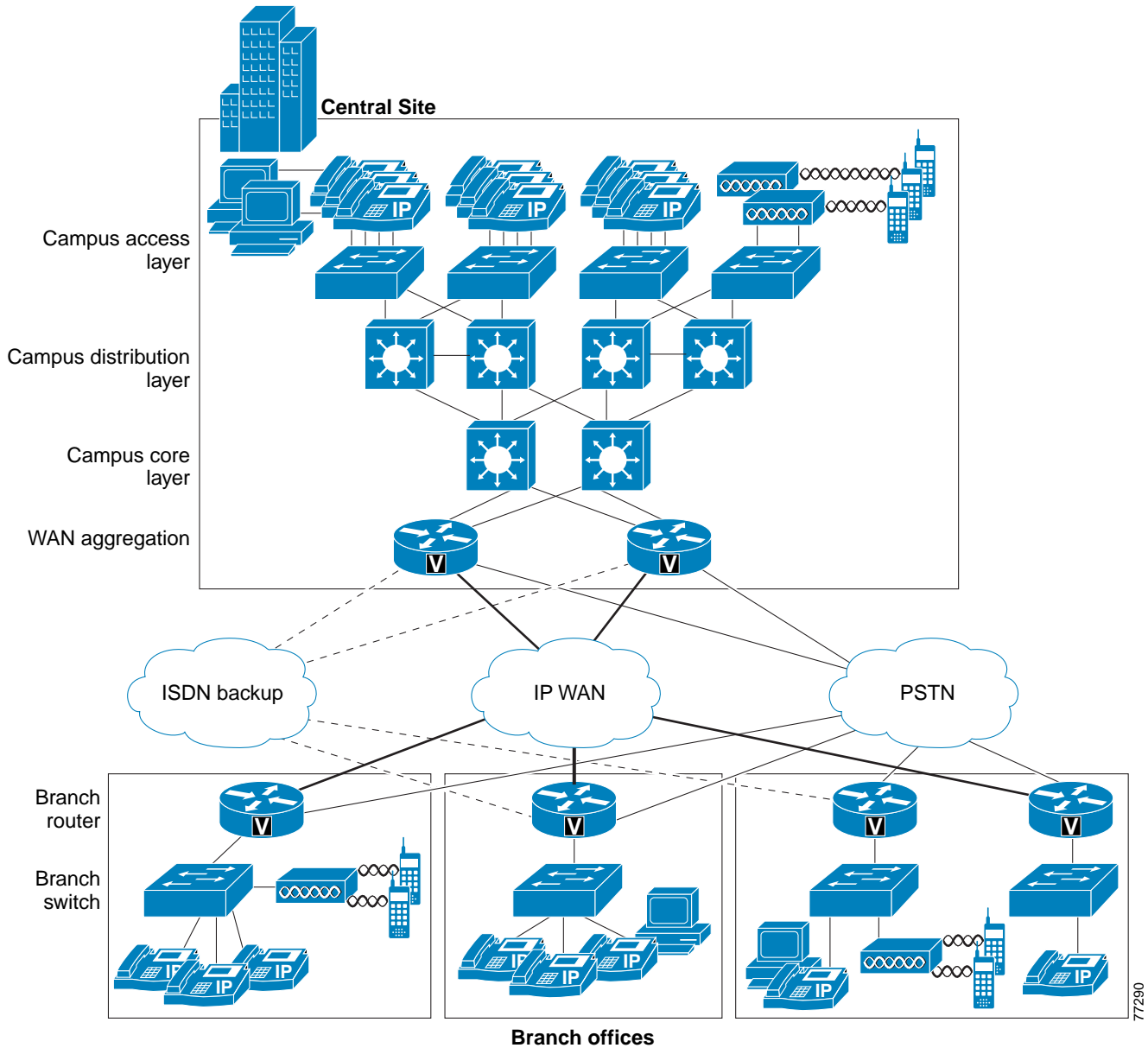

Table 3-1 Required Features for Each Role in the Network Infrastructure

Infrastructure Role	Required Features
Campus Access Switch	<ul style="list-style-type: none"> • In-Line Power¹ • Multiple Queue Support • 802.1p and 802.1Q • Fast Link Convergence
Campus Distribution or Core Switch	<ul style="list-style-type: none"> • Multiple Queue Support • 802.1p and 802.1Q • Traffic Classification • Traffic Reclassification
WAN Aggregation Router (Site that is at the hub of the network)	<ul style="list-style-type: none"> • Multiple Queue Support • Traffic Shaping • Link Fragmentation and Interleaving (LFI)² • Link Efficiency • Traffic Classification • Traffic Reclassification • 802.1p and 802.1Q
Branch Router (Spoke site)	<ul style="list-style-type: none"> • Multiple Queue Support • LFI² • Link Efficiency • Traffic Classification • Traffic Reclassification • 802.1p and 802.1Q
Branch or Smaller Site Switch	<ul style="list-style-type: none"> • In-Line Power¹ • Multiple Queue Support • 802.1p and 802.1Q

1. Recommended.

2. For link speeds less than 786 kbps.

What's New in This Chapter

[Table 3-2](#) lists the topics that are new in this chapter or that have changed significantly from previous releases of this document.

Table 3-2 New or Changed Information Since the Previous Release of This Document

New or Revised Topic	Described in	Revision Date
Proxy TFTP	Proxy TFTP, page 3-31	February 7, 2017
Quality of service for the WAN	WAN Quality of Service (QoS), page 3-36	June 15, 2015

LAN Infrastructure

Campus LAN infrastructure design is extremely important for proper Unified Communications operation on a converged network. Proper LAN infrastructure design requires following basic configuration and design best practices for deploying a highly available network. Further, proper LAN infrastructure design requires deploying end-to-end QoS on the network. The following sections discuss these requirements:

- [LAN Design for High Availability, page 3-4](#)
- [LAN Quality of Service \(QoS\), page 3-14](#)

LAN Design for High Availability

Properly designing a LAN requires building a robust and redundant network from the top down. By structuring the LAN as a layered model (see [Figure 3-1](#)) and developing the LAN infrastructure one step of the model at a time, you can build a highly available, fault tolerant, and redundant network. Once these layers have been designed correctly, you can add network services such as DHCP and TFTP to provide additional network functionality. The following sections examine the infrastructure layers and network services:

- [Campus Access Layer, page 3-4](#)
- [Campus Distribution Layer, page 3-9](#)
- [Campus Core Layer, page 3-11](#)
- [Network Services, page 3-22](#)

For more information on campus design, refer to the *Design Zone for Campus* at <http://www.cisco.com/go/designzone>

Campus Access Layer

The access layer of the Campus LAN includes the portion of the network from the desktop port(s) to the wiring closet switch. Access layer switches have traditionally been configured as Layer 2 devices with Layer 2 uplinks to the distribution layer. The Layer 2 and spanning tree recommendations for Layer 2 access designs are well documented and are discussed briefly below. For newer Cisco Catalyst switches supporting Layer 3 protocols, new routed access designs are possible and offer improvements in convergence times and design simplicity. Routed access designs are discussed in the section on [Routed Access Layer Designs, page 3-7](#).

Layer 2 Access Design Recommendations

Proper access layer design starts with assigning a single IP subnet per virtual LAN (VLAN). Typically, a VLAN should not span multiple wiring closet switches; that is, a VLAN should have presence in one and only one access layer switch (see [Figure 3-2](#)). This practice eliminates topological loops at Layer 2, thus avoiding temporary flow interruptions due to Spanning Tree convergence. However, with the introduction of standards-based IEEE 802.1w Rapid Spanning Tree Protocol (RSTP) and 802.1s Multiple Instance Spanning Tree Protocol (MISTP), Spanning Tree can converge at much higher rates. More importantly, confining a VLAN to a single access layer switch also serves to limit the size of the broadcast domain. There is the potential for large numbers of devices within a single VLAN or broadcast domain to generate large amounts of broadcast traffic periodically, which can be problematic. A good rule of thumb is to limit the number of devices per VLAN to about 512, which is equivalent to two

Class C subnets (that is, a 23-bit subnet masked Class C address). For more information on the campus access layer, refer to the documentation on available at <http://www.cisco.com/en/US/products/hw/switches/index.html>.



Note

The recommendation to limit the number of devices in a single Unified Communications VLAN to approximately 512 is not solely due to the need to control the amount of VLAN broadcast traffic. Installing Unified CM in a VLAN with an IP subnet containing more than 1024 devices can cause the Unified CM server ARP cache to fill up quickly, which can seriously affect communications between the Unified CM server and other Unified Communications endpoints.

Figure 3-2 Access Layer Switches and VLANs for Voice and Data

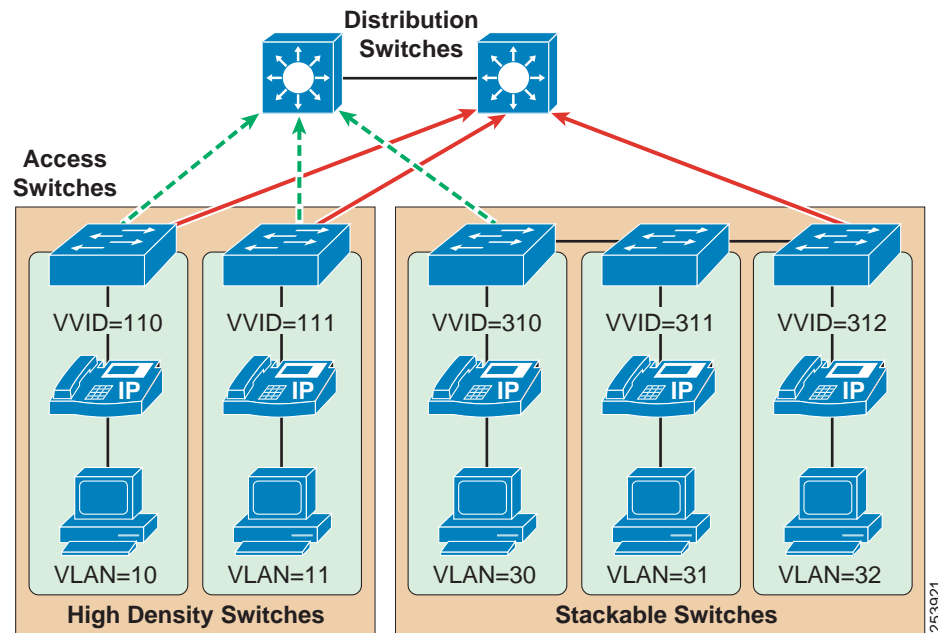

When you deploy voice, Cisco recommends that you enable two VLANs at the access layer: a native VLAN for data traffic (VLANs 10, 11, 30, 31, and 32 in [Figure 3-2](#)) and a voice VLAN under Cisco IOS or Auxiliary VLAN under CatOS for voice traffic (represented by VVIDs 110, 111, 310, 311, and 312 in [Figure 3-2](#)).

Separate voice and data VLANs are recommended for the following reasons:

- Address space conservation and voice device protection from external networks

Private addressing of phones on the voice or auxiliary VLAN ensures address conservation and ensures that phones are not accessible directly through public networks. PCs and servers are typically addressed with publicly routed subnet addresses; however, voice endpoints may be addressed using RFC 1918 private subnet addresses.

- QoS trust boundary extension to voice and video devices

QoS trust boundaries can be extended to voice and video devices without extending these trust boundaries and, in turn, QoS features to PCs and other data devices. For more information on trusted and untrusted devices, see the chapter on [Bandwidth Management, page 13-1](#).

- Protection from malicious network attacks
VLAN access control, 802.1Q, and 802.1p tagging can provide protection for voice devices from malicious internal and external network attacks such as worms, denial of service (DoS) attacks, and attempts by data devices to gain access to priority queues through packet tagging.
- Ease of management and configuration
Separate VLANs for voice and data devices at the access layer provide ease of management and simplified QoS configuration.

To provide high-quality voice and to take advantage of the full voice feature set, access layer switches should provide support for:

- 802.1Q trunking and 802.1p for proper treatment of Layer 2 CoS packet marking on ports with phones connected
- Multiple egress queues to provide priority queuing of RTP voice packet streams
- The ability to classify or reclassify traffic and establish a network trust boundary
- Inline power capability (Although inline power capability is not mandatory, it is highly recommended for the access layer switches.)
- Layer 3 awareness and the ability to implement QoS access control lists (These features are recommended if you are using certain Unified Communications endpoints such as a PC running a softphone application like Jabber that cannot benefit from an extended trust boundary.)

Spanning Tree Protocol (STP)

To minimize convergence times and maximize fault tolerance at Layer 2, enable the following STP features:

- PortFast
Enable PortFast on all access ports. The phones, PCs, or servers connected to these ports do not forward bridge protocol data units (BPDUs) that could affect STP operation. PortFast ensures that the phone or PC, when connected to the port, is able to begin receiving and transmitting traffic immediately without having to wait for STP to converge.
- Root guard or BPDU guard
Enable root guard or BPDU guard on all access ports to prevent the introduction of a rogue switch that might attempt to become the Spanning Tree root, thereby causing STP re-convergence events and potentially interrupting network traffic flows. Ports that are set to **errdisable** state by BPDU guard must either be re-enabled manually or the switch must be configured to re-enable ports automatically from the errdisable state after a configured period of time.
- UplinkFast and BackboneFast
Enable these features where appropriate to ensure that, when changes occur on the Layer 2 network, STP converges as rapidly as possible to provide high availability. When using Cisco stackable switches, enable Cross-Stack UplinkFast (CSUF) to provide fast failover and convergence if a switch in the stack fails.
- UniDirectional Link Detection (UDLD)
Enable this feature to reduce convergence and downtime on the network when link failures or misbehaviors occur, thus ensuring minimal interruption of network service. UDLD detects, and takes out of service, links where traffic is flowing in only one direction. This feature prevents defective links from being mistakenly considered as part of the network topology by the Spanning Tree and routing protocols.

**Note**

With the introduction of RSTP 802.1w, features such as PortFast and UplinkFast are not required because these mechanisms are built in to this standard. If RSTP has been enabled on the Catalyst switch, these commands are not necessary.

Routed Access Layer Designs

For campus designs requiring simplified configuration, common end-to-end troubleshooting tools, and the fastest convergence, a hierarchical design using Layer 3 switching in the access layer (routed access) in combination with Layer 3 switching at the distribution layer provides the fastest restoration of voice and data traffic flows.

Migrating the L2/L3 Boundary to the Access Layer

In the typical hierarchical campus design, the distribution layer uses a combination of Layer 2, Layer 3, and Layer 4 protocols and services to provide for optimal convergence, scalability, security, and manageability. In the most common distribution layer configurations, the access switch is configured as a Layer 2 switch that forwards traffic on high-speed trunk ports to the distribution switches. The distribution switches are configured to support both Layer 2 switching on their downstream access switch trunks and Layer 3 switching on their upstream ports toward the core of the network, as shown in [Figure 3-3](#).

Figure 3-3 Traditional Campus Design — Layer 2 Access with Layer 3 Distribution

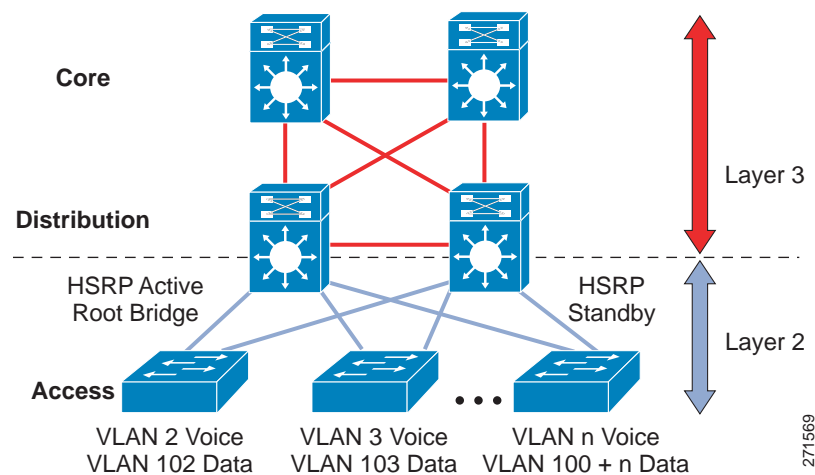

The purpose of the distribution switch in this design is to provide boundary functions between the bridged Layer 2 portion of the campus and the routed Layer 3 portion, including support for the default gateway, Layer 3 policy control, and all the multicast services required.

An alternative configuration to the traditional distribution layer model illustrated in [Figure 3-3](#) is one in which the access switch acts as a full Layer 3 routing node (providing both Layer 2 and Layer 3 switching) and the access-to-distribution Layer 2 uplink trunks are replaced with Layer 3 point-to-point routed links. This alternative configuration, in which the Layer 2/3 demarcation is moved from the distribution switch to the access switch (as shown in [Figure 3-4](#)), appears to be a major change to the design but is actually just an extension of the current best-practice design.

Figure 3-4 Routed Access Campus Design — Layer 3 Access with Layer 3 Distribution

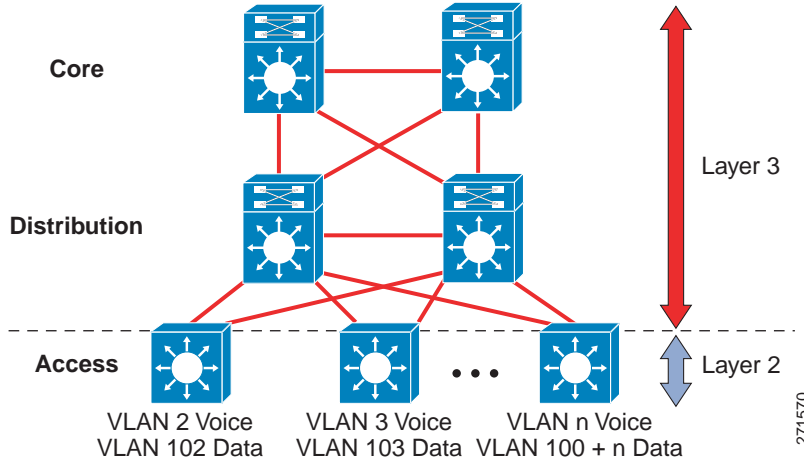

In both the traditional Layer 2 and the Layer 3 routed access designs, each access switch is configured with unique voice and data VLANs. In the Layer 3 design, the default gateway and root bridge for these VLANs is simply moved from the distribution switch to the access switch. Addressing for all end stations and for the default gateway remains the same. VLAN and specific port configurations remain unchanged on the access switch. Router interface configuration, access lists, "ip helper," and any other configuration for each VLAN remain identical but are configured on the VLAN Switched Virtual Interface (SVI) defined on the access switch instead of on the distribution switches.

There are several notable configuration changes associated with the move of the Layer 3 interface down to the access switch. It is no longer necessary to configure a Hot Standby Router Protocol (HSRP) or Gateway Load Balancing Protocol (GLBP) virtual gateway address as the "router" interfaces because all the VLANs are now local. Similarly, with a single multicast router, for each VLAN it is not necessary to perform any of the traditional multicast tuning such as tuning PIM query intervals or ensuring that the designated router is synchronized with the active HSRP gateway.

Routed Access Convergence

The many potential advantages of using a Layer 3 access design include the following:

- Improved convergence
- Simplified multicast configuration
- Dynamic traffic load balancing
- Single control plane
- Single set of troubleshooting tools (for example, ping and traceroute)

Of these advantages, perhaps the most significant is the improvement in network convergence times possible when using a routed access design configured with Enhanced Interior Gateway Routing Protocol (EIGRP) or Open Shortest Path First (OSPF) as the routing protocol. Comparing the convergence times for an optimal Layer 2 access design (either with a spanning tree loop or without a loop) against that of the Layer 3 access design, you can obtain a four-fold improvement in convergence times, from 800 to 900 msec for the Layer 2 design to less than 200 msec for the Layer 3 access design.

For more information on routed access designs, refer to the document on *High Availability Campus Network Design – Routed Access Layer using EIGRP or OSPF*, available at

http://www.cisco.com/application/pdf/en/us/guest/netsol/ns432/c649/ccmigration_09186a0080811468.pdf

Campus Distribution Layer

The distribution layer of the Campus LAN includes the portion of the network from the wiring closet switches to the next-hop switch. For more information on the campus distribution layer switches, refer to the product documentation available at

<http://www.cisco.com/en/US/products/hw/switches/index.html>

At the distribution layer, it is important to provide redundancy to ensure high availability, including redundant links between the distribution layer switches (or routers) and the access layer switches. To avoid creating topological loops at Layer 2, use Layer 3 links for the connections between redundant Distribution switches when possible.

First-Hop Redundancy Protocols

In the campus hierarchical model, where the distribution switches are the L2/L3 boundary, they also act as the default gateway for the entire L2 domain that they support. Some form of redundancy is required because this environment can be large and a considerable outage could occur if the device acting as the default gateway fails.

Gateway Load Balancing Protocol (GLBP), Hot Standby Router Protocol (HSRP), and Virtual Router Redundancy Protocol (VRRP) are all first-hop redundancy protocols. Cisco initially developed HSRP to address the need for default gateway redundancy. The Internet Engineering Task Force (IETF) subsequently ratified Virtual Router Redundancy Protocol (VRRP) as the standards-based method of providing default gateway redundancy. More recently, Cisco developed GLBP to overcome some the limitations inherent in both HSRP and VRRP.

HSRP and VRRP with Cisco enhancements both provide a robust method of backing up the default gateway, and they can provide failover in less than one second to the redundant distribution switch when tuned properly.

Gateway Load Balancing Protocol (GLBP)

Like HSRP and VRRP, Cisco's Gateway Load Balancing Protocol (GLBP) protects data traffic from a failed router or circuit, while also allowing packet load sharing between a group of redundant routers. When HSRP or VRRP are used to provide default gateway redundancy, the backup members of the peer relationship are idle, waiting for a failure event to occur for them to take over and actively forward traffic.

Before the development of GLBP, methods to utilize uplinks more efficiently were difficult to implement and manage. In one technique, the HSRP and STP/RSTP root alternated between distribution node peers, with the even VLANs homed on one peer and the odd VLANs homed on the alternate. Another technique used multiple HSRP groups on a single interface and used DHCP to alternate between the multiple default gateways. These techniques worked but were not optimal from a configuration, maintenance, or management perspective.

GLBP is configured and functions like HSRP. For HSRP, a single virtual MAC address is given to the endpoints when they use Address Resolution Protocol (ARP) to learn the physical MAC address of their default gateways (see [Figure 3-5](#)).

Figure 3-5 HSRP Uses One Virtual MAC Address

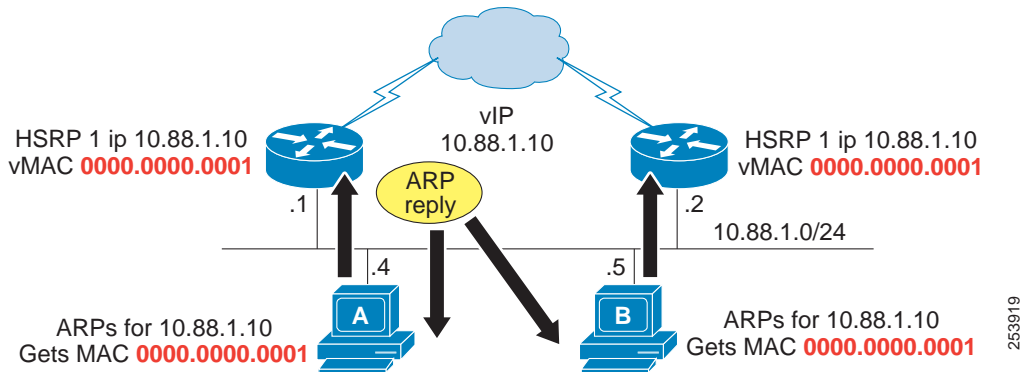

Two virtual MAC addresses exist with GLBP, one for each GLBP peer (see Figure 3-6). When an endpoint uses ARP to determine its default gateway, the virtual MAC addresses are checked in a round-robin basis. Failover and convergence work just like with HSRP. The backup peer assumes the virtual MAC address of the device that has failed, and begins forwarding traffic for its failed peer.

Figure 3-6 GLBP Uses Two Virtual MAC Addresses, One for Each GLBP Peer

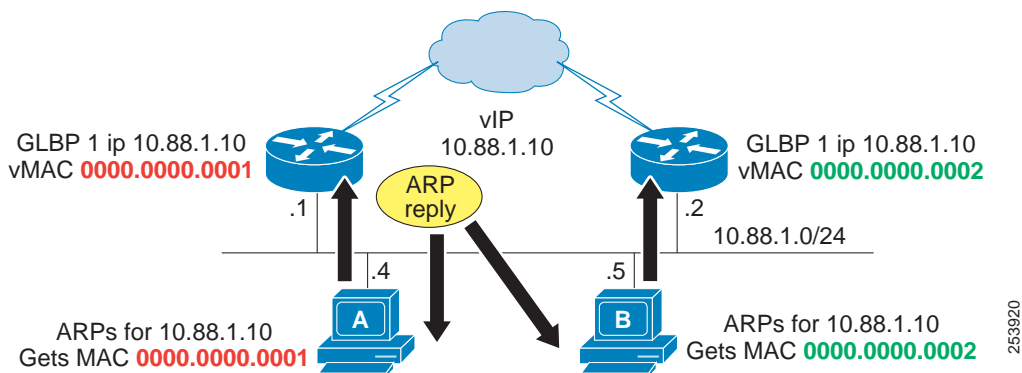

The end result is that a more equal utilization of the uplinks is achieved with minimal configuration. As a side effect, a convergence event on the uplink or on the primary distribution node affects only half as many hosts, giving a convergence event an average of 50 percent less impact.

For more information on HSRP, VRRP, and GLBP, refer to the *Campus Network for High Availability Design Guide*, available at

http://www.cisco.com/application/pdf/en/us/guest/netsol/ns431/c649/ccmigration_09186a008093b876.pdf

Routing Protocols

Configure Layer 3 routing protocols such as OSPF and EIGRP at the distribution layer to ensure fast convergence, load balancing, and fault tolerance. Use parameters such as routing protocol timers, path or link costs, and address summaries to optimize and control convergence times as well as to distribute traffic across multiple paths and devices. Cisco also recommends using the **passive-interface** command to prevent routing neighbor adjacencies via the access layer. These adjacencies are typically unnecessary, and they create extra CPU overhead and increased memory utilization because the routing protocol keeps track of them. By using the **passive-interface** command on all interfaces facing the access layer, you prevent routing updates from being sent out on these interfaces and, therefore, neighbor adjacencies are not formed.

Campus Core Layer

The core layer of the Campus LAN includes the portion of the network from the distribution routers or Layer 3 switches to one or more high-end core Layer 3 switches or routers. Layer 3-capable Catalyst switches at the core layer can provide connectivity between numerous campus distribution layers. For more details on the campus core layer switches, refer to the documentation on available at <http://www.cisco.com/en/US/products/hw/switches/index.html>.

At the core layer, it is again very important to provide the following types of redundancy to ensure high availability:

- Redundant link or cable paths

Redundancy here ensures that traffic can be rerouted around downed or malfunctioning links.

- Redundant devices

Redundancy here ensures that, in the event of a device failure, another device in the network can continue performing tasks that the failed device was doing.

- Redundant device sub-systems

This type of redundancy ensures that multiple power supplies and modules are available within a device so that the device can continue to function in the event that one of these components fails.

The Cisco Catalyst switches with Virtual Switching System (VSS) is a method to ensure redundancy in all of these areas by pooling together two Catalyst supervisor engines to act as one. For more information regarding VSS, refer to the product documentation available at

<http://www.cisco.com/en/US/products/ps9336/index.html>

Routing protocols at the core layer should again be configured and optimized for path redundancy and fast convergence. There should be no STP in the core because network connectivity should be routed at Layer 3. Finally, each link between the core and distribution devices should belong to its own VLAN or subnet and be configured using a 30-bit subnet mask.

Data Center and Server Farm

Typically, Cisco Unified Communications Manager (Unified CM) cluster servers, including media resource servers, reside in a firewall-secured data center or server farm environment. In addition, centralized gateways and centralized hardware media resources such as conference bridges, DSP or transcoder farms, and media termination points may be located in the data center or server farm. The placement of firewalls in relation to Cisco Unified Communications Manager (Unified CM) cluster servers and media resources can affect how you design and implement security in your network. For design guidance on firewall placement in relation to Unified Communications systems and media resources, see [Firewalls, page 4-22](#).

Because these servers and resources are critical to voice networks, Cisco recommends distributing all Unified CM cluster servers, centralized voice gateways, and centralized hardware resources between multiple physical switches and, if possible, multiple physical locations within the campus. This distribution of resources ensures that, given a hardware failure (such as a switch or switch line card failure), at least some servers in the cluster will still be available to provide telephony services. In addition, some gateways and hardware resources will still be available to provide access to the PSTN and to provide auxiliary services. Besides being physically distributed, these servers, gateways, and hardware resources should be distributed among separate VLANs or subnets so that, if a broadcast storm or denial of service attack occurs on a particular VLAN, not all voice connectivity and services will be disrupted.

Power over Ethernet (PoE)

PoE (or inline power) is 48 Volt DC power provided over standard Ethernet unshielded twisted-pair (UTP) cable. Instead of using wall power, IP phones and other inline powered devices (PDs) such as the Aironet Wireless Access Points can receive power provided by inline power-capable Catalyst Ethernet switches or other inline power source equipment (PSE). Inline power is enabled by default on all inline power-capable Catalyst switches.

Deploying inline power-capable switches with uninterruptible power supplies (UPS) ensures that IP phones continue to receive power during power failure situations. Provided the rest of the telephony network is available during these periods of power failure, then IP phones should be able to continue making and receiving calls. You should deploy inline power-capable switches at the campus access layer within wiring closets to provide inline-powered Ethernet ports for IP phones, thus eliminating the need for wall power.



Caution

The use of power injectors or power patch panels to deliver PoE can damage some devices because power is always applied to the Ethernet pairs. PoE switch ports automatically detect the presence of a device that requires PoE before enabling it on a port-by-port basis.

In addition to Cisco PoE inline power, Cisco now supports the IEEE 802.3af PoE and the IEEE 802.3at Enhanced PoE standards. For information on which Cisco Unified IP Phones support the 802.3af and 802.3at standards, refer to the product documentation for your particular phone models.

Energy Conservation for IP Phones

Cisco EnergyWise Technology provides intelligent management of energy usage for devices on the IP network, including Unified Communications endpoints that use Power over Ethernet (PoE). Cisco EnergyWise architecture can turn power on and off to devices connected with PoE on EnergyWise enabled switches, based on a configurable schedule. For more information on EnergyWise, refer to the documentation at

<http://www.cisco.com/en/US/products/ps10195/index.html>

When the PoE switch powers off IP phones for EnergyWise conservation, the phones are completely powered down. EnergyWise shuts down inline power on the ports that connect to IP phones and does so by a schedule or by commands from network management tools. When power is disabled, no verification occurs to determine whether a phone has an active call. The power is turned off and any active call is torn down. The IP phone loses registration from Cisco Unified Communications Manager and no calls can be made to or from the phone. There is no mechanism on the phone to power it on, therefore emergency calling will not be available on that phone.

The IP phone can be restarted only when the switch powers it on again. After power is restored, the IP phones will reboot and undergo a recovery process that includes requesting a new IP address, downloading a configuration file, applying any new configuration parameters, downloading new firmware or locales, and registering with Cisco Unified CM.

The EnergyWise schedule is configured and managed on the Cisco Network Infrastructure. It does not require any configuration on the IP phone or on Cisco Unified CM. However, power consumption on the phone can also be managed by a device profile configured on Unified CM. The energy saving options provided by Unified CM include the following:

- [Power Save Plus Mode, page 3-13](#)
- [Power Save Mode, page 3-13](#)

Power Save Plus Mode

In Power Save Plus mode, the phone on and off times and the idle timeout periods can be configured on the IP phones. The Cisco IP Phones' EnergyWise Power Save Plus configuration options specify the schedule for the IP phones to sleep (power down) and wake (power up). This mode requires an EnergyWise enabled network. If EnergyWise is enabled, then the sleep and wake times, as well as other parameters, can be used to control power to the phones. The Power Save Plus parameters are configured in the product-specific device profile in Cisco Unified CM Administration and sent to the IP phones as part of the phone configuration XML file.

During the configured power off period in this power saving mode, the IP phone sends a request to the switch asking for a wake-up at a specified time. If the switch is EnergyWise enabled, it accepts the request and reduces the power to the phone port, putting the phone to sleep. The sleep mode reduces the power consumption of the phone to 1 watt or less. The phone is not completely powered off in this case. When the phone is sleeping, the PoE switch provides minimal power that illuminates the Select key on the phone. A user can wake up the IP phone by using the Select button. The IP phone does not go into sleep mode if a call is active on the phone. Audio and visual alerts can optionally be configured to warn users before a phone enters the Power Save Plus mode. While the phone is in sleep mode, it is not registered to Cisco Unified CM and cannot receive any inbound calls. Use the Forward Unregistered setting in the phone's device configuration profile to specify how to treat any inbound calls to the phone's number.



Note

The Cisco EnergyWise Power Save Plus mode is supported on most Cisco IP Phones and Collaboration Desk Endpoints. To learn which endpoints support EnergyWise Power Save Plus, refer to the data sheets for your endpoint models:

<http://www.cisco.com/c/en/us/products/collaboration-endpoints/product-listing.html>

Power Save Mode

In Power Save mode, the backlight on the screen is not lit when the phone is not in use. The phone stays registered to Cisco Unified CM in this mode and can receive inbound calls and make outbound calls. Cisco Unified CM Administration has product-specific configuration options to turn off the display at a designated time on some days and all day on other days. The phone remains in Power Save mode for the scheduled duration or until the user lifts the handset or presses any button. An EnergyWise enabled network is not required for the Power Save mode. Idle times can be scheduled so that the display remains on until the timeout and then turns off automatically. The phone is still powered on in this mode and can receive inbound calls.

The Power Save mode can be used together with the Power Save Plus mode. Using both significantly reduces the total power consumption by Cisco Unified IP Phones.

For information on configuring these modes, refer to the administration guides for the Cisco IP Phones and Collaboration Desk Endpoints:

<http://www.cisco.com/c/en/us/products/collaboration-endpoints/product-listing.html>

LAN Quality of Service (QoS)

Until recently, quality of service was not an issue in the enterprise campus due to the asynchronous nature of data traffic and the ability of network devices to tolerate buffer overflow and packet loss. However, with new applications such as voice and video, which are sensitive to packet loss and delay, buffers and not bandwidth are the key QoS issue in the enterprise campus.

Figure 3-7 illustrates the typical oversubscription that occurs in LAN infrastructures.

Figure 3-7 Data Traffic Oversubscription in the LAN

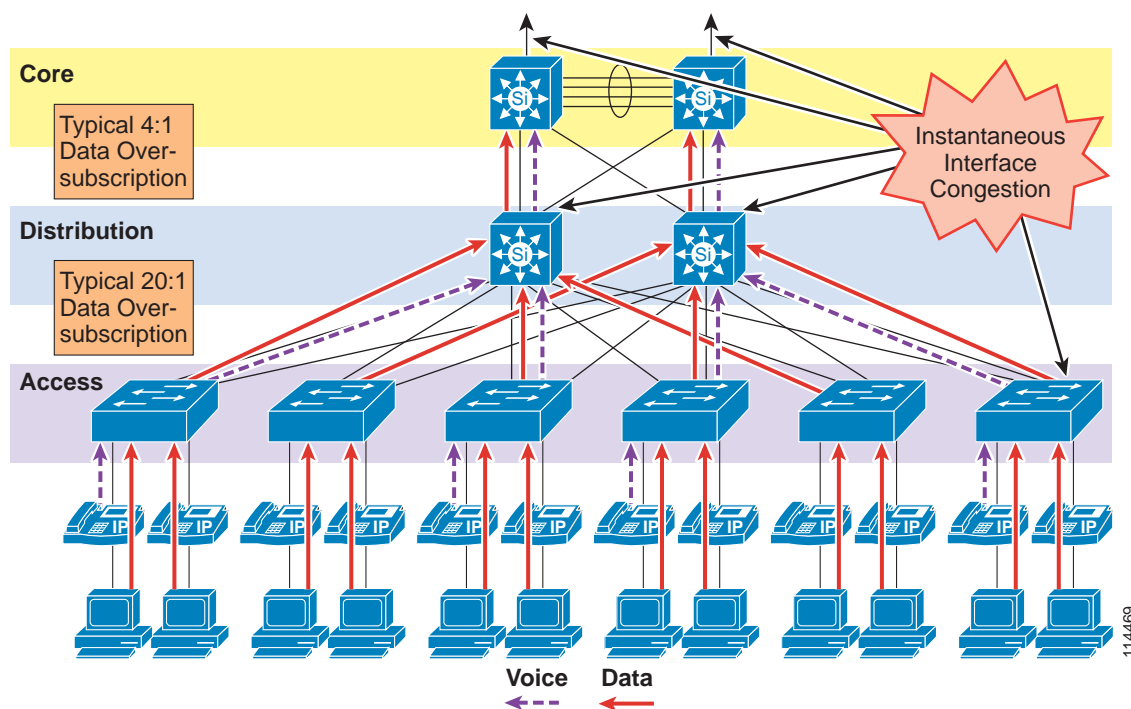

This oversubscription, coupled with individual traffic volumes and the cumulative effects of multiple independent traffic sources, can result in the egress interface buffers becoming full instantaneously, thus causing additional packets to drop when they attempt to enter the egress buffer. The fact that campus switches use hardware-based buffers, which compared to the interface speed are much smaller than those found on WAN interfaces in routers, merely increases the potential for even short-lived traffic bursts to cause buffer overflow and dropped packets.

Applications such as file sharing (both peer-to-peer and server-based), remote networked storage, network-based backup software, and emails with large attachments, can create conditions where network congestion occurs more frequently and/or for longer durations. Some of the negative effects of recent worm attacks have been an overwhelming volume of network traffic (both unicast and broadcast-storm based), increasing network congestion. If no buffer management policy is in place, loss, delay, and jitter performance of the LAN may be affected for all traffic.

Another situation to consider is the effect of failures of redundant network elements, which cause topology changes. For example, if a distribution switch fails, all traffic flows will be reestablished through the remaining distribution switch. Prior to the failure, the load balancing design shared the load between two switches, but after the failure all flows are concentrated in a single switch, potentially causing egress buffer conditions that normally would not be present.

For applications such as voice, this packet loss and delay results in severe voice quality degradation. Therefore, QoS tools are required to manage these buffers and to minimize packet loss, delay, and delay variation (jitter).

The following types of QoS tools are needed end-to-end on the network to manage traffic and ensure voice and video quality:

- Traffic classification

Classification involves the marking of packets with a specific priority denoting a requirement for class of service (CoS) from the network. The point at which these packet markings are trusted or not trusted is considered the trust boundary. Trust is typically extended to voice devices (phones) and not to data devices (PCs).

- Queuing or scheduling

Interface queuing or scheduling involves assigning packets to one of several queues based on classification for expedited treatment throughout the network.

- Bandwidth provisioning

Provisioning involves accurately calculating the required bandwidth for all applications plus element overhead.

The following sections discuss the use of these QoS mechanisms in a campus environment:

- [Traffic Classification, page 3-15](#)
- [Interface Queuing, page 3-17](#)
- [Bandwidth Provisioning, page 3-18](#)
- [Impairments to IP Communications if QoS is Not Employed, page 3-18](#)

Traffic Classification

It has always been an integral part of the Cisco network design architecture to classify or mark traffic as close to the edge of the network as possible. Traffic classification is an entrance criterion for access into the various queuing schemes used within the campus switches and WAN interfaces. Cisco IP Phones mark voice control signaling and voice RTP streams at the source, and they adhere to the values presented in [Table 3-3](#). As such, the IP phone can and should classify traffic flows.

[Table 3-3](#) lists the traffic classification requirements for the LAN infrastructure.

Table 3-3 Traffic Classification Guidelines for Various Types of Network Traffic

Application	Layer-3 Classification			Layer-2 Classification
	Type of Service (ToS) IP Precedence (IPP)	Per-Hop Behavior (PHB)	Differentiated Services Code Point (DSCP)	Class of Service (CoS)
Routing	6	CS6	48	6
Voice Real-Time Transport Protocol (RTP)	5	EF	46	5
Videoconferencing	4	AF41	34	4
IP video	4	AF41	34	4
Immersive video Real-Time Interactive	4	CS4	32	4
Streaming video	3	AF31	26	3
Call signaling	3	CS3	24	3
Transactional data	2	AF21	18	2
Network management	2	CS2	16	2
Scavenger	1	CS1	8	1
Best effort	0	0	0	0

For more information about traffic classification, refer to the QoS design guides available at

<http://www.cisco.com/c/en/us/solutions/enterprise/design-zone-ipv6/design-guide-listing.html>

Traffic Classification for Video Telephony

The main classes of interest for IP Video Telephony are:

- Voice
Voice is classified as CoS 5 (IP Precedence 5, PHB EF, or DSCP 46).
- Videoconferencing
Videoconferencing is classified as CoS 4 (IP Precedence 4, PHB AF41, or DSCP 34).
- Call signaling
Call signaling for voice and videoconferencing is classified as CoS 3 (IP Precedence 3, PHB CS3, or DSCP 24).

Cisco highly recommends these classifications as *best practices* in a Cisco Unified Communications network.

QoS Marking Differences Between Video Calls and Voice-Only Calls

The voice component of a call can be classified in one of two ways, depending on the type of call in progress. A voice-only telephone call would have its media classified as CoS 5 (IP Precedence 5 or PHB EF), while the voice channel of a video conference would have its media classified as CoS 4 (IP Precedence 4 or PHB AF41). All the Cisco IP Video Telephony products adhere to the Cisco

Corporate QoS Baseline standard, which requires that the audio and video channels of a video call both be marked as CoS 4 (IP Precedence 4 or PHB AF41). The reasons for this recommendation include, but are not limited to, the following:

- To preserve lip-sync between the audio and video channels
- To provide separate classes for audio-only calls and video calls

Cisco is in the process of changing this requirement for endpoints to mark the audio and video channels of a video call separately, thus providing the flexibility to mark both the audio and video channels of a video call with the same DSCP value or different DSCP values, depending on the use cases. For more information on DSCP marking, see the chapter on [Bandwidth Management](#), page 13-1.

The signaling class is applicable to all voice signaling protocols (such as SCCP, MGCP, and so on) as well as video signaling protocols (such as SCCP, H.225, RAS, CAST, and so on).

Given the recommended classes, the first step is to decide where the packets will be classified (that is, which device will be the first to mark the traffic with its QoS classification). There are essentially two places to mark or classify traffic:

- On the originating endpoint — the classification is then trusted by the upstream switches and routers
- On the switches and/or routers — because the endpoint is either not capable of classifying its own packets or is not trustworthy to classify them correctly

QoS Enforcement Using a Trusted Relay Point (TRP)

A Trusted Relay Point (TRP) can be used to enforce and/or re-mark the DSCP values of media flows from endpoints. This feature allows QoS to be enforced for media from endpoints such as softphones, where the media QoS values might have been modified locally.

A TRP is a media resource based upon the existing Cisco IOS media termination point (MTP) function.

Endpoints can be configured to "Use Trusted Relay Point," which will invoke a TRP for all calls.

For QoS enforcement, the TRP uses the configured QoS values for media in Unified CM's Service Parameters to re-mark and enforce the QoS values in media streams from the endpoint.

TRP functionality is supported by Cisco IOS MTPs and transcoding resources. (Use Unified CM to check "Enable TRP" on the MTP or transcoding resource to activate TRP functionality.)

Interface Queuing

After packets have been marked with the appropriate tag at Layer 2 (CoS) and Layer 3 (DSCP or PHB), it is important to configure the network to schedule or queue traffic based on this classification, so as to provide each class of traffic with the service it needs from the network. By enabling QoS on campus switches, you can configure all voice traffic to use separate queues, thus virtually eliminating the possibility of dropped voice packets when an interface buffer fills instantaneously.

Although network management tools may show that the campus network is not congested, QoS tools are still required to guarantee voice quality. Network management tools show only the average congestion over a sample time span. While useful, this average does not show the congestion peaks on a campus interface.

Transmit interface buffers within a campus tend to congest in small, finite intervals as a result of the bursty nature of network traffic. When this congestion occurs, any packets destined for that transmit interface are dropped. The only way to prevent dropped voice traffic is to configure multiple queues on campus switches. For this reason, Cisco recommends always using a switch that has at least two output queues on each port and the ability to send packets to these queues based on QoS Layer 2 and/or Layer 3

classification. The majority of Cisco Catalyst Switches support two or more output queues per port. For more information on Cisco Catalyst Switch interface queuing capabilities, refer to the documentation at <http://www.cisco.com/en/US/products/hw/switches/index.html>

Bandwidth Provisioning

In the campus LAN, bandwidth provisioning recommendations can be summarized by the motto, *Over provision and under subscribe*. This motto implies careful planning of the LAN infrastructure so that the available bandwidth is always considerably higher than the load and there is no steady-state congestion over the LAN links.

The addition of voice traffic onto a converged network does not represent a significant increase in overall network traffic load; the bandwidth provisioning is still driven by the demands of the data traffic requirements. The design goal is to avoid extensive data traffic congestion on any link that will be traversed by telephony signaling or media flows. Contrasting the bandwidth requirements of a single G.711 voice call (approximately 86 kbps) to the raw bandwidth of a FastEthernet link (100 Mbps) indicates that voice is not a source of traffic that causes network congestion in the LAN, but rather it is a traffic flow to be protected from LAN network congestion.

Impairments to IP Communications if QoS is Not Employed

If QoS is not deployed, packet drops and excessive delay and jitter can occur, leading to impairments of the telephony services. When media packets are subjected to drops, delay, and jitter, the user-perceivable effects include clicking sound, harsh-sounding voice, extended periods of silence, and echo.

When signaling packets are subjected to the same conditions, user-perceivable impairments include unresponsiveness to user input (such as delay to dial tone), continued ringing upon answer, and double dialing of digits due to the user's belief that the first attempt was not effective (thus requiring hang-up and redial). More extreme cases can include endpoint re-initialization, call termination, and the spurious activation of SRST functionality at branch offices (leading to interruption of gateway calls).

These effects apply to all deployment models. However, single-site (campus) deployments tend to be less likely to experience the conditions caused by sustained link interruptions because the larger quantity of bandwidth typically deployed in LAN environments (minimum links of 100 Mbps) allows for some residual bandwidth to be available for the IP Communications system.

In any WAN-based deployment model, traffic congestion is more likely to produce sustained and/or more frequent link interruptions because the available bandwidth is much less than in a LAN (typically less than 2 Mbps), so the link is more easily saturated. The effects of link interruptions can impact the user experience, whether or not the voice media traverses the packet network, because signaling traffic between endpoints and the Unified CM servers can also be delayed or dropped.

QoS Design Considerations for Virtual Unified Communications with Cisco UCS Servers

Unified Communications applications such as Cisco Unified Communications Manager (Unified CM) run as virtual machines on top of the VMware Hypervisor. These Unified Communications virtual machines are connected to a virtual software switch rather than a hardware-based Ethernet. The following types of virtual software switches are available:

- VMware vSphere Standard Switch
Available with all VMware vSphere editions and independent of the type of VMware licensing scheme. The vSphere Standard Switch exists only on the host on which it is configured.
- VMware vSphere Distributed Switch
Available only with the Enterprise Plus Edition of VMware vSphere. The vSphere Distributed Switch acts as a single switch across all associated hosts on a datacenter and helps simplify manageability of the software virtual switch.
- Cisco Nexus 1000V Switch
Cisco has a software switch called the Nexus 1000 Virtual (1000V) Switch. The Cisco Nexus 1000V requires the Enterprise Plus Edition of VMware vSphere. It is a distributed virtual switch visible to multiple VMware hosts and virtual machines. The Cisco Nexus 1000V Series provides policy-based virtual machine connectivity, mobile virtual machine security, enhanced QoS, and network policy.

From the point of view of virtual connectivity, each virtual machine can connect to any one of the above virtual switches residing on a blade server. When using Cisco UCS B-Series blade servers, the blade servers physically connect to the rest of the network through a Fabric Extender in the UCS chassis to a UCS Fabric Interconnect Switch (for example, Cisco UCS 6100 or 6200 Series). The UCS Fabric Interconnect Switch is where the physical wiring connects to a customer's Ethernet LAN and FC SAN.

From the point of view of traffic flow, traffic from the virtual machines first goes to the software virtual switch (for example, vSphere Standard Switch, vSphere Distributed Switch, or Cisco Nexus 1000V Switch). The virtual switch then sends the traffic to the physical UCS Fabric Interconnect Switch through its blade server's Network Adapter and Fabric Extender. The UCS Fabric Interconnect Switch carries both the IP and fibre channel SAN traffic via Fibre Channel over Ethernet (FCoE) on a single wire. The UCS Fabric Interconnect Switch sends IP traffic to an IP switch (for example, Cisco Catalyst or Nexus Series Switch), and it sends SAN traffic to a Fibre Channel SAN Switch (for example, Cisco MDS Series Switch).

Congestion Scenario

In a deployment with Cisco UCS B-Series blades servers and with Cisco Collaboration applications only, network congestion or an oversubscription scenario is unlikely because the UCS Fabric Interconnect Switch provides a high-capacity switching fabric, and the usable bandwidth per server blade far exceeds the maximum traffic requirements of a typical Collaboration application.

However, there might be scenarios where congestion could arise. For example, with a large number of B-Series blade servers and chassis, a large number of applications, and/or third-party applications requiring high network bandwidth, there is a potential for congestion on the different network elements of the UCS B-Series system (adapters, IO modules, Fabric Interconnects). In addition, FCoE traffic is sharing the same network elements as IP traffic, therefore applications performing a high amount of storage transfer would increase the utilization on the network elements and contribute to this potential congestion.

To address this potential congestion, QoS should be implemented.

QoS Implementation with Cisco UCS B-Series

Cisco UCS Fabric Interconnect Switches and adapters such as the Cisco VIC adapter perform QoS based on Layer 2 CoS values. Traffic types are classified by CoS value into QoS system classes that determine, for example, the minimum amount of bandwidth guaranteed and the packet drop policy to be used for each class. However, Cisco Collaboration applications perform QoS marking at Layer 3 only, not at the Layer 2. Hence the need for mapping the L3 values used by the applications to the L2 CoS values used by the Cisco UCS elements.

The VMware vSphere Standard Switch, vSphere Distributed Switch, Cisco UCS Fabric Interconnect switches, and other UCS network elements do not have the ability to perform this mapping between L3 and L2 values. Use the Cisco Nexus 1000V, which like the traditional Cisco switches, can perform this mapping. For example, the Nexus 1000V can map PHB EF (real-time media traffic) to CoS 5 and PHB CS3 (voice/video signaling traffic) to CoS 3.

**Note**

Fibre Channel over Ethernet (FCoE) traffic has a reserved QoS system class that should not be used by any other type of traffic. By default, this system class has a CoS value of 3, which is the same value assigned to the system class used by voice and video signaling traffic in the example above. To prevent voice and video signaling traffic from using the FCoE system class, assign a different CoS value to the FCoE system class (2 or 4, for instance).

**Note**

The decision to use the Nexus 1000V will vary on a case-by-case basis, depending on the available bandwidth for Unified Communications applications within the UCS architecture. If there is a possibility that a congestion scenario will arise, then the Nexus 1000V switch should be deployed.

If the Nexus 1000V is not deployed, it is still possible to provide some QoS, but it would not be an optimal solution. For example, you could create multiple virtual switches and assign a different CoS value for the uplink ports of each of those switches. For example, virtual switch 1 would have uplink ports configured with a CoS value of 1, virtual switch 2 would have uplink ports configured with a CoS value of 2, and so forth. Then the application virtual machines would be assigned to a virtual switch, depending on the desired QoS system class. The downside to this approach is that all traffic types from a virtual machine will have the same CoS value. For example, with a Unified CM virtual machine, real-time media traffic such as MoH traffic, signaling traffic, and non-voice traffic (for example, backups, CDRs, logs, Web traffic, and so forth) would share the same CoS value.

QoS Design Considerations for Video

Cisco recommends using different DSCP markings for different video applications. Unified CM 9.x provides support for different DSCP markings for immersive video traffic and videoconferencing (IP video telephony) traffic. By default, Unified CM 9.x has preconfigured the recommended DSCP values for TelePresence (immersive video) calls at CS4 and video (IP video telephony) calls at AF41.

Figure 3-8 depicts the different video applications in a converged environment using the recommended DSCP values.

Figure 3-8 Recommended QoS Traffic Markings in a Converged Network

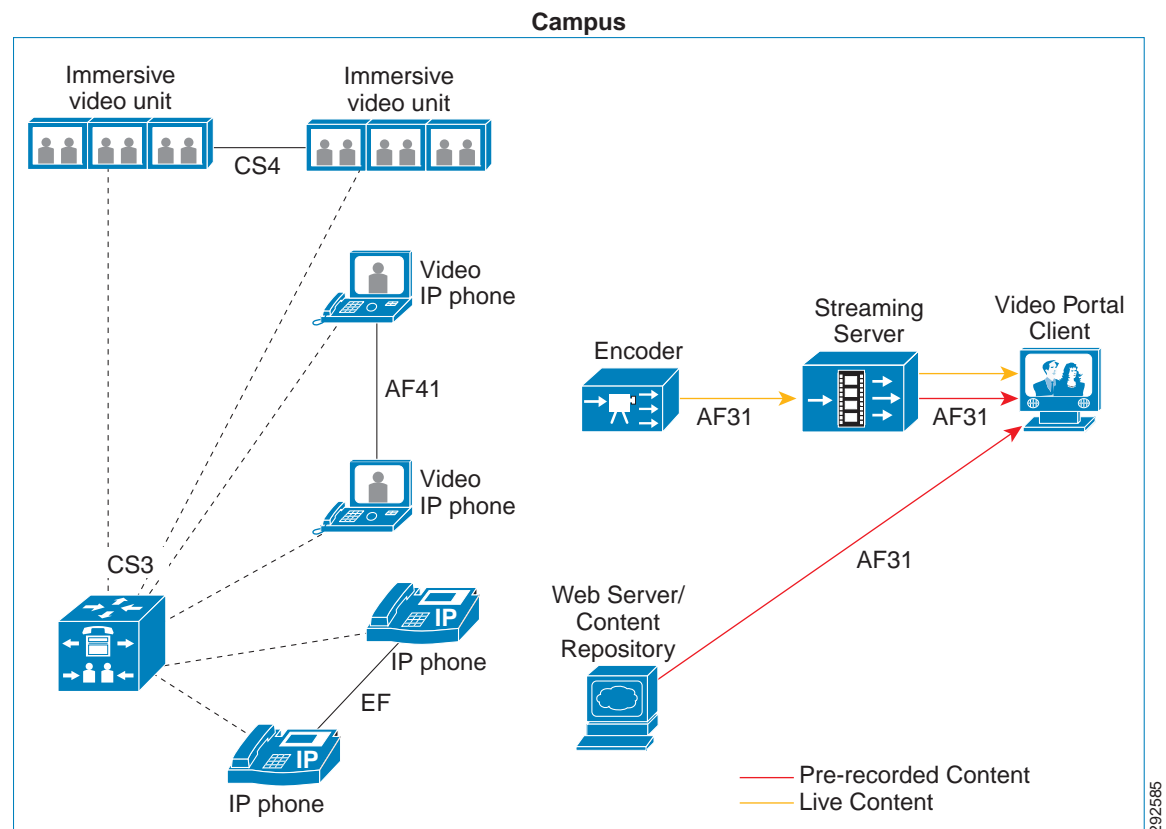

Calculating Overhead for QoS

Unlike voice, real-time IP video traffic in general is a somewhat bursty, variable bit rate stream. Therefore video, unlike voice, does not have clear formulas for calculating network overhead because video packet sizes and rates vary proportionally to the degree of motion within the video image itself. From a network administrator's point of view, bandwidth is always provisioned at Layer 2, but the variability in the packet sizes and the variety of Layer 2 media that the packets may traverse from end-to-end make it difficult to calculate the real bandwidth that should be provisioned at Layer 2. However, the conservative rule that has been thoroughly tested and widely used is to over-provision video bandwidth by 20%. This accommodates the 10% burst and the network overhead from Layer 2 to Layer 4.

Network Services

The deployment of an IP Communications system requires the coordinated design of a well structured, highly available, and resilient network infrastructure as well as an integrated set of network services including Domain Name System (DNS), Dynamic Host Configuration Protocol (DHCP), Trivial File Transfer Protocol (TFTP), and Network Time Protocol (NTP).

Domain Name System (DNS)

DNS enables the mapping of host names and network services to IP addresses within a network or networks. DNS server(s) deployed within a network provide a database that maps network services to hostnames and, in turn, hostnames to IP addresses. Devices on the network can query the DNS server and receive IP addresses for other devices in the network, thereby facilitating communication between network devices.

A complete collaboration solution relies on DNS in order to function correctly for a number of services and thus requires a highly available DNS structure in place. For basic IP telephony deployments where reliance on DNS is not desired, Unified CM can be configured to support and ensure communication between Unified CM(s), gateways, and endpoint devices using IP addresses rather than hostnames.

Deploying Unified CM without DNS

For basic IP telephony deployments where DNS is not desired, Cisco recommends that you configure Unified CM(s), gateways, and endpoint devices to use IP addresses rather than hostnames. This should be done during installation of the Unified CM cluster. During installation of the publisher and subscriber nodes, Cisco recommends that you do not select the option to enable DNS. After the initial installation of the publisher node in a Unified CM cluster, the publisher will be referenced in the server table by the hostname you provided for the system. Before installation and configuration of any subsequent subscriber nodes or the definition of any endpoints, you should change this server entry to the IP address of the publisher node rather than the hostname. Each subscriber node added to the cluster should be defined in this same server table by IP address and not by hostname. Each subscriber node should be added to this server table one device at a time, and there should be no definitions for non-existent subscriber nodes at any time other than for the new subscriber node being installed.

Deploying Unified CM with DNS

You should always deploy DNS servers in a geographically redundant fashion so that a single DNS server failure will not prevent network communications between IP telephony devices. By providing DNS server redundancy in the event of a single DNS server failure, you ensure that devices relying on DNS to communicate on the network can still receive hostname-to-IP-address mappings from a backup or secondary DNS server.

Unified CM can use DNS to:

- Provide simplified system management
- Resolve fully qualified domain names to IP addresses for trunk destinations
- Resolve fully qualified domain names to IP addresses for SIP route patterns based on domain name
- Resolve service (SRV) records to host names and then to IP addresses for SIP trunk destinations
- Provide certificate-based security

Collaboration clients use DNS for:

- Single Sign-On (SSO)
- Jabber deployments requiring user registration auto-discovery
- Certificate-based security for secure signaling and media

When DNS is used, Cisco recommends defining each Unified CM cluster as a member of a valid sub-domain within the larger organizational DNS domain, defining the DNS domain on each Cisco Unified CM server, and defining the primary and secondary DNS server addresses on each Unified CM server.

Table 3-4 shows an example of how DNS server could use A records (Hostname-to-IP-address resolution), Cname records (aliases), and SRV records (service records for redundancy, load balancing, and service discovery) in a Unified CM environment.

Table 3-4 Example Use of DNS with Unified CM

Host Name	Type	TTL	Data
CUCM-Admin.cluster1.cisco.com	Host (A)	12 Hours	182.10.10.1
CUCM1.cluster1.cisco.com	Host (A)	Default	182.10.10.1
CUCM2.cluster1.cisco.com	Host (A)	Default	182.10.10.2
CUCM3.cluster1.cisco.com	Host (A)	Default	182.10.10.3
CUCM4.cluster1.cisco.com	Host (A)	Default	182.10.10.4
TFTP-server1.cluster1.cisco.com	Host (A)	12 Hours	182.10.10.11
TFTP-server2.cluster1.cisco.com	Host (A)	12 Hours	182.10.10.12
CUP1.cluster1.cisco.com	Host (A)	Default	182.10.10.15
CUP2.cluster1.cisco.com	Host (A)	Default	182.10.10.16
www.CUCM-Admin.cisco.com	Alias (CNAME)	Default	CUCM-Admin.cluster1.cisco.com
_sip._tcp.cluster1.cisco.com.	Service (SRV)	Default	CUCM1.cluster1.cisco.com
_sip._tcp.cluster1.cisco.com.	Service (SRV)	Default	CUCM2.cluster1.cisco.com
_sip._tcp.cluster1.cisco.com.	Service (SRV)	Default	CUCM3.cluster1.cisco.com
_sip._tcp.cluster1.cisco.com.	Service (SRV)	Default	CUCM4.cluster1.cisco.com

For Jabber clients, refer to the *Cisco Jabber DNS Configuration Guide*, available at

<http://www.cisco.com/web/products/voice/jabber.html>

Dynamic Host Configuration Protocol (DHCP)

DHCP is used by hosts on the network to obtain initial configuration information, including IP address, subnet mask, default gateway, and TFTP server address. DHCP eases the administrative burden of manually configuring each host with an IP address and other configuration information. DHCP also provides automatic reconfiguration of network configuration when devices are moved between subnets. The configuration information is provided by a DHCP server located in the network, which responds to DHCP requests from DHCP-capable clients.

You should configure IP Communications endpoints to use DHCP to simplify deployment of these devices. Any RFC 2131 compliant DHCP server can be used to provide configuration information to IP Communications network devices. When deploying IP telephony devices in an existing data-only

network, all you have to do is add DHCP voice scopes to an existing DHCP server for these new voice devices. Because IP telephony devices are configured to use and rely on a DHCP server for IP configuration information, you must deploy DHCP servers in a redundant fashion. At least two DHCP servers should be deployed within the telephony network such that, if one of the servers fails, the other can continue to answer DHCP client requests. You should also ensure that DHCP server(s) are configured with enough IP subnet addresses to handle all DHCP-reliant clients within the network.

DHCP Option 150

IP telephony endpoints can be configured to rely on DHCP Option 150 to identify the source of telephony configuration information, available from a server running the Trivial File Transfer Protocol (TFTP).

In the simplest configuration, where a single TFTP server is offering service to all deployed endpoints, Option 150 is delivered as a single IP address pointing to the system's designated TFTP server. The DHCP scope can also deliver two IP addresses under Option 150, for deployments where there are two TFTP servers within the same cluster. The phone would use the second address if it fails to contact the primary TFTP server, thus providing redundancy. To achieve both redundancy and load sharing between the TFTP servers, you can configure Option 150 to provide the two TFTP server addresses in reverse order for half of the DHCP scopes.



Note

If the primary TFTP server is available but is not able to grant the requested file to the phone (for example, because the requesting phone is not configured on that cluster), the phone will not attempt to contact the secondary TFTP server.

Cisco highly recommends using a direct IP address (that is, not relying on a DNS service) for Option 150 because doing so eliminates dependencies on DNS service availability during the phone boot-up and registration process.



Note

Even though IP phones support a maximum of two TFTP servers under Option 150, you could configure a Unified CM cluster with more than two TFTP servers. For instance, if a Unified CM system is clustered over a WAN at three separate sites, three TFTP servers could be deployed (one at each site). Phones within each site could then be granted a DHCP scope containing that site's TFTP server within Option 150. This configuration would bring the TFTP service closer to the endpoints, thus reducing latency and ensuring failure isolation between the sites (one site's failure would not affect TFTP service at another site).

Phone DHCP Operation Following a Power Recycle

If a phone is powered down and comes back up while the DHCP server is still offline, it will attempt to use DHCP to obtain IP addressing information (as normal). In the absence of a response from a DHCP server, the phone will re-use the previously received DHCP information to register with Unified CM.

DHCP Lease Times

Configure DHCP lease times as appropriate for the network environment. Given a fairly static network in which PCs and telephony devices remain in the same place for long periods of time, Cisco recommends longer DHCP lease times (for example, one week). Shorter lease times require more frequent renewal of the DHCP configuration and increase the amount of DHCP traffic on the network. Conversely, networks that incorporate large numbers of mobile devices, such as laptops and wireless telephony devices, should be configured with shorter DHCP lease times (for example, one day) to

prevent depletion of DHCP-managed subnet addresses. Mobile devices typically use IP addresses for short increments of time and then might not request a DHCP renewal or new address for a long period of time. Longer lease times will tie up these IP addresses and prevent them from being reassigned even when they are no longer being used.

Cisco Unified IP Phones adhere to the conditions of the DHCP lease duration as specified in the DHCP server's scope configuration. Once half the lease time has expired since the last successful DHCP server acknowledgment, the IP phone will request a lease renewal. This DHCP client Request, once acknowledged by the DHCP server, will allow the IP phone to retain use of the IP scope (that is, the IP address, default gateway, subnet mask, DNS server (optional), and TFTP server (optional)) for another lease period. If the DHCP server becomes unavailable, an IP phone will not be able to renew its DHCP lease, and as soon as the lease expires, it will relinquish its IP configuration and will thus become unregistered from Unified CM until a DHCP server can grant it another valid scope.

In centralized call processing deployments, if a remote site is configured to use a centralized DHCP server (through the use of a DHCP relay agent such as the IP Helper Address in Cisco IOS) and if connectivity to the central site is severed, IP phones within the branch will not be able to renew their DHCP scope leases. In this situation, branch IP phones are at risk of seeing their DHCP lease expire, thus losing the use of their IP address, which would lead to service interruption. Given the fact that phones attempt to renew their leases at half the lease time, DHCP lease expiration can occur as soon as half the lease time since the DHCP server became unreachable. For example, if the lease time of a DHCP scope is set to 4 days and a WAN failure causes the DHCP server to be unavailable to the phones in a branch, those phones will be unable to renew their leases at half the lease time (in this case, 2 days). The IP phones could stop functioning as early as 2 days after the WAN failure, unless the WAN comes back up and the DHCP server is available before that time. If the WAN connectivity failure persists, all phones see their DHCP scope expire after a maximum of 4 days from the WAN failure.

This situation can be mitigated by one of the following methods:

- Set the DHCP scope lease to a long duration (for example, 8 days or more).

This method would give the system administrator a minimum of half the lease time to remedy any DHCP reachability problem. Long lease durations also have the effect of reducing the frequency of network traffic associated with lease renewals.

- Configure co-located DHCP server functionality (for example, run a DHCP server function on the branch's Cisco IOS router).

This approach is immune to WAN connectivity interruption. One effect of such an approach is to decentralize the management of IP addresses, requiring incremental configuration efforts in each branch. (See [DHCP Network Deployments, page 3-25](#), for more information.)



Note The term *co-located* refers to two or more devices in the same physical location, with no WAN or MAN connection between them.

DHCP Network Deployments

There are two options for deploying DHCP functionality within an IP telephony network:

- Centralized DHCP Server

Typically, for a single-site campus IP telephony deployment, the DHCP server should be installed at a central location within the campus. As mentioned previously, redundant DHCP servers should be deployed. If the IP telephony deployment also incorporates remote branch telephony sites, as in a centralized multisite Unified CM deployment, a centralized server can be used to provide DHCP service to devices in the remote sites. This type of deployment requires that you configure the **ip helper-address** on the branch router interface. Keep in mind that, if redundant DHCP servers are

deployed at the central site, both servers' IP addresses must be configured as **ip helper-address**. Also note that, if branch-side telephony devices rely on a centralized DHCP server and the WAN link between the two sites fails, devices at the branch site will be unable to send DHCP requests or receive DHCP responses.



Note By default, **service dhcp** is enabled on the Cisco IOS device and does not appear in the configuration. Do not disable this service on the branch router because doing so will disable the DHCP relay agent on the device, and the **ip helper-address** configuration command will not work.

- Centralized DHCP Server and Remote Site Cisco IOS DHCP Server

When configuring DHCP for use in a centralized multisite Unified CM deployment, you can use a centralized DHCP server to provide DHCP service to centrally located devices. Remote devices could receive DHCP service from a locally installed server or from the Cisco IOS router at the remote site. This type of deployment ensures that DHCP services are available to remote telephony devices even during WAN failures. [Example 3-1](#) lists the basic Cisco IOS DHCP server configuration commands.

Example 3-1 Cisco IOS DHCP Server Configuration Commands

```
! Activate DHCP Service on the IOS Device

service dhcp

! Specify any IP Address or IP Address Range to be excluded from the DHCP pool

ip dhcp excluded-address <ip-address>|<ip-address-low> <ip-address-high>

! Specify the name of this specific DHCP pool, the subnet and mask for this
! pool, the default gateway and up to four TFTP

ip dhcp pool <dhcp-pool name>
  network <ip-subnet> <mask>
  default-router <default-gateway-ip>
  option 150 ip <tftp-server-ip-1> ...

! Note: IP phones use only the first two addresses supplied in the option 150
! field even if more than two are configured.
```

Unified CM DHCP Sever (Standalone versus Co-Resident DHCP)

Typically DHCP servers are dedicated machine(s) in most network infrastructures, and they run in conjunction with the DNS and/or the Windows Internet Naming Service (WINS) services used by that network. In some instances, given a small Unified CM deployment with no more than 1000 devices registering to the cluster, you may run the DHCP server on a Unified CM server to support those devices. However, to avoid possible resource contention such as CPU contention with other critical services running on Unified CM, Cisco recommends moving the DHCP Server functionality to a dedicated server. If more than 1000 devices are registered to the cluster, DHCP must *not* be run on a Unified CM server but instead must be run on a dedicated or standalone server(s).



Note The term *co-resident* refers to two or more services or applications running on the same server or virtual machine.

Trivial File Transfer Protocol (TFTP)

Within a Cisco Unified CM system, endpoints such as IP phones rely on a TFTP-based process to acquire configuration files, software images, and other endpoint-specific information. The Cisco TFTP service is a file serving system that can run on one or more Unified CM servers. It builds configuration files and serves firmware files, ringer files, device configuration files, and so forth, to endpoints.

The TFTP file systems can hold several file types, such as the following:

- Phone configuration files
- Phone firmware files
- Certificate Trust List (CTL) files
- Identity Trust List (ITL) files
- Tone localization files
- User interface (UI) localization and dictionary files
- Ringer files
- Softkey files
- Dial plan files for SIP phones

The TFTP server manages and serves two types of files, those that are not modifiable (for example, firmware files for phones) and those that can be modified (for example, configuration files).

A typical configuration file contains a prioritized list of Unified CMs for a device (for example, an SCCP or SIP phone), the TCP ports on which the device connects to those Unified CMs, and an executable load identifier. Configuration files for selected devices contain locale information and URLs for the messages, directories, services, and information buttons on the phone.

When a device's configuration changes, the TFTP server rebuilds the configuration files by pulling the relevant information from the Unified CM database. The new file(s) is then downloaded to the phone once the phone has been reset. As an example, if a single phone's configuration file is modified (for example, during Extension Mobility login or logout), only that file is rebuilt and downloaded to the phone. However, if the configuration details of a device pool are changed (for example, if the primary Unified CM server is changed), then all devices in that device pool need to have their configuration files rebuilt and downloaded. For device pools that contain large numbers of devices, this file rebuilding process can impact server performance.



Note

The TFTP server can perform a local database read from the database on its co-resident subscriber server. Local database read not only provides benefits such as the preservation of user-facing features when the publisher is unavailable, but also allows multiple TFTP servers to be distributed by means of clustering over the WAN. (The same latency rules for clustering over the WAN apply to TFTP servers as apply to servers with registered phones.) This configuration brings the TFTP service closer to the endpoints, thus reducing latency and ensuring failure isolation between the sites.

When a device requests a configuration file from the TFTP server, the TFTP server searches for the configuration file in its internal caches, the disk, and then remote Cisco TFTP servers (if specified). If the TFTP server finds the configuration file, it sends it to the device. If the configuration file provides Unified CM names, the device resolves the name by using DNS and opens a connection to the Unified CM. If the device does not receive an IP address or name, it uses the TFTP server name or IP address to attempt a registration connection. If the TFTP server cannot find the configuration file, it sends a "file not found" message to the device.

A device that requests a configuration file while the TFTP server is processing the maximum number of requests, will receive a message from the TFTP server that causes the device to request the configuration file later. The Maximum Serving Count service parameter, which can be configured, specifies the maximum number of requests that can be concurrently handled by the TFTP server. (Default value = 2,500 requests.) Use the default value if the TFTP service is run along with other Cisco CallManager services on the same server. For a dedicated TFTP server, use the following suggested values for the Maximum Serving Count: 2,500 for a single-processor system or 3,000 for a dual-processor system.

The Cisco Unified IP Phones 8900 Series and 9900 Series request their TFTP configuration files over the HTTP protocol (port 6970), which is much faster than TFTP.

An Example of TFTP in Operation

Every time an endpoint reboots, the endpoint will request a configuration file (via TFTP) whose name is based on the requesting endpoint's MAC address. (For a Cisco Unified IP Phone 7961 with MAC address ABCDEF123456, the file name would be SEPABCDEF123456.cnf.xml.) The received configuration file includes the version of software that the phone must run and a list of Cisco Unified CM servers with which the phone should register. The endpoint might also download, via TFTP, ringer files, softkey templates, and other miscellaneous files to acquire the necessary configuration information before becoming operational.

If the configuration file includes software file(s) version numbers that are different than those the phone is currently using, the phone will also download the new software file(s) from the TFTP server to upgrade itself. The number of files an endpoint must download to upgrade its software varies based on the type of endpoint and the differences between the phone's current software and the new software.

TFTP File Transfer Times

Each time an endpoint requests a file, there is a new TFTP transfer session. For centralized call processing deployments, the time to complete each of these transfers will affect the time it takes for an endpoint to start and become operational as well as the time it takes for an endpoint to upgrade during a scheduled maintenance. While TFTP transfer times are not the only factor that can affect these end states, they are a significant component.

The time to complete each file transfer via TFTP is predictable as a function of the file size, the percentage of TFTP packets that must be retransmitted, and the network latency or round-trip time.

At first glance, network bandwidth might seem to be missing from the previous statement, but it is actually included via the percentage of TFTP packets that must be retransmitted. This is because, if there is not enough network bandwidth to support the file transfer(s), then packets will be dropped by the network interface queuing algorithms and will have to be retransmitted.

TFTP operates on top of the User Datagram Protocol (UDP). Unlike Transmission Control Protocol (TCP), UDP is not a reliable protocol, which means that UDP does not inherently have the ability to detect packet loss. Obviously, detecting packet loss in a file transfer is important, so RFC 1350 defines TFTP as a lock-step protocol. In other words, a TFTP sender will send one packet and wait for a response before sending the next packet (see [Figure 3-9](#)).

Figure 3-9 Example of TFTP Packet Transmission Sequence

Round Trip Time = 10ms

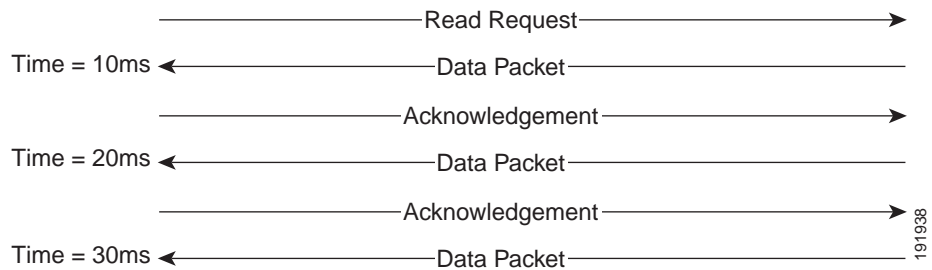

If a response is not received in the timeout period (4 seconds by default), the sender will resend the data packet or acknowledgment. When a packet has been sent five times without a response, the TFTP session fails. Because the timeout period is always the same and not adaptive like a TCP timeout, packet loss can significantly increase the amount of time a transfer session takes to complete.

Because the delay between each data packet is, at a minimum, equal to the network round-trip time, network latency also is a factor in the maximum throughput that a TFTP session can achieve.

In [Figure 3-10](#), the round-trip time has been increased to 40 ms and one packet has been lost in transit. While the error rate is high at 12%, it is easy to see the effect of latency and packet loss on TFTP because the time to complete the session increased from 30 ms (in [Figure 3-9](#)) to 4160 ms (in [Figure 3-10](#)).

Figure 3-10 Effect of Packet Loss on TFTP Session Completion Time

Round Trip Time = 40ms

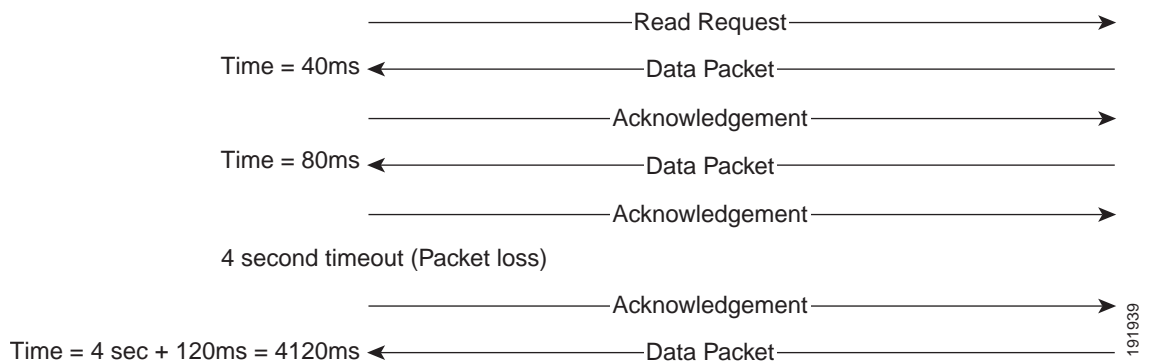

Use the following formula to calculate how long a TFTP file transfer will take to complete:

$$\text{FileTransferTime} = \text{FileSize} * [(\text{RTT} + \text{ERR} * \text{Timeout}) / 512000]$$

Where:

FileTransferTime is in seconds.

FileSize is in bytes.

RTT is the round-trip time in milliseconds.

ERR is the error rate, or percentage of packets that are lost.

Timeout is in milliseconds.

$$512000 = (\text{TFTP packet size}) * (1000 \text{ millisecond per seconds}) = \\ (512 \text{ bytes}) * (1000 \text{ millisecond per seconds})$$

Cisco Unified IP Phone Firmware Releases 7.x have a 10-minute timeout when downloading new files. If the transfer is not completed within this time, the phone will discard the download even if the transfer completes successfully later. If you experience this problem, Cisco recommends that you use a local TFTP server to upgrade phones to the 8.x firmware releases, which have a timeout value of 61 minutes.

Because network latency and packet loss have such an effect on TFTP transfer times, a local TFTP Server can be advantageous. This local TFTP server may be a Unified CM subscriber in a deployment with cluster over the WAN or an alternative local TFTP "Load Server" running on a Cisco Integrated Services Router (ISR), for example. Newer endpoints (which have larger firmware files) can be configured with a Load Server address, which allows the endpoint to download the relatively small configuration files from the central TFTP server but use a local TFTP Server (which is not part of the Unified CM cluster) to download the larger software files. For details on which Cisco Unified IP Phones support an alternative local TFTP Load Server, refer to the product documentation for your particular phone models (available at <http://www.cisco.com>).

**Note**

The exact process each phone goes through on startup and the size of the files downloaded will depend on the phone model, the signaling type configured for the phone (SCCP, MGCP, or SIP) and the previous state of the phone. While there are differences in which files are requested, the general process each phone follows is the same, and in all cases the TFTP server is used to request and deliver the appropriate files. The general recommendations for TFTP server deployment do not change based on the protocol and/or phone models deployed.

TFTP Server Redundancy

Option 150 allows up to two IP addresses to be returned to phones as part of the DHCP scope. The phone tries the first address in the list, and it tries the subsequent address only if it cannot establish communications with the first TFTP server. This address list provides a redundancy mechanism that enables phones to obtain TFTP services from another server even if their primary TFTP server has failed.

TFTP Load Sharing

Cisco recommends that you grant different ordered lists of TFTP servers to different subnets to allow for load balancing. For example:

- In subnet 10.1.1.0/24: Option 150: TFTP1_Primary, TFTP1_Secondary
- In subnet 10.1.2.0/24: Option 150: TFTP1_Secondary, TFTP1_Primary

Under normal operations, a phone in subnet 10.1.1.0/24 will request TFTP services from TFTP1_Primary, while a phone in subnet 10.1.2.0/24 will request TFTP services from TFTP1_Secondary. If TFTP1_Primary fails, then phones from both subnets will request TFTP services from TFTP1_Secondary.

Load balancing avoids having a single TFTP server hot-spot, where all phones from multiple clusters rely on the same server for service. TFTP load balancing is especially important when phone software loads are transferred, such as during a Unified CM upgrade, because more files of larger size are being transferred, thus imposing a bigger load on the TFTP server.

Proxy TFTP

In multi-cluster systems, the proxy TFTP service is able provide TFTP files from multiple clusters via a single primary TFTP server. The proxy TFTP can serve as a single TFTP reference for scenarios where a single subnet or VLAN contains phones from multiple clusters or in any scenario where multiple clusters share the same DHCP TFTP option (150).

The Proxy TFTP service functions as a single-level hierarchy, as illustrated in [Figure 3-11](#). More complicated multi-level hierarchies are not supported.

Figure 3-11 Proxy TFTP Single-Level Hierarchy

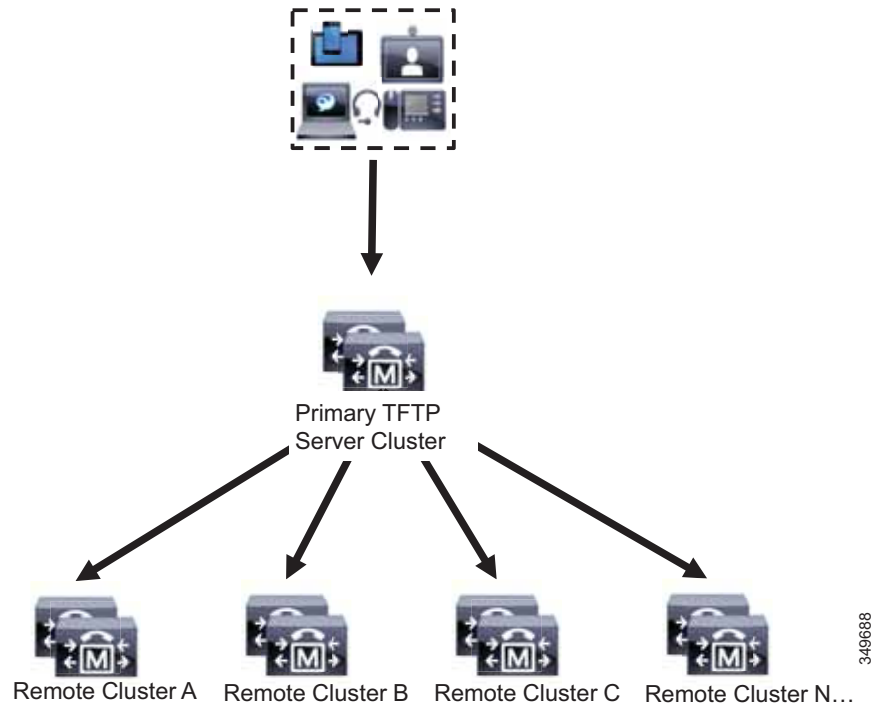

In [Figure 3-11](#) a group of devices contacts the Primary TFTP server for their configuration files. When it receives a request for TFTP from a device, the primary TFTP looks into its own local cache for the configuration file as well as any other remotely configured clusters such as Remote Cluster A, B, C, or N (any other remote clusters configured).

It is possible to configure any number of remote clusters on the primary TFTP server; however, each remote cluster may contain only up to 3 TFTP IP addresses. The recommended design for redundancy is 2 TFTP servers per cluster, and thus 2 IP addresses per remote cluster on the Primary TFTP server for redundancy.

Network Time Protocol (NTP)

NTP allows network devices to synchronize their clocks to a network time server or network-capable clock. NTP is critical for ensuring that all devices in a network have the same time. When troubleshooting or managing a telephony network, it is crucial to synchronize the time stamps within all error and security logs, traces, and system reports on devices throughout the network. This synchronization enables administrators to recreate network activities and behaviors based on a common timeline. Billing records and call detail records (CDRs) also require accurate synchronized time.

Unified CM NTP Time Synchronization

Time synchronization is especially critical on Unified CM servers. In addition to ensuring that CDR records are accurate and that log files are synchronized, having an accurate time source is necessary for any future IPsec features to be enabled within the cluster and for communications with any external entity.

Unified CM automatically synchronizes the NTP time of all subscribers in the cluster to the publisher. During installation, each subscriber is automatically configured to point to an NTP server running on the publisher. The publisher considers itself to be a master server and provides time for the cluster based on its internal hardware clock unless it is configured to synchronize from an external server. Cisco highly recommends configuring the publisher to point to a Stratum-1, Stratum-2, or Stratum-3 NTP server to ensure that the cluster time is synchronized with an external time source.

Using Windows Time Services as an NTP server is not recommended or supported because Windows Time Services often use Simple Network Time Protocol (SNTP), and Cisco Unified CM cannot successfully synchronize with SNTP.

The external NTP server specified for the primary node should be NTP v4 (version 4) to avoid potential compatibility, accuracy, and network jitter problems. External NTP servers *must* be NTP v4 if IPv6 addressing is used.

Cisco IOS and CatOS NTP Time Synchronization

Time synchronization is also important for other devices within the network. Cisco IOS routers and Catalyst switches should be configured to synchronize their time with the rest of the network devices via NTP. This is critical for ensuring that debug, syslog, and console log messages are time-stamped appropriately. Troubleshooting telephony network issues is simplified when a clear timeline can be drawn for events that occur on devices throughout the network.

WAN Infrastructure

Proper WAN infrastructure design is also extremely important for normal Unified Communications operation on a converged network. Proper infrastructure design requires following basic configuration and design best practices for deploying a WAN that is as highly available as possible and that provides guaranteed throughput. Furthermore, proper WAN infrastructure design requires deploying end-to-end QoS on all WAN links. The following sections discuss these requirements:

- [WAN Design and Configuration, page 3-33](#)
- [WAN Quality of Service \(QoS\), page 3-36](#)
- [Bandwidth Provisioning, page 3-51](#)

For more information on bandwidth management, see the chapter on [Bandwidth Management, page 13-1](#).

WAN Design and Configuration

Properly designing a WAN requires building fault-tolerant network links and planning for the possibility that these links might become unavailable. By carefully choosing WAN topologies, provisioning the required bandwidth, and approaching the WAN infrastructure as another layer in the network topology, you can build a fault-tolerant and redundant network. The following sections examine the required infrastructure layers and network services:

- [Deployment Considerations, page 3-33](#)
- [Guaranteed Bandwidth, page 3-34](#)
- [Best-Effort Bandwidth, page 3-35](#)

Deployment Considerations

WAN deployments for voice and video networks may use a hub-and-spoke, fully meshed, or partially meshed topology. A hub-and-spoke topology consists of a central hub site and multiple remote spoke sites connected into the central hub site. In this scenario, each remote or spoke site is one WAN-link hop away from the central or hub site and two WAN-link hops away from all other spoke sites. A meshed topology may contain multiple WAN links and any number of hops between the sites. In this scenario there may be many different paths to the same site or there may be different links used for communication with some sites compared to other sites. The simplest example is three sites, each with a WAN link to the other two sites, forming a triangle. In that case there are two potential paths between each site to each other site.

For more information about centralized and distributed multisite deployment models as well as Multiprotocol Label Switching (MPLS) implications for these deployment models, see the chapter on [Collaboration Deployment Models, page 10-1](#).

WAN links should, when possible, be made redundant to provide higher levels of fault tolerance. Redundant WAN links provided by different service providers or located in different physical ingress/egress points within the network can ensure backup bandwidth and connectivity in the event that a single link fails. In non-failure scenarios, these redundant links may be used to provide additional bandwidth and offer load balancing of traffic on a per-flow basis over multiple paths and equipment within the WAN.

Voice, video, and data should remain converged at the WAN, just as they are converged at the LAN. QoS provisioning and queuing mechanisms are typically available in a WAN environment to ensure that voice, video, and data can interoperate on the same WAN links. Attempts to separate and forward voice, video, and data over different links can be problematic in many instances because the failure of one link typically forces all traffic over a single link, thus diminishing throughput for each type of traffic and in most cases reducing the quality of voice. Furthermore, maintaining separate network links or devices makes troubleshooting and management difficult at best.

Because of the potential for WAN links to fail or to become oversubscribed, Cisco recommends deploying non-centralized resources as appropriate at sites on the other side of the WAN. Specifically, media resources, DHCP servers, voice gateways, and call processing applications such as Survivable Remote Site Telephony (SRST) and Cisco Unified Communications Manager Express (Unified CME) should be deployed at non-central sites when and if appropriate, depending on the site size and how critical these functions are to that site. Keep in mind that de-centralizing voice applications and devices can increase the complexity of network deployments, the complexity of managing these resources throughout the enterprise, and the overall cost of a the network solution; however, these factors can be mitigated by the fact that the resources will be available during a WAN link failure.

When deploying voice in a WAN environment, it is possible to reduce bandwidth consumption by using the lower-bandwidth G.729 codec for any voice calls that will traverse WAN links because this practice will provide bandwidth savings on these lower-speed links. Furthermore, media resources such as MoH can also be configured to use multicast transport mechanism when possible because this practice will provide additional bandwidth savings.

Delay in IP Voice Networks

Recommendation G.114 of the International Telecommunication Union (ITU) states that the one-way delay in a voice network should be less than or equal to 150 milliseconds. It is important to keep this in mind when implementing low-speed WAN links within a network. Topologies, technologies, and physical distance should be considered for WAN links so that one-way delay is kept at or below this 150-millisecond recommendation. Implementing a VoIP network where the one-way delay exceeds 150 milliseconds introduces issues not only with the quality of the voice call but also with call setup and media cut-through times because several call signaling messages need to be exchanged between each device and the call processing application in order to establish the call.

Guaranteed Bandwidth

Because voice is typically deemed a critical network application, it is imperative that bearer and signaling voice traffic always reaches its destination. For this reason, it is important to choose a WAN topology and link type that can provide guaranteed dedicated bandwidth. The following WAN link technologies can provide guaranteed dedicated bandwidth:

- Leased Lines
- Frame Relay
- Asynchronous Transfer Mode (ATM)
- ATM/Frame-Relay Service Interworking
- Multiprotocol Label Switching (MPLS)
- Cisco Voice and Video Enabled IP Security VPN (IPSec V3PN)

These link technologies, when deployed in a dedicated fashion or when deployed in a private network, can provide guaranteed traffic throughput. All of these WAN link technologies can be provisioned at specific speeds or bandwidth sizes. In addition, these link technologies have built-in mechanisms that help guarantee throughput of network traffic even at low link speeds. Features such as traffic shaping, fragmentation and packet interleaving, and committed information rates (CIR) can help ensure that packets are not dropped in the WAN, that all packets are given access at regular intervals to the WAN link, and that enough bandwidth is available for all network traffic attempting to traverse these links.

Dynamic Multipoint VPN (DMVPN)

Spoke-to-spoke DMVPN networks can provide benefits for Cisco Unified Communications compared with hub-and-spoke topologies. Spoke-to-spoke tunnels can provide a reduction in end-to-end latency by reducing the number of WAN hops and decryption/encryption stages. In addition, DMVPN offers a simplified means of configuring the equivalent of a full mesh of point-to-point tunnels without the associated administrative and operational overhead. The use of spoke-to-spoke tunnels also reduces traffic at the hub, thus providing bandwidth and router processing capacity savings. Spoke-to-spoke DMVPN networks, however, are sensitive to the delay variation (jitter) caused during the transition of RTP packets routing from the spoke-hub-spoke path to the spoke-to-spoke path. This variation in delay during the DMVPN path transition occurs very early in the call and is generally unnoticeable, although a single momentary audio distortion might be heard if the latency difference is above 100 ms.

For information on the deployment of multisite DMVPN WANs with centralized call processing, refer to the *Cisco Unified Communications Voice over Spoke-to-Spoke DMVPN Test Results and Recommendations*, available at <http://www.cisco.com/go/designzone>.

Best-Effort Bandwidth

There are some WAN topologies that are unable to provide guaranteed dedicated bandwidth to ensure that network traffic will reach its destination, even when that traffic is critical. These topologies are extremely problematic for voice traffic, not only because they provide no mechanisms to provision guaranteed network throughput, but also because they provide no traffic shaping, packet fragmentation and interleaving, queuing mechanisms, or end-to-end QoS to ensure that critical traffic such as voice will be given preferential treatment.

The following WAN network topologies and link types are examples of this kind of best-effort bandwidth technology:

- The Internet
- DSL
- Cable
- Satellite
- Wireless

In most cases, none of these link types can provide the guaranteed network connectivity and bandwidth required for critical voice and voice applications. However, these technologies might be suitable for personal or telecommuter-type network deployments. At times, these topologies can provide highly available network connectivity and adequate network throughput; but at other times, these topologies can become unavailable for extended periods of time, can be throttled to speeds that render network throughput unacceptable for real-time applications such as voice, or can cause extensive packet losses and require repeated retransmissions. In other words, these links and topologies are unable to provide guaranteed bandwidth, and when traffic is sent on these links, it is sent best-effort with no guarantee that it will reach its destination. For this reason, Cisco recommends that you do *not* use best-effort WAN topologies for voice-enabled networks that require enterprise-class voice services and quality.



Note

There are some new QoS mechanisms for DSL and cable technologies that can provide guaranteed bandwidth; however, these mechanisms are not typically deployed by many service providers. For any service that offers QoS guarantees over networks that are typically based on best-effort, it is important to review and understand the bandwidth and QoS guarantees offered in the service provider's service level agreement (SLA).



Note

Upstream and downstream QoS mechanisms are now supported for wireless networks. For more information on QoS for Voice over Wireless LANs, refer to the *Voice over Wireless LAN Design Guide*, available at http://www.cisco.com/en/US/solutions/ns340/ns414/ns742/ns818/landing_wireless_uc.html.

WAN Quality of Service (QoS)

The case for Quality of Service over the enterprise WAN and VPN is largely self-evident, as these links are often orders of magnitude slower than the (Gigabit or Ten-Gigabit Ethernet) campus or branch LAN links to which they connect. As such, these WAN and VPN edges usually represent the greatest bottlenecks in the network and therefore require the most attention to QoS design.

Two key strategic QoS design principles are highly applicable to WAN/VPN QoS design:

- Enable queuing policies at every node where the potential for congestion exists, which generally equates to attaching a comprehensive queuing policy to every WAN/VPN edge.
- Protect the control plane and data plane by enabling control plane policing (on platforms supporting this feature) as well as data plane policing (scavenger class QoS) to mitigate and constrain network attacks.

To this end, this design section provides best-practice recommendations for enabling QoS over the wide area network. However, it is important to note that the recommendations in this section are not autonomous, but rather, they depend on the campus QoS design recommendations presented in the section on [LAN Quality of Service \(QoS\), page 3-14](#), having already been implemented. Traffic traversing the WAN can thus be assumed to be correctly classified and marked with Layer 3 DSCP (as well as policed at the access-edge, as necessary).

Furthermore, this design section covers fundamental considerations relating to wide area networks. Before strategic QoS designs for the WAN can be derived, a few WAN-specific considerations need to be taken into account, as are discussed below. Further information on bandwidth management in a Collaboration solution can be found in the chapter on [Bandwidth Management, page 13-1](#).

WAN QoS Design Considerations

Several considerations factor into WAN and VPN QoS designs, including:

- [WAN Aggregation Router Platforms, page 3-36](#)
- [Hardware versus Software QoS, page 3-37](#)
- [Latency and Jitter, page 3-37](#)
- [Tx-Ring, page 3-39](#)
- [Class-Based Weighted-Fair Queuing, page 3-40](#)
- [Low-Latency Queuing, page 3-42](#)
- [Weighted-Random Early Detect, page 3-43](#)

Each of these WAN QoS design considerations is discussed in the following sections.

WAN Aggregation Router Platforms

Extending an enterprise campus network over a wide area to interconnect with other campus and/or branch networks usually requires two types of routers to be deployed: WAN aggregation routers and branch routers. WAN aggregation routers serve to connect large campus networks to the WAN/VPN, whereas branch routers serve to connect smaller branch LANs to the WAN/VPN.

Hardware versus Software QoS

Unlike Cisco Catalyst switches utilized within the campus, which perform QoS exclusively in hardware, Cisco routers perform QoS operations in Cisco IOS software, although some platforms (such as the Cisco Catalyst 6500 Series, 7600 Series, and Cisco ASRs) perform QoS in a hybrid mix of software and hardware.

Performing QoS in Cisco IOS software allows for several advantages, including:

- Cross-platform consistency in QoS features

For example, rather than having hardware-specific queuing structures on a per-platform or per-line-card basis (as is the case for Cisco Catalyst switches), standard software queuing features such as Low-Latency Queuing (LLQ) and Class-Based Weighted-Fair Queuing (CBWFQ) can be utilized across WAN and branch router platforms.

- Consistent QoS configuration syntax

The configuration syntax for Cisco IOS QoS, namely the Modular QoS Command Line Interface (MQC) syntax is (with very few exceptions) identical across these WAN and branch router platforms.

- Richer QoS features

Many Cisco IOS QoS features such as Network Based Application Recognition (NBAR) and Hierarchical QoS (HQoS) are not available on most Catalyst hardware platforms.

Latency and Jitter

Some real-time applications have fixed latency budgets; for example, the ITU G.114 specification sets the target for one-way latency for real-time voice/video conversations to be 150 ms. In order to meet such targets, it is important for administrators to understand the components of network latency so they know which factors they can and cannot control with the network and QoS design. Network latency can be divided into fixed and variable components:

- Serialization (fixed)
- Propagation (fixed)
- Queuing (variable)

Serialization refers to the time it takes to convert a Layer 2 frame into Layer 1 electrical or optical pulses onto the transmission media. Therefore, serialization delay is fixed and is a function of the line rate (that is, the clock speed of the link). For example, a (1.544 Mbps) T1 circuit would require about 8 ms to serialize a 1,500 byte Ethernet frame onto the wire, whereas a (9.953 Gbps) OC-192/STM-64 circuit would require just 1.2 microseconds to serialize the same frame.

Usually, the most significant network factor in meeting the latency targets for over the WAN is propagation delay, which can account for over 95% of the network latency time budget. Propagation delay is also a fixed component and is a function of the physical distance that the signals have to travel between the originating endpoint and the receiving endpoint. The gating factor for propagation delay is the speed of light, which is 300,000 km/s or 186,000 miles per second in a vacuum. However, the speed of light in an optical fiber is about one third the speed of light in a vacuum. Thus, the propagation delay for most fiber circuits is approximately 6.3 microseconds per km or 8.2 microseconds per mile.

Another point to keep in mind when calculating propagation delay is that optical fibers are not always physically placed over the shortest path between two geographic points, especially over transoceanic links. Due to installation convenience, circuits may be hundreds or even thousands of miles longer than theoretically necessary.

Nonetheless, the G.114 real-time communications network latency budget of 150 ms allows for nearly 24,000 km or 15,000 miles worth of propagation delay (which is approximately 60% of the earth's circumference). The theoretical worst-case scenario (exactly half of the earth's circumference) would require only 126 ms of latency. Therefore, this latency target is usually achievable for virtually any two locations (via a terrestrial path), given relatively direct transmission paths; however, in some scenarios meeting this latency target might simply not be possible due to the distances involved and the relative directness of their respective transmission paths. In such scenarios, if the G.114 150 ms one-way latency target cannot be met due to the distances involved, administrators should be aware that both the ITU and Cisco Technical Marketing have shown that real-time communication quality does not begin to degrade significantly until one-way latency exceeds 200 ms, as is illustrated in the ITU G.114 graph of real-time speech quality versus absolute delay, which is reproduced in Figure 3-12.

Figure 3-12 ITU G.114 Graph of Real-time Speech Quality versus Latency

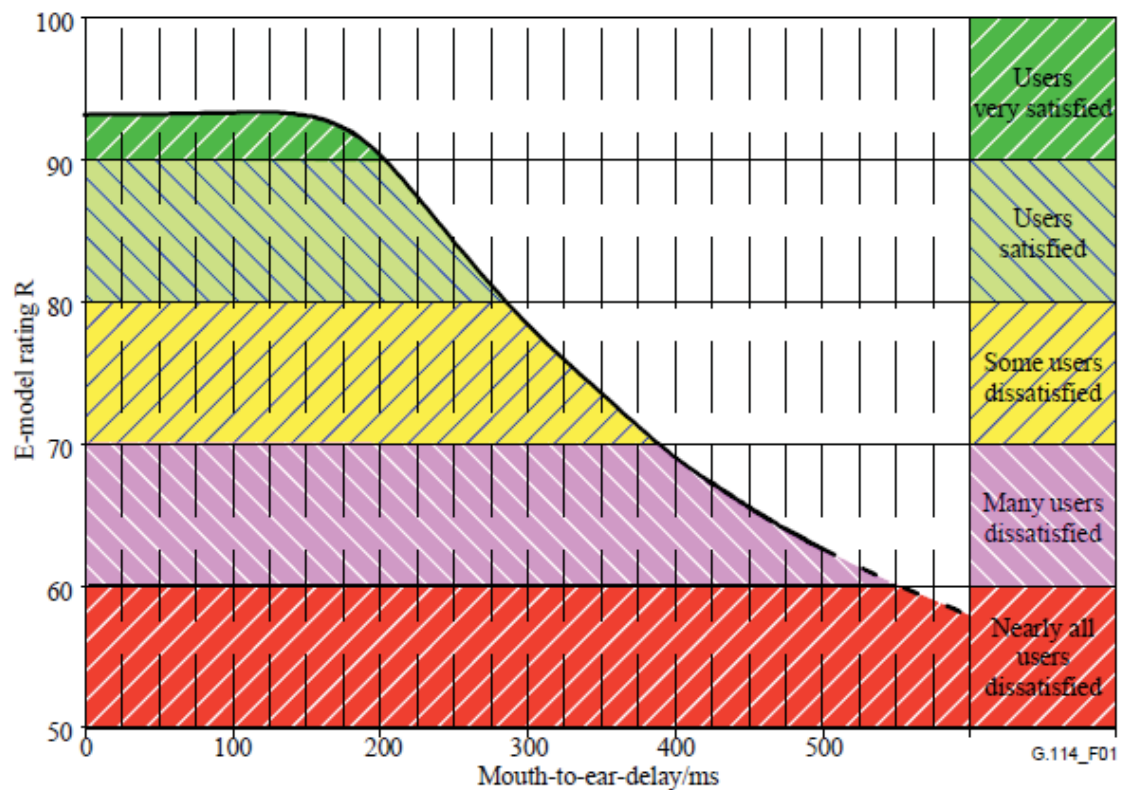

Source: ITU-T Recommendation G.114 (05/2003), available at <http://www.itu.int/rec/T-REC-G.114-200305-I/en>

348825



Note

This discussion so far has focused on WAN circuits over terrestrial paths. For satellite circuits, the expected latency can be in the range of 250 to 900 ms. For example, signals being relayed via geostationary satellites will need to be sent to an altitude of 35,786 km (22,236 miles) above sea level (from the equator) out into space and then back to Earth again. There is nothing an administrator can do

to decrease latency in such scenarios because they can do nothing about increasing the speed of light or radio waves. All that can be done to address the effect of latency in these scenarios is to educate the user-base so that realistic performance expectations are set.

The final network latency component to be considered is queuing delay, which is variable (variable delay is also known as jitter). Queuing delay is a function of whether a network node is congested and, if so, what scheduling policies have been applied to resolve congestion events. Real-time applications are often more sensitive to jitter than latency, because packets need to be received in de-jitter buffers prior to being played out. If a packet is not received within the time allowed by the de-jitter buffer, it is essentially lost and can affect the overall voice or video call quality.

Given that the majority of factors contributing to network latency are fixed, careful attention has to be given to queuing delay, since this is the only latency factor that is directly under the network administrator's control via queuing policies. Therefore, a close examination of the Cisco IOS queuing system, including the Tx-Ring and LLQ/CBWFQ operation, will assist network administrators to optimize these critical policies.

Tx-Ring

The Tx-Ring is the final Cisco IOS output buffer for a WAN interface (a relatively small FIFO queue), and it maximizes physical link bandwidth utilization by matching the outbound packet rate on the router with the physical interface rate. The Tx-Ring is illustrated in Figure 3-13.

Figure 3-13 Cisco IOS Tx-Ring Operation

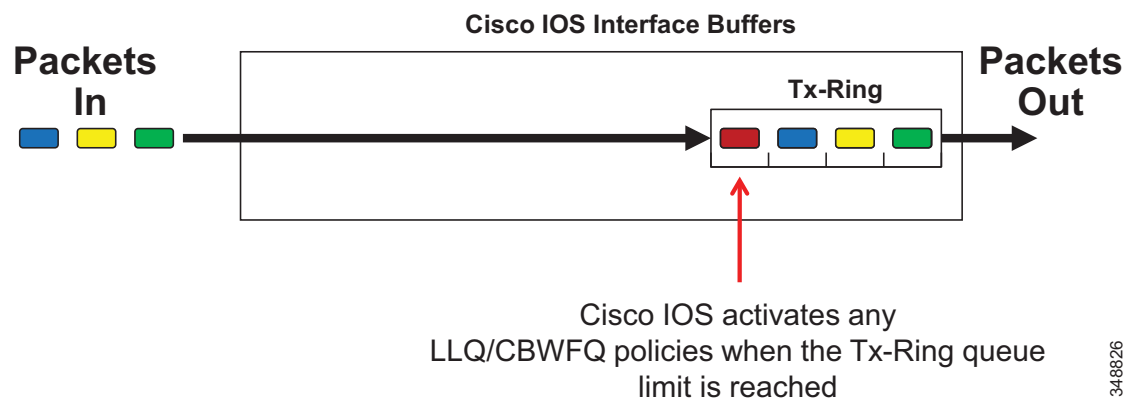

The Tx-Ring also serves to indicate interface congestion to the Cisco IOS software. Prior to interface congestion, packets are sent on a FIFO basis to the interface via the Tx-Ring. However, when the Tx-Ring fills to its queue limit, then it signals to the Cisco IOS software to engage any LLQ or CBWFQ policies that have been attached to the interface. Subsequent packets are then queued within Cisco IOS according to these LLQ and CBWFQ policies, dequeued into the Tx-Ring, and then sent out the interface in a FIFO manner.

The Tx-Ring can be configured on certain platforms with the **tx-ring-limit** interface configuration command. The default value of the Tx-Ring varies according to platform and link type and speed. For further details, refer to *Understanding and Tuning the tx-ring-limit Value*, available at

<http://www.cisco.com/c/en/us/support/docs/asynchronous-transfer-mode-atm/ip-to-atm-class-of-service/6142-txringlimit-6142.html>

Changing the Tx-Ring Default Setting

During Cisco Technical Marketing design validation, it was observed that the default Tx-Ring limit on some interfaces caused somewhat higher jitter values to some real-time application classes, particularly HD video-based real-time applications such as Cisco TelePresence traffic. The reason for this is the bursty nature of HD video traffic. For example, consider a fully-congested T3 WAN link (using a Cisco PA-T3+ port adapter interface) with active LLQ and CBWFQ policies. The default Tx-Ring depth in this case is 64 packets. Even if TelePresence traffic is prioritized via an LLQ, if there are no TelePresence packets to send, the FIFO Tx-Ring is filled with other traffic to a default depth of 64 packets. When a new TelePresence packet arrives, even if it gets priority treatment from the Layer 3 LLQ/CBWFQ queuing system, the packets are dequeued into the FIFO Tx-Ring when space is available. However, with the default settings, there can be as many as 63 packets in the Tx-Ring in front of that TelePresence packet. In such a worst-case scenario it could take as long as 17 ms to transmit these non-real-time packets out of this (45 Mbps) T3 interface. This 17 ms of instantaneous and variable delay (jitter) can affect the video quality for TelePresence to the point of being visually apparent to the end user. However, lowering the value of the Tx-Ring on this link will force in the Cisco IOS software engaging congestion management policies sooner and more often, resulting in lower overall jitter values for real-time applications such as TelePresence.

On the other hand, setting the value of the Tx-Ring too low might result in significantly higher CPU utilization rates because the processor is continually being interrupted to engage queuing policies, even when congestion rates are just momentary bursts and not sustained rates. Thus, when tuning the Tx-Ring, a trade-off setting is required so that jitter is minimized, but not at the expense of excessive CPU utilization rates.

Therefore, explicit attention needs be given to link types and speeds when the Tx-Ring is tuned away from default values.

Class-Based Weighted-Fair Queuing

Class-Based Weighted-Fair Queuing (CBWFQ) is a Cisco IOS queuing algorithm that combines the ability to guarantee bandwidth with the ability to dynamically ensure fairness to other flows within a class of traffic.

The Cisco IOS software engages CBWFQ policies (provided they have been attached to an interface) only if the Tx-Ring for the interface is full, which occurs only in the event of congestion. Once congestion has thus been signaled to the software, each CBWFQ class is assigned its own queue. CBWFQ queues may also have a fair-queuing pre-sorter applied to them, so that multiple flows contending for a single queue are managed fairly. Additionally, each CBWFQ queue is serviced in a Weighted-Round-Robin (WRR) fashion based on the bandwidth assigned to each class. The CBWFQ scheduler then forwards packets to the Tx-Ring. The operation of CBWFQ is illustrated in [Figure 3-14](#).

Figure 3-14 Cisco IOS CBWFQ Operation

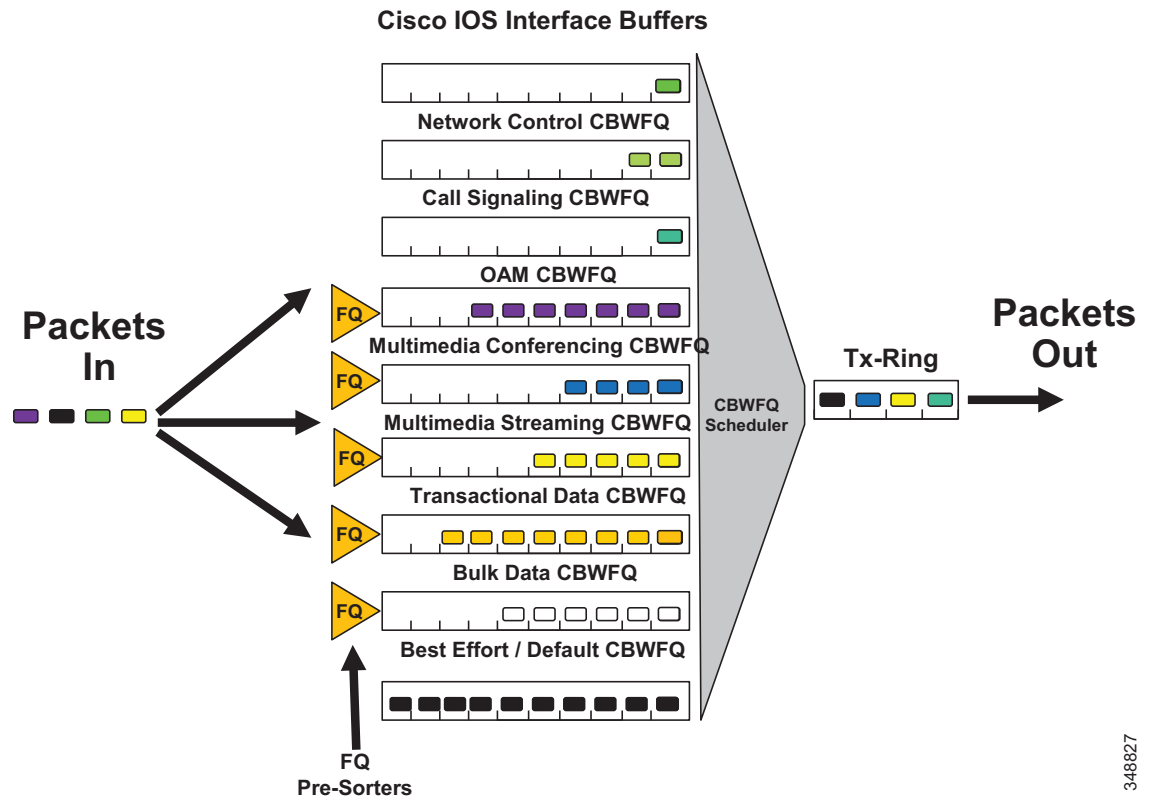

348827

Each CBWFQ class is guaranteed bandwidth via a **bandwidth** policy-map class configuration statement. CBWFQ derives the weight for packets belonging to a class from the bandwidth allocated to the class. CBWFQ then uses the weight to ensure that the queue for the class is serviced fairly, via WRR scheduling.

An important point regarding bandwidth assigned to a given CBWFQ class is that the bandwidth allocated is not a static bandwidth reservation, but rather represents a minimum bandwidth guarantee to the class, provided there are packets offered to the class. If there are no packets offered to the class, then the scheduler services the next queue and can dynamically redistribute unused bandwidth allocations to other queues as necessary.

Additionally, a fair-queuing pre-sorter may be applied to specific CBWFQ queues with the **fair-queue** policy-map class configuration command. It should be noted that this command enables a flow-based fair-queuing pre-sorter, and not a weighted fair-queuing pre-sorter, as the name for this feature implies (and as such, the fair-queuing pre-sorter does not take into account the IP Precedence values of any packets offered to a given class). For example, if a CBWFQ class was assigned 1 Mbps of bandwidth and there were 4 competing traffic flows contending for this class, a fair-queuing pre-sorter would ensure that each flow receives $(1 / (\text{total-number-of-flows}))$ of bandwidth, or in this example $(1/4)$ of 1 Mbps) 250 kbps of bandwidth.

**Note**

Prior to Cisco IOS Release 12.4(20)T, a fair-queue pre-sorter could be applied only to class-default; however, subsequent Cisco IOS releases include the support of the Hierarchical Queuing Framework (HQF) which, among many other QoS feature enhancements, allows for a fair-queue pre-sorter to be applied to any CBWFQ class. HQF details are documented at http://www.cisco.com/c/en/us/td/docs/ios-xml/ios/qos_hrhqf/configuration/15-mt/qos-hrhqf-15-mt-book.html.

The depth of a CBWFQ is defined by its queue limit, which varies according to link speeds and platforms. This queue limit can be modified with the **queue-limit** policy-map class configuration command. In some cases, such as provisioning (bursty) TelePresence traffic in a CBWFQ, it is recommended to increase the queue limit from the default value. This is discussed in more detail in the section on [Weighted-Random Early Detect](#), page 3-43.

Older (pre-HQF and pre-12.4(20)T) versions of Cisco IOS software include a legacy feature that disallows LLQ/CBWFQ policies from being attached to an interface if those policies explicitly allocate more than 75% of the interface's bandwidth to non-default traffic classes. This was intended as a safety feature that would always allow the default class as well as control-traffic classes to receive adequate bandwidth, and it allowed provisioning for Layer 2 bandwidth overhead. This feature can be overridden by applying the **max-reserved-bandwidth** interface command, which takes as a parameter the total percentage of interface bandwidth that can be explicitly provisioned (typically this value is set to 100). However, if this safety feature is overridden, then it is highly recommended that the default class be explicitly assigned no less than 25% of the link's bandwidth.

Low-Latency Queuing

Low-Latency Queuing (LLQ) is essentially CBWFQ combined with a strict priority queue. Basic LLQ operation is illustrated in [Figure 3-15](#).

Figure 3-15 Cisco IOS (Single) LLQ Operation

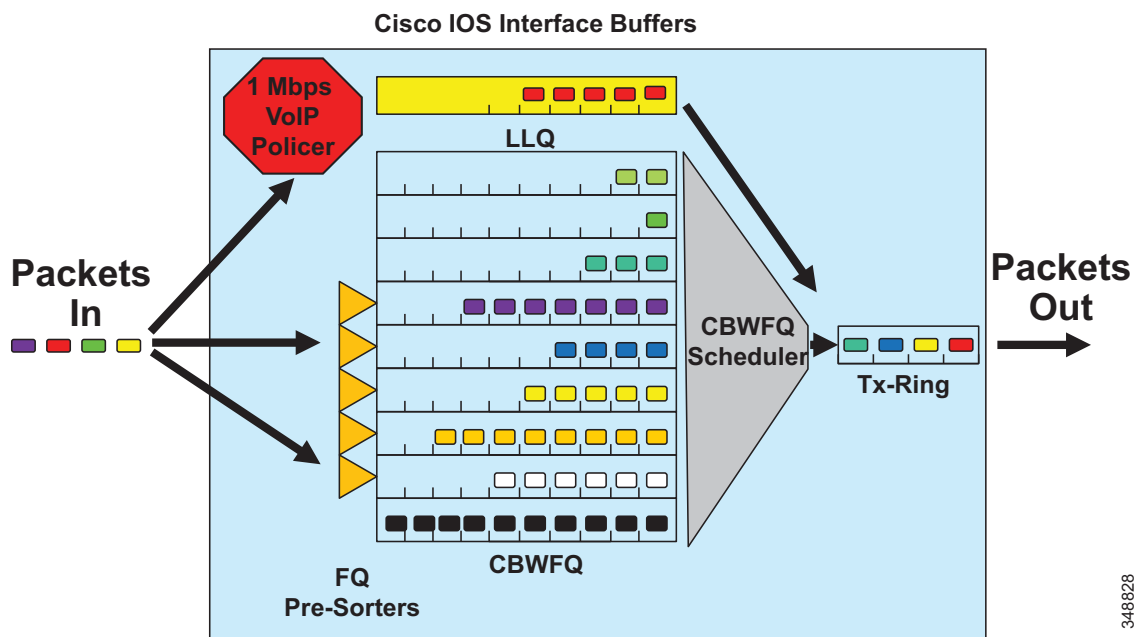

As shown in [Figure 3-15](#), LLQ adds a strict-priority queue to the CBWFQ subsystem. The amount of bandwidth allocated to the LLQ is set by the **priority** policy-map class configuration command. An interesting facet of Cisco IOS LLQ is the inclusion of an implicit policer that admits packets to the strict-priority queue. This implicit policer limits the bandwidth that can be consumed by servicing the real-time queue, and it thus prevents bandwidth starvation of the non-real-time flows serviced by the CBWFQ scheduler. The policing rate for this implicit policer is always set to match the bandwidth allocation of the strict-priority queue. If more traffic is offered to the LLQ class than it has been provisioned to accommodate, then the excess traffic will be dropped by the policer. And like the LLQ/CBWFQ systems, the implicit policer is active only during the event of congestion (as signaled to the Cisco IOS software by means of a full Tx-Ring).

Weighted-Random Early Detect

While congestion management mechanisms such as LLQ/CBWFQ manage the front of the queue, congestion avoidance mechanisms such as Weighted-Random Early Detect (WRED) manage the tail of the queue. Congestion avoidance mechanisms work best with TCP-based applications because selective dropping of packets causes the TCP windowing mechanisms to "throttle-back" and adjust the rate of flows to manageable rates.

The primary congestion avoidance mechanism in Cisco IOS is WRED, which randomly drops packets as queues fill to capacity. However, the randomness of this selection can be skewed by traffic weights. The weight can be IP Precedence (IPP) values, as is the case with default WRED which drops lower IPP values more aggressively (for example, statistically IPP 1 would be dropped more aggressively than IPP 6), or the weights can be AF Drop Precedence values, as is the case with DSCP-based WRED which statistically drops higher AF Drop Precedence values more aggressively (for example, AF43 is dropped more aggressively than AF42, which in turn is dropped more aggressively than AF41). DSCP-based WRED is enabled with the **dscp** keyword in conjunction with the **random-detect** policy-map class configuration command. The operation of DSCP-based WRED is illustrated in [Figure 3-16](#).

Figure 3-16 Cisco IOS DSCP-Based WRED Operation

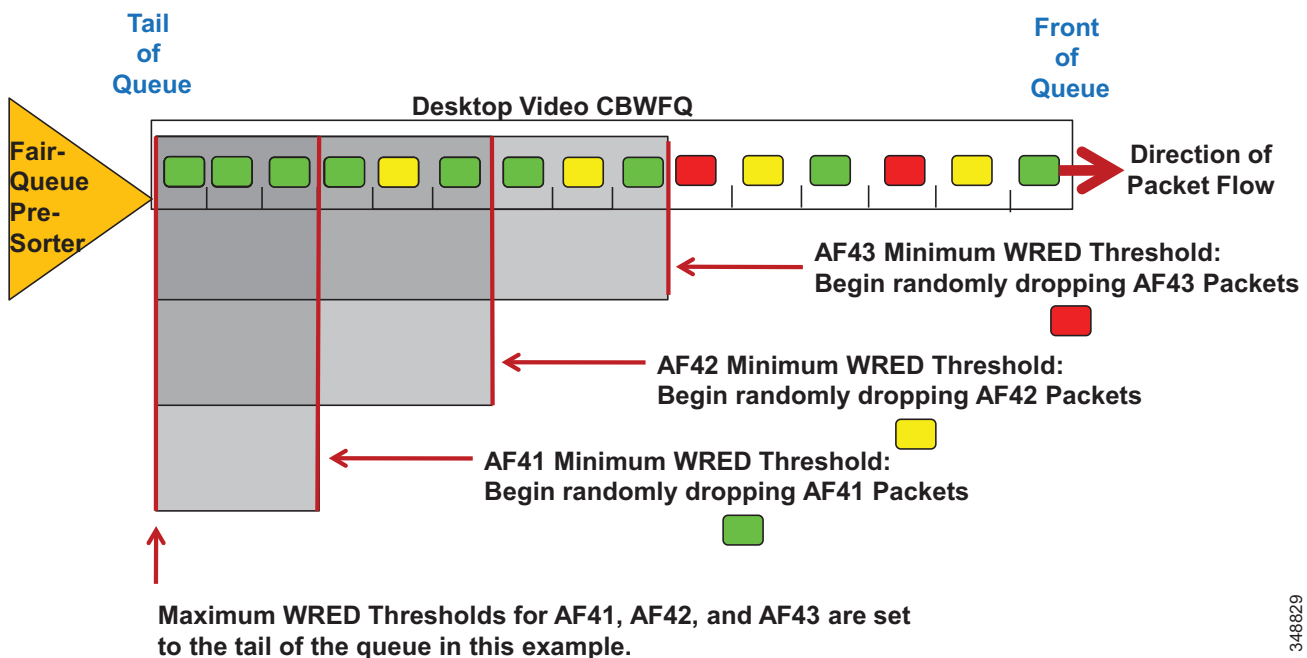

348829

As shown in [Figure 3-16](#), packets marked with a given Drop Precedence (AF43, AF42, or AF41) will begin to be dropped only when the queue fills beyond the minimum WRED threshold for the Drop Precedence value. Packets are always dropped randomly, but their probability of being dropped increases as the queue fills nearer the maximum WRED threshold for the Drop Precedence value. The maximum WRED thresholds are typically set at 100% (the tail of the queue), as shown in [Figure 3-16](#); but the thresholds are configurable, and some advanced administrators may tune these WRED thresholds according to their needs, constraints, and preferences.

Additionally, the WRED thresholds on the AF class may be optimized. By default the minimum WRED thresholds for each AF class are 24, 28, and 32 packets for Drop-Precedence values 3, 2, and 1 respectively. These thresholds represent 60%, 70%, and 80% respectively of the default queue-depth of 64 packets. Also, by default the maximum WRED thresholds are set to 40 packets for all Drop-Precedence values for each AF class. Considering that the default queue-limit or depth is 64 packets, these default settings are inefficient on links experiencing sustained congestion that can cause a queue-depth of 40 packets (at which point all code points will be tail-dropped, despite the queue having the capacity to accommodate another 24 packets). Thus, an administrator may choose to tune these WRED thresholds so that each AF class has a minimum WRED threshold of 40, 45, and 50 packets for Drop-Precedence values 3, 2, and 1 respectively, which represent approximately 60%, 70%, and 80% of the default queue-depth of 64 packets, and/or the administrator may choose to tune the maximum WRED thresholds for each Drop-Precedence value for each AF class to the default queue-depth of 64 packets.

An example design is presented in the chapter on [Bandwidth Management, page 13-1](#).

Considerations for Lower-Speed Links

Before placing voice and video traffic on a network, it is important to ensure that there is adequate bandwidth for all required applications. Once this bandwidth has been provisioned, voice priority queuing must be performed on all interfaces. This queuing is required to reduce jitter and possible packet loss if a burst of traffic oversubscribes a buffer. This queuing requirement is similar to the one for the LAN infrastructure.

Next, the WAN typically requires additional mechanisms such as traffic shaping to ensure that WAN links are not sent more traffic than they can handle, which could cause dropped packets.

Finally, link efficiency techniques can be applied to WAN paths. For example, link fragmentation and interleaving (LFI) can be used to prevent small voice packets from being queued behind large data packets, which could lead to unacceptable delays on low-speed links.

The goal of these QoS mechanisms is to ensure reliable, high-quality voice by reducing delay, packet loss, and jitter for the voice traffic. [Table 3-5](#) lists the QoS features and tools required for the WAN infrastructure to achieve this goal based on the WAN link speed.

Table 3-5 QoS Features and Tools Required to Support Unified Communications for Each WAN Technology and Link Speed

WAN Technology	Link Speed: 56 kbps to 768 kbps	Link Speed: Greater than 768 kbps
Leased Lines	<ul style="list-style-type: none"> • Multilink Point-to-Point Protocol (MLP) • MLP Link Fragmentation and Interleaving (LFI) • Low Latency Queuing (LLQ) • Optional: Compressed Real-Time Transport Protocol (cRTP) 	<ul style="list-style-type: none"> • LLQ
Frame Relay (FR)	<ul style="list-style-type: none"> • Traffic Shaping • LFI (FRF.12) • LLQ • Optional: cRTP • Optional: Voice-Adaptive Traffic Shaping (VATS) • Optional: Voice-Adaptive Fragmentation (VAF) 	<ul style="list-style-type: none"> • Traffic Shaping • LLQ • Optional: VATS
Asynchronous Transfer Mode (ATM)	<ul style="list-style-type: none"> • TX-ring buffer changes • MLP over ATM • MLP LFI • LLQ • Optional: cRTP (requires MLP) 	<ul style="list-style-type: none"> • TX-ring buffer changes • LLQ
Frame Relay and ATM Service Inter-Working (SIW)	<ul style="list-style-type: none"> • TX-ring buffer changes • MLP over ATM and FR • MLP LFI • LLQ • Optional: cRTP (requires MLP) 	<ul style="list-style-type: none"> • TX-ring buffer changes • MLP over ATM and FR • LLQ
Multiprotocol Label Switching (MPLS)	<ul style="list-style-type: none"> • Same as above, according to the interface technology • Class-based marking is generally required to re-mark flows according to service provider specifications 	<ul style="list-style-type: none"> • Same as above, according to the interface technology • Class-based marking is generally required to re-mark flows according to service provider specifications

The following sections highlight some of the most important features and techniques to consider when designing a WAN to support voice, video, and data traffic:

- [Traffic Prioritization, page 3-46](#)
- [Link Efficiency Techniques, page 3-47](#)
- [Traffic Shaping, page 3-49](#)

Traffic Prioritization

In choosing from among the many available prioritization schemes, the major factors to consider include the type of traffic involved and the type of media on the WAN. For multi-service traffic over an IP WAN, Cisco recommends low-latency queuing (LLQ) for all links. This method supports up to 64 traffic classes, with the ability to specify, for example, priority queuing behavior for voice and interactive video, minimum bandwidth class-based weighted fair queuing for voice control traffic, additional minimum bandwidth weighted fair queues for mission critical data, and a default best-effort queue for all other traffic types.

Figure 3-17 shows an example prioritization scheme.

Figure 3-17 Optimized Queuing for VoIP over the WAN

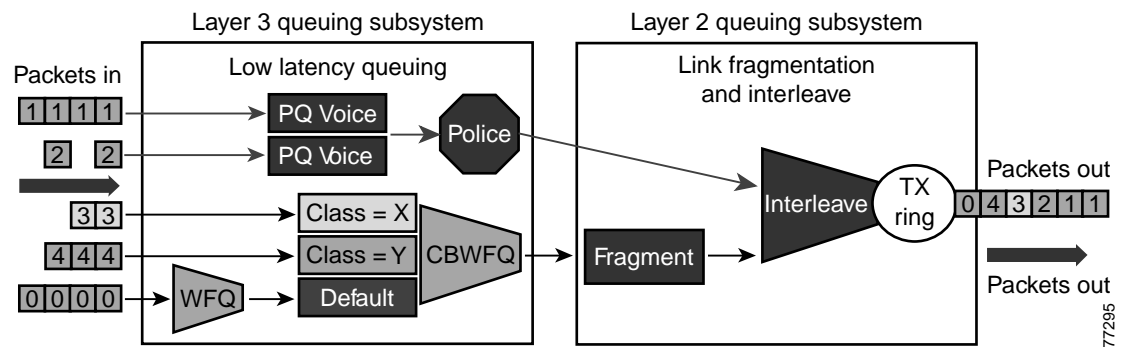

Cisco recommends the following prioritization criteria for LLQ:

- The criterion for *voice* to be placed into a priority queue is a DSCP value of 46 (EF).
- The criterion for *video conferencing* traffic to be placed into a class-based weighted fair queue (CBWFQ) is a DSCP value of 34 (AF41). Due to the larger packet sizes of video traffic, link speeds below 768 Kbps require packet fragmentation, which can happen only when video is placed in a separate CBWFQ. Video in a priority queue (PQ) is not fragmented.
- As the WAN links become congested, it is possible to starve the *voice control* signaling protocols, thereby eliminating the ability of the IP phones to complete calls across the IP WAN. Therefore, voice control protocols, such as H.323, MGCP, and Skinny Client Control Protocol (SCCP), require their own class-based weighted fair queue. The entrance criterion for this queue is a DSCP value of 24 (CS3).
- In some cases, certain data traffic might require better than best-effort treatment. This traffic is referred to as *mission-critical data*, and it is placed into one or more queues that have the required amount of bandwidth. The queuing scheme within this class is first-in-first-out (FIFO) with a minimum allocated bandwidth. Traffic in this class that exceeds the configured bandwidth limit is placed in the default queue. The entrance criterion for this queue could be a Transmission Control Protocol (TCP) port number, a Layer 3 address, or a DSCP/PHB value.
- All remaining enterprise traffic can be placed in a default queue for best-effort treatment. If you specify the keyword **fair**, the queuing algorithm will be weighted fair queuing (WFQ).

Scavenger Class

The Scavenger class is intended to provide less than best-effort services to certain applications. Applications assigned to this class have little or no contribution to the organizational objectives of the enterprise and are typically entertainment oriented in nature. Assigning Scavenger traffic to a minimal bandwidth queue forces it to be squelched to virtually nothing during periods of congestion, but it allows it to be available if bandwidth is not being used for business purposes, such as might occur during off-peak hours.

- Scavenger traffic should be marked as DSCP CS1.
- Scavenger traffic should be assigned the lowest configurable queuing service. For instance, in Cisco IOS, this means assigning a CBWFQ of 1% to Scavenger class.

Link Efficiency Techniques

The following link efficiency techniques improve the quality and efficiency of low-speed WAN links.

Compressed Real-Time Transport Protocol (cRTP)

You can increase link efficiency by using Compressed Real-Time Transport Protocol (cRTP). This protocol compresses a 40-byte IP, User Datagram Protocol (UDP), and RTP header into approximately two to four bytes. cRTP operates on a per-hop basis. Use cRTP on a particular link only if that link meets *all* of the following conditions:

- Voice traffic represents more than 33% of the load on the specific link.
- The link uses a low bit-rate codec (such as G.729).
- No other real-time application (such as video conferencing) is using the same link.

If the link fails to meet any one of the preceding conditions, then cRTP is not effective and you should not use it on that link. Another important parameter to consider before using cRTP is router CPU utilization, which is adversely affected by compression and decompression operations.

cRTP on ATM and Frame Relay Service Inter-Working (SIW) links requires the use of Multilink Point-to-Point Protocol (MLP).

Note that cRTP compression occurs as the final step before a packet leaves the egress interface; that is, after LLQ class-based queueing has occurred. Beginning in Cisco IOS Release 12.(2)2T and later, cRTP provides a feedback mechanism to the LLQ class-based queueing mechanism that allows the bandwidth in the *voice* class to be configured based on the compressed packet value. With Cisco IOS releases prior to 12.(2)2T, this mechanism is not in place, so the LLQ is unaware of the compressed bandwidth and, therefore, the *voice* class bandwidth has to be provisioned as if no compression is taking place. [Table 3-6](#) shows an example of the difference in *voice* class bandwidth configuration given a 512-kbps link with G.729 codec and a requirement for 10 calls.

Note that [Table 3-6](#) assumes 24 kbps for non-cRTP G.729 calls and 10 kbps for cRTP G.729 calls. These bandwidth numbers are based on voice payload and IP/UDP/RTP headers only. They do not take into consideration Layer 2 header bandwidth. However, actual bandwidth provisioning should also include Layer 2 header bandwidth based on the type WAN link used.

Table 3-6 LLQ Voice Class Bandwidth Requirements for 10 Calls with 512 kbps Link Bandwidth and G.729 Codec

Cisco IOS Release	With cRTP Not Configured	With cRTP Configured
Prior to 12.2(2)T	240 kbps	240 kbps ¹
12.2(2)T or later	240 kbps	100 kbps

1. 140 kbps of unnecessary bandwidth must be configured in the LLQ *voice* class.

It should also be noted that, beginning in Cisco IOS Release 12.2(13)T, cRTP can be configured as part of the voice class with the Class-Based cRTP feature. This option allows cRTP to be specified within a class, attached to an interface via a service policy. This new feature provides compression statistics and bandwidth status via the **show policy interface** command, which can be very helpful in determining the offered rate on an interface service policy class given the fact that cRTP is compressing the IP/RTP headers.

For additional recommendations about using cRTP with a Voice and Video Enabled IPsec VPN (V3PN), refer to the V3PN documentation available at

http://www.cisco.com/en/US/solutions/ns340/ns414/ns742/ns817/landing_voice_video.html

Link Fragmentation and Interleaving (LFI)

For low-speed links (less than 768 kbps), use of link fragmentation and interleaving (LFI) mechanisms is required for acceptable voice quality. This technique limits jitter by preventing voice traffic from being delayed behind large data frames, as illustrated in [Figure 3-18](#). The two techniques that exist for this purpose are Multilink Point-to-Point Protocol (MLP) LFI (for Leased Lines, ATM, and SIW) and FRF.12 for Frame Relay.

Figure 3-18 Link Fragmentation and Interleaving (LFI)

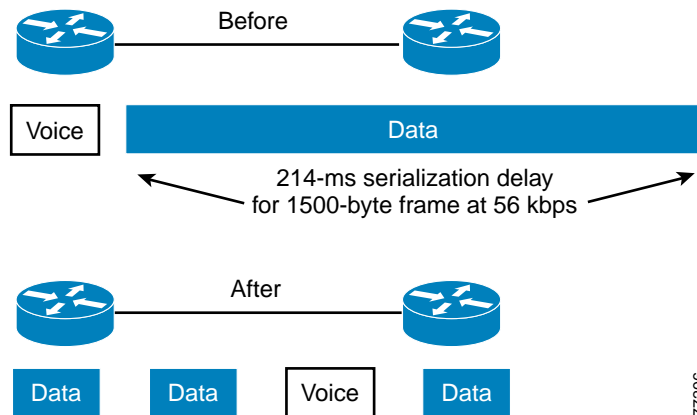

Voice-Adaptive Fragmentation (VAF)

In addition to the LFI mechanisms mentioned above, voice-adaptive fragmentation (VAF) is another LFI mechanism for Frame Relay links. VAF uses FRF.12 Frame Relay LFI; however, once configured, fragmentation occurs only when traffic is present in the LLQ priority queue or when H.323 signaling packets are detected on the interface. This method ensures that, when voice traffic is being sent on the

WAN interface, large packets are fragmented and interleaved. However, when voice traffic is not present on the WAN link, traffic is forwarded across the link unfragmented, thus reducing the overhead required for fragmentation.

VAF is typically used in combination with voice-adaptive traffic shaping (see [Voice-Adaptive Traffic Shaping \(VATS\)](#), page 3-50). VAF is an optional LFI tool, and you should exercise care when enabling it because there is a slight delay between the time when voice activity is detected and the time when the LFI mechanism engages. In addition, a configurable deactivation timer (default of 30 seconds) must expire after the last voice packet is detected and before VAF is deactivated, so during that time LFI will occur unnecessarily. VAF is available in Cisco IOS Release 12.2(15)T and later.

Traffic Shaping

Traffic shaping is required for multiple-access, non-broadcast media such as ATM and Frame Relay, where the physical access speed varies between two endpoints and several branch sites are typically aggregated to a single router interface at the central site.

[Figure 3-19](#) illustrates the main reasons why traffic shaping is needed when transporting voice and data on the same IP WAN.

Figure 3-19 Traffic Shaping with Frame Relay and ATM

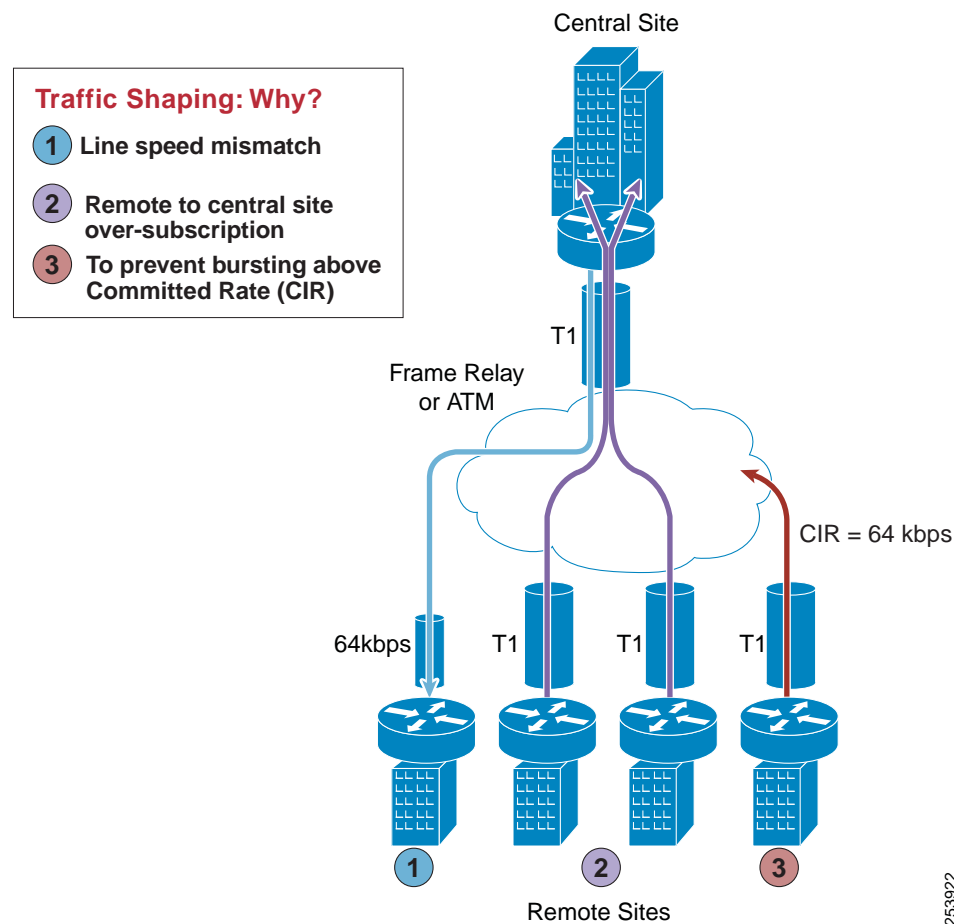

Figure 3-19 shows three different scenarios:

1. Line speed mismatch

While the central-site interface is typically a high-speed one (such as T1 or higher), smaller remote branch interfaces may have significantly lower line speeds, such as 64 kbps. If data is sent at full rate from the central site to a slow-speed remote site, the interface at the remote site might become congested, resulting in dropped packets which causes a degradation in voice quality.

2. Oversubscription of the link between the central site and the remote sites

It is common practice in Frame Relay or ATM networks to oversubscribe bandwidth when aggregating many remote sites to a single central site. For example, there may be multiple remote sites that connect to the WAN with a T1 interface, yet the central site has only a single T1 interface. While this configuration allows the deployment to benefit from statistical multiplexing, the router interface at the central site can become congested during traffic bursts, thus degrading voice quality.

3. Bursting above Committed Information Rate (CIR)

Another common configuration is to allow traffic bursts above the CIR, which represents the rate that the service provider has guaranteed to transport across its network with no loss and low delay. For example, a remote site with a T1 interface might have a CIR of only 64 kbps. When more than 64 kbps worth of traffic is sent across the WAN, the provider marks the additional traffic as "discard eligible." If congestion occurs in the provider network, this traffic will be dropped with no regard to traffic classification, possibly having a negative effect on voice quality.

Traffic shaping provides a solution to these issues by limiting the traffic sent out an interface to a rate lower than the line rate, thus ensuring that no congestion occurs on either end of the WAN. Figure 3-20 illustrates this mechanism with a generic example, where R is the rate with traffic shaping applied.

Figure 3-20 Traffic Shaping Mechanism

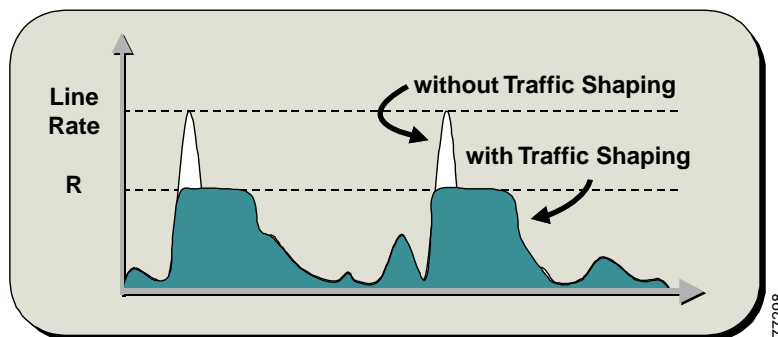

Voice-Adaptive Traffic Shaping (VATS)

VATS is an optional dynamic mechanism that shapes traffic on Frame Relay permanent virtual circuits (PVCs) at different rates based on whether voice is being sent across the WAN. The presence of traffic in the LLQ voice priority queue or the detection of H.323 signaling on the link causes VATS to engage. Typically, Frame Relay shapes traffic to the guaranteed bandwidth or CIR of the PVC at all times. However, because these PVCs are typically allowed to burst above the CIR (up to line speed), traffic shaping keeps traffic from using the additional bandwidth that might be present in the WAN. With VATS enabled on Frame Relay PVCs, WAN interfaces are able to send at CIR when voice traffic is present on the link. However, when voice is not present, non-voice traffic is able to burst up to line speed and take advantage of the additional bandwidth that might be present in the WAN.

When VATS is used in combination with voice-adaptive fragmentation (VAF) (see [Link Fragmentation and Interleaving \(LFI\)](#), page 3-48), all non-voice traffic is fragmented and all traffic is shaped to the CIR of the WAN link when voice activity is detected on the interface.

As with VAF, exercise care when enabling VATS because activation can have an adverse effect on non-voice traffic. When voice is present on the link, data applications will experience decreased throughput because they are throttled back to well below CIR. This behavior will likely result in packet drops and delays for non-voice traffic. Furthermore, after voice traffic is no longer detected, the deactivation timer (default of 30 seconds) must expire before traffic can burst back to line speed. It is important, when using VATS, to set end-user expectations and make them aware that data applications will experience slowdowns on a regular basis due to the presence of voice calls across the WAN. VATS is available in Cisco IOS Release 12.2(15)T and later.

For more information on the Voice-Adaptive Traffic Shaping and Fragmentation features and how to configure them, refer to the documentation at

http://www.cisco.com/c/en/us/td/docs/ios-xml/ios/wan_frly/configuration/15-mt/wan-frly-15-mt-book.html

Bandwidth Provisioning

Properly provisioning the network bandwidth is a major component of designing a successful IP network. You can calculate the required bandwidth by adding the bandwidth requirements for each major application (for example, voice, video, and data). This sum then represents the minimum bandwidth requirement for any given link, and it should not exceed approximately 75% of the total available bandwidth for the link. This 75% rule assumes that some bandwidth is required for overhead traffic, such as routing and Layer 2 keep-alives. [Figure 3-21](#) illustrates this bandwidth provisioning process.

Figure 3-21 Link Bandwidth Provisioning

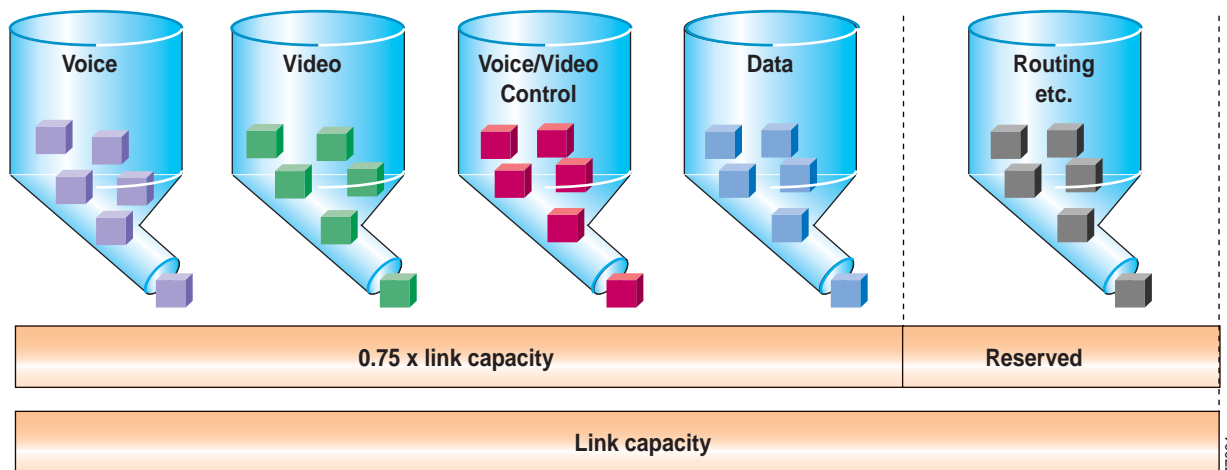

In addition to using no more than 75% of the total available bandwidth for data, voice, and video, the total bandwidth configured for all LLQ priority queues should typically not exceed 33% of the total link bandwidth. Provisioning more than 33% of the available bandwidth for the priority queue can be problematic for a number of reasons. First, provisioning more than 33% of the bandwidth for voice can result in increased CPU usage. Because each voice call will send 50 packets per second (with 20 ms samples), provisioning for large numbers of calls in the priority queue can lead to high CPU levels due to high packet rates. In addition, if more than one type of traffic is provisioned in the priority queue (for

example, voice and video), this configuration defeats the purpose of enabling QoS because the priority queue essentially becomes a first-in, first-out (FIFO) queue. A larger percentage of reserved priority bandwidth effectively dampens the QoS effects by making more of the link bandwidth FIFO. Finally, allocating more than 33% of the available bandwidth can effectively starve any data queues that are provisioned. Obviously, for very slow links (less than 192 kbps), the recommendation to provision no more than 33% of the link bandwidth for the priority queue(s) might be unrealistic because a single call could require more than 33% of the link bandwidth. In these situations, and in situations where specific business needs cannot be met while holding to this recommendation, it may be necessary to exceed the 33% rule.

From a traffic standpoint, an IP telephony call consists of two parts:

- The voice and video bearer streams, which consists of Real-Time Transport Protocol (RTP) packets that contain the actual voice samples.
- The call control signaling, which consists of packets belonging to one of several protocols, according to the endpoints involved in the call (for example, H.323, MGCP, SCCP, or (J)TAPI). Call control functions are, for instance, those used to set up, maintain, tear down, or redirect a call.

Bandwidth provisioning should include not only the bearer traffic but also the call control traffic. In fact, in multisite WAN deployments, the call control traffic (as well as the bearer traffic) must traverse the WAN, and failure to allocate sufficient bandwidth for it can adversely affect the user experience.

The next three sub-sections describe the bandwidth provisioning recommendations for the following types of traffic:

- Voice and video bearer traffic in all multisite WAN deployments (see [Provisioning for Bearer Traffic, page 3-52](#))
- Call control traffic in multisite WAN deployments with centralized call processing (see [Provisioning for Call Control Traffic with Centralized Call Processing, page 3-56](#))
- Call control traffic in multisite WAN deployments with distributed call processing (see [Provisioning for Call Control Traffic with Distributed Call Processing, page 3-60](#))

Provisioning for Bearer Traffic

The section describes bandwidth provisioning for the following types of traffic:

- [Voice Bearer Traffic, page 3-52](#)
- [Video Bearer Traffic, page 3-55](#)

Voice Bearer Traffic

As illustrated in [Figure 3-22](#), a voice-over-IP (VoIP) packet consists of the voice payload, IP header, User Datagram Protocol (UDP) header, Real-Time Transport Protocol (RTP) header, and Layer 2 Link header. When Secure Real-Time Transport Protocol (SRTP) encryption is used, the voice payload for each packet is increased by 4 bytes. The link header varies in size according to the Layer 2 media used.

Figure 3-22 Typical VoIP Packet

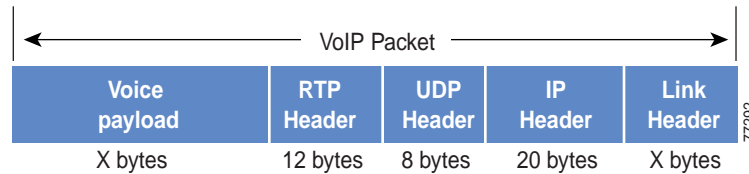

The bandwidth consumed by VoIP streams is calculated by adding the packet payload and all headers (in bits), then multiplying by the packet rate per second, as follows:

$$\text{Layer 2 bandwidth in kbps} = [(\text{Packets per second}) * (X \text{ bytes for voice payload} + 40 \text{ bytes for RTP/UDP/IP headers} + Y \text{ bytes for Layer 2 overhead}) * 8 \text{ bits}] / 1000$$

$$\text{Layer 3 bandwidth in kbps} = [(\text{Packets per second}) * (X \text{ bytes for voice payload} + 40 \text{ bytes for RTP/UDP/IP headers}) * 8 \text{ bits}] / 1000$$

$$\text{Packets per second} = [1/(\text{sampling rate in msec})] * 1000$$

$$\text{Voice payload in bytes} = [(\text{codec bit rate in kbps}) * (\text{sampling rate in msec})] / 8$$

Table 3-7 details the Layer 3 bandwidth per VoIP flow. Table 3-7 lists the bandwidth consumed by the voice payload and IP header only, at a default packet rate of 50 packets per second (pps) and at a rate of 33.3 pps for both non-encrypted and encrypted payloads. Table 3-7 does not include Layer 2 header overhead and does not take into account any possible compression schemes, such as compressed Real-Time Transport Protocol (cRTP). You can use the Service Parameters menu in Unified CM Administration to adjust the codec sampling rate.

Table 3-7 Bandwidth Consumption for Voice Payload and IP Header Only

CODEC	Sampling Rate	Voice Payload in Bytes	Packets per Second	Bandwidth per Conversation
G.711 and G.722-64k	20 ms	160	50.0	80.0 kbps
G.711 and G.722-64k (SRTP)	20 ms	164	50.0	81.6 kbps
G.711 and G.722-64k	30 ms	240	33.3	74.7 kbps
G.711 and G.722-64k (SRTP)	30 ms	244	33.3	75.8 kbps
iLBC	20 ms	38	50.0	31.2 kbps
iLBC (SRTP)	20 ms	42	50.0	32.8 kbps
iLBC	30 ms	50	33.3	24.0 kbps
iLBC (SRTP)	30 ms	54	33.3	25.1 kbps
G.729A	20 ms	20	50.0	24.0 kbps
G.729A (SRTP)	20 ms	24	50.0	25.6 kbps
G.729A	30 ms	30	33.3	18.7 kbps
G.729A (SRTP)	30 ms	34	33.3	19.8 kbps

A more accurate method for provisioning is to include the Layer 2 headers in the bandwidth calculations. Table 3-8 lists the amount of bandwidth consumed by voice traffic when the Layer 2 headers are included in the calculations.

Table 3-8 Bandwidth Consumption with Layer 2 Headers Included

CODEC	Header Type and Size						
	Ethernet 14 Bytes	PPP 6 Bytes	ATM 53-Byte Cells with a 48-Byte Payload	Frame Relay 4 Bytes	MLPPP 10 Bytes	MPLS 4 Bytes	WLAN 24 Bytes
G.711 and G.722-64k at 50.0 pps	85.6 kbps	82.4 kbps	106.0 kbps	81.6 kbps	84.0 kbps	81.6 kbps	89.6 kbps
G.711 and G.722-64k (SRTP) at 50.0 pps	87.2 kbps	84.0 kbps	106.0 kbps	83.2 kbps	85.6 kbps	83.2 kbps	N/A
G.711 and G.722-64k at 33.3 pps	78.4 kbps	76.3 kbps	84.8 kbps	75.7 kbps	77.3 kbps	75.7 kbps	81.1 kbps
G.711 and G.722-64k (SRTP) at 33.3 pps	79.5 kbps	77.4 kbps	84.8 kbps	76.8 kbps	78.4 kbps	76.8 kbps	N/A
iLBC at 50.0 pps	36.8 kbps	33.6 kbps	42.4 kbps	32.8 kbps	35.2 kbps	32.8 kbps	40.8 kbps
iLBC (SRTP) at 50.0 pps	38.4 kbps	35.2 kbps	42.4 kbps	34.4 kbps	36.8 kbps	34.4 kbps	42.4 kbps
iLBC at 33.3 pps	27.7 kbps	25.6 kbps	28.3 kbps	25.0 kbps	26.6 kbps	25.0 kbps	30.4 kbps
iLBC (SRTP) at 33.3 pps	28.8 kbps	26.6 kbps	42.4 kbps	26.1 kbps	27.7 kbps	26.1 kbps	31.5 kbps
G.729A at 50.0 pps	29.6 kbps	26.4 kbps	42.4 kbps	25.6 kbps	28.0 kbps	25.6 kbps	33.6 kbps
G.729A (SRTP) at 50.0 pps	31.2 kbps	28.0 kbps	42.4 kbps	27.2 kbps	29.6 kbps	27.2 kbps	35.2 kbps
G.729A at 33.3 pps	22.4 kbps	20.3 kbps	28.3 kbps	19.7 kbps	21.3 kbps	19.8 kbps	25.1 kbps
G729A (SRTP) at 33.3 pps	23.5 kbps	21.4 kbps	28.3 kbps	20.8 kbps	22.4 kbps	20.8 kbps	26.2 kbps

While it is possible to configure the sampling rate above 30 ms, doing so usually results in very poor voice quality. As illustrated in [Figure 3-23](#), as sampling size increases, the number of packets per second decreases, resulting in a smaller impact to the CPU of the device. Likewise, as the sample size increases, IP header overhead is lower because the payload per packet is larger. However, as sample size increases, so does packetization delay, resulting in higher end-to-end delay for voice traffic. The trade-off between packetization delay and packets per second must be considered when configuring sample size. While this trade-off is optimized at 20 ms, 30 ms sample sizes still provide a reasonable ratio of delay to packets per second; however, with 40 ms sample sizes, the packetization delay becomes too high.

Figure 3-23 Voice Sample Size: Packets per Second vs. Packetization Delay

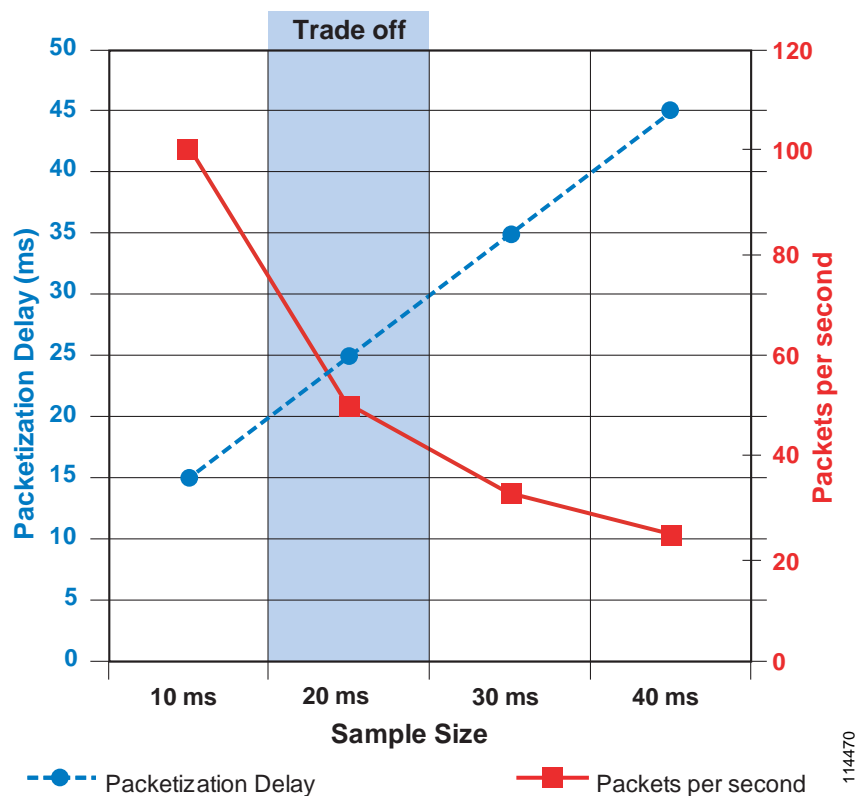

Video Bearer Traffic

For audio, it is relatively easy to calculate a percentage of overhead per packet given the sample size of each packet. For video, however, it is nearly impossible to calculate an exact percentage of overhead because the payload varies depending upon how much motion is present in the video (that is, how many pixels changed since the last frame).

To resolve this inability to calculate the exact overhead ratio for video, Cisco recommends that you add 20% to the call speed regardless of which type of Layer-2 medium the packets are traversing. The additional 20% gives plenty of headroom to allow for the differences between Ethernet, ATM, Frame Relay, PPP, HDLC, and other transport protocols, as well as some cushion for the bursty nature of video traffic.

Note that the call speed requested by the endpoint (for example, 128 kbps, 256 kbps, and so forth) represents the maximum burst speed of the call, with some additional amount for a cushion. The average speed of the call is typically much less than these values.

Provisioning for Call Control Traffic

When Unified Communications endpoints are separated from their call control application by a WAN, or when two interconnected Unified Communications systems are separated by a WAN, consideration must be given to the amount of bandwidth that must be provisioned for call control and signaling traffic between these endpoints and systems. This section discusses WAN bandwidth provisioning for call signaling traffic where centralized or distributed call processing models are deployed. For more information on Unified Communications centralized and distributed call processing deployment models, see [Collaboration Deployment Models, page 10-1](#).

Provisioning for Call Control Traffic with Centralized Call Processing

In a centralized call processing deployment, the Unified CM cluster and the applications (such as voicemail) are located at the central site, while several remote sites are connected through an IP WAN. The remote sites rely on the centralized Unified CMs to handle their call processing.

The following considerations apply to this deployment model:

- Each time a remote branch phone places a call, the control traffic traverses the IP WAN to reach the Unified CM at the central site, even if the call is local to the branch.
- The signaling protocols that may traverse the IP WAN in this deployment model are SCCP (encrypted and non-encrypted), SIP (encrypted and non-encrypted), H.323, MGCP, and CTI-QBE. All the control traffic is exchanged between a Unified CM at the central site and endpoints or gateways at the remote branches.

As a consequence, you must provision bandwidth for control traffic that traverses the WAN between the branch routers and the WAN aggregation router at the central site.

The control traffic that traverses the WAN in this scenario can be split into two categories:

- Quiescent traffic, which consists of keep-alive messages periodically exchanged between the branch endpoints (phones and gateways) and Unified CM, regardless of call activity. This traffic is a function of the quantity of endpoints.
- Call-related traffic, which consists of signaling messages exchanged between the branch endpoints and the Unified CM at the central site when a call needs to be set up, torn down, forwarded, and so forth. This traffic is a function of the quantity of endpoints and their associated call volume.

To obtain an estimate of the generated call control traffic, it is necessary to make some assumptions regarding the average number of calls per hour made by each branch IP phone. In the interest of simplicity, the calculations in this section assume an average of 10 calls per hour per phone.



Note

If this average number does not satisfy the needs of your specific deployment, you can calculate the recommended bandwidth by using the advanced formulas provided in [Advanced Formulas, page 3-58](#).

Given the assumptions made, and initially considering the case of a remote branch with no signaling encryption configured, the recommended bandwidth needed for call control traffic can be obtained from the following formula:

Equation 1A: Recommended Bandwidth Needed for SCCP Control Traffic without Signaling Encryption.

$$\text{Bandwidth (bps)} = 265 * (\text{Number of IP phones and gateways in the branch})$$

Equation 1B: Recommended Bandwidth Needed for SIP Control Traffic without Signaling Encryption.

$$\text{Bandwidth (bps)} = 538 * (\text{Number of IP phones and gateways in the branch})$$

If a site features a mix of SCCP and SIP endpoints, the two equations above should be employed separately for the quantity of each type of phone used, and the results added.

Equation 1 and all other formulas within this section include a 25% over-provisioning factor. Control traffic has a bursty nature, with peaks of high activity followed by periods of low activity. For this reason, assigning just the minimum bandwidth required to a control traffic queue can result in undesired effects such as buffering delays and, potentially, packet drops during periods of high activity. The default queue depth for a Class-Based Weighted Fair Queuing (CBWFQ) queue in Cisco IOS equals 64 packets. The bandwidth assigned to this queue determines its servicing rate. Assuming that the bandwidth configured is the average bandwidth consumed by this type of traffic, it is clear that, during the periods of high activity, the servicing rate will not be sufficient to "drain" all the incoming packets out of the queue, thus causing them to be buffered. Note that, if the 64-packet limit is reached, any subsequent packets are either assigned to the best-effort queue or are dropped. It is therefore advisable to introduce this 25% over-provisioning factor to absorb and smooth the variations in the traffic pattern and to minimize the risk of a temporary buffer overrun. This is equivalent to increasing the servicing rate of the queue.

If encryption is configured, the recommended bandwidth is affected because encryption increases the size of signaling packets exchanged between Unified CM and the endpoints. The following formula takes into account the impact of signaling encryption:

Equation 2A: Recommended Bandwidth Needed for SCCP Control Traffic with Signaling Encryption.

Bandwidth with signaling encryption (bps) = 415 * (Number of IP phones and gateways in the branch)

Equation 2B: Recommended Bandwidth Needed for SIP Control Traffic with Signaling Encryption.

Bandwidth with signaling encryption (bps) = 619 * (Number of IP phones and gateways in the branch)

If we now take into account the fact that the smallest bandwidth that can be assigned to a queue on a Cisco IOS router is 8 kbps, we can summarize the values of minimum and recommended bandwidth for various branch office sizes, as shown in [Table 3-9](#).

Table 3-9 Recommended Layer 3 Bandwidth for Call Control Traffic With and Without Signaling Encryption

Branch Office Size (Number of IP Phones and Gateways)	Recommended Bandwidth for SCCP Control Traffic (no encryption)	Recommended Bandwidth for SCCP Control Traffic (with encryption)	Recommended Bandwidth for SIP Control Traffic (no encryption)	Recommended Bandwidth for SIP Control Traffic (with encryption)
1 to 10	8 kbps	8 kbps	8 kbps	8 kbps
20	8 kbps	9 kbps	11 kbps	12 kbps
30	8 kbps	13 kbps	16 kbps	19 kbps
40	11 kbps	17 kbps	22 kbps	25 kbps
50	14 kbps	21 kbps	27 kbps	31 kbps
100	27 kbps	42 kbps	54 kbps	62 kbps
150	40 kbps	62 kbps	81 kbps	93 kbps

Advanced Formulas

The previous formulas presented in this section assume an average call rate per phone of 10 calls per hour. However, this rate might not correspond to your deployment if the call patterns are significantly different (for example, with call center agents at the branches). To calculate call control bandwidth requirements in these cases, use the following formulas, which contain an additional variable (CH) that represents the average calls per hour per phone:

Equation 3A: Recommended Bandwidth Needed for SCCP Control Traffic for a Branch with No Signaling Encryption.

$$\text{Bandwidth (bps)} = (53 + 21 * \text{CH}) * (\text{Number of IP phones and gateways in the branch})$$

Equation 3B: Recommended Bandwidth Needed for SIP Control Traffic for a Branch with No Signaling Encryption.

$$\text{Bandwidth (bps)} = (138 + 40 * \text{CH}) * (\text{Number of IP phones and gateways in the branch})$$

Equation 4A: Recommended Bandwidth Needed for SCCP Control Traffic for a Remote Branch with Signaling Encryption.

$$\text{Bandwidth with signaling encryption (bps)} = (73.5 + 33.9 * \text{CH}) * (\text{Number of IP phones and gateways in the branch})$$

Equation 4B: Recommended Bandwidth Needed for SIP Control Traffic for a Remote Branch with Signaling Encryption.

$$\text{Bandwidth with signaling encryption (bps)} = (159 + 46 * \text{CH}) * (\text{Number of IP phones and gateways in the branch})$$



Note

Equations 3A and 4A are based on the default SCCP keep-alive period of 30 seconds, while equations 3B and 4B are based on the default SIP keep-alive period of 120 seconds.

Considerations for Shared Line Appearances

Calls placed to shared line appearances, or calls sent to line groups using the Broadcast distribution algorithm, have two net effects on the bandwidth consumed by the system:

- Because all the phones on which the line is configured ring simultaneously, they represent a load on the system corresponding to a much higher calls-per-hour (CH) value than the CH of the line. The corresponding bandwidth consumption is therefore increased. The network infrastructure's bandwidth provisioning requires adjustments when WAN-connected shared line functionality is deployed. The CH value employed for Equations 3 and 4 must be increased according to the following formula:

$$\text{CHS} = \text{CHL} * (\text{Number line appearances}) / (\text{Number of lines})$$

Where CHS is the shared-line calls per hour to be used in Equations 3 and 4, and CHL is the calls-per-hour rating of the line. For example, if a site is configured with 5 lines making an average of 6 calls per hour but 2 of those lines are shared across 4 different phones, then:

$$\text{Number of lines} = 5$$

$$\text{Number of line appearances} = (2 \text{ lines appear on } 4 \text{ phones, and } 3 \text{ lines appear on only one phone}) = (2 * 4) + 3 = 11 \text{ line appearances}$$

$$\text{CHL} = 6$$

$$\text{CHS} = 6 * (11 / 5) = 13.2$$

- Because each of the ringing phones requires a separate signaling control stream, the quantity of packets sent from Unified CM to the same branch is increased in linear proportion to the quantity of phones ringing. Because Unified CM is attached to the network through an interface that supports 100 Mbps or more, it can instantaneously generate a very large quantity of packets that must be buffered while the queuing mechanism is servicing the signaling traffic. The servicing speed is limited by the WAN interface's effective information transfer speed, which is typically two orders of magnitude smaller than 100 Mbps.

This traffic may overwhelm the queue depth of the central site's WAN router. By default, the queue depth available for each of the classes of traffic in Cisco IOS is 64. In order to prevent any packets from being dropped before they are queued for the WAN interface, you must ensure that the signaling queue's depth is sized to hold all the packets from at least one full shared-line event for each shared-line phone. Avoiding drops is paramount in ensuring that the call does not create a race condition where dropped packets are retransmitted, causing system response times to suffer.

Therefore, the quantity of packets required to operate shared-line phones is as follows:

- SCCP protocol: 13 packets per shared-line phone
- SIP protocol: 11 packets per shared-line phone

For example, with SCCP and with 6 phones sharing the same line, the queue depth for the signaling class of traffic must be adjusted to a minimum of 78. [Table 3-10](#) provides recommended queue depths based on the quantity of shared line appearances within a branch site.

Table 3-10 Recommended Queue Depth per Branch Site

Number of Shared Line Appearances	Queue Depth (Packets)	
	SCCP	SIP
5	65	55
10	130	110
15	195	165
20	260	220
25	325	275

When using a Layer 2 WAN technology such as Frame Relay, this adjustment must be made on the circuit corresponding to the branch where the shared-line phones are located.

When using a Layer 3 WAN technology such as MPLS, there may be a single signaling queue servicing multiple branches. In this case, adjustment must be made for the total of all branches serviced.

Provisioning for Call Control Traffic with Distributed Call Processing

In distributed call processing deployments, Unified CM Clusters, each following either the single-site model or the centralized call processing model, are connected through an IP WAN. The signaling protocol used to place a call across the WAN is SIP (H.323 trunks are no longer recommended between Unified CM clusters). This SIP protocol control traffic that traverses the WAN belongs to signaling traffic associated with a media stream, exchanged over an intercluster trunk when a call needs to be set up, torn down, forwarded, and so on.

Because the total amount of control traffic depends on the number of calls that are set up and torn down at any given time, it is necessary to make some assumptions about the call patterns and the link utilization. Using a traditional telephony analogy, we can view the portion of the WAN link that has been provisioned for voice and video as a number of *virtual tie lines* and derive the protocol signaling traffic associated with the virtual tie lines.

Assuming an average call duration of 2 minutes and 100 percent utilization of each virtual tie line, we can derive that each tie line carries a volume of 30 calls per hour. This assumption allows us to obtain the following formula that expresses the recommended bandwidth for call control traffic as a function of the number of virtual tie lines.

Equation 6: Recommended Bandwidth Based on Number of Virtual Tie Lines.

$$\text{Recommended Bandwidth (bps)} = 116 * (\text{Number of virtual tie lines})$$

If we take into account the fact that 8 kbps is the smallest bandwidth that can be assigned to a queue on a Cisco IOS router, we can deduce that a minimum queue size of 8 kbps can accommodate the call control traffic generated by up to 70 virtual tie lines or 2,100 calls per hour. This amount of 8 kbps for SIP signaling traffic between clusters should be sufficient for most large enterprise deployments.

Wireless LAN Infrastructure

Wireless LAN infrastructure design becomes important when collaboration endpoints are added to the wireless LAN (WLAN) portions of a converged network. With the introduction of Cisco Unified Wireless endpoints, voice and video traffic has moved onto the WLAN and is now converged with the existing data traffic there. Just as with wired LAN and wired WAN infrastructure, the addition of voice and video in the WLAN requires following basic configuration and design best-practices for deploying a highly available network. In addition, proper WLAN infrastructure design requires understanding and deploying QoS on the wireless network to ensure end-to-end voice and video quality on the entire network. The following sections discuss these requirements:

- [Architecture for Voice and Video over WLAN, page 3-61](#)
- [High Availability for Voice and Video over WLAN, page 3-65](#)
- [Capacity Planning for Voice and Video over WLAN, page 3-67](#)
- [Design Considerations for Voice and Video over WLAN, page 3-67](#)

For more information about voice and video over wireless LANs, refer to the *Real-Time Traffic over Wireless LAN Solution Reference Network Design Guide*, available at

http://www.cisco.com/en/US/docs/solutions/Enterprise/Mobility/RTtoWLAN/CCVP_BK_R7805F2_0_00_rowlan-srnd.html

Architecture for Voice and Video over WLAN

IP telephony architecture has used wired devices since its inception, but enterprise users have long sought the ability to communicate while moving through the company premises. Wireless IP networks have enabled IP telephony to deliver enterprise mobility by providing on-premises roaming communications to the users with wireless IP telephony devices.

Wireless IP telephony and wireless IP video telephony are extensions of their wired counterparts, which leverage the same call elements. Additionally, wireless IP telephony and IP video telephony take advantage of wireless 802.11-enabled media, thus providing a cordless IP voice and video experience. The cordless experience is achieved by leveraging the wireless network infrastructure elements for the transmission and reception of the control and media packets.

The architecture for voice and video over wireless LAN includes the following basic elements, illustrated in [Figure 3-24](#):

- [Wireless Access Points, page 3-62](#)
- [Wireless LAN Controllers, page 3-63](#)
- [Authentication Database, page 3-63](#)
- [Supporting Wired Network, page 3-63](#)
- [Wireless Collaboration Endpoints, page 3-64](#)
- [Wired Call Elements, page 3-64](#)

Figure 3-24 Basic Layout for a Voice and Video Wireless Network

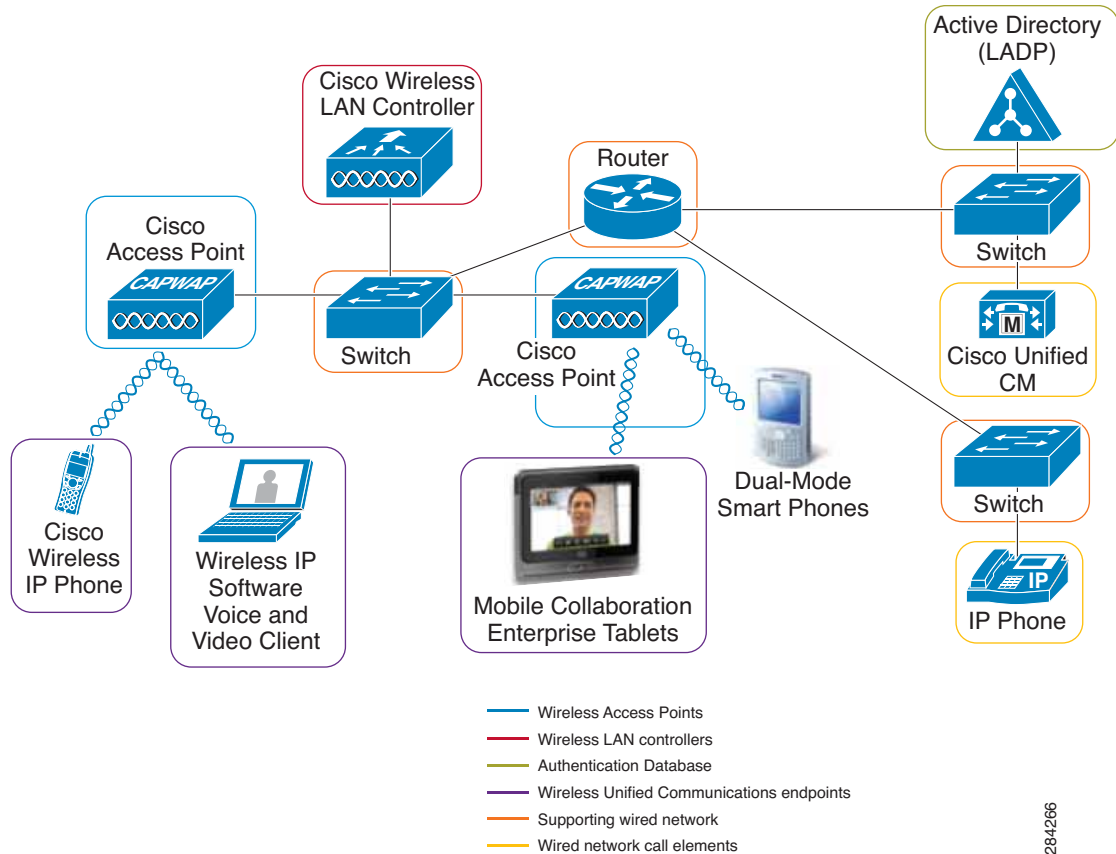

284266

Wireless Access Points

The wireless access points enable wireless devices (Unified Communications endpoints in the case of voice and video over WLAN) to communicate with wired network elements. Access points function as adapters between the wired and wireless world, creating an entry-way between these two media. Cisco access points can be managed by a wireless LAN controller (WLC) or they can function in autonomous mode. When the access points are managed by a WLC they are referred as Lightweight Access Points, and in this mode they use the Lightweight Access Point Protocol (LWAPP) or Control and Provisioning of Wireless Access Points (CAPWAP) protocol, depending on the controller version, when communicating with the WLC.

Figure 3-25 illustrates the basic relationship between lightweight access points and WLCs. Although the example depicted in Figure 3-25 is for a CAPWAP WLC, from the traffic flow and relationship perspective there are no discernible differences between CAPWAP and LWAPP, so the example also applies to wireless LWAPP networks. Some advantages of leveraging WLCs and lightweight access points for the wireless infrastructure include ease of management, dynamic network tuning, and high availability. However, if you are using the managed mode instead of the autonomous mode in the access points, you need to consider the network tunneling effect of the LWAPP-WLC communication architecture when designing your solution. This network tunneling effect is discussed in more depth in the section on [Wireless LAN Controller Design Considerations](#), page 3-72.

Figure 3-25 Lightweight Access Point

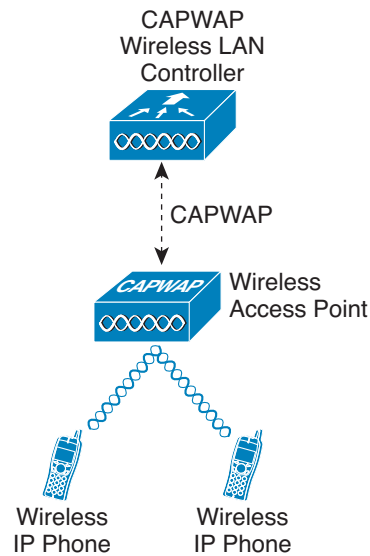

Wireless LAN Controllers

Many corporate environments require deployment of wireless networks on a large scale. The wireless LAN controller (WLC) is a device that assumes a central role in the wireless network and helps to make it easier to manage such large-scale deployments. Traditional roles of access points, such as association or authentication of wireless clients, are done by the WLC. Access points, called Lightweight Access Points (LWAPs) in the Unified Communications environment, register themselves with a WLC and tunnel all the management and data packets to the WLCs, which then switch the packets between wireless clients and the wired portion of the network. All the configurations are done on the WLC. LWAPs download the entire configuration from WLCs and act as a wireless interface to the clients.

Authentication Database

The authentication database is a core component of the wireless networks, and it holds the credentials of the users to be authenticated while the wireless association is in progress. The authentication database provides the network administrators with a centralized repository to validate the credentials. Network administrators simply add the wireless network users to the authentication database instead of having to add the users to all the wireless access points with which the wireless devices might associate.

In a typical wireless authentication scenario, the WLC couples with the authentication database to allow the wireless association to proceed or fail. Authentication databases commonly used are LDAP and RADIUS, although under some scenarios the WLC can also store a small user database locally that can be used for authentication purposes.

Supporting Wired Network

The supporting wired network is the portion of the system that serves as a path between WLCs, APs, and wired call elements. Because the APs need or might need to communicate to the wired world, part of the wired network has to enable those communications. The supporting wired network consists of the switches, routers, and wired medium (WAN links and optical links) that work together to communicate with the various components that form the architecture for voice and video over WLAN.

Wireless Collaboration Endpoints

The wireless collaboration endpoints are the components of the architecture for voice and video over WLAN that users employ to communicate with each other. These endpoints can be voice-only or enabled for both voice and video. When end users employ the wireless communications endpoints to call a desired destination, the endpoints in turn forward the request to their associated call processing server. If the call is allowed, the endpoints process the voice or video, encode it, and send it to the receiving device or the next hop of processing. Typical Cisco wireless endpoints are wireless IP phones, voice and video software clients running on desktop computers, mobile smart phones connected through wireless media, and mobile collaboration enterprise tablets.

Wired Call Elements

Whether the wireless collaboration endpoints initiate a session between each other or with wired endpoints, wired call elements are involved in some way. Wired call elements (gateways and call processing entities) are the supporting infrastructure, with voice and video endpoints coupled to that infrastructure.

Wired call elements are needed typically to address two requirements:

- [Call Control, page 3-64](#)
- [Media Termination, page 3-64](#)

Call Control

Cisco wireless endpoints require a call control or call processing server to route calls efficiently and to provide a feature-rich experience for the end users. The call processing entity resides somewhere in the wired network, either in the LAN or across a WAN.

Call control for the Cisco wireless endpoints is achieved through a call control protocol, either SIP or SCCP.

Media Termination

Media termination on wired endpoints occurs when the end users of the wireless endpoints communicate with IP phones, PSTN users, or video endpoints. Voice gateways, IP phones, video terminals, PBX trunks, and transcoders all serve as termination points for media when a user communicates through them. This media termination occurs by means of coding and decoding of the voice or video session for the user communication.

High Availability for Voice and Video over WLAN

Providing high availability in collaboration solutions is a critical requirement for meeting the modern demands of continuous connectivity. Collaboration deployments designed for high availability increase reliability and up time. Using real-time applications such as voice or video over WLAN without high availability could have very adverse effects on the end user experience, including an inability to make voice or video calls.

Designing a solution for voice and video over WLAN with high availability requires focusing of the following main areas:

- [Supporting Wired Network High Availability, page 3-65](#)
- [WLAN High Availability, page 3-65](#)
- [Call Processing High Availability, page 3-67](#)

Supporting Wired Network High Availability

When deploying voice and video over WLAN, the same high-availability strategies used in wired networks can be applied to the wired components of the solution for voice and video over WLAN. For example, you can optimize layer convergence in the network to minimize disruption and take advantage of equal-cost redundant paths.

See [LAN Design for High Availability, page 3-4](#), for further information about how to design highly available wired networks.

WLAN High Availability

A unique aspect of high availability for voice and video over WLAN is high availability of radio frequency (RF) coverage to provide Wi-Fi channel coverage that is not dependent upon a single WLAN radio. The Wi-Fi channel coverage is provided by the AP radios in the 2.4 GHz and 5 GHz frequency bands. The primary mechanism for providing RF high availability is cell boundary overlap. In general, a cell boundary overlap of 20% to 30% on non-adjacent channels is recommended to provide high availability in the wireless network. For mission-critical environments there should be at least two APs visible at the required signal level (-67 dBm or better). An overlap of 20% means that the RF cells of APs using non-adjacent channels overlap each other on 20% of their coverage area, while the remaining 80% of the coverage area is handled by a single AP. [Figure 3-26](#) depicts a 20% overlap of AP non-adjacent channel cells to provide high availability. Furthermore, when determining the locations for installing the APs, avoid mounting them on reflective surfaces (such as metal, glass, and so forth), which could cause multi-path effects that result in signal distortion.

Figure 3-26 Non-Adjacent Channel Access Point Overlap

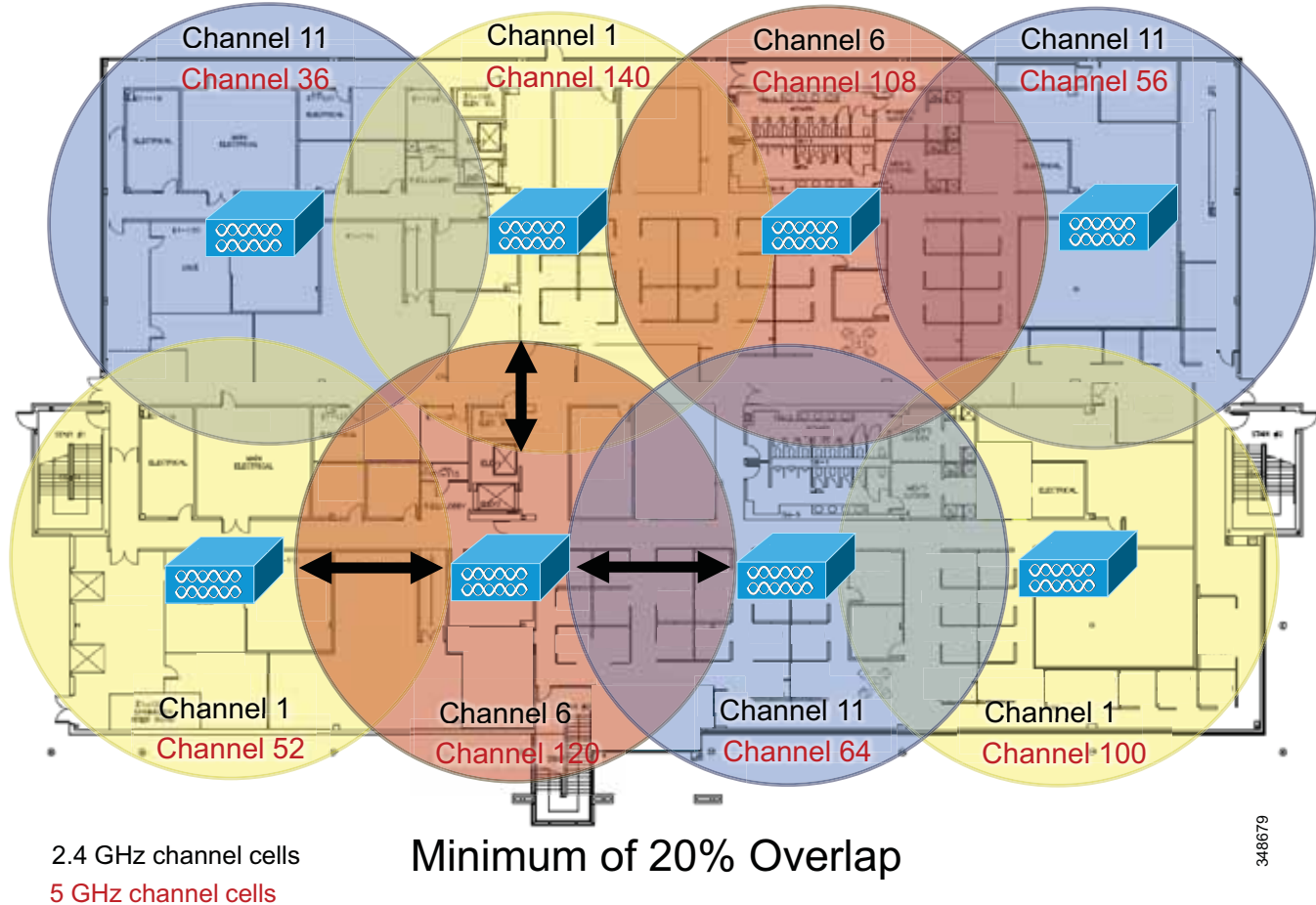

Careful deployment of APs and channel configuration within the wireless infrastructure are imperative for proper wireless network operation. For this reason, Cisco requires customers to conduct a complete and thorough site survey before deploying wireless networks in a production environment. The survey should include verifying non-overlapping channel configurations, Wi-Fi channel coverage, and required data and traffic rates; eliminating rogue APs; and identifying and mitigating the impact of potential interference sources.

Additionally, evaluate utilizing a 5 GHz frequency band, which is generally less crowded and thus usually less prone to interference. If Bluetooth is used then 5 GHz 802.11a is highly recommended. Similarly, the usage of Cisco CleanAir technology will increase the WLAN reliability by detecting radio frequency interference in real time and providing a self-healing and self-optimizing wireless network. For further information about Cisco CleanAir technology, refer to the product documentation available at

<http://www.cisco.com/en/US/netsol/ns1070/index.html>

For further information on how to provide high availability in a WLAN that supports rich media, refer to the *Real-Time Traffic over Wireless LAN Solution Reference Network Design Guide*, available at

http://www.cisco.com/en/US/docs/solutions/Enterprise/Mobility/RToWLAN/CCVP_BK_R7805F2_0_00_rowlan-srnd.html

Call Processing High Availability

For information regarding call processing resiliency, see [High Availability for Call Processing](#), page 9-13.

Capacity Planning for Voice and Video over WLAN

A crucial piece in planning for voice and video over WLAN is adequately sizing the solution for the desired call capacity. Capacity is defined as the number of simultaneous voice and video sessions over WLAN that can be supported in a given area. Capacity can vary depending upon the RF environment, the collaboration endpoint features, and the WLAN system features. For instance, a solution using Cisco Unified Wireless IP Phones 7925G on a WLAN that provides optimized WLAN services (such as the Cisco Unified Wireless Network) would have a maximum call capacity of 27 simultaneous sessions per channel at a data rate of 24 Mbps or higher for both 802.11a and 802.11g. On the other hand, a similar solution with a wireless device such as a tablet making video calls at 720p and a video rate of 2,500 kbps on a WLAN, where access points are configured as 802.11a/n with a data rate index of Modulation and Coding Scheme 7 in 40 MHz channels, would have a maximum capacity of 7 video calls (two bidirectional voice and video streams) per channel.

To achieve these capacities, there must be minimal wireless LAN background traffic and radio frequency (RF) utilization, and Bluetooth must be disabled in the devices. It is also important to understand that call capacities are established per non-overlapping channel because the limiting factor is the channel capacity and not the number of access points (APs).

The call capacity specified by the actual wireless endpoint should be used for deployment purposes because it is the supported capacity of that endpoint. For capacity information about the wireless endpoints, refer to the product documentation for your specific endpoint models:

<http://www.cisco.com/c/en/us/products/collaboration-endpoints/product-listing.html>

For further information about calculating call capacity in a WLAN, refer to the *Real-Time Traffic over Wireless LAN Solution Reference Network Design Guide*, available at

http://www.cisco.com/en/US/docs/solutions/Enterprise/Mobility/RToWLAN/CCVP_BK_R7805F2_0_00_rtowlan-srnd.html

Design Considerations for Voice and Video over WLAN

This section provides additional design considerations for deploying collaboration endpoints over WLAN solutions. WLAN configuration specifics can vary depending on the voice or video WLAN devices being used and the WLAN design. The following sections provide general guidelines and best practices for designing the WLAN infrastructure:

- [VLANs](#), page 3-68
- [Roaming](#), page 3-68
- [Wireless Channels](#), page 3-68
- [Wireless Interference and Multipath Distortion](#), page 3-69
- [Multicast on the WLAN](#), page 3-70
- [Wireless AP Configuration and Design](#), page 3-71
- [Wireless LAN Controller Design Considerations](#), page 3-72
- [WAN Quality of Service \(QoS\)](#), page 3-36

VLANs

Just as with a wired LAN infrastructure, when deploying voice or video in a wireless LAN, you should enable at least two virtual LANs (VLANs) at the Access Layer. The Access Layer in a wireless LAN environment includes the access point (AP) and the first-hop access switch. On the AP and access switch, you should configure both a native VLAN for data traffic and a voice VLAN (under Cisco IOS) or Auxiliary VLAN (under CatOS) for voice traffic. This auxiliary voice VLAN should be separate from all the other wired voice VLANs in the network. However, when the wireless clients (for example, smart phones or software rich-media clients) do not support the concept of an auxiliary VLAN, alternative packet marking strategies (for example, packet classification per port) must be applied to segregate the important traffic such as voice and video and treat it with priority. When deploying a wireless infrastructure, Cisco also recommends configuring a separate management VLAN for the management of WLAN APs. This management VLAN should not have a WLAN appearance; that is, it should not have an associated service set identifier (SSID) and it should not be directly accessible from the WLAN.

Roaming

To improve the user experience, Cisco recommends designing the cell boundary distribution with a 20% to 30% overlap of non-adjacent channels to facilitate seamless roaming of the wireless client between access points. Furthermore, when devices roam at Layer 3, they move from one AP to another AP across native VLAN boundaries. When the WLAN infrastructure consists of autonomous APs, a Cisco Wireless LAN Controller allows the Cisco Unified Wireless endpoints to keep their IP addresses and roam at Layer 3 while still maintaining an active call. Seamless Layer 3 roaming occurs only when the client is roaming within the same mobility group. For details about the Cisco Wireless LAN Controller and Layer 3 roaming, refer to the product documentation available at

<http://www.cisco.com/en/US/products/hw/wireless/index.html>

Seamless Layer 3 roaming for clients across a lightweight access point infrastructure is accomplished by WLAN controllers that use dynamic interface tunneling. Cisco Wireless Unified Communications endpoints that roam across WLAN controllers and VLANs can keep their IP address when using the same SSID and therefore can maintain an active call.



Note

In dual-band WLANs (those with 2.4 GHz and 5 GHz bands), it is possible to roam between 802.11b/g and 802.11a with the same SSID, provided the client is capable of supporting both bands. However, this can cause gaps in the voice path. If Cisco Unified Wireless IP Phones 7921 or 7925 are used, make sure that firmware version 1.3(4) or higher is installed on the phones to avoid these gaps; otherwise use only one band for voice. (The Cisco Unified Wireless IP Phone 7926 provides seamless inter-band roaming from its first firmware version.)

Wireless Channels

Wireless endpoints and APs communicate by means of radios on particular channels. When communicating on one channel, wireless endpoints typically are unaware of traffic and communication occurring on other non-overlapping channels.

Optimal channel configuration for 2.4 GHz 802.11b/g/n requires a minimum of five-channel separation between configured channels to prevent interference or overlap between channels. Non-overlapping channels have 22 MHz of separation. Channel 1 is 2.412 GHz, channel 6 is 2.437 GHz, and channel 11 is 2.462 GHz. In North America, with allowable channels of 1 to 11, channels 1, 6, and 11 are the three usable non-overlapping channels for APs and wireless endpoint devices. However, in Europe where the allowable channels are 1 to 13, multiple combinations of five-channel separation are possible. Multiple combinations of five-channel separation are also possible in Japan, where the allowable channels are 1 to 14.

Optimal channel configuration for 5 GHz 802.11a and 802.11n requires a minimum of one-channel separation to prevent interference or overlap between channels. In North America, there are 20 possible non-overlapping channels: 36, 40, 44, 48, 52, 56, 60, 64, 100, 104, 108, 112, 116, 132, 136, 140, 149, 153, 157, and 161. Europe and Japan allow 16 possible non-overlapping channels: 36, 40, 44, 48, 52, 56, 60, 64, 100, 104, 108, 112, 116, 132, 136, and 140. Because of the larger set of non-overlapping channels, 802.11a and 5 GHz 802.11n allow for more densely deployed WLANs; however, Cisco recommends not enabling all channels but using a 12-channel design instead.

Note that the 802.11a and 802.11n bands (when using channels operating at 5.25 to 5.725 GHz, which are 15 of the 24 possible channels) do require support for Dynamic Frequency Selection (DFS) and Transmit Power Control (TPC) on some channels in order to avoid interference with radar (military, satellite, and weather). Regulations require that channels 52 to 64, 100 to 116, and 132 to 140 support DFS and TPC. TPC ensures that transmissions on these channels are not powerful enough to cause interference. DFS monitors channels for radar pulses and, when it detects a radar pulse, DFS stops transmission on the channel and switches to a new channel.

AP coverage should be deployed so that no (or minimal) overlap occurs between APs configured with the same channel. Same-channel overlap should typically occur at 19 dBm of separation. However, proper AP deployment and coverage on non-overlapping channels requires a minimum overlap of 20%. This amount of overlap ensures smooth roaming for wireless endpoints as they move between AP coverage cells. Overlap of less than 20% can result in slower roaming times and poor voice quality.

Deploying wireless devices in a multi-story building such as an office high-rise or hospital introduces a third dimension to wireless AP and channel coverage planning. Both the 2.4 GHz and 5.0 GHz wave forms of 802.11 can pass through floors and ceilings as well as walls. For this reason, not only is it important to consider overlapping cells or channels on the same floor, but it is also necessary to consider channel overlap between adjacent floors. With the 2.4 GHz wireless spectrum limited to only three usable non-overlapping channels, proper overlap design can be achieved only through careful three-dimensional planning.

**Note**

Careful deployment of APs and channel configuration within the wireless infrastructure are imperative for proper wireless network operation. For this reason, Cisco requires that a complete and thorough site survey be conducted before deploying wireless networks in a production environment. The survey should include verifying non-overlapping channel configurations, AP coverage, and required data and traffic rates; eliminating rogue APs; and identifying and mitigating the impact of potential interference sources.

Wireless Interference and Multipath Distortion

Interference sources within a wireless environment can severely limit endpoint connectivity and channel coverage. In addition, objects and obstructions can cause signal reflection and multipath distortion. Multipath distortion occurs when traffic or signaling travels in more than one direction from the source to the destination. Typically, some of the traffic arrives at the destination before the rest of the traffic, which can result in delay and bit errors in some cases. You can reduce the effects of multipath distortion by eliminating or reducing interference sources and obstructions, and by using diversity antennas so that only a single antenna is receiving traffic at any one time. Interference sources should be identified during the site survey and, if possible, eliminated. At the very least, interference impact should be alleviated by proper AP placement and the use of location-appropriate directional or omni-directional diversity radio antennas.

Possible interference and multipath distortion sources include:

- Other APs on overlapping channels
- Other 2.4 GHz and 5 GHz devices, such as 2.4 GHz cordless phones, personal wireless network devices, sulphur plasma lighting systems, microwave ovens, rogue APs, and other WLAN equipment that takes advantage of the license-free operation of the 2.4 GHz and 5 GHz bands
- Metal equipment, structures, and other metal or reflective surfaces such as metal I-beams, filing cabinets, equipment racks, wire mesh or metallic walls, fire doors and fire walls, concrete, and heating and air conditioning ducts
- High-power electrical devices such as transformers, heavy-duty electric motors, refrigerators, elevators, and elevator equipment
- High-power electrical devices such as transformers, heavy-duty electric motors, refrigerators, elevators and elevator equipment, and any other power devices that could cause electromagnetic interference (EMI)

Because Bluetooth-enabled devices use the same 2.4 GHz radio band as 802.11b/g/n devices, it is possible that Bluetooth and 802.11b/g/n devices can interfere with each other, thus resulting in connectivity issues. Due to the potential for Bluetooth devices to interfere with and disrupt 802.11b/g/n WLAN voice and video devices (resulting in poor voice quality, de-registration, call setup delays, and/or reduce per-channel-cell call capacity), Cisco recommends, when possible, that you deploy all WLAN voice and video devices on the 5 GHz Wi-Fi band using 802.11a and/or 802.11n protocols. By deploying wireless clients on the 5 GHz radio band, you can avoid interference caused by Bluetooth devices. Additionally, Cisco CleanAir technology is recommended within the wireless infrastructure because it enables real-time interference detection. For more information about Cisco CleanAir technology, refer to the product documentation available at

<http://www.cisco.com/en/US/netsol/ns1070/index.html>



Note

802.11n can operate on both the 2.4 GHz and 5 GHz bands; however, Cisco recommends using 5 GHz for Unified Communications.

Multicast on the WLAN

By design, multicast does not have the acknowledgement level of unicast. According to 802.11 specifications, the access point must buffer all multicast packets until the next Delivery Traffic Indicator Message (DTIM) period is met. The DTIM period is a multiple of the beacon period. If the beacon period is 100 ms (typical default) and the DTIM value is 2, then the access point must wait up to 200 ms before transmitting a single buffered multicast packet. The time period between beacons (as a product of the DTIM setting) is used by battery-powered devices to go into power save mode temporarily. This power save mode helps the device conserve battery power.

Multicast on WLAN presents a twofold problem in which administrators must weigh multicast traffic quality requirements against battery life requirements. First, delaying multicast packets will negatively affect multicast traffic quality, especially for applications that multicast real-time traffic such as voice and video. In order to limit the delay of multicast traffic, DTIM periods should typically be set to a value of 1 so that the amount of time multicast packets are buffered is low enough to eliminate any perceptible delay in multicast traffic delivery. However, when the DTIM period is set to a value of 1, the amount of time that battery-powered WLAN devices are able to go into power save mode is shortened, and therefore battery life is shortened. In order to conserve battery power and lengthen battery life, DTIM periods should typically be set to a value of 2 or more.

For WLAN networks with no multicast applications or traffic, the DTIM period should be set to a value of 2 or higher. For WLAN networks where multicast applications are present, the DTIM period should be set to a value of 2 with a 100 ms beacon period whenever possible; however, if multicast traffic quality

suffers or if unacceptable delay occurs, then the DTIM value should be lowered to 1. If the DTIM value is set to 1, administrators must keep in mind that battery life of battery-operated devices will be shortened significantly.

Before enabling multicast applications on the wireless network, Cisco recommends testing these applications to ensure that performance and behavior are acceptable.

For additional considerations with multicast traffic, see the chapter on [Media Resources](#), page 7-1.

Wireless AP Configuration and Design

Proper AP selection, deployment, and configuration are essential to ensure that the wireless network handles voice traffic in a way that provides high-quality voice to the end users.

AP Selection

For recommends on deploying access points for wireless voice, refer to the documentation at http://www.cisco.com/en/US/products/ps5678/Products_Sub_Category_Home.html.

AP Deployment

The number of devices active with an AP affects the amount of time each device has access to the transport medium, the Wi-Fi channel. As the number of devices increases, the traffic contention increases. Associating more devices to the AP and the bandwidth of the medium can result in poor performance and slower response times for all the endpoint devices associated to the AP.

While there is no specific mechanism prior to Cisco Wireless LAN Controller release 7.2 to ensure that only a limited number of devices are associated to a single AP, system administrators can manage device-to-AP ratios by conducting periodic site surveys and analyzing user and device traffic patterns. If additional devices and users are added to the network in a particular area, additional site surveys should be conducted to determine whether additional APs are required to handle the number of endpoints that need to access the network.

Additionally, APs that support Cisco CleanAir technology should be considered because they provide the additional function of remote monitoring of the Wi-Fi channel.

AP Configuration

When deploying wireless voice, observe the following specific AP configuration requirements:

- Enable Address Resolution Protocol (ARP) caching.

ARP caching is required on the AP because it enables the AP to answer ARP requests for the wireless endpoint devices without requiring the endpoint to leave power-save or idle mode. This feature results in extended battery life for the wireless endpoint devices.

- Enable Dynamic Transmit Power Control (DTPC) on the AP.

This ensures that the transmit power of the AP matches the transmit power of the voice endpoints. Matching transmit power helps eliminate the possibility of one-way audio traffic. Voice endpoints adjust their transmit power based on the Limit Client Power (mW) setting of the AP to which they are associated.

- Assign a Service Set Identifier (SSID) to each VLAN configured on the AP.

SSIDs enable endpoints to select the wireless VLAN they will use for sending and receiving traffic. These wireless VLANs and SSIDs map to wired VLANs. For voice endpoints, this mapping ensures priority queuing treatment and access to the voice VLAN on the wired network.

- Enable **QoS Element for Wireless Phones** on the AP.

This feature ensures that the AP will provide QoS Basic Service Set (QBSS) information elements in beacons. The QBSS element provides an estimate of the channel utilization on the AP, and Cisco wireless voice devices use it to help make roaming decisions and to reject call attempts when loads are too high. The APs also provide 802.11e clear channel assessment (CCA) QBSS in beacons. The CCA-based QBSS values reflect true channel utilization.

- Configure two QoS policies on the AP, and apply them to the VLANs and interfaces.

To ensure that voice traffic is given priority queuing treatment, configure a voice policy and a data policy with default classifications for the respective VLANs. (See [Interface Queuing, page 3-75](#), for more information).

Wireless LAN Controller Design Considerations

When designing a wireless network that will service voice or video, it is important to consider the role that the wireless LAN controller plays with regard to the voice and video media path if the access points used are not autonomous or stand alone. Because all wireless traffic is tunneled to its correspondent wireless LAN controller regardless of its point of origin and destination, it is critical to adequately size the network connectivity entry points of the wireless controllers. [Figure 3-27](#) is a representation of this problem. If any mobile device tries to call another mobile device, the traffic has to be hairpinned in the wireless LAN controller and sent to the receiving device. This includes the scenario where both devices are associated to the same AP.

The switch ports where the wireless LAN controllers are connected should provide enough bandwidth coverage for the traffic generated by collaboration devices, whether they are video or voice endpoints and whether their traffic is control or media traffic.

Figure 3-27 Traffic Concentrated at the Wireless LAN Controller Network Entry Point

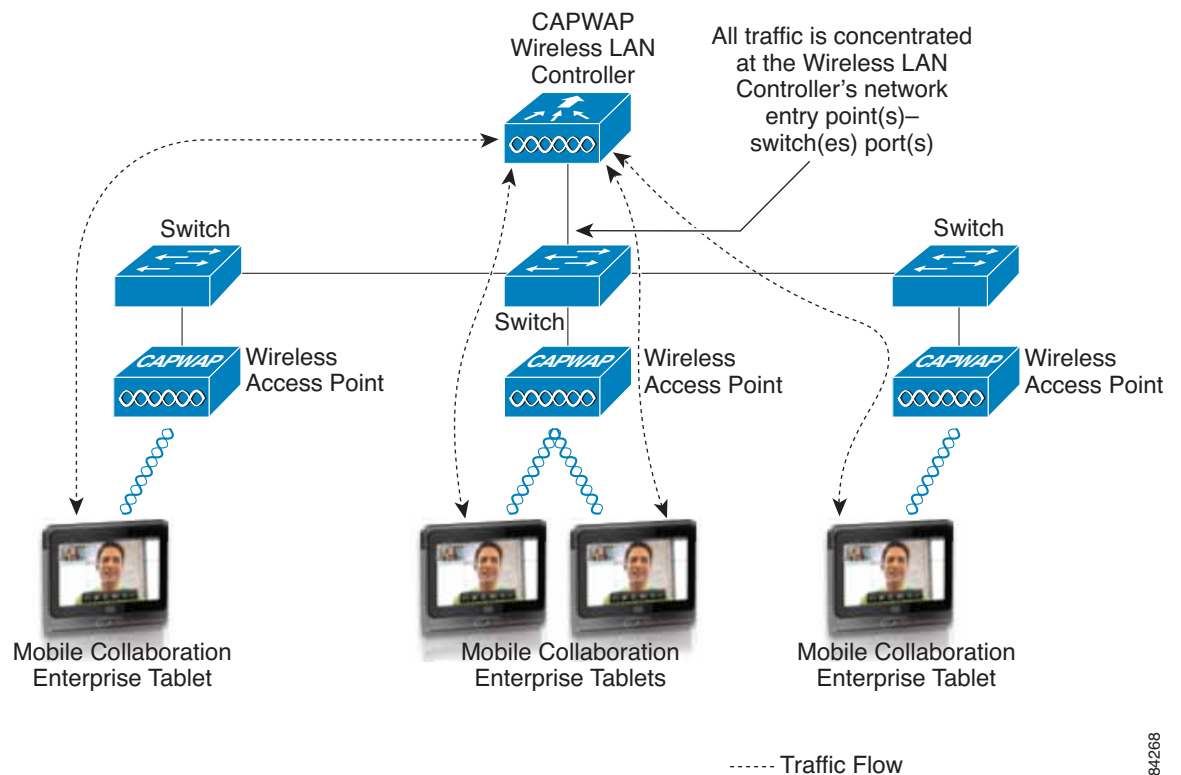

284268

Additionally, the switch interface and switch platform egress buffer levels should match the maximum combined burst you plan to support in your wireless network.

Failure to select adequate buffer levels could lead to packet drops and severely affect the user experience of video over a wireless LAN, while lack of bandwidth coverage would cause packets to be queued and in extreme cases cause delayed packets

WLAN Quality of Service (QoS)

Just as QoS is necessary for the LAN and WAN wired network infrastructure in order to ensure high voice quality, QoS is also required for the wireless LAN infrastructure. Because of the bursty nature of data traffic and the fact that real-time traffic such as voice and video are sensitive to packet loss and delay, QoS tools are required to manage wireless LAN buffers, limit radio contention, and minimize packet loss, delay, and delay variation.

However, unlike most wired networks, wireless networks are a shared medium, and wireless endpoints do not have dedicated bandwidth for sending and receiving traffic. While wireless endpoints can mark traffic with 802.1p CoS, ToS, DSCP, and PHB, the shared nature of the wireless network means limited admission control and access to the network for these endpoints.

Wireless QoS involves the following main areas of configuration:

- [Traffic Classification, page 3-74](#)
- [User Priority Mapping, page 3-74](#)
- [Interface Queuing, page 3-75](#)
- [Wireless Call Admission Control, page 3-76](#)

Traffic Classification

As with the wired network infrastructure, it is important to classify or mark pertinent wireless traffic as close to the edge of the network as possible. Because traffic marking is an entrance criterion for queuing schemes throughout the wired and wireless network, marking should be done at the wireless endpoint device whenever possible. Marking or classification by wireless network devices should be identical to that for wired network devices, as indicated in [Table 3-11](#).

In accordance with traffic classification guidelines for wired networks, the Cisco wireless endpoints mark voice media traffic or voice RTP traffic with DSCP 46 (or PHB EF), video media traffic or video RTP traffic with DSCP 34 (or PHB AF41), and call control signaling traffic (SCCP or SIP) with DSCP 24 (or PHB CS3). Once this traffic is marked, it can be given priority or better than best-effort treatment and queuing throughout the network. All wireless voice and video devices that are capable of marking traffic should do it in this manner. All other traffic on the wireless network should be marked as best-effort or with some intermediary classification as outlined in wired network marking guidelines. If the wireless voice or video devices are unable to do packet marking, alternate methods such as port-based marking should be implemented to provide priority to video and voice traffic.

User Priority Mapping

While 802.1p and Differentiated Services Code Point (DSCP) are the standards to set priorities on wired networks, 802.11e is the standard used for wireless networks. This is commonly referred as User Priority (UP), and it is important to map the UP to its appropriate DSCP value. [Table 3-11](#) lists the values for collaboration traffic.

Table 3-11 QoS Traffic Classification

Traffic Type	DSCP (PHB)	802.1p UP	IEEE 802.11e UP
Voice	46 (EF)	5	6
Video	34 (AF41)	4	5
Voice and video control	24 (CS3)	3	4

For further information about 802.11e and its configuration, refer to your corresponding product documentation available at

http://www.cisco.com/en/US/products/ps6302/Products_Sub_Category_Home.html

Interface Queuing

Once traffic marking has occurred, it is necessary to enable the wired network APs and devices to provide QoS queuing so that voice and video traffic types are given separate queues to reduce the chances of this traffic being dropped or delayed as it traverses the wireless LAN. Queuing on the wireless network occurs in two directions, upstream and downstream. Upstream queuing concerns traffic traveling from the wireless endpoint up to the AP, and from the AP up to the wired network. Downstream queuing concerns traffic traveling from the wired network to the AP and down to the wireless endpoint.

For upstream queuing, devices that support Wi-Fi Multimedia (WMM) are able to take advantage of queuing mechanisms, including priority queuing.

As for downstream QoS, Cisco APs currently provide up to eight queues for downstream traffic being sent to wireless clients. The entrance criterion for these queues can be based on a number of factors, including DSCP, access control lists (ACLs), and VLAN. Although eight queues are available, Cisco recommends using only two queues when deploying wireless voice. All voice media and signaling traffic should be placed in the highest-priority queue, and all other traffic should be placed in the best-effort queue. This ensures the best possible queuing treatment for voice traffic.

In order to set up this two-queue configuration for autonomous APs, create two QoS policies on the AP. Name one policy **Voice**, and configure it with the class of service **Voice < 10 ms Latency (6)** as the Default Classification for all packets on the VLAN. Name the other policy **Data**, and configure it with the class of service **Best Effort (0)** as the Default Classification for all packets on the VLAN. Then assign the Data policy to the incoming and outgoing radio interface for the data VLAN(s), and assign the Voice policy to the incoming and outgoing radio interfaces for the voice VLAN(s). With the QoS policies applied at the VLAN level, the AP is not forced to examine every packet coming in or going out to determine the type of queuing the packet should receive.

For lightweight APs, the WLAN controller has built-in QoS profiles that can provide the same queuing policy. Voice VLAN or voice traffic is configured to use the **Platinum** policy, which sets priority queuing for the voice queue. Data VLAN or data traffic is configured to use the **Silver** policy, which sets best-effort queuing for the Data queue. These policies are then assigned to the incoming and outgoing radio interfaces based on the VLAN.

The above configurations ensure that all voice and video media and signaling are given priority queuing treatment in a downstream direction.



Note

Because Wi-Fi Multimedia (WMM) access is based on Enhanced Distributed Channel Access (EDCA), it is important to assign the right priorities to the traffic to avoid Arbitration Inter-Frame Space (AIFS) alteration and delivery delay. For further information on Cisco Unified Wireless QoS, refer to the latest version of the *Enterprise Mobility Design Guide*, available at http://www.cisco.com/en/US/netsol/ns820/networking_solutions_design_guidances_list.html.

Wireless Call Admission Control

To avoid exceeding the capacity limit of a given AP channel, some form of call admission control is required. Cisco APs and wireless Unified Communications clients now use Traffic Specification (TSPEC) instead of QoS Basic Service Set (QBSS) for call admission control.

Wi-Fi Multimedia Traffic Specification (WMM TSPEC) is the QoS mechanism that enables WLAN clients to provide an indication of their bandwidth and QoS requirements so that APs can react to those requirements. When a client is preparing to make a call, it sends an Add Traffic Stream (ADDTTS) message to the AP with which it is associated, indicating the TSPEC. The AP can then accept or reject the ADDTTS request based on whether bandwidth and priority treatment are available. If the call is rejected, the client receives a Network Busy message. If the client is roaming, the TSPEC request is embedded in the re-association request message to the new AP as part of the association process, and the TSPEC response is embedded in the re-association response.

Alternatively, endpoints without WMM TSPEC support, but using SIP as call signaling, can be managed by the AP. Media snooping must be enabled for the service set identifier (SSID). The client's implementation of SIP must match that of the Wireless LAN Controller, including encryption and port numbers. For details about media snooping, refer to the *Cisco Wireless LAN Controller Configuration Guide*, available at

<http://www.cisco.com/en/US/docs/wireless/controller/7.0/configuration/guide/c70wlan.html>



Note

Currently there is no call admission control support for video. The QoS Basic Service Set (QBSS) information element is sent by the AP only if **QoS Element for Wireless Phones** has been enable on the AP. (Refer to [Wireless AP Configuration and Design](#), page 3-71.)
